

## ***Kia, THE COMPANY***

---



Thank you for becoming the owner of a new Kia vehicle.

As a global car manufacturer focused on building high-quality, value for money prices, Kia Motors is dedicated to providing you with a customer service experience that exceeds your expectations.

All information contained in this Owner's Manual is accurate at the time of publication. However, Kia reserves the right to make changes at any time so that our policy of continual product improvement can be carried out.

This manual applies to all Kia models and includes descriptions and explanations of optional as well as standard equipment. As a result, you may encounter material in this manual that is not applicable to your specific Kia vehicle.

***Drive safely and enjoy your Kia!***

## FOREWORD

---

Thank you for choosing a Kia vehicle.

When you require service, remember that your Kia Dealer knows your vehicle best. Your dealer has factory-trained technicians, recommended special tools, genuine Kia replacement parts and is dedicated to your complete satisfaction.

Because subsequent owners require this important information as well, this publication should remain with the vehicle if it is sold.

This manual will familiarize you with operational, maintenance and safety information about your new vehicle. It is supplemented by a Warranty and Consumer Information manual that provides important information on all warranties regarding your vehicle.

We urge you to read these publications carefully and follow the recommendations to help assure enjoyable and safe operation of your new vehicle.

Kia offers a great variety of options, components and features for its various models. Therefore, some of the equipment described in this manual, along with the various illustrations, may not be applicable to your particular vehicle.

The information and specifications provided in this manual were accurate at the time of printing. Kia reserves the right to discontinue or change specifications or design at any time without notice and without incurring any obligation. If you have questions, always check with your Kia dealer.

We assure you of our continuing interest in your motoring pleasure and satisfaction in your Kia vehicle.

© 2011 Kia Canada Inc.

All rights reserved. Reproduction by any means, electronic or mechanical, including photocopying, recording, or by any information storage and retrieval system or translation in whole or part is not permitted without written authorization from Kia Canada Inc..

Printed in Korea

---

## ***TABLE OF CONTENTS***

---

Introduction	1
Your vehicle at a glance	2
Safety features of your vehicle	3
Features of your vehicle	4
Driving your vehicle	5
What to do in an emergency	6
Maintenance	7
Specifications & Consumer information	8
Index	I

Index

I

**A**

Active eco system .....5-41

Air bag warning label .....3-53

Air bag warning light.....3-33

Air bags.....3-30

    Air bag warning label .....3-53

    Air bag warning light .....3-33

    Curtain air bag .....3-45

    Driver's and passenger's front air bag.....3-41

    Occupant detection system.....3-36

    Side impact air bag.....3-44

    SRS components and functions.....3-33

Air cleaner .....7-31

Antenna (Roof) .....4-102

Anti-lock brake system (ABS) .....5-24

Appearance care.....7-60

    Exterior care .....7-60

    Interior care .....7-64

Ashtray.....4-96

Audio system .....4-102

    Roof antenna.....4-102

    Steering wheel audio control.....4-103

Automatic transaxle .....5-15

    Shift lock .....5-19

    Sports mode.....5-17

Automatic transaxle fluid .....7-30

Aux, USB and iPod port.....4-104

**B**

Base curb weight .....5-56

Battery.....7-34

Battery saver function.....4-70

Before driving .....5-3

Bottle holders, see cup holders.....4-97

Brake system.....5-21

    Anti-lock brake system (ABS) .....5-24

    Electronic stability program (ESC) .....5-25

    Hill-start assist control.....5-28

    Parking brake.....5-22

    Power brakes.....5-21

    Vehicle stability management.....5-29

Brakes/clutch fluid.....7-29

Bulb wattage .....8-3

**C**

Calendar .....4-100

Capacities (Lubricants).....8-5

Car option .....4-50

Care

    Exterior care .....7-60

    Interior care .....7-64

    Tire care.....7-37

Cargo capacity .....	5-52
Cargo weight .....	5-56
Center console storage .....	4-92
Central door lock switch .....	4-17
Certification label .....	5-54, 8-7
Changing tires .....	6-14
Checking tire inflation pressure .....	7-38
Child restraint system .....	3-22
Lower anchor .....	3-27
Seat belt .....	3-24
Tether anchor system .....	3-26
Child-protector rear door lock .....	4-18
Cigarette lighter .....	4-96
Climate control air filter .....	4-81, 7-32
Clock (Digital) .....	4-99
Clothes hanger .....	4-100
Combined instrument, see instrument cluster .....	4-41
Compact spare tire .....	6-19
Compact spare tire replacement .....	7-41
Coolant .....	7-26
Cooling fluid, see engine coolant .....	7-26
Crankcase emission control system .....	7-66
Cruise control system .....	5-32
Cup holder .....	4-97
Curtain air bag .....	3-45

## D

Dashboard illumination, see instrument panel illumination .....	4-42
Dashboard, see instrument cluster .....	4-41
Defogging (Windshield) .....	4-90
Defogging logic (Windshield) .....	4-91
Defroster (Rear window) .....	4-80
Defrosting (Windshield) .....	4-90
Digital clock .....	4-99
Dimensions .....	8-2
Display illumination, see instrument panel illumination .....	4-42
Displays, see instrument cluster .....	4-41
Door locks .....	4-15
Central door lock switch .....	4-17
Child-protector rear door lock .....	4-18
Drinks holders, see cup holders .....	4-97
Driver's 3-point seat belt .....	3-14
Driver's and passenger's front air bag .....	3-41
Driving at night .....	5-45
Driving in flooded areas .....	5-46
Driving in the rain .....	5-46

**E**

Economical operation .....5-42  
 Electric power steering .....4-35  
 Electronic stability program (ESC) .....5-25  
 Emergency starting .....6-4  
     Jump starting .....6-4  
     Push starting .....6-6  
 Emergency while driving .....6-2  
 Emission control system .....7-66  
     Crankcase emission control system .....7-66  
     Evaporative emission control System .....7-66  
     Exhaust emission control system .....7-66  
 Engine .....8-2  
 Engine compartment .....2-4  
 Engine compartment panel fuse .....7-58  
 Engine coolant .....7-26  
 Engine coolant temperature gauge .....4-43  
 Engine number .....8-8  
 Engine oil .....7-25  
 Engine overheats .....6-7  
 Engine start/stop button .....5-6  
 Engine will not start .....6-3  
 Evaporative emission control System .....7-66  
 Exhaust emission control system .....7-66  
 Explanation of scheduled maintenance items .....7-22  
 Exterior care .....7-60

**F**

Flat tire (with spare tire) .....6-13  
     Jack and tools .....6-13  
     Changing tires .....6-14  
     Compact spare tire .....6-19  
     Removing and storing the spare tire .....6-14  
 Flat tire (with tire mobility kit) .....6-21  
 Floor mat anchor(s) .....4-101  
 Fluid  
     Automatic transaxle fluid .....7-30  
     Brakes/clutch fluid .....7-29  
     Washer fluid .....7-30  
 Folding the outside rearview mirror .....4-40  
 Folding the rear seat .....3-10  
 Front passenger and rear seat belt .....3-16  
 Front seat adjustment .....3-4  
 Fuel filler lid .....4-28  
 Fuel gauge .....4-43  
 Fuel requirements .....1-3  
 Fuses .....7-50  
     Engine compartment panel fuse .....7-52  
     Fuse/relay panel description .....7-54  
     Instrument panel fuse .....7-51  
     Memory fuse .....7-51  
     Multi fuse .....7-53

**G**

Gauge  
 Engine coolant temperature gauge .....4-42  
 Fuel gauge .....4-43  
 GAW (Gross axle weight) .....5-56  
 GAWR (Gross axle weight rating) .....5-56  
 Glove box .....4-92  
 GVW (Gross vehicle weight) .....5-56  
 GVWR (Gross vehicle weight rating) .....5-56

**H**

Hazard warning flasher .....4-70  
 Hazardous driving conditions .....5-44  
 Headrest(front) .....3-5  
 Headrest(rear) .....3-9  
 Hight adjustment .....3-15  
 Highway driving .....5-47  
 Hill-start assist control .....5-28  
 Hood .....4-26  
 Horn .....4-37  
 How to use this manual .....1-2

**I**

Idle stop and go system .....5-37  
 Immobilizer system .....4-10  
 Indicator symbols on the instrument cluster .....1-5  
 Indicators and warnings .....4-53  
 Inside rearview mirror .....4-38  
 Instrument cluster .....4-41  
   Car option .....4-50  
   Engine coolant temperature gauge .....4-43  
   Fuel gauge .....4-43  
   Instrument panel illumination .....4-42  
   LCD display warning .....4-63  
   Maintenance .....4-51  
   Odometer .....4-44  
   Speedometer .....4-42  
   Tachometer .....4-42  
   Trip computer .....4-45  
   User settings .....4-49  
   Warning and indicators .....4-53  
 Instrument panel fuse .....7-55  
 Instrument panel illumination .....4-42  
 Instrument panel overview .....2-3  
 Interior care .....7-64  
 Interior features .....4-96  
   Ashtray .....4-96  
   Aux, USB and iPod port .....4-104  
   Cigarette lighter .....4-96



## Index

---

Clothes hanger .....	4-100
Cup holder .....	4-97
Digital clock and calendar .....	4-99
Floor mat anchor(s) .....	4-101
Power outlet .....	4-98
Shopping bag holder .....	4-99
Sliding armrest .....	4-97
Sunvisor .....	4-98
Interior light .....	4-78
Interior overview .....	2-2
ISG system .....	5-37

### J

Jack and tools .....	6-13
Jump starting .....	6-4

### K

Key positions .....	5-4
Keys .....	4-2
Immobilizer key .....	4-10
Remote(or Smart) key battery replacement .....	4-97

### L

#### Label

Air bag warning label .....	3-53
Refrigerant label .....	8-8
Tire sidewall labeling .....	7-42
Tire specification and pressure label .....	8-8
Vehicle certification label .....	8-7
LCD display warning .....	4-63
Lighting .....	4-70
Battery saver function .....	4-70
Lower anchor .....	3-27
Lubricants and capacities .....	8-5
Luggage net .....	4-93
Luggage tray .....	4-94

### M

Maintenance .....	4-51
Explanation of scheduled maintenance items .....	7-22
Maintenance services .....	7-3
Maintenance under severe usage conditions .....	7-20
Normal maintenance schedule .....	7-8
Owner maintenance .....	7-5
Scheduled maintenance service .....	7-7
Tire maintenance .....	7-42

Maintenance schedule.....7-7  
 Maintenance under severe usage conditions .....7-20  
     Normal maintenance schedule.....7-8  
 Maintenance services.....7-3  
 Manual climate control system.....4-81  
     Air conditioning .....4-86  
     Climate control air filter.....4-89  
     Heating and air conditioning .....4-82  
 Manual transaxle.....5-12  
 Memory fuse.....7-51  
 Mirrors .....4-38  
     Day/night rearview mirror.....4-38  
     Folding the outside rearview mirror.....4-40  
     Inside rearview mirror .....4-38  
     Outside rearview mirror .....4-38  
     Remote control .....4-39  
 Multi fuse.....7-53

**O**

Occupant detection system .....3-36  
 Odometer .....4-44  
 Oil (Engine) .....7-25  
 Outside rearview mirror.....4-38  
 Outside rearview mirror remote control.....4-39  
 Overheats .....6-7  
 Owner maintenance .....7-5

**P**

Parking brake.....5-22,7-31  
 Power brakes.....5-21  
 Power outlet .....4-99  
 Power window lock button .....4-25  
 Pre-tensioner seat belt.....3-17  
 Push starting.....6-6

**R**

Rear seat.....3-9  
 Rearview camera.....4-69  
 Recommended cold tire inflation pressures .....7-37  
 Recommended lubricants and capacities.....8-5  
     Recommended SAE viscosity number.....8-6  
 Refrigerant label .....8-8  
 Remote control (Mirror) .....4-39  
 Remote keyless entry.....4-7  
 Remote(or Smart) key battery replacement.....4-9  
 Road warning.....6-2  
 Rocking the vehicle .....5-44  
 Roof antenna.....4-102

**S**

Scheduled maintenance service .....7-7  
 Maintenance under severe usage conditions .....7-20  
 Normal maintenance schedule.....7-8  
 Seat belt warning .....3-13  
 Seat belts .....3-12  
 3 Point rear center belt .....3-16  
 Hight adjustment .....3-15  
 Pre-tensioner seat belt .....3-17  
 Seat belt - Driver's 3-point system .....3-14  
 Seat belt warning .....3-13  
 Seat belts - Front passenger and rear seat .....3-16  
 Seat Warmer.....3-7  
 Seatback pocket .....3-8  
 Seating capacity .....5-52  
 Seats .....3-2  
 Folding the rear seat .....3-10  
 Front seat adjustment.....3-4  
 Headrest(front) .....3-5  
 Headrest(rear) .....3-9  
 Rear seat .....3-9  
 Seatback pocket .....3-8  
 Warmer .....3-7  
 Shift Lock .....5-19  
 Shopping bag holder.....4-99  
 Side impact air bag .....3-44  
 Smart key .....4-4

Smooth cornering.....5-45  
 Snow tires .....5-48  
 Spare tire  
 Compact spare tire.....6-19  
 Compact spare tire replacement .....7-41  
 Removing and storing the spare tire.....6-14  
 Special driving conditions .....5-44  
 Driving at night .....5-45  
 Driving in flooded areas .....5-46  
 Driving in the rain .....5-46  
 Hazardous driving conditions .....5-44  
 Highway driving .....5-47  
 Rocking the vehicle .....5-44  
 Smooth cornering .....5-45  
 Speedometer.....4-42  
 Sports mode .....5-17  
 SRS components and functions .....3-33  
 Starting difficulties, see engine will not start .....6-3  
 Steering wheel .....4-35  
 Electric power steering .....4-35  
 Horn .....4-37  
 Tilt & Telescoping steering .....4-36  
 Steering wheel audio control .....4-103  
 Steps For Determining Correct Load Limit .....5-52  
 Storage compartment .....4-92  
 Center console storage.....4-92  
 Cool box .....4-93  
 Glove box .....4-92

Luggage net .....4-93  
 Luggage tray .....4-94  
 Sunroof .....4-31  
 Sunvisor .....4-98

**T**

Tachometer .....4-42  
 Tailgate .....4-20  
     Emergency safety release .....4-21  
 Telescoping steering .....4-36  
 Tether anchor system .....3-26  
 Theft-alarm system .....4-12  
 Tie-down hook .....6-30  
 Tilt steering .....4-36  
 Tire and loading information label .....5-51  
 Tire mobility kit .....6-21  
 Tire pressure monitoring system (TPMS) .....6-8  
 Tire specification and pressure label .....8-8  
 Tires and wheels .....7-37,8-4  
     Checking tire inflation pressure .....7-38  
     Compact spare tire replacement .....7-41  
     Recommended cold tire inflation pressures .....7-37  
     Tire care .....7-37  
     Tire maintenance .....7-42  
     Tire replacement .....7-41  
     Tire rotation .....7-39  
     Tire sidewall labeling .....7-42

Tire traction .....7-42  
 Wheel alignment and tire balance .....7-40  
 Wheel replacement .....7-42  
 Towing .....6-27  
 Towing  
     Tie-down hook .....6-30  
 Towing capacity .....5-52  
 Transaxle  
     Automatic transaxle .....5-15  
     Manual transaxle .....5-12  
 Trip computer .....4-45

**U**

User settings .....4-49

**V**

Vehicle break-in process .....1-4  
 Vehicle capacity weight .....5-51  
 Vehicle certification label .....8-7  
 Vehicle curb weight .....5-56  
 Vehicle identification number (VIN) .....8-7  
 Vehicle load limit .....5-51  
     Cargo capacity .....5-52  
     Certification label .....5-54  
     Seating capacity .....5-52  
     Steps For Determining Correct Load Limit .....5-52

## Index

---

Tire and loading information label	5-51	Windows	4-22
Towing capacity	5-52	Auto down window	4-23
Vehicle capacity weight	5-51	Auto up/down window	4-24
Vehicle stability management	5-29	Power window lock button	4-25
Volume/weight	8-4	Windshield defrosting and defogging	4-90
Base curb weight	5-56	Defogging logic	4-91
Cargo weight	5-56	Winter driving	5-48
GAW (Gross axle weight)	5-56	Snow tires	5-48
GAWR (Gross axle weight rating)	5-56	Wiper blades	7-32
GVW (Gross vehicle weight)	5-56	Wipers and washers	4-74
GVWR (Gross vehicle weight rating)	5-56		
Vehicle curb weight	5-56		

## W

Warning and indicators	4-53
Washer fluid	7-30
Weight/volume	8-4
Wheel alignment and tire balance	7-40
Wheel replacement	7-41

# Introduction

1

**How to use this manual / 1-2**

**Fuel requirements / 1-3**

**Vehicle break-in process / 1-4**

**Indicator symbols on the instrument cluster / 1-5**

### HOW TO USE THIS MANUAL

We want to help you get the greatest possible driving pleasure from your vehicle. Your Owner's Manual can assist you in many ways. We strongly recommend that you read the entire manual. In order to minimize the chance of death or injury, you must read the **WARNING** and **CAUTION** sections in the manual.

Illustrations complement the words in this manual to best explain how to enjoy your vehicle. By reading your manual, you will learn about features, important safety information, and driving tips under various road conditions.

The general layout of the manual is provided in the Table of Contents. Use the index when looking for a specific area or subject; it has an alphabetical listing of all information in your manual.

Sections: This manual has eight sections plus an index. Each section begins with a brief list of contents so you can tell at a glance if that section has the information you want.

You will find various types of safety instructions in this manual. These instructions were prepared to enhance your personal safety. Carefully read and follow ALL procedures and recommendations provided in these instructions.

#### **WARNING**

**A WARNING indicates a situation in which harm, serious bodily injury or death could result if the warning is ignored.**

#### **CAUTION**

**A CAUTION indicates a situation in which damage to your vehicle could result if the caution is ignored.**

#### **\* NOTICE**

**A NOTICE indicates interesting or helpful information is being provided.**

## FUEL REQUIREMENTS

Your new Kia vehicle is designed to use only unleaded fuel having a pump octane number ((R+M)/2) of 87 (Research Octane Number 91) or higher.

Your new vehicle is designed to obtain maximum performance with UNLEADED FUEL, as well as minimize exhaust emissions and spark plug fouling.

Never add any fuel system cleaning agents to the fuel tank other than what has been specified. (Consult an authorized Kia dealer for details.)

### **WARNING - Refueling**

- Do not "top off" after the nozzle automatically shuts off when refueling.
- Always check that the fuel cap is installed securely to prevent fuel spillage in the event of an accident.

### \* NOTICE

Tighten the cap until it clicks one time, otherwise the fuel cap open warning indicator  will illuminate.

### ***Gasoline containing alcohol and methanol***

Gasohol, a mixture of gasoline and ethanol (also known as grain alcohol), and gasoline or gasohol containing methanol (also known as wood alcohol) are being marketed along with or instead of leaded or unleaded gasoline.

Do not use gasohol containing more than 10% ethanol, and do not use gasoline or gasohol containing any methanol. Either of these fuels may cause drivability problems and damage to the fuel system.

Discontinue using gasohol of any kind if drivability problems occur.

Vehicle damage or drivability problems may not be covered by the manufacturer's warranty if they result from the use of:

1. Gasohol containing more than 10% ethanol.
2. Gasoline or gasohol containing methanol.
3. Leaded fuel or leaded gasohol.

"E85" fuel is an alternative fuel comprised of 85 percent ethanol and 15 percent gasoline, and is manufactured exclusively for use in Flexible Fuel Vehicles. "E85" is not compatible with your vehicle. Use of "E85" may result in poor engine performance and damage to your vehicle's engine and fuel system. Kia recommends that customers do not use fuel with an ethanol content exceeding 10 percent.

### \* NOTICE

**Your New Vehicle Limited Warranty does not cover damage to the fuel system or any performance problems caused by the use of "E85" fuel.**



### ***Use of MTBE***

Kia recommends avoiding fuels containing MTBE (Methyl Tertiary Butyl Ether) over 15.0% vol. (Oxygen Content 2.7% weight) in your vehicle.

Fuel containing MTBE over 15.0% vol. (Oxygen Content 2.7% weight) may reduce vehicle performance and produce vapor lock or hard starting.

### **\* NOTICE**

**Your New Vehicle Limited Warranty may not cover damage to the fuel system and any performance problems that are caused by the use of fuels containing methanol or fuels containing MTBE (Methyl Tertiary Butyl Ether) over 15.0% vol. (Oxygen Content 2.7% weight.)**

### ***Do not use methanol***

Fuels containing methanol (wood alcohol) should not be used in your vehicle. This type of fuel can reduce vehicle performance and damage components of the fuel system.

### ***Fuel Additives***

Kia recommends that you use good quality gasolines treated with detergent additives such as TOP TIER Detergent Gasoline, which help prevent deposit formation in the engine. These gasolines will help the engine run cleaner and enhance performance of the Emission Control System. For more information on TOP TIER Detergent Gasoline, please go to the website ([www.toptiergas.com](http://www.toptiergas.com)).

For customers who do not use TOP Tier Detergent Gasoline regularly, and have problems starting or the engine does not run smoothly, additives that you can buy separately may be added to the gasoline. If TOP TIER Detergent Gasoline is not available, one bottle of additive added to the fuel tank at every 12,000 km or every engine oil change is recommended. Additives are available from your authorized Kia dealer along with information on how to use them. Do not mix other additives.

### ***Operation in foreign countries***

If you are going to drive your vehicle in another country, be sure to:

- Observe all regulations regarding registration and insurance.
- Determine that acceptable fuel is available.

## **VEHICLE BREAK-IN PROCESS**

No special break-in period is needed. By following a few simple precautions for the first 1,000 km (600 miles) you may add to the performance, economy and life of your vehicle.

- Do not race the engine.
- While driving, keep your engine speed (rpm, or revolutions per minute) between 2,000 rpm and 4,000 rpm.
- Do not maintain a single speed for long periods of time, either fast or slow. Varying engine speed is needed to properly break-in the engine.
- Avoid hard stops, except in emergencies, to allow the brakes to seat properly.
- Don't let the engine idle longer than 3 minutes at one time.
- Don't tow a trailer during the first 2,000 km (1,200 miles) of operation.

## INDICATOR SYMBOLS ON THE INSTRUMENT CLUSTER

 Air bag warning light	 Charging system warning light	 ESC indicator
 ABS warning light	 Tailgate open ajar warning light	 ESC OFF indicator
 Seat belt warning light	 Door ajar warning light	 Electric power steering (EPS) system warning light*
 Turn signal indicator	 Immobilizer indicator	 ECO indicator*
 High beam indicator	 KEY OUT Key out warning light*	 Auto stop for ISG system indicator*
 Low beam indicator	 Shift pattern indicator*	 Low tire pressure telltale* / TPMS malfunction indicator*
 Tail light indicator	 Manual transaxle shift indicator*	 CRUISE Cruise control indicator*
 Front fog light indicator*	 Low fuel level warning light	 SET Cruise SET indicator*
 Engine oil pressure warning light	 Malfunction indicator light	 Fuel cap open warning indicator
 Parking brake & Brake fluid warning light	 Engine coolant temperature warning light*	* : if equipped

\* For more detailed explanations, refer to “Instrument cluster” in section 4.

## Your vehicle at a glance

2

**Interior overview / 2-2**

**Instrument panel overview / 2-3**

**Engine compartment / 2-4**

## INTERIOR OVERVIEW

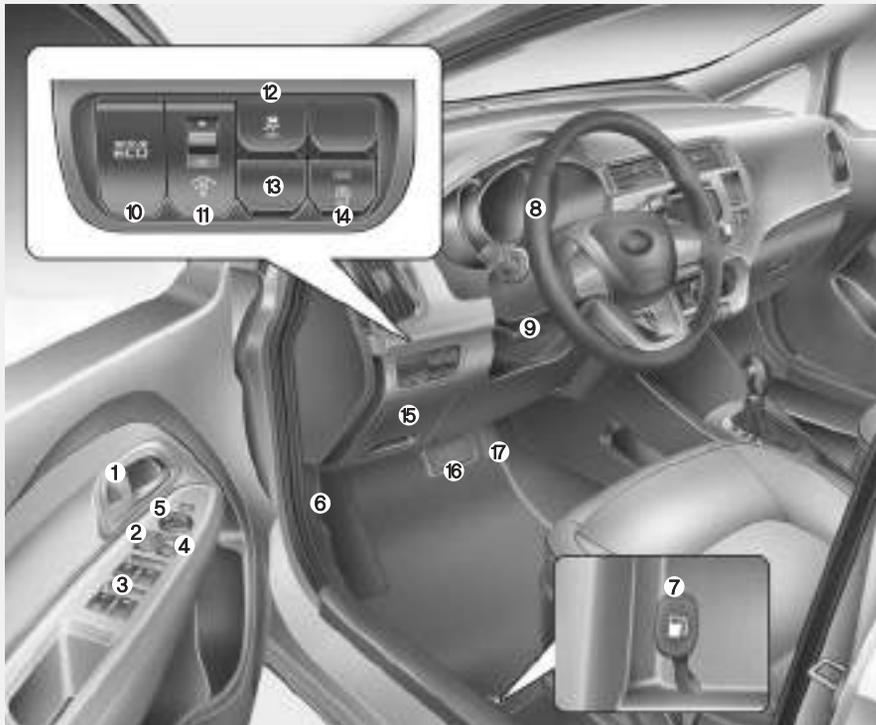

- 1. Door lock/unlock button .....4-16
- 2. Central door lock switch.....4-17
- 3. Power window switches .....4-22
- 4. Power window lock button .....4-25
- 5. Outside rearview mirror control switch .....4-39
- 6. Hood release lever.....4-26
- 7. Fuel filler lid release lever .....4-28
- 8. Steering wheel .....4-35
- 9. Steering wheel tilt control lever.....4-36
- 10. Active eco button .....5-41
- 11. Instrument panel illumination control switch .....4-42
- 12. ESC OFF button .....5-25
- 13. Heated steering wheel switch (if equipped) .....4-36
- 14. Idle Stop and Go system OFF button .....5-37
- 15. Fuse box .....7-50
- 16. Brake pedal.....5-21
- 17. Accelerator pedal

\* The actual interior in the vehicle may differ from the illustration.

OUB021001N

## INSTRUMENT PANEL OVERVIEW



- 1. Instrument cluster.....4-41
- 2. Horn .....4-37
- 3. Driver's front air bag.....3-41
- 4. Light control/Turn signals .....4-70
- 5. Wiper/Washer.....4-74
- 6. Ignition switch or ENGINE START/  
STOP button .....5-4, 5-6
- 7. Hazard warning flasher switch .....4-70, 6-2
- 8. Audio .....4-102
- 9. Climate control system.....4-81
- 10. Shift lever.....5-12, 5-15
- 11. Steering wheel audio control.....4-103
- 12. Passenger's front air bag .....3-41
- 13. Glove box .....4-92
- 14. Parking brake lever .....5-22
- 15. Power outlet .....4-99
- 16. Cigarette lighter .....4-96
- 17. Seat warmer .....3-7

\* The actual instrument panel in the vehicle may differ from the illustration.

## ENGINE COMPARTMENT

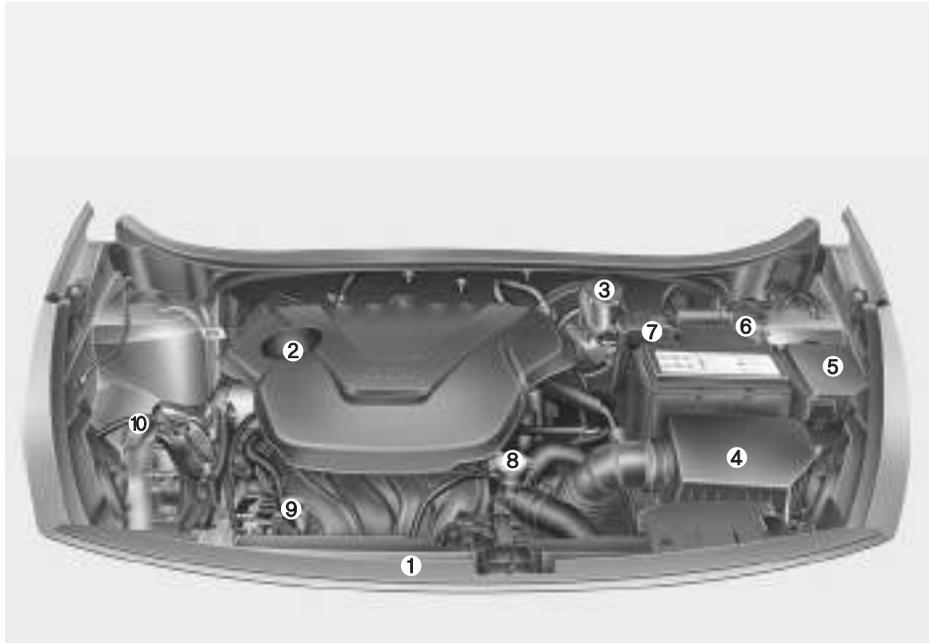

- 1. Engine Coolant Reservoir .....7-26
- 2. Engine Oil Filler Cap .....7-25
- 3. Brake/Clutch Fluid Reservoir .....7-29
- 4. Air Cleaner .....7-31
- 5. Fuse Box .....7-50
- 6. Negative Battery Terminal .....7-34
- 7. Positive Battery Terminal .....7-34
- 8. Radiator Cap .....7-27
- 9. Engine Oil Dipstick .....7-25
- 10. Windshield Washer Fluid Reservoir..7-30

\* The actual engine compartment in the vehicle may differ from the illustration.

OUB071103N

**Seat / 3-2**

**Seat belts / 3-12**

**Child restraint system / 3-22**

**Airbag-advanced supplemental restraint system / 3-30**

## Safety features of your vehicle

3

## SEAT

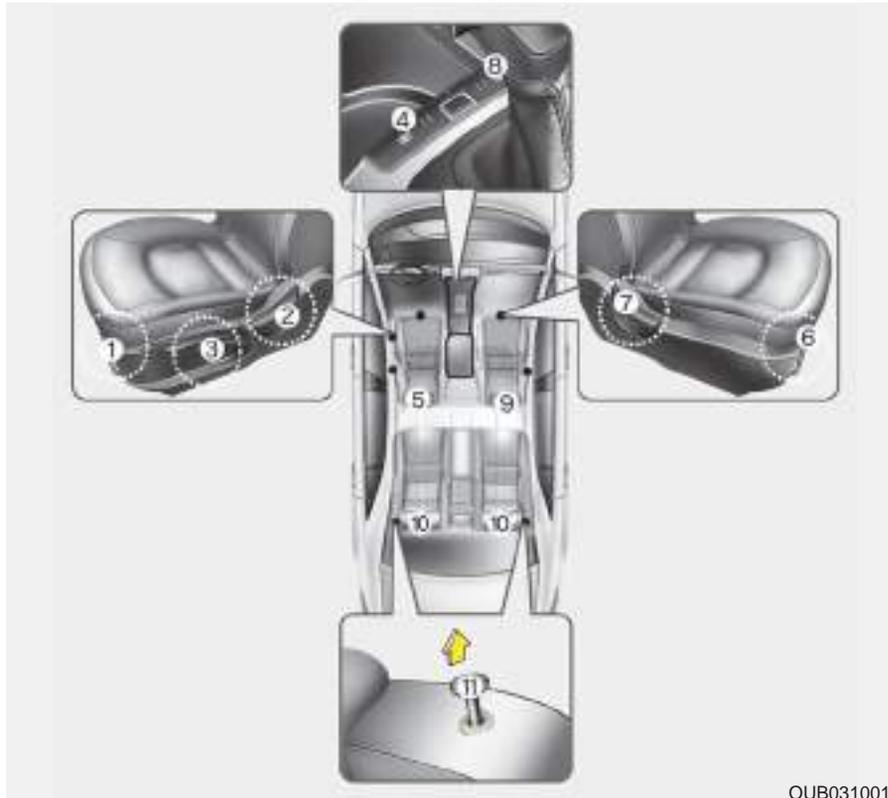

OUB031001N

### Driver's seat

- (1) Forward and rearward
- (2) Seatback angle
- (3) Seat cushion height
- (4) Seat warmer
- (5) Headrest

### Front passenger's seat

- (6) Forward and rearward
- (7) Seatback angle
- (8) Seat warmer
- (9) Headrest

### Rear seat

- (10) Headrest
- (11) Seatback folding



**⚠ WARNING - Loose objects**  
Do not place anything in the driver's foot well or under the front seats. Loose objects in the driver's foot area could interfere with the operation of the foot pedals.

**⚠ WARNING - Uprighting seat**

Do not press the release lever on a manual seatback without holding and controlling the seatback. The seatback will spring upright possibly impacting you or other passengers.

**⚠ WARNING - Driver responsibility for passengers**

The driver must advise the passenger to keep the seatback in an upright position whenever the vehicle is in motion. If a seat is reclined during an accident, the occupant's hips may slide under the lap portion of the seat belt, applying great force to the unprotected abdomen.

**⚠ WARNING- Seat cushion**

Occupants should never sit on seat cushions. The passenger's hips may slide under the lap portion of the seat belt during an accident or a sudden stop.

**⚠ WARNING - Driver's seat**

- Never attempt to adjust the seat while the vehicle is moving. This could result in loss of control of your vehicle.
- Do not allow anything to interfere with the normal position of the seatback. Storing items against a seatback or in any other way interfering with proper locking of a seatback.
- Sit as far back as possible from the steering wheel while still maintaining comfortable control of your vehicle. A distance of at least 10" from your chest to the steering wheel is recommended. Failure to do so can result in airbag inflation injuries to the driver.

### **⚠ WARNING - Seat adjustment**

- Do not adjust the seat while wearing seat belts. Moving the seat forward will cause strong pressure on the abdomen.
- Do not place your hand near the seat bottom or seat track while adjusting the seat. Your hand could get caught in the seat mechanism.



### **Front seat adjustment**

#### *Forward and backward*

To move the seat forward or backward:

1. Pull the seat slide adjustment lever up and hold it.
2. Slide the seat to the position you desire.
3. Release the lever and make sure the seat is locked in place.

Adjust the seat before driving, and make sure the seat is locked securely by trying to move forward and backward without using the lever. If the seat moves, it is not locked properly.

### **⚠ WARNING - Unexpected seat movement**

After adjusting a manual seat, always check that it is locked by shifting your weight to the front and back. Sudden or unexpected movement of the driver's seat could cause you to lose control of the vehicle.

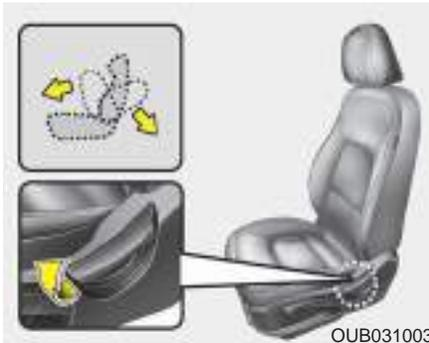

### **Seatback angle**

To recline the seatback:

1. Lean forward slightly and lift up the seatback recline lever.
2. Carefully lean back on the seat and adjust the seatback of the seat to the position you desire.
3. Release the lever and make sure the seatback is locked in place. (The lever MUST return to its original position for the seatback to lock.)



### **Seat height (for driver's seat)**

To change the height of the seat, move the lever upwards or downwards.

- To lower the seat cushion, push down the lever several times.
- To raise the seat cushion, pull up the lever several times.

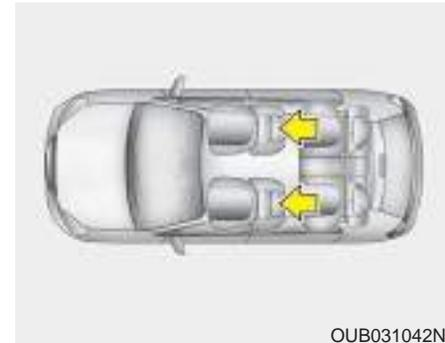

### **Headrest**

The driver's and front passenger's seats are equipped with a headrest for the occupant's safety and comfort.

The headrest not only provides comfort for the driver and front passenger, but also helps protect the head and neck in the event of a collision.

For maximum effectiveness in case of an accident, the headrest should be adjusted so the middle of the headrest is at the same height of the center of gravity of an occupant's head. Generally, the center of gravity of most people's head is similar with the height of the top of their eyes. Also, adjust the headrest as close to your head as possible.

## Safety features of your vehicle

For this reason, the use of a cushion that holds the body away from the seatback is not recommended.

### **⚠ WARNING - Headrest removal/adjustment**

- Do not operate the vehicle with the headrests removed. Headrests can provide critical neck and head support in a crash.
- Do not adjust the headrest height while the vehicle is in motion. Driver may lose control of the vehicle.

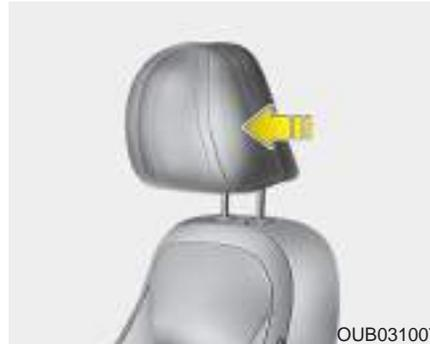

#### **Forward and backward adjustment**

The headrest may be adjusted forward to 4 different positions by pulling the headrest forward to the desired detent. To adjust the headrest to its furthest backwards position, pull it fully forward to the farthest position and release it. Adjust the headrest so that it properly supports the head and neck.

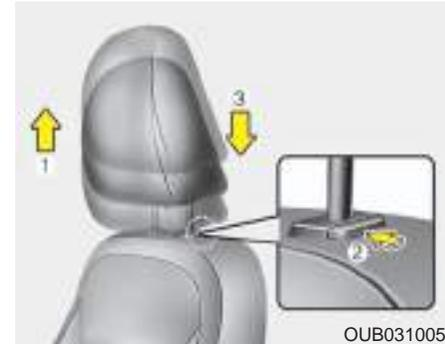

#### **Adjusting the height up and down**

To raise the headrest, pull it up to the desired position (1). To lower the headrest, push and hold the release button (2) on the headrest support and lower the headrest to the desired position (3).

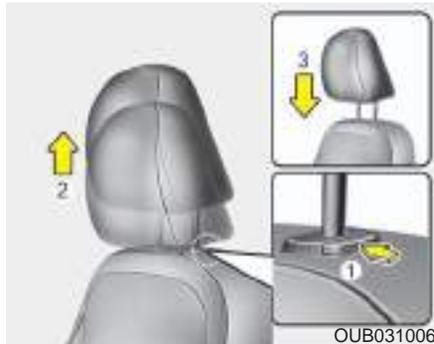

OUB031006

#### Removal and installation

To remove the headrest, raise it as far as it can go then press the release button (1) while pulling the headrest up (2).

To reinstall the headrest, put the headrest poles (3) into the holes while pressing the release button (1). Then adjust it to the appropriate height.



OUB031008

#### Seat warmer (if equipped)

The seat warmers are provided to warm the front seats during cold weather. With the ignition switch in the ON position, push either of the switches to warm the driver's seat or the front passenger's seat.

During mild weather or under conditions where the operation of the seat warmer is not needed, keep the switches in the OFF position.

With the seat warmer switch in the ON position, the heating system in the seat turns off or on automatically depending on the seat temperature.

#### **⚠ CAUTION - Seat damage**

- *When cleaning the seats, do not use an organic solvent such as paint thinner, benzene, alcohol and gasoline. Doing so may damage the surface of the heater or seats.*
- *To prevent overheating the seat warmer, do not place anything on the seats that insulates against heat, such as blankets, cushions or seat covers while the seat warmer is in operation.*
- *Do not place heavy or sharp objects on seats equipped with seat warmers. Damage to the seat warming components could occur.*

**⚠ WARNING - Seat warmer burns**

Passengers should use extreme caution when using seat warmers due to the possibility of excess heating or burns. The seat warmer may cause burns even at low temperatures, especially if used for long periods of time. The occupants must be able to feel if the seat is becoming too warm and to turn the seat warmer off. The seat warmer may cause burns even at low temperatures, especially if used for long periods of time.

In particular, the driver must exercise extreme care for the following types of passengers:

1. Infants, children, elderly or disabled persons, or hospital outpatients
2. Persons with sensitive skin or those that burn easily
3. Fatigued individuals
4. Intoxicated individuals
5. Individuals taking medication that can cause drowsiness or sleepiness (sleeping pills, cold tablets, etc.)

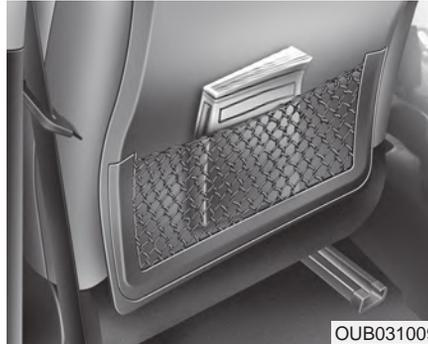

***Seatback pocket***

The seatback pocket is provided on the back of the front passenger's seatback.

**⚠ WARNING - Seatback pocket**

Do not put heavy or sharp objects in the seatback pocket. An occupant could contact such objects in a crash. Heavy objects in the front passenger seatback could also interfere with the airbag sensing system.

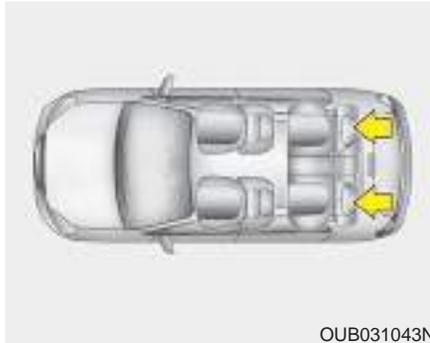

OUB031043N

## Rear seat adjustment

### Headrest

The rear seat is equipped with headrests in all the seating positions for the occupant's safety and comfort.

The headrest not only provides comfort for passengers, but also helps protect the head and neck in the event of a collision. For maximum effectiveness in case of an accident, the headrest should be adjusted so the middle of the headrest is at the same height of the center of gravity of an occupant's head. Generally, the center of gravity of most people's head is similar with the height as the top of their eyes.

Also adjust the headrest as close to your head as possible. For this reason, the use of a cushion that holds the body away from the seatback is not recommended.

### **⚠ WARNING - Headrest removal**

**Do not operate the vehicle with the headrests removed. Headrests can provide critical neck and head support in a crash.**

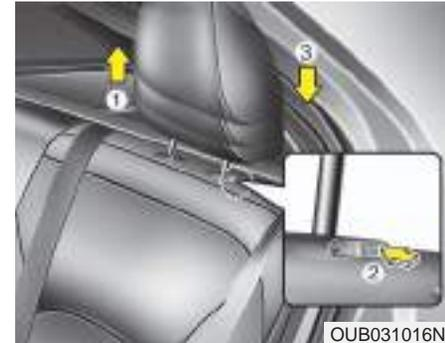

OUB031016N

### Adjusting the height up and down (if equipped)

To raise the headrest, pull it up to the desired position (1). To lower the headrest, push and hold the release button (2) on the headrest support and lower the headrest to the desired position (3).



### Removal and installation

To remove the headrest, raise it as far as it can go then press the release button (1) while pulling the headrest upward (2).

To reinstall the headrest, put the headrest poles (3) into the holes while pressing the release button (1). Then adjust it to the appropriate height and ensure that it locks in position.

Make sure the headrest locks in position after adjusting.

### Folding the rear seat

The rear seatbacks may be folded to facilitate carrying long items or to increase the luggage capacity of the vehicle.

#### **⚠ WARNING**

**Never allow passengers sit on top of the folded down seatback while the vehicle is moving. This is not a proper seating position and no seat belts are available for use. This could result in serious injury or death in case of an accident or sudden stop.**

#### **⚠ WARNING - Objects**

**Objects carried on the folded down seatback should not extend higher than the top of the front seatbacks. This could allow cargo to slide forward and cause injury or damage during sudden stops.**



### To fold down the rear seatback:

1. Insert the rear seat belt metal tab into the holder to prevent the seat belt from being damaged.
2. Set the front seatback to the upright position and if necessary, slide the front seat forward.
3. Lower the rear headrests to lowest position.





4. Pull the lock release lever (1) and fold the rear seatback forward and down firmly.

If the seat belt locks after unfolding the rear seatback, pull out the locked seat belt, release it then pull it out again.

**To unfold the rear seat**

1. To use the rear seat, lift and pull the seatback backward. Pull the seatback firmly until it clicks into place. Make sure the seatback is locked in place. When you return the seatback to its upright position, always be sure it has locked into position by pushing on the top of the seatback.

If you can not see the red line at the bottom of folding lever, it means the seatback is locked completely.

2. Return the rear seat belt to the proper position.
3. When the seatback is completely installed, check the seatback folding lever again.

When returning the rear seatbacks to the upright position, remember to return the rear shoulder belts to their proper position.

**⚠ WARNING - Rear seatback**  
**When returning the rear seatback from a folded to an upright position, hold the seatback and return it slowly. Ensure that the seatback is completely locked into its upright position by pushing on the top of the seatback. In an accident or sudden stop, the unlocked seatback could allow cargo to move forward with great force and enter the passenger compartment.**

**⚠ WARNING - Cargo**  
**Do not place heavy objects in the rear seats, since they cannot be properly secured and may hit vehicle occupants in a frontal collision.**

### SEAT BELTS

#### Seat belt restraint system

Seat belts are designed to bear upon the bony structure of the body, and should be worn low across the front of the pelvis or the pelvis, chest and shoulders, as applicable; wearing the lap section of the belt across the abdominal area must be avoided.

Seat belts should be adjusted as firmly as possible, consistent with comfort, to provide the protection for which they have been designed.

A slack belt will greatly reduce the protection afforded to the wearer.

Care should be taken to avoid contamination of the webbing with polishes, oils and chemicals, and particularly battery acid. Cleaning may safely be carried out using mild soap and water. The belt should be replaced if webbing becomes frayed, contaminated or damaged.

- For maximum restraint system protection, the seat belts must always be used whenever the vehicle is moving. A properly positioned shoulder belt should be positioned midway over your shoulder across your collarbone.
- Never allow children to ride in the front passenger seat. See child restraint system section for further discussion.

 **WARNING - Shoulder belt**  
Never wear the shoulder belt under your arm or behind your back. An improperly positioned shoulder belt cannot protect the occupant in a crash.

 **WARNING - Damaged seat belt**  
Replace the entire seat belt assembly if any part of the webbing or hardware is damaged as you can no longer be sure that a damaged seat belt will provide protection in a crash.

 **WARNING - Twisted seat belt**  
Make sure your seat belt is not twisted when worn. A twisted seat belt may not properly protect you in an accident and could even cut into your body.

 **WARNING - Seat belt buckle**  
Do not allow foreign material (gum, crumbs, coins, etc.) to obstruct the seat belt buckle. This may prevent the seat belt from fastening securely.



**Seat belt warning (for driver's seat)**

The driver's seat belt warning light and chime will activate to the following table when the ignition switch is in "ON" position.

Conditions		Warning Pattern	
Seat Belt	Vehicle Speed	Light-Blink	Chime-Sound
Unbuckled		6 seconds	
Buckled		6 seconds	None
Buckled → Unbuckled	Below 5 km/h (3 mph)	6 seconds	None
	5 km/h~10 km/h	6 seconds	
	Above 10 km/h (6 mph)	6 sec. on / 24 sec. off (11 times)	
Unbuckled	Above 10 km/h (6 mph)	6 seconds *1	
	↓ Below 5 km/h (3 mph)	↓ Stop *2	

\*1 Warning pattern repeats 11 times with an interval of 24 seconds. If the driver's seat belt is buckled, the light will stop within 6 seconds and chime will stop immediately.

\*2 The light will stop within 6 seconds and chime will stop immediately.



**Seat belt warning (for front passenger's seat)**

The front passenger's seat belt warning light will activate to the following table when the ignition switch is in "ON" position.

## Safety features of your vehicle

Conditions		Warning Pattern
Seat Belt	Vehicle Speed	Light-Blink
Unbuckled		6 seconds
Unbuckled	Above 10 km/h (6mph)	Continuously
Buckled		6 seconds
Buckled →	Above 10 km/h (6mph)	Continuously *1
Unbuckled	Below 10 km/h (6mph)	None

\*1 The seat belt warning light will go off if the vehicle speed decreases below 5 km/h (3 mph). If the vehicle speed increases above 5 km/h (3 mph), the warning light will blink again.

- You can find the front passenger's seat belt warning light on the center fascia panel.
- Although the front passenger seat is not occupied, the seat belt warning light will blink for 6 seconds.
- The seat belt warning light can blink when a briefcase or purse is placed on the front passenger seat.

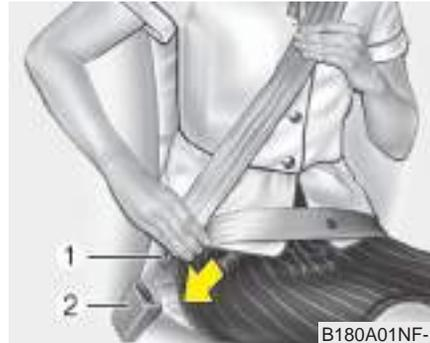

### **Seat belt - Driver's 3-point system with emergency locking retractor**

#### **To fasten your seat belt:**

To fasten your seat belt, pull it out of the retractor and insert the metal tab (1) into the buckle (2). There will be an audible "click" when the tab locks into the buckle.

The seat belt automatically adjusts to the proper length only after the lap belt portion is adjusted manually so that it fits snugly around your hips. If you lean forward in a slow, easy motion, the belt will extend and let you move around. If there is a sudden stop or impact, however, the belt will lock into position. It will also lock if you try to lean forward too quickly.

If you are not able to pull out the seat belt from the retractor, firmly pull the belt out and release it. Then you will be able to pull the belt out smoothly.

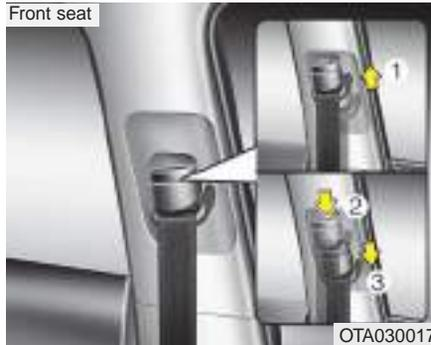

To raise the height adjuster, pull it up (1). To lower it, push it down (3) while pressing the height adjuster button (2). Release the button to lock the anchor into position. Try sliding the height adjuster to make sure that it has locked into position.

**⚠ WARNING - Shoulder belt position**

**Never position the shoulder belt across your neck or face.**

**Height adjustment**

You can adjust the height of the shoulder belt anchor to one of the 4 positions for maximum comfort and safety.

The height of the adjusting seat belt should not be too close to your neck. The shoulder portion should be adjusted so that it lies across your chest and midway over your shoulder near the door and not your neck.

To adjust the height of the seat belt anchor, lower or raise the height adjuster into an appropriate position.

**⚠ WARNING - Seat belt replacement**

**Replace your seat belts after being in an accident. Failure to replace seat belts after an accident could leave you with damaged seat belts that will not provide protection in the event of another collision.**



You should place the lap belt portion as low as possible and snugly across your hips. If the lap belt is located too high on your waist, it may increase the chance of injury in the event of a collision.

The arm closest to the seat belt buckle should be over the belt while the other arm should be under the belt as shown in the illustration.

## Safety features of your vehicle

### ***Seat belts - Front passenger and rear seat 3-point system with combination locking retractor***

#### **To fasten your seat belt:**

Combination retractor type seat belts are installed in the rear seat positions to help accommodate the installation of child restraint systems. Although a combination retractor is also installed in the front passenger seat position, it is strongly recommended that children always be seated in the rear seat. NEVER place any infant restraint system in the front seat of the vehicle.

This type of seat belt combines the features of both an emergency locking retractor seat belt and an automatic locking retractor seat belt. To fasten your seat belt, pull it out of the retractor and insert the metal tab into the buckle. There will be an audible "click" when the tab locks into the buckle. When not securing a child restraint, the seat belt operates in the same way as the driver's seat belt (Emergency Locking Retractor Type). It automatically adjusts to the proper length only after the lap belt portion of the seat belt is adjusted manually so that it fits snugly around your hips.

When the seat belt is fully extended from the retractor to allow the installation of a child restraint system, the seat belt operation changes to allow the belt to retract, but not to extend (Automatic Locking Retractor Type). Refer to "Using a child restraint system" in this section.

To convert from the automatic locking feature to the emergency locking operation mode, allow the unbuckled seat belt to fully retract.

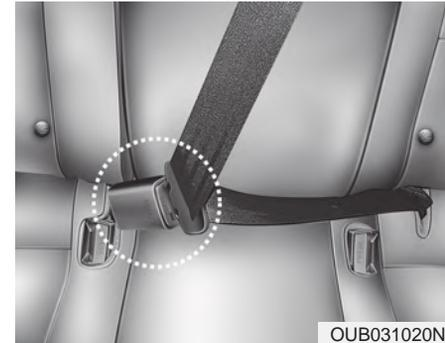

When using the rear center seat belt, the buckle with the "CENTER" mark must be used.

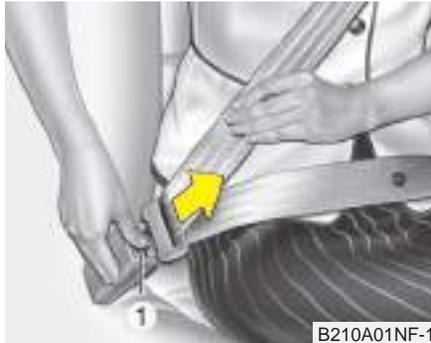

### To release the seat belt:

The seat belt is released by pressing the release button (1) of the locking buckle. When it is released, the belt should automatically draw back into the retractor.

If this does not happen, check the belt to be sure it is not twisted, then try again.



### Pre-tensioner seat belt

Your vehicle is equipped with driver's and front passenger's pre-tensioner seat belts. The purpose of the pre-tensioner is to make sure that the seat belts fit tightly against the occupant's body in certain frontal collisions (or side collisions). The pre-tensioner seat belts may be activated in crashes, where the frontal collision is severe enough.

When the vehicle stops suddenly, or if the occupant tries to lean forward too quickly, the seat belt retractor will lock into position. In certain frontal collisions, the pre-tensioner will activate and pull the seat belt into tighter contact against the occupant's body.

If the system senses excessive seat belt tension on the driver or passenger's seat belt when the pre-tensioner activates, the load limiter inside the pre-tensioner will release some of the pressure on the affected seat belt.

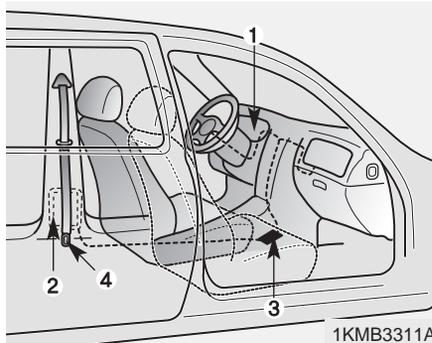

The seat belt pre-tensioner system consists mainly of the following components. Their locations are shown in the illustration:

1. SRS air bag warning light
2. Retractor pre-tensioner assembly
3. SRS control module
4. Anchor pre-tensioner assembly

Both the driver's and front passenger's pre-tensioner seat belts may be activated in certain frontal collisions.

The pre-tensioners will not be activated if the seat belts are not being worn at the time of the collision.

### \* NOTICE

When the pre-tensioner seat belts are activated, a loud noise may be heard and fine dust, which may appear to be smoke, may be visible in the passenger compartment. These are normal operating conditions and are not hazardous.

**⚠ WARNING - Skin irritation**  
Wash all exposed skin areas thoroughly after an accident in which the pre-tensioner seat belts were activated. The fine dust from the pre-tensioner activation may cause skin irritation and should not be breathed for prolonged periods.

Because the sensor that activates the SRS air bag is connected with the pre-tensioner seat belt, the SRS air bag warning light (🚨) on the instrument panel will illuminate for approximately 6 seconds after the ignition switch has been turned to the ON position, and then it should turn off.

If the pre-tensioner seat belt does not work properly, this warning light will illuminate even if the SRS air bag has not malfunctioned. If the SRS air bag warning light does not illuminate when the ignition switch is turned ON, or if it remains illuminated after illuminating for approximately 6 seconds, or if it illuminates while the vehicle is being driven, please have an authorized Kia dealer inspect the pre-tensioner seat belt or SRS air bag system as soon as possible.



**\* NOTICE**

Do not attempt to service or repair the pre-tensioner seat belt system in any manner. Do not attempt to inspect or replace the pre-tensioner seat belts yourself. This must be done by an authorized Kia dealer.

**⚠ WARNING - Hot pretensioner**  
**Do not touch the pre-tensioner seat belt assemblies for several minutes after they have been activated. When the pre-tensioner seat belt mechanism fires during a collision the pre-tensioner becomes hot and can burn you.**

Pre-tensioners are designed to operate only one time. After activation, pre-tensioner seat belts must be replaced. If the pre-tensioner must be replaced, contact an authorized Kia dealer.

**Seat belt precautions**

*Infant or small child*

You should be aware of the specific requirements in your country. Child and/or infant seats must be properly placed and installed in the rear seat. For more information about the use of these restraints, refer to “Child restraint system” in this section.

### **Larger children**

Children who are too large for child restraint systems should always occupy the rear seat and use the available lap/shoulder belts. The lap portion should be fastened and snugged on the hips and as low as possible. Check if the belt fits periodically. A child's squirming could put the belt out of position. Children are given the most safety in the event of an accident when they are restrained by a proper restraint system in the rear seat. If a larger child (over age 12) must be seated in the front seat, the child should be securely restrained by the available lap/shoulder belt and the seat should be placed in the rearmost position. Children age 12 and under should be restrained securely in the rear seat. NEVER place a child age 12 and under in the front seat. NEVER place a rear facing child seat in the front seat of a vehicle.

If the shoulder belt portion slightly touches the child's neck or face, try placing the child closer to the center of the vehicle. If the shoulder belt still touches their face or neck they need to be returned to a child restraint system.

 **WARNING - Small children**  
**Do not allow small children to ride in the vehicle without an appropriate child restraint system. If the shoulder belt comes in contact with your child's neck or face your child is too small to ride in the vehicle. In a crash the seat belt will inflict injury to your child's neck, throat and face.**

### **Restraint of pregnant women**

Pregnant women should wear lap/shoulder belt assemblies whenever possible according to specific recommendations by their doctors. The lap portion of the belt should be worn AS SNUGLY AND LOW AS POSSIBLE.

 **WARNING - Pregnant women**  
**Pregnant women must never place the lap portion of the seat belt above or on the abdomen where the fetus is located. The force of the seat belt during a collision will crush the fetus.**

### ***Injured person***

A seat belt should be used when an injured person is being transported. When this is necessary, you should consult a physician for recommendations.

### ***One person per belt***

Two people (including children) should never attempt to use a single seat belt. This could increase the severity of injuries in case of an accident.

### ***Do not lie down***

To reduce the chance of injuries in the event of an accident and to achieve maximum effectiveness of the restraint system, all passengers should be sitting up and the front seats should be in an upright position when the vehicle is moving. A seat belt cannot provide proper protection if the person is lying down in the rear seat or if the front seat is in a reclined position.

### **Care of seat belts**

Seat belt systems should never be disassembled or modified. In addition, care should be taken to assure that seat belts and belt hardware are not damaged by seat hinges, doors or other abuse.



#### **WARNING - Pinched seat belt**

**Make sure that the webbing and/or buckle does not get caught or pinched in the rear seat when returning the rear seatback to its upright position. A caught or pinched webbing/buckle may become damaged and could fail during a collision or sudden stop.**

### ***Periodic inspection***

All seat belts should be inspected periodically for wear or damage of any kind. Any damaged parts should be replaced as soon as possible.

### ***Keep belts clean and dry***

Seat belts should be kept clean and dry. If belts become dirty, they can be cleaned by using a mild soap solution and warm water. Bleach, dye, strong detergents or abrasives should not be used because they may damage and weaken the fabric.

### ***When to replace seat belts***

The entire in-use seat belt assembly or assemblies should be replaced if the vehicle has been involved in an accident. This should be done even if no damage is visible. Additional questions concerning seat belt operation should be directed to an authorized Kia dealer.

### CHILD RESTRAINT SYSTEM

Children riding in the car should sit in the rear seat and must always be properly restrained to minimize the risk of injury in an accident, sudden stop or sudden maneuver. According to accident statistics, children are safer when properly restrained in the rear seats than in the front seat. Larger children not in a child restraint should use one of the seat belts provided.

You should be aware of the specific requirements in your country. Child and/or infant safety seats must be properly placed and installed in the rear seat. You must use a commercially available child restraint system that meets the requirements of the safety standards of your country.

Child restraint systems are designed to be secured in vehicle seats by seat belt, or by a tether anchor and/or LATCH anchors (if equipped).

Children could be injured or killed in a crash if their restraints are not properly secured. For small children and babies, a child seat or infant seat must be used. Before buying a particular child restraint system, make sure it fits your vehicle seat and seat belts, and fits your child. Follow all the instructions provided by the manufacturer when installing the child restraint system.

 **WARNING- Restraint location**

**Never install a child or infant seat on the front passenger's seat. A child riding in the front passenger seat can be forcefully struck by an inflating airbag.**

 **WARNING- Hot child restraint**

**A child restraint system can become very hot if it is left in a closed vehicle on a sunny day. Be sure to check the seat cover, buckles and latches before placing a child in the restraint system.**

When the child restraint system is not in use, store it in the luggage area or fasten it with a seat belt so that it will not be thrown forward in case of a sudden stop or an accident.

**⚠ WARNING - Holding children**

Never hold a child in your arms or lap when riding in a vehicle. The violent forces created during a crash will tear the child from your arms and throw the child against the car's interior.

Always use a child restraint system which is appropriate for your child's height and weight.

**⚠ WARNING - Unattended Children**

Never leave children unattended in a vehicle. The car can heat up very quickly, resulting in injuries to the child in the vehicle.

**⚠ WARNING - Seat belt use**

Do not use one seat belt for two occupants at the same time. This will eliminate any safety benefit provided by the seat belt to the occupants.

Rearward-facing child restraint system



CRS09

Forward-facing child restraint system



OUB031012N

**Using a child restraint system**

For small children and babies, the use of a child seat or infant seat is required. This child seat or infant seat should be of appropriate size for the child and should be installed in accordance with the manufacturer's instructions.

For safety reasons, we recommend that the child restraint system be used in the rear seats.

## Safety features of your vehicle

Since all passenger seat belts move freely under normal conditions and only lock under extreme or emergency conditions (emergency lock mode), you must manually change these seat belts to the auto lock mode to secure a child restraint.

If the seat belt does not operate as described in this section, have the system checked immediately by your authorized Kia dealer.

### **⚠ WARNING - Child seat installation**

- **Always follow the instructions provided by the child restraint system manufacturer. Child restraint system manufacturers know their products best.**
- **Failure to observe this manual's instructions regarding child restraint system and the instructions provided with the child restraint system could result in the improper installation of the child restraint system which may reduce the protection to your child in a crash or a sudden stop.**

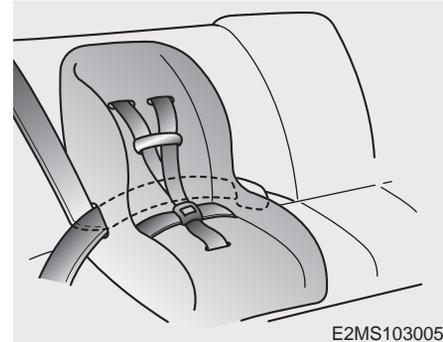

### ***lacing a passenger seat belt into the auto lock mode***

The auto lock mode will help prevent the normal movement of the child in the vehicle from causing the seat belt to loosen and compromise the child restraint system. To secure a child restraint system, use the following procedure.

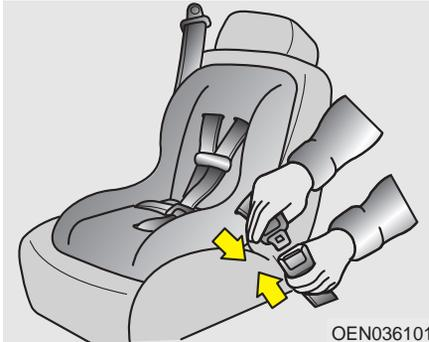

To install a child restraint system on the outboard or center rear seats, do the following:

1. Place the child restraint system in the seat and route the lap/shoulder belt around or through the restraint, following the restraint manufacturer's instructions. Be sure the seat belt webbing is not twisted.
2. Fasten the lap/shoulder belt latch into the buckle. Listen for the distinct "click" sound.

*Position the release button so that it is easy to access in case of an emergency.*

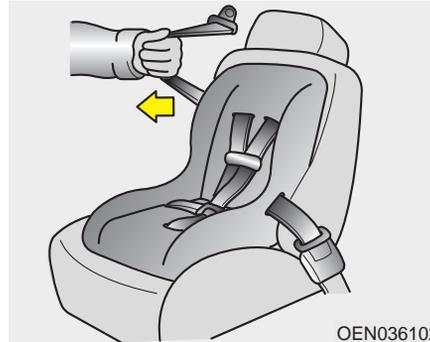

3. Pull the shoulder portion of the seat belt all the way out. When the shoulder portion of the seat belt is fully extended, it will shift the retractor to the "Auto Lock" (child restraint) mode.



4. Slowly allow the shoulder portion of the seat belt to retract and listen for an audible "clicking" or "ratcheting" sound. This indicates that the retractor is in the "Auto Lock" mode. If no distinct sound is heard, repeat steps 3 and 4.

## Safety features of your vehicle

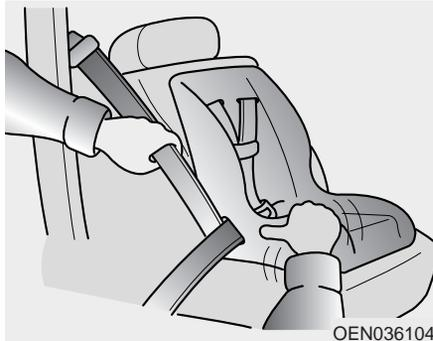

5. Remove as much slack from the belt as possible by pushing down on the child restraint system while feeding the shoulder belt back into the retractor.
6. Push and pull on the child restraint system to confirm that the seat belt is holding it firmly in place. If it is not, release the seat belt and repeat steps 2 through 6.
7. Double check that the retractor is in the "Auto Lock" mode by attempting to pull more of the seat belt out of the retractor. If you cannot, the retractor is in the "Auto Lock" mode.

The lap/shoulder belt automatically returns to the "emergency lock mode" whenever the belt is allowed to retract fully.

Therefore, the preceding seven steps must be followed each time a child restraint is installed.

To remove the child restraint, press the release button on the buckle and then pull the lap/shoulder belt out of the restraint and allow the seat belt to retract fully.

**⚠ WARNING - Auto lock mode**

**Set the retractor to Automatic Lock mode when installing any child restraint system.**

**If the retractor is not in the Automatic Locking mode, the child restraint can move when your vehicle turns or stops suddenly.**

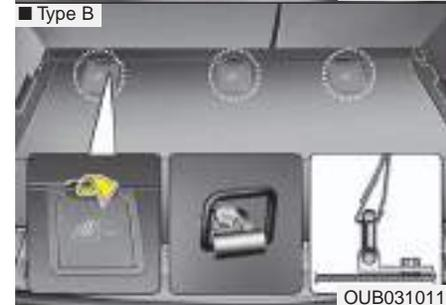
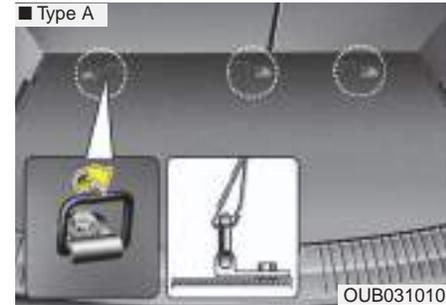

***Securing a child restraint seat with tether anchorage system***

Child restraint hook holders are located on the floor behind the rear seats.





1. Route the child restraint seat tether strap over the seatback.  
For vehicles with adjustable headrest, route the tether strap under the headrest and between the headrest posts, otherwise route the tether strap over the top of the seatback.

2. Connect the tether strap hook to the appropriate child restraint hook holder and tighten to secure the child restraint seat.

**⚠ WARNING - Tether strap**  
Never mount more than one child restraint to a single tether or to a single lower anchorage point. The increased load caused by multiple seats may cause the tethers or anchorage points to break.

Check that the child restraint system is secure by pushing and pulling it in different directions. Incorrectly fitted child restraints may swing, twist, tip or separate causing death or serious injury.

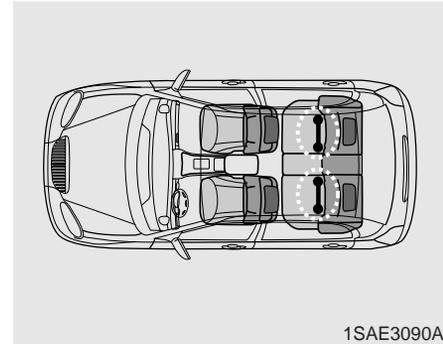

***Securing a child restraint seat with child seat lower anchor system***

Some child seat manufacturers make child restraint seats that are labeled as LATCH or LATCH-compatible child restraint seats. LATCH stands for "Lower Anchors and Tethers for Children". These seats include two rigid or webbing mounted attachments that connect to two LATCH anchors at specific seating positions in your vehicle. This type of child restraint seat eliminates the need to use seat belts to attach the child seat in the rear seats.

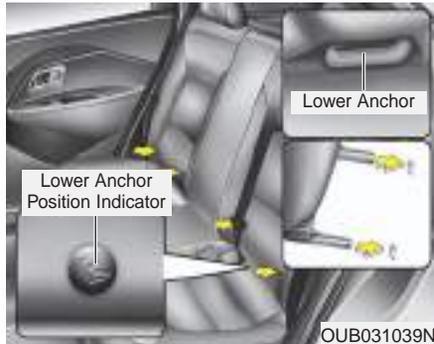

Child restraint symbols are located on the left and right rear seat backs to indicate the position of the lower anchors for child restraints.

### **⚠ WARNING - Unused rear seatbelts**

**Always fasten the seatbelts behind the child restraint seat when they are not used to secure the child seat. Failure to do so may result in child strangulation.**

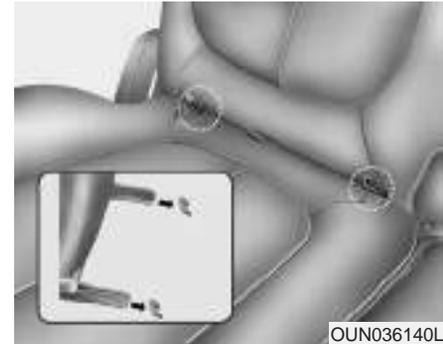

LATCH anchors have been provided in your vehicle. The LATCH anchors are located in the left and right outboard rear seating positions. Their locations are shown in the illustration. There is no LATCH anchor provided for the center rear seating position.

The LATCH anchors are located between the seatback and the seat cushion of the rear seat left and right outboard seating positions.

When you install your child's restraint system using the LATCH anchors buckle the shoulder lap belt, then lock the retractor and pull the belt to remove the slack in the belt so it lies flat against the vehicle seat.

Follow the child seat manufacturer's instructions to properly install child restraint seats with LATCH or LATCH-compatible attachments.

Once you have installed the LATCH child restraint, assure that the seat is properly attached to the LATCH and tether anchors.

Also, test the child restraint seat before you place the child in it. Tilt the seat from side to side. Also try to tug the seat forward. Check to see if the anchors hold the seat in place.

 **WARNING - LATCH lower anchors**

**Never attempt to attach a LATCH equipped seat in the center seating position. LATCH lower anchors are only to be used with the left and right rear outboard seating positions. You may damage the anchors or the anchors may fail and break in a collision.**

## AIR BAG - ADVANCED SUPPLEMENTAL RESTRAINT SYSTEM

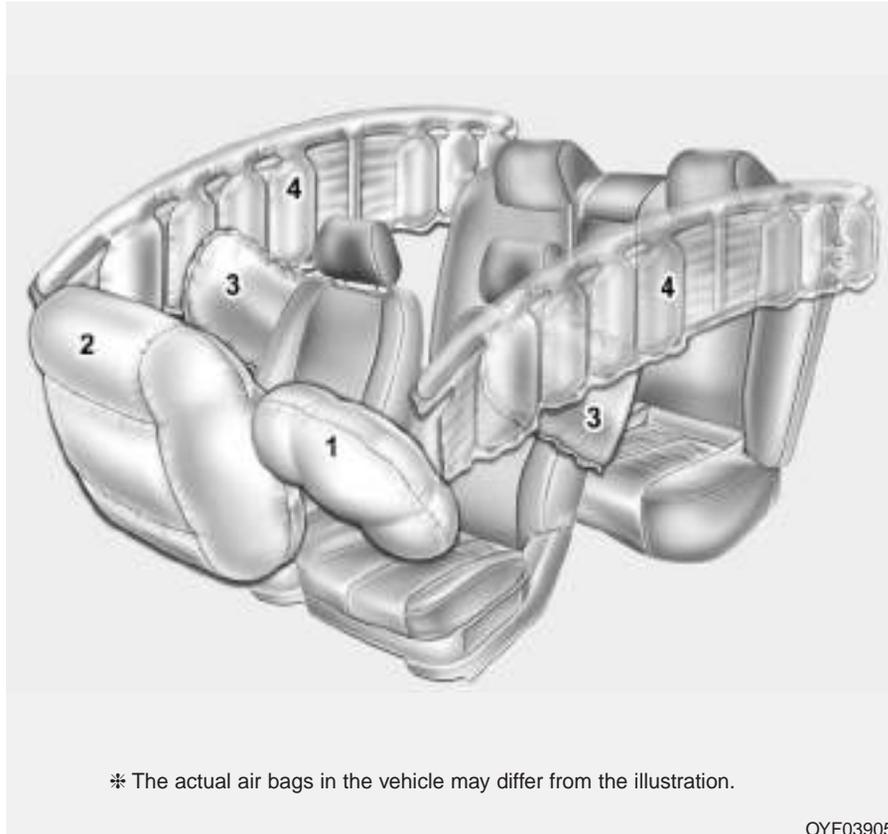

- (1) Driver's front air bag
- (2) Passenger's front air bag
- (3) Side impact air bag
- (4) Curtain air bag

Even in vehicles with air bags, you and your passengers must always wear the safety belts provided in order to minimize the risk and severity of injury in the event of a collision or rollover.

OYF039050

### How does the air bag system operate

- Air bags are activated (able to inflate if necessary) only when the ignition switch is turned to the ON or START the appropriate position.
- Air bags inflate instantly in the event of serious frontal or side collision (if equipped with side impact air bag or curtain air bag) in order to help protect the occupants from serious physical injury.
- There is no single speed at which the air bags will inflate.

Generally, air bags are designed to inflate based upon the severity of a collision and its direction. These two factors determine whether the sensors produce an electronic deployment/inflation signal.

- Air bag deployment depends on a number of complex factors including vehicle speed, angles of impact and the density and stiffness of the vehicles or objects which your vehicle hits in the collision. Though, factors are not limited to those mentioned above.
- The front air bags will completely inflate and deflate in an instant.

It is virtually impossible for you to see the air bags inflate during an accident. It is much more likely that you will simply see the deflated air bags hanging out of their storage compartments after the collision.

- In order to help provide protection in a severe collision, the air bags must inflate rapidly. The speed of air bag inflation is a consequence of extremely short time in which a collision occurs and the need to get the air bag between the occupant and the vehicle structures before the occupant impacts those structures. This speed of inflation reduces the risk of serious or life-threatening injuries in a severe collision and is thus a necessary part of air bag design.

However, air bag inflation can also cause injuries which can include facial abrasions, bruises and broken bones because the inflation speed also causes the air bags to expand with a great deal of force.

- **There are even circumstances under which contact with the steering wheel air bag can cause fatal injuries, especially if the occupant is positioned excessively close to the steering wheel.**

### **WARNING - Airbag inflation**

**Sit as far back as possible from the steering wheel while still maintaining comfortable control of your vehicle. A distance of at least 10" from your chest to the steering wheel is recommended. Failure to do so can result in airbag inflation injuries to the driver.**

### **Noise and smoke**

When the air bags inflate, they make a loud noise and they leave smoke and powder in the air inside of the vehicle. This is normal and is a result of the ignition of the air bag inflator. After the air bag inflates, you may feel substantial discomfort in breathing due to the contact of your chest to both the seat belt and the air bag, as well as from breathing the smoke and powder. **Open your doors and/or windows as soon as possible after the impact in order to reduce discomfort and prevent prolonged exposure to smoke and powder.**

Though smoke and powder are non-toxic, it may cause irritation to the skin (eyes, nose and throat etc). If this is the case, wash and rinse with the cold water immediately and consult the doctor if the symptom persists.

### **⚠ WARNING**

#### **- Hot components**

**Do not touch the air bag storage area's internal components immediately after airbag inflation. The air bag related parts in the steering wheel, instrument panel and the roof rails above the front and rear doors are very hot. Hot components can result in burn injuries.**



### ***Installing a child restraint on a front passenger's seat is forbidden***

Never place a rear-facing child restraint in the front passenger's seat. If the air bag deploys, it would impact the rear-facing child restraint, causing serious or fatal injury.

In addition, do not place front-facing child restraint in the front passenger's seat either. If the front passenger air bag inflates, it would cause serious or fatal injuries to the child.

**⚠ WARNING - Air bag deployment**

When children are seated in the rear outboard seats of a vehicle equipped with side and/or curtain air bags, install the child restraint system as far away from the door side as possible. Inflation of the side and/or curtain air bags could impact the child.



**Air bag warning light**

The purpose of the air bag warning light in your instrument panel is to alert you of a potential problem with your air bag - Supplemental Restraint System (SRS).

When the ignition switch is turned ON, the indicator light should illuminate for approximately 6 seconds, then go off.

Have the system checked by an authorized Kia dealer if:

- The light does not turn on briefly when you turn the ignition ON.
- The light stays on after illuminating for approximately 6 seconds.
- The light comes on while the vehicle is in motion.

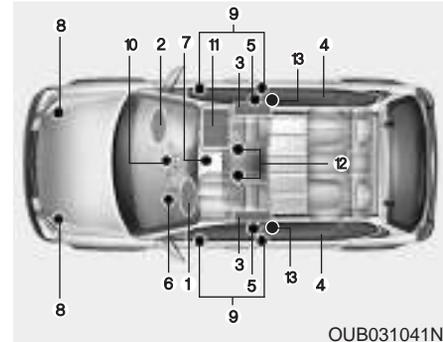

**SRS components and functions**

The SRS consists of the following components:

1. Driver's front air bag module
2. Passenger's front air bag module
3. Side impact air bag modules
4. Curtain air bag modules
5. Retractor pre-tensioner assemblies\*
6. Air bag warning light
7. SRS control module (SRSCM)
8. Front impact sensors
9. Side impact sensors
10. PASSENGER AIR BAG "OFF" indicator (Front passenger's seat only)
11. Occupant detection system (Front passenger's seat only)

## Safety features of your vehicle

12. Driver's and front passenger's seat belt buckle sensors

13. Anchor pre-tensioner assemblies

\*: if equipped

The SRSCM continually monitors all SRS components while the ignition switch is ON to determine if a crash impact is severe enough to require air bag deployment or pre-tensioner seat belt deployment.

The SRS air bag warning light on the instrument panel will illuminate for about 6 seconds after the ignition switch is turned to the ON position, after which the air bag warning light should go out.

If any of the following conditions occurs, this indicates a malfunction of the SRS. Have an authorized Kia dealer inspect the air bag system as soon as possible.

- The light does not turn on briefly when you turn the ignition ON.
- The light stays on after illuminating for approximately 6 seconds.
- The light comes on while the vehicle is in motion.



The air bag modules are located both in the center of the steering wheel and in the front passenger's panel above the glove box. When the SRSCM detects a sufficiently severe impact to the front of the vehicle, it will automatically deploy the front air bags.



Upon deployment, tear seams molded directly into the pad covers will separate under pressure from the expansion of the air bags. Further opening of the covers then allows full inflation of the air bags.



Driver's front air bag (3)



B240B03L

Passenger's front air bag



B240B05L

A fully inflated air bag, in combination with a properly worn seat belt, slows the driver's or the passenger's forward motion, reducing the risk of head and chest injury.

After complete inflation, the air bag immediately starts deflating, enabling the driver to maintain forward visibility and the ability to steer or operate other controls.

### \* NOTICE

Before you replace a fuse or disconnect a battery terminal, turn the ignition switch to the LOCK position and remove the ignition key. Never remove or replace the air bag related fuse(s) when the ignition switch is in the ON position. Failure to heed this warning will cause the SRS air bag warning light to illuminate.

#### **⚠ WARNING - Air bag obstructions**

**Do not install or place any accessories on the steering wheel, instrument panel, or on the front passenger's panel above the glove box in a vehicle. Such objects may become dangerous projectiles if the air bag deploys.**



OUB031037N

### **Occupant detection system**

Your vehicle is equipped with an occupant detection system in the front passenger's seat.

The occupant detection system is designed to detect the presence of a properly-seated front passenger and determine if the passenger's front air bag should be enabled (may inflate) or not. The driver's front air bag is not affected or controlled by the occupant detection system.

### ***Main components of occupant detection system***

- A detection device located within the front passenger seat track.
- Electronic system to determine whether passenger air bag systems should be activated or deactivated.
- An indicator light located on the instrument panel which illuminates the words PASSENGER AIR BAG "OFF" indicating the front passenger air bag system is deactivated.
- The instrument panel air bag warning light is interconnected with the occupant detection system.

If the front passenger seat is occupied by a person that the system determines to be of adult size, and he/she sits properly (sitting upright with the seatback in an upright position, centered on the seat cushion with their seat belt on, legs comfortably extended and their feet on the floor), the PASSENGER AIR BAG "OFF" indicator will turn off and the front passenger's air bag will be able to inflate, if necessary, in frontal crashes.

You will find the PASSENGER AIR BAG "OFF" indicator on the center facia panel. This system detects the conditions 1~4 in the following table and activates or deactivates the front passenger air bag based on these conditions.

Always be sure that you and all vehicle occupants are seated and restrained properly (sitting upright with the seat in an upright position, centered on the seat cushion, with the person's legs comfortably extended, feet on the floor, and wearing the safety belt properly) for the most effective protection by the air bag and the safety belt.

- The ODS (Occupant Detection System) may not function properly if the passenger takes actions which can defeat the detection system. These include:
  - (1) Failing to sit in an upright position.
  - (2) Leaning against the door or center console.
  - (3) Sitting towards the sides or the front of the seat.
  - (4) Putting legs on the dashboard or resting them on other locations which reduce the passenger weight on the front seat.
  - (5) Improperly wearing the safety belt.
  - (6) Reclining the seat back.

### Condition and operation in the front passenger occupant detection system

Condition detected by the occupant detection system	Indicator/Warning light		Devices
	PASSENGER AIR BAG "OFF" indicator light	SRS warning light	Front passenger air bag
1. Adult *1 or child age 13 and up*2	Off	Off	Activated
2. Infant or child restraint system with 12 months old*3 *4	On	Off	Deactivated
3. Unoccupied	On	Off	Deactivated
4. Malfunction in the system	Off	On	Activated

- \*1) The system judges a person of adult size as an adult. When a smaller adult sits in the front passenger seat, the system may recognize him/her as a child depending on his/her physique and posture.
- \*2) Do not allow children to ride in the front passenger seat. When a smaller child than the same age sits in the front passenger seat, the system may recognize him/her as an infant depending on his/her physique or posture.
- \*3) Never install a child restraint system on the front passenger seat.
- \*4) The PASSENGER AIR BAG "OFF" indicator may turn on or off when a child above 12 months to 12 years old (with or without child restraint system) sits in the front passenger seat. This is a normal condition.

**⚠ WARNING - ODS system**  
 Riding in an improper position adversely affects the occupant detection system (ODS) and may result in the deactivation of front passenger airbag. It is important for the driver to instruct the passenger as to the proper seating instructions as contained in this manual.  
**(Continued)**

(Continued)



B990A08O

- Never put a heavy load in the front passenger seat.



1KMN3663

- Never sit with the hips shifted towards the front of the seat.



1KMN3665

- Never place the feet on the dashboard.



OVQ036014N

- Never place the feet on the front passenger seatback.



1KMN3662

- Never excessively recline the front passenger seatback.



1KMN3664

- Never lean on the door or center console.
- Never sit on one side of the front passenger seat.

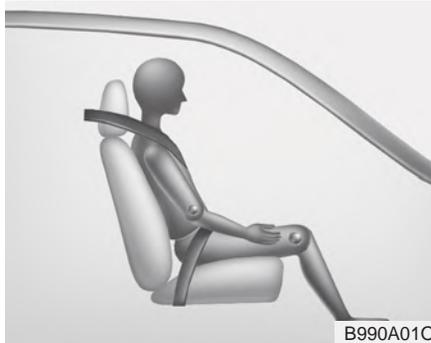

When an adult is seated in the front passenger seat, if the PASSENGER AIR BAG “OFF” indicator is on, turn the ignition switch to the LOCK position and ask the passenger to sit properly (sitting upright with the seat back in an upright position, centered on the seat cushion with their seat belt on, legs comfortably extended and their feet on the floor). Restart the engine and have the person remain in that position. This will allow the system to detect the person and to enable the passenger air bag.

If the PASSENGER AIR BAG “OFF” indicator is still on, ask the passenger to move to the rear seat.

**⚠ WARNING - “AIR BAG OFF” light**

**Do not allow an adult passenger to ride in the front seat when the PASSENGER AIR BAG “OFF” indicator is illuminated, because the air bag will not deploy in the event of a crash. The driver must instruct the passenger to reposition himself in the seat. Failure to properly position yourself may lead to airbag deactivation resulting in airbag non-deployment and in a collision. If the PASSENGER AIR BAG “OFF” indicator remains illuminated after the passenger repositions themselves properly and the car is restarted, it is recommended that passenger move to the rear seat because the passenger’s front air bag will not deploy.**

**\* NOTICE**

The PASSENGER AIR BAG “OFF” indicator illuminates for about 4 seconds after the ignition switch is turned to the ON position or after the engine is started. If the front passenger seat is occupied, the occupant detection sensor will then classify the front passenger after several more seconds.

Any child age 12 and under should ride in the rear seat. Children too large for child restraints should use the available lap/shoulder belts. No matter what type of crash, children of all ages are safer when restrained in the rear seat.

### \* NOTICE

**Do not modify or replace the front passenger seat. Don't place anything on or attach anything such as a blanket, front seat covers or after market seat heater to the front passenger seat. This can adversely affect the occupant detection system.**

If the occupant detection system is not working properly, the SRS air bag warning light  on the instrument panel will illuminate because the passenger's front air bag is connected with the occupant detection system. If there is a malfunction of the occupant detection system, the PASSENGER AIR BAG "OFF" indicator will not illuminate and the passenger's front air bag will inflate in frontal impact crashes even if there is no occupant in the front passenger's seat.



Passenger's front air bag

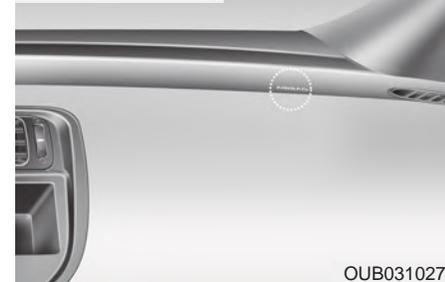

### Driver's and passenger's front air bag

Your vehicle is equipped with an Advanced Supplemental Restraint (Air Bag) System and lap/shoulder belts at both the driver and passenger seating position.

## Safety features of your vehicle

---

The indications of the system's presence are the letters "AIR BAG" embossed on the air bag pad cover in the steering wheel and the passenger's side front panel pad above the glove box.

The SRS consists of air bags installed under the pad covers in the center of the steering wheel and the passenger's side front panel above the glove box.

The purpose of the SRS is to provide the vehicle's driver and/or the front passenger with additional protection than that offered by the seat belt system alone in case of a frontal impact of sufficient severity. The SRS uses sensors to gather information about the driver's seat position, the driver's and front passenger's seat belt usage and impact severity.

The advanced SRS offers the ability to control the air bag inflation with two levels. A first stage level is provided for moderate-severity impacts. A second stage level is provided for more severe impacts.

The passenger's front air bag is designed to help reduce the injury of children sitting close to the instrument panel in low speed collisions. However, children are safer if they are restraint in the rear seat.

According to the impact severity, seating position and seat belt usage, the SRSCM (SRS Control Module) controls the air bag inflation. Failure to properly wear seat belts can increase the risk or severity of injury in an accident.

Additionally, your vehicle is equipped with an occupant detection system in the front passenger's seat. The occupant detection system detects the presence of a passenger in the front passenger's seat and will turn off the front passenger's air bag under certain conditions. For more detail, see "Occupant detection system" in this section.

Do not place any objects that may cause magnetic fields near the front seat. These may cause a malfunction of the seat track position sensor.



Manufacturers are required by government regulations to provide a contact point concerning modifications to the vehicle for persons with disabilities, which modifications may affect the vehicle's advanced air bag system.

However, Kia does not endorse nor will it support any changes to any part or structure of the vehicle that could affect the advanced air bag system, including the occupant detection system.

**⚠ WARNING - Replacement/modifications**

The front passenger seat, dashboard or door should not be replaced except by an authorized Kia dealer using original Kia parts designed for this vehicle and model. Any other such replacement or modification could adversely affect the operation of the occupant detection system and your advanced air bags.

Advanced air bags are combined with pre-tensioner seat belts to help provide enhanced occupant protection in frontal crashes. Front air bags are not intended to deploy in collisions in which sufficient protection can be provided by the pre-tensioner seat belt alone.

**⚠ WARNING - SRS Wiring**

Do not tamper with or disconnect SRS wiring or other components of the SRS system. Doing so could result in injury, due to accidental deployment of the air bags or by rendering the SRS inoperative.

Front air bags are not intended to deploy in side-impact, rear-impact or rollover crashes. In addition, front air bags will not deploy in frontal crashes below the deployment threshold.

## Safety features of your vehicle

Rear impact



Side impact



Rollover



Front



\* The actual air bags in the vehicle may differ from the illustration.

### Side impact air bag

Your vehicle is equipped with a side impact air bag in each front seat.

The purpose of the air bag is to provide the vehicle's driver and/or the front passenger with additional protection than that offered by the seat belt alone.

The side impact air bags are designed to deploy only during certain side-impact collisions, depending on the crash severity, angle, speed and point of impact. The side air bags are not designed to deploy in all side impact situations.

### **⚠ WARNING - Unexpected deployment**

**Avoid impact to the side impact airbag sensor when the ignition switch is ON to prevent unexpected deployment of the side impact air bag.**

The side impact air bag is supplemental to the driver's and the passenger's seat belt systems and is not a substitute for them. Therefore your seat belts must be worn at all times while the vehicle is in operation.

For best protection from the side air bag system and to avoid being injured by the deploying side air bag, both front seat occupants should sit in an upright position with the seat belt properly fastened. The driver's hands should be placed on the steering wheel at the 9:00 and 3:00 positions. The passenger's arms and hands should be placed on their laps.

**⚠ WARNING - Deployment**

**Do not install any accessories including seat covers, on the side or near the side impact air bag as this may affect the deployment of the side air bags.**

If seat or seat cover is damaged, have the vehicle checked and repaired by an authorized Kia dealer. Inform that your vehicle is equipped with side impact air bag and an occupant detection system.

**⚠ WARNING - Flying objects**

**Do not place any objects (an umbrella, bag, etc.) between the front door and the front seat. Such objects may become dangerous projectiles if the side airbag inflates.**

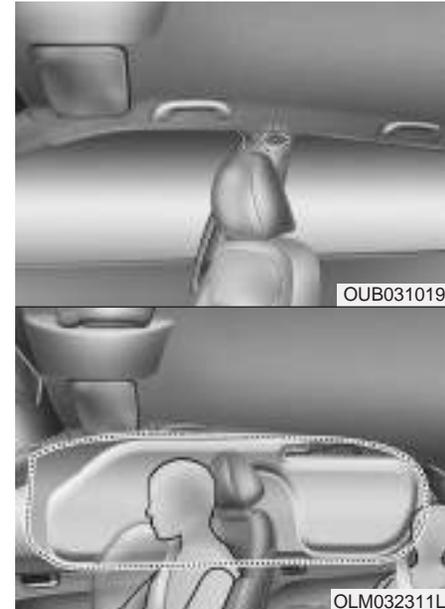

\* The actual air bags in the vehicle may differ from the illustration.

**Curtain air bag**

Curtain air bags are located along both sides of the roof rails above the front and rear doors.

They are designed to help protect the heads of the front seat occupants and the rear outboard seat occupants in certain side impact collisions.

The curtain air bags are designed to deploy only during certain side impact collisions, depending on the crash severity, angle, speed and impact. The curtain air bags are not designed to deploy in all side impact situations, collisions from the front or rear of the vehicle or in most rollover situations.

Do not allow the passengers to lean their heads or bodies onto doors, put their arms on the doors, stretch their arms out of the window, or place objects between the doors and passengers when they are seated on seats equipped with side and/or curtain air bags.

### **\* NOTICE**

**Never try to open or repair any components of the side curtain air bag system. This should only be done by an authorized Kia dealer.**

**Why didn't my air bag go off in a collision? (Inflation and non-inflation conditions of the air bag)**

There are many types of accidents in which the air bag would not be expected to provide additional protection.

These include rear impacts, second or third collisions in multiple impact accidents, as well as low speed impacts. In other words, just because your vehicle is damaged and even if it is totally unusable, don't be surprised that the air bags did not inflate.



OUB031031N/OUB031032/OUB031040N/OUB031033/OUB031047N

***Air bag collision sensors***

- (1) SRS control module
- (2) Front impact sensor

- (3) Side impact sensor

### **⚠ WARNING - Air bag sensors**

- Do not hit or allow any objects to impact the locations where air bag or sensors are installed. This may cause unexpected air bag deployment, which could result in serious personal injury or death.
- If the installation location or angle of the sensors is altered in any way, the air bags may deploy when they should not or they may not deploy when they should. Therefore, do not try to perform maintenance on or around the air bag sensors. Have the vehicle checked and repaired by an authorized Kia dealer.

Problems may arise if the sensor installation angles are changed due to the deformation of the front bumper, body or B pillar where side collision sensors are installed. Have the vehicle checked and repaired by an authorized Kia dealer.

Installing aftermarket bumper guards or replacing a bumper with non-genuine parts may adversely affect your vehicle's collision and air bag deployment performance.



### ***Air bag inflation conditions***

#### **Front air bags**

Front air bags are designed to inflate in a frontal collision depending on the intensity, speed or angles of impact of the front collision.

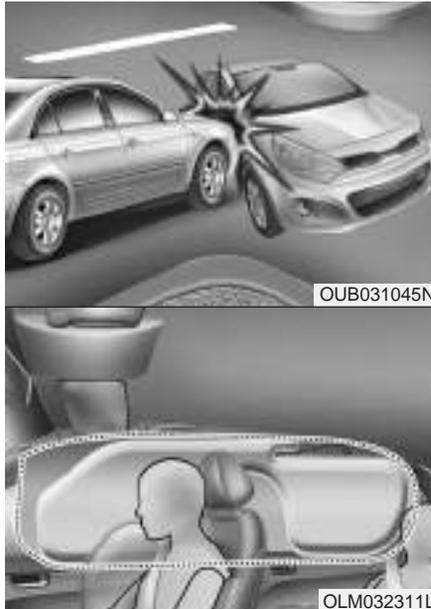

Although the front air bags (driver's and front passenger's air bags) are designed to inflate in frontal collisions, they also may inflate in other types of collisions if the front impact sensors detect a sufficient frontal force in another type of impact. Side impact and curtain air bags are designed to inflate in certain side impact collisions. They may inflate in other type of collisions where a side force is detected by the sensors.

If the vehicle chassis is impacted by bumps or objects on unimproved roads or sidewalks, air bags may deploy. Drive carefully on unimproved roads or on surfaces not designed for vehicle traffic to prevent unintended air bag deployment.

\* The actual air bags in the vehicle may differ from the illustration.

### Side air bags

Side air bags (side impact and/or curtain air bags) are designed to inflate when an impact is detected by side collision sensors depending on the strength, speed or angles of impact resulting from a side impact collision.



### Air bag non-inflation conditions

- In certain low-speed collisions the air bags may not deploy. The air bags are designed not to deploy in such cases because they may not provide benefits beyond the protection of the seat belts in such collisions.

## Safety features of your vehicle

---



- Air bags are not designed to inflate in rear collisions, because occupants are moved backward by the force of the impact. In this case, inflated air bags would not be able to provide any additional benefit.



- Front air bags may not inflate in side impact collisions, because occupants move to the direction of the collision, and thus in side impacts, front air bag deployment would not provide additional occupant protection.

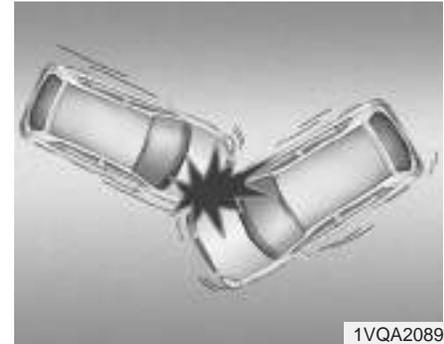

- In a slant or angled collision, the force of impact may direct the occupants in a direction where the air bags would not be able to provide any additional benefit, and thus the sensors may not deploy any air bags.





- Just before impact, drivers often brake heavily. Such heavy braking lowers the front portion of the vehicle causing it to “ride” under a vehicle with a higher ground clearance. Air bags may not inflate in this “under-ride” situation because deceleration forces that are detected by sensors may be significantly replaced by such “under-ride” collisions.

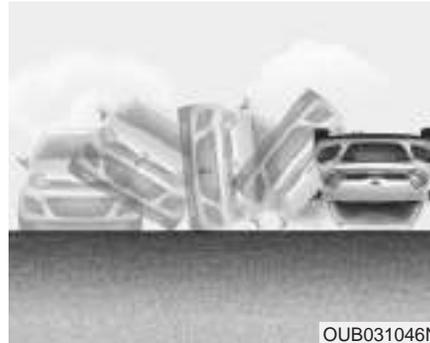

- Air bags do not inflate in most rollover accidents, even though the vehicle is equipped with side impact air bags and curtain air bags.



- Air bags may not inflate if the vehicle collides with objects such as utility poles or trees, where the point of impact is concentrated to one area and the full force of the impact is not delivered to the sensors.

### SRS Care

The SRS is virtually maintenance-free and there are no parts you can safely service by yourself. If the SRS air bag warning light does not illuminate, or continuously remains on, have your vehicle immediately inspected by an authorized Kia dealer.

Any work on the SRS system, such as removing, installing, repairing, or any work on the steering wheel must be performed by an authorized Kia dealer. Improper handling of the SRS system may result in serious personal injury.

For cleaning the air bag pad covers, use only a soft, dry cloth or one which has been moistened with plain water. Solvents or cleaners could adversely affect the air bag covers and proper deployment of the system.



### **WARNING - Tampering with SRS**

**Do not tamper with or disconnect SRS wiring, or other components of the SRS system. Doing so could result in the accidental inflation of the air bags or by rendering the SRS inoperative.**

If components of the air bag system must be discarded, or if the vehicle must be scrapped, certain safety precautions must be observed. An authorized Kia dealer knows these precautions and can give you the necessary information. Failure to follow these precautions and procedures could increase the risk of personal injury.

### **Adding equipment to or modifying your air bag-equipped vehicle**

If you modify your vehicle by changing your vehicle's frame, bumper system, front end or side sheet metal or ride height, this may affect the operation of your vehicle's air bag system.



OAM039041



OUB031035N

### **Air bag warning label**

Air bag warning labels, some required by the Canada Motor Vehicle Safety Standards (CMVSS), are attached to the sunvisor to alert the driver and passengers of potential risks of the air bag system.

**Keys / 4-2**  
**Smart key / 4-4**  
**Remote keyless entry / 4-7**  
**Theft-alarm system / 4-12**  
**Door locks / 4-15**  
**Tailgate / 4-20**  
**Windows / 4-22**  
**Hood / 4-26**  
**Fuel filler lid / 4-28**

## Features of your vehicle

4

**Sunroof / 4-31**  
**Steering wheel / 4-35**  
**Mirrors / 4-38**  
**Instrument cluster / 4-41**  
**Rearview camera / 4-69**  
**Hazard warning flasher / 4-70**  
**Lighting / 4-70**  
**Wipers and washers / 4-74**  
**Interior light / 4-78**  
**Defroster / 4-80**  
**Manual climate control system / 4-81**  
**Windshield defrosting and defogging / 4-90**  
**Storage compartment / 4-92**  
**Interior features / 4-96**  
**Audio system / 4-102**

### KEYS



#### Record your key number

The key code number is stamped on the bar code tag attached to the key set. Should you lose your keys, this number will enable an authorized Kia dealer to duplicate the keys easily. Remove the bar code tag and store it in a safe place. Also, record the code number and keep it in a safe place (not in the vehicle).



#### Key operations

##### Type A

Used to start the engine, lock and unlock the doors.

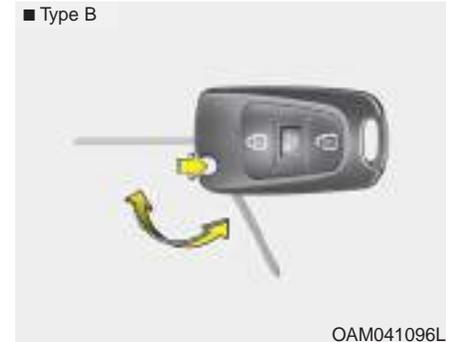

##### Type B

To unfold the key, press the release button then the key will unfold automatically. To fold the key, fold the key manually while pressing the release button.

 **CAUTION - Key button operation**

***Do not fold the key without pressing the release button. This may damage the key.***

## ■ Type C



OUB041001N

\* The actual feature may differ from the illustration.

***Type C***

To remove the mechanical key, press and hold the release button and remove the mechanical key.

To reinstall the mechanical key, put the key into the hole and push it until a click sound is heard.

**⚠ WARNING - Aftermarket keys**

Use only Kia original parts for the ignition key in your vehicle. If an aftermarket key is used, the ignition switch may not return to ON after START. If this happens, the starter will continue to operate causing possible fire due to excessive current in the wiring.

### SMART KEY (IF EQUIPPED)

#### ■ Type A



OUB041002N

#### ■ Type B



OXM049001L

With a smart key, you can lock or unlock a door and even start the engine without inserting the key.

The functions of the buttons on a smart key are similar to the remote keyless entry. (Refer to the “Remote keyless entry” in this section.)

#### Smart key functions

Carrying the smart key, you may lock and unlock the vehicle doors. Also, you may start the engine. Refer to the following, for more details.



OUB041004

#### **Locking**

Pressing the button of the front outside door handles with all doors closed and any door unlocked, locks all the doors. The hazard warning lights will blink and the chime will sound once to indicate that all doors are locked. The button will only operate when the smart key is within 0.7~1 m (28~40 in.) from the outside door handle. If you want to make sure that a door has locked or not, you should check the door lock button inside the vehicle or pull the outside door handle.

Even though you press the button, the doors will not lock and the chime will sound for 3 seconds if any of the following occurs:

- The smart key is in the vehicle.
- The ignition switch is in the ACC or ON position.
- Any door except the trunk (or tailgate) is opened.

### ***Unlocking***

Pressing the button of the driver's outside door handle with all doors closed and locked, unlocks the driver's door. The hazard warning lights will blink and the chime will sound twice to indicate that the driver's door is unlocked. All doors are unlocked if the button is pressed once more within 4 seconds. The hazard warning lights will blink and the chime will sound twice to indicate that all the doors are unlocked.

Pressing the button in the front passenger's outside door handle with all doors closed and locked, unlocks all the doors. The hazard warning lights will blink and the chime will sound twice to indicate that all doors are unlocked. The button will only operate when the smart key is within 0.7~1 m (28~40 in.) from the outside door handle.

### ***Tailgate unlocking (if equipped)***

If you are within 0.7 m (28 in.) from the outside tailgate handle, with your smart key in possession, the tailgate will unlock and open when you press the tailgate handle switch.

The hazard warning lights will blink twice to indicate that the tailgate is unlocked. Also, once the tailgate is opened and then closed, the tailgate will lock automatically.

### ***Start-up***

You can start the engine without inserting the key. For detailed information refer to "Starting the engine with a smart key" in section 5.



### Smart key precautions

- If you lose your smart key, you will not be able to start the engine. Tow the vehicle, if necessary, and contact an authorized Kia dealer.
- A maximum of 2 smart keys can be registered to a single vehicle. If you lose a smart key, you should immediately take the vehicle and key to your authorized Kia dealer to protect it from potential theft.
- The smart key will not work if any of following occurs:
  - The smart key is close to a radio transmitter such as a radio station or an airport which can interfere with normal operation of the smart key.
  - The smart key near a mobile two-way radio system or a cellular phone.
  - Another vehicle's smart key is being operated close to your vehicle.

When the smart key does not work correctly, open and close the door with the mechanical key. If you have a problem with the smart key, contact an authorized Kia dealer.



### **CAUTION - Transmitter**

***Keep the smart key away from water or any liquid as it can become damaged and not function properly.***

### **This device complies with Industry Canada Standard RSS-210.**

Operation is subject to the following two conditions:

1. This device may not cause harmful interference, and
2. This device must accept any interference received, including interference that may cause undesired operation.

### **\* NOTICE**

**Changes or modifications not expressly approved by the party responsible for compliance could void the user's authority to operate the equipment. If the keyless entry system is inoperative due to changes or modifications not expressly approved by the party responsible for compliance, it will not be covered by your manufacturer's vehicle warranty.**

## REMOTE KEYLESS ENTRY (IF EQUIPPED)

■ Type A

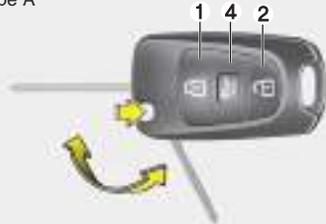

OAM041096L

■ Type B

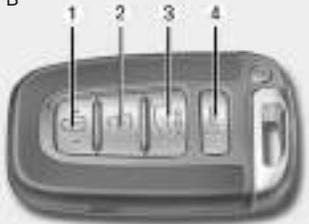

OUB041003N

■ Type C



OXM049001L

### Remote keyless entry system operations

#### *Lock (1)*

All doors are locked if the lock button is pressed. If all doors (and trunk or tailgate) are closed, the hazard warning lights will blink once to indicate that all doors (and trunk or tailgate) are locked.

Also, if the lock button is pressed once more within 4 seconds, the hazard warning lights will blink and the chime will sound once to confirm that the door is locked.

However, if any door remains open, the hazard warning lights (and/or the chime) will not operate. But if all doors are closed after the lock button is pressed, the hazard warning lights will blink once.

#### *Unlock (2)*

The driver's door is unlocked if the unlock button is pressed once. The hazard warning lights will blink (for smart key, the chime also sounds) twice to indicate that the driver's door is unlocked.

All doors are unlocked if the unlock button is pressed once more within 4 seconds. The hazard warning lights will blink (for smart key, the chime also sounds) twice again to indicate that all doors are unlocked. After pressing this button, the doors will lock automatically unless you open any door within 30 seconds.

#### **\* NOTICE**

**If the keyless entry system is inoperative due to exposure to water or liquids, it will not be covered by your manufacturer's vehicle warranty.**

### ***Tailgate open (3) (if equipped)***

The tailgate is opened if the button is pressed for more than 1 second.

Once the tailgate is opened and then closed, the tailgate will lock automatically.

### ***Alarm (4)***

The horn sounds and the hazard warning lights blink for about 30 seconds if this button is pressed for more than 0.5 seconds. To stop the horn and lights, press any button on the transmitter.

### **Transmitter precautions**

The transmitter (or smart key) will not work if any of following occurs:

- The ignition key is in the ignition switch.
- You exceed the operating distance limit (about 30 m [90 feet]).
- The battery in the transmitter (or smart key) is weak.
- Other vehicles or objects may be blocking the signal.
- The weather is extremely cold.
- The transmitter (or smart key) is close to a radio transmitter such as a radio station or an airport which can interfere with normal operation of the transmitter.

When the transmitter (or smart key) does not work properly, open and close the door with the ignition key. If you have a problem with the transmitter (or smart key), contact an authorized Kia dealer.

### **This device complies with Industry Canada Standard RSS-210.**

Operation is subject to the following two conditions:

1. This device may not cause harmful interference, and
2. This device must accept any interference received, including interference that may cause undesired operation.

### **\* NOTICE**

**Changes or modifications not expressly approved by the party responsible for compliance could void the user's authority to operate the equipment. If the keyless entry system is inoperative due to changes or modifications not expressly approved by the party responsible for compliance, it will not be covered by your manufacturer's vehicle warranty.**



### Battery replacement

A battery should last for several years, but if the transmitter or smart key is not working properly, try replacing the battery with a new one. If you are unsure how to use or replace the battery, contact an authorized Kia dealer.

1. Pry open the transmitter or smart key center cover.
2. Replace the battery with a new battery (CR2032). When replacing the battery, make sure the battery positive “+” symbol faces up as indicated in the illustration.
3. Install the battery in the reverse order of removal.

The transmitter or smart key is designed to give you years of trouble-free use, however it can malfunction if exposed to moisture or static electricity. If you are unsure how to use or replace the battery, contact an authorized Kia dealer.

Using the wrong battery can cause the transmitter or smart key to malfunction. Be sure to use the correct battery.

An inappropriately disposed battery can be harmful to the environment and human health.

Dispose the battery according to your local law(s) or regulation.

**⚠ CAUTION - Transmitter damage**

*Do not drop, wet or expose the keyless entry system transmitter to heat or sunlight.*



### Immobilizer system

Your vehicle may be equipped with an electronic engine immobilizer system to reduce the risk of unauthorized vehicle use.

Your immobilizer system is comprised of a small transponder in the ignition key and electronic devices inside the vehicle. With the immobilizer system, whenever you insert your ignition key into the ignition switch and turn it to ON, it checks and determines and verifies that the ignition key is valid.

If the key is determined to be valid, the engine will start.

If the key is determined to be invalid, the engine will not start.

#### ***To deactivate the immobilizer system:***

Insert the ignition key into the key cylinder and turn it to the ON position.

#### ***To activate the immobilizer system:***

Turn the ignition key to the OFF position. The immobilizer system activates automatically. Without a valid ignition key for your vehicle, the engine will not start.

Your Immobilizer password is a customer unique password and should be kept confidential. Do not leave this number anywhere in your vehicle.

#### **\* NOTICE**

**Keep each key separately in order to avoid a starting malfunction.**

Do not put metal accessories near the ignition switch.

Metal accessories may interrupt the transponder signal and may prevent the engine from being started.

If you need additional keys or lose your keys, consult an authorized Kia dealer.



#### **CAUTION - Immobilizer damage**

***Do not expose your immobilizer system to moisture, static electricity and rough handling. This may damage your immobilizer.***



#### **CAUTION - Immobilizer alterations**

***Do not change, alter or adjust the immobilizer system because it could cause the immobilizer system to malfunction.***

**This device complies with Industry Canada Standard RSS-210.**

Operation is subject to the following two conditions:

1. This device may not cause harmful interference, and
2. This device must accept any interference received, including interference that may cause undesired operation.

**⚠ WARNING**  
**Changes or modifications not expressly approved by the party responsible for compliance could void the user's authority to operate the equipment.**

**Limp home (override) procedure**

When you turn the ignition switch to the ON position, if the immobilizer indicator (  ) goes off after blinking 5 times, your transponder equipped in the ignition key is out of order. You cannot start the engine without the limp home procedure. To start the engine, you have to input your password by using the ignition switch. Your password is only available from an authorized Kia dealership. Contact an authorized dealer for more information.

The following procedure is how to input your password of "2345" as an example.

1. Turn the ignition switch to the ON position. The immobilizer indicator (  ) will blink 5 times and go off indicating the beginning of the limp home procedure.
2. Turn the ignition switch to the ACC position.
3. To enter the first digit (in this example "2"), turn the ignition switch to the ON and ACC position twice. Perform the same procedure for the next digits between 3 seconds and 10 seconds (for example, for "3", turn the ignition ON and ACC 3 times).

4. If all of the digits have been input successfully, you have to start the engine within 30 seconds. If you attempt to start the engine after 30 seconds, the engine will not start and you will have to input your password again.

After performing the limp home procedure, you have to see an authorized Kia dealer immediately to inspect and repair your ignition key or immobilizer system.

### THEFT-ALARM SYSTEM (IF EQUIPPED)

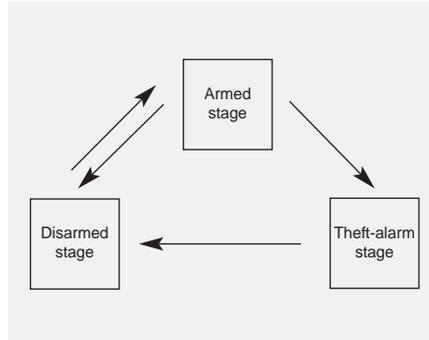

This system is designed to provide protection from unauthorized entry into the vehicle. This system is operated in three stages: the first is the "Armed" stage, the second is the "Theft-alarm" stage, and the third is the "Disarmed" stage. If triggered, the system provides an audible alarm with blinking of the hazard warning lights.

#### Armed stage

Park the vehicle and stop the engine. Arm the system as described below.

1. Remove the ignition key from the ignition switch and exit the vehicle.
2. Make sure that all doors (and tailgate) and engine hood are closed and latched.
3. • Lock the doors by depressing the door lock button on the transmitter (or smart key).

After completion of the steps above, the hazard warning lights will blink once to indicate that the system is armed.

If any door, tailgate or engine hood remains open, the hazard warning lights won't operate and theft-alarm will not arm. After this, if all doors, tailgate and engine hood are closed, the hazard warning lights blink once.

- Lock the doors by pressing the button of the front outside door handles with the smart key in your possession.

After completion of the steps above, the hazard warning lights will blink once to indicate that the system is armed.

If any door remains open, the hazard warning lights won't operate and theft-alarm will not arm. Close the door and try again to lock the doors.

If tailgate or engine hood remains open, the hazard warning lights won't operate and theft-alarm will not arm. Close the tailgate or engine hood. The hazard warning lights blink once and theft-alarm arms.

**\* NOTICE**

The theft-alarm system by the key can be activated by an authorized Kia dealer. If you want this feature, consult an authorized Kia dealer.

**Do not arm the system until all passengers have left the vehicle. If the system is armed while a passenger(s) remains in the vehicle, the alarm may be activated when the remaining passenger(s) leaves the vehicle. If any door (or tailgate) or engine hood is opened within 30 seconds after the system enters the armed stage, the system will be disarmed to prevent unnecessary alarm.**

**Theft-alarm stage**

The alarm will be activated if any of the following occurs while the system is armed.

- A front or rear door is opened without using the transmitter (or smart key).
- The tailgate is opened without using the transmitter (or smart key).
- The engine hood is opened.

The horn will sound and the hazard warning lights will blink continuously for approximately 27 seconds. To turn off the system, unlock the doors with the transmitter (or smart key).

**Disarmed stage**

The system will be disarmed when:

***Transmitter***

- The door unlock button is pressed.
- The engine is started. (within 3 seconds)
- The ignition switch is in the "ON" position for 30 seconds or more.

***Smart key***

- The door unlock button is pressed.
- The button of the front outside door is pressed while carrying the smart key.
- The engine is started. (within 3 seconds)

After the doors are unlocked, the hazard warning lights will blink twice to indicate that the system is disarmed.

After pressing the unlock button, if any door (or tailgate) is not opened within 30 seconds, the system will be rearmed.



## Features of your vehicle

---

- Avoid trying to start the engine while the alarm is activated. The vehicle starting motor is disabled during the theft-alarm stage.

If the system is not disarmed with the transmitter, insert the key into the ignition switch, turn the ignition switch to the ON position and wait for 30 seconds. Then the system will be disarmed.

- If you lose your keys, consult your authorized Kia dealer.
- If the system is not disarmed with the transmitter, insert the key into the ignition switch and start the engine. Then the system will be disarmed.
- If you lose your keys, consult your authorized Kia dealer.

## DOOR LOCKS

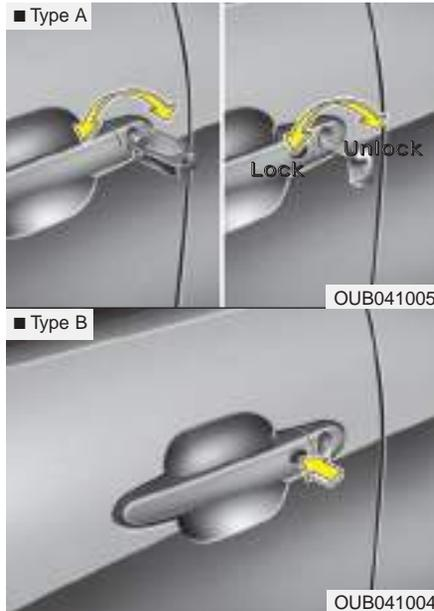

### Operating door locks from outside the vehicle

- Turn the key toward the rear of the vehicle to unlock and toward the front of the vehicle to lock.
- If you lock/unlock the door with a key, all vehicle doors will lock/unlock automatically.

- From the driver's door, turn the key toward the rear of the vehicle once to unlock the driver's door and once more within 4 seconds to unlock all doors.
- Doors can also be locked and unlocked with the transmitter key (or smart key). (if equipped)
- Once the doors are unlocked, they may be opened by pulling the door handle.
- When closing the door, push the door by hand. Make sure the doors are closed securely.

### \* NOTICE

- In cold and wet climates, door lock and door mechanisms may not work properly due to freezing conditions.
- If the door is locked/unlocked multiple times in rapid succession with either the vehicle key or door lock switch, the system may stop operating temporarily in order to protect the circuit and prevent damage to system components.



- To lock a door without the key, push the inside door lock button (1) or central door lock switch (2, if equipped) to the “Lock” position and close the door (3).
- If you lock the door with the central door lock switch (2), all vehicle doors will lock automatically. (if equipped with central door lock system)

Always remove the ignition key, engage the parking brake, close all windows and lock all doors when leaving your vehicle unattended.



### Operating door locks from inside the vehicle

#### *With the door lock button*

- To unlock a door, push the door lock button (1) to the “Unlock” position. The red mark (2) on the button will be visible.
- To lock a door, push the door lock button (1) to the “Lock” position. If the door is locked properly, the red mark (2) on the door lock button will not show.
- To open a door, pull the door handle (3) outward.

- If the inner door handle of the front door is pulled when the door lock button is in the lock position, the button will unlock and the door will open. (if equipped)
- Front doors cannot be locked if the ignition key is in the ignition switch (or if the smart key is in the vehicle) and any front door is opened. (if equipped)

If a power door lock ever fails to function while you are in the vehicle, try one or more of the following techniques to exit:

- Operate the door unlock feature repeatedly (both electronic and manual) while simultaneously pulling on the door handle.
- Operate the other door locks and handles, front and rear.
- Lower a front window and use the key to unlock the door from outside.



***With central door lock switch  
(if equipped)***

Operate by pressing the central door lock switch.

- Press the switch to the "Lock" position (1), all vehicle doors will lock.
- Press the switch to the "Unlock" position (2), all vehicle doors will unlock.
- If the key is in the ignition switch (or if the smart key is in the vehicle) and any front door is opened, the doors will not lock when the "Lock" position (1) of the central door lock switch is pressed. (if equipped)

**⚠ WARNING - Doors**

The doors should always be fully closed and locked while the vehicle is in motion to prevent accidental opening of the door.

**⚠ WARNING  
- Unattended children/  
animals**

Never leave children or animals unattended in your vehicle.

An enclosed vehicle can become extremely hot, causing death or severe injury to unattended children or animals who cannot escape the vehicle.

### **Impact sensing door unlock system (if equipped)**

All doors will automatically unlock when an impact causes the air bags to deploy.

### **Auto door lock/unlock feature (if equipped)**

- All doors will automatically lock when the transaxle shift lever is shifted out of P (Park).
- All doors will automatically unlock when the transaxle shift lever is shifted into P (Park).

An authorized Kia dealer can activate or deactivate some auto door lock/ unlock features as follows;

- Auto door unlock by using the driver's door lock button
- Auto door lock/unlock by shifting the transaxle shift lever out of P (Park) or into P (Park)
- Auto door unlock when the ignition key is removed from the ignition switch (for smart key, when the ENGINE START/STOP button is turned to the OFF position)

If you want to activate or deactivate some door lock/unlock feature, consult an authorized Kia dealer.

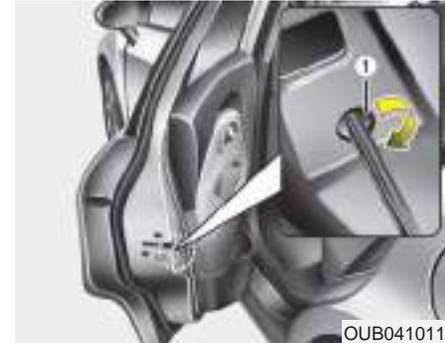

### **Child-protector rear door lock**

The child safety lock is provided to help prevent children from accidentally opening the rear doors from inside the vehicle. The rear door safety locks should be used whenever children are in the vehicle.

1. Open the rear door.
2. Insert a key (or screwdriver) into the hole and turn it to the lock position. The child safety lock (1) located on the rear edge of the door to the lock position. When the child safety lock is in the lock position, rear door will not open even when the inner door handle is pulled.

3. Close the rear door.

To open the rear door, pull the outside door handle.

Even though the doors may be unlocked, the rear door will not open by pulling the inner door handle until the rear door child safety lock is unlocked.

 **WARNING - Rear door locks**

**Use the rear door safety locks whenever children are in the vehicle. If a child accidentally opens the rear doors while the vehicle is motion, he can fall out.**

## TAILGATE



### Opening the tailgate

#### ■ Type A

- The tailgate is locked or unlocked by turning the key to the "Lock" or "Unlock" position.
- If unlocked, the tailgate can be opened by pressing the handle and then pulling up the hatch.



#### ■ Type B

- The tailgate is locked or unlocked when all doors are locked or unlocked with the transmitter (or smart key) or central door lock switch.
- If unlocked, the tailgate can be opened by pressing the handle and pulling it up.
- All doors are locked if the tailgate unlock button on the smart key is pressed for more than 1 second and the tailgate is unlocked. Once the tailgate is opened and then closed, the tailgate is locks automatically.

\* There is no key hole on this type.

The tailgate swings upward. Make sure no objects or people are near the rear of the vehicle when opening the tailgate.

#### **CAUTION - Tailgate lift cylinders**

***Make certain that you close the tailgate before driving your vehicle. Possible damage may occur to the tailgate lift cylinders and attaching hardware if the tailgate is not closed prior to driving.***



OUB041014

### Closing the tailgate

To close the tailgate, lower and push down the tailgate firmly. Make sure that the tailgate is securely latched.

Make sure your hands, feet and other parts of your body are safely out of the way before closing the tailgate.

**⚠ CAUTION- Closing tailgate**  
*Make sure nothing is near the tailgate latch and striker while closing the tailgate. It may damage the tailgate's latch.*

### **⚠ WARNING - Exhaust fumes**

Driving with the tailgate open is not advisable. Dangerous exhaust fumes can enter the passenger compartment.

If you must drive with the tailgate opened, keep the air vents and all windows open so that additional outside air can enter.

### **⚠ WARNING - Riding in cargo area**

**Occupants should never ride in the rear cargo area where no restraints are available. Occupants should always be properly restrained.**



OUB041015

### Emergency tailgate safety release

Your vehicle is equipped with the emergency tailgate safety release lever located on the bottom of the tailgate. When someone is inadvertently locked in the luggage compartment, the tailgate can be opened by doing as follows:

1. Remove the cover.
2. Push the release lever to the right.
3. Push up the tailgate.



## WINDOWS

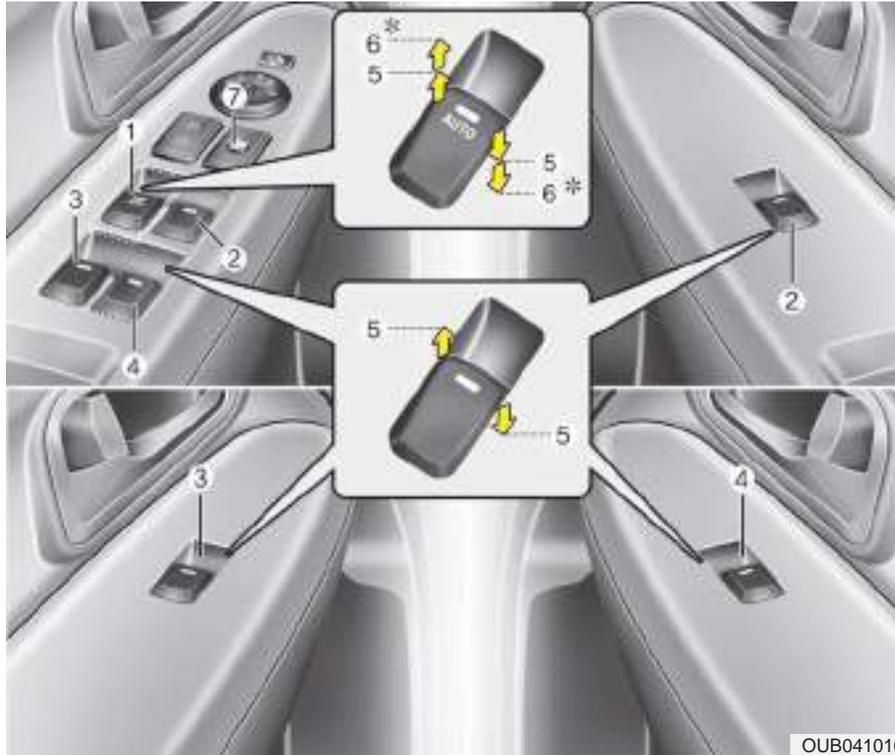

- (1) Driver's door power window switch\*
- (2) Front passenger's door power window switch\*
- (3) Rear door (left) power window switch\*
- (4) Rear door (right) power window switch\*
- (5) Window opening and closing
- (6) Automatic power window down\*
- (7) Power window lock button\*

\*: if equipped

## Power windows

The ignition switch must be in the ON position for power windows to operate. Each door has a power window switch that controls the door's window. The driver has a power window lock switch which can block the operation of passenger windows.

The power windows can be operated for approximately 30 seconds after the ignition key is removed or turned to the ACC or LOCK position. However, if the front doors are opened, the power windows cannot be operated even within the 30 second period.

In cold and wet climates, power windows may not work properly due to freezing conditions.

## \* NOTICE

**While driving with the rear windows down or with the sunroof (if equipped) in an open (or partially open) position, your vehicle may demonstrate a wind buffeting or pulsation noise. This noise is a normal occurrence and can be reduced or eliminated by taking the following actions. If the noise occurs with one or both of the rear windows down, partially lower both front windows approximately one inch. If you experience the noise with the sunroof open, slightly reduce the size of the sunroof opening.**

## *Window opening and closing (if equipped)*

The driver's door has a master power window switch that controls all the windows in the vehicle.

To open or close a window, press down or pull up the front portion of the corresponding switch to the first detent position (5).

## *Auto down window (if equipped) (Driver's window)*

Pressing the power window switch momentarily to the second detent position (6) completely lowers the driver's window even when the switch is released. To stop the window at the desired position while the window is in operation, momentarily pull up the switch to the opposite direction of the window movement.



OTA040015

### Auto up/down window (if equipped)

Pressing or pulling up the power window switch momentarily to the second detent position (6) completely lowers or lifts the window even when the switch is released. To stop the window at the desired position while the window is in operation, pull up or press and release the switch to the opposite direction of the movement.

If the power window is not operated correctly, the automatic power window system must be reset as follows:

1. Turn the ignition switch to the ON position.
2. Close the window and continue pulling up on the driver's power window switch for at least 1 second after the window is completely closed.



OUN026013

### Automatic reversal

If the upward movement of the window is blocked by an object or part of the body, the window will detect the resistance and will stop upward movement. The window will then lower approximately 30 cm (11.8 in.) to allow the object to be cleared.

If the window detects the resistance while the power window switch is pulled up continuously, the window will stop upward movement then lower approximately 2.5 cm (1 in.). And if the power window switch is pulled up continuously again within 5 seconds after the window is lowered by the automatic window reversal feature, the automatic window reversal will not operate.

### \* NOTICE

The automatic reverse feature for the driver's window is only active when the "auto up" feature is used by fully pulling up the switch. The automatic reverse feature will not operate if the window is raised using the halfway position on the power window switch.

### ⚠ WARNING

Always check for obstructions before raising any window to avoid injuries or vehicle damage. If an object less than 4 mm (0.16 in.) in diameter is caught between the window glass and the upper window channel, the automatic reverse window may not detect the resistance and will not stop and reverse direction.



OUB041020

**Power window lock button (if equipped)**

- The driver can disable the power window switches on the passenger doors by pressing the power window lock switch, located on the driver's door to the LOCK position (pressed).
- **When the power window lock button is in the LOCK position (pressed), the driver's master control cannot operate the passenger door power windows.**

**⚠ CAUTION - Opening / closing Window**

*To prevent possible damage to the power window system, do not open or close two windows or more at the same time. This will also ensure the longevity of the fuse.*

**⚠ WARNING - Power windows**

**Do not allow children to play with the power windows. Keep the driver's door power window lock switch in the LOCK position (pressed).**

Always double check to make sure all arms, hands, head and other obstructions are safely out of the way before closing a window.

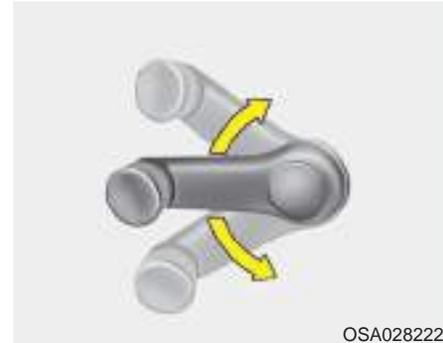

OSA028222

**Manual windows (if equipped)**

To raise or lower the window, turn the window regulator handle clockwise or counterclockwise.

When closing the windows, make sure your passenger's arms, hands and body are safely out of the way.

## HOOD



### Opening the hood

1. Pull the release lever to unlatch the hood. The hood should pop open slightly.

Open the hood after turning off the engine on a flat surface, shifting the shift lever to the P(Park) position for automatic transaxle and to the 1st(First) gear or R(Reverse) for manual transaxle, and setting the parking brake.



2. Go to the front of the vehicle, raise the hood slightly, push the secondary latch (1) inside of the hood center and lift the hood (2).

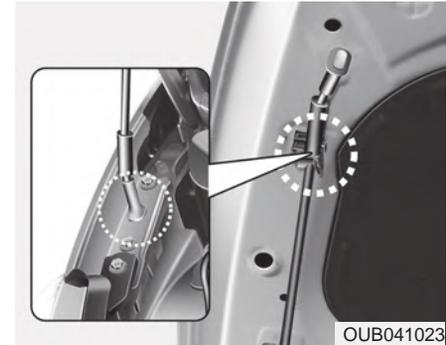

3. Pull out the support rod from the hood.
4. Hold the hood opened with the support rod.

**⚠ WARNING - Hot parts**  
Grasp the support rod in the area wrapped in rubber. The plastic will help prevent you from being burned by hot metal when the engine is hot.

## Closing the hood

1. Before closing the hood, check the following:
  - All filler caps in the engine compartment must be correctly installed.
  - Gloves, rags or any other combustible material must be removed from the engine compartment.
2. Return the support rod to its clip to prevent it from rattling.
3. Lower the hood until it is about 30 cm (1 ft.) above the closed position and let it drop. Make sure that it locks into place.

### **WARNING - Fire risk**

**Do not leave gloves, rags or any other combustible material in the engine compartment. Doing so may cause a heat-induced fire.**

### **WARNING - Unsecured engine Hood**

**Always double check to be sure that the hood is firmly latched before driving away. If the engine hood is not secured properly, it is likely to fly up blocking your vision and causing a crash.**

The support rod must be inserted completely into the hole whenever you inspect the engine compartment. This will prevent the hood from falling and possibly injuring you.

## FUEL FILLER LID



### Opening the fuel filler lid

The fuel filler lid must be opened from inside the vehicle by pulling up the fuel filler lid opener.

If the fuel filler lid does not open because ice has formed around it, tap lightly or push on the lid to break the ice and release the lid. Do not pry on the lid. If necessary, spray around the lid with an approved de-icer fluid (do not use radiator anti-freeze) or move the vehicle to a warm place and allow the ice to melt.



1. Stop the engine.
2. To open the fuel filler lid, pull the fuel filler lid opener up.
3. Pull open the fuel filler lid (1).
4. To remove the cap (2), turn the fuel filler cap counterclockwise.
5. Refuel as needed.

### Closing the fuel filler lid

1. To install the cap, turn it clockwise until it “clicks” one time. This indicates that the cap is securely one time tightened.
2. Close the fuel filler lid and push it in lightly and make sure that it is securely closed.

### **⚠ WARNING - Refueling**

**Always remove the fuel cap carefully and slowly. If the cap is venting fuel or if you hear a hissing sound, wait until the condition stops before completely removing the cap.**

**If pressurized fuel sprays out, it can cover your clothes or skin and subject you to the risk of fire and burns.**

### **\* NOTICE**

**Tighten the cap until it clicks one time, otherwise the fuel cap open warning indicator  light will illuminate.**

Always check that the fuel cap is installed securely to prevent fuel spillage in the event of an accident.

**⚠ WARNING - Fire/explosion risk**

Read and follow all warnings posted at the gas station facility. Failure to follow all warnings will result in severe personal injury, severe burns or death due to fire or explosion.

**⚠ WARNING - Static electricity**

- Before touching the fuel nozzle, you should eliminate potentially dangerous static electricity discharge by touching another metal part of the vehicle, a safe distance away from the fuel filler neck, nozzle, or other gas source.
- Do not get back into a vehicle once you have begun refueling since you can generate static electricity by touching, rubbing or sliding against any item or fabric (polyester, satin, nylon, etc.) capable of producing static electricity. Static electricity discharge can ignite fuel vapors resulting in rapid burning. If you must re-enter the vehicle, you should once again eliminate potentially dangerous static electricity discharge by touching a metal part of the vehicle, away from the fuel filler neck, nozzle or other gasoline source.

**\* NOTICE**

When using an approved portable fuel container, be sure to place the container on the ground prior to refueling. Static electricity discharge from the container can ignite fuel vapors causing a fire. Once refueling has begun, contact with the vehicle should be maintained until the filling is complete. Use only approved portable plastic fuel containers designed to carry and store gasoline.

**⚠ WARNING - Cell phone fires**

Do not use cellular phones while refueling. Electric current and/or electronic interference from cellular phones can potentially ignite fuel vapors causing a fire.



**⚠ WARNING - Refueling & Vehicle fires**

When refueling, always shut the engine off. Sparks produced by electrical components related to the engine can ignite fuel vapors causing a fire. Once refueling is complete, check to make sure the filler cap and filler door are securely closed, before starting the engine.

**⚠ WARNING - Smoking**

DO NOT use matches or a lighter and DO NOT SMOKE or leave a lit cigarette in your vehicle while at a gas station especially during refueling. Automotive fuel is highly flammable and can, when ignited, result in fire.

Make sure to refuel your vehicle according to the "Fuel requirements" suggested in section 1.

If the fuel filler cap requires replacement, use only a genuine Kia cap or the equivalent specified for your vehicle. An incorrect fuel filler cap can result in a serious malfunction of the fuel system or emission control system.

**⚠ CAUTION - Exterior paint**

*Do not spill fuel on the exterior surfaces of the vehicle. Any type of fuel spilled on painted surfaces may damage the paint.*

## SUNROOF (IF EQUIPPED)



OAM049018

If your vehicle is equipped with a sunroof, you can slide or tilt your sunroof with the sunroof control lever located on the overhead console.

The sunroof can only be opened, closed, or tilted when the ignition switch is in the ON position.

In cold and wet climates, the sunroof may not work properly due to freezing conditions.

After the vehicle is washed or in a rain-storm, be sure to wipe off any water that is on the sunroof before operating it.

**⚠ CAUTION - Sunroof control lever**

***Do not continue to press the sunroof control lever after the sunroof is fully opened, closed, or tilted. Damage to the motor or system components could occur.***

The sunroof cannot slide when it is in the tilt position nor can it be tilted while in an open or slide position.



OUB041027

### Sliding the sunroof

To open the sunroof, pull the sunroof control lever backward.

To close the sunroof, push the sunroof control lever forward.

## Features of your vehicle

### To open the sunroof automatically:

Pull the sunroof control lever backward to the second detent position and then release it. The sunroof will slide all the way open.

To stop the sunroof sliding at any point, pull or push the sunroof control lever momentarily.

### To close the sunroof automatically:

Push the sunroof control lever forward to the second detent position and then release it. The sunroof will automatically close all the way.

To stop the sunroof sliding at any point, pull or push the sunroof control lever momentarily.

While driving with the sunroof in an open (or partially open position), your vehicle may demonstrate a wind buffeting or pulsation noise. This noise is a normal occurrence and can be reduced or eliminated by taking the following actions. If you experience the noise with the sunroof open, slightly reduce the size of the sunroof opening



### *Automatic reversal*

If an object or part of the body is detected while the sunroof is closing automatically, it will reverse direction, and then stop.

The auto reverse function does not work if a tiny obstacle is between the sliding glass and the sunroof sash. You should always check that all passengers and objects are away from the sunroof before closing it.



### **Tilting the sunroof**

To open the sunroof, push the sunroof control lever upward until the sunroof moves to the desired position.

To close the sunroof, push the sunroof lever forward or pull downward until the sunroof moves to the desired position.

**⚠ WARNING - Sunroof operation**

**When closing the sunroof, make sure there are no body parts in the movement range of the sliding roof. Parts of the body could become trapped or crushed.**

Do not extend the face, neck, arms or body outside the sunroof while driving. Periodically remove any dirt that may accumulate on the guide rail.

While using sunroof for a long time, a dust between sunroof and roof panel can make a noise. Open the sunroof and remove regularly the dust using clean cloth.

**⚠ CAUTION - Sunroof motor damage**

***If you try to open the sunroof when the temperature is below freezing or when the sunroof is covered with snow or ice, the glass or the motor could be damaged.***



**Sunshade**

When opening the sunroof, the sunshade will also open. Once the sunroof is closed, the sunshade can be manually closed.

### Resetting the sunroof

Whenever the vehicle battery is disconnected or discharged, or related fuse is blown, you must reset your sunroof system as follows:

1. Turn the ignition switch to the ON position and close the sunroof completely.
2. Release the control lever.
3. Push and hold the control lever forward (for more than 10 seconds) until the sunroof tilts and slightly moves. Then, release the lever.
4. Within 3 seconds, push and hold the control lever forward (for more than 5 seconds) until the sunroof is operated as follows;

TILT DOWN → SLIDE OPEN →  
SLIDE CLOSE

Then, release the control lever.

When this is complete, the sunroof system is reset.

※ For more detailed information, contact an authorized Kia dealer.

### \* NOTICE

**If the sunroof is not reset when the vehicle battery is disconnected or discharged, or related fuse is blown, the sunroof may operate improperly.**

## STEERING WHEEL

### Electric power steering

Power steering uses the motor to assist you in steering the vehicle. If the engine is off or if the power steering system becomes inoperative, the vehicle may still be steered, but it will require increased steering effort.

The motor driven power steering is controlled by the power steering control unit which senses the steering wheel torque and vehicle speed to command the motor.

The steering wheel becomes heavier as the vehicle's speed increases and becomes lighter as the vehicle's speed decreases for better control of the steering wheel.

Should you notice any change in the effort required to steer during normal vehicle operation, have the power steering checked by an authorized Kia dealer.

### \* NOTICE

**The following symptoms may occur during normal vehicle operation:**

- **The steering effort is high immediately after turning the ignition switch on. This happens as the system performs the EPS system diagnostics. When the diagnostics is completed, the steering wheel will return to its normal condition.**
- **A click noise may be heard from the EPS relay after the ignition switch is turned to the ON or LOCK position.**
- **Motor noise may be heard when the vehicle is at a stop or at a low driving speed.**
- **The steering effort increases if the steering wheel is rotated continuously when the vehicle is not in motion. However, after a few minutes, it will return to its normal conditions.**
- **When you operate the steering wheel in low temperature, abnormal noise could occur. If temperature rises, the noise will disappear. This is a normal condition.**

If the Electric Power Steering System does not operate normally, the warning light will illuminate on the instrument cluster. The steering wheel may become difficult to control or operate abnormally. Take your vehicle to an authorized Kia dealer and have the vehicle checked as soon as possible.

### Tilt and telescoping (if equipped) steering

Tilt steering allows you to adjust the steering wheel before you drive. You can also raise it to give your legs more room when you exit and enter the vehicle.

The steering wheel should be positioned so that it is comfortable for you to drive, while permitting you to see the instrument panel warning lights and gauges.

**⚠ WARNING - Steering wheel adjustment**  
**Never adjust the angle and height of the steering wheel while driving. You may lose steering control**



To change the steering wheel angle, pull down the lock release lever (1), adjust the steering wheel to the desired angle (2) and height (if equipped) (3), then pull up the lock-release lever to lock the steering wheel in place. Be sure to adjust the steering wheel to the desired position before driving.



### Heated steering wheel (if equipped)

When the ignition switch is in the ON position, pressing the heated steering wheel button warms the steering wheel. The indicator on the button will illuminate. To turn the steering wheel off, press the button once again. The indicator on the button will turn off.

It will turn off automatically approximately 30 minutes after the heated steering wheel is turned on.

If the ignition is turned off and then on again within a half hour (while the heated steering wheel button is pressed), the steering wheel heating system will remain on.

**⚠ CAUTION**

- *Do not install any grip to operate the steering wheel. This causes damage to the heated steering wheel system.*
- *When cleaning the heated steering wheel, do not use an organic solvent such as paint thinner, benzene, alcohol and gasoline. Doing so may damage the surface of the steering wheel.*
- *If the surface of steering wheel is damaged by sharp object, damage to the heated steering wheel components could occur.*



OUB041031

**Horn**

To sound the horn, press the horn symbol on your steering wheel. Check the horn regularly to be sure it operates properly.

To sound the horn, press the area indicated by the horn symbol on your steering wheel (see illustration). The horn will operate only when this area is pressed.



### MIRRORS

#### Inside rearview mirror

Adjust the rearview mirror so that the center view through the rear window is seen. Make this adjustment before you start driving.

Do not place objects in the rear seat which would interfere with your vision through the rear window.

**⚠ WARNING - Mirror adjustment**

**Do not adjust the rearview mirror while the vehicle is moving. This could result in loss of control.**



#### *Day/night rearview mirror (if equipped)*

Make this adjustment before you start driving and while the day/night lever is in the day position.

Pull the day/night lever toward you to reduce the glare from the headlights of the vehicles behind you during night driving.

*Remember that you lose some rearview clarity in the night position.*

#### Outside rearview mirror

Be sure to adjust the mirror angles before driving.

Your vehicle is equipped with both left-hand and right-hand outside rearview mirrors. The mirrors can be adjusted remotely with the remote switch (if equipped). The mirror heads can be folded to prevent damage during an automatic car wash or when passing through a narrow street.

The right outside rearview mirror is convex. Objects seen in the mirror are closer than they appear.

Use your interior rearview mirror or direct observation to determine the actual distance of following vehicles when changing lanes.

**CAUTION - Rearview mirror**

*Do not scrape ice off the mirror face; this may damage the surface of the glass. If ice should restrict movement of the mirror, do not force the mirror for adjustment. To remove ice, use a deicer spray, or a sponge or soft cloth with very warm water.*

**WARNING - Mirror adjustment**

**Do not adjust or fold the outside rearview mirrors while the vehicle is moving. This could result in loss of control.**



**Remote control**

**Electric type**

The electric remote control mirror switch allows you to adjust the position of the left and right outside rearview mirrors. To adjust the position of either mirror the ignition switch should be in the ACC or ON position.

Move the lever (1) to R or L to select the right side mirror or the left side mirror, then press a corresponding point on the mirror adjustment control to position the selected mirror up, down, left or right.

After the adjustment, put the lever into neutral (center) position to prevent inadvertent adjustment.

**CAUTION - Outside mirror**

- *The mirrors stop moving when they reach the maximum adjusting angles, but the motor continues to operate while the switch is pressed. Do not press the switch longer than necessary, the motor may be damaged.*
- *Do not attempt to adjust the outside rearview mirror by hand. Doing so may damage the related parts.*



### Folding the outside rearview mirror

#### Electric Type (if equipped)

To fold the outside rearview mirror, depress the button.

To unfold it, depress the button again.



### **CAUTION - Electric type outside rearview mirror**

*The electric type outside rearview mirror operates even though the ignition switch is in the OFF position. However, to prevent unnecessary battery discharge, do not adjust the mirrors longer than necessary while the engine is not running.*

*In case it is an electric type outside rearview mirror, don't fold it by hand. It could cause motor failure.*

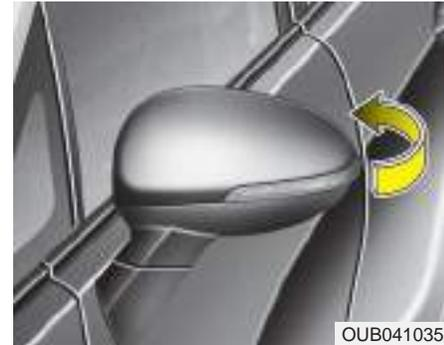

### Manual type

To fold outside rearview mirror, grasp the housing of mirror and then fold it toward the rear of the vehicle.

## INSTRUMENT CLUSTER

### ■ Type A



1. Tachometer
2. Turn signal indicators
3. Speedometer
4. Fuel gauge
5. Engine coolant temperature gauge
6. Warning and indicator lights
7. Shift position indicator (A/T) or  
Manual transaxle shift indicator (M/T)
8. Odometer/Trip computer

### ■ Type B



- ✱ The actual cluster in the vehicle may differ from the illustration.  
For more details refer to the "Gauges" in the next pages.

OUB041036C/OUB041037C



### Instrument panel illumination

When the vehicle's parking lights or headlights are on, push upward or downward the illumination control knob to adjust the brightness of the instrument panel illumination.

The brightness of the instrument panel (Type B) illumination can be adjusted by rotating the control knob when the ignition switch is in ON position.

#### ■ Type A



#### ■ Type B

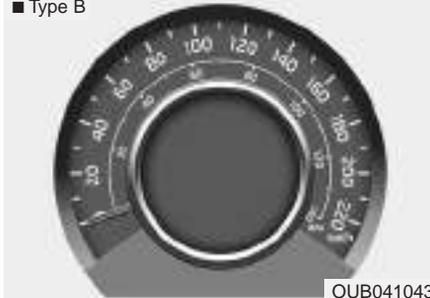

### Gauges

#### *Speedometer*

The speedometer indicates the forward speed of the vehicle.

The speedometer is calibrated in kilometers per hour and/or miles per hour.



#### *Tachometer*

The tachometer indicates the approximate number of engine revolutions per minute (rpm).

Use the tachometer to select the correct shift points and to prevent lugging and/or over-revving the engine.

The tachometer pointer may move slightly when the ignition switch is in ACC or ON position with the engine OFF. This movement is normal and will not affect the accuracy of the tachometer once the engine is running.



#### **CAUTION - Red zone**

***Do not operate the engine within the tachometer's RED ZONE. This may cause severe engine damage.***



OUB041048N

**Engine coolant temperature gauge  
(for Type B cluster)**

This gauge shows the temperature of the engine coolant when the ignition switch is ON.

Do not continue driving with an overheated engine. If your vehicle overheats, refer to “If the engine overheats” in section 6.

If the gauge pointer moves beyond the normal range area toward the “H” position, it indicates overheating that may damage the engine.

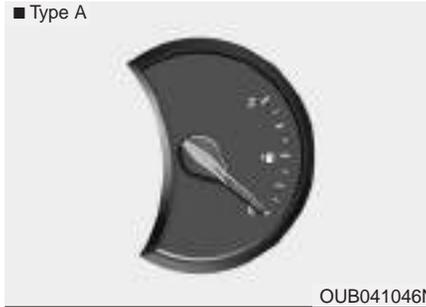

OUB041046N

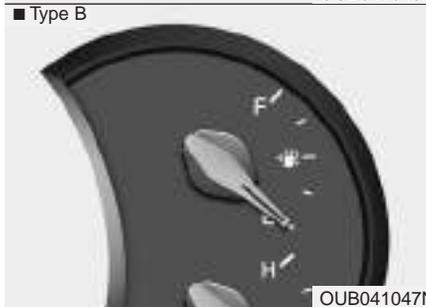

OUB041047N

**Fuel gauge**

The fuel gauge indicates the approximate amount of fuel remaining in the fuel tank. The fuel tank capacity is given in section 8. The fuel gauge is supplemented by a low fuel warning light, which will illuminate when the fuel tank is nearly empty.

On inclines or curves, the fuel gauge pointer may fluctuate or the low fuel warning light may come on earlier than usual due to the movement of fuel in the tank.

### **⚠ WARNING - Fuel gauge**

Stop and obtain additional fuel as soon as possible after the warning light comes on or when the gauge indicator comes close to the E level. Running out of fuel can expose vehicle occupants to danger.

### **⚠ CAUTION - Low fuel**

*Avoid driving with extremely low fuel level. Running out of fuel could cause the engine to misfire, damaging the catalytic converter.*

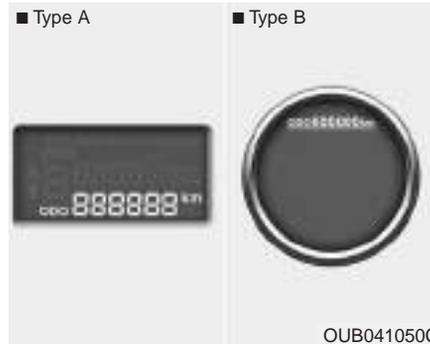

### **Odometer**

#### **Odometer**

The odometer indicates the total distance the vehicle has been driven.

You will also find the odometer useful to determine when periodic maintenance should be performed.

### **\* NOTICE**

It is forbidden to alter the odometer of all vehicles with the intent to change the mileage registered on the odometer. The alteration may void your warranty coverage.



**Trip computer (Tripmeter)  
(if equipped)**

The trip computer is a microcomputer-controlled driver information system that displays information related to driving, when the ignition switch is in the ON position. All stored driving information (except distance to empty and instant fuel consumption) will reset if the battery is disconnected.

■ Cluster Type A

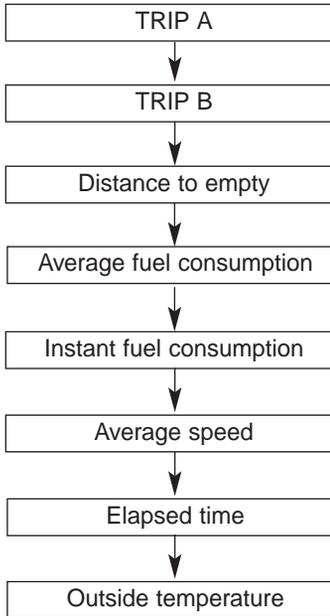

■ Cluster Type B

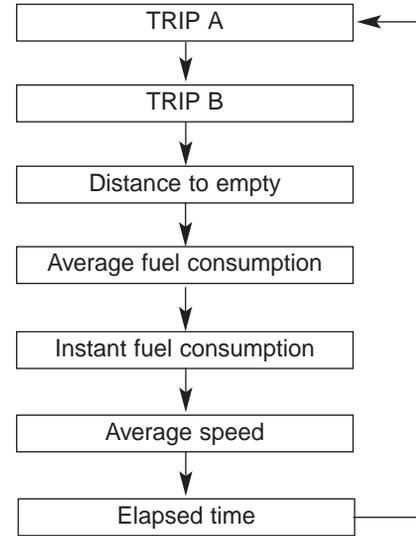



## Features of your vehicle

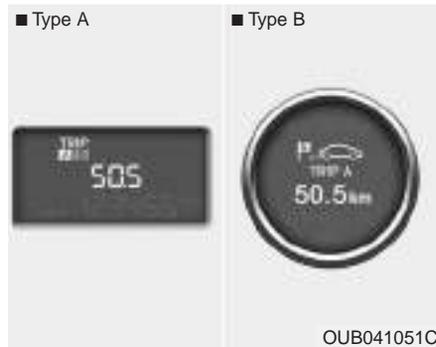

### Tripmeter

TRIP A: Tripmeter A

TRIP B: Tripmeter B

This mode indicates the distance of individual trips selected since the last tripmeter reset.

The meter's working range is from 0.0 to 999.9 km (0.0 to 999.9 miles).

Pressing the TRIP button for more than 1 second, when the tripmeter (TRIP A or TRIP B) is being displayed, clears the tripmeter to zero (0.0).



### Distance to empty

This mode indicates the estimated distance to empty based on the current fuel in the fuel tank and the amount of fuel delivered to the engine. When the remaining distance is below 50 km (30 miles), "----" will be displayed and the distance to empty indicator will blink.

The meter's working range is from 50 to 999 km (30 to 990 miles).

- If the vehicle is not on level ground or the battery power has been interrupted, the "Distance to empty" function may not operate correctly.

The trip computer may not register additional fuel if less than 6 liters (1.6 gallons) of fuel are added to the vehicle.

- The fuel consumption and distance to empty values may vary significantly based on driving conditions, driving habits, and condition of the vehicle.
- The distance to empty value is an estimate of the available driving distance. This value may differ from the actual driving distance available.

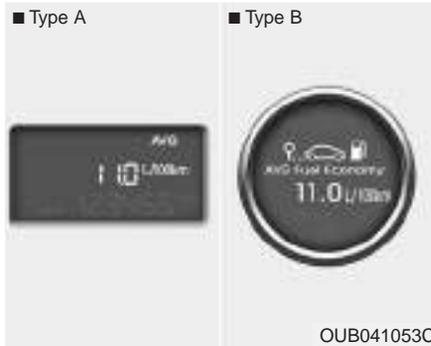

### Average fuel consumption

This mode calculates the average fuel consumption from the total fuel used and the distance since the last average consumption reset. The total fuel used is calculated from the fuel consumption input. For an accurate calculation, drive more than 50 m (0.03 mile).

Pressing the TRIP button for more than 1 second, when the average fuel consumption is displayed, clears the average fuel consumption to zero (---).

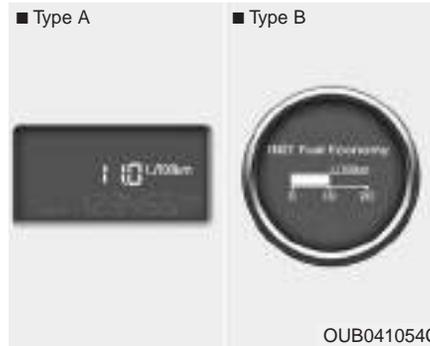

### Instant fuel consumption

This mode calculates the instant fuel consumption during the last few seconds.

### \* NOTICE

**You must drive more than 10 km/h (6 MPH) (type A) or 5 km/h (3 MPH) (type B) for this mode to calculate the instant fuel consumption.**

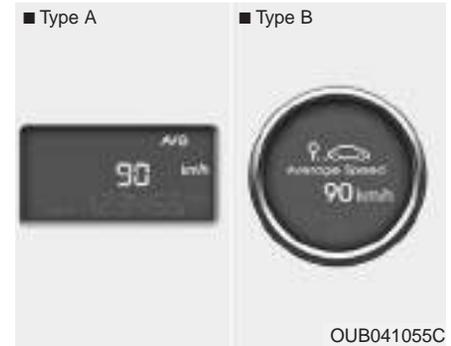

### Average speed

This mode calculates the average speed of the vehicle since the last average speed reset.

Even if the vehicle is not in motion, the average speed keeps going while the engine is running.

Pressing the TRIP button for more than 1 second, when the average speed is displayed, clears the average speed to zero (---).



### Driving time

This mode indicates the total time traveled since the last driving time reset.

Even if the vehicle is not in motion, the driving time keeps going while the engine is running.

The meter's working range is from 0:00~99:59.

Pressing the TRIP button for more than 1 second, when the driving time is being displayed, clears the driving time to zero (0:00).

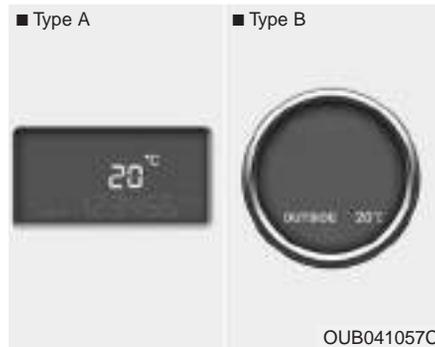

### Outside temperature (if equipped)

This mode indicates the outside temperature around the vehicle.

The meter's working range is from -40°C to 60°C (-40°F to 140°F).

#### Type A

To change the outside temperature display unit (°C ↔ °F), press the RESET button more than 1 second in this mode.

#### Type B

To Change the outside temperature display unit (°C ↔ °F), see the following pages in the following pages in Vehicle option section.



### Manual transaxle shift indicator (if equipped)

This indicator informs you which gear is desired while driving to save fuel.

For example

▲3: Indicates that shifting up to the 3rd gear is desired (currently the shift lever is in the 2nd or 1st gear).

▼3: Indicates that shifting down to the 3rd gear is desired (currently the shift lever is in the 4th or 5th gear).

When the system is not working properly, the indicator is not displayed.

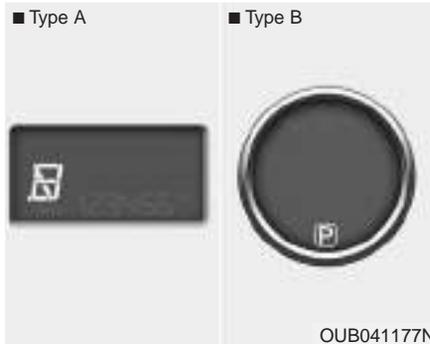

**Automatic transaxle shift position indicator (if equipped)**

The indicator displays which automatic transaxle shift lever is selected.

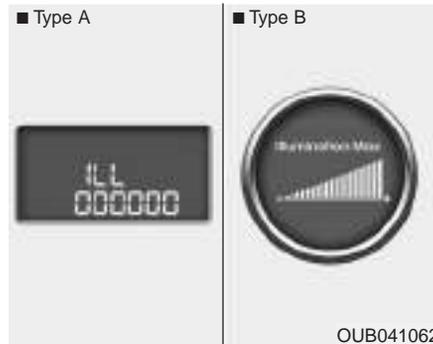

**Illumination intensity**

The illumination intensity of the instrument panel is shown when adjusting it with the illumination control switch.

For more details, refer to “Instrument panel illumination” in section 4.



**User Settings (only for Type B cluster, if equipped)**

1. Stop the vehicle with the ignition switch in the ON position or engine running.
2. Press the TRIP button until the User setting is displayed.
3. With the User setting displayed, press the TRIP button for 2 seconds.
4. You can change the item by pressing the TRIP button and select an item by pressing the RESET button.



### **Car option (only for Type B cluster, if equipped)**

1. When the vehicle is at a standstill, pressing the TRIP button for more than 2 seconds with the ENGINE START/STOP button in the ON position or engine running, the LCD display on the cluster will change to the "User Setting" mode.  
You can move to items by pressing the TRIP button and select the item by pressing the RESET button.
2. In the "User Setting" mode, select "Vehicle Option".
3. Move (TRIP button) to the desired item and select (RESET button).



### **Align steering wheel (Steering position) (if equipped)**

- On - The warning illuminates on the LCD display when the steering wheel is not aligned with the ENGINE START/STOP button in the ON position.
- Off - The warning does not illuminate on the LCD display when the steering wheel is not aligned with the ENGINE START/STOP button in the ON position.



### **Outside temperature unit (if equipped)**

You can exchange the outside temperature unit °C ↔ °F.



OUB041067

### Language

Choose a language you prefer within the LCD display.



OUB041068

### Maintenance system (only for Type B cluster, if equipped)

The Maintenance system informs the driver when to replace engine oil and rotate tires.



OUB041069

### Maintenance

1. When the vehicle is at a standstill, pressing the TRIP button for more than 2 seconds with the ENGINE START/STOP button in the ON position or engine running, the LCD display on the cluster will change to the "User Setting" mode.

You can move to the items by pressing the TRIP button and select the item by pressing the RESET button.

2. In the "User Setting" mode select "Maintenance".



### **Maintenance schedule**

1. Select the desired engine oil (tire rotation) maintenance schedule.
2. If finished, you can come out of the Maintenance mode by pressing the TRIP button for more than 2 seconds.



### **Engine Oil(Tire Rotation) Service Required**

1. If service is required, the message will be displayed.



2. If you would like to reset or inactivate the maintenance system press the RESET button for more than 1 second. The display will change to "Engine Oil Service Message" mode. You can move to items by pressing the TRIP button and select the desired item by pressing the RESET button.

## Warnings and indicators

All warning lights are checked by turning the ignition switch ON (do not start the engine). Any light that does not illuminate should be checked by an authorized Kia dealer.

After starting the engine, check to make sure that all warning lights are off. If any warning lights are still on, this indicates a situation that needs attention. When releasing the parking brake, the brake system warning light should go off. The fuel warning light will stay on if the fuel level is low.

### *Air bag warning light*



This warning light will illuminate for approximately 6 seconds each time you turn the ignition switch to the ON position.

This light also comes on when the Supplement Restraint System (SRS) is not working properly. If the air bag warning light does not come on, or continuously remains on after operating for about 6 seconds when you turned the ignition switch to the ON position or started the engine, or if it comes on while driving, have the SRS inspected by an authorized Kia dealer.

### *Anti-lock brake system (ABS) warning light (if equipped)*



This warning light illuminates if the ignition switch is turned ON and goes off in approximately 3 seconds if the system is operating normally.

If the ABS warning light remains on, comes on while driving, or does not come on when the ignition switch is turned to the ON position, this indicates that the ABS may have malfunctioned.

If this occurs, have your vehicle checked by an authorized Kia dealer as soon as possible. The normal braking system will still be operational, but without the assistance of the anti-lock brake system.



### Electronic brake force distribution (EBD) system warning light



If these two warning lights illuminate at the same time while driving, your vehicle's ABS and EBD system may have malfunctioned.

In this case, your ABS and regular brake system may not work normally. Have the vehicle checked by an authorized Kia dealer as soon as possible.

### **⚠ WARNING** - ABS/brake lights

If both ABS and Brake warning lights are on and stay on, your vehicle's brake system will not work normally during sudden braking. In this case, avoid high speed driving and abrupt braking. Have your vehicle checked by an authorized Kia dealer as soon as possible.

If the ABS warning light or EBD warning light is on and stays on, the speedometer or odometer/tripmeter may not work. In this case, have your vehicle checked by an authorized Kia dealer as soon as possible.

### *Seat belt warning*



As a reminder to the driver, the seat belt warning light will blink for approximately 6 seconds each time you turn the ignition switch ON, regardless of belt fastening.

If the driver's seat belt is not fastened when the ignition switch is turned on, the seat belt warning light and the seat belt warning chime will operate for approximately 6 seconds. But if the belts are refastened within the 6 seconds, the warning chime will turn off and the warning light will blink for the remainder of the 6 second period.

If the driver's seat belt is disconnected after the ignition switch is turned to the ON position, the seat belt warning light will blink for approximately 6 seconds. But if it is fastened within the 6 seconds the warning light will turn off immediately. If the driver's seat belt is not fastened when the vehicle speed exceeds 10 km/h (6 mph), the seat belt warning light and chime will operate approximately 11 times with a pattern of 6 seconds on and 24 seconds off until the belt is fastened or the vehicle speed decreases below 5 km/h (3 mph).

**Turn signal indicator**



The blinking green arrows on the instrument panel show the direction indicated by the turn signals. If the arrow comes on but does not blink, blinks more rapidly than normal, or does not illuminate at all, it indicates a malfunction in the turn signal system. You should consult your dealer for repairs.

This indicator also blinks when the hazard warning switch is turned on.

**High beam indicator**



This indicator illuminates when the headlights are on and in the high beam position or when the turn signal lever is pulled into the Flash-to-Pass position.

**Front fog light indicator (if equipped)**



The indicator illuminates when the front fog lights ON.

**Tail light indicator**



This indicator illuminates when the tail lights are on.

**Engine oil pressure warning light**



This warning light indicates the engine oil pressure is low. If the warning light illuminates while driving:

1. Drive safely to the side of the road and stop.
2. With the engine off, check the engine oil level. If the level is low, add oil as required.

If the warning light remains on after adding oil or if oil is not available, call an authorized Kia dealer.

**⚠ CAUTION - Engine damage**  
*If the engine is not stopped immediately after the engine oil pressure warning light is illuminated and stays on while the engine is running, serious engine damage may result.*

The oil pressure warning light comes on whenever there is insufficient oil pressure. In normal operation, it should come on when the ignition switch is turned on, then go out when the engine is started. If the oil pressure warning light stays on while the engine is running, there is a serious malfunction.

### ***Parking brake & brake fluid warning light***



#### **Parking brake warning**

This warning light illuminates for 3 seconds after the ignition switch is turned to the ON position and then it will go out.

Also, this light illuminates when the parking brake is applied with the ignition switch in the START or ON position. The warning light should go out when the parking brake is released.

#### **Low brake fluid level warning**

If the warning light remains on, it may indicate that the brake fluid level in the reservoir is low.

If the warning light remains on:

1. Drive carefully to the nearest safe location and stop your vehicle.
2. With the engine stopped, check the brake fluid level immediately and add fluid as required. Then check all brake components for fluid leaks.
3. Do not drive the vehicle if leaks are found, the warning light remains on or the brakes do not operate properly. Have the vehicle towed to any authorized Kia dealer for a brake system inspection and necessary repairs.

Your vehicle is equipped with dual-diagonal braking systems. This means you still have braking on two wheels even if one of the dual systems should fail. With only one of the dual systems working, more than normal pedal travel and greater pedal pressure are required to stop the vehicle. Also, the vehicle will not stop in as short a distance with only a portion of the brake system working. If the brakes fail while you are driving, shift to a lower gear for additional engine braking and stop the vehicle as soon as it is safe to do so.

To check bulb operation, check whether the parking brake and brake fluid warning light illuminates when the ignition switch is in the ON position.

**Engine coolant temperature warning light (for Type A cluster)**



The warning light shows the temperature of the engine coolant when the ignition switch is ON.

The warning light illuminates if the temperature of the engine coolant is above  $120\pm 3^{\circ}\text{C}$  ( $248\pm 5.5^{\circ}\text{F}$ ).

Do not continue driving with an overheated engine. If your vehicle overheats, refer to “Overheating” in the Index.

**\* NOTICE - Coolant temperature**  
If the engine coolant temperature warning light illuminates, it indicates overheating that may damage the engine.

**Charging system warning light**

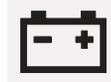

This warning light indicates a malfunction of either the generator or electrical charging system.

If the warning light illuminates while the vehicle is in motion:

1. Drive to the nearest safe location.
2. With the engine off, check the generator drive belt for looseness or breakage.
3. If the belt is adjusted properly, a problem exists somewhere in the electrical charging system. Have an authorized Kia dealer correct the problem as soon as possible.

**Trunk lid (or tailgate) open warning light**



This warning light illuminates when the trunk lid (or tailgate) is not closed securely with the ignition switch in any position.

**Door ajar warning light**



This warning light illuminates when a door is not closed securely with the ignition switch in any position.

### *Immobilizer indicator*



If any of the following occurs in a vehicle equipped with the smart key, the immobilizer indicator illuminates, blinks or goes off.

- When the smart key is in the vehicle, if the ENGINE START/STOP button is in the ACC or ON position, the indicator will illuminate for a few minutes to indicate that you are able to start the engine. However, when the smart key is not in the vehicle, if the ENGINE START/STOP button is pressed, the indicator will blink for a few minutes to indicate that you are not able to start the engine.
- When the ENGINE START/STOP button changes to the ON position from the ACC position without the smart key in the vehicle, the indicator blinks for a few minutes to indicate that you are not able to start the engine.

- When the battery is weak, if the ENGINE START/STOP button is pressed, the indicator will blink and you are not able to start the engine. However, you are able to start the engine by inserting the smart key in the smart key holder. If the smart key system related parts have a problem, the indicator will blink.

### *Low fuel level warning light*



This warning light indicates the fuel tank is nearly empty. When it comes on, you should add fuel as soon as possible. Driving with the fuel level warning light on or with the fuel level below “E” can cause the engine to misfire and damage the catalytic converter (if equipped).

**Malfunction indicator lamp (MIL) (check engine light)**



This indicator is part of the Engine Control System which monitors various emission control system components. If this indicator illuminates while driving, it indicates that a potential malfunction has been detected somewhere in the emission control system.

This indicator will also illuminate when the ignition switch is turned to the ON position, and will go off in a few seconds after the engine is started. If it illuminates while driving, or does not illuminate when the ignition switch is turned to the ON position, take your vehicle to the nearest authorized Kia dealer and have the system checked.

Generally, your vehicle will continue to be drivable, but have the system checked by an authorized Kia dealer promptly.



**CAUTION - MIL illumination**

- ***Prolonged driving with the Emission Control System Malfunction Indicator Light illuminated may cause damage to the emission control systems which could effect drivability and/or fuel economy.***
- ***If the Emission Control System Malfunction Indicator Light illuminates, potential catalytic converter damage. This could result in loss of engine power. Have the Engine Control System inspected as soon as possible by an authorized Kia dealer.***

**ESC indicator (Electronic Stability Control)**



The ESC indicator will illuminate when the ignition switch is turned ON, but should go off after approximately 3 seconds. When the ESC is on, it monitors the driving conditions under normal driving conditions, the ESC light will remain off. When a slippery or low traction condition is encountered, the ESC will operate, and the ESC indicator will blink to indicate the ESC is operating.

If the ESC indicator stays on, the ESC may have a malfunction. Take your car to an authorized Kia dealer and have the system checked.

### *ESC OFF indicator*



The ESC OFF indicator will illuminate when the ignition switch is turned ON, but should go off after approximately 3 seconds. To switch to ESC OFF mode, press the ESC OFF button. The ESC OFF indicator will illuminate indicating the ESC is deactivated.

### *Low tire pressure telltale (if equipped)*



The low tire pressure telltale comes on for 3 seconds after the ignition key is turned to the "ON" position.

If the warning light does not come on, or continuously remains on after coming on for about 3 seconds when you turned the ignition key to the "ON" position, the Tire Pressure Monitoring System is not working properly. If this occurs, have your vehicle checked by an Kia authorized dealer as soon as possible.

This warning light will also illuminate if one or more of your tires is significantly under-inflated. You should stop and check your tires as soon as possible. If the warning light illuminates while driving, reduce vehicle speed immediately and stop the vehicle.

Avoid hard braking and overcorrecting at the steering wheel. Inflate the tires to the proper pressure as indicated on the vehicle's tire information placard.

### **⚠ WARNING - Low tire pressure**

**Significantly low tire pressure makes the vehicle unstable and can contribute to loss of vehicle control and increased braking distances.**

**Continued driving on tires with low pressure will cause the tires to overheat and fail.**

**Cruise indicator (if equipped)**

**CRUISE** indicator

**CRUISE**

The indicator illuminates when the cruise control system is enabled.

The cruise indicator in the instrument cluster is illuminated when the cruise control ON/OFF button on the steering wheel is pushed.

The indicator goes off when the cruise control ON/OFF button is pushed again. For more Information, refer to “Cruise control system” in section 5.

**Cruise SET indicator**

**SET**

The indicator illuminates when the cruise function switch (SET- or RES+) is ON. The cruise SET indicator in the instrument cluster illuminates when the cruise control switch (SET- or RES+) is pushed. The cruise SET indicator does not illuminate when the cruise control switch (CANCEL) is pushed or the system is disengaged.

**Key reminder warning chime (if equipped)**

If the driver’s door is opened while the ignition key is left in the ignition switch (ACC or LOCK position), the key reminder warning chime will sound. This is to prevent you from locking your keys in the vehicle. The chime sounds until the key is removed from the ignition switch or the driver’s door is closed.

**Electric power steering (EPS) system warning light (if equipped)**



This warning light illuminates after the ignition key is turned to the ON position and then it will go off when the engine starts.

This light also comes on when the EPS has malfunctioned. If it comes on while driving, have your vehicle inspected by an authorized Kia dealer.

**Fuel cap open warning indicator**



This warning light indicates the fuel filler cap is not tightened securely. Always make sure that the fuel filler cap is tight.



### **ECOMINDER® indicator** (if equipped)

The image shows a black rectangular button with the word "ECO" in white capital letters.

The ECOMINDER® indicator is displayed to help you improve fuel efficiency when you are driving.

- The ECOMINDER® indicator will turn the ECO light green on the instrument panel when you are driving efficiently in the ECO ON mode.

If you don't want the indicator displayed, you can turn the ECO ON mode to OFF mode by pressing the TRIP button.

- When the instant fuel consumption mode(if equipped) is displayed on the LCD display or the system is not working properly, the indicator turns off. If the indicator turns off when the instant fuel consumption mode or ECO OFF mode is not selected, have the system checked by an authorized Kia dealer as soon as possible.
- Fuel efficiency depends on the driver's driving habit and road condition.
- The system stops operating when the transaxle is in the P (Park), R (Reverse), N (Neutral) position or sports mode, or when the instant fuel consumption mode is selected.

A yellow warning triangle with a black exclamation mark inside.

### **WARNING - ECOMINDER® indicator**

**Don't keep watching the "ECO" ECOMINDER® indicator while driving. It may distract you while driving and cause an accident.**

### **Auto stop indicator** (if equipped)



This indicator will illuminate when the engine enters the Idle Stop mode of the ISG (Idle Stop and Go) system.

When the automatic starting occurs, the auto stop indicator on the cluster will blink for 5 seconds.

For more details, refer to the ISG (Idle Stop and Go) system in chapter 5.

### **\* NOTICE**

**When the engine automatically starts by the ISG system, some warning lights (ABS, ESC, ESC OFF, ESC or Parking brake warning light) may turn on for a few seconds.**

**This happens because of the low battery voltage. It does not mean the system is malfunctioning.**

**LCD display warning (if equipped)**

- For vehicle's equipped with smart key system

**Key is not in vehicle**



OUB041073

If the smart key is not in the vehicle and if any door is opened or closed with the engine start/stop button in the ACC, ON, or START position, the warning illuminates on the LCD display. Also, the chime sounds for 5 seconds when the smart key is not in the vehicle and the door is closed.

Always have the smart key with you.

**Key is not detected**



OUB041074

If the smart key is not in the vehicle or is not detected and you press the engine start/stop button, the warning illuminates on the LCD display for 10 seconds. Also, the immobilizer indicator blinks for 10 seconds.

**Press start with smart key**



OUB041075

If you press the engine start/stop button while the warning "Key is not detected" is illuminated, the warning "Press the start button with smart key" illuminates for 10 seconds on the LCD display. Also, the immobilizer indicator blinks for 10 seconds.

- For vehicle's equipped with smart key system

### Low key battery



OUB041076

If the engine start/stop button changes to the OFF position when the smart key in the vehicle discharges, the warning illuminates on the LCD display for about 10 seconds. Also, the warning chime sounds once.

Replace the battery with a new one.

### Press brake pedal to start engine (for automatic transaxle)



OUB041077

If the engine start/stop button changes to the ACC position twice by pressing the button repeatedly without depressing the brake pedal, the warning illuminates on the LCD display for about 10 seconds to indicate that you should depress the brake pedal to start the engine.

### Press clutch pedal to start engine (for manual transaxle)



OUB041078

If the engine start/stop button turns to the ACC position twice by pressing the button repeatedly without depressing the clutch pedal, the warning illuminates on the LCD display for about 10 seconds to indicate that you should depress the clutch pedal to start the engine.

• For vehicle's equipped with smart key system

**Shift to "P" position  
(for automatic transaxle)**



OUB041079

If you try to turn off the engine without the shift lever in the P (Park) position, the engine start/stop button will turn to the ACC position. If the button is pressed once more it will turn to the ON position. The warning illuminates on the LCD display for about 10 seconds to indicate that you should press the engine start/stop button with the shift lever in the P (Park) position to turn off the engine.

Also, the warning chime sounds for about 10 seconds. (if equipped)

**Press start button again**



OUB041080

If you can not operate the engine start/stop button when there is a problem with the engine start/stop button system, the warning illuminates for 10 seconds and the chime sounds continuously to indicate that you could start the engine by pressing the engine start/stop button once more.

The chime will stop if the engine start/stop button system works normally or the theft alarm system is armed.

If the warning illuminates each time you press the engine start/stop button, take your vehicle to an authorized Kia dealer and have the system checked.

**Shift to "P" or "N" to start the engine  
(for automatic transaxle)**



OUB041081

If you try to start the engine with the shift lever not in the P(Park) or N(Neutral) position, the warning illuminates for about 10 seconds on the LCD display.

You can also start the engine with the shift lever in the N(Neutral) position, but for your safety start the engine with the shift lever in the P(Park) position.

### Press start button while turn steering



OUB041082

If the steering wheel does not unlock normally when the engine start/stop button is pressed, the warning illuminates for 10 seconds on the LCD display. Also, the warning chime sounds once and the engine start/stop button light blinks for 10 seconds.

When you are warned, press the engine start/stop button while turning the steering wheel right and left.

### Check steering wheel lock system



OUB041084

If the steering wheel does not lock normally when the engine start/stop button changes to the OFF position, the warning illuminates for 10 seconds on the LCD display. Also, the warning chime sounds for 3 seconds and the engine start/stop button light blinks for 10 seconds.

**Check stop lamp fuse (if equipped)**



OUB041085

When the stop lamp fuse is disconnected, the warning illuminates for 10 seconds on the LCD display.

Replace the fuse with a new one. If that is not possible you can start the engine by pressing the engine start/stop button for 10 seconds in ACC.

**Door open! (if equipped)**



OUB041087

It displays the corresponding door or tailgate that is not closed securely.

**Fuel cap open warning (if equipped)**



OUB041170

This warning light indicates the fuel filler cap is not tight securely.

Always make sure that the fuel filler cap is tight.

### Align steering wheel (if equipped)



OUB041088

If you start the engine when the steering wheel is turned 90 degrees to the left after a couple of seconds, "Align steering wheel" illuminates on the LCD display for 5 seconds.

Turn the steering wheel to the right and make it turned to the left less than 30 degrees.

### Align steering wheel (if equipped)



OUB041089

If you start the engine when the steering wheel is turned 90 degrees to the right after a couple of seconds, "Align steering wheel" illuminates on the LCD display for 5 seconds.

Turn the steering wheel to the left and make it turned to the right less than 30 degrees.

## REARVIEW CAMERA (IF EQUIPPED)

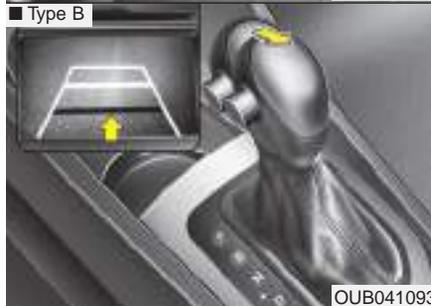

Always keep the camera lens clean. If lens is covered with foreign matter, the camera may not operate normally.

### **⚠ WARNING - Rearview camera**

The rear view camera is not a safety device. It only serves to assist the driver in identifying objects directly behind the middle of the vehicle. The camera does NOT cover the complete area behind the vehicle. While the camera's display is generally accurate, objects can be much closer than they appear in the display screen and can be distorted in both size and proportion.

### **⚠ WARNING - Backing & using camera**

Never rely solely on the rear view camera when backing. You must always use methods of viewing the area behind you including looking over both shoulders as well as continuously checking all three rear view mirrors. Due to the difficulty of ensuring that the area behind you remains clear, always back slowly and stop immediately if you even suspect that a person, and especially a child, might be behind you.

The rearview camera will activate when the back-up light is ON with the ignition switch ON and the shift lever in the R (Reverse) position.

This system is a supplemental system that shows behind the vehicle through the uvo audio or navigation display back-up.



### HAZARD WARNING FLASHER



OUB041094

The hazard warning flasher should be used whenever you find it necessary to stop the car in a hazardous location. When you must make such an emergency stop, always pull off the road as far as possible.

The hazard warning lights are turned on by pushing in the hazard switch. Both turn signal lights will blink. The hazard warning lights will operate even though the key is not in the ignition switch.

To turn the hazard warning lights off, push the switch again.

### LIGHTING

#### Battery saver function

- The purpose of this feature is to prevent the battery from being discharged. The system automatically turns off the parking lights when the driver removes the ignition key and opens the driver-side door.
- With this feature, the parking lights will turn off automatically if the driver parks on the side of the road at night. If necessary, to keep the lights on when the ignition key is removed, perform the following :

- 1) Open the driver-side door.
- 2) Turn the parking lights OFF and ON again using the light switch on the steering column.

#### Daytime running light

Daytime Running Lights (DRL) can make it easier for others to see the front of your vehicle during the day. DRL can be helpful in many different driving conditions, and it is especially helpful after dawn and before sunset.

The DRL system turns OFF when:

1. The headlight are ON.
2. Engine stops.



OXM049110

#### Lighting control

The light switch has a Headlight and a Parking light position.

To operate the lights, turn the knob at the end of the control lever to one of the following positions:

- (1) OFF position
- (2) Parking light position
- (3) Headlight position
- (4) Auto light position (if equipped)



OAM049041

**Parking light position (P)**

When the light switch is in the parking light position (1st position), the tail, position, license and instrument panel lights will turn ON.



OAM049042

**Headlight position (H)**

When the light switch is in the headlight position (2nd position) the head, tail, position, license and instrument panel lights will turn ON.

The ignition switch must be in the ON position to turn on the headlights.



OFS040084

**Auto light position (if equipped)**

When the light switch is in the AUTO light position, the taillights and headlights will turn ON or OFF automatically depending on the amount of light outside the vehicle.

Never place anything over sensor (1) located on the instrument panel. This will ensure better auto-light system control.

Don't clean the sensor using a window cleaner. The cleaner may leave a light film which could interfere with sensor operation.

If your vehicle has window tint or other types of metallic coating on the front windshield, the Auto light system may not work properly.



### High beam operation

To turn on the high beam headlights, push the lever away from you. Pull it back for low beams.

The high-beam indicator will light when the headlight high beams are switched on.

To prevent the battery from being discharged, do not leave the lights on for a prolonged time while the engine is not running.

#### **⚠ WARNING - High beams**

**Do not use high beam when there are other vehicles. Using high beam could obstruct the other driver's vision.**



To flash the headlights, pull the lever towards you. It will return to the normal (low-beam) position when released. The headlight switch does not need to be on to use this flashing feature.

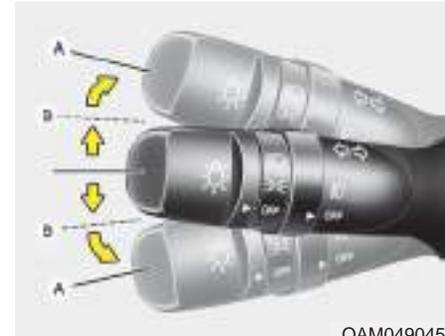

### Turn signals and lane change signals

The ignition switch must be on for the turn signals to function. To turn on the turn signals, move the lever up or down (A). The green arrow indicators on the instrument panel indicate which turn signal is operating. They will self-cancel after a turn is completed. If the indicator continues to flash after a turn, manually return the lever to the OFF position.

To signal a lane change, move the turn signal lever slightly and hold it in position (B). The lever will return to the OFF position when released.

If an indicator stays on and does not flash or if it flashes abnormally, one of the turn signal bulbs may be burned out and will require replacement.

If an indicator flash is abnormally quick or slow, a bulb may be burned out or have a poor electrical connection in the circuit.



**Front fog light (if equipped)**

Fog lights are used to provide improved visibility when visibility is poor due to fog, rain or snow etc. The fog lights will turn on when the fog light switch (1) is turned to the on position after the headlights are turned on.

To turn off the fog lights, turn the switch (1) to the off position.

When in operation, the fog lights consume large amounts of vehicle electrical power. Only use the fog lights when visibility is poor.

## WIPERS AND WASHERS

Front

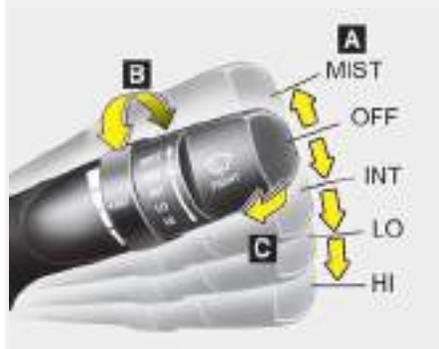

Rear (if equipped)



### A : Wiper speed control (front)

- HI – High wiper speed
- LO – Low wiper speed
- INT – Intermittent wipe
- AUTO\* – Automatic control wipe
- OFF – Off
- MIST – Single wipe

### B : Intermittent control wipe time adjustment

### C : Wash with brief wipes (front)

### D : Rear wiper/washer control

- ON – Continuous wipe
- INT – Intermittent wipe
- OFF – Off

### E : Wash with brief wipes (rear)

\* : if equipped

## Windshield wipers

Operates as follows when the ignition switch is turned ON.

**MIST** : For a single wiping cycle, move the lever upward and release it. The wipers will operate continuously if the lever is held in this position.

**OFF** : Wiper is not in operation

**INT** : Wiper operates intermittently at the same wiping intervals. Use this mode in a light rain or mist. To vary the speed setting, turn the speed control knob.

**LO** : Normal wiper speed

**HI** : Fast wiper speed

If there is heavy accumulation of snow or ice on the windshield, defrost the windshield for about 10 minutes, or until the snow and/or ice is removed before using the windshield wipers to ensure proper operation.

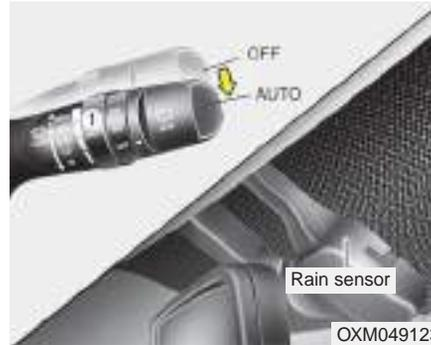

### ***AUTO (Automatic) control (if equipped)***

The rain sensor located on the upper end of the windshield glass senses the amount of rainfall and controls the wiping cycle for the proper interval. The more it rains, the faster the wiper operates. When the rain stops, the wiper stops.

To vary the speed setting, turn the speed control knob (1).

If the wiper switch is set in AUTO mode when the ignition switch is ON, the wiper will operate once to perform a self-check of the system. Set the wiper to off position when the wiper is not in use.

Always remove all snow and ice and defrost the windshield properly prior to operating the windshield wipers.

### **\* NOTICE - Sensor cover**

**Do not remove the sensor cover located on the upper end of the passenger side windshield glass as this may damage the sensor system.**

### **\* NOTICE - Winter driving**

**Always set the auto wiper switch to the off position in the winter to avoid auto activation during icy conditions which may damage the windshield wipers.**

 **CAUTION - Wiper position**  
*When washing the vehicle, set the wiper switch in the off position to stop the auto wiper operation.*  
*The wiper may operate and be damaged if the switch is set in the AUTO mode while washing the vehicle.*

### Windshield washers

In the OFF position, pull the lever gently toward you to spray washer fluid on the windshield and to run the wipers 1-3 cycles.

Use this function when the windshield is dirty.

The spray and wiper operation will continue until you release the lever. If the washer does not work, check the washer fluid level.

If the fluid level is not sufficient, you will need to add appropriate non-abrasive windshield washer fluid to the washer reservoir.

The reservoir filler neck is located in the front of the engine compartment on the passenger side.

 **CAUTION - Washer pump**  
*To prevent possible damage to the washer pump, do not operate the washer when the fluid reservoir is empty.*

 **WARNING - Obscured visibility**  
**Do not use the washer in freezing temperatures without first warming the windshield with the defrosters; the washer solution could freeze on the windshield and obscure your vision.**

**⚠ CAUTION - Wipers & windshields**

- *To prevent possible damage to the wipers or windshield, do not operate the wipers when the windshield is dry.*
- *To prevent damage to the wiper blades, do not use gasoline, kerosene, paint thinner, or other solvents on or near them.*
- *To prevent damage to the wiper arms and other components, do not attempt to move the wipers manually.*



**Rear window wiper and washer switch**

The rear window wiper and washer switch is located at the end of the wiper and washer switch lever. Turn the switch to the desired position to operate the rear wiper and washer.

- ON - Normal wiper operation
- INT - Intermittent wiper operation (if equipped)
- OFF - Wiper is not in operation



Push the lever away from you to spray rear washer fluid and to run the rear wipers 1~3 cycles. The spray and wiper operation will continue until you release the lever.



### INTERIOR LIGHT

Do not use the interior lights for extended periods when the engine is not running. It may cause battery discharge.

**⚠ WARNING - Interior light**  
Do not use the interior lights when driving in the dark. The glare from the interior lights may obstruct your view and cause an accident.



#### Map lamp (if equipped)

1. Push the lens to turn the light on or off.
2. DOOR : The light comes on or goes off when a door is opened or closed.
3. OFF (Door switch is not pressed) : The light stays off at all times even when a door is opened.  
When the light is turned on with the lens pressed, the light is not turned off even with the switch in the OFF position.



#### Room lamp

1. ON : The light stays on at all times.
  2. DOOR : The light comes on or off when a door is opened or closed.
  3. OFF : The light stays off at all times even when a door is opened.
- Do not leave the switch in the ON position for an extended period of time when the vehicle is not running.



OUB041099

### Luggage room lamp

The luggage room lamp comes on when the tailgate is opened.

To prevent unnecessary charging system drain, close the tailgate securely after using the luggage room.



OLM049105

### Vanity mirror lamp (if equipped)

Push the switch to turn the light on or off.

-  : The lamp will turn on if this button is pressed.
-  : The lamp will turn off if this button is pressed.

Always have the switch in the off position when the vanity mirror lamp is not in use. If the sunvisor is closed without the lamp off, it may discharge the battery or damage the sunvisor.



OUB041100

### Glove box lamp

The glove box lamp comes on when the glove box is opened.

To prevent unnecessary charging system drain, close the glove box securely after using the glove box.

## DEFROSTER

### **CAUTION - Conductors**

*To prevent damage to the conductors bonded to the inside surface of the rear window, never use sharp instruments or window cleaners containing abrasives to clean the window.*

If you want to defrost and defog the front windshield, refer to “Windshield Defrosting and Defogging” in this section.



### **Rear window defroster**

The defroster heats the window to remove frost, fog and thin ice from the interior and exterior of the rear window, while the engine is running.

To activate the rear window defroster, press the rear window defroster button located in the center facia switch panel. The indicator on the rear window defroster button illuminates when the defroster is ON.

If there is heavy accumulation of snow on the rear window, brush it off before operating the rear defroster.

The rear window defroster automatically turns off after approximately 20 minutes or when the ignition switch is turned off. To turn off the defroster manually, press the rear window defroster button again.

### ***Outside mirror defroster (if equipped)***

If your vehicle is equipped with the outside rearview mirror defrosters, they will operate at the same time you turn on the rear window defroster.

## MANUAL CLIMATE CONTROL SYSTEM



1. Fan speed control knob
2. Mode selection knob
3. Temperature control knob
4. Air conditioning button (if equipped)
5. Rear window defroster button
6. Air intake control button

OUB041103

### Heating and air conditioning

1. Start the engine.
2. Set the mode to the desired position.  
To improve the effectiveness of heating and cooling :
  - Heating: 
  - Cooling: 
3. Set the temperature control to the desired position.
4. Set the air intake control to the outside (fresh) air or recirculated air position.
5. Set the fan speed control to the desired speed.
6. If air conditioning is desired, turn the air conditioning system (if equipped) on.



OUB041104N



OUB041105

**Mode selection**

The mode selection knob controls the direction of the air flow through the ventilation system.

Air can be directed to the floor, dashboard outlets, or windshield. Six symbols are used to represent Face, Bi-Level, Floor, Floor-Defrost and Defrost air position.



**Face-Level (B, D)**

Air flow is directed toward the upper body and face. Additionally, each outlet can be controlled to direct the air discharged from the outlet.



**Bi-Level (B, D, E, C)**

Air flow is directed towards the face and the floor.



**Floor-Level (C, A, D, E)**

Most of the air flow is directed to the floor, with a small amount of the air being directed to the windshield and side window defrosters.



**Floor/Defrost-Level (A, C, D, E)**

Most of the air flow is directed to the floor and the windshield with a small amount directed to the side window defrosters.



**Defrost-Level (A, D)**

Most of the air flow is directed to the windshield with a small amount of air directed to the side window defrosters.

## Features of your vehicle

---



OUB041106

### **MAX A/C-Level (B, D) (if equipped)**

The MAX A/C mode is used to cool the inside of the vehicle faster.

In this mode, the air conditioning and the recirculated air position will be selected automatically.



OUB041107

### **Instrument panel vents**

The outlet vents can be opened or closed separately using the thumbwheel.

Also, you can adjust the direction of air delivered from these vents using the vent control lever as shown.



OUB041108

### **Temperature control**

The temperature control knob allows you to control the temperature of the air flowing from the ventilation system. To change the air temperature in the passenger compartment, turn the knob to the right for warm air or left for cooler air.



OUB041109

**Air intake control**

This is used to select outside (fresh) air position or recirculated air position. To change the air intake control position, push the control button.

**Recirculated air position**



The indicator light on the button illuminates when the recirculated air position is selected.

With the recirculated air position selected, air from passenger compartment will be drawn through the heating system and heated or cooled according to the function selected.

**Outside (fresh) air position**



The indicator light on the button will not illuminate when the outside (fresh) air position is selected.

With the outside (fresh) air position selected, air enters the vehicle from outside and is heated or cooled according to the function selected.

Prolonged operation of the heater in the recirculated air position (without air conditioning selected) may cause fogging of the windshield and side windows and the air within the passenger compartment may become stale.

In addition, prolonged operation of the air conditioning with the recirculated air position selected will result in excessively dry air in the passenger compartment.

**⚠ WARNING - Recirculated air**

**Continuous use of the climate control system in the recirculated air position can cause drowsiness or sleepiness, and loss of vehicle control. Set the air intake control to the outside (fresh) air position as much as possible while driving.**



**⚠ WARNING - Reduced visibility**

Continuous use of the climate control system in the recirculated air position may allow humidity to increase inside the vehicle which may fog the glass and obscure visibility.



OUB041110

### ***Fan speed control***

The ignition switch must be in the ON position for fan operation.

The fan speed control knob allows you to control the fan speed of the air flowing from the ventilation system. To change the fan speed, turn the knob to the right for higher speed or left for lower speed.

Setting the fan speed control knob to the "0" position turns off the fan.



OUB041111

### ***Air conditioning (if equipped)***

Press the A/C button to turn the air conditioning system on (indicator light will illuminate). Press the button again to turn the air conditioning system off.

## System operation

### Ventilation

1. Set the mode to the  position.
2. Set the air intake control to the outside (fresh) air position.
3. Set the temperature control to the desired position.
4. Set the fan speed control to the desired speed.

### Heating

1. Set the mode to the  position.
2. Set the air intake control to the outside (fresh) air position.
3. Set the temperature control to the desired position.
4. Set the fan speed control to the desired speed.
5. If dehumidified heating is desired, turn the air conditioning system (if equipped) on.
  - If the windshield fogs up, set the mode to the  ,  position.

### Operation Tips

- To prevent dust or unpleasant fumes from entering the vehicle through the ventilation system, temporarily set the air intake control to the recirculated air position. Be sure to return the control to the fresh air position when the irritation has passed to keep fresh air in the vehicle. This will help keep the driver alert and comfortable.
- Air for the heating/cooling system is drawn in through the grilles just ahead of the windshield. Care should be taken that these are not blocked by leaves, snow, ice or other obstructions.
- To prevent interior fog on the windshield, set the air intake control to the fresh air position and fan speed to the desired position, turn on the air conditioning system, and adjust the temperature control to desired temperature.

### Air conditioning (if equipped)

Kia Air Conditioning Systems are filled with environmentally friendly R-134a refrigerant which does not damage the ozone layer.

1. Start the engine. Push the air conditioning button.
2. Set the mode to the  position.
3. Set the air intake control to the recirculated air position. However, prolonged operation of the recirculated air position will excessively dry the air. In this case, change the air position.
4. Adjust the fan speed control and temperature control to maintain maximum comfort.
  - When maximum cooling is desired, set the temperature control to the extreme left position, set the mode control to the MAX A/C position, then set the fan speed control to the highest speed.



### **CAUTION - Excessive AC**

*While using the air conditioning system, monitor the temperature gauge closely while driving up hills or in heavy traffic when outside temperatures are high. Air conditioning system operation may cause engine overheating and potential engine damage. Continue to use the blower fan but turn the air conditioning system off if the temperature gauge indicates engine overheating.*

### **Air conditioning system operation tips**

- If the vehicle has been parked in direct sunlight during hot weather, open the windows for a short time to let the hot air inside the vehicle escape.
- To help reduce moisture inside of the windows on rainy or humid days, decrease the humidity inside the vehicle by operating the air conditioning system.
- During air conditioning system operation, you may occasionally notice a slight change in engine speed as the air conditioning compressor cycles. This is a normal system operation characteristic.
- Use the air conditioning system every month only for a few minutes to ensure maximum system performance.
- When using the air conditioning system, you may notice clear water dripping (or even puddling) on the ground under the passenger side of the vehicle. This is a normal system operation characteristic.
- Operating the air conditioning system in the recirculated air position provides maximum cooling, however, continual operation in this mode may cause the air inside the vehicle to become stale.
- During cooling operation, you may occasionally notice a misty air flow because of rapid cooling and humid air intake. This is a normal system operation characteristic.

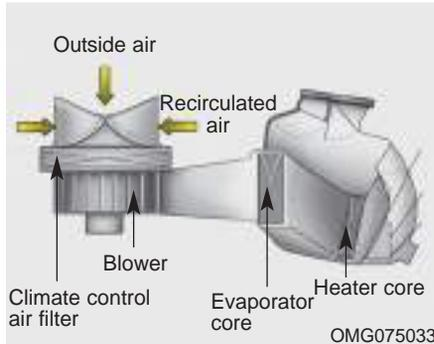

### Climate control air filter

The climate control air filter installed behind the glove box filters the dust or other pollutants that come into the vehicle from the outside through the heating and air conditioning system. If dust or other pollutants accumulate in the filter over a period of time, the air flow from the air vents may decrease, resulting in moisture accumulation on the inside of the windshield even when the outside (fresh) air position is selected. If this happens, have the climate control air filter replaced by an authorized Kia dealer.

### \* NOTICE

- Replace the filter according to the Maintenance Schedule. If the vehicle is being driven in severe conditions such as dusty, rough roads, more frequent climate control air filter inspections and changes are required.
- When the air flow rate suddenly decreases, the system should be checked at an authorized Kia dealer.

### Checking the amount of air conditioner refrigerant and compressor lubricant

When the amount of refrigerant is low, the performance of the air conditioning is reduced. Overfilling also has a negative influence on the air conditioning system. Therefore, if abnormal operation is found, have the system inspected by an authorized Kia dealer.

### CAUTION - Compressor damage

*It is important that the correct type and amount of oil and refrigerant is used. Otherwise, damage to the compressor and abnormal system operation may occur.*

The air conditioning system should be serviced by an authorized Kia dealer.

## WINDSHIELD DEFROSTING AND DEFOGGING

### **⚠ WARNING - Windshield heating**

Do not use the  or  position during cooling operation in extremely humid weather. The difference between the temperature of the outside air and the windshield could cause the outer surface of the windshield to fog up, causing loss of visibility. In this case, set the mode selection knob or button to the  position and fan speed control knob or button to a lower speed.

- For maximum defrosting, set the temperature control to the extreme right/hot position and the fan speed control to the highest speed.
- If warm air to the floor is desired while defrosting or defogging, set the mode to the floor-defrost position.
- Before driving, clear all snow and ice from the windshield, rear window, outside rear view mirrors, and all side windows.
- Clear all snow and ice from the hood and air inlet in the cowl grill to improve heater and defroster efficiency and to reduce the probability of fogging up the inside of the windshield.



### **Manual climate control system**

#### *To defog inside windshield*

1. Select any fan speed except “0” position.
2. Select desired temperature.
3. Select the  or  position.
4. The outside (fresh) air will be selected automatically.

If the outside (fresh) air position is not selected automatically, press the corresponding button manually.



### Defogging logic

To reduce the probability of fogging up inside of the windshield, the air intake or air conditioning are controlled automatically according to certain conditions such as  or  position. To cancel or return to the defogging logic, do the followings.

#### *To defrost outside windshield*

1. Set the fan speed to the highest (extreme right) position.
2. Set the temperature to the extreme hot position.
3. Select the  position.
4. The outside (fresh) air will be selected automatically.



#### *Manual climate control system*

1. Turn the ignition switch to the ON position.
2. Turn the mode selection knob to the defrost position ().
3. Push the air intake control button at least 5 times within 3 seconds.

The indicator light in the air intake control button will blink 3 times with 0.5 second of interval. It indicates that the defogging logic is canceled or returned to the programmed status.

If the battery has been discharged or disconnected, it resets to the defog logic status.

### STORAGE COMPARTMENT

These compartments can be used to store small items.

To avoid possible theft, do not leave valuables in the storage compartment.

Always keep the storage compartment covers closed while driving. Do not attempt to place so many items in the storage compartment that the storage compartment cover can not close securely.

**⚠ WARNING - Flammable materials**

**Do not store, propane cylinders, or other flammable/explosive materials in the vehicle. These items may catch fire and/or explode if the vehicle is exposed to hot temperatures for extended periods.**

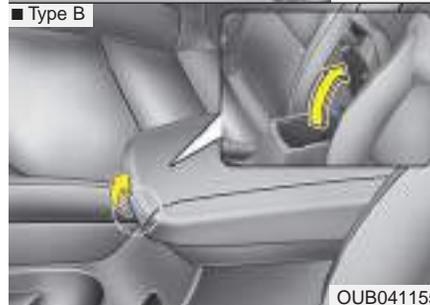

#### Center console storage (if equipped)

To open the center console storage, pull up the lever.

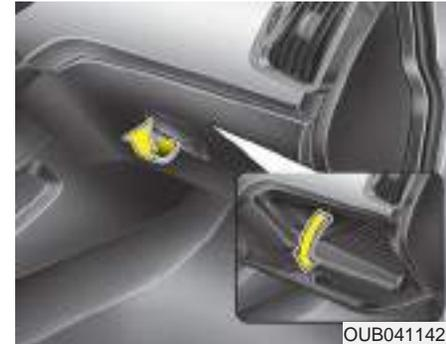

#### Glove box

To open the glove box, pull the handle and the glove box will automatically open. Close the glove box after use.

Always keep the glove box closed while the vehicle is in operation.



**\* NOTICE**

Do not put perishable food in the cool box because it may not maintain the necessary consistent temperature to keep the food fresh.

**\* NOTICE**

If the temperature control knob is in the warm or hot position, warm or hot air will flow into the glove box.

**Cool box (if equipped)**

You can keep beverage cans or other items cool in the glove box.

1. Turn on the air conditioning.
2. Slide the open/close lever of the vent installed in the glove box to the open position.
3. When the cool box is not used, slide the lever to the closed position.

If some items in the cool box block the vent, the cooling effectiveness of the coolbox is reduced.

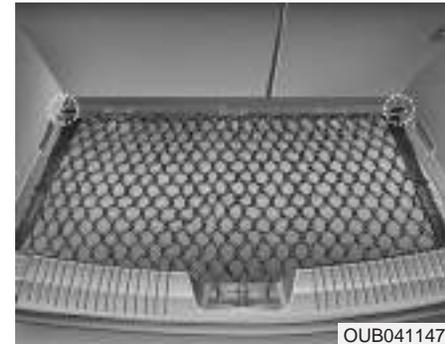

**Luggage net holder (if equipped)**

To keep items from shifting in the cargo area, you can use the 4 holders located in the cargo area to attach the luggage net.

If necessary, contact your authorized Kia dealer to obtain a luggage net.

To prevent damage to the goods or the vehicle, care should be taken when carrying fragile or bulky objects in the luggage compartment.



**⚠ WARNING - Luggage net**  
Always keep your face and body out of the luggage net recoil path and avoid using the luggage net when the straps have visible signs of wear or damage. The luggage net can snap and cause injuries.



### **Luggage tray (if equipped)**

You can place a first aid kit, a reflector triangle, tools, etc. in the box for easy access.

1. Grasp the handle on the top of the cover and lift it.
2. Fold the rear part of luggage tray board frontward.
3. Lift up luggage tray board frontward (Luggage tray board stand itself)

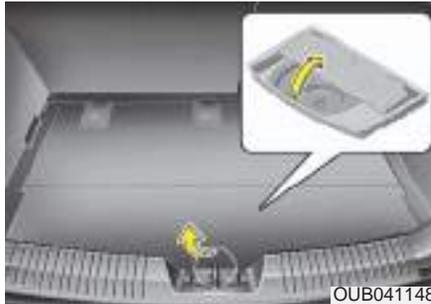

### Increase cargo space (if equipped)

If you want to increase cargo space,

1. Grasp the handle on the top of the cover and lift it
2. Fold the rear part of the luggage tray board frontward
3. Lift the luggage tray board hinge and pull it to the end of sliding slot.
4. Rotate it downward and slide it frontward (refer to the above pictures)

## INTERIOR FEATURES



### Cigarette lighter (if equipped)

For the cigarette lighter to work, the ignition switch must be in the ACC or ON position.

To use the cigarette lighter, push it all the way into its socket. When the element is heated, the lighter will pop out to the “ready” position.

If it is necessary to replace the cigarette lighter, use only a genuine Kia replacement or its approved equivalent.

- Do not hold the lighter in after it is already heated because it will over-heat.
- If the lighter does not pop out within 30 seconds, remove it to prevent over-heating.

**⚠ CAUTION - Cigarette lighter**

*Do not insert accessories into the cigarette lighter socket. Doing so can damage the lighter socket*



### Ashtray (if equipped)

To use the ashtray, open the cover.

To clean or empty the ashtray, pull it out.

**⚠ WARNING - Ashtray use**  
**Putting lit cigarettes or matches in an ashtray with other combustible materials may cause a fire.**

Cup holder

**⚠ WARNING - Hot liquids**  
 Do not place uncovered cups of hot liquid in the cup holder while the vehicle is in motion. If the hot liquid spills, you may burn yourself. Such a burn to the driver could lead to loss of control of the vehicle.

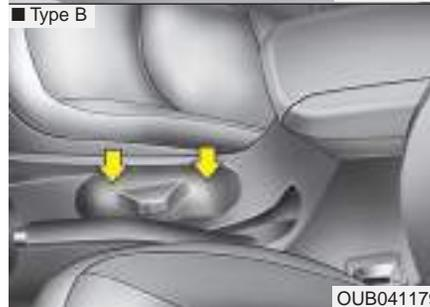
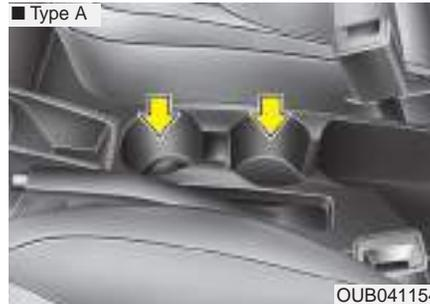

Cups or small beverage cans may be placed in the cup holders.

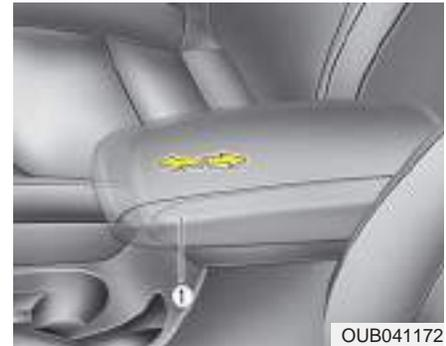

**Sliding armrest (if equipped)**

*To move forward*

Grab the front portion of the armrest (1) then pull it forward

*To move rearward*

Push the armrest rearward with your palm.



### Photo frame (if equipped)

If you want to insert the photo in the frame,

1. Press the cover and the photo frame will come out.
2. Insert the photo into the slit at the top of the photo frame.
3. Push the cover to fix the photo frame in its original place.

The information card is in the photo frame.

If you want to resize your digital picture to fit the photo frame, access the QR code or web address on the information card.



### Sunvisor

Use the sunvisor to shield direct light through the front or side windows.

To use the sunvisor, pull it downward.

To use the sunvisor for the side window, pull it downward, unsnap it from the bracket (1) and swing it to the side (2).

To use the vanity mirror, pull down the visor and slide the mirror cover (3).

The ticket holder (4, if equipped) is provided for holding a tollgate ticket.

### CAUTION - Vanity mirror lamp

*Close the vanity mirror cover securely and return the sunvisor to its original position after use. If the vanity mirror is not closed securely, the lamp will stay on and could result in battery discharge and possible sunvisor damage.*



OUB041157

### Power outlet (if equipped)

The power outlet is designed to provide power for mobile telephones or other devices designed to operate with vehicle electrical systems. The devices should draw less than 10 amps with the engine running.

Use the power outlet only when the engine is running and remove the accessory plug after use. Using the accessory plug for prolonged periods of time with the engine off could cause the battery to discharge.

Only use 12V electric accessories which are less than 10A in electric capacity.

Adjust the air-conditioner or heater to the lowest operating level when using the power outlet.

Close the cover when not in use.

Some electronic devices can cause electronic interference when plugged into a vehicle's power outlet. These devices may cause excessive audio static and malfunctions in other electronic systems or devices used in your vehicle.

**⚠ WARNING - Electric shock**  
**Do not put a finger or a foreign element (pin, etc.) into a power outlet and do not touch with a wet hand. You may get an electric shock.**

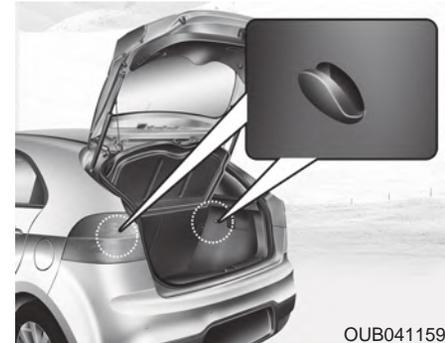

OUB041159

### Shopping bag holder

- Do not hang a bag weighing more than 3 kg (7 lbs.). It may cause damage to the shopping bag holder.
- Do not hang the frail objects when you drive rough road, the objects may be damaged.

### Digital clock and calendar (if equipped)

Whenever the battery terminals or related fuses are disconnected, you must reset the clock and the calendar.

When the ignition switch is in the ACC or ON position, the clock buttons operate as follows:

## Features of your vehicle



OUB041161N

### Setup the clock and calendar

#### With audio off

1. Press the [SETUP] or [Clock] button (1) until the clock of the display blinks.
2. Set the clock by turning the knob (2) and press it.

#### With audio on

1. Press the [SETUP] or [Clock] button (1) until the clock adjust mode displayed.
2. Set the clock by turning the knob(2) and press it.

### **⚠ WARNING**

**Do not adjust the clock while driving. You may lose your steering control and cause an accident that results in severe personal injury or death.**



OUN026348

### **Clothes hanger (if equipped)**

To use the hanger, pull down the upper portion of hanger.

### **⚠ CAUTION - Hanging clothing**

**Do not hang heavy clothes, since those may damage the hook.**

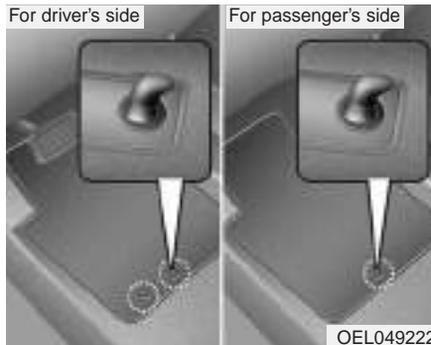

### Floor mat anchor(s)

When using a floor mat on the front floor carpet, make sure it attaches to the floor mat anchor(s) in your vehicle. This keeps the floor mat from sliding forward.

**⚠ WARNING - After market floor mat**

**Do not install aftermarket floor mats that are not capable of being securely attached to the vehicle's floor mat anchors. Unsecured floor mats can interfere with pedal operation.**

The following must be observed when installing ANY floor mat to the vehicle.

- Ensure that the floor mats are securely attached to the vehicle's floor mat anchor(s) before driving the vehicle.
- Do not use ANY floor mat that cannot be firmly attached to the vehicle's floor mat anchors.
- Do not stack floor mats on top of one another (e.g. all-weather rubber mat on top of a carpeted floor mat). Only a single floor mat should be installed in each position.

**IMPORTANT** - Your vehicle was manufactured with driver's side floor mat anchors that are designed to securely hold the floor mat in place. To avoid any interference with pedal operation, Kia recommends that only the Kia floor mat designed for use in your vehicle be installed.



### Navigation system (if equipped)

The navigation system ascertains the present position of your vehicle by using information from satellites and guides you to the place you assign as the destination.

Detailed information for the navigation system is described in a separately supplied manual.



### AUDIO SYSTEM

If you install an aftermarket HID head lamp, your vehicle's audio and electronic device may malfunction.



#### Antenna

Your vehicle uses a roof antenna to receive both AM and FM broadcast signals. This antenna can be removed. To remove the antenna, turn it counterclockwise. To install the antenna, turn it clockwise.



#### **CAUTION - Antenna**

***Before entering a place with a low height clearance or a car wash, remove the antenna by rotating it counter-clockwise. If not, the antenna may be damaged.***

When reinstalling your antenna, it is important that it is fully tightened and adjusted to the upright position to ensure proper reception. But it could be removed when parking the vehicle.



OUB041163

### Steering wheel audio control (if equipped)

The steering wheel audio control button is installed to promote safe driving.

Do not operate the audio remote control buttons simultaneously.

#### **VOLUME (+/-) (1)**

- Push the lever up to increase volume.
- Push the lever down to decrease volume.

#### **MODE (3)**

Press the button to select Radio or CD (compact disc).

#### **MUTE (4)**

- Press the MUTE button to cancel the sound.
- Press the MUTE button again to activate the sound.

#### **SEEK/PRESET (^ / v) (2)**

The SEEK/PRESET button has different functions base on the system mode. For the following functions the button should be pressed for 0.8 second or more.

#### **RADIO mode**

It will function as the AUTO SEEK select button.

#### **CDP/USB/iPod® mode**

It will function as the FF/REW button. iPod® is a registered trademark of Apple Inc.

If the SEEK button is pressed for less than 0.8 second, it will work as follows in each mode.

#### **RADIO mode**

It will function as the PRESET STATION select buttons.

#### **CDP/USB/iPod® mode**

It will function as the TRACK UP/DOWN button.

Detailed information for audio control buttons is described in the following pages in this section.

### **Bluetooth® Wireless Technology (if equipped)**

You can use a compatible phone via using the *Bluetooth®* Wireless technology. Detailed information for the *Bluetooth®* Wireless Technology is described in the Audio system section.

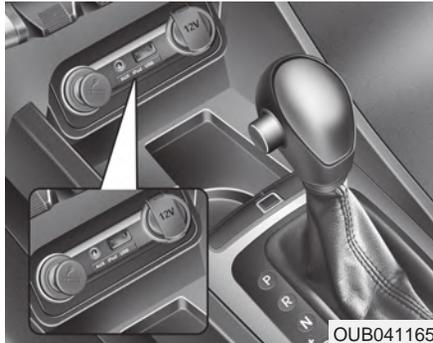

OUB041165

### Aux, USB and iPod®\* (if equipped)

If your vehicle has an aux and/or USB (universal serial bus) port or iPod port, you can use an aux port to connect audio devices and an USB port to plug in an USB and also an iPod port to plug in an iPod.

When using a portable audio device connected to the power outlet, noise may occur during playback. If this happens, use the power source of the portable audio device.

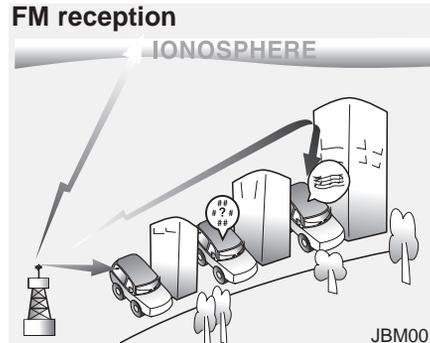

JBM001

### How vehicle audio works

AM and FM radio signals are broadcast from transmitter towers located around your city. They are intercepted by the radio antenna on your vehicle. This signal is then received by the radio and sent to your vehicle speakers.

When a strong radio signal has reached your vehicle, the precise engineering of your audio system ensures the best possible quality reproduction. However, in some cases the signal coming to your vehicle may not be strong and clear. This can be due to factors, such as the distance from the radio station, closeness of other strong radio stations or the presence of buildings, bridges or other large obstructions in the area.

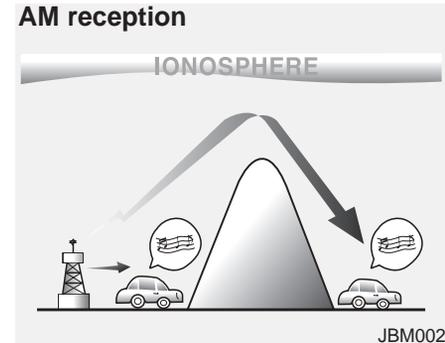

JBM002

AM broadcasts can be received at greater distances than FM broadcasts. This is because AM radio waves are transmitted at low frequencies. These long, low frequency radio waves can follow the curvature of the earth rather than travelling straight out into the atmosphere. In addition, they curve around obstructions so that they can provide better signal coverage.

### FM radio station

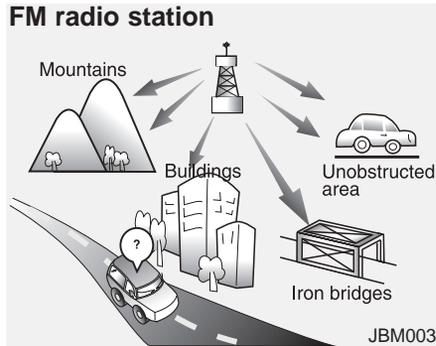

FM broadcasts are transmitted at high frequencies and do not bend to follow the earth's surface. Because of this, FM broadcasts generally begin to fade at short distances from the station. Also, FM signals are easily affected by buildings, mountains, or other obstructions. These can result in certain listening conditions which might lead you to believe a problem exists with your radio. The following conditions are normal and do not indicate radio trouble:

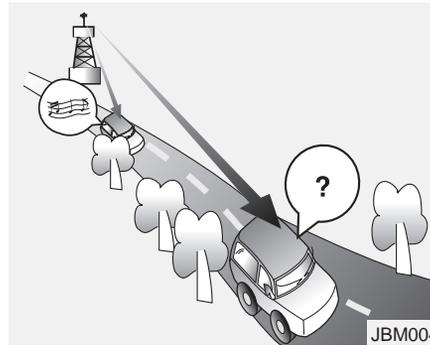

- **Fading** - As your vehicle moves away from the radio station, the signal will weaken and sound will begin to fade. When this occurs, we suggest that you select another stronger station.
- **Flutter/Static** - Weak FM signals or large obstructions between the transmitter and your radio can disturb the signal causing static or fluttering noises to occur. Reducing the treble level may lessen this effect until the disturbance clears.

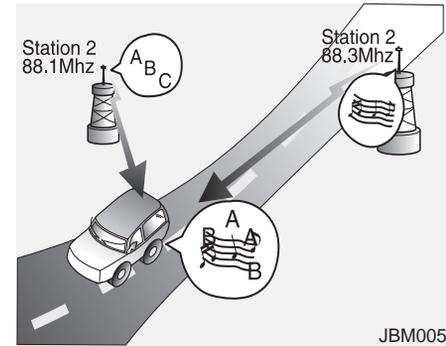

- **Station Swapping** - As a FM signal weakens, another more powerful signal near the same frequency may begin to play. This is because your radio is designed to lock onto the clearest signal. If this occurs, select another station with a stronger signal.
- **Multi-Path Cancellation** - Radio signals being received from several directions can cause distortion or fluttering. This can be caused by a direct and reflected signal from the same station, or by signals from two stations with close frequencies. If this occurs, select another station until the condition has passed.

### Satellite radio reception

You may experience difficulties in receiving SIRIUS satellite radio signals in the following situations.

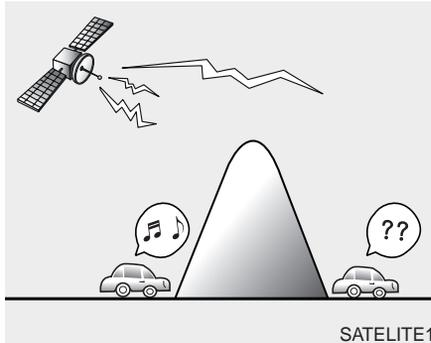

- If you are driving in a tunnel or a covered parking area.
- If you are driving beneath the top level of a multi-level freeway.
- If you drive under a bridge.
- If you are driving next to a tall vehicle (such as a truck or a bus) that blocks the signal.
- If you are driving in a valley where the surrounding hills or peaks block the signal from the satellite.

- If you are driving on a mountain road where the signal is blocked by mountains.

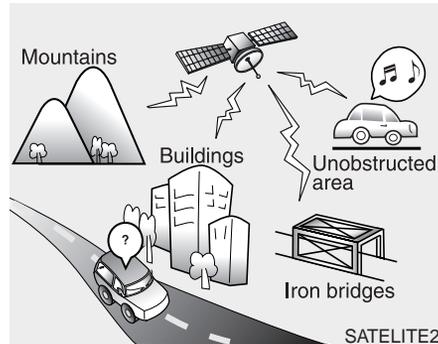

- If you are driving in an area with tall trees that block the signal (10m / 30 ft. or more), for example on a road that goes through a dense forest.
- The signal can become weak in some areas that are not covered by the SIRIUS repeater network.

There may be other unforeseen circumstances leading to reception problems with the SIRIUS satellite radio signal.

### Using a cellular phone or a two-way radio

When a cellular phone is used inside the vehicle, noise may be produced from the audio system. This does not mean that something is wrong with the audio equipment. In such a case, use the cellular phone at a place as far as possible from the audio equipment.

#### **⚠ WARNING - Cell phone use**

**Do not use a cellular phone while driving. Stop at a safe location to use a cellular phone.**

### Care of disc (if equipped)

- If the temperature inside the car is too high, open the car windows for ventilation before using your car audio.
- It is illegal to copy and use MP3/WMA/AAC/WAVE files without permission. Use CDs that are created only by lawful means.
- Do not apply volatile agents such as benzene and thinner, normal cleaners and magnetic sprays made for analogue disc onto CDs.
- To prevent the disc surface from getting damaged. Hold and carry CDs by the edges or the edges of the center hole only.
- Clean the disc surface with a piece of soft cloth before playback (wipe it from the center to the outside edge).
- Do not damage the disc surface or attach pieces of sticky tape or paper onto it.
- Make sure on undesirable matter other than CDs are inserted into the CD player (Do not insert more than one CD at a time).
- Keep CDs in their cases after use to protect them from scratches or dirt.

- Depending on the type of CD-R/CD-RW CDs, certain CDs may not operate normally according to manufacturing companies or making and recording methods. In such circumstances, if you still continue to use those CDs, they may cause the malfunction of your car audio system.

### \* NOTICE - Playing an Incompatible Copy-Protected Audio CD

Some copy protected CDs, which do not comply with the international audio CD standards (Red Book), may not play on your car audio. Please note that if you try to play copy protected CDs and the CD player does not perform correctly the CDs maybe defective, not the CD player.

#### NOTE:

Order of playing files (folders) :

1. Song playing order : ① to ⑭ sequentially.

2. Folder playing order :

\* If no song file is contained in the folder, that folder is not displayed.

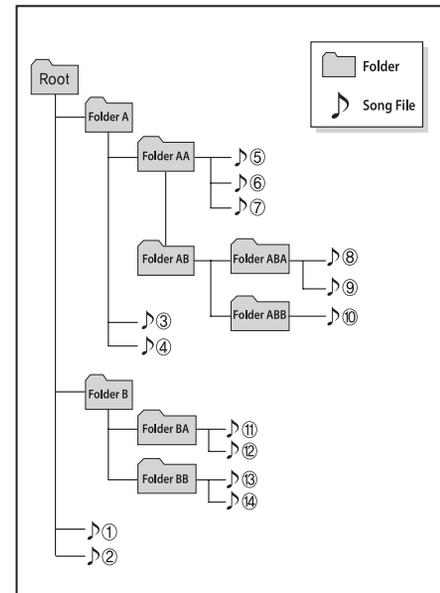
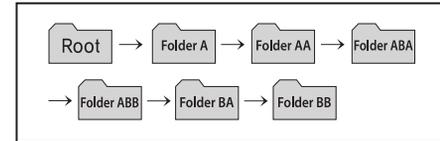

## Features of your vehicle

Type A



Type B



\*No  Bluetooth logo will be shown if the *Bluetooth*<sup>®</sup> wireless technology feature is not supported.

## SYSTEM CONTROLLERS AND FUNCTIONS

### Audio Head Unit



1. **EJECT** (EJECT)  
 • Ejects the disc.

#### 2. **RADIO**

- Changes to FM/AM/SIRIUS mode.
- Each time the key is pressed, the mode is changed in order of FM1 → FM2 → AM → SAT1 → SAT2 → SAT3
- \* In Setup>Display, the radio pop up screen will be displayed when [Mode Pop up] is turned (On).
- When the pop up screen is displayed, use the **TUNE** knob or keys **1** ~ **6** to select the desired mode.

#### 3. **MEDIA**

- Changes to CD, USB, iPod, AUX, My Music, BT Audio modes.
- Each time the key is pressed, the mode is changed in order of CD, USB, iPod, AUX, My Music, BT Audio modes.
- \* In Setup>Display, the media pop up screen will be displayed when [Mode Pop up] is turned (On).
- When the pop up screen is displayed, use the **TUNE** knob or keys **1** ~ **5** to select the desired mode.

#### 4. **PHONE**

- Operates Phone Screen
- \* When a phone is not connected, the connection screen is displayed.

#### 5. **SEEK TRACK**

- Radio Mode : Automatically searches for broadcast frequencies.
- CD, USB, iPod, My Music modes :
  - Shortly press the key (under 0.8 seconds): Moves to next or previous song(file)
  - Press and hold the key (over 0.8 seconds): Rewinds or fast-forwards the current song(file)

#### 6. **PWR/VOL knob**

- **Power Knob**: Turns power On/Off by pressing the knob
- **Volume Knob**: Sets volume by turning the knob left/right

#### 7. **1** ~ **6** (Preset)

- Radio Mode: Saves frequencies (channels) or receives saved frequencies (channels)
- CD, USB, iPod, My Music mode
  - **1** : Repeat
  - **2** : Random
- In the Radio, Media, Setup, and Menu pop up screen, the number menu is selected.



## Features of your vehicle



### 8. **DISP**

- Each time the button is shortly pressed (under 0.8 seconds), it sets the screen Off → Screen On → Screen Off

※ Audio operation is maintained and only the screen will be turned Off. In the screen Off state, press any key to turn the screen On again.

### 9. **SCAN**

- Radio Mode

- Shortly press the key (under 0.8 seconds): Previews each broadcast for 5 seconds each

- Press and hold the key (over 0.8 seconds): Previews the broadcasts saved in Preset **1** ~ **6** for 5 seconds each.

※ Press the **SCAN** key again to continue listening to the current frequency.

※ SIRIUS Radio does not support the Preset scan feature.

- CD, USB, iPod mode

- Shortly press the key (under 0.8 seconds): Previews each song (file) for 10 seconds each

※ Press the **SCAN** key again to continue listening to the current song (file).

### 10. **SETUP** CLOCK

- Shortly press the key (under 0.8 seconds) : Moves to the Display, Sound, Phone, System setting modes

Press and hold the key (over 0.8 seconds) : Move to the Time setting screen

### 11. **MENU**

- Displays menus for the current mode.

### 12. **CAT** FOLDER

- Radio Mode

SIRIUS RADIO : Category Search

- MP3, CD, USB mode : Folder Search

- iPod mode: Moves to parent folder

※ May differ depending on the selected audio.

### 13. **TUNE** knob

- Radio mode : Changes frequency by turning the knob left/right

- CD, USB, iPod mode: Searches songs (files) by turning the knob left/right

※ When the desired song is displayed, press the knob to play the song.

- Moves focus in all selection menus and selects menus



### 14. **FM/AM**

- Changes to FM/AM mode.

• Each time the key is pressed, the mode is changed in order of FM1 → FM2 → AM

### 15. **SAT** (SIRIUS Satellite Radio)

- Changes to SIRIUS Satellite Radio mode.

• Each time the key is pressed, the mode is changed in order of SAT1 → SAT2 → SAT3

## DISPLAY SETTINGS

Press the **SETUP** key ▶ Select [Display] through **TUNE** knob or **1** key ▶ Select menu through **TUNE** knob

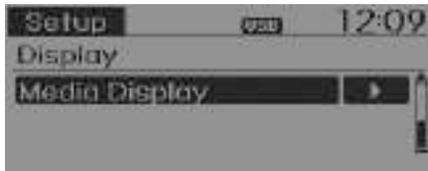
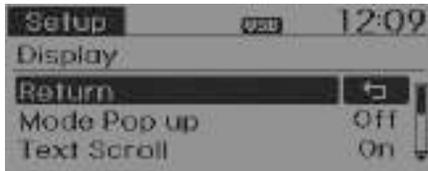

### Mode Pop up

[Mode Pop up] ▶ Changes  On /  Off selection mode

- During On state, press the **RADIO** or **MEDIA** key to display the mode change pop up screen.

### Text Scroll

[Text Scroll] ▶ Set  On /  Off

- On : Maintains scroll
- Off : Scrolls only one (1) time.

### Media Display

When playing an MP3 file, select the desired display info from 'Folder/File' or 'Album/Artist/Song'.

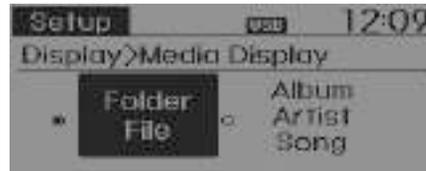

## SOUND SETTINGS

Press the **SETUP** key ▶ Select [Sound] through **TUNE** knob or **2** key ▶ Select menu through **TUNE** knob

### Sound Settings

This menu allows you to set the 'Bass, Middle, Treble' and the Sound Fader and Balance.

Select [Sound Settings] ▶ Select menu through **TUNE** knob ▶ Turn **TUNE** knob left/right to set

- Bass, Middle, Treble : Selects the sound tone.

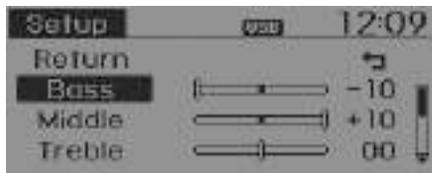

- Fader, Balance : Moves the sound fader and balance.

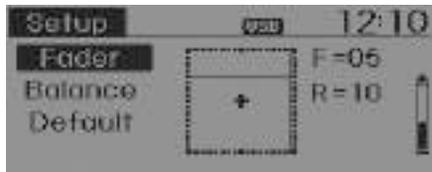

- Default : Restores default settings.
- \* Back : While adjusting values, repressing the **TUNE** knob will restore the parent menu.

### Virtual Sound

The PoewrBass, PowerTreble, and Surround can be set.

Select [Virtual Sound] ▶ Set menu through **TUNE** knob ▶ Set **On** / **Off** through **TUNE** knob

- PowerBass : This is a sound system feature that provides live bass.
- PowerTreble : This is a sound system feature that provides live tremble.
- Surround : This is a sound system feature that provides surround sound.

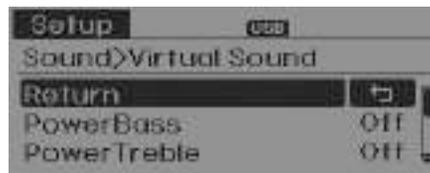

### Speed Dependent Volume Control

This feature is used to automatically control the volume level according to the speed of the vehicle.

Select [SDVC] ▶ Set in 4 levels [Off/Low/Mid/High] of **TUNE** knob

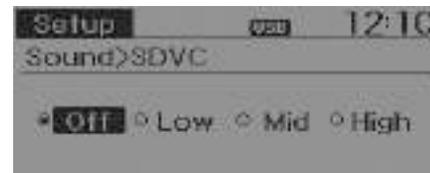

### Voice Recognition Volume

Adjusts voice recognition volume.

Select [Voice Recognition Vol.] ▶ Set volume of **TUNE** knob



## CLOCK SETTINGS

Press the **SETUP** key ▶ Select [Clock] through **TUNE** knob or **3** key ▶ Select menu through **TUNE** knob

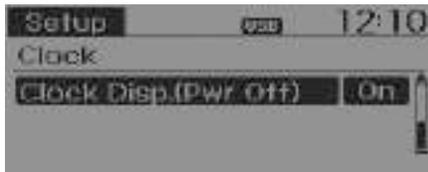

### Clock Settings

This menu is used to set the time.

Select [Clock Settings] ▶ Set through **TUNE** knob ▶ Press **TUNE** knob



※ Adjust the number currently in focus to set the [hour] and press the tune knob to set the [minute].

### Calendar Settings

This menu is used to set the date (MM/DD/YYYY).

Select [Calendar Settings] ▶ Set through **TUNE** knob ▶ Press **TUNE** knob

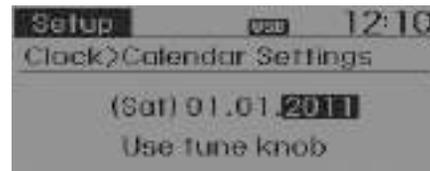

※ Adjust the number currently in focus to make the settings and press the tune knob to move to the next setting. (Set in order of Month/Day/Year)

### Clock Display when Power is OFF

Select [Clock Disp.(Pwr Off)] ▶ Set **On** / **Off** through **TUNE** knob

- **On** : Displays time/date on screen
- **Off** : Turn off.

### PHONE SETUP

Press the **SETUP** key ▶ Select [Phone] through **TUNE** knob or **4** key ▶ Select menu through **TUNE** knob

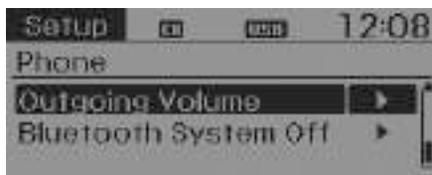
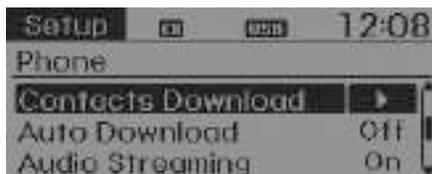
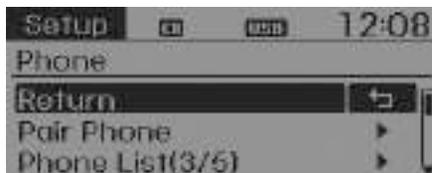

### Pair Phone

#### ⚠ CAUTION

*To pair a Bluetooth® wireless technology mobile phone, authentication and connection processes are first required. As a result, you cannot pair your mobile phone while driving the vehicle. First park your vehicle before use.*

Select [Pair Phone] ▶ Set through **TUNE** knob



- ① Search for device names as displayed on your mobile phone and connect.
- ② Input the passkey displayed on the screen. (Passkey : 0000)

\* The device name and passkey will be displayed on the screen for up to 3 minutes. If pairing is not completed within the 3 minutes, the mobile phone pairing process will automatically be canceled.

③ Pairing completion is displayed.

\* In some mobile phones, pairing will automatically be followed by connection.

\* It is possible to pair up to five Bluetooth® wireless technology mobile phones.

### Phone List

The names of up to 5 paired phones will be displayed.

A [▶] is displayed in front of the currently connected phone.

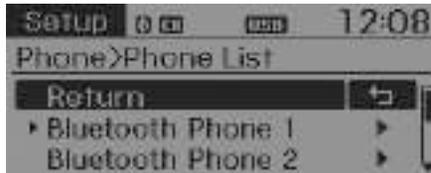

Select the desired name to setup the selected phone.

#### • Connecting a phone

Select [Phone List]▶Select mobile phone through **⊙** TUNE knob▶Select [Connect Phone]

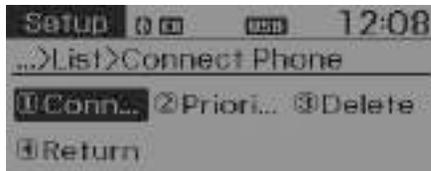

- ① Select a mobile phone that is not currently connected.

- ② Connect the selected mobile phone.
  - ③ Connection completion is displayed.
- \* If a phone is already connected, disconnect the currently connected phone and select a new phone to connect.

#### • Disconnecting a connected phone

Select [Phone List]▶Select mobile phone through **⊙** TUNE knob▶Select [Disconnect Phone]

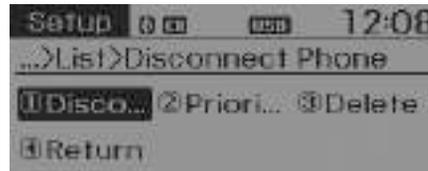

- ① Select the currently connected mobile phone.
- ② Disconnect the selected mobile phone.
- ③ Disconnection completion is displayed.

#### • Changing connection sequence (Priority)

This is used to change the order (priority) of automatic connection for the paired mobile phones.

Select [Phone List]▶Select [Priority] through **⊙** TUNE knob▶Select No. 1 Priority mobile phone

- ① Select [Priority].
- ② From the paired phones, select the phone desired for No.1 priority.
- ③ The changed priority sequence is displayed.

\* Once the connection sequence (priority) is changed, the new no. 1 priority mobile phone will be connected.

- when the no. 1 priority cannot be connected: Automatically attempts to connect the most recently connected phone.
- Cases when the most recently connected phone cannot be connected: Attempts to connect in the order in which paired phones are listed.
- The connected phone will automatically be changed to No. 1 priority.

### • Delete

Select [Phone List] ▶ Select mobile phone through  TUNE knob ▶ Select [Delete]

- ① Select the desired mobile phone.
  - ② Delete the selected mobile phone.
  - ③ Deletion completion is displayed.
- \* When attempting to delete a currently connected phone, the phone is first disconnected.

#### CAUTION

- *When you delete a mobile phone, the mobile phone contacts will also be erased.*
- *For stable Bluetooth® communication, delete the mobile phone from the audio and also delete the audio from your mobile phone.*

### Contacts Download

This feature is used to download contacts and call histories into the audio system.

Select [Contacts Download] ▶ Select through 

#### CAUTION

- *The download feature may not be supported in some mobile phones.*
- *If a different operation is performed while Contacts are being downloaded, downloading will be discontinued. Contacts already downloaded will be saved.*
- *When downloading new Contacts, delete all previously saved Contacts before starting download.*

### Auto Download

When connecting a mobile phone, it is possible to automatically download new Contacts and Call Histories.

Select [Auto Download] ▶ Set  /  through 

### Audio Streaming

Songs (files) saved in your Bluetooth® wireless technology mobile phone can be played through the audio system.

Select [Audio Streaming] ▶ Set  /  through 

#### CAUTION

- *The Bluetooth® wireless technology audio streaming feature may not be supported in some mobile phones.*

### Outgoing Volume

This is used to set the volume of your voice as heard by the other party while on a Bluetooth® wireless technology handsfree call.

Select [Outgoing Volume] ▶ Set volume through 

- \* Even while on a call, the volume can be changed by using the  key.

## Bluetooth® wireless technology System Off

This feature is used when you do not wish to use the Bluetooth® wireless technology system.

Select [Bluetooth System Off] ▶ Set through  TUNE knob

※ If a phone is already connected, disconnect the currently connected phone and turn the Bluetooth® wireless technology system off.

## Using the Bluetooth® wireless technology System

To use Bluetooth wireless technology when the system is currently off, follow these next steps.

- Turning On Bluetooth® wireless technology through the **PHONE** Key  
Press the **PHONE** key ▶ Screen Guidance
- ※ Moves to the screen where Bluetooth® wireless technology functions can be used and displays guidance.

- Turning On Bluetooth® wireless technology through the **SETUP** Key

Press the **SETUP** key ▶ Select [Phone] through  TUNE knob or **4** key

- ① A screen asking whether to turn on Bluetooth® wireless technology will be displayed.
  - ② On the screen, select **YES** to turn on Bluetooth® wireless technology and display guidance.
- ※ If the Bluetooth® wireless technology system is turned on, the system will automatically try to connect the most recently connected Bluetooth® wireless technology mobile phone.



### CAUTION

*Bluetooth® wireless technology connection may become intermittently disconnected in some mobile phones. Follow these next steps to try again.*

- 1) Turn the Bluetooth® wireless technology function within the mobile phone ON/OFF and try to connect again.*
- 2) Turn the mobile phone power ON/OFF and try to connect again.*
- 3) Completely remove the mobile phone battery, reboot, and then try to connect again.*
- 4) Reboot the audio system and try to connect again*
- 5) Delete all paired devices in your mobile phone and the audio system and pair again for use.*



### SYSTEM SETTINGS

Press the **SETUP** key ▶ Select [System] through tune knob or **5** key ▶ Select menu through **TUNE** knob



### Memory Information

Displays currently used memory and total system memory.

Select [Memory Information] ▶ OK

The currently used memory is displayed on the left side while the total system memory is displayed on the right side.



### Prompt Feedback

This feature is used to change voice command feedback between Normal and Expert modes.

Select [Prompt Feedback] ▶ Set through **TUNE** knob

- Normal : This mode is for beginner users and provides detailed instructions during voice command operation.
- Expert : This mode is for expert users and omits some information during voice command operation. (When using Expert mode, guidance instructions can be heard through the [Help] or [Menu] commands.

### Language

This menu is used to set the display and voice recognition language.

Select [Language] ▶ Set through **TUNE** knob

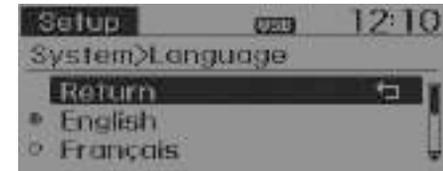

\* The system will reboot after the language is changed.

\* Language support by region

English, Français, Español

## RADIO : FM, AM OR SIRIUS

### Changing RADIO mode (FM, AM or SIRIUS)

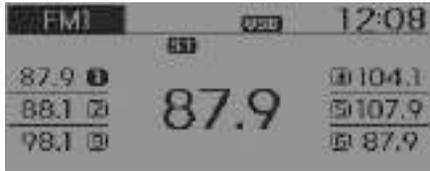

Press the **RADIO** key to change the mode in order of FM1→FM2→AM→SAT1→SAT2→SAT3.

- When the power is off, press the **RADIO** key to turn on the audio system and receive radio broadcasts.
- [Mode Pop up] On state : Displays the change radio mode pop up screen. While the pop up screen is displayed, you can change the radio mode (FM1→FM2→AM→SAT1→SAT2→SAT3) through the tune knob or **1** ~ **6** keys.

### Adjust Volume

Turn the **VOL** knob left/right to adjust the volume.

## SEEK

Press the **RADIO** key ▶ **SEEK TRACK** ^

- Shortly pressing the key (under 0.8 seconds): Changes the frequency.
- Pressing and holding the key (over 0.8 seconds): Automatically searches for the next frequency.

## Preset SEEK

Press the **RADIO** key ▶ **1** ~ **6**

- Shortly pressing the key (under 0.8 seconds): Plays the frequency saved in the corresponding key.
- Pressing and holding the key (over 0.8 seconds): Pressing and holding the desired key from **1** ~ **6** will save the currently playing broadcast to the selected key and sound a BEEP.

## SCAN

Press the **RADIO** key ▶ **SCAN**

- Shortly pressing the key (under 0.8 seconds): The broadcast frequency increases and previews each broadcast for 5 seconds each. After scanning all frequencies, returns and plays the current broadcast frequency.
- Pressing and holding the key (over 0.8 seconds): Previews the broadcasts saved in Preset **1** ~ **6** for 5 seconds each.

## Selecting through manual search

Turn the **TUNE** knob left/right to adjust the frequency.

- FM : Changes by 200KHz
- AM : Changes by 10MHz

### MENU

Within **MENU** key are the A.Store (Auto Store).

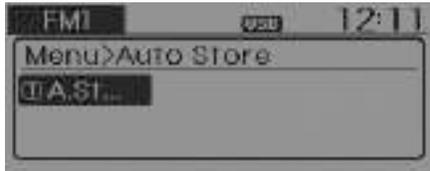

#### A.Store

Press the **MENU** key ▶ Set [A.Store] through **TUNE** knob or **1** key.

Saves broadcasts with superior reception to **1** ~ **6** keys. If no frequencies are received, then the most recently received frequency will be broadcast.

## SIRIUS Satellite Radio information (if equipped)

### Satellite Radio channels:

SIRIUS Satellite Radio has over 130 channels, including 69 channels of 100% commercial-free music, plus sports, news, talk and entertainment available nationwide in your vehicle. For more information and a complete list of SIRIUS Satellite Radio channels, visit [sirius.com](http://sirius.com) in the United States, [sirius-canada.ca](http://sirius-canada.ca) in Canada, or call SIRIUS at 1-888-539-7474.

### Satellite Radio reception factors:

To receive the satellite signal, your vehicle has been equipped with a satellite radio antenna located on the roof of your vehicle. The vehicle roof provides the best location for an unobstructed, open view of the sky, a requirement of a satellite radio system. Like AM/FM, there are several factors that can affect satellite radio reception performance:

- **Antenna obstructions:** For optimal reception performance, keep the antenna clear of snow and ice build-up and keep luggage and other material as far away from the antenna as possible.
- **Terrain:** Hills, mountains, tall buildings, bridges, tunnels, freeway overpasses, parking garages, dense tree foliage and thunderstorms can interfere with your reception.

### SIRIUS Satellite Radio service:

SIRIUS Satellite Radio is a subscription-based satellite radio service that broadcasts music, sports, news and entertainment programming to radio receivers, which are available for installation in motor vehicles or factory installed, as well as for the home, portable and wireless devices, and through an Internet connection on personal computer.

Vehicles that are equipped with a factory installed SIRIUS Satellite Radio system include:

- Hardware and an introductory trial subscription term, which begins on the date of sale or lease of the vehicle.
- For a small upgrade fee, access to SIRIUS music channels, and other select channels over the Internet using any computer connected to the Internet (U.S. customers only).

For information on extended subscription terms, contact SIRIUS at 1-888-539-7474.

### NOTE:

**Satellite Radio requires SIRIUS® compatible receiver and a subscription service fee after trial period.**

**Vehicles without a factory-installed radio receiver require hardware purchase and installation. Please see your dealer for further details. All fees and programming subject to change.**

**Subscriptions governed by the SIRIUS Terms & Conditions available at [www.sirius.com](http://www.sirius.com) / service terms.**

**Available only in the 48 contiguous United States and the District of Columbia. Service available in Canada; see [www.siriuscanada.ca](http://www.siriuscanada.ca)**

**Kia shall not be responsible for any such programming changes.**

### Satellite Radio Electronic Serial Number (ESN):

This 12-digit Satellite Serial Number is needed to re-activate, modify or track your satellite radio account. You will need this number when communicating with SIRIUS.

### SIRIUS RADIO

#### Using SIRIUS Satellite Radio

Your Kia vehicle is equipped with a 3 month complimentary period of SIRIUS Satellite Radio so you have access to over 130 channels of music, information, and entertainment programming.



#### Activation

In order to extend or reactivate your subscription to SIRIUS Satellite Radio, you will need to contact SIRIUS Customer Care at 1-888-539-7474. Have your 12 digit SID (Sirius Identification Number)/ESN (Electronic Serial Number) ready. To retrieve the SID/ESN, turn on the radio, press the [SAT] button, and tune to channel zero.

Please note that the vehicle will need to be turned on, in Sirius mode, and have an unobstructed view of the sky in order for the radio to receive the activation signal.

### SEEK

Press the **RADIO** key ▶

- Shortly pressing the key (under 0.8 seconds): select previous or next channel.
  - Pressing and holding the key (over 0.8 seconds): continuously move to previous or next channel.
- \* If the “Category” icon is displayed, channels are changed within the current category.

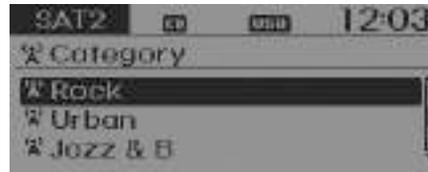

### SCAN

Press the **RADIO** key ▶ **SCAN**

- Shortly pressing the key (under 0.8 seconds): Previews each broadcast for 5 seconds each
- \* Press the **SCAN** key again to continue listening to the current frequency
- \* If the “Category” icon is displayed, channels are changed within the current category.

#### Category

Press the **∨**<sup>CAT</sup>**∧**<sub>FOLDER</sub> key ▶ Set through the **TUNE** knob

- The display will indicate the category menus, highlight the category that the current channel belongs to.
- In the Category List Mode, press the **∨**<sup>CAT</sup>**∧**<sub>FOLDER</sub> key to navigate category list.
- Press the tune knob to select the lowest channel in the highlighted category.
- \* If channel is selected by selecting category, then the “CATEGORY” icon is displayed at the top of the screen.

## Preset

Press the **RADIO** key ▶ **1** ~ **6**

- Shortly pressing the key (under 0.8 seconds): Plays the frequency saved in the corresponding key.
- Pressing and holding the key (over 0.8 seconds): Pressing and holding the desired key from **1** ~ **6** will save the current broadcast to the selected key and sound a BEEP.

## \* Troubleshooting

### 1. Antenna Error

If this message is displayed, the antenna or antenna cable is broken or unplugged. Please consult with your Kia dealership.

### 2. Acquiring Signal

If this message is displayed, it means that the antenna is covered and that the SIRIUS Satellite Radio signal is not available. Ensure the antenna is uncovered and has a clear view of the sky.

## Tune

- Rotate **TUNE** knob : Changes the channel number or scrolls category list.
- Press **TUNE** knob : Selects the menu.

## Menu

Select category menu through the **TUNE** knob ▶ Press the **MENU** key ▶ Select **[Info]** through the **TUNE** knob or **1** key

### Info (Information)

Displays the Artist/Song info of the current song.

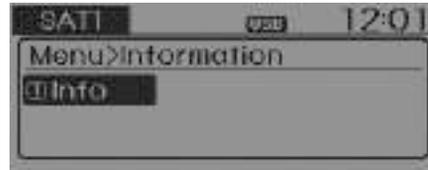

### Care of disc

- If the temperature inside the car is too high, open the car windows to ventilate before using the system.
- It is illegal to copy and use MP3/WMA files without permission. Use CDs that are created only by lawful means.
- Do not apply volatile agents, such as benzene and thinner, normal cleaners and magnetic sprays made for analogue disc onto CDs.
- To prevent the disc surface from getting damaged, hold CDs by the edges or the center hole only.
- Clean the disc surface with a piece of soft cloth before playback (wipe it from the center to the outside edge).
- Do not damage the disc surface or attach pieces of sticky tape or paper.
- Make certain only CDs are inserted into the CD player (Do not insert more than one CD at a time).
- Keep CDs in their cases after use to protect them from scratches or dirt.
- Depending on the type of CD-R/CD-RW CDs, certain CDs may not operate normally according to manufacturing companies or making and recording methods. In such circumstances, continued use may cause malfunctions to your audio system.

### \* NOTICE - Playing an Incompatible Copy Protected Audio CD

Some copy protected CDs, which do not comply with international audio CD standards (Red Book), may not play on your car audio. Please note that inability to properly play a copy protected CD may indicate that the CD is defective, not the CD player.

#### NOTE:

##### Order of playing files (folders) :

1. Song playing order : ① to ⑭ sequentially.

2. Folder playing order :

\* If no song file is contained in the folder, that folder is not displayed.

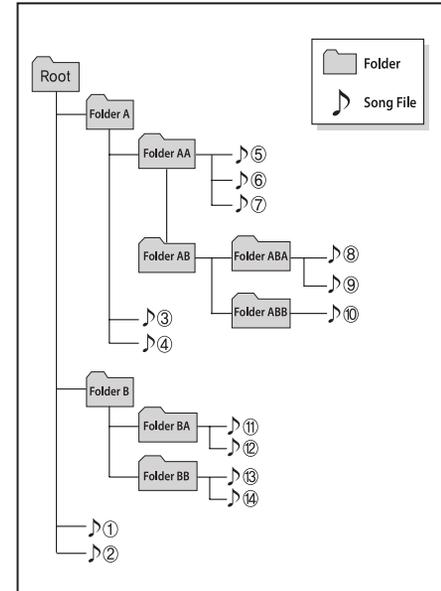
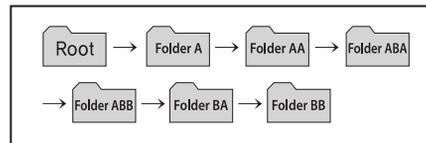

### CAUTION IN USING USB DEVICE

- To use an external USB device, make sure the device is not connected when starting up the vehicle. Connect the device after starting up.
- If you start the engine when the USB device is connected, it may damage the USB device. (USB flashdrives are very sensitive to electric shock.)
- If the engine is started up or turned off while the external USB device is connected, the external USB device may not work.
- The System may not play inauthentic MP3 or WMA files.
  - 1) It can only play MP3 files with the compression rate between 8Kbps~320Kbps.
  - 2) It can only play WMA music files with the compression rate between 8Kbps~320Kbps.
- Take precautions for static electricity when connecting or disconnecting the external USB device.

(Continued)

(Continued)

- An encrypted MP3 PLAYER is not recognizable.
- Depending on the condition of the external USB device, the connected external USB device can be unrecognizable.
- When the formatted byte/sector setting of External USB device is not either 512BYTE or 2048BYTE, then the device will not be recognized.
- Use only a USB device formatted to FAT 12/16/32.
- USB devices without USB I/F authentication may not be recognizable.
- Make sure the USB connection terminal does not come in contact with the human body or other objects.
- If you repeatedly connect or disconnect the USB device in a short period of time, it may break the device.
- You may hear a strange noise when connecting or disconnecting a USB device.

(Continued)

(Continued)

- If you disconnect the external USB device during playback in USB mode, the external USB device can be damaged or may malfunction. Therefore, disconnect the external USB device when the audio is turned off or in another mode. (e.g, Radio, SIRIUS or CD)
- Depending on the type and capacity of the external USB device or the type of the files stored in the device, there is a difference in the time taken for recognition of the device.
- Do not use the USB device for purposes other than playing music files.
- Playing videos through the USB is not supported.
- Use of USB accessories such as rechargers or heaters using USB I/F may lower performance or cause trouble.
- If you use devices such as a USB hub purchased separately, the vehicle's audio system may not recognize the USB device. In that case, connect the USB device directly to the multimedia terminal of the vehicle.

(Continued)



**(Continued)**

- *If the USB device is divided by logical drives, only the music files on the highest-priority drive are recognized by car audio.*
- *Devices such as MP3 Player/ Cellular phone/Digital camera can be unrecognizable by standard USB I/F can be unrecognizable.*
- *Charging through the USB may not be supported in some mobile devices.*
- *USB HDD or USB types liable to connection failures due to vehicle vibrations are not supported.  
(i-stick type)*
- *Some non-standard USB devices (METAL COVER TYPE USB) can be unrecognizable.*
- *Some USB flash memory readers (such as CF, SD, micro SD, etc.) or external-HDD type devices can be unrecognizable.*
- *Music files protected by DRM (DIGITAL RIGHTS MANAGEMENT) are not recognizable.*

**(Continued)**

**(Continued)**

- *The data in the USB memory may be lost while using this audio. Always back up important data on a personal storage device.*
- *Please avoid using USB memory products which can be used as key chains or cellular phone accessories as they could cause damage to the USB jack. Please make certain only to use plug type connector products as shown below.*



### \* NOTICE FOR USING THE iPod® DEVICE

- Some iPod models may not support communication protocol and files may not properly play.  
Supported iPod models:
  - iPod Mini
  - iPod 4th(Photo) ~ 6th(Classic) generation
  - iPod Nano 1st~4th generation
  - iPod Touch 1st~2nd generation
- The order of search or playback of songs in the iPod can be different from the order searched in the audio system.
- If the iPod disabled due to its own malfunction, reset the iPod. (Reset: Refer to iPod manual)
- An iPod may not operate normally on low battery.
- Some iPod devices, such as the iPhone, can be connected through the -interface. The device must have audio Bluetooth® wireless technology capability (such as stereo headphone Bluetooth® wireless technology ). The device can play, but it will not be controlled by the audio system.

(Continued)

(Continued)

- To use iPod features within the audio, use the cable provided upon purchasing an iPod device.
- Skipping or improper operation may occur depending on the characteristics of your iPod/Phone device.
- If your iPhone is connected to both the Bluetooth® wireless technology and USB, the sound may not be properly played. In your iPhone, select the Dock connector or Bluetooth® wireless technology to change the sound output (source).



### CAUTION IN USING THE iPod® DEVICE

- *When connecting iPod with the iPod Power Cable, insert the connector to the multimedia socket completely. If not inserted completely, communications between iPod and audio may be interrupted.*
- *When adjusting the sound effects of the iPod and the audio system, the sound effects of both devices will overlap and might reduce or distort the quality of the sound.*
- *Deactivate (turn off) the equalizer function of an iPod when adjusting the audio system's volume, and turn off the equalizer of the audio system when using the equalizer of an iPod.*
- *When not using iPod with car audio, detach the iPod cable from iPod. Otherwise, iPod may remain in accessory mode, and may not work properly.*

### **\* NOTICE FOR USING THE My Music**

- Even if memory is available, a maximum of 6,000 songs can be stored.
- The same song can be copied up to 1,000 times.
- Memory info can be checked in the System menu of Setup.

### **\* NOTICE FOR USING THE AUX**

- Fully insert the AUX cable into the AUX terminal for use.

## BASIC METHOD OF USE : Audio CD / MP3 CD / USB / iPod / My Music

Press the **MEDIA** key to change the mod mode in order of CD→USB(iPod)→AUX →My Music→BT Audio.

The folder/file name is displayed on the screen.

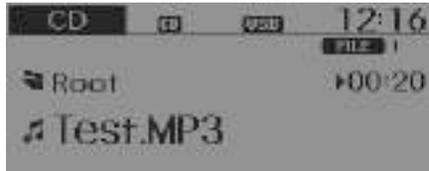

- \* The CD is automatically played when a CD is inserted.
- \* The USB music is automatically played when a USB is connected.

Press the **SETUP** key ▶ Select [**T**] Display through the **TUNE** knob or **1** key ▶ Select [Media Display] ▶ Media Display

- [Media Display] : The screen display info can be changed to Album/Artist/ Song name.

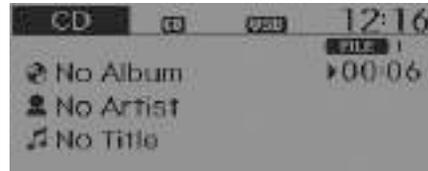

### Repeat

While song (file) is playing ▶ **1** (RPT) key

Audio CD, MP3 CD, USB, iPod, My Music mode: RPT on screen

- To repeat one song (Shortly pressing the key (under 0.8 seconds)): Repeats the current song.  
MP3 CD, USB mode: FLD.RPT on screen
- To repeat folder (Pressing and holding the key (over 0.8 seconds)): repeats all files within the current folder.
- \* Press the **1** key again to turn off repeat.

### Random

While song (file) is playing ▶ **2** (RDM) key

Audio CD, My Music mode: RDM on screen

- Random (Shortly pressing the key (under 0.8 seconds)): Plays all songs in random order.

MP3 CD, USB mode: FLD.RDM on screen

- Folder Random (Shortly pressing the key (under 0.8 seconds)): Plays all files within the current folder in random order.

iPod mode: ALB RDM on screen

- Album Random (Shortly pressing the key (under 0.8 seconds)): Plays all files within albums of the current category in random order.

MP3 CD, USB, iPod mode: ALL RDM on screen

- All Random (pressing and holding the key (over 0.8 seconds)): Plays all files in random order.

- \* Press the **2** key again to turn off repeat.

### Changing Song/File

While song (file) is playing ▶  key

- Shortly pressing the key (under 0.8 seconds): Plays the current song from the beginning.
- \* If the  key is pressed again within 1 second, the previous song is played.
- Pressing and holding the key (over 0.8 seconds): Rewinds the song.

While song (file) is playing ▶  key

- Shortly pressing the key (under 0.8 seconds): Plays the next song.
- Pressing and holding the key (over 0.8 seconds): Fast forwards the song.

### Scan

While song (file) is playing ▶  key

Scans all songs for 10 seconds starting from the next song.

- \* Press the  key again to turn off.
- \* The SCAN function is not supported in iPod mode.

### Folder Search : MP3 CD, USB Mode

While file is playing ▶  key  
() (Folder Up) key

- Searches the next folder.

While file is playing ▶  key  
() (Folder Down) key

- Searches the previous folder.
- \* If a folder is selected by pressing the  TUNE knob, the first file within the selected folder will be played.
- \* In iPod mode, moves to the Parent Folder.

### Searching Songs (File)

- Turning  TUNE knob : Searches for songs (files)
- Pressing  TUNE knob : Plays selected song (file).

**MENU : Audio CD**

Press the CD MP3 mode **MENU** key to set the Repeat, Random, Information features.

**Repeat**

Press the **MENU** key ▶ Set [**1 RPT**] through the **TUNE** knob or **1** key to repeat the current song.

\* Press RPT again to turn off.

**Random**

Press the **MENU** key ▶ Set [**2 RDM**] through the **TUNE** knob or **2** key to randomly play songs within the current folder.

\* Press RDM again to turn off.

**Information**

Press the **MENU** key ▶ Set [**3 Info**] through the **TUNE** knob or **3** key to display information of the current song.

\* Press the **MENU** key to turn off info display.

### MENU : MP3 CD / USB

Press the CD MP3 mode **MENU** key to set the Repeat, Folder Random, Folder Repeat, All Random, Information, and Copy features.



#### Repeat

Press the **MENU** key ▶ Set [**RPT**] through the **TUNE** knob or **1** key to repeat the current song.

\* Press RPT again to turn off.

#### Folder Random

Press the **MENU** key ▶ Set [**F.RDM**] through the **TUNE** knob or **2** key to randomly play songs within the current folder.

\* Press F.RDM again to turn off.

#### Folder Repeat

Press the **MENU** key ▶ Set [**F.RPT**] through the **TUNE** knob or **3** key to repeat songs within the current folder.

\* Press F.RPT again to turn off.

#### All Random

Press the **MENU** key ▶ Set [**A.RDM**] through the **TUNE** knob or **4** key to randomly play all songs within the CD.

\* Press A.RDM again to turn off.

#### Information

Press the **MENU** key ▶ Set [**Info**] through the **TUNE** knob or **5** key to display information of the current song.

\* Press the **MENU** key to turn off info display.

#### Copy

Press the **MENU** key ▶ Set [**Copy**] through the **TUNE** knob or **6** key.

This is used to copy the current song into My Music. You can play the copied Music in My Music mode.

\* If another key is pressed while copying is in progress, a pop up asking you whether to cancel copying is displayed.

\* If another media is connected or inserted (USB, CD, iPod, AUX) while copying is in progress, copying is canceled.

\* Music will not be played while copying is in progress.

**MENU : iPod**

In iPod mode, press the **MENU** key to set the Repeat, Album Random, All Random, and Information features.

**Repeat**

Press the **MENU** key ▶ Set [**RPT**] through the **TUNE** knob or **1** key to repeat the current song.

\* Press RPT again to turn repeat off.

**Album Random**

Press the **MENU** key ▶ Set [**Alb.RDM**] through the **TUNE** knob or **2** key.

Plays albums within the currently playing category in random order.

\* Press Alb.RDM again to turn off.

**All Random**

Press the **MENU** key ▶ Set [**A.RDM**] through the **TUNE** knob or **3** key.

Plays all songs within the currently playing category in random order.

\* Press A.RDM again to turn off.

**Information**

Press the **MENU** key ▶ Set [**Info**] through the **TUNE** knob or **4** key.

Displays information of the current song.

\* Press the **MENU** key to turn off info display.



### MENU : My Music Mode

In My Music mode, press the **MENU** key to set the Repeat, Random, Information, Delete, Delete All, and Delete Selection features.

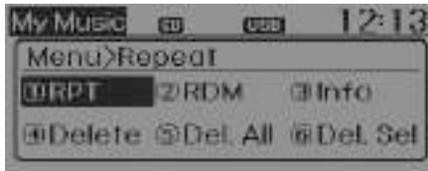

#### Repeat

Press the **MENU** key ▶ Set [**RPT**] through the **TUNE** knob or **1** key.

Repeats the currently playing song.

\* Press RPT again to turn repeat off.

#### Random

Press the **MENU** key ▶ Set [**RDM**] through the **TUNE** knob or **2** key.

Plays all songs within the currently playing folder in random order.

\* Press RDM again to turn random off.

#### Information

Press the **MENU** key ▶ Set [**Info**] through the **TUNE** knob or **3** key.

Displays information of the current song.

\* Press the **MENU** key to turn off info display.

#### Delete

Press the **MENU** key ▶ Set [**Delete**] through the **TUNE** knob or **4** key.

- Deletes currently playing file

In the play screen, pressing delete will delete the currently playing song.

- Deletes file from list

① Select the file you wish to delete by using the **TUNE** knob.

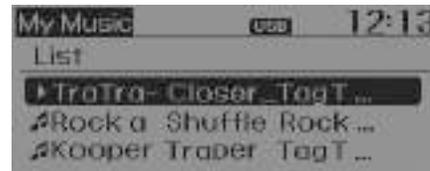

② Press the **MENU** key and select the delete menu to delete the selected file.

#### Delete All

Press the **MENU** key ▶ Set [**Del.All**] through the **TUNE** knob or **5** key.

Deletes all songs of My Music.

#### Delete Selection

Press the **MENU** key ▶ Set [**Del.Sel**] through the **TUNE** knob or **6** key.

Songs within My Music are selected and deleted.

① Select the songs you wish to delete from the list.

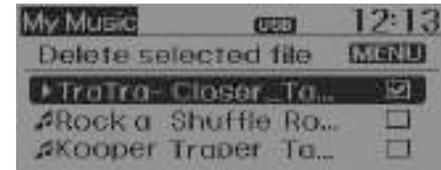

② After selecting, press the **MENU** key and select the delete menu.

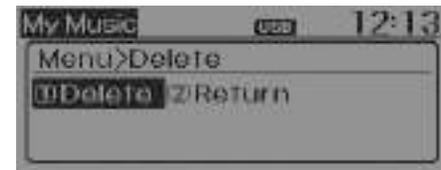

## AUX

AUX is used to play external MEDIA currently connected with the AUX terminal.

AUX mode will automatically start when an external device is connected to the AUX terminal.

If an external device is connected, you can also press the **MEDIA** key to change to AUX mode.



\* AUX mode cannot be started unless there is an external device connected to the AUX terminal.

**⚠ CAUTION IN USING  
BLUETOOTH® WIRELESS  
TECHNOLOGY CELLU-  
LAR PHONE**

- *Do not use a cellular phone or perform Bluetooth® wireless technology settings (e.g. pairing a phone) while driving.*
- *Some Bluetooth® wireless technology-enabled phones may not be recognized by the system or fully compatible with the system.*
- *Before using Bluetooth® wireless technology related features of the audio system, refer your phone's User's Manual for phone-side Bluetooth® wireless technology operations.*
- *The phone must be paired to the audio system to use Bluetooth® wireless technology related features.*
- *You will not be able to use the hands-free feature when your phone (in the car) is outside of the cellular service area (e.g. in a tunnel, in a underground, in a mountainous area, etc.).*

*(Continued)*

*(Continued)*

- *If the cellular phone signal is poor or the vehicles interior noise is too loud, it may be difficult to hear the other person's voice during a call.*
- *Do not place the phone near or inside metallic objects, otherwise communications with Bluetooth® wireless technology system or cellular service stations can be disturbed.*
- *While a phone is connected through Bluetooth® wireless technology your phone may discharge quicker than usual for additional Bluetooth® wireless technology-related operations.*
- *Some cellular phones or other devices may cause interference noise or malfunction to audio system. In this case, store the device in a different location may resolve the condition.*
- *Phone contact names should be saved in English or they may not be displayed correctly.*

*(Continued)*

*(Continued)*

- *If Priority is set upon vehicle ignition(IGN/ACC ON), the Bluetooth® wireless technology phone will be automatically connected. Even if you are outside, the Bluetooth® wireless technology-phone will be automatically connected once you are in the vicinity of the vehicle.  
If you do not want automatic Bluetooth® wireless technology-connection, turn the Bluetooth® wireless technology feature off.*
- *The hands-free call volume and quality may differ depending on the mobile phone type.*

**NOTE:**

If you need more information about Kia's Bluetooth® wireless technology Contact [kia website](http://kia.com) "www.kia.com" (OWNERS>General Info>BLUETOOTH).

**What is Bluetooth®?**

Bluetooth® wireless technology that allows multiple devices to be connected in a short range, low-powered devices like hands-free, stereo headset, wireless remote controller, etc. For more information, visit the Bluetooth® wireless technology website at [www.Bluetooth.com](http://www.Bluetooth.com)

**⚠ CAUTION**

- *Bluetooth® wireless technology features can be used only when the mobile phone has been paired and connected with the device. For more information on pairing and connecting Bluetooth® wireless technology mobile phones, refer to the "Phone Setup" section.*
- *When a Bluetooth® wireless technology mobile phone is connected, a (📶) icon will appear at the top of the screen. If a (📶) icon is not displayed, this indicates that a Bluetooth® wireless technology device has not been connected. You must connect the device before use. For more information on Bluetooth® wireless technology mobile phones, refer to the "Phone Setup" section.*

*(Continued)**(Continued)*

- *Pairing and connecting a Bluetooth® wireless technology mobile phone will work only when the Bluetooth® wireless technology option within your mobile phone has been turned on. (Methods of turning on the Bluetooth® wireless technology feature may differ depending on the mobile phone.)*
- *In some mobile phones, starting the ignition while talking through Bluetooth® wireless technology handsfree call will result in the call becoming disconnected. (Switch the call back to your mobile phone when starting the ignition.)*
- *Some features may not be supported in some Bluetooth® wireless technology mobile phone and devices.*
- *Bluetooth® wireless technology operation may be unstable depending on the communication state.*

### Bluetooth® wireless technology Audio

Before using Bluetooth® wireless technology audio features

- Bluetooth® wireless technology audio may not be supported depending on the compatibility of your Bluetooth® wireless technology mobile phone.
- In order to use Bluetooth® wireless technology audio, you must first pair and connect the Bluetooth® wireless technology mobile phone.
- Bluetooth® wireless technology audio can be used only when the [Audio Streaming] of Phone is turned **On**.
- \* Setting Bluetooth® wireless technology Audio Streaming : Press the **SETUP** key ▶ Select [Phone] through the tune knob or **4** key ▶ Select [Audio Streaming] through the **TUNE** knob ▶ Set **On**/**Off**

### Starting Bluetooth® wireless technology Audio

- Press the **MEDIA** key to change the mode in order of CD→USB→AUX→My Music→BT Audio.
- If BT Audio is selected, Bluetooth® wireless technology audio will start playing.
  - \* Audio may not automatically start playing in some mobile phones.



### Using the Bluetooth® wireless technology audio features

- Play / Stop  
Press the **TUNE** knob to play and pause the current song.
  - \* The previous song / next song / play / pause functions may not be supported in some mobile phones.

## PHONE

Before using the Bluetooth® wireless technology phone features

- In order to use Bluetooth® wireless technology phone, you must first pair and connect the Bluetooth® wireless technology mobile phone.
- If the mobile phone is not paired or connected, it is not possible to enter Phone mode. Once a phone is paired or connected, the guidance screen will be displayed.
- If Priority is set upon vehicle ignition (IGN/ACC ON), the Bluetooth® wireless technology phone will be automatically connected. Even if you are outside, the Bluetooth® wireless technology phone will be automatically connected once you are in the vicinity of the vehicle. If you do not want automatic Bluetooth® wireless technology phone connection, set the Bluetooth® wireless technology power to OFF.

### Making a call using the steering wheel remote controller(if equipped)



1. **VOL +**, **VOL -** button : Raises or lowers speaker volume.
2. **MODE** : Mode Change Each time the button pressed.
3. **MUTE** : Turns the sound on and off.
4. **☎** button : Places and transfers calls.
5. **☎** button : Ends calls or cancels functions.
6. **🗣** button : Activates voice recognition.

- Check call history and making call
  - ① Shortly press (under 0.8 seconds) the **☎** key on the steering remote controller .
  - ② The call history list will be displayed on the screen.
  - ③ Press the **☎** key again to connect a call to the selected number.
- Redialing the most recently called number
  - ① Press and hold (over 0.8 seconds) the **☎** key on the steering remote controller.
  - ② The most recently called number is redialed.
- \* If call history does not exist, a screen asking whether to download call history is displayed. (The download feature may not be supported in some mobile phones)

### Phone MENU

Press the **PHONE** key to display three menus (Call History, Contacts, Phone Setup).

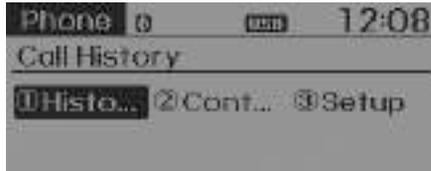

#### Call history

Press the **PHONE** key ▶ Set [**1**Call History] through the **TUNE** knob or **1** key.

The call history is displayed and can be used to select a number and make a call. If call history does not exist, a screen asking whether to download call history is displayed. (The download feature may not be supported in some mobile phones)

#### Contacts

Press the **PHONE** key ▶ Set [**2**Contacts] through the **TUNE** knob or **2** key.

The Contacts are displayed and can be used to select a number and make a call.

- \* If more than one number is saved to one contact, then a screen showing the mobile phone number, house and office number are displayed. Select the desired number to make the call.
- \* If Contacts do not exist, a screen asking whether to download Contacts is displayed. (The download feature may not be supported in some mobile phones)

#### Phone Setup

Press the **PHONE** key ▶ Set [**3**Phone Setup] through the **TUNE** knob or **3** key.

The Bluetooth® wireless technology mobile phone setup screen is displayed. For more information, refer to "Phone Setup".

### CAUTION IN USING VOICE COMMAND

- *The voice recognition feature of this product supports recognition of the commands listed within this user's manual.*
- *While using voice recognition, operating the steering remote control or the device will terminate voice recognition and allow you to manually operate desired functions.*
- *Position of the microphone is above the head of the driver's seat. For superior performance, maintain good posture when saying voice commands.*
- *Voice recognition may not function properly due to outside noise. The following conditions can affect the performance of Voice Recognition:*
  - *When the windows and sunroof are open*
  - *When the heating/cooling system is on*
  - *When passing a tunnel*
  - *When driving on rugged and uneven roads*

(Continued)

(Continued)

- *After downloading Bluetooth® wireless technology contacts, the system requires some times to convert the contacts into voice information. During this time, voice recognition may not operate properly.*
- *Upon inputting your contacts, special symbols and numbers cannot be recognized by voice. For example, “# John Doe%&” will be recognized as “John Doe”.*

## VOICE COMMAND

### Starting Voice Command

- To start voice command, shortly press the  key on the steering wheel remote controller.
- If voice command is in [Normal Mode], then the system will say “Please say a command. Beep”
- \* If voice command is in [Expert Mode], then the system will only say a “Beep.”
- \* Setting Voice command [Normal Mode]/[Expert Mode]:  
Press the **SETUP** key ▶ Select [System] through the  TUNE knob or **5** key ▶ Select [Prompt Feedback] through the  TUNE knob ▶ Set [Normal Mode]/[Expert Mode]
- Say the voice command.

### CAUTION

*For proper voice recognition, say the voice command after the guidance message and the “Beep” sound.*



### Skipping the Guidance Message

While the guidance message is being stated, shortly press the  key (under 0.8 seconds) to discontinue the guidance message and sound the “beep”.

After the “beep”, say the voice command.

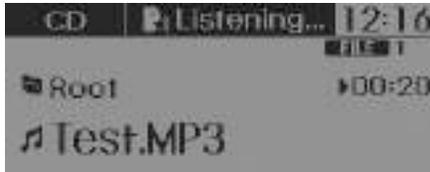

### Ending Voice Command

- While using voice command, press and hold the  key (over 0.8 seconds) to end voice command.
- While using voice command, pressing the steering wheel remote controller or a different key will end voice command.
- In a state where the system is waiting for your voice command, say “cancel” or “end” to end voice command.
- In a state where the system is waiting for your voice command, shortly press the  key (under 0.8 seconds) to end voice command.

\* Illustration on using voice commands

• Starting voice command.

Shortly pressing the  key (under 0.8 seconds):

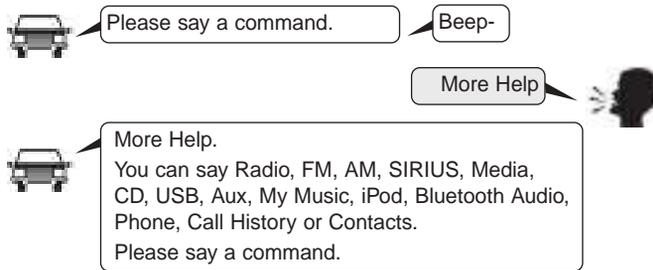

• Skipping Voice Recognition

Shortly pressing the  key (under 0.8 seconds):

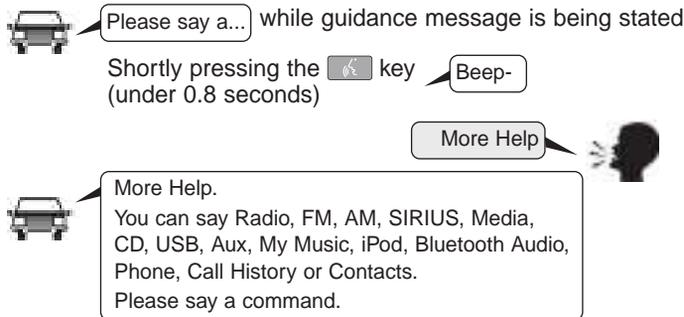

• End voice command.

Shortly pressing the  key (under 0.8 seconds):



### Voice Command List

- **Common Commands:** These are commands that can be used in all situations. (However, some commands may not be supported in special circumstances.)

Command	Function
More Help	Provides guidance on commands that can be used anywhere in the system.
Help	Provides guidance on commands that can be used within the current mode.
Call <Name>	Calls <Name> saved in Contacts.
Dial <Number>	Call can be made by dialing the spoken numbers.
Phone	Provides guidance on Phone related commands. After saying this command, say "Call History", "Contacts" to execute corresponding functions.
Call History	Displays the Call History screen.
Contacts (Call by Name)	Displays the Contacts screen. After saying this command, say the name of a contact saved in the Contacts to automatically connect the call.
Dial Number	Display the Dial number screen. After saying this command, you can say the number what you want to call.
Redial	Connects the most recently called number.
Radio	<ul style="list-style-type: none"> <li>• When listening to the radio, displays the next radio screen. (FM1→FM2→AM→SAT1→SAT2→SAT3→FM1)</li> <li>• When listening to a different mode, displays the most recently played radio screen.</li> </ul>
FM	<ul style="list-style-type: none"> <li>• When currently listening to the FM radio, maintains the current state.</li> <li>• When listening to a different mode, displays the most recently played FM screen.</li> </ul>

Command	Function
FM1(FM One)	Displays the FM1 screen.
FM2(FM Two)	Displays the FM2 screen.
AM	Displays the AM screen.
FM Preset 1~6	Plays the most recently played broadcast saved in FM Preset 1~6.
AM Preset 1~6	Plays the broadcast saved in AM Preset 1~6.
FM 87.5~107.9	Plays the FM broadcast of the corresponding frequency.
AM 530~1710	Plays the AM broadcast of the corresponding frequency.
SIRIUS(Satellite)	<ul style="list-style-type: none"> <li>• When currently listening to the SIRIUS, maintains the current state.</li> <li>• When listening to a different mode, displays the most recently played SIRIUS screen.</li> </ul>
SIRIUS(Satellite) 1~3	Displays the selected SIRIUS screen.
SIRIUS Channel 0~223	Plays the selected SIRIUS channel.
Media	Moves to the most recently played media screen.
Play Track 1~30	If a music CD has been inserted, plays the corresponding track.
CD	Plays the music saved in the CD.

- FM/AM radio commands: Commands that can be used while listening to FM, AM radio.

Command	Function
Search CD	Moves to the CD track or file selection screen. <ul style="list-style-type: none"> <li>• For audio CDs, move to the screen and say the track number to play the corresponding track.</li> <li>• Moves to the MP3 CD file selection screen. After manually operate the device to select and play music.</li> </ul>
USB	Plays USB music.
Search USB	Moves to the USB file selection screen. After manually operate the device to select and play music.
iPod	Plays iPod music.
Search iPod	Moves to the iPod file selection screen. After, manually operate the device to select and play music.
My Music	Plays the music saved in My Music.
Search My Music	Moves to the My Music file selection screen. After manually operate the device to select and play music.
AUX (Auxiliary)	Plays the connected external device.
Bluetooth Audio	Plays the music saved in connected Bluetooth® device.
Mute	Mutes the radio or music volume.
Pardon?	Repeats the most recent comment.
Cancel (Exit)	Ends voice command.

Command	Function
Preset 1~6	Plays the broadcast saved in Preset 1~6.
Auto Store	Automatically selects radio broadcast frequencies with superior reception and saves in Presets 1~6.
Preset Save 1~6	Saves the current broadcast frequency to Preset 1~6.
Seek up	Plays the next receivable broadcast.
Seek down	Plays the previous receivable broadcast.
Next Preset	Selects the preset number next to the most recently selected preset. (Example: When currently listening to preset no. 3, then preset no. 4 will be selected.)
Previous Preset	Selects the preset number previous to the most recently selected preset. (Example: When currently listening to preset no. 3, then preset no. 2 will be selected.)
Scan	Scans receivable frequencies from the current broadcast and plays for 5 seconds each.
Preset Scan	Moves to the next preset from the current present and plays for 10 seconds each.
Information	Displays the information of the current broadcast. (This feature can be used when receiving RBDS broadcasts.)

## Features of your vehicle

---

- **Satellite radio commands:** Commands that can be used while listening to Satellite Radio.

<b>Command</b>	<b>Function</b>
Channel Up	Plays the channel next to the current broadcast.
Channel Down	Plays the channel previous to the current broadcast.
Next Preset	Selects the preset number next to the most recently selected preset. (Example: When currently listening to preset no. 3, then preset no. 4 will be selected.)
Previous Preset	Selects the preset number previous to the most recently selected preset. (Example: When currently listening to preset no. 3, then preset no. 2 will be selected.)
Category	Moves to the Category selection screen.
Scan	Scans receivable channels from the current broadcast and plays for 5 seconds each.
Preset 1~6	Plays the broadcast saved in Preset 1~6.
Preset Save 1~6	Saves the current broadcast channel to 1~6.
Information	Displays the information of the current broadcast.

- **Audio CD commands:** Commands that can be used while listening to Audio CD.

<b>Command</b>	<b>Function</b>
Random	Randomly plays the tracks within the CD.
Random Off	Cancel random play to play tracks in sequential order.
Repeat	Repeats the current track.
Repeat Off	Cancel repeat play to play tracks in sequential order.
Next Track	Plays the next track.
Previous Track	Plays the previous track.
Scan	Scans the tracks from the next track for 10 seconds each.
Track 1~30	Plays the desired track number.
Search Track	Moves to the track selection screen. After, say the track name to play the corresponding track.
Information	Displays the information screen of the current track.

- MP3 CD / USB commands: Commands that can be used while listening to music files saved in CD and USB.

Command	Function
Random	Randomly plays the files within the current folder.
All Random	Randomly plays all saved files.
Random Off	Cancels random play to play files in sequential order.
Repeat	Repeats the current file.
Folder Repeat	Repeats all files in the current folder.
Repeat Off	Cancels repeat play to play files in sequential order.
Next File	Plays the next file.
Previous File	Plays the previous file.
Scan	Scans the files from the next files for 10 seconds each.
Search File	Moves to the file selection screen.
Search Folder	Moves to the folder selection screen.
Information	Displays the information screen of the current file.
Copy	Copies the current file into My Music.

- iPod Commands: Commands that can be used while playing iPod.

Command	Function
All Random	Randomly plays all saved songs.
Album Random	Randomly plays the songs within the current category.
Random Off	Cancels random play to play songs in sequential order.
Repeat	Repeats the current song.
Repeat Off	Cancels repeat play to play songs in sequential order.
Next Song	Plays the next song.
Previous Song	Plays the previous song.
Search Song	Moves to the song selection screen.
Information	Displays the information screen of the current song.

## Features of your vehicle

---

- My Music Commands: Commands that can be used while playing My Music.

Command	Function
Random	Randomly plays all saved files.
Random Off	Cancels random play to play files in sequential order.
Repeat	Repeats the current file.
Repeat Off	Cancels repeat play to play files in sequential order.
Next File	Plays the next file.
Previous File	Plays the previous file.
Scan	Scans the files from the next files for 10 seconds each.
Search File	Moves to the file selection screen.
Information	Displays the information screen of the current file.
Delete	Deletes the current file. You will bypass an additional confirmation process.
Delete All	Deletes all files saved in My Music. You will bypass an additional confirmation process.

- Bluetooth® wireless technology Audio Commands: Commands that can be used while playing Phone Music.

Command	Function
Play	Plays the currently paused song.
Pause	Pauses the current song.

**Before driving / 5-3**  
**Key positions / 5-4**  
**ENGINE START/STOP button / 5-6**  
**Starting the engine / 5-9**  
**Manual transaxle / 5-12**  
**Automatic transaxle / 5-15**  
**Brake system / 5-21**  
**Cruise control system / 5-32**  
**ISG (Idle Stop and Go) system / 5-37**  
**Active eco system / 5-41**  
**Economical operation / 5-42**

## Driving your vehicle

5

**Special driving conditions / 5-44**  
**Winter driving / 5-48**  
**Trailer towing / 5-50**  
**Vehicle load limit / 5-51**  
**Vehicle weight / 5-56**



### **Be sure the exhaust system does not leak.**

The exhaust system should be checked whenever the vehicle is raised to change the oil or for any other purpose. If you hear a change in the sound of the exhaust or if you drive over something that strikes the underneath side of the car, have the exhaust system checked as soon as possible by an authorized Kia dealer.

#### **WARNING - Engine exhaust**

Do not inhale exhaust fumes or leave your engine running in a enclosed area for a prolonged time. Exhaust fumes contain carbon monoxide, a colorless, odorless gas that can cause unconsciousness and death by asphyxiation.

#### **WARNING - Open tailgate**

**Do not drive with the tailgate open. Poisonous exhaust gases can enter the passenger compartment**

**If you must drive with the tailgate open proceed as follows:**

- 1. Close all windows.**
- 2. Open side vents.**
- 3. Set the air intake control at "Fresh", the air flow control at "Floor" or "Face" and the fan at the highest speed.**

## BEFORE DRIVING

### Before entering vehicle

- Be sure that all windows, outside mirror(s), and outside lights are clean.
- Check the condition of the tires.
- Check under the vehicle for any sign of leaks.
- Be sure there are no obstacles behind you if you intend to back up.

### Necessary inspections

Fluid levels, such as engine oil, engine coolant, brake fluid, and washer fluid should be checked on a regular basis, with the exact interval depending on the fluid. Further details are provided in Section 7, "Maintenance".

**WARNING - Distracted driving**

**Focus on the road while driving. The driver's primary responsibility is in the safe and legal operation of the vehicle. Use of any handled devices, other equipment or vehicle systems that distract the drive should not be used during vehicle operation.**

### Before starting

- Close and lock all doors.
  - Position the seat so that all controls are easily reached.
  - Buckle your seat belt.
  - Adjust the inside and outside rearview mirrors.
  - Be sure that all lights work.
  - Check all gauges.
  - Check the operation of warning lights when the ignition switch is turned to the ON position.
  - Release the parking brake and make sure the brake warning light goes out.
- For safe operation, be sure you are familiar with your vehicle and its equipment.

**WARNING - Check surrounding**

**Always check the surrounding areas near your vehicle for people, especially children, before putting a vehicle into D (Drive) or R (Reverse).**

**⚠ WARNING - Driving while intoxicated**

Do not drive while intoxicated. Drinking and driving is dangerous. Even a small amount of alcohol will affect your reflexes, perceptions and judgment. Driving while under the influence of drugs is as dangerous as or more dangerous than driving drunk.

**⚠ WARNING - Loose object**

Securely store items in your vehicle. When you make a sudden stop or turn the steering wheel rapidly, loose objects may drop on the floor and it could interfere with the operation of the foot pedals, possibly causing an accident.

**⚠ WARNING - Fire risk**

When you intend to park or stop the vehicle with the engine on, be careful not to depress the accelerator pedal for a long period of time. It may overheat the engine or exhaust system and cause fire.

**KEY POSITIONS**



OUB051001

**Illuminated ignition switch (if equipped)**

Whenever a front door is opened, the ignition switch will illuminate for your convenience, provided the ignition switch is not in the ON position. The light will go off immediately when the ignition switch is turned on. It will also go off after about 30 seconds when the door is closed.



OTD059016

### Ignition switch position

#### **LOCK**

The ignition key can be removed only in the LOCK position.

When turning the ignition switch to the LOCK position, push the key inward at the ACC position and turn the key toward the LOCK position.

Before leaving the driver's seat, always make sure the shift lever is engaged in 1st gear for the manual transaxle or P (Park) for automatic transaxle, set the parking brake fully and shut the engine off.

#### **ACC (Accessory)**

The electrical accessories are operative.

#### **ON**

The warning lights can be checked before the engine is started. This is the normal running position after the engine is started. *Do not leave the ignition switch ON if the engine is not running to prevent battery discharge.*

#### **START**

Turn the ignition switch to the START position to start the engine. The engine will crank until you release the key; then it returns to the ON position. The brake warning light can be checked in this position.

#### **⚠ WARNING - Ignition switch**

**Never turn the ignition switch to LOCK or ACC while the vehicle is moving. This would result in loss of directional control and braking function, which could cause an accident.**

#### **⚠ WARNING - Steering wheel**

**Never reach for any controls through the steering wheel while the vehicle is in motion. The presence of your hand or arm in this area could cause a loss of vehicle control.**

## ENGINE START/STOP BUTTON (IF EQUIPPED)



### Illuminated ENGINE START/STOP button

Whenever the front door is opened, the ENGINE START/STOP button will illuminate for your convenience. The light will go off after about 30 seconds when the door is closed.

### ENGINE START/STOP button position *OFF*



To turn off the engine (START/RUN position) or vehicle power (ON position), press the ENGINE START/STOP button with the shift lever in the P (Park) position. When you press the ENGINE START/STOP button without the shift lever in the P (Park) position, the ENGINE START/STOP button will not change to the OFF position but to the ACC position.

In an emergency situation while the vehicle is in motion, you are able to turn the engine off and to the ACC position by pressing the ENGINE START/STOP button for more than 2 seconds or 3 times successively within 3 seconds. If the vehicle is still moving, you can restart the engine without depressing the brake pedal by pressing the ENGINE START/STOP button with the shift lever in the N (Neutral) position.

**ACC(Accessory)**



Orange

**ON**



Blue

**START/RUN**



Not illuminated

Press the ENGINE START/STOP button while it is in the OFF position without depressing the brake pedal.

The electrical accessories are operational.

If the ENGINE START/STOP button is in the ACC position for more than 1 hour, the button is turned off automatically to prevent battery discharge.

Press the ENGINE START/STOP button while it is in the ACC position without depressing the brake pedal.

The warning lights can be checked before the engine is started. Do not leave the ENGINE START/STOP button in the ON position for a long time. The battery may discharge, because the engine is not running.

To start the engine, depress the brake pedal and press the ENGINE START/STOP button with the shift lever in the P (Park) or the N (Normal) position. For your safety, start the engine with the shift lever in the P (Park) position.

If you press the ENGINE START/STOP button without depressing the brake pedal, the engine will not start and the button will change as follow:

OFF → ACC → ON → OFF

If you leave the ENGINE START/ STOP button in the ACC or ON position for a long time, the battery will discharge.

 **WARNING - Starting vehicle**

Never press the ENGINE START/STOP button while the vehicle is in motion. This would result in loss of directional control and braking function, which could cause an accident.

## STARTING THE ENGINE

### **WARNING - Proper footwear**

Always wear appropriate shoes when operating your vehicle. Unsuitable shoes (high heels, ski boots, sandals, etc.) may interfere with your ability to use the brake and accelerator pedal.

### Starting the engine with an ignition key (if equipped)

1. Make sure the parking brake is applied.
2. **Manual Transaxle** - Depress the clutch pedal fully and shift the transaxle into Neutral. Keep the clutch pedal and brake pedal depressed while turning the ignition switch to the start position.

**Automatic Transaxle** - Place the transaxle shift lever in P (Park). Depress the brake pedal fully.

*You can also start the engine when the shift lever is in the N (Neutral) position.*

3. Turn the ignition switch to START and hold it there until the engine starts (a maximum of 10 seconds), then release the key.
4. In extremely cold weather (below -18°C / 0°F) or after the vehicle has not been operated for several days, let the engine warm up without depressing the accelerator.

*Whether the engine is cold or warm, it should be started **without depressing the accelerator.***

If the engine stalls while the vehicle is in motion, do not attempt to move the shift lever to the P (Park) position. If traffic and road conditions permit, you may put the shift lever in the N (Neutral) position while the vehicle is still moving and turn the ignition switch to the START position in an attempt to restart the engine.

### **CAUTION - Starter**

***Do not engage the starter for more than 10 seconds. If the engine stalls or fails to start, wait 5 to 10 seconds before re-engaging the starter. Improper use of the starter may damage it.***





### Starting the engine with a smart key (if equipped)

1. Carry the smart key or leave it inside the vehicle.
2. Make sure the parking brake is firmly applied
3. Place the transaxle shift lever in P (Park).
4. Press the ENGINE START/STOP button while depressing the brake pedal.
5. In extremely cold weather (below -18°C / 0°F) or after the vehicle has not been operated for several days, let the engine warm up without depressing the accelerator.

Whether the engine is cold or warm, it should be started without depressing the accelerator.

- Even if the smart key is in the vehicle, if it is far away from you, the engine may not start.
- When the ENGINE START/STOP button is in the ACC position or above, if any door is opened, the system checks for the smart key. If the smart key is not in the vehicle, the "KEY OUT" or "KEY NOT IN VEHICLE" indicator will blink or the warning "Key not in vehicle" will illuminate on the LCD display. And if all doors are closed, the chime will sound for 5 seconds. The indicator or warning will turn off while the vehicle is moving. Always have the smart key with you.

The engine will start, only when the smart key is in the vehicle.

### **⚠ WARNING - Unintended vehicle movement**

**Never leave the smart key in the vehicle with children or vehicle occupants who are unfamiliar with the vehicle operation. Pushing the ENGINE START/STOP button while the smart key is in the vehicle may result in unintended engine activation and/or unintended vehicle movement.**



(Continued)

- When the stop lamp fuse is blown, you can't start the engine normally. Replace the fuse with a new one. If it is not possible, you can start the engine by pressing the ENGINE START/STOP button for 10 seconds while it is in the ACC position. The engine can start without depressing the brake pedal. But for your safety always depress the brake pedal before starting the engine.

Do not press the ENGINE START/ STOP button for more than 10 seconds except when the stop lamp fuse is blown.

**\* NOTICE**

- If the battery is weak or the smart key does not work correctly, you can start the engine by pressing the engine start/stop button with the smart key.

(Continued)

## MANUAL TRANSAXLE (IF EQUIPPED)



⇒ The shift lever can be moved without pressing the button.

➔ The button (1) should be pressed when moving the shift lever into reverse.

OUB051013

### Manual transaxle operation

The manual transaxle has 6 forward gears.

This shift pattern is imprinted on the shift knob. The transaxle is fully synchronized in all forward gears so shifting to either a higher or a lower gear is easily accomplished.

Depress the clutch pedal down fully while shifting, then release it slowly.

If your vehicle is equipped with an ignition lock switch, the engine will not start when starting the engine without depressing the clutch pedal.

The shift lever must be returned to the neutral position before shifting into R (Reverse). The ring (1) located below the shift knob must be pulled upward while moving the shift lever to the R (Reverse) position.

*Make sure the vehicle is completely stopped before shifting into R (Reverse).*

*Never operate the engine with the tachometer (rpm) in the red zone.*



### **CAUTION - Downshifting**

***Do not downshift more than 2 gears or downshift the gear when the engine is running at high speed (5,000 RPM or higher). Such a downshifting may damage the engine.***

- During cold weather, shifting may be difficult until the transaxle lubricant is warmed up. This is normal and not harmful to the transaxle.
- If you've come to a complete stop and it's hard to shift into 1st or R (Reverse), leave the shift lever at neutral position and release the clutch. Depress the clutch pedal back down, and then shift into 1st or R (Reverse) gear position.

 **CAUTION - Premature wear**

- *Do not drive with your foot resting on the clutch pedal or use the clutch pedal to hold the vehicle stopped on an uphill or at a traffic light. This will result in premature clutch wear.*
- *Do not use the shift lever as a handrest during driving, as this can result in premature wear of the transaxle shift forks.*

 **WARNING - Incline parking**  
**Before leaving the driver's seat, always set the parking brake fully and shut the engine off. Then make sure the transaxle is shifted into 1st gear when the vehicle is parked on a level or uphill grade, and shifted into R (Reverse) on a downhill grade. Unexpected and sudden vehicle movement can occur if these precautions are not followed in the order identified.**

***Using the clutch***

The clutch should be depressed all the way to the floor before shifting, then released slowly. The clutch pedal should always be fully released while driving. Do not rest your foot on the clutch pedal while driving. This can cause unnecessary wear. Do not partially engage the clutch to hold the vehicle on an incline. This causes unnecessary wear. Use the foot brake or parking brake to hold the vehicle on an incline. Do not operate the clutch pedal rapidly and repeatedly.

***Downshifting***

When you must slow down in heavy traffic or while driving up steep hills, downshift before the engine starts to labor. Downshifting reduces the chance of stalling and gives better acceleration when you need to increase your speed again. When the vehicle is traveling down steep hills, downshifting helps maintain safe speed and prolongs brake life.

### Good driving practices

- Never take the vehicle out of gear and coast down a hill. This is extremely hazardous. Always leave the vehicle in gear.
- Don't "ride" the brakes. This can cause them to overheat and malfunction. Instead, when you are driving down a long hill, shift to a lower gear. When you do this, engine braking will help slow down the vehicle.
- Slow down before shifting to a lower gear. This will help avoid over-revving the engine, which can cause damage.
- Slow down when you encounter cross winds. This gives you much better control of your vehicle.
- Be sure the vehicle is completely stopped before you attempt to shift into R (Reverse). The transaxle can be damaged if you do not.
- Exercise extreme caution when driving on a slippery surface. Be especially careful when braking, accelerating or shifting gears. On a slippery surface, an abrupt change in vehicle speed can cause the drive wheels to lose traction and the vehicle to go out of control.
- Always buckle-up! In a collision, an unbelted occupant is significantly more likely to be seriously injured or killed than a properly belted occupant.
- Never exceed posted speed limits.

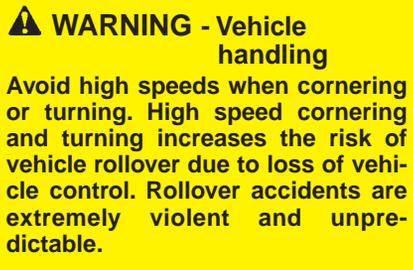

## AUTOMATIC TRANSAXLE (IF EQUIPPED)

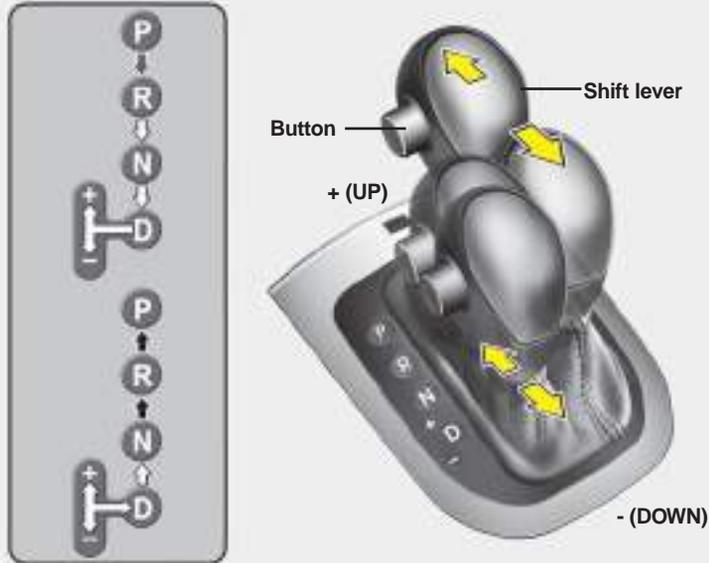

-  To shift, depress the brake pedal and press the button.
-  Press the button when shifting.
-  The shift lever can be shifted freely.

OUB051014

### Automatic transaxle operation

The automatic transaxle has 6 forward speeds and one reverse speed. The individual speeds are selected automatically, depending on the position of the shift lever.

### \* NOTICE

The first few shifts on a new vehicle, if the battery has been disconnected, may be somewhat abrupt. This is a normal condition, and the shifting sequence will adjust after shifts are cycled a few times by the TCM (Transaxle Control Module) or PCM (Powertrain Control Module).

For smooth operation, depress the brake pedal when shifting from N (Neutral) to a forward or reverse gear.

**⚠ WARNING - Automatic transaxle**

Before leaving the driver's seat, always make sure the shift lever is in the P (Park) position; then set the parking brake fully and shut the engine off. Do not use the P position in place of the parking brake. Always make sure the shift lever is latched in the P position and set the parking brake fully. Unexpected and sudden vehicle movement can occur if these precautions are not followed.

**⚠ CAUTION - Transaxle**

*To avoid damage to your transaxle, do not accelerate the engine in R (Reverse) or any forward gear position with the brakes on. The transaxle may be damaged if you shift into P (Park) while the vehicle is in motion.*

When stopped on an upgrade, do not hold the vehicle with engine power. Use the service brake or the parking brake.

***Transaxle ranges***

The indicator light in the instrument cluster displays the shift lever position when the ignition switch is in the ON position.

**P (Park)**

Always come to a complete stop before shifting into P (Park). This position locks the transaxle and prevents the front wheels from rotating.

Shifting into P (Park) while the vehicle is in motion will cause the drive wheels to lock which will cause you to lose control of the vehicle.

**R (Reverse)**

Use this position to drive the vehicle backward.

 **CAUTION - Shifting**

*Always come to a complete stop before shifting into or out of R (Reverse); you may damage the transaxle if you shift into R (Reverse) while the vehicle is in motion, except when "Rocking the Vehicle" explained in this section.*

**N (Neutral)**

The wheels and transaxle are not engaged. The vehicle will roll freely even on the slightest incline unless the parking brake or service brakes are applied.

**D (Drive)**

This is the normal forward driving position. The transaxle will automatically shift through a 6-gear sequence, providing the best fuel economy and power.

For extra power when passing another vehicle or climbing grades, depress the accelerator fully, at which time the transaxle will automatically downshift to the next lower gear.

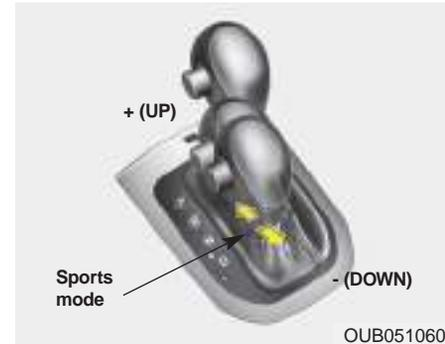
**Sports mode**

Whether the vehicle is stopped or in motion, sports mode is selected by pushing the shift lever from the D (Drive) position into the manual gate. To return to D (Drive) range operation, push the shift lever back into the main gate.

In sports mode, moving the shift lever backwards and forwards will allow you to make gearshifts rapidly. In contrast to a manual transaxle, the sports mode allows gearshifts with the accelerator pedal depressed.



Up (+) : Push the lever forward once to shift up one gear.

Down (-) : Pull the lever backwards once to shift down one gear.

- In sports mode, the driver must execute upshifts in accordance with road conditions, taking care to keep the engine speed below the red zone.
- In sports mode, only the 6 forward gears can be selected. To reverse or park the vehicle, move the shift lever to the R (Reverse) or P (Park) position as required.
- In sports mode, downshifts are made automatically when the vehicle slows down. When the vehicle stops, 1st gear is automatically selected.
- In sports mode, when the engine rpm approaches the red zone shift points are varied to upshift automatically.
- To maintain the required levels of vehicle performance and safety, the system may not execute certain gearshifts when the shift lever is operated.

- When driving on a slippery road, push the shift lever forward into the +(up) position. This causes the transaxle to shift into the 2nd gear which is better for smooth driving on a slippery road. Push the shift lever to the -(down) side to shift back to the 1st gear.

### ***Shift lock system (if equipped)***

For your safety, the automatic transaxle has a shift lock system which prevents shifting the transaxle out of P (Park) unless the brake pedal is depressed.

To shift the transaxle from P (Park) into R (Reverse):

1. Depress and hold the brake pedal.
2. Start the engine or turn the ignition switch to the ON position.
3. Move the shift lever.

If the brake pedal is repeatedly depressed and released with the shift lever in the P (Park) position, a chattering noise near the shift lever may be heard. This is a normal condition.

### **WARNING - Shifting from park**

**Always fully depress the brake pedal before and while shifting out of the P (Park) position into another position to avoid inadvertent motion of the vehicle.**

### Shift-lock override

If the shift lever cannot be moved from the P (Park) or N (Neutral) position into the R (Reverse) position with the brake pedal depressed, continue depressing the brake, then do the following:



### Shift-lock override (with smart key system)

1. Carefully remove the cap covering the shift-lock access hole (1).
2. Insert a key (or screwdriver) into the access hole and press down on the key (or screwdriver).
3. Move the shift lever.
4. Have your vehicle inspected by an authorized Kia dealer immediately

### Ignition key interlock system (if equipped)

The ignition key cannot be removed unless the shift lever is in the P (Park) position.

### Good driving practices

- Never move the shift lever from P (Park) or N (Neutral) to any other position with the accelerator pedal depressed.
- Never move the shift lever into P (Park) when the vehicle is in motion.
- Slow down before shifting to a lower gear. Otherwise, the lower gear may not be engaged.
- Always use the parking brake. Do not depend on placing the transaxle in P (Park) to keep the vehicle from moving.
- Optimum vehicle performance and economy is obtained by smoothly depressing and releasing the accelerator pedal.

### ***Moving up a steep grade from a standing start***

To move up a steep grade from a standing start, depress the brake pedal, shift the shift lever to D (Drive). Select the appropriate gear depending on load weight and steepness of the grade, and release the parking brake. Depress the accelerator gradually while releasing the service brakes.

## BRAKE SYSTEM

### Power brakes

Your vehicle has power-assisted brakes that adjust automatically through normal usage.

In the event that the power-assisted brakes lose power because of a stalled engine or some other reason, you can still stop your vehicle by applying greater force to the brake pedal than you normally would. The stopping distance, however, will be longer.

When the engine is not running, the reserve brake power is partially depleted each time the brake pedal is applied. Do not pump the brake pedal when the power assist has been interrupted.

Pump the brake pedal only when necessary to maintain steering control on slippery surfaces.



### **CAUTION - Brake pedal**

***Do not drive with your foot resting on the brake pedal. This will create abnormally high brake temperatures which can cause excessive brake lining and pad wear.***



### **WARNING - Steep hill braking**

**Avoid continuous application of the brakes when descending a long or steep hill by shifting to a lower gear. Continuous brake application will cause the brakes to overheat and could result in a temporary loss of braking performance.**

Wet brakes may impair the vehicle's ability to safely slow down; the vehicle may also pull to one side when the brakes are applied. Applying the brakes lightly will indicate whether they have been affected in this way. To dry the brakes, apply them lightly while maintaining a safe forward speed until brake performance returns to normal.

### *In the event of brake failure*

If service brakes fail to operate while the vehicle is in motion, you can make an emergency stop with the parking brake. The stopping distance, however, will be much greater than normal.



### **WARNING - Parking brake**

**Avoid applying the parking brake to stop the vehicle while it is moving except in an emergency situation. Applying the parking brake while the vehicle is moving at normal speeds can cause a sudden loss of control of the vehicle. If you must use the parking brake to stop the vehicle, use great caution in applying the brake.**

### ***Disc brakes wear indicator***

When your brake pads are worn and new pads are required, you will hear a high-pitched warning sound from your front brakes or rear brakes (if equipped). You may hear this sound come and go or it may occur whenever you depress the brake pedal.

Please remember that some driving conditions or climates may cause a brake squeal when you first apply (or lightly apply) the brakes. This is normal and does not indicate a problem with your brakes.

### **⚠ CAUTION - Replace brake pedal**

***Do not continue to drive with worn brake pads. Continuing to drive with worn brake pads can damage the braking system and result in costly brake repairs.***

Always replace the front or rear brake pads as pairs.

### **⚠ WARNING - Brake wear**

**Do not ignore high pitched wear sounds from your brakes. If you ignore this audible warning, you will eventually lose braking performance, which could lead to a serious accident.**

### ***Rear drum brakes (if equipped)***

Your rear drum brakes do not have wear indicators. Therefore, have the rear brake linings inspected if you hear a rubbing noise. Also have your rear brakes inspected each time you change or rotate your tires and when you have the front brakes replaced.

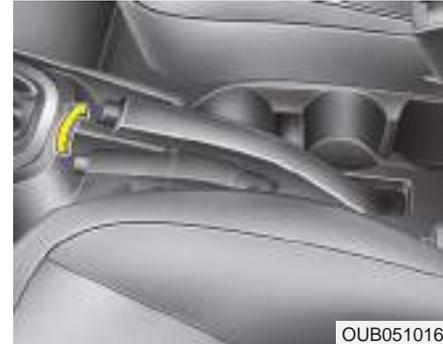

OUB051016

### **Parking brake**

#### ***Applying the parking brake***

To engage the parking brake, first apply the foot brake and then without pressing the release button in, pull the parking brake lever up as far as possible. In addition it is recommended that when parking the vehicle on a gradient, the shift lever should be positioned in the appropriate low gear for manual transaxle vehicles or in the P (Park) position for automatic transaxle vehicles.

### **⚠ CAUTION - Parking brake**

***Driving with the parking brake applied will cause excessive brake pad (or lining) and brake rotor wear.***

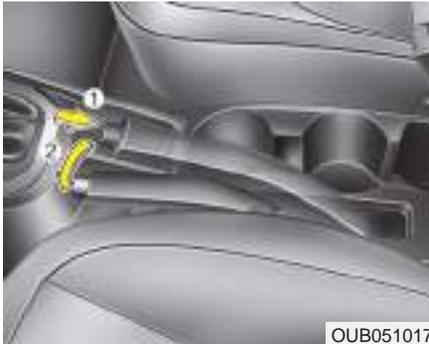

OUB051017

### ***Releasing the parking brake***

To release the parking brake, first apply the foot brake and pull up the parking brake lever slightly. Secondly, press the release button (1) and lower the parking brake lever (2) while holding the button.

### **⚠ WARNING - Parking brake use**

All vehicles should always have the parking brake fully engaged when parking to avoid inadvertent movement of the vehicle which can injure occupants or pedestrians.



W-75

Check the brake warning light by turning the ignition switch ON (do not start the engine). This light will illuminate when the parking brake is applied with the ignition switch in the START or ON position.

Before driving, be sure the parking brake is fully released and the brake warning light is off.

If the brake warning light remains on after the parking brake is released while the engine is running, there may be a malfunction in the brake system. Immediate attention is necessary.

If at all possible, stop driving the vehicle immediately. If that is not possible, use extreme caution while operating the vehicle and only continue to drive the vehicle until you can reach a safe location or repair shop.

### **Anti-lock brake system (ABS) (if equipped)**

ABS (or ESC) will not prevent accidents due to improper or dangerous driving maneuvers. Even though vehicle control is improved during emergency braking, always maintain a safe distance between you and objects ahead. Vehicle speeds should always be reduced during extreme road conditions.

The vehicle should be driven at reduced speeds in the following circumstances:

- When driving on rough, gravel or snow-covered roads
- When driving on roads where the road surface is pitted or has different surface heights.

Driving in these conditions increases the stopping distance for your vehicle.

The ABS continuously senses the speed of the wheels. If the wheels are going to lock, the ABS system repeatedly modulates the hydraulic brake pressure to the wheels.

When you apply your brakes under conditions which may lock the wheels, you may hear a “tik-tik” sound from the brakes, or feel a corresponding sensation in the brake pedal. This is normal and it means your ABS is active.

In order to obtain the maximum benefit from your ABS in an emergency situation, do not attempt to modulate your brake pressure and do not try to pump your brakes. Press your brake pedal as hard as possible or as hard as the situation allows the ABS to control the force being delivered to the brakes.

### **\* NOTICE**

**A click sound may be heard in the engine compartment when the vehicle begins to move after the engine is started. These conditions are normal and indicate that the anti-lock brake system is functioning properly.**

- Even with the anti-lock brake system, your vehicle still requires sufficient stopping distance. Always maintain a safe distance from the vehicle in front of you.
- Always slow down when cornering. The anti-lock brake system cannot prevent accidents resulting from excessive speeds.
- On loose or uneven road surfaces, operation of the anti-lock brake system may result in a longer stopping distance than for vehicles equipped with a conventional brake system.



W-78

The ABS warning light will stay on for approximately 3 seconds after the ignition switch is ON. During that time, the ABS will go through self-diagnosis and the light will go off if everything is normal. If the light stays on, you may have a problem with your ABS but your regular brakes will work normally. Contact an authorized Kia dealer as soon as possible.

- When you drive on a road with poor traction, such as an icy road, and operated your brakes continuously, the ABS will be active continuously and the ABS warning light may illuminate. Pull your vehicle over to a safe place and stop the engine.
- Restart the engine. If the ABS warning light is off, then your ABS is normal. Otherwise, you may have a problem with the ABS. Contact an authorized Kia dealer as soon as possible.

#### \* NOTICE

**When you jump start your vehicle because of a drained battery, the engine may not run as smoothly and the ABS warning light may turn on at the same time. This happens because of the low battery voltage. It does not mean your ABS has malfunctioned.**

- **Do not pump your brakes!**
- **Have the battery recharged before driving the vehicle.**



OUB051018

#### Electronic stability control (ESC)

The Electronic Stability control (ESC) system is designed to stabilize the vehicle during cornering maneuvers. ESC checks where you are steering and where the vehicle is actually going. ESC applies the brakes on individual wheels and intervenes with the engine management system to stabilize the vehicle.



Electronic stability control (ESC) will not prevent accidents. Excessive speed in turns, abrupt maneuvers and hydroplaning on wet surfaces can still result in serious accidents. Only a safe and attentive driver can prevent accidents by avoiding maneuvers that cause the vehicle to lose traction. Even with ESC installed, always follow all the normal precautions for driving - including driving at safe speeds for the conditions.

The Electronic Stability Control (ESC) system is an electronic system designed to help the driver maintain vehicle control under adverse conditions. It is not a substitute for safe driving practices. Factors including speed, road conditions and driver steering input can all affect whether ESC will be effective in preventing a loss of control. It is still your responsibility to drive and corner at reasonable speeds and to leave a sufficient margin of safety.

When you apply your brakes under conditions which may lock the wheels, you may hear a “tik-tik” sound from the brakes, or feel a corresponding sensation in the brake pedal. This is normal and it means your ESC is active.

### **ESC operation**

#### **ESC ON condition**



- When the ignition is turned ON, ESC and ESC OFF indicator lights illuminate for approximately 3 seconds, then ESC is turned on.
- Press the ESC OFF button for at least half a second after turning the ignition ON to turn ESC off. (ESC OFF indicator will illuminate). To turn the ESC on, press the ESC OFF button (ESC OFF indicator light will go off).
- When starting the engine, you may hear a slight ticking sound. This is the ESC performing an automatic system self-check and does not indicate a problem.

### **When operating**



When the ESC is in operation, ESC indicator light blinks.

- When the Electronic Stability Control is operating properly, you can feel a slight pulsation in the vehicle. This is only the effect of brake control and indicates nothing unusual.
- When moving out of the mud or slippery road, pressing the accelerator pedal may not cause the engine rpm (revolutions per minute) to increase.

**ESC operation off****ESC OFF state**

- To cancel ESC operation, press the ESC OFF button (ESC OFF indicator light illuminates).
- If the ignition switch is turned to LOCK position when ESC is off, ESC remains off. Upon restarting the engine, the ESC will automatically turn on again.

## ■ ESC indicator light



## ■ ESC OFF indicator light

**Indicator light**

When the ignition switch is turned ON, the indicator light illuminates, then goes off if ESC system is operating normally.

The ESC indicator light blinks whenever ESC is operating.

The ESC indicator light blinks whenever ESC is operating or illuminates when ESC fails to operate.

The ESC OFF indicator light comes on when the ESC is turned off with the button.

Driving with varying tire or wheel sizes may cause the ESC system to malfunction. When replacing tires, make sure they are the same size as your original tires.

**⚠ WARNING****- Electronic stability control**

Drive carefully even though your vehicle has Electronic Stability Control. It can only assist you in maintaining control under certain circumstances.

### *ESC OFF usage*

#### **When driving**

- It's a good idea to keep the ESC turned on for daily driving whenever possible.
- To turn ESC off while driving, press the ESC OFF button while driving on a flat road surface.

Never press the ESC OFF button while ESC is operating (ESC indicator light blinks).

If ESC is turned off while ESC is operating, the vehicle may slip out of control.

 **WARNING - Operating ESC**  
**Never press the ESC OFF button while ESC is operating.**  
**If the ESC is turned off while ESC is operating, the vehicle may go out of control.**

### **Hill-start assist control (HAC)**

Hill start Assist Control is a comfort function. The main intent is to prevent the vehicle from rolling backwards while driving off uphill on an inclined surface. HAC holds the braking pressure built up by driver during stopping procedure for 2 seconds after releasing brake pedal.

During the pressure-hold period, the driver has enough time to press the accelerator pedal to drive off.

The braking pressure is reduced as soon as the system detects the driver's intention to drive off.

 **WARNING - Activating HAC**

**Drivers should pay close attention when activating the HAC. The vehicle may roll backward causing an accident due to insufficient brake hold pressure.**

- The HAC does not operate when the transaxle shift lever is in the P (Park) or N (Neutral) position.
- The HAC activates even though the ESC is off but it does not activate when the ESC has malfunctioned.

### **Vehicle stability management (VSM)**

This system provides further enhancements to vehicle stability and steering responses when a vehicle is driving on a slippery road or a vehicle detected changes in coefficient of friction between right wheels and left wheels when braking.

#### ***VSM operation***

When the VSM is in operation, ESC indicator light (  ) blinks.

When the vehicle stability management is operating properly, you can feel a slight pulsation in the vehicle and/or abnormal steering responses (EPS). This is only the effect of brake and EPS control and indicates nothing unusual.

#### **The VSM does not operate when:**

- Driving on bank road such as gradient or incline
- Driving rearward
- ESC OFF indicator light (  ) remains on the instrument cluster
- EPS indicator light remains on the instrument cluster

#### ***VSM operation off***

If you press the ESC OFF button to turn off the ESC, the VSM will also cancel and the ESC OFF indicator light (  ) illuminates.

To turn on the VSM, press the button again. The ESC OFF indicator light goes out.

#### ***Malfunction indicator***

The VSM can be deactivated even if you don't cancel the VSM operation by pressing the ESC OFF button. It indicates that a malfunction has been detected somewhere in the Electric Power Steering system or VSM system. If the ESC indicator light (  ) or EPS warning light remains on, take your vehicle to an authorized Kia dealer and have the system checked.

- The VSM is designed to function above approximately 15 km/h (9 mph) on curves.
- The VSM is designed to function above approximately 30 km/h (18 mph) when a vehicle is braking on a split-mu road. The split-mu road is made of surfaces which have different friction forces.

- The Vehicle Stability Management system is not a substitute for safe driving practices but a supplementary function only. It is the responsibility of the driver to always check the speed and the distance to the vehicle ahead. Always hold the steering wheel firmly while driving.
- Your vehicle is designed to activate according to the driver's intention, even with installed VSM. Always follow all the normal precautions for driving at safe speeds for the conditions – including driving in inclement weather and on a slippery road.

**⚠ WARNING - Tire/Wheel size**

**When replacing tires and wheels, make sure they are the same size as the original tires and wheels installed. Driving with varying tire or wheel sizes may diminish any supplemental safety benefits of the VSM system.**

### Good braking practices

- Check to be sure the parking brake is not engaged and that the parking brake indicator light is out before driving away.
- Driving through water may get the brakes wet. They can also get wet when the vehicle is washed. Wet brakes can be dangerous! Your vehicle will not stop as quickly if the brakes are wet. Wet brakes may cause the vehicle to pull to one side.  
To dry the brakes, apply the brakes lightly until the braking action returns to normal, taking care to keep the vehicle under control at all times. If the braking action does not return to normal, stop as soon as it is safe to do so and call an authorized Kia dealer for assistance.
- Don't coast down hills with the vehicle out of gear. This is extremely hazardous. Keep the vehicle in gear at all times, use the brakes to slow down, then shift to a lower gear so that engine braking will help you maintain a safe speed.

- Don't "ride" the brake pedal. Resting your foot on the brake pedal while driving can be dangerous because the brakes might overheat and lose their effectiveness. It also increases the wear of the brake components.
- If a tire goes flat while you are driving, apply the brakes gently and keep the vehicle pointed straight ahead while you slow down. When you are moving slowly enough for it to be safe to do so, pull off the road and stop in a safe place.
- If your vehicle is equipped with an automatic transaxle, don't let your vehicle creep forward. To avoid creeping forward, keep your foot firmly on the brake pedal when the vehicle is stopped.

- Be cautious when parking on a hill. Firmly engage the parking brake and place the shift lever in P (automatic transaxle) or in first or reverse gear (manual transaxle). If your vehicle is facing downhill, turn the front wheels into the curb to help keep the vehicle from rolling. If your vehicle is facing uphill, turn the front wheels away from the curb to help keep the vehicle from rolling. If there is no curb or if it is required by other conditions to keep the vehicle from rolling, block the wheels.
- Under some conditions your parking brake can freeze in the engaged position. This is most likely to happen when there is an accumulation of snow or ice around or near the rear brakes or if the brakes are wet. If there is a risk that the parking brake may freeze, apply it only temporarily while you put the shift lever in P (automatic transaxle) or in first or reverse gear (manual transaxle) and block the rear wheels so the vehicle cannot roll. Then release the parking brake.
- Do not hold the vehicle on the upgrade with the accelerator pedal. This can cause the transaxle to overheat. Always use the brake pedal or parking brake.

### CRUISE CONTROL SYSTEM (IF EQUIPPED)

The cruise control system allows you to program the vehicle to maintain a constant speed without depressing the accelerator pedal.

This system is designed to function above approximately 40 km/h (25 mph).

If the cruise control is left on, (CRUISE indicator light in the instrument cluster illuminated) the cruise control can be switched on accidentally. Keep the cruise control system off (CRUISE indicator light OFF) when the cruise control is not in use, to avoid inadvertently setting a speed.

Use the cruise control system only when traveling on open highways in good weather.

Do not use the cruise control when driving in heavy or varying traffic, or on slippery (rainy, icy or snow-covered) or winding roads or over 6% up-hill or down-hill roads.

#### \* NOTICE

During normal cruise control operation, when the SET switch is activated or reactivated after applying the brakes, the cruise control will energize after approximately 3 seconds. This delay is normal.

#### **⚠ WARNING - Misuse cruise control**

**Do not use cruise control if the traffic situation does not allow you to drive safely at a constant speed and with sufficient distance to the vehicle in front.**



#### To set cruise control speed:

1. Press the CRUISE ON-OFF button on the steering wheel to turn the system on. The CRUISE indicator light in the instrument cluster will illuminate.
2. Accelerate to the desired speed, which must be more than 40 km/h (25 mph).



- Move the lever (1) up (to RES+) and release it immediately. The cruising speed will increase by 1.6 km/h (1.0 mph) each time the lever is operated in this manner.

3. Move the lever (1) down (to SET-), and release it at the desired speed. The SET indicator light in the instrument cluster will illuminate. Release the accelerator at the same time. The desired speed will automatically be maintained.

*On a steep grade, the vehicle may slow down or speed up slightly while going downhill.*

**To increase cruise control set speed:**

Follow either of these procedures:

- Move the lever (1) up (to RES+) and hold it. Your vehicle will accelerate. Release the lever at the speed you want.



### ■ Type A



### ■ Type B



- Move the lever (1) down (to SET-) and release it immediately. The cruising speed will decrease by 1.6 km/h (1.0 mph) each time the lever is operated in this manner.

### **To temporarily accelerate with the cruise control on:**

If you want to speed up temporarily when the cruise control is on, depress the accelerator pedal. Increased speed will not interfere with the cruise control operation or change the set speed.

To return to the set speed, take your foot off the accelerator.

### **To decrease the cruising speed:**

Follow either of these procedures:

- Move the lever (1) down (to SET-) and hold it. Your vehicle will gradually slow down. Release the lever at the speed you want to maintain.

■ Type A



■ Type B



- Decrease the vehicle speed lower than the memory speed by 15 km/h (9 mph).
- Decrease the vehicle speed to less than approximately 40 km/h (25 mph).

*Each of these actions will cancel cruise control operation (the SET indicator light in the instrument cluster will go off), but it will not turn the system off. If you wish to resume cruise control operation, move the lever up (to RES+). You will return to your previously preset speed.*

■ Type A



■ Type B



**To cancel cruise control, do one of the following:**

- Depress the brake pedal.
- Depress the clutch pedal with a manual transaxle.
- Shift into N (Neutral) with an automatic transaxle.
- Press the CANCEL switch.

**To resume cruising speed at more than approximately 40 km/h (25 mph):**

If any method other than the CRUISE ON-OFF switch was used to cancel cruising speed and the system is still activated, the most recent set speed will automatically resume when you move the lever (1) up (to RES+).

It will not resume, however, if the vehicle speed has dropped below approximately 40 km/h (25 mph).

**To turn cruise control off, do one of the following:**

- Press the CRUISE ON-OFF button (the CRUISE indicator light in the instrument cluster will go off).
- Turn the ignition off.

*Both of these actions will cancel the cruise control operation. If you want to resume the cruise control operation, repeat the steps provided in "To set cruise control speed" on the previous page.*

## ISG (IDLE STOP AND GO) SYSTEM (IF EQUIPPED)

Your vehicle may be equipped with the ISG system, which reduces fuel consumption by automatically shutting down the engine, when the vehicle is at a standstill. (For example : red light, stop sign and traffic jam)

The engine starts automatically as soon as the starting conditions are met.

The ISG system is ON whenever the engine is running.

### \* NOTICE

When the engine automatically starts by the ISG system, some warning lights (ABS, ESC, ESC OFF, ESC or Parking brake warning light) may turn on for a few seconds.

This happens because of low battery voltage. It does not mean the system is malfunctioning.

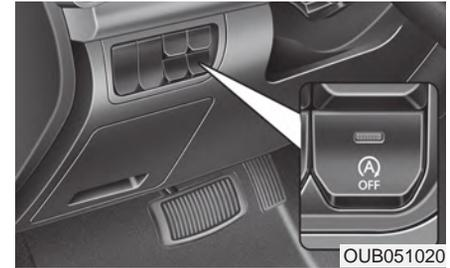
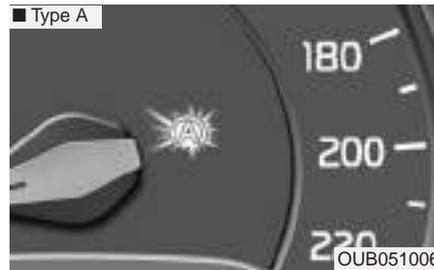

### Auto stop

#### To stop the engine in idle stop mode

Stop the vehicle completely by pressing the brake pedal.

You must reach a speed of at least 8km/h (5mph) since last idle stop.

The engine will stop and the green AUTO STOP indicator ((A)) on the instrument cluster will illuminate. If your vehicle is equipped with the type B cluster, the notice will illuminate on the LCD display.

If you open the engine hood in auto stop mode, the light on the ISG OFF button will illuminate and ISG system is deactivated. If your vehicle is equipped with the type B cluster, the notice will illuminate on the LCD display.

Turn the ignition switch to the START position to start the engine manually.

### Auto start

**To restart the engine from idle stop mode**

- Release the brake pedal.
- Move the shift lever in the R(reverse) or Sports mode with pressing the brake pedal

The engine will start and the green AUTO STOP indicator (A) on the instrument cluster will go out.

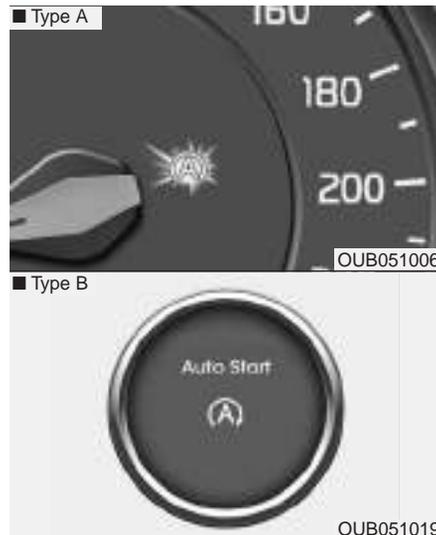

**The engine will restart automatically without the driver's any actions if the following occurs:**

- When the front defroster is on.
- The brake vacuum pressure is low.
- The battery charging status is low.
- The vehicle speed exceeds 1 mph (1.6 km/h).
- The fan speed is in the highest position when the air conditioning is on.

- Engine is turned off by Auto Stop for a long time.
- If you unfasten the sea belt or open the driver's door while depressing the brake pedal.

The green AUTO STOP indicator (A) on the instrument cluster will blink for 5 seconds and the notice will illuminate on the LCD display (for type B cluster).

### Condition of ISG system operation

*The ISG system will operate under the following condition:*

- The driver's seat belt is fastened.
- The driver's door and hood are closed.
- The brake vacuum pressure is adequate.
- The battery is sufficiently charged.
- The outside temperature is more than 28.4°F (-2°C).
- The outside temperature is under 89.6°F (32°C).
- The engine coolant temperature is not low.



OUB051022



OUB051067N

- If the ISG system does not meet that operation condition, the ISG system is deactivated. The light on the ISG OFF button will illuminate.
- If the light comes on continuously, please check the operation condition.



OUB051011

### ISG system deactivation

- If you want to deactivate the ISG system, press the ISG OFF button. The light on the ISG OFF button will illuminate and the notice will illuminate on the LCD display (for type B cluster).
- If you press the ISG OFF button again, the system will be activated and the light on the ISG OFF button will turn off.

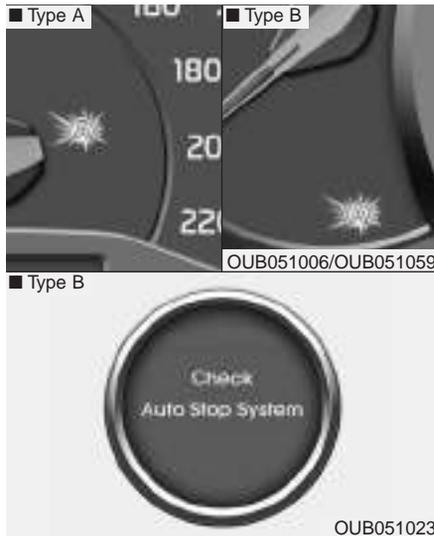

### ISG system malfunction

*The system may not operate when:*

- The ISG related sensors or system error occurs.

The yellow AUTO STOP indicator ((A)) on the instrument cluster will stay on after blinking for 5 seconds and the light on the ISG OFF button will illuminate. If your vehicle is equipped with cluster type B cluster, the notice will illuminate on the LCD display.

If the ISG OFF button light is not turned off by pressing the ISG OFF button again or if the ISG system continuously does not work correctly, please contact an authorized Kia dealer as soon as possible.

**⚠ WARNING - Engine Repair**  
Turn the ignition switch to the **LOCK (OFF)** position or remove the key from the ignition completely before performing work on the vehicle in the engine area. Failure to do so could result in serious injuries due to sudden engine reactivation.

### \* NOTICE

If the AGM battery is reconnected or replaced, ISG function will not operate immediately.

If you want to use the ISG function, the battery sensor needs to be calibrated for approximately 4 hours with the ignition off and then, turn the engine on and off 2 or 3 times.

## ACTIVE ECO SYSTEM (IF EQUIPPED)



### Active ECO operation

Active ECO helps improve fuel efficiency by controlling the engine and transaxle. But fuel-efficiency can be changed by the driver's driving habits and road conditions.

- When the Active ECO button is pressed the ECO indicator (green) will illuminate to show that the Active ECO is operating.
- When the Active ECO is activated, it does not turn off even though the engine is restarted again. To turn off the system, press the active ECO button again.
- If Active ECO is turned off, it will return to the normal mode.

### Limitation of Active ECO operation:

If the following conditions occur while Active ECO is operating, the system operation is limited even though there is no change in the ECO indicator.

- When the coolant temperature is low:  
The system will be limited until engine performance becomes normal.
- When driving up a hill:  
The system will be limited to gain power when driving uphill because the engine torque is restricted.
- When using sports mode:  
The system will be limited according to the shift location.
- When the accelerator pedal is deeply pressed for a few seconds:  
The system will be limited, Judging that the driver wants to speed up.



### ECONOMICAL OPERATION

Your vehicle's fuel economy depends mainly on your style of driving, where you drive and when you drive.

Each of these factors affects how many miles (kilometers) you can get from a gallon (liter) of fuel. To operate your vehicle as economically as possible, use the following driving suggestions to help save money in both fuel and repairs:

- Drive smoothly. Accelerate at a moderate rate. Don't make "jack-rabbit" starts or full-throttle shifts and maintain a steady cruising speed. Don't race between stoplights. Try to adjust your speed to the traffic so you don't have to change speeds unnecessarily. Avoid heavy traffic whenever possible. Always maintain a safe distance from other vehicles so you can avoid unnecessary braking. This also reduces brake wear.
- Drive at a moderate speed. The faster you drive, the more fuel your vehicle uses. Driving at a moderate speed, especially on the highway, is one of the most effective ways to reduce fuel consumption.
- Don't "ride" the brake pedal. This can increase fuel consumption and also increase wear on these components. In addition, driving with your foot resting on the brake pedal may cause the brakes to overheat, which reduces their effectiveness and may lead to more serious consequences.
- Take care of your tires. Keep them inflated to the recommended pressure. Incorrect inflation, either too much or too little, results in unnecessary tire wear. Check the tire pressures at least once a month.
- Be sure that the wheels are aligned correctly. Improper alignment can result from hitting curbs or driving too fast over irregular surfaces. Poor alignment causes faster tire wear and may also result in other problems as well as greater fuel consumption.
- Keep your vehicle in good condition. For better fuel economy and reduced maintenance costs, maintain your vehicle in accordance with the maintenance schedule in section 7. If you drive your vehicle in severe conditions, more frequent maintenance is required (see section 7 for details).
- Keep your vehicle clean. For maximum service, your vehicle should be kept clean and free of corrosive materials. It is especially important that mud, dirt, ice, etc. not be allowed to accumulate on the underside of the vehicle. This extra weight can result in increased fuel consumption and also contribute to corrosion.
- Travel lightly. Don't carry unnecessary weight in your vehicle. Weight reduces fuel economy.
- Don't let the engine idle longer than necessary. If you are waiting (and not in traffic), turn off your engine and restart only when you're ready to go.

- Remember, your vehicle does not require extended warm-up. After the engine has started, allow the engine to run for 10 to 20 seconds prior to placing the vehicle in gear. In very cold weather, however, give your engine a slightly longer warm-up period.
  - Don't "lug" or "over-rev" the engine. Lugging is driving too slowly in a very high gear resulting in engine bucking. If this happens, shift to a lower gear. Over-revving is racing the engine beyond its safe limit. This can be avoided by shifting at the recommended speed.
  - Use your air conditioning sparingly. The air conditioning system is operated by engine power so your fuel economy is reduced when you use it.
  - Open windows at high speeds can reduce fuel economy.
  - Fuel economy is less in crosswinds and headwinds. To help offset some of this loss, slow down when driving in these conditions.
- Keeping a vehicle in good operating condition is important both for economy and safety. Therefore, have an authorized Kia dealer perform scheduled inspections and maintenance.

 **WARNING - Engine off during motion**

**Never turn the engine off to coast down hills or anytime the vehicle is in motion. The power steering and power brakes will not function properly without the engine running. In addition, turning off the ignition while driving could engage the steering wheel lock resulting in loss of vehicle steering. Keep the engine on and downshift to an appropriate gear for engine braking effect.**

### SPECIAL DRIVING CONDITIONS

#### Hazardous driving conditions

When hazardous driving conditions are encountered such as water, snow, ice, mud, sand, or similar hazards, follow these suggestions:

- Drive cautiously and allow extra distance for braking.
- Avoid sudden braking or steering.
- When braking with non-ABS brakes pump the brake pedal with a light up-and-down motion until the vehicle is stopped.

Do not pump the brake pedal on a vehicle equipped with ABS.

- If stalled in snow, mud, or sand, use second gear. Accelerate slowly to avoid spinning the drive wheels.
- Use sand, rock salt, or other non-slip material under the drive wheels to provide traction when stalled in ice, snow, or mud.

 **WARNING - Downshifting**  
**Do not downshift with an automatic transaxle while driving on slippery surfaces. The sudden change in tire speed could cause the tires to skid and result in an accident.**

#### Rocking the vehicle

If it is necessary to rock the vehicle to free it from snow, sand, or mud, first turn the steering wheel right and left to clear the area around your front wheels. Then, shift back and forth between 1st (First) and R (Reverse) in vehicles equipped with a manual transaxle or R (Reverse) and any forward gear in vehicles equipped with an automatic transaxle. Do not race the engine, and spin the wheels as little as possible. If you are still stuck after a few tries, have the vehicle pulled out by a tow vehicle to avoid engine overheating and possible damage to the transaxle. The ESC system should be turned OFF prior to rocking the vehicle.

 **CAUTION - Vehicle rocking**  
***Prolonged rocking may cause engine overheating, transaxle damage or failure, and tire damage.***

**⚠ CAUTION - Spinning tires**  
*Do not spin the wheels, especially at speeds more than 56 km/h (35 mph). Spinning the wheels at high speeds when the vehicle is stationary could cause a tire to overheat which could result in tire damage.*

**⚠ WARNING - Sudden vehicle movement**  
**Do not attempt to rock the vehicle if people or objects are nearby. The vehicle may suddenly move forward or backwards as it becomes unstuck.**



**Smooth cornering**

Avoid braking or gear changing in corners, especially when roads are wet. Ideally, corners should always be taken under gentle acceleration. If you follow these suggestions, tire wear will be held to a minimum.



**Driving at night**

Because night driving presents more hazards than driving in the daylight, here are some important tips to remember:

- Slow down and keep more distance between you and other vehicles, as it may be more difficult to see at night, especially in areas where there may not be any street lights.

- Adjust your mirrors to reduce the glare from other driver's headlights.
- Keep your headlights clean and properly aimed on vehicles not equipped with the automatic headlight aiming feature. Dirty or improperly aimed headlights will make it much more difficult to see at night.
- Avoid staring directly at the headlights of oncoming vehicles. You could be temporarily blinded, and it will take several seconds for your eyes to readjust to the darkness.



### Driving in the rain

Rain and wet roads can make driving dangerous, especially if you're not prepared for the slick pavement. Here are a few things to consider when driving in the rain:

- A heavy rainfall will make it harder to see and will increase the distance needed to stop your vehicle, so slow down.
- Keep your windshield wiping equipment in good shape. Replace your windshield wiper blades when they show signs of streaking or missing areas on the windshield.

- If your tires are not in good condition, making a quick stop on wet pavement can cause a skid and possibly lead to an accident. Be sure your tires are in good shape.
- Turn on your headlights to make it easier for others to see you.
- Driving too fast through large puddles can affect your brakes. If you must go through puddles, try to drive through them slowly.
- If you believe you may have gotten your brakes wet, apply them lightly while driving until normal braking operation returns.

### Driving in flooded areas

Avoid driving through flooded areas unless you are sure the water is no higher than the bottom of the wheel hub. Drive through any water slowly. Allow adequate stopping distance because brake performance may be affected.

After driving through water, dry the brakes by gently applying them several times while the vehicle is moving slowly.

## Highway driving

### *Tires*

Adjust the tire inflation pressures to specification. Low tire inflation pressures will result in overheating and possible failure of the tires.

Avoid using worn or damaged tires which may result in reduced traction or tire failure.

Never exceed the maximum tire inflation pressure shown on the tires.

 **WARNING - Under/over inflated tires**

Always check the tires for proper inflation before driving. Underinflated or overinflated tires can cause poor handling, loss of vehicle control, and sudden tire failure leading to accidents, injuries, and even death. For proper tire pressures, refer to "Tires and wheels" in section 8.

 **WARNING - Tire tread**

Always check the tire tread before driving your vehicle. Worn-out tires can result in loss of vehicle control. Worn-out tires should be replaced as soon as possible. For further information and tread limits, refer to "Tires and wheels" in section 7.

### *Fuel, engine coolant and engine oil*

High speed travel consumes more fuel than urban motoring. Do not forget to check both the engine coolant and engine oil.

### *Drive belt*

A loose or damaged drive belt may overheat the engine.

## WINTER DRIVING



OBH058040

Severe weather conditions in the winter result in greater wear and other problems. To minimize the problems of winter driving, you should follow these suggestions:

### **Snowy or Icy conditions**

To drive your vehicle in deep snow, it may be necessary to use snow tires on your tires. If snow tires are needed, it is necessary to select tires equivalent in size and type of the original equipment tires. Failure to do so may adversely affect the safety and handling of your car. Furthermore, speeding, rapid acceleration, sudden brake applications, and sharp turns are potentially very hazardous practices.

During deceleration, use engine braking to the fullest extent. Sudden brake applications on snowy or icy roads may cause skids. You need to keep sufficient distance between the vehicle in operation in front and your vehicle. Also, apply the brake gently.

### **Snow tires**

If you mount snow tires on your vehicle, make sure they are radial tires of the same size and load range as the original tires. Mount snow tires on all four wheels to balance your vehicle's handling in all weather conditions. Keep in mind that the traction provided by snow tires on dry roads may not be as high as your vehicle's original equipment tires. You should drive cautiously even when the roads are clear. Check with the tire dealer for maximum speed recommendations.

*Do not install studded tires without first checking local, state and municipal regulations for possible restrictions against their use.*

### **Use high quality ethylene glycol coolant**

Your vehicle is delivered with high quality ethylene glycol coolant in the cooling system. It is the only type of coolant that should be used because it helps prevent corrosion in the cooling system, lubricates the water pump and prevents freezing. Be sure to replace or replenish your coolant in accordance with the maintenance schedule in section 7. Before winter, have your coolant tested to assure that its freezing point is sufficient for the temperatures anticipated during the winter.

### **Check battery and cables**

Winter puts additional burdens on the battery system. Visually inspect the battery and cables as described in section 7. The level of charge in your battery can be checked by an authorized Kia dealer or a service station.

### **Change to "winter weight" oil if necessary**

In some climates it is recommended that a lower viscosity "winter weight" oil be used during cold weather. See section 8 for recommendations. If you aren't sure what weight oil you should use, consult an authorized Kia dealer.

### **Check spark plugs and ignition system**

Inspect your spark plugs as described in section 7 and replace them if necessary. Also check all ignition wiring and components to be sure they are not cracked, worn or damaged in any way.

### **To keep locks from freezing**

To keep the locks from freezing, squirt an approved de-icer fluid or glycerine into the key opening. If a lock is covered with ice, squirt it with an approved de-icing fluid to remove the ice. If the lock is frozen internally, you may be able to thaw it out by using a heated key. Handle the heated key with care to avoid injury.

### **Use approved window washer anti-freeze in system**

To keep the water in the window washer system from freezing, add an approved window washer anti-freeze solution in accordance with instructions on the container. Window washer anti-freeze is available from an authorized Kia dealer and most auto parts outlets. Do not use engine coolant or other types of anti-freeze as these may damage the paint finish.



### **Don't let your parking brake freeze**

Under some conditions your parking brake can freeze in the engaged position. This is most likely to happen when there is an accumulation of snow or ice around or near the rear brakes or if the brakes are wet. If there is a risk the parking brake may freeze, apply it only temporarily while you put the shift lever in P (automatic transaxle) or in first or reverse gear (manual transaxle) and block the rear wheels so the vehicle cannot roll. Then release the parking brake.

### **Don't let ice and snow accumulate underneath**

Under some conditions, snow and ice can build up under the fenders and interfere with the steering. When driving in severe winter conditions where this may happen, you should periodically check underneath the car to be sure the movement of the front wheels and the steering components is not obstructed.

### **Carry emergency equipment**

Depending on the severity of the weather you should carry appropriate emergency equipment. Some of the items you may want to carry include tow straps or chains, flashlight, emergency flares, sand, a shovel, jumper cables, a window scraper, gloves, ground cloth, coveralls, a blanket, etc.

## **TRAILER TOWING**

**We do not recommend using this vehicle for trailer towing.**

**VEHICLE LOAD LIMIT**

**TIRE AND LOADING INFORMATION**  
RENSEIGNEMENTS SUR LES PNEUS ET LE CHARGEMENT

SEATING CAPACITY NOMBRE DE PLACES	TOTAL 5	FRONT AVANT 2	REAR ARRIÈRE 3
--------------------------------------	---------	------------------	-------------------

The combined weight of occupants and cargo should never exceed 420 kg or 926 lbs.  
Le poids total des occupants et du chargement ne doit jamais dépasser 420 kg ou 926 lb.

TIRE PNEU	SIZE DIMENSIONS	COLD TIRE PRESSURE PRESSION DES PNEUS À FROID	SEE OWNER'S MANUAL FOR ADDITIONAL INFORMATION
FRONT AVANT	P185/65R15	220kPa, 32psi	VOIR LE MANUEL DE L'USAGER POUR PLUS DE RENSEIGNEMENTS
REAR ARRIÈRE	P185/65R15	220kPa, 32psi	
SPARE DE SECOURS	T125/80D15	420kPa, 60psi	

**TIRE AND LOADING INFORMATION**  
RENSEIGNEMENTS SUR LES PNEUS ET LE CHARGEMENT

SEATING CAPACITY NOMBRE DE PLACES	TOTAL 5	FRONT AVANT 2	REAR ARRIÈRE 3
--------------------------------------	---------	------------------	-------------------

The combined weight of occupants and cargo should never exceed 420 kg or 926 lbs.  
Le poids total des occupants et du chargement ne doit jamais dépasser 420 kg ou 926 lb.

TIRE PNEU	SIZE DIMENSIONS	COLD TIRE PRESSURE PRESSION DES PNEUS À FROID	SEE OWNER'S MANUAL FOR ADDITIONAL INFORMATION
FRONT AVANT	P205/45R17	220kPa, 32psi	VOIR LE MANUEL DE L'USAGER POUR PLUS DE RENSEIGNEMENTS
REAR ARRIÈRE	P205/45R17	220kPa, 32psi	
SPARE DE SECOURS	T125/80D15	420kPa, 60psi	

**TIRE AND LOADING INFORMATION**  
RENSEIGNEMENTS SUR LES PNEUS ET LE CHARGEMENT

SEATING CAPACITY NOMBRE DE PLACES	TOTAL 5	FRONT AVANT 2	REAR ARRIÈRE 3
--------------------------------------	---------	------------------	-------------------

The combined weight of occupants and cargo should never exceed 420 kg or 926 lbs.  
Le poids total des occupants et du chargement ne doit jamais dépasser 420 kg ou 926 lb.

TIRE PNEU	SIZE DIMENSIONS	COLD TIRE PRESSURE PRESSION DES PNEUS À FROID	SEE OWNER'S MANUAL FOR ADDITIONAL INFORMATION
FRONT AVANT	P195/55R16	220kPa, 32psi	VOIR LE MANUEL DE L'USAGER POUR PLUS DE RENSEIGNEMENTS
REAR ARRIÈRE	P195/55R16	220kPa, 32psi	
SPARE DE SECOURS	T125/80D15	420kPa, 60psi	

**TIRE AND LOADING INFORMATION**  
RENSEIGNEMENTS SUR LES PNEUS ET LE CHARGEMENT

SEATING CAPACITY NOMBRE DE PLACES	TOTAL 5	FRONT AVANT 2	REAR ARRIÈRE 3
--------------------------------------	---------	------------------	-------------------

The combined weight of occupants and cargo should never exceed 420 kg or 926 lbs.  
Le poids total des occupants et du chargement ne doit jamais dépasser 420 kg ou 926 lb.

TIRE PNEU	SIZE DIMENSIONS	COLD TIRE PRESSURE PRESSION DES PNEUS À FROID	SEE OWNER'S MANUAL FOR ADDITIONAL INFORMATION
FRONT AVANT	P185/65R15	220kPa, 32psi	VOIR LE MANUEL DE L'USAGER POUR PLUS DE RENSEIGNEMENTS
REAR ARRIÈRE	P185/65R15	220kPa, 32psi	
SPARE DE SECOURS	NOUE 420kPa		

**TIRE AND LOADING INFORMATION**  
RENSEIGNEMENTS SUR LES PNEUS ET LE CHARGEMENT

SEATING CAPACITY NOMBRE DE PLACES	TOTAL 5	FRONT AVANT 2	REAR ARRIÈRE 3
--------------------------------------	---------	------------------	-------------------

The combined weight of occupants and cargo should never exceed 420 kg or 926 lbs.  
Le poids total des occupants et du chargement ne doit jamais dépasser 420 kg ou 926 lb.

TIRE PNEU	SIZE DIMENSIONS	COLD TIRE PRESSURE PRESSION DES PNEUS À FROID	SEE OWNER'S MANUAL FOR ADDITIONAL INFORMATION
FRONT AVANT	P185/65R15	220kPa, 32psi	VOIR LE MANUEL DE L'USAGER POUR PLUS DE RENSEIGNEMENTS
REAR ARRIÈRE	P185/65R15	220kPa, 32psi	
SPARE DE SECOURS	NOUE 420kPa		

**TIRE AND LOADING INFORMATION**  
RENSEIGNEMENTS SUR LES PNEUS ET LE CHARGEMENT

SEATING CAPACITY NOMBRE DE PLACES	TOTAL 5	FRONT AVANT 2	REAR ARRIÈRE 3
--------------------------------------	---------	------------------	-------------------

The combined weight of occupants and cargo should never exceed 420 kg or 926 lbs.  
Le poids total des occupants et du chargement ne doit jamais dépasser 420 kg ou 926 lb.

TIRE PNEU	SIZE DIMENSIONS	COLD TIRE PRESSURE PRESSION DES PNEUS À FROID	SEE OWNER'S MANUAL FOR ADDITIONAL INFORMATION
FRONT AVANT	P205/45R17	220kPa, 32psi	VOIR LE MANUEL DE L'USAGER POUR PLUS DE RENSEIGNEMENTS
REAR ARRIÈRE	P205/45R17	220kPa, 32psi	
SPARE DE SECOURS	NOUE 420kPa		

OUB061016N/OUB061015N/OUB061018N

OUB061014N/OUB061019N/OUB061017N

**Tire and loading information label**

The label located on the driver's door sill gives the original tire size, cold tire pressures recommended for your vehicle, the number of people that can be in your vehicle and vehicle capacity weight.

**Vehicle capacity weight:**

385 kg (849 lb)

Vehicle capacity weight is the maximum combined weight of occupants and cargo. If your vehicle is equipped with a trailer, the combined weight includes the tongue load.

### **Seating capacity:**

Total : 5 persons

(Front seat : 2 persons,  
Rear seat : 3 persons)

Seating capacity is the maximum number of occupants including a driver, your vehicle may carry.

However, the seating capacity may be reduced based upon the weight of all of the occupants, and the weight of the cargo being carried or towed.

Do not overload the vehicle as there is a limit to the total weight, or load limit including occupants and cargo, the vehicle can carry.

### **Towing capacity:**

**We do not recommend using this vehicle for trailer towing.**

### **Cargo capacity:**

The cargo capacity of your vehicle will increase or decrease depending on the weight and the number of occupants and the tongue load, if your vehicle is equipped with a trailer.

### **Steps For Determining Correct Load Limit -**

1. Locate the statement "The combined weight of occupants and cargo should never exceed XXX kg or XXX lbs." on your vehicle's placard.
2. Determine the combined weight of the driver and passengers that will be riding in your vehicle.
3. Subtract the combined weight of the driver and passengers from XXX kg or XXX lbs.
4. The resulting figure equals the available amount of cargo and luggage load capacity. For example, if the "XXX" amount equals 635 kg (1400 lbs.) and there will be five 68 kg (150 lbs.) passengers in your vehicle, the amount of available cargo and luggage load capacity is 295 kg (650 lbs).  
(635-340 (5 x 68) = 295 kg or  
1400-750 (5 x 150) = 650 lbs.)
5. Determine the combined weight of luggage and cargo being loaded on the vehicle. That weight may not safely exceed the available cargo and luggage load capacity calculated in Step 4.
6. If your vehicle will be towing a trailer, load from your trailer will be transferred to your vehicle. Consult this manual to determine how this reduces the available cargo and luggage load capacity of your vehicle.

**Example 1**

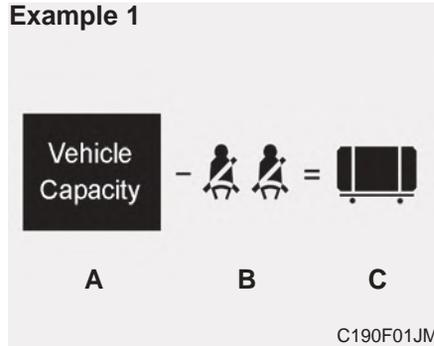

Item	Description	Total
A	Vehicle Capacity Weight	420 kg (926 lbs)
B	Subtract Occupant Weight 68 kg (150 lbs) × 2	136 kg (300 lbs)
C	Available Cargo and Luggage weight	284 kg (626 lbs)

**Example 2**

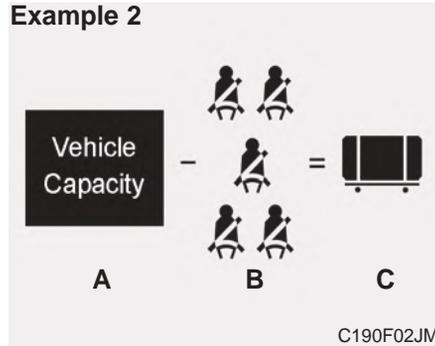

Item	Description	Total
A	Vehicle Capacity Weight	420 kg (926 lbs)
B	Subtract Occupant Weight 68 kg (150 lbs) × 5	340 kg (750 lbs)
C	Available Cargo and Luggage weight	80 kg (176 lbs)

**Example 3**

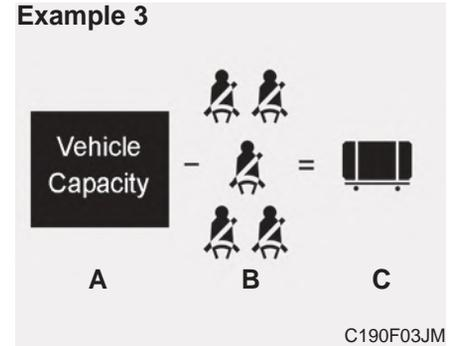

Item	Description	Total
A	Vehicle Capacity Weight	420 kg (926 lbs)
B	Subtract Occupant Weight 73 kg (161 lbs) × 3	365 kg (805 lbs)
C	Available Cargo and Luggage weight	55 kg (121 lbs)

Refer to your vehicle's tire and loading information label for specific information about your vehicle's capacity weight and seating positions. The combined weight of the driver, passengers and cargo should never exceed your vehicle's capacity weight.

### Certification label

The certification label is located on the driver's door sill at the center pillar.

This label shows the maximum allowable weight of the fully loaded vehicle. This is called the GVWR (Gross Vehicle Weight Rating). The GVWR includes the weight of the vehicle, all occupants, fuel and cargo.

This label also tells you the maximum weight that can be supported by the front and rear axles, called Gross Axle Weight Rating (GAWR).

To find out the actual loads on your front and rear axles, you need to go to a weigh station and weigh your vehicle. Your dealer can help you with this. Be sure to spread out your load equally on both sides of the centerline.

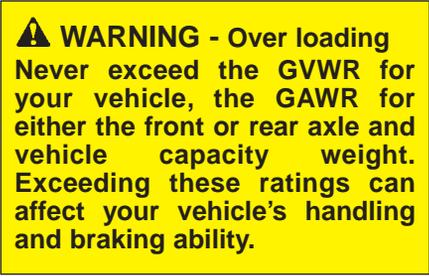

**⚠ WARNING - Over loading**  
**Never exceed the GVWR for your vehicle, the GAWR for either the front or rear axle and vehicle capacity weight. Exceeding these ratings can affect your vehicle's handling and braking ability.**

The label will help you decide how much cargo and installed equipment your vehicle can carry.

If you carry items inside your vehicle - like suitcases, tools, packages, or anything else - they are moving as fast as the vehicle. If you have to stop or turn quickly, or if there is a crash, the items will keep going and can cause an injury if they strike the driver or a passenger.

**⚠ WARNING - Over loading**

Do not overload your vehicle. Overloading your vehicle can cause heat buildup in your vehicle's tires and possible tire failure, increased stopping distances and poor vehicle handling--all of which may result in a crash.

**⚠ WARNING - Loose cargo**

Do not travel with unsecured blunt objects in the passenger compartment of your vehicle (e.g. suit cases or unsecured child seats). These items may strike occupant during a sudden stop or crash.

**\* NOTICE**

Overloading your vehicle may cause damage. Repairs would not be covered by your warranty. Do not overload your vehicle.

### VEHICLE WEIGHT

This section will guide you in the proper loading of your vehicle and/or trailer, to keep your loaded vehicle weight within its design rating capability, with or without a trailer. Properly loading your vehicle will provide maximum return of the vehicle design performance. Before loading your vehicle, familiarize yourself with the following terms for determining your vehicle's weight ratings, with or without a trailer, from the vehicle's specifications and the compliance label:

#### **Base curb weight**

This is the weight of the vehicle including a full tank of fuel and all standard equipment. It does not include passengers, cargo, or optional equipment.

#### **Vehicle curb weight**

This is the weight of your new vehicle when you picked it up from your dealer plus any aftermarket equipment.

#### **Cargo weight**

This figure includes all weight added to the Base Curb Weight, including cargo and optional equipment.

#### **GAW (Gross axle weight)**

This is the total weight placed on each axle (front and rear) - including vehicle curb weight and all payload.

#### **GAWR (Gross axle weight rating)**

This is the maximum allowable weight that can be carried by a single axle (front or rear). These numbers are shown on the compliance label.

The total load on each axle must never exceed its GAWR.

#### **GVW (Gross vehicle weight)**

This is the Base Curb Weight plus actual Cargo Weight plus passengers.

#### **GVWR (Gross vehicle weight rating)**

This is the maximum allowable weight of the fully loaded vehicle (including all options, equipment, passengers and cargo). The GVWR is shown on the certification label located on the driver's door sill.

**Road warning / 6-2**

**In case of an emergency while driving / 6-2**

**If the engine will not start / 6-3**

**Emergency starting / 6-4**

**If the engine overheats / 6-7**

**Tire pressure monitoring system (TPMS) / 6-8**

**If you have a flat tire / 6-13, 21**

**Towing / 6-27**

**What to do in an emergency**

**6**



### ROAD WARNING



OUB041094

#### Hazard warning flasher

The hazard warning flasher serves as a warning to other drivers to exercise extreme caution when approaching, overtaking, or passing your vehicle.

It should be used whenever emergency repairs are being made or when the vehicle is stopped near the edge of a roadway.

Depress the flasher switch with the ignition switch in any position. The flasher switch is located in the center console switch panel. All turn signal lights will flash simultaneously.

- The hazard warning flasher operates whether your vehicle is running or not.
- The turn signals do not work when the hazard flasher is on.
- Care must be taken when using the hazard warning flasher while the vehicle is being towed.

### IN CASE OF AN EMERGENCY WHILE DRIVING

#### If the engine stalls at a crossroad or crossing

If the engine stalls at a crossroad or crossing, set the shift lever in the N (Neutral) position and then push the vehicle to a safe place.

#### If you have a flat tire while driving

If a tire goes flat while you are driving:

1. Take your foot off the accelerator pedal and let the vehicle slow down while driving straight ahead. Do not apply the brakes immediately or attempt to pull off the road as this may cause a loss of control. When the vehicle has slowed down to such a speed that it is safe to do so, brake carefully and pull off the road. Drive off the road as far as possible and park on a firm level ground. If you are on a divided highway, do not park in the median area between the two traffic lanes.

2. When the vehicle is stopped, turn on your emergency hazard flashers, set the parking brake and put the transaxle in P (automatic transaxle) or reverse (manual transaxle).
3. Have all passengers get out of the vehicle. Be sure they all get out on the side of the vehicle that is away from traffic.
4. When changing a flat tire, follow the instruction provided later in this section.

#### **If engine stalls while driving**

1. Reduce your speed gradually, keeping a straight line. Move cautiously off the road to a safe place.
2. Turn on your emergency flashers.
3. Try to start the engine again. If your vehicle will not start, contact an authorized Kia dealer or seek other qualified assistance.

## **IF THE ENGINE WILL NOT START**

### **If the engine doesn't turn over or turns over slowly**

1. If your vehicle has an automatic transaxle, be sure the shift lever is in N (Neutral) or P (Park) and the emergency brake is set.
2. Check the battery connections to be sure they are clean and tight.
3. Turn on the interior light. If the light dims or goes out when you operate the starter, the battery is discharged.
4. Check the starter connections to be sure they are securely tightened.
5. Do not push or pull the vehicle to start it. See instructions for "Jump starting".

 **WARNING - Push/pull start**  
**Do not push or pull the vehicle to start it. Push or pull starting may cause the catalytic converter to overload and create a fire hazard.**

### **If engine turns over normally but does not start**

1. Check fuel level.
2. With the ignition switch in the LOCK position, check all connectors at the ignition coil and spark plugs. Reconnect any that may be disconnected or loose.
3. Check the fuel line in the engine compartment.
4. If the engine still does not start, call an authorized Kia dealer or seek other qualified assistance.

## EMERGENCY STARTING

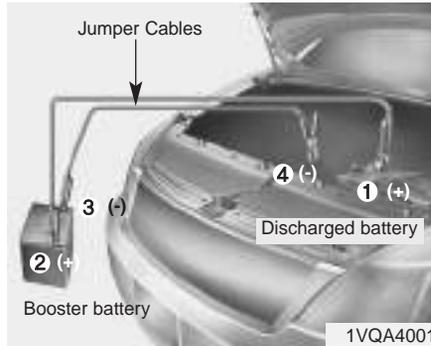

Connect cables in numerical order and disconnect in reverse order.

### Jump starting

Jump starting can be dangerous if done incorrectly. Therefore, to avoid harm to yourself or damage to your vehicle or battery, follow these jump starting procedures. If in doubt, we strongly recommend that you have a competent technician or towing service jump start your vehicle.

**⚠ CAUTION - 12 volt battery**  
*Use only a 12-volt jumper system. You can damage a 12-volt starting motor, ignition system, and other electrical parts beyond repair by use of a 24-volt power supply (either two 12-volt batteries in series or a 24-volt motor generator set).*

**⚠ WARNING - Battery**  
Never attempt to check the electrolyte level of the battery as this may cause the battery to rupture or explode.

**⚠ WARNING - Frozen batteries**  
Do not attempt to jump start the vehicle if the discharged battery is frozen or if the electrolyte level is low as the battery may rupture or explode.

**⚠ WARNING - Battery**  
Keep all flames or sparks away from the battery. The battery produces hydrogen gas which will explode if exposed to flame or sparks.

**⚠ WARNING - Sulfuric acid risk**  
When jump starting your vehicle be careful not to get acid on yourself, your clothing or on the vehicle. Automobile batteries contain sulfuric acid. This is poisonous and highly corrosive.

### ***Jump starting procedure***

Absorbent Glass Matt (AGM) batteries are maintenance-free and should only be serviced by an authorized Kia dealer. For charging your AGM battery, use only fully automatic battery chargers that are specially developed for AGM batteries.

When replacing the AGM battery, use only the Kia genuine battery for the ISG system.

### **\* NOTICE**

If the AGM battery is reconnected or replaced, ISG function will not operate immediately.

If you want to use the ISG function, the battery sensor needs to be calibrated for approximately 4 hours with the ignition off and then, turn the engine on and off 2 or 3 times.

### **CAUTION - AGM battery cap**

***Do not open or remove the cap on top of the battery. This may cause the leak of dangerous internal electrolytes.***

1. Make sure the booster battery is 12-volt and that its negative terminal is grounded.
2. If the booster battery is in another vehicle, do not allow the vehicles to touch.
3. Turn off all unnecessary electrical loads.
4. Connect the jumper cables in the exact sequence shown in the illustration. First connect one end of a jumper cable to the positive terminal of the discharged battery (1), then connect the other end to the positive terminal on the booster battery (2).

Proceed to connect one end of the other jumper cable to the negative terminal of the booster battery (3), then the other end to a solid, stationary, metallic point (for example, the engine lifting bracket) away from the battery (4). Do not connect it to or near any part that moves when the engine is cranked.

Do not allow the jumper cables to contact anything except the correct battery terminals or the correct ground. Do not lean over the battery when making connections.

### **CAUTION - Battery cables**

***Do not connect the jumper cable from the negative terminal of the booster battery to the negative terminal of the discharged battery. This can cause the discharged battery to overheat and crack, releasing battery acid.***

5. Start the engine of the vehicle with the booster battery and let it run at 2,000 rpm, then start the engine of the vehicle with the discharged battery.

*If the cause of your battery discharging is not apparent, you should have your vehicle checked by an authorized Kia dealer.*

### **Push-starting**

Your manual transaxle-equipped vehicle should not be push-started because it might damage the emission control system.

Vehicles equipped with automatic transaxle cannot be push-started.

Follow the directions in this section for jump-starting.

 **WARNING - Tow starting vehicle**

**Never tow a vehicle to start it because the sudden surge forward when the engine starts could cause a collision with the tow vehicle.**

## IF THE ENGINE OVERHEATS

If your temperature gauge indicates overheating, you will experience a loss of power, or hear loud pinging or knocking, the engine is probably too hot. If this happens, you should:

1. Pull off the road and stop as soon as it is safe to do so.
2. Place the shift lever in P (automatic transaxle) or neutral (manual transaxle) and set the parking brake. If the air conditioning is on, turn it off.
3. If engine coolant is running out under the vehicle or steam is coming out from underneath the hood, stop the engine. Do not open the hood until the coolant has stopped running or the steaming has stopped. If there is no visible loss of engine coolant and no steam, leave the engine running and check to be sure the engine cooling fan is operating. If the fan is not running, turn the engine off.
4. Check to see if the water pump drive belt is missing. If it is not missing, check to see that it is tight. If the drive belt seems to be satisfactory, check for coolant leaking from the radiator, hoses or under the vehicle. (If the air conditioning had been in use, it is normal for cold water to be draining from it when you stop).

 **WARNING - Under the hood**

**While the engine is running, keep hair, hands and clothing away from moving parts such as the fan and drive belts.**

5. If the water pump drive belt is broken or engine coolant leaks, stop the engine immediately and call the nearest authorized Kia dealer for assistance.

 **WARNING - Radiator cap**

**Do not remove the radiator cap when the engine is hot. This can allow coolant to be blown out of the opening and cause serious burns.**

6. If you cannot find the cause of the overheating, wait until the engine temperature has returned to normal. Then, if coolant has been lost, carefully add coolant to the reservoir to bring the fluid level in the reservoir up to the halfway mark.
  7. Proceed with caution, keeping alert for further signs of overheating. If overheating happens again, call an authorized Kia dealer for assistance.
- Serious loss of coolant indicates there is a leak in the cooling system and this should be checked as soon as possible by an authorized Kia dealer.

## TIRE PRESSURE MONITORING SYSTEM (TPMS) (IF EQUIPPED)



WK-14

### (1) Low tire pressure telltale / TPMS malfunction indicator

Each tire, including the spare (if provided), should be checked monthly when cold and inflated to the inflation pressure recommended by the vehicle manufacturer on the vehicle placard or tire inflation pressure label. (If your vehicle has tires of a different size than the size indicated on the vehicle placard or tire inflation pressure label, you should determine the proper tire inflation pressure for those tires.)

As an added safety feature, your vehicle has been equipped with a tire pressure monitoring system (TPMS) that illuminates a low tire pressure telltale when one or more of your tires is significantly under-inflated. Accordingly, when the low tire pressure telltale illuminates, you should stop and check your tires as soon as possible, and inflate them to the proper pressure. Driving on a significantly under-inflated tire causes the tire to overheat and can lead to tire failure. Under-inflation also reduces fuel efficiency and tire tread life, and may affect the vehicle's handling and stopping ability.

Please note that the TPMS is not a substitute for proper tire maintenance, and it is the driver's responsibility to maintain correct tire pressure, even if under-inflation has not reached the level to trigger illumination of the TPMS low tire pressure telltale.

Your vehicle has also been equipped with a TPMS malfunction indicator to indicate when the system is not operating properly. The TPMS malfunction indicator is combined with the low tire pressure telltale. When the system detects a malfunction, the telltale will flash for approximately one minute and then remain continuously illuminated. This sequence will continue upon subsequent vehicle start-ups as long as the malfunction exists. When the malfunction indicator is illuminated, the system may not be able to detect or signal low tire pressure as intended. TPMS malfunctions may occur for a variety of reasons, including the installation of replacement or alternate tires or wheels on the vehicle that prevent the TPMS from functioning properly. Always check the TPMS malfunction telltale after replacing one or more tires or wheels on your vehicle to ensure that the replacement or alternate tires and wheels allow the TPMS to continue to function properly.

If the TPMS indicator does not illuminate for 3 seconds when the ignition switch is turned to the ON position or engine is running, or if it comes on after blinking for approximately one minute, take your car to your nearest authorized Kia dealer and have the system checked.



### **Low tire pressure telltale**

When the tire pressure monitoring system warning indicator is illuminated, one or more of your tires is significantly under-inflated.

If the telltale illuminates, immediately reduce your speed, avoid hard cornering and anticipate increased stopping distances. You should stop and check your tires as soon as possible. Inflate the tires to the proper pressure as indicated on the vehicle's placard or tire inflation pressure label located on the driver's side center pillar outer panel. If you cannot reach a service station or if the tire cannot hold the newly added air, replace the low pressure tire with the spare tire.

Then the Low Tire Pressure telltale may flash for approximately one minute and then remain continuously illuminated after restarting and about 20 minutes of continuous driving before you have the low pressure tire repaired and replaced on the vehicle.

In winter or cold weather, the low tire pressure telltale may be illuminated if the tire pressure was adjusted to the recommended tire inflation pressure in warm weather. It does not mean your TPMS is malfunctioning because the decreased temperature leads to a proportional lowering of tire pressure.

When you drive your vehicle from a warm area to a cold area or from a cold area to a warm area, or the outside temperature is greatly higher or lower, you should check the tire inflation pressure and adjust the tires to the recommended tire inflation pressure.



**⚠ WARNING - Low pressure damage**

**Do not drive on low pressure tires. Significantly low tire pressure can cause the tires to overheat and fail making the vehicle unstable resulting in increased braking distances and a loss of vehicle control.**



**TPMS (Tire Pressure Monitoring System) malfunction indicator**

The TPMS malfunction indicator will illuminate after it blinks for approximately one minute when there is a problem with the Tire Pressure Monitoring System. If the system is able to correctly detect an under inflation warning at the same time as system failure then it will illuminate the TPMS malfunction indicator.

Have the system checked by an authorized kia dealer as soon as possible to determine the cause of the problem.

The TPMS malfunction indicator may be illuminated if the vehicle is moving around electric power supply cables or radios transmitter such as at police stations, government and public offices, broadcasting stations, military installations, airports, or transmitting towers, etc. This can interfere with normal operation of the Tire Pressure Monitoring System (TPMS).

The TPMS malfunction indicator may illuminate if snow chains or some separately purchased devices such as notebook computers, mobile charger, remote starter, navigation etc. are used in the vehicle. This can interfere with normal operation of the Tire Pressure Monitoring System (TPMS).

### Changing a tire with TPMS

If you have a flat tire, the Low Tire Pressure will come on. Have the flat tire repaired by an authorized Kia dealer as soon as possible or replace the flat tire with the spare tire.

#### CAUTION

***Never use a puncture-repairing agent not approved by Kia to repair and/or inflate a low pressure tire. The tire sealant not approved by Kia may damage the tire pressure sensor. The sealant on the tire pressure sensor and wheel shall be eliminated when you replace the tire with a new one.***

Each wheel is equipped with a tire pressure sensor mounted inside the tire behind the valve stem. You must use TPMS specific wheels. It is recommended that you always have your tires serviced by an authorized Kia dealer.

Even if you replace the low pressure tire with the spare tire, the Low Tire Pressure Telltale will blink or remain on until the low pressure tire is repaired and placed on the vehicle.

After you replace the low pressure tire with, the TPMS spare tire, the Low Tire Pressure telltale may blink or illuminate after a few minutes because the TPMS sensor mounted on the spare wheel is not initiated.

Once the low pressure tire is reinflated to the recommended pressure and installed on the vehicle or the TPMS sensor mounted on the replaced spare wheel is initiated by an authorized Kia dealer, the TPMS malfunction indicator and the low tire pressure telltale will extinguish within a few minutes of driving.

If the indicator is not extinguished after a few minutes of driving, please visit an authorized Kia dealer.

If original mounted tire is replaced with the spare tire, the TPMS sensor on the replaced spare wheel should be initiated and the TPMS sensor on the original mounted wheel should be deactivated. If the TPMS sensor on the original mounted wheel located in the spare tire carrier still activates, the tire pressure monitoring system may not operate properly. Have the tire with TPMS serviced or replaced by an authorized Kia dealer.

You may not be able identify a low tire by simply looking at it. Always use a good quality tire pressure gauge to measure the tire's inflation pressure. Please note that a tire that is hot (from being driven) will have a higher pressure measurement than a tire that is cold.

A cold tire means the vehicle has been sitting for 3 hours and driven for less than 1.6 km (1 mile) in that 3 hour period.

Allow the tire to cool before measuring the inflation pressure. Always be sure the tire is cold before inflating to the recommended pressure.

The TPMS cannot alert you to severe and sudden tire damage caused by external factors such as nails or road debris.

If you feel any vehicle instability, immediately take your foot off the accelerator, apply the brakes gradually and with light force, and slowly move to a safe position off the road.

### **\* NOTICE**

**Tampering with, modifying, or disabling the Tire Pressure Monitoring System (TPMS) components may interfere with the system's ability to warn the driver of low tire pressure conditions and/or TPMS malfunctions. Tampering with, modifying, or disabling the Tire Pressure Monitoring System (TPMS) components may void the warranty for that portion of the vehicle.**

### **This device complies with Industry Canada Standard RSS-210.**

Operation is subject to the following two conditions:

1. This device may not cause harmful interference, and
2. This device must accept any interference received, including interference that may cause undesired operation.

## IF YOU HAVE A FLAT TIRE

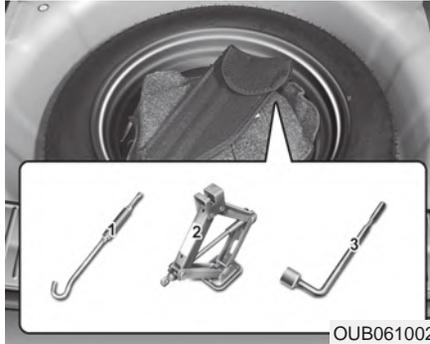

### Jack and tools

The spare tire, jack, jack handle and wheel lug nut wrench are stored in the luggage compartment.

Remove the luggage under tray out of the way to reach the equipment.

- (1) Jack handle
- (2) Jack
- (3) Wheel lug nut wrench

### Jacking instructions

The jack is provided for emergency tire changing only.

To prevent the jack from “rattling” while the vehicle is in motion, store it properly.

Follow jacking instructions to reduce the possibility of personal injury.

**⚠ WARNING - Changing tires**  
**Never attempt vehicle repairs in the traffic lanes of a public road or highway.**

Always move the vehicle completely off the road and onto the shoulder before trying to change a tire. The jack should be used on firm level ground. If you cannot find a firm level place off the road, call a towing service company for assistance.

Be sure to use the correct front and rear jacking positions on the vehicle; never use the bumpers or any other part of the vehicle for jack support.

**⚠ WARNING - Jack**  
**Do not place any portion of your body under a vehicle that is only supported by a jack since the vehicle can easily roll off the jack. Use vehicle support stands.**

## What to do in an emergency

Do not allow anyone to remain in the vehicle while it is on the jack.

Make sure any children present are in a secure place away from the road and from the vehicle to be raised with the jack.

**⚠ WARNING - Running vehicle on jack**  
**Do not start or run the engine of the vehicle while the vehicle is on the jack as this may cause the vehicle to fall off the jack.**



### Removing and storing the spare tire

Turn the tire hold-down wing bolt counterclockwise.

Store the tire in the reverse order of removal.

To prevent the spare tire and tools from “rattling” while the vehicle is in motion, store them properly.



### Changing tires

1. Park on a level surface and apply the parking brake firmly.
2. Shift the shift lever into R (Reverse) for manual transaxle or P (Park) for automatic transaxle.
3. Activate the hazard warning flasher.



4. Remove the wheel lug nut wrench, jack, jack handle, and spare tire from the vehicle.
5. Block both the front and rear of the wheel that is diagonally opposite the jack position.

To prevent vehicle movement while changing a tire, always set the parking brake fully, and always block the wheel diagonally opposite the wheel being changed.

We recommend that the wheels of the vehicle be chocked, and that no person remain in a vehicle that is being jacked.



6. Loosen the wheel lug nuts counterclockwise one turn each, but do not remove any nut until the tire has been raised off the ground.



7. Place the jack at the front or rear jacking position closest to the tire you are changing. Place the jack at the designated locations under the frame. The jacking positions are plates welded to the frame with two tabs and a raised dot to index with the jack.



8. Insert the jack handle into the jack and turn it clockwise, raising the vehicle until the tire just clears the ground. This measurement is approximately 30 mm (1 in). Before removing the wheel lug nuts, make sure the vehicle is stable and that there is no chance for movement or slippage.

9. Loosen the wheel nuts and remove them with your fingers. Slide the wheel off the studs and lay it flat so it cannot roll away. To put the wheel on the hub, pick up the spare tire, line up the holes with the studs and slide the wheel onto them. If this is difficult, tip the wheel slightly and get the top hole in the wheel lined up with the top stud. Then jiggle the wheel back and forth until the wheel can be slid over the other studs.

Wheels and wheel covers may have sharp edges. Handle them carefully to avoid possible injury. Before putting the wheel into place, be sure that there is nothing on the hub or wheel (such as mud, tar, gravel, etc.) that prevents with the wheel from fitting solidly against the hub.

**⚠ WARNING - Installing a wheel**

**Make sure the wheel makes good contact with the hub when installed. If the contact of the mounting surface between the wheel and hub is not good, the wheel nuts could come loose and cause the loss of a wheel. Loss of a wheel may result in loss of control of the vehicle.**

10. To install the wheel, hold it on the studs, put the wheel nuts on the studs and tighten them finger tight. Jiggle the tire to be sure it is completely seated, then tighten the nuts as much as possible with your fingers again.
11. Lower the vehicle to the ground by turning the wheel nut wrench counterclockwise.



Then position the wrench as shown in the drawing and tighten the wheel nuts. Be sure the socket is seated completely over the nut. Do not stand on the wrench handle or use an extension pipe over the wrench handle.

Go around the wheel tightening every nut following the numerical sequence shown in the image until they are tight. Then double-check each nut for tightness. After changing the wheels, have an authorized Kia dealer tighten the wheel nuts to their proper torque as soon as possible.

**Wheel nut tightening torque:**

Steel wheel & aluminium alloy wheel:  
9~11 kg.m (65~79 lb.ft)



If you have a tire gauge, remove the valve cap and check the air pressure. If the pressure is lower than recommended, drive slowly to the nearest service station and inflate to the correct pressure. If it is too high, adjust it until it is correct. Always reinstall the valve cap after checking or adjusting the tire pressure. If the cap is not replaced, air may leak from the tire. If you lose a valve cap, buy another and install it as soon as possible.

After you have changed wheels, always secure the flat tire in its place and return the jack and tools to their proper storage locations.

 **CAUTION - Reducing lug nuts**

***Make certain during wheel removal that the same nuts that were removed are reinstalled - or, if replaced, that nuts with metric threads and the same chamfer configuration are used. Your vehicle has metric threads on the wheel studs and nuts. Installation of a non-metric thread nut on a metric stud will not secure the wheel to the hub properly and will damage the stud so that it must be replaced.***

Note that most lug nuts do not have metric threads. Be sure to use extreme care in checking for thread style before installing aftermarket lug nuts or wheels. If in doubt, consult an authorized Kia dealer.

 **WARNING - Wheel studs**

**Do not drive your vehicle with damaged wheel studs. If the studs are damaged, they may lose their ability to retain the wheel. This could lead to the loss of the wheel and a collision.**

To prevent the jack, jack handle, wheel lug nut wrench and spare tire from rattling while the vehicle is in motion, store them properly.

Check the inflation pressures as soon as possible after installing the spare tire. Adjust it to the specified pressure, if necessary. Refer to "Tires and wheels" in section 8.

***Important - use of compact spare tire (if equipped)***

Your vehicle is equipped with a compact spare tire. This compact spare tire takes up less space than a regular-size tire. This tire is smaller than a conventional tire and is designed for temporary use only.

You should drive carefully when the compact spare is in use. The compact spare should be replaced by the proper conventional tire and rim at the first opportunity.

The operation of this vehicle is not recommended with more than one compact spare tire in use at the same time.

**⚠ WARNING - Spare tire**  
**Do not operate your vehicle on this compact spare at speeds over 80 km/h (50 mph). The compact spare tire is for emergency use only. The original tire should be repaired or replaced as soon as is possible to avoid failure of the spare.**

The compact spare should be inflated to 420 kPa (60 psi).

Check the inflation pressure after installing the spare tire. Adjust it to the specified pressure, as necessary.

When using a compact spare tire, observe the following precautions:

- Under no circumstances should you exceed 80 km/h (50 mph); a higher speed could damage the tire.
- Ensure that you drive slowly enough for the road conditions to avoid all hazards. Any road hazard, such as a pothole or debris, could seriously damage the compact spare.
- Any continuous road use of this tire could result in tire failure, loss of vehicle control, and possible personal injury.
- Do not exceed the vehicle's maximum load rating or the load-carrying capacity shown on the sidewall of the compact spare tire.
- Avoid driving over obstacles. The compact spare tire diameter is smaller than the diameter of a conventional tire and reduces the ground clearance approximately 25 mm (1 inch), which could result in damage to the vehicle.

## What to do in an emergency

---

- Do not take this vehicle through an automatic car wash while the compact spare tire is installed.
- The compact spare tire should not be installed on the front axle if the vehicle must be driven in snow or on ice.
- Do not use the compact spare tire on any other vehicle because this tire has been designed especially for your vehicle.
- The compact spare tire's tread life is shorter than a regular tire. Inspect your compact spare tire regularly and replace worn compact spare tires with the same size and design, mounted on the same wheel.
- The compact spare tire should not be used on any other wheels, nor should standard tires, snow tires, wheel covers or trim rings be used with the compact spare wheel. If such use is attempted, damage to these items or other car components may occur.
- Do not use more than one compact spare tire at a time.
- Do not tow a trailer while the compact spare tire is installed.

## IF YOU HAVE A FLAT TIRE (TIRE MOBILITY KIT, IF EQUIPPED)



OUB061009

For safe operation, carefully read and follow the instructions in this manual before use.

- (1) Compressor
- (2) Sealant bottle

The Tire Mobility Kit is a temporary fix to the tire and the tire should be inspected by an authorized Kia dealer as soon as possible.

**⚠ CAUTION - One sealant for one tire**

*When two or more tires are flat, do not use the tire mobility kit because the supported one sealant of Tire Mobility Kit is only used for one flat tire.*

**⚠ WARNING - Tire wall**

**Do not use the Tire Mobility Kit to repair punctures in the tire walls. This can result in an accident due to tire failure.**

**⚠ WARNING - Temporary fix**

**Have your tire repaired as soon as possible. The tire may lose air pressure at any time after inflating with the Tire Mobility Kit.**



OUB061010

### Introduction

With the Tire Mobility Kit you stay mobile even after experiencing a tire puncture.

The system of compressor and sealing compound effectively and comfortably seals most punctures in a passenger car tire caused by nails or similar objects and reinflates the tire.

After you ensured that the tire is properly sealed you can drive cautiously on the tire (distance up to 200 km (120 miles)) at a max. speed of (80 km/h) in order to reach a service station or tire dealer for the tire replacement.

It is possible that some tires, especially with larger punctures or damage to the sidewall, cannot be sealed completely.

Air pressure loss in the tire may adversely affect tire performance.

For this reason, you should avoid abrupt steering or other driving maneuvers, especially if the vehicle is heavily loaded or if a trailer is in use.

The Tire Mobility Kit is not designed or intended as a permanent tire repair method and is to be used for one tire only.

This instruction shows you step by step how to temporarily seal the puncture simply and reliably.

Read the section "Notes on the safe use of the Tire Mobility Kit".

### **Notes on the safe use of the Tire Mobility Kit**

- Park your car at the side of the road so that you can work with the Tire Mobility Kit away from moving traffic.
  - To be sure your vehicle will not move, even when you're on fairly level ground, always set your parking brake.
  - Only use the Tire Mobility Kit for sealing/inflation passenger car tires. Only punctured areas located within the tread region of the tire can be sealed using the tire mobility kit.
  - Do not use on motorcycles, bicycles or any other type of tires.
  - When the tire and wheel are damaged, do not use Tire Mobility Kit for your safety.
  - Use of the Tire Mobility Kit may not be effective for tire damage larger than approximately 6 mm (0.24 in). Please contact the nearest Kia dealership if the tire cannot be made roadworthy with the Tire Mobility Kit.
- Do not use the Tire Mobility Kit if a tire is severely damaged by driving run flat or with insufficient air pressure.
  - Do not remove any foreign objects such as nails or screws that have penetrated the tire.
  - Provided the car is outdoors, leave the engine running. Otherwise operating the compressor may eventually drain the car battery.
  - Never leave the Tire Mobility Kit unattended while it is being used.
  - Do not leave the compressor running for more than 10 min. at a time or it may overheat.
  - Do not use the Tire Mobility Kit if the ambient temperature is below -30°C (-22°F).

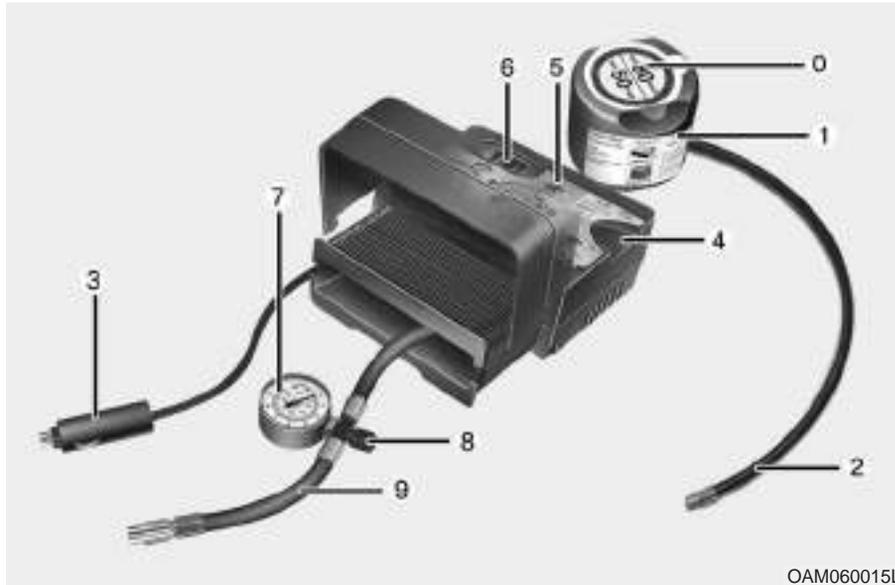

OAM060015L

### Components of the Tire Mobility Kit

- |  |  |
|--|--|
| 0. Speed restriction label                                     | 4. Holder for the sealant bottle                             |
| 1. Sealant bottle and label with speed restriction             | 5. Compressor  |
| 2. Filling hose from sealant bottle to wheel                   | 6. On/off switch   |
| 3. Connectors and cable for the power outlet direct connection | 7. Pressure gauge for displaying the tire inflation pressure |
|  | 8. Screw cap for reducing tire inflation pressure            |

9. Hose to connect compressor and sealant bottle or compressor and wheel

Connectors, cable and connection hose are stored in the compressor housing.

**⚠ WARNING - Expired sealant**

Do not use the Tire sealant after the sealant has expired (i.e. pasted the expiration date on the sealant container). This can increase the risk of tire failure.

**⚠ WARNING - Sealant**

- Keep out of reach of children.
- Avoid contact with eyes.
- Do not swallow.

Strictly follow the specified sequence, otherwise the sealant may escape under high pressure.

### Using the Tire Mobility Kit

1. Detach the speed restriction label (0) from the sealant bottle (1), and place it in a highly visible place inside the vehicle such as on the steering wheel to remind the driver not to drive too fast.
2. Screw connection hose (9) onto the connector of the sealant bottle.
3. Ensure that screw cap (8) is closed.
4. Unscrew the valve cap from the valve of the defective wheel and screw filling hose (2) of the sealant bottle onto the valve.
5. Insert the sealant bottle into the housing (4) of the compressor so that the bottle is upright.



6. Ensure that the compressor is switched off, position 0.
7. Plug the compressor power cord into the vehicle power outlet.
8. With the engine start/stop button position on or ignition switch position on, switch on the compressor and let it run for approximately 5~7 minutes to fill the sealant up to proper pressure. (refer to the Tire and Wheels, chapter 8). The inflation pressure of the tire after filling is unimportant and will be checked/corrected later.

Be careful not to overinflate the tire and stay away from the tire when filling it.

**⚠ CAUTION - Tire pressure**  
*Do not attempt to drive your vehicle if the tire pressure is below 200kpa (29 PSI). This could result in an accident due to sudden tire failure.*

9. Switch off the compressor.
10. Detach the hoses from the sealant bottle connector and from the tire valve.

Return the Tire Mobility Kit to its storage location in the vehicle.

**⚠ WARNING - Carbon monoxide**  
**Do not leave your vehicle running in a poorly ventilated area for extended periods of time. Carbon monoxide poisoning and suffocation can occur.**

### Distributing the sealant

11. Immediately drive approximately 7~10km (4~6miles or, about 10min) to evenly distribute the sealant in the tire.

Do not exceed a speed of 80 km/h (50 mph). If possible, do not fall below a speed of 20 km/h (12 mph).

While driving, if you experience any unusual vibration, ride disturbance or noise, reduce your speed and drive with caution until you can safely pull off of the side of the road.

Call for road side service or towing.

When you use the Tire Mobility Kit, the tire pressure sensors and wheel may be damaged by sealant, remove the sealant stained with tire pressure sensors and wheel and inspect in authorized dealer.

### Checking the tire inflation pressure

1. After driving approximately 7~10km (4 ~6miles or about 10min), stop at a safety location.
2. Connect connection hose (9) of the compressor directly to the tire valve.
3. Plug the compressor power cord into the vehicle power outlet.
4. Adjust the tire inflation pressure to the recommended tire inflation.

With the ignition switched on, proceed as follows.

**- To increase the inflation pressure :** Switch on the compressor, position I. To check the current inflation pressure setting, briefly switch off the compressor.

### \* NOTICE

The pressure gauge may show higher than actual reading when the compressor is running. To get an accurate tire pressure, the compressor needs to be turned off.

**- To reduce the inflation pressure:** Loosen the screw cap (8) on the compressor hose.



 **CAUTION - Tire pressure sensor**

*When you use the Tire Mobility Kit including sealant not approved by Kia, the tire pressure sensors may be damaged by sealant. The sealant on the tire pressure sensor and wheel should be removed when you replace the tire with a new one and inspect the tire pressure sensors in authorized dealer.*

**Technical Data**

System voltage: DC 12 V

Working voltage: DC 10 - 15 V

Amperage rating: max. 15 A

Suitable for use at temperatures:

-30 ~ +70°C (-22 ~ +158°F)

Max. working pressure:

6 bar (87 psi)

Size

Compressor: 170 x 150 x 60 mm

(6.7 x 5.9 x 2.4 in.)

Sealant bottle: 85 x ø 77 mm

(3.3 x ø 3.0 in.)

Compressor weight:

0.8 kg (1.8 lbs)

Sealant volume:

200 ml (12.2 cu. in.)

## TOWING

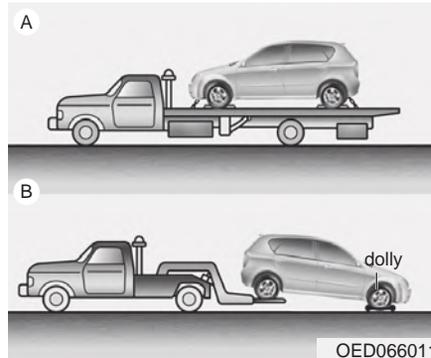

When being towed by a commercial tow truck and wheel dollies are not used, the front of the vehicle should always be lifted, not the rear.

### Towing service

If emergency towing is necessary, we recommend having it done by an authorized Kia dealer or a commercial tow-truck service. Proper lifting and towing procedures are necessary to prevent damage to the vehicle. The use of wheel dollies or flatbed is recommended.

*For trailer towing guidelines information, refer to "Trailer towing" in section 5.*

It is acceptable to tow the vehicle with the rear wheels on the ground (without dollies) and the front wheels off the ground.

If any of the loaded wheels or suspension components are damaged or the vehicle is being towed with the front wheels on the ground, use a towing dolly under the front wheels.

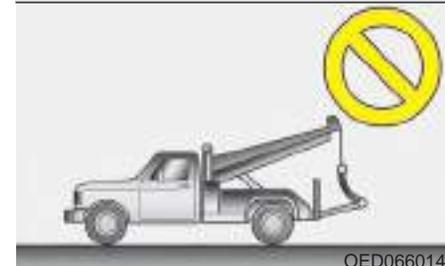

### **⚠ CAUTION - Towing**

- **Do not tow the vehicle backwards with the front wheels on the ground as this may cause damage to the vehicle.**
- **Do not tow with sling-type equipment. Use wheel lift or flatbed equipment.**

## What to do in an emergency

When towing your vehicle in an emergency without wheel dollies :

1. Set the ignition switch in the ACC position.
2. Place the transaxle shift lever in N (Neutral).
3. Release the parking brake.

### **CAUTION - Towing gear position**

*Always place the transaxle shift lever in Neutral (N) when towing your vehicle. Failure to place the transaxle shift lever in N (Neutral) may cause internal damage to the transaxle.*



### Removable towing hook (front) (if equipped)

1. Remove the towing hook from the tool case.
2. Remove the hole cover pressing the lower part of the cover on the front bumper.
3. Install the towing hook by turning it clockwise into the hole until it is fully secured.
4. Remove the towing hook and install the cover after use.



### Emergency towing

**If towing is necessary, we recommend you to have it done by an authorized Kia dealer or a commercial tow truck service.**

If towing service is not available in an emergency, your vehicle may be temporarily towed using a cable or chain secured to the emergency towing hook under the front (or rear) of the vehicle. Use extreme caution when towing the vehicle. A driver must be in the vehicle to steer it and operate the brakes.

Towing in this manner may be done only on hard-surfaced roads for a short distance and at low speeds. Also, the wheels, axles, power train, steering and brakes must all be in good condition.

- Do not use the towing hooks to pull a vehicle out of mud, sand or other conditions from which the vehicle cannot be driven out under its own power.
- Avoid towing a vehicle heavier than the vehicle doing the towing.
- The drivers of both vehicles should communicate with each other frequently.
- Attach a towing strap to the towing hook.
- Using a portion of the vehicle other than the tow hooks for towing may damage the body of your vehicle.
- Use only a cable or chain specifically intended for use in towing vehicles. Securely fasten the cable or chain to the towing hook provided.
- Before emergency towing, check that the hook is not broken or damaged.
- Fasten the towing cable or chain securely to the hook.
- Do not jerk the hook. Apply it steadily with even force.
- To avoid damaging the hook, do not pull from the side or at a vertical angle. Always pull straight ahead.

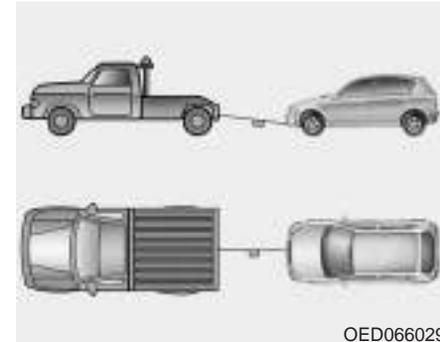

- Use a towing strap less than 5 m (16 feet) long. Attach a white or red cloth (about 30 cm (12 inches) wide) in the middle of the strap for easy visibility.
- Drive carefully so that the towing strap is not loosened during towing.

### **Emergency towing precautions**

- Turn the ignition switch to ACC so the steering wheel isn't locked.
- Place the transaxle shift lever in N (Neutral).
- Release the parking brake.
- Press the brake pedal with more force than normal since you will have reduced brake performance.
- More steering effort will be required because the power steering system will be disabled.
- If you are driving down a long hill, the brakes may overheat and brake performance will be reduced. Stop often and let the brakes cool off.

If the car is being towed with all four wheels on the ground, it can be towed only from the front. Be sure that the transmission is in neutral. Be sure the steering is unlocked by placing the ignition switch in the ACC position. A driver must be in the towed vehicle to operate the steering and brakes.

#### **⚠ CAUTION - Automatic transaxle**

- ***To avoid serious damage to the automatic transmission, limit the vehicle speed to 15 km/h (10 mph) and drive less than 1.5 km (1 mile) when towing.***
- ***Before towing, check the automatic transmission fluid leak under your vehicle. If the automatic transmission fluid is leaking, a flatbed equipment or towing dolly must be used.***

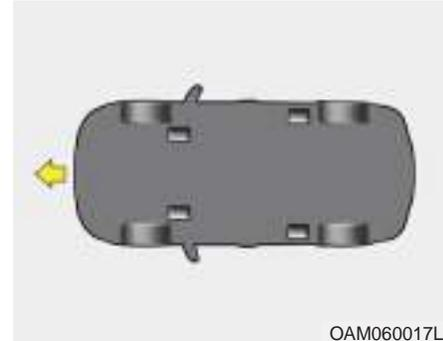

OAM060017L

#### **Tie-down hook (for flatbed towing, if equipped)**

#### **⚠ CAUTION - Tie-down hooks**

***Do not use the tie-down hooks for towing purposes. These hooks are designed ONLY for transport tie-down. If the tie-down hooks are used for towing, the tie-down hooks or front bumper will be damaged.***

**Engine compartment / 7-2**  
**Maintenance services / 7-3**  
**Owner maintenance / 7-5**  
**Scheduled maintenance service / 7-7**  
**Explanation of scheduled maintenance items / 7-22**  
**Engine oil / 7-25**  
**Engine coolant / 7-26**  
**Brake/clutch fluid / 7-29**  
**Automatic transaxle fluid / 7-30**  
**Washer fluid / 7-30**  
**Parking brake / 7-31**  
**Air cleaner / 7-31**  
**Climate control air filter / 7-32**  
**Wiper blades / 7-32**  
**Battery / 7-34**  
**Tires and wheels / 7-37**

## Maintenance

7

**Fuses / 7-50**  
**Appearance care / 7-60**  
**Emission control system / 7-66**

## ENGINE COMPARTMENT

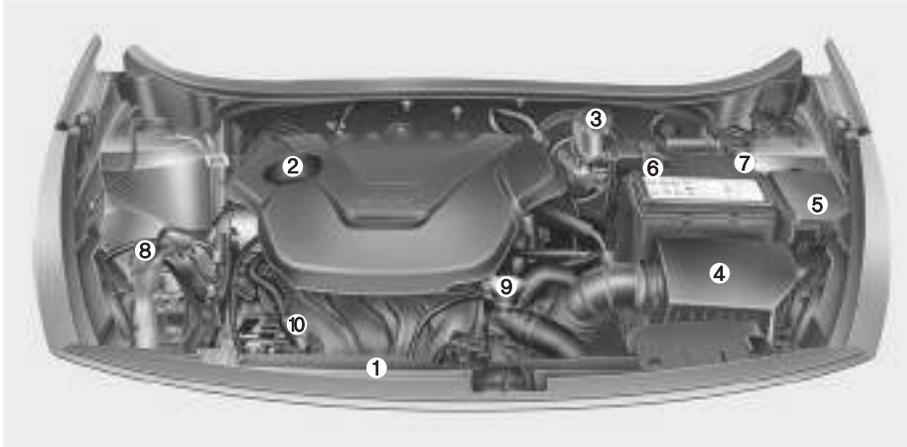

1. Engine coolant reservoir
2. Engine oil filler cap
3. Brake/clutch fluid reservoir
4. Air cleaner
5. Fuse box
6. Positive battery terminal
7. Negative battery terminal
8. Windshield washer fluid reservoir
9. Radiator cap
10. Engine oil dipstick

\* The actual engine room in the vehicle may differ from the illustration.

OUB071103N

## MAINTENANCE SERVICES

You should exercise the utmost care to prevent damage to your vehicle and injury to yourself whenever performing any maintenance or inspection procedures.

Should you have any doubts concerning the inspection or servicing of your vehicle, we strongly recommend that you have an authorized Kia dealer perform this work.

An authorized Kia dealer has factory-trained technicians and genuine Kia parts to service your vehicle properly. For expert advice and quality service, see an authorized Kia dealer.

Inadequate, incomplete or insufficient servicing may result in operational problems with your vehicle that could lead to vehicle damage, an accident, or personal injury.

### Owner's responsibility

#### \* NOTICE

#### **Maintenance Service and Record Retention are the owner's responsibility.**

You should retain documents that show proper maintenance has been performed on your vehicle in accordance with the scheduled maintenance service charts shown on the following pages. You need this information to establish your compliance with the servicing and maintenance requirements of your vehicle warranties. Detailed warranty information is provided in your Warranty & Consumer Information manual.

Repairs and adjustments required as a result of improper maintenance or a lack of required maintenance are not covered. We recommend you have your vehicle maintained and repaired by an authorized Kia dealer. An authorized Kia dealer meets Kia's high service quality standards and receives technical support from Kia in order to provide you with a high level of service satisfaction.



### Owner maintenance precautions

Improper or incomplete service may result in problems. This section gives instructions only for the maintenance items that are easy to perform.

As explained earlier in this section, several procedures can be done only by an authorized Kia dealer with special tools.

### \* NOTICE

Improper owner maintenance during the warranty period may affect warranty coverage. For details, read the separate Warranty & Consumer Information manual provided with the vehicle. If you're unsure about any servicing or maintenance procedure, have it done by an authorized Kia dealer.

### **WARNING - Maintenance work**

**Do not wear jewelry or loose clothing while working under the hood of your vehicle with the engine running. These can become entangled in moving parts, if you must run the engine while working under the hood, make certain that you remove all jewelry (especially rings, bracelets, watches, and necklaces) and all neckties, scarves, and similar loose clothing before getting near the engine or cooling fans.**

## OWNER MAINTENANCE

The following lists are vehicle checks and inspections that should be performed by the owner or an authorized Kia dealer at the frequencies indicated to help ensure safe, dependable operation of your vehicle.

Any adverse conditions should be brought to the attention of your dealer as soon as possible.

These Owner Maintenance Checks are generally not covered by warranties and you may be charged for labor, parts and lubricants used.

### Owner maintenance schedule

#### *When you stop for fuel:*

- Check the engine oil level.
- Check the coolant level in coolant reservoir.
- Check the windshield washer fluid level.
- Look for low or under-inflated tires.

**⚠ WARNING - Hot coolant**  
**Be careful when checking your engine coolant level when the engine is hot. Scalding hot coolant and steam may blow out under pressure.**

#### *While operating your vehicle:*

- Note any changes in the sound of the exhaust or any smell of exhaust fumes in the vehicle.
- Check for vibrations in the steering wheel. Notice any increased steering effort or looseness in the steering wheel, or change in its straight-ahead position.
- Notice if your vehicle constantly turns slightly or “pulls” to one side when traveling on smooth, level road.
- When stopping, listen and check for unusual sounds, pulling to one side, increased brake pedal travel or “hard-to-push” brake pedal.
- If any slipping or changes in the operation of your transaxle occurs, check the transaxle fluid level.
- Check the automatic transaxle P (Park) function.
- Check the parking brake.
- Check for fluid leaks under your vehicle (water dripping from the air conditioning system during or after use is normal).

### ***At least monthly:***

- Check the coolant level in the engine coolant reservoir.
- Check the operation of all exterior lights, including the stoplights, turn signals and hazard warning flashers.
- Check the inflation pressures of all tires including the spare.

### ***At least twice a year (i.e., every Spring and Fall) :***

- Check the radiator, heater and air conditioning hoses for leaks or damage.
- Check the windshield washer spray and wiper operation. Clean the wiper blades with clean cloth dampened with washer fluid.
- Check the headlight alignment.
- Check the muffler, exhaust pipes, shields and clamps.
- Check the lap/shoulder belts for wear and function.
- Check for worn tires and loose wheel lug nuts.

### ***At least once a year :***

- Clean the body and door drain holes.
- Lubricate the door hinges and checks, and hood hinges.
- Lubricate the door and hood locks and latches.
- Lubricate the door rubber weatherstrips.
- Check the air conditioning system.
- Check the power steering fluid level.
- Inspect and lubricate automatic transaxle linkage and controls.
- Clean the battery and terminals.
- Check the brake/clutch fluid level.

## SCHEDULED MAINTENANCE SERVICE

Follow the Normal Maintenance Schedule if the vehicle is usually operated where none of the following conditions apply. If any of the following conditions apply, follow the Maintenance Under Severe Usage Conditions.

- Repeated short distance driving.
- Driving in dusty conditions or sandy areas.
- Extensive use of brakes.
- Driving in areas where salt or other corrosive materials are being used.
- Driving on rough or muddy roads.
- Driving in mountainous areas.
- Extended periods of idling or low speed operation.
- Driving for a prolonged period in cold temperatures and/or extremely humid climates.
- More than 50% driving in heavy city traffic during hot weather above 32°C (90°F).

*If your vehicle is operated under the above conditions, you should inspect, replace or refill more frequently than the following Normal Maintenance Schedule. After 120 months or 240,000 km (150,000 miles) continue to follow the prescribed maintenance intervals.*

## NORMAL MAINTENANCE SCHEDULE

The following maintenance services must be performed to ensure good emission control and performance. Keep receipts for all vehicle emission services to protect your warranty. Where both mileage and time are shown, the frequency of service is determined by whichever occurs first.

### 12,000 km or 6 months

- Inspect air cleaner filter
- Inspect air conditioning compressor, air conditioner refrigerant and performance (if equipped)
- Inspect cooling system \*1
- Inspect drive shaft and boots
- Inspect visually the following items.
  - 1) Battery condition
  - 2) Brake fluid / clutch(if equipped) fluid
  - 3) Brake lines, hoses and connections
  - 4) Brake pedal and operation
  - 5) Chassis/body nuts and bolts
  - 6) Drum brake and linings (if equipped)
  - 7) Disc brakes and pads(if equipped)
  - 8) Exhaust pipe and muffler
  - 9) Front suspension ball joints
  - 10) Fuel tank, cap, lines and hoses
  - 11) Lubricate all locks and hinges
  - 12) Parking brakes
  - 13) Steering operation and linkage
  - 14) Suspension mounting bolts

(Continued)

(Continued)

- Replace engine oil and filter  
(Every 12,000 km or 12 months)
- Add fuel additive \*A  
(Every 12,000 km or 12 months)
- Rotate tires - including tire pressure and tread wear  
(Every 12,000 km or 12 months)

\*1 Inspect "Water Pump" when replacing the drive belt or timing belt.

\*A If TOP TIER Detergent Gasoline is not available, one bottle of additive is recommended. Additives are available from your authorized Kia dealer along with information on how to use them. Do not mix other additives.

**NORMAL MAINTENANCE SCHEDULE (CONT.)****24,000 km or 12 months**

- Inspect air cleaner filter
- Inspect air conditioning compressor, air conditioner refrigerant and performance (if equipped)
- Inspect cooling system \*<sup>1</sup>
- Inspect drive shaft and boots
- Inspect visually the following items
  - 1) Battery condition
  - 2) Brake fluid / clutch(if equipped) fluid
  - 3) Brake lines, hoses and connections
  - 4) Brake pedal and operation
  - 5) Chassis/body nuts and bolts
  - 6) Drum brake and linings (if equipped)
  - 7) Disc brakes and pads(if equipped)
  - 8) Exhaust pipe and muffler
  - 9) Front suspension ball joints
  - 10) Fuel tank, cap, lines and hoses
  - 11) Lubricate all locks and hinges
  - 12) Parking brakes
  - 13) Steering operation and linkage
  - 14) Suspension mounting bolts
- Replace climate control air filter (if equipped)
- Replace engine oil and filter  
(Every 12,000 km or 12 months)

(Continued)

(Continued)

- Add fuel additive \*<sup>A</sup>  
(Every 12,000 km or 12 months)
- Rotate tires - including tire pressure and tread wear  
(Every 12,000 km or 12 months)

\*<sup>1</sup> Inspect "Water Pump" when replacing the drive belt or timing belt.\*<sup>A</sup> If TOP TIER Detergent Gasoline is not available, one bottle of additive is recommended. Additives are available from your authorized Kia dealer along with information on how to use them. Do not mix other additives.

## NORMAL MAINTENANCE SCHEDULE (CONT.)

### 48,000 km or 24 months

- Inspect air conditioning compressor, air conditioner refrigerant and performance (if equipped)
- Inspect cooling system \*1
- Inspect drive shaft and boots
- Inspect fuel filter \*2
- Inspect fuel line, hoses and connection
- Inspect fuel tank air filter \*2
- Inspect manual transaxle fluid (if equipped)  
(Every 60,000 km or 48 months)
- Inspect vapor hose and fuel filler cap
- Inspect visually the following items
  - 1) Battery condition
  - 2) Brake fluid / clutch (if equipped) fluid
  - 3) Brake lines, hoses and connections
  - 4) Brake pedal and operation
  - 5) Chassis/body nuts and bolts
  - 6) Drum brake and linings (if equipped)
  - 7) Disc brakes and pads (if equipped)
  - 8) Exhaust pipe and muffler
  - 9) Front suspension ball joints
  - 10) Fuel tank, cap, lines and hoses
  - 11) Lubricate all locks and hinges
  - 12) Parking brakes
  - 13) Steering operation and linkage
  - 14) Suspension mounting bolts
- Replace air cleaner filter

(Continued)

(Continued)

- Replace climate control air filter (if equipped)
- Replace engine oil and filter  
(Every 12,000 km or 12 months)
- Add fuel additive \*A  
(Every 12,000 km or 12 months)
- Rotate tires - including tire pressure and tread wear  
(Every 12,000 km or 12 months)

\*1 Inspect "Water Pump" when replacing the drive belt or timing belt.

\*2 Fuel filter & Fuel tank air filter are considered to be maintenance free but periodic inspection is recommended for this maintenance schedule depends on fuel quality. If there are some important safety matters like fuel flow restriction, surging, loss of power, hard starting problem etc, replace the fuel filter immediately regardless of maintenance schedule and consult an authorized Kia dealer for details.

\*A If TOP TIER Detergent Gasoline is not available, one bottle of additive is recommended. Additives are available from your authorized Kia dealer along with information on how to use them. Do not mix other additives.

**NORMAL MAINTENANCE SCHEDULE (CONT.)****72,000 km or 36 months**

- Inspect air cleaner filter
- Inspect air conditioning compressor, air conditioner refrigerant and performance (if equipped)
- Inspect cooling system \*<sup>1</sup>
- Inspect drive shaft and boots
- Inspect visually the following items
  - 1) Battery condition
  - 2) Brake fluid / clutch (if equipped) fluid
  - 3) Brake lines, hoses and connections
  - 4) Brake pedal and operation
  - 5) Chassis/body nuts and bolts
  - 6) Drum brake and linings (if equipped)
  - 7) Disc brakes and pads (if equipped)
  - 8) Exhaust pipe and muffler
  - 9) Front suspension ball joints
  - 10) Fuel tank, cap, lines and hoses
  - 11) Lubricate all locks and hinges
  - 12) Parking brakes
  - 13) Steering operation and linkage
  - 14) Suspension mounting bolts

(Continued)

(Continued)

- Replace climate control air filter (if equipped)
- Replace engine oil and filter  
(Every 12,000 km or 12 months)
- Add fuel additive \*<sup>A</sup> (Every 12,000 km or 12 months)
- Rotate tires - including tire pressure and tread wear  
(Every 12,000 km or 12 months)

\*<sup>1</sup> Inspect "Water Pump" when replacing the drive belt or timing belt.

\*<sup>A</sup> If TOP TIER Detergent Gasoline is not available, one bottle of additive is recommended. Additives are available from your authorized Kia dealer along with information on how to use them. Do not mix other additives.



## NORMAL MAINTENANCE SCHEDULE (CONT.)

### 96,000 km or 48 months

- Inspect air conditioning compressor, air conditioner refrigerant and performance (if equipped)
- Inspect cooling system \*1
- Inspect drive belt \*4  
(First, 96,000 km or 72 months  
after every 24,000 km or 24 months)
- Inspect drive shaft and boots
- Inspect fuel filter \*2
- Inspect fuel line, hoses and connection
- Inspect fuel tank air filter \*2
- Inspect valve clearance \*3
- Inspect vapor hose and fuel filler cap
- Inspect visually the following items
  - 1) Battery condition
  - 2) Brake fluid / clutch (if equipped) fluid
  - 3) Brake lines, hoses and connections
  - 4) Brake pedal and operation
  - 5) Chassis/body nuts and bolts
  - 6) Drum brake and linings (if equipped)
  - 7) Disc brakes and pads (if equipped)

(Continued)

(Continued)

- 8) Exhaust pipe and muffler
  - 9) Front suspension ball joints
  - 10) Fuel tank, cap, lines and hoses
  - 11) Lubricate all locks and hinges
  - 12) Parking brakes
  - 13) Steering operation and linkage
  - 14) Suspension mounting bolts
- Replace air cleaner filter
  - Replace climate control air filter (if equipped)
  - Replace engine oil and filter  
(Every 12,000 km or 12 months)
  - Add fuel additive \*A  
(Every 12,000 km or 12 months)
  - Rotate tires - including tire pressure and tread wear  
(Every 12,000 km or 12 months)

\*1 Inspect "Water Pump" when replacing the drive belt or timing belt.

\*2 Fuel filter & Fuel tank air filter are considered to be maintenance free but periodic inspection is recommended for this maintenance schedule depends on fuel quality. If there are some important safety matters like fuel flow restriction, surging, loss of power, hard starting problem etc, replace the fuel filter immediately regardless of maintenance schedule and consult an authorized Kia dealer for details.

\*3 Inspect for excessive tappet noise and/or engine vibration and adjust if necessary.

\*4 The drive belt should be replaced when cracks occur or tension is reduced excessively.

\*A If TOP TIER Detergent Gasoline is not available, one bottle of additive is recommended. Additives are available from your authorized Kia dealer along with information on how to use them. Do not mix other additives.

**NORMAL MAINTENANCE SCHEDULE (CONT.)****120,000 km or 60 months**

- Inspect air cleaner filter
- Inspect air conditioning compressor, air conditioner refrigerant and performance (if equipped)
- Inspect cooling system \*<sup>1</sup>
- Inspect drive belt \*<sup>4</sup>  
(First 96,000 km or 72 months after every 24,000 km or 24 months)
- Inspect drive shaft and boots
- Inspect manual transaxle fluid (if equipped)  
(Every 60,000 km or 48 months)
- Inspect visually the following items
  - 1) Battery condition
  - 2) Brake fluid / clutch (if equipped) fluid
  - 3) Brake lines, hoses and connections
  - 4) Brake pedal and operation
  - 5) Chassis/body nuts and bolts
  - 6) Drum brake and linings (if equipped)
  - 7) Disc brakes and pads (if equipped)

(Continued)

(Continued)

- 8) Exhaust pipe and muffler
- 9) Front suspension ball joints
- 10) Fuel tank, cap, lines and hoses
- 11) Lubricate all locks and hinges
- 12) Parking brakes
- 13) Steering operation and linkage
- 14) Suspension mounting bolts
- Replace climate control air filter (if equipped)
- Replace engine oil and filter  
(Every 12,000 km or 12 months)
- Add fuel additive \*<sup>A</sup>  
(Every 12,000 km or 12 months)
- Rotate tires - including tire pressure and tread wear  
(Every 12,000 km or 12 months)

\*<sup>1</sup> Inspect "Water Pump" when replacing the drive belt or timing belt.\*<sup>4</sup> The drive belt should be replaced when cracks occur or tension is reduced excessively.\*<sup>A</sup> If TOP TIER Detergent Gasoline is not available, one bottle of additive is recommended. Additives are available from your authorized Kia dealer along with information on how to use them. Do not mix other additives.

## NORMAL MAINTENANCE SCHEDULE (CONT.)

### 144,000 km or 72 months

- Inspect air conditioning compressor, air conditioner refrigerant and performance (if equipped)
- Inspect cooling system \*1
- Inspect drive belt \*4  
(First 96,000 km or 72 months after every 24,000 km or 24 months)
- Inspect drive shaft and boots
- Inspect fuel filter \*2
- Inspect fuel line, hoses and connection
- Inspect fuel tank air filter \*2
- Inspect vapor hose and fuel filler cap
- Inspect visually the following items
  - 1) Battery condition
  - 2) Brake fluid / clutch (if equipped) fluid
  - 3) Brake lines, hoses and connections
  - 4) Brake pedal and operation
  - 5) Chassis/body nuts and bolts
  - 6) Drum brake and linings (if equipped)
  - 7) Disc brakes and pads (if equipped)
  - 8) Exhaust pipe and muffler
  - 9) Front suspension ball joints
  - 10) Fuel tank, cap, lines and hoses
  - 11) Lubricate all locks and hinges
  - 12) Parking brakes
  - 13) Steering operation and linkage
  - 14) Suspension mounting bolts

(Continued)

(Continued)

- Replace air cleaner filter
- Replace climate control air filter (if equipped)
- Replace engine oil and filter  
(Every 12,000 km or 12 months)
- Add fuel additive \*A  
(Every 12,000 km or 12 months)
- Rotate tires - including tire pressure and tread wear  
(Every 12,000 km or 12 months)

\*1 Inspect "Water Pump" when replacing the drive belt or timing belt.

\*2 Fuel filter & Fuel tank air filter are considered to be maintenance free but periodic inspection is recommended for this maintenance schedule depends on fuel quality. If there are some important safety matters like fuel flow restriction, surging, loss of power, hard starting problem etc, replace the fuel filter immediately regardless of maintenance schedule and consult an authorized Kia dealer for details.

\*4 The drive belt should be replaced when cracks occur or tension is reduced excessively.

\*A If TOP TIER Detergent Gasoline is not available, one bottle of additive is recommended. Additives are available from your authorized Kia dealer along with information on how to use them. Do not mix other additives.

**NORMAL MAINTENANCE SCHEDULE (CONT.)****168,000 km or 84 months**

- Inspect air cleaner filter
- Inspect air conditioning compressor, air conditioner refrigerant and performance (if equipped)
- Inspect cooling system \*<sup>1</sup>
- Inspect drive belt \*<sup>4</sup>  
(First 96,000 km or 72 months after every 24,000 km or 24 months)
- Inspect drive shaft and boots
- Inspect manual transaxle fluid (if equipped)  
(Every 60,000 km or 48 months)
- Inspect visually the following items
  - 1) Battery condition
  - 2) Brake fluid / clutch (if equipped) fluid
  - 3) Brake lines, hoses and connections
  - 4) Brake pedal and operation
  - 5) Chassis/body nuts and bolts
  - 6) Drum brake and linings (if equipped)
  - 7) Disc brakes and pads (if equipped)
  - 8) Exhaust pipe and muffler
  - 9) Front suspension ball joints
  - 10) Fuel tank, cap, lines and hoses
  - 11) Lubricate all locks and hinges
  - 12) Parking brakes
  - 13) Steering operation and linkage
  - 14) Suspension mounting bolts

(Continued)

(Continued)

- Replace climate control air filter (if equipped)
- Replace engine oil and filter  
(Every 12,000 km or 12 months)
- Add fuel additive \*<sup>A</sup>  
(Every 12,000 km or 12 months)
- Replace spark plugs (iridium coated),  
(Every 150,000 km or 120 months)
- Rotate tires - including tire pressure and tread wear  
(Every 12,000 km or 12 months)

\*<sup>1</sup> Inspect "Water Pump" when replacing the drive belt or timing belt.\*<sup>4</sup> The drive belt should be replaced when cracks occur or tension is reduced excessively.\*<sup>A</sup> If TOP TIER Detergent Gasoline is not available, one bottle of additive is recommended. Additives are available from your authorized Kia dealer along with information on how to use them. Do not mix other additives.

## NORMAL MAINTENANCE SCHEDULE (CONT.)

### 192,000 km or 96 months

- Inspect air conditioning compressor, air conditioner refrigerant and performance (if equipped)
- Inspect cooling system \*1
- Inspect drive belt \*4  
(First 96,000 km or 72 months after every 24,000 km or 24 months)
- Inspect drive shaft and boots
- Inspect fuel filter \*2
- Inspect fuel line, hoses and connection
- Inspect fuel tank air filter \*2
- Inspect valve clearance \*3
- Inspect vapor hose and fuel filler cap
- Inspect visually the following items
  - 1) Battery condition
  - 2) Brake fluid / clutch (if equipped) fluid
  - 3) Brake lines, hoses and connections
  - 4) Brake pedal and operation
  - 5) Chassis/body nuts and bolts
  - 6) Drum brake and linings (if equipped)
  - 7) Disc brakes and pads (if equipped)
  - 8) Exhaust pipe and muffler
  - 9) Front suspension ball joints
  - 10) Fuel tank, cap, lines and hoses
  - 11) Lubricate all locks and hinges
  - 12) Parking brakes

(Continued)

(Continued)

- 13) Steering operation and linkage
  - 14) Suspension mounting bolts
- Replace air cleaner filter
  - Replace climate control air filter (if equipped)
  - Replace engine coolant\*5  
(First, 192,000 km or 120 months after every 48,000 km or 24 months)
  - Replace engine oil and filter  
(Every 12,000 km or 12 months)
  - Add fuel additive \*A (Every 12,000 km or 12 months)
  - Rotate tires - including tire pressure and tread wear  
(Every 12,000 km or 12 months)

\*1 Inspect "Water Pump" when replacing the drive belt or timing belt.

\*2 Fuel filter & Fuel tank air filter are considered to be maintenance free but periodic inspection is recommended for this maintenance schedule depends on fuel quality. If there are some important safety matters like fuel flow restriction, surging, loss of power, hard starting problem etc, replace the fuel filter immediately regardless of maintenance schedule and consult an authorized Kia dealer for details.

\*3 Inspect for excessive tappet noise and/or engine vibration and adjust if necessary.

\*4 The drive belt should be replaced when cracks occur or tension is reduced excessively.

\*5 When replacing coolant, use only a qualified coolant additive for your vehicle and never mix hard water in the coolant filled at the factory.

An improper coolant mixture can result in serious malfunction or engine damage.

\*A If TOP TIER Detergent Gasoline is not available, one bottle of additive is recommended. Additives are available from your authorized Kia dealer along with information on how to use them. Do not mix other additives.

**NORMAL MAINTENANCE SCHEDULE (CONT.)****216,000 km or 108 months**

- Inspect air cleaner filter
- Inspect air conditioning compressor, air conditioner refrigerant and performance (if equipped)
- Inspect cooling system \*1
- Inspect drive belt \*\*  
(First 96,000 km or 72 months after every 24,000 km or 24 months)
- Inspect drive shaft and boots
- Inspect visually the following items
  - 1) Battery condition
  - 2) Brake fluid / clutch (if equipped) fluid
  - 3) Brake lines, hoses and connections
  - 4) Brake pedal and operation
  - 5) Chassis/body nuts and bolts
  - 6) Drum brake and linings (if equipped)
  - 7) Disc brakes and pads (if equipped)
  - 8) Exhaust pipe and muffler
  - 9) Front suspension ball joints
  - 10) Fuel tank, cap, lines and hoses
  - 11) Lubricate all locks and hinges
  - 12) Parking brakes
  - 13) Steering operation and linkage
  - 14) Suspension mounting bolts

(Continued)

(Continued)

- Replace climate control air filter (if equipped)
- Replace engine oil and filter  
(Every 12,000 km or 12 months)
- Add fuel additive \*\*  
(Every 12,000 km or 12 months)
- Rotate tires - including tire pressure and tread wear  
(Every 12,000 km or 12 months)

\*1 Inspect "Water Pump" when replacing the drive belt or timing belt.

\*\* The drive belt should be replaced when cracks occur or tension is reduced excessively.

\*\* If TOP TIER Detergent Gasoline is not available, one bottle of additive is recommended. Additives are available from your authorized Kia dealer along with information on how to use them. Do not mix other additives.

## NORMAL MAINTENANCE SCHEDULE (CONT.)

### 240,000 km or 120 months

- Inspect air conditioning compressor, air conditioner refrigerant and performance (if equipped)
- Inspect cooling system \*1
- Inspect drive belt \*4  
(First 96,000 km or 72 months after every 24,000 km or 24 months)
- Inspect drive shaft and boots
- Inspect fuel filter \*2
- Inspect fuel line, hoses and connection
- Inspect fuel tank air filter \*2
- Inspect manual transaxle fluid (if equipped)  
(Every 60,000 km or 48 months)
- Inspect vapor hose and fuel filler cap
- Inspect visually the following items
  - 1) Battery condition
  - 2) Brake fluid / clutch (if equipped) fluid
  - 3) Brake lines, hoses and connections
  - 4) Brake pedal and operation
  - 5) Chassis/body nuts and bolts
  - 6) Drum brake and linings (if equipped)
  - 7) Disc brakes and pads (if equipped)
  - 8) Exhaust pipe and muffler
  - 9) Front suspension ball joints
  - 10) Fuel tank, cap, lines and hoses
  - 11) Lubricate all locks and hinges
  - 12) Parking brakes

(Continued)

(Continued)

- 13) Steering operation and linkage
  - 14) Suspension mounting bolts
- Replace air cleaner filter
  - Replace climate control air filter (if equipped)
  - Replace engine coolant \*5  
(First 192,000 km or 120 months after every 48,000 km or 24 months)
  - Replace engine oil and filter  
(Every 12,000 km or 12 months)
  - Add fuel additive \*A  
(Every 12,000 km or 12 months)
  - Rotate tires - including tire pressure and tread wear  
(Every 12,000 km or 12 months)

\*1 Inspect "Water Pump" when replacing the drive belt or timing belt.

\*2 Fuel filter & Fuel tank air filter are considered to be maintenance free but periodic inspection is recommended for this maintenance schedule depends on fuel quality. If there are some important safety matters like fuel flow restriction, surging, loss of power, hard starting problem etc, replace the fuel filter immediately regardless of maintenance schedule and consult an authorized Kia dealer for details.

\*4 The drive belt should be replaced when cracks occur or tension is reduced excessively.

\*5 When replacing coolant, use only a qualified coolant additive for your vehicle and never mix hard water in the coolant filled at the factory.

An improper coolant mixture can result in serious malfunction or engine damage.

\*A If TOP TIER Detergent Gasoline is not available, one bottle of additive is recommended. Additives are available from your authorized Kia dealer along with information on how to use them. Do not mix other additives.

---

**NORMAL MAINTENANCE SCHEDULE**

**No check, No service required**

Automatic transaxle fluid (if equipped)



## MAINTENANCE UNDER SEVERE USAGE CONDITIONS

The following items must be serviced more frequently on cars normally used under severe driving conditions. Refer to the chart below for the appropriate maintenance intervals.

R : Replace    I : Inspect and, after inspection, clean, adjust, repair or replace if necessary

MAINTENANCE ITEM	MAINTENANCE OPERATION	MAINTENANCE INTERVALS	DRIVING CONDITION
ENGINE OIL AND FILTER	R	EVERY 6,000 km OR 6 MONTHS	A, B, C, D, E, F, G, H, I, K
AIR CLEANER FILTER	R	MORE FREQUENTLY	C, E
SPARK PLUGS	R	MORE FREQUENTLY	A, B, H, I, K
DISC BRAKE/ PADS, CALIPERS AND ROTORS	R	MORE FREQUENTLY	C, D, G, H
REAR BRAKE DRUMS/ LININGS, PARKING BRAKE	R	MORE FREQUENTLY	C, D, G, H
STEERING GEAR BOX, LINKAGE & BOOTS/ LOWER ARM BALL JOINT, UPPER ARM BSALL JOINT	I	MORE FREQUENTLY	C, D, E, F, G, H, I
DRIVE SHAFTS AND BOOTS	I	EVERY 12,000 km OR 6 MONTHS	C, D, E, F, G, H, I

MAINTENANCE ITEM	MAINTENANCE OPERATION	MAINTENANCE INTERVALS	DRIVING CONDITION
MANUAL TRANSAXLE OIL*	R	EVERY 120,000 km	C, D, E, G, H, I, J
AUTOMATIC TRANSAXLE FLUID*	R	EVERY 96,000 km	A, C, E, F, G, H, I
CLIMATE CONTROL AIR FILTER (FOR EVAPORATOR AND BLOWER UNIT)	R	MORE FREQUENTLY	C, E

**SEVERE DRIVING CONDITIONS**

- A - Repeatedly driving shorts distanse of less than 8 km in normal temperature or less than 16 km in freezing temperature
- B - Extensive engine idling or low speed driving for long distances
- C - Driving on rough, dusty, muddy, unpaved, graveled or salt-spread roads
- D - Driving in areas using salt or other corrosive materials or in very cold weather

- E - Driving in sandy areas
- F - Driving in heavy traffic area over 32°C (90°F)
- G - Driving on uphill, downhill, or mountain road
- H - Towing a Trailer, or using a camper, or roof rack
- I - Driving as a patrol car, taxi, other commercial use or vehicle towing
- J - Driving over 170 km/h
- K - Frequently driving in stop-and-go conditions

\* : if equipped

### EXPLANATION OF SCHEDULED MAINTENANCE ITEMS

#### Engine oil and filter

The engine oil and filter should be changed at the intervals specified in the maintenance schedule. If the vehicle is being driven in severe conditions, more frequent oil and filter changes are required.

#### Drive belts

Inspect all drive belts for evidence of cuts, cracks, excessive wear or oil saturation and replace if necessary. Drive belts should be checked periodically for proper tension and adjusted as necessary.

#### Fuel filter

A clogged filter can limit the speed at which the vehicle may be driven, damage the emission system and cause multiple issues such as hard starting. If an excessive amount of foreign matter accumulates in the fuel tank, the filter may require replacement more frequently.

After installing a new filter, run the engine for several minutes, and check for leaks at the connections. Fuel filters should be installed by an authorized Kia dealer.

#### Fuel lines, fuel hoses and connections

Check the fuel lines, fuel hoses and connections for leakage and damage. Have an authorized Kia dealer replace any damaged or leaking parts immediately.

#### Vapor hose and fuel filler cap

The vapor hose and fuel filler cap should be inspected at those intervals specified in the maintenance schedule. Make sure that a new vapor hose or fuel filler cap is correctly replaced.

#### Vacuum crankcase ventilation hoses (if equipped)

Inspect the surface of hoses for evidence of heat and/or mechanical damage. Hard and brittle rubber, cracking, tears, cuts, abrasions, and excessive swelling indicate deterioration. Particular attention should be paid to examine those hose surfaces nearest to high heat sources, such as the exhaust manifold.

Inspect the hose routing to assure that the hoses do not come in contact with any heat source, sharp edges or moving component which might cause heat damage or mechanical wear. Inspect all hose connections, such as clamps and couplings, to make sure they are secure, and that no leaks are present. Hoses should be replaced immediately if there is any evidence of deterioration or damage.

**Air cleaner filter**

A Genuine Kia air cleaner filter is recommended when the filter is replaced.

**Spark plugs**

Make sure to install new spark plugs of the correct heat range.

**Valve clearance (if equipped)**

Inspect for excessive valve noise and/or engine vibration and adjust if necessary. An authorized Kia dealer should perform the operation.

**Cooling system**

Check the cooling system components, such as the radiator, coolant reservoir, hoses and connections for leakage and damage. Replace any damaged parts.

**Coolant**

The coolant should be changed at the intervals specified in the maintenance schedule.

**Manual transaxle fluid (if equipped)**

Inspect the manual transaxle fluid according to the maintenance schedule.

**Automatic transaxle fluid (if equipped)**

Automatic transaxle fluid should not be checked under normal usage conditions. But in severe conditions, the fluid should be changed at an authorized Kia dealer in accordance to the scheduled maintenance at the beginning of this chapter.

**\* NOTICE**

**Automatic transaxle fluid color is basically red.**

**As the vehicle is driven, the automatic transaxle fluid will begin to look darker. This is a normal condition and you should not judge the need to replace the fluid based upon the changed color.**

**CAUTION - Specified fluid**

***The use of a non-specified fluid could result in transaxle malfunction and failure.***

***Use only specified automatic transaxle fluid. (Refer to "Recommended lubricants and capacities" in section 8.)***

**Brake hoses and lines**

Visually check for proper installation, chafing, cracks, deterioration and any leakage. Replace any deteriorated or damaged parts immediately.

**Brake/Clutch (if equipped) fluid**

Check the brake fluid level in the brake fluid reservoir. The level should be between "MIN" and "MAX" marks on the side of the reservoir. Use only hydraulic brake fluid conforming to DOT 3 or DOT 4 specification.

**Parking brake**

Inspect the parking brake system including the parking brake lever and cables.

### **Rear brake drums and linings (if equipped)**

Check the rear brake drums and linings for scoring, burning, leaking fluid, broken parts, and excessive wear.

### **Brake discs, pads, calipers and rotors**

Check the pads for excessive wear, discs for run out and wear, and calipers for fluid leakage.

### **Suspension mounting bolts**

Check the suspension connections for looseness or damage. Retighten to the specified torque.

### **Steering gear box, linkage & boots/lower arm ball joint**

With the vehicle stopped and engine off, check for excessive free-play in the steering wheel.

Check the linkage for bends or damage. Check the dust boots and ball joints for deterioration, cracks, or damage. Replace any damaged parts.

### **Drive shafts and boots**

Check the drive shafts, boots and clamps for cracks, deterioration, or damage. Replace any damaged parts and, if necessary, repack the grease.

### **Air conditioning refrigerant (if equipped)**

Check the air conditioning lines and connections for leakage and damage.

## ENGINE OIL

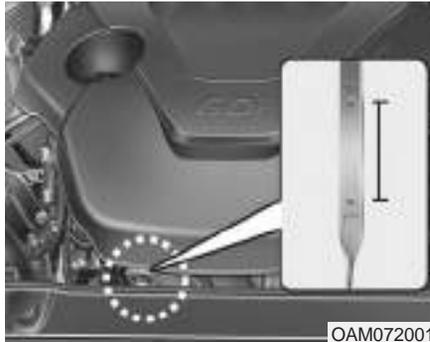

OAM072001

### Checking the engine oil level

1. Be sure the vehicle is on level ground.
2. Start the engine and allow it to reach normal operating temperature.
3. Turn the engine off and wait for a few minutes (about 5 minutes) for the oil to return to the oil pan.
4. Pull the dipstick out, wipe it clean, and reinsert it fully.

**⚠ WARNING - Radiator hose**  
 Be very careful not to touch the radiator hose when checking or adding the engine oil as it may be hot enough to burn you.

5. Pull the dipstick out again and check the level. The level should be between F and L.

**⚠ CAUTION - Replace engine oil**  
*Do not overfill with engine oil. Engine damage may result.*



OAM072003

If it is near or at L, add enough oil to bring the level to F. **Do not overfill.**

**Use a funnel to help prevent oil from being spilled on engine components.**

*Use only the specified engine oil. (Refer to "Recommended lubricants and capacities" in section 8.)*

### Changing the engine oil and filter

Have engine oil and filter changed by an authorized Kia dealer according to the Maintenance Schedule at the beginning of this section.

#### **WARNING**

Used engine oil may cause irritation or cancer of the skin if left in contact with the skin for prolonged periods of time. Used engine oil contains chemicals that have caused cancer in laboratory animals. Always protect your skin by washing your hands thoroughly with soap and warm water as soon as possible after handling used oil.

### ENGINE COOLANT

The high-pressure cooling system has a reservoir filled with year-round antifreeze coolant. The reservoir is filled at the factory.

Check the antifreeze protection and coolant level at least once a year, at the beginning of the winter season, and before traveling to a colder climate.

#### **WARNING - Cooling fan**



Use caution when working near the blade of the cooling fan. The electric motor (cooling fan) is controlled by engine coolant temperature, refrigerant pressure and vehicle speed. It may sometimes operate even when the engine is not running.



OAM072005

### Checking the coolant level

Check the condition and connections of all cooling system hoses and heater hoses. Replace any swollen or deteriorated hoses.

The coolant level should be filled between F (MAX) and L (MIN) marks on the side of the coolant reservoir when the engine is cool.

If the coolant level is low, add enough specified coolant to provide protection against freezing and corrosion. Bring the level to F (MAX), but do not overfill. If frequent coolant addition is required, see an authorized Kia dealer for a cooling system inspection.

**Recommended engine coolant**

- When adding coolant, use only deionized water or soft water for your vehicle and never mix hard water in the coolant filled at the factory. An improper coolant mixture can result in serious malfunction or engine damage.
- The engine in your vehicle has aluminum engine parts and must be protected by an ethylene-glycol-based coolant to prevent corrosion and freezing.
- DO NOT USE alcohol or methanol coolant or mix them with the specified coolant.
- Do not use a solution that contains more than 60% antifreeze or less than 35% antifreeze, which would reduce the effectiveness of the solution.

For mixture percentage, refer to the following table.

Ambient Temperature	Mixture Percentage (volume)	
	Antifreeze	Water
-15°C (5°F)	35	65
-25°C (-13°F)	40	60
-35°C (-31°F)	50	50
-45°C (-49°F)	60	40



**⚠ WARNING**  
**Radiator cap**



**Do not remove the radiator cap when the engine and radiator are hot. Scalding hot coolant and steam may blow out under pressure.**





### **CAUTION - Removing radiator cap**



***Never attempt to remove the radiator cap while the engine is operating or hot. Doing so might lead to cooling system and engine damage.***

Turn the engine off and wait until it cools down. Use care when removing the radiator cap. Wrap a thick towel around it, and turn it counterclockwise slowly to the first stop. Step back while the pressure is released from the cooling system. When you are sure all the pressure has been released, press down on the cap, using a thick towel, and continue turning counterclockwise to remove it.

### **Changing the coolant**

Have the coolant changed by an authorized Kia dealer according to the Maintenance Schedule at the beginning of this section.

Put a thick cloth or fabric around the radiator cap before refilling the coolant in order to prevent the coolant from overflowing into engine parts such as the alternator.

## BRAKE/CLUTCH (IF EQUIPPED) FLUID

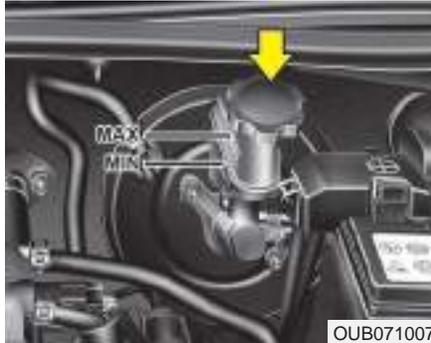

### Checking the brake/clutch\* fluid level

Check the fluid level in the reservoir periodically. The fluid level should be between MAX and MIN marks on the side of the reservoir.

Before removing the reservoir cap and adding brake/clutch\* fluid, clean the area around the reservoir cap thoroughly to prevent brake/clutch\* fluid contamination.

\* if equipped



### CAUTION - Proper fluid

**Only use brake/clutch fluid in brake/clutch system. Small amounts of improper fluids (such as engine oil) can cause damage to the brake/clutch system.**

If the level is low, add fluid to the MAX level. The level will fall with accumulated mileage. This is a normal condition associated with the wear of the brake linings and/or clutch disc (if equipped). If the fluid level is excessively low, have the brake/clutch\* system checked by an authorized Kia dealer.

*Use only the specified brake/clutch\* fluid. (Refer to "Recommended lubricants and capacities" in section 8.)*

*Never mix different types of fluid.*

In the event the brake/clutch\* system requires frequent additions of fluid, the vehicle should be inspected by an authorized Kia dealer.

When changing and adding brake/clutch\* fluid, handle it carefully. Do not let it come in contact with your eyes. If brake/clutch\* fluid should come in contact with your eyes, immediately flush them with a large quantity of fresh tap water. Have your eyes examined by a doctor as soon as possible.



### CAUTION - Brake/clutch fluid

**Do not allow brake/clutch\* fluid to contact the vehicle's body paint, as paint damage will result.**

Brake/clutch\* fluid, which has been exposed to open air for an extended time should never be used as its quality cannot be guaranteed. It should be disposed of properly.

### AUTOMATIC TRANSAXLE FLUID

It is recommended that the automatic transaxle fluid should be checked by an authorized Kia dealer.

In severe conditions, the fluid should be changed at an authorized Kia dealer in accordance to the scheduled maintenance at the beginning of this chapter.

### WASHER FLUID

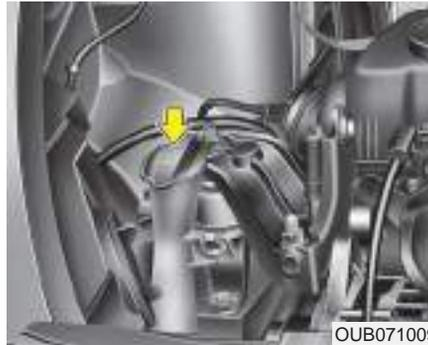

#### Checking the washer fluid level

Check the fluid level in the washer fluid reservoir and add fluid if necessary. Plain water may be used if washer fluid is not available. However, use washer solvent with antifreeze characteristics in cold climates to prevent freezing.

#### **⚠ WARNING - Windshield fluid**

**Do not drink the windshield washer fluid. The windshield washer fluid is poisonous to humans and animals.**

#### **⚠ WARNING - Flammable fluid**

**Do not allow the washer fluid to come in contact with open flames or sparks. The windshield washer fluid can be flammable under certain circumstances. This can result in a fire.**

## PARKING BRAKE

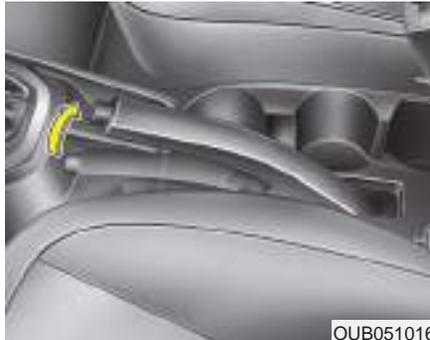

OUB051016

### Checking the parking brake

Check the stroke of the parking brake by counting the number of “clicks” heard while fully applying it from the released position. Also, the parking brake alone should securely hold the vehicle on a fairly steep grade. If the stroke is more or less than specified, have the parking brake adjusted by an authorized Kia dealer.

Stroke : 6~8 “clicks” at a force of 20 kg (44 lbs, 196 N).

## AIR CLEANER



OUB071010

### Filter replacement

It must be replaced when necessary, and should not be washed. You can clean the filter when inspecting the air cleaner element. Clean the filter by using compressed air.

Replace the filter according to the Maintenance Schedule.

*If the vehicle is operated in extremely dusty or sandy areas, replace the element more often than the usual recommended intervals. (Refer to “Maintenance under severe usage conditions” in this section.)*

### **⚠ CAUTION - Air filter maintenance**

- **Do not drive with the air cleaner removed; this will result in excessive engine wear.**
- **When removing the air cleaner filter, be careful that dust or dirt does not enter the air intake, or damage may result.**
- **Use a Kia genuine part. Use of nongenuine part could damage the air flow sensor.**

### CLIMATE CONTROL AIR FILTER (IF EQUIPPED)

#### Filter inspection

The climate control air filter should be replaced according to the Maintenance Schedule. If the vehicle is operated in severely air-polluted cities or on dusty rough roads for a long period, it should be inspected more frequently and replaced earlier. When you replace the climate control air filter, replace it performing the following procedure, and be careful to avoid damaging other components.

### WIPER BLADES

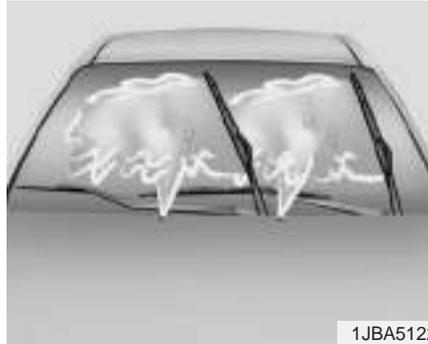

#### Blade inspection

Commercial hot waxes applied by automatic car washes have been known to make the windshield difficult to clean.

Contamination of either the windshield or the wiper blades with foreign matter can reduce the effectiveness of the windshield wipers. Common sources of contamination are insects, tree sap, and hot wax treatments used by some commercial car washes. If the blades are not wiping properly, clean both the window and the blades with a good cleaner or mild detergent, and rinse thoroughly with clean water.



#### **CAUTION - Wiper blades**

*To prevent damage to the wiper blades, do not use gasoline, kerosene, paint thinner, or other solvents on or near them.*

## Blade replacement

When the wipers no longer clean adequately, the blades may be worn or cracked, and require replacement.

To prevent damage to the wiper arms or other components, do not attempt to move the wipers manually.

The use of a non-specified wiper blade could result in wiper malfunction and failure.

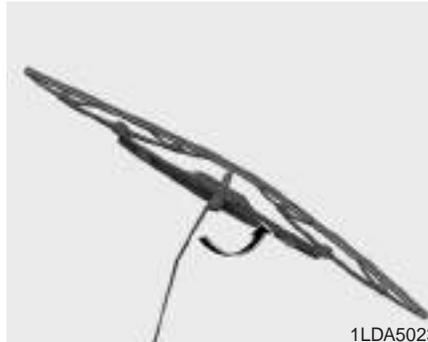

*Front windshield wiper blade*

### CAUTION

***Do not allow the wiper arm to fall against the windshield, since it may chip or crack the windshield.***

1. Raise the wiper arm and turn the wiper blade assembly to expose the plastic locking clip.

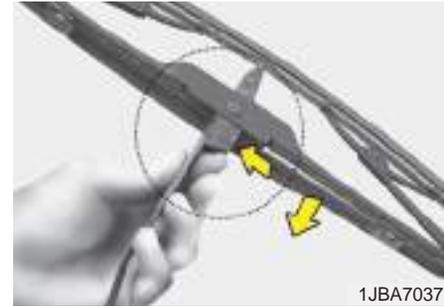

2. Compress the clip and slide the blade assembly downward.
3. Lift it off the arm.
4. Install the blade assembly in the reverse order of removal.



### **Rear window wiper blade**

1. Raise the wiper arm and pull out the wiper blade assembly.



2. Install the new blade assembly by inserting the center part into the slot in the wiper arm until it clicks into place.
3. Make sure the blade assembly is installed firmly by trying to pull it slightly.

To prevent damage to the wiper arms or other components, have an authorized Kia dealer replace the wiper blade.

## BATTERY



### **For best battery service**

- Keep the battery securely mounted.
- Keep the battery top clean and dry.
- Keep the terminals and connections clean, tight, and coated with petroleum jelly or terminal grease.
- Rinse any spilled electrolyte from the battery immediately with a solution of water and baking soda.
- If the vehicle is not going to be used for an extended time, disconnect the battery cables.

**⚠ WARNING - Risk of explosion**



Keep Lit cigarettes and all other flames or sparks away from the battery.



The battery contains hydrogen -- a highly combustible gas, which will explode if it comes in contact with a flame or spark.

**⚠ WARNING - Sulfuric acid in batteries**



Keep batteries out of the reach of children because batteries contain highly corrosive SULFURIC ACID and electrolytes. Do not allow battery acid to contact your skin, eyes, clothing or paint finish.



Wear eye protection when charging or working near a battery. Always provide ventilation when working in an enclosed space.



Always read the following instructions carefully when handling a battery.



If any electrolyte gets into your eyes, flush your eyes with clean water for at least 15 minutes and get immediate medical attention. If electrolyte gets on your skin, thoroughly wash the contacted area. If you feel pain or burning sensation, get medical attention immediately.



An inappropriately disposed battery can be harmful to the environment and human health. Dispose the battery according to your local law(s) or regulation.



The battery contains lead. Do not dispose of it after use. Please return the battery to an authorized Kia dealer to be recycled.

**⚠ WARNING - Recharging battery**

**Never attempt to recharge the battery when the battery cables are connected.**

When you don't use the vehicle for a long time in the low temperature area, separate the battery and keep it indoors.

**⚠ WARNING - Risk of electrocution**

**Never touch the electrical ignition system while the vehicle is running. This system works with high voltage which can "zap" you.**



### Battery recharging

Your vehicle has a maintenance-free, calcium-based battery.

- If the battery becomes discharged in a short time (because, for example, the headlights or interior lights were left on while the vehicle was not in use), recharge it by slow charging (trickle) for 10 hours.
- If the battery gradually discharges because of high electric load while the vehicle is being used, recharge it at 20-30A for two hours.

When recharging the battery, observe the following precautions:

- The battery must be removed from the vehicle and placed in an area with good ventilation.
- Watch the battery during charging, and stop or reduce the charging rate if the battery cells begin gassing (boiling) violently or if the temperature of the electrolyte of any cell exceeds 49°C (120°F).
- Wear eye protection when checking the battery during charging.
- Disconnect the battery charger in the following order.
  1. Turn off the battery charger main switch.
  2. Unhook the negative clamp from the negative battery terminal.
  3. Unhook the positive clamp from the positive battery terminal.
- Before performing maintenance or recharging the battery, turn off all accessories and stop the engine.
- The negative battery cable must be removed first and installed last when the battery is disconnected.

### Reset items

Items should be reset after the battery has been discharged or the battery has been disconnected.

- Auto down window (See section 4)
- Sunroof (See section 4)
- Trip computer (See section 4)
- Climate control system (See section 4)
- Clock (See section 4)
- Audio (See section 4)

## TIRES AND WHEELS

### Tire care

For proper maintenance, safety, and maximum fuel economy, you must always maintain recommended tire inflation pressures and stay within the load limits and weight distribution recommended for your vehicle.

### Recommended cold tire inflation pressures

All tire pressures (including the spare) should be checked when the tires are cold. "Cold Tires" means the vehicle has not been driven for at least three hours or driven less than 1.6 km (one mile).

Recommended pressures must be maintained for the best ride, top vehicle handling, and minimum tire wear.

For recommended inflation pressure refer to "Tire and wheels" in section 8.



All specifications (sizes and pressures) can be found on a label attached to the driver's side center pillar.

### **⚠ WARNING - Tire underinflation**

**Inflate your tires consistent with the instructions provided in this manual. Severe underinflation (70 kPa (10 psi) or more) can lead to severe heat build-up, causing blowouts, tread separation and other tire failures that can result in the loss of vehicle control. This risk is much higher on hot days and when driving for long periods at high speeds.**

- Underinflation also results in excessive wear, poor handling and reduced fuel economy. Wheel deformation also is possible. Keep your tire pressures at the proper levels. If a tire frequently needs refilling, have it checked by an authorized Kia dealer.
- Overinflation produces a harsh ride, excessive wear at the center of the tire tread, and a greater possibility of damage from road hazards.
- Warm tires normally exceed recommended cold tire pressures by 28 to 41 kPa (4 to 6 psi). Do not release air from warm tires to adjust the pressure or the tires will be underinflated.
- Be sure to reinstall the tire inflation valve caps. Without the valve cap, dirt or moisture could get into the valve core and cause air leakage. If a valve cap is missing, install a new one as soon as possible.

Always observe the following:

- Check tire pressure when the tires are cold. (After vehicle has been parked for at least three hours or hasn't been driven more than 1.6 km (one mile) since startup.)
- Check the pressure of your spare tire each time you check the pressure of other tires.
- Never overload your vehicle. Be careful not to overload a vehicle luggage rack if your vehicle is equipped with one.

### **Checking tire inflation pressure**

Check your tires once a month or more.

Also, check the tire pressure of the spare tire.

#### *How to check*

Use a good quality gauge to check tire pressure. You can not tell if your tires are properly inflated simply by looking at them. Radial tires may look properly inflated even when they're underinflated.

Check the tire's inflation pressure when the tires are cold. - "Cold" means your vehicle has been sitting for at least three hours or driven no more than 1.6 km (1 mile).

Remove the valve cap from the tire valve stem. Press the tire gauge firmly onto the valve to get a pressure measurement. If the cold tire inflation pressure matches the recommended pressure on the tire and loading information label, no further adjustment is necessary. If the pressure is low, add air until you reach the recommended amount.

If you overfill the tire, release air by pushing on the metal stem in the center of the tire valve. Recheck the tire pressure with the tire gauge. Be sure to put the valve caps back on the valve stems. They help prevent leaks by keeping out dirt and moisture.

- Inspect your tires frequently for proper inflation as well as wear and damage. Always use a tire pressure gauge.
- Tires with too much or too little pressure wear unevenly causing poor handling, loss of vehicle control, and sudden tire failure leading to accidents, injuries, and even death. The recommended cold tire pressure for your vehicle can be found in this manual and on the tire label located on the driver's side center pillar.
- Remember to check the pressure of your spare tire. Kia recommends that you check the spare every time you check the pressure of the other tires on your vehicle.

### **Tire rotation**

To equalize tread wear, it is recommended that the tires be rotated every 12,000 km miles (7,500) or sooner if irregular wear develops.

During rotation, check the tires for correct balance.

When rotating tires, check for uneven wear and damage. Abnormal wear is usually caused by incorrect tire pressure, improper wheel alignment, out-of-balance wheels, severe braking or severe cornering. Look for bumps or bulges in the tread or side of tire. Replace the tire if you find either of these conditions. Replace the tire if fabric or cord is visible. After rotation, be sure to bring the front and rear tire pressures to specification and check lug nut tightness.

Refer to "Tire and wheels" in section 8.

Without a spare tire

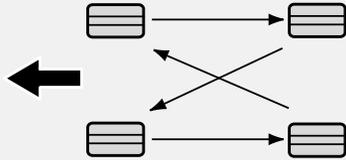

S2BLA790A

Directional tires (if equipped)

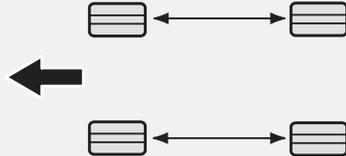

CBGQ0707A

*Disc brake pads should be inspected for wear whenever tires are rotated.*

Rotate radial tires that have an asymmetric tread pattern only from front to rear and not from right to left. Do not use the compact spare tire for tire rotation.

**⚠ WARNING - Mixing tire types**

**Do not mix bias ply and radial ply tires under any circumstances. This may cause unusual handling characteristics.**

### **Wheel alignment and tire balance**

The wheels on your vehicle were aligned and balanced carefully at the factory to give you the longest tire life and best overall performance.

In most cases, you will not need to have your wheels aligned again. However, if you notice unusual tire wear or your vehicle pulling one way or the other, the alignment may need to be reset.

If you notice your vehicle vibrating when driving on a smooth road, your wheels may need to be rebalanced.

**⚠ CAUTION - Wheel weight**

***Improper wheel weights can damage your vehicle's aluminum wheels. Use only approved wheel weights.***



### Tire replacement

If the tire is worn evenly, a tread wear indicator will appear as a solid band across the tread. This shows there is less than 1.6 mm (1/16 inch) of tread left on the tire. Replace the tire when this happens.

Do not wait for the band to appear across the entire tread before replacing the tire.

The ABS works by comparing the speed of the wheels. Tire size can affect wheel speed. When replacing tires, all 4 tires must use the same size originally supplied with the vehicle. Using tires of a different size can cause the ABS (Anti-lock Brake System) and ESC (Electronic Stability Control) (if equipped) to work irregularly.

### *Compact spare tire replacement*

A compact spare tire has a shorter tread life than a regular size tire. Replace it when you can see the tread wear indicator bars on the tire. The replacement compact spare tire should be the same size and design tire as the one provided with your new vehicle and should be mounted on the same compact spare tire wheel. The compact spare tire is not designed to be mounted on a regular size wheel, and the compact spare tire wheel is not designed for mounting a regular size tire.

### Wheel replacement

When replacing the metal wheels for any reason, make sure the new wheels are equivalent to the original factory units in diameter, rim width and offset.

A wheel that is not the correct size may adversely affect wheel and bearing life, braking and stopping abilities, handling characteristics, ground clearance, body-to-tire clearance, snow chain clearance, speedometer and odometer calibration, headlight aim and bumper height.

#### CAUTION - Wheel

***Wheels that do not meet Kia's specifications may fit poorly and result in damage to the vehicle or unusual handling and poor vehicle control.***

### Tire traction

Tire traction can be reduced if you drive on worn tires, tires that are improperly inflated or on slippery road surfaces. Tires should be replaced when tread wear indicators appear. Slow down whenever there is rain, snow or ice on the road, to reduce the possibility of losing control of the vehicle.

### Tire maintenance

In addition to proper inflation, correct wheel alignment helps to decrease tire wear. If you find a tire is worn unevenly, have your dealer check the wheel alignment.

When you have new tires installed, make sure they are balanced. This will increase vehicle ride comfort and tire life. Additionally, a tire should always be rebalanced if it is removed from the wheel.

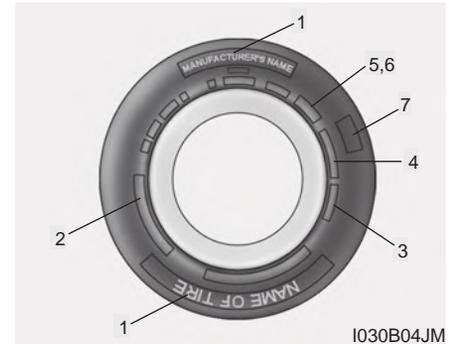

### Tire sidewall labeling

This information identifies and describes the fundamental characteristics of the tire and also provides the tire identification number (TIN) for safety standard certification. The TIN can be used to identify the tire in case of a recall.

#### **1. Manufacturer or brand name**

Manufacturer or Brand name is shown.

**2. Tire size designation**

A tire’s sidewall is marked with a tire size designation. You will need this information when selecting replacement tires for your car. The following explains what the letters and numbers in the tire size designation mean.

Example tire size designation:

(These numbers are provided as an example only; your tire size designator could vary depending on your vehicle.)

**P205/55R16 89H**

P - Applicable vehicle type (tires marked with the prefix “P” are intended for use on passenger vehicles or light trucks; however, not all tires have this marking).

205 - Tire width in millimeters.

55 - Aspect ratio. The tire’s section height as a percentage of its width.

R - Tire construction code (Radial).

16 - Rim diameter in inches.

89 - Load Index, a numerical code associated with the maximum load the tire can carry.

H - Speed Rating Symbol. See the speed rating chart in this section for additional information.

**Wheel size designation**

Wheels are also marked with important information that you need if you ever have to replace one. The following explains what the letters and numbers in the wheel size designation mean.

Example wheel size designation:

**6.0JX16**

6.0 - Rim width in inches.

J - Rim contour designation.

16 - Rim diameter in inches.

**Tire speed ratings**

The chart below lists many of the different speed ratings currently being used for passenger vehicles. The speed rating is part of the tire size designation on the sidewall of the tire. This symbol corresponds to that tire’s designed maximum safe operating speed.

Speed Rating Symbol	Maximum Speed
S	180 km/h (112 mph)
T	190 km/h (118 mph)
H	210 km/h (130 mph)
V	240 km/h (149 mph)
Z	240 km/h (Above 149 mph)



### **3. Checking tire life (TIN : Tire Identification Number)**

Any tires that are over 6 years old, based on the manufacturing date, (including the spare tire) should be replaced by new ones. You can find the manufacturing date on the tire sidewall (possibly on the inside of the wheel), displaying the DOT Code. The DOT Code is a series of numbers on a tire consisting of numbers and English letters. The manufacturing date is designated by the last four digits (characters) of the DOT code.

#### **DOT : XXXX XXXX OOOO**

The front part of the DOT means a plant code number, tire size and tread pattern and the last four numbers indicate week and year manufactured.

For example:

DOT XXXX XXXX 1611 represents that the tire was produced in the 16th week of 2011.

**⚠ WARNING - Tire age**  
**Replace tires within the recommended time frame. Failure to replace tires as recommended can result in sudden tire failure, which could lead to a loss of control and an accident.**

### **4. Tire ply composition and material**

The number of layers or plies of rubber-coated fabric in the tire. Tire manufacturers also must indicate the materials in the tire, which include steel, nylon, polyester, and others. The letter "R" means radial ply construction; the letter "D" means diagonal or bias ply construction; and the letter "B" means belted-bias ply construction.

### **5. Maximum permissible inflation pressure**

This number is the greatest amount of air pressure that should be put in the tire. Do not exceed the maximum permissible inflation pressure. Refer to the Tire and Loading Information label for recommended inflation pressure.

### **6. Maximum load rating**

This number indicates the maximum load in kilograms and pounds that can be carried by the tire. When replacing the tires on the vehicle, always use a tire that has the same load rating as the factory installed tire.

### **7. Uniform tire quality grading**

Quality grades can be found where applicable on the tire sidewall between tread shoulder and maximum section width.

For example:

TREADWEAR 440  
TRACTION A  
TEMPERATURE A

#### **Tread wear**

The tread wear grade is a comparative rating based on the wear rate of the tire when tested under controlled conditions on a specified government test course. For example, a tire graded 150 would wear one-and-a-half times (1½) as well on the government course as a tire graded 100.

The relative performance of tires depends upon the actual conditions of their use, however, and may depart significantly from the norm due to variations in driving habits, service practices and differences in road characteristics and climate.

Tires degrade over time, even when they are not being used. Regardless of the remaining tread, we recommend that tires be replaced after approximately six (6) years of normal service. Heat caused by hot climates or frequent high loading conditions can accelerate the aging process.

These grades are molded on the side-walls of passenger vehicle tires. The tires available as standard or optional equipment on your vehicles may vary with respect to grade.

#### **Traction - AA, A, B & C**

The traction grades, from highest to lowest, are AA, A, B and C. Those grades represent the tires ability to stop on wet pavement as measured under controlled conditions on specified government test surfaces of asphalt and concrete. A tire marked C may have poor traction performance.

The traction grade assigned to this tire is based on straight-ahead braking traction tests, and does not include acceleration, cornering, hydroplaning, or peak traction characteristics.

### Temperature -A, B & C

The temperature grades are A (the highest), B and C representing the tire's resistance to the generation of heat and its ability to dissipate heat when tested under controlled conditions on a specified indoor laboratory test wheel.

Sustained high temperature can cause the material of the tire to degenerate and reduce tire life, and excessive temperature can lead to sudden tire failure. Grades B and A represent higher levels of performance on the laboratory test wheel than the minimum required by law.

### Tire terminology and definitions

**Air Pressure:** The amount of air inside the tire pressing outward on the tire. Air pressure is expressed in kilopascal (kPa) or pounds per square inch (psi).

**Accessory Weight:** This means the combined weight of optional accessories. Some examples of optional accessories are, automatic transaxle, power seats, and air conditioning.

**Aspect Ratio:** The relationship of a tire's height to its width.

**Belt:** A rubber coated layer of cords that is located between the plies and the tread. Cords may be made from steel or other reinforcing materials.

**Bead:** The tire bead contains steel wires wrapped by steel cords that hold the tire onto the rim.

**Bias Ply Tire:** A pneumatic tire in which the plies are laid at alternate angles less than 90 degrees to the centerline of the tread.

**Cold Tire Pressure:** The amount of air pressure in a tire, measured in kilopascals (kPa) or pounds per square inch (psi) before a tire has built up heat from driving.

**Curb Weight:** This means the weight of a motor vehicle with standard and optional equipment including the maximum capacity of fuel, oil and coolant, but without passengers and cargo.

**DOT Markings:** The DOT code includes the Tire Identification Number (TIN), an alphanumeric designator which can also identify the tire manufacturer, production plant, brand and date of production.

**GVWR:** Gross Vehicle Weight Rating

**GAWR FRT:** Gross Axle Weight Rating for the Front Axle.

**GAWR RR:** Gross Axle Weight Rating for the Rear axle.

**Intended Outboard Sidewall:** The side of an asymmetrical tire, that must always face outward when mounted on a vehicle.

**Kilopascal (kPa):** The metric unit for air pressure.

**Load Index:** An assigned number ranging from 1 to 279 that corresponds to the load carrying capacity of a tire.

**Maximum Inflation Pressure:** The maximum air pressure to which a cold tire may be inflated. The maximum air pressure is molded onto the sidewall.

**Maximum Load Rating:** The load rating for a tire at the maximum permissible inflation pressure for that tire.

**Maximum Loaded Vehicle Weight:** The sum of curb weight; accessory weight; vehicle capacity weight; and production options weight.

**Normal Occupant Weight:** The number of occupants a vehicle is designed to seat multiplied by 68 kg (150 pounds).

**Occupant Distribution:** Designated seating positions.

**Outward Facing Sidewall:** The side of a asymmetrical tire that has a particular side that faces outward when mounted on a vehicle. The outward facing sidewall bears white lettering or bears manufacturer, brand, and/or model name molding that is higher or deeper than the same moldings on the inner facing sidewall.

**Passenger (P-Metric) Tire:** A tire used on passenger cars and some light duty trucks and multipurpose vehicles.

**Recommended Inflation Pressure:** Vehicle manufacturer's recommended tire inflation pressure and shown on the tire placard.

**Radial Ply Tire:** A pneumatic tire in which the ply cords that extend to the beads are laid at 90 degrees to the centerline of the tread.

**Rim:** A metal support for a tire and upon which the tire beads are seated.

**Sidewall:** The portion of a tire between the tread and the bead.

**Speed Rating:** An alphanumeric code assigned to a tire indicating the maximum speed at which a tire can operate.

**Traction:** The friction between the tire and the road surface. The amount of grip provided.

**Tread:** The portion of a tire that comes into contact with the road.

**Treadwear Indicators:** Narrow bands, sometimes called "wear bars," that show across the tread of a tire when only 2/32 inch of tread remains.

**UTQGS:** Uniform Tire Quality Grading Standards, a tire information system that provides consumers with ratings for a tire's traction, temperature and treadwear. Ratings are determined by tire manufacturers using government testing procedures. The ratings are molded into the sidewall of the tire.

**Vehicle Capacity Weight:** The number of designated seating positions multiplied by 68 kg (150 lbs.) plus the rated cargo and luggage load.

### **Vehicle Maximum Load on the**

**Tire:** Load on an individual tire due to curb and accessory weight plus maximum occupant and cargo weight.

### **Vehicle Normal Load on the Tire:**

Load on an individual tire that is determined by distributing to each axle its share of the curb weight, accessory weight, and normal occupant weight and driving by 2.

**Vehicle Placard:** A label permanently attached to a vehicle showing the original equipment tire size and recommended inflation pressure.

### **All season tires**

Kia specifies all season tires on some models to provide good performance for use all year round, including snowy and icy road conditions. All season tires are identified by ALL SEASON and/or M+S (Mud and Snow) on the tire sidewall. Snow tires have better snow traction than all season tires and may be more appropriate in some areas.

### **Summer tires**

Kia specifies summer tires on some models to provide superior performance on dry roads. Summer tire performance is substantially reduced in snow and ice. Summer tires do not have the tire traction rating M+S (Mud and Snow) on the tire side wall. if you plan to operate your vehicle in snowy or icy conditions. Kia recommends the use of snow tires or all season tires on all four wheels.

### **Snow tires**

If you equip your car with snow tires, they should be the same size and have the same load capacity as the original tires. Snow tires should be installed on all four wheels; otherwise, poor handling may result.

Snow tires should carry 28 kPa (4 psi) more air pressure than the pressure recommended for the standard tires on the tire label on the driver's side of the center pillar, or up to the maximum pressure shown on the tire sidewall, whichever is less.

Do not drive faster than 120 km/h (75 mph) when your vehicle is equipped with snow tires.

**Radial-ply tires**

Radial-ply tires provide improved tread life, road hazard resistance and smoother high speed ride. The radial-ply tires used on this vehicle are of belted construction, and are selected to complement the ride and handling characteristics of your vehicle. Radial-ply tires have the same load carrying capacity, as bias-ply or bias belted tires of the same size, and use the same recommended inflation pressure. Mixing of radial-ply tires with bias-ply or bias belted tires is not recommended. Any combinations of radial-ply and bias-ply or bias belted tires when used on the same vehicle will seriously deteriorate vehicle handling. The best rule to follow is: Identical radial-ply tires should always be used as a set of four.

Longer wearing tires can be more susceptible to irregular tread wear. It is very important to follow the tire rotation interval shown in this section to achieve the tread life potential of these tires. Cuts and punctures in radial-ply tires are repairable only in the tread area, because of sidewall flexing. Consult your tire dealer for radial-ply tire repairs.

### FUSES

Blade type

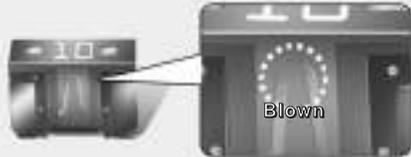

Cartridge type



Fusible link



OTA070039

A vehicle's electrical system is protected from electrical overload damage by fuses.

This vehicle has 2 fuse panels, one located in the driver's side panel bolster, the other in the engine compartment near the battery.

If any of your vehicle's lights, accessories, or controls do not work, check the appropriate circuit fuse. If a fuse has blown, the element inside the fuse will melt.

If the electrical system does not work, first check the driver's side fuse panel.

Always replace a blown fuse with one of the same rating.

If the replacement fuse blows, this indicates an electrical problem. Avoid using the system involved and immediately consult an authorized Kia dealer.

*Three kinds of fuses are used: blade type for lower amperage rating, cartridge type, and multi fuse for higher amperage ratings.*

#### **WARNING - Fuse replacement**

- Never replace a fuse with anything but another fuse of the same rating.
- A higher capacity fuse could cause damage and possibly a fire.
- Never install a wire or aluminum foil instead of the proper fuse - even as a temporary repair. It may cause extensive wiring damage and a possible fire.

#### **CAUTION - Fuse replacement**

*Do not use a screwdriver or any other metal object to remove fuses because it may cause a short circuit and damage the system.*



OUB071019

### ***Instrument panel fuse replacement***

1. Turn the ignition switch and all other switches off.
  2. Open the fuse panel cover.
  3. Pull the suspected fuse straight out. Use the removal tool provided in the engine compartment fuse panel.
  4. Check the removed fuse; replace it if it is blown.
  5. Push in a new fuse of the same rating, and make sure it fits tightly in the clips.
- If it fits loosely, consult an authorized Kia dealer.

*If you do not have a spare, use a fuse of the same rating from a circuit you may not need for operating the vehicle, such as the cigar lighter fuse.*

If the headlights or other electrical components do not work and the fuses are OK, check the fuse block in the engine compartment. If a fuse is blown, it must be replaced.



OUB071021

### **Memory fuse**

Your vehicle is equipped with the memory fuse to prevent battery discharge if your vehicle is parked without being operated for prolonged periods. Use the following procedures before parking the vehicle for prolonged periods.

1. Turn off the engine.
2. Turn off the headlights and tail lights.
3. Open the driver's side panel cover and pull up the memory fuse.



If the memory fuse is pulled up from the fuse panel, the warning chime, audio, clock and interior lamps, etc., will not operate. Some items must be reset after replacement. Refer to “Battery” in this section.

Even though the memory fuse is pulled up, the battery can still be discharged by operation of the headlights or other electrical devices.

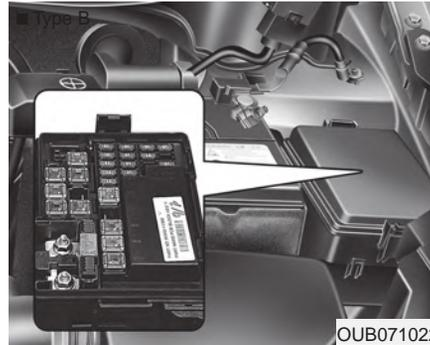

### ***Engine compartment panel fuse replacement***

1. Turn the ignition switch and all other switches off.
2. Remove the fuse box cover by pressing the tap and pulling up the cover.
3. Check the removed fuse; replace it if it is blown. To remove or insert the fuse, use the fuse puller in the engine compartment fuse panel.
4. Push in a new fuse of the same rating, and make sure it fits tightly in the clips. If it fits loosely, consult an authorized Kia dealer.

### **⚠ CAUTION - Fuse panel covers**

***After checking the fuse panel in the engine compartment, securely install the fuse panel cover to prevent electrical failures which may occur from water leaking in.***

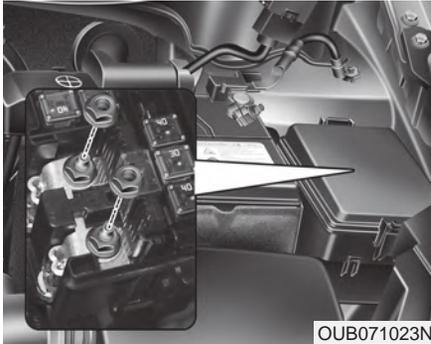

If the multi fuse is blown, consult an authorized Kia dealer.

***Multi fuse***

If the multi fuse is blown, it must be removed as follows:

1. Turn off the engine.
2. Disconnect the negative battery cable.
3. Remove the fuse panel on the right side in the engine compartment.
4. Remove the nuts shown in the picture above.
5. Replace the fuse with a new one of the same rating.
6. Reinstall in the reverse order of removal.

## Fuse/Relay panel description

Inside the fuse/relay box covers, you can find the fuse/relay label describing fuse/relay name and capacity.

**Instrument panel fuse panel**



**Engine compartment fuse panel**



OUB071025/OUB071026

## Instrument panel fuse panel

Fuse Name	Fuse rating	Circuit Protected
POWER OUTLET	15A	Power Outlet
C/LIGHTER	20A	Cigarette Lighter
ACC	10A	Front Map Lamp, Power Outside Mirror Switch, BCM, Low DC-DC Convertor, Smart Key Control Module, Audio, A/V & Navigation Head Unit, Digital Clock
A/BAG IND	10A	Instrument Cluster
A/BAG	10A	SBR PAB Indicator, SRS Control Module Passenger Weight Classification Sensor
MODULE 2	10A	BCM
MDPS 2	10A	EPS Control Module
WIPER RR	15A	Multifunction Switch, Rear Wiper Relay, Rear Wiper Motor
HTD STRG	15A	Steering Wheel Heater
FOG LP RR	10A	-
FOG LP FRT	15A	Front Fog Lamp Relay
MODULE 1	10A	ATM Shift Lever Switch, Door Warning Switch
STOP LP	15A	Data Link Connector, Smart Key Control Module, Stop Lamp Switch Stop Lamp Relay, PCB Fuse & Relay Box (HAC Relay)
CLUSTER	10A	Audio, BCM, ATM Shift Lever ILL., Crash Pad Switch Instrument Cluster, Tire Pressure Monitoring Module
IG1 1	10A	Multipurpose Check Connector, Driver CCS Seat Warmer Module Passenger Seat Warmer Module With ISG : Crash Pad Switch, Low DC-DC Convertor
ABS 3	10A	Crash Pad Switch, ESC Module PCB Fuse & Relay Box (HAC Relay)
B/UP LP	10A	Back-Up Lamp Switch

## Maintenance

Fuse Name	Fuse rating	Circuit Protected
PCU	10A	Vehicle Speed Sensor, Stop Lamp Switch, Inverter A/C Control Module
HAZARD	15A	Hazard Switch, BCM
PDM 1	25A	Smart Key Control Module
SUNROOF	15A	Sunroof Motor
PDM 2	10A	Immobilizer Module, Start/Stop Button Switch, Smart Key Control Module
TCU	15A	Smart Key Control Module, Immobilizer Module, ECM/PCM, Transaxle Range Switch
IGN COIL	15A	Ignition Coil #1/#2/#3/#4, Condenser
IG2 1	10A	BCM, Smart Key Control Module, Driver CCS Seat Warmer Module Cluster Ionizer, Rain Sensor, A/C Control Module, Sunroof Motor PCB Fuse & Relay Box (Blower Relay, Head Lamp (HI) Relay, Fuel Pump #1 Relay)
WIPER FRT	25A	Multifunction Switch, Front Wiper Motor PCB Fuse & Relay Box (Rain Sensor Relay, Front Wiper Relay)
DOOR LOCK	20A	Door Lock/Unlock Relay, Tail Gate Unlock Relay, Two Turn Unlock Relay
SAFETY POWER WINDOW	25A	Driver Safety Power Window Module
S/HEATER 2	15A	Seat Warmer Switch, Driver CCS Seat Warmer Module, Passenger Seat Warmer Module
FOLD'G MIRR	10A	Power Outside Mirror Switch
ROOM LP	10A	BCM, Door Warning Switch, Tire Pressure Monitoring Module Instrument Cluster, Digital Clock, A/C Control Module Luggage Lamp

Fuse Name	Fuse rating	Circuit Protected
AUDIO	20A	With ISG : Low DC-DC Convertor W/O ISG : Audio, A/V & Navigation Head Unit
TAIL LP LH	10A	Head Lamp LH, License Lamp Rear Combination Lamp (IN/OUT) LH
TAIL LP RH	10A	Head Lamp RH, License Lamp, ILL. (+), Rear Combination Lamp (IN/OUT) RH
START	10A	With Burglar Alarm : Burglar Alarm Relay W/O Burglar Alarm : Transaxle Range Switch (A/T), Smart Key Control Module (M/T), Ignition Lock Switch (M/T), ECM (M/T), PCB Fuse & Relay Box (Start Relay) (M/T)
P/WDW LH	25A	Power Window Main Switch, Rear Power Window Switch LH Driver Safety Power Window Module
P/WDW RH	25A	Power Window Main Switch, Rear Power Window Switch RH Passenger Power Window Switch
HTD MIRR	10A	ECM/PCM, A/C Control Module Driver/Passenger Power Outside Mirror
A/CON	10A	A/C Control Module

## Engine compartment fuse panel

	Fuse Name	Fuse rating	Circuit Protected
MULTI FUSE	MDPS	80A	EPS Control Module
	ALT	125A	Alternator
FUSE	B+1	50A	I/P Junction Box (Power Connector Fuse : ROOM LP 10A / AUDIO 20A, Fuse : FOG LP FRT 15A / MODULE 1 10A / STOP LP 15A, Tail Lamp Relay)
	INVERTER	40A	Inverter
	B+2	50A	I/P Junction Box (Fuse : HAZARD 15A / PDM 1 25A / PDM 2 10A / SUNROOF 15A / DR LOCK 20A / SAFETY POWER WINDOW 25A / S/HEATER 2 15A, FOLD'G MIRR 10A / Power Window Relay)
	IG1	40A	With Smart Key - PDM Relay Box (ESCL (ACC) Relay, ESCL (IG1) Relay) W/O Smart Key - Ignition Switch
	ABS1	40A	ESC Module, Multipurpose Check Connector
	ABS2	40A	ESC Module
	RR HTD	40A	I/P Junction Box (Rear Defogger Relay)
	ECU_VM	10A	PCM
	H/LP HI IND	10A	Instrument Cluster

**Engine compartment main fuse panel**

Fuse Name	Fuse rating	Circuit Protected
IG2	40A	PCB Fuse & Relay Box (Start Relay), W/O Smart Key - Ignition Switch, With Smart Key - PDM Relay Box (ESCL (IG2) Relay)
ECU1	30A	PCB Fuse & Relay Box (Engine Control Relay, ECU2 10A)
BLOWER	40A	PCB Fuse & Relay Box (Blower Relay)
C/FAN	40A	PCB Fuse & Relay Box (Cooling Fan (Low) Relay, Cooling Fan (Hi) Relay)
F/PUMP1	20A	PCB Fuse & Relay Box (Fuel Pump #1 Relay)
H/LP HI	20A	PCB Fuse & Relay Box (Head Lamp (HI) Relay)
H/LP	20A	PCB Fuse & Relay Box (Head Lamp (LO) Relay)
HORN	10A	PCB Fuse & Relay Box (Horn Relay, Burglar Alarm Horn Relay)
ECU2	10A	M/T - ECM, A/T - E/R Junction Box (ECU_VM 10A)
B/UP LP	10A	A/T - PCM, Transaxle Range Switch
WIPER	10A	ECM/PCM, Rain Sensor
ECU4	20A	ECM/PCM
INJECTOR	15A	ECM/PCM, PCB Fuse & Relay Box (Fuel Pump #1 Relay)
H/LP LH	10A	Head Lamp LH
SENSOR1	10A	Purge Control Solenoid Valve, Variable Intake Solenoid Valve, Canister Close Valve, PCB Fuse & Relay Box (Cooling Fan (Low) Relay, Cooling Fan (Hi) Relay)
SENSOR2	10A	Oil Control Valve #1/#2, Oxygen Sensor (Up/Down)
H/LP RH	10A	Head Lamp RH



### APPEARANCE CARE

#### Exterior care

##### *Exterior general caution*

It is very important to follow the label directions when using any chemical cleaner or polish. Read all warning and caution statements that appear on the label.

#### *Finish maintenance*

##### **Washing**

To help protect your vehicle's finish from rust and deterioration, wash it thoroughly and frequently at least once a month with lukewarm or cold water.

If you use your vehicle for off-road driving, you should wash it after each off-road trip. Pay special attention to the removal of any accumulation of salt, dirt, mud, and other foreign materials. Make sure the drain holes in the lower edges of the doors and rocker panels are kept clear and clean.

Insects, tar, tree sap, bird droppings, industrial pollution and similar deposits can damage your vehicle's finish if not removed immediately.

Even prompt washing with plain water may not completely remove all these deposits. A mild soap, safe for use on painted surfaces, may be used.

After washing, rinse the vehicle thoroughly with lukewarm or cold water. Do not allow soap to dry on the finish.

After washing the vehicle, test the brakes while driving slowly to see if they have been affected by water. If braking performance is impaired, dry the brakes by applying them lightly while maintaining a slow forward speed.



OJB037800

### Waxing

Wax the vehicle when water will no longer bead on the paint.

Always wash and dry the vehicle before waxing. Use a good quality liquid or paste wax, and follow the manufacturer's instructions. Wax all metal trim to protect it and to maintain its luster.

Removing oil, tar, and similar materials with a spot remover will usually strip the wax from the finish. Be sure to re-wax these areas even if the rest of the vehicle does not yet need waxing.

### Finish damage repair

Deep scratches or stone chips in the painted surface must be repaired promptly. Exposed metal will quickly rust and may develop into a major repair expense.

If your vehicle is damaged and requires any metal repair or replacement, be sure the body shop applies anti-corrosion materials to the parts repaired or replaced.

#### CAUTION - Wetting engine

- *Water washing in the engine compartment including high pressure water washing may cause the failure of electrical circuits located in the engine compartment.*
- *Never allow water or other liquids to come in contact with electrical/electronic components inside the vehicle as this may damage them.*

#### CAUTION - Drying vehicle

- *Wiping dust or dirt off the body with a dry cloth will scratch the finish.*
- *Do not use steel wool, abrasive cleaners, or strong detergents containing highly alkaline or caustic agents on chrome-plated or anodized aluminum parts. This may result in damage to the protective coating and cause discoloration or paint deterioration.*

### ***Bright-metal maintenance***

- To remove road tar and insects, use a tar remover, not a scraper or other sharp object.
- To protect the surfaces of bright-metal parts from corrosion, apply a coating of wax or chrome preservative and rub to a high luster.
- During winter weather or in coastal areas, cover the bright metal parts with a heavier coating of wax or preservative. If necessary, coat the parts with non-corrosive petroleum jelly or other protective compound.

### ***Underbody maintenance***

Corrosive materials used for ice and snow removal and dust control may collect on the underbody. If these materials are not removed, accelerated rusting can occur on underbody parts such as the fuel lines, frame, floor pan and exhaust system, even though they have been treated with rust protection.

Thoroughly flush the vehicle underbody and wheel openings with lukewarm or cold water once a month, after off-road driving and at the end of each winter. Pay special attention to these areas because it is difficult to see all the mud and dirt. It will do more harm than good to wet down the road grime without removing it. The lower edges of doors, rocker panels, and frame members have drain holes that should not be allowed to clog with dirt; trapped water in these areas can cause rusting.

### ***Aluminum or chrome wheel maintenance***

The aluminum or chrome wheels are coated with a clear protective finish.

- Do not use any abrasive cleaner, polishing compound, solvent, or wire brushes on aluminum or chrome wheels. They may scratch or damage the finish.
- Clean the wheel when it has cooled.
- Use only a mild soap or neutral detergent, and rinse thoroughly with water. Also, be sure to clean the wheels after driving on salted roads. This helps prevent corrosion.
- Avoid washing the wheels with high-speed car wash brushes.
- Do not use any alkaline or acid detergents. It may damage and corrode the aluminum or chrome wheels coated with a clear protective finish.

### ***Corrosion protection***

#### **Protecting your vehicle from corrosion**

By using the most advanced design and construction practices to combat corrosion, we produce vehicles of the highest quality. However, this is only part of the job. To achieve the long-term corrosion resistance your vehicle can deliver, the owner's cooperation and assistance is also required.

#### **Common causes of corrosion**

The most common causes of corrosion on your vehicle are:

- Road salt, dirt and moisture that is allowed to accumulate underneath the vehicle.
- Removal of paint or protective coatings by stones, gravel, abrasion or minor scrapes and dents which leave unprotected metal exposed to corrosion.

#### **High-corrosion areas**

If you live in an area where your vehicle is regularly exposed to corrosive materials, corrosion protection is particularly important. Some of the common causes of accelerated corrosion are road salts, dust control chemicals, ocean air and industrial pollution.

#### **Moisture breeds corrosion**

Moisture creates the conditions in which corrosion is most likely to occur. For example, corrosion is accelerated by high humidity, particularly when temperatures are just above freezing. In such conditions, the corrosive material is kept in contact with the vehicle surfaces by moisture that is slow to evaporate.

Mud is particularly corrosive because it dries slowly and holds moisture in contact with the vehicle. Although the mud appears to be dry, it can still retain the moisture and promote corrosion.

High temperatures can also accelerate corrosion of parts that are not properly ventilated so the moisture can be dispersed. For all these reasons, it is particularly important to keep your vehicle clean and free of mud or accumulations of other materials. This applies not only to the visible surfaces but particularly to the underside of the vehicle.

#### **To help prevent corrosion**

You can help prevent corrosion from getting started by observing the following:

#### **Keep your vehicle clean**

The best way to prevent corrosion is to keep your vehicle clean and free of corrosive materials. Attention to the underside of the vehicle is particularly important.

- If you live in a high-corrosion area — where road salts are used, near the ocean, areas with industrial pollution, acid rain, etc.—, you should take extra care to prevent corrosion. In winter, hose off the underside of your vehicle at least once a month and be sure to clean the underside thoroughly when winter is over.

- When cleaning underneath the vehicle, give particular attention to the components under the fenders and other areas that are hidden from view. Do a thorough job; just dampening the accumulated mud rather than washing it away will accelerate corrosion rather than prevent it. Water under high pressure and steam are particularly effective in removing accumulated mud and corrosive materials.
- When cleaning lower door panels, rocker panels and frame members, be sure that drain holes are kept open so that moisture can escape and not be trapped inside to accelerate corrosion.

### Keep your garage dry

Don't park your vehicle in a damp, poorly ventilated garage. This creates a favorable environment for corrosion. This is particularly true if you wash your vehicle in the garage or drive it into the garage when it is still wet or covered with snow, ice or mud. Even a heated garage can contribute to corrosion unless it is well ventilated so moisture is dispersed.

### Keep paint and trim in good condition

Scratches or chips in the finish should be covered with "touch-up" paint as soon as possible to reduce the possibility of corrosion. If bare metal is showing through, the attention of a qualified body and paint shop is recommended.

**Bird droppings :** Bird droppings are highly corrosive and may damage painted surfaces in just a few hours. Always remove bird droppings as soon as possible.

### Don't neglect the interior

Moisture can collect under the floor mats and carpeting and cause corrosion. Check under the mats periodically to be sure the carpeting is dry. Use particular care if you carry fertilizers, cleaning materials or chemicals in the car.

These should be carried only in proper containers and any spills or leaks should be cleaned up, flushed with clean water and thoroughly dried.

### Interior care

#### *Interior general precautions*

Prevent caustic solutions such as perfume and cosmetic oil from contacting the dashboard because they may cause damage or discoloration. If they do contact the dashboard, wipe them off immediately. See the instructions for the proper way to clean vinyl.



#### **CAUTION - Electrical components**

***Never allow water or other liquids to come in contact with electrical/electronic components inside the vehicle as this may damage them.***



#### **CAUTION - Leather**

***When cleaning leather products (steering wheel, seats etc.), use neutral detergents or low alcohol content solutions. If you use high alcohol content solutions or acid/alkaline detergents, the color of the leather may fade or the surface may get stripped off.***

### ***Cleaning the upholstery and interior trim***

#### **Vinyl**

Remove dust and loose dirt from vinyl with a whisk broom or vacuum cleaner. Clean vinyl surfaces with a vinyl cleaner.

#### **Fabric**

Remove dust and loose dirt from fabric with a whisk broom or vacuum cleaner. Clean with a mild soap solution recommended for upholstery or carpets. Remove fresh spots immediately with a fabric spot cleaner. If fresh spots do not receive immediate attention, the fabric can be stained and its color can be affected. Also, its fire-resistant properties can be reduced if the material is not properly maintained.

Using anything but recommended cleaners and procedures may affect the fabric's appearance and fire-resistant properties.

### ***Cleaning the lap/shoulder belt webbing***

Clean the belt webbing with any mild soap solution recommended for cleaning upholstery or carpet. Follow the instructions provided with the soap. Do not bleach or re-dye the webbing because this may weaken it.

### ***Cleaning the interior window glass***

If the interior glass surfaces of the vehicle become fogged (that is, covered with an oily, greasy or waxy film), they should be cleaned with glass cleaner. Follow the directions on the glass cleaner container.



#### **CAUTION - Rear windows**

***Do not scrape or scratch the inside of the rear window. This may result in damage to the rear window defroster grid.***

### EMISSION CONTROL SYSTEM

The emission control system of your vehicle is covered by a written limited warranty. Please see the warranty information contained in the Warranty & Maintenance booklet in your vehicle.

Your vehicle is equipped with an emission control system to meet all applicable emission regulations.

There are three emission control systems, as follows.

- (1) Crankcase emission control system
- (2) Evaporative emission control system
- (3) Exhaust emission control system

In order to assure the proper function of the emission control systems, it is recommended that you have your vehicle inspected and maintained by an authorized Kia dealer in accordance with the maintenance schedule in this manual.

#### **Caution for the Inspection and Maintenance Test (With Electronic Stability Control (ESC) system)**

- **To prevent the vehicle from misfiring during dynamometer testing, turn the Electronic Stability Control (ESC) system off by pressing the ESC switch.**
- **After dynamometer testing is completed, turn the ESC system back on by pressing the ESC switch again.**

#### **1. Crankcase emission control system**

The positive crankcase ventilation system is employed to prevent air pollution caused by blow-by gases being emitted from the crankcase. This system supplies fresh filtered air to the crankcase through the air intake hose. Inside the crankcase, the fresh air mixes with blow-by gases, which then pass through the PCV valve into the induction system.

#### **2. Evaporative emission control (including ORVR: Onboard Refueling Vapor Recovery) system**

The Evaporative Emission Control System is designed to prevent fuel vapors from escaping into the atmosphere.

(The ORVR system is designed to allow the vapors from the fuel tank to be loaded into a canister while refueling at the gas station, preventing the escape of fuel vapors into the atmosphere.)

### **Canister**

Fuel vapors generated inside the fuel tank are absorbed and stored in the onboard canister. When the engine is running, the fuel vapors absorbed in the canister are drawn into the surge tank through the purge control solenoid valve.

### **Purge Control Solenoid Valve (PCSV)**

The purge control solenoid valve is controlled by the Engine Control Module (ECM); when the engine coolant temperature is low during idling, the PCSV closes so that evaporated fuel is not taken into the engine. After the engine warms up during ordinary driving, the PCSV opens to introduce evaporated fuel to the engine.

## **3. Exhaust emission control system**

The Exhaust Emission Control System is a highly effective system which controls exhaust emissions while maintaining good vehicle performance.

### **Vehicle modifications**

This vehicle should not be modified. Modification of your vehicle could affect its performance, safety or durability and may even violate governmental safety and emissions regulations.

In addition, damage or performance problems resulting from any modification may not be covered under warranty.

- If you use unauthorized electronic devices, it may cause the vehicle to operate abnormally, wire damage, battery discharge and fire. For your safety, do not use unauthorized electronic devices.

### **Engine exhaust gas precautions (carbon monoxide)**

- Carbon monoxide can be present with other exhaust fumes. Therefore, if you smell exhaust fumes of any kind inside your vehicle, have it inspected and repaired immediately. If you ever suspect exhaust fumes are coming into your vehicle, drive it only with all the windows fully open. Have your vehicle checked and repaired immediately.



### **WARNING - Exhaust**

**Engine exhaust gases contain carbon monoxide (CO). Though colorless and odorless, it is dangerous and could be lethal if inhaled. Follow the instructions on this page to avoid CO poisoning.**



- Do not operate the engine in confined or closed areas (such as garages) any more than what is necessary to move the vehicle in or out of the area.
- When the vehicle is stopped in an open area for more than a short time with the engine running, adjust the ventilation system (as needed) to draw outside air into the vehicle.
- Never sit in a parked or stopped vehicle for any extended time with the engine running.
- When the engine stalls or fails to start, excessive attempts to restart the engine may cause damage to the emission control system.

**⚠ WARNING - Catalytic converter**

**Keep away from the catalytic converter and exhaust system while the vehicle is running or immediately thereafter. The exhaust and catalytic systems are very hot and may burn you.**

***Operating precautions for catalytic converters (if equipped)***

**⚠ WARNING - Fire**

- **Do not park, idle or drive the vehicle over or near flammable objects, such as grass, vegetation, paper, leaves, etc. A hot exhaust system can ignite flammable items under your vehicle.**
- **Also, do not remove the heat sink around the exhaust system, do not seal the bottom of the vehicle or do not coat the vehicle for corrosion control. It may present a fire risk under certain conditions.**

Your vehicle is equipped with a catalytic converter emission control device. Therefore, the following precautions must be observed:

- Use only UNLEADED FUEL for gasoline engines.
- Do not operate the vehicle when there are signs of engine malfunction, such as misfire or a noticeable loss of performance.
- Do not misuse or abuse the engine. Examples of misuse are coasting with the ignition off and descending steep grades in gear with the ignition off.
- Do not operate the engine at high idle speed for extended periods (5 minutes or more).
- Do not modify or tamper with any part of the engine or emission control system. All inspections and adjustments must be made by an authorized Kia dealer.
- Avoid driving with a extremely low fuel level. Running out of fuel could cause the engine to misfire, damaging the catalytic converter.

Failure to observe these precautions could result in damage to the catalytic converter and to your vehicle. Additionally, such actions could void your warranties.

**Engine / 8-2**  
**Dimensions / 8-2**  
**Bulb wattage / 8-3**  
**Tires and wheels / 8-4**  
**Weight/Volume / 8-4**  
**Recommended lubricants and capacities / 8-5**  
**Vehicle identification number (VIN) / 8-7**  
**Vehicle certification label / 8-7**  
**Tire specification and pressure label / 8-8**  
**Engine number / 8-8**  
**Refrigerant label / 8-8**

## ENGINE

Item	Gasoline 1.6
Displacement [cc(cu.in)]	1,591 (97.09)
Bore x Stroke [mm(in)]	77 x 85.44 (3.03 x 3.36)
Firing order	1-3-4-2
No. of cylinders	4, In-line

## DIMENSIONS

Item	mm (in)	
Overall length	4045 (159.2)	
Overall width	1720 (67)	
Overall height	1455 (57.2)	
Front tread	185/65R15	1521 (59.8)
	195/55R16	1507 (59.3)
	205/45R17	1507 (59.3)
Rear tread	185/65R15	1525 (60)
	195/55R16	1511 (59.4)
	205/45R17	1511 (59.4)
Wheelbase	2570 (101.1)	

## BULB WATTAGE

Light Bulb			Wattage	Bulb type
Front	Head lamp	Low	55W	H11B
		High	55W	H11B
	Position lamp		8W or LED	PY28/8W or LED
	DRL (Day time Running Lamp)*		21W or LED	P21/5W or LED
	Turn signal lamp		21W or 28W	PY21W or PY28/8W
	Front fog lamp*		55W	9006
Side marker light		5W	W5W	
Rear	Tail lamp	Inside	5W or LED	W5W or LED
		Outside	8W or LED	28/8W or LED
	Stop lamp	Inside	8.7W	LED *
		Outside	8W or LED	28/8W or LED
	Turn signal lamp		21W	PY21W
	Back up lamp		16W	W16W
	High mounted stop lamp		2.2W	LED
	License plate lamp		5W X 2EA	W5W
Side marker light*			as tail bulb*	
		LED	LED*	
Interior	Map lamps*		10W X 2EA	W10W
	Room lamps		10W	FESTON
	Luggage lamp		5W	FESTON
	Glove box lamp		5W	FESTON
	Vanity mirror lamps*		5W	FESTON

\* : if equipped

## TIRES AND WHEELS

Item	Tire size	Wheel size	Cold tire inflation pressure kPa (psi)				Wheel lug nut torque kg•m (lb•ft, N•m)
			Normal load		Maximum load		
			Front	Rear	Front	Rear	
Full size tire	P185/65R15*	5.5J X 15	220 (32)	220 (32)	220 (32)	220 (32)	9~11 (65~79, 88~107)
	P195/55R16*	6.0J X 16					
	P205/45R17*	6.5J X 17					
Compact* spare tire	T125/80D15	3.5J X 15	420 (60)	420 (60)	420 (60)	420 (60)	

\* : if equipped

## WEIGHT/VOLUME

Item		Gasoline 1.6	
		M/T	A/T
Gross vehicle weight kg (lbs.)		1600 (3525)	1630 (3595)
Luggage volume l (cu ft)	MIN	288 (10)	
	MAX	923 (32)	

## RECOMMENDED LUBRICANTS AND CAPACITIES

To help achieve proper engine and powertrain performance and durability, use only lubricants of the proper quality. The correct lubricants also help promote engine efficiency that results in improved fuel economy.

These lubricants and fluids are recommended for use in your vehicle.

Lubricant		Volume	Classification
Engine oil <sup>*1 *2</sup> (drain and refill) Recommended (or equivalent)		 3.3 l (3.49 US qt.)	API Service SM <sup>*3</sup> , ILSAC GF-4 or above
Manual transaxle fluid		1.8 ~ 1.9 l (1.9 ~ 2.01 US qt.)	API GL-4, SAE 75W/85 approved by Kia Motors Corp.
Automatic transaxle fluid	1.6 Engine	7.3 l (7.71 US qt.)	MICHANG ATF SP-IV, SK ATF SP-IV NOCA ATF SP-IV, Kia genuine ATF SP-IV
Coolant	Automatic transaxle	5.5 l (5.6 US qt.)	Mixture of antifreeze and distilled water (Ethylene glycol base coolant for aluminum radiator)
	Manual transaxle	5.3 l (5.8 US qt.)	
Brake/Clutch fluid		0.7~0.8 l (0.7~0.8 US qt.)	FMVSS116 DOT-3 or DOT-4
Fuel		43 l (11.3 US gal.)	Refer to "Fuel requirements" in section 1

\*1 Refer to the recommended SAE viscosity numbers on the next page.

\*2 Engine oils labeled Energy Conserving Oil are now available. Along with other additional benefits, they contribute to fuel economy by reducing the amount of fuel necessary to overcome engine friction. Often, these improvements are difficult to measure in everyday driving, but in a year's time, they can offer significant cost and energy savings.

\*3 If the API service SM engine oil is not available in your country, you are able to use API service SL.

**Recommended SAE viscosity number**

Always be sure to clean the area around any filler plug, drain plug, or dipstick before checking or draining any lubricant. This is especially important in dusty or sandy areas and when the vehicle is used on unpaved roads. Cleaning the plug and dipstick areas will prevent dirt and grit from entering the engine and other mechanisms that could be damaged.

Engine oil viscosity (thickness) has an effect on fuel economy and cold weather operation (engine start and engine oil flowability). Lower viscosity engine oils can provide better fuel economy and cold weather performance, however, higher viscosity engine oils are required for satisfactory lubrication in hot weather. Using oils of any viscosity other than those recommended could result in engine damage.

When choosing an oil, consider the range of temperature your vehicle will be operated in before the next oil change. Proceed to select the recommended oil viscosity from the chart.

Temperature Range for SAE Viscosity Numbers										
Temperature	°C	-30	-20	-10	0	10	20	30	40	50
	(°F)	-10	0	20	40	60	80	100	120	
Gasoline Engine Oil *1		10W-30								
		5W-20, 5W-30								

- For better fuel economy, it is recommended to use the engine oil of a viscosity grade SAE 5W-20 (API SM / ILSAC GF-4). However, if the engine oil is not available in your country, select the proper engine oil using the engine oil viscosity chart.



## VEHICLE IDENTIFICATION NUMBER (VIN)

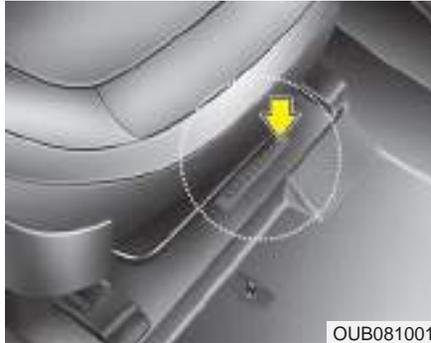

The vehicle identification number (VIN) is the number used in registering your vehicle and in all legal matters pertaining to its ownership, etc.



### ***VIN label***

The VIN is also on a plate attached to the top of the dashboard. The number on the plate can easily be seen through the windshield from outside.

## VEHICLE CERTIFICATION LABEL



The vehicle certification label attached on the driver's side center pillar gives the vehicle identification number (VIN).



### TIRE SPECIFICATION AND PRESSURE LABEL



OUB071018

The tires supplied on your new vehicle are chosen to provide the best performance for normal driving.

The tire label located on the driver's side center pillar gives the tire pressures recommended for your vehicle.

### ENGINE NUMBER



OUB081004N

The engine number is stamped on the engine block as shown in the drawing.

### REFRIGERANT LABEL (IF EQUIPPED)



OUB071062N

The refrigerant label is located on the underside of the hood.