



KIA MOTORS

SEDONA

Owner's Manual

Now that you are the owner of a Kia Vehicle, you'll probably be asked a lot of questions about your vehicle and the company like "What the heck is a Kia?," "Who is Kia?," "What does 'Kia' mean?"

Here are some answers. First, Kia is the oldest car company in Korea. It's a company that has thousands of employees focused on building high-quality vehicles at affordable prices.

The first syllable, **Ki**, in the word "Kia" means "to arise from to the world" or "to come up out of to the world." The second syllable, **a**, means "Asia." So, the word **Kia**, means "to arise from" or "to come up out of Asia to the world."

Enjoy your Vehicle

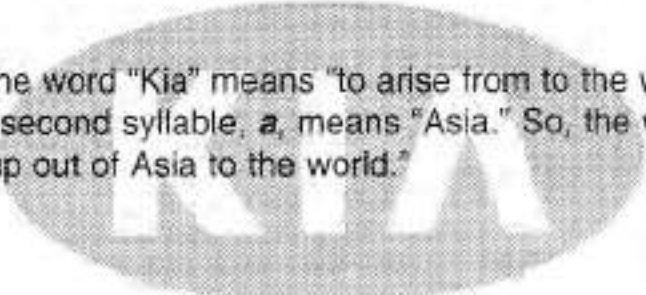
The Kia logo, consisting of the word "KIA" in a bold, sans-serif font, is centered within a light gray oval background.

FOREWORD

Thank you for choosing a Kia vehicle.

When you require service, remember that your dealer knows your vehicle best. Your dealer has factory-trained technicians, recommended special tools, genuine Kia replacement parts and is dedicated to your complete satisfaction.

Because subsequent owners require this important information as well, this publication should remain with the vehicle if it is sold.

This manual will familiarize you with operational, maintenance and safety information about your new vehicle. It is supplemented by a Warranty and Consumer Information Manual that provides important information on all warranties regarding your vehicle. If your vehicle is equipped with an audio system, you will also have a Kia Integrated Audio System manual explaining its operation. We urge you to read these publications carefully and follow the recommendations to help assure enjoyable and safe operation of your new vehicle.

Kia offers a great variety of options, components and features for its various models.

Therefore, the equipment described in this manual, along with the various illustrations, may not all be applicable to your particular vehicle. The information and specifications provided in this manual were accurate at the time of printing. Kia reserves the right to discontinue or change specifications or design at any time without notice and without incurring any obligation. If you have questions, always check with your Kia Dealer.

We assure you of our continuing interest in your motoring pleasure and satisfaction in your Kia vehicle.

© 2001 Kia Motors Corp.

All rights reserved. Reproduction by any means, electronic or mechanical, including photocopying, recording, or by any information storage and retrieval system or translation in whole or part is not permitted without written authorization from Kia Motors Corporation.

Printed in Korea

TABLE OF CONTENTS

INTRODUCTION	1
YOUR VEHICLE AT A GLANCE	2
KNOWING YOUR VEHICLE	3
DRIVING YOUR VEHICLE	4
DRIVING TIPS	5
IN CASE OF AN EMERGENCY	6
MAINTENANCE	7
SPECIFICATIONS	8
INDEX	9

INTRODUCTION

1

How To Use This Manual	1-2
Vehicle Break-In Process	1-3

HOW TO USE THIS MANUAL

We want to help you get the greatest possible driving pleasure from your vehicle. Your Owner's Manual can assist you in many ways. **We strongly urge that you review the entire manual. However, in order to prevent death or injury, at the very least, you must review the WARNING and CAUTION sections spread throughout the manual, which are easily recognized by their special markings listed below.**

Illustrations complement the words in this manual to best explain how to enjoy your vehicle. By reading your manual, you learn about features, important safety information, and driving under various road conditions.

The general layout of the manual is provided in the Table of Contents. A good place to start is the index; it has an alphabetical listing of all information in your manual.

Sections: This manual has eight sections plus an index. Each section begins with a brief list of contents so you can tell at a glance if that section has the information you want.

You'll find various WARNING's, CAUTION's, and NOTICE's in this manual. These WARNING's, CAUTION's and NOTICE's were prepared to enhance your personal safety and continued satisfaction with your Kia vehicle. You should carefully read and follow ALL procedures and recommendations provided in these WARNING's, CAUTION's and NOTICE's.

WARNING

A WARNING indicates a situation in which serious bodily injury or death could result if the warning is ignored.

CAUTION

A CAUTION indicates a situation in which personal injury, perhaps severe, could result if the caution is ignored.

NOTICE

A NOTICE indicates a situation in which damage to your vehicle could result if the notice is ignored.

VEHICLE BREAK-IN PROCESS

No special break-in period is needed. By following a few simple precautions for the first 600 miles (1,000 km) you may add to the performance, economy and life of your vehicle.

- Do not race the engine.
- Do not maintain a single speed for long periods of time, either fast or slow. Varying engine speed is needed to properly break in the engine.
- Avoid hard stops, except in emergencies, to allow the brakes to seat properly.
- Avoid full-throttle starts.

Interior and Exterior Overview	2-2
Instrument Panel Overview	2-3

YOUR VEHICLE AT A GLANCE

INTERIOR AND EXTERIOR OVERVIEW

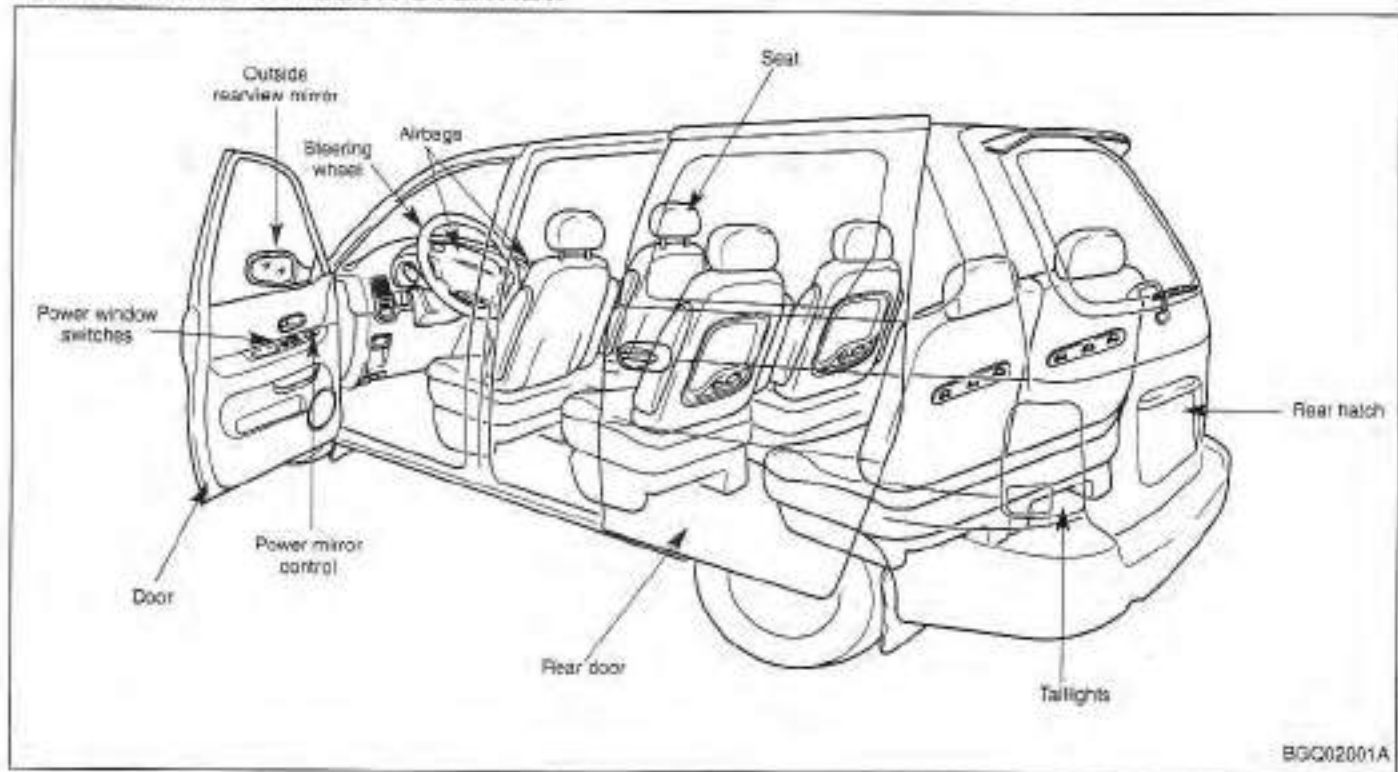

BGC20201A

YOUR VEHICLE AT A GLANCE

INSTRUMENT PANEL OVERVIEW

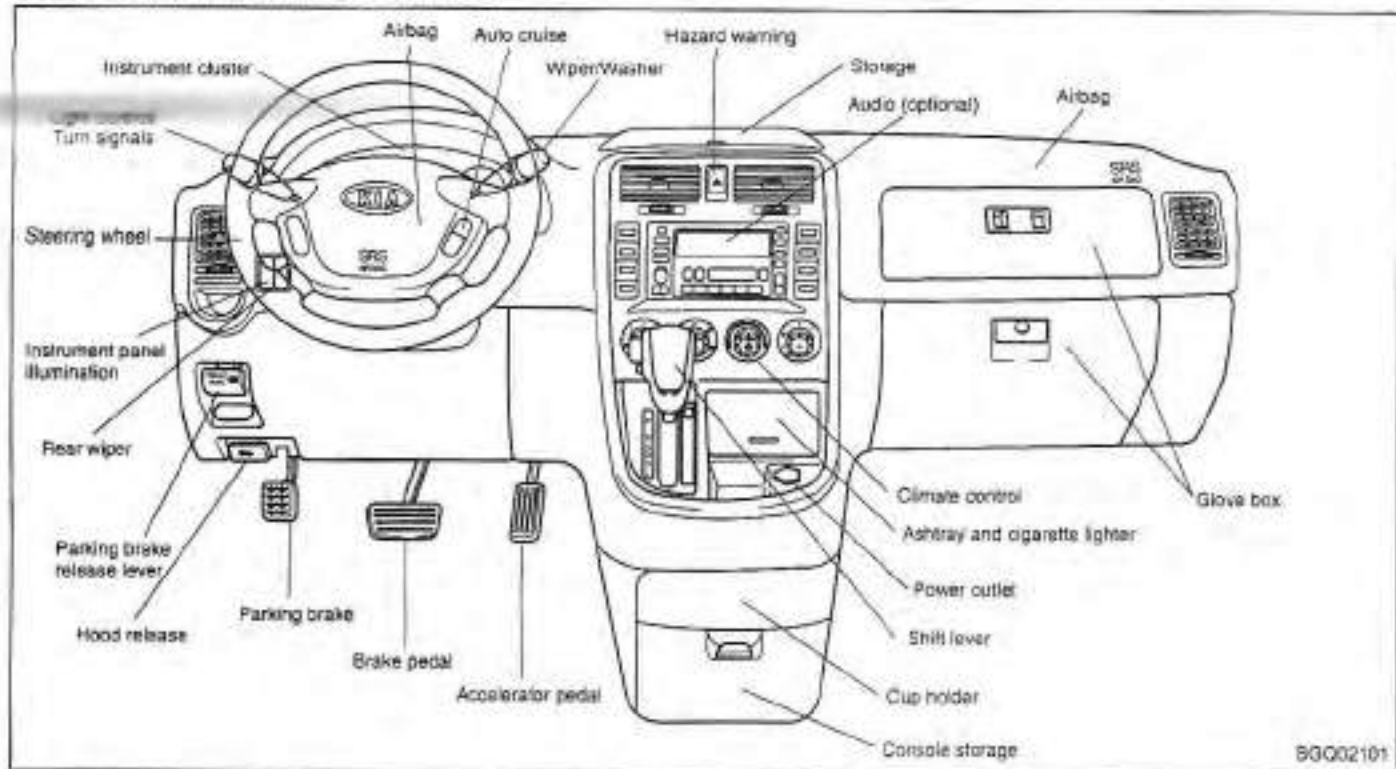

Keys	3-2
Door Locks	3-2
Windows - Front	3-7
Windows - Quarter	3-10
Front Seats	3-11
Rear Seats	3-19
Safety Belts	3-26
Airbags	3-43
Rear Hatch	3-51
Hood	3-52
Fuel Filler Lid	3-54
Steering Wheel	3-55
Mirrors	3-56
Interior Lights	3-58
Cup Holder	3-60
Console Storage Compartment	3-61
Sunroof	3-63
Sunglass Holder	3-65

KEYS

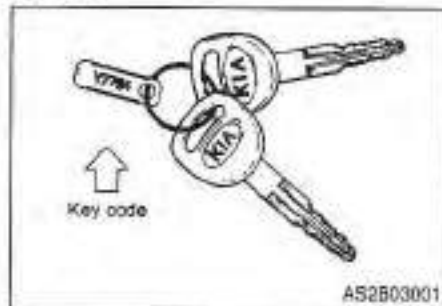

The key code number is stamped on the plate attached to the key set. If you should lose your keys, this number will enable an authorized Kia dealer to duplicate the keys easily. Remove the plate and store it in a safe place. Also, record the code number and keep it in a safe and handy place, but not in the vehicle.

⚠ WARNING - Ignition Key
 Leaving children unattended in a vehicle with the ignition key is dangerous even if the key is not in the ignition. Children copy adults and they could place the key in the ignition. The ignition key would enable children to operate power windows or other controls, or even make the vehicle move which could result in serious bodily injury or even death. Never leave the keys in your vehicle with unsupervised children.

DOOR LOCKS

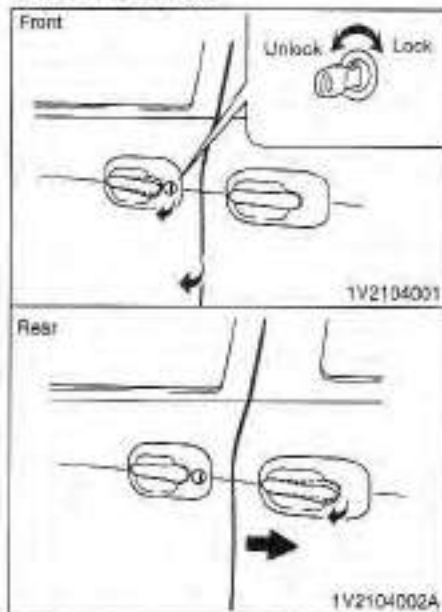

Automatic Door Locks

Operating door locks - with key

- Turn the key to the left to unlock and to the right to lock.
- Once the doors are unlocked, they may be opened by pulling the door handle.
- All four doors and rear hatch can be locked and unlocked from the driver or passenger door with the key.



Two turn unlock system

To unlock the other doors from the driver's door, turn the driver's door key to the left twice within 3 seconds. To lock all doors from the driver's door, the driver's door key need only be turned once to the right.

Operating door locks - with remote keyless entry (if equipped)

If your vehicle has this feature, you can lock and unlock your doors and rear hatch from up to 5m (15 feet) away using the key chain transmitter supplied with your vehicle.

- **LOCK** : If you depress the corresponding button on the transmitter, all four doors and rear hatch will lock and sound the horn.
- **UNLOCK** : If you depress the corresponding button once, only the driver's door will unlock. If you depress the corresponding button twice, all four doors and rear hatch will unlock.



Battery Replacement

1. Insert a coin into the slot and gently pry open the transmitter.
2. Remove and replace the two 3-volt batteries with the (+) facing down.
3. Reassemble the transmitter.
4. Check the transmitter operation.

* NOTICE

- The keyless entry system does not operate when;
 - the ignition key is in the ignition switch
 - you exceed the operating distance limit (5m)
 - the batteries in the transmitter are weak
 - other vehicles or objects may be blocking the signal. Check the location.
- If you have a problem with the keyless entry system, contact an authorized Kia dealer as soon as possible.

Z CAUTION

- *Using the wrong battery can cause the transmitter to malfunction. Be sure to use the correct battery.*
- *To avoid damaging the transmitter, don't drop it, get it wet, or expose it to heat or sunlight.*

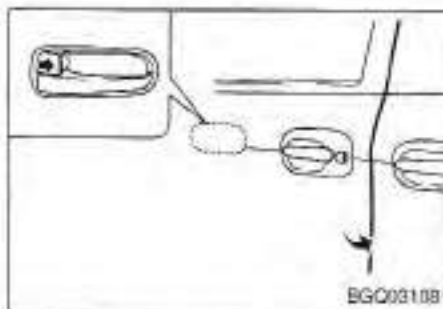

Operating door locks - without key

The driver's door can also be locked without using the key by depressing the door lock knob prior to shutting the door. Make sure all other doors are locked if the vehicle will be left unattended.

* NOTICE

If you wish to leave your vehicle unattended, you can lock all doors from the outside using the key at the driver's or passenger's door lock.

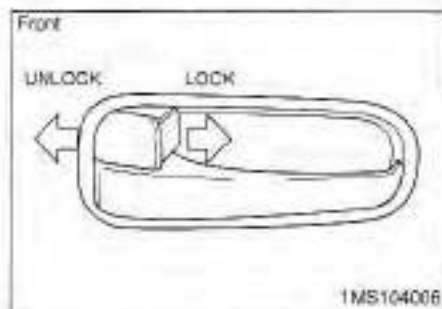

Operating door locks from inside the vehicle

- To lock a door, push the door lock knob to the "LOCK" position.
- To unlock a door, pull the door lock knob to the "UNLOCK" position.
- To open a door, pull the door handle outward.

* NOTICE

Always remove the ignition key, engage the parking brake, close all windows and lock all doors when leaving your vehicle unattended.

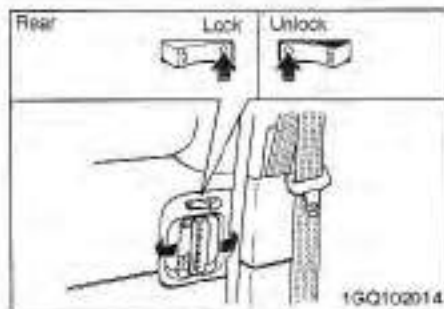

Rear Sliding Doors

- To lock a door, push the door lock switch to the lock position.
- To unlock, push the door lock switch to the unlock position.
- To open a door, pull the door handle towards the rear of your vehicle.
- When the door is opened fully, it is locked in position. To close the door, pull the door handle toward the front of your vehicle and slide the door forward.

*NOTICE

- When the door is locked, the red mark on the switch is not visible.
- The rear sliding doors are designed to only open from the inside when holding the handle with the palm facing out (toward the door). This is to prevent possible injury to occupants.

⚠ WARNING - Unattended Children

Never leave children or animals unattended in the vehicle. An enclosed vehicle can become extremely hot, causing death or severe injury to children or animals trapped inside vehicle.

⚡ CAUTION

The doors should always be fully closed and locked while the vehicle is in motion to prevent accidental opening of the door. Locked doors will also discourage potential intruders when the vehicle stops or slows.

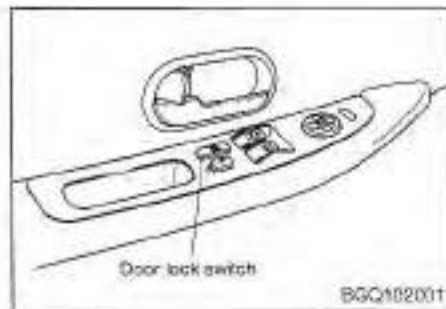

Central Door Locks

- If you press the front portion of the door lock switch, all the doors and rear hatch will lock automatically.
- If you press the rear portion of the door lock switch, all the doors and rear hatch will unlock automatically.
- If you lock/unlock the driver's door or the passenger door with a key or the door lock knob, all the doors and rear hatch will lock/unlock automatically. (When you unlock the driver's door with a key, refer to "Two Turn Unlock System" on page 3-3.) But, if you lock/unlock the driver's door with the door lock knob, only driver's door will lock/unlock.



Rear Door Child Safety Lock

The child safety lock prevents children from opening the rear doors from the inside. It should be used whenever children are in the vehicle.

- To lock a rear door so that it cannot be opened from the inside, push the child safety lock located on the forward edge of the door to the "LOCK" position before closing the door.
- To open a rear door while the child safety lock is engaged, push the door lock knob to the "UNLOCK" position (red mark is visible) then pull the outside door handle.

⚠ WARNING - Rear Door Locks
If children accidentally open the rear doors while the vehicle is in motion, they could fall out and be severely injured or killed. To prevent children from opening the rear doors from the inside, the rear door safety locks should be used whenever children are in the vehicle.

WINDOWS

Power Windows

The ignition switch must be in the ON position for power windows to operate. Each door has a power window switch that controls that door's window. However, the driver has a power window switch which can block the operation of a passenger window.

* NOTICE

To prevent the power window system from the possibility of damage, do not open or close two windows at the same time. This will also ensure the longevity of the fuse.

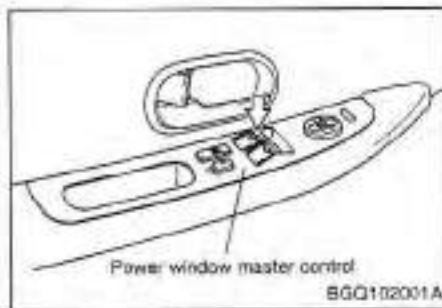

Driver's door power window controls

All windows can be opened or closed using the power window master control on the driver's door. To open a window, press down on the corresponding power window switch. To close a window, pull up on the corresponding power window switch.

Driver's Window Automatic-Down Window Switch

The driver's window has an "Automatic-Down" feature. To activate the express-down feature, momentarily depress the front of the switch to the second detent position. To cancel this feature, pull up on the front of the switch and then release it.

Power window timer (if equipped)

The power windows can be operated for approximately 30 seconds after the ignition key is turned to the ACC or LOCK position.

Driver's Power Window Switch

The driver's power window switch provides two (2) separate window-down functions.

- Depressing the driver's power window switch completely automatically lowers (Automatic-Down) the driver's window automatically. To cancel this function, pull up on the front of the switch and release it.
- Depressing the driver's power window switch partially (to the first detent) provides precise control of the window-down position. To raise/close the driver's window, pull up on the power window switch.

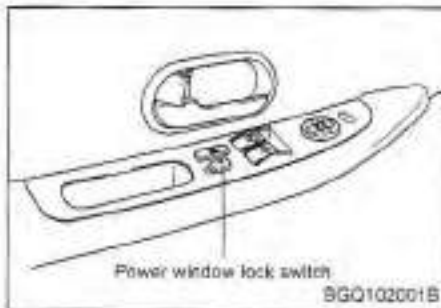

Power window lock switch feature

The driver can disable the power window switches on a passenger door by depressing the power window lock switch located on the driver's door to ON. When the power window lock switch is ON, only the driver's master control can operate the windows.

⚠ WARNING - Power Windows

- Keep the power window lock switch in the driver's door in the ON (depressed) position, except when someone is operating a passenger door window. Serious injury can result (especially to children) from unintentional window operation.
- Always double check to make sure all arms, hands, and other obstructions are safely out of the way before closing a window.

*** NOTICE**

If you notice buffeting and pulsation (wind shock) with either side window open, you should open the opposite window slightly to reduce the condition.

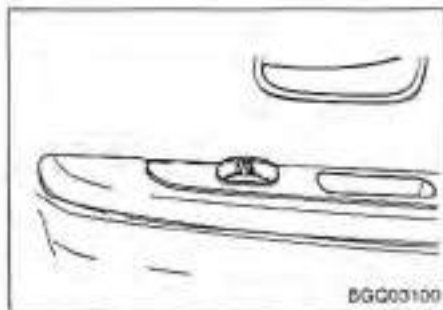

⚠ WARNING - Passengers
Do not allow children to play with the power windows. They may seriously injure themselves or others.

Passenger doors power window controls

To open a window, press down on the front portion of the power window switch. To close a window, pull up on the front portion of the power window switch.

QUARTER WINDOWS

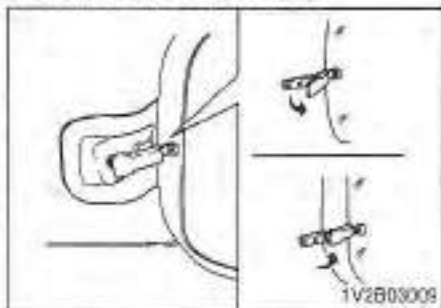

Manual Flip - Open

To open the quarter windows, pull the rear portion of the latch out. Swing the latch forward and out, then lock it into the open position by pushing rearward until you hear a click. To close the windows, pull the handle inward. Then push the handle inward until you hear a click.

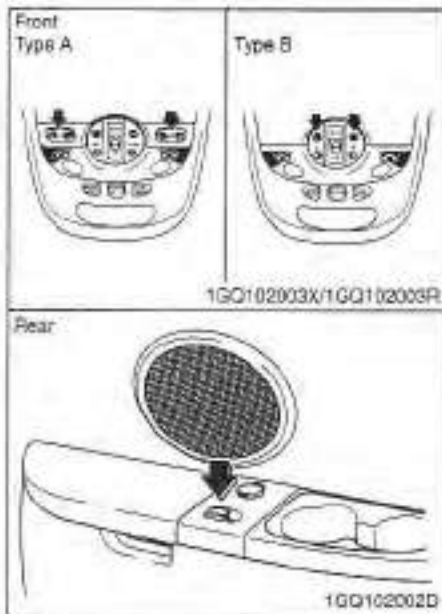

Power Open (if equipped)

Front

The power rear quarter vent windows operate with the ignition in the ON position. The vent windows are controlled by the right and left switch located on the overhead console.

To open the windows, press the open side of switches. To close, press the close side of the switches.

Rear

To open, pull up on the forward part of the switch. To close it, push down on the forward part of the switch.

When the power window lock switch on the driver's door is ON, the rear power open switch does not control the vent windows.

FRONT SEAT

⚠ WARNING - Driver's Seat

- Never adjust the manual controls on the driver's seat while the vehicle is in motion. Doing so could cause loss of vehicular control and serious personal injury or death.
- Do not allow anything to interfere with the normal position of a seatback. Such interference may prevent the seatback from locking which could result in serious injury or death in the event of a sudden stop or collision.
- Always ride with your seatback upright in the normal seating position and the lap portion of the safety belt, snug and low across the hips.

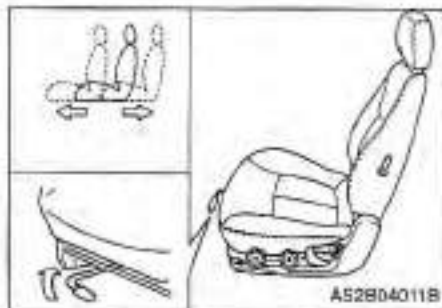

Front Seat Adjustment - Manual

Moving the front seat forward and backward

To move the seat forward or backward:

1. Pull the seat slide adjustment lever under the front edge of the seat cushion up and hold it.
2. Slide the seat to the position you desire.
3. Release the lever and make sure the seat is locked in place.

⚠ CAUTION

Do not place anything under the front seats. Loose objects might interfere with the seat slide mechanism or roll out from under the seat. Objects rolling around in the driver's foot area could interfere with the operation of the brake, clutch or accelerator foot pedals.



Adjusting the front seatback recliner

To recline the seatback:

1. Lean forward slightly and lift up on the seatback recline lever located on the outside of the seat, toward the rear.
2. Carefully lean back on the seat and adjust the back of the seat to the position you desire.
3. Release the lever and make sure the seatback is locked in place. (The lever **MUST** return to its original position for the seatback to lock.)

⚠ WARNING - Passengers

To reduce the risk of sliding under the lap portion of the lap/shoulder belt, and potentially suffering severe injury or death in the event of a collision, our vehicle's restraint system is designed to provide maximum effectiveness when the seatbelt is worn in close proximity to the body and the seatback is in a normal sitting position.

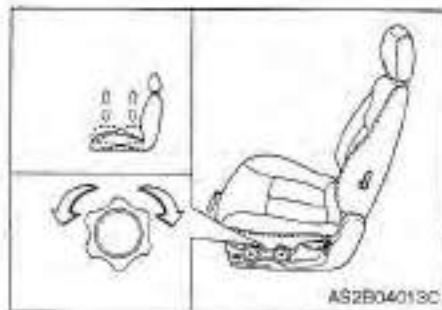

Adjusting the height of front seat cushion

To change the height (front portion) of the seat cushion, rotate the knob located on the outside of the seat cushion.

- To lower the seat cushion, rotate the knob toward the front of the vehicle.
- To raise the seat cushion, rotate the knob toward the rear of the vehicle.

To change the height (rear portion) of the seat cushion, rotate the knob located on the outside of the seat cushion.

- To lower the seat cushion, rotate the knob toward the front of the vehicle.
- To raise the seat cushion, rotate the knob toward the rear of the vehicle.

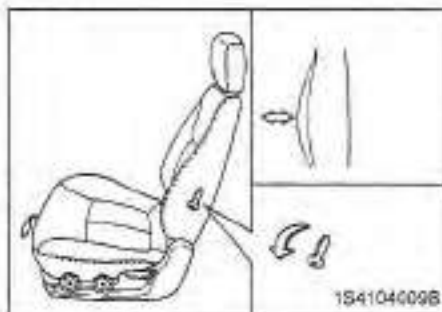

Lumbar support (for driver's seat)

You can adjust the lumbar support by moving the lever on the side of the driver's seatback. Pivoting the lever toward the front of the vehicle increases the lumbar support. Pivoting the lever toward the rear of the vehicle decreases the lumbar support.

Front Seat Adjustment - Power (if equipped)

The driver's seat can be adjusted by using the control knob on the left side of the seat. Before driving, adjust the seat to the proper position so as to easily control the steering wheel, pedals and switches on the instrument panel.

CAUTION

Do not operate two knobs at the same time.

⚠ WARNING - Driver's Seat

- Never attempt to adjust seat while the vehicle is moving. This could result in loss of control, and an accident causing death, serious injury, or property damage.
- In order to avoid unnecessary airbag injuries including the possibility of severe injury or death, always sit as far back as possible from the steering wheel while still being able to maintain comfortable control of your vehicle.
- The Canadian Motor Vehicle Safety Standards (CMVSS) recommends that the driver sit at least 250 mm (10 inches) away from the steering wheel to avoid the risk of serious injury or death due to the deployment of the driver's airbag.
- The power seats are operable with the ignition OFF. Therefore, children should never be left unattended in the car.

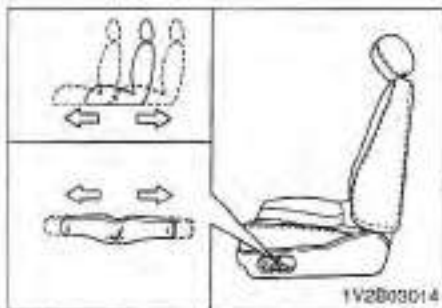

Moving the front seat forward and backward

Push the control knob forward or backward to move the seat to the desired position. Release the knob and the seat will lock in that position.

1. Reclining Control Knob
2. Sliding and Height Adjusting Control Knob

*** NOTICE**

Prior to operating the vehicle, ensure the seat is locked securely by trying to move the seat forward or backward without using the control knob. If the seat moves, it is not locked properly.

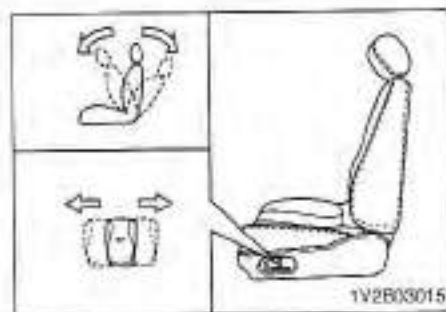

Adjusting the front seatback recliner

Rotate the upper portion of the control knob forward or backward to recline the seatback to the desired position. Release the control knob and the seatback will lock in position.

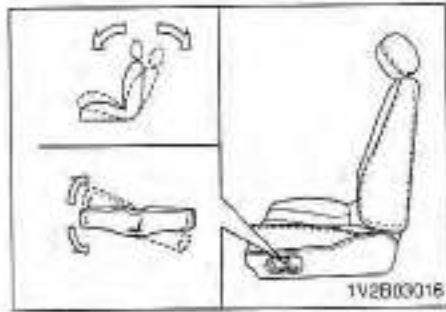

Adjusting the height of front seat cushion

Front height of front seat cushion
Move the front portion of the control knob up to raise or down to lower the front part of the seat cushion.

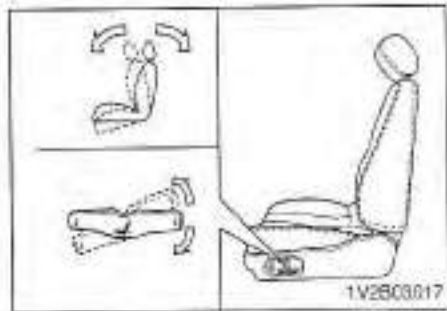

Rear height of front seat cushion
Move the rear portion of the control knob up to raise or down to lower the rear part of the seat cushion.

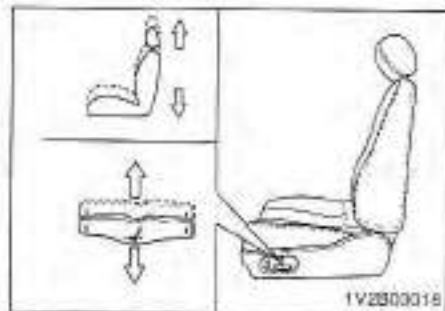

1V2B03018

Height of front seat cushion

To raise or lower the seat cushion totally, pull up and push down on the center of the corresponding switch.

⚠ WARNING

To minimize the risk of possible severe personal injury in the event of a collision, both the driver's and passenger's seatbacks should be in a normal seating position while the car is in motion. The protection provided by the vehicle's restraint system may be reduced significantly when the seatbacks are reclined. All parts of the restraint system are designed to absorb energy in an accident and this can best be accomplished if the seatback is in a normal seating position and the seatbelt is worn properly.



1V2B03019

Lumbar support (for driver's seat)

You can adjust the lumbar support by pressing the switch located on the outside of the seat cushion. Pressing the top of the switch increases the lumbar support. Pressing the bottom of the switch decreases the lumbar support.

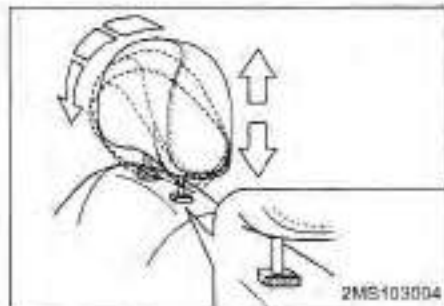

Headrest

All the seat headrests provide comfort and also help protect your head and neck in the event of certain kinds of collisions.

Hold the headrest and pull up to raise it. It will lock into position. To lower the headrest, push the lock lever on the left side and push down on the headrest.

The headrest may be adjusted forward to three positions by pulling it forward. To adjust the headrest backwards, pull it forward and release it.

⚠ WARNING - Headrests

- Adjust the top of the headrest so that it is even with the top of your ears in order to reduce the chance of possible severe injury in the event of a collision.
- Do not operate the vehicle with the headrest removed or improperly positioned.
- Do not attempt to adjust the headrest while driving.

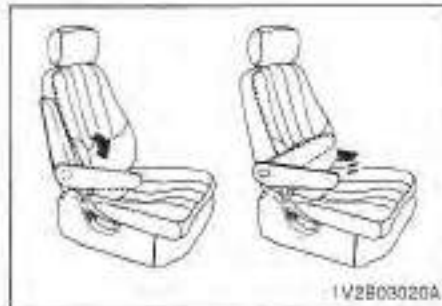

Armrest (if equipped)

Type A (adjustable armrest)

Your front seats have the armrest located on the side of seatback.

To use the armrest, swing down the armrest to the lowest position then pull it up to the desired position.



Type B (non-adjustable armrest)

Your second row seats have armrests located on the side seatbacks.

To use the armrests, swing them down to the lowest position.

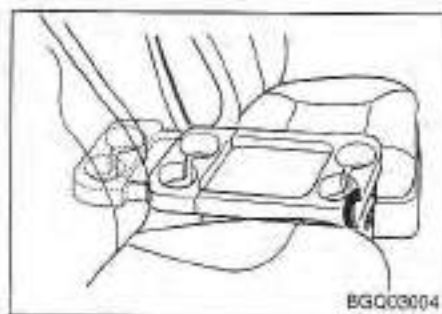

Side Table (if equipped)

The side table is located on the inner portion of the passenger's seat.

To use the table, pull the table all the way up until it locks into place. Verify the table is locked by trying to push it down. If the table moves down, it is not locked properly.

You can extend it by pulling the rear portion backward.

To fold down the table, pull up the release lever and press down the edge of the table.

REAR SEAT

WARNING - Rear Seatback

- The rear seatback must be securely latched. If not, passengers and objects could be thrown forward and front seat occupants especially could suffer serious injury or death in the event of a sudden stop or collision.
- Luggage and other cargo should be laid flat in the cargo area. If objects are large, heavy, or must be piled, they must be secured. Under no circumstances should cargo be piled higher than the seatbacks. Failure to follow these warnings could result in serious injury or death in the event of a sudden stop, collision or rollover.
- Passengers should not ride in the cargo area or sit or recline on folded seatbacks while the vehicle is in motion.
- When resetting the seatback to the upright position, make sure it is securely latched by pushing it forward and rearward.
- To avoid the possibility of burns, do not remove the carpet in the cargo area. Emission controls beneath this floor generate high exhaust temperatures.



Rear Seat - Second Row (separate seat)

Moving the rear seat forward and backward

To move the rear seat forward or backward, pull the sliding lever under the front of the seat cushion to the right, slide the seat to the desired position, and release the lever. To make sure the seat is locked in position, try to move the seat.



Adjusting the rear seatback recliner

To change the rear seatback angle, lean forward slightly and raise the lever located on the side of the seat. Then lean back to the desired angle and release the lever. After adjustment, make sure that the lever has returned to its original locked position.

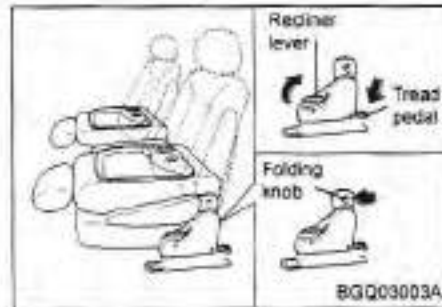

Folding the rear seatback

To use the rear seatback as a table:

1. Lower the headrest.
2. Pull up the recliner lever or push down the tread pedal.
3. Push the folding knob forward and fold the rear seatback.

To unfold the rear seat for passenger use:

1. Pull up the seatback.
2. Adjust seatback to the upright position and make sure that the recliner lever has returned to the original locked position.

KNOWING YOUR VEHICLE



Rear Seat - Second Row (bench seat)

Moving the rear bench seat forward and backward

To move the rear bench seat forward or backward, pull the sliding lever under the front of the seat cushion to the right, slide the seat to the desired position, and release the lever. To make sure the seat is locked in position, try to move the seat.



Adjusting the rear bench seatback recliner

To change the rear bench seatback angle, lean forward slightly and raise the lever located on the side of the seat. Then lean back to the desired angle and release the lever. After adjustment, make sure that the lever has returned to its original locked position.



Folding the rear bench seatback

To fold the rear seatback:

1. Lower the headrest.
2. Pull up the recliner lever or push down the tread pedal.
3. Push the folding knob forward and fold the rear seatback.

To unfold the rear seatback:

1. Pull up the seatback.
2. Adjust seatback to the upright position and make sure that the recliner lever has returned to the original locked position.

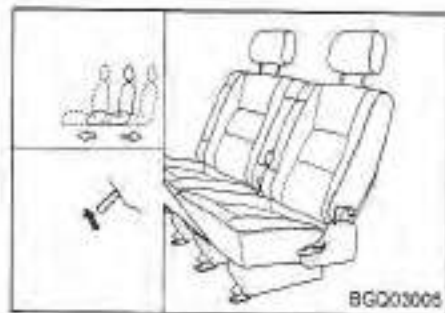

Rear Seat - Third Row

Moving the third row seat forward and backward

To move the rear seat forward or backward, pull the sliding lever under the front of the seat cushion to the right, slide the seat to the desired position, and release the lever. To make sure the seat is located in position try to move the seat.



Adjusting the rear seatback recliner

To change the rear seatback angle, lean forward slightly and raise the lever located on the side of the seat. Then lean back to the desired angle and release the lever. After adjustment, make sure that the lever has returned to its original locked position.



Folding the rear seatback.

You can increase the cargo area by folding the rear seatback forward and sliding it forward. To fold the rear seatback, open the rear hatch and pull out on the strap loop located on the rear corner of the seat cushion. Then push the folding knob, and the seatback will fold forward to a near-horizontal position.

⚠ WARNING

To avoid the possibility of injury or death in case of an accident or a sudden stop, do not carry luggages or cargo on the folded seatback top while the vehicle is moving.

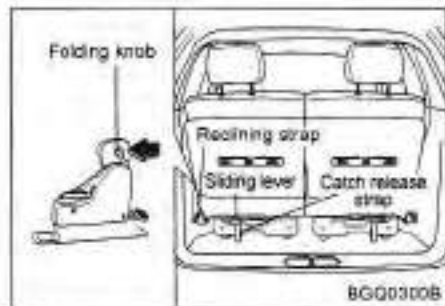

Double-folding the rear seat

To fold the rear seat forward for cargo area.

1. Remove the headrest.
2. Pull up the rear sliding lever and move the rear seat to rear-most position.
3. Pull out on the reclining strap.
4. Push the folding knob forward and fold the rear seatback.
5. Pull out on the catch release strap and lift the rear portion of the seat cushion.



6. Pull the folding loop out of the pocket located under the rear seat cushion.
7. Lift the entire folded seat forward and place the hook over the headrest pole at the 2nd row seat.

To unfold the rear seat for passenger use:

1. Remove the folding loop hook from the headrest pole.
2. Insert the folding loop into the pocket.
3. Lift the rear portion of the seat cushion then push down firmly to lock the catches into the rear anchors until an audible "click" is heard.
4. Make sure the catches are locked in position by moving the seat forward and backward or lifting the rear portion of the seat. If the seat moves, it is not locked properly.
5. Pull up the seatback.
6. Adjust seatback to the upright position and make sure that the recliner lever has returned to the original locked position.



Removal of The Rear Seats (2nd Row & 3rd Row)

To remove a rear seat :

1. Press down the tread pedal located on the rear corner of seat cushion and push the folding knob forward and fold the rear seatback.



2. Pull up the catch release strap located under the rear of the seat cushion to release the rear catches from the anchors.

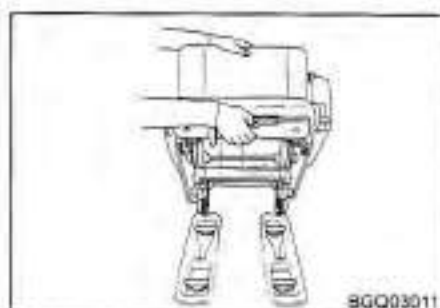

3. Lift the rear portion of the seat cushion and remove the seat from the four anchors on the floor.

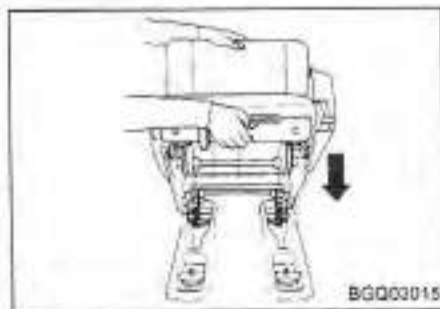
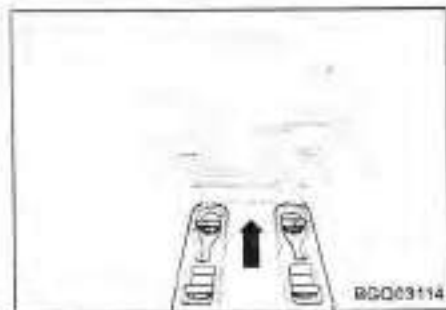

To install a rear seat :

1. Put the front anchor strikers along the front anchors on the floor to slide the seat forward.
2. Insert two front anchor strikers into the front anchors.

3. Lift the rear portion of the seat cushion then push down firmly to lock the catches into the rear anchors until an audible "click" is heard.
4. Make sure the catches are locked in position by moving the seat forward and backward or lifting the rear portion of the seat. If the seat moves, it is not locked properly.

5. Pull up the seatback
6. Adjust seatback to the upright position and make sure that the recliner lever has returned to the original locked position.

SAFETY BELTS



Pre-tensioner Seat Belt

Your vehicle is equipped with driver's and front passenger's pre-tensioner safety belts. The purpose of the pre-tensioner is to pull the safety belt snugly against the occupant's body in certain frontal collisions.

The pre-tensioner safety belts can be activated alone or, together with the airbags, where the frontal collision is severe enough.



When the vehicle stops suddenly, or if the occupant tries to lean forward too quickly, the seat belt retractor will lock into position. However, in certain frontal collisions, the pretensioner will also activate and pull the seat belt into tighter contact against the occupant's body.

The safety belt pre-tensioner system consists mainly of the following components.

Their locations are shown in the illustration.

1. SRS airbag warning light.
2. Seatbelt pre-tensioner assembly
3. SRS control module.

⚠ WARNING

To obtain maximum benefit from a pre-tensioner, safety belt must be worn correctly.

CAUTION - Pre-tensioner Noise and Powder

- *When the pre-tensioner safety belts are activated, a loud noise may be heard and fine powder, which may appear to be smoke, may be visible in the passenger compartment. The powder is not toxic.*
- *The powder may cause skin irritation and should not be breathed for prolonged periods. Wash your hands and face thoroughly after an accident in which such powder has been released.*

- *If the pre-tensioner seat belt is not working properly, the airbag warning light will illuminate, since both device are on the same electrical circuit. If the SRS airbag warning light does not illuminate when the ignition key is turned to "ON" or "ACC", or if it remains illuminated for more than 6 seconds, or if it illuminates while the vehicle is being driven, please have an authorized Kia dealer inspect the system as soon as possible.*

WARNING - Pre-tensioner Repair or Replacement

- Pre-tensioners are designed to operate once. After activation, pre-tensioner safety belts must be replaced.
- Do not attempt to inspect, repair or replace the pre-tensioner safety belts yourself. You can permanently damage the system.

Safety Belt Restraint System

WARNING - Safety Belts

The driver and all passengers should always use the safety belts provided in order to minimize the risk of severe bodily injury.

We strongly recommend that the driver and all passengers be properly restrained at all times by using the safety belts provided with the vehicle. Proper use of the safety belts decreases the risk of severe injury or death in accidents or sudden stops.

Safety belts provide the best restraint when :

- The seatback is adjusted so the occupant is in a normal seated position.
- The occupant is sitting upright (not reclined or bent over)
- The lap belt portion of the safety belt is snug and low on the hips
- The shoulder belt portion of the safety belt is snug against the chest
- The knees are straight forward

To help you remember to fasten your safety belt, a warning light will flash and a chime will sound.

All seats, except the center rear seat have lap/shoulder belts. Inertial locks in the safety belt retractors allow all of the lap/shoulder safety belts to remain unlocked during normal vehicle operation. This allows the occupants some freedom of movement and increased comfort while using the safety belts. If a force is applied to the vehicle, such as a strong stop, a sharp turn, or a collision, the safety belt retractors will automatically lock the safety belts.

Since the inertial locks do not require a collision in order to lock up, you may become aware of the safety belts locking while braking or going around sharp corners.

The center rear seat safety belt does not have an inertial lock so it is always in a locked condition.

Whenever possible, use the center rear seat position to install your child restraint. The center rear seat is the safest position for a child to sit in.

WARNING - Safety Belt Usage

- 1) Never wear the shoulder belt under the outside arm.
- 2) Never swing the safety belt around your neck to put it over the inside shoulder.
- 3) Never use a belt for more than one person.

 **WARNING - After a Collision**
Lap/shoulder belt assemblies may be stretched or damaged when subjected to the stress and forces of a collision. The entire restraint system should be inspected following any collision. All belts, retractors, anchors and hardware damaged by a collision should be replaced before the vehicle is operated again.

WARNING - Safety Belt Care

Safety belts should be inspected periodically for excessive wear or damage. Pull out each belt fully and look for excessive fraying, cuts, burns or other damage. Make sure that the lap/shoulder belts return smoothly and easily into the retractor. Check the latches to make sure they latch and release without interference or delay. Any belt not in good condition or in good working order should be promptly replaced.

WARNING - Twisted Safety Belts

Never drive or ride with a twisted or jammed safety belt. If you cannot untwist or unjam the safety belt, see your Kia dealer immediately.

CAUTION - Damage to Safety Belts

Never close the doors on any part of the lap or shoulder belt. It can damage the safety belt or buckle which could increase the risk of injury in case of an accident.

Restraint of Pregnant Women

Pregnant women should wear lap/shoulder belt assemblies whenever possible according to specific recommendations by their doctors. The lap portion of the belt should be worn **AS SNUGLY AND LOW AS POSSIBLE.**

WARNING - Pregnant Women

Pregnant women must never place the lap portion of the safety belt over the area of the abdomen where the fetus is located or above the abdomen where the belt could crush the fetus during an impact.

Restraint of Infants and Small Children

Children and infants should be restrained by an approved child-restraint system to help protect them while riding in a vehicle.

Never allow a child to stand or kneel on the seat of a moving vehicle. Never allow a safety belt to be placed around both a child and an adult or around two children at the same time.

Children can be killed or injured by the passenger air bag. The rear seats are the safest seats for children 12 and under.

WARNING - Children on Laps

Never hold a child on your lap or in your arms in a moving vehicle.

Even a very strong person cannot hold onto a child in the event of even a minor collision.

CAUTION - Hot Metal Parts

Safety belts and seats can become hot in a vehicle that has been closed during warm/hot weather; they could burn a child. Check seat covers and buckles before you place a child anywhere near them.

Many companies manufacture child restraint systems (often called child seats) for infants and small children. An acceptable child restraint system must always satisfy the Motor Vehicle Safety Standards of your country. Make sure that any child-restraint system you use in your vehicle is labeled as complying with those safety standards.

The child-restraint system should be chosen to fit both the size of the child and the size of the vehicle seat. Be sure to follow any instructions provided by the child-restraint system manufacturer when installing the child-restraint system.

Restraint of Larger Children

As children grow, they may need to use new child-restraint systems, including larger child seats or booster seats, which are appropriate for their increased size.

A child who has outgrown available child-restraint systems should use the belts provided in the vehicle. When seated in the rear outboard seats, the child should be restrained by the lap/shoulder belt.

If the shoulder belt portion slightly touches the child's neck or face, try placing the child closer to the center of the vehicle. If the shoulder belt still touches their face or neck they may need to be returned to a child restraint system. In addition, after-market devices are available from independent manufacturers which help pull the shoulder belt down and away from the child's face or neck.

WARNING - Shoulder belts on Small Children

- Never allow a shoulder belt to be in contact with a child's neck or face while the vehicle is in motion.
- If safety belts are not properly worn and adjusted, there is a risk of death or serious injury to such a child.

WARNING - Child Restraints

- All child restraint systems are designed to be secured in vehicle seats by lap belts or the lap-belt portion of a lap/shoulder belt. Children could be injured or killed in a crash if their child restraint systems are not properly secured by the safety belts in the vehicle.
- According to accident statistics, children are safer when properly restrained in the rear seating positions rather than the front seating positions.
- Always ensure that a child seat is secured by a safety belt. If not secured, store it in the trunk so that it will not be thrown forward in the event of a sudden stop or accident.

Placement of a Child-Restraint System

We recommend that, whenever possible, you put the child-restraint system in the center position of the rear seat and secure it to the vehicle with the lap/shoulder belt.

If the center rear seat is not available, or you are using more than one child restraint system in the vehicle at the same time, rear outboard safety belts have been designed to allow a child-restraint system to be used in these positions.

▲ WARNING - Restraint Instructions

Failure to observe this manual's instructions regarding child seat and the instructions provided with the child seat could increase the chance and/or severity of injury in an accident.



Installing a child restraint in the rear center seat

To install a child restraint in the rear center seat, do the following:

1. Place the child-restraint in the desired position. Route the lap/shoulder belt through the restraint according to the seat manufacturer's instructions.
2. Insert the tongue plate into the buckle.
3. Adjust the lap/shoulder safety belt for a snug hold on the child restraint by pulling on the loose end of the belt.

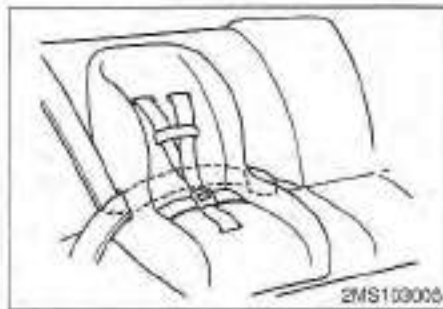

Installing a child-restraint system in rear outboard seats

▲ WARNING - Child Restraint Placement

NEVER use a child seat in the front passenger seat. A child in a child seat in the front passenger seat can be severely or fatally injured by a rapidly inflating airbag.

Placing a passenger safety belt into the "Auto Lock" mode (if equipped)

The use of the auto lock mode will ensure that the normal movement of the child in the vehicle does not cause the safety belt to be pulled out and loosen the firmness of its hold on the child restraint.

To secure a child restraint in the front passenger seat or rear outboard seats, follow the procedure below.

1. Place the child restraint system in the seat and route the lap/shoulder belt around or through the restraint, following the restraint manufacturer's instructions. Be sure the belt webbing is not twisted.



2. Insert the lap/shoulder belt latch into the buckle. Listen for the distinct "click" sound.

Position the release button so that it is easy to access in case of an emergency.

KNOWING YOUR VEHICLE



3. Grasp the shoulder portion of the belt and pull downward until the entire belt is extracted. When the belt is fully extracted, the retractor changes to the automatic locking mode (child restraint mode).
4. Slowly allow the belt to retract. Pull up on the shoulder webbing. A "clicking" or "ratcheting" sound will be heard as the belt retracts. This indicates the retractor is now in the automatic locking mode. Push down on the child restraint while you pull up on the belt in order to remove any slack in the belt.
5. Before placing the child in the child restraint, forcibly try to push the seat from side to side and forward to make sure that the seat is securely held in place.
6. Double check that the retractor is in the automatic locking mode by trying to pull the shoulder portion of the safety belt out of the retractor. If you cannot pull the belt out of the retractor, it is in the automatic locking mode. If you can, repeat step 4.

To remove the child restraint, press the release button on the buckle and then pull the lap/shoulder belt out of the restraint and allow the safety belt to retract fully.

⚠ WARNING - Auto Lock Mode
The lap/shoulder belt automatically returns to the "emergency lock mode" whenever the belt is allowed to retract fully. Therefore, the preceding six steps must be followed each time a child restraint is installed. If the safety belt is not placed in the "auto lock" mode, severe injury or death could occur to the child and/or other occupants in the vehicle in a collision, since the child seat will not be effectively held in place.

To return the safety belt retractor to the emergency lock mode, allow the seat belt to retract fully to its stowed position and the retractor will automatically switch back to the emergency lock mode for normal adult usage.

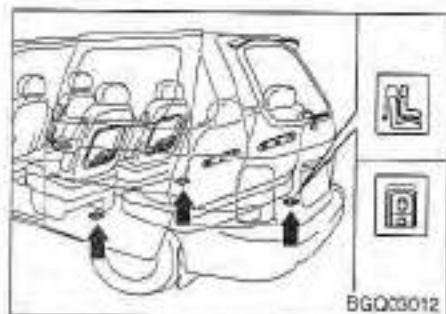

Child seat anchorage position

Your vehicle is equipped with an anchor for securing the tether strap of a child restraint system (child seat). The child restraint anchor fittings are installed on the package tray behind the rear seat.

⚠ WARNING - Child Seat
Anchor fitting

- Infants and small children should be restrained at all times in an approved child seat designed for use with your vehicle.
- Child seat anchorage is designed to withstand only those loads imposed by correctly fitted child seat. Under no circumstances are they to be used for adult seat belts or harnesses or for attaching other items or equipment to the vehicle.

- Check that the child seat is secured by pushing and pulling it in different directions. Incorrectly fitted child seat may swing, twist or tip thus increasing the risk of death or severe injury in an accident.

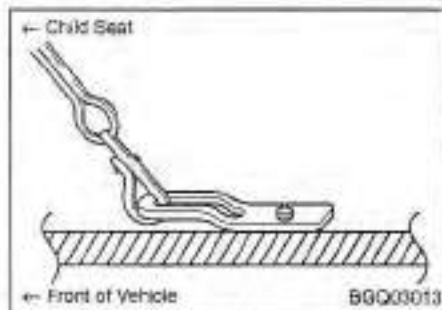

Placement of a child restraint system

To install the child seat on the rear seat, use the anchorage fitting located on the shelf behind the rear seat.



Child seat lower anchors

The lower anchors are located between rear seat and seatback.

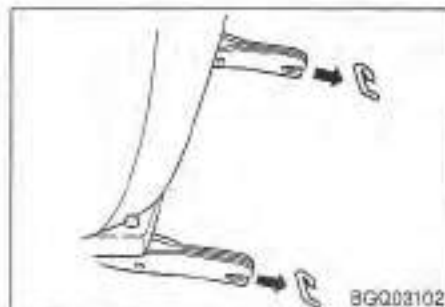

To attach the child seat to the lower anchor, insert the child seat latch into the lower anchor hold. Listen for the audible "Click" sound.



Safety Belt Warning Light and Chime

If the driver's lap/shoulder belt is not fastened when the key is turned ON, the safety belt warning chime sounds for approximately six seconds and the safety belt warning light flashes for approximately six seconds.



Lap/Shoulder Belt

To fasten the lap/shoulder belt :

1. Grasp the buckle and tongue plate.
2. Slowly pull the lap/shoulder belt out from the retractor.



3. Insert the tongue plate into the open end of the buckle until an audible "click" is heard, indicating the belt is locked in the buckle.



4. Position the lap portion of the belt across your lap as **LOW ON THE HIPS** as possible to reduce the risk of sliding under it during an accident. Adjust the belt to a **SNUG FIT** by pulling up on the shoulder portion of the safety belt. The belt retractor applies tension to the belt in order to take up excess webbing automatically and to maintain tension on the belt. For maximum safety, do not put any excess slack into the safety belt.

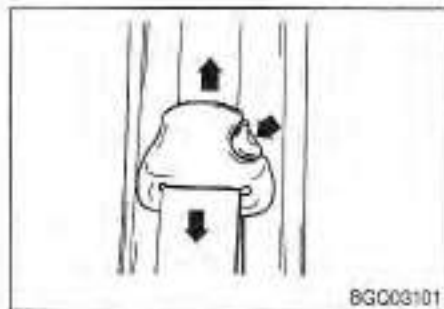

5. You can adjust the height of the shoulder anchor to one of the four positions. Adjust the shoulder anchor position to your size. To raise the anchor position, push the knob and push the anchor up. To lower the anchor position, push the knob and slide the anchor down. After adjustment, make sure the anchor is locked in position.

⚠ WARNING - Safety Belts

- The seatbacks should always remain in a comfortable, upright position while the vehicle is in motion. The safety belt system will provide the most protection with the seatbacks in an upright position.
 - Never wear the shoulder portion of the safety belt under the outside arm or behind the back.
 - Never wear the shoulder portion of the safety belt across the neck or face.
 - Wear the lap portion of the safety belt as low on the hips as possible. Be sure the lap belt fits snugly around the hips. Never wear the lap belt over your waist.
 - Never drive or ride with a twisted or jammed safety belt. If you cannot untwist or unjam the safety belt, see the nearest Kia dealer immediately.
- Never use a single belt to restrain more than one person at a time. Failure to follow these warnings will increase the risk and severity of injury in an accident.



To unfasten the lap/shoulder belt:

Press the release button on the buckle.

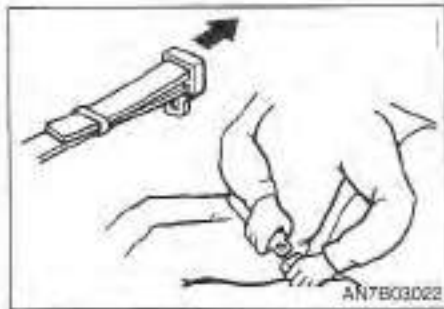

Lap Belt

To fasten the lap belt:

1. Grasp the buckle end and pull it low over the abdomen.
2. Insert the tongue plate into the open end of the buckle until an audible "click" is heard, indicating the latch is locked. Make sure the belt is not twisted.



3. Grasp the free portion of the belt webbing and pull until the belt is snug over the hips and lower abdomen. If it becomes necessary to lengthen or shorten the belt, hold the latch plate tongue at right angles to the webbing and pull.
4. Make sure that the belt is placed as **LOW ON THE HIPS** as possible.

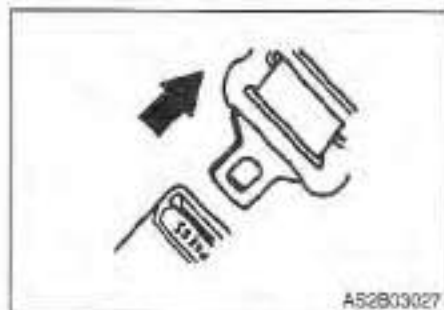

To unfasten the lap belt:

Press the release button on buckle.

⚠ WARNING - Lap Belt

Be sure the lap belt is positioned snugly around the hips, and not on the waist. Failure to position the lap belt snugly around the hips will increase the chance and severity of injury in the event of a collision.

Proper Use and Care of the Safety Belt System

To ensure that the safety belts provide the maximum protection, please follow these instructions:

- Use the belts at all times - even on short trips.
- If the safety belt is twisted, straighten it prior to use.
- Keep sharp edges and damaging objects away from the belts.
- Periodically inspect belt webbing, anchors, buckles and all other parts for signs of wear and damage.
- Replace damaged, excessively worn or questionable parts immediately.
- To clean the belt webbing, use any mild soap solution recommended for cleaning upholstery or carpets.
- Do not bleach or dye on the webbing. This may weaken the webbing and allow it to fail in a collision.
- Do not make modifications or additions to the safety belt.
- Do not allow the belt to get caught in the door when you close it.

AIRBAG - SUPPLEMENTAL RESTRAINT SYSTEM

What your airbag system does

Your vehicle is equipped with a dual Supplemental Restraint System (SRS), which includes an airbag for the driver and another airbag for the front passenger.

What your airbag system does not do

The airbag system is designed to supplement or add to the protection provided to properly belted occupants in moderate to severe frontal collisions. It is not a substitute for the driver's or front passenger's safety belt and it does not provide restraint to the lower body.

Why didn't my airbag go Off in a collision?

There are many types of accidents in which the airbag cannot provide additional protection. These include side or rear impacts, rollovers, and second or third impacts in multiple-impact accidents, as well as low speed impacts.

Remember, airbags are only designed to inflate when the impact would throw the occupant into the airbags - generally from a little to the left to a little to the right of straight ahead.

In other words, just because your vehicle is damaged and even if it is totally unusable, don't be surprised that the airbag(s) did not inflate.

The importance of using safety belts

There are four very important reasons to use safety belts even with an airbag supplemental restraint system. They:

- Help keep you in the proper position (away from the airbag) when it inflates.
- Reduce the risk of harm in rollover, side or rear impact collisions, because an airbag is not designed to inflate in such situations.
- Reduce the risk of harm in frontal collisions which are not severe enough to actuate the airbag supplemental restraint system.
- Reduce the risk of being thrown from your vehicle.

⚠ WARNING - Airbags & Safety Belts

- Even in vehicles with airbags, you and your passengers must always wear the safety belts provided in order to minimize the risk and severity of injury in the event of a collision or rollover.
- Your vehicle's airbags provide the most protection when the vehicle occupants are seated away from the airbags as the collision starts. Your safety belt can help keep your occupants away from the airbags during heavy braking just before a collision.
- Airbags are designed to inflate only in severe frontal collisions and will generally not provide protection in side or rear impacts, rollovers or less severe frontal collisions. They will not provide protection from later impacts in a multi-impact collision.
- If your vehicle has been subjected to flood conditions (e.g. soaked carpeting/standing water on the floor of the vehicle, etc.), do not attempt to start the vehicle or even put the key in the ignition. This may cause airbag deployment while you are too close to the airbag, which could result in serious personal injury or death. Have the vehicle towed to an authorized Kia dealer for inspection and necessary repairs.

Airbag System Components

The main components of your SRS are:

- One airbag in the steering wheel for the driver, and another in the dashboard for the front passenger.
- A diagnostic system that continually monitors the system operation.
- An indicator light to warn you of a possible problem with the system.
- Emergency power backup in case your car's electrical system is disconnected in a crash.

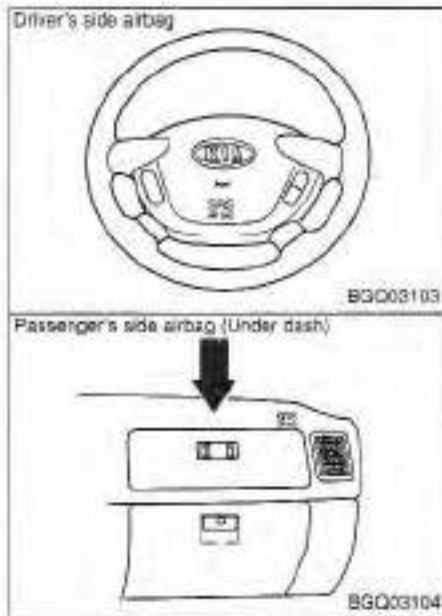

To indicate that your vehicle is equipped with airbags, the airbag covers on the steering wheel and on the dashboard are marked with "SRS airbag".

How the Airbags System Works

The driver's airbag is stored in the center of the steering wheel. The passenger's side airbag is stored in the front instrument panel above the glove box.

If you ever have a severe frontal collision, your airbags will instantly inflate to help protect you from serious physical injury.

There is no single vehicle speed at which the airbags will inflate. Generally, airbags are designed to inflate in severe frontal collisions. The airbag Supplemental Restraint System (SRS) reacts to the severity of a collision and its direction. These two factors determine whether the sensors send out an electronic deployment or inflation signal.

Whether the airbags will inflate depends on a number of factors including, but not limited to, vehicle speed, angle of impact and the density and stiffness of the vehicles or objects and the objects being impacted.

The airbags will completely inflate and deflate in less than 1/10 of one second. The speed of inflation and deflation protects the driver's ability to operate the vehicle. This is important in crashes where a vehicle continues to move after an impact and the driver still has some control of the vehicle's steering, braking, throttle and/or transmission systems.

It is virtually impossible for you to see the airbags inflate during an accident. It is much more likely that you will simply see the deflated airbags hanging out of their storage compartments after the collision.

In order to help provide protection in a severe collision, the airbags must inflate rapidly. However, that speed also causes the airbags to expand with a great deal of force. The speed of this inflation has been determined by the Canadian Motor Vehicle Safety Standards (CMVSS) to reduce the likelihood of serious or life-threatening injuries and is thus a mandatory part of airbag design.

However, airbag inflation can also cause injuries which normally can include facial abrasions, bruises and broken bones.



However, there are even circumstances under which contact with the steering wheel airbag can cause fatal injuries, especially if the occupant is positioned excessively close to the steering wheel.

YOU MUST ALWAYS SIT AS FAR BACK FROM THE STEERING WHEEL AIRBAG AS POSSIBLE, WHILE STILL MAINTAINING A COMFORTABLE SEATING POSITION FOR GOOD VEHICLE CONTROL, IN ORDER TO REDUCE THE RISK OF INJURY OR DEATH IN A COLLISION WHEN THE AIRBAG DEPLOYS.

⚠ WARNING - Airbag Injuries

- Sit as far back from the steering wheel as possible without interfering with your control of the vehicle. Positioning yourself too close to the steering wheel can result in serious or even fatal injuries if the airbag deploys.
- Never place objects over the airbag storage compartments or between the airbags and yourself. Due to the speed and force of the airbag inflation, such objects could hit your body at high speed and cause severe bodily injury and even death.
- Do not put stickers or ornaments etc. on the steering wheel cover. These may interfere with the airbag's deployment.

Noise and Smoke

When the airbags inflate, they make a loud noise and they leave powder which may appear to be smoke in the air inside of the vehicle. This is normal and is a result of the ignition of the airbag inflator.

After the airbags inflate, you may feel substantial discomfort in breathing due both to the contact by your chest with both the safety belt and the airbag, as well as from breathing the smoke and powder.

WE STRONGLY URGE YOU TO OPEN YOUR DOORS AND/OR WINDOWS AS PROMPTLY AS POSSIBLE AFTER IMPACT IN ORDER TO REDUCE DISCOMFORT AND PREVENT PROLONGED EXPOSURE TO THE SMOKE AND POWDER.

⚠ WARNING - Hot Metal Parts

When the airbags deploy, the airbag inflators in the steering wheel and/or in the dashboard are very hot. To prevent injury, do not touch the airbag storage area's internal components immediately after an airbag has inflated.

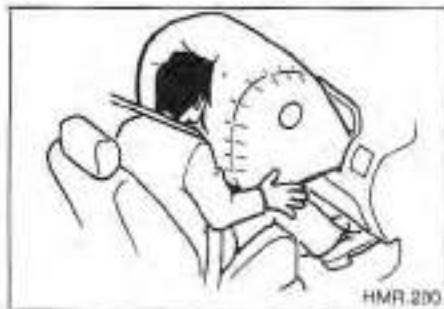

The Importance of The Passenger Being Properly Seated

⚠ WARNING - Passenger

The front seat passenger's airbag is much larger than the driver's airbag and inflates with considerably more force. It can seriously hurt or kill a passenger who is not in the proper position and wearing the safety belt properly.

The front passenger should always move their seat as far back as practical and sit well back in the seat. It is essential that the front passenger always wear their safety belt, even when driving in a parking lot or up a driveway into a garage.

The reason for this is that in most frontal impacts there is substantial pre-impact braking which tends to throw the occupants forward. If the right front passenger is not using their safety belt, they will be directly in front of or even touching the airbag storage compartment when inflation occurs. In that situation, death or severe injury is possible.

⚠ WARNING - Pre-Impact Braking

Pre-impact braking could throw an unbelted passenger toward or onto the airbag storage compartment. Upon impact in a collision, the airbag would rapidly inflate and possibly severely injure or kill that occupant who failed to wear their safety belt.



Airbag Warning Light

The purpose of the airbag warning light in your instrument panel is to alert you of a potential problem with your Airbag - Supplemental Restraint System (SRS).

Have the system checked if:

- The light does not illuminate briefly when you turn the ignition ON.
- The light stays ON after the engine starts.
- The light comes ON or flashes while you are driving.

Supplemental Restraint System Service

Your Supplemental Restraint System is virtually maintenance-free. There are no parts which you can service.

You must have the system serviced under the following circumstances:

- If an airbag ever inflates, the airbag must be replaced. Do not try to remove or discard the airbag by yourself. This must be done by an authorized Kia dealer.
- If the airbag warning indicator light alerts you of a problem, have the airbag system checked as soon as possible. Otherwise, your airbag might not inflate when you need it.

▲ WARNING - SRS

Modifications

- Do not modify your steering wheel or any other part of the airbag system. Modification could make the system ineffective.
- Do not work on the system's components or wiring. This could cause the airbags to inflate inadvertently, possibly seriously injuring someone. Working on the system could also disable the system so that the airbags do not deploy in a collision.



**Airbag warning label
(sunvisor - front side)**

To remind you of the dangers of the airbag, airbag warning labels which are now required by the Canadian Motor Vehicle Safety Standards (CMVSS) are adhered to the driver's and passenger's sunvisors and attached to the glove box.

Note that these government warnings focus on the risk to children, Kia also wants you to be aware of the risks which adults are exposed to. Those have been described in previous pages.

REAR HATCH

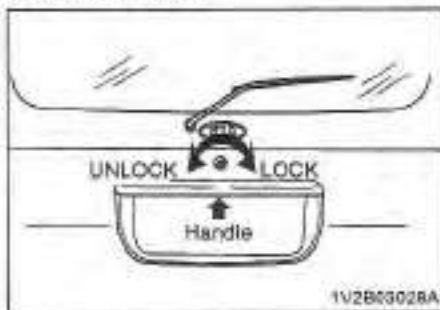

Opening the Rear Hatch

To open the rear hatch from the outside:

1. Insert the door key into the lock and turn it counterclockwise. You can also unlock the latch (but not release it) with the power door lock system.
2. Reach under the license plate light shield and pull the rear hatch handle to release the latch.

3. Pull the rear hatch back and up to open.

Make certain that you close the rear hatch door before driving your vehicle. Possible damage may occur to the rear hatch lift cylinders and attaching hardware if the rear hatch door is not closed prior to driving.

CAUTION

The rear hatch swings upward. Make sure no objects or people are near the rear of the vehicle when opening the hatch.

WARNING - Rear Hatch

- Check to be sure the rear hatch is completely closed before driving. If the rear hatch is open, exhaust gases can enter the vehicle.
- Occupants should never ride in the rear cargo area where no restraints are available. To avoid injury in the event of an accident or sudden stops, occupants should always be properly restrained.

KNOWING YOUR VEHICLE

HOOD

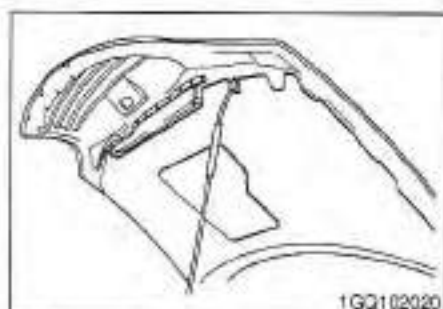
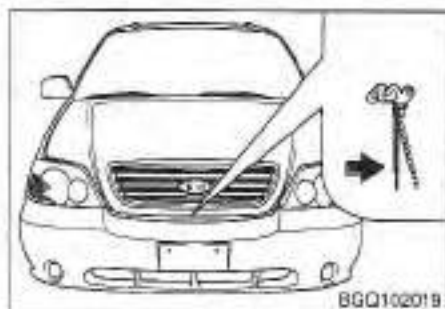

Opening the Hood:

1. Pull the release lever on the lower left side of the instrument panel to unlatch the hood.
2. Go to the front of the vehicle, raise the hood until the secondary latch catches then pull the secondary latch up (located under the hood at the center of the grille).
3. Hold the hood open with the support rod by inserting the free end of the rod into the slot located below the arrow stamped into the hood.

CAUTION

Always grasp the support rod in the area wrapped in rubber. The rubber will help prevent you from being burned by hot metal when the engine is hot.

Closing the Hood:

- Check the area under the hood to make certain all filler caps are in place and that all loose items have been removed.
- Secure the support rod in its clip.
- Lower the hood to about 12 inches (30 cm) height and then let it drop to properly lock in place.
- Check to make sure the hood is closed.

CAUTION

Before closing the hood, make sure that all parts and tools have been removed from the engine area and that everyone is clear of the hood opening.

FUEL FILLER LID

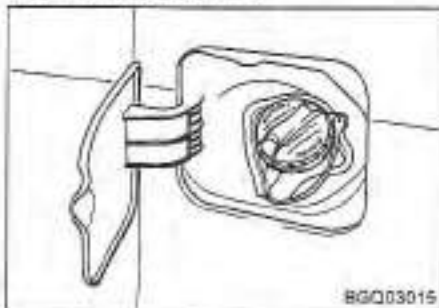

1. Pull the fuel filler lid out to open.
2. To remove the cap, turn it counterclockwise.
3. Refuel the fuel.
4. To install the cap, place it on the fuel filler neck and turn it clockwise until it "CLICKS". This indicates that the cap is securely tightened.

⚠ WARNING - Refueling

- Fuel may be under pressure. Always remove the fuel cap carefully and slowly. If the cap is venting fuel or if a hissing sound is heard, wait until the condition stops before completely removing the cap. If these precautions are not followed, fuel may spray out and cause serious personal injury.
- Fuel vapor is extremely hazardous and can burn rapidly. When refueling, always stop the engine and never allow sparks or open flames near the filler neck. Do not use smoking materials while refueling.

*** NOTICE**

- If the fuel filler cap requires replacement, use only a genuine Kia cap. An incorrect fuel filler cap can result in a serious malfunction of the fuel system or emission control system. Correct replacement caps are available at authorized Kia dealers.

- A loose fuel filler cap may cause the "Check Engine" light in the instrument panel to illuminate unnecessarily.
- Do not spill fuel on the exterior surfaces of the vehicle. Fuel spilled on painted surfaces may damage the paint.

If the fuel filler lid will not open in cold weather because the area around it is frozen, push or lightly tap the lid.

The fuel filler neck is designed to prevent filling the fuel tank with anything but unleaded fuel.

The driver's side sliding door cannot be opened when the fuel filler lid is open. However, if the driver's side sliding door is already open, it can be slid rearward even if the fuel filler door is opened. In this case, close the driver's side sliding door to prevent possible damage to the sliding door or the fuel filler door.

STEERING WHEEL

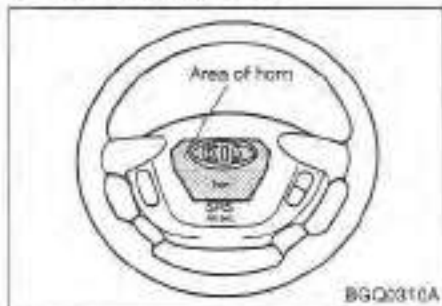

Horn

To sound the horn, press the horn symbol on your steering wheel.

Check the horn regularly to be sure it operates properly.

CAUTION

- *To sound the horn, press the area indicated by the horn symbol on your steering wheel (see illustration). The horn will operate only when this area is pressed.*
- *Do not strike the horn severely to operate it, or hit it with your fist. Do not press on the horn with a sharp-pointed object.*

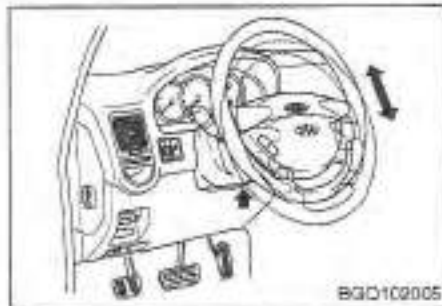

Tilt Steering (If Equipped)

A tilt steering wheel allows you to adjust the steering wheel before you drive the vehicle. You can also raise it to the highest level to give your legs more room when you exit the vehicle.

The steering wheel should be positioned so that it feels comfortable to you for driving, while permitting you to see the instrument panel warning lights and gauges.

1. To tilt the wheel, push up on the lock release lever located on the lower center of the steering column.

2. Move the steering wheel to a comfortable position and release the lever.

WARNING - Tilt Steering

- Never adjust the position of the steering wheel while the vehicle is in motion, or you may lose control of the vehicle.
- After adjusting, push the steering wheel both up and down to be certain it is locked in position.

MIRRORS

Outside Rearview Mirror

Be sure to adjust mirror angles before driving.

CAUTION

- *The right outside rearview mirror is convex. Objects seen in the mirror are closer than they appear.*
- *Use your interior rearview mirror or direct observation to determine the actual distance of following vehicles when changing lanes.*

* NOTICE

Do not scrape ice off the mirror face; this may damage the surface of the glass. If ice should restrict movement of the mirror, do not force the mirror for adjustment. To remove ice, use a de-icer spray, or a sponge or soft cloth with very warm water.

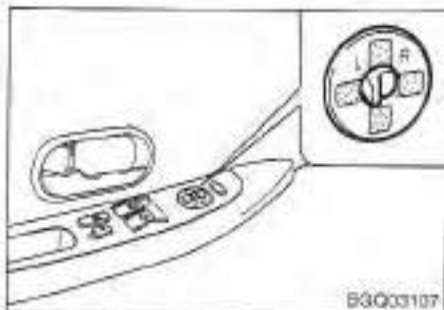

Electric Remote Control (if equipped)

The electric remote control mirror switch, located on the driver's door, allows you to adjust the position of the left and right outside rearview mirrors. To adjust the position of either mirror, move the lever to R or L to select the right side mirror or the left side mirror, then press an arrow on the mirror adjustment control to position the selected mirror up, down, left or right.

* NOTICE

The mirrors stop moving when they reach the maximum adjusting angles, but the motor continues to operate while the switch is depressed. Do not depress the switch longer than necessary, the motor may be damaged.

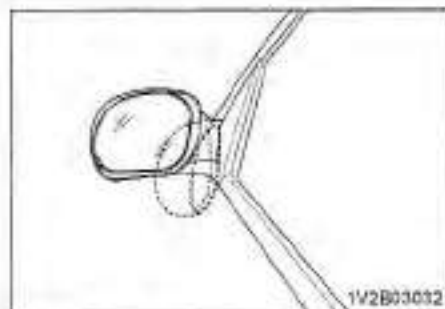

Folding the Outside Rearview mirror

To fold the outside rearview mirror, grasp the mirror housing and fold it towards the door window as shown in the illustration.

Outside Rearview Mirror Heater (If equipped)

The outside door mirror heater is actuated in with the rear window defroster. To heat the outside door mirror glass, push the switch for the rear window defroster.

The outside door mirror glass will be heated for defrosting or defogging and will give you improved rear vision in inclement weather conditions. Push the switch again to turn the heater off. The outside door mirror heater automatically turns itself off after 15 minutes.

CAUTION

Do not allow objects in the rear seat or cargo area to interfere with your vision out the rear window.

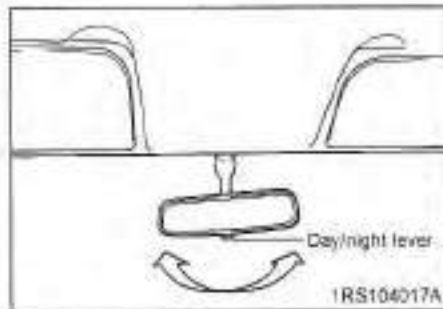

Day/Night Rearview Mirror

Adjust the rearview mirror to center on the view through the rear window. Make this adjustment before you start driving and while the day/night lever is in the day position.

Pull the day/night lever toward you to reduce glare from the headlights of vehicles behind you during night driving.

Remember that you lose some rearview clarity in the night position.

INTERIOR LIGHTS

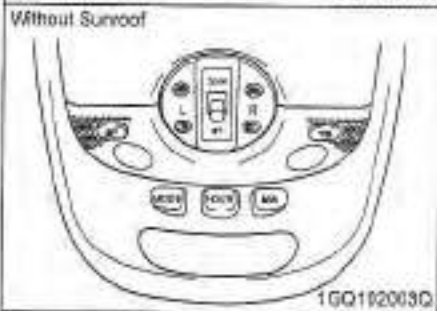
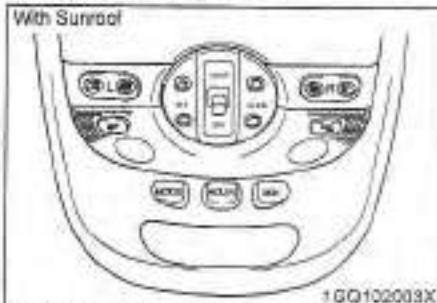

Dome Light - Front

The front dome light switch has three positions.

OFF - The light stays OFF even when a door is opened.

DOOR - The light turns ON or OFF when a door is opened or closed.

- The lights are switched ON or OFF by pressing the corresponding switches.



Dome Light - Rear

The rear dome lights are switched ON or OFF by pressing the switch located on the center console.

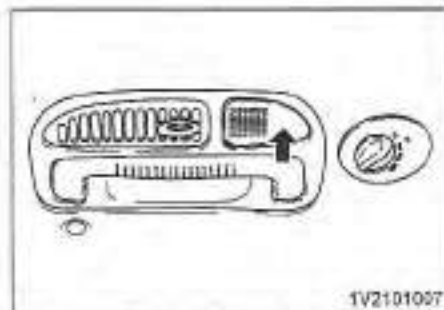

The rear dome lights are switched ON or OFF by pressing the corresponding lens.

* NOTICE

The rear dome lights are switched on when the rear dome light control switch is ON.

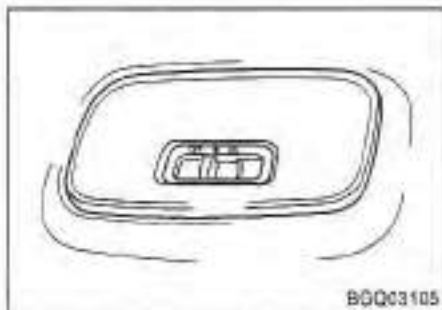

Rear Cargo Area Light

The cargo area light is located on the inside of rear hatch. The switch has three positions:

OFF - The light stays off even when a door is open.

- - The light turns on or off when a door is opened or closed.

ON - The light turns on and stays on even when the doors are all closed.

CUP HOLDER

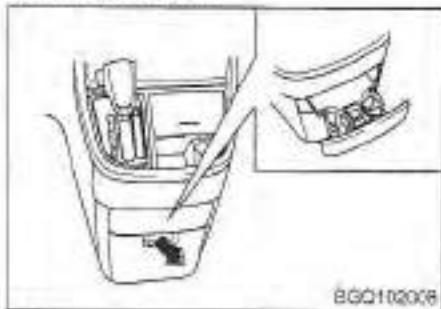

Front Cup Holder

To use the cup holder, pull out the front face all the way until the cup supports are fully extended.

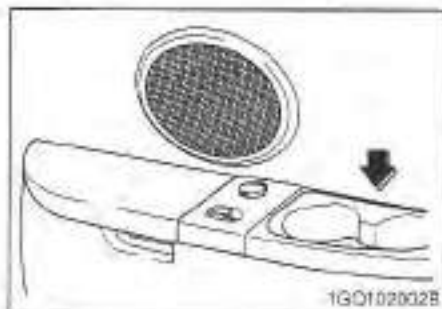

Rear Cup Holder - Third row seats

⚠ WARNING - Hot Liquids

- Do not place uncovered cups of hot liquid in the cup holder while the vehicle is in motion. If the hot liquid spills, you could be burned. Such a burn to the driver could cause a loss of control of the vehicle.
- To reduce the risk of personal injury in the event of a sudden stop or collision, do not place bottles, glasses, cans, etc in the cup holders.

CONSOLE STORAGE COMPARTMENT



1GQ102006A



1V2105041A

Front Seat Storage Bin (if equipped)

The storage bin is located under the front passenger's seat and can be locked with a key. Make sure the storage bin is securely locked when leaving the vehicle unattended.

*** NOTICE**

Do not leave valuables in the storage to avoid theft.

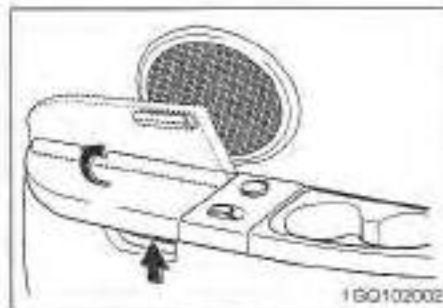

1GQ102002

Rear Console Storage

To access the rear console storage compartment, pull the latch, and lift the cover.

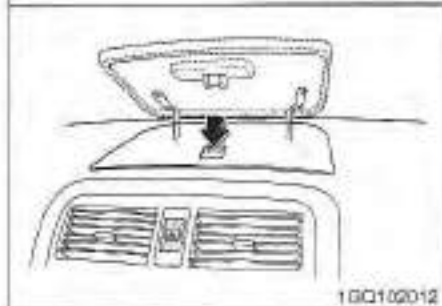

1GQ102012

Storage

To access a storage compartment, open by releasing the latch.

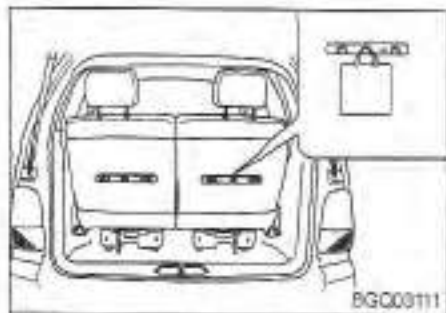

Plastic Grocery Bag Retainer (If equipped)

The plastic grocery bag retainer hooks are designed to hold grocery bag handles while the floor supports the partial weight of the bagged goods.

* NOTICE

Do not hang fragile or heavy items on the hooks.

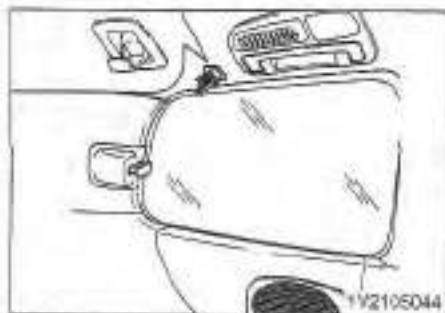

Clothes Hanger (If equipped)

The clothes hanger is designed with a hook. Press the hanger cover to extend the clothes hook.

* NOTICE

Do not hang heavy clothes, since those may damage the hook.

SUNROOF (IF EQUIPPED)

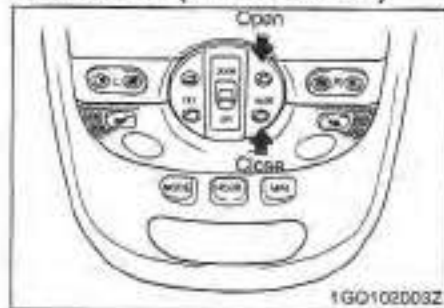

If your vehicle is equipped with this feature, you can slide or tilt your sunroof with the sunroof switches located on the overhead console.

Sliding the sunroof

The sunroof can be opened or closed when the ignition switch is in the "ON" position. To slide the sunroof, press "Open" on the SLIDE switch once. The sunroof will slide all the way open. To stop the sunroof sliding at any point, press "Open" on the switch again. To close the sunroof, press "Close" on the SLIDE switch and hold it until it is closed completely.

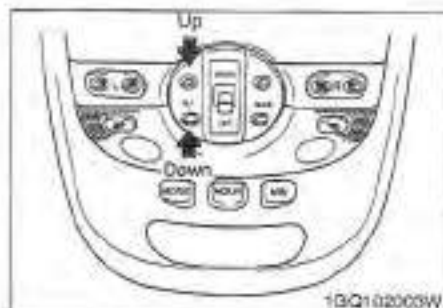

Tilting the sunroof

To tilt the sunroof, press "Up" on the TILT switch. To close it, press "Down" on the TILT switch.

*** NOTICE**

The sunroof cannot slide when it is in the tilt position nor can it be tilted while in an open or slide position.

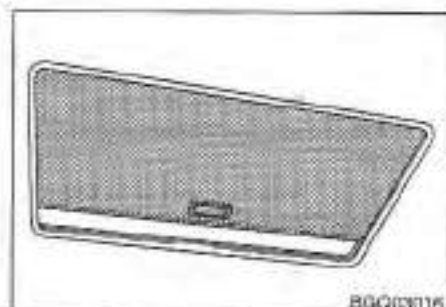

Sunshade

The sunshade will open automatically when the glass panel is slid open. However, the sunshade must be closed manually when you want it closed.

* NOTICE

- The sunroof is made to slide together with sunshade. Do not leave the sunshade closed while the sunroof is open.
- Do not depress the sunroof switch for prolonged periods or damage to the sunroof motor could result.
- Make sure the sunroof is closed fully when you leave your vehicle unattended.
- Remove any dirt that may be accumulated on the guide rail periodically.

CAUTION

If you try to open the sunroof when the temperature is below freezing or when the sunroof is covered with snow or ice the glass pane or the sunroof motor could become damaged.

In case of an emergency

If the sunroof does not open electrically:

1. Remove the overhead console.
2. Insert the emergency handle (provided with the vehicle) and turn the handle clockwise to open or counterclockwise to close.

WARNING

Do not stick your head or arms out of the slid sunroof when the vehicle is moving.

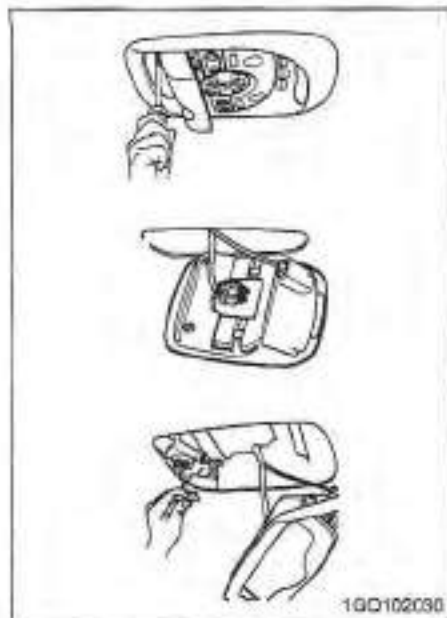

**SUNGLASS HOLDER
(IF EQUIPPED)**

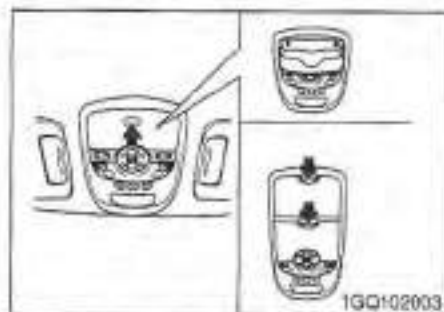

At the overhead console a compartment is provided for the storage of a sunglasses. To open the sunglasses holder, press the cover and the holder will slowly open. Place your sunglasses in the compartment door with the lenses facing out.

*** NOTICE**

Please close the sunglasses holder while driving.

Ignition Switch	4-2
Starting	4-4
Automatic Transaxle	4-6
Brake System	4-12
Power Steering	4-17
Cruise Control	4-18
Instrument Cluster	4-21
Gauges	4-22
Warnings and Indicators	4-24
Lighting	4-30
Wipers and Washers	4-34
Defroster	4-37
Interior Features	4-38
Trip Computer	4-42
Climate Control System	4-44
Windshield Defrosting and Defogging	4-50

IGNITION SWITCH

Illuminated Ignition Switch

Whenever a door is opened, the ignition switch will be illuminated for your convenience. The light will go off approximately 30 seconds after closing the door or when the ignition key is inserted into the ignition key cylinder.

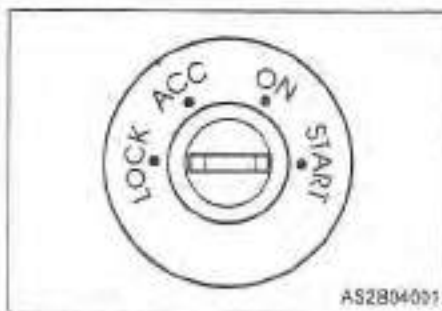

Ignition Switch and Anti-Theft Steering Column Lock

Ignition switch positions

LOCK

The steering wheel is locked to protect against theft. The ignition key can be removed only in the LOCK position.

When turning the ignition switch to the LOCK position, push the key inward at the ACC position and turn the key toward the LOCK position.

ACC (Accessory)

The steering wheel is unlocked and some electrical accessories (such as the radio) are operative when the engine is off.

ON

Turning the ignition switch to this position allows you to test your vehicle's warning lights to make sure they work before you start the engine. The ignition key returns to the ON position once the engine is started and remains in this position while the engine is running.

Do not leave the ignition switch in the ON position for extended periods with the engine OFF because the battery will discharge.

START

Turn the ignition key to the START position to start the engine. The engine will crank until you release the key, then it returns to the ON position. Also, the brake warning indicator illuminates to check the bulb in this position.

Difficulty in turning the ignition key to the START position can be caused by pressure on the switch from the steering column. To allow the ignition key to turn, move the steering wheel right or left to release the tension and then turn the key.

WARNING - Ignition Key

- Never turn the ignition switch to LOCK or ACC while the vehicle is moving. This would result in loss of directional control and braking function, which could cause an immediate accident.
- The anti-theft steering column lock is not a substitute for the parking brake. Before leaving the driver's seat, always make sure the shift lever is in P (Park), set the parking brake fully AND shut the engine off.
- Never reach for the ignition switch, or any other controls through the steering wheel while the vehicle is in motion. Failure to observe this warning can result in loss of vehicle steering control, which may result in an accident.

STARTING THE ENGINE

1. Make sure the parking brake is applied.
2. Place the transaxle shift lever in P (Park). Depress the brake pedal fully. *You can also start the engine when the shift lever is in the N (Neutral) position.*
3. Turn the Ignition switch to START and hold it there until the engine starts (a maximum of 10 seconds), then release the key.
4. In extremely cold weather - below 0°F (-18°C) - or after the vehicle has not been operated for several days, let the engine warm up without depressing the accelerator.

Whether the engine is cold or warm, it should be started without depressing the accelerator.

CAUTION

If the engine stalls while you are in motion, do not attempt to move the shift lever to the P (Park) position. If traffic and road conditions permit, you may put the shift lever in the N (Neutral) position while the vehicle is still moving and turn the ignition switch to the START position in an attempt to restart the engine.

If the engine fails to start when the engine is cold:

1. Make sure the parking brake is applied.

2. Place the transaxle shift lever in P (Park) or N (Neutral). Depress the brake pedal fully.
3. Depress the accelerator fully and hold it.
4. While holding the accelerator fully depressed, turn the ignition switch to the START position and hold it (a maximum of 10 seconds) to discharge the excess fuel. If the engine starts, the engine speed will increase suddenly; immediately release the ignition key and the accelerator.
5. If the engine has not started yet release the accelerator and crank the engine until it starts (a maximum of 10 seconds).

If the engine fails to start when the engine is warm:

A no-start condition, characterized by failure to restart a warmed engine despite repeated attempts may be eliminated by using the following procedure.

1. Make sure the parking brake is applied.
2. Place the transaxle shift lever in P (Park) or N (Neutral). Depress the brake pedal fully.
3. While depressing the accelerator about halfway, turn the ignition switch to the START position and hold it (a maximum of 10 seconds).
4. After the engine starts, let it idle for about 10 seconds before driving.

* NOTICE

Do not engage the starter for more than 10 seconds. If the engine stalls or fails to start, wait 5 to 10 seconds before re-engaging the starter. Improper use of the starter may damage it.

The starter will not operate if the shift lever is NOT in the P (Park) or N (Neutral) position.

Excessive engine noise may occur if the engine has not been operated for an extended period. The noise should stop after the engine has reached normal operating temperature. If the noise does not stop, have the vehicle inspected by an authorized Kia dealer.

AUTOMATIC TRANSAXLE

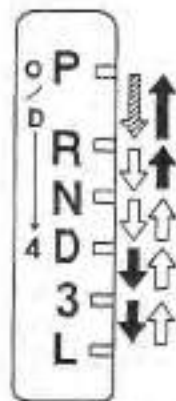

Normal transmission gear ranges are provided on the right side of the indicator.



To move the shift lever from the P position, the ignition switch must be in the ON position, the brake pedal must be depressed and the lock release button must be depressed.



The lock release button must be depressed while moving the shift lever.



The shift lever can be moved without depressing the lock release button.

Lock release button
Prevents shift lever movement without first depressing the button.

OVD System
Pressing the button de-activates the OVD mode. Pressing again re-activates the OVD mode.

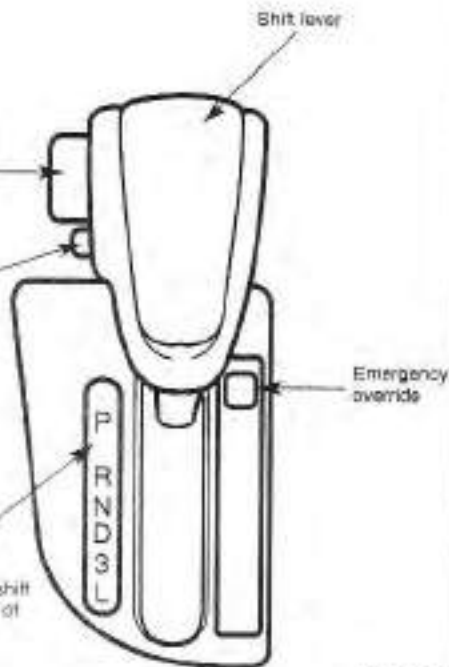

BGC04200

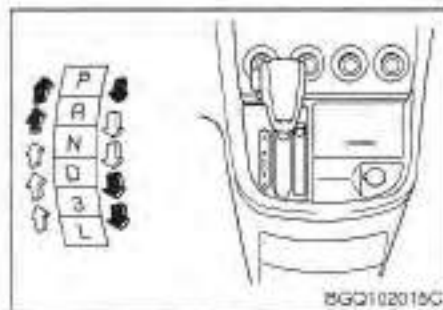

Automatic Transaxle Operation

All normal forward driving is done with the shift lever in the D (Drive) position.

To move the shift lever from the P (Park) position, the ignition switch must be in the ON position, the brake pedal must be depressed, and the lock release button must be depressed.

For smooth operation, depress the brake pedal when shifting from N (Neutral) to a forward or Reverse gear.

⚠ WARNING - Automatic Transaxle

Before leaving the driver's seat, always make sure the shift lever is in the P (Park) position; then set the parking brake fully and shut the engine off.

*** NOTICE**

- Do not accelerate the engine in R (Reverse) or any forward gear position with the brakes on.
- When stopped on an upgrade, do not hold the vehicle stationary with engine power. Use the service brake or the parking brake.
- Do not shift into any gear when the engine is above idle speed.



Transaxle Ranges

O/D (OverDrive) System

Pressing the O/D system button cancels and engages the overdrive system. When the O/D system is cancelled (button is pressed), the O/D OFF indicator illuminates and the transaxle gear range is limited to 1st through 4th. The transaxle will not shift to 5th gear until the O/D system button is pressed again to release the switch.

When driving down a sloping road with the transaxle in O/D (5th), you can decrease the vehicle speed without using the brakes by pressing the O/D OFF button.

When the ignition is switched OFF, O/D OFF mode is automatically cancelled.

O/D OFF indicator

This indicator light illuminates in the instrument panel when the O/D mode is cancelled.

* NOTICE

If the O/D OFF indicator flashes, it indicates an electrical problem with the transaxle. Should this occur, have the vehicle checked by an Authorized Kia Dealer as soon as possible.

P (Park)

This position locks the transaxle and prevents the front wheels from rotating. Always come to a complete stop before shifting into this position.

WARNING

- Shifting into P (Park) while the vehicle is in motion will cause the drive wheels to lock and you will lose control of the vehicle.
- Always make sure the shift lever is latched in the P (Park) position so that it cannot be moved unless the lock release button is depressed
- Never leave a child unattended in a vehicle.

CAUTION

The transaxle may be damaged if you shift into P (Park) while the vehicle is in motion.

R (Reverse)

Use this position for backing-up the vehicle.

CAUTION

Always come to a complete stop before shifting into or out of R (Reverse); you may damage the transaxle if you shift into R while the vehicle is in motion, except as explained in "Rocking the Vehicle".

N (Neutral)

The wheels and transaxle are not locked. The vehicle will roll freely even on the slightest incline unless the parking brake or service brakes are applied.

D (Drive)

This is the normal forward driving position. The transaxle will automatically shift through a five-gear sequence, providing the best economy and power.

For faster warm-up, the transaxle will stay in 2nd gear until the automatic transaxle fluid temperature reaches approximately -29°C (-20.2°F).

3 (Third Gear)

Use 3 (Third Gear) for more power climbing hills and for increased braking when going down hills. This position also helps reduce wheel spin on slippery surfaces. When the shift lever is placed in 3 (Third Gear), the transaxle will automatically shift from first to third gear.

L (Low)

Move the shift lever to this position in hard pulling situations and for climbing steep grades.

Moving up a steep grade from a standing start

To move up a steep grade from a standing start, press the brake pedal, shift the shift lever to D (Drive), 3 (Third) or L (Low) depending on load weight and steepness of the grade, and release the parking brake. Press the accelerator gradually while releasing the service brakes.

Shift Lock System

For your safety, the Automatic Transaxle has a shift lock system which prevents shifting the transaxle out of P (Park) unless the brake pedal is depressed.

To shift the transaxle out of P (Park):

1. Depress and hold the brake pedal.
2. Start the engine or turn the ignition key to the ON position.
3. Depress the lock release button on the shift lever and move the shift lever.

When the ignition switch is in the ACC or LOCK position, the transaxle cannot be shifted from P (Park).

If the brake pedal is repeatedly depressed and released with the shift lever in the P (Park) position, a clicking noise near the shift lever may be heard.

This is a normal condition.

Also, the ignition key cannot be removed unless the shift lever is in the P (Park) position. If the ignition switch is in any other position, the key cannot be removed.



Shift lock override

If the shift lever should fail to move from the P (Park) position with the brake pedal depressed, continue depressing the brake, then do the following:

1. Carefully remove the cap covering the emergency override access hole which is located on the right side of the shift lever.



2. Insert a screwdriver (cross or flat blade) into the access hole, then depress the screwdriver.



3. Press the brake pedal.
4. Depress the lock release button and move the shift lever.
5. Have your vehicle inspected by an Authorized Kia Dealership immediately.

BRAKE SYSTEM

Power Brakes

Your vehicle has power-assisted brakes that adjust automatically through normal usage.

In the event that the power-assisted brakes lose power because of a stalled engine or some other reason, you can still stop your vehicle by applying greater force to the brake pedal than you normally would. The stopping distance, however, will be longer.

When the engine is not running, the reserve brake power is partially depleted each time the brake pedal is applied. Do not pump the brake pedal when the power assist has been interrupted. Pump the brake pedal only when necessary to maintain steering control on slippery surfaces.

In the Event of Brake Failure

If the service brakes should fail to operate while the vehicle is in motion, you can make an emergency stop with the parking brake. The stopping distance, however, will be much greater than normal.

WARNING - Parking Brake

Pulling on the parking brake while the vehicle is moving at normal speeds can cause a sudden loss of control of the vehicle. If you must use the parking brake to stop the vehicle, use great caution in applying the brake.

WARNING - Brakes

Do not drive with your foot resting on the brake pedal. This will create abnormally high brake temperatures, excessive brake lining and pad wear, and increased stopping distances.

- When descending a long or steep hill, shift to a lower gear and avoid continuous application of the brakes. Continuous brake application will cause the brakes to overheat and could result in a temporary loss of braking performance.
- Wet brakes may result in the vehicle not slowing down at the usual rate and pulling to one side when the brakes are applied. Applying the brakes lightly will indicate whether they have been affected in this way. Always test your brakes in this fashion after driving through deep water. To dry the brakes, apply them lightly while maintaining a safe forward speed until brake performance returns to normal.

Disc Brake Wear Indicators

Your vehicle has front disc brakes.

When your front brake pads are worn and it's time for new pads, you will hear a high-pitched warning sound from your front brakes. You may hear this sound come and go or it may occur whenever you depress the brake pedal.

▲ WARNING - Brake Wear

This brake wear warning sound means your vehicle needs service. If you ignore this audible warning, you will eventually lose braking performance, which could lead to a serious accident.

*** NOTICE**

To avoid costly brake repairs, do not continue to drive with worn brake pads.

Please remember that some driving conditions or climates may cause a brake squeal when you first apply (or lightly apply) the brakes. This is normal and does not indicate a problem with your brakes.

Rear Drum Brakes

Your rear drum brakes do not have wear indicators. Therefore, have the rear brake linings inspected if you hear a rear brake rubbing noise. Also have your rear brakes inspected each time you change or rotate your tires and when you have the front brakes replaced.

⚡ CAUTION

Always replace brake pads or linings as complete front or rear axle sets.

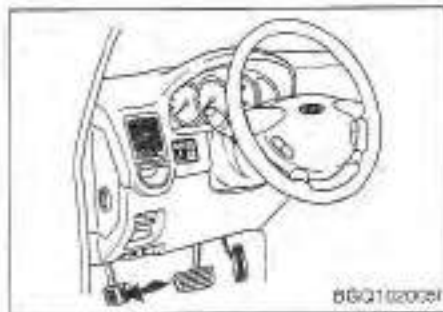

Parking Brake

- To set the parking brake, depress the parking brake pedal fully and firmly downward while applying the service brake.



- To release the parking brake, pull the handle forward you while applying the service brake.

CAUTION

When stopped, do not use the gearshift lever in place of the parking brake. Always set the parking brake fully AND make sure the gearshift lever is securely positioned in P (Park).



Check the brake warning light by turning the ignition switch ON (do not start the engine). This light will be illuminated when the parking brake is set with the ignition switch in the START or ON position.

Before driving, be sure the parking brake is fully released and the brake warning light is off.

If the brake warning light remains on after the parking brake is released, there may be a malfunction in the brake system. Immediate attention is necessary.

If at all possible, cease driving the vehicle immediately. If that is not possible, use extreme caution while operating the vehicle and only continue to drive the vehicle until you can reach a safe location or repair shop.

Parking on Curbed Streets

- When parking your vehicle on an uphill grade, park as close to the curb as possible and turn the front wheels away from the curb so that the front wheels will contact the curb if the vehicle moves backward.
- When parking your vehicle on a downhill grade, park as close to the curb as possible and turn the front wheels toward the curb so that the front wheels will contact the curb if the vehicle moves forward.

Anti-Lock Brake System (ABS) (if equipped)

Anti Lock Brakes (ABS) (if equipped)

The anti-lock brake system is designed to prevent lock-up of the wheels during sudden braking or braking on slippery surfaces. Compared to a conventional brake system, the anti-lock brake system provides greater steering control during braking in such situations.

WARNING - ABS Brakes

For safety driving, don't depend too much on your ABS system.

Use common sense.

- The anti-lock brake system (ABS) cannot compensate for bad road conditions, for unsafe or reckless driving or for bad judgement.
- The ABS is designed to improve maximum braking effectiveness on typical highways and roads in good condition. On road surfaces which are in poor condition, the ABS may actually reduce braking effectiveness.

- Always operate your vehicle at reasonable speeds that are safe for weather and traffic conditions.

During normal driving conditions, the anti-lock brake system operates the same as a conventional brake system. When the anti-lock brake system is engaged due to imminent loss of traction, a pulsation of the brake pedal will result and you may hear or feel "chattering." This is a normal condition and indicates the system is functioning properly.

When driving a vehicle equipped with anti-lock brakes, adjust your driving according to the road and traffic conditions and keep the following in mind:

- Do not pump the brakes as you would when driving a vehicle not equipped with an anti-lock brake system (ABS). In order for the ABS to function normally, press the brake pedal firmly, without pumping the pedal.

- Even with the anti-lock brake system, your vehicle still requires a sufficient stopping distance. Always maintain a safe distance from the vehicle in front of you.
- Always slow down when cornering. The anti-lock brake system cannot prevent accidents resulting from excessive speeds.
- On loose or uneven road surfaces, operation of the anti-lock brake system may result in a longer stopping distance than for vehicles equipped with a conventional brake system.
- Avoid high speeds on wet roads. The anti-lock brake system cannot eliminate the risk of hydroplaning. If the anti-lock brake system should fail, the brake system will function as a conventional brake system. Have your vehicle checked by an Authorized Kia Dealer as soon as possible.

* NOTICE

- If the ABS warning light is on and stays on, you may have a problem with the ABS system. In this case, however, your regular brakes will work normally.
- The ABS warning light will stay on for 2-3 seconds after the ignition "ON." During that time, the ABS will go through self-diagnosis and the light will go off if everything is normal. If the light stays on you may have a problem with your ABS. Contact an authorized Kia dealer for service as soon as possible.

* NOTICE

- If the battery is discharged and the engine is jump started, the ABS warning light may come on. This condition occurs because of a discharged battery and not because there is an anti-lock brake system malfunction.
- Have the battery recharged before driving the vehicle.

POWER STEERING

Power steering uses energy from the engine to assist you in steering the vehicle. If the engine is off or if the power steering system becomes inoperative, the vehicle may still be steered, but it will require increased steering effort.

Should you notice any change in the effort required to steer during normal vehicle operation, have the power steering system checked by an authorized Kia dealer or another competent service center.

* NOTICE

- Never hold the steering wheel against a stop (extreme right or left turn) for more than fifteen seconds with the engine running. Holding the steering wheel for more than fifteen seconds in either position may cause damage to the power steering pump.
- If the power steering drive belt breaks or if the power steering pump malfunctions, the steering effort will greatly increase.

* NOTICE

If the vehicle is parked for extended periods outside in cold weather (below -10°C (14°F)), the power steering may require increased effort when the engine is first started. This is caused by increased fluid viscosity due to the cold weather and does not indicate a malfunction.

When this happens, increase the engine RPM by depressing accelerator until the RPM reaches 1500 rpm then release or let the engine idle for two or three minutes to warm up the fluid.

CRUISE CONTROL (IF EQUIPPED)

The cruise control system can maintain a constant cruising speed of more than 25 mph (40 km/h) without manual control of the accelerator. A slight fluctuation in vehicle speed (2-3 mph) while the cruise control system is active is normal. The cruise control system is useful when cruising on freeways, tollroads or other non-congested highways where frequent deceleration and acceleration are not required.

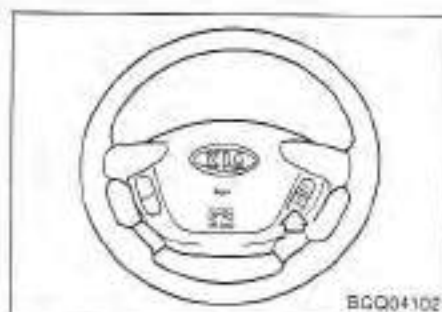
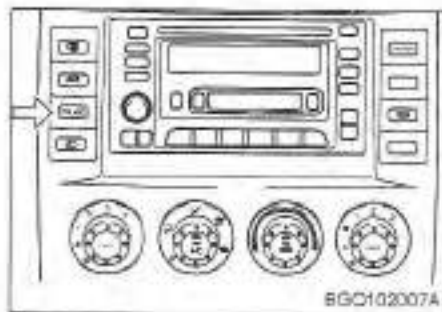

To set the cruise:

1. Push in the cruise control main switch. This turns the system on, then the AUTO CRUISE indicator light in the instrument cluster will illuminate.
2. Accelerate to desired cruising speed above 25 mph (40 km/h).
3. Push the "SET/COAST" control switch and release it.
4. Remove your foot from the accelerator pedal and the desired speed will automatically be maintained.

5. To increase speed, temporarily depress the accelerator pedal enough for the vehicle to exceed the preset speed. When you remove your foot from the accelerator pedal, the vehicle will return to the speed you have set.

⚠ WARNING - Cruise Control
Using cruise control in the following conditions could cause you to lose control of the vehicle:

- Heavy or unsteady traffic
- Slippery or winding roads
- Situations that involve varying speeds

Do not use cruise control in these situations.

⚠ WARNING

If the CRUISE switch is left on, the cruise control can be turned on accidentally. Keep the CRUISE switch off when cruise control is not in use.

*** NOTICE**

The SET function cannot be activated until approximately 2 seconds after the CRUISE MAIN switch has been engaged.

On a steep grade, the vehicle may momentarily slow down after the SET function has been engaged.

Cruise control will cancel at about 11 mph (18 km/h) below the preset speed.

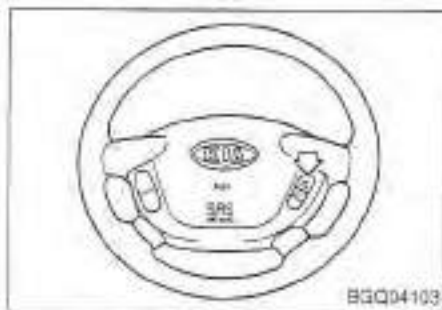

To increase cruise control set speed:

Follow either of these procedures.

- Depress the RES/ACCEL switch and hold it. Your vehicle will accelerate. Release the switch at the new speed you want to maintain.
- Depress and immediately release the RES/ACCEL switch. Vehicle speed will be increased only 1 mph. Using this technique provides for small vehicle speed increases.



To decrease the cruising speed:

Follow either of these procedures.

- Depress the SET/COAST switch and hold it. Your vehicle will gradually slow down. Release the switch at the speed you want to maintain.
- Depress and immediately release the SET/COAST switch. Vehicle speed will be decreased 1 mph (1.6 km/h). Using this technique provides for small vehicle speed decreases.

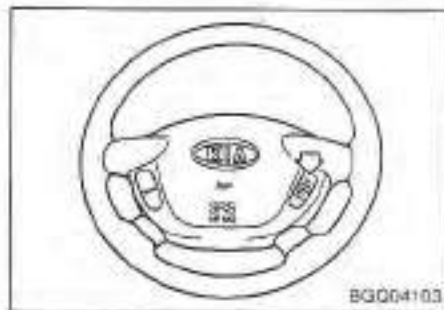

To resume cruising speed at more than 25 mph (40 km/h)

If something besides the CRUISE switch was used to cancel cruising speed and the system is still activated, the most recent set speed will automatically resume when the RES/ACCEL function is activated by briefly depressing the switch. It will not resume, however, if the vehicle speed has dropped below 25 mph (40 km/h).

To cancel cruise control do one of the following:

- Depress the brake pedal.
- Shift into N (Neutral).
- Depress the CANCEL switch located on your steering wheel.
- Depress the SET/COAST and RES/ACCEL switches at the same time.

Each of these actions will cancel cruise control operation, but it will not turn the system off. If you wish to resume cruise control operation, depress the RESUME/ACCEL switch located on your steering wheel. You will return to your previously preset speed.

To turn cruise control OFF:

- Depress the CRUISE switch (OFF position).
- Turn the ignition off.

Both of these actions also cancel cruise control operation. If you want to resume cruise control operation, repeat the steps provided in "To Set Cruise Control Speed" on the previous page.

INSTRUMENT CLUSTER

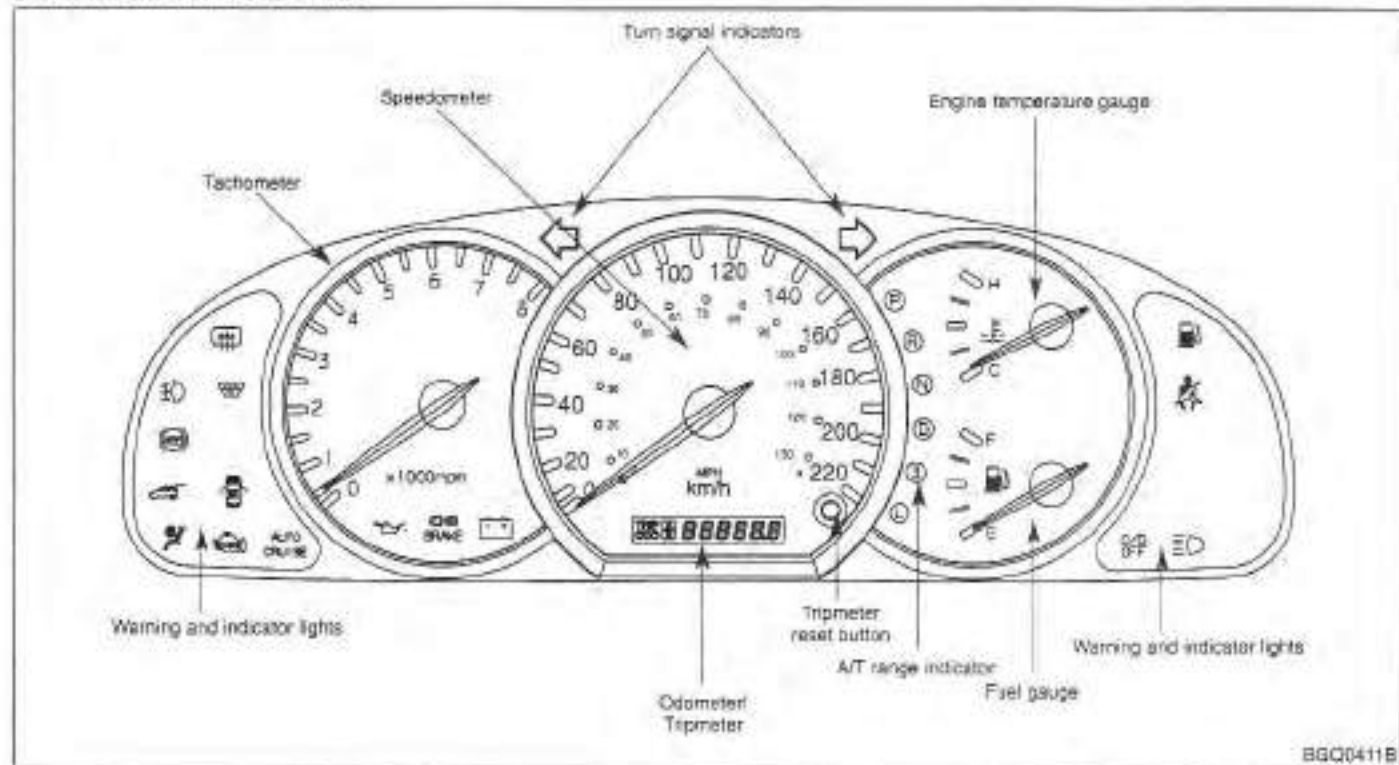

BGQ0411B

GAUGES

Speedometer

The speedometer indicates the forward speed of the vehicle.

Odometer

The odometer indicates the total distance the vehicle has been driven.

Trip Meter

The trip meter indicates the distance since the last time the trip meter reset button was pressed. It can be returned to zero by pushing the reset button.

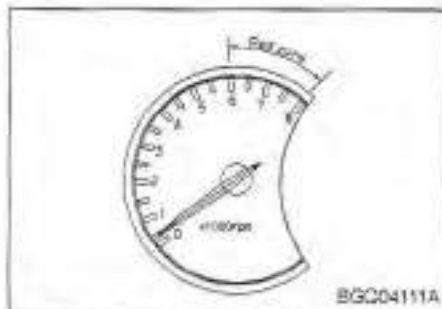

Tachometer

The tachometer indicates the approximate number of engine revolutions per minute (rpm).

Use the tachometer to select the correct shift points and to prevent lugging and/or over-revving the engine.

The tachometer pointer may move slightly when the ignition switch is in ACC or ON position with the engine OFF. This movement is normal and will not affect the accuracy of the tachometer once the engine is running.

* NOTICE

Do not operate the engine within the tachometer's RED ZONE.

This may cause severe engine damage.

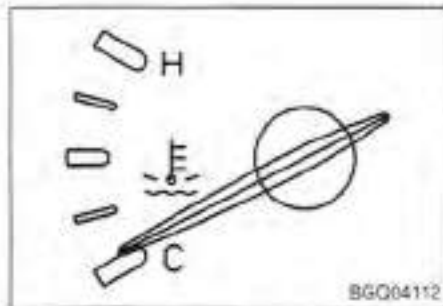

Engine Temperature Gauge

This gauge shows the temperature of the engine coolant when the ignition switch is ON.

If the gauge pointer moves beyond the normal range area toward the H position, it indicates overheating that may damage the engine.

Do not continue driving with an overheated engine. If your vehicle overheats, refer to "Overheating" in the Index.

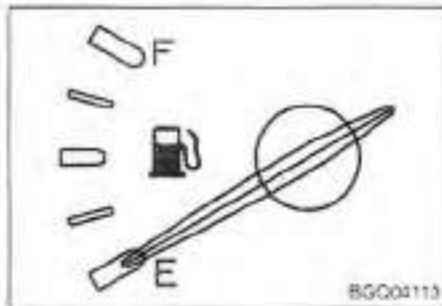

Fuel Gauge

The fuel gauge indicates the approximate amount of fuel remaining in the fuel tank.

Fuel tank capacity - 19.5 US gal. (75 liters).

The fuel gauge is supplemented by a low fuel warning light, which will illuminate when the fuel level has dropped to about 2.6 US gal. (10 liters).



Instrument Panel Illumination

When the vehicle's parking lights or headlights are on, rotate the illumination control knob to adjust the instrument panel illumination intensity.

WARNINGS AND INDICATORS

Warning Lights/Audible Indicators

Checking operation

All warning lights are checked by turning the ignition switch ON (do not start the engine). Any light that does not illuminate should be checked by an authorized Kia dealer.

After starting the engine, check to make sure that all warning lights are off. If any are still on, this indicates a situation that needs attention. When releasing the parking brake, the brake system warning light should go off. The fuel warning light will stay on if the vehicle is low on fuel.

**Anti-Lock Brake System
(ABS) Warning Light
(if equipped)**

This light illuminates when you start the engine. The light will go off if the ABS system is operating normally.

Also, this light illuminates if the key is turned to ON and goes off in 2-3 seconds if the system is operating normally.

O/D OFF Indicator

This indicator comes on when the O/D system is deactivated.

**Engine Oil Pressure
Warning**

This warning light indicates the engine oil pressure is low.

If the warning light illuminates while driving:

1. Drive safely to the side of the road and stop.
2. With the engine off, check the engine oil level. If the level is low, add oil as required.

If the warning light remains on after adding oil or if oil is not available, call an authorized Kia dealer.

*** NOTICE**

If the engine is not stopped as soon as possible, severe damage could result.

Charging System Warning



This warning light indicates a malfunction of either the generator or electrical charging system.

If the warning light comes on while the vehicle is in motion:

1. Drive to the nearest safe location.
2. With the engine off, check the generator drive belt for looseness or breakage.
3. If the belt is adjusted properly, a problem exists somewhere in the electrical charging system. Have an authorized Kia dealer locate and correct the problem as soon as possible.

Safety Belt Warning



If the driver's lap/shoulder belt is not fastened when the key is turned ON or if it is unfastened after the key is ON, a chime sounds and the safety belt warning light remains on for six seconds. If the system does not operate as described, see an authorized Kia dealer for assistance.

Front Fog Indicator (If Equipped)



This light comes on when the fog lights are ON.

Parking Brake & Brake Fluid Warning



Parking brake warning

This light is illuminated when the parking brake is applied with the ignition switch in the START or ON position. The warning light should go off when the parking brake is released.

Low brake fluid level warning

If the warning light remains on, it may indicate that the brake fluid level in the reservoir is low.

If the warning light remains on:

1. Drive to the nearest safe location and carefully stop your vehicle.
2. With the engine stopped, check the brake fluid level immediately and add fluid as required. Then check all brake components for fluid leaks.

3. Do not drive the vehicle if leaks are found, the warning light remains on or the brakes do not operate properly. Have it towed to any authorized Kia dealer for a brake system inspection and necessary repairs.

⚠ WARNING - Brake Warning Light

Driving the vehicle with a warning light on is dangerous. If the brake warning light remains on, have the brakes checked and repaired immediately by an authorized Kia dealer.

To check bulb operation, the parking brake and brake fluid warning light illuminates when the ignition switch is in the ON position.

Rear Hatch Ajar Warning



This warning light activates when the rear hatch is not closed securely.

Low Fuel Level Warning



This warning light indicates the fuel tank is near empty. The warning light will come on when the fuel level has dropped to about 2.6 US gal. (10 liters). Refuel as soon as possible.

Door Ajar Warning



This warning light comes on when a door is not closed securely with the ignition switch in any position.

Headlight High Beam Indicator



This indicator activates when the headlights are on and in the high beam position or when the turn signal lever is pulled into the Flash-to-Pass position.

Rear Window Defroster Indicator



This light comes on when the rear defroster switch is depressed to remove the frost on the rear glass. Press the switch again to shut off the defroster when the frost is removed. The rear window defroster will automatically turn off after 15 minutes. It will also turn off whenever you remove the ignition key.

Front Windshield Defroster Indicator



This light comes on when the front defroster switch is depressed to remove the frost on the front windshield. Press the switch again to shut off the defroster when the frost is removed. It will also turn off whenever you remove the ignition key.

Air Bag Warning (if equipped)



This warning light will come ON and flash for approximately 6 seconds each time you turn the ignition switch to the ON position. If this warning indicator does not do this or if it illuminates while the vehicle is being driven, see an authorized Kia dealer or another competent service center for immediate service.

Auto Cruise Indicator

The indicator light is illuminated when the main cruise control switch is activated.

**AUTO
CRUISE**

Key Reminder Warning Chime

If the driver's door is opened and the ignition key is left in the ignition switch, the key reminder warning chime will sound. This is to prevent you from locking your keys in the vehicle.

Lights On Warning Chime

The lights on warning chime will sound if the headlight switch is left in the first or second position and the driver's door is opened.

Door Ajar Warning Chime

If the driver's door is open with the ignition switch on, the warning chime will sound.

Malfunction Indicator



The CHECK ENGINE or malfunction indicator light is installed in your vehicle's instrument panel and responds to signals from the vehicle's On Board Diagnostic (OBD -II) System. The OBD-II System monitors the performance of the vehicle's Emission Control System (ECS), which is designed to reduce the amount of air pollutants in engine exhaust to the levels required by government regulations.

When you first start the engine, the CHECK ENGINE light will illuminate briefly as a system check to confirm that the OBD-II System is operating properly. As the engine starts, this light turns off. However, if at any time the OBD-II system detects a faulty signal or determines that the ECS is not performing to specification, the CHECK ENGINE light will illuminate continuously or flash.

Continuously ON :



If the CHECK ENGINE light comes ON while driving and illuminates continuously, a potential problem has been discovered in the ECS or one of the exhaust system components. Generally, the vehicle will continue to be driveable but it should be checked by an authorized Kia dealer as soon as possible. This condition is unlikely to lead to engine damage unless a decrease in vehicle power or poor running conditions is immediately apparent.

Flashing ON and OFF :

If the CHECK ENGINE light begins to flash ON and OFF, a more serious problem with the ECS or exhaust system component has been detected. If this happens, and there is no degradation to performance, the vehicle is still driveable (avoid high speeds) but should be checked by an authorized Kia dealer at your earliest possible convenience. If the flashing CHECK ENGINE light is accompanied by a decrease in power or poor running conditions, safely stop the vehicle and immediately contact Kia Roadside Assistance.

Note that the CHECK ENGINE light will illuminate for a problem like a loose or missing gas cap, but will not illuminate as a result of low engine oil or coolant, low automatic transaxle fluid or engine overheating. The driver will be alerted to these conditions by other indicators on the instrument panel.

CAUTION

- *Prolonged driving with the On Board Diagnostic System Malfunction Indicator Light () illuminated may cause damage to the emission control systems which could effect driveability and/or fuel economy.*
- *If the On Board Diagnostic System Malfunction Indicator Light () begins to flash ON and OFF, potential catalytic converter damage is possible which could result in loss of engine power. Have the On Board Diagnostic System inspected as soon as possible by an authorized Kia dealer.*

* NOTICE

A loose fuel filler cap may cause the On Board Diagnostic System Malfunction Indicator Light () in the instrument panel to illuminate unnecessarily. Always make sure that the fuel filler cap is tight.

LIGHTING

Battery Saver Function

* NOTICE

- The purpose of this feature is to prevent the battery from being discharged. The system automatically turns off the small light when the driver removes the ignition key and opens the driver-side door.
- With this feature, the taillights will be turned off automatically if the driver parks on the side of the road at night. If necessary, to keep the taillights on when the ignition key is removed, perform the following:
 - 1) Open the driver-side door.
 - 2) Turn the taillights OFF and ON again using the light switch on the steering column.

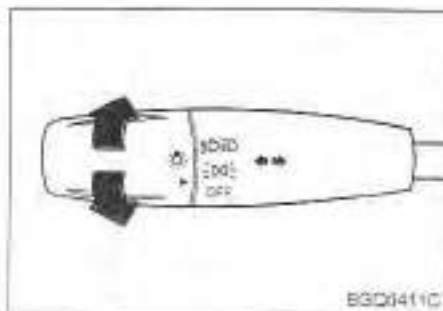

Lighting Control

The light switch has a Headlight and a Taillight position.

To turn the lights on, turn the knob on the end of the control lever.

Taillight position.

When the light switch is in the taillight position (first position), the tail, position, license and instrument panel lights are ON.

Headlight position.

When the light switch is in the headlight position (second position), the head, tail, position, license and instrument panel lights are ON.

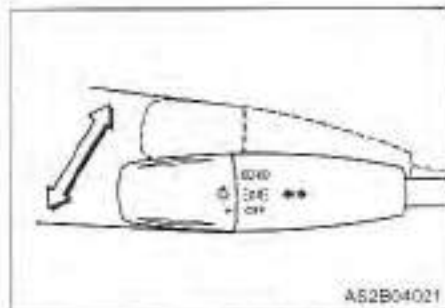

High-Beam Operation

To turn on the high-beam headlights, push the lever away from you. Pull it back for low beams.

The high-beam indicator will light when the headlight high beams are switched on.

To prevent the battery from being discharged, do not leave the lights on for a prolonged time while the engine is not running.

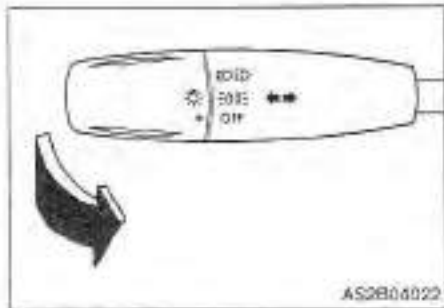

Flashing Headlights

To flash the headlights, pull the lever toward you. It will return to the normal position when released. The headlight switch does not need to be on to use this flashing feature.

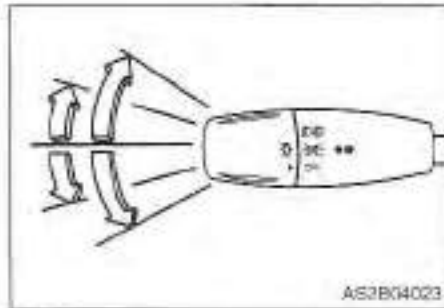

Turn Signals

The ignition switch must be on for the turn signals to function. To turn on the turn signals, move the lever up or down. Green arrow indicators on the instrument panel indicate which turn signal is operating. They will self-cancel after a turn is completed. If the indicator continues to flash after a turn, manually return the lever to the OFF (middle) position.

Lane change signals

To signal a lane change, move the turn signal lever slightly and hold it in position. The lever will return to the OFF (center) position when released.

If an indicator stays on and does not flash or if it flashes abnormally, one of the turn signal bulbs may be burned out and will require replacement.

Daytime Running Lights (DRL)

Daytime Running Light (DRL) can make it easier for others to see the front of your vehicle during the day. DRL can be helpful in many different driving conditions, but they can be especially helpful in the short periods after dawn and before sunset. The DRL system will make your low-beam headlights turn OFF when:

- The headlight switch is ON
- The parking brake is engaged
- The taillights switch is ON



Front Fog Lights (if equipped)

To turn the front fog lights ON, turn the headlights ON and then depress the front fog lights switch. To turn it OFF, depress it again or turn the headlights OFF.



Hazard warning flasher

The hazard warning flasher causes the rear taillights and front turn signal lights to flash on and off, which serves as a warning to other drivers to exercise caution when approaching or passing your vehicle.

To activate the flasher, depress the hazard warning flasher switch. This switch operates in any ignition switch position.

To turn the flashers off, depress the switch again.

WIPERS AND WASHERS

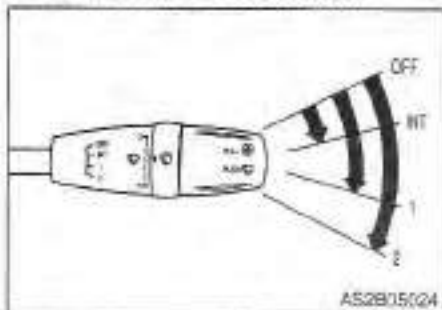

Windshield Wipers

The ignition switch must be ON.

To turn the wipers on, move the lever down.

INT - Intermittent wiper operation

1 - Normal wiper speed

2 - Fast wiper speed

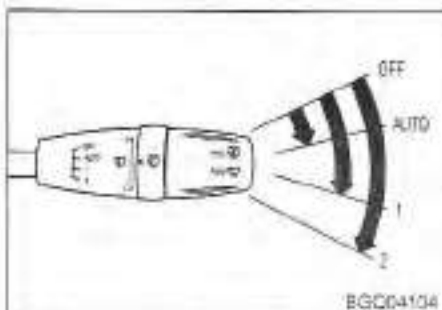

Auto Control (if equipped)

When the windshield wiper switch is placed in the "AUTO" position, the rain sensor located on the upper end of windshield glass senses the amount of rainfall and controls for the appropriate length of the intervals between wipes.

*NOTICE

If there is heavy accumulation of snow or ice on the windshield, there will be a 10 minute waiting period prior to the operation of the windshield wipers.

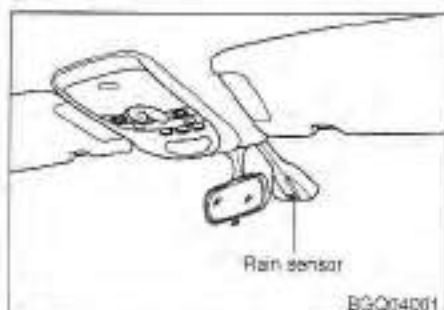

⚠ WARNING

When the ignition switch is on and the windshield wiper switch is placed in the "AUTO" mode, please use caution in the following cases to avoid any hand injury :

- Do not touch the upper end of the windshield facing the rain sensor.
- Do not wipe the upper end of the windshield with a cloth.
- Do not put pressure on the windshield.

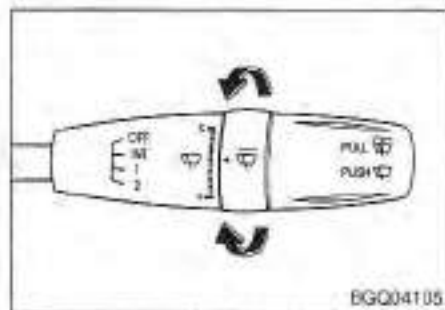

Variable Intermittent Wipers

Set the lever to the INT/AUTO position and choose the desired wiper interval by turning the ring.

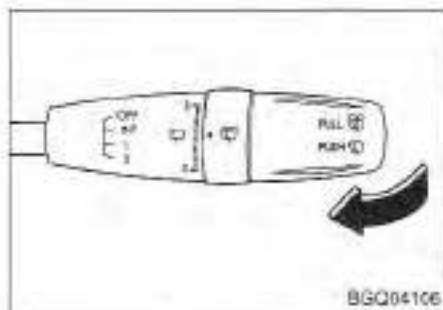

One-Touch Wipers

For a single wiping cycle, push the lever forward and release it with the lever in the OFF position.

The wipers will operate continuously if the lever is pushed forward and held.

* NOTICE

- To prevent possible damage to the wipers or windshield, do not operate the wipers when the windshield is dry.
- To prevent damage to the wiper blades, do not use gasoline, kerosene, paint thinner, or other solvents on or near them.
- To prevent damage to the wiper arms and other components, do not attempt to move the wipers manually.

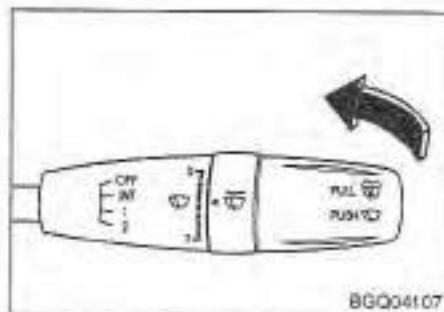

BGQ04107

Windshield Washers

In the OFF position, pull the lever gently toward you to spray washer fluid on the windshield and to run the wipers 2-3 cycles.

Use this function when the windshield is dirty.

The spray and wiper operation will continue until you release the lever.

If the washer does not work, check the washer fluid level. If the fluid level is not sufficient, you will need to add an appropriate non-abrasive windshield washer fluid to the washer reservoir.

The reservoir filler neck is located in the front of the engine compartment on the passenger side.

CAUTION

Do not use the washer in freezing temperatures without first warming the windshield with the defrosters; the washer solution could freeze on contact with the windshield and obscure your vision.

* NOTICE

To prevent possible damage to the washer pump, do not operate the washer when the fluid reservoir is empty.

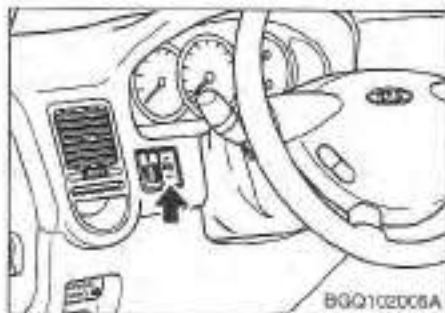

BGQ102005A

Rear Window Wiper/Washer Switch

The rear window wiper/washer switch is located to the left of the steering column.

Push the button to operate the rear wiper and washer.

ON - Normal wiper operation

- Spraying washer fluid and wiping

INT - Intermittent wiper operation

DEFROSTER

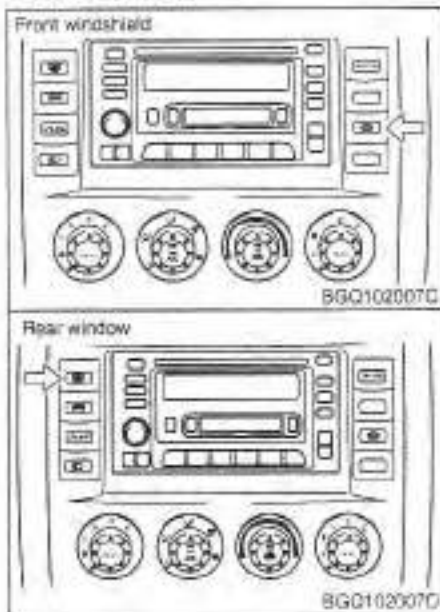

The defroster clears frost, fog and thin ice from the interior and exterior of the front windshield and rear window. The ignition switch must be ON to operate the defrosters.

If your vehicle is equipped with the outside rearview mirror defroster, you can also clear frost from the mirror by depressing this rear window defroster switch.

To activate the defroster, depress the corresponding defroster switch located on the center console switch panel. Front windshield and rear window defroster indicators illuminate when the defrosters are on. The defrosters automatically turn off after about 15 minutes, or when the ignition switch is turned off. To turn off the defroster, press the corresponding defroster switch again.

If there is heavy accumulation of snow on the rear window, brush it off before operating the rear defroster.

If your vehicle is equipped with an outside rearview mirror defroster, it is operated at the same time you operate the rear window defroster.

* NOTICE

- To prevent damage to the conductors bonded to the inside surface of the bottom of the front windshield and the rear window, never use sharp instruments or window cleaners containing abrasives to clean the window.
- To prevent the battery from being discharged, operate the defroster only while the engine is running.
- The front windshield defroster is designed to defrost wiper blades. If you want to defrost and defog on the front windshield, refer to "Windshield Defrosting and Defogging" in this section.

INTERIOR FEATURES

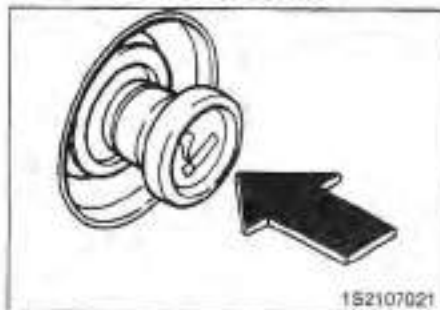

Cigarette Lighter

To operate the cigarette lighter, press it in and release it. When it is heated, it automatically pops out ready for use. If the engine is not running, the ignition switch must be in the ACC position for the lighter to operate.

* NOTICE

- Do not hold the lighter in after it is already heated because it will overheat.
- Only a genuine Kia lighter should be used in the cigarette lighter socket. The use of plug-in accessories (shavers, hand-held vacuums, and coffee pots, for example) may damage the socket or cause electrical failure.
- If the lighter does not pop out within 30 seconds, remove it to prevent overheating.

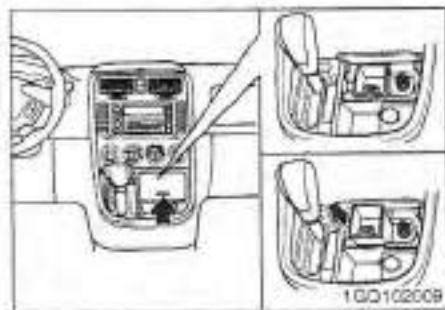

Ashtrays

Front ashtray

To use the ashtray, open the cover.

To remove the ashtray, open the cover, grasp the ashtray bucket and carefully pull it out.

⚠ WARNING - Ashtray Use

- Do not use the vehicle's ashtrays as waste receptacles.
- Putting lit cigarettes or matches in an ashtray with other combustible materials may cause a fire.

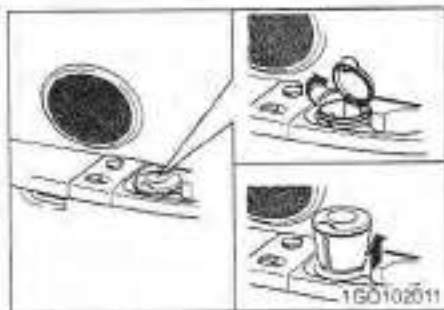

Rear ashtray

To use the ashtray, open the cover.

To remove the ashtray, pull it up and out.

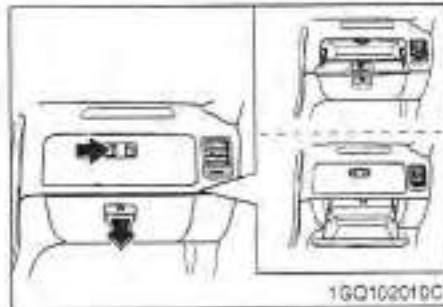

Glove Box

To open the glove box door, pull the latch out and let the glove box open.

⚠ CAUTION

To reduce the risk of injury in case of an accident or sudden stop, always keep the glove box door closed while driving.

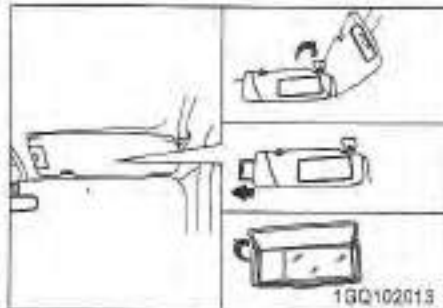

Sunvisors

To use a sunvisor, pull it *downward*.

To use a sunvisor for a side window, pull it downward, unsnap it from the bracket and swing it to the side.

You can extend the side of the sunvisor to provide additional shade.

Vanity mirror

To use the vanity mirror, pull down the visor and pull up the mirror cover.

Power Socket (if equipped)

Power outlet sockets are provided on the front console, on the third row seat left armrest and the right side of the cargo area. The power outlets are designed to provide power for mobile telephones or other devices designed to operate with vehicle electrical systems. The devices should draw less than 10 amps with the engine running.

CAUTION

- *Use when the engine is running.*
- *Only use the electric appliances which are less than 12V and 10A in electric capacity.*
- *Adjust the air-conditioner or heater to the lowest operation level when you have to use the power socket while using air-conditioner or heater.*
- *Close the cover when not in use.*

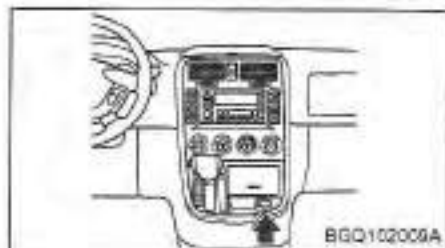



Coin Holder

The coin holder is located to the left of the steering column.

Do not use the coin holder as an ashtray.

TRIP COMPUTER

The trip computer is a driver controlled microcomputer that provides the driver with important driving information such as a clock, possible driving distance, average speed, drive time and ambient temperature.

Mode

Pushing the MODE button allows you to select the trip meter functions. Each push of the button changes the display as follows:

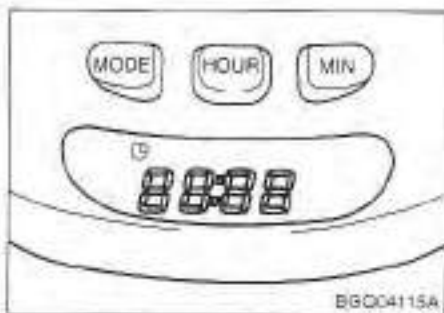
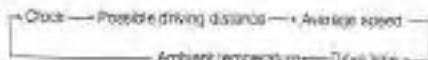

Clock

There are three control buttons for the clock. Their functions are as follows:

HOUR - Push "HOUR" to advance the hour indicated.

MIN - Push "MIN" to advance the minute indicated.

MODE - Push "MODE" for over 1sec. to reset minutes to ":00" to facilitate resetting the clock to the correct time. When this is done, pressing "MODE" between 10:30 and 11:29 changes the readout to 11:00.

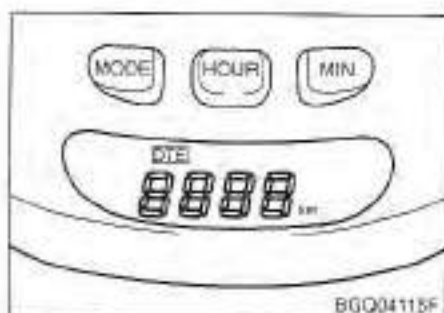

Possible driving distance

This mode indicates the approximate driving distance possible with the current amount of fuel in the fuel tank. When the fuel level is low and the possible distance is below approximately 30 miles, the display will indicate "###.#".

* NOTICE

If the battery has been removed and reinstalled, or the vehicle is driving on an inclined surface, the "possible driving distance function" may not operate correctly. The possible driving distance may be somewhat different than the actual driving distance depending on the driving conditions.

DRIVING YOUR VEHICLE

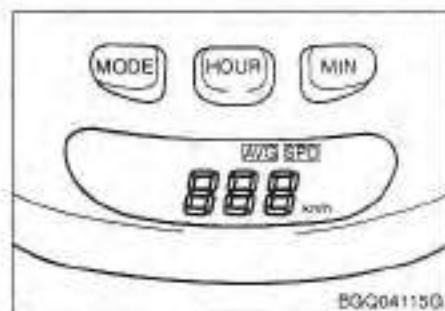

Average speed

This mode indicates the average speed from ignition key "ON" to ignition key "OFF". To reset the average speed, push "MODE" for approximately 1 sec.

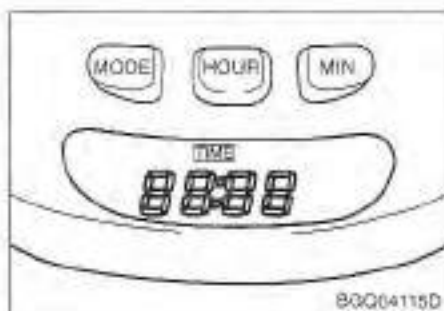

Drive time

This mode indicates the total time from ignition key "ON" to ignition key "OFF". To reset the drive time, push "MODE" for approximately 1 sec.

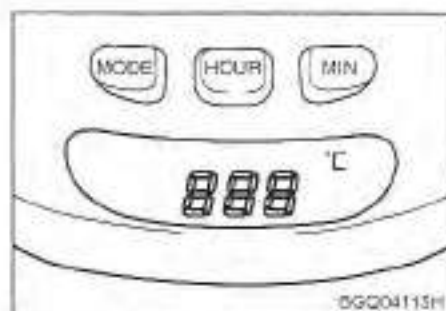

Ambient temperature

This mode indicates the ambient temperature around the vehicle.

CLIMATE CONTROL SYSTEM

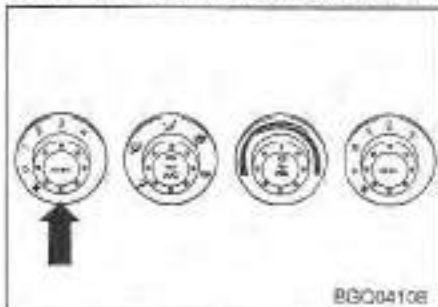
**Fan Speed Control Knob (front)**

Four (4) adjustable fan speeds are provided which increase as the number increases. The ignition switch must be in the ON position for fan operation.

- 0 - Fan off
- 1 - Low speed
- 2 - Medium speed
- 3 - High speed
- 4 - Maximum speed

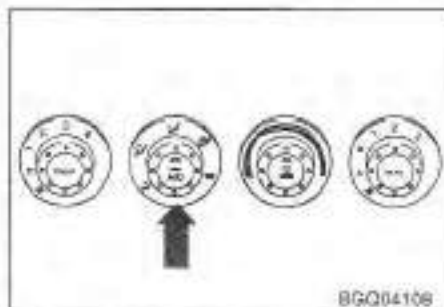
**Mode Selection knob**

The mode selection knob controls the direction of air flow through the ventilation system.

**Face position**

Air flow is directed toward the upper body and face through all four (4) center instrument panel ventilation outlets. Additionally, each outlet can be controlled to direct the air discharged from the outlet.

**Face-floor position**

Air flow is directed toward the face and the floor. The air to the floor is warmer than to the face (except when the temperature control is set to the extreme cold position).

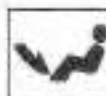
**Floor position**

Most of the air flow is directed to the floor, with a small amount being directed to the windshield and side window defrosters.

**Floor-defrost position**

Most of the air flow is directed to the floor and the windshield with a small amount directed to the side window defrosters.



Defrost position

Most of the air flow is directed to the windshield with a small amount of air directed to the side window defrosters.

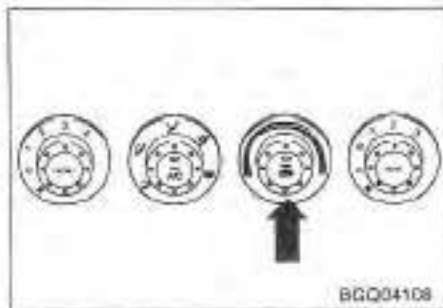

BGQ04108

Temperature Control Knob

The temperature control knob allows you to control the temperature of the air flowing from the ventilation system. To change the air temperature in the passenger compartment turn the knob to the right for warm to hot air or left for cooler air.



BGC04106

Air Intake Control Button

It is recommended that under normal conditions the outside (fresh) air position be selected.

Recirculated Air Position

If you press the air intake control button once (recirculate), almost all outside air flow into the vehicle is shut off, and air within the vehicle will be recirculated.

This position can be used temporarily for maximum heating or cooling (if equipped with air conditioning) and to help prevent undesirable outside air flow into the vehicle.

CAUTION

Continued climate control system operation in the recirculated air position may allow humidity to increase inside the vehicle which may fog the glass and obscure visibility.

Outside (Fresh) Air Position

If you press the air intake control button again, the air position will be changed to outside (Fresh) air and air will enter the ventilation system from outside the vehicle. Use this position for normal ventilation and heating.

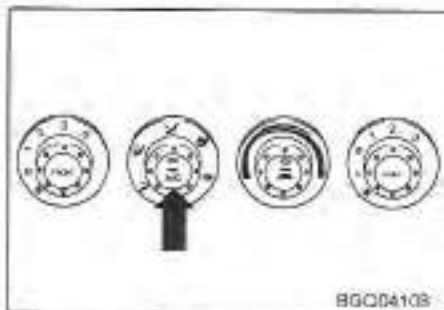
**Air Conditioning Button (If equipped)**



Push the A/C button to turn the air conditioning system on. An indicator light in the button will illuminate when the fan switch is on. Push the button again to turn the air conditioning system off.

System Operation**Ventilation**

1. Set the mode selection knob to the  position.
2. Set the air intake control button to the outside air position.
3. Set the temperature control knob to the desired position.
4. Set the fan speed control knob to the desired speed.

Heating

1. Set the mode selection knob to the  position.
2. Set the air intake control button to the recirculated air position.

3. Set the temperature control knob to the desired position.
4. Set the fan speed control knob to the desired speed.
5. If dehumidified heating is desired, turn the air conditioning system (if equipped) on.
 - If cool air is desired at face level for bi-level operation, set the mode selection knob to the  position.
 - If the windshield fogs up, set the mode selection knob to the  position.

Air conditioning (optional)

All Kia Air Conditioning Systems are filled with environmentally friendly R134a refrigerant which is not damaging to the ozone layer.

1. Start the engine. Push the air conditioning button.
2. Set the mode selection knob to the  position.
3. Set the air intake control button to the outside air or recirculated air position.
4. Set the temperature control knob to the desired position.
5. Set the fan speed control knob to the desired speed.
6. Adjust the fan speed control lever and temperature control knob to maintain maximum comfort.

- If warmer air is desired at floor level for bi-level operation, set the mode selection knob to the  position and adjust the temperature control knob to maintain maximum comfort.
- When maximum cooling is desired, rotate the temperature control knob to the extreme left position and set the air intake control button to the recirculated air position, then set the fan speed control knob to the highest speed.

* NOTICE

When using the air conditioning system, monitor the temperature gauge closely while driving up long hills or in heavy traffic when outside temperatures are high. Air conditioning system operation may cause engine overheating. Continue to use the blower fan but turn the air conditioning system off if the temperature gauge indicates engine overheating.

Air conditioning system operating tips:

- If the vehicle has been parked in direct sunlight during hot weather, open the windows for a short time to let hot air inside the vehicle escape.
- To help reduce moisture on the inside of windows on rainy humid days, decrease the humidity inside the vehicle by operating the Air Conditioning System.
- During Air Conditioning System operation, you may occasionally notice a slight change in engine speed at idle as the A/C Compressor cycles on. This is a normal system operating characteristic.
- Use the Air Conditioning System every month if only for a few minutes.
- After Air Conditioning System use, you may notice clear water dripping (or even puddling) on the ground under the passenger side of the vehicle. This is a normal system operating characteristic.
- The Air Conditioning System includes a function that will automatically turn the A/C Compressor off if engine coolant temperature approaches an overheating level. A/C Compressor operation will resume once engine coolant temperature returns to the "normal" range. Also, the A/C Compressor is automatically turned off for a few seconds when the accelerator is fully depressed.
- When operating the Air Conditioning System use the Outside (fresh) air position.
- Operating the Air Conditioning System in the recirculated air position does provide maximum cooling, however, continual operation in this mode may cause the air inside the vehicle to become stale.

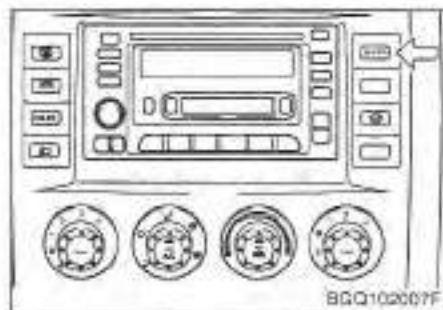

Rear Climate Control System

You can control the rear climate control system for rear passenger compartment in front seat.

To turn the rear climate control system ON, depress the rear heater button and turn the rear fan speed control knob clockwise to the desired position. Three (3) adjustable fan speeds are provided which increase as the number increases. The ignition switch must be in the ON position for rear fan operation.

- 0 - Fan off
- 1 - Low speed
- 2 - Medium speed
- 3 - High speed
- R - In this position, your rear passenger can control the rear fan speed.

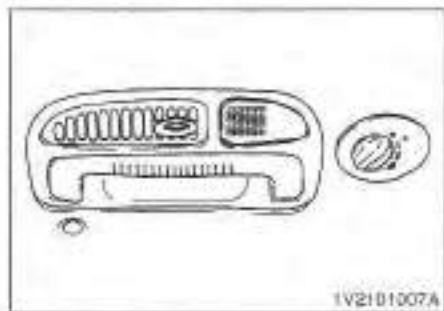

The rear fan speed control knob located on the roof at the rear seat has three (3) adjustable fan speeds which increase with the size bar beside the knob.

WINDSHIELD DEFROSTING AND DEFOGGING

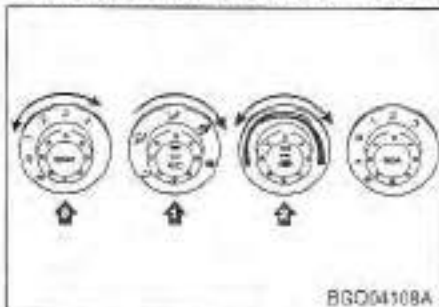
*To defog inside windshield*

1. Set the mode selection knob to the or position.
When you select or position, the system automatically turns on the A/C and outside (fresh) air mode.
2. Set the temperature control knob to the desired position.
3. Set the fan speed control knob to any desired speed except "0".
For maximum defogging, set the fan speed control knob to the "3" or "4" position.

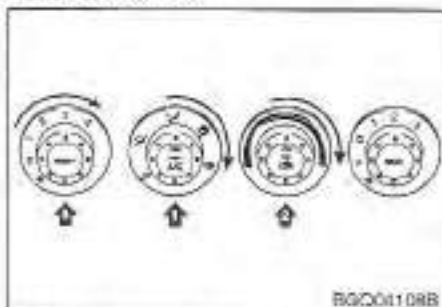
*To defrost outside windshield*

1. Set the mode selection knob to the position.
When you select position, the system automatically turns on the A/C and outside (fresh) air mode.
2. Set the temperature control knob to the extreme right/hot position.
3. Set the fan speed control knob to the "3" or "4" position.

⚠ WARNING



Do not use the or position during cool operation in extremely humid weather. The difference between the temperature of the outside air and that of the windshield could cause the outer surface of the windshield to fog up, causing loss of visibility. In this case, set the mode selection knob to the position and fan speed control knob to the lower speed.



- For maximum defrosting, set the temperature control knob to the extreme right/hot position and the fan speed control knob to the highest speed.
- If warm air to the floor is desired while defrosting or defogging, set the mode selection knob to the  position.
- Before driving, clear all snow and ice from the windshield, rear window, outside rear view mirrors, and all side windows.
- Clear all snow and ice from the hood and the air inlet in the cowl grille to improve heater and defroster efficiency and to reduce the probability of fogging on the inside of the windshield.

* NOTICE

If you don't want air-conditioning or outside (fresh) air when operating in either of these modes, pressing the air-conditioning switch or air intake control switch again will deactivate the air-conditioning or outside (fresh) air mode.

* NOTICE

When you select the  or  position the system automatically turns on the air-conditioning system and outside (fresh) air mode. If you don't want air-conditioning and outside (fresh) air when operating the defrost, you can turn off the automatic air-conditioning system operation and outside (fresh) air mode by performing the following:

- 1) Turn the front fan speed control knob to the "0" position.
- 2) Turn the mode selection knob to the  position.
- 3) While holding the "A/C" button depressed, push the air intake () button at least six times within three seconds.

The air intake () indicator light will then blink three times. If you want to return to the automatic air-conditioning system and outside (fresh) air mode, repeat the procedure.

Fuel Requirements	5-2
Emission Control System.....	5-3
Before Driving.....	5-5
Suggestions for Economical Operation.....	5-6
Special Driving Conditions.....	5-7
Trailer Towing	5-11
Overloading.....	5-16
Label Information	5-17

FUEL REQUIREMENTS

Your new Kia vehicle is designed to use only unleaded fuel having an octane rating of 87 or higher.

Your new Kia is designed to obtain maximum performance with UNLEADED FUEL, as well as minimize exhaust emissions and spark plug fouling.

* NOTICE

NEVER USE LEADED FUEL. The use of leaded fuel is detrimental to the catalytic converter and will damage the engine control system's oxygen sensor and affect emission control.

Never add any fuel system cleaning agents to the fuel tank other than what Kia has specified. (Consult an authorized Kia dealer for details.)

Gasoline Containing Alcohol and Methanol

Gasohol, a mixture of gasoline and ethanol (also known as grain alcohol), and gasoline or gasohol containing methanol (also known as wood alcohol) are being marketed along with or instead of leaded or unleaded gasoline.

Do not use gasohol containing more than 10% ethanol, and do not use gasoline or gasohol containing any methanol. Either of these fuels may cause driveability problems and damage to the fuel system.

Discontinue using gasohol of any kind if driveability problems occur.

Vehicle damage or driveability problems may not be covered by the manufacturer's warranty if they result from the use of:

1. Gasohol containing more than 10% ethanol.
2. Gasoline or gasohol containing methanol.
3. Leaded fuel or leaded gasohol.

* NOTICE

Never use gasohol which contains methanol. Discontinue use of any gasohol product which impairs driveability.

EMISSION CONTROL SYSTEM

The vehicle emission control system is covered by a written limited warranty. Please see the warranty information contained in the Warranty and Consumer Information Manual in your vehicle.

Vehicle Modifications

This vehicle should not be modified. Modification of your Kia could affect its performance, safety or durability and may even violate governmental safety and emissions regulations.

In addition, damage or performance problems resulting from any modification may not be covered under warranty.

Engine Exhaust Gas Precautions (Carbon Monoxide)

Engine exhaust gases contain carbon monoxide. Though colorless and odorless, it is dangerous and could be lethal if inhaled.

- Carbon monoxide can be present with other exhaust fumes. Therefore, if you smell exhaust fumes of any kind inside your vehicle, have it inspected and repaired immediately by an authorized Kia dealer or other competent repair shop. If you ever suspect exhaust fumes are coming into your vehicle, drive it only with all the windows fully open. Have your vehicle checked and repaired immediately.
- Do not operate the engine in confined or closed areas (such as garages) any more than what is necessary to move the vehicle in or out of the area.

- When the vehicle is stopped in an open area for more than a short time with the engine running, adjust the ventilation system (as needed) to draw outside air into the vehicle.
- Never sit in a parked or stopped vehicle for any extended time with the engine running.

Operating Precautions for Catalytic Converters

Your vehicle is equipped with a catalytic converter emission control device.

Therefore, the following precautions must be observed:

- Use only UNLEADED FUEL.
 - Do not park the vehicle over or near flammable objects, such as dry grass, paper, leaves, etc. Under certain conditions, they could be ignited by a hot exhaust system.
 - Do not operate the vehicle when there are signs of engine malfunction, such as misfire or a noticeable loss of performance.
 - Do not misuse or abuse the engine. Examples of misuse are coasting with the ignition off and descending steep grades in gear with the ignition off.
 - Do not operate the engine at high idle speed for extended periods (5 minutes or more).
- Do not modify or tamper with any part of the engine or emission control system. All inspections and adjustments must be made by a qualified technician.

Failure to observe these precautions could result in damage to the catalytic converter and to your vehicle.

Additionally, such actions could void your warranties.

BEFORE DRIVING

Before entering vehicle:

- Be sure that all windows, outside mirror(s), and outside lights are clean.
- Check the condition of the tires.
- Check under the vehicle for any sign of leaks.
- Be sure there are no obstacles behind you if you intend to back up.

Necessary Inspections

Fluid levels, such as engine oil, engine coolant, brake/clutch fluid, and washer fluid should be checked on a regular basis, with the exact interval depending on the fluid. Further details are provided in Section 7, Maintenance.

Before Starting

- Close and lock all doors.
- Position the seat so that all controls are easily reached.
- Adjust the inside and outside rearview mirrors.
- Be sure that all lights work.
- Check all gauges.

- Check the operation of warning lights when the ignition switch is turned to the ON position.
- Release the parking brake and make sure the brake warning light goes out.

For safe operation, be sure you are familiar with your vehicle and its equipment.

Drunk Driving

Drinking and driving is dangerous. Drunk driving is the number one contributor to the highway death toll each year. Alcohol impairs a driver's judgment, vision and muscular coordination. Even a small amount of alcohol will affect a driver's reflexes, perceptions and judgment.

Please don't drink and drive, or ride with a driver who has been drinking. Choose a designated driver if you're with a group, or if you're alone, call a taxi.

Drugs and Driving

Driving while under the influence of drugs is as dangerous or more dangerous than driving drunk, depending on the drug used and the quantity consumed. Don't take drugs and drive.

SUGGESTIONS FOR ECONOMICAL OPERATION

Your vehicle's fuel economy depends mainly on your style of driving, where you drive and when you drive.

Each of these factors affects how many miles (kilometers) you can get from a gallon (liter) of fuel. To operate your vehicle as economically as possible, use the following driving suggestions to help save money in both fuel and repairs:

- Avoid lengthy warm-up idling. Once the engine is running smoothly, begin driving. Remember, engine warm-up may take a little longer on cold days.
- Save fuel by accelerating slowly after stopping.
- Keep the engine in tune and follow the recommended periodic maintenance schedule. This will increase the life of all parts and lower your operating costs.
- Do not use the air conditioner unnecessarily.
- Slow down when driving on rough roads.

- For longer tire life and better fuel economy, always keep the tires inflated to the recommended pressures.
- Maintain a safe distance from other vehicles to avoid sudden stops. This will reduce wear on brake linings and pads. Driving in such a way will also save fuel because extra fuel is required to accelerate back to driving speed.
- Do not carry unnecessary weight in the vehicle.
- Do not rest your foot on the brake pedal while driving. This can cause needless wear, possible damage to the brakes, and poor fuel economy.
- Improper wheel alignment results in faster tire wear and lower fuel economy.
- Open windows at high speeds can reduce fuel economy.
- Fuel economy is less in crosswinds and headwinds. To help offset some of this loss, slow down when driving in these conditions.

Keeping a vehicle in good operating condition is important both for economy and safety. Therefore, have an authorized Kia dealer perform scheduled inspections and maintenance.

WARNING - Engine off Motion

Never turn the engine off to coast down hills or anytime the vehicle is in motion. The power steering and power brakes will not function without the engine running. Instead, downshift to an appropriate gear for engine braking effect.

SPECIAL DRIVING CONDITIONS

Hazardous Driving Conditions

When hazardous driving conditions are encountered such as water, snow, ice, mud, sand, or similar hazards, follow these suggestions:

- Drive cautiously and allow extra distance for braking.
- Avoid sudden movements in braking or steering.
- When braking, pump the brake pedal with a light up-and-down motion until the vehicle is stopped.
- If stalled in snow, mud, or sand, use second gear. Accelerate slowly to avoid spinning the drive wheels.
- Use sand, rock salt, tire chains, or other non-slip material under the drive wheels to provide traction when stalled in ice, snow, or mud.

WARNING - Downshifting

Downshifting into first gear with a manual transaxle, or L (Low) with an automatic transaxle, while driving on slippery surfaces can cause an accident. The sudden change in tire speed could cause the tires to skid. Be careful when downshifting on slippery surfaces.

Rocking the Vehicle

If it is necessary to rock the vehicle to free it from snow, sand, or mud, first turn the steering wheel right and left to clear the area around your front wheels. Then, shift back and forth between 1 (First) and R (Reverse) in vehicles equipped with a manual transaxle or R (Reverse) and any forward gear in vehicles equipped with an automatic transaxle. Do not race the engine, and spin the wheels as little as possible. If you are still stuck after a few tries, have the vehicle pulled out by a tow vehicle to avoid engine overheating and possible damage to the transaxle.

* **NOTICE**

Prolonged rocking may cause engine over-heating, transaxle damage or failure, and tire damage.

WARNING - Spinning Tires

Do not spin the wheels especially at speeds more than 35 mph (56 km/h). Spinning the wheels at high speeds when the vehicle is stationary could cause a tire to overheat, explode and injure bystanders.

Driving at Night

Because night driving presents many more hazards than driving in the daylight, here are some important tips to remember:

- Slow down and keep more distance between you and other vehicles, as it may be more difficult to see at night, especially in areas where there may not be any street lights.
- Adjust your mirrors to reduce the glare from other driver's headlights.
- Keep your headlights clean and properly aimed. Dirty or improperly aimed headlights will make it much more difficult to see at night.
- Avoid staring directly at the headlights of oncoming vehicles. You could be temporarily blinded, and it will take several seconds for your eyes to readjust to the darkness.

Driving in the Rain

Rain and wet roads can make driving dangerous, especially if you're not prepared for the slick pavement. Here are a few things to consider when driving in the rain:

- A heavy rainfall will make it harder to see and will increase the distance needed to stop your vehicle, so slow down.
- Keep your windshield wiping equipment in good shape. Replace your windshield wiper blades when they show signs of streaking or missing areas on the windshield.
- If your tires are not in good condition, making a quick stop on wet pavement can cause a skid and possibly lead to an accident. Be sure your tires are in good shape.
- Turn on your headlights to make it easier for others to see you.
- Driving too fast through large puddles can affect your brakes. If you must go through puddles, try to drive through them slowly.

- If you believe you may have gotten your brakes wet, apply them lightly while driving until normal braking operation returns.

Winter Driving

- We recommend that you carry emergency equipment, including tire chains, a window scraper, windshield de-icer, a bag of sand or salt, flares, a small shovel and jumper cables.
- Make sure you have sufficient ethylene-glycol coolant in the radiator.
- Check the battery condition and cables. Cold temperatures reduce the capacity of any battery, so it must be in excellent condition to provide enough winter starting power.
- Make sure the engine oil viscosity is suitable for cold weather.
- Check the ignition system for loose connections and damage.
- Use antifreeze-formulated windshield washer fluid. (Do not use engine coolant antifreeze.)

- Do not use the parking brake if it might freeze. When parking, shift to P (Park) and block the rear wheels.

Snow tires

If you mount snow tires on your Kia, make sure they are radial tires of the same size and load range as the original tires. Mount snow tires on all four wheels to balance your vehicle's handling in all weather conditions. Keep in mind that the traction provided by snow tires on dry roads may not be as high as your vehicle's original equipment tires. You should drive cautiously even when the roads are clear. Check with the tire dealer for maximum speed recommendations.

⚠ WARNING - Snow Tire Size
Snow tires should be equivalent in size and type to the vehicle's standard tires. Otherwise, the safety and handling of your vehicle may be adversely affected.

Do not install studded tires without first checking local, provincial and municipal regulations for possible restrictions against their use.

Tire chains

Mount snow chains on your vehicle when warranted by driving conditions or required by local laws. Make sure the chains are the correct size for your tires. Install them only on the front tires. If metal chains are used, they must be SAE class "S". Cable-type traction devices can also be used.

Chain installation

When installing chains, follow the manufacturer's instructions and mount them as tightly as you can. Drive slowly with chains installed. If you hear the chains contacting the body or chassis, stop and tighten them. If they still make contact, slow down until it stops. Remove the chains as soon as you begin driving on cleared roads.

⚠ WARNING - Tire Chains

- The use of chains may adversely affect vehicle handling.
- Do not exceed 30 mph (50 km/h) or the chain manufacturer's recommended speed limit, whichever is lower.
- Drive carefully and avoid bumps, holes, sharp turns, and other road hazards, which may cause the vehicle to bounce.
- Avoid sharp turns or locked-wheel braking.
- Chains that are the wrong size or improperly installed can damage your vehicle's brake lines, suspension, body and wheels.
- Stop driving and retighten the chains any time you hear them hitting the vehicle.

Driving in Flooded Areas

Avoid driving through flooded areas unless you are sure the water is no higher than the bottom of the wheel hub. Drive through any water slowly. Allow adequate stopping distance because brake performance may be affected.

After driving through water, dry the brakes by gently applying them several times while the vehicle is moving slowly.

TRAILER TOWING

⚠ WARNING - Towing a Trailer

If you don't use the correct equipment and drive properly, you can lose control when you pull a trailer. For example, if the trailer is too heavy, the brakes may not work well - or even at all. You and your passengers could be seriously or fatally injured. Pull a trailer only if you have followed all the steps in this section.

• TOWING CAPACITY

(unit : kg/lb)

NUMBERS	TOWING CAPA.
DRIVER	1,590/3,500
D + P (1)	1,500/3,300
D + P (3)	1,300/2,860
D + P (6)	800/1,760

P: Passenger

*** NOTICE**

Pulling a trailer improperly can damage your vehicle and result in costly repairs not covered by your warranty. To pull a trailer correctly, follow the advice in this section.

Your vehicle can tow a trailer. To identify what the vehicle towing capacity is for your vehicle, you should read the information in "Weight of the Trailer" that appears later in this section. Remember that towing is different than just driving your vehicle by itself. Towing means changes in handling, durability, and fuel economy. Successful, safe trailering takes correct equipment, and it has to be used properly.

This section contains many time-tested, important trailering tips and safety rules. Many of these are important for your safety and that of your passengers. Please read this section carefully before you pull a trailer.

Load-pulling components such as the engine, transmission, wheel assemblies, and tires are forced to work harder against the load of the added weight. The engine is required to operate at relatively higher speeds and under greater loads. This additional burden generates extra heat. The trailer also adds considerably to wind resistance, increasing the pulling requirements.

If You Do Decide to Pull a Trailer

Here are some important points if you decide to pull a trailer:

- Consider using a sway control. You can ask a hitch dealer about sway control.
- After your odometer indicates 500 miles (800 km) or more, you can tow a trailer. For the first 500 miles that you tow a trailer, don't drive over 50 mph (80 km/h) and don't make starts at full throttle. This helps your engine and other parts of your vehicle "wear-in" at the heavier loads.

- The weight of the trailer is one of the most important considerations when towing.

Weight of the trailer

How heavy can a trailer safely be? It should never weigh more than 1,590 kg (3,500 lb). But even that can be too heavy.

It depends on how you plan to use your trailer. For example, speed, altitude, road grades, outside temperature and how much your vehicle is used to pull a trailer are all important. The ideal trailer weight can also depend on any special equipment that you have on your vehicle.

Weight of the trailer tongue

The tongue load of any trailer is an important weight to measure because it affects the total gross vehicle weight (GVW) of your vehicle. This weight includes the curb weight of the vehicle, any cargo you may carry in it, and the people who will be riding in the vehicle. And if you will tow a trailer, you must add the tongue load to the GVW because your vehicle will also be carrying that weight.

The trailer tongue should weigh a maximum of 10% of the total loaded trailer weight. After you've loaded your trailer, weigh the trailer and then the tongue, separately, to see if the weights are proper. If they aren't, you may be able to correct them simply by moving some items around in the trailer.

CAUTION

- *Never load a trailer with more weight in the rear than in the front. The front should be loaded with approximately 60% of the total trailer load; the rear should be loaded with approximately 40% of the total trailer load.*
- *Never exceed the maximum weight limits of the trailer or trailer towing equipment. Improper loading can result in damage to your vehicle and/or personal injury. Check weights and loading at a commercial scale or highway patrol office equipped with scales.*

Hitches

It's important to have the correct hitch equipment. Crosswinds, large trucks going by, and rough roads are a few reasons why you'll need the right hitch. Here are some rules to follow:

- Will you have to make any holes in the body of your vehicle when you install a trailer hitch? If you do, then be sure to seal the holes later when you remove the hitch. If you don't seal them, deadly carbon monoxide (CO) from your exhaust can get into your vehicle, as well as dirt and water.
- The bumpers on your vehicle are not intended for hitches. Do not attach rental hitches or other bumper-type hitches to them. Use only a frame-mounted hitch that does not attach to the bumper.

Safety chains

You should always attach chains between your vehicle and your trailer. Cross the safety chains under the tongue of the trailer so that the tongue will not drop to the road if it becomes separated from the hitch.

Instructions about safety chains may be provided by the hitch manufacturer or by the trailer manufacturer. Follow the manufacturer's recommendation for attaching safety chains. Always leave just enough slack so you can turn with your trailer. And, never allow safety chains to drag on the ground.

Trailer brakes

If your trailer weighs more than 570 kg (1,250 pounds) loaded, then it needs its own brakes - and they must be adequate. Be sure to read and follow the instructions for the trailer brakes so you'll be able to install, adjust and maintain them properly.

- Don't tap into your vehicle's brake system.
- Do not use a trailer with its own brakes unless you are absolutely certain that you have properly set up the brake system. This is not a task for amateurs. Use an experienced, competent trailer shop for this work.

Driving with a Trailer

Towing a trailer requires a certain amount of experience. Before setting out for the open road, you must get to know your trailer. Acquaint yourself with the feel of handling and braking with the added weight of the trailer. And always keep in mind that the vehicle you are driving is now a good deal longer and not nearly so responsive as your vehicle is by itself.

Before you start, check the trailer hitch and platform, safety chains, electrical connector(s), lights, tires and mirror adjustment. If the trailer has electric brakes, start your vehicle and trailer moving and then apply the trailer brake controller by hand to be sure the brakes are working. This lets you check your electrical connection at the same time.

During your trip, check occasionally to be sure that the load is secure, and that the lights and any trailer brakes are still working.

Following distance

Stay at least twice as far behind the vehicle ahead as you would when driving your vehicle without a trailer. This can help you avoid situations that require heavy braking and sudden turns.

Passing

You'll need more passing distance up ahead when you're towing a trailer. And, because you're a good deal longer, you'll need to go much farther beyond the passed vehicle before you can return to your lane.

Backing Up

Hold the bottom of the steering wheel with one hand. Then, to move the trailer to the left, just move your hand to the left. To move the trailer to the right, move your hand to the right. Always back up slowly and, if possible, have someone guide you.

Making turns

When you're turning with a trailer, make wider turns than normal. Do this so your trailer won't strike soft shoulders, curbs, road signs, trees, or other objects. Avoid jerky or sudden maneuvers. Signal well in advance.

Turn signals when towing a trailer

When you tow a trailer, your vehicle has to have a different turn signal flasher and extra wiring. The green arrows on your instrument panel will flash whenever you signal a turn or lane change. Properly connected, the trailer lights will also flash to alert other drivers you're about to turn, change lanes, or stop.

When towing a trailer, the green arrows on your instrument panel will flash for turns even if the bulbs on the trailer are burned out. Thus, you may think drivers behind you are seeing your signals when, in fact, they are not. It's important to check occasionally to be sure the trailer bulbs are still working. You must also check the lights every time you disconnect and then reconnect the wires.

Do not connect a trailer lighting system directly to your vehicle's lighting system. Use only an approved trailer wiring harness.

Your authorized Kia dealer can assist you in installing the wiring harness.

CAUTION

Failure to use an approved trailer wiring harness could result in damage to the vehicle electrical system and/or personal injury.

Driving on grades

Reduce speed and shift to a lower gear before you start down a long or steep downgrade. If you don't shift down, you might have to use your brakes so much that they would get hot and no longer operate efficiently.

On a long uphill grade, shift down and reduce your speed to around 45 mph (70 km/h) to reduce the possibility of engine and transaxle overheating.

If your trailer weighs more than 570 kg (1,250 lbs), you should drive with the shift lever in D (Drive) when towing a trailer.

Operating your vehicle in D (Drive) when towing a trailer will minimize heat buildup and extend the life of your transmission.

Parking on hills

Generally, you should not park your vehicle, with a trailer attached, on a hill. People can be seriously or fatally injured, and both your vehicle and the trailer can be damaged if they begin a downhill trajectory.

 **WARNING - Parking on a Hill**
Parking your vehicle on a hill with a trailer attached could cause serious injury or death should a down hill trajectory happen.

However, if you ever have to park your trailer on a hill, here's how to do it:

1. Apply your brakes, but don't shift into gear.
2. Have someone place chocks under the trailer wheels.
3. When the wheel chocks are in place, release the brakes until the chocks absorb the load.
4. Reapply the brakes. Apply your parking brake, and then shift to P (Park).
5. Release the brakes.

WARNING - Parking Brake

It can be dangerous to get out of your vehicle if the parking brake is not firmly set.

If you have left the engine running, the vehicle can move suddenly. You or others could be seriously or fatally injured.

When you are ready to leave after parking on a hill

1. With the transmission in P (Park), apply your brakes and hold the brake pedal down while you:
 - Start your engine;
 - Shift into gear; and
 - Release the parking brake.
2. Slowly remove your foot from the brake pedal.
3. Drive slowly until the trailer is clear of the chocks.
4. Stop and have someone pick up and store the chocks.

Maintenance When Trailer Towing

Your vehicle will need service more often when you regularly pull a trailer. Important items to pay particular attention to include engine oil, automatic transmission fluid, axle lubricant and cooling system fluid. Brake condition is another important item to frequently check. Each item is covered in this manual, and the Index will help you find them quickly. If you're trailering, it's a good idea to review these sections before you start your trip.

Don't forget to also maintain your trailer and hitch. Follow the maintenance schedule that accompanied your trailer and check it periodically. Preferably, conduct the check at the start of each day's driving. Most importantly, all hitch nuts and bolts should be tight.

OVERLOADING

CAUTION

The gross axle weight rating (GAWR) and the gross vehicle weight rating (GVWR) for your vehicle are on the manufacturer's label attached to the driver's door. Exceeding these ratings can cause an accident or vehicle damage. You can calculate the weight of your load by weighing the items (or people) before putting them in the vehicle. Be careful not to overload your vehicle.

DRIVING TIPS

LABEL INFORMATION

There are several important labels and identification numbers located on your vehicle. The label locations are identified in the illustrations follows:

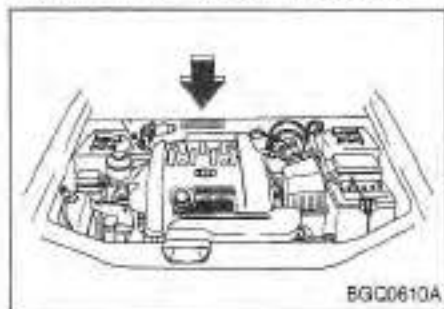

Vehicle Identification Number (VIN)



Tire Specification / Pressure Label

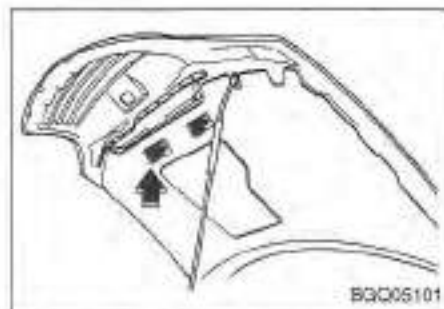

Vehicle Emission Control
Information and Vacuum Hose
Routing Diagram

Road Warning	6-2
Overheating	6-3
Emergency Starting	6-4
Electrical Circuit Protection	6-7
Towing	6-12
If You Have a Flat Tire	6-14

ROAD WARNING



- *The hazard warning flasher operates whether your vehicle is running or not.*
- *The turn signals do not work when the hazard flasher is on.*
- *Care must be taken when using the hazard warning flasher while the vehicle is being towed.*

Hazard Warning Flasher

The hazard warning flasher serves as a warning to other drivers to exercise extreme caution when approaching, overtaking, or passing your vehicle. It should be used whenever emergency repairs are being made or when the vehicle is stopped near the edge of a roadway.

Depress the flasher switch with the ignition switch in any position. The flasher switch is located in the center console switch panel. All turn signal lights will flash simultaneously.

OVERHEATING

If your temperature gauge indicates overheating, if you experience a loss of power, or if you hear a loud knocking or pinging noise, the engine has probably overheated. Should any of these symptoms occur, use the following procedure:

1. Turn on the hazard warning flasher, then drive to the nearest safe location and stop your vehicle; shift to P (Park) and apply the parking brake.
2. Make sure the air conditioner is off.
3. If coolant or steam is boiling out of the radiator, stop the engine and call an authorized Kia dealer for assistance. If coolant is not boiling out, allow the engine to idle and open the hood to permit the engine to cool gradually. If the temperature does not go down with the engine idling, stop the engine and allow sufficient time for it to cool.

4. The coolant level should then be checked. Use the coolant reservoir dipstick to check the level. If the level in the reservoir is low, look for leaks at the radiator hoses and connections, heater hoses and connections, radiator, and water pump. If you find a major leak or another problem that may have caused the engine to overheat, do not operate the engine until it has been corrected. Call an authorized Kia dealer for assistance. If you do not find a leak or other problem, carefully add coolant to the reservoir.



WARNING - Removing Radiator Cap

Do not remove the radiator cap when the engine and radiator are hot. Scalding hot coolant and steam may blow out under pressure. This could cause serious injury.

If the engine frequently overheats, have the cooling system checked and repaired.

EMERGENCY STARTING

Jump Starting

Jump starting can be dangerous if done incorrectly. Therefore, to avoid harm to yourself or damage to your vehicle or battery, follow the jump starting procedures on this page. If in doubt, we strongly recommend that you have a Kia Roadside Assistance technician jump start your vehicle.

* NOTICE

Use only a 12-volt jumper system. You can damage a 12-volt starting motor, ignition system, and other electrical parts beyond repair by use of a 24-volt power supply (either two 12-volt batteries in series or a 24-volt motor generator set).

WARNING - Battery

- Keep all flames or sparks away from the battery. The battery produces hydrogen gas which may explode if exposed to flame or sparks.
- Do not attempt to jump start the vehicle if the discharged battery is frozen or if the electrolyte level is low; the battery may rupture or explode.

Jump starting procedure

1. Make sure the booster battery is 12-volt and that its negative terminal is grounded.
2. Check the electrolyte level of each of the battery cells.
3. If the booster battery is in another vehicle, do not allow the vehicles to touch.

IN CASE OF AN EMERGENCY

Connecting jumper cables

Connect cables in numerical order and disconnect in reverse order.

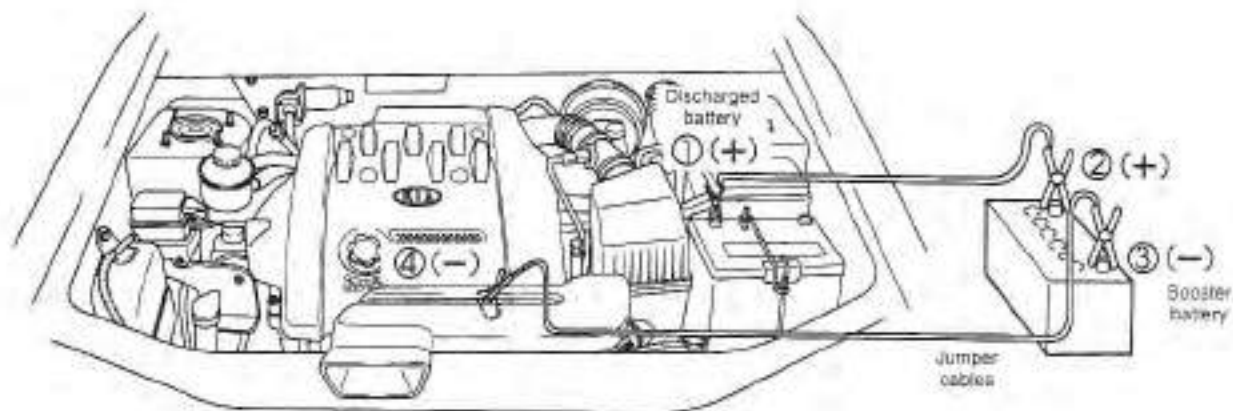

BGQ06001

4. Turn off all unnecessary electrical loads.
5. Connect the jumper cables in the exact sequence shown in the previous illustration. First connect one end of a jumper cable to the positive terminal of the discharged battery, then connect the other end to the positive terminal on the booster battery. Proceed to connect one end of the other jumper cable to the negative terminal of the booster battery, then the other end to a solid, stationary, metallic point (for example, the engine lifting bracket) away from the battery. Do not connect it to or near any part that moves when the engine is cranked. Do not connect the jumper cable from the negative terminal of the booster battery to the negative terminal of the discharged battery. Do not allow the jumper cables to contact anything except the correct battery terminals or the correct ground. Do not lean over the battery when making connections.

6. Start the engine of the vehicle with the booster battery and let it run at 2,000 rpm, then start the engine of the vehicle with the discharged battery.

If the cause of your battery discharging is not apparent, you should have your vehicle checked by an authorized Kia dealer.

Push-Starting

Vehicles equipped with automatic transaxle cannot be push-started. Follow the directions on page 6-4 for jump-starting.

CAUTION

Never tow a vehicle to start it because the sudden surge forward when the engine starts could cause a collision with the tow vehicle.

IN CASE OF AN EMERGENCY

ELECTRICAL CIRCUIT PROTECTION

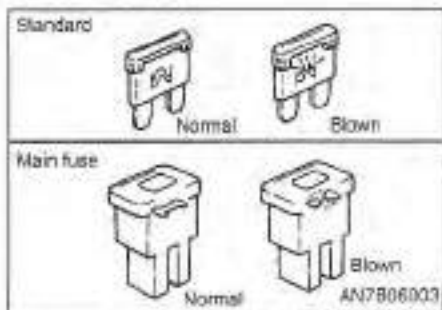

Fuses

A vehicle's electrical system is protected from electrical overload damage by fuses.

This vehicle has two fuse panels, one located in the driver's side kick panel, the other in the engine compartment near the battery.

If any of your vehicle's lights, accessories, or controls do not work, check the appropriate circuit fuse. If a fuse has blown, the element inside the fuse will be melted.

Always replace a blown fuse with one of the same rating.

If the replacement fuse blows out, this indicates an electrical problem. Avoid using the system involved and immediately consult an authorized Kia dealer.

Two kinds of fuses are used: standard for lower amperage rating and main for higher amperage ratings.

Fuse replacement

⚠ WARNING - Fuse Replacement

- Never replace a fuse with anything but another fuse of the same rating.
- A higher capacity fuse could cause damage and possibly a fire.
- Never install a wire instead of the proper fuse - even as a temporary repair. It may cause extensive wiring damage and possibly a fire.
- Do not use a screwdriver or any other metal object to remove fuses because it may cause a short circuit and damage the system.

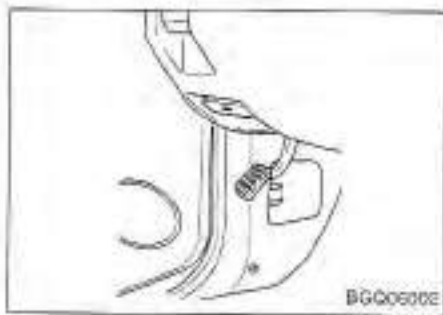

If you do not have a spare, use a fuse of the same rating from a circuit you may not need for operating the vehicle, such as the radio or clock (Room) fuse.

If the electrical system does not work, first check the driver's side fuse panel.

1. Turn the ignition switch and all other switches off.
2. Pull the suspected fuse straight out.
3. Check the removed fuse; replace it if it is blown.
Four (4) spare fuses are provided in the fuse panel.
4. Push in a new fuse of the same rating, and make sure it fits tightly in the clips.

If it fits loosely, consult an authorized Kia dealer.

IN CASE OF AN EMERGENCY

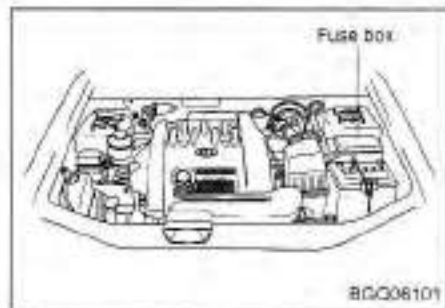

If the headlights or other electrical components do not work and the fuses are OK, check the fuse block in the engine compartment. If a fuse is blown, it must be replaced.

1. Turn the ignition switch and all other switches off.
2. Remove the fuse block cover by unhooking the tab on one end and tilting the cover back toward the other end.
3. Check the fuses. If one is blown, replace it with a new one of the same rating.

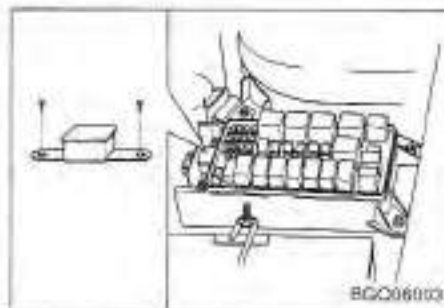

If the 120A "MAIN" fuse is blown, it must be removed as follows:

1. Disconnect the negative battery cable.
2. Remove the bolts in the photo above.
3. Replace the fuse with a new one of the same 120A rating.
4. Reinstall in the reverse order of removal.

IN CASE OF AN EMERGENCY

Fuse Panel Description

Driver-side kick panel

1	W/SHD 15A	2	(S/R/OOF) 20A	3	START 10A
4	HAZARD 15A	5	P/SCK(FRT) 20A	6	CIGAR 20A
7	OBD-II 50A	8	W/PER(FRT) 20A	9	P/SCK(RR) 30A
10		11	W/PER(RR) 10A	12	ACC 10A
13	F/FOG 15A	14	AT 15A	15	
16	ROOM LAMP 10A	17		18	
19	STOP LAMP 10A	20	TURN LAMP 10A	21	A/BAG 10A
22	METER 10A	23		24	ENGINE 10A

USE THE DESIGNATED FUSES ONLY.
1. IS OPTION.

Description	FUSE RATING	PROTECTED COMPONENT
1. W/SHD	15 A	Defroster
2. S/R/OOF	20 A	Sunroof
3. SRART	10 A	Starting system, PCM, ACC
4. HAZARD	15 A	Turn & Hazard flasher unit
5. P/SCK(FRT)	20 A	Front Power Socket
6. CIGAR	20 A	Cigar lighter
7. OBD-II	10 A	Check connector
8. WIPER (FRT)	20 A	Wiper & Washer, Head light, Front heater & Aircon, Cooling system, Defroster
9. P/SCK (RR)	30 A	Rear power socket
10.	-	-
11. WIPER (RR)	10 A	Wiper & Washer, ETWIS, Heater & Aircon, Trip computer, sunroof
12. ACC	10 A	Power mirror, Cigar lighter, Power Socket, Clock, Keyless entry, Audio
13. F/FOG	15 A	Front fog lamp
14. AT	15 A	PCM (Power train control system)
15.	-	-
16. ROOM LAMP	10 A	Instrument cluster, ETWIS, Head light, DRL, Keyless entry, Room lamp, Survivor lamp, Clock
17.	-	-
18.	-	-
19. STOP LAMP	20 A	Stop light
20. TURN LAMP	10 A	Turn & Hazard flasher unit
21. A/BAG	10 A	Airbag
22. METER	10 A	PCM, ACC, Trip computer, Stop light, DRL, ETWIS, Instrument cluster, Front heater & Aircon
23.	-	-
24. ENGINE	10 A	PCM, Cooling, Speed sensor, Diagnosis connector, ACC, Instrument cluster, ABS

IN CASE OF AN EMERGENCY

Engine compartment

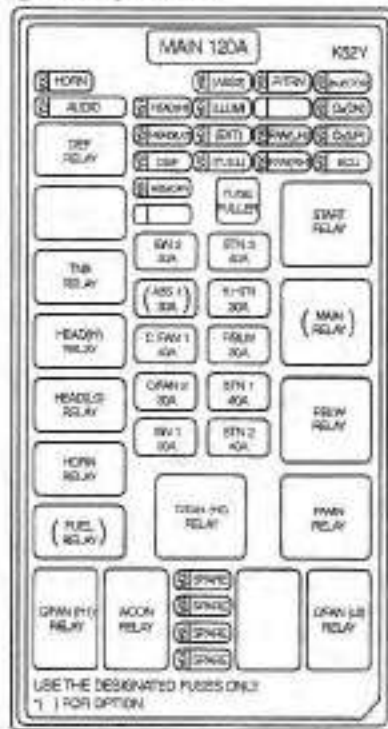

HORN	20 A	Horn
ABS2	30 A	ABS
P/TRN	10 A	PCM, Main relay
INJECTOR	15 A	PCM
AUDIO	15 A	Audio
HEAD (HI)	15 A	Head Light
ILLUM	10 A	Key hole illumination
O2 (DN)	15 A	PCM
HEAD (LO)	15 A	Head light
EXT	10 A	DRL, License lamp, Tail lamp, Position lamp, Turn lamp
P/W (LH)	25 A	Power window
O2 (UP)	15 A	PCM
DEF	25 A	Defroster
FUEL	15 A	Fuel pump relay
P/W (RH)	25 A	Power window
ECU	10 A	PCM, Cooling
Memory	10 A	Front heater & aircon, Etwis, Keyless entry system
IGN 2	30 A	Ignition switch
BTN 3	30 A	Turn & Hazard flasher unit, Power door lock
ABS 1	30 A	ABS
R. HTR	30 A	Rear heater & Aircon
C/FAN 1	40 A	Cooling system
F/BLW	30 A	Front heater & Aircon
C/FAN 2	30 A	Cooling system
BTN 1	40 A	Cigar lighter, Power socket
IGN 1	30 A	Ignition switch
BTN 2	40 A	Power seat, PCM

TOWING

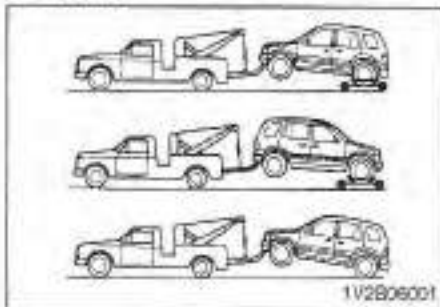

If emergency towing is necessary, we recommend having it done by an authorized Kia dealer or a commercial tow-truck service. Proper lifting and towing procedures are necessary to prevent damage to the vehicle. The use of wheel dollies is recommended.

When being towed by a commercial tow truck and wheel dollies are not used, the front of the vehicle should always be lifted, not the rear.

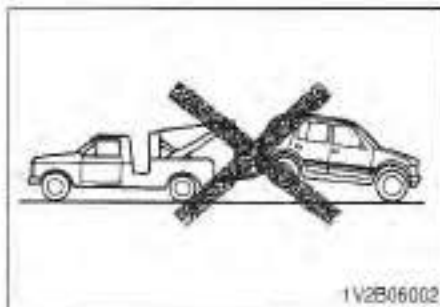

When towing your vehicle in an emergency without wheel dollies:

1. Set the Ignition switch in the ACC position;
2. Place the transaxle shift lever in Neutral;
3. Release the parking brake.

*** NOTICE**

Failure to place the transaxle shift lever in neutral may cause internal damage to the transaxle.



Towing With a Vehicle Other Than a Tow Truck

In case of an emergency, there are tow hooks on the front and rear of the vehicle.

*** NOTICE**

- Attach a towing strap to the tow hook.
- Using a portion of the vehicle other than the tow hooks for towing may damage the body of your vehicle.

IN CASE OF AN EMERGENCY



- Do not try to tow your vehicle when the wheels are stuck in mud.
- Avoid towing a vehicle heavier than the vehicle doing the towing.
- The drivers of both vehicles should communicate with each other frequently.

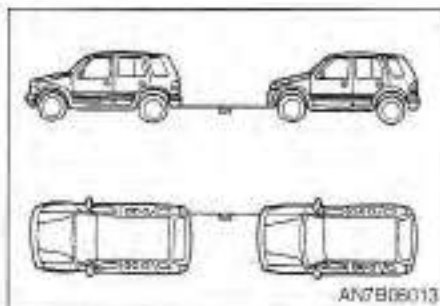

- Use a towing strap less than 16 feet (5 m) long. Attach a white or red cloth (about 12 inches (30cm) wide) in the middle of the strap for easy visibility.
- Drive carefully so that the towing strap is not loosened during towing.

IN CASE OF AN EMERGENCY

IF YOU HAVE A FLAT TIRE

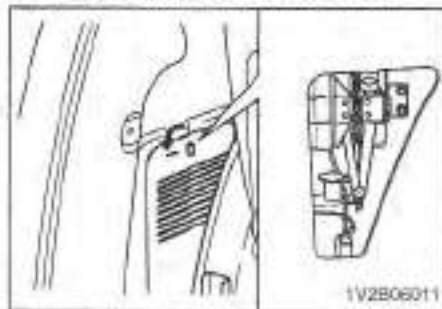

Storing the Jack and Tools

The jack handle and wheel lug nut wrench are stored in the tool bag located in the rear washer compartment with the jack.

The rear washer compartment is located on the left side of the cargo area.

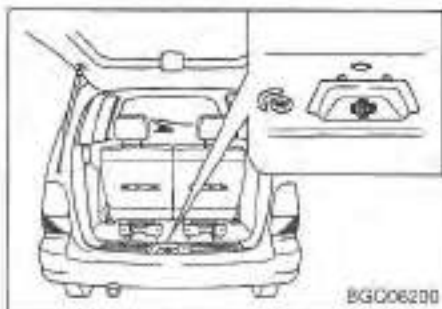

Removing the Spare Tire

Your spare tire is stored underneath your vehicle, directly below the cargo area.

To remove it:

1. Open the rear hatch and find the plastic hex bolt cover in the rear hatch door sill.
2. Remove the cover.

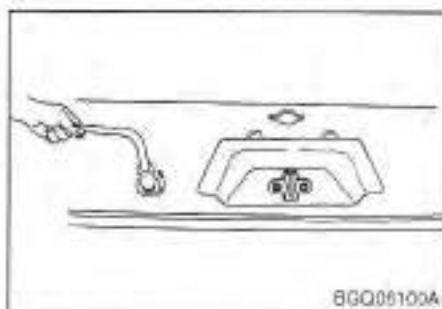

3. Use the wheel lug nut wrench to loosen the bolt enough to lower the spare tire carrier assembly, enough to access to the wing-nut securing the spare tire

IN CASE OF AN EMERGENCY

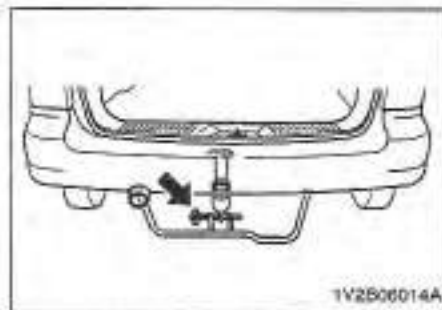

4. Loosen the wing nut located on the spare tire carrier assembly and then disconnect the latch connecting the spare tire carrier to the spare tire lock assembly.

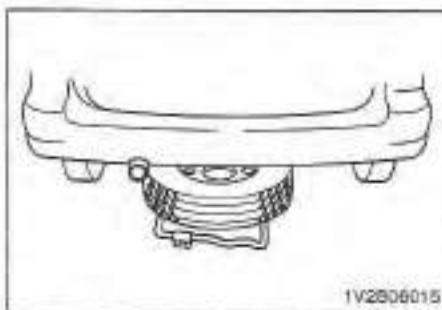

5. Remove the spare tire.
6. Store the jack and tire in the reverse order of removal.

* NOTICE

Check the inflation pressures as soon as possible after installing the spare tire. Adjust it to the specified pressure, as necessary.

Changing Tires

Jacking Instructions

The jack is provided for emergency tire changing only.

Follow jacking instructions to reduce the possibility of personal injury.

⚠ WARNING - Changing Tires

- Never attempt vehicle repairs in the traffic lanes of a public road or highway.
- Always move the vehicle completely off the road and onto the shoulder before trying to change a tire. If you cannot find a firm, level place off the road, call a towing service company for assistance.
- Do not exceed the jack's maximum permissible load: 2,200 lbs. (1,000 kg).

(Continued)

IN CASE OF AN EMERGENCY

- Be sure to use the correct front and rear jacking positions on the vehicle; never use the bumpers or any other part of the vehicle for jack support.
- The vehicle can easily roll off the jack causing serious injury or death. Never allow any portion of your body to get beneath the vehicle while using the jack.
- Do not start or run the engine while the vehicle is on the jack.

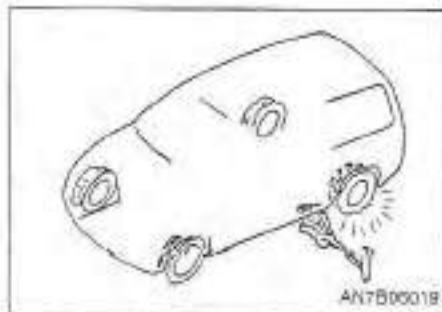

Tire replacement

1. Park on a level surface and set the parking brake firmly.
2. Shift into P (Park).
3. Activate the hazard warning flasher.
4. Remove the wheel lug nut wrench, jack, jack handle, and spare tire from the vehicle.
5. Block both the front and rear of the wheel that is diagonally opposite the jack position.

⚠ WARNING - Changing a Tire
To prevent vehicle movements while changing a tire, always set the parking brake fully, and always block the wheel diagonally opposite the wheel being changed.

IN CASE OF AN EMERGENCY

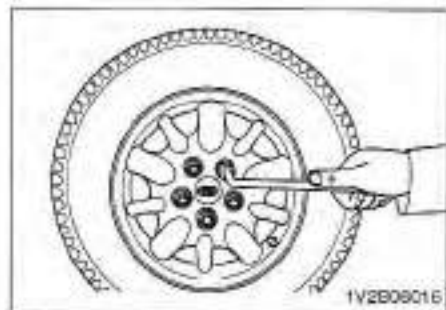

6. Loosen the wheel nuts counterclockwise one turn each, but do not remove any nut until the tire has been raised off the ground.

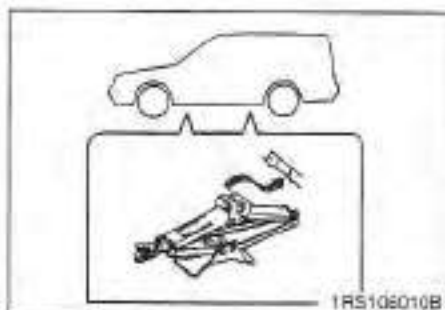

7. Place the jack at the front or rear jacking position closest to the tire you are changing. Place the jack at the designated locations under the frame. The jacking positions are plates welded to the frame with two tabs and a raised dot to index with the jack.

WARNING - Jack Location

To reduce the possibility of injury, be sure to use only the jack provided with the vehicle and in the correct jack position; never use any other part of the vehicle for jack support.

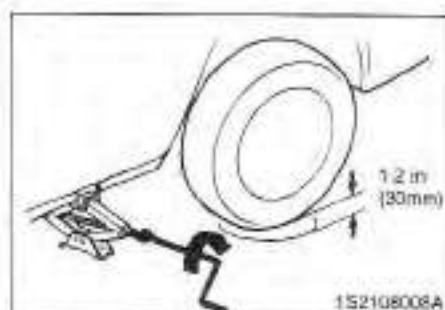

8. Assemble the jack handle and insert the jack handle into the jack, then turn it clockwise, raising the vehicle until the tire just clears the ground (approximately 1.2 in (30 mm)). Before removing the wheel lug nuts, make sure the vehicle is stable and that there is no chance for it to slip or move.
9. Remove the wheel lug nuts by turning them counterclockwise, then remove the wheel.

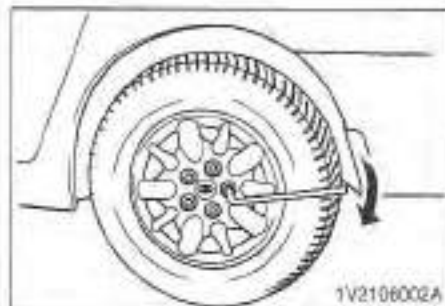

10. Mount the spare tire into position and install the wheel lug nuts with the beveled edge inward.

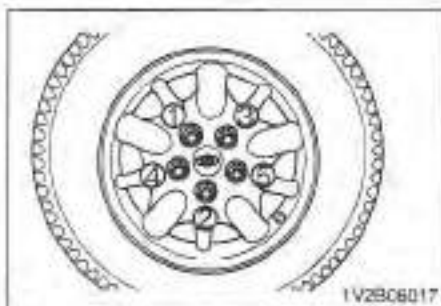

11. Turn the jack handle counterclockwise and lower the vehicle until it touches the ground. Tighten the wheel lug nuts firmly in a "star" pattern. Once the lug nuts have been tightened, lower the vehicle fully to the ground and continue to tighten the lug nuts until they are fully secured. If you are unsure of the tightness of the wheel lug nuts, have them checked at the nearest service station. The specified tightening torque is 65-87 ft. lb. (88-118 N•m).

CAUTION

Your vehicle has metric threads on the wheel studs and nuts. Make certain during wheel removal that the same nuts removed are reinstalled - or, if replaced, that nuts with metric threads and the same chamfer configuration are used. Installation of a non-metric thread nut on a metric stud or vice-versa will not secure the wheel to the hub properly and will damage the stud so that it must be replaced. Note that most lug nuts do not have metric threads. Be sure to use extreme care in checking for thread style before installing aftermarket lug nuts or wheels. If in doubt, consult an Authorized Kia Dealer.

▲ WARNING - Wheel Studs

If the studs are damaged, they may lose their ability to retain the wheel. This could lead to the loss of the wheel and a collision.

To prevent the jack, jack handle, wheel lug nut, wrench and spare tire from rattling while the vehicle is in motion, store them properly.

Maintenance Services.....	7-2
Maintenance Schedule.....	7-4
Owner Maintenance.....	7-8
Engine Compartment.....	7-10
Engine Oil and Oil Filter.....	7-11
Engine Cooling System.....	7-13
Brakes.....	7-16
Parking Brake.....	7-16
Power Steering.....	7-17
Automatic Transaxle.....	7-18
Lubricants and Fluids.....	7-20
Air Cleaner.....	7-21
Wiper Blades.....	7-22
Battery.....	7-24
Tires and Wheels.....	7-26
Bulb Replacement.....	7-31
Lubricant Specifications.....	7-40
Exterior Care.....	7-42
Interior Care.....	7-45

MAINTENANCE SERVICES

You should exercise the utmost care to prevent damage to your vehicle and injury to yourself whenever performing any maintenance or inspection procedures.

Should you have any doubts concerning the inspection or servicing of your vehicle, we strongly recommend that you have a reliable and qualified service shop perform this work, preferably an authorized Kia dealer.

An authorized Kia dealer has factory-trained technicians and genuine Kia parts to service your vehicle properly. For expert advice and quality service, see an authorized Kia dealer.

Inadequate, incomplete or insufficient servicing may result in operational problems with your vehicle that could lead to vehicle damage, an accident, or personal injury.

Owner's Responsibility

* NOTICE

Maintenance Service and Record Retention are the owner's responsibility.

You should retain documents that show proper maintenance has been performed on your vehicle in accordance with the scheduled maintenance service charts shown on the following pages. You need this information to establish your compliance with the servicing and maintenance requirements of your Kia warranties.

Detailed warranty information is provided in your Warranty and Consumer Information Manual.

Repairs and adjustments required as a result of improper maintenance or a lack of required maintenance are not covered.

We strongly recommend that all vehicle maintenance be performed by an authorized Kia dealer using genuine Kia parts.

MAINTENANCE

MAINTENANCE SCHEDULE

Engine Control system

MAINTENANCE INTERVALS MAINTENANCE ITEM	Kilometers or Time in Months, Whichever Comes First																	
	Months	6	12	18	24	30	36	42	48	54	60	66	72	78	84	90	96	
	km x 1,000	12	24	36	48	60	72	84	96	108	120	132	144	156	168	180	192	
Engine oil & Engine oil filter (1)	Change every 6,000 km or 3 months, whichever comes first																	
Drive belt (tension)			I			I			I			I			I			
Cooling system hoses & connections		I		I		I		I		I		I		I		I		
Engine coolant (1)	I	I	I	R	I	I	I	R	I	I	I	R	I	I	I	I	R	
Fuel filter						R						R						
Fuel tank cap, lines and hoses			I					I				I					I	
Air cleaner element (2)	I	I	I	R	I	I	I	R	I	I	I	R	I	I	I	I	R	
Ignition wires				I				I				I					I	
Spark plugs*				R				R				R					R	

I : Inspect these items and their related parts. If necessary, correct, clean, refill, adjust or replace.

R : Replace or change.

NOTE

Check the engine oil and coolant levels every week.

* PFR5N-11, RC10PYPB4 : Replace every 96,000 km.

MAINTENANCE

MAINTENANCE SCHEDULE

Engine Control system (cont.)

MAINTENANCE INTERVALS MAINTENANCE ITEM	Kilometers or Time in Months, Whichever Comes First																	
	Months	6	12	18	24	30	36	42	48	54	60	66	72	78	84	90	96	
	km x 1,000	12	24	36	48	60	72	84	96	108	120	132	144	156	168	180	192	
Idle speed		I		I		I		I		I		I		I		I		
Evaporative emission canister & vapour lines						I					I					I		
PCV valve							I					I						
Engine timing belt	Replace every 102,000 km																	

I : Inspect these items and their related parts. If necessary, correct, clean, refill, adjust or replace.

R : Replace or change.

(1) Refer to the lubricant and coolant specifications in the Owner's Manual.

(2) More frequent maintenance is required if driving under dusty conditions.

MAINTENANCE

MAINTENANCE SCHEDULE

Chassis and Body

MAINTENANCE INTERVALS MAINTENANCE ITEM	Kilometers or Time in Months, Whichever Comes First																
	Months	6	12	18	24	30	36	42	48	54	60	66	72	78	84	90	96
	km x 1,000	12	24	36	48	60	72	84	96	108	120	132	144	156	168	180	192
Air conditioner compressor operation & refrigerant amount		I		I		I		I		I		I		I		I	
Air conditioner air filter	Replace every 15,000 km																
Exhaust pipes, heat shield & mounting	I		I		I		I		I		I		I		I		I
Front suspension ball joints			I			I			I			I			I		
Brakes / clutch fluid (1)	I	I	I	I	R	I	I	I	I	R	I	I	I	I	I	R	I
Front brake pads & discs (3)	I	I	I	I	I	I	I	I	I	I	I	I	I	I	I	I	I
Rear brake pads & discs / drums (3)	I	I	I	I	I	I	I	I	I	I	I	I	I	I	I	I	I
Parking brake		I		I		I		I		I		I		I		I	
Brake line & connections (including booster)				I			I				I			I			I
Clutch & brake pedal free play	I	I	I	I	I	I	I	I	I	I	I	I	I	I	I	I	I
Automatic transaxle fluid (1)	I	I	R	I	I	R	I	I	R	I	I	R	I	I	R	I	I
Chasis & underbody bolts & nuts	I	I	I	I	I	I	I	I	I	I	I	I	I	I	I	I	I
Tire condition & inflation pressure	I	I	I	I	I	I	I	I	I	I	I	I	I	I	I	I	I

I : Inspect these items and their related parts. If necessary, correct, clean, refill, adjust or replace.

R : Replace or change.

MAINTENANCE

MAINTENANCE SCHEDULE

Chassis and Body (cont.)

MAINTENANCE INTERVALS MAINTENANCE ITEM	Kilometers or Time in Months, Whichever Comes First																
	Months km x 1,000	6	12	18	24	30	36	42	48	54	60	66	72	78	84	90	96
Wheel alignment (4)	Inspect when abnormal condition noted																
Tire rotation	Rotate the tires every 12,000 km																
Steering operation & linkage	I	I	I	I	I	I	I	I	I	I	I	I	I	I	I	I	I
Power steering fluid & lines		I		I		I		I		I		I		I		I	
Driveshaft dust boots			I			I		I		I		I		I		I	
Seat belts, buckles & anchors	I	I	I	I	I	I	I	I	I	I	I	I	I	I	I	I	I
Locks, hinges & hood latch	L	L	L	L	L	L	L	L	L	L	L	L	L	L	L	L	L

I : Inspect these items and their related parts. If necessary, correct, clean, refill, adjust or replace.

R : Replace or change.

L : Lubricate

(1) Refer to the lubricant and coolant specifications in the Owner's Manual.

(3) More frequent maintenance is required if the vehicle is operated under any of the following conditions :

- a. Short-distance driving.
- b. Driving on dusty roads.
- c. Extensive idling or slow-speed driving in stop-and-go traffic.

(4) if necessary, rotate and balance the wheels.

OWNER MAINTENANCE

Owner Maintenance Schedule

The following lists are vehicle checks and inspections that should be performed by the owner at the frequencies indicated to help ensure safe, dependable operation of your vehicle.

Any adverse conditions should be brought to the attention of your dealer for service advice as soon as possible.

These Owner Maintenance Checks are generally not covered by warranties and you may be charged for labor, parts and lubricants used.

When you stop for fuel:

- Check the engine oil level.
- Check coolant level in coolant reservoir.
- Check the windshield washer fluid level.
- Look for low or under-inflated tires.

While operating your vehicle:

- Note any changes in the sound of the exhaust or any smell of exhaust fumes in the vehicle.
- Check for vibrations in the steering wheel. Notice any increased steering effort or looseness in the steering wheel, or change in its straight-ahead position.
- Notice if your vehicle constantly turns slightly or "pulls" to one side when traveling on smooth, level road.
- When stopping, listen and check for strange sounds, pulling to one side, increased brake pedal travel or "hard-to-push" brake pedal.
- If any slipping or changes in the operation of your transaxle occurs, check the transaxle fluid level.
- Check automatic transaxle P (Park) function.
- Check parking brake.
- Check for fluid leaks under your vehicle (water dripping from the air conditioning system after use is normal).

At least monthly

- Check coolant level in the coolant recovery reservoir.
- Check the operation of all exterior lamps, including the brake lamps, turn signals and hazard warning flashers.

At least twice a year (i. e., every Spring and Fall):

- Check radiator, heater and air conditioning hoses for leaks or damage.
- Check windshield washer spray and wiper operation. Clean wiper blades with clean cloth dampened with washer fluid.
- Check headlamp alignment.
- Inspect halfshaft dust boots.
- Check muffler, exhaust pipes, shields and clamps.
- Check the lap/shoulder belts for wear and function.
- Check air pressure in spare tire.
- Check for worn tires and loose wheel lug nuts.

At least once a year:

- Clean body and door drain holes.
- Lubricate door hinges and checks, and hood hinges.
- Lubricate door and hood locks and latches.
- Lubricate door rubber weatherstrips.
- Check the air conditioning system before the warm weather season.
- Check the power steering fluid level.
- Inspect and lubricate automatic transaxle linkage and controls.
- Clean battery and terminals, check electrolyte level on low maintenance (auxiliary and replacement) batteries.
- Check the brake fluid level.



WARNING - Maintenance Work

- Performing maintenance work on a vehicle can be dangerous. You can be seriously injured while performing some maintenance procedures. If you lack sufficient knowledge and experience or the proper tools and equipment to do the work, have it done by a Kia technician.
- Working under the hood with the engine running is dangerous. It becomes even more dangerous when you wear jewelry or loose clothing. These can become entangled in moving parts and result in injury. Therefore, if you must run the engine while working under the hood, make certain that you remove all jewelry (especially rings, bracelets, watches, and necklaces) and all neckties, scarves, and similar loose clothing before getting near the engine or cooling fans.

ENGINE COMPARTMENT

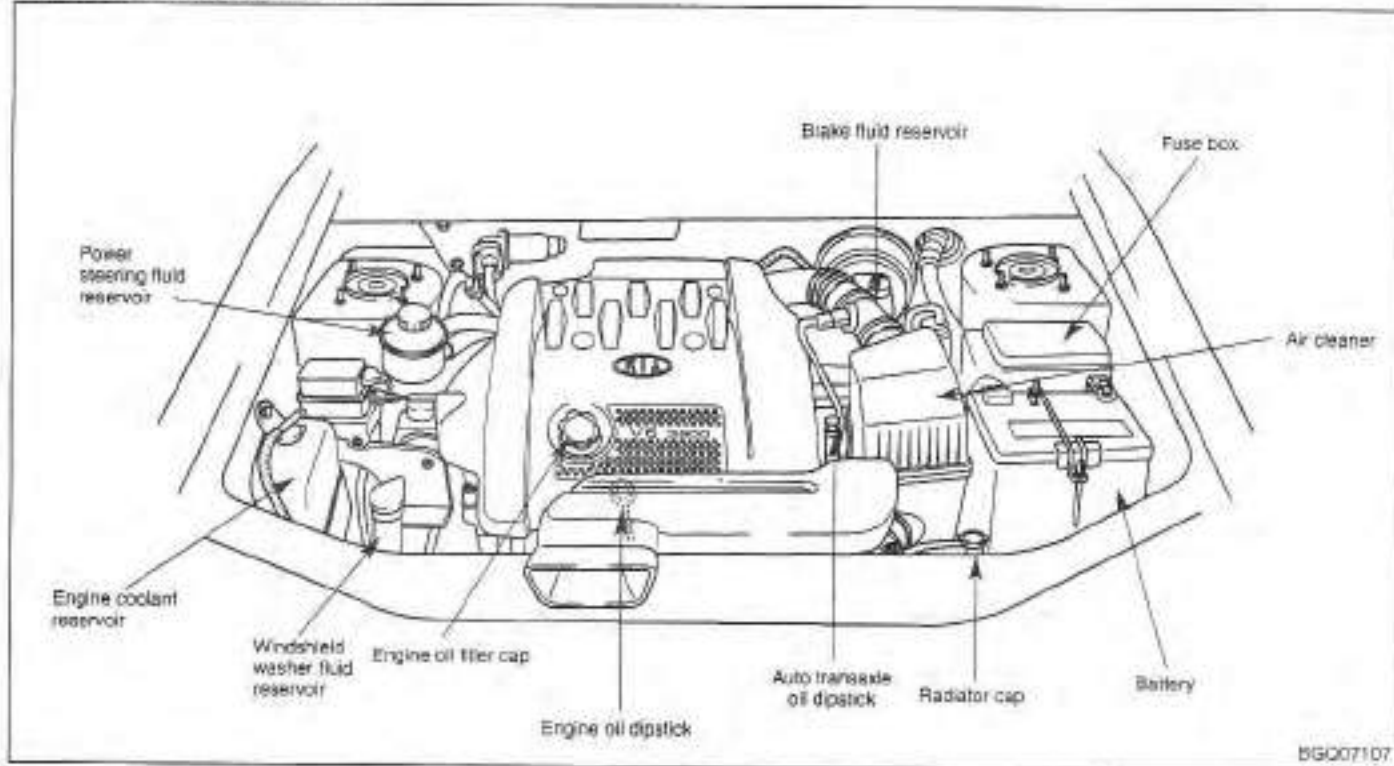

BGQ07107

ENGINE OIL AND OIL FILTER

Checking the Engine Oil Level

1. Be sure the vehicle is on level ground.
2. Start the engine and allow it to reach normal operating temperature.
3. Turn the engine off and wait a few minutes for the oil to return to the oil pan.
4. Pull the dipstick out, wipe it clean, and re-insert it fully.
5. Pull the dipstick out again and check the level. The level should be between F and L.

If it is near or at L, add enough oil to bring the level to F. **Do not overfill.**

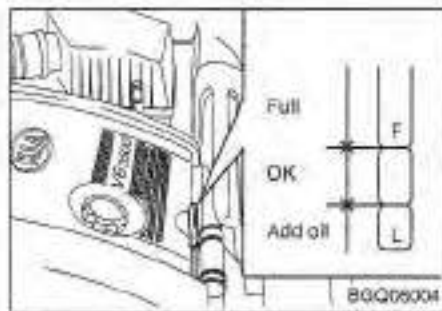

*Use only the specified engine oil.
(Refer to "Recommended Lubricants"
later in this section.)*

Changing the Engine Oil and Filter

Change engine oil and filter according to the Scheduled Maintenance at the beginning of this section.

⚠ WARNING - Engine Oil
Continuous contact with **USED engine oil has caused skin cancer in laboratory mice. Protect your skin by washing with soap and water.**

Keep all engine oil out of the reach of children.

1. Warm the engine up for a few minutes and then turn it off. Remove the oil filler cap.
2. Drain the oil into a suitable container after removing the oil filler cap and drain plug.

⚠ CAUTION

Both the oil and engine are hot. Do not burn yourself.

3. Remove the engine oil filter with an oil filter wrench.

* NOTICE

Do not allow the oil filter gasket to remain on the oil filter mounting surface. This will cause oil leakage and engine damage. Remove the old gasket completely so that a new gasket may be properly seated.

4. Use a clean rag to clean the oil filter mounting surface on the engine.
5. Apply a small amount of engine oil to the new oil filter O-ring seal.
6. Install the oil filter and tighten it. (Refer to the oil filter caution label for tightening instructions.)
7. Install a new washer on the drain plug.
8. Replace the drain plug after the oil has thoroughly drained. Torque the plug to 22 lb-ft (30 N•m).
9. Refill the engine with new oil to the F mark on the dipstick. Do not overfill.

10. Replace the oil filler cap securely.
11. Start the engine and inspect around the oil filter seal for leaks. Stop the engine.
12. Check the oil level and fill to the F mark as necessary.

Oil capacity

Use only the specified Service Grade engine oil.

* NOTICE

- Although oil filters may have the same external appearance, their internal designs differ significantly. These filters are not interchangeable. To avoid potential engine damage, always consult an authorized Kia dealer and use a genuine Kia oil filter.
- Follow these instructions carefully. An improper oil filter installation can cause oil leakage and engine damage.

ENGINE COOLING SYSTEM

The high-pressure cooling system has a reservoir filled with year-round antifreeze coolant. The reservoir is filled at the factory.

Check the antifreeze protection and coolant level at least once a year, at the beginning of the winter season, and before traveling to a colder climate.

Checking the Coolant Level

WARNING - Removing Radiator Cap

- Never attempt to remove the radiator cap while the engine is operating. Doing so might lead to cooling system and engine damage and could result in serious personal injury from escaping hot coolant or steam.
- Turn the engine off and wait until it has cooled. Even then, use extreme care when removing the radiator cap. Wrap a thick towel around it, and turn it counterclockwise slowly to the first stop. Step back while the pressure is released from the cooling system. When you are sure all the pressure has been released, press down on the cap, using a thick towel, and continue turning counterclockwise to remove it.
- Even if the engine is not operating, do not remove the radiator cap or the drain plug while the engine and radiator are hot. Hot coolant and steam may still blow out under pressure, causing serious injury.

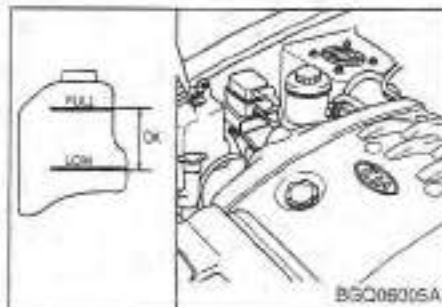

Check the condition and connections of all cooling system hoses and heater hoses. Replace any swollen or deteriorated hoses.

The coolant level should be full in the radiator and between Full and Low on the coolant reservoir when the engine is cool.

If the coolant level is low, add enough specified coolant to provide protection against freezing and corrosion. Bring the level to Full, but do not overfill. If frequent additions are required, see an authorized Kia dealer for a cooling system inspection.

Changing Coolant

Change coolant according to the Maintenance Schedule.

- Use only soft (de-mineralized) water in the coolant mixture.
- The engine in your vehicle has aluminum engine parts and must be protected by an ethylene-glycol-based coolant to prevent corrosion and freezing.
- DO NOT USE alcohol or methanol coolant or mix them with the specified coolant.
- Do not use a solution that contains more than 60% coolant, which would reduce the effectiveness of the solution.

For mixture percentage, refer to the following table.

PROTECTION	Mixture Percentage (volume)	
	Coolant Solution	Water
Above 3°F (-16°C)	35	65
Above -15°F (-26°C)	45	55
Above -40°F (-40°C)	55	45

CAUTION

To prevent burning yourself, do not remove the radiator cap or loosen the drain plug if the engine is hot.

1. Turn the radiator cap counterclockwise to remove it.
2. Loosen the radiator drain plug and drain the coolant into a suitable container.
3. With the plug loose, flush the system with running water.

4. Drain the system completely and retighten the drain plug. Add the necessary amount of ethylene-glycol-based coolant and water to provide the required protection against freezing and corrosion. In extremely cold climates, add ethylene-glycol based coolant in accordance with the instructions of the manufacturer.
5. Run the engine at idle with the radiator cap off. Slowly add additional coolant as necessary.
6. At this point, wait until the engine reaches normal operating temperature. Depress the accelerator two or three times; then add coolant as required. Be careful not to burn yourself.
7. Replace the radiator cap. Inspect all connections for leaks and recheck the coolant level in the reservoir. Recheck again after a few days and add coolant as necessary.

BRAKES

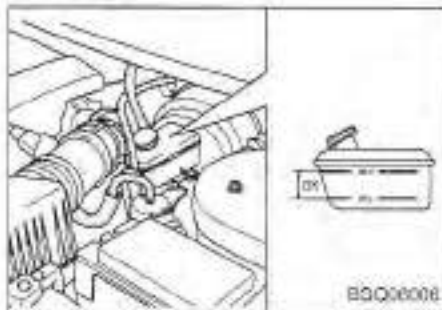

Checking Brake Fluid Level

The brake system has a master cylinder reservoir. Check the fluid level in the reservoir periodically. The fluid level should be between MAX and MIN on the side of the reservoir.

Before removing the reservoir cap and adding brake fluid, clean the area around the reservoir cap thoroughly to prevent brake fluid contamination.

If the level is low, add fluid to the MAX level. The level will fall with accumulated mileage. This is a normal condition associated with the wear of the brake linings. If the fluid level is excessively low, have the brake system checked by an authorized Kia dealer.

Use only the specified brake fluid. (Refer to "Recommended Lubricants" later in this section.)

Never mix different types of fluid.

* NOTICE

In the event the brake system requires frequent additions of fluid, the vehicle should be inspected by an authorized Kia dealer.

PARKING BRAKE



Checking Parking Brake Lever Stroke

Check whether the lever stroke is within specification when the parking brake pedal is depressed with 196 N (44 lb, 20 kg) of force.

Lever stroke : 3.54-4.33 in
(90-110 mm)

POWER STEERING

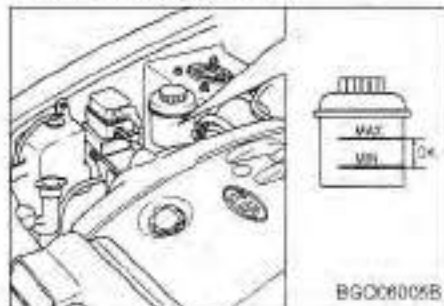

Checking the Power Steering Fluid Level

With the vehicle on level ground, check the fluid level in the power steering reservoir periodically. The fluid should be between MAX and MIN on the side of the reservoir.

If the level is low, add fluid to the MAX level.

In the event the power steering system requires frequent addition of fluid, the vehicle should be inspected by an authorized Kia dealer.

* NOTICE

To avoid damage to the power steering pump, do not operate the vehicle for prolonged periods with a low power steering fluid level.

Use only the specified power steering fluid. (Refer to "Recommended Lubricants" later in this section.)

AUTOMATIC TRANSAXLE

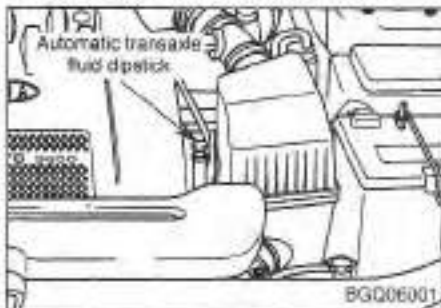

Checking the Automatic Transaxle Fluid Level

The automatic transaxle fluid level should be checked regularly.

The volume of the transaxle fluid changes with temperature. Although it is best to check the level after having driven the vehicle for at least 30 minutes, the level can be checked after warming the fluid using the procedure below.

CAUTION

- *Low fluid level causes transaxle slippage. Overfilling can cause foaming, loss of fluid and transaxle malfunction.*
- *The use of a non-specified fluid could result in transaxle malfunction and failure.*

WARNING - Parking Brake

To avoid sudden movement of the vehicle, set the parking brake and depress the brake pedal before moving the shift lever.

1. Park the vehicle on level ground and firmly set the parking brake.
2. Allow the engine to idle for about 2 minutes.
3. Depress the brake pedal and move the shift lever slowly through all ranges then set it in P (Park).
4. With the engine still idling, pull out the dipstick, wipe it clean and reinsert it fully.

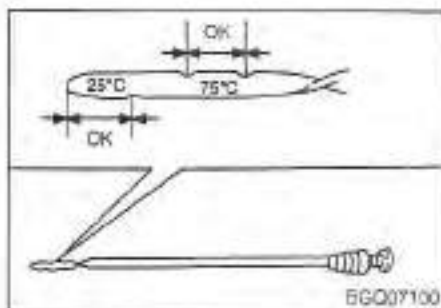

5. Pull out the dipstick again and check the fluid level.

If the fluid has been warmed to normal operating temperature of approximately 167°F (75°C), the fluid level should be between the 2 notches marked 75°C.

*** NOTICE**

The notch on the 25°C scale is for reference only and should NOT be used to determine transaxle fluid level.

Changing the Automatic Transaxle Fluid

1. Raise and suitably support the vehicle.
2. Remove the drain plug located at the bottom center front of the transaxle pan.
3. After the oil has drained completely, install a new washer on the plug, reinstall the drain plug, and tighten to 22 lb-ft (30 N•m).
4. Lower the vehicle.
5. Remove the Automatic Transaxle dipstick located near the center of the engine compartment bulkhead and, using a funnel, add approximately 2 US quarts (2 liters) of automatic transaxle fluid (Diamond ATF SP-III).

* NOTICE

Do NOT overfill the automatic transaxle reservoir. Doing so can cause a seal "blow out", loss of fluid, and damage to the transaxle. If you overfill the reservoir, you must drain the excess prior to driving the vehicle. The transaxle will hold 2.6 US qts. (2.5L) when completely empty. However, it is likely that there will be fluid left in the transaxle after draining, especially if the front of the vehicle was raised to remove the drain plug.

6. Check the fluid level. If necessary, add a small amount of fluid and check the level again. Continue this process until the level reads between the 75°C notches.
7. Replace the dipstick and properly dispose of the used transaxle fluid.

Lubricants and Fluids



Checking the Front Washer Fluid Level

The reservoir is translucent so that you can check the level with a quick visual inspection.

Check the fluid level in the washer fluid reservoir and add fluid if necessary. Plain water may be used if washer fluid is not available. However, use washer solvent with antifreeze characteristics in cold climates to prevent freezing.



Checking the Rear Washer Fluid Level

The reservoir is translucent so that you can check the level with a quick visual inspection. Check the fluid level in the rear washer fluid reservoir and add fluid if necessary.

The rear washer fluid reservoir is located along the left side of the cargo area, just below the pillar at the very rear of your vehicle. Remove the small access panel to reach the reservoir.

CAUTION

- Do not use radiator coolant or antifreeze in the washer fluid reservoir.
- Radiator coolant can severely obscure visibility when sprayed on the windshield and may cause loss of vehicle control or damage to paint and body trim.

Body Lubrication

All moving points of the body, such as door hinges, hood hinges, and locks, should be lubricated each time the engine oil is changed. Use a non-freezing lubricant on locks during cold weather.

Make sure the engine hood secondary latch keeps the hood from opening when the primary latch is released.

AIR CLEANER

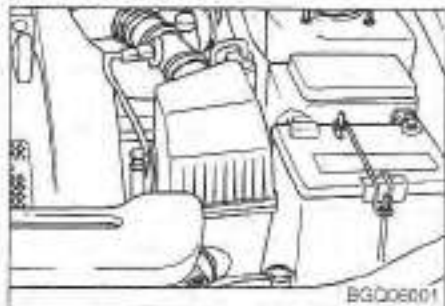

Element Replacement

A viscous paper air cleaner filter is used. It must be replaced when necessary, and should not be cleaned and reused.

1. Loosen the intake air hose clamp and remove the intake air hose.
2. Remove the four (4) cover bolts on the air cleaner cover and remove the cover.

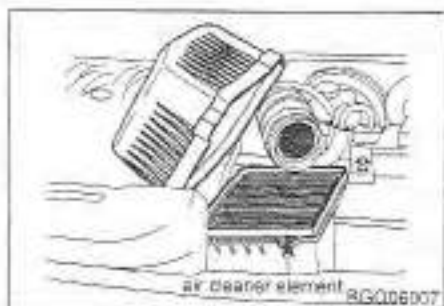

3. Wipe the inside of the air cleaner housing with a damp cloth.
4. Replace the air cleaner element.
5. Install the cover. Install and tighten the four (4) cover bolts.

Replace the element according to the Scheduled Maintenance Section.

If the vehicle is operated in extremely dusty or sandy areas, replace the element more often than the usual recommended intervals.

CAUTION

- *Do not drive with the air cleaner removed; this will result in excessive engine wear.*
- *Driving without an air cleaner encourages backfiring, which could cause a fire in the engine compartment.*
- *When removing the air cleaner element, be careful that dust or dirt does not enter the air intake, or damage may result.*

WIPER BLADES

Wiper Blade Maintenance

* NOTICE

Commercial hot waxes applied by automatic car washes have been known to make the windshield difficult to clean.

Contamination of either the windshield or the wiper blades with foreign matter can reduce the effectiveness of the windshield wipers. Common sources of contamination are insects, tree sap, and hot wax treatments used by some commercial car washes. If the blades are not wiping properly, clean both the window and the blades with a good cleaner or mild detergent, and rinse thoroughly with clean water.

* NOTICE

To prevent damage to the wiper blades, do not use gasoline, kerosene, paint thinner, or other solvents on or near them.

Windshield Wiper Blade Replacement

When the wipers no longer clean adequately, the blades may be worn or cracked, and require replacement.

* NOTICE

To prevent damage to the wiper arms or other components, do not attempt to move the wipers manually.

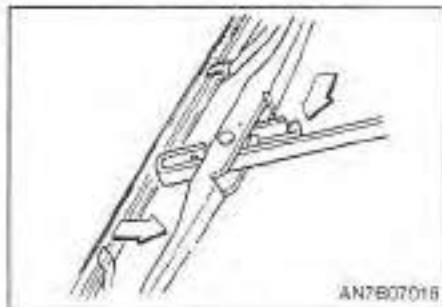

1. Raise the wiper arm and turn the wiper blade assembly to expose the plastic locking clip. Compress the clip and slide the blade assembly downward; then lift it off the arm.

* NOTICE

Do not allow the wiper arm to fall against the windshield.

MAINTENANCE

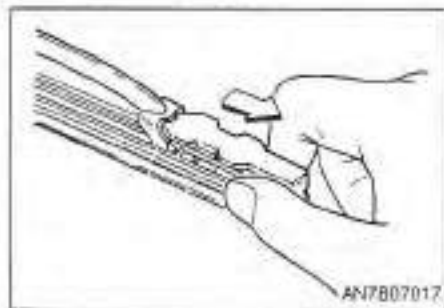

2. Firmly grasp the end of the rubber blade and pull until the tabs are free of the metal support.

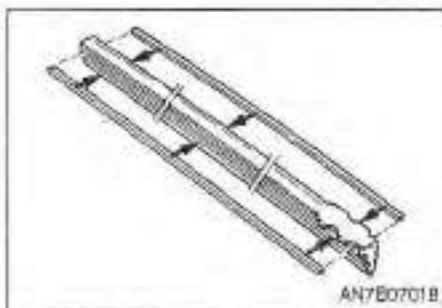

3. Remove the metal retainers from the rubber blade and install them in the new rubber blade.



4. Carefully insert a new rubber blade and install the blade assembly.
Install the blade with the tabs facing towards the bottom of the wiper arm.

* NOTICE

Do not bend the metal retainers.

BATTERY

⚠ WARNING - Battery Dangers

- Keep lighted cigarettes and all other flames or sparks away from the battery. Hydrogen, which is a highly combustible gas, is always present in battery cells and may explode if ignited.
- Keep batteries out of the reach of children because batteries contain highly corrosive SULFURIC ACID. Do not allow battery acid to contact your skin, eyes, clothing or paint finish.
- If any electrolyte gets into your eyes, flush your eyes with clean water for at least 15 minutes and get immediate medical attention. If possible, continue to apply water with a sponge or cloth until medical attention is received.
- If electrolyte gets on your skin, thoroughly wash the contacted area. If you feel a pain or a burning sensation, get medical attention immediately.
- When charging or working near a battery, wear eye protection. Always provide ventilation when working in an enclosed space.
- When lifting a plastic-cased battery, excessive pressure on the case may cause battery acid to spew through the vent caps, resulting in personal injury. Lift with a battery carrier or with your hands on opposite corners.
- Never attempt to charge the battery when the battery cables are connected.

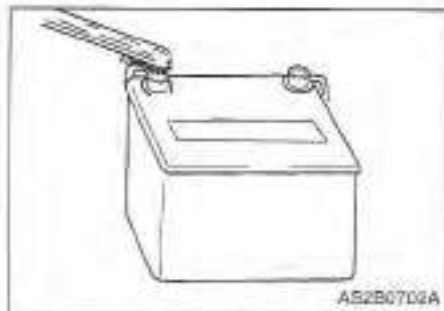

For best battery service:

- Keep the battery securely mounted.
- Keep the battery top clean and dry.
- Keep the terminals and connections clean, tight, and coated with petroleum jelly or terminal grease.
- Rinse any spilled electrolyte from the battery immediately with a solution of water and baking soda.
- If the vehicle is not going to be used for an extended time, disconnect the battery cables.

Battery Recharging

Your vehicle has a maintenance-free, calcium-based battery.

- If the battery becomes discharged in a short time (because, for example, the headlights or interior lights were left on while the vehicle was not in use), recharge it by slow charging (trickle) for 10 hours.
- If the battery gradually discharges because of high electric load while the vehicle is being used, recharge it at 20-30A for two hours.

WARNING - Recharging Battery

When recharging the battery, observe the following precautions:

- The battery must be removed from the vehicle and placed in an area with good ventilation.
- Do not allow cigarettes, sparks, or flame near the battery.
- Watch the battery during charging, and stop or reduce the charging rate if the battery cells begin gassing (boiling) violently or if the temperature of the electrolyte of any cell exceeds 120°F (49°C).
- Wear eye protection when checking the battery during charging.

- Disconnect the battery charger in the following order:

1. Turn off the battery charger main switch.
2. Unhook the negative clamp from the negative battery terminal.
3. Unhook the positive clamp from the positive battery terminal.

* **NOTICE**

- Before performing maintenance or recharging the battery, turn off all accessories and stop the engine.
- The negative battery cable must be removed first and installed last when the battery is disconnected.

TIRES AND WHEELS

Tire Care

For proper maintenance, safety, and maximum fuel economy, you must always maintain recommended tire inflation pressures and stay within the load limits and weight distribution recommended for your vehicle.

Inflation Pressures

All tire pressures (including the spare) should be checked monthly when the tires are cold. "Cold Tires" means the vehicle has not been driven for at least three hours or driven less than one mile (1.6 km). Recommended pressures must be maintained for the best ride, top vehicle handling, and minimum tire wear.

The front and rear tires should be 35 psi (240 kPa).

WARNING

Severe underinflation (10 psi or more) can lead to severe heat build-up, especially on hot days and when driving at high speed. This can potentially cause tread separation and other tire irregularities to appear that can result in the loss of vehicle control leading to severe injury or death.

* NOTICE

- Warm tires normally exceed recommended cold tire pressures by 4 to 6 psi (28 to 41 kPa). Do not release air from warm tires to adjust the pressure or the tires will be underinflated.
- Underinflation results in excessive wear, poor handling, reduced fuel economy, and the possibility of blowouts from overheated tires. Also, low tire pressure can cause poor sealing of the tire bead. If the tire pressure is excessively low, wheel deformation and/or tire separation is possible. So, keep your tire pressures at the proper levels. If a tire frequently needs refilling, have it checked by an authorized Kia dealer.
- Overinflation produces a harsh ride, handling problems, excessive wear at the center of the tire tread, and a greater possibility of damage from road hazards.

⚠ WARNING - Tire Inflation

Overinflation or underinflation can reduce tire life, adversely affect vehicle handling, and lead to sudden tire failure. This could result in loss of vehicle control.

Tire rotation

To equalize tread wear, it is recommended that the tires be rotated every 7,500 miles (12 000 km) or sooner if irregular wear develops.

During rotation, check the tires for correct balance.

When rotating tires, check for uneven wear and damage. Abnormal wear is usually caused by incorrect tire pressure, improper wheel alignment, out-of-balance wheels, severe braking or severe cornering. Look for bumps or bulges in the tread or side of tire. Replace the tire if you find either of these conditions. Replace the tire also if you can see fabric or cord. After rotation, be sure to bring the front and rear tire pressures to specification and check lug nut tightness.

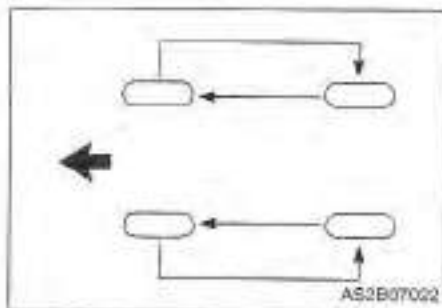

Disc brake pads and rear brake shoes should be inspected for wear whenever tires are rotated.

*** NOTICE**

Rotate radial tires that have an asymmetric tread pattern only from front to rear and not from right to left.

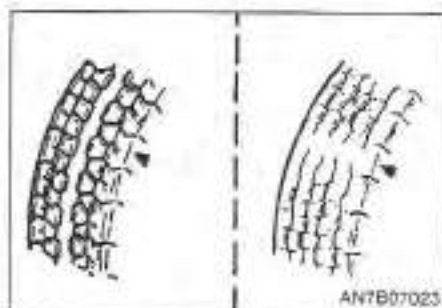

Tire replacement

If the tire is worn evenly, a tread wear indicator will appear as a solid band 1/2 inch wide (12.7 mm) across the tread. This shows there is less than 1/16 inch (1.6 mm) of tread left on the tire. Replace the tire when this happens.

Do not wait for the band to appear across the entire tread before replacing the tire.

Wheel alignment and tire balance

The wheels on your vehicle were aligned and balanced carefully at the factory to give you the longest tire life and best overall performance.

In most cases, you will not need to have your wheels aligned again. However, if you notice unusual tire wear or your vehicle pulling one way or the other, the alignment may need to be reset.

If you notice your vehicle vibrating when driving on a smooth road, your wheels may need to be rebalanced.

*** NOTICE**

Improper wheel weights can damage your vehicle's aluminum wheels. Use only Kia-approved wheel weights.

⚠ CAUTION

- *When replacing tires, never mix radial, bias-belted, and bias-type tires. All four tires should be of the same size, design and construction. Use only the tire sizes listed on the Tire Label found below the door striker on the driver's side. Make sure that all tires and wheels are the same size and have the same load-carrying capacity. Use only tire and wheel combinations recommended on the Tire Label or by an authorized Kia dealer. Failure to follow these precautions can adversely affect the safety and handling of your vehicle.*
- *The use of any other tire size or type may seriously affect ride, handling, ground clearance, tire clearance, and speedometer calibration.*

- *Driving on worn-out tires is very hazardous and will reduce braking effectiveness, steering accuracy, and traction.*
- *It is best to replace all four tires at the same time. If that is not possible, or necessary, then replace the two front or two rear tires as a pair. Replacing just one tire can seriously affect your vehicle's handling.*

Wheel replacement

When replacing the metal wheels for any reason, make sure the new wheels are equivalent to the original factory units in diameter, rim width and offset.

⚠ CAUTION

A wheel that is not the correct size may adversely affect wheel and bearing life, braking and stopping abilities, handling characteristics, ground clearance, body-to-tire clearance, snow chain clearance, speedometer calibration, headlight aim and bumper height.

Tire size designation

A tire's sidewall is marked with a tire size designation. You will need this information when selecting replacement tires for your car. The following explains what the letters and numbers in the tire size designation mean.

Example tire size designation:
215/70R15 97H

215 - Tire width in millimeters.

70 - Aspect ratio. The tire's section height as a percentage of its width.

R - Tire construction code (Radial).

15 - Rim diameter in inches.

97 - Load Index, a numerical code associated with the maximum load the tire can carry.

H - Speed Rating Symbol. See the speed rating chart in this section for additional information.

Wheel size designation

Wheels are also marked with important information that you need if you ever have to replace one. The following explains what the letters and numbers in the wheel size designation mean.

Example wheel size designation: 6.0 J JX15

6.0 - Rim width in inches.

J - Rim contour designation.

15 - Rim diameter in inches.

Tire speed ratings

The chart below shows many of the different speed ratings currently being used for passenger car and light truck tires. The speed rating symbol is part of the tire size designation on the sidewall of the tire. This symbol corresponds to that tire's designed maximum safe operating speed.

Speed Rating Symbol	Maximum Speed
S	112 mph (180 km/h)
T	118 mph (190 km/h)
H	130 mph (210 km/h)
V	149 mph (240 km/h)
Z	Above 149 mph (240 km/h)

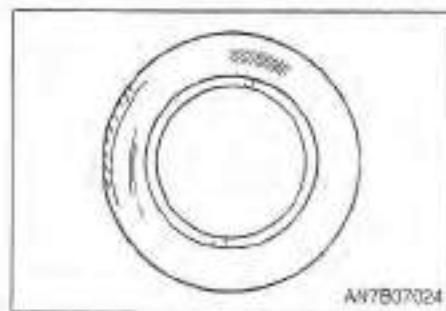

Uniform tire quality grading

Tread wear

The tread wear grade is a comparative rating based on the wear rate of the tire when tested under controlled conditions on a specified government test course. For example, a tire graded 150 would wear one-and-a-half times as well on the government course as a tire graded 100.

The relative performance of tires depends upon the actual conditions of their use. However, performance may differ from the norm because of variations in driving habits, service practices and differences in road characteristics and climate.

These grades are molded on the sidewalls of passenger vehicle tires. The tires available as standard or optional equipment on Kia vehicles may vary with respect to grade.

Traction - A, B & C

The traction grades, from highest to lowest, are A, B and C. The grades represent the tire's ability to stop on wet pavement as measured under controlled conditions on specified government test surfaces of asphalt and concrete. A tire marked C may have poor traction performance.

Temperature - A, B & C

The temperature grades are A (the highest), B and C. The grades represent the tire's resistance to the generation of heat and its ability to dissipate heat when tested under controlled conditions on a specified indoor laboratory test wheel. Sustained high temperature can cause the material of the tire to degenerate and reduce tire life, and excessive temperature can lead to sudden tire failure. Grades A and B represent higher levels of performance on the laboratory test wheel than the minimum required by the law.

WARNING - Tire Temperature

The temperature grade for this tire is established for a tire that is properly inflated and not overloaded. Excessive speed, underinflation, or excessive loading, either separately or in combination, can cause heat build-up and possible sudden tire failure. This can cause loss of vehicle control and serious injury or death.

BULB REPLACEMENT

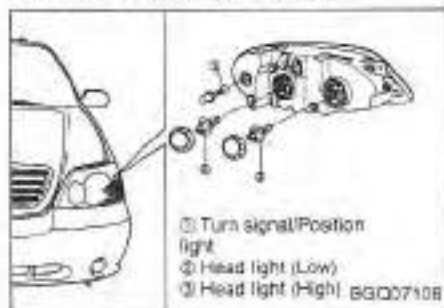

Headlight Bulb Replacement

⚠ WARNING - Halogen Bulbs

- Halogen bulbs contain pressurized gas that will produce flying pieces of glass if broken.
- Always handle them carefully, and avoid scratches and abrasions. If the bulbs are lit, avoid contact with liquids. Never touch the glass with bare hands. Residual oil may cause the bulb to overheat and burst when lit. A bulb should be operated only when installed in a headlight.
- If a bulb becomes damaged or cracked, replace it immediately and carefully dispose of it.
- Wear eye protection when changing a bulb. Allow the bulb to cool before handling it.

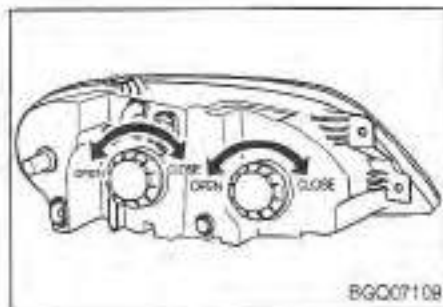

1. Remove the headlight bulb cover by turning it counterclockwise.

MAINTENANCE

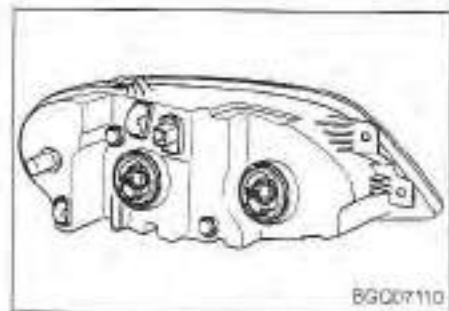

2. Disconnect the headlight bulb electrical connector.

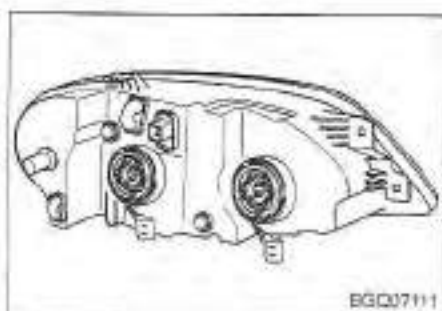

3. Unsnap the headlight bulb retaining wire.

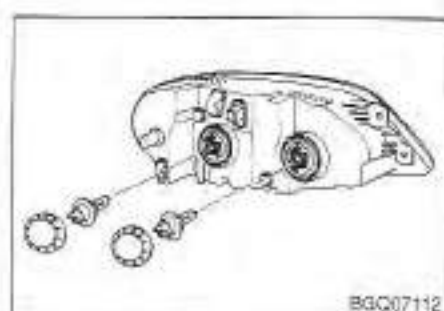

4. Remove the bulb from the three (3) slots on the headlight assembly.
5. Install a new headlight bulb in the three (3) slots on the headlight assembly and snap the headlight bulb retaining wire into position.
6. Connect the headlight bulb electrical connector.
7. Install the headlight bulb cover by turning it clockwise.

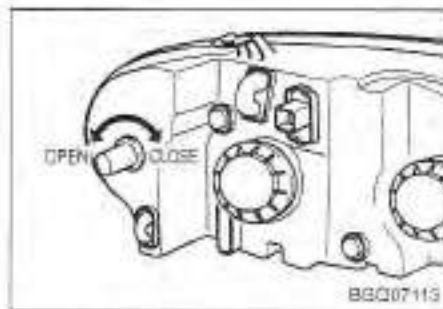

Front Turn Signal Light Bulb Replacement

1. Turn the front turn signal bulb socket counterclockwise and remove it from the headlight housing.

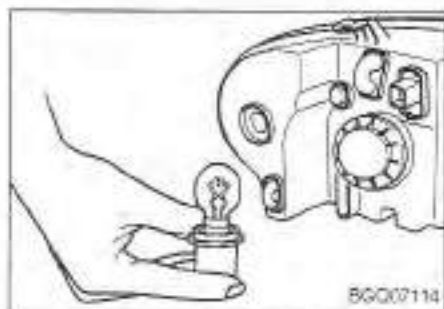

2. Push the bulb in, rotate it one-quarter turn counterclockwise and remove the bulb from the socket.

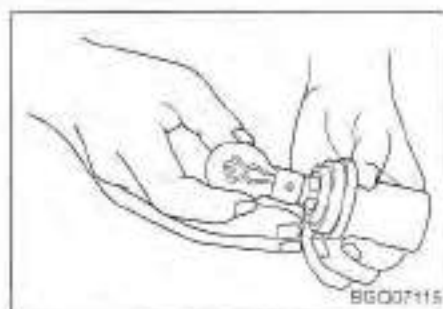

3. Insert a new bulb in the socket, then push the bulb in and rotate it one-quarter turn clockwise to lock the bulb in place.

MAINTENANCE

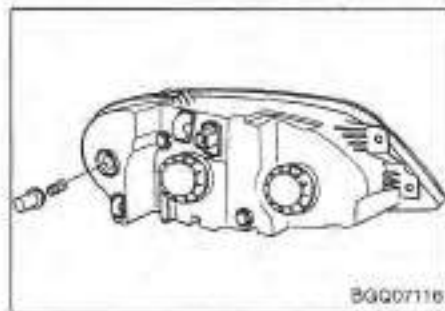

4. Re-install the turn signal bulb socket into the headlight housing and rotate it one-quarter turn clockwise to lock the socket in place.

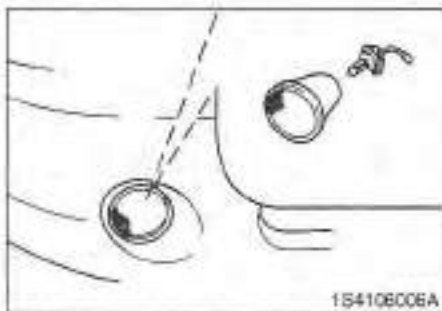

Front Fog Light Bulb Replacement

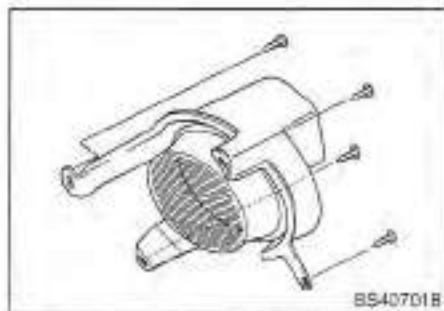

1. Remove the front fog light assembly from the front bumper after removing the four (4) bolts.

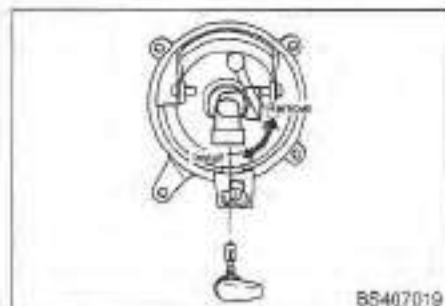

2. Rotate the socket one-quarter turn counter clockwise and remove the front fog light bulb-socket from the assembly.
3. Insert a new bulb-socket into the assembly, then rotate it one-quarter turn clockwise to lock the bulb in place.
4. Re-install the assembly into the front bumper.

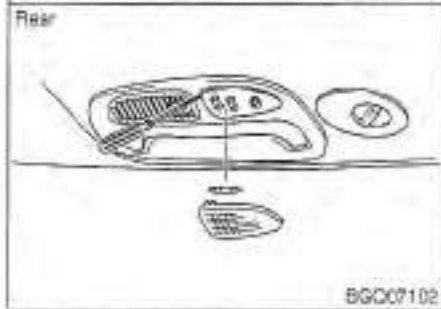

Dome Light Bulb Replacement

1. Carefully pull down on the notch to remove it.

CAUTION

Prior to working on the Dome Light, ensure that the "OFF" button is depressed to avoid burning your fingers or receiving an electric shock.

2. Push up on the metal spring clip until the bulb drops down to remove it.
3. Install a new bulb. The easiest way to do this is to place the bulb into the spring clip first, then slide the other end into place.
4. When installing the lens, align the tabs with the notches before pushing up on the rear of the lens.



Rear Cargo Area Light Bulb Replacement

Your rear cargo area light is located on the rear hatch.

1. Using a flat-blade screwdriver, gently pry the lens from the rear cargo area light housing.

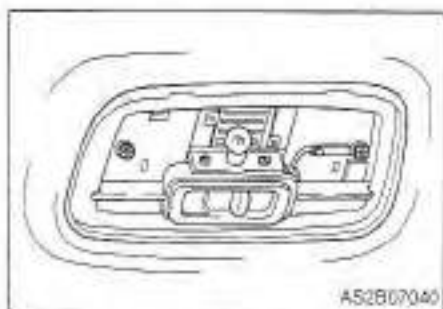

2. Push the bulb in, then rotate it one-quarter turn counterclockwise and remove it from the socket.
3. Insert a new bulb in the socket, then push the bulb in and rotate it one-quarter turn clockwise to lock the bulb in place.
4. Align the lens tabs with the rear cargo area light housing notches and snap the lens into place.

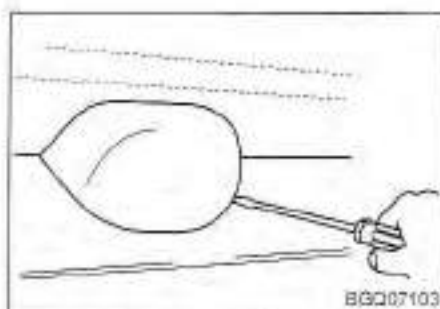

Center High-Mounted Stoplight Bulb Replacement

1. Using a flat-blade screwdriver gently pry the cover from the housing.

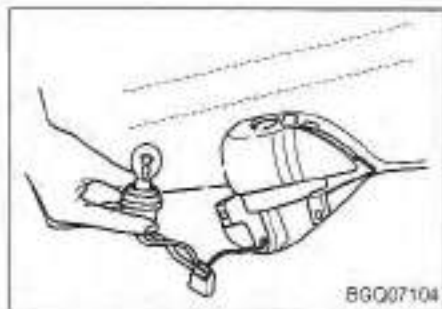

2. Rotate the socket one-quarter turn counter-clockwise and remove it from the housing.
3. Push the bulb in, rotate it one-quarter turn counterclockwise and remove the bulb from the socket.

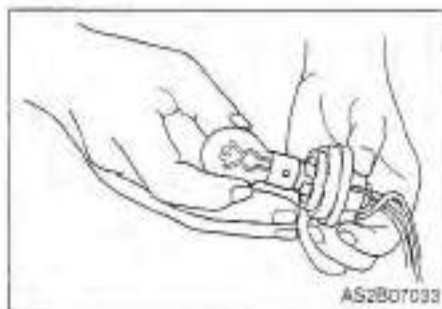

4. Install a new bulb in the socket.
5. Insert the socket in the housing and secure it by rotating it one quarter turn clockwise.
6. Reinstall the cover.

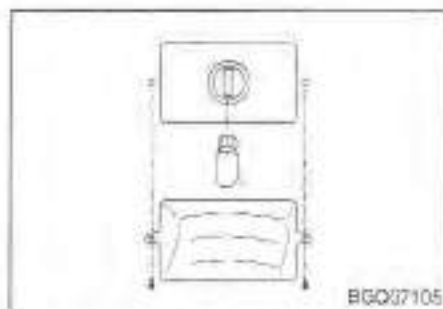

License Plate Light Bulb Replacement

1. Using a cross-tip screwdriver, remove the two lens retaining screws.
2. Remove the lens.

3. Pull the bulb holder assembly down.
4. Remove the bulb by pulling it straight out.
5. Install a new bulb.
6. Reassemble the lens and bulb holder assembly and secure with the two lens retaining screws.

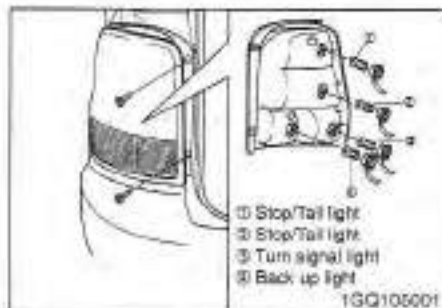

Rear Combination Light Bulb Replacement

1. Open the rear hatch.
2. Using a cross-tip screwdriver, remove the two (2) screws.

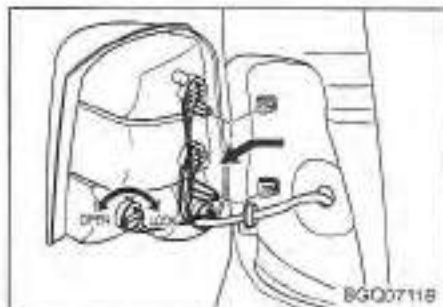

3. Slide the rear combination light out to disconnect the rear combination light assembly from the body of the vehicle.

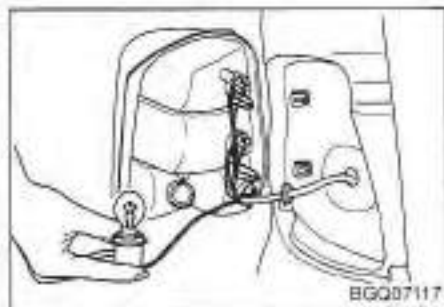

4. Remove the bulb from the three (3) slots on the light assembly.

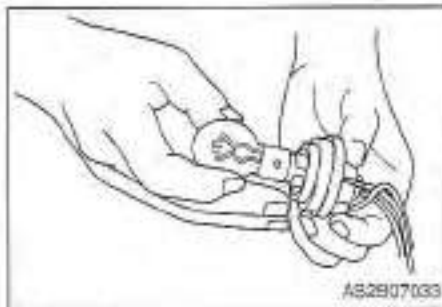

5. Install a new bulb and reinsert into the light.
6. Reinstall the light assembly to the body of the vehicle.
7. Install the two (2) screws.

LUBRICANT SPECIFICATIONS

Recommended Lubricants

To help achieve proper engine and powertrain performance and durability, use only lubricants of the proper quality. The correct lubricants also help promote engine efficiency that results in improved fuel economy.

Engine oils labeled Energy Conserving Oil are now available. Along with other additional benefits, they contribute to fuel economy by reducing the amount of fuel necessary to overcome engine friction. Often, these improvements are difficult to measure in everyday driving, but in a year's time, they can offer significant cost and energy savings.

These lubricants and fluids are recommended for use in your vehicle.

Lubricant	Classification
Engine oil	API Service SD or above, SAE 5W-30
Automatic transaxle fluid	Diamond ATF SP-III
Power steering fluid	PSF-III
Brake fluid	SAEJ1703 or FMVSS116 DOT-3 or DOT-4

Recommended SAE Viscosity Number

*** NOTICE**

Always be sure to clean the area around any filler plug, drain plug, or dipstick before checking or draining any lubricant. This is especially important in dusty or sandy areas and when the vehicle is used on unpaved roads. Cleaning the plug and dipstick areas will prevent dirt and grit from entering the engine and other mechanisms that could be damaged.

Engine oil viscosity (thickness) has an effect on fuel economy and cold weather operating (starting and oil flow). Lower viscosity engine oils can provide better fuel economy and cold weather performance, however, higher viscosity engine oils are required for satisfactory lubrication in hot weather. Using oils of any viscosity other than those recommended could result in engine damage.

EXTERIOR CARE

Exterior General Caution

It is very important to follow the label directions when using any chemical cleaner or polish. Read all warning and caution statements that appear on the label.

Finish Maintenance

Washing

To help protect your vehicle's finish from rust and deterioration, wash it thoroughly and frequently at least once a month with lukewarm or cold water.

If you use your vehicle for off-road driving, you should wash it after each off-road trip. Pay special attention to the removal of any accumulation of salt, dirt, mud, and other foreign materials. Make sure the drain holes in the lower edges of the doors and rocker panels are kept clear and clean. Insects, tar, tree sap, bird droppings, industrial pollution and similar deposits can damage your vehicle's finish if not removed immediately.

Even prompt washing with plain water may not completely remove all these deposits. A mild soap, safe for use on painted surfaces, may be used.

After washing, rinse the vehicle thoroughly with lukewarm or cold water. Do not allow soap to dry on the finish.

* NOTICE

Do not use strong soap, chemical detergents or hot water, and do not wash the vehicle in direct sunlight or when the body of the vehicle is warm.

CAUTION

After washing the vehicle, test the brakes while driving slowly to see if they have been affected by water. If braking performance is impaired, dry the brakes by applying them lightly while maintaining a slow forward speed.

CAUTION

- *Water washing in the engine compartment may cause the failure of electrical circuits located in the engine compartment.*
- *Pay extreme attention to wash the engine compartment by using water.*

Waxing

Wax the vehicle when water will no longer bead on the paint.

Always wash and dry the vehicle before waxing. Use a good quality liquid or paste wax, and follow the manufacturer's instructions. Wax all metal trim to protect it and to maintain its luster.

Removing oil, tar, and similar materials with a spot remover will usually strip the wax from the finish. Be sure to re-wax these areas even if the rest of the vehicle does not yet need waxing.

* NOTICE

- Wiping dust or dirt off the body with a dry cloth will scratch the finish.
- Do not use steel wool, abrasive cleaners, or strong detergents containing highly alkaline or caustic agents on chrome-plated or anodized aluminum parts. This may result in damage to the protective coating and cause discoloration or paint deterioration.

Finish Damage Repair

Deep scratches or stone chips in the painted surface must be repaired promptly. Exposed metal will quickly rust and may develop into a major repair expense.

* NOTICE

If your vehicle is damaged and requires any metal repair or replacement, be sure the body shop applies anti-corrosion materials to the parts repaired or replaced.

Bright-Metal Maintenance

- To remove road tar and insects, use a tar remover, not a scraper or other sharp object.
- To protect the surfaces of bright-metal parts from corrosion, apply a coating of wax or chrome preservative and rub to a high luster.
- During winter weather or in coastal areas, cover the bright metal parts with a heavier coating of wax or preservative. If necessary, coat the parts with non-corrosive petroleum jelly or other protective compound.

Underbody Maintenance

Corrosive materials used for ice and snow removal and dust control may collect on the underbody. If these materials are not removed, accelerated rusting can occur on underbody parts such as the fuel lines, frame, floor pan and exhaust system, even though they have been treated with rust protection.

Thoroughly flush the vehicle underbody and wheel openings with lukewarm or cold water once a month, after off-road driving and at the end of each winter. Pay special attention to these areas because it is difficult to see all the mud and dirt. It will do more harm than good to wet down the road grime without removing it. The lower edges of doors, rocker panels, and frame members have drain holes that should not be allowed to clog with dirt; trapped water in these areas can cause rusting.

CAUTION

After washing the vehicle, test the brakes while driving slowly to see if they have been affected by water.

Aluminum Wheel Maintenance

The aluminum wheels are coated with a clear protective finish.

- Do not use any abrasive cleaner, polishing compound, solvent, or wire brushes on aluminum wheels. They may scratch or damage the finish.
- Use only a mild soap or neutral detergent, and rinse thoroughly with water. Also, be sure to clean the wheels after driving on salted roads. This helps prevent corrosion.
- Avoid washing the wheels with high-speed car wash brushes.

Interior Care

Interior General Precautions

Prevent caustic solutions such as perfume and cosmetic oil from contacting the dashboard because they may cause damage or discoloration. If they do contact the dashboard, wipe them off immediately. See the instructions that follow for the proper way to clean vinyl.

Cleaning the Upholstery and Interior Trim

Vinyl

Remove dust and loose dirt from vinyl with a whisk broom or vacuum cleaner. Clean vinyl surfaces with a vinyl cleaner.

Fabric

Remove dust and loose dirt from fabric with a whisk broom or vacuum cleaner. Clean with a mild soap solution recommended for upholstery or carpets. Remove fresh spots immediately with a fabric spot cleaner. If fresh spots do not receive immediate attention, the fabric can be stained and its color can be affected. Also, its fire-resistant properties can be reduced if the material is not properly maintained.

CAUTION

Using anything but recommended cleaners and procedures may affect the fabric's appearance and fire-resistant properties.

Cleaning the lap/shoulder belt webbing

Clean the belt webbing with any mild soap solution recommended for cleaning upholstery or carpet. Follow the instructions provided with the soap. Do not bleach or re-dye the webbing because this may weaken it.

Cleaning the Interior window glass

If the interior glass surfaces of the vehicle become fogged (that is, covered with an oily, greasy or waxy film), they should be cleaned with glass cleaner. Follow the directions on the glass cleaner container.

* NOTICE

Do not scrape or scratch the inside of the rear window. This may result in damage to the rear window defroster grid.

SPECIFICATIONS

8

Specifications	8-2
--------------------------	-----

SPECIFICATIONS

SPECIFICATIONS

The specifications given here are for general information only. Please check with an authorized Kia dealer for more precise and more up-to-date information.

Dimensions

Item	mm (in)
Overall length w/o fitting	4680 (184.3)
Overall length with fitting	4930 (194.1)
Overall width	1895 (74.6)
Overall height w/o roof rack	1750 (68.9)
Overall height with roof rack	1760 (69.3)
Front tread	1635 (64.4)
Rear tread	1610 (63.4)
Wheelbase	2910 (114.6)

Air Conditioner

Refrigerant complies with SAE J639	R134A
Maximum operating charge	35 oz (1,000 g)

Weights

kg (lb)

Item	Grade	
	L	GL
Curb Weight	2112 (4656)	2121 (4676)
GVWR	2625 (5787)	2674 (5895)

SPECIFICATIONS

Light bulbs

Light Bulb	Wattage
Exterior Lights	
Headlights (High/Low)	55 / 55
Front turn signal / position lights	28 / 8
Front fog lights (if equipped)	27
Rear turn signal lights	27
Stop and tail lights	27 / 8
Back-up lights	27
License plate lights	5
Interior Lights	
Dome light	10
Rear cargo area light (if equipped)	10
High-mounted stop light (if equipped)	18 (2EA)
Door courtesy lights	5

Tires

Size		Inflation Pressure
Tire	Wheel	
P215/70 R15	6JJX15	35 psi (2.4 kg/cm ² , 240 kPa)

Gear Ratio

Gear	Engine	Gasoline
	A/T	
1st	3.789	
2nd	2.057	
3rd	1.421	
4th	1.000	
5th	0.731	
Reverse	3.865	
F.G.R	3.333	

SPECIFICATIONS

Engine

Item	Gasoline Engine
BoreXStroke	93 mm X 85.8 mm (3.66 in X 3.38 in)
Displacement	3497 cc (213.3 cu.in)
Compression Ratio	10.0

Electrical System

Size		Gasoline Engine
Battery	Type	55-26 FL (MF)
	Capacity	12V / 70AH (20HR)
Alternator		13.5V / 120A
Starter		12V-1.2KW
Spark Plug	Gap	1.0 mm ~ 1.1 mm
	Specification	RC10PYP4, PFR5N-11, RC10PYPB4

Capacities

Lubricant	Volume (l)		Classification
Engine oil	With oil filter	4.3	API SERVICE SD or above
	Without oil filter	4.0	
Transaxle oil	A/T	8.5	Diamond ATF SP-III
Coolant	8.2		NALL-K5
Brake fluid	1.3		SAE J1703, FMVSS116 DOT-3 or DOT-4
Fuel	75		

A/T : Automatic Transaxle

INDEX

- ABS**4-15
- Adjustment, front seat3-11
- Adjustment, rear seat-row 23-20
- Adjustment, rear seat-row 33-22
- Airbag3-43
- Airbag warning light3-49
- Air cleaner7-21
- Air conditioning4-46
- Air intake control4-45
- Anti-lock brake system4-15
- Armrest3-17
- Ashtrays4-39
- Automatic door locks3-2
- Automatic transaxle4-6
- Automatic transaxle fluid7-18
- Battery**7-24
- Belt, lap3-38
- Belt, lap/shoulder3-36
- Box, glove4-39
- Brake, parking4-25, 7-16
- Brake and clutch fluid7-16
- Brake system4-12
- Brake system, anti-lock4-15
- Bulb replacement7-31
- Care, exterior**7-42
- Care, interior7-45
- Chains, tire5-9
- Changing the engine oil and filter7-11
- Changing tires6-15
- Child restraint system, placement of3-35
- Child safety lock, rear door3-6
- Cigarette lighter4-38
- Circuit protection, electrical6-7
- Climate control system4-44
- Clothes hanger4-62
- Compartment, engine7-10
- Console storage compartment3-61
- Control, air intake4-45
- Control, mode selection4-44
- Control, temperature4-45
- Control system, climate4-44
- Control system, emission5-3
- Coolant7-14
- Cooling system, engine7-13

INDEX

- Cruise control.....4-18
Cup holder.....3-60
- Day/night rearview mirror**.....3-57
Daytime running lights (DRL).....4-32
Defroster, rear window.....4-37
Defrosting and defogging, windshield.....4-50
Dome light.....3-58
Door locks.....3-2
 Automatic door locks.....3-2
 Rear door child safety lock.....3-7
 Remote keyless entry.....3-3, 3-8
Driving conditions, special.....5-7
- Economical operation, suggestion for**.....5-6
Electrical circuit protection.....6-7
Emergency starting.....6-4
Emission control system.....5-3
Engine compartment.....7-10
Engine cooling system.....7-13
Engine oil and oil filter.....7-11
Exterior care.....7-42
- Filler lid, fuel.....3-54
Flasher, hazard warning.....4-38, 6-2
Flat tire, if you have a.....6-14
Fluid, automatic transaxle.....7-18
Fluid, brake and clutch.....7-16
Fluid, power steering.....7-17
Fluid, washer.....7-20
Fog light, front.....4-33
Front fog light.....4-33
Front seat.....3-11
Front seat adjustment.....3-11
Front seat storage bin.....3-61
Front window.....3-7
Fuel filler lid.....3-54
Fuel requirement.....5-2
Fuses.....6-7
- Gauges**.....4-22
Glove box.....4-39
- Hatch, rear**.....3-51
Hazard warning flasher.....4-33, 6-2
Headrest.....3-17

INDEX

Hood	3-52	Light, front fog	4-33
Horn	3-55	Light, rear cargo area	3-59
How to use this manual	1-2	Lighter, cigarette	4-38
		Lighting	4-30
If you have a flat tire	6-14	Lubricants and fluids	7-20
Ignition switch	4-2	Lubricant specifications	7-40
Immobilizer system	3-9	Lumbar support	3-13, 3-16
Indicators, warning and	4-24		
Instrument cluster	4-21	Maintenance, owner	7-8
Instrument panel overview	2-3	Maintenance schedule	7-4
Interior and exterior overview	2-2	Maintenance service	7-2
Interior care	7-45	Mirror, day/night rearview	3-57
Interior features	4-38	Mirror, outside rearview	3-56
		Mirrors	3-56
Jack and tools, storing the	6-14	Mode selection	4-44
Jump starting	6-4		
		Oil and oil filter, engine	7-11
Keys	3-2	Outside rearview mirror	3-56
		Overheating	6-2
Label information	6-17	Overloading	5-16
Lap/shoulder belt	3-36	Overview, instrument panel	2-3
Lap belt	3-38	Overview, interior and exterior	2-2
Light, dome	3-58	Owner maintenance	7-8

INDEX

Parking brake	4-13	Safety belts	3-26
Plastic grocery bag retainer	3-62	Child restraint system, placement of	3-35
Power adjustment, front seat	3-13	Lap/shoulder belt	3-36
Power socket	4-40	Lap belt	3-38
Power steering	4-17	Proper use and care of the safety belt	3-39
Power steering fluid	7-17	Restraint of large children	3-31
Power window	3-7	Restraint of pregnant women	3-30
Proper use and care of the safety - belt	3-39	Safety belt warning light	3-36
Push starting	6-6	Schedule, maintenance	7-4
		Seat, front	3-11
Rear cargo area light	3-59	Armrest	3-17, 3-23
Rear door child safety lock	3-6	Headrest	3-17
Rear hatch	3-51	Lumbar support	3-13, 3-16
Rear seat	3-20	Power adjustment	3-13
Rear window defroster	4-37	Seat, rear	3-19
Rear window wiper/washer switch	4-36	Adjustment, row 2	3-20
Remote keyless entry	3-3	Adjustment, row 3	3-22
Replacement, bulb	7-31	Seat adjustment, front	3-11
Restraint of large children	3-31	Service, maintenance	7-2
Restraint of pregnant women	3-30	Snow tires	5-9
Road warning	6-2	Special driving conditions	5-7
		Specifications	8-2
Safety belt, proper use and care of	3-39	Specifications, lubricant	7-40

INDEX

Starting, emergency.....	6-4	Transaxle, automatic.....	4-6
Starting, jump.....	6-4	Trip computer.....	4-42
Starting, push.....	6-6	Vehicle break-in process.....	1-3
Starting the engine.....	4-4	Warning and indicators.....	4-24
Steering, power.....	4-17	Warning flasher, hazard.....	4-38, 6-2
Steering, tilt.....	3-55	Washer fluid.....	7-20
Steering wheel.....	3-55	Washers, wipers and.....	4-34
Suggestion for economical operation.....	5-6	Wheel, steering.....	3-53
Sunglass holder.....	3-65	Wheels, tires and.....	7-26
Sunroof.....	3-63	Window, front.....	3-7
Survivors.....	4-40	Power window.....	3-7
Switch, ignition.....	4-2	Window, quarter.....	3-10
Switch, rear window wiper/washer.....	4-36	Window defroster, rear.....	4-37
Temperature control.....	4-45	Windshield washers.....	4-36
Tilt steering.....	3-55	Windshield wipers.....	4-34
Tire, if you have a flat.....	6-14	Wiper blades.....	7-22
Tire chains.....	5-9	Wipers and washers.....	4-34
Tires, changing.....	6-15		
Tires, snow.....	5-9		
Tires and wheels.....	7-26		
Towing.....	6-12		
Towing, trailer.....	5-11		
Trailer towing.....	5-11		