

TABLE OF CONTENTS

1	Before driving	Adjusting and operating features such as door locks, mirrors, and steering column.
2	When driving	Driving, stopping and safe-driving information.
3	Interior features	Air conditioning and audio systems, as well as other interior features for a comfortable driving experience.
4	Maintenance and care	Cleaning and protecting your vehicle, performing do-it-yourself maintenance, and maintenance information.
5	When trouble arises	What to do if the vehicle needs to be towed, gets a flat tire, or is involved in an accident.
6	Vehicle specifications	Detailed vehicle information.
7	For owners	Reporting safety defects for U.S. owners and seat belt instructions for Canadian owners
	Index	Alphabetical listing of information contained in this manual.

1 Before driving

1-1. **Hybrid system**..... 24
 Hybrid system..... 24

1-2. **Key information** 34
 Keys 34

1-3. **Opening, closing and locking the doors**..... 36
 Wireless remote control 36
 Side doors 39
 Back door 44

1-4. **Adjustable components (seats, mirrors, steering wheel)**..... 49
 Front seats..... 49
 Rear seats..... 52
 Driving position memory 55
 Head restraints..... 57
 Seat belts 58
 Steering wheel (manually adjustable type) 65
 Steering wheel (power-adjustable type)..... 66
 Anti-glare inside rear view mirror 67
 Outside rear view mirrors..... 68
 Roof luggage carrier 70

1-5. **Opening and closing the windows and moon roof** 72
 Power windows..... 72
 Moon roof 75

1-6. **Refueling**..... 78
 Opening the fuel tank cap..... 78

1-7. **Theft deterrent system**..... 83
 Hybrid vehicle immobilizer system 83
 Alarm..... 85
 Theft prevention labels (U.S.A.)..... 88

1-8. **Safety information**..... 89
 Correct driving posture 89
 SRS airbags 91
 Front passenger occupant classification system 103
 Child restraint systems 108
 Installing child restraints 112

2 When driving

2-1. **Driving procedures**..... 122
 Driving the vehicle..... 122
 Engine (ignition) switch 131
 Transmission 135
 Turn signal lever..... 136
 Parking brake 137

2-2. Instrument cluster.....	138
Gauges and meters	138
Indicators and warning lights ...	140
Multi-information display.....	143
Trip information display (without navigation system).....	146
2-3. Operating the lights and windshield wipers.....	148
Headlight switch.....	148
Fog light switch	151
Windshield wipers and washer.....	152
Rear window wiper and washer.....	156
Headlight cleaner switch	157
2-4. Using other driving systems... 158	
Cruise control	158
Dynamic laser cruise control	161
Driving assist systems.....	170
2-5. Driving information.....	174
Utility vehicle precautions.....	174
Cargo and luggage.....	179
Vehicle load limits.....	182
Winter driving tips	183
Trailer towing.....	187
Dinghy towing	196

3 Interior features

3-1. Using the air conditioning system and defogger	198
Automatic air conditioning system.....	198
Rear window and outside rear view mirror defoggers, and windshield wiper de-icer	204
3-2. Using the front audio system	205
Audio system type	205
Using the radio.....	207
Using the CD player.....	214
Playing back MP3 and WMA discs.....	220
Optimal use of the audio system.....	228
Using the steering wheel audio switches.....	231
3-3. Using the rear audio system	233
Rear seat entertainment system features	233
Using the DVD player (DVD video).....	239
Using the DVD player (video CD).....	246
Using the DVD player (audio CD/ CD text).....	248

Using the DVD player
(MP3 discs)..... 249

Using the video mode 251

Changing the initial setting 253

3-4. Using the interior lights 260

Interior lights list..... 260

- Interior lights 263
- Personal lights 264

3-5. Using the storage features 265

List of storage features..... 265

- Glove box..... 265
- Console boxes 266
- Coin holder..... 268
- Overhead console..... 269
- Cup holders..... 269
- Door pockets..... 271

3-6. Other interior features..... 272

Sun visors..... 272

Vanity mirror..... 273

Clock..... 274

Outside temperature
display 275

Multi-display light control..... 276

Power outlets..... 277

Seat heaters..... 280

Armrest 282

Floor mat..... 283

Luggage compartment
features..... 284

Garage door opener..... 287

Compass..... 292

4 Maintenance and care

4-1. Maintenance and care..... 298

Cleaning and protecting the
vehicle exterior 298

Cleaning and protecting the
vehicle interior..... 301

4-2. Maintenance..... 304

Maintenance requirements 304

General maintenance..... 306

Emission inspection and
maintenance (I/M)
programs 309

4-3. Do-it-yourself maintenance... 310

Do-it-yourself service
precautions..... 310

Hood..... 313

Positioning a floor jack..... 314

Engine compartment..... 316

Tires 331

Tire inflation pressure..... 340

Wheels..... 344

Air conditioning filter..... 346

Wireless remote control
battery..... 348

Rear seat entertainment
system controller..... 350

Checking and replacing
fuses 352

Headlight aim (vehicles with discharge headlights).....	364
Light bulbs.....	365

5 When trouble arises

5-1. Essential information	378
If your vehicle needs to be towed.....	378
If you think something is wrong	385
Event data recorder	386
5-2. Steps to take in an emergency	388
If a warning light turns on or a warning buzzer sounds... ..	388
If a warning message is displayed.....	398
If you have a flat tire.....	408
If the hybrid system will not start.....	418
If the shift lever cannot be shifted from P.....	419
If you lose your keys	420
If the 12-volt battery is discharged	421
If your vehicle overheats	424
If the vehicle becomes stuck ...	427

6 Vehicle specifications

6-1. Specifications.....	430
Maintenance data (fuel, oil level, etc.).....	430
Fuel information.....	442
Tire section names.....	445
6-2. Customization	458
Customizable features	458
6-3. Initialization	462
Items to initialize	462

7 For owners

Reporting safety defects for U.S. owners.....	464
Seat belt instructions for Canadian owners (in French).....	465

Index

Abbreviation list	470
Alphabetical index.....	472
What to do if... ..	482

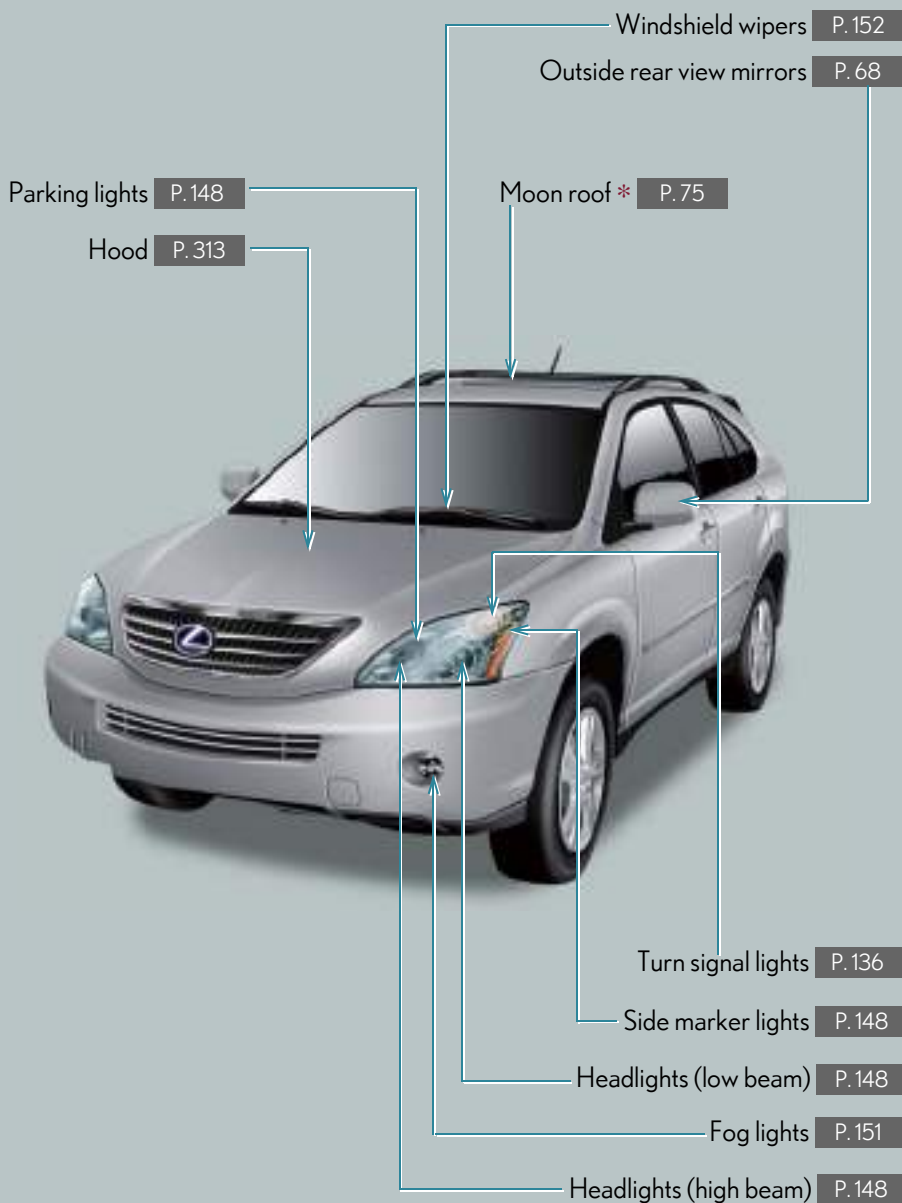

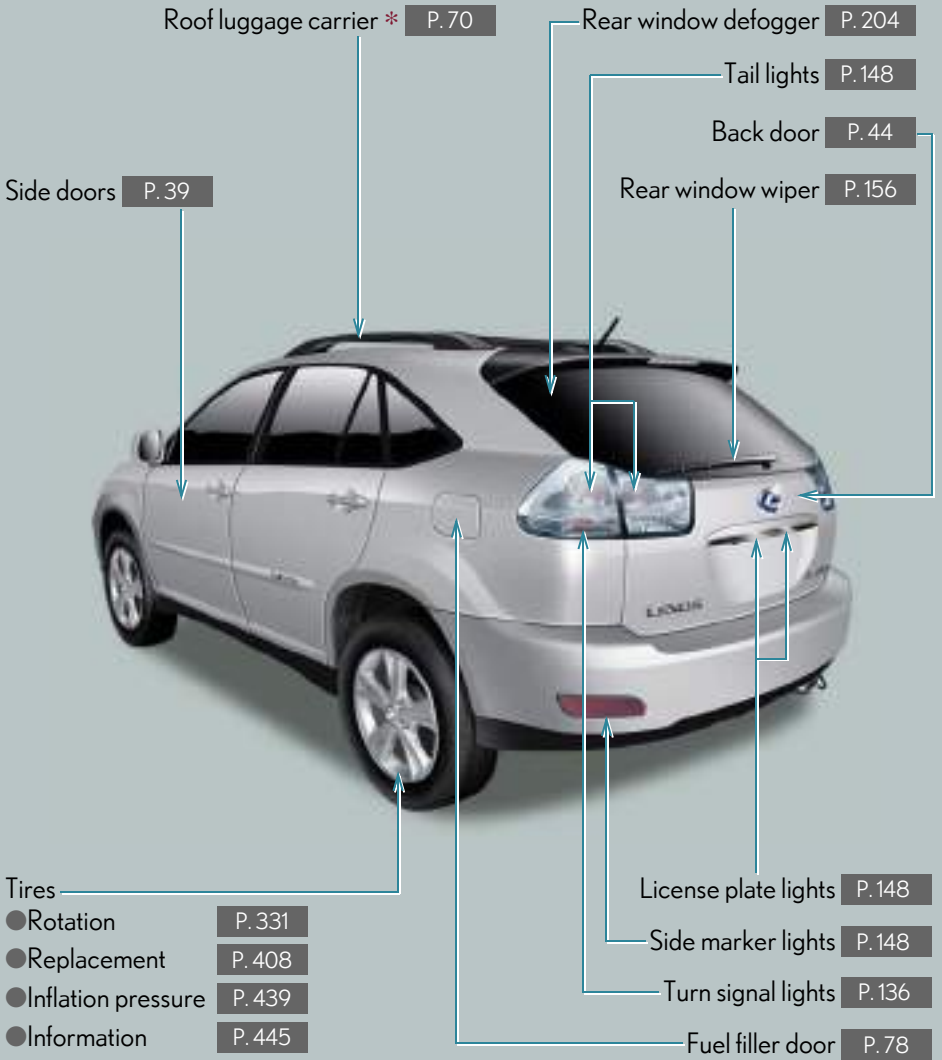

*: If equipped

Pictorial index

Interior

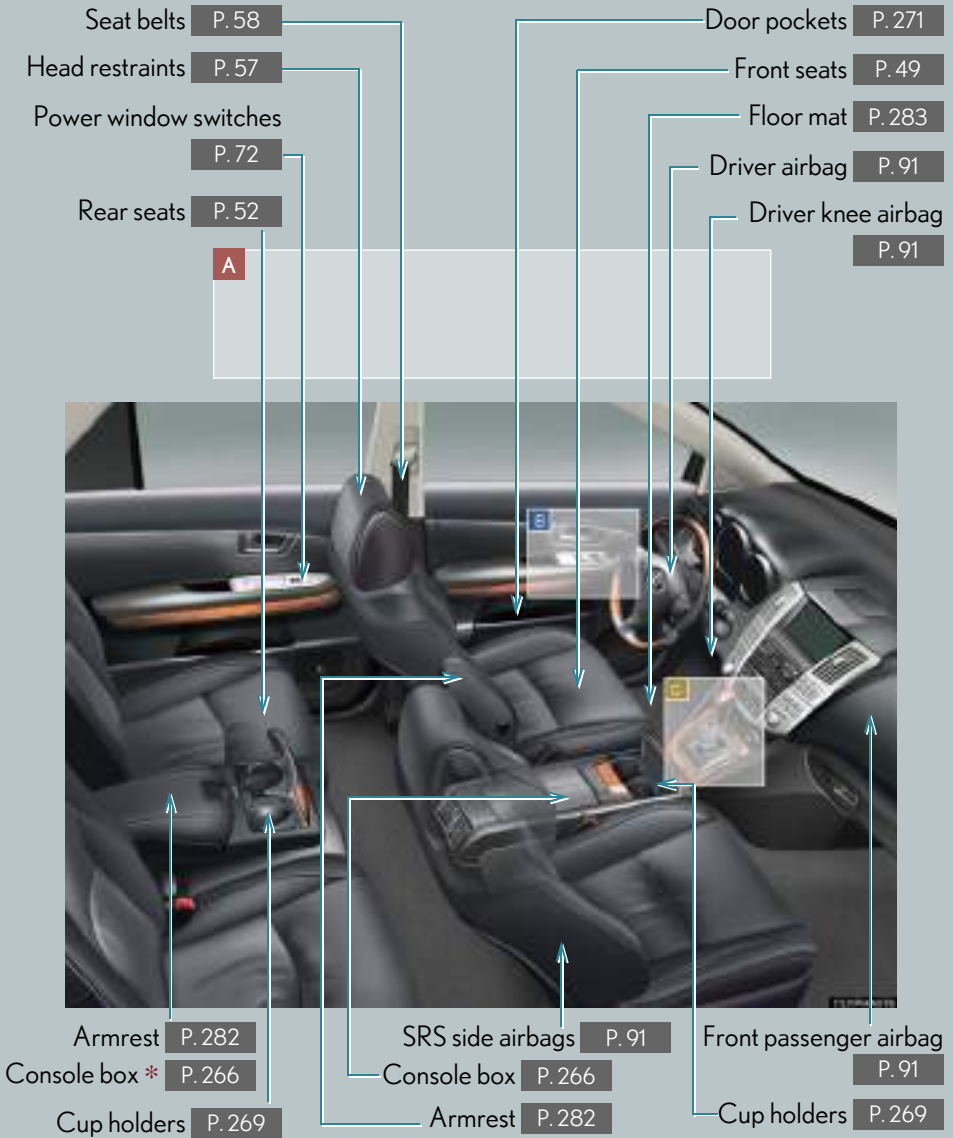

A

Overhead console P. 269

Personal lights P. 264

Interior lights P. 263

Rear seat entertainment system *

P. 233

SRS curtain shield airbags P. 91



Garage door opener switches P. 287

Moon roof switches *

P. 75

Vanity mirrors P. 273

Sun visors P. 272

Anti-glare inside rear view mirror P. 67

Compass P. 292

*: If equipped

B

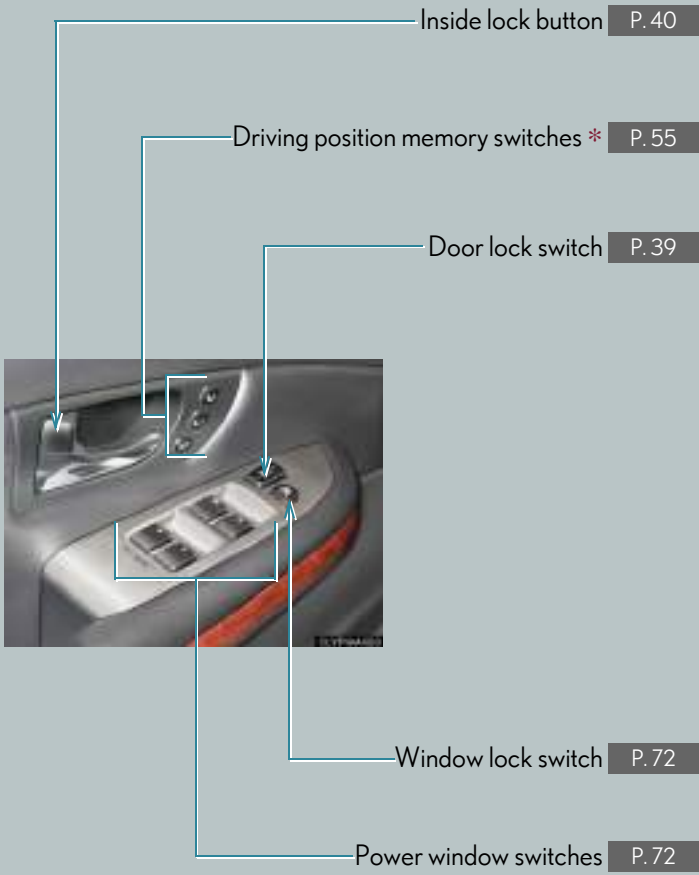

C

Power outlet P. 277
Headlight cleaner switch * P. 157
Seat heater switches * P. 280

Shift lever P. 135

Shift lock override
button P. 419



Power outlet P. 277

*: If equipped

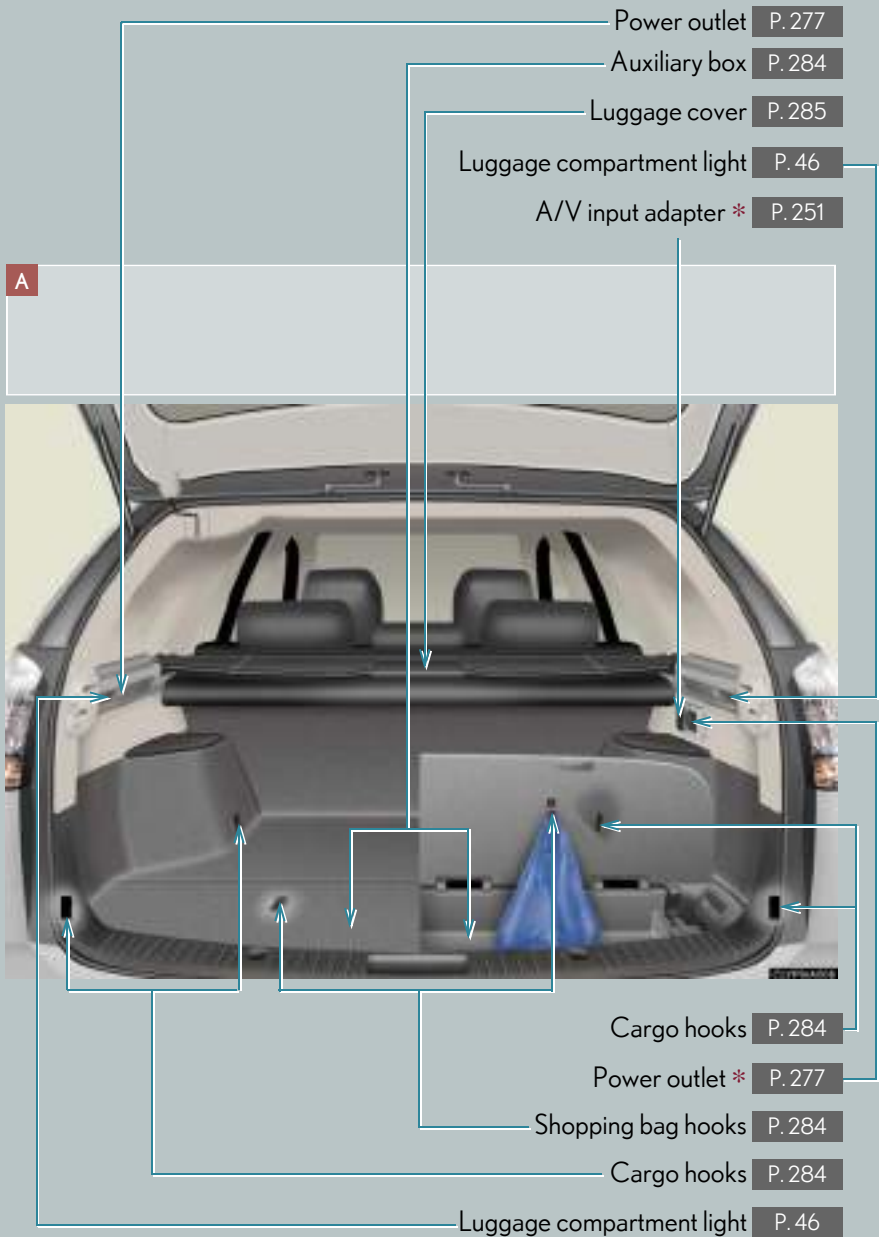

A

Power back door switch * P. 44



Luggage compartment light P. 46

*: If equipped

Pictorial index

Instrument panel

Headlight switch P. 148

Turn signal lever P. 136

Fog light switch P. 151

Tire pressure warning select switch P. 335

Glove box P. 265

Power back door main switch * P. 45

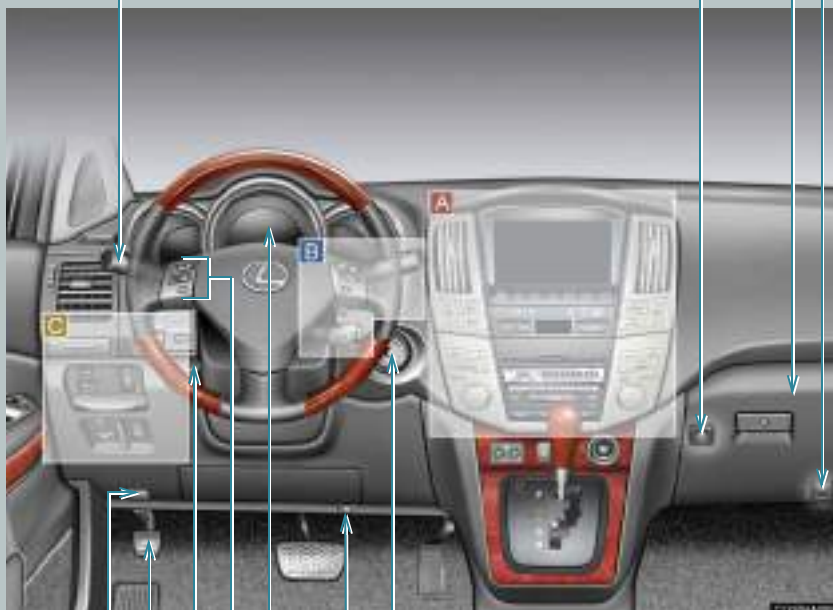

Engine (ignition) switch P. 131

Tire pressure warning reset switch P. 332

Gauges and meters P. 138

Audio remote control switches P. 231

Tilt steering lock release lever * P. 65

Tilt and telescopic steering control switch * P. 66

Parking brake pedal P. 137

Hood release lever P. 313

A

▶ **Without navigation system**

Multi-display light control button
P. 276

Security indicator
P. 83, 85

Audio system
P. 205

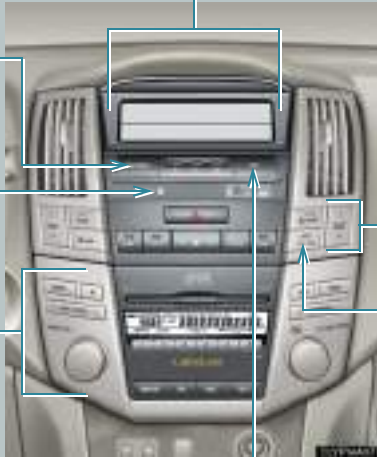

Multi-display

● Trip information display
P. 146

● Outside temperature display
P. 275

● Clock
P. 274

● Automatic air conditioning display
P. 198

Air conditioning system
P. 198

Rear window and outside rear view mirror defoggers, and windshield wiper de-icer *
P. 204

Trip information display control button
P. 146

▶ **With navigation system**

Security indicator
P. 83, 85

Audio system *

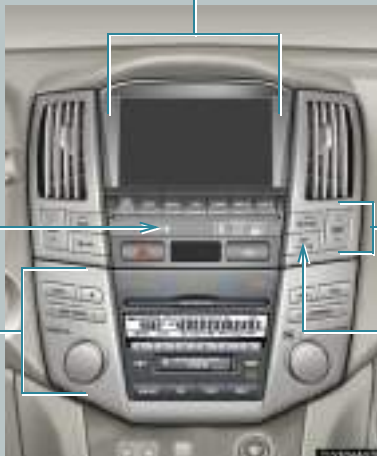

Rear view monitor/
navigation system *

Air conditioning system *

Rear window and outside rear view mirror defoggers, and windshield wiper de-icer *
P. 204

*: If equipped

*: Refer to "Navigation System Owner's Manual".

B



Telephone switch *

Windshield wipers and washer switch P. 152

Rear window wiper and washer switch P. 156

DISP. switch P. 143

Talk switch *

Distance switch * P. 161

Cruise control switch P. 158, 161

C

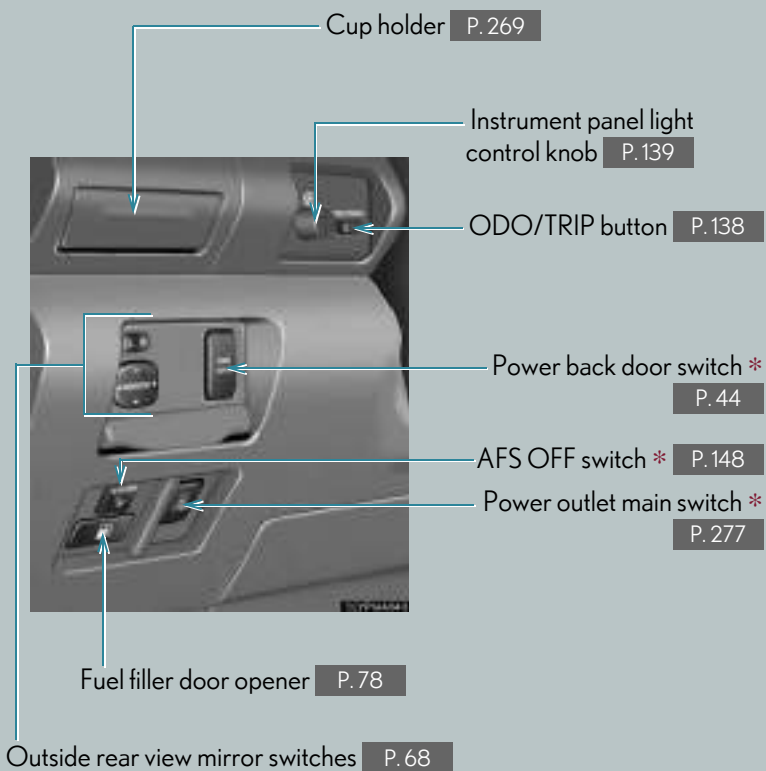

*: If equipped

*: Refer to "Navigation System Owner's Manual".

For your information

Main Owner's Manual

Please note that this manual applies to all models and explains all equipment, including options. Therefore, you may find some explanations for equipment not installed on your vehicle.

All specifications provided in this manual are current at the time of printing. However, because of the Lexus policy of continual product improvement, we reserve the right to make changes at any time without notice.

Depending on specifications, the vehicle shown in the illustration may differ from your vehicle in terms of color and equipment.

Accessories, spare parts and modification of your Lexus

A wide variety of non-genuine spare parts and accessories for Lexus vehicles are currently available in the market. You should know that Toyota does not warrant these products and is not responsible for their performance, repair, or replacement, or for any damage they may cause to, or adverse effect they may have on, your Lexus vehicle.

This vehicle should not be modified with non-genuine Lexus products. Modification with non-genuine Lexus products could affect its performance, safety or durability, and may even violate governmental regulations. In addition, damage or performance problems resulting from the modification may not be covered under warranty.

Installation of a mobile two-way radio system

As the installation of a mobile two-way radio system in your vehicle may affect electronic systems such as the hybrid system, multiport fuel injection system/sequential multiport fuel injection system, cruise control system, vehicle dynamics integrated management, anti-lock brake system, SRS airbag system and seat belt pretensioner system, be sure to check with your Lexus dealer for precautionary measures or special instructions regarding installation.

High voltage parts and cables on the hybrid vehicles emit approximately the same amount of electromagnetic waves as the conventional gasoline powered vehicles or home electronic appliances despite of their electromagnetic shielding.

Scrapping of your Lexus

The SRS airbag and seat belt pretensioner devices in your Lexus contain explosive chemicals. If the vehicle is scrapped with the airbags and seat belt pretensioners left as they are, this may cause an accident such as fire. Be sure to have the systems of the SRS airbag and seat belt pretensioner removed and disposed of by a qualified service shop or by your Lexus dealer before you scrap your vehicle.

Perchlorate Material

Special handling may apply, See www.dtsc.ca.gov/hazardouswaste/perchlorate.

Your vehicle has components that may contain perchlorate. These components may include airbag, seat belt pretensioners, and wireless remote control batteries.

 **CAUTION**

■ **General precautions while driving**

Driving under the influence: Never drive your vehicle when under the influence of alcohol or drugs that have impaired your ability to operate your vehicle. Alcohol and certain drugs delay reaction time, impair judgment and reduce coordination, which could lead to an accident that will hurt or kill you, your occupants or others.

Defensive driving: Always drive defensively. Anticipate mistakes that other drivers or pedestrians might make and be ready to avoid accidents.

Driver distraction: Always give your full attention to driving. Anything that distracts the driver, such as adjusting controls, talking on a cellular phone or reading can result in a collision with resulting death or serious injury to you, your occupants or others.

■ **General precaution regarding children's safety**

Never leave children unattended in the vehicle, and never allow children to have or use the key.

Children may be able to start the vehicle or shift the vehicle into neutral. There is also a danger that children may injure themselves by playing with the cigarette lighter, the windows, the moon roof, or other features of the vehicle. In addition, heat build-up or extremely cold temperatures inside the vehicle can be fatal to children.

■ **Dispose of the hybrid battery (traction battery)**

If your vehicle is disposed of without the hybrid battery having been removed, there is a danger of serious electric shock if high voltage parts, cables and their connectors are touched. In the event of that your vehicle must be disposed of, the hybrid battery must be disposed of your Lexus dealer or a qualified service shop. If the hybrid battery is not disposed of properly, they may cause electric shock that can result in death or serious injury.

Symbols used throughout this manual

Cautions & Notices

CAUTION

This is a warning against anything which may cause injury to people if the warning is ignored. You are informed about what you must or must not do in order to reduce the risk of injury to yourself and others.

NOTICE

This is a warning against anything which may cause damage to the vehicle or its equipment if the warning is ignored. You are informed about what you must or must not do in order to avoid or reduce the risk of damage to your Lexus and its equipment.

Symbols used in illustrations





Safety symbol

The symbol of a circle with a slash through it means “Do not”, “Do not do this”, or “Do not let this happen.”



Arrows indicating operations

 Indicates the action (pushing, turning, etc.) used to operate switches and other devices.

 Indicates the outcome of an operation (e.g. a lid opens).

1-1. Hybrid system	24	1-5. Opening and closing the windows and moon roof	72
Hybrid system	24	Power windows	72
1-2. Key information	34	Moon roof	75
Keys.....	34	1-6. Refueling	78
1-3. Opening, closing and locking the doors	36	Opening the fuel tank cap	78
Wireless remote control.....	36	1-7. Theft deterrent system ...	83
Side doors.....	39	Hybrid vehicle immobilizer system.....	83
Back door	44	Alarm.....	85
1-4. Adjustable components (seats, mirrors, steering wheel)	49	Theft prevention labels (U.S.A.).....	88
Front seats.....	49	1-8. Safety information	89
Rear seats.....	52	Correct driving posture	89
Driving position memory	55	SRS airbags	91
Head restraints	57	Front passenger occupant classification system	103
Seat belts	58	Child restraint systems	108
Steering wheel (manually adjustable type)	65	Installing child restraints.....	112
Steering wheel (power-adjustable type).....	66		
Anti-glare inside rear view mirror.....	67		
Outside rear view mirrors.....	68		
Roof luggage carrier.....	70		

1-1. Hybrid system

Hybrid system

Your vehicle is a hybrid vehicle. It has characteristics different from conventional vehicles. Be sure you are closely familiar with the characteristics of your vehicle, and operate with care.

The hybrid system combines a gasoline engine and an electric motor (traction motor) according to driving conditions, improving fuel efficiency and reducing exhaust emissions.



- 1 Gasoline engine
- 2 Front electric motor (traction motor)
- 3 Rear electric motor (traction motor)*

*: With AWD models only

■ When stopped/during take-off

The gasoline engine stops when the vehicle is stopped. During take-off, the electric motor (traction motor) drives the vehicle. At slow speeds or when traveling down a gentle slope, the engine is stopped and the motor is used.

■ During normal driving

The gasoline engine is predominantly used. The electric motor (traction motor) charges the hybrid battery as necessary.

■ When accelerating sharply

The power of the hybrid battery (traction battery) is added via electric motor (traction motor) to that of the gasoline engine.

■ When braking (regenerative brake)

The electric motor (traction motor) charges the hybrid battery (traction battery).

■ Regenerative braking

The motor generator converts kinetic energy to electric energy when:

- The accelerator pedal is released.
- The brake pedal is depressed with the shift lever in D.

■ Conditions in which the gasoline engine may not stop

The gasoline engine starts and stops automatically. However, it may not stop automatically in the following conditions:

- During gasoline engine warm-up
- During hybrid battery (traction battery) charging
- During low or high hybrid battery (traction battery) temperature

■ Charging the battery

- As the gasoline engine charges the hybrid battery (traction battery), the battery does not need to be charged from an outside source. However, if the vehicle is left parked for a long time the hybrid battery will slowly discharge. For this reason, be sure to drive the vehicle at least once every several months for at least 30 minutes or 10 miles (16 km). If the hybrid battery becomes fully discharged and you are unable to jump-start the vehicle with the battery, contact your Lexus dealer.
- If the shift lever is in N, the hybrid battery (traction battery) will not be charged. When driving in heavy traffic, operate the vehicle with the shift lever in D to avoid discharging the battery.

■ After the 12-volt battery has discharged or has been changed or removed

The gasoline engine may not stop even if the vehicle is running on the hybrid battery (traction battery). If this continues for a few days, contact your Lexus dealer.

■ Sounds and vibrations specific to a hybrid vehicle

There may be no engine sounds or vibration even though the vehicle is able to move. Always put the shift lever in P when parked.

The following sounds or vibrations may occur when the hybrid system is operating, and are not a malfunction.

- Motor sounds may be heard from the engine compartment.
- Sounds may be heard from the hybrid battery (traction battery) behind the rear seat when the hybrid system starts or stops.
- Sounds may be heard from the transmission when the hybrid system starts or stops, or while the vehicle is idling.
- Engine sounds may be heard when accelerating sharply.
- Sounds may be heard from the regenerative brake when you press the brake pedal.
- Vibration may be felt when the gasoline engine starts or stops.
- You may hear cooling fan sounds coming from the air intake vents under the rear seat.

■ Maintenance, repair, recycling, and disposal

Contact your Lexus dealer regarding maintenance, repair, recycling and disposal. Do not dispose of the vehicle yourself.

High voltage components

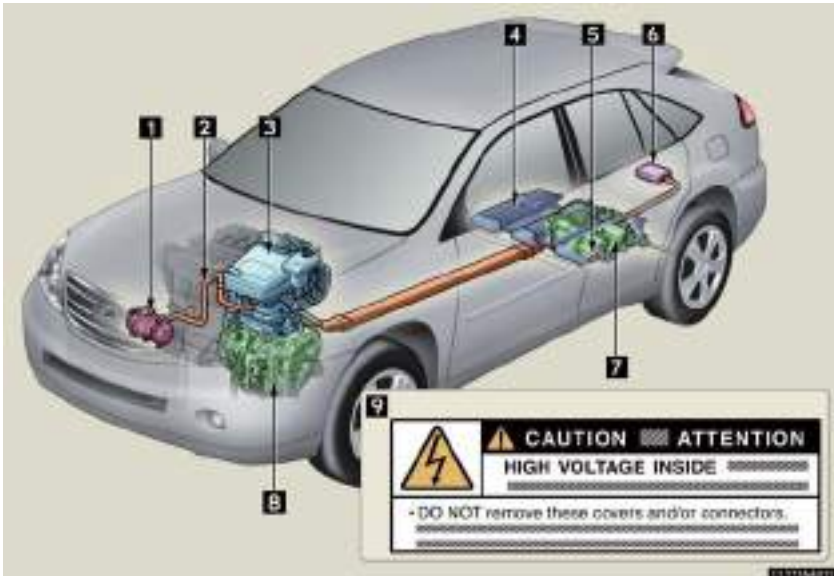

- 1 Air conditioning compressor
- 2 High voltage cables (orange color)
- 3 Power control unit
- 4 Hybrid battery (traction battery)
- 5 Service plug
- 6 DC/DC converter
- 7 Rear electric motor (traction motor)*
- 8 Front electric motor (traction motor)
- 9 Caution label

*: With AWD models only

Take care when handling the hybrid system, as it contains a high voltage system (about 650V at maximum) as well as parts that become extremely hot when the hybrid system is operating. Obey the caution labels attached to the vehicle.

■ Hybrid battery air vent



There is an air intake vent under the rear seats to cooling the hybrid battery (traction battery). If the vent becomes blocked, the hybrid battery may overheat, leading to a reduction in hybrid battery output.

Emergency shut off system

The emergency shut off system blocks off the high voltage current and stops the fuel pump to minimize the risk of electrocution and fuel leakage when a certain level of impact is detected by the impact sensor. If the emergency shut off system activates, your vehicle will not restart. To restart the hybrid system, contact your Lexus dealer.

Energy monitor/consumption screen

You can view the status of your hybrid system on the multi-information display (→P. 143) and the navigation system screen. The following images are examples only, and may vary slightly from actual conditions.

■ Energy monitor

- How to display on the navigation system screen:















STEP 1 Press INFO.

STEP 2 Touch  on the Information screen.

If the Consumption screen is displayed, touch .

- How to display on the multi-information display:

STEP 1 Push the  button several times to select the energy monitor display.

	Navigation system screen	Multi-information display
When the vehicle is powered by the electric motor (traction motor)		
When the vehicle is powered by both the gasoline engine and the electric motor (traction motor)		
When the vehicle is powered by the gasoline engine		
When the vehicle is charging the hybrid battery (traction battery)		
When there is no energy flow		
Hybrid battery (traction battery) status	Low  ↔  Full	Low  ↔  Full

■ Consumption

STEP 1 Press .

STEP 2 Touch  on the Information screen.

If the “Energy Monitor” screen is displayed, touch .

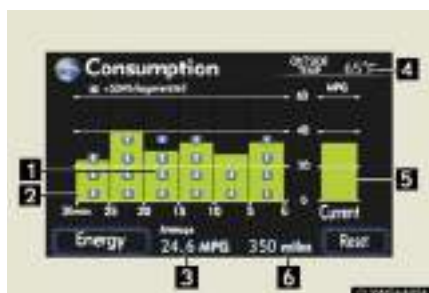

- 1 Regenerated energy in the past 30 minutes
One symbol indicates 50 Wh. Up to 4 symbols are shown.
- 2 Fuel consumption in the past 30 minutes
- 3 Average fuel consumption
- 4 Outside temperature
- 5 Instantaneous fuel consumption
- 6 Cruising range

■ Resetting the consumption data

Touching  will reset the average fuel consumption.

Hybrid warning message

A message is automatically displayed when a malfunction occurs in the hybrid system or an improper operation is attempted.



If a warning message is shown on the multi-information display and the navigation system screen (if equipped), read the message and follow the instructions. (→P. 398)

■ **If a warning light comes on or a warning message is displayed, or the 12-volt battery is disconnected**

The hybrid system may not start. In that case, try to start the system again. If the READY light does not come on, contact your Lexus dealer.

■ **Emergency shut off system**

The emergency shut off system blocks off the high voltage current and stops the fuel pump to minimize the risk of the electric leakage and the fuel leakage when a certain level of impact is detected by the impact sensor. If the system activates, your vehicle will not restart. To restart the hybrid system, contact a Lexus dealer.

 **CAUTION**

■ **High voltage precautions**

The vehicle has high voltage DC and AC systems as well as a system. DC and AC high voltage is very dangerous and can cause severe burns and electric shock that may result in death or serious injury.

- Never touch, disassemble, remove or replace the high voltage parts, cables and their connectors.
- The hybrid system will become hot after starting as the system uses high voltage. Be careful of both the high voltage and the high temperature, and always obey the caution labels attached to the vehicle.
- Never try to open the service plug access hole located in the luggage compartment. The service plug is used only when the vehicle is serviced and is subject to high voltage.

CAUTION

■ Road accident cautions

Observe the following precautions to reduce the risk of injury.

- Pull your vehicle off the road, put the shift lever in P, apply the parking brake, turn the hybrid system off and remove the key.
- Do not touch the high voltage parts, cables and connectors.
- If electric wires are exposed inside or outside your vehicle, an electric shock may occur. Never touch exposed electric wires.
- If a fluid leak occurs, do not touch it as it may be strong alkaline electrolyte from the hybrid battery (traction battery). If it comes into contact with your skin or eyes, wash it off immediately with a large amount of water or if possible, boric acid solution. Seek immediate medical attention.
- If a fire occurs in the hybrid vehicle, leave the vehicle as soon as possible. Never use a fire extinguisher that is not meant for electric fires. Using even a small amount of water may be dangerous.
- If your vehicle needs to be towed, do so with the front wheels (for 2WD models) or four wheels (for AWD models) raised. If the wheels with the electric motor (traction motor) are on the ground when towing, the motor may continue to generate electricity. This may cause an electricity leakage leading to a fire.(→P. 378)

■ Nickel-metal hydride battery

Your vehicle contains a sealed nickel-metal hydride battery. If disposed of improperly, it is hazardous to the environment and there is a risk of severe burns and electrical shock that may result in death or serious injury.

■ If the system activates

- Carefully check to see if there are exposed high voltage parts or cables. Never touch the parts or cables. (→P. 27)
- Carefully inspect the ground under the vehicle. If you find that liquid has leaked onto the ground, the fuel system may have been damaged. Leave the vehicle as soon as possible.

 NOTICE**■ Hybrid battery air vent**

- Do not put foreign objects over the air vent. The hybrid battery (traction battery) may overheat and be damaged.
- Clean the air vent regularly to prevent the hybrid battery (traction battery) from overheating.
- Do not wet the air vent. It may cause a short circuit and damage the hybrid battery (traction battery).
- Do not load a large amount of water such as an aquarium into the vehicle. If water spills over the hybrid battery (traction battery), the battery may be damaged.

1-2. Key information

Keys

The following keys are provided with the vehicle.

► Vehicles without power back door system



► Vehicles with power back door system



- 1 Master keys
- 2 Valet key
- 3 Key number plate
- 4 Flat key

■ When required to leave a key to the vehicle with a parking attendant

Lock the glove box as circumstances demand. (→ P. 265)

Carry the master key for your own use and leave the valet key only with the attendant.

■ Key number plate

Keep the plate in a safe place such as your wallet, not in the vehicle. In the event that a key is lost, a new key can be made at your Lexus dealer using the key number plate. (→P. 420)

 **NOTICE****■ To prevent key damage**

- Do not subject the keys to strong shocks, expose them to high temperatures by placing them in direct sunlight, or get them wet.
- Do not expose the keys to electromagnetic materials or attach any material that blocks electromagnetic waves to the key surface.

1-3. Opening, closing and locking the doors

Wireless remote control

The wireless remote control can be used to lock/unlock the vehicle and open/close the back door from outside the vehicle.

► Vehicles without power back door



- 1 Locks all doors
- 2 Unlocks all doors

Pressing the button unlocks the driver's door. Pressing the button again within 3 seconds unlocks the other doors.

- 3 Opens the windows and moon roof

Push and hold.

- 4 Sounds alarm (→P. 85)

Push and hold.

► Vehicles with power back door



- 1 Locks all doors
- 2 Sounds alarm (→P. 85)

Push and hold.

- 3 Unlocks all doors

Pressing the button unlocks the driver's door. Pressing the button again within 3 seconds unlocks the other doors.

- 4 Opens the windows and moon roof

Push and hold.

- 5 Opens and closes the back door

Push and hold.

■ Back door operation

The back door can be opened even if it is locked. Lock the back door again when you leave the vehicle. The back door will not lock automatically after it has been opened and then closed.

■ Operation signals

Side doors: A buzzer sounds and the emergency flashers flash to indicate that the doors have been locked/unlocked. (Locked: Once; Unlocked: Twice)

Back door: A buzzer sounds twice and the emergency flashers flash twice to indicate that the back door has been opened/closed.

Windows and moon roof: A buzzer sounds to indicate that the windows and moon roof are operating.

■ Door lock buzzer

If a door is not fully closed, a buzzer sounds continuously if an attempt to lock the door is made. Fully close the door to stop the buzzer, and lock the vehicle once more.

■ Security feature

If a door is not opened within approximately 60 seconds after the vehicle is unlocked, the anti-theft system automatically locks the vehicle again.

■ Battery depletion

→P. 348

■ Customization that can be configured at Lexus dealer

Settings (e.g. door unlocking function) can be changed. (Customizable features →P. 458)

■ Reversing the operation of the power back door

Pressing the wireless remote control switch again while the power back door is operating will cause the operation to reverse. However, the reverse operation cannot be performed for the first second after automatic operation starts, even if the wireless remote control switch is pressed again.

■ Certification for wireless remote control

- ▶ For vehicles sold in the U.S.A.

NOTE:

This device complies with Part 15 of the FCC Rules. Operation is subject to the following two conditions: (1) This device may not cause harmful interference, and (2) this device must accept any interference received, including interference that may cause undesired operation.

NOTICE:

This equipment has been tested and found to comply with the limits for a Class B digital device, pursuant to Part 15 of the FCC Rules. These limits are designed to provide reasonable protection against harmful interference in a residential installation. This equipment generates, uses and can radiate radio frequency energy and, if not installed and used in accordance with the instructions, may cause harmful interference to radio communications. However, there is no guarantee that interference will not occur in a particular installation. If this equipment does cause harmful interference to radio or television reception, which can be determined by turning the equipment off and on, the user is encouraged to try to correct the interference by one or more of the following measures:

- Reorient or relocate the receiving antenna.
- Increase the separation between the equipment and receiver.
- Connect the equipment into an outlet on a circuit different from that to which the receiver is connected.
- Consult the dealer or an experienced radio-TV technician for help.

FCC WARNING:

Changes or modifications not expressly approved by the party responsible for compliance could void the user's authority to operate the equipment.

- ▶ For vehicles sold in Canada

NOTE:

Operation is subject to the following two conditions: (1) this device may not cause interference, and (2) this device must accept any interference, including interference that may cause undesired operation of the device.

1-3. Opening, closing and locking the doors

Side doors

The vehicle can be locked and unlocked using a key, wireless remote control or door lock switch.

■ Key



- 1 Locks all doors
- 2 Closes the windows and moon roof (turn and hold)
- 3 Unlocks all doors

Turning the key unlocks the driver's door. Turning the key again unlocks the other doors.

- 4 Opens the windows and moon roof (turn and hold)

■ Wireless remote control

→P. 36

■ Door lock switch



- 1 Locks all doors
- 2 Unlocks all doors

■ Inside lock button

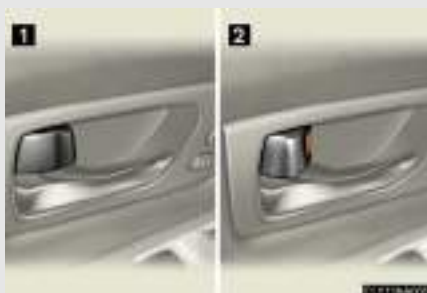

- 1 Locks the door
- 2 Unlocks the door

The front doors can be opened by pulling the inside handle even if the lock buttons are in the lock position.

Locking the front doors from the outside without a key

The door cannot be locked if either of the front doors is open and the key is in the engine switch.

Rear door child-protector lock



- 1 The rear door cannot be opened from inside the vehicle when the locks are set.

These locks can be set to prevent children from opening the rear doors. Push down on each rear door switch to lock both rear doors.

Automatic door locking and unlocking systems

The following functions can be set or cancelled:

Function	Operation
Shift position linked door locking function	Shifting the shift lever out of P locks all doors.
Shift position linked door unlocking function	Shifting the shift lever to P unlocks all doors.
Speed linked door locking function	All doors are locked when the vehicle speed is approximately 12 mph (20 km/h) or higher.
Driver's door linked door unlocking function	All doors are unlocked when the driver's door is opened within 10 seconds after turning the engine switch to the LOCK position.

To switch between setting and canceling, follow the procedure below:

STEP 1 Close all the doors and turn the engine switch to the ON position. (Perform the step 2 within 10 seconds.)

STEP 2 Shift the shift lever to P or N, and press and hold the driver's door lock switch (1 or 2) for approximately 5 seconds and then release.

The shift lever and switch positions corresponding to the desired function to be set or canceled are shown as follows.



1-3. Opening, closing and locking the doors

Function	Shift lever position	Switch position
Shift position linked door locking function	P	1
Shift position linked door unlocking function		2
Speed linked door locking function	N	1
Driver's door linked door unlocking function		2

When the setting or canceling operation is complete, all doors are locked and then unlocked.

■ Impact detection door lock release system

In the event that the vehicle is subject to a strong impact, all the doors are unlocked. Depending on the force of the impact or the type of accident, however, the system may not operate.

■ If a wrong key is used

The key cylinder rotates freely to isolate inside mechanism.

■ Customization that can be configured at Lexus dealer

Settings (e.g. unlocking function using a key) can be changed. (Customizable features →P. 458)

 **CAUTION****■ To prevent an accident**

Observe the following precautions while driving the vehicle.

Failing to do so may result in a door opening and an occupant falling out, resulting in death or serious injury.

- Always use a seat belt.
- Always lock all doors.
- Ensure that all doors are properly closed.
- Do not pull the inside handle of the doors while driving.

The doors may be opened and the passengers are thrown out of the vehicle and it may result in serious injury or death.

Be especially careful for the front doors, the doors may be opened even if the inside lock buttons are in locked position.

- Set the rear door child protector locks when children are seated in the rear seat.

1-3. Opening, closing and locking the doors

Back door

The back door can be opened using the back door opener.

In addition, the power back door can be opened/closed using the power back door switch or wireless remote control.

■ Back door opener



1 Push up

2 Raise

■ Power back door switches (vehicles with power back door)

► Instrument panel



Push the switch for 1 second to open/close.

Pressing the switch again while the power back door is operating will cause the operation to reverse.

However, the reverse operation cannot be performed for the first second after pressing the switch to operate the door.

► Back door



Push the switch to close.

Pressing the switch again while the power back door is closing will cause it to open again.

However, the reverse operation cannot be performed for the first second after pressing the switch to close the door.

The back door can be opened even if it is locked. Lock the back door again when you leave the vehicle. The back door will not lock automatically after it has been opened and then closed.

A buzzer sounds twice and the emergency flashers flash twice to indicate that the back door has been opened/closed.

■ Wireless remote control (vehicles with power back door)

→P. 36

Canceling the power back door system (vehicles with power back door)

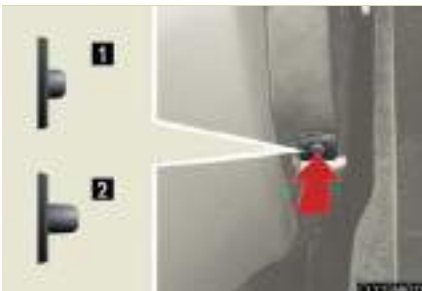

Turn off the main switch in the glove box to disable the power back door system.

- 1 ON
- 2 OFF

The back door cannot be opened even with the wireless remote control or power back door switch.

■ Luggage compartment light



The luggage compartment light turns on when the back door is opened and the light switch is ON.

■ Back door handle



Use the back door handle when closing.

If the vehicle is equipped with a power back door, the back door automatically pulls closed in the event that the door is not properly latched when closed.

■ If the back door opener is inoperative

The back door can be opened from the inside.



Remove the cover.



Push the lever.

■ **The power back door can be opened when**

The engine switch is in the ON position, and the shift lever is in P.

■ **Jam protection function**

If anything obstructs the power back door while it is closing/opening, the back door will automatically operate in the opposite direction.

■ **If the power back door does not work**

The back door must be initialized. To initialize, close the back door completely by hand.

■ **Customization that can be configured at Lexus dealer**

Settings (e.g. beep sound) can be changed. (Customizable features →P. 458)

 **CAUTION**

Observe the following precautions.

Falling to do so may result in death or serious injury.

■ **Keep the back door closed while driving**

If the back door is opening, the luggage will be thrown out and exhaust gases will be entered in the vehicle.

■ **When the back door is opened while parking**

The open back door hides the rear lights. Other road users must be warned of the presence of your vehicle by a warning triangle or other device.

■ **Operating the power back door**

- Check to make sure that passengers do not have any part of their body in a position where it could be caught or hit when the back door is being operated.
- Careful attention is needed so as not to get your fingers trapped as the back door automatically closes when it has not been fully closed.
- Do not allow children to operate the back door.
Closing the back door on someone can cause serious injury, and in some instances, even death.

CAUTION

■ Jam protection function

- Never try jamming any part of your body to activate the jam protection function intentionally.
- The jam protection function may not work if something gets caught just before the back door is fully closed.

NOTICE

■ To prevent damage to the back door components

- Do not apply any force, paint or let any other foreign matter on the damper.
- Do not apply excessive force when the back door closer is operating.
- Make sure there is nothing in the doorway before closing.

1-4. Adjustable components (seats, mirrors, steering wheel)

Front seats



- 1 Seat position switch
- 2 Seatback angle switch
- 3 Seat cushion (front) angle switch
- 4 Vertical height adjustment switch
- 5 Lumbar support switch

Flattening seatback

■ Before flattening seatbacks

Slide the rear seats as far back as possible. (→P. 52)

■ Flattening seatbacks

STEP 1



Move the seat forward, raise the seat, and remove the headrest.

After returning the seat to its original position, be certain to replace the head restraint.

STEP 2



Move the seatback angle control switch backward to flatten the seatback.

STEP 3



Push the vertical height adjustment switch downward.

 **CAUTION**

■ **Seat adjustment**

Do not recline the seat more than necessary when the vehicle is in motion to reduce the risk of sliding under the lap belt.

If the seat is too reclined, the lap belt may slide past the hips and apply restraint forces directly to the abdomen or your neck may contact the shoulder belt, increasing the risk of death or serious injury in the event of an accident.

■ **While driving**

- Do not allow passengers to ride on the flattened seat.
- Do not drive with the head restraints removed.

1-4. Adjustable components (seats, mirrors, steering wheel)

Rear seats



Folding down rear seatbacks

■ Before folding down rear seatbacks

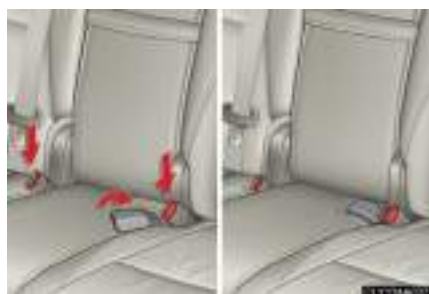

Stow the rear seat belt buckles.



Use the seat belt hangers to prevent the belts from being tangled.

■ Folding down rear seatbacks



Pulling the seatback angle lever and fold them down until they lock.

When return the rear seatbacks to their original positions, unlock the seatbacks by pulling the seatback angle lever and lift them up until they lock.

■ Folding down rear center seatback



Pulling the center seatback angle lever behind the seatback and fold it down.

When return the rear center seatback to its original position, lift it up until it locks.

CAUTION

■ Seat adjustment

- Do not recline the seat more than necessary when the vehicle is in motion to reduce the risk of sliding under the lap belt. If the seat is too reclined, the lap belt may slide past the hips and apply restraint forces directly to the abdomen or your neck may contact the shoulder belt, increasing the risk of death or serious injury in the event of an accident.
- Be careful not to get hands or feet pinched between the rear console box and the rear seat when folding down the rear seatback.

■ When returning the seatback to the upright position

Observe the following precautions. Failure to do so may result in death or serious injury.

- Press forward and rearward on the top of the seatback.
- Check that the seat belts are not twisted or caught under the seat.
- Arrange the seat belts in the proper positions for ready use.

NOTICE

■ Stowing the seatbelts

The seat belts and the buckles must be stowed before you fold down the rear seatbacks.

1-4. Adjustable components (seats, mirrors, steering wheel)

Driving position memory (if equipped)

Your preferred driving position (the position of the driver's seat, steering wheel and outside rear view mirrors) can be memorized and recalled with the touch of a button.

Two different driving positions can be entered into memory.

■ Entering a position to memory

Check that the shift lever is set in P.

STEP 1 Turn the engine switch to the ON position.

STEP 2 Adjust the driver's seat, steering wheel, and outside rear view mirrors to the desired positions.



While pushing the SET button, push button 1 or 2 until the signal beeps.

If the selected button has already been preset, the previously recorded position will be overwritten.

■ Recalling the memorized position

Check that the shift lever is set in P.

STEP 1 Turn the engine switch to the ON position.



Push button 1 or 2 to recall the memorized position.

■ Retained accessory power

Memorized positions (except for the steering wheel positions) can be activated up to 30 seconds after the driver's door is opened, even if the key is removed from the engine switch.

■ If any position memory button is pushed while the adjustments are being made

The operation will stop. To reactivate the system, push the desired button (1 or 2) again.

■ If the battery is disconnected

The memorized are erased when the battery is disconnected.

CAUTION

■ Seat adjustment caution

Take care during seat adjustment that the seat does not strike the rear passenger or squeeze your body against the steering wheel.

1-4. Adjustable components (seats, mirrors, steering wheel)

Head restraints

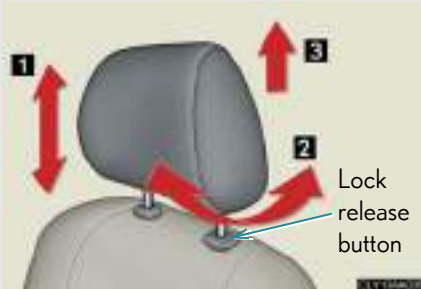

1 Vertical adjustment

Push and hold the lock release button when lowering the head restraint.

2 Angle adjustment *

3 Removal

Pull the head restraint up while pushing the lock release button.

*: Front seats only

1

Before driving

■ Adjusting the height of the head restraints



Make sure that the head restraints are adjusted so that the center of the head restraint is closest to the top of your ears.

■ Adjusting the rear center seat head restraints

Always raise the head restraint to the lock position when using.

⚠ CAUTION

■ Head restraint precautions

Observe the following precautions regarding the head restraints. Failure to do so may result in death or serious injury.

- Use the head restraints designed for each respective seat.
- Adjust the head restraints to the correct position at all times.
- Do not drive with the head restraints removed.

1-4. Adjustable components (seats, mirrors, steering wheel)

Seat belts

Make sure that all occupants are wearing their seat belts before driving the vehicle.

■ Correct use of the seat belts



- Extend the shoulder belt so that it comes fully over the shoulder, but does not come into contact with the neck or slide off the shoulder.
- Position the lap belt as low as possible over the hips.
- Adjust the position of the seatback. Sit up straight and well back in the seat.
- Do not twist the seat belt.

■ Fastening and releasing the seat belt



- 1 Fastening the belt
Push the tab into the buckle until a clicking sound is heard.
- 2 Releasing the belt
Press the release button.

■ Adjusting the height of the belt (front seats)

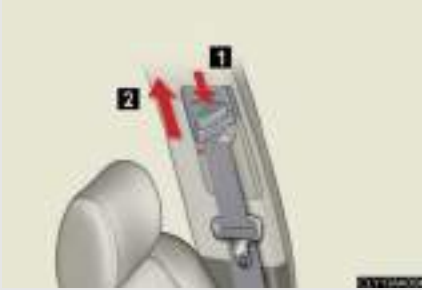

1 Down

2 Up

Move the height adjuster up and down as needed until you hear a click.

Seat belt comfort guide (outside rear seats)

If the shoulder belt sits close to a person's neck, use the seat belt comfort guide.



Pull the comfort guide from the pocket.

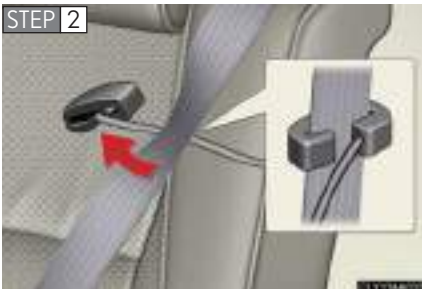

Slide the belt past the slot of the guide.

The elastic cord must be behind the seat belt.

STEP 3



Buckle, position and release the seat belt.

Seat belt pretensioners (front seats)



The pretensioner helps the seat belt to quickly restrain the occupant by retracting the seat belt when the vehicle is subjected to certain types of severe frontal collision or a vehicle rollover.

The pretensioner may not activate in the event of a minor frontal impact, a side impact or a rear impact.

■ Emergency locking retractor (ELR)

The retractor will lock the belt during a sudden stop or on impact. It may also lock if you lean forward too quickly. A slow, easy motion will allow the belt to extend so that you can move around fully.

■ Automatic locking retractor (ALR)

When a passenger's shoulder belt is completely extended and then retracted even slightly, the belt is locked in that position and cannot be extended. This feature is used to hold the child restraint system (CRS) firmly. To free the belt again, fully retract the belt and then pull the belt out once more. (→P. 112)

■ Pregnant women



Obtain medical advice and wear the seat belt in the proper way. (→P. 58)

Women who are pregnant should position the lap belt as low as possible over the hips in the same manner as other occupants. Extend the shoulder belt completely over the shoulder and position the belt across the chest. Avoid belt contact over the rounding of the abdominal area.

If the seat belt is not worn properly, not only a pregnant woman, but also the fetus could suffer death or serious injury as a result of sudden braking or a collision.

■ People suffering illness

Obtain medical advice and wear the seat belt in the proper way. (→P. 58)

■ Child seat belt usage

The seat belts of your vehicle were principally designed for persons of adult size.

- Use a child restraint system appropriate for the child, until the child become large enough to properly wear the vehicle's seat belt. (→P. 108)
- When the child becomes large enough to properly wear the vehicle's seat belt, follow the instructions on P. 58 regarding seat belt usage.

■ Replacing the belt after the pretensioner has been activated

If the vehicle is involved in multiple collisions, the pretensioner will activate for the first collision, but will not activate for the second or subsequent collisions.

■ Seat belt extender



If your seat belts cannot be fastened securely because they are not long enough, a personalized seat belt extender is available from your Lexus dealer free of charge.

⚠ CAUTION

Observe the following precautions to reduce the risk of injury in the event of sudden braking or an accident.

Failing to do so may cause death or severe injury.

■ Wearing a seat belt

- Ensure that all passengers wear a seat belt.
- Always wear a seat belt properly.
- Each seat belt should be used by one person only. Do not use a seat belt for more than one person at once, including children.
- Lexus recommends that children be seated in the rear seat and always use a seat belt and/or an appropriate child restraint system.

 **CAUTION**

- Do not recline the seat any more than necessary to achieve a proper seating position. The seat belt is most effective when the occupants are sitting up straight and well back in the seats.
- Do not wear the shoulder belt under your arm.
- Always wear your seat belt low and snug across your hips.

■ Seat belt pretensioners

- Do not place anything, such as a cushion, on the front passenger's seat. Doing so will disperse the passenger's weight, which prevents the sensor from detecting the passenger's weight properly. As a result, the seat belt pretensioner for the front passenger's seat may not activate in the event of a collision.
- If the pretensioner has activated, the seat belt becomes locked: it cannot be further extended, nor will it return to the stowed position. The seat belt cannot be used again and must be replaced at your Lexus dealer.

■ Child restraint lock function belt

Do not allow children to play with the child restraint lock function belt.

■ Seat belt damage and wear

- Do not damage the seat belts by allowing the belt, plate, or buckle to be jammed in the door.
- Inspect the seat belt system periodically. Check for cuts, fraying, and loose parts. Do not use a damaged seat belt until it is replaced. Damaged seat belts cannot protect an occupant from death or serious injury.
- Ensure that the belt and tab are locked and the belt is not twisted. If the seat belt does not function correctly, immediately contact your Lexus dealer.

CAUTION

- Replace the seat assembly, including the belts, if your vehicle has been involved in a serious accident, even if there's no obvious damage.
- Do not attempt to install, remove, modify, disassemble or dispose of the seat belts. Have any necessary repairs carried out by your Lexus dealer. Inappropriate handling of the pretensioner may prevent it from operating properly resulting in death or serious injury.

■ Using a seat belt comfort guide

- Make sure the belt is not twisted and that it lies flat. The elastic cord must be behind the belt and the guide must be on the front.
- To reduce the chance of injury in case of an accident or a sudden stop while driving, remove and store the comfort guide in its pocket when it is not in use.
- Always make sure the shoulder belt is positioned across the center of the shoulder. The belt should be kept away from the neck, and should not fall off the shoulder.
Failure to observe these precautions could reduce the effectiveness of the seat belt in an accident, causing death or serious injury.

■ Using a seat belt extender

- Do not wear the seat belt extender if you can fasten the seat belt without the extender.
- Do not use the seat belt extender when installing a child restraint system because the belt will not securely hold the child restraint system, increasing the risk of death or injury in the event of a collision.
- The personalized extender may not be safe on another vehicle, when used by another person, or at a different seating position other than the one originally intended.

NOTICE

■ When using a seat belt extender

When releasing the seat belt, press on the buckle release button on the extender, not on the seat belt.

This helps prevent damage to the vehicle interior and the extender itself.

1-4. Adjustable components (seats, mirrors, steering wheel)

Steering wheel (manually adjustable type)

The steering wheel can be adjusted to a comfortable position.



STEP 1 Hold the steering wheel and pull up the lever.

STEP 2 Adjust to the ideal position by moving the steering wheel.

STEP 3 Release the lever.

1

Before driving

CAUTION

■ Caution while driving

Do not adjust the steering wheel while driving.

Doing so may cause the driver to mishandle the vehicle and an accident, resulting in death or serious injury.

■ After adjusting the steering wheel

Make sure that the steering wheel is securely locked.

Otherwise, the steering wheel may move suddenly, possibly causing an accident.

1-4. Adjustable components (seats, mirrors, steering wheel)

Steering wheel (power-adjustable type)

The steering wheel can be adjusted to a comfortable position.



- 1 Up
- 2 Down
- 3 Away from the driver
- 4 Toward the driver

Auto tilt away



When the key is removed from the engine switch, the steering wheel returns to its stowed position by moving up and away to enable easier driver entry and exit.

Inserting the key into the engine switch returns the steering wheel to its original position.

■ Customization that can be configured at Lexus dealer

Setting of the auto tilt-away function can be disabled. (Customizable features →P. 458)

⚠ CAUTION

■ Caution while driving

Do not adjust the steering wheel while driving.

Doing so may cause the driver to mishandle the vehicle and an accident, resulting in death or serious injury.

Anti-glare inside rear view mirror

In automatic mode, sensors are used to detect the headlights of vehicles behind and automatically reduces the reflected light.



- 1 To turn automatic mode on/off, press and hold the switch for 3 seconds.

The indicator comes on when automatic mode is turned on.

The anti-glare mirror default mode is automatic mode. The anti-glare mirror is automatically set to automatic mode whenever the engine switch is in the ON position.

■ To prevent sensor error



To ensure that the sensors operate properly, do not touch or cover them.

⚠ CAUTION

■ Caution while driving

Do not adjust the position of the mirror while driving.

Doing so may lead to mishandling of the vehicle and an accident, resulting in death or serious injury.

1-4. Adjustable components (seats, mirrors, steering wheel)

Outside rear view mirrors

Mirror angle can be adjusted using the switch when the engine switch is in the ACC or ON position.



- 1 Pull down the cover
- 2 Select a mirror to adjust (L: left or R: right)
- 3 Adjust the mirror up, down, in, or out using the switch

■ When the mirrors are fogged up

Turn on the outside rear view mirror defoggers to defog the mirrors. (→P. 204)

■ Folding back the mirrors



Push back in the direction of the vehicle's rear.

■ One-touch adjustment of the mirror angle (vehicles with driving position memory)

A desired mirror face angle can be entered to memory and adjusted with the touch of a button. (→P. 55)

■ Linked mirror function when reversing (vehicles with driving position memory)

The outside rear view mirrors will automatically angle downwards when the vehicle is reversing in order to give a better view of the ground. However, this function will not operate when the mirror select switch is in the neutral position (between L and R).

■ Auto anti-glare function

When the anti-glare inside rear view mirror is set to automatic mode, the outside rear view mirrors will activate in conjunction with the anti-glare inside rear view mirror to reduce reflected light. (→P. 67)

⚠ CAUTION**■ When driving the vehicle**

Observe the following precautions while driving.

Failing to do so may result in loss of control of the vehicle and cause an accident, resulting in death or serious injury.

- Do not adjust the mirrors while driving.
- Do not drive with the mirrors folded back.
- Both the driver and passenger side mirrors must be extended and properly adjusted before driving.

■ When the mirror defoggers are operating

Do not touch the surface of the mirror, as it may be hot.

1-4. Adjustable components (seats, mirrors, steering wheel)

Roof luggage carrier (if equipped)



- 1 Cross rails
- 2 Roof rails

Adjusting the position of cross rails

STEP 1



Pull the lock release lever up to release the cross rails.

STEP 2

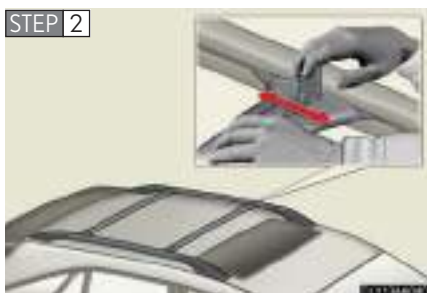

Slide the cross rails to the appropriate position for loading luggage and release the lever.

 **CAUTION****■ Cross rail adjustment**

Make sure the cross rails are locked securely by pushing forward and rearward them.

Failure to do so may cause an unexpected accident or severe injury in the event of emergency braking or a collision.

■ When loading cargo

Observe the following precautions.

- Place the cargo so that its weight is distributed evenly between the front and rear axles.
- If loading long or wide cargo, never exceed the vehicle overall length or width. (→P. 430)
- Before driving, make sure the cargo is securely fastened on the roof luggage carrier.
- Loading cargo on the roof luggage carrier will make the center of the vehicle gravity higher. Avoid high speeds, sudden starts, sharp turns, sudden braking or abrupt maneuvers, otherwise it may result in loss of control or vehicle rollover due to failure to operate this vehicle correctly.
- If driving for a long distance, on rough roads, or at high speeds, stop the vehicle now and then during the trip to make sure the cargo remains in its place.
- Do not exceed 165 lb. (75 kg) cargo weight on the roof luggage carrier.

 **NOTICE****■ When loading the luggage**

Be careful not to scratch the surface of the moon roof.

1-5. Opening and closing the windows and moon roof

Power windows

The power windows can be opened and closed using the following switches.



- 1 Closing
- 2 One-touch closing*
- 3 Opening
- 4 One-touch opening*

*: Pushing the switch in the opposite direction will stop window travel partway.

Lock switch



Press the switch down to lock passenger window switches.

Use this switch to prevent children from accidentally opening or closing a passenger window.

■ The power windows can be operated when

The engine switch must be in the ON position.

■ Door lock linked window operation

- The power windows can be opened and closed using the key. (→P. 39)
- The power windows can be opened using the wireless remote control. (→P. 36)

■ Retained accessory power

The power windows can be operated for approximately 45 seconds even after the engine switch is turned to the ACC or LOCK position. They cannot, however, be operated once either front door is opened.

■ Jam protection function

If an object becomes caught between the window and the window frame, window travel is stopped and the window is opened slightly.

■ If the power window does not work correctly

The power windows must be initialized in order to ensure proper operation. (Perform for each window with the switch for each seat.)

STEP 1 Open the window halfway.

STEP 2 Fully close the window by pulling the switch up and continue holding the switch for one second.

The indicator on the switch changes from a flashing pattern to being on when initial settings are complete.

■ Customization that can be configured at Lexus dealer

Settings (e.g. linked door lock operation) can be changed. (Customizable features →P. 458)

CAUTION

■ Closing the windows

Observe the following precautions.

Failing to do so may result in death or serious injury.

- Check to make sure that all passengers do not have any part of their body in a position where it could be caught when a window is being operated.
- Do not allow children to operate the power windows.
Closing a power window on someone can cause serious injury, and in some instances, even death.

■ Jam protection function

- Never try jamming any part of your body to activate the jam protection function intentionally.
- The jam protection function may not work if something gets caught just before the window fully closes.

1-5. Opening and closing the windows and moon roof

Moon roof (if equipped)

Use the overhead switches to open, close and tilt the moon roof up and down.

■ Opening and closing



1 Open

The moon roof stops slightly before the fully opened position.

Push the switch again to fully open.

2 Close

Push the switch in the either direction to stop the moon roof partway.

■ Tilting up and down



1 Tilt up

2 Tilt down

Push the switch in the either side to stop the moon roof partway.

■ The moon roof can be operated when

The engine switch must be in the ON position.

■ Door lock linked moon roof operation

- The moon roof can be opened and closed using the key. (→P. 39)
- The moon roof can be opened using the wireless remote control. (→P. 36)

■ Operating the moon roof after turning the engine switch to the ACC or LOCK position

The moon roof can be operated for approximately 45 seconds even after the engine switch is turned to the ACC or LOCK position. It cannot, however, be operated once either front door is opened.

■ Jam protection function

If an object is detected between the moon roof and the frame while closing or tilting down, travel is stopped and the moon roof opens slightly.

■ To reduce moon roof wind noise

Drive with the moon roof where it has stopped when opening automatically.

■ Sunshade

The sunshade can be opened and closed manually. However, the sunshade will open automatically when the moon roof is opened.

■ Customization that can be configured at Lexus dealer

Settings (e.g. linked door lock operation) can be changed. (Customizable features →P. 458)

 **CAUTION****■ Opening the moon roof**

Observe the following precautions.

Failing to do so may cause death or serious injury.

- Do not allow any passengers to put their hands or heads outside the vehicle while it is moving.
- Do not sit on top of the moon roof.

■ Closing the moon roof

Observe the following precautions.

Failing to do so may result in death or serious injury.

- Check to make sure that all passengers do not have any part of their bodies in a position where they could be caught when the moon roof is being operated.
- Do not allow children to operate the moon roof.
Closing the moon roof on someone can cause death or serious injury.

■ Jam protection function

- Never try jamming any part of your body to activate the jam protection function intentionally.
- The jam protection function may not work if something gets caught just before the moon roof fully closes.

1-6. Refueling

Opening the fuel tank cap

Perform the following steps to open the fuel tank cap.

■ Before refueling the vehicle

Stop the hybrid system and ensure that all the doors and windows are closed.

■ Opening the fuel tank cap

STEP 1



Push the fuel filler door opener switch.

STEP 2



When the message REFUEL READY appears, the fuel filler door will open.



If the pressure in the fuel tank is high, the message PLEASE WAIT NOW OPENING will appear on the multi-information display. It may take up to 10 seconds.

STEP 3



Turn the fuel tank cap slowly to open.

STEP 4



Hang the fuel tank cap on the back of the fuel filler door.

Closing the fuel tank cap



When replacing the fuel tank cap, turn it until one clicking sound is heard.

After releasing your hand, the cap will turn slightly to the opposite direction.

■ Fuel types

Use unleaded gasoline. (91 Octane rating [Research Octane Number 96] or higher)

■ Fuel tank capacity

Approximately 17.2 gal. (65 L, 14.3 Imp. gal.)

■ Open fuel filler door warning

→P. 407

■ When the fuel filler door opener is inoperable



The handle can be used to open the fuel filler door if the fuel filler door cannot be opened using the inside switch because the battery is discharged or for any other reason.

 **CAUTION****■ Refueling the vehicle**

Observe the following precautions while refueling the vehicle. Failure to do so, may result in death or serious injury.

- Touch the vehicle or some other metal surface to discharge any static electricity. Sparks resulting from discharging static electricity may cause the fuel vapors to ignite.
- Always hold the grips on the fuel tank cap and turn it slowly to remove it. A whooshing sound may be heard when the fuel tank cap is loosened. Wait until the sound cannot be heard before fully removing the cap. In hot weather, pressurized fuel may spray out the filler neck and cause injury.
- Do not allow anyone that has not discharged static electricity from their bodies to come close to an open fuel tank.
- Do not inhale vaporized fuel. Fuel contains substances that are harmful if inhaled.
- Do not smoke while refueling the vehicle. Doing so may cause the fuel to ignite and cause a fire.
- Do not return to the vehicle or touch any person or object that is statically charged. This may cause static electricity to build up, resulting in a possible ignition hazard.

■ When replacing the fuel cap

Do not use anything but a genuine Lexus fuel tank cap designed for your vehicle. Doing so may cause a fire or other incident which may result in death or serious injury.

■ When opening the fuel cap

Do not remove the cap quickly. In hot weather, fuel under pressure could cause injury by spraying out of the filler neck if the cap is suddenly removed.

NOTICE

■ Refueling the vehicle

- Finish refueling within 30 minutes. If more than 30 minutes passes, the internal valve closes. In this condition, fuel may spill out if you continue to refuel the vehicle. About 5 minutes after the valve is closed, a message CLOSE FUEL LID will appear on the multi-information display. To refuel the vehicle again, tighten the fuel tank cap and close the fuel filler door, and then push the fuel filler door opener switch again.
- Do not spill fuel during refueling.
Doing so may damage the vehicle, such as causing the exhaust systems to operate abnormally or damaging fuel system components or the vehicle's painted surface.

Hybrid vehicle immobilizer system

The vehicle's keys have built-in transponder chips that prevent the hybrid system from starting if the key has not been previously registered in the vehicle's on-board computer.

Never leave the keys inside the vehicle when you leave the vehicle.



The indicator light flashes after the key has been removed from the engine switch to indicate that the system is operating.

■ System maintenance

The vehicle has a maintenance-free type of immobilizer system.

■ Conditions that may cause the system to malfunction

- If the grip portion of the key is in contact with a metallic object
- If the key is in close proximity to or touching a key to the security system (key with a built-in transponder chip) of another vehicle

■ Certifications for the hybrid vehicle immobilizer system

- ▶ For vehicles sold in the U.S.A.

FCC ID: MOZRI-20BTY (Made in Japan)

This device complies with Part 15 of the FCC Rules. Operation is subject to the following two conditions: (1) this device may not cause harmful interference, and (2) this device must accept any interference received, including interference that may cause undesired operation.

- ▶ For vehicles sold in Canada

This device complied with RSS-210 of Industry Canada.

Operation is subject to the following two conditions: (1) this device may not cause interference, and (2) this device must accept any interference, including interference that may cause undesired operation of the device.

CAUTION

Changes or modifications not expressly approved by the party responsible for compliance could void the user's authority to operate the equipment.

NOTICE

■ To prevent damage to the key

Do not modify, remove or disable the hybrid vehicle immobilizer system. If any unauthorized changes or modifications are made, the proper operation of the system cannot be guaranteed.

Alarm

The system sounds the alarm and flashes lights when forcible entry is detected.

■ Triggered of the alarm

The alarm is triggered in the following situations.

- A locked door is unlocked or opened in any way other than using the key or wireless remote control with the alarm being set.
- The hood is opened with the alarm being set.

■ Setting the alarm system



Close the doors, hood, and lock all doors using the key or wireless remote door lock function. The system will be set automatically after 30 seconds.

The indicator light changes from being on to flashing when the system is set.

■ Deactivating or stopping the alarm

Do one of the following to deactivate or stop the alarm.

- Unlock the doors using the key or wireless remote control.
- Turn the engine switch to the ON position. (The alarm will be deactivated or stopped after a few seconds.)

■ Items to check before locking the vehicle

To prevent unexpected triggering of the alarm and vehicle theft, make sure of the following.

- Nobody is in the vehicle.
- The windows and moon roof are closed before the alarm is set.
- No valuables or other personal items are left in the vehicle.

■ Triggering of the alarm

The alarm may be triggered in the following situations.

Stopping the alarm deactivates the alarm system.

- The doors is unlocked using the key.
- A person inside the vehicle opens a door or hood.
- The battery is recharged or replaced when the vehicle is locked.

■ Panic mode

- ▶ Vehicles with power back door



When PANIC is pushed for longer than about one second, an alarm will sound for about 30 seconds and the vehicle lights will flash to deter any person from trying to break into or damage your vehicle.

To stop the alarm, push any button on the wireless remote control.

- ▶ Vehicles without power back door



■ When the 12-volt battery is disconnected

Be sure to cancel the alarm system.

If the battery is discharged before canceling the alarm, the system may be triggered when the battery is reconnected.

■ When using the key to unlock the doors

Deactivate the alarm.

If the doors are unlocked using the key with the alarm operational, the alarm will be triggered.

1-7. Theft deterrent system

Theft prevention labels (U.S.A.)



These labels are attached to the vehicle to reduce vehicle theft by facilitating the tracing and recovery of parts from stolen vehicles. Do not remove under penalty of law.

Correct driving posture

Drive in a good posture as follows:



- 1 Sit upright and well back in the seat. (→P. 49)
- 2 Adjust the position of the seat forward or backward to ensure the pedals can be reached and easily depressed to the extent required. (→P. 49)
- 3 Adjust the seatback so that the controls are easily operable.
- 4 Adjust the tilt and telescopic positions of the steering wheel downward so the air-bag is facing your chest. (→P. 65, 66)
- 5 Lock the head restraint in place with the center of the head restraint closest to the top of your ears. (→P. 57)
- 6 Wear the seat belt correctly. (→P. 58)

 **CAUTION**

■ **While driving**

- Do not adjust the position of the driver's seat while driving.
Doing so could cause the driver to lose control of the vehicle.
- Do not place a cushion between the driver or passenger and the seatback.
A cushion may prevent correct posture from being achieved, and reduce the effectiveness of the seat belt and head restraint, increasing the risk of death or serious injury to the driver or passenger.
- Do not place anything under the front seats.
Objects placed under the front seats may become jammed in the seat tracks and stop the seat from locking in place. This may lead to an accident. The adjustment mechanism may also be damaged.

■ **Adjusting the seat position:**

- Take care when adjusting the seat position to ensure that other passengers are not injured by the moving seat.
- Do not put your hands under the seat or near the moving parts to avoid injury.
Fingers or hands may become jammed in the seat mechanism.

1-8. Safety information

SRS airbags

The SRS airbags inflate when the vehicle is subjected to certain types of severe impacts that may cause significant injury to the occupants. They work together with the seat belts to help reduce the risk of death or serious injury.



► Front airbags

1 Driver airbag/front passenger airbag

Can help protect the head and chest of the driver and front passenger from impact with interior components.

2 Driver knee airbag

Can help provide driver protection.

► Side and curtain shield airbags

3 Side airbags

Can help protect the torso of the front seat occupants.

4 Curtain shield airbags

Can help protect primarily the head of outside occupants.

Airbag system components

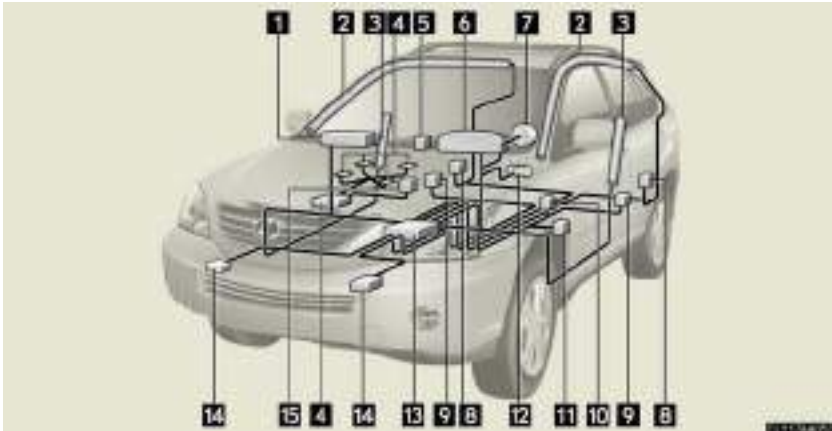

- | | |
|--|---|
| 1 Front passenger airbag | 9 Side and curtain shield airbag sensors |
| 2 Curtain shield airbags | 10 Driver's seat belt buckle switch |
| 3 Side airbags | 11 Driver's seat position sensor |
| 4 Occupant detection system (ECU and sensors) | 12 Driver knee airbag |
| 5 AIR BAG ON and AIR BAG OFF indicator lights | 13 Airbag sensor assembly |
| 6 SRS warning light | 14 Front airbag sensors |
| 7 Driver airbag | 15 Front passenger's seat belt buckle switch |
| 8 Curtain shield airbag sensors | |

Your vehicle is equipped with ADVANCED AIRBAGS designed based on US motor vehicle safety standards (FMVSS208). The airbag system controls airbag deployment power for the driver and front passenger. The driver airbag system consists of the driver seat's position sensor etc. The front passenger's airbag system consists of the front passenger occupant classification sensor etc.

The main SRS airbag system components are shown above. The SRS airbag system is controlled by the airbag sensor assembly. The airbag sensor assembly consists of a safing sensor and an airbag sensor.

In certain types of severe frontal or side impacts, the SRS airbag system triggers the airbag inflators. A chemical reaction in the inflators quickly fills the airbags with non-toxic gas to help restrain the motion of the occupants.

■ SRS warning light

This warning light system monitors the airbag sensor assembly, front airbag sensors, side and curtain shield airbag sensor assemblies, curtain shield airbag sensor assemblies, driver's seat position sensor, driver's seat belt buckle switch, front passenger occupant classification system, AIR BAG ON indicator light, AIR BAG OFF indicator light, front passenger's seat belt buckle switch, front seat belt pretensioner assemblies, inflators, interconnecting wiring and power sources.
(→P. 389)

■ If the SRS airbags deploy (inflate)

- Bruising and slight abrasions may result from contact with a deploying (inflating) SRS airbag.
- A loud noise and white powder will be emitted.
- Parts of the airbag module (steering wheel hub, airbag cover and inflator) as well as the front seats, and parts of the front pillar and roof side rail, may be hot for several minutes. The airbag itself may also be hot.
- The front windshield may crack.

■ Operating conditions (front airbags)

- The SRS front airbags will deploy if the severity of the frontal impact is above the designed threshold level, comparable to an approximate 15 mph (25 km/h) collision when the vehicle impacts straight into a fixed barrier that does not move or deform.

However, this threshold velocity will be considerably higher if the vehicle strikes an object, such as a parked vehicle or sign pole, which can move or deform on impact, or if the vehicle is involved in an underride collision (e.g. a collision in which the front of the vehicle "underrides", or goes under, the bed of a truck, etc.).

- It is possible that in some collisions where the forward deceleration of the vehicle is very close to the designed threshold level, the SRS front airbags and the seat belt pretensioners may not activate together.

- The SRS front passenger airbag will not activate if there is no passenger sitting in the front passenger seat. However, the front passenger airbag may deploy if luggage is put in the seat, or the seat belt is fastened, even if the seat is unoccupied. (→P. 103)

■ Operating conditions (side airbags)

- The SRS side airbags are designed to inflate when the passenger compartment is subjected to a severe impact from the side.
- The SRS side airbag on the passenger seat will not activate if there is no passenger sitting in the front passenger seat. However, the side airbag on the passenger seat may deploy if luggage is put in the seat, or the seat belt is fastened, even if the seat is unoccupied. (→P. 103)

■ Operating conditions (curtain shield airbags)

The SRS curtain shield airbags are designed to inflate when the passenger compartment is subjected to a severe impact from the side or vehicle rollover.

■ Conditions under which the SRS airbags may deploy (inflate), other than a collision

The SRS front airbags may also deploy if a serious impact occurs to the underside of your vehicle. Some examples are shown in the illustration.

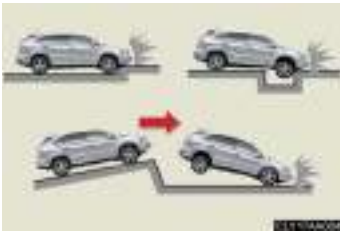

- Hitting a curb, edge of pavement or hard surface
- Falling into or jumping over a deep hole
- Landing hard or vehicle falling

The SRS curtain shield airbags may also deploy under the situations shown in the illustration.



- The angle of vehicle tip-up is marginal.
- The vehicle skids and hits a curb stone.

■ Types of collisions that may not deploy the SRS airbag (front airbags)

The SRS front airbags are generally not designed to inflate if the vehicle is involved in a side or rear collision, if it rolls over, or if it is involved in a low-speed frontal collision. But, whenever a collision of any type causes sufficient forward deceleration of the vehicle, deployment of the SRS front airbags may occur.



- Collision from the side
- Collision from the rear
- Vehicle rollover

■ Types of collisions that may not deploy the SRS airbag (side and curtain shield airbags)

The SRS side airbag and curtain shield airbag system may not activate if the vehicle is subjected to a collision from the side at certain angles, or a collision to the side of the vehicle body other than the passenger compartment.



- Collision from the side to the vehicle body other than the passenger compartment
- Collision from the side at an angle

1-8. Safety information

The SRS side airbags are not generally designed to inflate if the vehicle is involved in a frontal or rear collision, if it rolls over, or if it is involved in a low-speed side collision.



- Collision from the front
- Collision from the rear
- Vehicle rollover

The SRS curtain shield airbags are not generally designed to inflate if the vehicle is involved in a frontal or rear collision, if it pitches end over end, or if it is involved in a low-speed side collision.



- Collision from the front
- Collision from the rear
- Pitching end over end

■ When to contact your Lexus dealer

In the following cases, contact your Lexus dealer as soon as possible. Do not disconnect the battery cables before contacting your Lexus dealer.

- Any of the SRS airbags have been inflated.



- The front of the vehicle is damaged or deformed, or was involved in an accident that was not severe enough to cause the SRS airbags to inflate.



- A portion of the doors is damaged or deformed, or the vehicle was involved in an accident that was not severe enough to cause the SRS side airbags and curtain shield airbags to inflate.



- The pad section of the steering wheel, front passenger airbag cover or lower portion of the instrument panel is scratched, cracked, or otherwise damaged.



- The surface of the seats with the side airbag is scratched, cracked, or otherwise damaged.
- The portion of the front pillars, rear pillars or roof side rail garnishes (padding) containing the curtain shield airbags inside is scratched, cracked, or otherwise damaged.

CAUTION

■ SRS airbag precautions

Observe the following precautions regarding the airbags.

Failure to do so may cause death or serious injury.

- The driver and all passengers in the vehicle must wear their seat belts properly. The SRS airbags are supplemental devices to be used with the seat belts.
- The SRS driver airbag deploys with considerable force, and can cause death or serious injury especially if the driver is very close to the airbag. The National Highway Traffic Safety Administration (“NHTSA”) advises:

Since the risk zone for driver airbag is the first 2 - 3 in. (50 - 75 mm) of inflation, placing yourself 10 in. (250 mm) from your driver airbag provides you with a clear margin of safety. This distance is measured from the center of the steering wheel to your breastbone. If you sit less than 10 in. (250 mm) away now, you can change your driving position in several ways:

- Move your seat to the rear as far as you can while still reaching the pedals comfortably.
- Slightly recline the back of the seat.
Although vehicle designs vary, many drivers can achieve the 10 in. (250 mm) distance, even with the driver seat all the way forward, simply by reclining the back of the seat somewhat. If reclining the back of your seat makes it hard to see the road, raise yourself by using a firm, non-slippery cushion, or raise the seat if your vehicle has that feature.
- If your steering wheel is adjustable, tilt it downward. This points the airbag toward your chest instead of your head and neck.

The seat should be adjusted as recommended by NHTSA above, while still maintaining control of the foot pedals, steering wheel, and your view of the instrument panel controls.

 CAUTION

 SRS airbag precautions

- If the seat belt extender has been connected to the driver's seat belt buckle but the seat belt extender has not also been fastened to the latch plate of the driver's seat belt, the SRS driver's airbag system will judge that the driver is wearing the seat belt even though the seat belt has not been connected. In this case, the driver's airbag may not activate correctly in a collision, resulting in death or serious injury in the event of collision. Be sure to wear the seat belt with the seat belt extender.
- The SRS front passenger airbag also deploys with considerable force, and can cause death or serious injury especially if the front passenger is very close to the airbag. The front passenger seat should be as far from the airbag as possible with the seatback adjusted, so the front passenger sits upright.
- Improperly seated and/or restrained infants and children can be killed or seriously injured by a deploying airbag. An infant or child who is too small to use a seat belt should be properly secured using a child restraint system. Lexus strongly recommends that all infants and children be placed in the rear seats of the vehicle and properly restrained. The rear seats are the safest for infants and children. (→P.108)

! CAUTION

■ SRS airbag precautions



- Do not sit on the edge of the seat or lean against the dashboard.



- Do not allow a child to stand in front of the SRS front passenger airbag unit or sit on the knees of a front passenger.
- Do not drive the vehicle while the driver or passenger have items resting on their knees.



- Do not lean against the door, the roof side rail or the front, side and rear pillars.



- Do not allow anyone to kneel on the passenger seat toward the door or put their head or hands outside the vehicle.

 CAUTION

 SRS airbag precautions

- Do not attach anything to or lean anything against areas such as the dashboard, steering wheel pad or lower portion of the instrument panel.
These items can become projectiles when SRS driver, front passenger and knee airbags deploy.
 - Do not attach anything to areas such as the door, windshield glass, side door glass, front and rear pillars, roof side rail or assist grip.
 - Do not hang coat hangers or other hard objects on the coat hooks. All of these items could become projectiles and seriously injure or kill you, should the SRS curtain shield airbag deploy.
 - Do not attach any heavy, sharp or hard objects such as other keys or accessories to the keychain. The objects may restrict the SRS knee airbag inflation or be thrust into the driver's seat area by the force of the deploying airbag, thus causing a danger.
- If the vinyl cover is put on the area where the SRS knee airbag will deploy, be sure to remove it.
 - Do not use seat accessories which cover the parts where the SRS side airbags inflate as they may interfere with inflation of the airbags.
 - Do not strike or apply significant levels of force to the area of the SRS airbag components shown on P. 92.
Doing so can cause the SRS airbags to malfunction.
 - Do not touch any of the component parts immediately after the SRS airbags have deployed (inflated) as they may be hot.

CAUTION

■ SRS airbag precautions

- If breathing becomes difficult after the SRS airbag has deployed, open a door or window to allow fresh air in, or leave the vehicle if it is safe to do so. Wash off any residue as soon as possible to prevent skin irritation.
- If the areas where the SRS airbags are stored, such as the steering wheel pad and front pillar garnish, are damaged or cracked, have them replaced by your Lexus dealer.
- Do not place anything, such as a cushion, on the front passenger's seat. Doing so will disperse the passenger's weight, which prevents the sensor from detecting the passenger's weight properly. As a result, the SRS front passenger airbag may not deploy in the event of a collision.

■ Modification and disposal of SRS airbag system components

Do not dispose of your vehicle or perform any of the following modifications without consulting your Lexus dealer.

The SRS airbag may malfunction or deploy (inflate) accidentally, causing death or serious injury.

- Installation, removal, disassembly and repair of the SRS airbags
- Repairs, modifications, removal or replacement of the steering wheel, instrument panel, dashboard, seats or seat upholstery, front, side and rear pillars or roof side rails
- Repairs or modifications of the front fender, front bumper, or side of the occupant compartment
- Installation of snow plows, winches, etc. to the front grille (bull bars, kangaroo bar etc.)
- Modifications to the vehicle's suspension system
- Installation of electronic devices such as mobile two-way radios or CD players
- Modifications to your vehicle for a person with a physical disability.

1-8. Safety information

Front passenger occupant classification system

Your vehicle is equipped with a front passenger occupant classification system. This system detects the conditions of the front passenger seat and activates or deactivates the devices for front passenger.



- ❶ SRS warning light
- ❷ Front passenger's seat belt reminder light
- ❸ AIR BAG OFF indicator light
- ❹ AIR BAG ON indicator light

1

Before driving

Condition and operation in the front passenger occupant classification system

■ Adult*¹

Indicator/ warning light	AIR BAG ON and AIR BAG OFF indicator lights	AIR BAG ON
	SRS warning light	Off
	Front passenger's seat belt reminder light	Flashing* ²
Devices	Front passenger airbag	Activated
	Side airbag on the front passenger seat	
	Curtain shield airbag in the front passenger side	
	Front passenger's seat belt pretensioner	

■ Child^{*3} or child restraint system^{*4}

Indicator/ warning light	AIR BAG ON and AIR BAG OFF indicator lights	AIR BAG OFF ^{*5}
	SRS warning light	Off
	Front passenger's seat belt reminder light	Flashing ^{*2}
Devices	Front passenger airbag	Deactivated
	Side airbag on the front passenger seat	
	Curtain shield airbag in the front passenger side	Activated
	Front passenger's seat belt pretensioner	

■ Unoccupied

Indicator/ warning light	AIR BAG ON and AIR BAG OFF indicator lights	Not illumi- nated
	SRS warning light	Off
	Front passenger's seat belt reminder light	
Devices	Front passenger airbag	Deactivated
	Side airbag on the front passenger seat	
	Curtain shield airbag in the front passenger side	Activated
	Front passenger's seat belt pretensioner	Deactivated

■ There is a malfunction in the system

Indicator/ warning light	AIR BAG ON and AIR BAG OFF indicator lights	AIR BAG OFF
	SRS warning light	On
	Front passenger's seat belt reminder light	Off
Devices	Front passenger airbag	Deactivated
	Side airbag on the front passenger seat	
	Curtain shield airbag in the front passenger side	Activated
	Front passenger's seat belt pretensioner	

1

Before driving

- *1: The system judges a person of adult size as an adult. When a smaller adult sits in the front passenger seat, the system may recognize him/her as a child depending on his/her physique and posture.
- *2: In the event the front passenger does not wear a seat belt.
- *3: When a larger child who has outgrown a child restraint system sits in the front passenger seat, the system may recognize him/her as an adult depending on his/her physique or posture.
- *4: Never install a rear-facing child restraint system on the front passenger seat. A forward-facing child restraint system should only be installed on the front passenger seat when it is unavoidable. (→P. 108)
- *5: In case the indicator is not illuminated, consult this manual as for installing the child restraint system properly. (→P. 112)

 **CAUTION**

■ Front passenger occupant classification system precautions

Observe the following precautions regarding front passenger occupant classification system.

Failure to do so may cause death or serious injury.

- Wear the seat belt properly.
- Make sure the front passenger's seat belt plate has not been left inserted into the buckle before someone sits in the front passenger seat.
- Make sure the AIR BAG OFF indicator light is not illuminated when using the seat belt extender for the front passenger seat. If the AIR BAG OFF indicator light is illuminated, disconnect the extender tongue from the seat belt buckle, then reconnect the seat belt. Reconnect the seat belt extender after making sure the AIR BAG ON indicator light is illuminated. If you use the seat belt extender while the AIR BAG OFF indicator light is illuminated, the front passenger airbag and side airbag on the front passenger side may not activate correctly, which could cause death or serious injury in the event of collision.
- Do not apply a heavy load to the front passenger seat or equipment (e.g. seat-back pocket or armrest).
- Do not put weight on the front passenger seat by putting your hands or feet on the front passenger seat seatback from the rear passenger seat.
- Do not let a rear passenger lift the front passenger seat with their feet or press on the seatback with their legs.
- Do not put objects under the front passenger seat.
- Do not recline the front passenger seatback so far that it touches a rear seat. This may cause the AIR BAG OFF indicator light to be illuminated, which indicates that the passenger's airbags will not deploy in the event of a severe accident. If the seatback touches the rear seat, return the seatback to a position where it does not touch the rear seat. Keep the front passenger seatback as upright as possible when the vehicle is moving. Reclining the seatback excessively may lessen the effectiveness of the seat belt system.

 **CAUTION****■ Front passenger occupant classification system precautions**

- If an adult sits in the front passenger seat, the AIR BAG ON indicator light is illuminated. If the AIR BAG OFF indicator is illuminated, ask the passenger to sit up straight, well back in the seat, feet on the floor, and with the seat belt worn correctly. If the AIR BAG OFF indicator still remain illuminated, either ask the passenger to move to the rear seat, or if that is not possible, move the front passenger seat fully rearward.
- When it is unavoidable to install the forward-facing child restraint system on the front passenger seat, install the child restraint system on the front passenger seat in the proper order. (→P. 112)
- Do not modify or remove the seat.
- Do not kick the front passenger seat or subject it to severe impact. Otherwise, the SRS warning light may come on to indicate a malfunction of the detection system. In this case, contact your Lexus dealer immediately.
- Child restraint systems installed on the rear seat should not contact the front seat-backs.

1-8. Safety information

Child restraint systems

A child restraint system for a small child or baby must itself be properly restrained on the seat with the lap portion of the lap/shoulder belt.

The laws of all 50 states of the U.S.A. and Canada now require the use of child restraint systems.

Points to remember

Studies have shown that installing a child restraint on a rear seat is much safer than installing one to the front passenger seat.

- Choose a child restraint system appropriate to the age and size of the child.
- For installation details, follow the instructions provided with the child restraint system.
General installation instructions are provided in this manual. (→P. 112)

Types of child restraints

Child restraint systems are classified into the following 3 types according to the age and size of the child.



▶ Infant seat



▶ Convertible seat



▶ Booster seat

■ Selecting an appropriate child restraint system

Get an appropriate child restraint system for the child. If a child is too large for a child restraint system, sit the child on a rear seat and use the vehicle's seat belt. (→P. 58)

⚠ CAUTION

■ Child restraint precautions

- For effective protection in automobile accidents and sudden stops, a child must be properly restrained, using a seat belt or child restraint system depending on the age and size of the child. Holding a child in your arms is not a substitute for a child restraint system. In an accident, the child can be crushed against the windshield, or between you and the vehicle's interior.

CAUTION

■ Child restraint precautions

- Lexus strongly urges the use of a proper child restraint system that conforms to the size of the child, installed on the rear seat. According to accident statistics, the child is safer when properly restrained in the rear seat than in the front seat.
- Never install a rear-facing child restraint system on the front passenger seat even if AIR BAG OFF indicator light is illuminated. In the event of an accident, the force of the rapid inflation of the front passenger airbag can cause death or serious injury to the child if the rear-facing child restraint system is installed on the front passenger seat.
- A forward-facing child restraint system should allowed to be installed on the front passenger seat only when it is unavoidable. Always move the seat as far back as possible even if AIR BAG OFF indicator light is illuminated, because the front passenger airbag could inflate with considerable speed and force. Otherwise, the child may be killed or seriously injured.
- Do not use the seat belt extender when installing a child restraint system on the front or rear passenger seat. If installing a child restraint system with the seat belt extender connected to the seat belt, the seat belt will not securely hold the child restraint system, which could cause death or serious injury to the child or other passengers in the event of collision.
- Do not allow the child to lean his/her head or any part of his/her body against the door or the area of the seat, front pillar or roof side rail from which the side airbags or curtain shield airbags deploy even if the child is seated in the child restraint system. It is dangerous if the side airbags and curtain shield airbags inflate, and the impact could cause death or serious injury to the child.
- Make sure you have complied with all installation instructions provided by the child restraint manufacturer and that the system is properly secured. If it is not secured properly, it may cause death or serious injury to the child in the event of a sudden stop or accident.

 **CAUTION****■ Child restraint lock function belt precaution**

Do not allow children to play with the child restraint lock function belt. If the belt becomes twisted around a child's neck, it will not be possible to pull the belt out leading to choking or other serious injuries that could result in death. If this occurs and the buckle cannot be unfastened, scissors should be used to cut the belt.

■ When the child restraint system is not in use

- Keep the child restraint system properly secured on the seat even if it is not in use. Do not store the restraint unsecured in the passenger compartment.
- If it is necessary to detach the child restraint system, remove it from the vehicle or store it securely in the luggage compartment. This will prevent it from injuring passengers in the event of a sudden stop or accident.

1-8. Safety information

Installing child restraints

Follow the child restraint system manufacturer's instructions. Firmly secure child restraints to the rear seats using a seat belt or a child restraint lower anchorage. Attach the top strap when installing a child restraint.



- 1** Seat belts equipped with a child restraint locking mechanism (ALR/ELR belts except driver's seat belt) (→P. 58)



- 2** Child restraint lower anchorages

Lower anchorages are provided for the outside rear seats. (Buttons displaying the location of the anchorages are attached to the seats.)



- 3** Anchor bracket (for top strap)

Anchor brackets are provided for all rear seats.

Installing child restraints using a seat belt (child restraint lock function belt)

■ Rear facing — Infant seat/convertible seat

STEP 1



Place the child restraint system on the rear seat facing the rear of the vehicle.

STEP 2



Run the seat belt through the child restraint system and insert the plate into the buckle. Make sure that the belt is not twisted.

STEP 3



Fully extend the shoulder belt and then allow it to retract slightly in order to activate the ALR lock mode.

Lock mode allows the seat belt to retract only.

1

Before driving

STEP 4



While pushing the child restraint system down into the rear seat, allow the shoulder belt to retract until the child restraint system is securely in place.

After the shoulder belt has retracted to a point where there is no slack in the belt, pull the belt to check that it cannot be extended.

■ Forward facing — Convertible seat

STEP 1



Place the child restraint system on the seat facing the front of the vehicle.

STEP 2



Run the seat belt through the child restraint system and insert the plate into the buckle. Make sure that the belt is not twisted.

STEP 3



Fully extend the shoulder belt and then allow it to retract slightly into the ALR lock mode.

Lock mode allows the seat belt to retract only.

STEP 4



While pushing the child restraint system into the rear seat, allow the shoulder belt to retract until the child restraint system is securely in place.

After the shoulder belt has retracted to a point where there is no slack in the belt, pull the belt to check that it cannot be extended.

■ Booster seat

STEP 1



Place the child restraint system on the seat facing the front of the vehicle.

STEP 2



Sit the child in the child restraint system. Fit the seat belt to the child restraint system according to the manufacturer's instructions and insert the plate into the buckle. Make sure that the belt is not twisted.

Check that the shoulder belt is correctly positioned over the child's shoulder, and that the lap belt is as low as possible. (→P. 58)

Removing a child restraint installed with a seat belt



Push the buckle release button and fully retract the seat belt.

Installation with child restraint lower anchorages

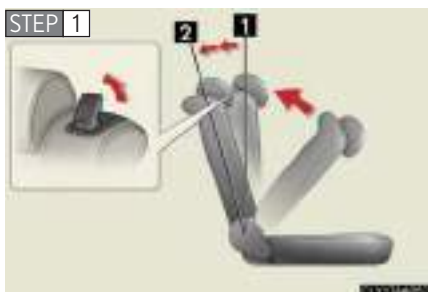

Fold the seatback forward and then back to the 1st lock position (most upright position) until it locks into place. Adjust the seatback to the 3rd lock position.

- 1 1st lock position
- 2 3rd lock position

STEP 2 Widen the gap between the seat cushion and seatback slightly.

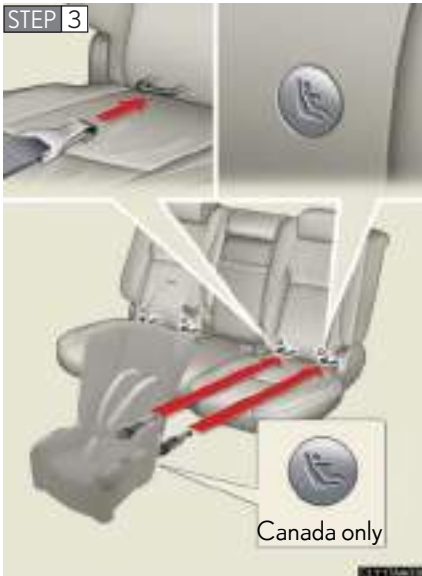

► Type A

Latch the hooks of lower straps onto the anchorages.

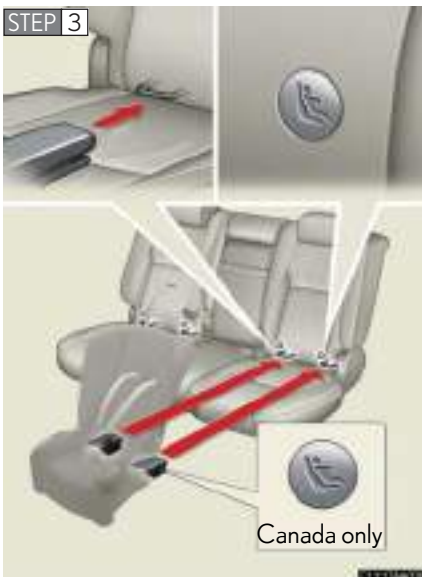

► Type B

Latch the buckles onto the anchorages.

If the child restraint has a top strap, the top strap should be latched onto the anchorages. (→P. 118)

For owners in Canada:

The symbol on a child restraint system indicates the presence of a lower connector system.

Child restraint systems with a top strap

STEP 1



Secure the child restraint using a seat belt or a lower anchorage, and remove the head restraint.

STEP 2



Open the anchor bracket cover, latch the hook onto the anchor bracket and tighten the top strap.

STEP 3



Replace the head restraint and lift it up to the uppermost lock position.

■ Laws and regulations pertaining to anchorages

Anchorages conform to FMVSS225 or CMVSS210.2.

Child restraint systems conforming to FMVSS213 or CMVSS213 specifications can be used.

This vehicle is designed to conform to the SAE J1819.

⚠ CAUTION

■ When installing a booster seat

Do not fully extend the shoulder belt to prevent the belt from going to ALR lock mode: (→P. 61)

ALR mode causes the belt to tighten only which could cause injury or discomfort to the child.

■ When installing a child restraint system

Follow the directions given in the child restraint system installation manual and fix the child restraint system securely in place.

If the child restraint system is not correctly fixed in place, the child or other passengers may be injured or even killed in the event of sudden braking or an accident.



- If the driver's seat interferes with the child restraint system and prevents it from being attached correctly, attach the child restraint system to the right-hand rear seat.



- Only put a forward facing or booster child seat on the front seat when unavoidable. When installing a forward facing or booster seat on the front passenger seat, move the seat as far back as possible even if AIR BAG OFF indicator light is illuminated. Failing to do so may result in death or serious injury if the airbags deploy (inflate).

CAUTION

■ When installing a child restraint system

- When installing a child restraint system in the rear center position, adjust both seat cushions to the same position and align both seatbacks at the same angle. Otherwise, the child restraint system cannot be securely restrained and this may cause death or serious injuries in a collision.
- When using the lower anchorages for a child restraint system, ensure that the seat is moved to the rear-most position, with the seatback close to the child restraint system.
- When a booster seat is installed, always ensure that the shoulder belt is positioned across the center of the child's shoulder. The belt should be kept away from the child's neck, but not so that it could fall off the child's shoulder. Failing to do so may result in death or serious injury in the event of an accident or sudden braking.
- Ensure that the belt and tab are securely locked and the seat belt is not twisted.
- Push and pull the child seat in different directions to be sure it is secure.
- Follow all installation instructions provided by the child restraint system manufacturer.

■ Do not use a seat belt extender

If a seat belt extender is used when installing a child restraint system, the seat belt will not securely hold the child restraint system, which could cause death or serious injury to the child or other passengers in the event of a collision.

■ To correctly attach a child restraint system to the anchorages

When using the lower anchorages, be sure that there are no foreign objects around the anchorages and that the seat belt is not caught behind the child restraint. Make sure the child restraint system is securely attached, or it may cause death or serious injury to the child or other passengers in the event of a sudden stop or accident.

2-1. Driving procedures	122	2-4. Using other driving	158
Driving the vehicle.....	122	systems	158
Engine (ignition) switch	131	Cruise control	158
Transmission.....	135	Dynamic laser cruise	
Turn signal lever	136	control.....	161
Parking brake	137	Driving assist systems.....	170
2-2. Instrument cluster	138	2-5. Driving information.....	174
Gauges and meters	138	Utility vehicle	
Indicators and warning		precautions.....	174
lights	140	Cargo and luggage	179
Multi-information display	143	Vehicle load limits	182
Trip information display		Winter driving tips.....	183
(without navigation		Trailer towing.....	187
system).....	146	Dinghy towing.....	196
2-3. Operating the lights and			
windshield wipers.....	148		
Headlight switch.....	148		
Fog light switch	151		
Windshield wipers and			
washer	152		
Rear window wiper and			
washer	156		
Headlight cleaner switch.....	157		

2-1. Driving procedures

Driving the vehicle

The following procedures should be observed to ensure safe driving.

■ Starting the hybrid system

→P. 131

■ Driving

STEP 1 With the brake pedal depressed, shift the shift lever to D. (→P. 135)

STEP 2 Release the parking brake. (→P. 137)

STEP 3 Gradually release the brake pedal and gently push the accelerator pedal to accelerate the vehicle.

■ Stopping

STEP 1 With the shift lever in D, push the brake pedal.

STEP 2 If necessary, set the parking brake.

When the vehicle is stopped for an extended period of time, shift the shift lever to P. (→P.135)

■ Parking the vehicle

STEP 1 With the shift lever in D, push the brake pedal.

STEP 2 Set the parking brake. (→P.137)

STEP 3 Shift the shift lever to P. (→P.135)

STEP 4 Turn the engine switch to stop the hybrid system.

STEP 5 Lock the door, making sure that you have the key on your person.

Starting on a steep uphill

STEP 1 Firmly set the parking brake and shift the shift lever to D.

STEP 2 Gently depress the accelerator pedal.

STEP 3 Release the parking brake.

■ Driving in the rain

- Drive carefully when it is raining, because visibility will be reduced, the windows may become fogged-up, and the road will be slippery.
- Drive carefully when it starts to rain, because the road surface will be especially slippery.
- Refrain from high speeds when driving on an expressway in the rain, because there may be a layer of water between the tires and the road surface, preventing the steering and brakes from operating properly.

■ Breaking in your new Lexus

To extend the life of the vehicle, the following precautions are recommended to observe:

- For the first 200 miles (300 km):
Avoid sudden stops.
- For the first 500 miles (800 km):
Do not tow a trailer.
- For the first 1000 miles (1600 km):
 - Do not drive at extremely high speeds.
 - Avoid sudden acceleration.
 - Do not drive continuously in the low gears.
 - Do not drive at a constant speed for extended periods.

■ Drum-in-disc type parking brake system

Your vehicle has a drum-in-disc type parking brake system. This type of brake system needs bedding-down of the brake shoes periodically or whenever the parking brake shoes and/or drum are replaced. Have your Lexus dealer perform the bedding down.

■ Operating your vehicle in a foreign country

Comply with the relevant vehicle registration laws and confirm the availability of the correct fuel. (→P. 433)

■ For efficient use of the hybrid battery

- Put the shift lever into D when driving

In the N position, the gasoline engine operates but electricity cannot be generated. The hybrid battery (traction battery) will be discharged requiring unnecessary engine power to recharge.

- Drive your vehicle smoothly

Avoid abrupt acceleration and deceleration. Gradual acceleration and deceleration will make more effective use of the traction motor without having to use gasoline engine power.

- Avoid repeated acceleration

Repeated acceleration consumes hybrid battery (traction battery) power, resulting in poor acceleration. Battery power can be restored by driving with the accelerator pedal slightly released.

- Put the shift lever into P when parking

In the N position, the hybrid battery (traction battery) does not recharge.

Leaving the shift lever in the N position for an extended period of the time may discharge the hybrid battery. The vehicle cannot run if the hybrid battery is discharged.

■ Normal characteristics after turning off the hybrid system

Approximately five hours after the hybrid system is turned off, you may hear sound coming from under the vehicle for several minutes. This is the sound of a fuel evaporation leakage check and, it does not indicate a malfunction.

CAUTION

■ When starting the vehicle

Always keep your foot on the brake pedal while stopped with the hybrid system running. This prevents the vehicle from creeping.

 **CAUTION**
■ When driving the vehicle

- Do not drive if you are unfamiliar with the location of the brake and accelerator pedals to avoid depressing the wrong pedal.
 - Accidentally depressing the accelerator pedal instead of the brake pedal will result in sudden acceleration that may lead to an accident that could result in death or serious injury.
 - When backing up, you may twist your body around, leading to a difficulty in operating the pedals. Make sure to operate the pedals properly.
 - Make sure to keep a correct driving posture even when moving the vehicle only slightly, allowing you to depress the brake and accelerator pedals properly.
 - Depress the brake pedal using your right foot. Depressing the brake pedal using your left foot may delay response in an emergency, resulting in an accident.
- The driver should pay attention to pedestrians when the vehicle is powered only by the electric motor (traction motor). Because there is no engine noise, the pedestrians may misjudge the vehicle's movement.
- Do not drive the vehicle over or stop the vehicle near flammable materials.
- Do not let the vehicle roll backwards while the shift lever is in a driving position, or roll forward while the shift lever is in R.
Doing so may cause the hybrid system to stall or lead to poor brake and steering performance, resulting in an accident or damage to the vehicle.
- If the smell of exhaust is noticed inside the vehicle, open the windows and check that the back door is closed. Large amounts of exhaust in the vehicle can cause driver drowsiness and an accident, resulting in death or a serious health hazard. Have the vehicle inspected by your Lexus dealer immediately.
- Do not under any circumstances shift the shift lever to P, R or N while the vehicle is moving.
Doing so can cause significant damage to the transmission system and may result in a loss of vehicle control.
- Do not shift the shift lever to N while the vehicle is moving.
Doing so may cause the engine brake to not operate properly and lead to an accident.

CAUTION

■ When driving the vehicle

- Use engine braking to maintain a safe speed when driving down a steep hill. Using the brakes continuously may cause the brakes to overheat and lose effectiveness. (→P. 135)
- When stopped on an inclined surface, use the brake pedal and parking brake to prevent the vehicle from rolling backward or forward and causing an accident.
- Do not adjust the position of the steering wheel, the seat, or the inside or outside rear view mirrors while driving. Doing so may result in a loss of vehicle control that can cause accidents that may result in death or serious injury.
- Always check that all passengers' arms, heads or other parts of their bodies are not outside the vehicle, as this may result in death or serious injury.
- Do not drive in excess of the speed limit. Even if the legal speed limit permits it, do not drive over 85 mph (140 km/h) unless your vehicle has high-speed capability tires. Driving over 85 mph (140 km/h) may result in tire failure, loss of control and possible injury. Be sure to consult a tire dealer to determine whether the tires on your vehicle are high-speed capability tires or not before driving at such speeds.

■ When driving on slippery road surfaces

- Sudden braking, acceleration and steering may cause tire slippage and reduce your ability to control the vehicle, resulting in an accident.
- Sudden changes in engine speed, such as engine braking caused by up-shifting or down-shifting, may cause the vehicle to skid, resulting in an accident.
- After driving through a puddle, lightly depress the brake pedal to make sure that the brakes are functioning properly. Wet brake pads may prevent the brakes from functioning properly. If the brakes on only one side are wet and not functioning properly, steering control may be affected, resulting in an accident.

■ When shifting the shift lever

Be careful not to shift the shift lever with the accelerator pedal depressed. This may lead to unexpected rapid acceleration of the vehicle that may cause an accident and result in death or serious injury.

 **CAUTION**
■ When the vehicle is stopped

- Do not race the hybrid system.
If the vehicle is in any gear other than P or N the vehicle may accelerate suddenly and unexpectedly, and may cause an accident.
- Do not leave the vehicle with the hybrid system on for a long time.
If such a situation cannot be avoided, park the vehicle in an open space and check that exhaust fumes do not enter the vehicle interior.
- Always keep a foot on the brake pedal while the hybrid system is operating to prevent an accident caused by the vehicle moving.

■ When the vehicle is parked

- Do not leave glasses, cigarette lighters, spray cans, or soft drink cans in the vehicle when it is in the sun.
Doing so may result in the following.
 - Gas may leak from a cigarette lighter or spray can, and may lead to a fire.
 - The temperature inside the vehicle may cause the plastic lenses and plastic material of eye glasses to deform or crack.
 - Soft drink cans may fracture, causing the contents to spray over the interior of the vehicle, and may also cause a short circuit in the vehicle's electrical components.
- Always apply the parking brake, shift the shift lever to P, stop the hybrid system and lock the vehicle.
Do not leave the vehicle unattended while the hybrid system operating.
- Do not touch the exhaust pipe while the hybrid system or immediately after turning the hybrid system off.
Doing so may cause burns.
- Do not leave the hybrid system operating in an area with snow build-up, or where it is snowing. If snowbanks build up around the vehicle while the hybrid system is operating, exhaust gases may collect and enter the vehicle. This may lead to death or a serious health hazard.

CAUTION

■ Exhaust gases

Exhaust gases include harmful carbon monoxide (CO) that is colorless and odorless. Inhaling exhaust gases may lead to death or a serious health hazard.

- If the vehicle is in a poorly ventilated area, stop the hybrid system. In a closed area, such as a garage, exhaust gases may collect and enter the vehicle. This may lead to death or a serious health hazard.
- The exhaust should be checked occasionally. If there is a hole or crack caused by corrosion, damage to a joint or abnormal exhaust noise, be sure to have the vehicle inspected and repaired by your Lexus dealer. Failure to do so may allow exhaust gases to enter the vehicle, resulting in death or a serious health hazard.

■ When taking a nap in the vehicle

Always turn the hybrid system off. Otherwise, you may accidentally move the shift lever or depress the accelerator pedal, which could cause an accident or fire due to hybrid system overheating. Additionally, if the vehicle is parked in a poorly ventilated area, exhaust gases may collect and enter the vehicle, leading to death or a serious health hazard.

■ When braking the vehicle

- When the brakes are wet, drive more cautiously.
Braking distance increases when the brakes are wet, and may cause one side of the vehicle to brake differently than the other side. Also the parking brake may not securely hold the vehicle.
- If the power brake assist function does not operate, do not follow other vehicles closely and avoid downhills or sharp turns that require braking.
In this case, braking is still possible, but it will require more force on the pedal than usual. Braking distance may also increase.
- The brake system consists of 3 individual hydraulic systems: if one of the systems fails, the other will still operate. In this case, the brake pedal should be depressed more firmly than usual and braking distance becomes longer.
Do not drive your vehicle with only a single brake system. Have your brakes fixed immediately.

■ If the vehicle becomes stuck or bogged (AWD models)

Do not spin the wheels recklessly when any of the tires is up in the air, or stuck in sand or mud, etc. This may damage the drive system components or propel the vehicle forward (or in another direction) and cause an accident.

 NOTICE

■ While driving the vehicle

Do not use the accelerator pedal or depress accelerator and brake pedals together to hold the vehicle on a hill.

■ When parking the vehicle

Always put the shift lever in P.

Failure to do so may cause the vehicle to move or the vehicle may accelerate suddenly if the accelerator pedal is accidentally depressed.

■ Avoiding damage to vehicle parts

- Do not turn the steering wheel fully in either direction and hold it there for a long time.
Doing so may damage the power steering pump.
- When driving over bumps in the road, drive as slowly as possible to avoid damaging the wheels, underside of the vehicle, etc.

■ If you hear a squealing or scraping noise (brake pad wear limit indicators)

Have your Lexus dealer check and replace the brake pads as soon as possible.

The rotor damage can result if the pads are not replaced when needed.

It is dangerous to drive the vehicle when the wear limits of the brake pads and/or that of the brake discs are exceeded.

■ If you get a flat tire while driving

A flat or damaged tire may cause the following situations. Hold the steering wheel firmly and gradually press the brake pedal to slow down the vehicle.

- It may be difficult to control your vehicle.
- The vehicle will make abnormal sounds.
- The vehicle will behave abnormally.

Replace a flat tire with a new one. (→P. 412)

NOTICE

■ When encountering flooded roads

Do not drive on a road that has flooded after heavy rain etc. Doing so may cause the following serious damage to the vehicle.

- Engine stalling
- Short in electrical components
- Engine damage caused by water immersion

In the event that you drive on a flooded road and the vehicle is flooded, be sure to have your Lexus dealer check the following.

- Brake function
- Changes in quantity and quality of oil and fluid used for the engine, transaxle, differential, etc.
- Lubricant condition for the bearings and suspension joints (where possible) and the function of all joints, bearings, etc.

■ Engine switch



1 LOCK

The hybrid system is off and the steering wheel is locked and the key can be removed from the engine switch.

2 ACC

The hybrid system is off and some electrical components such as the audio system can be used.

3 ON

The hybrid system is on and all electrical components can be used.

4 START

■ Starting the hybrid system

STEP 1 Check that the parking brake is set.

STEP 2 Turn off unnecessary lights and accessories.

STEP 3 Check that the shift lever is set in P.

STEP 4 Sit in the driver's seat and firmly depress the brake pedal.



Turn the engine switch to the START position.

After a few seconds, the READY light will flash and come on with a beep sound.

The vehicle can move when the READY light is on, even if the hybrid system is stopped.

As the hybrid system starts only with the transmission in the P position, put the selector lever in P whenever starting the system.

■ Turning the key from ACC to LOCK



STEP 1 Shift the shift lever to P.

STEP 2 Push in the key and turn to the LOCK position.

■ Steering lock release



When starting the hybrid system, the engine switch may seem stuck in the LOCK position. To free it, turn the key while turning the steering wheel slightly in either direction.

■ If the hybrid system does not start

The hybrid vehicle immobilizer system may not have been deactivated. (→P. 83)

■ If the 12-volt battery is disconnected or run down...

→P. 328

■ If the READY light does not come on

If the READY light does not come on when you turn the engine switch with the shift lever in P and the brake pedal pressed, contact your Lexus dealer immediately.

■ Starting the hybrid system using the flat key

STEP 1



Remove the flat key from its case. Insert the key into the engine switch.

STEP 2



Bring the key case close to the engine switch within 10 seconds as indicated by an arrow.

STEP 3

Put the key case away when the indicator light goes out. This means the hybrid vehicle immobilizer system has turned off.

STEP 4

Start the hybrid system within 60 seconds after the indicator light goes off.

■ When the ambient temperature is low

Such as during winter driving conditions, it may take time until the READY light comes on.

■ Sounds and vibrations specific to a hybrid vehicle

→P. 26

■ When the hybrid system is malfunctioning

→P. 398

CAUTION

■ When starting the hybrid system

Always start the hybrid system while sitting in the driver's seat. Do not press the accelerator pedal while starting the hybrid system under any circumstances. Doing so may cause an accident resulting in death or serious injury.

■ Caution when driving

Do not turn the engine switch to the LOCK position while driving. If, in an emergency, you must turn the hybrid system off while the vehicle is moving, turn the engine switch only to the ACC position.

NOTICE

■ To prevent 12-volt battery discharge

Do not leave the engine switch in the ACC or ON position for long periods without the hybrid system on.

■ When starting the hybrid system

- If any service reminder indicator light comes on or warning message appears on the multi-information display or the 12-volt battery is disconnected, the hybrid system may not start. In that case, turn the ignition on again. If the READY light does not come on, contact your Lexus dealer.
- Do not race the hybrid system.
- If the hybrid system becomes difficult to start or stalls frequently, have the hybrid system checked immediately.

Select a shift position appropriate for the driving conditions.

■ Shifting the shift lever



While the engine switch is in the ON position, depress the brake pedal and move the shift lever.

■ Shift position uses

Shift position	Function
P	Parking the vehicle or starting the hybrid system
R	Reversing
N	Neutral
D	Normal driving
B	Engine braking

■ If the shift lever cannot be shifted from P

→P. 419

2-1. Driving procedures

Turn signal lever



- 1 Left turn
- 2 Right turn
- 3 Move and hold the lever part-way to signal a lane change
The left hand signal will flash until you release the lever.
- 4 Move and hold the lever part-way to signal a lane change
The right hand signal will flash until you release the lever.

■ Turn signals can be operated when

The engine switch is in the ON position.

■ If the indicators flash faster than usual

Check that a light bulb in the front or rear turn signal lights has not burned out.

2-1. Driving procedures

Parking brake



Sets the parking brake*
(Depressing the pedal again releases the parking brake.)

*: Fully depress the parking brake pedal with your left foot while depressing the brake pedal with your right foot.

NOTICE

■ Before driving

Fully release the parking brake.

Driving the vehicle with the parking brake set will lead to brake components overheating, which may affect braking performance and increase brake wear.

2-2. Instrument cluster

Gauges and meters



The units used on the speedometer and the power meter gauge display may differ depending on the model/type.

The following gauges and meters illuminate when the engine switch is in the ON position.

1 Power meter

Displays the instantaneous output from the hybrid system in approximate kilowatts.

2 Speedometer

Displays the vehicle speed.

3 Fuel gauge

Displays the quantity of fuel remaining in the tank.

4 Engine coolant temperature gauge

Displays the engine coolant temperature.

5 Multi-information display (→P. 143)

6 Odometer/trip meter and trip meter reset button

Switches between odometer and trip meter displays. Pushing and holding the button will reset the trip meter when the trip meter is being displayed.

Instrument panel light control

The brightness of the instrument panel lights can be adjusted.



- 1 Darker
- 2 Brighter

NOTICE

■ To prevent damage to the engine and its components

The engine may be overheating if the engine coolant temperature gauge is in the red zone (H). In this case, immediately stop the vehicle in a safe place, and check the engine after it has cooled completely. (→P. 424)

2-2. Instrument cluster

Indicators and warning lights

The indicator and warning lights on the instrument cluster and center panel inform the driver of the status of the vehicle's various systems.

► Instrument cluster



The units used on the speedometer and the power meter gauge display may differ depending on the model/type.

► Center panel



■ Indicators

The indicators inform the driver of the operating state of the vehicle's various systems.



Turn signal indicator
(→P. 136)



Slip indicator
(→P. 171)



Headlight high beam indicator (→P. 148)



(vehicles with discharge headlights)

AFS OFF indicator
(→P. 149)



(U.S.A.)

Headlight indicator
(→P. 148)



Driving ready indicator
(→P. 131)



(Canada)

Tail light indicator
(→P. 148)



AIR BAG ON indicator
(→P. 103)



Cruise control indicator
(→P. 158, 161)



AIR BAG OFF indicator
(→P. 103)



Shift position indicator (→P. 135)

■ Warning lights

Warning lights inform the driver of malfunctions in any of the vehicle's systems.



*: These lights turn on when the engine switch is turned to the ON position to indicate that a system check is being performed. They will turn off after the hybrid system is started, or after a few seconds. There may be a malfunction in a system if a light does not come on, or if the lights do not turn off. Have the vehicle inspected by your Lexus dealer.

! CAUTION

■ If a safety system warning light does not come on

Should a safety system light such as ABS and the SRS airbag warning light not come on when you start the hybrid system, this could mean that these systems are not available to help protect you in an accident, which could result in death or serious injury. Have the vehicle inspected by your Lexus dealer immediately if this occurs.

Multi-information display

The multi-information display presents the driver with a variety of driving related data, including the status of the hybrid system.



- Odometer and trip meter display

Odometer displays the total distance the vehicle has been driven.

Trip meter displays the distance the vehicle has been driven since the meter was last reset. Trip meters A and B can be used to record and display different distances independently.

- Energy monitor (→P. 28)

Displays the status of the hybrid system.

- Dynamic laser cruise control display (if equipped) (→P. 161)

Automatically displayed when using dynamic laser cruise control.

- Warning messages (→P. 398)

Automatically displayed when a malfunction occurs in one of the vehicle's systems.



Display items can be switched by pushing the DISP. switch.

Trip information

■ Outside temperature



Displays the outside air temperature.

The temperature range that can be displayed is from -22°F (-30°C) to 122°F (50°C).

■ Average fuel consumption after refueling



Displays the average fuel consumption since the vehicle was last refueled.

■ Current fuel consumption



Displays the current rate of fuel consumption.

■ Outside temperature display

In the following situations, the correct outside temperature may not be displayed, or the display may take longer than normal to change.

- When stopped, or driving at low speeds (less than 12 mph [20 km/h])
- When the outside temperature has changed suddenly (at the entrance/exit of a garage, tunnel, etc.)

NOTICE

■ The multi-information display at low temperatures

Allow the interior of the vehicle to warm up before using the liquid crystal information display. At extremely low temperatures, the information display monitor may respond slowly, and display changes may be delayed.

2-2. Instrument cluster

Trip information display (without navigation system)

The trip information display presents the driver with a variety of driving-related data.



1 Trip information display

- Driving time
- Average fuel consumption
- Current fuel consumption
- Driving distance

Display and operation



Display items can be switched by pushing the INFO switch.

■ Driving time



Displays the elapsed time after the hybrid system starts.

When the hybrid system is started, driving time is counted from 0:00. Up to 11:59 (11 hours, 59 minutes) can be displayed.

■ Average fuel consumption



Displays the average fuel consumption since the vehicle was last refueled.

■ Current fuel consumption



Displays the current rate of fuel consumption.

■ Driving distance



Displays the driving distance since the hybrid system was started.

The function can be reset by pushing the INFO switch for longer than one second when the driving distance is displayed.

⚠ CAUTION

■ Caution while driving

Do not adjust the display while driving.

Doing so may cause the driver to mishandle the vehicle and an accident, resulting in death or serious injury.

2-3. Operating the lights and windshield wipers

Headlight switch

The headlights can be operated manually or automatically.

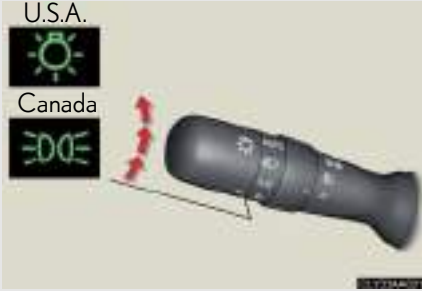

 The side marker, parking, tail, license plate and instrument panel lights turn on.

 The headlights and all lights listed above turn on.

AUTO The headlights and parking lights turn on and off automatically. (When the engine switch is in the ON position)

Turning on the high beam headlights



1 With the headlights on, push the lever forward to turn on the high beams.

Pull the lever back to the center position to turn the high beams off.

2 Pull the lever toward you to turn on the high beams.

Release to turn them off. You can flash the high beams with the headlights on or off.

AFS (vehicles with discharge headlights)

AFS (Adaptive Front Lighting System) improves visibility at intersections and on curves by automatically adjusting the direction light axis of the headlights according to vehicle speed and the degree of the tire angle that are controlled by steering input.

Operates at speeds of 18 mph (30 km/h) or higher.

■ Deactivating AFS

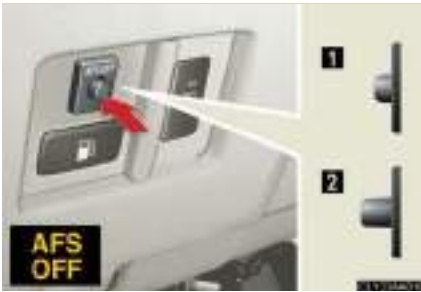

Turn the switch OFF to deactivate AFS.

- 1 OFF
- 2 ON

2

When driving

■ Daytime running light system

To make your vehicle more visible to other drivers, the headlights turn on automatically (at a reduced intensity) whenever the hybrid system is started and the parking brake is released. Daytime running lights are not designed for use at night.

■ Headlight control sensor





The sensor may not function properly if an object is placed on the sensor, or anything that blocks the sensor is affixed to the windshield.

Doing so interferes with the sensor detecting the level of ambient light and may cause the automatic headlight control system to malfunction.

■ Automatic light off system

- When the headlights come on: The headlights and tail lights turn off 30 seconds after all doors are closed with the engine switch turned to the ACC or LOCK position. (The light turns off immediately if the LOCK button on the key is pressed after all doors are locked.)
- When only the tail lights come on: The tail lights turn off automatically with the engine switch turned to the ACC or LOCK position and the driver's door is opened.

To turn the lights on again, turn the engine switch to the ON position, or turn the light switch OFF once and then back to the  or  position.

■ Automatic headlight leveling system (vehicles with discharge headlights)

The level of the headlights is automatically adjusted according to the number of passengers and the loading condition of the vehicle to ensure that the headlights do not interfere with other road users.

■ If the indicator flashes... (vehicles with discharge headlights)

It may indicate a malfunction in the system. Contact your Lexus dealer.

■ Customization that can be configured at Lexus dealer

Setting (e.g. light sensor sensitivity) can be changed. (Customizable features →P. 458)

NOTICE

■ To prevent 12-volt battery discharge

Do not leave the lights on longer than necessary when the hybrid system is off.

2-3. Operating the lights and windshield wipers

Fog light switch

The fog lights improve visibility in difficult driving conditions, such as in rain or fog. They can be turned on only when the headlights are on low beam.



- 1 To turn the front fog lights off
- 2 To turn the front fog lights on





2-3. Operating the lights and windshield wipers

Windshield wipers and washer

■ Intermittent wiper with interval adjuster (if equipped)

When intermittent wiper operation is selected, wiper intervals can be adjusted.



- 1  Off
- 2  Intermittent windshield wiper operation
- 3  Low speed windshield wiper operation
- 4  High speed windshield wiper operation
- 5  Temporary operation



- 6 Decrease the intermittent windshield wiper frequency
- 7 Increase the intermittent windshield wiper frequency









8 Washer/wiper dual operation

Wipers will automatically operate a couple of times after the washer squirts.

■ Rain-sensing windshield wipers (if equipped)

With **AUTO** selected, the wipers will operate automatically when the sensor detects falling rain. The system automatically adjusts wiper timing in accordance with rain volume.



- 1  Off
- 2 **AUTO** Rain-sensing wiper operation
- 3  Low speed wiper operation
- 4  High speed wiper operation
- 5  Temporary operation



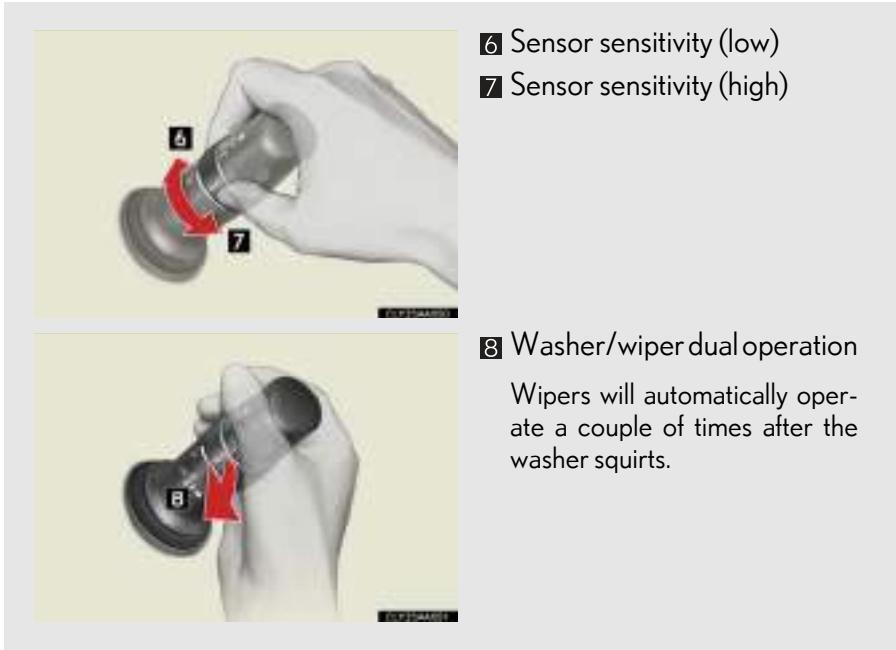

■ The windshield wiper and washer can be operated when

The engine switch must be in the ON position.

■ Effects of vehicle speed on wiper operation (vehicles with the rain-sensing windshield wipers)

When low speed wiper operation is selected, wiper operation will be switched from low speed to intermittent wiper operation when the vehicle is stationary.

(However, the mode will not be switched when the adjustment dial for the automatic wiper control sensitivity is set to high.)

■ **Rain drop sensor (vehicles with the rain-sensing windshield wipers)**



The sensor judges the amount of raindrops.

■ **If no windshield washer fluid sprays**

Check that the washer nozzles are not blocked if there is washer fluid in the windshield washer fluid reservoir.

■ **Customization that can be configured at Lexus dealer**

The setting of the wiper operation when the vehicle is stationary can be changed. (Customizable features →P. 458)

⚠ CAUTION

■ **Caution regarding the use of windshield wipers in AUTO mode**

The windshield wipers may operate unexpectedly if the sensor is touched or the windshield is subject to vibration in AUTO mode. Take care that your fingers or anything else do not become caught in the windshield wipers.

⚠ NOTICE

■ **When the windshield is dry**

Do not use the wipers, as they may damage the windshield.

■ **When there is no washer fluid spray from the nozzle**

Damage to the washer fluid pump may be caused if the lever is pulled toward you and held continually.

2-3. Operating the lights and windshield wipers

Rear window wiper and washer

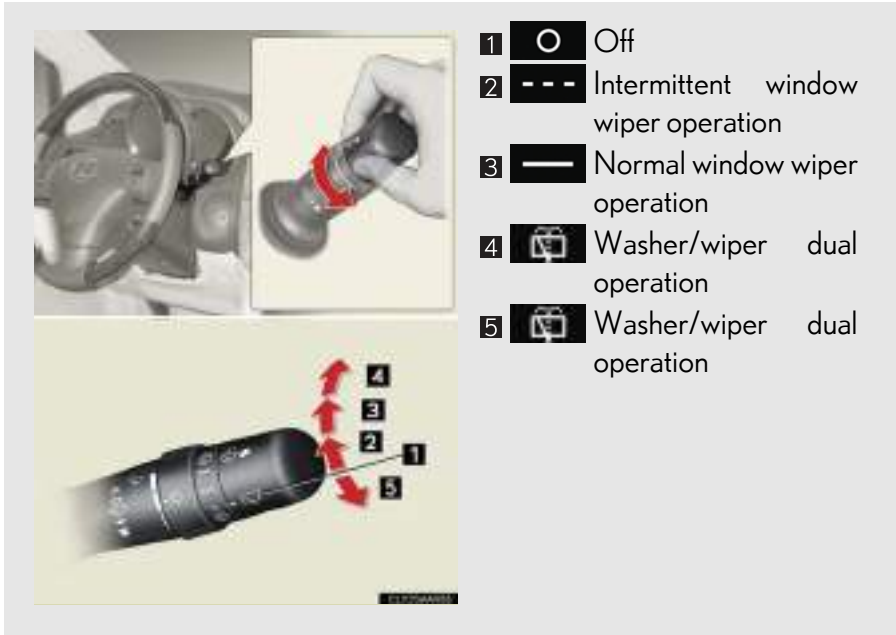

■ The rear window wiper and washer can be operated when

The engine switch must be in the ON position.

NOTICE

■ When the rear window is dry

Do not use the wipers, as they may damage the rear window.

2-3. Operating the lights and windshield wipers

Headlight cleaner switch (if equipped)

Washer fluid can be sprayed on the headlights.



Press the switch to clean the headlights.

2

When driving

■ The headlight cleaner can be operated when

When the engine switch must be in the ON position and the headlight switch is turned ON.

NOTICE

■ When the washer fluid tank is empty

Do not use this function when the washer fluid tank is empty. This may cause the washer fluid pump to overheat.

2-4. Using other driving systems

Cruise control (if equipped)

Use the cruise control to maintain a set speed without using the accelerator.

■ Set the vehicle speed



Turn the ON-OFF button ON.

Push the button once more to deactivate the cruise control.



Accelerate or decelerate to the desired speed and press the lever down to set the cruise control speed.

■ Adjusting the speed setting



1 Increase speed

2 Decrease speed

Hold the lever until the desired speed setting is obtained.

■ Canceling and resuming regular acceleration



1 Cancel

Push the lever towards you to cancel cruise control.

The speed setting is also canceled when the brakes are applied.

2 Resume

To resume cruise control and return to the set speed, push the lever up.

■ Fine adjustment of the set speed

Adjustment of the set speed by approximately 1.0 mph (1.6 km/h) can be made by lightly pressing the lever up or down and releasing it.

■ Cruise control can be set when

- The shift lever is in the D.
- Vehicle speed is between approximately 25 mph (40 km/h) and 125 mph (200 km/h).

■ Accelerating

The vehicle can be accelerated normally.

■ Automatic cruise control cancellation

The set speed is automatically cancelled in any of the following situations.

- Actual vehicle speed falls more than 10 mph (16 km/h) below the preset vehicle speed.
At this time, the memorized set speed is not retained.
- Actual vehicle speed is below 25 mph (40 km/h).
- VSC is activated.

■ If the cruise control indicator light flashes

Turn the ON-OFF button off once, and then reactivate the system.

If the cruise control speed cannot be set or if the cruise control cancels immediately after being activated, there may be a malfunction in the cruise control system. Have the vehicle inspected by your Lexus dealer.

CAUTION

■ To avoid operating the cruise control by mistake

Keep the ON-OFF button off when not in use.

■ Situations unsuitable for cruise control

Do not use cruise control in any of the following situations.

Doing so may result in control of the vehicle being lost and could cause serious or fatal accident.

- In heavy traffic
- On roads with sharp bends
- On slippery roads, such as those covered with rain, ice or snow
- On steep hills
- On winding roads

2-4. Using other driving systems

Dynamic laser cruise control (if equipped)

Dynamic laser cruise control supplements conventional cruise control with a vehicle-to-vehicle distance control. In the vehicle-to-vehicle distance control mode, the vehicle automatically accelerates or decelerates in order to maintain a set following distance from vehicles ahead.

■ Select cruise mode



Selecting vehicle-to-vehicle distance control mode

- 1 Turn the ON-OFF button ON.

Push the button once more to deactivate.



Selecting conventional constant speed control mode

- 1 Turn the ON-OFF button ON.

Push the button once more to deactivate.

Vehicle-to-vehicle distance control mode is always reset when the engine switch is turned to the ON position.

- 2 Switch to constant speed control mode.
(push and hold for approximately one second)

■ Driving in the selected cruise control mode



Accelerate or decelerate to the desired speed and press the lever down to set.

■ Adjusting the speed setting



- 1 Increase speed
- 2 Decrease speed

Hold the lever until the desired speed setting is displayed.

■ Canceling and resuming the speed setting



- 1 Cancel

Push the lever towards you to cancel cruise control.

The setting is also canceled when the brakes are applied.

- 2 Resume

To resume cruise control and return to the set speed, push the lever up.

■ Changing the vehicle-to-vehicle distance



Each push of the switch toward you changes the vehicle-to-vehicle distance

- 1 Long
- 2 Medium
- 3 Short

The vehicle-to-vehicle distance is automatically set to the long mode when the engine switch is turned to the ON position.

A mark will be displayed to indicate the presence of the vehicle if a vehicle is running ahead of you.

Driving in vehicle-to-vehicle distance control mode

This mode employs a laser radar sensor to detect the presence of vehicles within 400 ft. (120 m) ahead and to judge the distance between your vehicle and those vehicles.

Note that vehicle-to-vehicle distance will close when traveling on long downhill slopes.

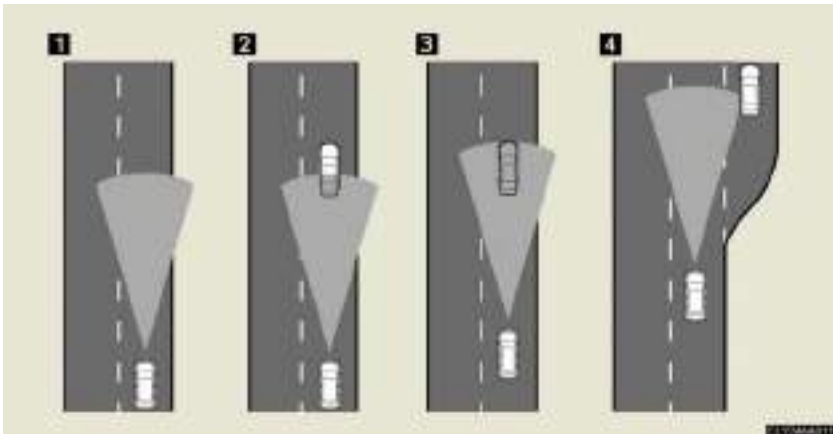

1 Example of constant speed cruising (when there are no vehicles ahead):

When set to 62 mph (100 km/h)

The vehicle travels at the speed set by the driver. The desired vehicle-to-vehicle distance can also be set by operating the vehicle-to-vehicle distance switch.

2 Example of deceleration cruising (when the vehicle ahead is driving slower than the set speed):

When fixed speed cruising is set at 62 mph (100 km/h) and the vehicle ahead is driving at 50 mph (80 km/h)

When a vehicle is detected running ahead of you, in the same lane, the system automatically decelerates your vehicle. When a greater reduction in vehicle speed is necessary, the system applies the brakes. A warning tone warns you when the system cannot decelerate sufficiently to prevent your vehicle from closing on the vehicle ahead.

- 3 Example of follow-up cruising (when following a vehicle driving slower than the set speed):

When the speed is set to 62 mph (100 km/h) and the vehicle ahead is driving at 50 mph (80 km/h)

The system continues follow-up cruising while adjusting for changes in the speed of the vehicle ahead in order to maintain the vehicle-to-vehicle distance set by the driver.

- 4 Example of acceleration (when there are no longer vehicles driving slower than the set speed in the lane ahead):

When the speed is set to 62 mph (100 km/h) and the vehicle ahead driving at 50 mph (80 km/h) is out of the lane

When the vehicle ahead of you executes a lane change, the system slowly accelerates until the set vehicle speed is reached. The system then returns to fixed speed cruising.

■ Fine adjustment of the set speed

Adjustment of the set speed by the following speed can be made by lightly pressing the lever up or down and releasing it.

In the constant speed control mode: Approximately 1.0 mph (1.6 km/h)

In the vehicle-to-vehicle distance control mode:

U.S.A.: Approximately 5 mph (8 km/h)

Canada: Approximately 3 mph (5 km/h)

■ Dynamic laser cruise control warning lights, display and buzzers

Warning lights, display and buzzers are used to indicate a system malfunction or to alert you to the need for caution while driving. (→P. 398)

■ The dynamic laser cruise can be set when

- The shift lever is in D.
- Vehicle speed is between approximately 27 mph (45 km/h) and 85 mph (135 km/h).

■ Accelerating

The vehicle can be accelerated normally.

■ Automatically canceling vehicle-to-vehicle distance control

Vehicle-to-vehicle distance control driving is automatically canceled in the following situations.

- Vehicle speed falls below 25 mph (40 km/h)
- VSC is activated
- The sensor cannot operate correctly because it is covered in some way.*
- The windshield wipers are operating at high or low speed.*

*: Vehicle-to-vehicle distance control driving must be reset by turning the ON-OFF button on again.

If vehicle-to-vehicle distance control driving is automatically canceled for any other reason, there may be a malfunction in the system. Contact your Lexus dealer.

■ Automatically cancelling constant speed control

The set speed is automatically canceled in the following situations.

- Actual vehicle speed is more than 10 mph (16 km/h) below the preset vehicle speed
At this time, the memorized set speed is not retained.
- Vehicle speed falls below 25 mph (40 km/h)
- VSC is activated

■ Vehicle-to-vehicle distance settings

Select a distance from the table below. Note that the distances shown correspond to a vehicle speed of 55 mph (88 km/h). Vehicle-to-vehicle distance increases/decreases in accordance with vehicle speed.

Distance options	Vehicle-to-vehicle distance
Long	Approximately 245 ft. (75 m)
Medium	Approximately 165 ft. (50 m)
Short	Approximately 100 ft. (30 m)

■ Laser radar sensor



Always keep the sensor clean to ensure that the vehicle-to-vehicle distance control operates properly. (Some obstructions, such as snow, ice or plastic objects, cannot be detected by the obstruction sensor.)

Dynamic laser cruise control is canceled if an obstruction is detected.

■ Certification

This product is a class I laser product complied with 21 C. F. R part 1040.10. and 1040.11.

CAUTION

■ Before using dynamic laser cruise control

Do not overly rely on vehicle-to-vehicle distance control.

Be aware of the set vehicle speed. If automatic deceleration/acceleration is not appropriate, adjust the vehicle speed, as well as the distance between your vehicle and vehicles ahead by applying the brakes, etc.

■ To avoid inadvertent cruise control activation

Keep the ON-OFF button off when not in use.

■ Situations unsuitable for dynamic laser cruise control

Do not use dynamic laser cruise control in any of the following situations.

Doing so may result in inappropriate control of speed and could cause serious or fatal accident.

- In heavy traffic
- On roads with sharp bends
- On winding roads
- On slippery roads, such as those covered with rain, ice or snow
- Where there are sudden changes between sharp up and down gradients
- At entrances to expressways
- When weather conditions are bad enough that they may prevent the sensors from functioning correctly (fog, snow, sandstorm, etc.)
- When buzzer can be heard often

 **CAUTION**
■ When the laser radar sensor may not be correctly detecting the vehicle ahead

Apply the brakes as necessary when any of the following types of vehicles are in front of you.

As the sensor may not be able to correctly detect these types of vehicles, the proximity alarm (→P. 165) will not be activated, and an accident may result.

- Vehicles that cut in suddenly
- Vehicles traveling at low speeds
- Vehicles that are not moving
- Vehicles with small rear ends (trailers with no load on board etc.)
- Motorcycles traveling in the same lane

■ Conditions under which the vehicle-to-vehicle distance control may not function correctly

Apply the brakes as necessary in the following conditions as the laser radar sensor may not be able to correctly detect vehicles ahead, and an accident may result.

- When water or snow thrown up by the surrounding vehicles hinders the functioning of the sensor
- When your vehicle is pointing upwards (caused by a heavy load in the luggage compartment, etc.)
- When the road curves or when the lanes are narrow
- When steering wheel operation or your position in the lane is unstable

■ To ensure the laser radar sensor functions correctly

Do not do the following to the sensor as doing so may cause the sensor not to function correctly and could result in an accident.

- Stick or attach anything to them
- Leave them dirty
- Disassemble, subject them to strong shocks
- Modify or paint them
- Replace them with non-genuine parts

2-4. Using other driving systems

Driving assist systems

To help enhance driving safety and performance, the following systems operate automatically in response to various driving situations. Be aware, however, that these systems are supplementary and should not be relied upon too heavily when operating the vehicle.

■ ABS (Anti-lock Brake System)

Helps to prevent wheel lock when the brakes are applied suddenly, or if the brakes are applied while driving on a slippery road surface.

■ Brake assist

Generates an increased level of braking force after the brake pedal is depressed, when the system detects a panic stop situation.

■ VSC (Vehicle Stability Control)

Helps the driver to control skidding when swerving suddenly or turning on slippery road surfaces.

■ Traction Control

Maintains drive power and prevents the front wheels (2WD models) or all wheels (AWD models) from spinning when starting the vehicle or accelerating on slippery roads.

■ EPS (Electric Power Steering)

Employs an electric motor to reduce the amount of effort needed to turn the steering wheel.

■ VDIM (Vehicle Dynamics Integrated Management)

Provides integrated control of the ABS, brake assist, VSC, traction control and EPS systems.

Maintains vehicle stability when swerving on slippery road surfaces by controlling the brakes, engine output, and the movement of the front wheels.

When the VSC/traction control are operating



If the vehicle is in danger of slipping, or if the front wheels (2WD models) or all wheels (AWD models) spin, the slip indicator light flashes to indicate that the VSC/traction control have been engaged.

A buzzer (intermittent) sounds to indicate that VSC is operating.

2

When driving

■ Sounds and vibrations caused by the ABS, brake assist, VSC and traction control

- A sound may be heard from the engine compartment when the hybrid system is started or just after the vehicle begins to move. This sound does not indicate that a malfunction has occurred in any of these systems.
- Any of the following conditions may occur when the above systems are operating. None of these indicates that a malfunction has occurred.
 - Vibrations may be felt through the vehicle body and steering.
 - A motor sound may be heard after the vehicle comes to a stop.
 - The brake pedal may pulsate slightly after the ABS is activated.
 - The brake pedal may move down slightly after the ABS is activated.

■ Reduced effectiveness of EPS

The effectiveness of EPS is reduced to prevent the system from overheating when there is frequent steering input over an extended period of time. The steering wheel may feel heavy as a result. Should this occur, refrain from excessive steering input or stop the vehicle and turn the hybrid system OFF. The system should return to normal within 10 minutes.

CAUTION

Any of the following conditions may result in an accident which could cause death or serious injury:

■ **The ABS does not operate effectively when**

- The limits of tire gripping performance have been exceeded.
- The vehicle hydroplanes while driving at high speed on the wet or slick road.

■ **Stopping distance when the ABS is operating will exceed that of normal conditions**

The ABS is not designed to shorten the vehicle's stopping distance. Always maintain a safe distance from the vehicle in front of you in the following situations.

- When driving on dirt, gravel or snow-covered roads
- When driving with tire chains
- When driving over bumps in the road
- When driving over roads with potholes or roads with uneven roads

■ **Traction control may not operate effectively when**

Directional control and power may not be achievable while driving on slippery road surfaces, even if the traction control system is operating.

Do not drive the vehicle in conditions where stability and power may be lost.

 **CAUTION****■ When the slip indicator flashes and a warning buzzer sounds**

This situation occurs immediately while VSC is activated. Always drive carefully. Reckless driving may cause an accident. Exercise particular care when the indicator light flashes and a buzzer sounds.

■ Replacing tires

Make sure that all tires are of the same size, brand, tread pattern and total load capacity. In addition, make sure that the tires are inflated to the recommended tire pressure level.

The ABS and VSC systems will not function correctly if different tires are fitted on the vehicle.

Contact your Lexus dealer for further information when replacing tires or wheels.

■ Handling of tires and suspension

Using tires with any kind of problem or modifying the suspension will affect the VDIM, and may cause the system to malfunction.

Utility vehicle precautions

This vehicle belongs to the utility vehicle class, which has higher ground clearance and narrower tread in relation to the height of its center of gravity.

Utility vehicle feature

- Specific design characteristics give it a higher center of gravity than ordinary passenger cars. This vehicle design feature causes this type of vehicle to be more likely to rollover. And, utility vehicles have a significantly higher rollover rate than other types of vehicles.
- It is not designed for cornering at the same speeds as ordinary passenger cars any more than low-slung sports cars designed to perform satisfactorily under off-road conditions. Therefore, sharp turns at excessive speeds may cause rollover.

 **CAUTION****■ Utility vehicle precautions**

Always observe the following precautions to minimize the risk of serious personal injury or damage to your vehicle:

- In a rollover crash, an unbelted person is significantly more likely to die than a person wearing a seat belt. Therefore, the driver and all passengers should fasten their seat belts whenever the vehicle is moving.
- Avoid sharp turns or abrupt maneuvers, if at all possible.
Failure to operate this vehicle correctly may result in loss of control or vehicle rollover causing death or serious injury.
- Loading cargo on the roof luggage carrier will make the center of the vehicle gravity higher. Avoid high speeds, sudden starts, sharp turns, sudden braking or abrupt maneuvers, otherwise it may result in loss of control or vehicle rollover due to failure to operate this vehicle correctly.
- Always slow down in gusty crosswinds. Because of its profile and higher center of gravity, your vehicle is more sensitive to side winds than an ordinary passenger car. Slowing down will allow you to have better control.
- Do not drive horizontally across steep slopes. Driving straight up or straight down is preferred. Your vehicle (or any similar off-road vehicle) can tip over sideways much more easily than forward or backward.

Off-road driving

Your vehicle is not designed to be driven off-road. However, in the event that off-road driving cannot be avoided, please observe the following precautions to help avoid the areas prohibited to vehicles.

- Drive your vehicle only in areas where off-road vehicles are permitted to travel.
- Respect private property. Get owner's permission before entering private property.
- Do not enter areas that are closed. Honor gates, barriers and signs that restrict travel.
- Stay on established roads. When conditions are wet, driving techniques should be changed or travel delayed to prevent damage to roads.
- Avoid driving on very steep, slippery roads and other surfaces, such as sand, where the tires are liable to lose traction. Your vehicle may not perform as well as conventional AWD on-road vehicles on these surfaces.

■ Additional information for off-road driving

► For owners in U.S. mainland, Hawaii and Puerto Rico:

To obtain additional information pertaining to driving your vehicle off-road, consult the following organizations.

- State and Local Parks and Recreation Departments
- State Motor Vehicle Bureau
- Recreational Vehicle Clubs
- U.S. Forest Service and Bureau of Land Management

 **CAUTION**
■ Off-road driving precautions

Always observe the following precautions to minimize the risk of serious personal injury or damage to your vehicle:

- Drive carefully when off the road. Do not take unnecessary risks by driving in dangerous places.
- Do not grip the steering wheel spokes when driving off-road. A bad bump could jerk the wheel and injure your hands. Keep both hands and especially your thumbs on the outside of the rim.
- Always check your brakes for effectiveness immediately after driving in sand, mud, water or snow.
- After driving through tall grass, mud, rock, sand, rivers, etc., check that there is no grass, bush, paper, rags, stone, sand, etc. adhering or trapped on the underbody. Clear off any such matter from the underbody. If the vehicle is used with these materials trapped or adhering to the underbody, a breakdown or fire could occur.
- When driving off-road or in rugged terrain, do not drive at excessive speeds, jump, make sharp turns, strike objects, etc. This may cause loss of control or vehicle rollover causing death or serious injury. You are also risking expensive damage to your vehicle's suspension and chassis.

 **NOTICE**
■ To prevent the water damage

Take all necessary safety measures to ensure that water damage to the hybrid battery, hybrid system or other components does not occur.

- Water entering the engine compartment may cause severe damage to the hybrid system. Water entering the interior may cause the hybrid battery stowed under the rear seats to short circuit.
- Water entering the hybrid transaxle will cause deterioration in transmission quality. The malfunction indicator may come on, and the vehicle may not be drivable.
- Water can wash the grease from wheel bearings, causing rusting and premature failure, and may also enter the transaxle case, reducing the gear oil's lubricating qualities.

NOTICE

■ **When you drive through water**

If driving through water, such as when crossing shallow streams, first check the depth of the water and the bottom of the river bed for firmness. Drive slowly and avoid deep water.

■ **Inspection after off-road driving**

- Sand and mud that has accumulated in brake drums and around brake discs may affect braking efficiency and may damage brake system components.
- Always perform a maintenance inspection after each day of off-road driving that has taken you through rough terrain, sand, mud, or water. For scheduled maintenance information, refer to the “Warranty and Services Guide/Owner’s Manual Supplement/Scheduled Maintenance”.

Cargo and luggage

Take notice of the following information about storage precautions, cargo capacity and load.

- Stow cargo and luggage in the luggage compartment whenever possible. Be sure all items are secured in place.
- Be careful to keep the vehicle level. Placing the weight as far forward as possible helps maintain vehicle balance.
- For better fuel economy, do not carry unnecessary weight.

Capacity and distribution

Cargo capacity depends on the total weight of the occupants.

(Cargo capacity) = (Total load capacity) – (Total weight of occupants)

Steps for Determining Correct Load Limit—

- (1) Locate the statement “The combined weight of occupants and cargo should never exceed XXX kg or XXX lbs.” on your vehicle’s placard.
- (2) Determine the combined weight of the driver and passengers that will be riding in your vehicle.
- (3) Subtract the combined weight of the driver and passengers from XXX kg or XXX lbs.
- (4) The resulting figure equals the available amount of cargo and luggage load capacity.

For example, if the “XXX” amount equals 1400 lbs. and there will be five 150 lb passengers in your vehicle, the amount of available cargo and luggage load capacity is 650 lbs. (1400 – 750 (5 × 150) = 650 lbs.)

- (5) Determine the combined weight of luggage and cargo being loaded on the vehicle. That weight may not safely exceed the available cargo and luggage load capacity calculated in Step 4.

- (6) If your vehicle will be towing a trailer, load from your trailer will be transferred to your vehicle. Consult this manual to determine how this reduces the available cargo and luggage load capacity of your vehicle.

Example on your vehicle

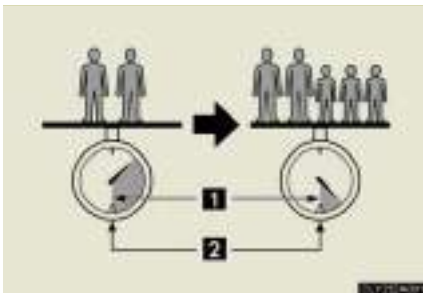

- 1 Cargo capacity
- 2 Total load capacity

When 2 people with the combined weight of 366 lb. (166 kg) are riding in your vehicle, which has a total load capacity of 925 lb. (420 kg), the available amount of cargo and luggage load capacity will be as follows:

$$925 \text{ lb.} - 366 \text{ lb.} = 559 \text{ lb.} \quad (420 \text{ kg} - 166 \text{ kg} = 254 \text{ kg})$$

In this condition, if 3 more passengers with the combined weight of 388 lb. (176 kg) get on, the available cargo and luggage load will be reduced as follows:

$$559 \text{ lb.} - 388 \text{ lb.} = 171 \text{ lb.} \quad (254 \text{ kg} - 176 \text{ kg} = 78 \text{ kg})$$

As shown in the above example, if the number of occupants increases, the cargo and luggage load equaling the combined weight of the occupants who got on later, by an amount. In other words, if an increase in the number of occupants causes an excess of the total load capacity (combined weight of occupants plus cargo and luggage load), you must reduce the cargo and luggage on your vehicle.

 **CAUTION****■ Storage precautions**

- Do not place anything on the luggage cover, and do not stack anything in the luggage compartment higher than the seatbacks. Such items may be thrown about and possibly injure people in the vehicle during sudden braking or in an accident.
- Do not drive with objects on top of the instrument panel. They may interfere with the driver's field of view or move during sharp acceleration or turning, thus impairing the driver's control of the vehicle. In an accident they may injure the vehicle occupants.
- Secure all items in the occupant compartment, as they may shift and injure someone during an accident or sudden braking.
- Never allow anyone to ride in the luggage compartment. It is not designed for passengers. They should ride in their seats with their seat belts properly fastened. Otherwise, they are much more likely to suffer serious bodily injury, in the event of sudden braking or a collision.

■ Capacity and distribution

- Improper loading may cause deterioration of steering or braking control resulting in an accident which may cause death or serious injury.
- Do not exceed the maximum axle weight rating or the total vehicle weight rating.
- Even if the total load of occupant's weight and the cargo load is less than the total load capacity, do not apply the load unevenly.

2-5. Driving information

Vehicle load limits

Vehicle load limits include total load capacity, seating capacity, towing capacity and cargo capacity.

■ Total load capacity: 925 lb. (420 kg)

Total load capacity means the combined weight of occupants, cargo and luggage.

■ Seating capacity: 5 occupants (Front 2, Rear 3)

Seating capacity means the maximum number of occupants whose estimated average weight is 150 lb. (68 kg) per person.

Even if the number of occupants are within the seating capacity, do not exceed the total load capacity.

■ Towing capacity

Without towing package: 2000 lb. (907 kg)

With towing package: 3500 lb. (1588 kg)

Towing capacity means the maximum gross trailer weight (trailer weight plus its cargo weight) that your vehicle is able to tow.

■ Cargo capacity

Cargo capacity may increase or decrease depending on the weight and the number of occupants.

■ Total load capacity and seating capacity

These details are also described on the tire and loading information label.
(→P. 340)

CAUTION

■ Overloading the vehicle

Do not overload the vehicle.

It may not only cause damage to the tires, but also degrade steering and braking ability, resulting in an accident.

Carry out the necessary preparations and inspections before driving the vehicle in winter. Always drive the vehicle in a manner appropriate to the prevailing weather conditions.

■ Pre-winter preparations

- Use fluids that are appropriate to the prevailing outside temperatures.
 - Engine oil
 - Engine/power control unit coolant
 - Washer fluid
 - Have a service technician inspect the level and specific gravity of battery electrolyte.
- Have the vehicle fitted with four snow tires or purchase a set of tire chains for the front tires.

Ensure that all tires are the same size and brand, and that chains match the size of the tires.

- Tire pressure falls in winter as the outside temperature falls. Add 2.9 to 4.3 psi (20 to 30 kPa, 0.2 to 0.3 kgf/cm² or bar) to the standard tire inflation pressure.

■ Before driving the vehicle

Perform the following according to the driving conditions.

- Do not try to forcibly open a window or move a wiper that is frozen. Pour warm water over the frozen area to melt the ice. Wipe away the water immediately to prevent it from freezing.
- To ensure proper operation of the climate control system fan, remove any snow that has accumulated on the air inlet vents in front of the windshield.
- Remove any ice that has accumulated on the vehicle chassis.
- Periodically check for and remove any excess ice or snow that may have accumulated in the wheel well or on the brakes.

■ When driving the vehicle

Accelerate the vehicle slowly and drive at a reduced speed suitable to road conditions.

■ When parking the vehicle

Park the vehicle and move the shift lever to P without setting the parking brake. The parking brake may freeze up, preventing it from being released.

Selecting snow chains

Use the correct snow chain size when mounting the snow chains. Chain size is regulated for each tire sizes.

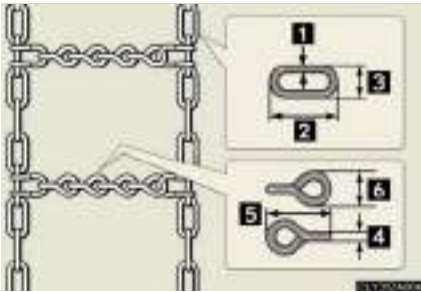

Side chain

- 1 0.12 in. (3 mm) in diameter
- 2 1.18 in. (30 mm) in length
- 3 0.39 in. (10 mm) in width

Cross chain

- 4 0.16 in. (4 mm) in diameter
- 5 0.98 in. (25 mm) in length
- 6 0.55 in. (14 mm) in width

Regulations on the use of snow chains

- Regulations regarding the use of tire chains vary according to location and type of road. Always check local regulations before installing chains.
- Install the chains on the front tires.
- Retighten the chains after driving 1/4 - 1/2 mile (0.5 - 1.0 km).

■ Snow chain installation

Observe the following precautions when installing and removing chains.

- Install and remove tire chains in a safe location.
- Install tire chains on the front tires only. Do not install tire chains on rear tires.
- Install tire chains following the instructions provided in the accompanying instructions.

CAUTION

■ Driving with snow tires

Observe the following precautions to reduce the risk of accidents.

Failing to do so may result in a loss of vehicle control and cause death or serious injury.

- Use tires of the size specified for your vehicle.
- Maintain the recommended level of air pressure.
- Do not drive in excess of 75 mph (120 km/h), regardless of the type of snow tires being used.
- Use snow tires on all, not just some wheels.

CAUTION

■ Driving with snow chains

Observe the following precautions to reduce the risk of accidents.

Failing to do so may result in the vehicle being unable to be driven safely, and may cause death or serious injury.

- Do not drive in excess of the speed limit specified for the tire chains being used, or 30 mph (50 km/h), whichever is lower.
- Avoid driving on bumpy road surfaces or over potholes.
- Avoid sudden turns and braking, as use of chains may adversely affect vehicle handling.
- Slow down sufficiently before entering a curve to ensure that vehicle control is maintained.

NOTICE

■ Repairing or replacing snow tires

Request repairs of and obtain replacement snow tires from Lexus dealers or legitimate tire retailers.

This is because the removal and attachment of snow tires affects the operation of the tire air pressure sensor.

■ Fitting tire chains

The tire air pressure sensor may not function correctly when tire chains are fitted.

2-5. Driving information

Trailer towing (if equipped)

Your vehicle is designed primarily as a passenger-and-load carrying vehicle. Towing a trailer will have an adverse effect on handling, performance, braking, durability, and fuel consumption. For your safety and the safety of others, do not overload the vehicle or trailer.

Lexus warranties do not apply to damage or malfunction caused by towing a trailer for commercial purposes.

■ Weight limits

Confirm that the total trailer weight, gross vehicle weight, gross axle weight and trailer tongue load are all within the limits.

■ Gross vehicle weight

The gross vehicle weight must not exceed the Gross Vehicle Weight Rating (GVWR) indicated on the Certification Label. The gross vehicle weight is the sum weight of the unloaded vehicle, driver, passengers, luggage, hitch and trailer tongue load. Also included is the weight of any special equipment installed on your vehicle.

■ Gross axle weight

The load on either the front or rear axle resulting from distribution of the gross vehicle weight on both axles must not exceed the Gross Axle Weight Rating (GAWR) listed on the Certification Label.



Certification Label

■ Trailer tongue load

The trailer cargo load should be distributed so that the tongue load is 9 to 11% of the total trailer weight, not exceeding the following.

Without towing package: 200 lb. (90 kg)

With towing package: 350 lb. (158 kg)

(Tongue load / Total trailer weight x 100 = 9 to 11%)

The total trailer weight and tongue load can be measured with platform scales found at a highway weighing stations, building supply companies, trucking companies, junk yards, etc.

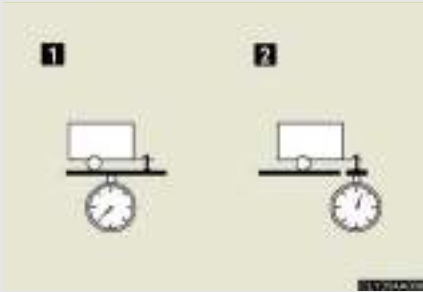

1 Total trailer weight

2 Tongue load

Towing a trailer

Contact your Lexus dealer for further information about additional requirements such as a towing kits, etc.

Hitch and tow hitch receiver

■ Hitch

Trailer hitch assemblies have different weight capacities established by the hitch manufacturer. Even though the vehicle may be rated for towing a higher weight, the operator must never exceed the maximum weight rating specified for the trailer hitch.

■ Tow hitch receiver



A tow hitch receiver installed under the rear bumper is rated for weight that does not exceed the vehicle's total towing weight.

Selecting trailer ball

Use the correct trailer ball for your application.

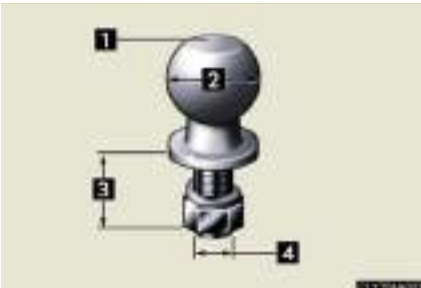

1 Trailer ball load rating

Matches or exceeds the gross trailer weight rating of the trailer.

2 Ball diameter

Matches the size of the trailer coupler. Most couplers are stamped with the required trailer ball size.

3 Shank length

Protrudes beyond the bottom of the lock washer and nut at least 2 threads.

4 Shank diameter

Matches the ball mount hole diameter size.

Connecting trailer lights

- ▶ With tow hitch receiver
Use the socket located under the rear bumper.
- ▶ Without tow hitch receiver
Use the wire harness stored in the rear end under body.

■ Front Emblem



- 1 With towing package
- 2 Without towing package

On vehicles with a towing package, the front emblem has openings, which are designed to improve the cooling performance.

■ Before towing

Check that the following conditions are met:

- The vehicle's tires are properly inflated. (→P. 340)
- Trailer tires are inflated according to the trailer manufacturer's recommendation.
- All trailer lights work
- All lights work each time you connect them.
- The trailer ball is set up at the proper height for the coupler on the trailer.
- The vehicle remains level when a loaded or unloaded trailer is hitched. Do not drive if the vehicle is not level, and check for improper tongue load, overloading, worn suspension, or other possible causes.
- The trailer cargo is securely loaded.
- The rear view mirrors conform to all applicable federal, state/provincial or local regulations. If they do not, install rear view mirrors appropriate for towing purposes.

■ Break-in schedule

Lexus recommends that you do not use a new vehicle or a vehicle with any new power train components (engine, transmission, differential, wheel bearings, etc.) to tow a trailer for the first 500 miles (800 km) of driving.

■ Maintenance

- If you tow a trailer, your vehicle will require more frequent maintenance due to the additional load. (See “Warranty and Services Guide/ Owner’s Manual Supplement/ Scheduled Maintenance”.)
- Retighten the fixing bolts of the towing ball and bracket after approximately 600 miles (1000 km) of trailer towing.

CAUTION

■ To avoid accident or injury

- The total trailer weight (trailer weight plus the weight of cargo) must not exceed the following.
 - Without towing package: 2000 lb. (907 kg)
 - With towing package: 3500 lb. (1588 kg)
- If a trailer and cargo weigh over 2000 lb. (907 kg), use a sway control device with sufficient capacity.
- The gross combined weight (sum of your vehicle weight plus its load and the total trailer weight) must not exceed the following.
 - Without towing package: 7265 lb. (3295 kg)
 - With towing package: 8765 lb. (3976 kg)
- Do not exceed the trailer hitch assembly weight, gross vehicle weight, gross axle weight and trailer tongue load capacities.
- Never load more weight in the back than in the front of the trailer. About 60% of the load should be in the front half of the trailer, and the remaining 40% in the rear.
- The tow hitch receiver installed on your vehicle must never be used on another vehicle.

CAUTION

■ Hitches

- If you wish to install a trailer hitch, contact your Lexus dealer.
- Use only a hitch that conforms to the total trailer weight requirement.
- Follow the directions supplied by the hitch manufacturer.
- Lubricate the hitch ball with a light coat of grease.
- Remove the trailer hitch whenever you are not towing a trailer. After removing the hitch, seal any mounting hole in the vehicle body to prevent entry of any substances into the vehicle.

■ When towing a trailer

- If the total trailer weight exceeds 1000 lb. (450 kg), trailer brakes are required.
- Never tap into your vehicle's hydraulic system, as this will lower the vehicle's braking effectiveness.
- Never tow a trailer without using a safety chain securely attached to both the trailer and the vehicle. If damage occurs to the coupling unit or hitch ball, there is danger of the trailer wandering into another lane.

NOTICE

■ When installing a trailer hitch

- Use only the position recommended by your Lexus dealer. Do not install the trailer hitch on the bumper; this may cause body damage.
- Do not use axle-mounted hitches, as they can cause damage to the axle housing, wheel bearings, wheels or tires.

■ Brakes

Lexus recommends trailers with brakes that conform to all applicable federal and state/provincial regulations.

 NOTICE**■ Safety chain**

A safety chain must always be used between the towing vehicle and the trailer. Leave sufficient slack in the chain for turns. The chain should cross under the trailer tongue to prevent the tongue from dropping to the ground in the case that it becomes damaged or separated. For the correct safety chain installation procedure, ask your Lexus dealer.

■ Do not directly splice trailer lights

Directly splicing trailer lights may damage your vehicle's electrical system and cause a malfunction.

Trailer towing tips

Your vehicle will handle differently when towing a trailer. The 3 main causes of vehicle-trailer accidents are driver error, excessive speed and improper trailer loading. Keep the following in mind when towing.

- Before starting out, check the trailer lights and the vehicle-trailer connections. Recheck after driving a short distance.
- Practice turning, stopping and reversing with the trailer attached in an area away from traffic until you become accustomed to the feel of the vehicle.
- Reversing with a trailer attached is difficult and requires practice. Grip the bottom of the steering wheel and move your hand to the left to move the trailer to the left. Move your hand to the right to move the trailer to right. (This is generally opposite to reversing without a trailer attached.) Avoid sharp or prolonged turning. Have someone guide you when reversing to reduce the risk of an accident.
- As stopping distance is increased when towing a trailer, vehicle-to-vehicle distance should be increased. For each 10 mph (16 km/h) of speed, allow at least one vehicle and trailer length.

- Avoid sudden braking as you may skid, resulting in jackknifing and loss of control. This is especially true on wet or slippery surfaces.
- Avoid jerky starts or sudden acceleration.
- Avoid jerky steering and sharp turns, and slow down before making turns.
- Note that when making a turn, the trailer wheels will be closer than the vehicle wheels to the inside of the turn. Compensate by making a larger than normal turning radius.
- Crosswinds and rough roads will adversely affect handling of your vehicle and trailer, causing sway. Periodically check the rear to prepare for being passed by large trucks or buses, which may cause your vehicle and trailer to sway. If swaying occurs, firmly grip the steering wheel, reduce speed immediately but gradually, and steer straight ahead. Never increase speed. If you make no extreme correction with the steering or brakes, your vehicle and trailer will stabilize.
- Take care when passing other vehicles. Passing requires considerable distance. After passing a vehicle, do not forget the length of your trailer, and be sure you have plenty of room before changing lanes.
- Due to the added load of the trailer, your vehicle's hybrid system may overheat on hot days (at temperatures over 85°F [30°C]) when driving up a long or steep grade. If the coolant temperature gauge indicates overheating, immediately turn off the air conditioning (if in use), pull your vehicle off the road and stop in a safe spot. (→P. 424)

- Always place wheel blocks under both the vehicle and the trailer wheels when parking. Apply the parking brake firmly, and put the transmission in P. Avoid parking on a slope, but if unavoidable, do so only after performing the following:

STEP 1 Apply the brakes and keep them applied.

STEP 2 Have someone place wheel blocks under both the vehicle and trailer wheels.

STEP 3 When the wheel blocks are in place, release the brakes slowly until the blocks absorb the load.

STEP 4 Apply the parking brake firmly.

STEP 5 Shift into P and turn off the hybrid system.

- When restarting after parking on a slope:

STEP 1 With the transmission in the P position, start the hybrid system. Be sure to keep the brake pedal pressed.

STEP 2 Shift into D or the R position (if reversing).

STEP 3 Release the parking brake and brake pedal, and slowly pull or back away from the wheel blocks. Stop and apply the brakes.

STEP 4 Have someone retrieve the blocks.

CAUTION

■ To avoid an accident

- Do not exceed 45 mph (72 km/h) or the posted towing speed limit, whichever is lower. As instability (swaying) of the towing vehicle-trailer combination increases as speed increases, exceeding 45 mph (72 km/h) may cause loss of control.
- Slow down and downshift before descending steep or long downhill grades. Do not make sudden downshifts.
- Avoid holding the brake pedal down too long or applying the brakes too frequently.
This could cause the brakes to overheat and result in reduced braking efficiency.

2-5. Driving information

Dinghy towing

Your vehicle is not designed to be dinghy towed (with four wheels on the ground) behind a motor home.



NOTICE

■ **To avoid serious damage to your vehicle**

Do not tow your vehicle with four wheels on the ground.

- 3-1. Using the air conditioning system and defogger ... 198**
- Automatic air conditioning system..... 198
 - Rear window and outside rear view mirror defoggers, and windshield wiper de-icer 204
- 3-2. Using the front audio system 205**
- Audio system type 205
 - Using the radio..... 207
 - Using the CD player 214
 - Playing back MP3 and WMA discs..... 220
 - Optimal use of the audio system 228
 - Using the steering wheel audio switches..... 231
- 3-3. Using the rear audio system 233**
- Rear seat entertainment system features 233
 - Using the DVD player (DVD video)..... 239
 - Using the DVD player (video CD)..... 246
 - Using the DVD player (audio CD/ CD text)..... 248
 - Using the DVD player (MP3 discs)..... 249
 - Using the video mode 251
- Changing the initial setting..... 253
- 3-4. Using the interior lights 260**
- Interior lights list 260
 - Interior lights 263
 - Personal lights 264
- 3-5. Using the storage features 265**
- List of storage features 265
 - Glove box..... 265
 - Console boxes 266
 - Coin holder 268
 - Overhead console..... 269
 - Cup holders 269
 - Door pockets 271
- 3-6. Other interior features 272**
- Sun visors 272
 - Vanity mirror..... 273
 - Clock..... 274
 - Outside temperature display..... 275
 - Multi-display light control... 276
 - Power outlets..... 277
 - Seat heaters 280
 - Armrest 282
 - Floor mat 283
 - Luggage compartment features 284
 - Garage door opener 287
 - Compass 292

3-1. Using the air conditioning system and defogger

Automatic air conditioning system

Airflow and outlets are automatically adjusted according to the temperature setting.

► With navigation system

Owners of models equipped with a navigation system should refer to the "Navigation System Owner's Manual".

► Without navigation system

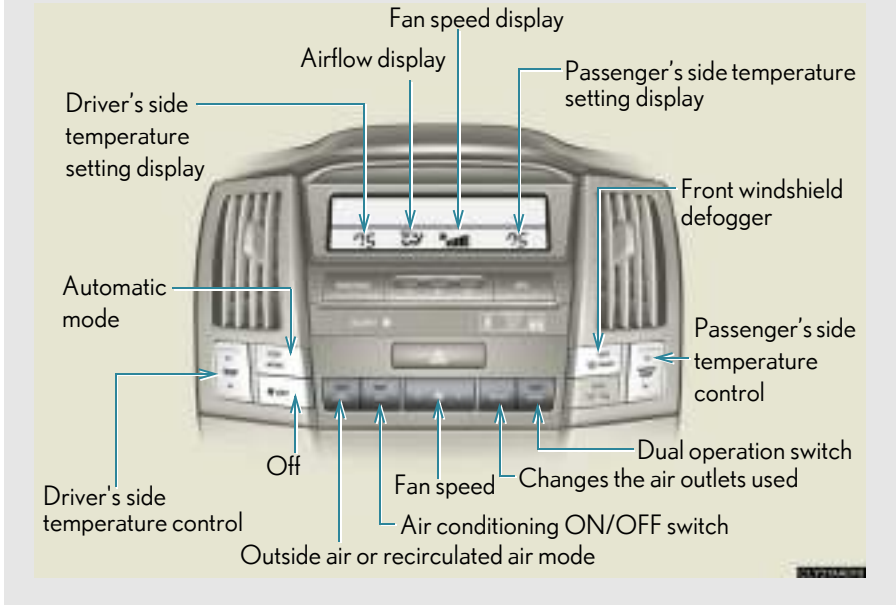

Using the automatic mode

STEP 1 Press .

➔ The air conditioning system will begin to operate. According to the temperature setting, air outlets and fan speed are automatically adjusted, and the mode automatically switches between outside air and recirculated air modes.



STEP 2 Press \wedge to increase the temperature and \vee to decrease the temperature on the .

The temperature for the driver and passenger seats can be set separately.

Adjusting the settings

■ Adjusting the temperature setting

Press \wedge to increase the temperature and \vee to decrease the temperature on the .

Press \wedge (increase) or \vee (decrease) on the  to separately adjust the temperature for the passenger and driver sides (dual mode). Press  to return the driver and passenger side temperatures to the same setting (simultaneous mode).

The air conditioning system switches between individual and simultaneous modes each time  is pressed.

■ Adjusting the fan speed

Press $>$ (increase) or $<$ (decrease) on the .

Press  to turn the fan off.

■ Changing the air outlets



Press .

The air outlets switch each time the button is pressed.

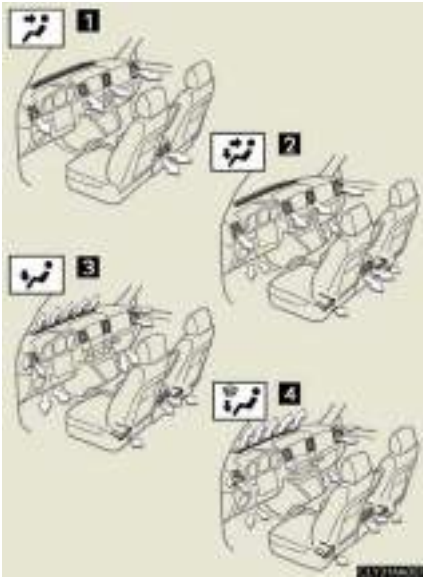

1 Air flows to the upper body.

2 Air flows to the upper body and feet.

3 Air flows to the feet.

4 Air flows to the feet and the front windshield defogger operates.

If recirculated air mode is selected, press  to switch to outside air mode.

■ Switching between outside air and recirculated air modes

Press .

The mode switches between outside air mode (indicator OFF) and recirculated air mode (indicator ON) modes each time the button is pressed.

Defogging the front windshield



1 Defogging

The air conditioning system control operates automatically.

Recirculated air mode will automatically switch to outside air mode. It is not possible to return to recirculated air mode when the switch is on.

Adjusting the position of and opening and closing the air outlets



► Front outlets (center)

- 1 Direct air flow to the left or right, up or down



► Front outlets (right and left side)

- 1 Direct air flow to the left or right, up or down
- 2 Turn the knob up to open the vent and down to close the vent

3-1. Using the air conditioning system and defogger



► Rear outlets

- 1 Direct air flow to the left or right, up or down
- 2 Turn the knob up to open the vent and down to close the vent

■ Using the automatic mode

Fan speed is adjusted automatically in accordance with the temperature setting and ambient conditions. As a result, the following may occur.

- The system may switch automatically to recirculated air mode when the coolest temperature setting is selected in summer.
- Immediately after the switch is pressed, the fan may stop for a while until warm or cool air is ready to flow.
- Cool air may flow to the area around the upper body when the heater is on.

■ Using the system in recirculated air mode

The windows will fog up more easily if the recirculated air mode is used for an extended period.

■ Window defogger feature

Recirculated air mode may automatically switch to outside air mode in situations where the windows need to be defogged.

■ Outside air temperature approaches 32°F (0°C).

The air conditioning system may not operate even when  is pressed.

■ When the indicator light on flashes

Press  and turn off the air conditioning system before turning it on once more. There may be a problem in the air conditioning system if the indicator light continues to flash. Turn the air conditioning system off and have it inspected by your Lexus dealer.

 CAUTION

■ **To prevent the windshield from fogging up**

Do not use  during cool air operation in extremely humid weather. The difference between the temperature of the outside air and that of the windshield can cause the outer surface of the windshield to fog up, blocking your vision.

 NOTICE

■ **To prevent 12-volt battery discharge**

Do not leave the automatic air conditioning system on longer than necessary when the hybrid system is off.

3-1. Using the air conditioning system and defogger

Rear window and outside rear view mirror defoggers, and windshield wiper de-icer

Defoggers are used to defog the rear window, and to remove raindrops, dew and frost from the outside rear view mirrors. De-icer* is used to prevent ice from building up on the windshield and wiper blades.



1 ON/OFF

The defoggers and de-icer will automatically turn off after approximately 15 minutes.

*: Vehicles for Canada only

■ The defogger and de-icer can be operated when

The engine switch must be in the ON position.

⚠ CAUTION

■ When the outside rear view mirror defoggers are on

Do not touch the outside surface of the rear view mirror, as it can become very hot and burn you.

■ When the windshield wiper de-icer is on

Do not touch the glass at the lower part of the windshield or to the side of the front pillars as the surfaces can become very hot and burn you.

3-2. Using the front audio system

Audio system type

▶ With navigation system

Owners of models equipped with a navigation system should refer to the "Navigation System Owner's Manual".

▶ Without navigation system

CD player with changer and AM/FM radio



Title	Page
Using the radio	P. 207
Using the CD player	P. 214
Playing back MP3 and WMA discs	P. 220
Optimal use of the audio system	P. 228
Using the steering wheel audio switches	P. 231

■ Using cellular phones

Interference may be heard through the audio system's speakers if a cellular phone is being used inside or close to the vehicle while the audio system is operating.

CAUTION

■ For vehicles sold in U.S.A. and Canada

● Part 15 of the FCC Rules

FCC Warning:

Any unauthorized changes or modifications to this equipment will void the user's authority to operate this device.

● Laser products

- Do not take this unit apart or attempt to make any changes yourself. This is an intricate unit that uses a laser pickup to retrieve information from the surface of compact discs. The laser is carefully shielded so that its rays remain inside the cabinet. Therefore, never try to disassemble the player or alter any of its parts since you may be exposed to laser rays and dangerous voltages.
- This product utilizes a laser. Use of controls or adjustments or performance of procedures other than those specified herein may result in hazardous radiation exposure.

NOTICE

■ To prevent 12-volt battery discharge

Do not leave the audio system on longer than necessary with the hybrid system off.

■ To avoid damaging the audio system



Take care not to spill drinks or other fluids over the audio system.

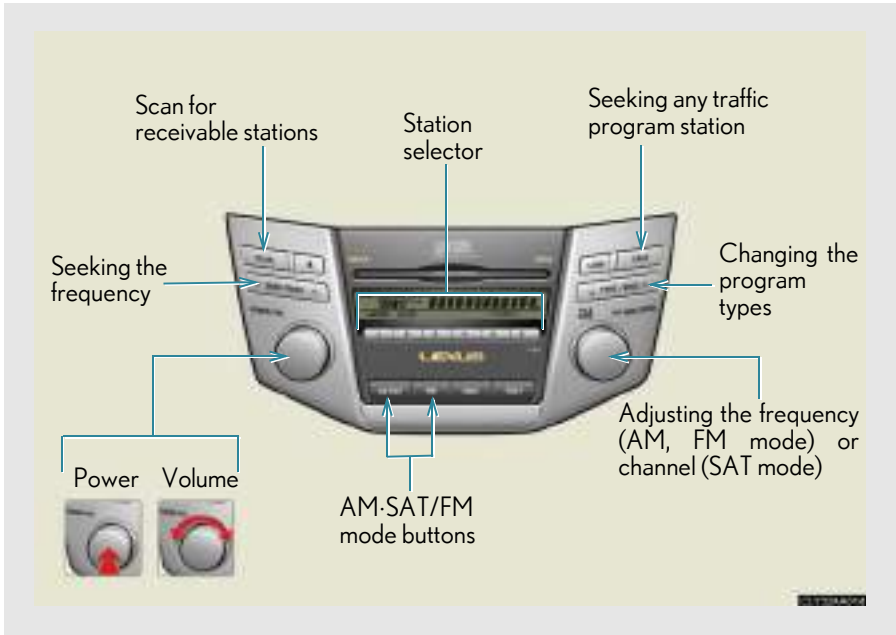

3-2. Using the front audio system

Using the radio



Setting station presets (excluding XM[®] Satellite Radio)

STEP 1 Search for desired stations by turning  or pressing \wedge or \vee on .

STEP 2 Press and hold the button (from  to ) the station is to be set to, and you hear a beep.

Scanning radio stations (excluding XM[®] Satellite Radio)

■ Scanning the preset radio stations

STEP 1 Press and hold  until you hear a beep.
Preset stations will be played for 5 seconds each.

STEP 2 When the desired station is reached, press the button once again.

■ Scanning all radio stations within range

STEP 1 Press .

All stations with reception will be played for 5 seconds each.

STEP 2 When the desired station is reached, press the button once again.

RDS (Radio Data System)

This feature allows your radio to receive station identification information and program information (classical, jazz, etc.) from radio stations which broadcast this information.



■ Receiving RDS broadcasts

STEP 1 Press \wedge or \vee on  during FM reception.

The type of program changes each time the button is pressed.

- ROCK
- EASYLIS (Easy listening)
- CLS/JAZZ (Classical music and Jazz)
- R & B (Rhythm and Blues)
- INFORM (Information)
- RELIGION
- MISC (Miscellaneous)
- ALERT (Emergency messages)

If the system receives no RDS stations, NO PTY appears on the display.

STEP 2 Press , or \wedge or \vee on .

The radio seeks or scans the station by the relevant program type.



■ Displaying radio station names

Press .

■ Displaying radio text messages

Press  twice.

If MSG is shown on the display, a text message will be displayed.

If the text continues past the end of the display,  is displayed. Press and hold  until you hear a beep.





XM[®] Satellite Radio (if equipped)

■ Receiving XM[®] Satellite Radio



STEP 1 Press  until SAT is shown on the display.

The display changes as follows each time the button is pressed.

AM → SAT1 → SAT2 → SAT3

STEP 2 Turn  to select the desired channel in the all categories or press  or  on  to select the desired channel in the current category.

■ Setting XM[®] Satellite Radio channel presets

Select the desired channel. Press and hold the button (from  to ) the channel is to be set to, and you hear a beep.

■ Changing the channel category

Press  or  on .

■ Scanning XM[®] Satellite Radio channels

● Scanning channels in the current category

STEP 1 Press .

STEP 2 When the desired channel is reached, press the button again.

- Scanning preset channels

STEP 1 Press and hold  until you hear a beep.

STEP 2 When the desired channel is reached, press the button again.

- **Displaying text information**

Press .

The display will show up to 10 characters.

The display changes as follows each time the button is pressed.

- CH NAME
- TITLE (SONG/PROGRAM TITLE)
- NAME (ARTIST NAME/FEATURE)
- CH NUMBER

■ When the 12-volt battery is disconnected

Station presets are erased.

■ Radio antenna type

- Detachable antenna

To remove a detachable antenna, carefully turn it counterclockwise.

- Wire antenna

The radio antenna is mounted inside the rear window.

■ Reception sensitivity

- Maintaining perfect radio reception at all times is difficult due to the continually changing position of the antenna, differences in signal strength and surrounding objects, such as trains, transmitters, etc.

- To maintain clear radio reception, do not attach metallic window tinting or other metallic objects to the antenna wire mounted inside the rear window.

■ Receiving XM[®] Satellite Radio

An XM[®] Satellite Radio is a tuner designed exclusively to receive broadcasts provided under a separate subscription. Availability is limited to the 48 contiguous states and 10 Canadian provinces.

- XM[®] subscriptions

For detailed information about XM[®] Satellite Radio or to subscribe:
U.S.A.—

Visit on the web at www.xmradio.com or call 1-877-515-3987.

Canada—

Visit on the web at www.xmradio.ca or call 1-877-438-9677.

- Radio ID

You will need the radio ID when activating XM[®] service or reporting a problem.

Select "CH000" using , and the receiver's 8-character ID number will

appear.

- Satellite tuner

The tuner supports only Audio Services (Music and Talk) and the accompanying Text Information of XM[®] Satellite Radio.

*: Terms and services provided by XM[®] Satellite Radio are subject to change without notice.

■ If the satellite radio does not operate normally

If a problem occurs with the XM[®] tuner, a message will appear on the display. Refer to the table below to identify the problem, and take the suggested corrective action.

ANTENNA	The XM [®] antenna is not connected. Check whether the XM [®] antenna cable is attached securely.
	There is a short-circuit in the antenna or the surrounding antenna cable. See a Lexus certified dealer.
UPDATING	You have not subscribed to the XM [®] Satellite Radio. The radio is being updated with the latest encryption code. Contact the XM [®] Satellite Radio for subscription information. When a contract is canceled, you can choose the "CH000" and all free-to-air channels.
	The premium channel you selected is not authorized. Wait for about 2 seconds until the radio returns to the previous channel or "CH001". If it does not change automatically, select another channel. If you want to listen to the premium channel, contact the XM [®] Satellite Radio.
NO SIGNAL	The XM [®] signal is too weak at the current location. Wait until your vehicle reaches a location with a stronger signal.
LOADING	The unit is acquiring audio or program information. Wait until the unit has received the information.
OFF AIR	The channel you selected is not broadcasting any programming. Select another channel.
-----	There is no song/program title or artist name/feature associated with the channel at that time. No action needed.

The channel you selected is no longer available. Wait for about 2 seconds until the radio returns to the previous channel or “CH001”. If it does not change automatically, select another channel.

Contact the XM[®] Listener Care Center at 1-877-515-3987 (U.S.A.) or 1-877-438-9677 (Canada).

■ Certifications for the radio tuner

This equipment has been tested and found to comply with the limits for a class B digital device, pursuant to Part 15 of the FCC Rules. These limits are designed to provide reasonable protection against harmful interference in a residential installation. This equipment generates, uses and can radiate radio frequency energy and, if not installed and used in accordance with the instructions, may cause harmful interference to radio communications. However, there is no guarantee that interference will not occur in a particular installation.

If this equipment does cause harmful interference to radio or television reception, which can be determined by turning the equipment off and on, the user is encouraged to try to correct the interference by trying one or more of the following:

- Reorienting or relocate the receiving antenna.
- Increasing the separation between the equipment and receiver.
- Connecting the equipment into an outlet on a circuit different from that to which the receiver is connected.
- Consulting the dealer or an experienced radio/TV technician for help.

3-2. Using the front audio system

Using the CD player

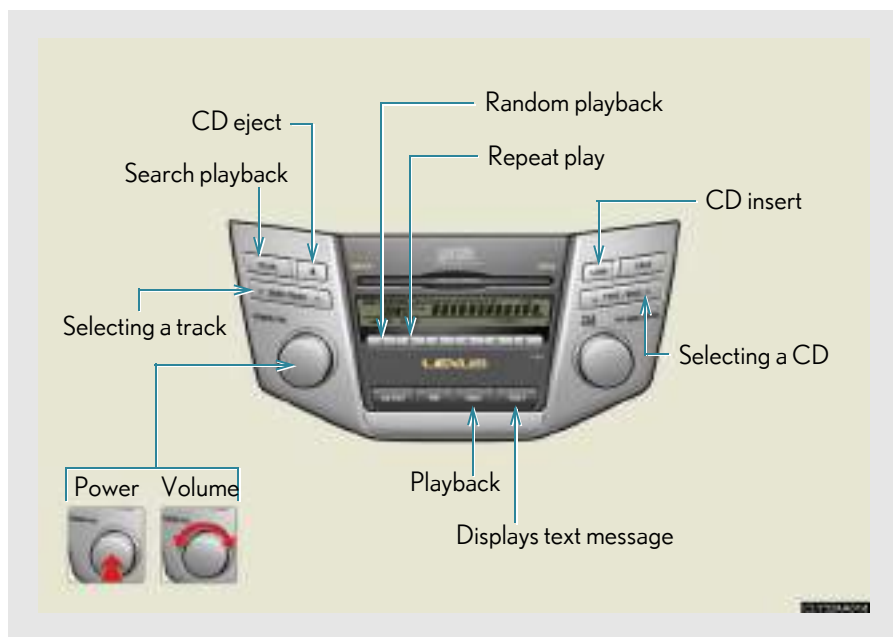

Loading CDs

■ Loading a CD

STEP 1 Press  .

WAIT is shown on the display.

STEP 2 Insert a CD when the indicator on the slot turns from amber to green.

The display changes from WAIT to LOAD.

■ Loading multiple CDs

STEP 1 Press and hold  until you hear a beep.

WAIT is shown on the display.

STEP 2 Insert a CD when the indicator on the slot turns from amber to green.

The display changes from WAIT to LOAD.

The indicator on the slot turns to amber when the CD is inserted.

STEP 3 Insert the next CD when the indicator on the slot turns from amber to green again.

Repeat the procedure for the remaining CDs.

To stop the operation, press .

Ejecting CDs

■ Ejecting a CD

STEP 1 To select the CD to be ejected, press \wedge or \vee on .

The number of the CD selected is shown on the display.

STEP 2 Press  and remove the CD.

■ Ejecting all the CDs

Press and hold  until you hear a beep, and then remove the CDs.

Selecting, fast-forwarding, rewind, and scanning tracks

■ Selecting a track

Press \wedge to move up and \vee to move down using  until the desired track number is displayed.

To fast-forward or rewind, press and hold \wedge or \vee on .

■ Scanning a CD

STEP 1 Press .

The first ten seconds of each track will be played.

STEP 2 Press the switch again when the desired track is reached.

Selecting a CD

■ To select a CD to play

To select the desired CD, press \wedge or \vee on .

■ To scan loaded CDs

STEP 1 Press and hold  until you hear a beep.

The first ten seconds of the first track on each CD will be played.

STEP 2 Press the button again when the desired CD is reached.

Repeat play

■ To repeat a track

Press  (RPT).

■ To repeat all of the tracks on a CD

Press and hold  (RPT) until you hear a beep.

Random playback

■ Current CD

Press  (RAND).

Tracks are played in random order until random playback is canceled.

■ All CDs

Press and hold  (RAND) until you hear a beep.

Tracks on all loaded CDs are played in a random order until the button is pressed once more.

Switching the display

Press .

Each time the button is pressed, the display changes in the order of Track no./ Elapsed time → CD title → Track name.

■ Canceling random, repeat and scan playback

Press  (RAND),  (RPT), or  again.

■ When LOAD, ERROR or WAIT is shown on the display

LOAD: This indicates that the CD player has completed loading the CD.

ERROR: This indicates is a trouble either in the CD or inside the player. The CD may be dirty, damaged, or inserted up-side down.

WAIT: Operation is stopped due to a high temperature inside the player. Wait for a while and then press . Contact your Lexus dealer if the CD still cannot be played back.

■ Discs that can be used

Discs with the marks shown below can be used.

Playback may not be possible depending on recording format or disc features, or due to scratches, dirt or deterioration.



CDs with copy-protect features may not be used.

■ CD player protection feature

To protect the internal components, playback is automatically stopped when a problem is detected.

■ If CDs are left inside the CD player or in the ejected position for extended periods

CDs may be damaged and may not play properly.

■ Lens cleaners

Do not use lens cleaners. Doing so may damage the CD player.

 NOTICE

■ **CDs and adapters that cannot be used**

Do not use the following types of CDs, 3 in. (8 cm) CD adapters or Dual Disc. Doing so may damage the CD player and/or the CD insert/eject function.



- CDs that have a diameter that is not 4.7 in. (12 cm).



- Low-quality and deformed CDs.



- CDs with a transparent or translucent recording area.



- CDs that have had tape, stickers or CD-R labels attached to them, or that have had the label peeled off.

 NOTICE**■ CD player precautions**

Failure to follow the precautions below may result in serious damage to the CDs or the player itself.

- Do not insert anything other than CDs into the CD slot.
- Do not apply oil to the CD player.
- Store CDs away from direct sunlight.
- Never try to disassemble any part of the CD player.



- Do not insert more than one CD at a time.

3-2. Using the front audio system

Playing back MP3 and WMA discs



Loading and ejecting MP3 and WMA discs

→P. 214

Selecting a folder

■ Selecting folders one at a time

Press **6** (Λ) or **3** (∨) to select the desired folder.

■ Selecting the desired folder by cueing the first file of each folder

Press and hold **SEARCH** until you hear a beep. The first ten seconds of the first file in each folder will be played. When the desired folder is reached, press the button once again.

■ Returning to the first folder

Press and hold **3** (∨) until you hear a beep.

Selecting and scanning files

■ Selecting one file at a time

Turn  or press \wedge or \vee on  to select the desired file.

■ Selecting the desired file by cueing the files in the folder

Press . The first ten seconds of each file will be played.

When the desired file is reached, press the button once again.

Repeat play

■ To repeat a file

Press  (RPT).

■ To repeat all of the files on a folder

Press and hold  (RPT) until you hear a beep.

Random playback

■ To play files from a particular folder in random order

Press  (RAND).

■ To play all of the files on a disc in random order

Press and hold  (RAND) until you hear a beep.

Switching the display

Press .

Each time the button is pressed, the display changes in the order of Folder no./File no./Elapsed time → Folder name → File name → Album title (MP3 only) → Track title → Artist name.

■ Canceling random, repeat and scan playback

Press  (RAND), , or  again.

■ When LOAD, ERROR or WAIT is shown on the display.

LOAD: This indicates that the CD player has completed loading the CD.

ERROR: This indicates is a trouble either in the CD or inside the player. The CD may be dirty, damaged, or inserted up-side down.

WAIT: Operation is stopped due to a high temperature inside the player. Wait for a while and then press . Contact your Lexus dealer if the CD still cannot be played back.

NO MUSIC: This indicates that the MP3/WMA file is not included in the CD.

■ Discs that can be used

Discs with the marks shown below can be used.

Playback may not be possible depending on recording format or disc features, or due to scratches, dirt or deterioration.



■ CD player protection feature

To protect the internal components, playback is automatically stopped when a problem is detected while the CD player is being used.

■ If CDs are left inside the CD player or in the ejected position for extended periods

CDs may be damaged and may not play properly.

■ Lens cleaners

Do not use lens cleaners. Doing so may damage the CD player.

■ MP3 and WMA files

MP3 (MPEG Audio LAYER 3) is a standard audio compression format.

Files can be compressed to approximately 1/10 of their original size by using MP3 compression.

WMA (Windows Media TMAudio) is a Microsoft audio compression format.

This format compresses audio data to a size smaller than that of the MP3 format.

There is a limit to the MP3 and WMA file standards and to the media/formats recorded by them that can be used.

● MP3 file compatibility

- Compatible standards
MP3 (MPEG1 LAYER3, MPEG2 LSF LAYER3)
- Compatible sampling frequencies
MPEG1 LAYER3: 32, 44.1, 48 (kHz)
MPEG2 LSF LAYER3: 16, 22.05, 24 (kHz)
- Compatible bit rates
MPEG1 LAYER3: 64, 80, 96, 112, 128, 160, 192, 224, 256, 320 (kbps)
- MPEG2 LSF LAYER3: 64, 80, 96, 112, 128, 144, 160 (kbps)
* Compatible with VBR
- Compatible channel modes: stereo, joint stereo, dual channel and monaural

● WMA file compatibility

- Compatible standards
WMA Ver. 7, 8, 9
- Compatible sampling frequencies
32, 44.1, 48 (kHz)
- Compatible bit rates
Ver. 7, 8: CBR 48, 64, 80, 96, 128, 160, 192 (kbps)
Ver. 9: CBR 48, 64, 80, 96, 128, 160, 192, 256, 320 (kbps)
* Only compatible with 2-channel playback

● Compatible media

Media that can be used for MP3 and WMA playback are CD-Rs and CD-RWs.

Playback in some instances may not be possible, depending on the status of the CD-R or CD-RW. Playback may not be possible or the audio may jump if the disc is scratched or marked with fingerprints.

● Compatible disc formats

The following disc formats can be used.

- Disc formats: CD-ROM Mode 1 and Mode 2
CD-ROM XA Mode 2, Form 1 and Form 2
- File formats: ISO9660 Level 1, Level 2, (Romeo, Joliet)
MP3 and WMA files written in any format other than those listed above may not play correctly, and their file names and folder names may not be displayed correctly.

Items related to standards and limitations are as follows.

- Maximum directory hierarchy: 8 levels
- Maximum length of folder names/file names: 32 characters
- Maximum number of folders: 192 (including the root)
- Maximum number of files per disc: 255

● File names

The only files that can be recognized as MP3/WMA and played are those with the extension .mp3 or .wma.

● Multi-sessions

As the audio system is compatible with multi-sessions, it is possible to play discs that contain MP3 and WMA files. However, only the first session can be played.

● ID3 and WMA tags

ID3 tags can be added to MP3 files, making it possible to record the track title and artist name, etc.

The system is compatible with ID3 Ver. 1.0, 1.1, and Ver. 2.2, 2.3 ID3 tags. (The number of characters is based on ID3 Ver. 1.0 and 1.1.)

WMA tags can be added to WMA files, making it possible to record the track title and artist name in the same way as with ID3 tags.

● MP3 and WMA playback

When a disc containing MP3 or WMA files is inserted, all files on the disc are first checked. Once the file check is finished, the first MP3 or WMA file is played. To make the file check finish more quickly, we recommend you do not write in any files other than MP3 or WMA files or create any unnecessary folders.

Discs that contain a mixture of music data and MP3 or WMA format data cannot be played.

● Extensions

If the file extensions .mp3 and .wma are used for files other than MP3 and WMA files, they will be mistakenly recognized and played as MP3 and WMA files. This may result in large amounts of interference and damage to the speakers.

● Playback

- To play MP3 file with steady sound quality, we recommend a fixed bit rate of 128 kbps and a sampling frequency of 44.1 kHz.
- CD-R or CD-RW playback may not be possible in some instances, depending on the characteristics of the disc.
- There is a wide variety of freeware and other encoding software for MP3 and WMA files on the market, and depending on the status of the encoding and the file format, poor sound quality or noise at the start of playback may result. In some cases, playback may not be possible at all.
- When files other than MP3 or WMA files are recorded on a disc, it may take more time to recognize the disc and in some cases, playback may not be possible at all.
- Microsoft, Windows, and Windows Media are the registered trademarks of Microsoft Corporation in the U.S.A. and other countries.

 NOTICE

■ **CDs and adapters that cannot be used**

Do not use the following types of CDs, 3 in. (8 cm) CD adapters or Dual Disc. Doing so may damage the CD player and render the CD insert/eject function unusable.



- CDs that have a diameter that is not 4.7 in. (12 cm).



- Low-quality and deformed CDs.



- CDs with a transparent or translucent recording area.



- CDs that have had tape, stickers or CD-R labels attached to them, or that have had the label peeled off.

 NOTICE**■ CD player precautions**

Failure to follow the precautions below may result in damage to the CDs or the player itself.

- Do not insert anything other than CDs into the CD slot.
- Do not apply oil to the CD player.
- Store CDs away from direct sunlight.
- Never try to disassemble any part of the CD player.



- Do not insert more than one CD at a time.

3-2. Using the front audio system

Optimal use of the audio system



- 1 Displays the current mode.
- 2 Changes the following settings.
 - Sound quality and volume balance (→P. 229)

The sound quality and balance setting can be changed to produce the best sound.
 - Automatic Sound Levelizer ON/OFF (→P. 229)
 - Listening position (→P. 230)

The sound feel setting can be changed to produce the best sound for each listening position.
 - Rear system lock ON/OFF of rear seat entertainment system (→P. 230)

Using the AUDIO CONTROL function

■ Changing modes

Pressing  selects the mode to be change in the following order.

BAS→MID→TRE→FAD→BAL→ASL→RSE→POS



■ Adjusting sound quality

Turning  adjusts the level.

Sound quality mode	Mode displayed	Level	Turn to the left	Turn to the right
Bass*	BAS	-5 to 5	Low	High
Mid-range*	MID	-5 to 5		
Treble*	TRE	-5 to 5		
Front/rear volume balance	FAD	F7 to R7	Shifts to rear	Shifts to front
Left/right volume balance	BAL	L7 to R7	Shifts to left	Shifts to right

*: The sound quality level is adjusted individually in each AM·SAT·FM or CD mode.

■ Adjusting the Automatic Sound Levelizer (ASL)

Turning  to the right turns ON the ASL, and turning  to the left turns OFF the ASL.

ASL automatically adjusts the volume and tone quality according to the noise level as you drive your vehicle.

■ Changing the listening position

Turning  changes the position in the following order.

Display	Listening position
DRIVER	Position best suited to the driver's seat
FRONT	Position best suited to the driver's and front passenger seats
REAR	Position best suited to the rear seats
ALL	Position best suited to all seats

■ Rear system lock ON/OFF



Turn  until ON/OFF is displayed, and press.

The rear system lock remains on, even when the engine switch is turned off.

3-2. Using the front audio system

Using the steering wheel audio switches

Some audio features can be controlled using the switches on the steering wheel.



- 1 Power on, select audio source
- 2 Volume
- 3 Radio: Select radio stations
CD: Select tracks, files (MP3 and WMA) and discs

Turning on the power

Press  when the audio system is turned OFF.

The audio system can be turned off by holding the switch down for a few seconds.

Changing the audio source

Press  when the audio system is turned ON. The audio source changes as follows each time the switch is pressed.

FM1→FM2→CD changer→AM→SAT1→SAT2→SAT3

Adjusting the volume

Press + on  to increase the volume and - to decrease the volume.

Hold down the switch to continue increasing or decreasing the volume.

Selecting a radio station

STEP 1 Press  to select the radio mode.

STEP 2 Press \wedge or \vee on the  to select a radio station.

To scan for receivable stations, press and hold the switch until you hear a beep.

Selecting a track/file

STEP 1 Press  to select the CD mode.

STEP 2 Press \wedge or \vee on  to select the desired track/file.

Selecting a disc in the CD player

STEP 1 Press  to select the CD mode.

STEP 2 Press and hold \wedge or \vee on  until a beep is heard.

CAUTION

To reduce the risk of an accident

Exercise care when operating the audio switches on the steering wheel.

3-3. Using the rear audio system

Rear seat entertainment system features (if equipped)

The rear seat entertainment system is designed for the rear passengers to enjoy audio and DVD video separately from the front audio system.



- 1 Front audio system
- 2 Display
- 3 Headphone volume control dials and headphone jacks
- 4 DVD player
- 5 A/V input adapter
- 6 Power outlet
- 7 Rear seat entertainment system controller
- 8 Power outlet main switch

Opening and closing the display

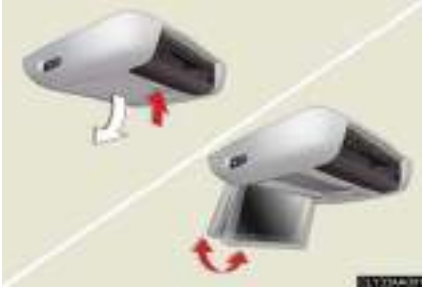

Press the lock release button to open the display.

Pull the display down to an easily viewable angle (between 90° and 125°).



To close the display, press the display up until a click is heard to close the display.

The illumination of the screen is automatically turned off when the display is closed. However, the rear seat entertainment system is not turned off.

Loading a disc



Insert the disc into the slot with the label side up.

The DISC indicator light turns on while the disc is loaded.

The player will play the track or chapter, and will repeat it after it reaches the end.

Ejecting a disc



Press  and remove the disc.

Headphone jacks

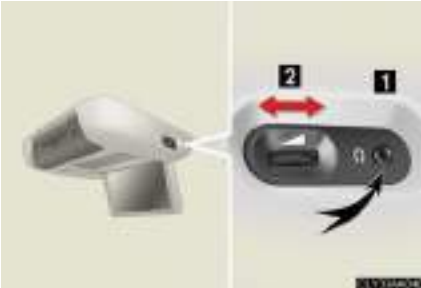

1 To use the headphones, connect them to the jack.

2 To adjust the volume

Right side dial: Turn it toward the front of the vehicle to increase the volume. Turn it toward the rear of the vehicle to decrease the volume.

Left side dial: Turn it toward the rear of the vehicle to increase the volume. Turn it toward the front of the vehicle to decrease the volume.

■ **The rear seat entertainment system can be used when**

The engine switch is in the ACC or ON position.

■ **Discs that can be used**

Discs with the marks shown below can be used.

Playback may not be possible depending on recording format or disc features, or due to scratches, dirt or deterioration.



■ **When  appears on the screen**

It indicates that the selected switch cannot work.

■ **Rear system lock**

→P. 230

■ Error messages

DISC CHECK: Indicates that the disc is dirty, damaged or was inserted upside down. Clean the disc or insert it correctly.

REGION ERROR: Indicates that the DVD region code is not set properly.

DVD ERROR: Indicates that there is a problem inside the player. Eject the disc. Set the disc again.
If the malfunction still exists, take the vehicle to your Lexus dealer.

■ Before using the remote control (for new vehicle owners)

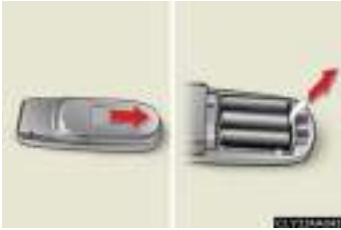

An insulating sheet is set to prevent the batteries from being discharged. Remove the insulating sheet before using the remote control.

■ Headphones

With some headphones generally available in the market, it may be difficult to catch signals properly. Lexus recommends the use of Lexus genuine wireless headphones.

Please contact your Lexus dealer for further details.

■ Volume

- Adjust the volume when you connect the headphones to the jack. Loud sounds may have a significant impact on the human body.
- Conversational speech on some DVDs is recorded at a low volume to emphasize the impact of sound effects. If you adjust the volume assuming that the conversations represent the maximum volume level that the DVD will play, you may be startled by louder sound effects or when you change to a different audio source. Be sure to adjust the volume with this in mind.

CAUTION

■ While driving

Do not use headphones.

Doing so may cause an accident, resulting in death or serious injury.

■ When the rear seat entertainment system is not used

Keep the display closed.

In the event of an accident or sudden braking, the opened display may hit an occupant's body, resulting in injury.

■ To prevent accidents and electric shock

Do not disassemble or modify the remote control.

■ When the remote control is not used

Stow the remote control.

Injuries may result in the event of an accident or sudden braking.

3-3. Using the rear audio system

Using the DVD player (DVD video)

■ Remote control

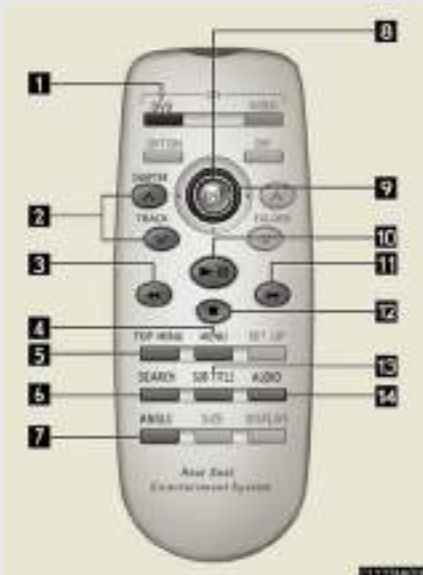

- 1 Turning on the DVD mode
- 2 Selecting a chapter
- 3 Reversing a screen
- 4 Turning on the menu screen
- 5 Turning on the title selection screen
- 6 Searching the title
- 7 Changing the screen angle
- 8 Inputting the selected switch
- 9 Selecting a switch
- 10 Playing/pausing a screen
- 11 Fast forwarding a screen
- 12 Stopping a screen
- 13 Changing the subtitle language
- 14 Changing the audio language

■ Unit

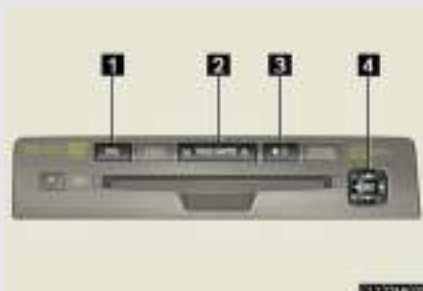

- 1 Turning on the DVD mode
- 2 Skipping to the desired chapter
- 3 Playing/pausing a screen
- 4 Selecting a switch/inputting the selected switch

■ Display (Page 1)



- 1 Turning off the operation switches on the display
- 2 Displaying to Page 2
- 3 Turning on or off the title selection screen for the disc
- 4 Turning on or off the menu screen for the disc
- 5 Reversing a screen
- 6 Stopping a screen
- 7 Pausing the disc/canceling the pause
- 8 Fast forwarding a screen

■ Display (Page 2)



- 9 Displaying to the initial setting screen
- 10 Displaying to Page 1
- 11 Search for a title
- 12 Returning to the previous screen
- 13 Changing the audio language
- 14 Changing the subtitle language
- 15 Changing the angle

 NOTICE

■ Cleaning the display

Wipe the display with a dry soft cloth.

If the screen is wiped with a rough cloth, the surface of the screen may be scratched.

■ To prevent damage to the remote control

- Keep the remote control away from direct sunlight, temperature heat and high humidity.



- Do not drop or knock the remote control against hard objects.



- Do not sit on or place heavy objects on the remote control.

■ DVD player



Never try to disassemble or oil any part of the DVD player. Do not insert anything other than a disc into the slot.

Turning on or off the operation switches



Press  or  to turn on the operation switches.

Press  or  once again or select  to turn off the operation switches.

Turning on the title selection screen

Press  or select  to turn on the title selection screen. For the operation of the title selection screen, see the separate manual for the DVD disc.

Turning on the menu screen

Press  or select  to turn on the menu screen. For the operation of the menu screen, see the separate manual for the DVD disc.

Returning to the previous screen

Press **Return** to return to the previous screen. For the operation of the menu screen, see the separate manual for the DVD disc.

Searching for a title



Press **SEARCH** or select **Search** to display the screen to search for a title.

Select the title number, and press ENT to input it.

Select **Back** to return to the previous screen.

Changing the subtitle language



Press **SUBTITLE** or select **Sub Title** to display the subtitle language screen.

Each time **SUBTITLE** is pressed or **Sub Title** is selected, another language stored on the disc is selected.

Select **Back** to return to the previous screen.

Changing the audio language



Press **AUDIO** or select **Audio** to display the audio language screen.

Each time **AUDIO** is pressed or **Audio** is selected, another language stored on the disc is selected.

Select **Back** to return to the previous screen.

Changing the angle



Press **ANGLE** or select **Angle** to display the screen to change the angle.

Each time **ANGLE** is pressed or **Angle** is selected, the angle changes.

Select **Back** to return to the previous screen.





■ DVD player and DVD video discs

This DVD player is compatible NTSC color TV formats. DVD video discs conforming to other formats such as PAL or SECAM cannot be used.

■ Region codes

Some DVD video discs have a region code indicating where you can use them. If the DVD video disc is not labeled ALL or 1, you cannot use it in this DVD player. If you attempt to play an inappropriate DVD video disc in this player, REGION CODE ERROR appears on the screen. Even if the DVD video disc does not have a region code, in some cases you cannot use it.

■ Marks shown on DVD video discs

NTSC	Indicates NTSC format of color TV.
	Indicates the number of audio tracks.
	Indicates the number of language subtitles.
	Indicates the number of angles.
	Indicates the screen to be selected. Wide screen: 16:9 Standard: 4:3
	Indicates regions in which this video disc can be played. ALL: all countries Number: region code

■ DVD video disc glossary

- **DVD video discs:** Digital Versatile Discs that holds world's standard video. DVD video discs have adopted "MPEG2", one of the world standards of digital compression technologies. The picture data is compressed by 1/40 on average and stored. Variable rate encoded technology has been adopted in which the volume of data assigned to the picture is changed depending on the picture format. Audio data is stored using PCM and Dolby digital, which enables higher sound. Furthermore, multi-angle and multi-language features will also help you enjoy the more advanced technology of DVD video.
- **Viewer restrictions:** This feature limits what can be viewed in conformity with the level of restrictions of the country. The level of restrictions varies depending on the DVD video disc. Some DVD video discs cannot be played at all, or violent scenes are skipped or replaced with other scenes.
 - Level 1: DVD video discs for children can be played.
 - Level 2 - 7: DVD video discs for children and G-rated movies can be played.
 - Level 8: All types of DVD video discs can be played.

- Multi-angle feature: Allows you to enjoy the same scene at different angles.
- Multi-language feature: Allows you to select the language of the subtitles and audio.
- Region codes: Region codes are provided on DVD players and DVD discs. If the DVD video disc does not have the same region code as the DVD player, you cannot play the disc on the DVD player.
- Audio: This DVD player can play liner PCM, Dolby digital, dts and MPEG audio format DVD. Other decoded type cannot be played.
- Title and chapter: Video and audio programs stored on DVD video discs are divided into sections by title and chapter.
- Title: The largest unit of the video and audio programs stored on DVD video discs. Usually, one piece of a movie, one album, or one audio program is assigned as a title.
- Chapter: A unit smaller than a title. A title comprises multiple chapters.

■ Audio

Manufactured under license from Dolby Laboratories. "Dolby", "Pro Logic", and  are trademarks of Dolby[®] Laboratories. Confidential unpublished works. 1992-1997 Dolby[®] Laboratories. All rights reserved.

"dts" is a trademark of Digital Theater Systems, Inc.

3-3. Using the rear audio system

Using the DVD player (video CD)

■ Remote control



- 1 Selecting a switch
- 2 Selecting a chapter
- 3 Playing/pausing a screen
- 4 Reversing a screen
- 5 Displaying operation switches
- 6 Inputting the selected switch
- 7 Fast forwarding a screen
- 8 Stopping a screen
- 9 Changing the initial setting

■ Unit

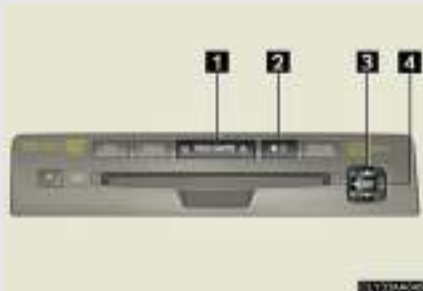

- 1 Skipping to the desired chapter
- 2 Playing/pausing a screen
- 3 Selecting a switch
- 4 Inputting the selected switch

■ Display (page 1)



- 1 Selecting a disc menu number
- 2 Turning off the menu screen
- 3 Displaying to page 2
- 4 Turning on the disc menu
- 5 Returning to the previous page screen (with the disc menu displayed)
- 6 Proceeding to the next page screen (with the disc menu displayed)
- 7 Changing to a multiplex transmission

■ Display (page 2)



- 8 Displaying to page 1
- 9 Reversing a screen
- 10 Pausing the disc/canceling the pause
- 11 Fast forwarding a screen

Selecting a disc menu number

Select **Select Number** to display the disc menu number search screen.

Select the disc menu number, and press ENT to input it.

Select **Back** to return to the previous screen.

3-3. Using the rear audio system

Using the DVD player (audio CD/ CD text)



The image shows a DVD player's control screen. At the top, it displays 'DVD' and 'CD'. Below that, it shows 'RPT', 'RAND', and 'SCAN' options. The current track is 'TRACK 00' and the time is '34:56'. At the bottom, there are three buttons: 'RPT', 'RAND', and 'SCAN'. Arrows point to these buttons with numbers 1, 2, and 3 respectively.

Using the control screen, press **DVD** or **RPT** to display the control screen.

- 1 Repeat play
- 2 Random playback
- 3 Search playback

■ Canceling random, repeat and scan play

Select **RPT**, **RAND** or **SCAN** again.

3-3. Using the rear audio system

Using the DVD player (MP3 discs)

■ Using the control screen

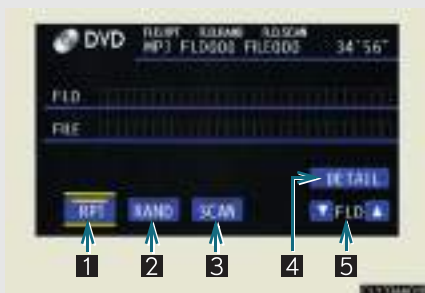

Press **DVD** or **MP3** to display the control screen.

- 1 Repeat play
- 2 Random playback
- 3 Search playback
- 4 Displaying file information
- 5 Selecting folder

Repeat play

■ Repeat a file

Select **RPI**.

■ Repeat all of files in a folder

Select **RPI**, and press and hold ENT on the remote control.

Random playback

■ Playing files from a particular folder in random order

Select **RAND**.

■ Playing all of the files on a disc in random order

Select **RAND**, and press and hold ENT on the remote control.

Search playback

■ Selecting the desired file by cueing the files in the folder

Select **SCAN**.

The player will scan all the files in the folder. Each file will be played for 10 seconds.

■ Selecting the desired file by cueing the folders on the disc

Select **SCAN**, and press and hold ENT the remote control.

The player will scan all the folders on the disc. The first file in each folder will be played for 10 seconds.

■ Canceling random, repeat and play back

Select **RPT**, **RAND** or **SCAN** again.

3-3. Using the rear audio system

Using the video mode



Press **VIDEO** or **VIDEO** to select the video mode.

Before switching to the video mode, connect the audio machine to the input terminal adapter.

Using the adapter



Open the cover.

The A/V input adapter is composed of 3 input adapters.

Yellow: Image input adapter

White: Audio input adapter

Red: Audio input adapter

■ A/V input adapter

The rear seat entertainment system plays videos and sound when audio-video equipment is connected to the A/V input adapter. For details, refer to the manufacturer's instructions.

■ Power outlet

The power outlet is used to connect the audio device. (→P. 277)

 NOTICE

■ **When the A/V input adapter is not in use**

Keep the A/V input adapter cover closed.

Inserting anything other than an appropriate plug may cause electrical failure or short circuit.

3-3. Using the rear audio system

Changing the initial setting



Press **SET UP** or select **Set Up** to display the initial setting screen.

The following initialization can be changed here.

- Audio language
- Subtitle language
- DVD language
- Angle mark
- Parental lock

Changing the audio language



Select "Audio Language".
Select the language you want to hear, and press ENT to input it.



Select "Others" if you cannot find the language you want to hear.
Enter the appropriate 4-digit language code. Select a number, and press ENT to input it.

Language code list (→P. 257)
If a code that is not in the list is entered, Incorrect Code will appear on the screen.

Changing the subtitle language



Select "Subtitle Language".
Select the language you want to read, and press ENT to input it.



Select "Others" if you cannot find the language you want to read.
Enter the appropriate 4-digit language code. Select a number, and press ENT to input it.

Language code list (→P. 257)

If a code that is not in the list is entered, Incorrect Code will appear on the screen.

Changing the DVD language



Select "DVD Language".
Select the language you want to read and press ENT to input it.



Select "Others" if you cannot find the language you want to read.
Enter the appropriate 4-digit language code. Select a number, and press ENT to input it.

Language code list (→P. 257)
If a code that is not in the list is entered, Incorrect Code will appear on the screen.

Turning on or off the angle mark

The angle mark can be turned on for discs that are multi-angle compatible.

Each time you press ENT when "Angle Mark" is selected, the angle mark turns on or off alternately.

Setting viewer restriction levels



Setting a password allows the viewer restriction to be effective.

Select "Parental Lock".

Enter the password and press ENT. The setting cannot be changed unless the password is entered.

When you forget the password, initialize the password. (→P. 257)



Select a restriction level (1-8), and press ENT. The smaller the level number, the stricter the age limit.

Setting the display mode



Pressing **SIZE** changes the display modes sequentially as follows:

Normal→Wide 1→Wide 2

■ Returning to the previous screen

Select , and press ENT.

■ To initialize the password

Press ◀ on the remote control or unit ten times when the screen to enter the personal code is displayed.

■ Language code list

Code	Language
1001	Japanese
0514	English
0618	French
0405	German
0920	Italian
0519	Spanish
2608	Chinese
1412	Dutch
1620	Portuguese
1922	Swedish
1821	Russian
1115	Korean
0512	Greek
0101	Afar
0102	Abkhazian
0106	Afrikaans
0113	Amharic
0118	Arabic
0119	Assamese
0125	Aymara
0126	Azerbaijani
0201	Bashkir
0205	Byelorussian

Code	Language
0207	Bulgarian
0208	Bihari
0209	Bislama
0214	Bengali
0215	Tibetan
0218	Breton
0301	Catalan
0315	Corsican
0319	Czech
0325	Welsh
0401	Danish
0426	Bhutani
0515	Esperanto
0520	Estonian
0521	Basque
0601	Persian
0609	Finnish
0610	Fiji
0615	Faroese
0625	Frisian
0701	Irish
0704	Scots-Gaelic
0712	Galician

3-3. Using the rear audio system

Code	Language
0714	Guarani
0721	Gujarati
0801	Hausa
0809	Hindi
0818	Croatian
1821	Hungarian
1825	Armenian
0901	Interlingua
0905	Interlingue
0911	Inupiak
0914	Indonesian
0919	Icelandic
0923	Hebrew
1009	Yiddish
1023	Javanese
1101	Georgian
1111	Kazakh
1112	Greenlandic
1113	Cambodian
1114	Kannada
1119	Kashmiri
1121	Kurdish
1125	Kirghiz
1201	Latin
1214	Lingala
1215	Laothian
1220	Lithuanian
1222	Latvian
1307	Malagasy
1309	Maori

Code	Language
1311	Macedonian
1312	Malayalam
1314	Mongolian
1315	Moldavian
1318	Marathi
1319	Malay
1320	Maltese
1325	Burmese
1401	Nauru
1405	Nepali
1415	Norwegian
1503	Occitan
1513	(Afan) Oromo
1518	Oriya
1601	Punjabi
1612	Polish
1619	Pashto, Pushto
1721	Quechua
1813	Rhaeto-Romance
1814	Kirundi
1815	Romanian
1823	Kinyarwanda
1901	Sanskrit
1904	Sindhi
1907	Sangho
1908	Serbo-Croatian
1909	Sinhalese
1911	Slovak
1912	Slovenian
1913	Samoan

Code	Language
1914	Shona
1915	Somali
1917	Albanian
1918	Serbian
1919	Siswati
1920	Sesotho
1921	Sundanese
1923	Swahili
2001	Tamil
2005	Telugu
2007	Tajik
2008	Thai
2009	Tigrinya
2011	Turkmen
2012	Tagalog

Code	Language
2014	Setswana
2015	Tonga
2018	Turkish
2019	Tsonga
2020	Tatar
2023	Twi
2111	Ukrainian
2118	Urdu
2126	Uzbek
2209	Vietnamese
2215	Volapük
2315	Wolof
2408	Xhosa
2515	Yoruba
2621	Zulu

■ Adjusting the screen



Press  .

Select the brightness, contrast, tone or color, and make adjustments. Press  or ENT to input it.

	- or Red	+ or Green
Brightness	Darkens	Brightens
Contrast	Weakens the contrast	Strengthens the contrast
Tone	Weakens the tone	Strengthens the tone
Color	Strengthens the red color	Strengthens the green color

3-4. Using the interior lights

Interior lights list



- 1 Meter ring light
- 2 Engine switch light
- 3 Front overhead courtesy lights
- 4 Front interior light (→P. 263)
- 5 Front personal lights (→P. 264)
- 6 Rear interior light
- 7 Front door courtesy lighting
- 8 Inside door handle lights (if equipped)
- 9 Scuff lighting (if equipped)
- 10 Footwell lighting (if equipped)

Turning the instrument panel light control knob fully to the left disables the foot well lighting and inside door handle lights.

■ Illuminated entry system

The following lights turn on when any of the doors are unlocked or opened. (The lights remain on for approximately 15 seconds when the doors are unlocked, but the lights turn off immediately if the doors are locked.)

- Footwell lightings
- Engine switch light
- Front interior light (interior light switch is in the DOOR position)
- Rear interior light (interior light switch is in the DOOR position)
- Inside door handle lights
- Scuff lightings

The following lights turn on for approximately 15 seconds when the engine switch is turned to the LOCK position from the ON or ACC position. (The lights turn off immediately if the engine switch is turned to the ACC or ON position.)

- Engine switch light
- Front interior light (interior light switch is in the DOOR position)
- Rear interior light (interior light switch is in the DOOR position)
- Scuff lightings

The following lights turn on when the engine switch is in the ON position. (The lights dim when the shift lever is moved out of the P position. The lights remain on for approximately 15 seconds after turning the engine switch to the LOCK position from the ON or ACC position.)

- Inside door handle lights
- Footwell lightings

The front overhead courtesy light turns on when the engine switch is in the ACC or ON position.

■ To prevent the 12-volt battery from being discharged

If the following lights remain ON when the door is not fully closed and the interior light switch is in the DOOR position, the lights will go off automatically after 20 minutes.

- Engine switch light
- Front interior light
- Rear interior light
- Inside door handle lights
- Scuff lightings
- Footwell lightings

■ Customization that can be configured at Lexus dealer

Setting (e.g. The time elapsed before lights turn off) can be changed. (Customizable features →P. 458)

Interior lights



- 1** Door position ON
- 2** ON
- 3** OFF

► Front (models without an electric moon roof)



► Front (models with an electric moon roof)



► Rear

Personal lights

1 ON/OFF



► Models without an electric moon roof



► Models with an electric moon roof

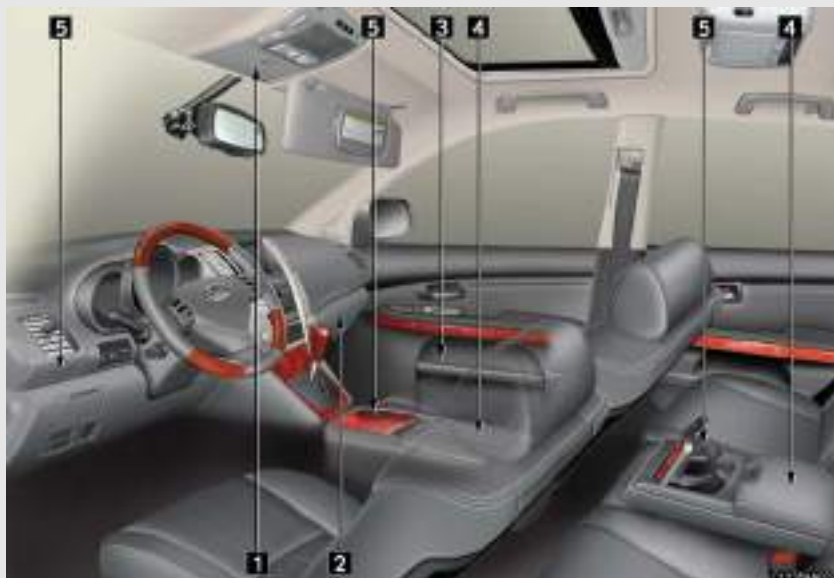

- 1** Overhead console
- 2** Glove box
- 3** Door pocket
- 4** Console boxes
- 5** Cup holders

Glove box



- 1** Unlock with the key
- 2** Lock with the key
- 3** Open (pull lever)

■ Glove box light

The glove box light turns on when the tail lights are turned on.

■ Power back door main switch

The power back door main switch is located in the glove box. (→P. 45)

⚠ CAUTION

■ Caution while driving

Keep the glove box closed.

Injuries may result in the event of an accident or sudden braking.

Console boxes

■ Using the console box

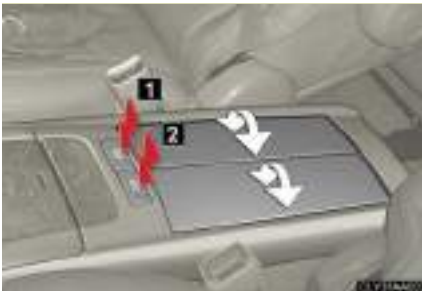

▶ Front

- 1 Open
- 2 Close



▶ Rear (if equipped)

- 1 Pull up the knob to release the lock.
- 2 Lift the armrest to open.

■ Adjusting the position of the console box (front)

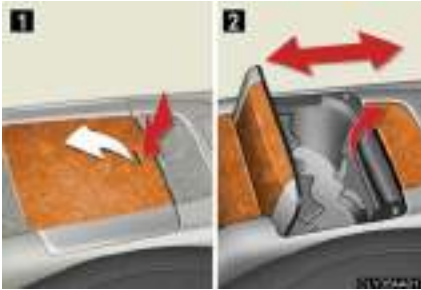

- 1 Open the cup holder lid on the console box.
- 2 Adjust the position of the box while lifting the lock release lever.

■ Removing the adapter tray



Pull up.

■ Console box light (front)

The console box light turn on when the tail lights are turned on.

⚠ CAUTION

■ Console box adjustment precaution

- Do not adjust the position of the console box while the vehicle is moving. This may cause the driver to mishandle the vehicle and may lead to an accident that results in death or serious injury.
- Be careful not to get hands or feet pinched between the front console box and the center panel or rear seat.
- Be careful not to allow the front console box to hit any passengers while adjusting its position.
- After adjusting the console box, make sure it is securely locked in position.

! CAUTION

■ Caution while driving

Keep the console box closed.
Injuries may result in the event of an accident or sudden braking.

Coin holder (if equipped)



- 1** Open the console box lid.
- 2** Push coins down into the holder.

■ Removing the coin holder



Pull up.

Overhead console



The overhead console is useful for temporarily storing sunglasses and similar small items.

⚠ CAUTION

■ Items that should not be left in the overhead console

Do not leave glasses or lighters in the console.

If the interior of the vehicle becomes hot, lighters may explode and glasses may warp or become cracked.

■ Caution while driving

Do not leave the overhead console open while driving.

Items may fall out and cause injury.

■ Maximum storage weight

Do not place any object heavier than 0.22 lb. (100 g) in it.

The console may be opened and cause injury.

Cup holders



► Front (type A)

To open, press in and release the front cup holder.



► Front (type B-1)

To open, press down and release the rear of the cup holder lid.



► Front (type B-2)

To open, press down and release the rear of the cup holder lid.



► Rear

To open, press down the button on the armrest.

■ Cup holder light (front-type B)

The cup holder light turn on when the tail lights are turned on.

■ Removing the separate tray (front-type B-2)



Pull up.

⚠ CAUTION

■ Items unsuitable for the cup holder

Do not place anything other than cups or aluminum cans in the cup holders. Other items may be thrown out of the holders in the event of an accident or sudden braking and cause injury. If possible, cover hot drinks to prevent burns.

■ When not in use

Keep the cup holders closed. Injuries may result in the event of an accident or sudden braking.

Door pockets



The door pocket can be opened and closed.

⚠ CAUTION

■ Caution while driving

Keep the door pockets closed. Injuries may result in the event of an accident or sudden braking.

3-6. Other interior features

Sun visors

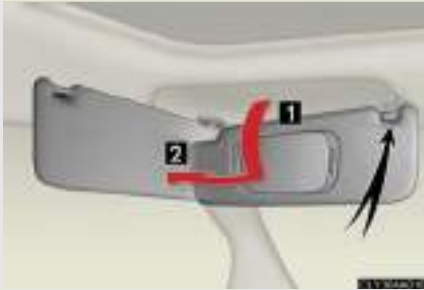

1 Forward position:

Flip down.

2 Side position:

Flip down, unhook, and swing to the side.

At this position, the visors can be slid backward.

3-6. Other interior features

Vanity mirror



1 Open

The light turns on when the cover is opened.

2 Adjust the brightness of the light

3-6. Other interior features

Clock

▶ With navigation system

Owners of models equipped with a navigation system should refer to the "Navigation System Owner's Manual".

▶ Without navigation system



- 1 Adjusts the hour.
- 2 Adjusts the minutes.
- 3 Rounds to the nearest hour.*

*: e.g. 1:00 to 1:29 → 1:00

1:30 to 1:59 → 2:00

■ The clock is displayed when

The engine switch is in the ACC or ON position.

3-6. Other interior features

Outside temperature display

▶ With navigation system

Owners of models equipped with a navigation system should refer to the "Navigation System Owner's Manual".

▶ Without navigation system



1 Displays the outside air temperature

The temperature range that can be displayed is from -22°F (-30°C) to 122°F (50°C).

■ **If the temperature does not appear or it shows**

Have the vehicle inspected by your Lexus dealer.

3-6. Other interior features

Multi-display light control

▶ With navigation system

Owners of models equipped with a navigation system should refer to the "Navigation System Owner's Manual".

▶ Without navigation system



Adjusts the brightness of the light

Push and release the button until the desired brightness is obtained.

3-6. Other interior features

Power outlets

The power outlet can be used for a following component.

12 V: Accessories that run on less than 10 A.

115 VAC: Accessories that use less than 100 W.



- ▶ On center cluster (12 V)



- ▶ Tray under the front console box (12 V)



- ▶ Luggage compartment (12 V)



► Luggage compartment (115 VAC*)

1 Main switch

To use the power outlet, turn on the main switch.

2 Power outlet socket

*: If equipped

■ The power outlet can be used when

► 12 V

The engine switch is in the ACC or ON position.

► 115 VAC

The engine switch is in the ON position.

 NOTICE

■ To avoid damaging the power outlet

Close the power outlet lid when the power outlet is not in use.

Foreign objects or liquids that enter the power outlet may cause a short circuit.

■ To prevent the fuse from being blown

► 12 V

Do not use an accessory that uses more than 12 V 10 A.

► 115 VAC

Do not use a 115 VAC appliance that requires more than 100 W.

If a 115 VAC appliance that consumes more than 100 W is used, the protection circuit will cut the power supply.

 NOTICE**■ To prevent the 12-volt battery from being discharged**

Do not use the power outlet longer than necessary when the hybrid system is off.

■ Appliances that may not operate properly (115 VAC)

The following 115 VAC appliances may not operate properly even if their power consumption is under 100 W.

- Appliances with high initial peak wattage
- Measuring devices that process precise data
- Other appliances that require an extremely stable power supply

3-6. Other interior features

Seat heaters (if equipped)

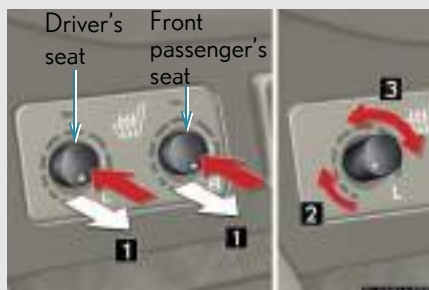

1 Pops the switch out

2 ON

The indicator light comes on.

3 Adjusts the seat temperature

The further you turn the knob clockwise, the warmer the seat becomes.

■ The seat heaters can be used when

The engine switch is in the ON position.

■ When not in use

Turn the knob counterclockwise. The indicator light turns off.

Press the knob into the recessed position.

! CAUTION

■ Burns

● Use caution when seating the following persons in a seat with the seat heater on to avoid the possibility of burns:

- Babies, small children, the elderly, the sick and the disabled
- Persons with sensitive skin
- Persons who are fatigued
- Persons who have taken alcohol or drugs that induce sleep (sleeping drugs, cold remedies, etc.)

● Do not cover the seat with anything when using the seat heater.

Using the seat heater with a blanket or cushion increases the temperature of the seat and may lead to overheating.

 NOTICE**■ To prevent seat heater damage**

Do not put unevenly weighted objects on the seat and do not stick sharp objects (needles, nails, etc.) into the seat.

■ To prevent 12-volt battery discharge

Turn the switches off when the hybrid system is off.

3-6. Other interior features

Armrest

■ Front



Pull the armrest down for use.

■ Rear



Pull the armrest down for use.

NOTICE

■ To prevent damage to the armrest

Do not place too much strain on the armrest.

3-6. Other interior features

Floor mat

Securely place a mat that matches the size of the space on the carpet.

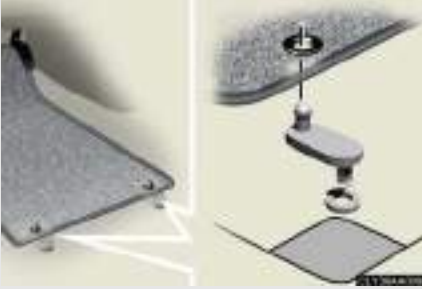

Secure the driver's floor mat using the hooks provided.

CAUTION

■ When inserting the floor mat

Observe the following precautions.

Failure to do so may result in the floor mat slipping and interfering with the movement of the pedals during driving, resulting in an accident.

- Make sure the floor mat is properly placed on the vehicle carpet and the correct side faces upward.
- Do not place floor mats on top of existing mats.

3-6. Other interior features

Luggage compartment features

■ Cargo hooks



Cargo hooks are provided for securing loose items.

■ Auxiliary box

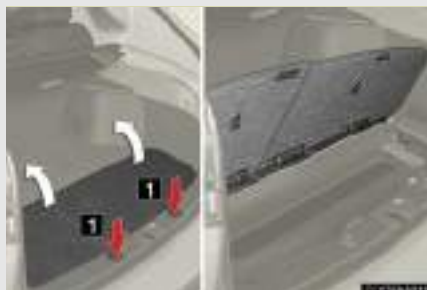

1 To lift the luggage mat up, press down the button.

An auxiliary box is under the luggage mat.

■ Shopping bag hooks



■ Luggage cover

STEP 1

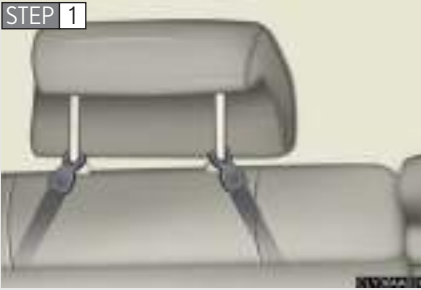

Attach the hooks to the head restraints.

STEP 2



Pull out the luggage cover and hook it onto the anchors.

Removing luggage cover



- 1 Push
- 2 Lift up

After removing the luggage cover, stow it in the auxiliary box or place it somewhere other than the passenger compartment.

Automatic retract function of luggage cover

The knob is in the active position, the luggage cover is retracted automatically when the back door is opened.



- 1 Active position
- 2 Inactive position

CAUTION

■ When the cargo hooks are not in use

To avoid injury, always return the cargo hooks to their positions when they are not in use.

NOTICE

■ Shopping bag hook weight capacity

Do not hang any object heavier than 4 lb. (2 kg) on shopping bag hooks.

3-6. Other interior features

Garage door opener

The garage door opener can be programmed to operate garage doors, gates, entry doors, door locks, home lighting systems, security systems, and other devices.

The garage door opener (HomeLink[®] Universal Transceiver) is manufactured under license from HomeLink[®].

Programming HomeLink[®] (for U.S.A. owners)

The HomeLink[®] compatible transceiver in your vehicle has 3 buttons which can be programmed to operate 3 different devices. Refer to the programming method below appropriate for the device.



- 1 Buttons
- 2 Indicator

■ Programming HomeLink[®]



Point the remote control transmitter for the device 1 to 3 in. (25 to 75 mm) from the HomeLink[®] buttons.

Keep the HomeLink[®] indicator light in view while programming.

STEP 2



Press and hold one of the HomeLink[®] buttons and the transmitter button. When the HomeLink[®] indicator light changes from a slow to a rapid flash, you can release both buttons.

If the HomeLink[®] indicator light comes on but does not flash, flashes rapidly for 2 seconds and remains lit, the HomeLink[®] button is already programmed. Use the other buttons or follow the "Reprogramming a HomeLink[®] button" instructions. (→P. 290)

STEP 3



Test the HomeLink[®] operation by pressing the newly programmed button.

If a HomeLink[®] button has been programmed for a garage door, check to see if the garage door opens and closes. If the garage door does not operate, see if your remote control transmitter is of the rolling code type. Press and hold the programmed HomeLink[®] button. The remote control transmitter is of the rolling code type if the HomeLink[®] indicator light flashes rapidly for 2 seconds and then remains lit. If your transmitter is of the rolling code type, proceed to the heading "Programming a rolling code system".

STEP 4

Repeat the steps above to program another device for each of the remaining HomeLink[®] buttons.

■ Programming a rolling code system

If your device is rolling code equipped, follow the steps under the heading “Programming the HomeLink[®]” before proceeding with the steps listed below.

STEP 1 Locate the training button on the ceiling mounted garage door opener motor. The exact location and color of the button may vary by brand of garage door opener motor.

Refer to the operation manual supplied with the garage door opener for the location of the training button.

STEP 2 Press the training button.

Following this step, you have 30 seconds in which to initiate step 3 below.

STEP 3 Press and hold the vehicle’s programmed HomeLink[®] button for 2 seconds and release it. Repeat this step once again. The garage door may open.

If the garage door opens, the programming process is complete. If the door does not open, press and release the button a third time. This third press and release will complete the programming process by opening the garage door.

The ceiling mounted garage door opener motor should now recognize the HomeLink[®] signal and operate the garage door.

STEP 4 Repeat the steps above to program another rolling code system for any of the remaining HomeLink[®] buttons.

■ Programming an entry gate (for U.S.A. owners)/Programming all devices in the Canadian market

STEP 1 Place your transmitter 1 to 3 in. (25 to 75 mm) away from the surface of the HomeLink[®].

Keep the HomeLink[®] indicator light in view while programming.

STEP 2 Press and hold the selected HomeLink[®] button.

STEP 3 Repeatedly press and release (cycle) the device’s remote control button for two seconds each until step 4 is completed.

STEP 4 When the indicator light on the HomeLink[®] compatible transceiver start to flash rapidly, release the buttons.

STEP 5 Test the operation of the HomeLink[®] by pressing the newly programmed button. Check to see if the gate/device operates correctly.

STEP 6 Repeat the steps above to program another device for each of the remaining HomeLink[®] buttons.

■ Programming other devices

To program other devices such as home security systems, home door locks or lighting, contact your authorized Lexus dealer for assistance.

■ Reprogramming a button

The individual HomeLink[®] buttons cannot be erased but can be reprogrammed. To reprogram a button, follow the “Reprogramming a HomeLink[®] button” instructions.

Operating HomeLink[®]

Press the appropriate HomeLink[®] button. The HomeLink[®] indicator light should come on.

The HomeLink[®] compatible transceiver in your vehicle continues to send a signal for up to 20 seconds as long as the button is pressed.

Reprogramming a HomeLink[®] button

Press and hold the desired HomeLink[®] button. After 20 seconds, the HomeLink[®] indicator light will start flashing slowly. Next, while still pressing and holding the HomeLink[®] button, press and hold the button on the transmitter until the HomeLink[®] indicator light changes from a slow to a rapid flash.

Erasing the entire HomeLink[®] memory (all three programs)



Press and hold the 2 outside buttons for 10 seconds until the indicator light flashes.

If you sell your vehicle, be sure to erase the programs stored in the HomeLink[®] memory.

■ Before programming

- Install a new battery in the remote control transmitter.
- The battery side of the remote control transmitter must be pointed away from the HomeLink[®] button.

■ Certification for the garage door opener

This device complies with Part 15 of the FCC Rules and with RSS-210 of the IC Rules.

Operation is subject to the following two conditions: (1) This device may not cause harmful interference, and (2) this device must accept any interference received, including interference that may cause undesired operation.

WARNING: This transmitter has been tested and complies with FCC and IC rules. Changes or modifications not expressly approved by the party responsible for compliance could void the user's authority to operate the device.

▲ CAUTION

■ When programming a garage door or other remote control devices

The garage door on other devices may operate, so ensure people and objects are out of danger to prevent potential harm.

■ Conforming to federal safety standards

Do not use the HomeLink[®] compatible transceiver with any garage door opener or device that lacks safety stop and reverse features as required by federal safety standards. This includes any garage door that cannot detect an interfering object. A door or device without these features increases the risk of death or serious injury.

3-6. Other interior features

Compass

The compass on the inside rear view mirror indicates the direction in which the vehicle is heading.

■ Operation



- 1 To turn the compass on or off, press the switch.

■ Displays and directions

Display	Direction
N	North
NE	Northeast
E	East
SE	Southeast
S	South
SW	Southwest
W	West
NW	Northwest

Calibrating the compass

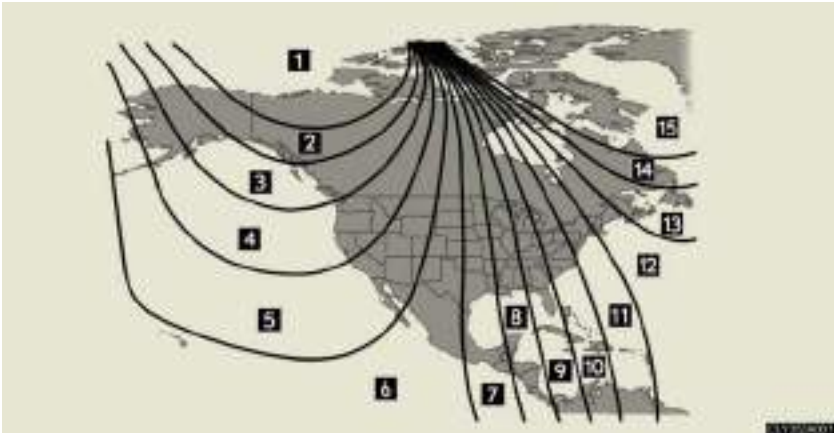

The direction display deviates from the true direction determined by the earth's magnetic field. The amount of deviation varies according to the geographic position of the vehicle.

If you cross over a map boundary shown in illustration, the compass will deviate.

To obtain higher precision or perfect calibration, refer to the following.

■ Deviation calibration

STEP 1 Stop the vehicle where it is safe to drive in a circle.

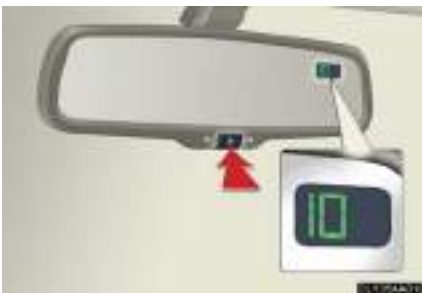

Press and hold the switch for 6 seconds.

A number (1 to 15) appears on the compass display.

STEP 3 Press the switch, and referring to the map above, select the number of the zone where you are.

If the direction is displayed several seconds after adjustment, the calibration is complete.

■ Circling calibration



If C appears on the display, drive the vehicle at 5 mph (8 km/h) or less in a circle until a direction is displayed.

If there is not enough space to drive in a circle, drive around the block until the direction is displayed.

■ Conditions unfavorable to correct operation

The compass may not show the correct direction in the following conditions:

- The vehicle is stopped immediately after turning.
- The vehicle is on an inclined surface.
- The vehicle is in a place where the earth's magnetic field is subject to interference by artificial magnetic fields (underground car park/parking lot, under a steel tower, between buildings, roof car park/parking lot, near an intersection, near a large vehicle, etc.).
- The vehicle has become magnetized.
(There is a magnet or metal object near the inside rear view mirror.)
- The battery has been disconnected.
- A door is open.

 **CAUTION****■ While driving the vehicle**

Do not adjust the display. Be sure to adjust the display only when the vehicle is stopped.

■ When doing the circling calibration

Be sure to secure a wide space, and watch out for people and vehicles in the neighborhood. Do not violate any local traffic rules while performing circling calibration.

 **NOTICE****■ To avoid the compass malfunctions**

Do not place magnets or any metal objects near the inside rear view mirror. Doing this may cause a malfunction of the compass sensor.

■ To ensure normal operation of the compass

- Do not perform circling calibration of the compass in a place where the earth's magnetic field is subject to interference by artificial magnetic fields.
- During calibration, do not operate electric systems (moon roof, power windows, etc.) as they may interfere with the calibration.

4-1. Maintenance and care 298

Cleaning and protecting the vehicle exterior 298

Cleaning and protecting the vehicle interior 301

4-2. Maintenance 304

Maintenance requirements 304

General maintenance 306

Emission inspection and maintenance (I/M) programs 309

4-3. Do-it-yourself maintenance 310

Do-it-yourself service precautions 310

Hood 313

Positioning a floor jack 314

Engine compartment 316

Tires 331

Tire inflation pressure 340

Wheels 344

Air conditioning filter 346

Wireless remote control battery 348

Rear seat entertainment system controller 350

Checking and replacing fuses 352

Headlight aim (vehicles with discharge headlights) 364

Light bulbs 365

Cleaning and protecting the vehicle exterior

Perform the following to protect the vehicle and maintain it in prime condition.

- Working from top to bottom, liberally apply water to the vehicle body, wheel wells and underside of the vehicle to remove any dirt and dust.
Wash the vehicle body using a sponge or soft cloth, such as a chamois.
- For hard-to-remove marks, use car wash soap and rinse thoroughly with water.
- Wipe away any water.
- Wax the vehicle when the waterproof coating deteriorates.

If water does not bead on a clean surface, apply wax when the vehicle body is cool.

■ Automatic car washes

- Before washing the vehicle:
 - Fold the mirrors back.
 - Remove the antenna.
 - Turn the power back door system off.
- Brushes used in automatic car washes may scratch the vehicle surface and harm your vehicle's paint.

■ High pressure car washes

- Do not allow the nozzles of the car wash to come within close proximity of the windows.
- Before car wash, check that the fuel filler door on your vehicle is closed properly.

■ Aluminum wheels

Remove any dirt immediately by using a neutral detergent. Do not use hard brushes or abrasive cleaners. Do not use strong or harsh chemical cleaners. Use the same mild detergent and wax as used on the paint.

■ Bumpers and side moldings

Do not scrub with abrasive cleaners.

■ To prevent deterioration and corrosion

- Wash the vehicle immediately in the following cases:
 - After driving near the sea coast
 - After driving on salted roads
 - If you see coal tar or tree sap on the paint surface
 - If you see dead insects or insect droppings on the paint
 - After driving in an area contaminated with soot, oily smoke, mine dust, iron powder or chemical substances
 - If the vehicle becomes heavily soiled in dust or mud
 - If liquids such as benzene and gasoline are spilled on the paint surface
- If the paint is chipped or scratched, have it repaired immediately.

CAUTION

■ Caution about the exhaust pipe

Exhaust gasses cause the exhaust pipe to become quite hot.

When washing the vehicle, be careful not to touch the pipe until it has cooled sufficiently, as touching a hot exhaust pipe can cause burns.

NOTICE

■ To protect your vehicle's painted surfaces

Do not use organic cleaners such as benzene or gasoline.

■ To protect your vehicle's

Do not splash water on the electric components in the engine compartment. This may cause malfunction of the electric components.

■ If the windshield washer nozzle become blocked

Contact your Lexus dealer. Do not try to clear it with a pin or other object. This may damage the nozzle.

■ Cleaning the exterior lights

● Wash carefully. Do not use organic substances or scrub with a hard brush. This may damage the surfaces of the lights.

● Do not apply wax on the surfaces of the lights. Wax may cause damage to the lenses.

■ When using an automatic car wash (vehicles with the rain-sensing windshield wipers)



Set the wiper switch to the off position. If the wiper switch is in AUTO, the wipers may operate and the wiper blades may be damaged.

■ To prevent damage to the windshield wiper arms

When lifting the wiper arms away from the windshield, pull the driver side wiper arm upward first, and repeat for the passenger side. When returning the wipers to their original position, do so from the passenger side first.

Cleaning and protecting the vehicle interior

The following procedures will help protect your vehicle's interior and keep it in top condition:

■ Protecting the vehicle interior

Remove dirt and dust using a vacuum cleaner. Wipe dirty surfaces with a cloth dampened with lukewarm water.

■ Cleaning the leather areas

- Remove dirt and dust using a vacuum cleaner.
- Wipe any excess dirt and dust with a soft cloth dampened with diluted detergent.

Use a diluted water solution of approximately 5% neutral wool detergent.

- Wring out any excess water from the cloth and thoroughly wipe off all remaining traces of detergent.
- Wipe the surface with a dry, soft cloth to remove any remaining moisture. Allow the leather to dry in shaded and ventilated area.

■ Synthetic leather areas

- Remove loose dirt using a vacuum cleaner.
- Apply a mild soap solution to the synthetic leather using a sponge or soft cloth.
- Allow the solution to soak in for a few minutes. Remove the dirt and wipe off the solution with a clean, damp cloth.

■ Cleaning the inside of the rear window

Do not use glass cleaner to clean the rear window, as this may cause damage to the rear window defogger heater wires or antenna. Use a cloth dampened with lukewarm water to gently wipe the window clean. Wipe the window in strokes running parallel to the heater wires or antenna.

■ Caring for leather areas

Lexus recommends cleaning the interior of the vehicle at least twice a year to maintain the quality of the vehicle's interior.

■ Shampooing the carpets

There are several commercial foaming-type cleaners available. Use a sponge or brush to apply the foam. Rub in overlapping circles. Do not apply water. The excellent results are obtained by keeping the carpet as dry as possible.

■ Seat belts

Clean with mild soap and lukewarm water using a cloth or sponge. Also check the belts periodically for excessive wear, fraying or cuts.

CAUTION

■ Water in the vehicle

- Do not splash or spill liquid in the vehicle, such as on the floor, in the hybrid battery (traction battery) air vents.
Doing so may cause the hybrid battery, electrical components etc. to malfunction or catch fire.
- Do not get any of the SRS components or wiring in the vehicle interior wet.
(→P. 91)
Electrical malfunction may cause the airbags to deploy or not function properly, resulting in death or severe injury.

 NOTICE**■ Cleaning detergents**

Do not use organic substances such as benzene or gasoline, acidic or alkaline solutions, dye, bleach or other detergent. Doing so may discolor the vehicle interior or cause streaks or damage to painted surfaces.

■ Preventing damage to leather surfaces

Observe the following precautions to avoid damage to and deterioration of leather surfaces.

- Remove any dust or dirt on leather surfaces immediately.
- Do not expose the vehicle to direct sunlight for extended periods of time. Park the vehicle in the shade, especially during summer.
- Do not place items made of vinyl, plastic, or that contain wax on the upholstery, as they may stick to the leather surface if the vehicle interior heats up significantly.

■ Water on the floor

Do not wash the vehicle floor with water.

Vehicle systems such as the audio system may be damaged if water comes into contact with electrical components under the floor of the vehicle, and may also cause the body to rust.

■ Cleaning the inside of the rear window

Be careful not to scratch or damage the heater wires or antenna.

4-2. Maintenance

Maintenance requirements

To ensure safe and economical driving, day-to-day care and regular maintenance is essential. It is the owner's responsibility to perform regular checks. Lexus recommends the following maintenance.

■ General maintenance

Should be performed on a daily basis. This can be done by yourself or by a Lexus dealer.

■ Scheduled maintenance

Should be performed at specified intervals according to the maintenance schedule.

For details about maintenance items and schedules, refer to the "Warranty and Services Guide/Owner's Manual Supplement/Scheduled Maintenance".

■ Do-it-yourself maintenance

You can perform some maintenance procedures yourself.

Please be aware that do-it-yourself maintenance may affect warranty coverage.

The use of Lexus Repair Manuals is recommended.

For details about warranty coverage, see the separate "Owner's Guide", "Warranty and Services Guide", "Owner's Manual Supplement" or "Warranty Booklet".

■ Repair and replacement

It is recommended that genuine Lexus parts be used for repair to ensure performance of each system. If non-Lexus parts are used in replacement or if a repair shop other than a Lexus dealer performs repairs, confirm the warranty coverage.

■ Allow inspection and repairs to be performed by a Lexus dealer

- Lexus technicians are well-trained specialists and are kept up to date with the latest service information. They are well informed about the operations of all systems on your vehicle.
- Keep a copy of the repair order. It proves that the maintenance that has been performed is under warranty coverage. If any problem should arise while your vehicle is under warranty, your Lexus dealer will promptly take care of it.

CAUTION

■ Warning in handling of battery

- Engine exhaust, some of its constituents, and a wide variety of automobile components contain or emit chemicals known to the State of California to cause cancer and birth defects and other reproductive harm. Work in a well ventilated area.
- Oils, fuels and fluids contained in vehicles as well as waste produced by component wear contain or emit chemicals known to the State of California to cause cancer and birth defects or other reproductive harm. Avoid exposure and wash any affected area immediately.
- Battery posts, terminals and related accessories contain lead and lead compounds which are known to cause brain damage. Wash your hands after handling. (→P. 327)

4-2. Maintenance

General maintenance

Listed below are the general maintenance items that should be performed at the intervals specified in the “Warranty and Services Guide” or “Owner’s Manual Supplement”. It is recommended that any problem you notice should be brought to the attention of your Lexus dealer or qualified service shop for advice.

Engine compartment

Items	Check points
12-volt battery	Maintenance-free. (→P. 327)
Brake fluid	At the correct level? (→P. 325)
Engine/power control unit coolant	At the correct level? (→P. 323)
Engine oil	At the correct level? (→P. 318)
Exhaust system	No fumes or strange sounds?
Radiator/condenser/hoses	Not blocked with foreign matter? (→P. 325)
Washer fluid	At the correct level? (→P. 329)

Vehicle interior

Items	Check points
Accelerator pedal	<ul style="list-style-type: none"> • Moves smoothly (without uneven pedal effort or catching)?
Transmission "Park" mechanism	<ul style="list-style-type: none"> • Can the vehicle be hold securely on an incline with the shift lever in P?
Brake pedal	<ul style="list-style-type: none"> • Moves smoothly? • Does it have appropriate clearance and correct amount of free play?
Brakes	<ul style="list-style-type: none"> • Not pull to one side when applied? • Loss of brake effectiveness? • Spongy feeling brake pedal? • Pedal almost touches floor?
Head restraints	<ul style="list-style-type: none"> • Move smoothly and lock securely?
Indicators/buzzers	<ul style="list-style-type: none"> • Function properly?
Lights	<ul style="list-style-type: none"> • Do all the lights come on? • Headlights aimed correctly? (→P. 364)
Parking brake	<ul style="list-style-type: none"> • Moves smoothly? • Can hold the vehicle securely on an incline?
Seat belts	<ul style="list-style-type: none"> • Does the seat belt system operate smoothly? • Are the belts undamaged?
Seats	<ul style="list-style-type: none"> • Do the seat controls operate properly?

Items	Check points
Steering wheel	<ul style="list-style-type: none"> • Moves smoothly? • Has correct free play? • No strange noises?

Vehicle exterior

Items	Check points
Door	<ul style="list-style-type: none"> • Operate smoothly?
Engine hood	<ul style="list-style-type: none"> • The lock system works properly?
Fluid leaks	<ul style="list-style-type: none"> • Is there any leakage after parking?
Tire	<ul style="list-style-type: none"> • Inflation pressure is correct? • Tire surfaces not worn or damaged? • Tires rotated according to the maintenance schedule? • Wheel nuts are not loose?

CAUTION

If the hybrid system is running

Turn the hybrid system off and ensure that there is adequate ventilation before performing maintenance checks.

Some states have vehicle emission inspection programs which include OBD (On Board Diagnostics) checks. The OBD system monitors the operation of the emission control system.

■ If the malfunction indicator lamp comes on

The OBD system determines that a problem exists somewhere in the emission control system. Your vehicle may not pass the I/M test and may need to be repaired. Contact your Lexus dealer to service the vehicle.

■ Your vehicle may not pass the I/M test:

- When the 12-volt battery is disconnected or discharged

Readiness codes that are set during ordinary driving are erased. Also, depending on your driving habits, the readiness codes may not be completely set.

- When the fuel tank cap is loose

The malfunction indicator lamp comes on as a temporary malfunction and your vehicle may not pass the I/M test.

■ When the malfunction indicator lamp goes off after several driving trips

The error code in the OBD system will not be cleared unless the vehicle is driven 40 or more times.

■ If your vehicle does not pass the I/M test

Contact your Lexus dealer to prepare the vehicle for re-testing.

4-3. Do-it-yourself maintenance

Do-it-yourself service precautions

If you perform maintenance yourself, be sure to follow the correct procedure given in these sections.

Items	Parts and tools
12-volt battery condition (→P. 327)	<ul style="list-style-type: none">• Grease• Conventional wrench (for terminal clamp bolts)
Brake fluid level (→P. 325)	—
Engine/power control unit coolant level (→P. 323)	<ul style="list-style-type: none">• “Toyota Super Long Life Coolant” or similar high quality ethylene glycol based non-silicate, non-amine, non-nitrite and non-borate coolant with long-life hybrid organic acid technology. For the U.S.A.: “Toyota Super Long Life Coolant” is pre-mixed with 50% coolant and 50% deionized water. For Canada: “Toyota Super Long Life Coolant” is pre-mixed with 55% coolant and 45% deionized water.• Funnel (used only for adding coolant)

Items	Parts and tools
Engine oil level (→P. 318)	<ul style="list-style-type: none"> • “Toyota Genuine Motor Oil” or equivalent • Rag or paper towel, funnel (used only for adding engine oil)
Fuses (→P. 352)	<ul style="list-style-type: none"> • Fuse with same amperage rating as original
Headlight aim (→P. 364)	<ul style="list-style-type: none"> • Phillips-head screwdriver
Radiator and condenser (→P. 325)	—
Tire inflation pressure (→P. 340)	<ul style="list-style-type: none"> • Tire pressure gauge • Compressed air source
Washer fluid (→P. 329)	<ul style="list-style-type: none"> • Water washer fluid containing anti-freeze (for winter use) • Funnel

CAUTION

The engine compartment contains many mechanisms and fluids that may move suddenly, become hot, or become electrically energized. To avoid death or serious injury:

■ When working on the engine compartment

- Keep hands, clothing, and tools away from the moving fan and engine drive belt.
- Be careful not to touch the engine, inverter, radiator, exhaust manifold, etc. right after driving as they may be hot. Oil and other fluids may also be hot.
- Do not leave anything that may burn easily, such as paper or rags, in the engine compartment.
- Do not smoke, cause sparks or expose an open flame to fuel or the battery. Fuel and battery fumes are flammable.
- Be extremely cautious when working on the battery. It contains poisonous and corrosive sulfuric acid.
- Never touch, disassemble, remove or replace the high voltage parts, cables and their connectors. It can cause severe burns or electric shock that may result in death or serious injury.
- When the hybrid system is operating with the READY light on, the engine may suddenly start in some cases. When you inspect the engine compartment, be sure to turn off the hybrid system.

■ When working near the electric cooling fan or radiator grille

Be sure the engine switch is off.

With the engine switch on, the electric cooling fan may automatically start to run if the air conditioning is on and/or the coolant temperature is high. (→P. 325)

■ Safety glasses

Wear safety glasses to prevent flying or falling material, fluid spray, etc. from getting in the eyes.

NOTICE

■ If you remove the air cleaner:

Driving with the air filter removed may cause excessive engine wear due to dirt in the air. Also a backfire could cause a fire in the engine compartment.

4-3. Do-it-yourself maintenance

Hood

Release the lock from the inside of the vehicle to open the hood.

STEP 1



Pull the hood release lever.

The hood will pop up slightly.

STEP 2



Lift the hood catch and lift the hood.

CAUTION

■ Pre-driving check

Check that the hood is fully closed and locked.

If the hood is not locked properly it may open while the vehicle is in motion and cause an accident, which may result in death or serious injury.

4-3. Do-it-yourself maintenance

Positioning a floor jack

When raising your vehicle with a floor jack, position the jack correctly. Improper placement may damage your vehicle or cause injury.

► Front



► Rear (2WD models)



► Rear (AWD models)



⚠ CAUTION

■ When raising your vehicle:

Make sure to observe the following to reduce the possibility of death or serious injury.



- Lift up the vehicle using a floor jack such as the one shown in the illustration.

- Do not use the jack that was supplied with your vehicle.
- Do not put any part of your body or get underneath the vehicle supported only by the floor jack.
Always use automotive jack stands on a solid, level, surface.
- Do not start the hybrid system while the vehicle is supported by the floor jack.
- Stop the vehicle on level firm ground, firmly set the parking brake and put the shift lever in P.
- Make sure to set the floor jack properly at the jack point.
Raising the vehicle with an improperly positioned floor jack will damage the vehicle and may cause the vehicle to fall off the floor jack.
- Do not raise the vehicle while someone is in the vehicle.
- When raising the vehicle, do not place any objects on top of or underneath the floor jack.

4-3. Do-it-yourself maintenance

Engine compartment

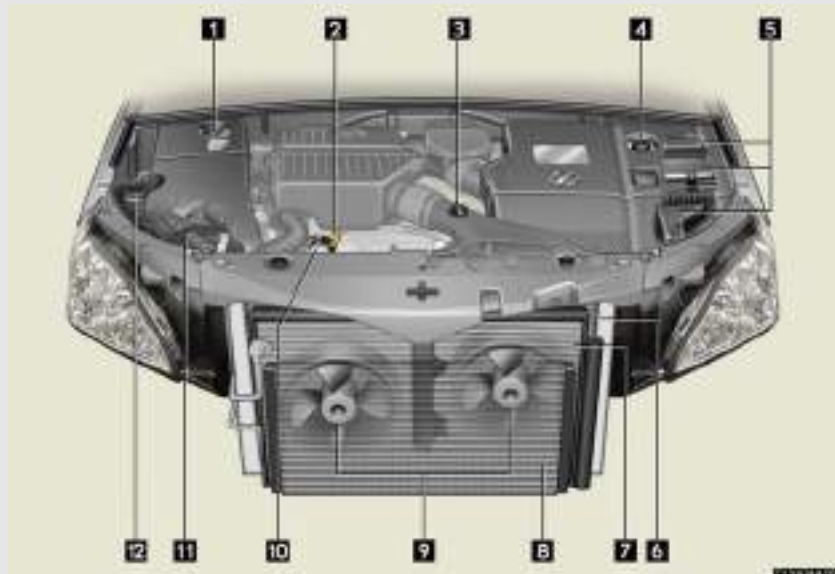

1 Brake fluid reservoir
(→P. 325)

2 Engine oil level dipstick
(→P. 318)

3 Engine oil filler cap
(→P. 318)

4 Power control unit coolant
reservoir (→P. 323)

5 Fuse boxes (→P. 352)

6 Engine coolant radiator
(→P. 325)

7 Condenser (→P. 325)

8 Power control unit coolant
radiator (→P. 325)

9 Electric cooling fans

10 Engine coolant reservoir
(→P. 323)

11 12-volt battery (→P. 327)

12 Washer fluid tank
(→P. 329)

Engine compartment cover

■ Removing the engine compartment left cover

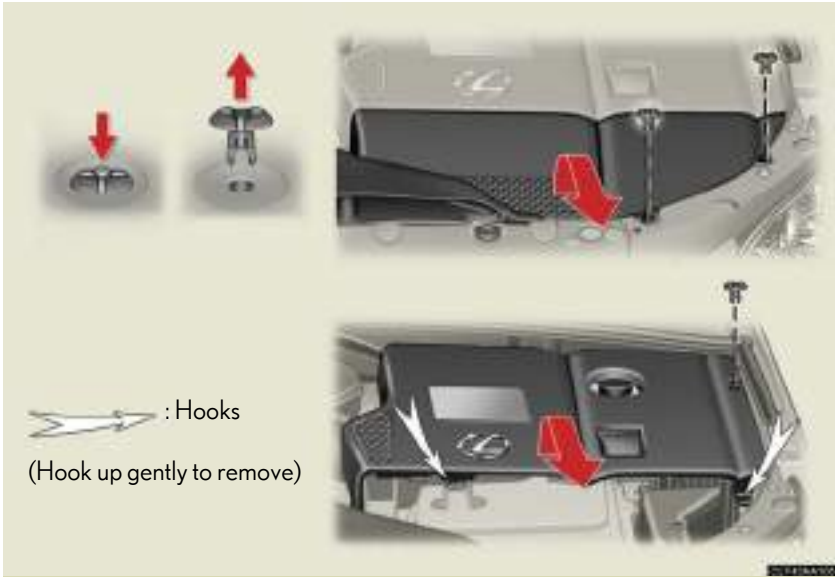

■ Removing the engine compartment right cover



■ Installing the clips

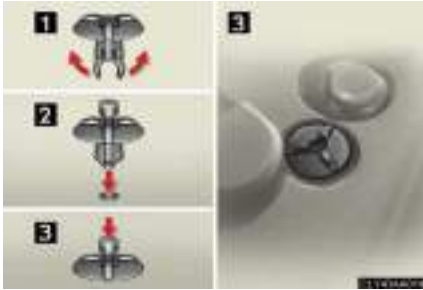

- 1 Open
- 2 Insert
- 3 Press

Engine oil

With the engine at operating temperature and turned off, check the oil level on the dipstick.

■ Checking the engine oil

STEP 1 Park the vehicle on level ground. After turning off the hybrid system, wait more than five minutes for the oil to drain back into the bottom of the engine.

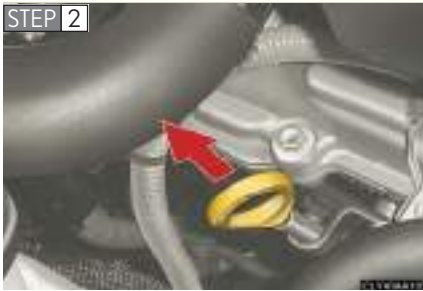

Hold a rag under the end and pull the dipstick out.

STEP 3 Wipe the dipstick clean.

STEP 4 Reinsert the dipstick fully.

STEP 5 Holding a rag under the end, pull the dipstick out and check the oil level.

STEP 6 Wipe the dipstick and reinsert it fully.

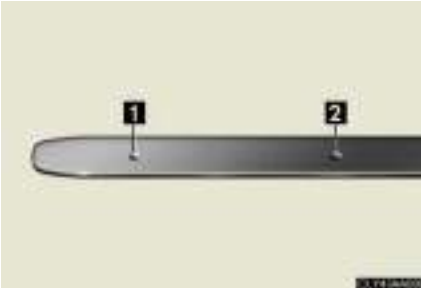

- 1** Low
- 2** Full

■ Adding engine oil



If the oil level is below or near the low level mark, add engine oil of the same type as already in the engine.

Make sure to check the oil type and prepare the items needed before adding oil.

Oil grade	ILSAC multi-grade engine oil
Items	Clean funnel

STEP 1 Remove the oil filler cap.

STEP 2 Add engine oil slowly, checking the dipstick.

STEP 3 Install the filler cap, turning it clockwise.

It takes about 1.6 qt. (1.5 L, 1.3 Imp. qt.) to raise the oil level from low to full on the dipstick.

■ Recommended viscosity

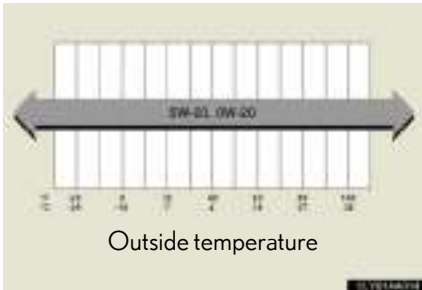

SAE 5W-20 or 0W-20

SAE 5W-20 or 0W-20 engine oil may be used. However, SAE 0W-20 is the best choice for good fuel economy and good starting in cold weather.

■ How to read oil container labels

The ILSAC (International Lubricant Standardization and Approval Committee) Certification Mark is added to some oil containers to help you select the oil you should use.



■ Engine oil consumption

- The amount of engine oil consumed depends on the oil viscosity, the quality of the oil and the way the vehicle is driven.
- More oil is consumed under driving conditions such as high speeds and frequent acceleration and deceleration.
- A new engine consumes more oil.
- When judging the amount of oil consumption, keep in mind that the oil may have become diluted, making it difficult to judge the true level accurately.
- Oil consumption: Max. 1.1 qt./600 miles, 0.9 Imp.qt./600 miles (1.0 L per 1000 km)
- If you consume more than 1.1 qt. (1.0 L, 0.9 Imp.qt.) every 600 miles (1000 km), contact your Lexus dealer.

■ After changing the engine oil (U.S.A. only)

The oil change system should be reset. Perform the following procedures:

- STEP 1** Switch the display to the odometer. (→P. 143)
- STEP 2** Turn the engine switch to the LOCK position.



While pressing the ODO/TRIP button, turn the engine switch to the ON position. A message MAINT REQD RESET MODE will appear on the display. To select the system, hold the button for at least 5 seconds. A message COMPLETE will appear and a beep will sound.

CAUTION

■ Used engine oil

- Used engine oil contains potentially harmful contaminants which may cause skin disorders such as inflammation or skin cancer, so care should be taken to avoid prolonged and repeated contact. To remove used engine oil from your skin, wash thoroughly with soap and water.
- Dispose of used oil and filters only in a safe and acceptable manner. Do not dispose of used oil and filters in household trash, in sewers or onto the ground. Call your Lexus dealer, service station or auto parts store for information concerning recycling or disposal.
- Do not leave used engine oil within the reach of children.

NOTICE

■ To prevent serious engine damage:

Check the oil level on regular basis.

■ When replacing the engine oil

- Be careful not to spill engine oil on the vehicle components.
- Avoid overfilling, or the engine could be damaged.
- Check the oil level on the dipstick every time you refill the vehicle.
- Be sure the engine oil filler cap is properly tightened.

Coolant

The coolant level is satisfactory if it is between the FULL and LOW lines on the reservoir when the hybrid system is cold.

► Engine coolant reservoir



- 1** Reservoir cap
- 2** Full (upper line)
- 3** Low (lower line)

If the level is on or below the LOW line, add coolant up to the FULL line.

► Power control unit coolant reservoir

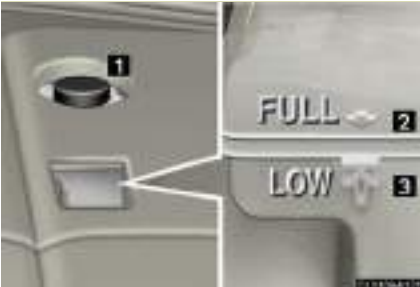

■ If the coolant level drops within a short time after replenishing

Visually check the radiator, hoses, reservoir cap, radiator cap, drain cock and water pump.

If you cannot find a leak, have your Lexus dealer pressure test the cap and check for leaks in the cooling system.

■ Coolant selection

Only use Toyota Super Long Life Coolant or similar high quality ethylene glycol based non-silicate, non-amine, non-nitrite, and non-borate coolant with long-life hybrid organic acid technology.

U.S.A.: Toyota Super Long Life Coolant is a mixture of 50% coolant and 50% deionized water. (Enabled: -31°F [-35°C])

Canada: Toyota Super Long Life Coolant is a mixture of 55% coolant and 45% deionized water. (Enabled: -44°F [-42°C])

For more details about coolant, contact your Lexus dealer.

CAUTION

■ When the coolant may be hot

Do not remove the radiator cap.

The cooling system may be under pressure and may spray hot coolant if the cap is removed, causing burns or other injuries.

NOTICE

■ When adding the coolant

Coolant is neither plain water nor straight antifreeze. The correct mixture of water and antifreeze must be used to provide proper lubrication, corrosion protection and cooling. Be sure to read the antifreeze or coolant label.

■ If you spill coolant

Be sure to wash it off with water to prevent it damaging parts or paint.

Radiator and condenser

Check the radiator and condenser and clear any foreign objects. If either of the above parts are extremely dirty or you are not sure of their condition, have your vehicle checked by your Lexus dealer.

⚠ CAUTION

■ When the engine is hot

Do not touch the radiator or condenser, as they may be hot and you may be burned.

Brake fluid

■ Checking fluid level

The brake fluid level should be between the MAX and MIN lines on the tank.



1 MAX

2 MIN

If the level is low, take your vehicle to a Lexus dealer as soon as possible. Do not drive your vehicle if the red brake system warning light is on. Call a Lexus dealer for assistance.

Make sure to check the fluid type.

■ Brake fluid can absorb moisture from the air

Excess moisture in the fluid can cause a dangerous loss of braking efficiency. Use only newly opened brake fluid.

CAUTION

■ When filling the reservoir

Take care because brake fluid can harm your hands or eyes and damage painted surfaces.

If fluid gets in your eyes, flush your eyes with clean water immediately.

If you still experience discomfort, see a doctor.

NOTICE

■ If the fluid level is low or high

It is normal for the brake fluid level to go down slightly as the brake pads wear or when the fluid level in the accumulator is high.

If the reservoir needs frequent refilling, it may indicate a serious problem.

12-volt battery

Check the 12-volt battery as follows.

12-volt battery exterior

Make sure that the 12-volt battery terminals are not corroded and that there are no loose connections, cracks, or loose clamps.



- 1 Terminals
- 2 Hold-down clamp

Checking the 12-volt battery condition

Check the 12-volt battery condition using the indicator color.

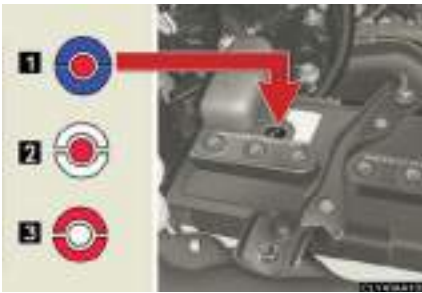

- 1 Blue: Good condition
- 2 White: Charging is necessary. Have the vehicle inspected by your Lexus dealer.
- 3 Red: Not working properly, have the 12-volt battery checked by your Lexus dealer.

Before recharging

When recharging, the 12-volt battery produces hydrogen gas which is flammable and explosive. Therefore, before recharging:

- If recharging with the 12-volt battery installed on the vehicle, be sure to disconnect the ground cable.
- Make sure the power switch on the charger is off when connecting and disconnecting the charger cables to the 12-volt battery.

■ After recharging/reconnecting the 12-volt battery

In some cases, the hybrid system may not start. If this happens, follow the procedure below. (If the system does not start first time, repeat the procedure.)

Turn the hybrid system off. Open and close the driver's door, and turn the hybrid system on.

If the system will not start even after repeating the procedure, contact your Lexus dealer.

CAUTION

■ Chemicals in the 12-volt battery:

The 12-volt battery contains poisonous and corrosive sulfuric acid and may produce hydrogen gas which is flammable and explosive. To reduce the risk of death or serious injury, take the following precautions while working on or near the 12-volt battery:

- Do not cause sparks by touching the 12-volt battery terminals with tools.
- Do not smoke or light a match near the 12-volt battery.
- Avoid contact with eyes, skin and clothes.
- Never inhale or swallow electrolyte.
- Wear protective safety glasses when working near the 12-volt battery.
- Keep children away from the 12-volt battery.

■ Where to safely charge the 12-volt battery

Always charge the 12-volt battery in an open area. Do not charge the 12-volt battery in a garage or closed room where there is not sufficient ventilation.

■ How to recharge the 12-volt battery

Only perform a slow charge (5 A or less). The 12-volt battery may explode if charged at a quicker rate.

■ Emergency measures regarding electrolyte

- If electrolyte gets in your eyes
Flush your eyes with clean water for at least 15 minutes and get immediate medical attention. If possible, continue to apply water with a sponge or cloth while traveling to the nearest medical facility.

! CAUTION**■ Emergency measures regarding electrolyte**

- If electrolyte gets on your skin
Wash the affected area thoroughly. If you feel pain or burning, get medical attention immediately.
- If electrolyte gets on your clothes
It can soak through clothing on to your skin. Immediately take off the clothing and follow the procedure above if necessary.
- If you accidentally swallow electrolyte
Drink a large quantity of water or milk. Follow with milk of magnesia, beaten raw egg or vegetable oil. Get emergency medical attention immediately.

■ When replacing the 12-volt battery

Use a 12-volt battery designed for the RX400h. Failure to do so may cause gas (hydrogen) to enter the passenger compartment, causing a fire or explosion.

For replacement of the 12-volt battery, contact your Lexus dealer.

! NOTICE**■ When recharging the 12-volt battery**

Never recharge the 12-volt battery while the hybrid system is running. Also, be sure all accessories are turned off.

Washer fluid

If any washer does not work or the low washer fluid warning light comes on, the washer tank may be empty. Add washer fluid.

CAUTION

■ When refilling washer fluid

Do not refill washer fluid when the hybrid system is hot or operating, as the washer fluid contains alcohol and may catch fire if spilled on the engine etc.

NOTICE

■ Do not use any fluid other than washer fluid

Do not use soapy water or engine antifreeze instead of washer fluid. Doing so may cause streaking on the vehicle's painted surfaces.

■ Diluting washer fluid

Dilute washer fluid with water as necessary. Refer to the freezing temperatures listed on the washer fluid tank.

4-3. Do-it-yourself maintenance

Tires

Replace or rotate tires in accordance with maintenance schedules and treadwear.

■ Checking tires



- 1 New tread
- 2 Treadwear indicator
- 3 Worn tread

The location of treadwear indicators is shown by the “TWI” or “Δ” marks, etc., molded on the sidewall of each tire.

Check spare tire condition and inflation pressure if not rotated.

■ Tire rotation

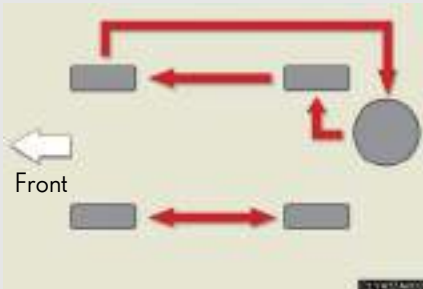

Rotate the tires in the order shown.

To equalize tire wear and extend tire life, Lexus recommends that tire rotation is carried out at the same interval as tire inspection.

■ The tire pressure warning system

Your Lexus is equipped with a tire pressure warning system that uses tire pressure warning valves and transmitters to detect low tire inflation pressure before serious problems arise. (→P. 391, 398)

Installing tire pressure warning valves and transmitters

When replacing tires or wheels, tire pressure warning valves and transmitters must also be installed.

When new tire pressure warning valves and transmitters are installed, new tire pressure warning valve and transmitter ID codes must be registered in the tire pressure warning computer and tire pressure warning system must be initialized. Have tire pressure warning valve and transmitter ID codes registered by your Lexus dealer. (→P. 334)

Initializing the tire pressure warning system

■ **The tire pressure warning system must be initialized in the following circumstances:**

- When changing the tire inflation pressure by changing traveling speed.
- When changing the tire size.

When the tire pressure warning system is initialized, the current tire inflation pressure is set as the pressure benchmark.

■ How to initialize the tire pressure warning system

STEP 1 Park the vehicle in safe place and turn off the hybrid system.

While the vehicle is moving, initialization is not performed.

STEP 2 Adjust the tire inflation pressure to the specified cold tire inflation pressure level. (→P. 439)

Make sure to adjust the tire pressure to the specified cold tire inflation pressure level. The tire pressure warning system will operate based on this pressure level.

STEP 3 Turn the engine switch to the ON position.

STEP 4



Push and hold the tire pressure warning reset switch until the tire pressure warning light blinks slowly three times.

STEP 5 Wait for a few minutes with the engine switch is in the ON position, and then turn the engine switch to the OFF position.

Registering and selecting ID codes

■ Registering ID codes

2 sets of tire pressure warning valve and transmitter ID codes can be registered. Once a second set of tires is registered at “2nd”, you can switch between tire set settings simply by pressing the tire pressure warning select switch.

There are 2 settings:

“MAIN” position: The ID code of the tire pressure warning valve and transmitter on the tires originally installed on the vehicle is registered.

“2nd” position: The ID code is not registered. When you replace a new set of tires, purchase tire pressure warning valves and transmitters from your Lexus dealer and have the new ID code registered by your Lexus dealer.

■ Selecting ID codes

When replacing tires, make sure to select the ID code set that matches the new tire set. If the tire pressure select switch is set to the wrong tire setting, the tire pressure warning system will not operate properly. After driving for about 20 minutes, the tire pressure warning light comes on after blinking for 1 minute to indicate a system malfunction.



1 "MAIN"

2 "2nd"

■ When to replace your vehicle's tires

Tires should be replaced if:

- You have tire damage such as cuts, splits, cracks deep enough to expose the fabric or bulges indicating internal damage.
- A tire goes flat repeatedly or cannot be properly repaired due to the size or location of a cut or other damage.

If you are not sure, consult with your Lexus dealer.

■ Replacing tires and wheels

If the ID code of the tire pressure warning valve and transmitter is not registered, the tire pressure warning system will not work properly. After driving for about 20 minutes, the tire pressure warning light comes on after blinking for 1 minute to indicate a system malfunction.

■ Tire life

Any tire over 6 years old must be checked by a qualified technician even if they have seldom or never been used or damage is not obvious.

■ If the tread wears down below 0.16 in. (4 mm) on snow tires

The effectiveness of snow tires is lost.

■ Maximum load of tire

Check that the maximum load of the replaced tire is greater than 1/2 of the Gross Axle Weight Ratings (GAWR) of either the front axle or the rear axle, whichever is greater.

As for the maximum load of the tire, see the load limit at maximum cold tire inflation pressure mentioned on the sidewall of the tire, and as for the Gross Axle Weight Ratings (GAWR), see the Certification Label. (→P. 340, 445).

■ Tire types

1 Summer tires

Summer tires are high-speed performance tires best suited to highway driving under dry conditions. Since summer tires do not have the same traction performance as snow tires, summer tires are inadequate for driving on snow-covered or icy roads. For driving on snow-covered roads or icy roads, the use of snow tires is recommended. When installing snow tires, be sure to replace all four tires.

2 All season tires

All season tires are designed to provide better traction in snow and to be adequate for driving in most winter conditions, as well as for use year round. All season tires, however, do not have adequate traction performance compared with snow tires in heavy or loose snow. Also, all season tires fall short in acceleration and handling performance compared with summer tires in highway driving.

3 Snow tires

For driving on snow-covered roads or icy roads, we recommend using snow tires. If you need snow tires, select tires of the same size, construction and load capacity as the originally installed tires. Since your vehicle has radial tires as original equipment, make sure your snow tires also have radial construction. Do not install studded tires without first checking local regulations for possible restriction. Snow tires should be installed on all wheels. (→P. 183)

■ Initializing the tire pressure warning system

Initialize the tires with the tire inflation pressure adjusted to the specified level.

■ If you push the tire pressure warning reset switch accidentally

If initialization is performed, adjust the tire inflation pressure to the specified level and initialize the tire pressure warning system again.

■ When the initialization of the tire pressure warning system has failed

Initialization can be completed in a few minutes. However, in the following cases, the settings have not been recorded and the system will not operate properly. If repeated attempts to record tire inflation pressure settings are unsuccessful, have the vehicle inspected by your Lexus dealer.

- When operating the tire pressure warning reset switch, the tire pressure warning light does not flash 3 times.
- After carrying out the initialization procedure, the tire pressure warning light blinks for 1 minute then stays on after driving for about 20 minutes.

■ Routine tire inflation pressure checks

The tire pressure warning system does not replace routine tire inflation pressure checks. Make sure to check tire inflation pressure as part of your routine of daily vehicle checks.

■ Tire pressure warning system certification

► For vehicles sold in the U.S.A.

This device complies with Part 15 of the FCC Rules. Operation is subject to the following two conditions: (1) this device may not cause harmful interference, and (2) this device must accept any interference received, including interference that may cause undesired operation.

NOTICE:

This equipment has been tested and found to comply with the limits for a Class B digital device, pursuant to Part 15 of the FCC Rules. These limits are designed to provide reasonable protection against harmful interference in a residential installation. This equipment generates, uses and can radiate radio frequency energy and, if not installed and used in accordance with the instructions, may cause harmful interference to radio communications. However, there is no guarantee that interference will not occur in a particular installation. If this equipment does cause harmful interference to radio or television reception, which can be determined by turning the equipment off and on, the user is encouraged to try to correct the interference by one or more of the following measures:

- Reorient or relocate the receiving antenna.
- Increase the separation between the equipment and receiver.

- Connect the equipment into an outlet on a circuit different from that to which the receiver is connected.
- Consult the dealer or an experienced radio/TV technician for help.

FCC WARNING:

Changes or modifications not expressly approved by the party responsible for compliance could void the user's authority to operate the equipment.

► For vehicles sold in Canada

Operation is subject to the following two conditions: (1) this device may not cause interference, and (2) this device must accept any interference, including interference that may cause undesired operation of the device.

CAUTION

■ When inspecting or replacing tires

Observe the following precautions to prevent accidents.

Failure to do so may cause damage to parts of the drive train, as well as dangerous handling characteristics, which may lead to fatal or injury accidents.

- Do not mix tires of different makes, models, tread patterns or treadwear.
- Do not use tire sizes other than those recommended by Lexus.
- Do not mix radial, bias-belted, or bias-ply tires.
- Do not mix summer, all season and winter tires.

■ When initializing the tire pressure warning system

Do not push the tire pressure warning reset switch without first adjusting the tire inflation pressure to the specified level. Otherwise, the tire pressure warning light may not come on even if the tire inflation pressure is low, or it may come on when the tire inflation pressure is actually normal.

 NOTICE**■ Repairing or replacing tires, wheels and tire pressure warning valves and transmitter**

When removing or fitting the wheels, tires or the tire pressure warning valve and transmitter, contact your Lexus dealer as the tire pressure warning valve and transmitter may be damaged if not handled correctly.

■ To avoid damaging the tire pressure warning valves and transmitters

Do not use liquid sealants on flat tires.

■ Driving on rough roads

Take particular care when driving on roads with loose surfaces or potholes. These conditions may cause losses in tire inflation pressure, reducing the cushioning ability of the tires. In addition driving on rough roads may cause damage to the tires themselves, as well as the vehicle's wheels and body.

■ If tire inflation pressures become low while driving

Do not continue driving, or your tires and/or wheels may be ruined.

4-3. Do-it-yourself maintenance

Tire inflation pressure

■ Tire inflation pressure

The recommended cold tire inflation pressure and tire size is displayed on the tire and loading information label. (→P. 439)



SEATING CAPACITY			WEIGHTS TO BE MAINTAINED		
DO NOT EXCEED THIS WEIGHT OR THE WEIGHT OF ANY INDIVIDUAL PASSENGER IS TO REMAIN BELOW 120 lb (55 kg).			DO NOT EXCEED THIS WEIGHT OR THE WEIGHT OF ANY INDIVIDUAL PASSENGER IS TO REMAIN BELOW 120 lb (55 kg).		
TYPE	SEAT	LOADING POSITION	FRONT	REAR/SEAT	EXAMPLES
FRONT	SEAT	FRONT	120 lb (55 kg)	120 lb (55 kg)	120 lb (55 kg)
FRONT	SEAT	FRONT	120 lb (55 kg)	120 lb (55 kg)	120 lb (55 kg)
FRONT	SEAT	FRONT	120 lb (55 kg)	120 lb (55 kg)	120 lb (55 kg)

■ Inspection and adjustment procedure



1 Tire valve

2 Tire pressure gauge

STEP 1 Remove the tire valve cap.

STEP 2 Press the tip of the tire pressure gauge onto the tire valve.

STEP 3 Read the pressure using the graduations of the gauge.

STEP 4 If the tire inflation pressure is not within the recommended levels, adjust inflate the tire.
If you add too much air, press the center of the valve to lower.

STEP 5 After completing the tire inflation pressure measurement and adjustment, apply soapy water to the valve and check for leakage.

STEP 6 Reinstall the tire valve cap.

■ Tire inflation pressure check interval

You should check tire inflation pressure every two weeks, or at least once a month. Do not forget to check the spare.

■ Effects of incorrect tire inflation pressure

Driving with incorrect tire inflation pressure may result in the following:

- Reduced fuel efficiency
- Reduced driving comfort and tire life
- Reduced safety
- Damage to the drive train

If a tire needs frequent refilling, have it checked by your Lexus dealer.

■ Instructions for checking tire inflation pressure

When checking tire inflation pressure, observe the following:

- Check only when the tires are cold.

If your vehicle has been parked for at least 3 hours and has not been driven for more than 1 mile or 1.5 km, you will get an accurate cold tire inflation pressure reading.

- Always use a tire pressure gauge.

The appearance of the tire can be misleading. In addition, tire inflation pressures that are even just a few pounds off can degrade ride and handling.

- Do not bleed or reduce tire inflation pressure after driving. It is normal for the tire inflation pressure to be higher after driving.

- Never exceed the vehicle capacity weight.

Passengers and luggage weight should be placed so that the vehicle is balanced.

 **CAUTION****■ Proper inflation is critical to save tire performance**

Keep your tires properly inflated.

Otherwise, the following conditions may occur and result in an accident causing death or serious injury.

- Excessive wear
- Uneven wear
- Poor handling
- Possibility of blowouts resulting from overheated tires
- Poor sealing of the tire bead
- Wheel deformation and/or tire separation
- A greater possibility of tire damage from road hazards

 **NOTICE****■ When inspecting and adjusting tire inflation pressure**

Be sure to reinstall the tire valve caps.

Without the valve caps, dirt or moisture could get into the valve and cause air leakage, which could result in an accident. If the caps have been lost, replace them as soon as possible.

Wheels

If a wheel is bent, cracked or heavily corroded, it should be replaced. Otherwise, the tire may separate from the wheel or cause loss of handling control.

■ Wheel selection

When replacing wheels, care should be taken to ensure that they are equivalent to those removed in load capacity, diameter, rim width, and offset.

Replacement wheels are available at your Lexus dealer.

Lexus does not recommend using:

- Wheels of different sizes or types
- Used wheels
- Bent wheels that have been straightened

■ Aluminum wheel precautions

- Use only Lexus wheel nuts and wrenches designed for use with your aluminum wheels.
- When rotating, repairing or changing your tires, check that the wheel nuts are still tight after driving 1000 miles (1600 km).
- Be careful not to damage the aluminum wheels when using tire chains.
- Use only Lexus genuine balance weights or equivalent and a plastic or rubber hammer when balancing your wheels.

■ When replacing wheels

The wheels of your Lexus are equipped with tire pressure warning valves and transmitters that allow the tire pressure warning system to provide advanced warning in the event of a loss in tire inflation pressure. Whenever wheels are replaced, the tire pressure warning valves and transmitters must be installed. (→P. 332)

 **CAUTION****■ When replacing wheels**

- Do not use wheels that are a different size from those recommended in the Owner's Manual, as this may result in loss of handling control.
- Never use an inner tube in a leaking wheel which is designed for a tubeless tire. Doing so may result in an accident, causing serious injury or death.

 **NOTICE****■ Replacing tire pressure warning valves and transmitters**

- Because tire repair or replacement may affect the tire pressure warning valves and transmitters, make sure to have tires serviced by your Lexus dealer or other qualified service shop. In addition, make sure to purchase your tire pressure warning valves and transmitters at your Lexus dealer.
- Ensure that only genuine Lexus wheels are used on your vehicle. Tire pressure warning valves and transmitters may not work properly with non-genuine wheels.

4-3. Do-it-yourself maintenance

Air conditioning filter

The air conditioning filter must be changed regularly to maintain air conditioning efficiency.

STEP 1 Turn the engine switch to the LOCK position.

STEP 2



Open the glove box.

Remove the 2 pins installed on the upper part of the glove box and lower the glove box.

STEP 3

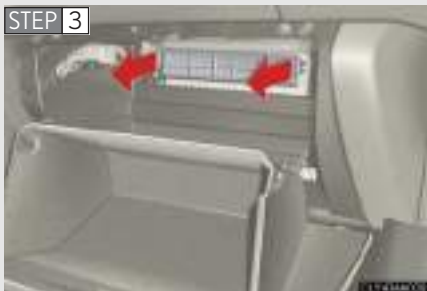

Remove the filter case.

STEP 4

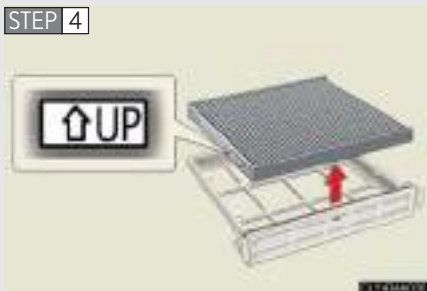

Remove the air conditioning filter from the filter case and replace it with a new one.

The ↑UP marks shown on the filter and the filter case should be pointing up.

■ Changing interval

Inspect and replace the air conditioning filter according to the maintenance schedule. In dusty areas or areas with heavy traffic flow, early replacement may be required. (For scheduled maintenance information, please refer to the “Warranty and Service Guide”, “Owner’s Manual Supplement” or “Scheduled Maintenance”.)

■ If air flow from the vents decreases dramatically

The filter may be clogged. Check the filter and replace if necessary.

 **NOTICE****■ When using the air conditioning system**

Make sure that a filter is always installed.

Using the air conditioning system without a filter may cause damage to the system.

4-3. Do-it-yourself maintenance

Wireless remote control battery

Replace the battery with a new one if it is discharged.

■ You will need the following items:

- Small Phillips-head screwdriver
- Lithium battery (CR2016)

■ Replacing the battery

STEP 1



Remove the screw and cover.

Push the cover in the arrow direction.

STEP 2



Remove the module.

STEP 3



Open the case cover and remove the depleted battery.

Insert a new battery with the + terminal facing up.

■ If the battery is discharged

The following symptoms may occur.

- The wireless remote control will not function properly.
- The operational range is reduced.

■ Use a CR2016 lithium battery

- Batteries can be purchased at your Lexus dealer, jewelers, or camera stores.
- Replace only with the same or equivalent type recommended by a Lexus dealer.
- Dispose of used batteries according to the local laws.

CAUTION

■ Removed battery and other parts

Keep away from children.

These parts are small and if swallowed by a child they can cause choking.

NOTICE

■ For normal operation after replacing the battery

Observe the following precautions to prevent accidents.

- Always work with dry hands.
Moisture may cause the battery to rust.
- Do not touch or move any other components inside the remote control.
- Do not bend either of the battery terminals.

4-3. Do-it-yourself maintenance

Rear seat entertainment system controller

Replace the batteries with new them if they are discharged.

■ Necessary item for replacing:

3 AA batteries

■ Replacing the batteries

STEP 1



Remove the cover.

STEP 2



Remove the depleted batteries and install the new them.

■ If the batteries are discharged

The following symptoms may occur.

- The rear seat entertainment system control will not function properly.
- The operational range is reduced.

■ When using 3 AA batteries

- Batteries can be purchased at your Lexus dealer, electric appliance shop, or camera stores.
- Replace only with the same or equivalent type recommended by a Lexus dealer.
- Dispose of used batteries according to the local laws.

 **CAUTION****■ Removed battery and other parts**

Keep away from children.

These parts are small and if swallowed by a child they can cause choking.

 **NOTICE****■ For normal operation after replacing the battery**

Observe the following precautions to prevent accidents.

- Always work with dry hands.
Moisture may cause the battery to rust.
- Do not touch or move any other components inside the remote control.
- Do not bend either of the battery terminals.

4-3. Do-it-yourself maintenance

Checking and replacing fuses

If any of the electrical components do not operate, a fuse may have blown. If this happens, check and replace the fuses as necessary.

STEP 1 Turn the engine switch to the LOCK position.

STEP 2 Remove the engine compartment cover. (→P. 317)

STEP 3 Open the fuse box cover.

▶ Engine compartment



Push the tabs in and lift the lid off.





► Driver's side instrument panel



Remove the lid.

STEP 4 After a system failure, see “Fuse layout and amperage ratings” (→P. 355) for details about which fuse to check.



STEP 5

Remove the fuse with the pull-out tool.

STEP 6 Check if the fuse has blown.



► Type A

1 Normal fuse

2 Blown fuse

Replace it with one of an appropriate amperage rating. The amperage rating can be found on the fuse box lid.

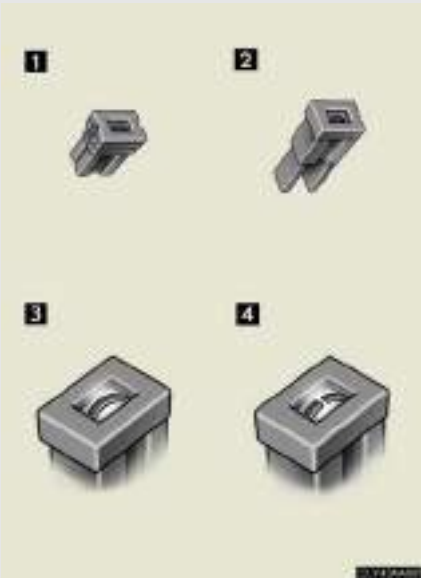

► Type B and C

1 Type B

2 Type C

3 Normal fuse

4 Blown fuse

Replace it with one of an appropriate amperage rating. The amperage rating can be found on the fuse box lid.

Fuse layout and amperage ratings

■ Engine compartment (type A)

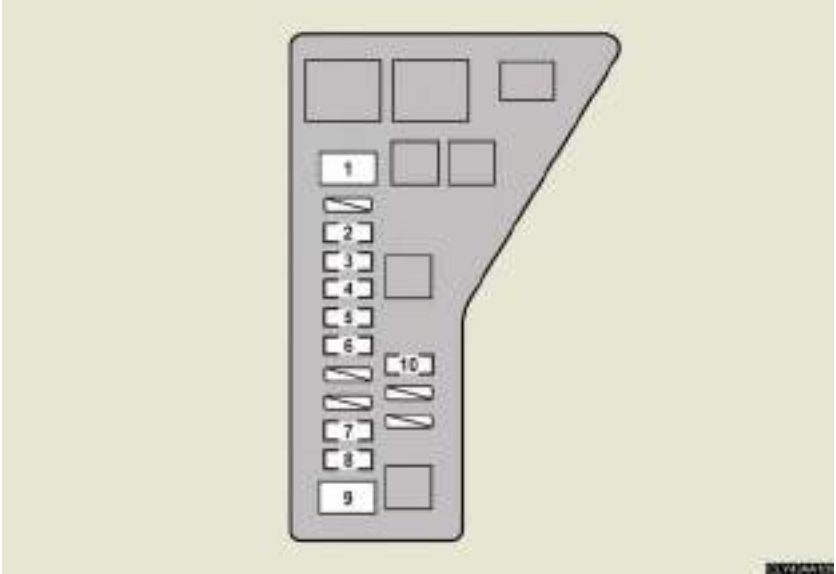

	Fuse	Ampere	Circuit
1	ABS MTR2	30	Electronically controlled brake system
2	ETCS	10	Hybrid system
3	DC/DC-S	10	Hybrid system
4	ABS NO.2	10	Electronically controlled brake system
5	ABS NO.1	10	Electronically controlled brake system
6	BATT FAN	15	Hybrid system
7	ABS NO.3	15	Electronically controlled brake system
8	OIL PUMP	10	Transaxle fluid cooling system
9	ABS MTR1	30	Electronically controlled brake system
10	ST	7.5	Hybrid system

■ Engine compartment (type B)

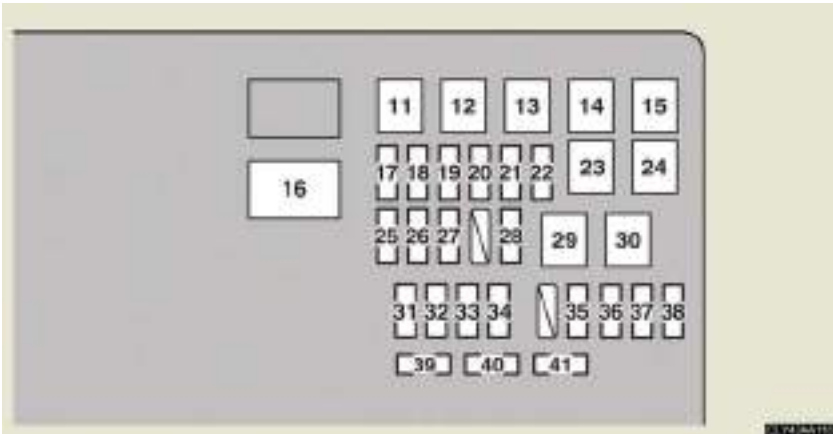

Fuse		Ampere	Circuit
11	HEATER	50	Air conditioning system, "WATER PUMP" fuse
12	IG1	30	"SEAT HTR" fuse
13	H-LP CLN	30	Headlight cleaner
14	RR DEF	40	Rear window defogger
15	RDI FAN No.1	40	Electric cooling fan
16	DC/DC	120	Hybrid system
17	DRL	7.5	Daytime running light system
18	H-LP L LWR	15	Left-hand headlight (low beam)
19	H-LP L UPR	15	Left-hand headlight
20	H-LP R UPR	15	Right-hand headlight (high beam)
21	PER OUTLET NO.2	20	Power outlet (115 VAC)
22	TOWING	30	Trailer lights
23	PBD	30	Power back door

	Fuse	Ampere	Circuit
24	RDI FAN NO.2	40	Electric cooling fan
25	HAZ	15	Turn signal lights, emergency flashers
26	MPX-B1	7.5	Electric power steering system
27	AM2 NO.1	30	"GAUGE NO.2", "IGN", "INJ" and "ST" fuses
28	HORN	10	Horns
29	MAIN	40	"H-LP L LWR", "H-LP L UPR", "H-LP R LWR", "H-LP R UPR" and "DRL" fuses
30	IGCT NO.1	50	"INV W/P", "IGCT NO.2", "IGCT NO.3", "IGCT NO.4" and "IGCT NO.5" fuses
31	RADIO NO.1	15	Audio system
32	ECU-B NO.1	7.5	Theft deterrent system, air conditioning system, gauges and meters, moon roof, multiplex communication system
33	DOME	7.5	Personal lights, interior lights, vanity lights, engine switch light, gauges and meters, navigation system
34	ECU-B NO.2	7.5	Wireless remote control
35	AMP	30	Audio system
36	DOOR NO.1	25	Power door lock system
37	A/F	25	Air/fuel control system
38	CRT	7.5	Navigation system screen, rear seat entertainment system
39	H-LP R LWR	15	Right-hand headlight (low beam)
40	INV W/P	15	Hybrid system

Fuse		Ampere	Circuit
41	IGCT NO.5	10	Hybrid system

■ Engine compartment (type C)

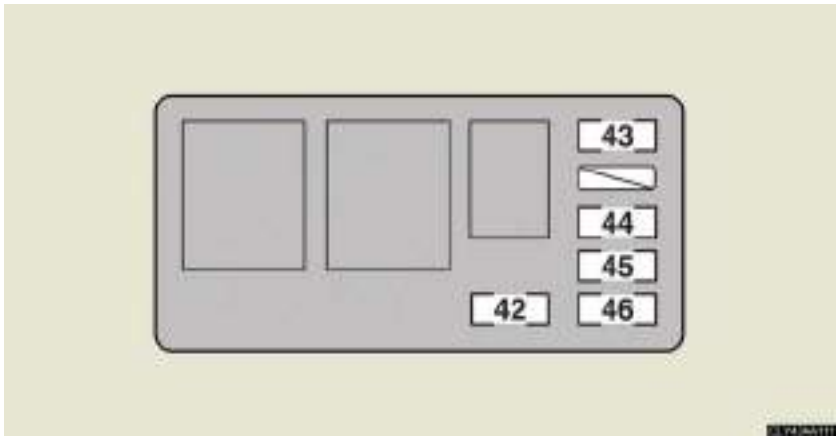

Fuse		Ampere	Circuit
42	WATER PUMP	10	Air conditioning system
43	SEAT HTR	20	Seat heaters
44	IGCT NO.2	10	Hybrid system
45	IGCT NO.3	10	Hybrid system, fuel pump
46	IGCT NO.4	10	Emission control system, transaxle control system, air/fuel control system

Driver's side instrument panel

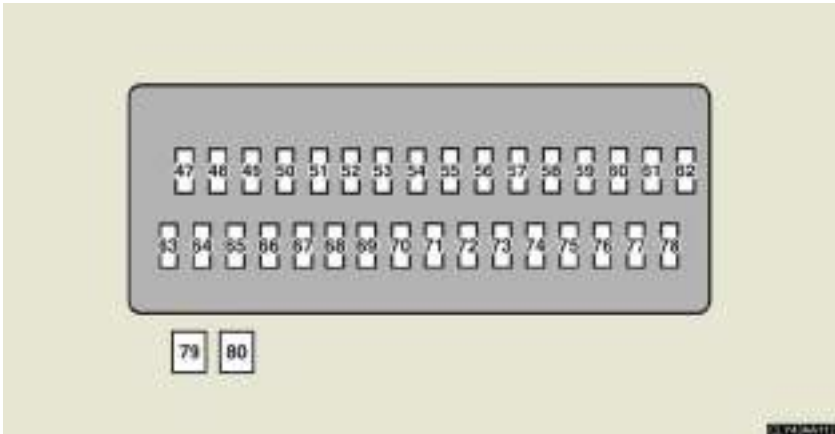

Fuse	Ampere	Circuit
47	20	Rear right side power window
48	20	Rear left side power window
49	7.5	Fuel filler door opener
50	15	Front fog lights
51	7.5	On-board diagnosis system
52	25	Windshield wiper de-icer and all components in "MIR HTR" fuses
53	10	Tail lights, high mounted stoplight, vehicle dynamics integrated management, shift lock control system, multiport fuel injection system/sequential multiport fuel injection system
54	30	Tilt and telescopic steering
55	7.5	Engine immobilizer system
56	7.5	Starter system
57	7.5	No circuit

4-3. Do-it-yourself maintenance

Fuse		Ampere	Circuit
58	AIR SUS	7.5	No circuit
59	DOOR NO.2	25	Multiplex communication system
60	S/ROOF	30	Moon roof
61	TAIL	10	Front fog lights, instrument cluster lights, instrument panel lights, front side marker lights, tail lights, license plate lights, towing converter
62	PANEL	7.5	Glove box light, instrument cluster lights, instrument panel lights, console box light, audio system, power outlet, garage door opener switch, transmission system, headlight cleaner, seat heaters, steering switches, power back door
63	ECU-IG NO.1	7.5	Power rear view mirror control, moon roof, multiplex communication system, shift lock control system, multiplex communication system (power door lock system, wireless remote control system), driving position memory system, vehicle dynamics integrated management, windshield wipers, transmission, seat heaters, power seats, tilt and telescopic steering, power back door
64	ECU-IG NO.2	10	Automatic headlight leveling system, vehicle dynamics integrated management, dynamic laser cruise control, headlight cleaner, adaptive front-lighting system

Fuse		Ampere	Circuit
65	HEATER	7.5	Electric cooling fan, air conditioning system, rear window defogger, engine switch, windshield wiper de-icer
66	WASHER	20	Windshield washer
67	SEAT HTR	20	No circuit
68	GAUGE NO.1	7.5	Instrument cluster lights, instrument panel lights, emergency flashers, seat belt, power outlet, multiport fuel injection system/sequential multiport fuel injection system, back-up lights
69	FR WIP	30	Windshield wipers
70	RR WIP	15	Rear window wiper
71	INJ	20	Multiport fuel injection system/ sequential multiport fuel injection system
72	IGN	10	SRS airbag system, multiport fuel injection system/sequential multiport fuel injection system, front passenger occupant classification system, stop lights, hybrid vehicle immobilizer system
73	GAUGE NO.2	7.5	Gauge and meters
74	ECU-ACC	7.5	Navigation system display, power rear view mirror control, shift lock control system, multiplex communication system
75	CIG	15	Power outlet
76	PWR OUTLET NO.1	15	Power outlet

Fuse		Ampere	Circuit
77	RADIO NO.2	7.5	Instrument cluster lights, instrument panel lights, navigation system, audio system
78	MIR HTR	10	Outside rear view mirror defogger
79	PWR	30	Power window, multiplex communication system (power door lock system, wireless remote control system), outside rear view mirror
80	P/SEAT	30	Power seats

■ After a fuse is replaced

- If the lights do not turn on even after the fuse has been replaced, a bulb may need replacement. (→P. 365)
- If the replaced fuse blows again, have the vehicle inspected by your Lexus dealer.

■ If there is an overload in the circuits

The fuses are designed to blow before the entire wiring harness is damaged.

CAUTION

■ To prevent system breakdowns and vehicle fire

Observe the following precautions.

Failing to do so may cause damage, and possibly a fire or injury.

- Never use a fuse of a higher amperage rating than indicated, or use any other object in place of a fuse.
- Always use a genuine Lexus fuse or equivalent.
Never replace a fuse with a wire, even as a temporary fix.
This can cause extensive damage or even fire.
- Do not modify fuses or the fuse box.

 NOTICE**■ Before replacing fuses**

Have the cause of electrical overload determined and repaired by your Lexus dealer.

4-3. Do-it-yourself maintenance

Headlight aim (vehicles with discharge headlights)

Vertical movement adjusting screw and bolt



1 Adjustment screw

2 Adjustment bolt

Before checking the headlight aim

STEP 1 Make sure the vehicle has a full tank of gas and the area around the headlight is not deformed.

STEP 2 Park the vehicle on level ground.

STEP 3 Sit in the driver's seat.

STEP 4 Bounce the vehicle several times.

Adjusting the headlight aim



Turn the screw in either direction using a Phillips-head screwdriver.

Remember the turning direction and the number of turns in mind.

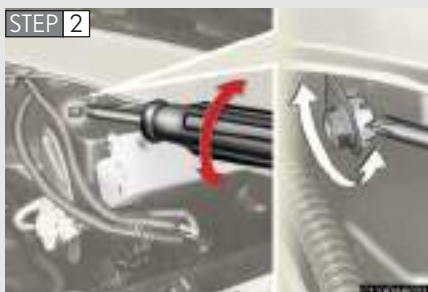

Turn the bolt the same number of turns and in the same direction as step 1 using a Phillips-head screwdriver.

If the error is over the value specified above, take the vehicle to your Lexus dealer to adjust the headlight aim.

4-3. Do-it-yourself maintenance

Light bulbs

You may replace the following bulbs yourself. For more information about replacing other light bulbs, contact your Lexus dealer.

■ Prepare a replacement light bulb.

Check the wattage of the light bulb being replaced. (→P. 441)

■ Remove the engine compartment cover.

→P. 317

■ Turn the power back door main switch OFF.

→P. 45

■ Front bulb locations

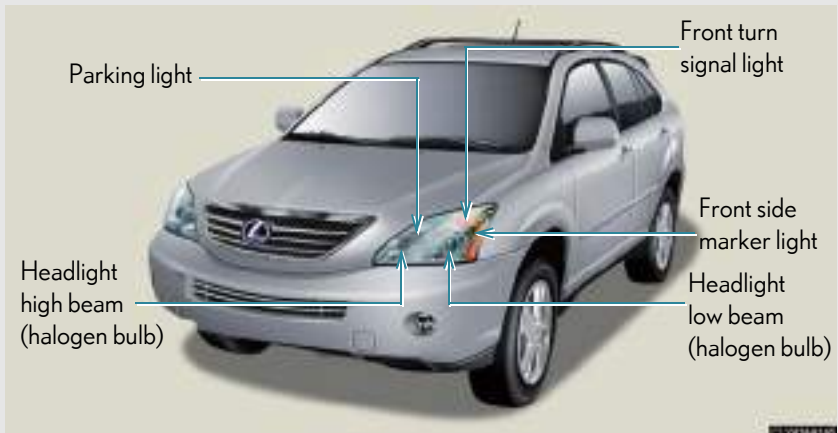

Rear bulb locations

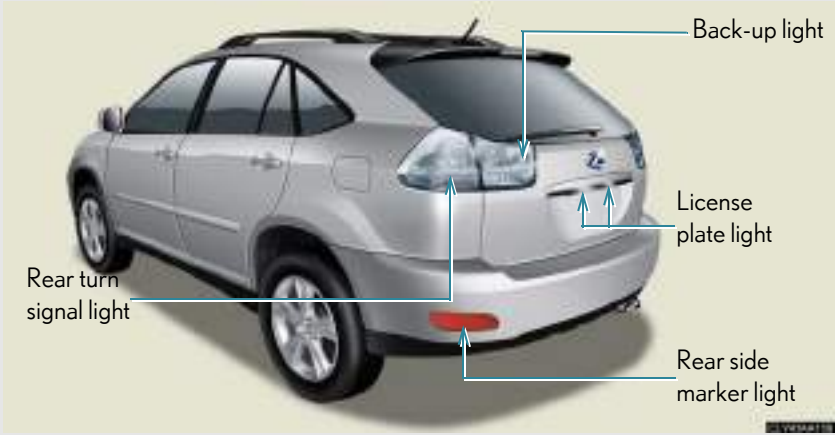

Replacing light bulbs

Headlight high beam (halogen bulb)

STEP 1

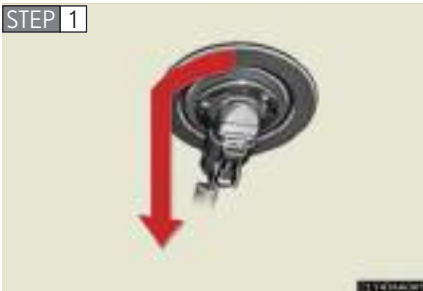

Turn the bulb base counterclockwise.

STEP 2



Unplug the connector while depressing the lock release.

■ Headlight low beam (halogen bulb)

STEP 1

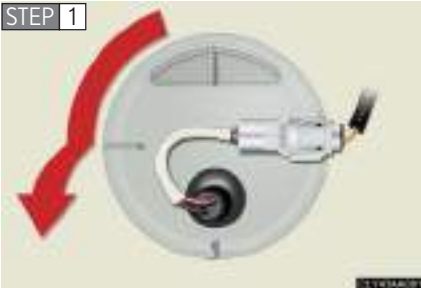

Turn the cover counterclockwise.

STEP 2



Turn the bulb base counterclockwise.

STEP 3



Unplug the connector while depressing the lock release.

■ Front turn signal lights

STEP 1



Turn the bulb base counterclockwise.

STEP 2

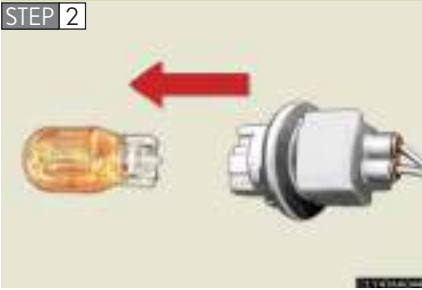

Remove the light bulb.

■ Front side marker lights

STEP 1



Turn the bulb base counterclockwise.

STEP 2

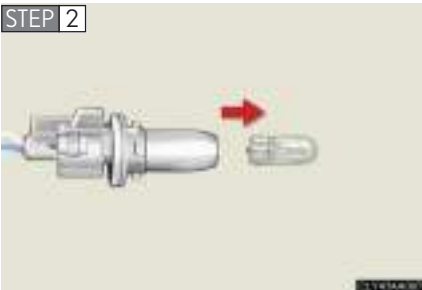

Remove the light bulb.

■ Parking lights

STEP 1



Turn the bulb base counterclockwise.

STEP 2



Remove the light bulb.

Rear side marker lights

STEP 1



Right-hand side only:

Remove the bolts using a Phillips-head screwdriver and remove the clips.

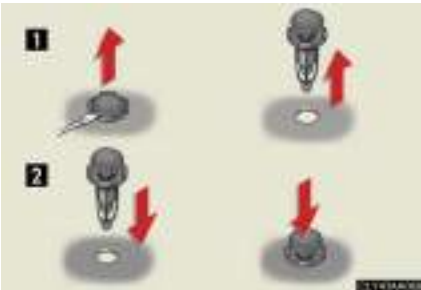

- 1 Removing clip
- 2 Installing clip

STEP 2



Turn the bulb base counterclockwise.

STEP 3

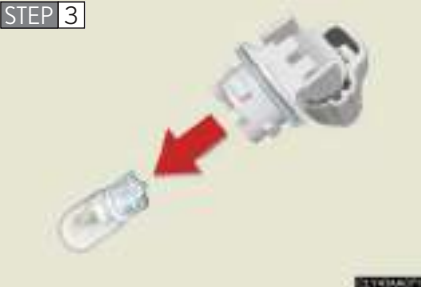

Remove the light bulb.

■ Rear turn signal lights

STEP 1



Remove the access hole cover.

Use a flathead screwdriver which is wrapped with a cloth.

STEP 2



Turn the bulb base counterclockwise.

STEP 3



Remove the light bulb.

■ Back-up lights

STEP 1

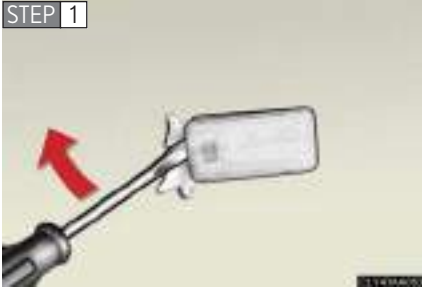

Open the back door and remove the luggage compartment light unit.

STEP 2

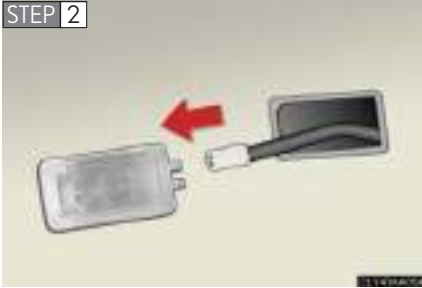

Pull out the connector.

STEP 3

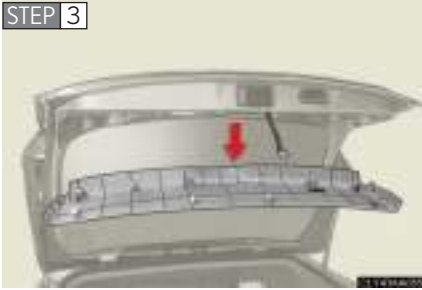

Remove the upper trim board.

STEP 4



Remove the lower trim board.



Turn the bulb base counterclockwise.

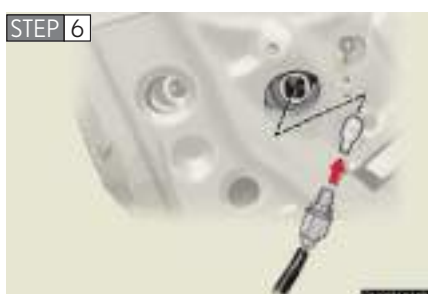

Remove the light bulb.

■ License plate lights

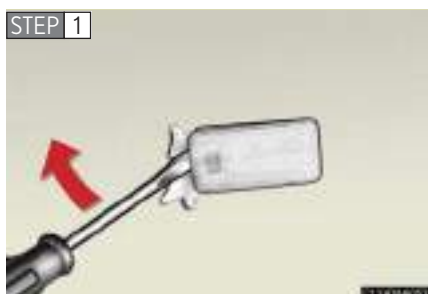

Open the back door and remove the luggage compartment light unit.

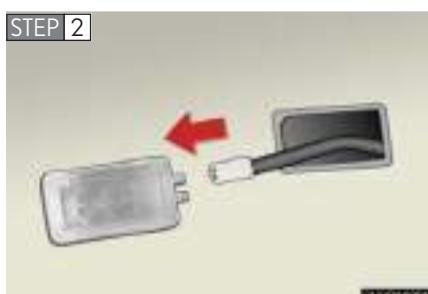

Pull out the connector.

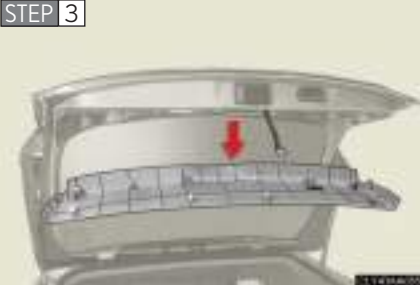
STEP 3

Remove the upper trim board.

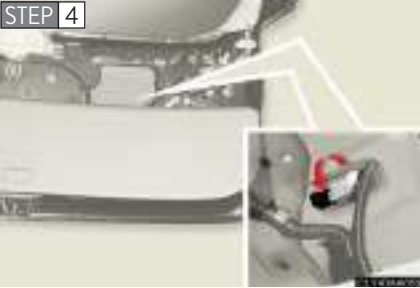
STEP 4

Turn the bulb base counterclockwise.

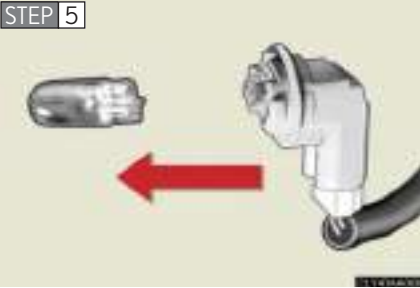
STEP 5

Remove the light bulb.

■ Bulbs other than the above

If any of the bulbs listed below has burnt out, have your Lexus dealer replace it.

- Headlight low beams (discharge bulbs)
- Fog lights
- Stop lights
- Tail lights
- High mounted stoplight

■ Condensation build-up on the inside of the lens

Contact your Lexus dealer for more information in the following situations. Temporary condensation build-up on the inside of the headlight lens does not indicate a malfunction.

- Large drops of water are built up on the inside of the lens.
- Water has built up inside the headlight.

■ Discharge headlights

If voltage to the discharge bulbs is insufficient, the bulbs may not come on, or may go out temporarily. The discharge bulbs will come on when normal power is restored.

■ LED stop lights

The stop lights, tail lights and high mounted stoplight consist of a number of LEDs. If any of the LEDs burn out, take your vehicle to your Lexus dealer to have the light replaced.

If two or more LEDs in a stop light burn out, your vehicle may not conform to local laws (SAE).

 **CAUTION****■ Replacing light bulbs**

- Turn off the headlights. Do not attempt to replace the bulb immediately after turning off the headlights.
The bulbs become very hot and may cause burns.
- Do not touch the glass portion of the light bulb with bare hands. Hold the bulb by the plastic or metal portion.
If the bulb is scratched or dropped it may blow out or crack.
- Fully install light bulbs and any parts used to secure them.
Failing to do so may result in heat damage, fire, or water entering the headlight unit. This may damage the headlights or cause condensation to build up on the lens.
- Do not attempt to take apart or repair the low beam discharge headlight bulbs, connectors, power supply circuits, or related components.
Doing so could result in electric shock and serious injury or death.

■ Discharge headlights

- Contact your Lexus dealer before replacing discharge headlights (including light bulbs).
- Do not touch the high-intensity discharge headlight's high voltage socket when the headlights are turned on.
An extremely high voltage of 20000 V will be discharged and could result in serious injury or death by electric shock.

■ To prevent damage or fire

Make sure bulbs are fully seated and locked.

5-1. Essential information 378

- If your vehicle needs to be towed 378
- If you think something is wrong 385
- Event data recorder 386

5-2. Steps to take in an emergency 388

- If a warning light turns on or a warning buzzer sounds... 388
- If a warning message is displayed..... 398
- If you have a flat tire 408
- If the hybrid system will not start 418
- If the shift lever cannot be shifted from P 419
- If you lose your keys 420
- If the 12-volt battery is discharged 421
- If your vehicle overheats 424
- If the vehicle becomes stuck..... 427

5-1. Essential information

If your vehicle needs to be towed

If towing is necessary, we recommend having your vehicle towed by your Lexus dealer or a commercial towing service, using a lift-type truck or a flat bed truck.

Use a safety chain system for all towing, and abide by all state/provincial and local laws.

If towing from the front, the vehicle's rear wheels and axles must be in good condition. (→P. 382)

If they are damaged, use a towing dolly or flat bed truck.

Before towing

The following may indicate a problem with your transmission. Contact your Lexus dealer before towing.

- The hybrid system is running, but the vehicle will not move.
- The vehicle makes an abnormal sound.

Emergency towing

If a tow truck is not available, in an emergency your vehicle may be temporarily towed using a cable or chain secured to the emergency towing eyelet(s). This should only be attempted on hard, surfaced roads for short distances at low speeds.

A driver must be in the vehicle to steer and operate the brakes. The vehicle's wheels, drive train, axles, steering and brakes must be in good condition.



1 Towing eyelets

■ Emergency towing procedure

STEP 1 Release the parking brake.

STEP 2 Shift the shift lever to N.

STEP 3 Turn the engine switch to the ACC (hybrid system off) or ON (hybrid system on) position.

CAUTION

■ Caution while towing

- Use extreme caution when towing the vehicle.
Avoid sudden starts or erratic driving maneuvers which place excessive stress on the emergency towing eyelets and the cables or chains.
- If the hybrid system is not running, the power assist for the brakes and steering will not function, making steering and braking more difficult.

NOTICE

■ To prevent causing serious damage to the transmission

Never tow this vehicle from the rear with four wheels on the ground.
This may cause serious damage to the transmission.

Installing towing eyelets

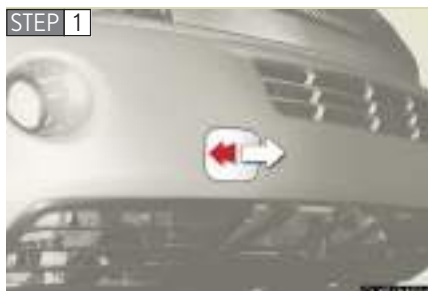

Remove the eyelet cover.



Insert the towing eyelet into the hole and tighten partially by hand.

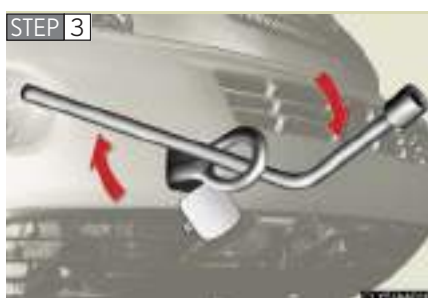

Tighten down the towing eyelet securely using a wheel nut wrench.

■ Location of the emergency towing eyelet

→P. 408

⚠ CAUTION**■ Installing towing eyelets to the vehicle**

Make sure that towing eyelets are installed securely.

If not securely installed, towing eyelets may come loose during towing. This may lead to accidents that cause serious injury or even death.

Towing with a sling-type truck**⚠ NOTICE****■ To prevent body damage**

Do not tow with a sling type truck, either from the front or rear.

Towing with a wheel lift-type truck

- ▶ From the front (2WD models)

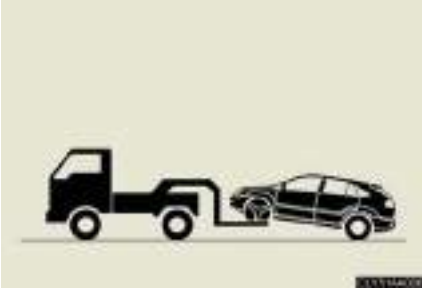

Release the parking brake.

- ▶ From the front (AWD models)

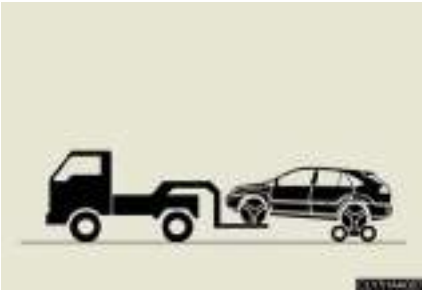

Use a towing dolly under the rear wheel.

NOTICE

■ To prevent damaging the vehicle

When raising the vehicle, ensure adequate ground clearance for towing at the opposite end of the raised vehicle.

Without adequate clearance, the vehicle could be damaged while being towed.

■ To prevent causing serious damage to the transmission (AWD models)

Never tow this vehicle from the front with the rear wheels on the ground.

► From rear

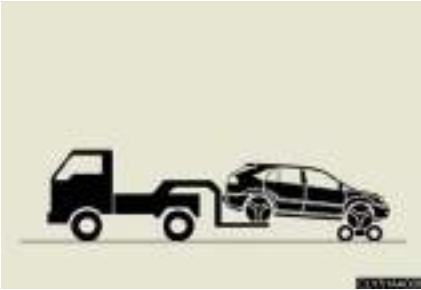

Use a towing dolly under the front wheels.

 NOTICE

■ To prevent causing serious damage to the transmission

Never tow this vehicle from the rear with the front wheels on the ground.

Using a flat bed truck

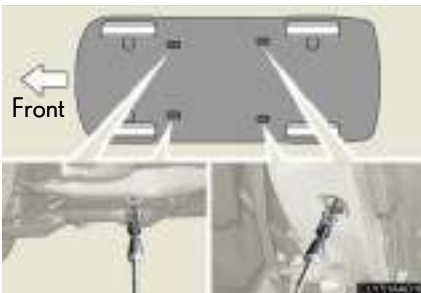

If your Lexus is transported by a flat bed truck, it should be tied down at the locations shown in the illustration.



If you use chains or cables to tie down your vehicle, the angles shaded in black must be 45°.

Do not overly tighten the tie downs or the vehicle may be damaged.

 NOTICE

■ To avoid serious damage to your vehicle



Do not use the rear emergency towing eyelets.

If you think something is wrong

If you notice any of the following symptoms, your vehicle probably needs adjustment or repair. Contact your Lexus dealer as soon as possible.

■ Visible symptoms

- Fluid leaks under the vehicle
(Water dripping from the air conditioning after use is normal.)
- Flat-looking tires or uneven tire wear
- Engine coolant temperature gauge needle continually points higher than normal

■ Audible symptoms

- Changes in exhaust sound
- Excessive tire squeal when cornering
- Strange noises related to the suspension system
- Pinging or other noises related to the hybrid system

■ Operational symptoms

- Engine missing, stumbling or running rough
- Appreciable loss of power
- Vehicle pulls heavily to one side when braking
- Vehicle pulls heavily to one side when driving on a level road
- Loss of brake effectiveness, spongy feeling, pedal almost touches the floor

5-1. Essential information

Event data recorder

Your vehicle has computers that monitor and control certain aspects of your vehicle. These computers assist in driving and maintaining optimal vehicle performance.

Besides storing data useful for troubleshooting, there is an event data recorder (EDR) that records data in a crash or a near car crash event.

In a crash or a near car crash event

The SRS airbag sensor assembly contains the EDR. In a crash or a near car crash event, this device may record some or all of the following information:

- Gasoline engine speed
- Whether the brake pedal was applied or not
- Vehicle speed
- To what extent the accelerator pedal was depressed
- Position of the transmission shift lever
- Whether the driver and front passenger wore seat belts or not
- Driver's seat position
- SRS airbag deployment data
- SRS airbag system diagnostic data
- Front passenger's occupant classification

The information above is intended to be used for the purpose of improving vehicle safety performance. Unlike general data recorders, the EDR does not record sound data such as conversation between passengers.

Disclosure of the data

Lexus will not disclose the data recorded in an EDR to a third party except when:

- An agreement from the vehicle's owner (or the leasing company for a leased vehicle) is obtained
- Officially requested by the police or other authorities
- Used as a defense for Lexus in a law suit
- Ordered by a court law

However, if necessary Lexus will:

- Use the data for research on Lexus vehicle safety performance
- Disclose the data to a third party for research purposes without disclosing details of the vehicle owner, and only when it is deemed necessary
- Disclose summarized data cleared of vehicle identification information to a non-Lexus organization for research purposes





5-2. Steps to take in an emergency

If a warning light turns on or a warning buzzer sounds...

Calmly perform the following actions if any of the warning lights turn on or flash. If a light turns on or flashes, but then turns off, this does not necessarily indicate a malfunction in the system.

Stop the vehicle immediately. Continuing to drive the vehicle may be dangerous.

The following warning indicates a possible problem in the brake system. Immediately stop the vehicle in a safe place and contact your Lexus dealer.

Warning light	Warning light/Details
 (U.S.A.)  (Canada)	Brake system warning light (warning buzzer)* <ul style="list-style-type: none">• Low brake fluid• Malfunction in the electronically controlled brake system This light also comes on when the parking brake is not released. If the light turns off after the parking brake is fully released the system is operating normally.
 (U.S.A.)  (Canada) 	Brake system warning light Indicates a malfunction in the vehicle's brake system.

*: Parking brake engaged warning buzzer:

→P. 402





Stop the vehicle immediately.





The following warnings indicate the possibility of damage to the vehicle that may lead to an accident. Immediately stop the vehicle in a safe place and contact your Lexus dealer.

Warning light	Warning light/Details
	Charging system warning light Indicates a malfunction in the vehicle's charging system.

Have the vehicle inspected by your Lexus dealer immediately.





Failing to investigate the cause of the following warnings may lead to the system operating abnormally and possibly cause an accident. Have the vehicle inspected by your Lexus dealer immediately.



Warning light	Warning light/Details
 (U.S.A.)  (Canada)	Malfunction indicator lamp Indicates a malfunction in: <ul style="list-style-type: none"> • The electronic engine control system or • The electronic throttle control system.
	Hybrid battery warning light Indicates a malfunction in the vehicle's hybrid battery.
	SRS warning light Indicates a malfunction in: <ul style="list-style-type: none"> • The SRS airbag system; • The front passenger occupant classification system; or • The seat belt pretensioner system.

Warning light	Warning light/Details
 (U.S.A.)  (Canada)	<p>ABS warning light</p> <p>Indicates a malfunction in:</p> <ul style="list-style-type: none"> • The ABS; • The brake assist system.
	<p>Brake system warning light</p> <p>Indicates a malfunction in:</p> <ul style="list-style-type: none"> • Electronically controlled brake system; or • Regenerative brake system.
	<p>Electric power steering warning light</p> <p>Malfunction in the EPS.</p>

Follow the correction procedures.

After taking the specified steps to correct the suspected problem, check that the warning light turns off.

Warning light	Warning light/Details	Correction procedure
	Open door warning light (warning buzzer) Indicates that one or more of the doors is not fully closed.	Close the indicated doors.
	Low fuel level warning light Remaining fuel (Approximately 2.6 gal. [9.8L, 2.2 Imp.gal.] or less)	Refuel the vehicle.
	Driver's seat belt reminder light (warning buzzer)*¹ Warns the driver to fasten his/her seat belt.	Fasten the seat belt.
	Front passenger's seat belt reminder light (warning buzzer)*² Warns the front passenger to fasten his/her seat belt.	Fasten the seat belt.

Warning light	Warning light/Details	Correction procedure
	<p>Tire pressure warning light</p>	
	<p>When the light comes on: Low tire inflation pressure.</p>	<p>Adjust the tire inflation pressure.</p>
	<p>When the light comes on after blinking for 1 minute: Malfunction in the tire pressure warning system</p>	<p>Have the system inspected by your Lexus dealer.</p>
	<p>Master warning light A buzzer sounds and the warning light comes on and flashes to indicate that the master warning system has detected a malfunction.</p>	<p>Take appropriate action in accordance with the message displayed on the multi-information display.</p>

***1: Driver's seat belt reminder:**

The driver's seat belt reminder sounds to alert the driver that his or her seat belt is not fastened. Once the engine switch is turned to the ON or START position, the buzzer sounds for 4 to 8 seconds. If the vehicle has reached a speed of at least 12 mph (20 km/h), the buzzer sounds intermittently for 10 seconds. Then, if the seat belt is still unfastened, the buzzer will sound in a different tone for 20 more seconds.

***2: Front passenger's seat belt reminder:**

The front passenger's seat belt reminder sounds to alert the front passenger that his or her seat belt is not fastened. The buzzer sounds intermittently for 10 seconds after the vehicle has reached a speed of at least 12 mph (20 km/h). Then, if the seat belt is still unfastened, the buzzer will sound in a different tone for 20 more seconds.

■ Key reminder buzzer

The buzzer indicates that the key has not been removed from the engine switch (with the engine switch in the ACC or LOCK position and the driver's door opened).

■ If the malfunction indicator lamp comes on while driving

First check the following:

- Is your vehicle low on gas?
If it is, refuel the vehicle immediately.
- Is the fuel tank cap loose?
If it is, tighten it securely.

The lamp will go off after taking several driving trips.

If the light does not go off even after several trips, contact your Lexus dealer as soon as possible.

■ Front passenger detection sensor and passenger seat belt reminder

- If luggage is placed on the front passenger seat, the front passenger detection sensor may cause the warning light to flash, even if a passenger is not sitting in the seat.
- If a cushion is placed on the seat, the sensor may not detect a passenger, and the warning light may not operate properly.

■ Changing the engine oil (U.S.A. only)

Make sure to reset the oil change system. (→P. 321)

■ When the tire pressure warning light comes on

Check the tire inflation pressure and adjust to the appropriate level. Pushing the tire pressure warning reset switch does not turn off the tire pressure warning light.

■ The tire pressure warning light may turn on due to natural causes

The tire pressure warning light may turn on due to natural causes such as natural air leaks or tire inflation pressure changes caused by temperature. In this case, adjusting the tire inflation pressure will turn off the warning light (after a few minutes).

■ When a tire is replaced with a spare tire

The spare tire is also equipped with the tire pressure warning valve and transmitter. The tire pressure warning light will turn on if the tire inflation pressure of the spare tire is low. If a tire goes flat, even though the flat tire is replaced with the spare tire, the tire pressure warning light does not turn off. Replace the spare tire with the repaired tire and adjust the proper tire inflation pressure. The tire pressure warning light will turn off after a few minutes.

■ If the tire pressure warning system is inoperative

The tire pressure warning system will be disabled in the following conditions:

(When the condition becomes normal, the system will work properly.)

- If tires not equipped with tire pressure warning valves and transmitters are used.
- If the ID code on the tire pressure warning valves and transmitters is not registered in the tire pressure warning computer.
- If the tire pressure warning select switch is set to a different tire setting.
- If the tire inflation pressure is 73 psi (500 kPa, 5.1 kgf/cm² or bar) or higher.

The tire pressure warning system may be disabled in the following conditions:

(When the condition becomes normal, the system will work properly.)

- If electronic devices or facilities using similar radio wave frequencies are nearby.
- If a radio set at similar frequencies is in use in the vehicle.
- If a window tint that affects the radio wave signals is installed.
- If there is a lot of snow or ice on the vehicle, in particular around the wheels or wheel housings.
- If non-genuine Lexus wheels are used. (Even if you use Lexus wheels, the tire pressure warning system may not work properly with some types of tires.)
- If tire chains are used.
- If the spare tire is in a location subject to poor radio wave signal reception.
- If a large metallic object which can interfere with signal reception is put in the trunk.

■ If the tire pressure warning light comes on after blinking for 1 minute frequently

If the tire pressure warning light comes on after blinking for 1 minute frequently when the engine switch is turned to ON position, have it checked by your Lexus dealer.

 **CAUTION****■ If the tire pressure warning light comes on**

Be sure to observe the following precautions. Failure to do so could cause loss of vehicle control and result in death or serious injury.

- Stop your vehicle in a safe place as soon as possible. Adjust the tire inflation pressure immediately.
- If the tire pressure warning light comes on even after tire inflation pressure adjustment, it is probable that you have a flat tire. Check the tires. If the tire is flat, change to the spare tire and have the flat tire repaired by the nearest Lexus dealer.
- Avoid abrupt maneuvering and braking. If the vehicle tires deteriorate, you could lose control of the steering wheel or the brakes.

■ If a blowout or sudden air leakage should occur

The tire pressure warning system may not activate immediately.

 **CAUTION**

■ **Maintenance of the tires**

Each tire, including the spare (if provided), should be checked monthly when cold and inflated to the inflation pressure recommended by the vehicle manufacturer on the vehicle placard or tire inflation pressure label (tire and load information label). (If your vehicle has tires of a different size than the size indicated on the vehicle placard or tire inflation pressure label [tire and load information label], you should determine the proper tire inflation pressure for those tires.)

As an added safety feature, your vehicle has been equipped with a tire pressure monitoring system (TPMS-tire pressure warning system) that illuminates a low tire pressure telltale (tire pressure warning light) when one or more of your tires is significantly under-inflated. Accordingly, when the low tire pressure telltale (tire pressure warning light) illuminates, you should stop and check your tires as soon as possible, and inflate them to the proper pressure. Driving on a significantly under-inflated tire causes the tire to overheat and can lead to tire failure. Under-inflation also reduces fuel efficiency and tire tread life, and may affect the vehicle's handling and stopping ability.

Please note that the TPMS (tire pressure warning system) is not a substitute for proper tire maintenance, and it is the driver's responsibility to maintain correct tire pressure, even if under-inflation has not reached the level to trigger illumination of the TPMS low tire pressure telltale (tire pressure warning light).

Your vehicle has also been equipped with a TPMS (tire pressure warning system) malfunction indicator to indicate when the system is not operating properly. The TPMS (tire pressure warning system) malfunction indicator is combined with the low tire pressure telltale (tire pressure warning light). When the system detects a malfunction, the telltale will flash for approximately one minute and then remain continuously illuminated. This sequence will continue upon subsequent vehicle start-ups as long as the malfunction exists. When the malfunction indicator is illuminated, the system may not be able to detect or signal low tire pressure as intended.

TPMS (tire pressure warning system) malfunctions may occur for a variety of reasons, including the installation of replacement or alternate tires or wheels on the vehicle that prevent the TPMS (tire pressure warning system) from functioning properly. Always check the TPMS (tire pressure warning system) malfunction telltale after replacing one or more tires or wheels on your vehicle to ensure that the replacement or alternate tires and wheels allow the TPMS (tire pressure warning system) to continue to function properly.

 NOTICE**■ Precaution when installing a different tire**

When a tire of a different specification or maker is installed, the tire pressure warning system may not operate properly.

5-2. Steps to take in an emergency If a warning message is displayed

If a warning is shown on the multi-information display, stay calm and perform the following actions:



1 Master warning light





The master warning light also comes on or flashes in order to indicate that a message is currently being displayed on the multi-information display.





2 Multi-information display

If any of the warning light turns on again after performing the following actions, contact your Lexus dealer.

Stop the vehicle immediately.



A buzzer sounds and a warning message is shown on the multi-information display. The following warnings indicate the possibility of damage to the vehicle that may lead to an accident. Immediately stop the vehicle in a safe place and contact your Lexus dealer.

Warning message	Details
  (Flashing)	<p>Indicates an abnormal engine oil pressure.</p> <p>The warning light may turn on if the engine oil pressure is too low.</p>
 	<p>Malfunction in the hybrid system.</p>

Warning message	Details
 	<p>Indicates a malfunction in the AWD system.</p>
  (Flashing)	<p>Indicates a hybrid system is over heating.</p>

Have the vehicle inspected by your Lexus dealer immediately.

A buzzer sounds and a warning message is shown on the multi-information display. Failing to investigate the cause of the following warnings may lead to the system operating abnormally and possibly cause an accident. Have the vehicle inspected by your Lexus dealer immediately.

Warning message	Details
 	<p>Malfunction in the automatic headlight leveling system.</p>

Warning message	Details
  (Flashing and then continuously on) 	<p>Indicates a malfunction in the tire pressure warning system. (→P. 332)</p>
  (Flashing) 	<p>Malfunction in the traction control system or VSC system.</p>
  (Flashing) 	<p>Indicates a malfunction in the dynamic laser cruise control system.</p>





Have the vehicle inspected by your Lexus dealer immediately.





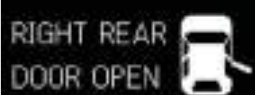

Failing to investigate the cause of the following warning may lead to the system operating abnormally and possibly cause an accident. Have the vehicle inspected by your Lexus dealer immediately.

Warning message	Details
 <p>The image shows a black rectangular display with the text "CHECK VSC SYSTEM" in white capital letters. Below the display is a red triangular warning icon with a white exclamation mark inside.</p>	<p>Indicates a malfunction in the traction control, VSC systems.</p>





Have the malfunction repaired immediately.







A buzzer sounds and a warning message is shown on the multi-information display. After taking the specified steps to correct the suspected problem, check that the warning message turns off.

Warning message	Details	Correction procedure
	<p>Indicates that one or more of the doors is not fully closed.</p> <p>The system also indicates which doors are not fully closed.</p>  flashes and a buzzer sounds to indicate that one or more of the doors is not fully closed (with the vehicle having reached a speed of 3 mph [5 km/h]).	<p>Make sure that all of the doors are closed.</p>
		
		
		
		

Warning message	Details	Correction procedure
  (Flashing)	Indicates that the moon roof is not fully closed (with the engine switch LOCK and the driver's door opened).	Close the moon roof.
  (Flashing)	Indicates that the parking brake is still engaged (with the vehicle having reached a speed of more than 3 mph [5 km/h]).	Release the parking brake.
 	Indicates that the washer fluid level is low.	Add washer fluid.

5-2. Steps to take in an emergency

Warning message	Details	Correction procedure
  (U.S.A. only)	<p>Indicates that the engine oil is scheduled to be changed.</p> <p>Comes on approximately 4500 miles (7200 km) after the engine oil is changed. (The indicator will not work properly unless the oil maintenance data has been reset.)</p>	<p>Check the engine oil, and change if necessary.</p>
  (U.S.A. only)	<p>Indicates that the engine oil should be changed.</p> <p>Comes on approximately 5000 miles (8000 km) after the engine oil is changed (and the oil maintenance data has been reset).</p>	<p>Check and change the engine oil.</p>

Warning message	Details	Correction procedure
 <p>LOW TIRE</p>  	<p>Indicates low tire pressure.</p>	<p>Check the tire inflation pressure, and adjust to the appropriate level.</p>
 <p>CLEAN RADAR SENSER</p> <p>(If equipped, flashing and then continuously on)</p>  <p>CRUISE (Flashing)</p> 	<p>Indicates that the radar cruise control sensor is dirty or covered with ice.</p>	<p>Clean the sensor.</p>

5-2. Steps to take in an emergency

Warning message	Details	Correction procedure
 <p>(If equipped, flashing and then continuously on)</p>  (Flashing) 	<p>Indicates that the radar cruise control system is unable to judge vehicle-to-vehicle distance.</p>	<p>If the windshield wipers are on, turn them off or set them to either the intermittent or the slow mode.</p>
 <p>(If equipped, flashing)</p>	<p>Indicates that your vehicle is nearing the vehicle ahead (in laser cruise mode).</p>	<p>Slow the vehicle by applying the brakes.</p>
  (Flashing)	<p>Indicates that the driver's door has been opened (with the shift lever out of in P, ignition on).</p>	<p>Shift the lever to P.</p>
  (Flashing)	<p>Indicates that the starting the hybrid system (with the shift lever out of in P).</p>	<p>Shift the lever to P and turn the ignition to START again.</p>

■ Changing the engine oil (U.S.A. only)

Make sure to reset the oil change system. (→P. 321)

■ Warning light display in radar cruise mode

In the following cases, the warning light may not be displayed even if vehicle-to-vehicle distance closes.

- When your vehicle and the vehicle ahead are traveling at the same speed or the vehicle ahead is traveling more quickly than your vehicle
- When the vehicle ahead is traveling at a very low speed
- Immediately after cruise control speed is set
- At the instant the accelerator pedal is depressed

Have the malfunction repaired immediately.

After taking the specified steps to correct the suspected problem, check that the warning light turns off.

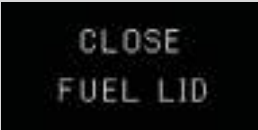
Warning message	Details	Correction procedure
 <p>(Comes on for 8 seconds.)</p>	<p>Indicates that the fuel door left open after refueling when start the vehicle/ leave the fuel door open for more than 30 minutes during refueling.</p>	<p>Close the fuel lid.</p>

5-2. Steps to take in an emergency If you have a flat tire

Remove the flat tire and replace it with the spare provided.

■ Before jacking up the vehicle

- Stop the vehicle on a hard, flat surface.
- Set the parking brake.
- Shift the shift lever to P.
- Stop the hybrid system.
- Turn on the emergency flashers.

■ Location of the spare tire, jack and tools

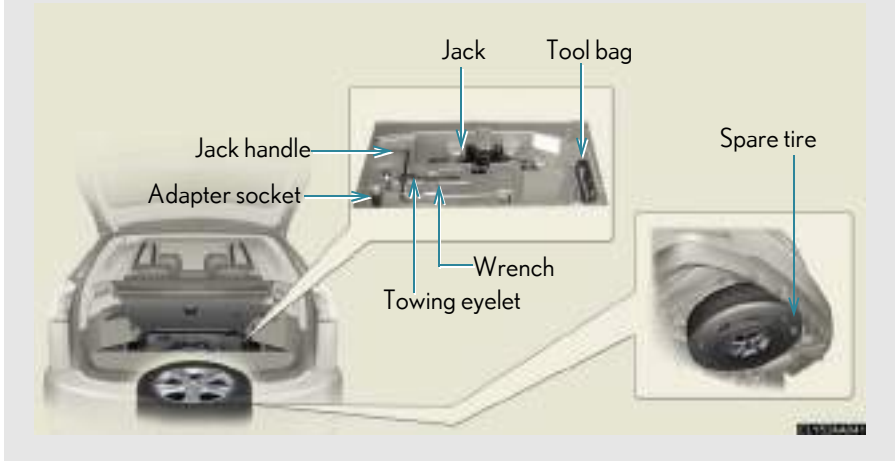

Taking out the jack and tools

STEP 1

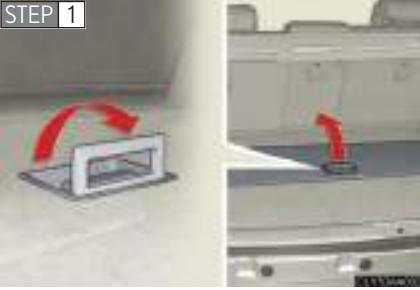

Pull up the front deck board.

STEP 2

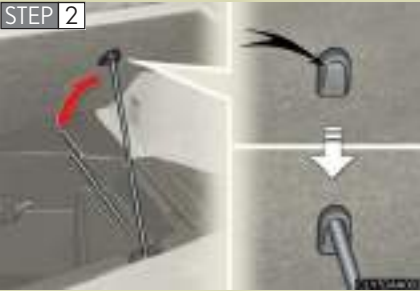

Hold the front deck board with the supporting rod.

When closing the board, return the supporting rod to its stored position.

STEP 3



- 1 Unhook
- 2 Loosen
- 3 Tighten

Taking out the spare tire



Remove the inside spare tire cover.

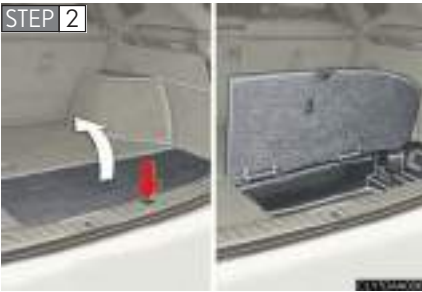

Open the right side auxiliary box.

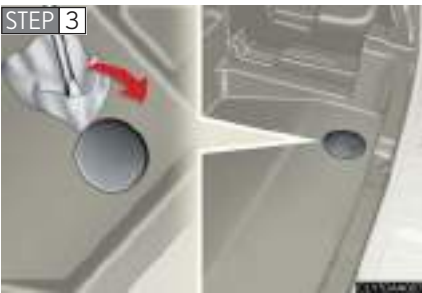

Remove the cover.

To protect the auxiliary box, place a rag between the screwdriver and the auxiliary box, as shown in the illustration.



Attach the adapter socket (for removing a spare tire).



Connect the jack handle and the adapter socket. Turn the jack handle.

The tire will lower completely to the ground.



Pull out the spare tire and stand it up against the bumper.

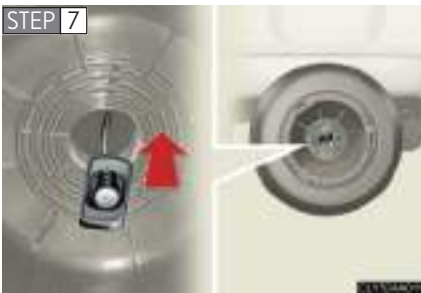

Remove the holding bracket.

Replacing a flat tire

STEP 1



Check the tires.

Flat tire		Wheel chock positions
Front	Left-hand side	Behind the rear right-hand side tire
	Right-hand side	Behind the rear left-hand side tire
Rear	Left-hand side	In front of the front right-hand side tire
	Right-hand side	In front of the front left-hand side tire

STEP 2

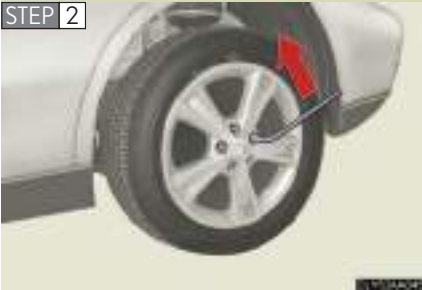

Slightly loosen the wheel nuts (one turn).

STEP 3



Turn the tire jack portion "A" by hand until the notch of the jack is in contact with the jack point.

STEP 4



Raise the vehicle until the tire is slightly raised off the ground.

STEP 5



Remove all the wheel nuts and the tire.

When resting the tire on the ground, place the tire so that the wheel design faces up to avoid scratching the wheel surface.

Installing the spare tire

STEP 1



Remove any dirt or foreign matter from the wheel contact surface.

If foreign matter is on the wheel contact surface, the wheel nuts may loosen while the vehicle is in motion, and the tire may come off the vehicle.

STEP 2

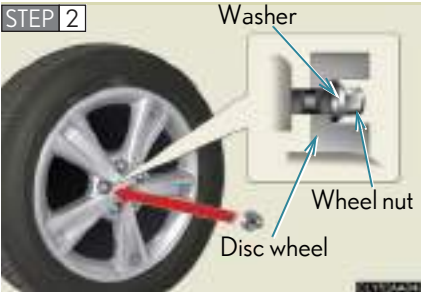

Install the spare tire and loosely tighten each nut by hand to approximately the same amount.

Tighten the wheel nuts until the tapered portion comes into loose contact with the disc wheel sheet.

STEP 3



Lower the vehicle.

STEP 4

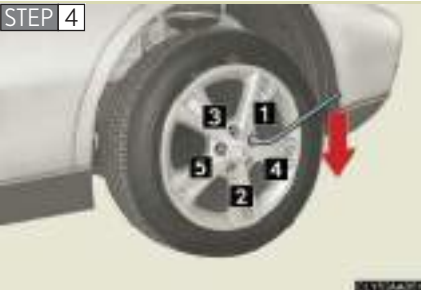

Firmly tighten each nut two or three times in the order shown in the illustration.

Tightening torque:

76 ft•lbf (103 N•m, 10.5 kgf•m)

Stowing the flat tire, jack and all tools

STEP 1 Install the inside spare tire cover on the outer side of the spare tire cover.



STEP 2 Put the flat tire in the spare tire cover with the outer side facing up and install the holding bracket.

STEP 3 Turn the spare tire clamp bolt clockwise with a jack handle and adapter socket until you hear a click.

STEP 4 Stow all the tools and jack securely.

■ After completing the tire change

The tire pressure warning system must be reset. (→P. 332)

 **CAUTION**

■ **Using the tire jack**

Improper use of the tire jack may lead to death or injuries due to the vehicle suddenly falling off the jack.

- Do not use the tire jack for any purpose other than replacing tires or installing and removing tire chains.
- Only use the tire jack that comes with this vehicle for replacing a flat tire. Do not use it on other vehicles, and do not use other tire jacks for replacing tires on this vehicle.
- Always check that the tire jack is securely set to the jack point.
- Do not put any part of your body under the vehicle supported by a jack.
- Do not start or run the engine while your vehicle is supported by the jack.
- Do not raise the vehicle while someone is in it.
- When raising the vehicle, do not put an object on or under the jack.
- Do not raise the vehicle to a height greater than that required to replace the tire.
- Use a jack stand if it is necessary to get under the vehicle.

Take particular care when lowering the vehicle to ensure that no one working on or near the vehicle may be injured.

■ **Replacing a flat tire**

Observe the following precautions to reduce the risk of death or serious injury:

- Never use oil or grease on the wheel bolts or wheel nuts.
The oil or grease can cause the wheel nuts to loosen, causing a serious accident. Remove any oil or grease on the wheel bolts or wheel nuts.
- Have the wheel nuts tightened with a torque wrench to 76 ft•lbf (103 N•m, 10.5 kgf•m) as soon as possible after changing wheels.
Failure to follow these precautions could cause the nuts to loosen and the wheels may fall off, which could lead to an accident causing death or serious injury.

 NOTICE**■ Do not drive the vehicle with a flat tire.**

Do not continue driving with a flat tire.

Driving even a short distance with a flat tire can damage the tire and the wheel beyond repair.

■ When replacing the tires

When removing or fitting the wheels, tires or the tire pressure warning valve and transmitter, contact your Lexus dealer as the tire pressure warning valve and transmitter may be damaged if not handled correctly.

■ To avoid damaging the tire pressure warning valves and transmitters

Do not use liquid sealants on flat tires.

■ When stowing the flat tire

- Ensure that there is no object caught between the tire and the vehicle underbody.
- Tighten the spare tire clamp bolt to hold the spare wheel carrier by the hook securely.

5-2. Steps to take in an emergency

If the hybrid system will not start

If the hybrid system will not start, even though correct starting procedures are being followed (→P. 131), consider each of the following points.

■ **The hybrid system will not start even when the starter motor operates normally.**

One of the following may be the cause of the problem.

- There may not be sufficient fuel in the vehicle's tank.

Refuel your vehicle.

- The hybrid system may be flooded.

Try to restart the hybrid system once more following correct starting procedures. (→P. 131)

- There may be a malfunction in the hybrid vehicle immobilizer system. (→P. 83)

■ **The interior lights and headlights are dim, or the horn does not sound or sounds at a low volume.**

One of the following may be the cause of the problem.

- The 12-volt battery may be discharged. (→P. 421)

- The 12-volt battery terminal connections may be loose or corroded.

■ **The interior lights and headlights do not turn on, or the horn does not sound.**

One of the following may be the cause of the problem.

- One or both of the 12-volt battery terminals may be disconnected.

- The 12-volt battery may be discharged. (→P. 421)

Contact your Lexus dealer if the problem cannot be repaired, or if repair procedures are unknown.

5-2. Steps to take in an emergency

If the shift lever cannot be shifted from P

If the shift lever cannot be shifted with your foot on the brake, there may be a problem with the shift lock system (a system to prevent accidental operation of the shift lever). Have the vehicle inspected by your Lexus dealer immediately.

The following steps may be used as an emergency measure to ensure that the shift lever can be shifted.

STEP 1 Set the parking brake.

STEP 2 Turn the engine switch to the ON position.

STEP 3 Depress the brake pedal.

STEP 4

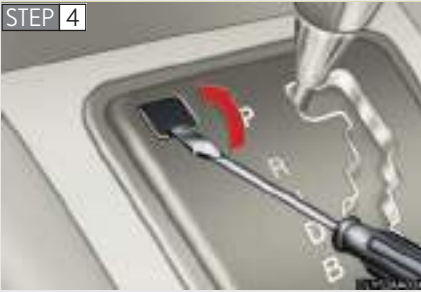

Pry the cover up with a flathead screwdriver or equivalent.

STEP 5



Press the shift lock override button.

The shift lever can be shifted while the button is pressed.

5-2. Steps to take in an emergency

If you lose your keys

New genuine Lexus keys can be made by your Lexus dealer using one of the other master keys and the key number stamped on your key number plate.

5-2. Steps to take in an emergency If the 12-volt battery is discharged

The following procedures may be used to start the hybrid system if the vehicle's battery is discharged.

You can call your Lexus dealer, or qualified repair shop.

If you have a set of jumper (or booster) cables and a second vehicle with a 12-volt battery, you can jump start your Lexus following the steps below.

STEP 1 Remove the engine compartment cover. (→P. 317)

STEP 2



Connecting the jumper cables.

- 1** If required, remove all vent plugs from the booster battery. Lay a cloth over the open vents on the booster battery. (This helps reduce the explosion hazard, personal injuries and burns.)
- 2** Positive (+) battery terminal on your vehicle
- 3** Positive (+) battery terminal on the second vehicle
- 4** Negative (-) battery terminal on the second vehicle
- 5** Connect the jumper cable to ground on your vehicle as shown in the illustration.

STEP 3 Start the hybrid system of the second vehicle. Increase the gasoline engine speed slightly and maintain at that level for approximately 5 minutes to recharge the battery of your vehicle.

STEP 4 Maintain the gasoline engine speed on the second vehicle and start the vehicle's hybrid system.

STEP 5 Once the vehicle's hybrid system has started, remove the jumper cables in the exact reverse order in which they were connected.

Once the hybrid system starts, have the vehicle checked at your Lexus dealer as soon as possible.

■ Starting the hybrid system when the 12-volt battery is discharged

The hybrid system cannot be started by push-starting.

■ Avoiding a discharged battery

- Turn off the headlights and the audio system while the hybrid system is turned off.
- Turn off any unnecessary electrical components when the vehicle is running at a low speed for an extended period, such as in heavy traffic, etc.

■ After recharging the 12-volt battery

(→P. 328)

■ When the battery is removed or discharged

The power windows, power back door and moon roof must be initialized.

(→P. 462)

CAUTION

■ Avoiding battery fires or explosions

Observe the following precautions to prevent accidentally igniting the flammable gas that may be emitted from the battery.

- Make sure the jumper cable is connected to the correct terminal and that it is not unintentionally in contact with any part other than the intended terminal.
- Do not allow the jumper cables to come into contact with the “+” and “-” terminals.
- Do not allow open flame or use matches, cigarette lighters or smoke near the battery.

 **CAUTION****■ Battery precautions**

The battery contains poisonous and corrosive acidic electrolyte, while related parts contain lead and lead compounds. Observe the following precautions when handling the battery.

- When working with the battery, always wear safety glasses and take care not to allow any battery fluids (acid) to come into contact with skin, clothing or the vehicle body.
- Do not lean over the battery.
- In the event that battery fluid comes into contact with the skin or eyes, immediately wash the affected area with water and seek medical attention.
Place a wet sponge or cloth over the affected area until medical attention can be received.
- Always wash your hands after handling the battery support, terminals, and other battery-related parts.
- Do not allow children near the battery.

 **NOTICE****■ When handling jumper cables**

Be careful that the jumper cables do not become tangled in the cooling fan or any of the belts when connecting or disconnecting them.

5-2. Steps to take in an emergency

If your vehicle overheats

■ Electric motor (traction motor) and inverter

If the message WATER TEMP is displayed on the multi-information display.

■ Gasoline engine

If the needle of the engine coolant temperature gauge enters the red zone, the gasoline engine has probably overheated.

Observe the following steps:

STEP 1 Stop the vehicle in a safe place and turn off the automatic air conditioning system.

STEP 2 Check to see if steam is coming out from under the hood.

If you see steam:

Stop the hybrid system. Carefully lift the hood after the steam subsides and then restart the hybrid system.

If you do not see steam:

Leave the hybrid system running and carefully lift the hood.

STEP 3 Check to see if the cooling fan is operating.

If the fan is operating:

Wait until the temperature of the engine (shown on the instrument cluster) begins to fall and then stop the hybrid system.

If the fan is not operating:

Stop the hybrid system immediately and call your local Lexus dealer.

STEP 4



After the hybrid system has cooled down sufficiently, check the engine coolant level and inspect the radiator core (radiator) for any leaks.

STEP 5



Add engine coolant if required.

Water can be used in an emergency measure if engine coolant is unavailable. (→P. 435)

Have the vehicle checked at your nearest Lexus dealer as soon as possible.

■ Overheating

If you observe the following, your vehicle may be overheating.

- The message WATER TEMP is displayed on the multi-information display.
- The engine coolant temperature gauge enters the red zone or a loss of power is experienced.
- Steam is coming from under the hood.

⚠ CAUTION

■ To prevent an accident or injury when inspecting under the hood of your vehicle

- If steam is seen coming from under the hood, do not open the hood until the steam has subsided. The engine compartment may be very hot, causing serious injury such as burns.
- Keep hands and clothing away from the fan and other belts while the hybrid system is running.
- Do not loosen the radiator cap while the hybrid system and radiator are hot. Serious injury, such as burns, may result from hot coolant and steam released under pressure.

 NOTICE

■ **When adding engine coolant**

Wait until the engine has cooled down before adding engine coolant.

When adding coolant, do so slowly. Adding cool coolant to a hot engine too quickly can cause damage to the hybrid system.

5-2. Steps to take in an emergency If the vehicle becomes stuck

Carry out the following procedures if the tires spin or the vehicle becomes stuck in mud, dirt, or snow.

- Stop the hybrid system. Set the parking brake and put the selector lever in P.
- Remove the mud, snow, or sand from around the stuck tire.
- Place wood, stones or some other material to help provide traction under the tires.
- Restart the hybrid system.
- Carefully apply the accelerator to free the vehicle.

CAUTION

■ When attempting to free a stuck vehicle

If you choose to rock the vehicle back and forth to free it, make sure the surrounding area is clear, to avoid striking other vehicles, objects or persons. The vehicle may also lunge forward or lunge back suddenly as it becomes free. Use extreme caution.

■ When shifting the shift lever

Be careful not to shift the shift lever with the accelerator pedal depressed. This may lead to unexpected rapid acceleration of the vehicle that may cause an accident and result in death or serious injury.

NOTICE

■ To avoid damaging the transmission and other components

- Avoid spinning the wheels and do not rev the hybrid system.
- If the vehicle remains stuck after trying these procedures, the vehicle may require towing to be freed.

6-1. Specifications.....	430
Maintenance data (fuel, oil level, etc.)	430
Fuel information.....	442
Tire section names	445
6-2. Customization.....	458
Customizable features	458
6-3. Initialization	462
Items to initialize	462

6-1. Specifications

Maintenance data (fuel, oil level, etc.)

Dimensions and weight

Overall length		187.2 in. (4755 mm)
Overall width		72.6 in. (1845 mm)
Overall height *1	2WD models	66.1 in. (1680 mm) *2 67.7 in. (1720 mm) *3 68.3 in. (1735 mm) *4
	AWD models	66.3 in. (1685 mm) *2 67.9 in. (1725 mm) *3 68.5 in. (1740 mm) *4
Wheelbase		106.9 in. (2715 mm)
Tread	2WD models -Front	62.2 in. (1580 mm)
	-Rear	61.6 in. (1565 mm)
	AWD models -Front	62.0 in. (1575 mm)
	-Rear	61.2 in. (1555 mm)
Vehicle capacity weight (Occupants + luggage)		925 lb. (420 kg)
Towing capacity (Trailer weight + cargo)	Without towing package	2000 lb. (907 kg)
	With towing package	3500 lb. (1588 kg)

*1. Unladen vehicle

*2. Vehicle without roof rails

*3. Vehicle with roof rails

*4. Vehicle with roof rails and cross rails

Vehicle identification

■ Vehicle identification number

The vehicle identification number (VIN) is the legal identifier for your vehicle. This is the primary identification number for your Lexus. It is used in registering the ownership of your vehicle.



This number is stamped on the top left of the instrument panel and under the front passenger's seat (on some models).



This number is also on the Certification Label.

Gasoline engine number and electric motor (traction motor) number

The gasoline engine number and traction motor number are stamped as shown.



- 1** Gasoline engine number
- 2** Electric motor (traction motor) number

Engine

Model	3MZ-FE
Type	6-cylinder V type, 4-cycle, gasoline
Bore and stroke	3.62 × 3.27 in. (92 × 83 mm)
Displacement	202.1 cu.in. (3311 cm ³)
Drive belt tension	Automatic adjustment
Valve clearance (engine cold)	Intake: 0.006 — 0.010 in. (0.15 — 0.25 mm) Exhaust: 0.010 — 0.014 in. (0.25 — 0.35 mm)

Fuel

Fuel type	Unleaded gasoline only
Octane rating	91 (Research octane number 96) or higher
Fuel tank capacity	17.2 gal. (65 L, 14.3 Imp.gal)

Front electric motor (traction motor)

Type	Permanent magnet synchronous motor
Maximum output	123 kW
Maximum torque	33.9 kgf•m (333 N•m, 245 ft•lbf)

Rear electric motor (traction motor with all wheel drive models)

Type	Permanent magnet synchronous motor
Maximum output	50 kW
Maximum torque	13.2 kgf•m (130 N•m, 95 ft•lbf)

Hybrid battery (traction battery)

Type	Nickel-Metal hybrid battery
Voltage	9.6 V/module
Capacity	6.5 Ah (3HR)
Quantity	30 modules
Overall voltage	288 V

Lubrication system

<p>Oil capacity drain and refill (reference)</p> <p>With filter</p> <p>Without filter</p>	<p>5.0 qt. (4.7 L, 4.1 Imp.qt.)</p> <p>4.8 qt. (4.5 L, 4.0 Imp.qt.)</p>
<p>Oil grade</p>	<p>ILSAC multi-grade engine oil</p>
<p>Recommended oil viscosity</p>	<p>Use Lexus approved “Toyota Genuine Motor Oil” or equivalent to satisfy the grade and viscosity shown below.</p> <div data-bbox="452 690 877 974" data-label="Figure"> <p>The diagram illustrates the recommended oil viscosity range. It features a horizontal scale with vertical tick marks labeled from 0 to 18. A large, dark grey double-headed arrow spans across the scale, starting at 0 and ending at 18. The text '5W-20 OW-20' is printed in the center of the arrow. Below the scale, the words 'Outside temperature' are written. The entire diagram is set against a light yellow background.</p> </div> <p>OW-20 is an oil that provides optimal levels of fuel efficiency.</p>

Oil viscosity

- The OW portion of the oil viscosity rating indicates the characteristic of the oil which allows cold startability. Oils with a lower value before the W allow for easier starting of the engine in cold weather.
- The 20 in OW-20 indicates the oil viscosity when the oil is at its operating temperature. An oil with a higher viscosity may be better suited if the vehicle is operated at high speeds, or under extreme load condition.

Cooling system

Capacity	
Gasoline engine	10.9 qt. (10.3 L, 9.0 Imp.qt.)
power control unit	3.6 qt. (3.4 L, 3.0 Imp.qt.)
Coolant type	<p>Use either of the following.</p> <ul style="list-style-type: none"> • “Toyota Super Long Life Coolant” • Similar high-quality ethylene glycol-based non-silicate, non-amine, non-nitrite, and non-borate coolant with long-life organic acid technology <p>Do not use plain water alone.</p>

Ignition system

Spark plug	
Make	
	DENSO SK20R11
	NGK IFR6A11
Gap	0.043 in. (1.1 mm)

NOTICE

■ Iridium-tipped spark plugs

Use only iridium-tipped spark plugs. Do not adjust gap when tuning the gasoline engine.

Electrical system

12-volt battery	
Open voltage at 68°F (20°C):	12.6 — 12.8 V Fully charged 12.2 — 12.4 V Half charged 11.8 — 12.0 V Discharged (Voltage checked 20 minutes after the key is removed from the engine switch with all the lights turned off)
Charging rates	5 A max.

Transaxle

Fluid capacity Drain and refill	
Front	
Without towing package	3.9 qt. (3.7L, 3.2 Imp. qt.)
With towing package	4.1 qt. (3.9 L, 3.4 Imp. qt.)
Rear (AWD models only)	1.8 qt. (1.7 L, 1.5 Imp. qt.)
	The fluid capacity is a reference quantity. If replacement is necessary, contact your Lexus dealer.
Fluid type	Toyota Genuine ATF WS

NOTICE

■ Transaxle fluid type

Using transmission fluid other than “Toyota Genuine ATF WS” may cause deterioration in shift quality, locking up of your transmission accompanied by vibration, and ultimately damage the transmission of your vehicle.

Brakes

Pedal clearance ^{*1}	3.5 in. (90 mm) Min.
Pedal free play	0.039 — 0.079 in. (1 — 2 mm)
Brake pad wear limit	0.04 in. (1.0 mm)
Parking brake lining wear limit	0.04 in. (1.0 mm)
Parking brake pedal travel ^{*2}	5 — 7 clicks
Fluid type	SAE J1703 or FMVSS No. 116 DOT 3

^{*1}: Minimum pedal clearance when depressed with a force of 112 lbf (500 N, 51 kgf) while the hybrid system is running.

^{*2}: Parking brake pedal travel when depressed with a force of 67 lbf (300 N, 31 kgf).

Steering

Free play	Less than 1.2 in. (30 mm)
-----------	---------------------------

Tires and wheels

► Type A

Tire size	225/65R17 101S
Tire inflation pressure (Recommended cold tire inflation pressure)	<p>Driving under normal conditions</p> <p>Front: 32 psi (220 kPa, 2.2 kgf/cm² or bar)</p> <p>Rear: 32 psi (220 kPa, 2.2 kgf/cm² or bar)</p> <p>Spare: 32 psi (220 kPa, 2.2 kgf/cm² or bar)</p> <p>Driving at high speeds above 100 mph (160 km/h) (in countries where such speeds are permitted by law) Add 1.5 psi (10 kPa, 0.1 kgf/cm² or bar) to the front tires and rear tires. Never exceed the maximum cold tire inflation pressure indicated on the tire sidewall.</p>
Wheel size	17 × 6 1/2 J
Wheel nut torque	10.5 kgf•m (103 N•m, 76 ft•lbf)

► Type B

Tire size	P235/55R18 99V
Tire inflation pressure (Recommended cold tire inflation pressure)	Driving under normal conditions Front: 30 psi (210 kPa, 2.1 kgf/cm ² or bar) Rear: 30 psi (210 kPa, 2.1 kgf/cm ² or bar) Spare: 30 psi (210 kPa, 2.1 kgf/cm ² or bar)
Wheel size	18 × 7 J
Wheel nut torque	10.5 kgf•m (103 N•m, 76 ft•lbf)

Light bulbs

	Light Bulbs	Bulb No.	W	Type
Exterior	Headlights (low beam) Discharge bulbs	—	35	A
	Halogen bulbs	—	55	B
	Front turn signal lights	—	21	C
	Headlights (high beam)	9005	60	D
	Parking lights	168	5	E
	Fog lights	9006	55	B
	Front side marker lights	168	5	E
	Rear turn signal lights	—	21	C
	Licence plate lights	168	5	E
	Back-up lights	921	16	E
	Rear side marker lights	194	3.8	E
Interior	Vanity lights	—	2.8	G
	Personal lights	—	8	G
	Interior lights	—	8	F
	Luggage compartment lights	—	5	F
	Door courtesy lights	—	5	G

- A: D2S discharge bulbs
- B: H11 halogen bulbs
- C: Wedge base bulbs (amber)
- D: HB3 halogen bulbs
- E: Wedge base bulbs (clear)
- F: Double end bulbs
- G: Single end bulbs

6-1. Specifications

Fuel information

Your vehicle must use only unleaded gasoline.

Premium unleaded gasoline with an octane rating of 91 (Research Octane Number 96) or higher required for optimum engine performance.

At minimum, the gasoline you use should meet the specifications of ASTM D4814 in the U.S.A. and CGSB3.5-M93 in Canada.

■ Fuel tank opening for unleaded gasoline

To help prevent incorrect fueling, your Lexus has a fuel tank opening that only accommodates the special nozzle on unleaded fuel pumps.

■ If premium gasoline is not available

If 91 rating gasoline cannot be obtained, you may use unleaded gasoline with an octane rating as low as 87 (Research Octane Rating 91).

■ If your engine knocks

- Consult your Lexus dealer.
- You may occasionally notice light knocking for a short time while accelerating or driving uphill. This is normal and there is no need for concern.

■ Gasoline quality

In very few cases, driveability problems may be caused by the brand of gasoline you are using. If driveability problems persist, try changing the brand of gasoline. If this does not correct the problem, consult your Lexus dealer.

■ Gasoline quality standards

- Automotive manufacturers in the US, Europe and Japan have developed a specification for fuel quality called World-Wide Fuel Charter (WWFC) that is expected to be applied worldwide.
- The WWFC consists of four categories that are based on required emission levels. In the US, category 4 has been adopted.
- The WWFC improves air quality by lowering emissions in vehicle fleets, and customer satisfaction through better performance.

■ Lexus recommends the use of gasoline containing detergent additives

- Lexus recommends the use of gasoline that contains detergent additives to avoid build-up of engine deposits.
- All gasoline sold in the US contains detergent additives to clean and/or keep clean intake systems.

■ Lexus recommends the use of cleaner burning gasoline

Cleaner burning gasoline, including reformulated gasoline that contains oxygenates such as ethanol or MTBE (Methyl Tertiary Butyl Ether) is available in many areas.

Lexus recommends the use of cleaner burning gasoline and appropriately blended reformulated gasoline. These types of gasoline provide excellent vehicle performance, reduce vehicle emissions and improve air quality.

■ Lexus does not recommend blended gasoline

- Lexus allows the use of oxygenate blended gasoline where the oxygenate content is up to 10% ethanol or 15% MTBE.
- If you use gasohol in your Lexus, be sure that it has an octane rating no lower than 87.
- Lexus does not recommend the use of gasoline containing methanol.

■ Lexus does not recommend gasoline containing MMT

Some gasoline contains octane enhancing additive called MMT (Methylcyclopentadienyl Manganese Tricarbonyl).

Lexus does not recommend the use of gasoline that contains MMT. If fuel containing MMT is used, your emission control system may be adversely affected.

The malfunction indicator lamp on the instrument cluster may come on. If this happens, contact your Lexus dealer for service.

NOTICE

■ **Notice on gasoline quality**

- Do not use leaded gasoline.

Leaded gasoline can cause damage to your vehicle's three-way catalytic converters causing the emission control system to malfunction.

- Do not use gasohol other than that stated here.

Other gasohol may cause fuel system damage or vehicle performance problems.

- Use of unleaded gasoline with an octane rating lower than 91 may result in gasoline engine knocking. Persistent knocking can lead to gasoline engine damage and should be corrected by refueling with higher octane unleaded gasoline.

At worst, this will lead to engine damage.

■ **Fuel-related poor driveability**

If after using a different type of fuel, poor driveability is encountered (poor hot starting, vaporization, engine knocking, etc.), discontinue the use of that type of fuel.

■ **When refueling with gasohol**

Take care not to spill gasohol.

It can damage your vehicle's paint.

Tire section names

Typical tire symbols



- 1** Tire size (→P. 447)
- 2** DOT and Tire Identification Number (TIN) (→P. 446)
- 3** Location of treadwear indicators (→P. 331)
- 4** Tire ply composition and materials
Plies are layers of rubber-coated parallel cords. Cords are the strands which form the plies in a tire.
- 5** Radial tires or bias-ply tires
A radial tire has RADIAL on the sidewall. A tire not marked RADIAL is a bias-ply tire.
- 6** TUBELESS or TUBE TYPE
A tubeless tire does not have a tube and air is directly filled in the tire. A tube type tire has a tube inside the tire and the tube maintains the air pressure.
- 7** Load limit at maximum cold tire inflation pressure (→P. 336)
- 8** Maximum cold tire inflation pressure (→P. 439)
This means the pressure to which a tire may be inflated.
- 9** Uniform tire quality grading
For details, see “Uniform tire quality grading” that follows.

10 Summer tire or all season tire

(→P. 336)

An all season tire has “M+S” on the sidewall. A tire not marked “M+S” is a summer tire.

Typical DOT and tire identification number (TIN)

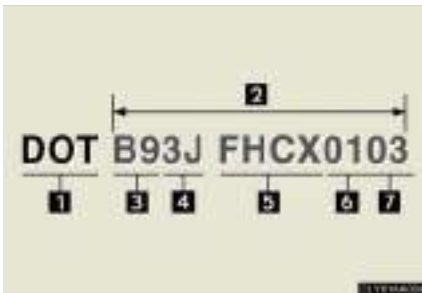

1 DOT symbol*

2 Tire Identification Number (TIN)

3 Tire manufacturer's identification mark

4 Tire size code

5 Manufacturer's optional tire type code (3 or 4 letters)

6 Manufacturing week

7 Manufacturing year

*:The DOT symbol certifies that the tire conforms to applicable Federal Motor Vehicle Safety Standards.

Tire size

■ Typical tire size information

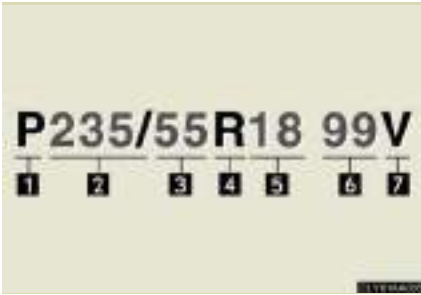

The illustration indicates typical tire size.

- 1 Tire use
(P = Passenger car,
T = Temporary use)
- 2 Section width (millimeters)
- 3 Aspect ratio
(tire height to section width)
- 4 Tire construction code
(R = Radial, D = Diagonal)
- 5 Wheel diameter (inches)
- 6 Load index (2 or 3 digits)
- 7 Speed symbol
(alphabet with one letter)

Tire dimensions

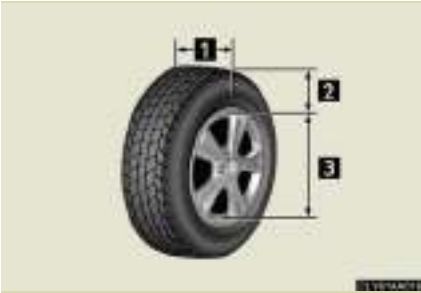

- 1 Section width
- 2 Tire height
- 3 Wheel diameter

Tire section names

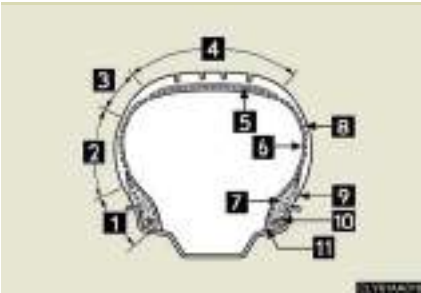

- 1 Bead
- 2 Sidewall
- 3 Shoulder
- 4 Tread
- 5 Belt
- 6 Inner liner
- 7 Reinforcing rubber
- 8 Carcass
- 9 Rim lines
- 10 Bead wires
- 11 Chafer

Uniform tire quality grading

This information has been prepared in accordance with regulations issued by the National Highway Traffic Safety Administration of the U.S.A. Department of Transportation.

It provides the purchasers and/or prospective purchasers of Lexus vehicles with information on uniform tire quality grading.

Your Lexus dealer will help answer any questions you may have as you read this information.

■ DOT quality grades

All passenger vehicle tires must conform to Federal Safety Requirements in addition to these grades. Quality grades can be found where applicable on the tire sidewall between tread shoulder and maximum section width.

For example: Treadwear 200 Traction AA Temperature A

■ Treadwear

The treadwear grade is a comparative rating based on the wear rate of the tire when tested under controlled conditions on a specified government test course.

For example, a tire graded 150 would wear one and a half (1 - 1/2) times as well on the government course as a tire graded 100.

The relative performance of tires depends upon the actual conditions of their use, however, and may depart significantly from the norm due to variations in driving habits, service practices and differences in road characteristics and climate.

■ Traction AA, A, B, C

The traction grades, from highest to lowest, are AA, A, B and C, and they represent the tire's ability to stop on wet pavement as measured under controlled conditions on specified government test surfaces of asphalt and concrete.

A tire marked C may have poor traction performance.

Warning: The traction grade assigned to this tire is based on braking (straight ahead) traction tests and does not include cornering (turning) traction.

■ Temperature A, B, C

The temperature grades are A (the highest), B, and C, representing the tire's resistance to the generation of heat and its ability to dissipate heat when tested under controlled conditions on a specified indoor laboratory test wheel.

Sustained high temperature can cause the material of the tire to degenerate and reduce tire life, and excessive temperature can lead to sudden tire failure.

The grade C corresponds to a level of performance which all passenger car tires must meet under the Federal Motor Vehicle Safety Standard No. 109.

Grades B and A represent higher levels of performance on the laboratory test wheel than the minimum required by law.

Warning: The temperature grades for this tire are established for a tire that is properly inflated and not overloaded.

Excessive speed, underinflation, or excessive loading, either separately or in combination, can cause heat buildup and possible tire failure.

Glossary of tire terminology

Tire related term	Meaning
Cold tire inflation pressure	Tire pressure when the vehicle has been parked for three hours or more, or has not been driven more than 1 mile or 1.5 km under that condition
Maximum inflation pressure	The maximum cold inflated pressure to which a tire may be inflated, shown on the sidewall of the tire
Recommended inflation pressure	Cold tire inflation pressure recommended by a manufacturer
Accessory weight	The combined weight (in excess of those standard items which may be replaced) of automatic transmission, power steering, power brakes, power windows, power seats, radio and heater, to the extent that these items are available as factory-installed equipment (whether installed or not)
Curb weight	The weight of a motor vehicle with standard equipment, including the maximum capacity of fuel, oil and coolant, and if so equipped, air conditioning and additional weight optional engine
Maximum loaded vehicle weight	The sum of: (a) Curb weight (b) Accessory weight (c) Vehicle capacity weight (d) Production options weight
Normal occupant weight	150 lb. (68 kg) times the number of occupants specified in the second column of Table 1* that follows

6-1. Specifications

Tire related term	Meaning
Occupant distribution	Distribution of occupants in a vehicle as specified in the third column of Table 1* below
Production options weight	The combined weight of installed regular production options weighing over 5 lb. (2.3 kg) in excess of the standard items which they replace, not previously considered in curb weight or accessory weight, including heavy duty brakes, ride levelers, roof rack, heavy duty 12-volt battery, and special trim
Rim	A metal support for a tire or a tire and tube assembly upon which the tire beads are seated
Rim diameter (Wheel diameter)	Nominal diameter of the bead seat
Rim size designation	Rim diameter and width
Rim type designation	The industry manufacturer's designation for a rim by style or code
Rim width	Nominal distance between rim flanges
Vehicle capacity weight (Total load capacity)	The rated cargo and luggage load plus 150 lb. (68 kg) times the vehicle's designated seating capacity
Vehicle maximum load on the tire	The load on an individual tire that is determined by distributing to each axle its share of the maximum loaded vehicle weight, and dividing by two
Vehicle normal load on the tire	The load on an individual tire that is determined by distributing to each axle its share of curb weight, accessory weight, and normal occupant weight (distributed in accordance with Table 1* below), and dividing by two
Weather side	The surface area of the rim not covered by the inflated tire

Tire related term	Meaning
Bead	The part of the tire that is made of steel wires, wrapped or reinforced by ply cords and that is shaped to fit the rim
Bead separation	A breakdown of the bond between components in the bead
Bias ply tire	A pneumatic tire in which the ply cords that extend to the beads are laid at alternate angles substantially less than 90 degrees to the centerline of the tread
Carcass	The tire structure, except tread and sidewall rubber which, when inflated, bears the load
Chunking	The breaking away of pieces of the tread or sidewall
Cord	The strands forming the plies in the tire
Cord separation	The parting of cords from adjacent rubber compounds
Cracking	Any parting within the tread, sidewall, or innerliner of the tire extending to cord material
CT	A pneumatic tire with an inverted flange tire and rim system in which the rim is designed with rim flanges pointed radially inward and the tire is designed to fit on the underside of the rim in a manner that encloses the rim flanges inside the air cavity of the tire
Extra load tire	A tire designed to operate at higher loads and at higher inflation pressures than the corresponding standard tire
Groove	The space between two adjacent tread ribs
Innerliner	The layer(s) forming the inside surface of a tubeless tire that contains the inflating medium within the tire
Innerliner separation	The parting of the innerliner from cord material in the carcass

Tire related term	Meaning
Intended outboard sidewall	(a) The sidewall that contains a whitewall, bears white lettering, or bears manufacturer, brand, and/or model name molding that is higher or deeper than the same molding on the other sidewall of the tire, or (b) The outward facing sidewall of an asymmetrical tire that has a particular side that must always face outward when mounted on a vehicle
Light truck (LT) tire	A tire designated by its manufacturer as primarily intended for use on lightweight trucks or multipurpose passenger vehicles
Load rating	The maximum load that a tire is rated to carry for a given inflation pressure
Maximum load rating	The load rating for a tire at the maximum permissible inflation pressure for that tire
Maximum permissible inflation pressure	The maximum cold inflation pressure to which a tire may be inflated
Measuring rim	The rim on which a tire is fitted for physical dimension requirements
Open splice	Any parting at any junction of tread, sidewall, or innerliner that extends to cord material
Outer diameter	The overall diameter of an inflated new tire
Overall width	The linear distance between the exteriors of the sidewalls of an inflated tire, including elevations due to labeling, decorations, or protective bands or ribs
Passenger car tire	A tire intended for use on passenger cars, multipurpose passenger vehicles, and trucks, that have a gross vehicle weight rating (GVWR) of 10,000 lb. or less.
Ply	A layer of rubber-coated parallel cords

Tire related term	Meaning
Ply separation	A parting of rubber compound between adjacent plies
Pneumatic tire	A mechanical device made of rubber, chemicals, fabric and steel or other materials, that, when mounted on an automotive wheel, provides the traction and contains the gas or fluid that sustains the load
Radial ply tire	A pneumatic tire in which the ply cords that extend to the beads are laid at substantially 90 degrees to the centerline of the tread
Reinforced tire	A tire designed to operate at higher loads and at higher inflation pressures than the corresponding standard tire
Section width	The linear distance between the exteriors of the sidewalls of an inflated tire, excluding elevations due to labeling, decoration, or protective bands
Sidewall	That portion of a tire between the tread and bead
Sidewall separation	The parting of the rubber compound from the cord material in the sidewall
Snow tire	A tire that attains a traction index equal to or greater than 110, compared to the ASTM E-1136 Standard Reference Test Tire, when using the snow traction test as described in ASTM F-1805-00, Standard Test Method for Single Wheel Driving Traction in a Straight Line on Snow- and Ice-Covered Surfaces, and which is marked with an Alpine Symbol () on at least one sidewall
Test rim	The rim on which a tire is fitted for testing, and may be any rim listed as appropriate for use with that tire

Tire related term	Meaning
Tread	That portion of a tire that comes into contact with the road
Tread rib	A tread section running circumferentially around a tire
Tread separation	Pulling away of the tread from the tire carcass
Treadwear indicators (TWI)	The projections within the principal grooves designed to give a visual indication of the degrees of wear of the tread
Wheel-holding fixture	The fixture used to hold the wheel and tire assembly securely during testing

*: Table 1— Occupant loading and distribution for vehicle normal load for various designated seating capacities

Designated seating capacity, Number of occupants	Vehicle normal load, Number of occupants	Occupant distribution in a normally loaded vehicle
2 through 4	2	2 in front
5 through 10	3	2 in front, 1 in second seat
11 through 15	5	2 in front, 1 in second seat, 1 in third seat, 1 in fourth seat
16 through 20	7	2 in front, 2 in second seat, 2 in third seat, 1 in fourth seat

6-2. Customization

Customizable features

Your vehicle includes a variety of electronic features that can be personalized to your preferences. Programming these preferences requires specialized equipment and may be performed by an authorized Lexus dealership.

Some function settings are changed simultaneously with other functions being customized. Contact your Lexus dealer for further details.

Item	Function	Default setting	Customized setting
Wireless remote control (→P. 36)	Wireless remote control	ON	OFF
	Unlocking operation	Driver's door unlocked in one step, all doors unlocked in two steps	All doors unlocked in one step
	Automatic door lock function to be activated if door is not opened after being unlocked	ON	OFF
	Time elapsed before automatic door lock function is activated if door is not opened after being unlocked	60 seconds	30 seconds
			120 seconds
	Operation signal (Emergency flashers)	ON	OFF
	Operation signal (Buzzer)	ON	OFF

Item	Function	Default setting	Customized setting
Wireless remote control (→P. 36)	Buzzer sounds when pushing LOCK with any door not closed	ON	OFF
	Power back door operation	Push and hold	Push twice*
			One short push*
Panic function	ON	OFF	
Power back door (→P. 44)	Switch operation	Push and hold	One short push
	Wireless remote control linked operation	ON	OFF
	Operation signal volume	OFF	High
			Low
	Operation when door locks	Possible	Impossible
	Assistance of opening with door opener	OFF	ON
Sensitivity of jam protection function	Level 1	Level 2 to 4	

*: It is possible to select them only when the power back door operation with the open/close switch is made impossible when the door is locked.

Item	Function	Default setting	Customized setting
Door lock (→P. 39)	Unlocking using a key	Driver's door unlocked in one step, all doors unlocked in two steps	All doors unlocked in one step
	Speed-detecting automatic door lock function	OFF	ON
	Opening driver's door unlocks all doors	OFF	ON
	Shifting gears to P unlocks all doors	ON	OFF
	Shifting gears to position other than P locks all doors	ON	OFF
Power windows (→P. 72)	Linked door lock/unlock operation	ON	OFF
	Wireless remote control linked operation	ON (open only)	OFF
Moon roof (→P. 75)	Linked door lock/unlock operation	ON	OFF
	Wireless remote control linked operation	ON (open only)	OFF
Automatic light control system (→P. 148)	Light sensor sensitivity	Level 3	Level 1 to 5
	Time elapsed before headlights automatically turn off after doors are closed	30 seconds	0 second
			60 seconds
90 seconds			

Item	Function	Default setting	Customized setting
Windshield wipers and washer (→P. 152)	Switching operation when the vehicle is stationary	ON	OFF
Illumination (→P. 260)	Time elapsed before lights turn off	15 seconds	7.5 seconds
			30 seconds
	Front footwell lighting	ON	OFF
	Inside door handle well lighting	ON	OFF
	Operation when the doors are unlocked	ON	OFF
	Operation after the hybrid system is off	ON	OFF
Steering wheel (→P. 66)	Automatic tilt-away steering column	ON	OFF

6-3. Initialization

Items to initialize

After reconnecting or performing maintenance on the 12-volt battery, the hybrid system may not start. (→P. 328) Also, the following items must be initialized for normal system operation.

Item	When to initialize	Reference
Power window	<ul style="list-style-type: none">• After reconnecting or changing the battery• After changing a fuse	P. 72
Power back door	<ul style="list-style-type: none">• After reconnecting or changing the battery• After changing a fuse	P. 44
Engine oil maintenance data	After changing engine oil	P. 318
Tire pressure warning system	<ul style="list-style-type: none">• When changing the tire inflation pressure by changing traveling speed or load weight, etc.• When changing the tire size.	P. 331

Reporting safety defects for U.S. owners	464
Seat belt instructions for Canadian owners (in French).....	465

Reporting safety defects for U.S. owners

If you believe that your vehicle has a defect which could cause a crash or could cause injury or death, you should immediately inform the National Highway Traffic Safety Administration (NHTSA) in addition to notifying the Lexus Division of Toyota Motor Sales, U.S.A., Inc. (Toll-free: 1-800-25-LEXUS).

If NHTSA receives similar complaints, it may open an investigation, and if it finds that a safety defect exists in a group of vehicles, it may order a recall and remedy campaign. However, NHTSA cannot become involved in individual problems between you, your dealer, or Lexus Division of Toyota Motor Sales, U.S.A., Inc.

To contact NHTSA, you may call the Vehicle Safety Hotline toll-free at 1-888-327-4236 (TTY: 1-800-424-9153); go to <http://www.safercar.gov>; or write to: Administrator, NHTSA, 1200 New Jersey Ave, S.E., Washington, DC 20590. You can also obtain other information about motor vehicle safety from <http://www.safercar.gov>.

Seat belt instructions for Canadian owners (in French)

The following is a French explanation of seat belt instructions extracted from the seat belt section in this manual.

See the seat belt section for more detailed seat belt instructions in English.

Utilisation correcte des ceintures de sécurité



- Déroulez la sangle diagonale de telle sorte qu'elle passe bien sur l'épaule, sans pour autant être en contact avec votre cou ou glisser de votre épaule.
- Placez la sangle abdominale le plus bas possible sur les hanches.
- Réglez la position du dossier de siège. Asseyez-vous le dos le plus droit possible et caliez-vous bien dans le siège.
- Ne vrillez pas la ceinture de sécurité.

Guide confort de ceinture de sécurité (sièges arrière extérieurs)

Si la sangle diagonale gêne la personne au niveau du cou, utilisez le guide confort de la ceinture de sécurité.

ÉTAPE 1



Sortez le guide confort de sa poche.

ÉTAPE 2

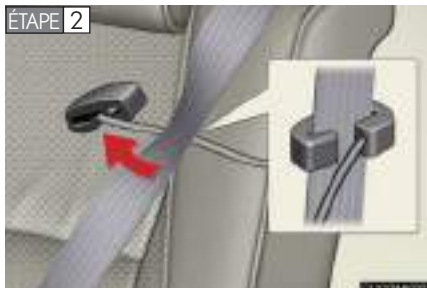

Engagez la ceinture dans le guide.

Le cordon élastique doit passer sous la ceinture de sécurité.

ÉTAPE 3



Bouclez la ceinture de sécurité, puis positionnez-la et lâchez-la.

Entretien et soin

■ Ceintures de sécurité

Nettoyez avec un chiffon ou une éponge humectée d'eau savonneuse tiède. Profitez de l'occasion pour vérifier régulièrement que les ceintures ne sont pas effilochées, entaillées, ou ne paraissent pas exagérément usées.

ATTENTION

■ Détérioration et usure des ceintures de sécurité

Inspectez les ceintures de sécurité périodiquement. Contrôlez qu'elles ne sont pas entaillées, effilochées, et que leurs ancrages ne sont pas desserrés. N'utilisez pas une ceinture de sécurité défectueuse avant qu'elle ne soit remplacée. Une ceinture de sécurité défectueuse n'apporte aucune garantie de protection de l'occupant en cas d'accident.



Index

Abbreviation list	470
Alphabetical index	472
What to do if...	482

For details of equipment related to the navigation system, such as the audio system and the air conditioning systems, refer to the “Navigation System Owner's Manual”.

Abbreviation list

Abbreviation/Acronym list

ABBREVIATIONS	MEANING
A/C	Air Conditioning
ABS	Anti-Lock Brake System
ACC	Accessory
AFS	Adaptive Front-lighting System
ALR	Automatic Locking Retractor
AWD	All-Wheel Drive
CRS	Child Restraint System
DISP	Display
ECU	Electronic Control Unit
EDR	Event Data Recorder
ELR	Emergency Locking Retractor
EPS	Electric Power Steering
GAWR	Gross Axle Weight Ratings
GVWR	Gross Vehicle Weight Ratings
I/M	Emission inspection and Maintenance
INFO	Information
INT	Intermittent
LED	Light Emitting Diode
LT	Light Truck
MMT	Methylcyclopentadienyl Manganese Tricarbonyl
M + S	Mud and Snow
MTBE	Methyl Tertiary Butyl Ether
OBD	On Board Diagnostics
PWR	Power
SRS	Supplemental Restraint System

ABBREVIATIONS	MEANING
TIN	Tire Identification Number
TWI	Treadwear Indicators
TPMS	Tire Pressure Warning System
VDIM	Vehicle Dynamics Integrated Management
VIN	Vehicle Identification Number
VSC	Vehicle Stability Control
2WD	2-Wheel Drive

A	A/C	198
	ABS.....	170
	Adaptive front lighting system	149
	AFS.....	149
	Air conditioning filter	346
	Air conditioning system	
	Air conditioning filter	346
	Automatic air conditioning system.....	198
	Air bags	
	Air bag operating conditions.....	93
	Air bag precautions for your child.....	98
	Air bag warning light.....	389
	Curtain shield airbag operating conditions.....	94
	Curtain shield airbag precautions	98
	Front passenger occupant classification system.....	103
	General airbag precautions	98
	Locations of airbags.....	91
	Modification and disposal of airbags.....	102
	Proper driving posture	89, 98
	Side airbag operating conditions.....	94
	Side airbag precautions	98
	SRS airbags	91
	Alarm	85
	Antenna	211
	Anti-lock brake system	170
	Armrest.....	282
	Audio system	
	Antenna	211

Audio visual input.....	251
A/V input adapter.....	251
CD player/changer.....	214
MP3/WMA disc.....	220
Optimal use	228
Radio	207
Steering wheel audio switch.....	231
Audio visual input.....	251
Automatic air conditioning system	198
Automatic headlight leveling system	150
Automatic light control system.....	148
A/V input adapter.....	251

B	Back door	
	Back door	44
	Wireless remote control	36
	Back-up lights	
	Replacing light bulbs.....	365
	Wattage.....	441
	Battery	
	Checking.....	327
	If the 12-volt battery is discharged	421
	Preparing and checking before winter.....	183
	Brake	
	Fluid.....	325
	Parking brake.....	137
	Brake assist	170
	Break-in tips.....	123
	Brightness control	
	Multi-display light control.....	276

C	Care	
	Exterior.....	298
	Interior.....	301
	Seat belts.....	302
	Cargo capacity.....	179
	Cargo hooks.....	284
	CD changer	
	CD.....	214
	MP3 disc.....	220
	WMA disc.....	220
	CD player.....	214
	Chains.....	184
	Child restraint system	
	Booster seats, definition.....	108
	Booster seats, installation.....	113
	Convertible seats, definition.....	108
	Convertible seats, installation.....	113
	Front passenger occupant classification system.....	103
	Infant seats, definition.....	108
	Infant seats, installation.....	113
	Installing CRS with lower anchorage.....	116
	Installing CRS with seat belts.....	113
	Installing CRS with top straps.....	118
	Child safety	
	Air bag precautions.....	98
	Battery precautions.....	328, 423
	Child restraint system.....	108
	Child-protectors.....	40
	How your child should wear the seat belt.....	62
	Installing child restraints.....	112
	Moon roof precautions.....	77
	Power window lock switch.....	72
	Power window precautions.....	74
	Removed rear seat entertainment system controller battery.....	351
	Removed wireless remote control battery precautions.....	349
	Seat belt comfort guide.....	59
	Seat belt extender precautions.....	64
	Seat belt precautions.....	62
	Seat heater precautions.....	280
	Child-protectors.....	40
	Cleaning	
	Exterior.....	298
	Interior.....	301
	Seat belts.....	302
	Clock.....	274
	Coin holder.....	268
	Compass.....	292
	Condenser.....	325
	Console box.....	266
	Cooling system	
	Engine overheating.....	424
	Cruise control	
	Cruise control.....	158
	Dynamic laser cruise control.....	161
	Cup holder.....	269
	Curtain shield airbags.....	91
	Customizable features.....	458
D	Daytime running light system.....	149
	Defogger	
	Rear window.....	204
	Side mirror.....	204
	Dimension.....	430
	Dinghy towing.....	196
	Display	
	Dynamic laser cruise control.....	161
	Trip information.....	146

Do-it-yourself maintenance 310

Door courtesy lights

- Door courtesy lights.....260
- Wattage.....441

Door lock

- Back door..... 44
- Side door.....39
- Wireless remote control..... 36

Door pockets.....271

Doors

- Back door..... 44
- Door glasses.....72
- Door lock..... 36, 39
- Power back door 44
- Side door.....39
- Side mirrors.....68

Driver's seat belt reminder light 391

Driving

- Break-in tips123
- Correct posture.....89
- Procedures.....122
- Winter driving tips.....183

Driving position memory.....55

DVD player

- Audio CD/CD text.....248
- DVD video239
- Initial setting253
- MP3 discs249
- Video CD.....246

E Electric power steering..... 170

Emergency, in case of

- If the back door opener is in
operative..... 46
- If the hybrid system will
not start 418

- If the shift lever cannot be
shifted from P..... 419
- If the 12-volt battery is
discharged 421
- If the warning buzzer sounds.....388
- If the warning light turns on.....388
- If you have a flat tire408
- If you lose your keys 420
- If you think something is
wrong385
- If your vehicle becomes stuck427
- If your vehicle needs to be
towed..... 378
- If your vehicle overheats.....424
- Energy monitor28

Engine

- Compartment316
- Engine switch131
- Hood.....313
- How to start the hybrid system.....131
- Identification number 431
- If the hybrid system will
not start.....418
- Ignition switch131
- Overheating424

Engine compartment cover317

Engine coolant

- Capacity 435
- Checking.....323
- Preparing and checking
before winter.....183

**Engine coolant temperature
gauge 138**

Engine oil

- Capacity434
- Checking.....318

Preparing and checking	
before winter.....	183
Engine oil maintenance data.....	321
Engine switch.....	131
Engine switch light.....	260
EPS.....	170
Event data recorder.....	386

F Floor mat..... 283

Fluid	
Brake.....	325
Washer.....	329

Fog lights	
Replacing light bulbs.....	365
Switch.....	151
Wattage.....	441

Foot well lighting..... 260

Front fog lights	
Replacing light bulbs.....	365
Switch.....	151
Wattage.....	441

Front passenger's seat belt	
reminder light.....	391

Front seats	
Adjustment.....	49
Driving position memory.....	55
Flattening seatbacks.....	50

Front side marker light	
Replacing light bulbs.....	365
Wattage.....	441

Front turn signal lights	
Replacing light bulbs.....	365
Wattage.....	441

Fuel	
Capacity.....	433
Fuel gauge.....	138
Gas station information.....	484
Information.....	442
Refueling.....	78
Type.....	442
Fuel door.....	78
Fuel filler door.....	78
Fuses.....	352

G Garage door opener..... 287

Gas station information.....	484
Gauges.....	138
Glove box.....	265
Glove box light.....	266

H Head restraints

Adjusting.....	57
----------------	----

Headlight aim..... 364

Headlight cleaner..... 157

Headlights	
Discharge headlights	
precautions.....	375
Replacing light bulbs.....	365
Switch.....	148
Wattage.....	441

Heaters	
Seat heaters.....	280
Side mirror.....	204

Hood..... 313

Hooks	
Cargo hook.....	284
Shopping bag hook.....	284

Hybrid system	
Energy monitor.....	28
High voltage cautions.....	27
High voltage components.....	27
Operating condition.....	28
Road accident cautions.....	32
Starting procedure.....	131
Hybrid vehicle immobilizer system.....	83

I I/M test..... 309

Identification	
Engine.....	431
Vehicle.....	431

Ignition	
Keys.....	34

Ignition switch.....	131
----------------------	-----

Illuminated entry system.....	261
-------------------------------	-----

Indicator lights.....	140
-----------------------	-----

Initialization	
Items to initialize.....	462

Inside door handle lights.....	260
--------------------------------	-----

Inside rear view mirror.....	67
------------------------------	----

Interior lights	
Interior lights.....	260
Switch.....	263
Wattage.....	441

J Jack

Positioning a floor jack.....	314
Replacing the wheel.....	408
Jack handle.....	408

K Keyless entry..... 36

Keys	
Engine switch.....	131
Flat key.....	34, 133
If you lose your keys.....	420
Ignition switch.....	131
Key number.....	34
Keyless entry.....	36
Keys.....	34
Wireless remote control key.....	36

L Laser cruise control..... 161

Licence plate lights	
Replacing light bulbs.....	365
Wattage.....	441

Light bulbs	
Replacing.....	365
Wattage.....	441

Lights	
Door courtesy lights.....	260
Engine switch light.....	260
Fog light switch.....	151
Headlights switch.....	148
Inside door handle lights.....	260
Interior light switch.....	263
Luggage compartment light.....	46
Meter ring light.....	260
Overhead courtesy light.....	260
Personal light switch.....	264
Replacing light bulbs.....	365
Scuff lighting.....	260
Turn signal lever.....	136
Vanity lights.....	273
Wattage.....	441

Load capacity.....	182
--------------------	-----

Lock steering column.....	132
---------------------------	-----

- Luggage compartment lights
 - Switch46
 - Wattage 441
- Luggage cover 284
- M** Maintenance
 - Do-it-yourself maintenance.....310
 - General maintenance.....306
 - Maintenance data430
 - Maintenance requirements.....304
- Meter
 - Instrument panel light control.....139
 - Meters.....138
- Meter ring light 260
- Mirrors
 - Inside rear view mirror67
 - Side mirror heater 204
 - Side mirrors.....68
 - Vanity mirrors273
- Moon roof.....75
- MP3 disc 220
- Multi-display
 - Brightness control.....276
- Multi-information display
 - Energy monitor 28
- O** Odometer138
- Oil
 - Engine oil.....318
- Opener
 - Back door44
 - Fuel filler door 78
 - Hood313
- Outside rear view mirrors
 - Adjusting and folding 68
 - Driving position memory 55
- Outside temperature display 275
- Overhead console269
- Overhead courtesy lights260
- Overheating, Engine..... 424
- P** Parking brake137
- Parking lights
 - Replacing light bulbs..... 365
 - Switch.....148
 - Wattage.....441
- Personal lights
 - Personal lights 260
 - Switch.....264
 - Wattage.....441
- Power meter 138
- Power outlet..... 277
- Power windows 72
- R** Radiator325
- Radio 207
- RDS 208
- Rear audio system233
- Rear seat entertainment system
 - Audio CD/CD text248
 - DVD video.....239
 - Initial setting253
 - MP3 discs.....249
 - Rear seat entertainment system 233
 - Replacing controller battery..... 350
 - Video 251
 - Video CD.....246
- Rear seats
 - Adjustment.....52
 - Folding down52

Rear side marker lights
 Wattage.....441

Rear turn signal lights
 Replacing light bulbs.....365
 Wattage.....441

Rear window defogger.....204

Rear window wiper156

Replacing
 Fuses352
 Light bulbs.....365
 Rear seat entertainment system
 controller battery.....350
 Tires408
 Wireless remote control
 battery348

Reporting safety defects for
 U.S.A. owners464

RSE
 Replacing controller battery350
 RSE233

Road accident cautions.....32

Roof luggage carrier70

S Scuff lighting260

Seat belts
 Adjusting the seat belt.....59
 Automatic Locking Retractor61
 Child restraint system
 installation112
 Cleaning and maintaining
 the seat belts.....302
 Emergency Locking Retractor61
 How to wear your seat belt.....58
 How your child should wear
 the seat belt62

Pregnant women,
 proper seat belt use61

Reminder light.....391

Seat belt extenders.....62

Seat belt pretensioners60

Seat heaters280

Seating capacity.....182

Seats
 Adjustment49, 52
 Adjustment precautions51, 54
 Child seats/child restraint
 system installation112
 Cleaning301
 Driver's seat position memory55
 Flattening seatbacks50
 Head restraint57
 Properly sitting in the seat.....89
 Seat heaters280

Service reminder indicators140

Shift lever
 Transmission.....135
 If the shift lever cannot be
 shifted from P.....419

Shopping bag hooks284

Side airbags91

Side marker lights
 Replacing light bulbs.....365
 Switch.....148
 Wattage.....441

Side mirror
 Adjusting and folding68
 Mirror position memory55

Spare tire	
Inflation pressure	340
Spare tire	408
Spark plug	435
Specifications.....	430
Speech command switch*	
Speedometer	
Speedometer	138
Steering	
Column lock release	132
Steering wheel	
Audio switches	231
Manual adjustment.....	65
Power adjustment.....	66
Steering wheel position	
memory	55
Storage feature	265
Stuck	
If your vehicle becomes stuck	427
Sun visors.....	272
Sunshade	
Roof.....	76
Switch	
Engine switch	131
Fog light switch.....	151
Ignition switch.....	131
Light switches.....	148
Power back door switch	44
Power door lock switch.....	39
Power window switch.....	72
Rear window wiper and washer	
switch.....	156
Window lock switch.....	72
Wipers and washer switch.....	152

T Tail lights	
Replacing light bulbs.....	365
Switch.....	148
Wattage.....	441
Talk switch*	
Telephone switch*	
Theft deterrent system	
Alarm.....	85
Hybrid vehicle immobilizer	
system	83
Theft prevention labels.....	88
Tire inflation pressure	340
Tire section names	
Glossary	451
Size.....	447
Tire identification number	446
Uniform tire quality grading	449
Tires	
Chains	183
Checking	331
If you have a flat tire	408
Inflation pressure.....	340
Inflation pressure sensor.....	332
Information.....	445
Replacing.....	408
Rotating tires	331
Size.....	439
Snow tires	183
Spare tire.....	408
Tools.....	408
Total load capacity	182
Towing	
Dinghy towing	196
Emergency towing.....	378
Trailer towing	187

*: Refer to the "Navigation System Owner's Manual".

Traction control..... 170
 Trailer towing..... 187
 Transmission
 Transmission.....135
 Trip information display..... 146
 Trip meter 138
 Turn signal lights
 Replacing light bulbs.....365
 Switch.....136
 Wattage.....441

V Valet key.....34
 Vanity lights
 Vanity lights 273
 Wattage.....441
 Vanity mirrors273
 Vehicle identification number 431
 Vehicle stability control..... 170
 Video mode 251
 VDIM..... 170
 VSC..... 170

W Warning buzzers
 Brake system 388
 Key reminder393
 Open door391
 Open moon roof reminder.....391
 Seat belt reminder.....391
 Warning lights
 Anti-lock brake system.....389
 Automatic headlight leveling
 system.....389
 Brake assist system.....389
 Brake system 388
 Charging system389

Electric power steering
 control system.....389
 Hybrid battery system389
 Low fuel level.....391
 Low tire pressure warning
 light.....391
 Master warning light.....391
 Open door391
 Pretensioners389
 Seat belt reminder light.....391
 SRS airbags.....389

Warning messages
 AWD system.....398
 Dynamic laser cruise
 control.....399, 402
 Engine oil maintenance..... 402
 Engine oil pressure.....398
 Fuel lid..... 407
 Head light level..... 399
 Hybrid system.....398
 Moon roof..... 402
 Open door 402
 Parking brake..... 402
 Vehicle stability control.....399, 401
 Washer fluid 402
 Water temp.....398
 Transmission selector lever 402

Washer
 Checking.....329
 Preparing and checking
 before winter.....183
 Switch.....152

Washing and waxing.....298

Weight
 Cargo capacity179
 Load limits.....182
 Weight.....430

Wheels	344
Window glasses	72
Window lock switch.....	72
Windows	
Power windows	72
Rear window defogger	204
Washer.....	152
Windshield wipers	152
Wireless remote control key	
Replacing the battery	348
Wireless remote control key.....	36
WMA disc.....	220

What to do if...

What to do if...



A tire punctures

P. 408

If you have a flat tire



The hybrid system does not start

P. 418

If the hybrid system will not start

P. 83

Hybrid vehicle immobilizer system

P. 421

If the 12-volt battery is discharged



The shift lever cannot be moved out

P. 419

If the shift lever cannot be shifted from P



The engine coolant temperature gauge enters the red zone

P. 424

If your vehicle overheats



Steam can be seen coming from under the hood



The key is lost

P. 420

If you lose your keys



The 12-volt battery runs out

P. 421

If the 12-volt battery is discharged



The doors cannot be locked

P. 39

Side doors

P. 44

Back door



The horn begins to sound

P. 85

Alarm



The vehicle is stuck in mud or sand

P. 427

If the vehicle becomes stuck



The warning light or indicator light comes on

P. 388

If a warning light turns on or a warning buzzer sounds...



Warning lights



Brake system warning light

or



or



P. 388



ABS warning light

or



P. 389



Low fuel level warning light

P. 391



SRS warning light

P. 389



Charging system warning light

P. 389



Hybrid battery warning light

P. 389



Malfunction indicator lamp

or



P. 389



Driver's seat belt reminder light

P. 391



Front passenger's seat belt reminder light

P. 391



Electric power steering warning light

P. 389



Master warning light

P. 391



Open door warning light

P. 391



Tire pressure warning light

P. 391

GAS STATION INFORMATION

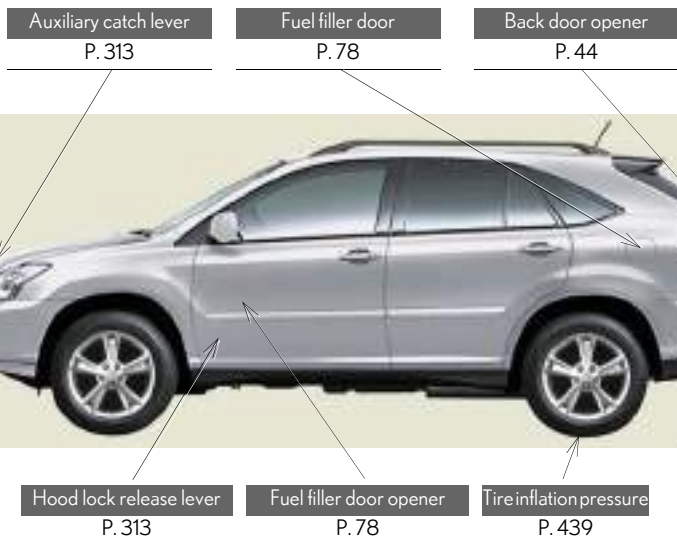

Fuel tank capacity	17.2 gal. (65 L, 14.3 Imp.gal.)	
Fuel type	Unleaded gasoline only	P. 80, 433
Cold tire inflation pressure		P. 439
Engine oil capacity (Drain and refill)	With filter	qt. (L, Imp.qt.) 5.0 (4.7, 4.1)
	Without filter	4.8 (4.5, 4.0)
Engine oil type	Toyota Genuine Motor Oil or equivalent Oil grade: ILSAC multigrade engine oil Recommended oil viscosity: SAE-OW-20	P. 434