



owner.lincoln.com



lincolncanada.com



HH6J19A321 AA



March 2016
First Printing
Owner's Manual
MKZ
Litho in U.S.A.

2017 MKZ Owner's Manual

2017 MKZ



Owner's Manual



The information contained in this publication was correct at the time of going to print. In the interest of continuous development, we reserve the right to change specifications, design or equipment at any time without notice or obligation. No part of this publication may be reproduced, transmitted, stored in a retrieval system or translated into any language in any form by any means without our written permission. Errors and omissions excepted.

© Ford Motor Company 2016

All rights reserved.

Part Number: 20160205164052

Table of Contents

Introduction

About This Manual.....	7
Symbols Glossary.....	7
Data Recording.....	9
California Proposition 65.....	12
Perchlorate.....	12
Lincoln Automotive Financial Services.....	12
Replacement Parts Recommendation.....	13
Special Notices.....	13
Mobile Communications Equipment.....	14
Export Unique Options.....	14

Environment

Protecting the Environment.....	16
---------------------------------	----

Child Safety

General Information.....	17
Installing Child Restraints.....	19
Booster Seats.....	28
Child Restraint Positioning.....	31
Child Safety Locks.....	32

Seatbelts

Principle of Operation.....	34
Fastening the Seatbelts.....	35
Seatbelt Height Adjustment.....	38
Seatbelt Warning Lamp and Indicator Chime.....	39
Seatbelt Reminder.....	40
Child Restraint and Seatbelt Maintenance.....	41
Seatbelt Extension.....	42

Personal Safety System™

Personal Safety System™.....	43
------------------------------	----

Supplementary Restraints System

Principle of Operation.....	44
Driver and Passenger Airbags.....	45
Front Passenger Sensing System.....	47
Side Airbags.....	49
Driver and Passenger Knee Airbags.....	50
Safety Canopy™.....	51
Crash Sensors and Airbag Indicator.....	52

Airbag Disposal.....	53
----------------------	----

Keys and Remote Controls

General Information on Radio Frequencies.....	54
Remote Control.....	55
Replacing a Lost Key or Remote Control.....	59

MyKey™

Principle of Operation.....	60
Creating a MyKey.....	61
Clearing All MyKeys.....	62
Checking MyKey System Status.....	62
Using MyKey With Remote Start Systems.....	63
MyKey Troubleshooting.....	63

Locks

Locking and Unlocking.....	65
Keyless Entry.....	71
Interior Luggage Compartment Release.....	73

Table of Contents

Security

Passive Anti-Theft System.....	75
Anti-Theft Alarm.....	76

Steering Wheel

Adjusting the Steering Wheel.....	78
Audio Control.....	79
Voice Control.....	80
Cruise Control.....	80
Information Display Control.....	80
Heated Steering Wheel.....	81

Wipers and Washers

Windshield Wipers.....	82
Autowipers.....	82
Windshield Washers.....	84

Lighting

Lighting Control.....	85
Autolamps.....	85
Instrument Lighting Dimmer.....	86
Headlamp Exit Delay.....	87
Daytime Running Lamps.....	87

Automatic High Beam Control.....	88
Adaptive Headlamps.....	89
Direction Indicators.....	90
Welcome Lighting.....	91
Interior Lamps.....	91
Ambient Lighting.....	92

Windows and Mirrors

Power Windows.....	93
Global Opening and Closing.....	94
Exterior Mirrors.....	94
Interior Mirror.....	97
Sun Visors.....	98
Sun Shades.....	98
Moonroof.....	98

Instrument Cluster

Gauges.....	101
Warning Lamps and Indicators.....	103
Audible Warnings and Indicators.....	107

Information Displays

General Information.....	108
--------------------------	-----

Information Messages.....	114
---------------------------	-----

Climate Control

Automatic Climate Control.....	134
Hints on Controlling the Interior Climate.....	136
Heated Windows and Mirrors.....	137
Cabin Air Filter.....	138
Remote Start.....	138

Seats

Sitting in the Correct Position.....	139
Head Restraints.....	139
Power Seats.....	141
Memory Function.....	145
Rear Seats.....	146
Heated Seats.....	147
Climate Controlled Seats.....	148
Rear Seat Armrest.....	150

Universal Garage Door Opener

Universal Garage Door Opener.....	151
-----------------------------------	-----

Table of Contents

Auxiliary Power Points

Auxiliary Power Points.....156

Storage Compartments

Center Console.....158

Overhead Console.....158

Starting and Stopping the Engine

General Information.....159

Keyless Starting.....159

Starting a Gasoline Engine.....160

Engine Block Heater.....163

Fuel and Refueling

Safety Precautions.....164

Fuel Quality.....165

Running Out of Fuel.....166

Refueling.....167

Fuel Consumption.....169

Emission Control System.....170

Transmission

Automatic Transmission.....173

All-Wheel Drive

Using All-Wheel Drive.....179

Brakes

General Information.....188

Hints on Driving With Anti-Lock Brakes.....188

Electric Parking Brake.....189

Auto Hold.....191

Traction Control

Principle of Operation.....194

Using Traction Control.....194

Stability Control

Principle of Operation.....196

Using Stability Control.....197

Parking Aids

Principle of Operation.....199

Rear Parking Aid.....200

Front Parking Aid.....200

Side Sensing System.....202

Active Park Assist.....203

Rear View Camera.....211

Cruise Control

Principle of Operation.....215

Using Cruise Control.....215

Using Adaptive Cruise Control.....216

Driving Aids

Driver Alert.....225

Lane Keeping System.....226

Blind Spot Information System.....231

Cross Traffic Alert.....233

Steering.....237

Pre-Collision Assist.....238

Drive Control.....241

Load Carrying

Load Limit.....244

Table of Contents

Towing		
Towing a Trailer.....	249	
Recommended Towing Weights.....	250	
Essential Towing Checks.....	252	
Towing the Vehicle on Four Wheels.....	254	
Driving Hints		
Breaking-In.....	256	
Economical Driving.....	256	
Driving Through Water.....	256	
Floor Mats.....	257	
Roadside Emergencies		
Roadside Assistance.....	259	
Hazard Warning Flashers.....	260	
Fuel Shutoff.....	260	
Jump Starting the Vehicle.....	261	
Post-Crash Alert System.....	264	
Transporting the Vehicle.....	264	
Towing Points.....	265	
Customer Assistance		
Getting the Services You Need.....	267	
In California (U.S. Only).....	268	
The Better Business Bureau (BBB) Auto Line Program (U.S. Only).....	269	
Utilizing the Mediation/Arbitration Program (Canada Only).....	270	
Getting Assistance Outside the U.S. and Canada.....	271	
Ordering Additional Owner's Literature.....	272	
Reporting Safety Defects (U.S. Only).....	273	
Reporting Safety Defects (Canada Only).....	273	
Fuses		
Fuse Specification Chart.....	275	
Changing a Fuse.....	292	
Maintenance		
General Information.....	295	
Opening and Closing the Hood.....	295	
Under Hood Overview - 2.0L.....	297	
Under Hood Overview - 3.0L.....	299	
Engine Oil Dipstick - 2.0L.....	301	
Engine Oil Dipstick - 3.0L.....	301	
Engine Oil Check.....	301	
Oil Change Indicator Reset.....	302	
Engine Coolant Check.....	303	
Automatic Transmission Fluid Check.....	307	
Brake Fluid Check.....	311	
Washer Fluid Check.....	312	
Fuel Filter.....	312	
Changing the 12V Battery.....	312	
Checking the Wiper Blades.....	314	
Changing the Wiper Blades.....	314	
Adjusting the Headlamps.....	315	
Changing a Bulb.....	316	
Bulb Specification Chart.....	316	
Changing the Engine Air Filter.....	319	
Vehicle Care		
General Information.....	320	
Cleaning Products.....	320	
Cleaning the Exterior.....	321	
Waxing.....	322	
Cleaning the Engine.....	322	
Cleaning the Windows and Wiper Blades.....	323	

Table of Contents

Cleaning the Interior.....	323
Cleaning the Instrument Panel and Instrument Cluster Lens.....	325
Cleaning Leather Seats.....	326
Repairing Minor Paint Damage.....	326
Cleaning the Alloy Wheels.....	327
Vehicle Storage.....	327

Wheels and Tires

Tire Sealant and Inflator Kit.....	330
Tire Care.....	337
Using Summer Tires.....	352
Using Snow Chains.....	352
Tire Pressure Monitoring System.....	353
Changing a Road Wheel.....	357
Technical Specifications.....	365

Capacities and Specifications

Engine Specifications - 2.0L.....	367
Engine Specifications - 3.0L.....	368
Motorcraft Parts - 2.0L.....	369
Motorcraft Parts - 3.0L.....	371
Vehicle Identification Number.....	372

Vehicle Certification Label.....	372
Transmission Code Designation.....	373
Capacities and Specifications - 2.0L.....	374
Capacities and Specifications - 3.0L.....	379

Audio System

General Information.....	386
Audio Unit - Vehicles With: Premium AM/ FM/CD.....	387
Media Hub.....	389

SYNC™ 3

General Information.....	390
Home Screen.....	407
Using Voice Recognition.....	408
Entertainment.....	419
Climate.....	432
Phone.....	436
Navigation.....	444
Apps.....	454
Settings.....	457
SYNC™ 3 Troubleshooting.....	474

Accessories

Accessories.....	491
------------------	-----

Lincoln Protect

Lincoln Protect.....	493
----------------------	-----

Scheduled Maintenance

General Maintenance Information.....	495
Normal Scheduled Maintenance.....	499
Special Operating Conditions Scheduled Maintenance.....	503
Scheduled Maintenance Record.....	507

Appendices

End User License Agreement.....	527
Type Approvals.....	546

Introduction

ABOUT THIS MANUAL

Thank you for choosing Lincoln. We recommend that you take some time to get to know your vehicle by reading this manual. The more that you know about it, the greater the safety and pleasure you will get from driving it.

WARNING



Driving while distracted can result in loss of vehicle control, crash and injury. We strongly recommend that you use extreme caution when using any device that may take your focus off the road. Your primary responsibility is the safe operation of your vehicle. We recommend against the use of any hand-held device while driving and encourage the use of voice-operated systems when possible. Make sure you are aware of all applicable local laws that may affect the use of electronic devices while driving.

Note: *This manual describes product features and options available throughout the range of available models, sometimes even before they are generally available. It may describe options not fitted to the vehicle you have purchased.*

Note: *Some of the illustrations in this manual may show features as used in different models, so may appear different to you on your vehicle.*

Note: *Always use and operate your vehicle in line with all applicable laws and regulations.*

Note: *Pass on this manual when selling your vehicle. It is an integral part of your vehicle.*

This manual may qualify the location of a component as left-hand side or right-hand side. The side is determined when facing forward in the seat.

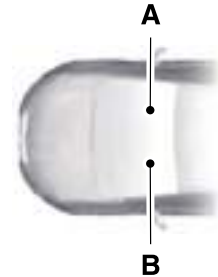

E154903

- A Right-hand side.
- B Left-hand side.

SYMBOLS GLOSSARY

These are some of the symbols you may see on your vehicle.



Safety alert



See Owner's Manual

Introduction



Air conditioning system



Anti-lock braking system



Avoid smoking, flames or sparks



Battery



Battery acid



Brake fluid - non petroleum based



Brake system



Cabin air filter



Check fuel cap



Child safety door lock or unlock



Child seat lower anchor



Child seat tether anchor



Cruise control



Do not open when hot



Engine air filter



Engine coolant



Engine coolant temperature



Engine oil



Explosive gas



Fan warning



Fasten seatbelt



Front airbag



Front fog lamps



Fuel pump reset



Fuse compartment



Hazard warning flashers



Heated rear window

Introduction



Heated windshield



Interior luggage compartment release



Jack



Keep out of reach of children



Lighting control



Low tire pressure warning



Maintain correct fluid level



Note operating instructions



Panic alarm



Parking aid



Parking brake



Power steering fluid



Power windows front/rear



Power window lockout



Service engine soon



Side airbag



Shield the eyes



Stability control



Windshield wash and wipe

DATA RECORDING

Service Data Recording

Service data recorders in your vehicle are capable of collecting and storing diagnostic information about your vehicle. This potentially includes information about the performance or status of various systems and modules in the vehicle, such as engine, throttle, steering or brake systems. In order to properly diagnose and service your vehicle, Ford Motor Company (Ford of Canada in Canada), and service and repair facilities may access or share among them vehicle diagnostic information received through a direct connection to your vehicle when diagnosing or servicing your vehicle. Additionally, Ford Motor Company (Ford of Canada, in Canada) may, where permitted by law, use vehicle diagnostic information for vehicle improvement or with other information we may have about you, (e.g., your contact information), to offer you

Introduction

products or services that may interest you. Data may be provided to our service providers such as part suppliers that may help diagnose malfunctions, and who are similarly obligated to protect data. We retain this data only as long as necessary to perform these functions or to comply with law. We may provide information where required in response to official requests to law enforcement or other government authorities or third parties acting with lawful authority or court order, and such information may be used in legal proceedings. For U.S. only (if equipped), if you choose to use connected apps and services, such as SYNC Vehicle Health Report or MyFord Mobile App, you consent that certain diagnostic information may also be accessed electronically by Ford Motor Company and Ford authorized service facilities, and that the diagnostic information may be used to provide services to you, personalizing your experience, troubleshoot, and to improve products and services and offer you products and services that may interest you, where permitted by law. For Canada only, for more information, please review the Ford of Canada privacy policy at www.ford.ca,

including our U.S. data storage and use of service providers in other jurisdictions who may be subject to legal requirements in Canada, the United States and other countries applicable to them, for example, lawful requirements to disclose personal information to governmental authorities in those countries. See **SYNC™ 3** (page 390).

Event Data Recording

This vehicle is equipped with an event data recorder. The main purpose of an event data recorder is to record, in certain crash or near crash-like situations, such as an airbag deployment or hitting a road obstacle; this data will assist in understanding how a vehicle's systems performed. The event data recorder is designed to record data related to vehicle dynamics and safety systems for a short period of time, typically 30 seconds or less.

The event data recorder in this vehicle is designed to record such data as:

- **How various systems in your vehicle were operating;**
- **Whether or not the driver and passenger safety belts were buckled/fastened;**
- **How far (if at all) the driver was depressing the accelerator and/or the brake pedal; and**
- **How fast the vehicle was traveling; and**
- **Where the driver was positioning the steering wheel.**

This data can help provide a better understanding of the circumstances in which crashes and injuries occur.

Introduction

Note: *Event data recorder data is recorded by your vehicle only if a non-trivial crash situation occurs; no data is recorded by the event data recorder under normal driving conditions and no personal data or information (e.g., name, gender, age, and crash location) is recorded (see limitations regarding 911 Assist and Traffic, directions and Information privacy below). However, parties, such as law enforcement, could combine the event data recorder data with the type of personally identifying data routinely acquired during a crash investigation.*

To read data recorded by an event data recorder, special equipment is required, and access to the vehicle or the event data recorder is needed. In addition to the vehicle manufacturer, other parties, such as law enforcement, that have such special equipment, can read the information if they have access to the vehicle or the event data recorder. Ford Motor Company and Ford of Canada do not access event data recorder information without obtaining consent, unless pursuant to court order or

where required by law enforcement, other government authorities or other third parties acting with lawful authority. Other parties may seek to access the information independently of Ford Motor Company and Ford of Canada.

Note: *Including to the extent that any law pertaining to Event Data Recorders applies to SYNC or its features, please note the following: Once 911 Assist (if equipped) is enabled (set ON), 911 Assist may, through any paired and connected cell phone, disclose to emergency services that the vehicle has been in a crash involving the deployment of an airbag or, in certain vehicles, the activation of the fuel pump shut-off. Certain versions or updates to 911 Assist may also be capable of being used to electronically or verbally provide to 911 operators the vehicle location (such as latitude and longitude), and/or other details about the vehicle or crash or personal information about the occupants to assist 911 operators to provide the most appropriate emergency services. If you do not want to disclose this information, do not activate the 911 Assist feature. See SYNC™ 3 (page 390).*

Introduction

Additionally, when you connect to Traffic, Directions and Information (if equipped, U.S. only), the service uses GPS technology and advanced vehicle sensors to collect the vehicle's current location, travel direction, and speed ("vehicle travel information"), only to help provide you with the directions, traffic reports, or business searches that you request. If you do not want Ford or its vendors to receive this information, do not activate the service. For more information, see Traffic, Directions and Information, Terms and Conditions. See SYNC™ 3 (page 390).

CALIFORNIA PROPOSITION 65

WARNINGS

 Some constituents of engine exhaust, certain vehicle components, certain fluids contained in vehicles and certain products of component wear contain or emit chemicals known to the State of California to cause cancer and birth defects or other reproductive harm.

WARNINGS

 Battery posts, terminals and related accessories contain lead and lead compounds, chemicals known to the State of California to cause cancer and reproductive harm. Batteries also contain other chemicals known to the State of California to cause cancer. Wash your hands after handling.

PERCHLORATE

Certain components in your vehicle such as airbag modules, seatbelt pretensioners and remote control batteries may contain perchlorate material. Special handling may apply for service or vehicle end of life disposal.

For more information visit:

Web Address
www.dtsc.ca.gov/hazard-ouswaste/perchlorate

LINCOLN AUTOMOTIVE FINANCIAL SERVICES

Lincoln Automotive Financial Services offers a full range of financing and lease plans to help you acquire your vehicle. We are dedicated to providing answers, information and a truly extraordinary experience.

Use the options below to contact us with questions about your account or financing and we will respond promptly:

Web Address
www.LincolnAFS.com

Phone: 1-888-498-8801

Mail: Lincoln Automotive Financial Services

Introduction

P.O. Box 542000
Omaha, NE 68154-8000

REPLACEMENT PARTS RECOMMENDATION

We have built your vehicle to the highest standards using quality parts. We recommend that you demand the use of genuine Ford and Motorcraft parts whenever your vehicle requires scheduled maintenance or repair. You can clearly identify genuine Ford and Motorcraft parts by looking for the Ford, FoMoCo or Motorcraft branding on the parts or their packaging.

Scheduled Maintenance and Mechanical Repairs

One of the best ways for you to make sure that your vehicle provides years of service is to have it maintained in line with our recommendations using parts that conform to the specifications detailed in this Owner's Manual. Genuine Ford and Motorcraft parts meet or exceed these specifications.

Collision Repairs

We hope that you never experience a collision, but accidents do happen. Genuine Ford replacement collision parts meet our stringent requirements for fit, finish, structural integrity, corrosion protection and dent resistance. During vehicle development we validate that these parts deliver the intended level of protection as a whole system. A great way to know for sure you are getting this level of protection is to use genuine Ford replacement collision parts.

Warranty on Replacement Parts

Genuine Ford and Motorcraft replacement parts are the only replacement parts that benefit from a Lincoln Warranty. Damage caused to your vehicle as a result of the failure of non-Ford parts may not be covered by the Lincoln Warranty. For additional information, refer to the terms and conditions of the Lincoln Warranty.

SPECIAL NOTICES

New Vehicle Limited Warranty

For a detailed description of what is covered and what is not covered by your vehicle's New Vehicle Limited Warranty, refer to the Warranty Manual that is provided to you along with your Owner's Manual.

Special Instructions

For your added safety, your vehicle is fitted with sophisticated electronic controls.

WARNINGS



You risk death or serious injury to yourself and others if you do not follow the instruction highlighted by the warning symbol. Failure to follow the specific warnings and instructions could result in personal injury.



Never place front seat mounted rear-facing child or infant seats in front of an active passenger airbag.

Introduction

On Board Diagnostics Data Link Connector

WARNING

 Use of wireless plug-in devices in the OBD Data Link Connector (DLC) may allow unauthorized third parties to gain access to vehicle systems and data which could impair the function of various vehicle systems, including safety-related systems. The DLC should only be used by a repair facility that operates in accordance with Ford's service and repair instructions.

Your vehicle has an OBD Data Link Connector (DLC) that is used in conjunction with a diagnostic scan tool for vehicle diagnostics, repairs and reprogramming services. Installing an aftermarket device that uses the DLC during normal driving for purposes such as remote insurance company monitoring, transmission of vehicle data to other devices or entities, or altering the performance of the vehicle, may cause

interference with or even damage to vehicle systems. We do not recommend or endorse the use of aftermarket plug-in devices unless approved by Ford. The vehicle Warranty will not cover damage caused by an aftermarket plug-in device.

MOBILE COMMUNICATIONS EQUIPMENT

WARNING

 Driving while distracted can result in loss of vehicle control, crash and injury. We strongly recommend that you use extreme caution when using any device that may take your focus off the road. Your primary responsibility is the safe operation of your vehicle. We recommend against the use of any hand-held device while driving and encourage the use of voice-operated systems when possible. Make sure you are aware of all applicable local laws that may affect the use of electronic devices while driving.

Using mobile communications equipment is becoming increasingly important in the conduct of business and personal affairs. However, you must not compromise your own or others' safety when using such equipment. Mobile communications can enhance personal safety and security when appropriately used, particularly in emergency situations. Safety must be paramount when using mobile communications equipment to avoid negating these benefits. Mobile communication equipment includes, but is not limited to, cellular phones, pagers, portable email devices, text messaging devices and portable two-way radios.

EXPORT UNIQUE OPTIONS

For your particular global region, your vehicle may be equipped with features and options that are different from the features and options that are described in this Owner's Manual. A market unique supplement may be supplied that complements this book. By referring to the market unique supplement, if provided, you can properly identify those features, recommendations and

Introduction

specifications that are unique to your vehicle. This Owner's Manual is written primarily for the U.S. and Canadian Markets. Features or equipment listed as standard may be different on units built for Export. **Refer to this Owner's Manual for all other required information and warnings.**

Environment

PROTECTING THE ENVIRONMENT

You must play your part in protecting the environment. Correct vehicle usage and the authorized disposal of waste, cleaning and lubrication materials are significant steps toward this aim.

Child Safety

GENERAL INFORMATION

See the following sections for directions on how to properly use safety restraints for children.

WARNINGS



Always make sure your child is secured properly in a device that is appropriate for their height, age and weight. Child safety restraints must be bought separately from your vehicle. Failure to follow these instructions and guidelines may result in an increased risk of serious injury or death to your child.

WARNINGS



All children are shaped differently. The recommendations for safety restraints are based on probable child height, age and weight thresholds from the National Highway Traffic Safety Administration and other safety organizations, or are the minimum requirements of law. We recommend checking with a NHTSA Certified Child Passenger Safety Technician (CPST) and consult your pediatrician to make sure your child seat is appropriate for your child, and is compatible with and properly installed in your vehicle. To locate a child seat fitting station and CPST, contact NHTSA toll free at 1-888-327-4236 or go to <http://www.nhtsa.dot.gov>. In Canada, contact

WARNINGS



Transport Canada toll free at 1-800-333-0371 or go to www.tc.gc.ca to find a Child Car Seat Clinic in your area. Failure to properly restrain children in safety seats made especially for their height, age, and weight may result in an increased risk of serious injury or death to your child.



Do not leave children or animals unattended in the vehicle. On hot days, the temperature in the trunk or vehicle interior can rise very quickly. Exposure of people or animals to these high temperatures for even a short time can cause death or serious heat-related injuries, including brain damage. Small children are particularly at risk.

Child Safety

Recommendations for Safety Restraints for Children

Child	Child size, height, weight, or age	Recommended restraint type
Infants or toddlers	Children weighing 40 lb (18 kg) or less (generally age four or younger).	Use a child safety seat (sometimes called an infant carrier, convertible seat, or toddler seat).
Small children	Children who have outgrown or no longer properly fit in a child safety seat (generally children who are less than 4 ft. 9 in. (1.45 m) tall, are greater than age four and less than age 12, and between 40 lb (18 kg) and 80 lb (36 kg) and upward to 100 lb (45 kg) if recommended by your child restraint manufacturer).	Use a belt-positioning booster seat.
Larger children	Children who have outgrown or no longer properly fit in a belt-positioning booster seat (generally children who are at least 4 ft. 9 in. (1.45 m) tall or greater than 80 lb (36 kg) or 100 lb (45 kg) if recommended by child restraint manufacturer).	Use a vehicle safety belt having the lap belt snug and low across the hips, shoulder belt centered across the shoulder and chest, and seat back upright.

Child Safety

- You are required by law to properly use safety seats for infants and toddlers in the United States and Canada.
- Many states and provinces require that small children use approved booster seats until they reach age eight, a height of 4 feet 9 inches (1.45 meters) tall, or 80 pounds (36 kilograms). Check your local and state or provincial laws for specific requirements about the safety of children in your vehicle.
- When possible, always properly restrain children 12 years of age and under in a rear seating position of your vehicle. Accident statistics suggest that children are safer when properly restrained in the rear seating positions than in a front seating position. See **Front Passenger Sensing System** (page 47).

INSTALLING CHILD RESTRAINTS

Child Seats



E142594

Use a child safety seat (sometimes called an infant carrier, convertible seat, or toddler seat) for infants, toddlers, or children weighing 40 pounds (18 kilograms) or less (generally age four or younger).

Using Lap and Shoulder Belts

WARNINGS

- ⚠️ Airbags can kill or injure a child in a child seat. Never place a rear-facing child seat in front of an active airbag. If you must use a forward-facing child seat in the front seat, move the seat upon which the child seat is installed all the way back.
- ⚠️ Airbags can kill or injure a child in a child seat. Children 12 and under should be properly restrained in the rear seat whenever possible.
- ⚠️ Depending on where you secure a child restraint, and depending on the child restraint design, you may block access to certain safety belt buckle assemblies and LATCH lower anchors, rendering those features potentially unusable. To avoid risk of injury, occupants should only use seating positions where they are able to be properly restrained.

Child Safety

When installing a child safety seat with combination lap and shoulder belts:

- Use the correct safety belt buckle for that seating position.
- Insert the belt tongue into the proper buckle until you hear a snap and feel it latch. Make sure the tongue is securely fastened in the buckle.
- Keep the buckle release button pointing up and away from the safety seat, with the tongue between the child seat and the release button, to prevent accidental unbuckling.
- Place the vehicle seat upon which the child seat will be installed in the upright position.
- Put the safety belt in the automatic locking mode. See Step 5. This vehicle does not require the use of a locking clip.

Perform the following steps when installing the child seat with combination lap and shoulder belts:

Note: Although the child seat illustrated is a forward facing child seat, the steps are the same for installing a rear facing child seat.

Standard safety belts



E142528

1. Position the child safety seat in a seat with a combination lap and shoulder belt.



E142529

2. After positioning the child safety seat in the proper seating position, pull down on the shoulder belt and then grasp the shoulder belt and lap belt together behind the belt tongue.



E142530

3. While holding the shoulder and lap belt portions together, route the tongue through the child seat according to the child seat manufacturer's instructions. Be sure the belt webbing is not twisted.

Child Safety

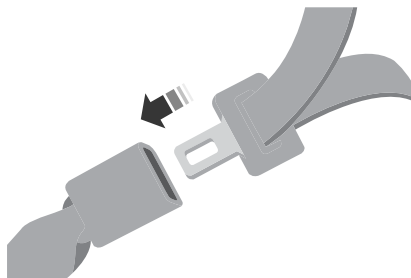

E142531

4. Insert the belt tongue into the proper buckle (the buckle closest to the direction the tongue is coming from) for that seating position until you hear a snap and feel the latch engage. Make sure the tongue is latched securely by pulling on it.



E142875

5. To put the retractor in the automatic locking mode, grasp the shoulder portion of the belt and pull downward until all of the belt is pulled out.

Note: *The automatic locking mode is available on the front passenger and rear seats.*

6. Allow the belt to retract to remove slack. The belt will click as it retracts to indicate it is in the automatic locking mode.

7. Try to pull the belt out of the retractor to make sure the retractor is in the automatic locking mode (you should not be able to pull more belt out). If the retractor is not locked, unbuckle the belt and repeat Steps 5 and 6.



E142533

8. Remove remaining slack from the belt. Force the seat down with extra weight, for example, by pressing down or kneeling on the child restraint while pulling up on the shoulder belt in order to force slack from the belt. This is necessary to remove the remaining slack that will exist once the extra weight of

Child Safety

the child is added to the child restraint. It also helps to achieve the proper snugness of the child seat to your vehicle. Sometimes, a slight lean toward the buckle will provide extra help to remove remaining slack from the belt.

9. Attach the tether strap (if the child seat is equipped).

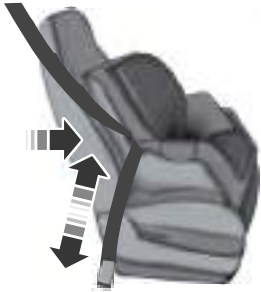

E142534

10. Before placing the child in the seat, forcibly move the seat forward and back to make sure the seat is securely held in place. To check this, grab the seat at the belt path and attempt to move it side to side and forward and back. There should be no more than 1 inch (2.5 centimeters) of movement for proper installation.

We recommend checking with a NHTSA Certified Child Passenger Safety Technician to make certain the child restraint is properly installed. In Canada, check with Transport Canada for referral to a Child Car Seat Clinic.

Inflatable safety belts



E142528

1. Position the child safety seat in a seat with a combination lap and shoulder belt.

Child Safety



E146522

2. After positioning the child safety seat in the proper seating position, grasp the shoulder belt and lap belt together behind the belt tongue.



E142530

3. While holding the shoulder and lap belt portions together, route the tongue through the child seat according to the child seat manufacturer's instructions. Be sure the belt webbing is not twisted.

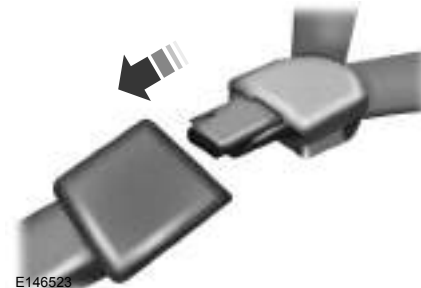

E146523

4. Insert the belt tongue into the proper buckle (the buckle closest to the direction the tongue is coming from) for that seating position until you hear a snap and feel the latch engage. Make sure the tongue is latched securely by pulling on it.

Child Safety



E146524

5. To put the retractor in the automatic locking mode, grasp the lap portion of the inflatable safety belt and pull upward until all of the belt is pulled out.

Note: The automatic locking mode is available on the front passenger and rear seats.

Note: Unlike the standard safety belt, the inflatable safety belt's unique lap portion locks the child seat for installation. The ability for the shoulder portion of the belt to move freely is normal, even after the lap belt has been put into the automatic locking mode.

Note: The lock-off device on some child restraints may not accommodate the shoulder portion of the inflatable safety belt. Follow all instructions provided by the manufacturer of the child restraint regarding the necessary and proper use of the lock-off device. In some instances, these devices have been provided only for use in vehicles with safety belt systems that would otherwise require a locking clip.

6. Allow the belt to retract to remove slack. The belt will click as it retracts to indicate it is in the automatic locking mode.
7. Try to pull the belt out of the retractor to make sure the retractor is in the automatic locking mode (you should not be able to pull more belt out). If the retractor is not locked, unbuckle the belt and repeat Steps 5 and 6.

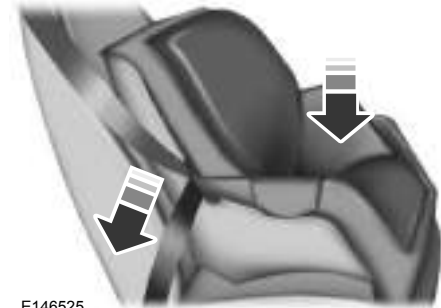

E146525

8. Remove remaining slack from the belt. Force the seat down with extra weight, for example, by pressing down or kneeling on the child restraint while pulling down on the lap belt in order to force slack from the belt. This is necessary to remove the remaining slack that will exist once the extra weight of the child is added to the child restraint. It also helps to achieve the proper snugness of the child seat to your vehicle. Sometimes, a slight lean toward the buckle will additionally help to remove remaining slack from the belt.

Child Safety

9. Attach the tether strap (if the child seat is equipped).

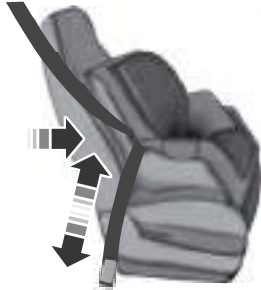



E142534

10. Before placing the child in the seat, forcibly move the seat forward and back to make sure the seat is securely held in place. To check this, grab the seat at the belt path and attempt to move it side to side and forward and back. There should be no more than 1 inch (2.5 centimeters) of movement for proper installation.

We recommend checking with a NHTSA Certified Child Passenger Safety Technician to make certain the child restraint is properly installed. In Canada, check with Transport Canada for referral to a Child Car Seat Clinic.

Using Lower Anchors and Tethers for Children (LATCH)

WARNINGS

-  Never attach two child safety seats to the same anchor. In a collision, one anchor may not be strong enough to hold two child safety seat attachments and may break, causing serious injury or death.
-  Depending on where you secure a child restraint, and depending on the child restraint design, you may block access to certain safety belt buckle assemblies or LATCH lower anchors, rendering those features potentially unusable. To avoid risk of injury, occupants should only use seating positions where they are able to be properly restrained.

The LATCH system is composed of three vehicle anchor points: two lower anchors located where seat back and seat cushion meet (called the seat bight) and one top tether anchor located behind that seating position.

LATCH compatible child safety seats have two rigid or webbing mounted attachments that connect to the two lower anchors at the LATCH equipped seating positions in your vehicle. This type of attachment method eliminates the need to use safety belts to attach the child seat, however the safety belt can still be used to attach the child seat. For forward-facing child seats, the top tether strap must also be attached to the proper top tether anchor, if a top tether strap has been provided with your child seat.

Child Safety

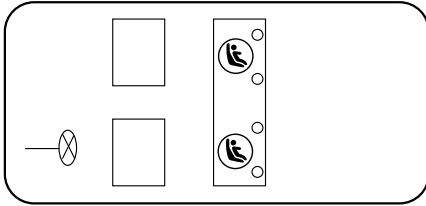

E142535

Your vehicle has LATCH lower anchors for child seat installation at the seating positions marked with the child seat symbol.



E144054

The LATCH anchors are located at the rear section of the rear seat between the cushion and seat back below the symbols as shown. Follow the child seat manufacturer's instructions to properly install a child seat with LATCH attachments. Follow the instructions on attaching child safety seats with tether straps.

Attach LATCH lower attachments of the child seat only to the anchors shown.

Use of Inboard Lower Anchors from the Outboard Seating Positions (Center Seating Use)

WARNING



The standardized spacing for LATCH lower anchors is 11 inches (28 centimeters) center to center. Do not use LATCH lower anchors for the center seating position unless the child seat manufacturer's instructions permit and specify using anchors spaced at least as far apart as those in this vehicle.

The lower anchors at the center of the second row rear seat are spaced 18 inches (46 centimeters) apart. A child seat with rigid LATCH attachments cannot be installed at the center seating position. LATCH compatible child seats (with attachments on belt webbing) can only be used at this seating position provided that the child seat manufacturer's instructions permit use with the anchor spacing stated. Do not attach a child seat to any lower anchor if an adjacent child seat is attached to that anchor.

Each time you use the safety seat, check that the seat is properly attached to the lower anchors and tether anchor, if applicable. Tug the child seat from side to side and forward and back where it is secured to your vehicle. The seat should move less than one inch when you do this for a proper installation.

If the safety seat is not anchored properly, the risk of a child being injured in a crash greatly increases.

Child Safety

Combining Safety Belt and LATCH Lower Anchors for Attaching Child Safety Seats

When used in combination, either the safety belt or the LATCH lower anchors may be attached first, provided a proper installation is achieved. Attach the tether strap afterward, if included with the child seat.

Using Tether Straps



Many forward-facing child safety seats include a tether strap which extends from the back of the child safety seat and hooks to an anchoring point called the top tether anchor. Tether straps are available as an accessory for many older safety seats.

Contact the manufacturer of your child seat for information about ordering a tether strap, or to obtain a longer tether strap if the tether strap on your safety seat does not reach the appropriate top tether anchor in your vehicle.

Once the child safety seat has been installed using either the safety belt, the lower anchors of the LATCH system, or both, you can attach the top tether strap.

The tether strap anchors in your vehicle are in the following positions (shown from top view):

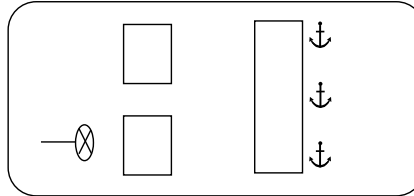

E142537

Perform the following steps to install a child safety seat with tether anchors:

Note: *If you install a child seat with rigid LATCH attachments, do not tighten the tether strap enough to lift the child seat off your vehicle seat cushion when the child is seated in it. Keep the tether strap just snug without lifting the front of the child seat. Keeping the child seat just touching your vehicle seat gives the best protection in a severe crash.*

1. Route the child safety seat tether strap over the back of the seat. For outboard seating positions, route the tether strap under the head restraint and between the head restraint posts. For the center seating positions, route the tether strap over the top of the head restraint. If needed, the head restraints can also be removed.



E144274

2. Locate the correct anchor for the selected seating position, then open the tether anchor cover.

Child Safety



E144275

3. Clip the tether strap to the anchor as shown.
4. Tighten the child safety seat tether strap according to the manufacturer's instructions.

If your child restraint system is equipped with a tether strap, and the child restraint manufacturer recommends its use, we also recommend its use.

BOOSTER SEATS

WARNING

 Never place, or allow a child to place, the shoulder belt under a child's arm or behind the back because it reduces the protection for the upper part of the body and may increase the risk of injury or death in a crash.

Note: *Some booster seat safety belt guides may not accommodate the shoulder portion of the inflatable safety belt.*

Use a belt-positioning booster seat for children who have outgrown or no longer properly fit in a child safety seat (generally children who are less than 4 feet 9 inches (1.45 meters) tall, are greater than age four (4) and less than age twelve (12), and between 40 pounds (18 kilograms) and 80 pounds (36 kilograms) and upward to 100

pounds (45 kilograms) if recommended by your child restraint manufacturer). Many state and provincial laws require that children use approved booster seats until they reach age eight, a height of 4 feet 9 inches (1.45 meters) tall, or 80 pounds (36 kilograms).

Booster seats should be used until you can answer YES to ALL of these questions when seated without a booster seat:

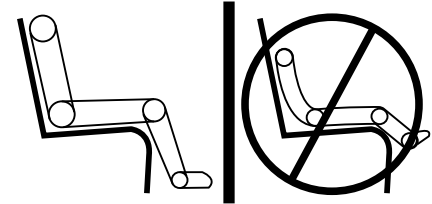

E142595

- Can the child sit all the way back against their vehicle seat back with knees bent comfortably at the edge of the seat cushion?
- Can the child sit without slouching?

Child Safety

- Does the lap belt rest low across the hips?
- Is the shoulder belt centered on the shoulder and chest?
- Can the child stay seated like this for the whole trip?

Always use booster seats in conjunction with your vehicle lap and shoulder belt.

Types of Booster Seats



E68924

- Backless booster seats

If your backless booster seat has a removable shield, remove the shield. If a vehicle seating position has a low seat back or no head restraint, a backless booster seat may place your child's head (as measured at the tops of the ears) above the top of the seat. In this case, move the backless booster to another seating position with a higher seat back or head restraint and lap and shoulder belts, or consider using a high back booster seat.



E70710

- High back booster seats

If, with a backless booster seat, you cannot find a seating position that adequately supports your child's head, a high back booster seat would be a better choice.

Children and booster seats vary in size and shape. Choose a booster that keeps the lap belt low and snug across the hips, never up across the stomach, and lets you adjust the shoulder belt to cross the chest and rest snugly near the center of the shoulder. The following drawings compare the ideal fit (center) to a shoulder belt uncomfortably close to the neck and a shoulder belt that could slip off the shoulder. The drawings also show how the lap belt should be low and snug across the child's hips.

Child Safety



E142596



E142597

Child Safety

If the booster seat slides on the vehicle seat upon which it is being used, placing a rubberized mesh sold as shelf or carpet liner under the booster seat may improve this condition. Do not introduce any item thicker than this under the booster seat. Check with the booster seat manufacturer's instructions.

CHILD RESTRAINT POSITIONING

WARNINGS

 Airbags can kill or injure a child in a child seat. Never place a rear-facing child seat in front of an active airbag. If you must use a forward-facing child seat in the front seat, move the vehicle seat upon which the child seat is installed all the way back. When possible, all children age 12 and under should be properly restrained in a rear seating position. If all children cannot be seated and restrained properly in a rear seating position, properly restrain the largest child in the front seat.

WARNINGS

 Always carefully follow the instructions and warnings provided by the manufacturer of any child restraint to determine if the restraint device is appropriate for your child's size, height, weight, or age. Follow the child restraint manufacturer's instructions and warnings provided for installation and use in conjunction with the instructions and warnings provided by your vehicle manufacturer. A safety seat that is improperly installed or utilized, is inappropriate for your child's height, age, or weight or does not properly fit the child may increase the risk of serious injury or death.

 Never let a passenger hold a child on his or her lap while your vehicle is moving. The passenger cannot protect the child from injury in a crash, which may result in serious injury or death.

WARNINGS

 Never use pillows, books, or towels to boost a child. They can slide around and increase the likelihood of injury or death in a crash.

 Always restrain an unoccupied child seat or booster seat. These objects may become projectiles in a crash or sudden stop, which may increase the risk of serious injury.

 Never place, or allow a child to place, the shoulder belt under a child's arm or behind the back because it reduces the protection for the upper part of the body and may increase the risk of injury or death in a crash.

 To avoid risk of injury, do not leave children or pets unattended in your vehicle.

Child Safety

Recommendations for attaching child safety restraints for children

Restraint Type	Combined weight of child and child seat	Use any attachment method as indicated below by X				
		LATCH (lower anchors and top tether anchor)	LATCH (lower anchors only)	Safety belt and top tether anchor	Safety belt and LATCH (lower anchors and top tether anchor)	Safety belt only
Rear facing child seat	Up to 65 lb (29.5 kg)		X			X
Rear facing child seat	Over 65 lb (29.5 kg)					X
Forward facing child seat	Up to 65 lb (29.5 kg)	X		X	X	
Forward facing child seat	Over 65 lb (29.5 kg)			X	X	

Note: *The child seat must rest tightly against the vehicle seat upon which it is installed. It may be necessary to lift or remove the head restraint. See **Seats** (page 139).*

CHILD SAFETY LOCKS

When these locks are set, the rear doors cannot be opened from the inside.

Child Safety



Right-Hand Side

Turn clockwise to lock and counterclockwise to unlock.

E112197

The childproof locks are located on the rear edge of each rear door and must be set separately for each door.

Left-Hand Side

Turn counterclockwise to lock and clockwise to unlock.

Seatbelts

PRINCIPLE OF OPERATION

WARNINGS

 Always drive and ride with your seatback upright and the lap belt snug and low across the hips.

 To reduce the risk of injury, make sure children sit where they can be properly restrained.

 Never let a passenger hold a child on his or her lap while the vehicle is moving. The passenger cannot protect the child from injury in a crash.

 All occupants of your vehicle, including the driver, should always properly wear their seatbelts, even when an airbag supplemental restraint system is provided. Failure to properly wear your seatbelt could seriously increase the risk of injury or death.

WARNINGS

 It is extremely dangerous to ride in a cargo area, inside or outside of a vehicle. In a crash, people riding in these areas are more likely to be seriously injured or killed. Do not allow people to ride in any area of your vehicle that is not equipped with seats and seatbelts. Be sure everyone in your vehicle is in a seat and using a seatbelt properly.

 In a rollover crash, an unbelted person is significantly more likely to die than a person wearing a seatbelt.

 Each seating position in your vehicle has a specific seatbelt assembly which is made up of one buckle and one tongue that are designed to be used as a pair. 1) Use the shoulder belt on the outside shoulder only. Never wear the shoulder belt under the arm. 2) Never swing the seatbelt around your neck over the inside shoulder. 3) Never use a single belt for more than one person.

 Airbags can kill or injure a child in a child restraint. Properly restrain children 12 and under in the rear seat whenever possible.

WARNINGS

 Seatbelts and seats can become hot in a vehicle that has been closed up in sunny weather. They could burn a small child. Check seat covers and buckles before you place a child anywhere near them.

 Front and rear seat occupants, including pregnant women, should wear seatbelts for optimum protection in an accident.

All seating positions in your vehicle have lap and shoulder seatbelts. All occupants of the vehicle should always properly wear their seatbelts, even when an airbag supplemental restraint system is provided.

The seatbelt system consists of:

- Lap and shoulder seatbelts.
- Shoulder seatbelt with automatic locking mode, (except driver seatbelt).
- Height adjuster at the front outboard seating positions.
- Seatbelt pretensioner at the front outboard seating positions.

Seatbelts



- Seatbelt warning light and chime.



- Crash sensors and monitoring system with readiness indicator.

The seatbelt pretensioners at the front seating positions are designed to tighten the seatbelts when activated. In frontal and near-frontal crashes, the seatbelt pretensioners may be activated alone or, if the crash is of sufficient severity, together with the front airbags. The pretensioners may also activate when the Safety Canopy is deployed.

FASTENING THE SEATBELTS

Standard belts shown, inflatable belts similar

The front outboard and rear safety restraints in the vehicle are combination lap and shoulder belts.



E142587

1. Insert the belt tongue into the proper buckle (the buckle closest to the direction the tongue is coming from) until you hear a snap and feel it latch. Make sure you securely fasten the tongue in the buckle.

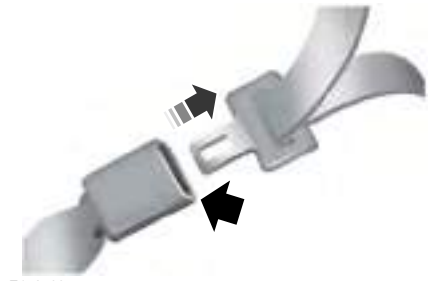

E142588

2. To unfasten, press the release button and remove the tongue from the buckle.

Using Seatbelts During Pregnancy

WARNING

 Always ride and drive with your seatback upright and the belt properly fastened. The lap portion of the seatbelt should fit snug and be positioned low across the hips. The shoulder portion of the seatbelt should be positioned across the chest. Pregnant women should also follow this practice. See the following figure.

Seatbelts

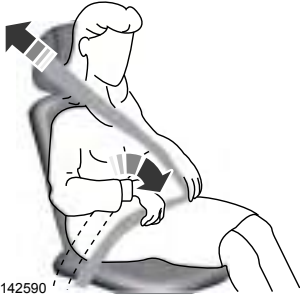

E142590

Pregnant women should always wear their seatbelt. The lap belt portion of a combination lap and shoulder belt should be positioned low across the hips below the belly and worn as tight as comfort will allow. The shoulder belt should be positioned to cross the middle of the shoulder and the center of the chest.

Seatbelt Locking Modes

WARNINGS



After any vehicle crash, the seatbelt system at all passenger seating positions must be checked by an authorized dealer to verify that the automatic locking retractor feature for child seats is still functioning properly. In addition, all seatbelts should be checked for proper function.



The belt and retractor assembly must be replaced if the seatbelt assembly automatic locking retractor feature or any other seatbelt function is not operating properly when checked by an authorized dealer. Failure to replace the belt and retractor assembly could increase the risk of injury in crashes.

All safety restraints in the vehicle are combination lap and shoulder belts. The driver seatbelt has the vehicle sensitive locking mode. The front outboard passenger and rear seatbelts have both the vehicle sensitive locking mode and the automatic locking mode.

Vehicle Sensitive Mode

This is the normal retractor mode, which allows free shoulder belt length adjustment to your movements and locking in response to vehicle movement. For example, if the driver brakes suddenly or turns a corner sharply, or the vehicle receives an impact of about 5 mph (8 km/h) or more, the combination seatbelts will lock to help reduce forward movement of the driver and passengers.

In addition, the retractor is designed to lock if the webbing is pulled out too quickly. If this occurs, let the belt retract slightly and pull webbing out again in a slow and controlled manner.

Automatic Locking Mode

In this mode, the shoulder belt is automatically pre-locked. The belt will still retract to remove any slack in the shoulder belt. The automatic locking mode is not available on the driver seatbelt.

Seatbelts

When to Use the Automatic Locking Mode

This mode should be used any time a child safety seat, except a booster, is installed in passenger front or rear seating positions. Children 12 years old and under should be properly restrained in a rear seating position whenever possible. See **Child Safety** (page 17).

How to Use the Automatic Locking Mode

Standard seatbelts



E142591

1. Buckle the combination lap and shoulder belt.

2. Grasp the shoulder portion and pull downward until the entire belt is pulled out. As the belt retracts, you will hear a clicking sound. This indicates the seatbelt is now in the automatic locking mode.

Rear outboard inflatable seatbelts (second row only—if equipped)



E146363

1. Buckle the combination lap and shoulder belt.
2. Grasp the lap portion of the belt and pull upward until the entire belt is pulled out.



3. Allow the belt to retract. As the belt retracts, you will hear a clicking sound. This indicates the seatbelt is now in the automatic locking mode.

How to Disengage the Automatic Locking Mode

Unbuckle the combination lap and shoulder belt and allow it to retract completely to disengage the automatic locking mode and activate the vehicle sensitive (emergency) locking mode.

Rear Inflatable Seatbelt (If Equipped)

WARNINGS

-  Do not attempt to service, repair, or modify the rear inflatable seatbelt.
-  If the rear inflatable seatbelt deploys, it will not function again. You must have an authorized dealer replace the rear inflatable seatbelt.

The rear inflatable seatbelts are fitted in the shoulder portion of the seatbelts of the second-row outboard seating positions.

Seatbelts

Note: *The rear inflatable seatbelts are compatible with most infant and child safety car seats and belt positioning booster seats when properly installed. This is because they are designed to fill with a cooled gas at a lower pressure and at a slower rate than traditional airbags. After inflation, the shoulder portion of the seatbelt remains cool to the touch.*

The rear inflatable seatbelt consists of the following:

- An inflatable bag located in the shoulder seatbelt webbing.
- Lap seatbelt webbing with automatic locking mode.
- The same warning light, electronic control and diagnostic unit as used for the front seatbelts.
- Impact sensors located in various parts of the vehicle.

How does the rear inflatable seatbelt system work?

The rear inflatable seatbelts will function like standard restraints in everyday usage.

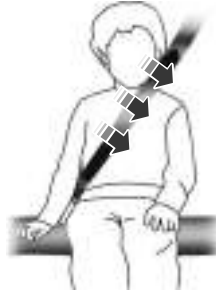

E146364

During a crash of sufficient force, the inflatable belt will inflate from inside the webbing.



E146365

The fully inflated belt's increased diameter more effectively holds the occupant in the appropriate seating position, and spreads crash forces over more area of the body than regular seatbelts. This helps reduce pressure on the chest and helps control head and neck motion for passengers.

The rear inflatable seatbelts are designed to inflate in frontal or near-frontal crashes and in some side impact crashes and rollover crashes. The fact that the rear inflatable seatbelt did not inflate in a crash does not mean that something is wrong with the system. Rather, it means the forces were not of the type sufficient to cause activation.

SEATBELT HEIGHT ADJUSTMENT

WARNING



Position the safety belt height adjusters so that the belt rests across the middle of your shoulder. Failure to adjust the safety belt properly could reduce the effectiveness of the safety belt and increase the risk of injury in a crash.

Seatbelts

Adjust the height of the shoulder belt so the belt rests across the middle of your shoulder.



E146191

To adjust the shoulder belt height:

1. Press the button and slide the height adjuster up or down.
2. Release the button and pull down on the height adjuster to make sure it is locked in place.

SEATBELT WARNING LAMP AND INDICATOR CHIME



This lamp illuminates and an audible warning will sound if the driver's safety belt has not been fastened when the vehicle's ignition is turned on.

Conditions of operation

If..	Then...
The driver's safety belt is not buckled before the ignition switch is turned to the on position...	The safety belt warning light illuminates 1-2 minutes and the warning chime sounds 4-8 seconds.
The driver's safety belt is buckled while the indicator light is illuminated and the warning chime is sounding...	The safety belt warning light and warning chime turn off.
The driver's safety belt is buckled before the ignition switch is turned to the on position...	The safety belt warning light and indicator chime remain off.

Seatbelts

SEATBELT REMINDER

Belt-Minder™

This feature supplements the safety belt warning function by providing additional reminders that intermittently sound a tone and illuminate the safety belt warning light when you are in the driver seat or you have a front seat passenger and a safety belt is

unbuckled.

The system uses information from the front passenger sensing system to determine if a front seat passenger is present and therefore potentially in need of a warning. To avoid activating the Belt-Minder feature for objects you place in the front passenger seat, only the front seat passengers receive warnings as determined by the front passenger sensing system.

If the Belt-Minder warnings expire (warnings for about five minutes) for one passenger (driver or front passenger), the other passenger can still cause the Belt-Minder feature to turn on.

If..	Then...
You and the front seat passenger buckle your safety belts before you switch the ignition on or less than 1-2 minutes elapse after you switch the ignition on...	The Belt-Minder feature will not activate.
You or the front seat passenger do not buckle your safety belts before your vehicle reaches at least 6 mph (9.7 km/h) and 1-2 minutes elapse after you switch the ignition on...	The Belt-Minder feature activates, the safety belt warning light illuminates and a warning tone sounds for 6 seconds every 25 seconds, repeating for about 5 minutes or until you and the front seat passenger buckle your safety belts.
The safety belt for the driver or front passenger is unbuckled for about 1 minute while the vehicle is traveling at least 6 mph (9.7 km/h) and more than 1-2 minutes elapse after you switch the ignition on...	The Belt-Minder feature activates, the safety belt warning light illuminates and a warning tone sounds for 6 seconds every 25 seconds, repeating for about 5 minutes or until you and the front seat passenger buckle your safety belts.

Seatbelts

Deactivating and Activating the Belt-Minder Feature

WARNING



While the system allows you to deactivate it, this system is designed to improve your chances of being safely belted and surviving an accident. We recommend you leave the system activated for yourself and others who may use the vehicle.

Note: *The driver and front passenger warnings switch on and off independently. When you perform this procedure for one seating position, do not buckle the other position as this will terminate the process.*

Read Steps 1 - 4 thoroughly before proceeding with the programming procedure.

Before following the procedure, make sure that:

- The parking brake is set.
- The transmission is in park (P) or neutral (N).

- The ignition is off.
 - The driver and front passenger safety belts are unbuckled.
1. Switch the ignition on. Do not start the vehicle.
 2. Wait until the safety belt warning light turns off (about one minute). After Step 2, wait an additional 5 seconds before proceeding with Step 3. Once you start Step 3, you must complete the procedure within 30 seconds.
 3. For the seating position you are switching off, buckle then unbuckle the safety belt three times at a moderate speed, ending in the unbuckled state. After Step 3, the safety belt warning light turns on.
 4. While the safety belt warning light is on, buckle and then unbuckle the safety belt. After Step 4, the safety belt warning light flashes for confirmation.
- This will switch the feature off for that seating position if it is currently on.
 - This will switch the feature on for that seating position if it is currently off.

CHILD RESTRAINT AND SEATBELT MAINTENANCE

Inspect the vehicle safety belts and child safety seat systems periodically to make sure they work properly and are not damaged. Inspect the vehicle and child seat safety belts to make sure there are no nicks, tears or cuts. Replace if necessary. All vehicle safety belt assemblies, including retractors, buckles, front safety belt buckle assemblies, buckle support assemblies (slide bar-if equipped), shoulder belt height adjusters (if equipped), shoulder belt guide on seat back (if equipped), rear inflatable safety belts (if equipped), child safety seat LATCH and tether anchors, and attaching hardware, should be inspected after a crash. Read the child restraint manufacturer's instructions for additional inspection and maintenance information specific to the child restraint.

Seatbelts

We recommend that all safety belt assemblies in use in vehicles involved in a crash be replaced. However, if the crash was minor and an authorized dealer finds that the belts do not show damage and continue to operate properly, they do not need to be replaced. Safety belt assemblies not in use during a crash should also be inspected and replaced if either damage or improper operation is noted.

Properly care for safety belts. See **Cleaning the Interior** (page 323).

SEATBELT EXTENSION

WARNINGS

 Persons who fit into the vehicle's seatbelt should not use an extension. Unnecessary use could result in serious personal injury in the event of a crash.

WARNINGS

 Only use extensions provided free of charge by Lincoln Motor Company dealers. The dealer will provide an extension designed specifically for this vehicle, model year and seating position. The use of an extension intended for another vehicle, model year or seating position may not offer you the full protection of your vehicle's seatbelt restraint system.

 Never use seatbelt extensions to install child restraints.

 Do not use a seatbelt extension with an inflatable seatbelt.

 Do not use extensions to change the fit of the belt across the torso, over the lap or to make the seatbelt buckle easier to reach.

seatbelt extensions made by the same company which made the original equipment seatbelts, should be used with Lincoln seatbelts. Ask your authorized dealer if your extension is compatible with your Lincoln vehicle restraint system.

If, because of body size or driving position, it is not possible to properly fasten the seatbelt over your lap and shoulder, an extension that is compatible with the seatbelts is available free of charge from Lincoln Motor Company dealers. Only Lincoln

Personal Safety System™

The Personal Safety System provides an improved overall level of frontal crash protection to front seat occupants and is designed to help further reduce the risk of airbag-related injuries. The system is able to analyze different occupant conditions and crash severity before activating the appropriate safety devices to help better protect a range of occupants in a variety of frontal crash situations.

The Vehicle Personal Safety System consists of:

- Driver and passenger dual-stage airbag supplemental restraints.
- Front seat outboard safety belts with pretensioners, energy management retractors and safety belt usage sensors.
- Driver seat position sensor.
- Front passenger sensing system.
- Passenger airbag off and on indicator lamp.
- Front crash severity sensors.
- Restraints control module with impact and safing sensors.

- Restraint system warning light and backup tone.
- The electrical wiring for the airbags, crash sensors, safety belt pretensioners, front safety belt usage sensors, driver seat position sensor, front passenger sensing system and indicator lights.

How Does the Personal Safety System Work?

The Personal Safety System can adapt the deployment strategy of the safety devices according to crash severity and occupant conditions. A collection of crash and occupant sensors provides information to the restraints control module. During a crash, the restraints control module may deploy the safety belt pretensioners, one or both stages of the dual-stage airbags based on crash severity and occupant conditions.

Supplementary Restraints System

PRINCIPLE OF OPERATION

WARNINGS

 Airbags do not inflate slowly or gently, and the risk of injury from a deploying airbag is the greatest close to the trim covering the airbag module.

 All occupants of your vehicle, including the driver, should always properly wear their safety belts, even when an airbag supplemental restraint system is provided. Failure to properly wear your safety belt could seriously increase the risk of injury or death.

 Always transport children 12 years old and under in the back seat and always properly use appropriate child restraints. Failure to follow this could seriously increase the risk of injury or death.

 Never place your arm over the airbag module as a deploying airbag can result in serious arm fractures or other injuries.

WARNINGS

 Airbags can kill or injure a child in a child seat. Never place a rear-facing child seat in front of an active airbag. If you must use a forward-facing child seat in the front seat, move the seat upon which the child seat is installed all the way back.

 Do not attempt to service, repair, or modify the airbag supplemental restraint systems or its fuses as you could be seriously injured or killed. Contact your authorized dealer as soon as possible.

 Several airbag system components get hot after inflation. To reduce the risk of injury, do not touch them after inflation.

 If the airbag has deployed, the airbag will not function again and must be replaced immediately. If the airbag is not replaced, the unrepaired area will increase the risk of injury in a crash.

The airbags are a supplemental restraint system and are designed to work with the safety belts to help protect the driver and right front passenger from certain upper body injuries. Airbags do not inflate slowly; there is a risk of injury from a deploying airbag.

Note: *You will hear a loud bang and see a cloud of harmless powdery residue if an airbag deploys. This is normal.*

The airbags inflate and deflate rapidly upon activation. After airbag deployment, it is normal to notice a smoke-like, powdery residue or smell the burnt propellant. This may consist of cornstarch, talcum powder (to lubricate the bag) or sodium compounds (for example, baking soda) that result from the combustion process that inflates the airbag. Small amounts of sodium hydroxide may be present which may irritate the skin and eyes, but none of the residue is toxic.

Supplementary Restraints System

While the system is designed to help reduce serious injuries, contact with a deploying airbag may also cause abrasions or swelling. Temporary hearing loss is also a possibility as a result of the noise associated with a deploying airbag. Because airbags must inflate rapidly and with considerable force, there is the risk of death or serious injuries such as fractures, facial and eye injuries or internal injuries, particularly to occupants who are not properly restrained or are otherwise out of position at the time of airbag deployment. Thus, it is extremely important that occupants be properly restrained as far away from the airbag module as possible while maintaining vehicle control.

Routine maintenance of the airbags is not required.

DRIVER AND PASSENGER AIRBAGS

WARNINGS



Never place your arm or any objects over an airbag module. Placing your arm over a deploying airbag can result in serious arm fractures or other injuries. Objects placed on or over the airbag inflation area may cause those objects to be propelled by the airbag into your face and torso causing serious injury.



Airbags can kill or injure a child in a child seat. Never place a rear-facing child seat in front of an active airbag. If you must use a forward-facing child seat in the front seat, move the seat upon which the child seat is installed all the way back.



E151127

The driver and front passenger airbags will deploy during significant frontal and near frontal crashes.

The driver and passenger front airbag system consists of:

- Driver and passenger airbag modules.
- Front passenger sensing system.



• Crash sensors and monitoring system with readiness indicator. See **Crash Sensors and Airbag Indicator** (page 52).

Supplementary Restraints System

Proper Driver and Front Passenger Seating Adjustment

WARNING

 National Highway Traffic Safety Administration (NHTSA) recommends a minimum distance of at least 10 inches (25 centimeters) between an occupant's chest and the driver airbag module.

To properly position yourself away from the airbag:

- Move your seat to the rear as far as you can while still reaching the pedals comfortably.
- Recline the seat slightly (one or two degrees) from the upright position.

After all occupants have adjusted their seats and put on safety belts, it is very important that they continue to sit properly. A properly seated occupant sits upright, leaning against the seat back, and centered on the seat cushion, with their feet comfortably extended on the floor. Sitting improperly can increase

the chance of injury in a crash event. For example, if an occupant slouches, lies down, turns sideways, sits forward, leans forward or sideways, or puts one or both feet up, the chance of injury during a crash is greatly increased.

Children and Airbags

WARNING

 Airbags can kill or injure a child in a child seat. Never place a rear-facing child seat in front of an active airbag. If you must use a forward-facing child seat in the front seat, move the seat upon which the child seat is installed all the way back.



E142846

Children must always be properly restrained. Accident statistics suggest that children are safer when properly restrained in the rear seating positions than in the front seating position. Failure to follow these instructions may increase the risk of injury in a crash.

Supplementary Restraints System

FRONT PASSENGER SENSING SYSTEM

WARNINGS

 Even with advanced restraints systems, properly restrain children 12 and under in a rear seating position. Failure to follow this could seriously increase the risk of injury or death.

 Sitting improperly, out of position or with the seatback reclined too far can take weight off the seat cushion and affect the decision of the passenger sensing system, resulting in serious injury or death in the event of a crash. Always sit upright against your seat back, with your feet on the floor.

 Any alteration or modification to the front passenger seat may affect the performance of the front passenger sensing system. This could seriously increase the risk of injury or death.

This system works with sensors that are part of the front passenger seat and seatbelt to detect the presence of a properly-seated occupant and determine if the front passenger's frontal airbag should be enabled (may inflate) or not.



E181984

The front passenger sensing system uses a passenger airbag status indicator that illuminates indicating that the front passenger frontal airbag is either ON (enabled) or OFF (disabled).

The indicator lamp is in the center stack of the instrument panel.

Note: *The passenger airbag status indicator OFF and ON indicator lamps illuminate for a short period of time when you first switch the ignition on to confirm it is functional.*

The front passenger sensing system is designed to disable (will not inflate) the front passenger frontal airbag when the front passenger seat is unoccupied, or a rear facing infant seat, a forward-facing child restraint, or a booster seat is detected. Even with this technology, parents are **strongly** encouraged to always properly restrain children in the rear seat. The sensor also turns off the passenger front airbag and seat-mounted side airbag when the passenger seat is empty.

- When the front passenger sensing system disables (will not inflate) the front passenger frontal airbag, the passenger airbag status indicator will illuminate the OFF lamp and stay lit to remind you that the front passenger frontal airbag is disabled.
- If the child restraint has been installed and the passenger airbag status indicator illuminates the ON lamp, then turn the vehicle off, remove the child restraint from the vehicle and reinstall the restraint following the child restraint manufacturer's instructions.

Supplementary Restraints System

The front passenger sensing system is designed to enable (may inflate) the front passenger frontal airbag anytime the system senses that a person of adult size is sitting properly in the front passenger seat.

- When the front passenger sensing system enables the front passenger frontal airbag (may inflate), the passenger airbag status indicator will illuminate the ON lamp and remain illuminated.

If a person of adult size is sitting in the front passenger seat, but the airbag off indicator lamp is lit, it is possible that the person isn't sitting properly in the seat. If this happens:

- Turn the vehicle off and ask the person to place the seat back in the full upright position.
- Have the person sit upright in the seat, centered on the seat cushion, with the person's legs comfortably extended.

- Restart the vehicle and have the person remain in this position for about two minutes. This will allow the system to detect that person and enable the passenger's frontal airbag.
- If the indicator OFF lamp remains lit even after this, the person should be advised to ride in the rear seat.

Occupant	Passenger airbag status indicator	Passenger airbag
Empty	OFF: Lit	Disabled
	ON: Unlit	
Child	OFF: Lit	Disabled
	ON: Unlit	
Adult	OFF: Unlit	Enabled
	ON: Lit	

Supplementary Restraints System

Note: When the passenger airbag status indicator OFF light is illuminated, the passenger (seat mounted) side airbag may be disabled to avoid the risk of airbag deployment injuries.

After all occupants have adjusted their seats and put on seatbelts, it is very important that they continue to sit properly. A properly seated occupant sits upright, leaning against the seat back, and centered on the seat cushion, with their feet comfortably extended on the floor. Sitting improperly can increase the chance of injury in a crash event. For example, if an occupant slouches, lies down, turns sideways, sits forward, leans forward or sideways, or puts one or both feet up, the chance of injury during a crash is greatly increased.

The conditions listed above may cause the weight of a properly seated occupant to be incorrectly interpreted by the front passenger sensing system. The person in the front passenger seat may appear heavier or lighter due to the conditions described in the list above.



To know if the front passenger sensing system is operating properly, See **Crash Sensors and Airbag Indicator** (page 52).

Do not attempt to repair or service the system. Take your vehicle immediately to an authorized dealer.

If it is necessary to modify an advanced front airbag system to accommodate a person with disabilities, contact the Ford Customer Relationship Center. See **Getting the Services You Need** (page 267).

SIDE AIRBAGS

WARNINGS



Do not place objects or mount equipment on or near the airbag cover, on the side of the seatbacks (of the front seats), or in front seat areas that may come into contact with a deploying airbag. Failure to follow these instructions may increase the risk of personal injury in the event of a crash.

WARNINGS



Do not use accessory seat covers. The use of accessory seat covers may prevent the deployment of the side airbags and increase the risk of injury in an accident.



Do not lean your head on the door. The side airbag could injure you as it deploys from the side of the seatback.



Do not attempt to service, repair, or modify the airbag, its fuses or the seat cover on a seat containing an airbag as you could be seriously injured or killed. Contact your authorized dealer as soon as possible.



If the side airbag has deployed, the airbag will not function again. The side airbag system (including the seat) must be inspected and serviced by an authorized dealer. If the airbag is not replaced, the unrepaired area will increase the risk of injury in a crash.

Supplementary Restraints System

The side airbags are located on the outboard side of the seatbacks of the front seats. In certain sideways crashes, the airbag on the side affected by the crash will be inflated. The airbag was designed to inflate between the door panel and occupant to further enhance the protection provided occupants in side impact crashes.



E152533

The system consists of the following:

- A label or embossed side panel indicating that side airbags are fitted to your vehicle.
- Side airbags located inside the driver and front passenger seatbacks.
- Front passenger sensing system.



- Crash sensors and monitoring system with readiness indicator. See **Crash Sensors and Airbag Indicator** (page 52).

Note: *The passenger sensing system will deactivate the passenger seat-mounted side airbag if it detects an empty passenger seat.*

The design and development of the side airbag system included recommended testing procedures that were developed by a group of automotive safety experts known as the Side Airbag Technical Working Group. These recommended testing procedures help reduce the risk of injuries related to the deployment of side airbags.

DRIVER AND PASSENGER KNEE AIRBAGS

Driver and passenger knee airbags are located under or within the instrument panel. During a crash, the restraints control module may activate the driver and passenger knee airbags (individually or both) based on crash severity and respective occupant conditions. Under certain crash and occupant conditions, the driver and passenger knee airbags may deploy (individually or both) but the corresponding front airbag may not activate. As with front and side airbags, it is important to be properly seated and restrained to reduce the risk of death or serious injury.





Make sure the knee airbags are operating properly. See **Crash Sensors and Airbag Indicator** (page 52).

Supplementary Restraints System

SAFETY CANOPY™

WARNINGS

 Do not place objects or mount equipment on or near the headliner at the siderail that may come into contact with a deploying curtain airbag. Failure to follow these instructions may increase the risk of personal injury in the event of a crash.

 Do not lean your head on the door. The curtain airbag could injure you as it deploys from the headliner.

 Do not attempt to service, repair, or modify the curtain airbags, its fuses, the A, B, or C pillar trim, or the headliner on a vehicle containing curtain airbags as you could be seriously injured or killed. Contact your authorized dealer as soon as possible.

 All occupants of your vehicle including the driver should always wear their safety belts even when an airbag supplemental restraint system and curtain airbag is provided. Failure to properly wear your safety belt could seriously increase the risk of injury or death.

WARNINGS

 To reduce risk of injury, do not obstruct or place objects in the deployment path of the curtain airbag.

 If the curtain airbags have deployed, the curtain airbags will not function again. The curtain airbags (including the A, B and C pillar trim and headliner) must be inspected and serviced by an authorized dealer. If the curtain airbag is not replaced, the unrepaired area will increase the risk of injury in a crash.

The Safety Canopy will deploy during significant side crashes or when a certain likelihood of a rollover event is detected by the rollover sensor. The Safety Canopy is mounted to the roof side-rail sheet metal, behind the headliner, above each row of seats. In certain sideways crashes or rollover events, the Safety Canopy will be activated, regardless of which seats are occupied. The Safety Canopy is designed to inflate between the side window area and occupants to further enhance protection provided in side impact crashes and rollover events.

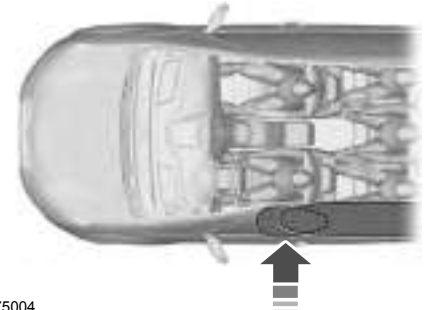

E75004

The system consists of the following:

- Safety canopy curtain airbags located above the trim panels over the front and rear side windows identified by a label or wording on the headliner or roof-pillar trim.
- A flexible headliner which opens above the side doors to allow air curtain deployment



• Crash sensors and monitoring system with a readiness indicator. See **Crash Sensors and Airbag Indicator** (page 52).

Supplementary Restraints System

Children 12 years old and under should always be properly restrained in the rear seats. The Safety Canopy will not interfere with children restrained using a properly installed child or booster seat because it is designed to inflate downward from the headliner above the doors along the side window opening.

The design and development of the Safety Canopy included recommended testing procedures that were developed by a group of automotive safety experts known as the Side Airbag Technical Working Group. These recommended testing procedures help reduce the risk of injuries related to the deployment of side airbags (including the Safety Canopy).

CRASH SENSORS AND AIRBAG INDICATOR

WARNING



Modifying or adding equipment to the front end of the vehicle (including frame, bumper, front end body structure and tow hooks) may affect the performance of the airbag system, increasing the risk of injury. Do not modify the front end of the vehicle.

Your vehicle has a collection of crash and occupant sensors which provide information to the restraints control module. The restraints control module deploys (activates) the front seatbelt system, the adaptive collapsible steering column, driver airbag, passenger airbag, knee airbag(s), seat mounted side airbags, Safety Canopy and optional rear inflatable seatbelts. Based on the type of crash, the restraints control module will deploy the appropriate safety devices.

The restraints control module also monitors the readiness of the above safety devices plus the crash and occupant sensors. The readiness of the safety system is indicated by a warning indicator light in the instrument cluster or a backup tone (if equipped). Routine maintenance of the airbag is not required.

A difficulty with the system is indicated by one or more of the following:



The readiness light will not illuminate immediately after the ignition is turned on.

- The readiness light will either flash or stay lit.
- A series of five beeps will be heard (If equipped). The tone pattern will repeat periodically until the problem, the light or both are repaired.

If any of these things happen, even intermittently, have the supplemental restraint system serviced at an authorized dealer immediately. Unless serviced, the system may not function properly in the event of a crash.

Supplementary Restraints System

The seatbelt pretensioners and the front airbag supplemental restraint system are designed to activate when the vehicle sustains frontal deceleration sufficient to cause the restraints control module to deploy a safety device.

The fact that the seatbelt pretensioners or front airbags did not activate for both front seat occupants in a crash does not mean that something is wrong with the system. Rather, it means the restraints control module determined the accident conditions (crash severity, belt usage) were not appropriate to activate these safety devices.

- The design of the front airbags is to activate only in frontal and near-frontal crashes (not rollovers, side impacts or rear impacts) unless the crash causes sufficient frontal deceleration.
- The seatbelt pretensioners and rear inflatable seatbelts are designed to activate in frontal, near-frontal and side crashes and rollovers.
- The knee airbag(s) may deploy based on crash severity and occupant conditions.

- The design of the side airbags is to inflate in certain side impact crashes. Side airbags may activate in other types of crashes if the vehicle experiences sufficient sideways motion or deformation.
- The design of the Safety Canopy is to inflate in certain side impact crashes or rollover events. The Safety Canopy may activate in other types of crashes if the vehicle experiences sufficient sideways motion or deformation, or a certain likelihood of rollover.

AIRBAG DISPOSAL

Contact your authorized dealer as soon as possible. Airbags must be disposed of by qualified personnel.

Keys and Remote Controls

GENERAL INFORMATION ON RADIO FREQUENCIES

This device complies with Part 15 of the FCC Rules and with Industry Canada license-exempt RSS standard(s). Operation is subject to the following two conditions: (1) This device may not cause harmful interference, and (2) This device must accept any interference received, including interference that may cause undesired operation.

Note: *Changes or modifications not expressly approved by the party responsible for compliance could void the user's authority to operate the equipment. The term IC before the radio certification number only signifies that Industry Canada technical specifications were met.*

The typical operating range for your transmitter is approximately 33 feet (10 meters). Vehicles with the remote start feature will have a greater range. One of the following could cause a decrease in operating range:

- weather conditions
- nearby radio towers
- structures around the vehicle
- other vehicles parked next to your vehicle

Other short-distance radio transmitters, such as amateur radios, medical equipment, wireless headphones, remote controls and alarm systems may operate on the same frequency as your remote control. If other transmitters are operating on those frequencies, you may not be able to use your remote control. Using your remote control near some types of electronic equipment, such as USB devices, computers or cell phones can interfere with remote operation. Operating your remote control near metal or metallic-finished purses, bags or clothing can interfere with remote operation. You can lock and unlock the doors with the key.

Note: *Make sure to lock your vehicle before leaving it unattended.*

Note: *If you are in range, the remote control will operate if you press any button unintentionally.*

Intelligent Access

The system uses a radio frequency signal to communicate with your vehicle and authorize your vehicle to unlock when one of the following conditions are met:

- You touch the inside of any exterior door handle within 3 ft (1 m) proximity of an intelligent access key.
- You press the luggage compartment button.
- You press a button on the transmitter.

If excessive radio frequency interference is present in the area or if the transmitter battery is low, you may need to mechanically unlock your door. You can use the mechanical key blade in your intelligent access key to open the driver door in this situation. See **Remote Control** (page 55).

Keys and Remote Controls

REMOTE CONTROL

Intelligent Access Key



E218688

The intelligent access keys operate the power locks and the remote start system. The key must be in your vehicle to use the push button start.



E151795

Note: Your vehicle keys came with a security label that provides important key cut information. Keep the label in a safe place for future reference.

Removable Key Blade

The intelligent access key also contains a removable key blade that you can use to unlock your vehicle.



E218689

Push the release button and pull the key blade out.

Replacing the Battery

Note: Refer to local regulations when disposing of transmitter batteries.

Note: Do not wipe off any grease on the battery terminals or on the back surface of the circuit board.

Keys and Remote Controls

Note: Replacing the battery does not erase the programmed key from your vehicle. The transmitter should operate normally.

A message appears in the information display when the remote control battery is low. See **Information Messages** (page 114).

The remote control uses one coin-type three-volt lithium battery CR2032 or equivalent.

1. Push the release button and pull the key blade out.



E218690

2. Twist a thin coin under the tab hidden behind the key blade head to remove the battery cover.



E218691

3. Insert a suitable tool, for example a screwdriver, in the position shown and carefully remove the battery.
4. Install a new battery with the + facing upward.



E218689

Keys and Remote Controls

5. Reinstall the battery cover and the key blade.

Car Finder



Press the button twice within three seconds. A tone sounds and the direction indicators will flash. We recommend you use this method to locate your vehicle, rather than using the panic alarm.

Sounding the Panic Alarm

Note: *The panic alarm only operates when the ignition is off.*



Press the button to sound the panic alarm. Press the button again or switch the ignition on to turn it off.

Remote Start

WARNING



To avoid exhaust fumes, do not use remote start if your vehicle is parked indoors or in areas that are not well ventilated.

Note: *Do not use remote start if your fuel level is low.*



The remote start button is on the transmitter.

This feature allows you to start your vehicle from the outside. The transmitter has an extended operating range.

If your vehicle has automatic climate control, you can configure it to operate when you remote start your vehicle. See **Climate Control** (page 134).

Many states and provinces have restrictions for the use of remote start. Check your local and state or provincial laws for specific requirements regarding remote start systems.

The remote start system does not work if any of the following occur:

- The ignition is on.
- The anti-theft alarm triggers.
- You switch the feature off in the information display.
- The hood is open.
- The transmission is not in park (P).
- The battery voltage is below the minimum operating voltage.

Remote Control Feedback (If Equipped)

An LED on the remote control provides status feedback of remote start or stop commands.

Keys and Remote Controls

LED.	Status
Solid green.	Remote start or extension successful.
Solid red.	Remote stop successful; vehicle off.
Blinking red.	Remote start or stop failed.
Blinking green.	Waiting for status update.

Remote Starting your Vehicle

Note: You must press each button within three seconds of each other. Your vehicle will not remote start if you do not follow this sequence.

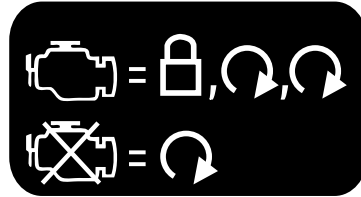

E138626

The label on your transmitter details the starting procedure.

1. Press the lock button to lock all the doors.
2. Press the remote start button twice. The exterior lamps flash twice.

A tone sounds if the system fails to start, unless quiet start is on. Quiet start runs the blower fan at a slower speed to reduce noise. You can switch this feature on or off in the information display. See **General Information** (page 108).

Note: You must press the push button ignition switch on the instrument panel once while applying the brake pedal before driving your vehicle.

The power windows do not work during remote start and the radio does not turn on automatically.

The parking lamps remain on and your vehicle will run for 5, 10 or 15 minutes, depending on the setting.

Extending the Engine Running Time

To extend the engine running time duration of your vehicle during remote start, repeat steps 1 and 2 while the engine is running. If the duration is set to 10 minutes, the duration extends by another 10 minutes. For example, if your vehicle had been running from the first remote start for 5 minutes, your vehicle continues to run now for a total of 20 minutes. You can extend the engine running time duration to a maximum of 30 minutes.

Wait at least five seconds before remote starting after the engine stops running.

Turning Your Vehicle Off After Remote Starting



Press the button once. Your vehicle and the parking lamps turn off.

Keys and Remote Controls

You may have to be closer to your vehicle than when starting due to ground reflection and the added noise of your running vehicle.

You can switch this feature on or off in the information display. See **General Information** (page 108).

Memory Feature

You can program your intelligent access key to recall memory positions. See **Memory Function** (page 145).

REPLACING A LOST KEY OR REMOTE CONTROL

Replacement keys or remote controls can be purchased from an authorized dealer. Authorized dealers can program remote controls for your vehicle. See **Passive Anti-Theft System** (page 75).

PRINCIPLE OF OPERATION

MyKey allows you to program keys with restricted driving modes to promote good driving habits. You can program the restrictions to all keys but one. Any keys that you did not program are administrator keys or admin keys.

You can use admin keys to:

- Create a MyKey with certain vehicle restrictions.
- Program certain MyKey settings.
- Clear all MyKey restrictions.

After you program a MyKey, you can view the following information through the information display:

- The total number of admin keys and MyKeys for your vehicle.
- The total distance a MyKey driver traveled with your vehicle.

Note: *Every MyKey receives the same restrictions and settings. You cannot program them individually.*

Note: *For vehicles equipped with a push-button start switch: When both a MyKey and an admin key are present when you start your vehicle, the system recognizes the admin key only.*

Standard Settings

Not every vehicle includes the features listed below. If your vehicle has this equipment, then you cannot change the following settings when using a MyKey:

- Seatbelt reminder or Belt-Minder™. MyKey mutes the audio system until drivers, and in some instances, passengers, fasten their seatbelts. **Note:** If your vehicle includes an AM/FM radio or a very basic audio system, then the radio may not mute.
- Earlier low-fuel warning. The low-fuel warning activates earlier for MyKey drivers, giving them more time to refuel.

- Certain driver alerts, stability systems or parking aids turn on automatically when you use the MyKey system. For example, Blind Spot Information System (BLIS), cross traffic alert, lane departure warning or forward collision warning. **Note:** MyKey drivers may be able to turn the lane departure warning feature off, but this feature turns back on automatically with every new key cycle.
- Restricted touchscreen operation in some markets. For example, MyKey may prevent manual navigation destination input while the vehicle is in any gear other than park (P) or when the vehicle reaches a certain rate of speed.
- Satellite radio adult content restrictions, if this feature is available in your market.

Optional Settings

You can configure certain vehicle feature settings when you first create a MyKey. You can also change the settings afterward with an admin key.

Note: *Not every feature applies to every vehicle in every market. When they are available for your vehicle, then they appear in your information display, providing choices to switch them on or off, or to select a more specific setting.*

- Various vehicle speed limits so the MyKey driver cannot exceed certain speeds. The information display shows warnings followed by an audible tone when the MyKey driver reaches the set speed. You cannot override the set speed by fully depressing the accelerator pedal.

WARNING



Do not set MyKey maximum speed limit to a limit that will prevent the driver from maintaining a safe speed considering posted speed limits and prevailing road conditions. The driver is always responsible to drive in accordance with local laws and prevailing conditions. Failure to do so could result in accident or injury.

- Various vehicle speed reminders so MyKey drivers know when their vehicle speed approaches the limits. Warnings appear in your information display and a tone sounds when the MyKey drivers exceed the set vehicle speed.
- The audio system's maximum volume limits to 45% so MyKey drivers can concentrate on the road. A message appears in the information display when MyKey drivers attempt to exceed the limited volume. MyKey also disables the automatic volume control. **Note:** If your vehicle includes an AM/FM radio or a very basic audio system, then the radio may not limit.
- Always on setting. This setting forces certain features to remain on and active for MyKey drivers. For example, E911 or emergency assistance and the do not disturb features stay on even if a MyKey driver uses the feature's control to switch it off.

CREATING A MYKEY

Use the information display to create a MyKey.

1. Switch the ignition on using the key or the transmitter you want to program.
2. Access the main menu in the information display and then scroll through the menus to begin programming your MyKey. See **Information Displays** (page 108).
3. Follow the instructions in the display.
4. A confirmation message appears in the display after you finish programming your MyKey. The programmed restrictions apply when you restart your vehicle with the programmed key or transmitter.

Note: *Make sure you label the programmed MyKey so you can distinguish it from the admin keys.*

You can also program the optional MyKey settings.

Programming or Changing Configurable Settings

Use the information display to program or change your optional MyKey settings.

1. Switch the ignition on using the key or the transmitter you want to program.
2. Access the main menu in the information display and then scroll through the menus to change the settings of your MyKey. See **Information Displays** (page 108).
3. Follow the instructions in the display.
4. A confirmation message appears in the display after you finish programming your MyKey. The programmed restrictions apply when you restart your vehicle with the programmed key or transmitter.

Note: *You can clear or change your MyKey settings at any time during the same key cycle as you created the MyKey. If you switch the engine off, you must use an admin key to change or clear your optional MyKey settings.*

CLEARING ALL MYKEYS

When you clear your MyKeys, you remove all restrictions and return all MyKeys to their original admin key status at once. To clear all MyKeys of all MyKey settings, use the information display.

1. Switch the ignition on using an admin key.
2. Access the main menu in the information display and then scroll through the menus to begin clearing your MyKey programming. See **Information Displays** (page 108).
3. Follow the instructions in the display.
4. A confirmation message appears in the display after you finish clearing your MyKeys.

Note: *When you clear your MyKeys, you remove all restrictions and return all MyKeys to their original admin key status. You cannot remove the MyKey restrictions individually.*

CHECKING MYKEY SYSTEM STATUS

You can find information about your programmed MyKeys by using the information display. See **Information Displays** (page 108).

MyKey Distance

Tracks the distance when drivers use a MyKey. The only way to delete the accumulated distance is by using an admin key to clear all MyKeys. If the distance does not accumulate as expected, then the intended user is not using the MyKey, or an admin key user recently cleared and then recreated a MyKey.

Number of MyKeys

Indicates the number of MyKeys programmed to your vehicle. Use this feature to detect how many MyKeys you have for your vehicle and determine when all MyKeys have been deleted.

Number of Admin Keys

Indicates how many admin keys are programmed to your vehicle. Use this feature to determine how many admin keys you have for your vehicle, and detect if an additional MyKey has been programmed.

USING MYKEY WITH REMOTE START SYSTEMS

MyKey is not compatible with non Ford-approved, aftermarket remote start systems. If you choose to install a remote start system, see an authorized dealer for a Ford-approved remote start system.

MYKEY TROUBLESHOOTING

Condition	Potential causes
I cannot create a MyKey.	<ul style="list-style-type: none"> · The key or transmitter used to start the vehicle does not have admin privileges. · Vehicles with keyless start: Make sure you place the transmitter into the backup position. See Starting a Gasoline Engine (page 160). · The key or transmitter used to start the vehicle is the only admin key. There always has to be at least one admin key. · SecuriLock passive anti-theft system is disabled or in unlimited mode.
I cannot program the configurable settings.	<ul style="list-style-type: none"> · The key or transmitter used to start the vehicle does not have admin privileges.

MyKey™

Condition	Potential causes
	<ul style="list-style-type: none"> · There are no MyKeys programmed to the vehicle. See Creating a MyKey (page 61).
For vehicles with keyless start: No MyKey restrictions are available when starting the vehicle.	<ul style="list-style-type: none"> · An admin transmitter is present when you started your vehicle. · There are no MyKeys programmed to the vehicle. See Creating a MyKey (page 61).
I cannot clear the MyKeys.	<ul style="list-style-type: none"> · The key or transmitter used to start the vehicle does not have admin privileges. · No MyKeys are created. See Creating a MyKey (page 61).
I lost the only admin key.	<ul style="list-style-type: none"> · Purchase a new key or transmitter from your authorized dealer.
I lost a key.	<ul style="list-style-type: none"> · Program a spare key or transmitter. You may need to see your authorized dealer. See Passive Anti-Theft System (page 75).
MyKey distances do not accumulate.	<ul style="list-style-type: none"> · The MyKey user is not using the MyKey. · An admin key holder cleared the MyKeys and created new MyKeys. · The key system has been reset.

Locks

LOCKING AND UNLOCKING

You can use the power door lock control or the remote control to lock and unlock your vehicle.

Power Door Locks

The power door lock control is on the driver and front passenger door panels.

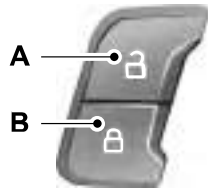

E138628

- A Unlock.
- B Lock.

Door Lock Indicator

An LED on each door window trim illuminates when you lock the door. It remains on for up to 10 minutes after you switch the ignition off.

Door Lock Switch Inhibitor

When you electronically lock your vehicle, the power door lock switch and interior trunk release switch will not operate after 20 seconds. You must unlock your vehicle with the remote control or keyless keypad, or switch the ignition on, to restore function to these switches. You can switch this feature on or off in the information display. See **General Information** (page 108).

Note: *Switch the ignition on and off after changing the setting in the information display.*

Rear Door Unlocking and Opening

Pull the interior door handle twice to unlock and open a rear door. The first pull unlocks the door and the second pull opens the door.

Remote Control

You can use the remote control at any time.

Unlocking the Doors (Two-Stage Unlock)



Press the button to unlock the driver door.

Press the button again within three seconds to unlock all doors. A tone sounds and the direction indicators will flash.

Press and hold both the lock and unlock buttons on the remote control for three seconds to change between driver door or all doors unlock mode. The direction indicators will flash twice to indicate a change to the unlocking mode. Driver door mode only unlocks the driver door when you press the unlock button once. All door mode unlocks all doors when you press the unlock button once. The unlocking mode applies to the remote control, keyless entry keypad and intelligent access. You can also change between the unlocking modes using the information display. See **General Information** (page 108).

Locks

Locking the Doors



Press the button to lock all doors. A tone sounds and the direction indicators will flash.

Press the button again within three seconds to confirm that all the doors are closed. The doors will lock again, a tone sounds and the direction indicators will flash if all the doors and the luggage compartment are closed.

Mislock

If any door or the luggage compartment is open, or if the hood is open on vehicles with an anti-theft alarm or remote start, a tone sounds and the direction indicators will not flash. You can switch this feature on or off in the information display. See **General Information** (page 108).

Opening the Luggage Compartment



Press twice within three seconds to open the luggage compartment.

Make sure to close and latch the luggage compartment before driving your vehicle. An unlatched luggage compartment may cause objects to fall out or block your view.

Note: *The luggage compartment release button only works when your vehicle speed is about 3 mph (5 km/h).*

Activating Intelligent Access

You must have the intelligent access key within 3 ft (1 m) of your vehicle.

At a Door

Pull an exterior door handle to unlock and open the door. Make sure not to touch the lock sensor on top of the handle.



E146044

Touch the top of the door handle to lock your vehicle. There is a brief delay before you can unlock your vehicle again.

Note: *Keep the door handle clean to make sure the system operates correctly.*

Locks

At the Luggage Compartment

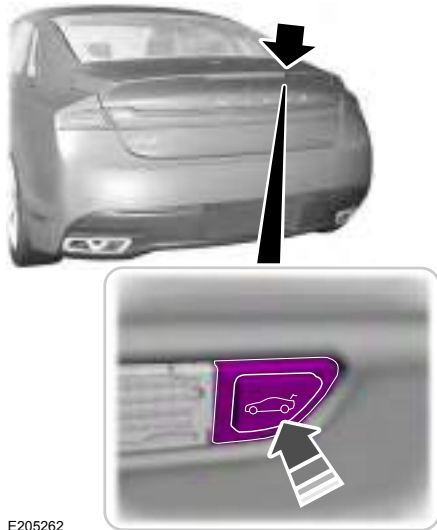

E205262

Press the exterior release button.

Locking and Unlocking the Doors with the Key Blade

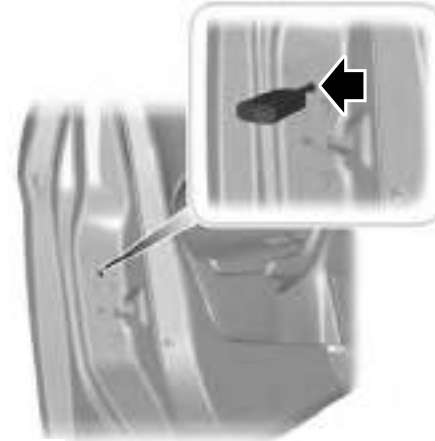

E112203

If the central locking function does not operate, lock the doors individually using the key in the position shown.

On the driver side, turn the key clockwise to lock. On the passenger side, turn the key counterclockwise to lock.

Smart Unlocks for Intelligent Access Keys

This feature helps to prevent you from locking your intelligent access key inside your vehicle's passenger compartment or rear cargo area.

When you electronically lock your vehicle with any door open, the transmission is in park (P) and the ignition is off, the system searches for an intelligent access key inside your vehicle after you close the last door. If the system finds a key, all of the doors will immediately unlock and a tone sounds, indicating that a key is inside.

You can override the smart unlock feature and intentionally lock the intelligent access key inside your vehicle.

To do this, lock your vehicle after you have closed all the doors by:

- Using the keyless entry keypad.
- Pressing the lock button on another intelligent access key.
- Touching the locking area on the front of the door handle with another intelligent access key in your hand.

Locks

When you open one of the front doors and lock your vehicle using the power door lock control, all doors will lock then unlock if:

- The ignition is on.
- The ignition is off and the transmission is not in park (P).

Autolock (If Equipped)

Autolock locks all the doors when:

- All doors are closed.
- The ignition is on.
- You shift into any gear putting your vehicle in motion.
- Your vehicle reaches a speed greater than 12 mph (20 km/h).

Autolock repeats when:

- You open then close any door while the ignition is on and your vehicle speed is 9 mph (15 km/h) or lower.
- Your vehicle reaches a speed greater than 12 mph (20 km/h).

Autounlock

Autounlock unlocks all the doors when:

- The ignition is on, all the doors are closed, and your vehicle has been moving at a speed greater than 12 mph (20 km/h).
- Your vehicle comes to a stop and you switch the ignition off or to the accessory position.
- You open the driver door within 10 minutes of switching the ignition off or to accessory.

Note: *The doors will not autounlock if you electronically lock your vehicle after you switch the ignition off and before you open the driver door.*

Enabling or Disabling Autolock and Autounlock

Note: *You can switch autounlock and autolock on or off independently of each other.*

Autolock is not configurable in all markets. If the autolock settings are not available in your information display, then the system is not configurable. See **General Information** (page 108).

Illuminated Entry

The interior lamps and some exterior lamps illuminate when you unlock the doors with the remote control.

The illuminated entry system will turn off the lights if:

- The ignition is on.
- You press the remote control lock button.
- After 25 seconds of illumination.

The lights do not turn off if:

- You turn them on with the lamp control.
- Any door is open.

Illuminated Exit

The interior lamps and some exterior lamps illuminate when all doors are closed and you switch the ignition off.

Locks

The lamps will turn off if all the doors remain closed and:

- 25 seconds have elapsed.
- You press the push button ignition switch.

Battery Saver

If you leave the courtesy lamps, interior lamps or headlamps on, the battery saver shuts them off 10 minutes after you switch the ignition off.

Accessory Mode Battery Saver for Intelligent Access Keys

If you leave the ignition switched on, it shuts off when it detects a certain amount of battery drain, or after 45 minutes.

Luggage Compartment

From Inside Your Vehicle



Press the button on the instrument panel to open the luggage compartment.

With the Remote Control



Press twice within three seconds to open the luggage compartment.

From Outside Your Vehicle

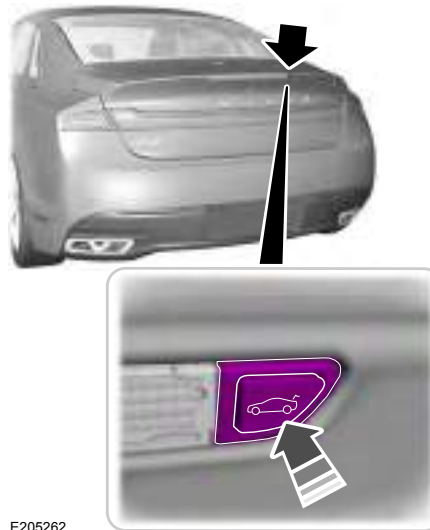

E205262

Press the exterior release button to open the luggage compartment. Your vehicle must be unlocked or have an intelligent access transmitter within 3 ft (1 m) of the luggage compartment.

Power Decklid (If Equipped)

WARNINGS



Make sure all persons are clear of the power decklid area before using the power decklid control.



Keep keys out of the reach of children. Do not allow children to operate or play near an open or moving power decklid. You should supervise the operation of the power decklid at all times.

Note: Do not drive with the decklid open unless you switch off the power feature. Make sure the decklid is fully closed before you drive your vehicle.

You can switch the power decklid feature on or off in the information display. See **General Information** (page 108). The remote control and instrument panel button will still operate the decklid regardless of the setting.

Locks

Opening and Closing the Power Decklid

Note: You can reverse the decklid movement. Press the instrument panel or decklid button again, or press the remote control button twice.

The decklid will only operate with the transmission in park (P).

If the decklid reverses or starts to close after an open request, you will hear a fast continuous chime. This indicates excessive load on the decklid or a possible gas strut failure. If the decklid continues to close after opening, have the system checked by an authorized dealer.

From Inside Your Vehicle



Press the button on the instrument panel.

With the Remote Control



Press the button twice within three seconds.

From Outside Your Vehicle

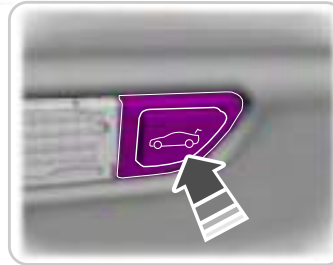
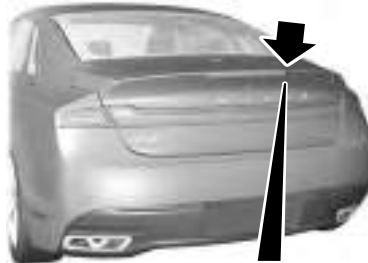

E205262

Press the exterior release button to open the luggage compartment. Your vehicle must be unlocked or have an intelligent access transmitter within 3 ft (1 m) of the luggage compartment.

Note: Let the power system operate the decklid after pressing the control. Pushing or pulling the decklid may activate the obstacle detection feature and stop the power operation.

With the Decklid Close Button



Press the button inside the decklid on the left-hand side.

Obstacle Detection

The decklid will reverse to full open if it detects an obstacle while closing. Three chimes will sound as the decklid begins to reopen. Remove the obstacle to close the decklid.

Note: Before driving your vehicle, check the instrument cluster for a trunk ajar or door ajar message or warning indicator. Failure to do this could result in unintentionally leaving the decklid open while driving.

The decklid will stop and three chimes will sound if it detects an obstacle while opening. Remove the obstacle to operate the decklid.

Locks

Resetting the Power Decklid

The decklid may not operate correctly and you may need to reset it if:

- The vehicle battery charge is low.
- You disconnect the battery.
- You manually close the decklid and leave it unlatched.

To reset the power decklid:

1. Disconnect the battery for 20 seconds then reconnect the battery.
2. Manually close the decklid making sure it is fully closed.
3. Power open the decklid using the remote control or instrument panel button.

KEYLESS ENTRY

SECURICODE™ KEYLESS ENTRY KEYPAD

The keypad is located near the driver window. It is invisible until touched and then it lights up so you can see and touch the appropriate buttons.

Note: *If you enter your entry code too fast on the keypad, the unlock function may not work. Re-enter your entry code more slowly.*

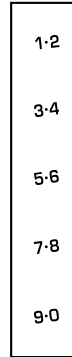

E138637

You can use the keypad to:

- lock or unlock the doors
- recall memory seat and mirror positions
- program and erase personal entry codes
- arm and disarm the anti-theft alarm
- release the trunk.

Note: *The keypad will not operate a power decklid.*

You can operate the keypad with the factory-set 5-digit entry code. The code is located on the owner's wallet card in the glove box and is available from an authorized dealer. You can also create up to five of your own 5-digit personal entry codes.

Programming a Personal Entry Code

To create your own personal entry code:

1. Enter the factory-set code.
2. Press **1-2** on the keypad within five seconds.
3. Enter your personal 5-digit code. You must enter each number within five seconds of each other.
4. Press **1-2** on the keypad to save personal code 1.

The doors will lock then unlock to confirm that programming was successful.

To program additional personal entry codes, repeat Steps 1-3, then for Step 4:

Locks

- press **3-4** to save personal code 2
- press **5-6** to save personal code 3
- press **7-8** to save personal code 4
- press **9-0** to save personal code 5.

You may also program a personal entry code using the touchscreen. See **Settings** (page 457).

Tips:

- Do not set a code that uses five of the same number.
- Do not use five numbers in sequential order.
- The factory-set code will work even if you have set your own personal code.

Recalling Memory Positions

The programmed entry codes will recall driver memory positions as follows:

- Entry code 1 will recall driver 1 memory positions.
- Entry code 2 will recall driver 2 memory positions.
- Entry code 3 will recall driver 3 memory positions.

Note: *Personal entry codes 4 and 5 will not recall memory positions.*

Erasing a Personal Code

1. Enter the factory-set 5-digit code.
2. Press and release **1-2** on the keypad within five seconds.
3. Press and hold **1-2** for two seconds. You must do this within five seconds of completing Step 2.

All personal codes are now erased and only the factory-set 5–digit code will work.

Anti-Scan Feature

The keypad will go into an anti-scan mode if you enter the wrong code seven times (35 consecutive button presses). This mode disables the keypad for one minute and the keypad lamp will flash.

The anti-scan feature will turn off after:

- one minute of keypad inactivity
- pressing the unlock button on the remote control

- switching the ignition on
- unlocking your vehicle using intelligent access.

Unlocking and Locking the Doors

To Unlock the Driver Door

Enter the factory-set 5-digit code or your personal code. You must press each number within five seconds of each other. The interior lamps will illuminate.

Note: *All doors will unlock if you enable the all-door unlocking mode. See **Locking and Unlocking** (page 65).*

To Unlock All Doors

Enter the factory-set code or your personal code, then press **3-4** within five seconds.

To Lock All Doors

Press and hold **7-8** and **9-0** at the same time (with the driver door closed). You do not need to enter the keypad code first.

Locks

To Release the Trunk

Enter the factory-set code or your personal code, then press **5-6** within five seconds.

Note: *The keypad will not operate a power decklid.*

Displaying the Factory Set Code

Note: *You will need to have two programmed intelligent access keys for this procedure.*

To display the factory-set code in the information display:

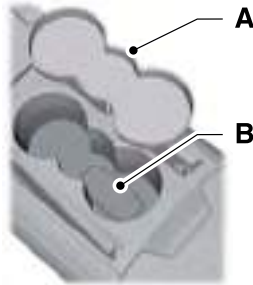

E155835

1. Remove the rubber covering (A) in the cupholder. Place the first programmed key in the backup slot (B) at the bottom of the cupholder.
2. Press the **START/STOP** button once and wait a few seconds.
3. Press the **START/STOP** button again and remove the key.
4. Insert the second programmed key into the backup slot, then press the **START/STOP** button.

The factory-set code will appear in the information display for a few seconds.

Note: *The code may not display until after any other warning messages first display.*

INTERIOR LUGGAGE COMPARTMENT RELEASE

WARNINGS

 Keep vehicle doors and luggage compartment locked and keep keys and remote transmitters out of a child's reach. Unsupervised children could lock themselves in the trunk and risk injury. Children should be taught not to play in vehicles.

 Do not leave children or animals unattended in the vehicle. On hot days, the temperature in the trunk or vehicle interior can rise very quickly. Exposure of people or animals to these high temperatures for even a short time can cause death or serious heat-related injuries, including brain damage. Small children are particularly at risk.

Your vehicle is equipped with a release handle that provides a means of escape for children and adults if they become locked inside the luggage compartment.

Locks

Adults should familiarize themselves with the operation and location of the release handle.

The handle is located inside the luggage compartment either on the luggage compartment door (lid) or near the tail lamps. It is composed of a material that will glow for hours in darkness following brief exposure to ambient light.

Pull the handle and push up on the luggage compartment door (lid) to open from within the luggage compartment.

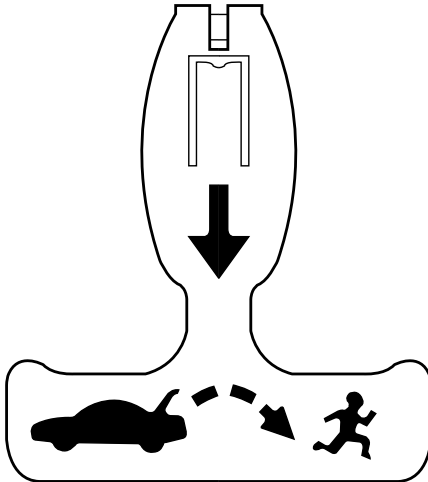

E144403

Security

PASSIVE ANTI-THEFT SYSTEM

Note: *The system is not compatible with non-Ford aftermarket remote start systems. Use of these systems may result in vehicle starting problems and a loss of security protection.*

Note: *Metallic objects, electronic devices or a second coded key on the same key chain may cause vehicle starting problems if they are too close to the key when starting your vehicle. Prevent these objects from touching the coded key while starting your vehicle. Switch the ignition off, move all objects on the key chain away from the coded key and restart your vehicle if a problem occurs.*

Note: *Do not leave a duplicate coded key in your vehicle. Always take your keys and lock all doors when leaving your vehicle.*

SecuriLock

The system helps prevent your vehicle from starting unless you use a coded key programmed to your vehicle. Using the wrong key may prevent your vehicle from starting. A message may appear in the information display.

If you are unable to start your vehicle with a correctly coded key, it is not operating properly. A message may appear in the information display.

Automatic Arming

Your vehicle arms immediately after switching the ignition off.

Automatic Disarming

Switching the ignition on with a coded key disarms your vehicle.

Replacement Keys

Note: *Your vehicle comes equipped with two intelligent access keys.*

The intelligent access key functions as a programmed key that operates the driver door lock and activates the intelligent access with push button start system, as well as a remote control.

If your programmed transmitters are lost or stolen and you do not have an extra coded key, have your vehicle towed to an authorized dealer. You need to erase the key codes from your vehicle and program new coded keys.

Store an extra programmed key away from your vehicle in a safe place to help prevent any inconveniences. See your authorized dealer to purchase additional spare or replacement keys.

Programming a Spare Intelligent Access Key

Note: *You can program a maximum of four intelligent access keys to your vehicle.*

Security

You must have two previously programmed intelligent access keys inside your vehicle and the new unprogrammed intelligent access keys readily accessible. See an authorized dealer to have the spare key programmed if two previously programmed keys are not available.

Make sure that your vehicle is off before beginning this procedure. Make sure that you close all the doors before beginning and that they remain closed throughout the procedure. Perform all steps within 30 seconds of starting the sequence. Stop and wait for at least one minute before starting again if you perform any steps out of sequence.

Read and understand the entire procedure before you begin.

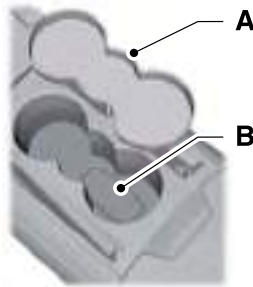

E155835

1. Remove the rubber covering (A) from the cupholder. Place the first programmed key in the backup slot (B) at the bottom of the cupholder, then press the push button ignition switch.
2. Wait five seconds and then press the push button ignition switch again.
3. Remove the intelligent access key.
4. Within 10 seconds, place a second programmed intelligent access key in the backup slot. Press the push button ignition switch.
5. Wait five seconds and then press the push button ignition switch again.

6. Remove the intelligent access key.
7. Place the unprogrammed intelligent access key in the backup slot and press the push button ignition switch.

Programming is now complete. Verify the remote control functions operate and your vehicle starts with the new intelligent access key.

If programming was not successful, wait 10 seconds and repeat Steps 1 through 7. If you are still unsuccessful, take your vehicle to your authorized dealer.

ANTI-THEFT ALARM

The system will warn you of an unauthorized entry to your vehicle. It will be triggered if any door, the luggage compartment or the hood is opened without using the key, remote control or keyless entry keypad.

The direction indicators will flash and the horn will sound if unauthorized entry is attempted while the alarm is armed.

Security

Take all remote controls to an authorized dealer if there is any potential alarm problem with your vehicle.

Arming the Alarm

The alarm is ready to arm when there is not a key in your vehicle. Electronically lock your vehicle to arm the alarm.

Disarming the Alarm

Disarm the alarm by any of the following actions:

- Unlock the doors or luggage compartment with the remote control or keyless entry keypad.
- Switch your vehicle on or start your vehicle.
- Use a key in the driver door to unlock your vehicle, then switch your vehicle on within 12 seconds.

Note: *Pressing the panic button on the remote control will stop the horn and signal indicators, but will not disarm the system.*

Steering Wheel

ADJUSTING THE STEERING WHEEL

WARNING

 Do not adjust the steering wheel when your vehicle is moving.

Note: Make sure that you are sitting in the correct position. See **Sitting in the Correct Position** (page 139).

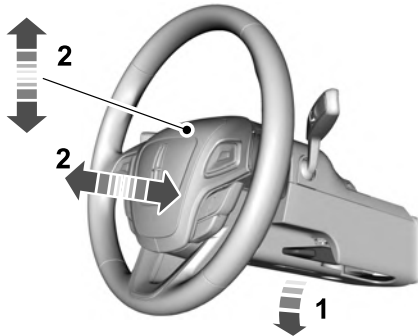

E223370

1. Unlock the steering column.

2. Adjust the steering wheel to the desired position.



E223495

3. Lock the steering column.

Power Tilt and Telescope Steering Column (If Equipped)

WARNING

 Do not adjust the steering wheel when your vehicle is moving.

Note: Make sure that you are sitting in the correct position. See **Sitting in the Correct Position** (page 139).



E161834

Use the control on the side of the steering column to adjust the position.

Steering Wheel

To adjust:

- Tilt: press the top or bottom of the control.
- Telescope: press the front or rear of the control.

The steering column sets a stopping position just short of the end of the column position to prevent damage to the steering column. A new stopping position sets if the steering column encounters an object when tilting or telescoping.

To reset the steering column to its normal stopping position:

1. Press the steering column control again after encountering the new stopping position.
2. Continue pressing the control until it reaches the end of the column position.

A new stopping position is set. The next time you tilt or telescope the steering column, it will stop just short of the end of the column position.

Memory Feature

You can save and recall the steering column position with the memory function. See **Memory Function** (page 145).

Note: *Pressing the adjustment control during memory recall cancels the operation. The column responds to the adjustment control.*

Easy Entry and Exit Feature

When you switch the ignition off, the steering column will move to the full up position to allow extra room to exit your vehicle. The column will return to the previous setting when you switch the ignition on. You can enable or disable this feature in the information display. See **Information Displays** (page 108).

AUDIO CONTROL (If Equipped)

You can operate the following functions with the control:

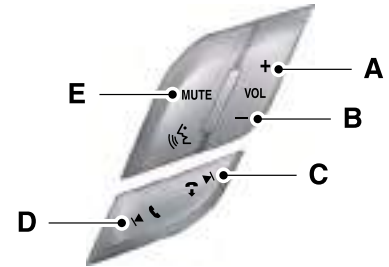

E145979

- A Volume up.
- B Volume down.
- C Seek up or next.
- D Seek down or previous.
- E Mute.

Seek, Next or Previous

Press the seek button to:

- Tune the radio to the next or previous stored preset.
- Play the next or the previous track.

Steering Wheel

Press and hold the seek button to:

- Tune the radio to the next station up or down the frequency band.
- Seek through a track.

VOICE CONTROL (If Equipped)

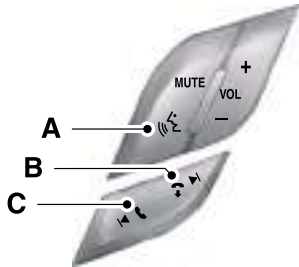

E145980

- A Voice recognition.
- B End call.
- C Answer call.

See **SYNC™ 3** (page 390).

CRUISE CONTROL

Type 1

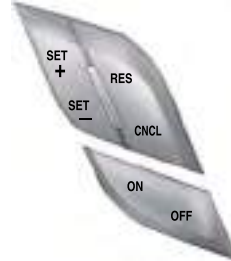

E145976

Type 2

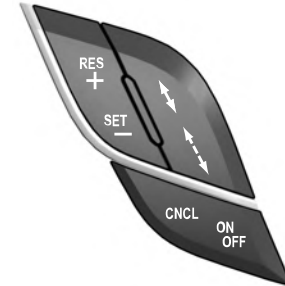

E222823

See **Cruise Control** (page 215).

INFORMATION DISPLAY CONTROL



E145981

See **Information Displays** (page 108).

Steering Wheel

HEATED STEERING WHEEL (If Equipped)

See your SYNC information.

Wipers and Washers

WINDSHIELD WIPERS

Note: Fully defrost the windshield before you switch the windshield wipers on.

Note: If streaks or smears appear on the windshield, clean the windshield and the wiper blades. See **Checking the Wiper Blades** (page 314). If that does not resolve the issue, install new wiper blades. See **Changing the Wiper Blades** (page 314).

Note: Do not operate the wipers on a dry windshield. This may scratch the glass, damage the wiper blades or cause the wiper motor to burn out. Always use the windshield washers before wiping a dry windshield.

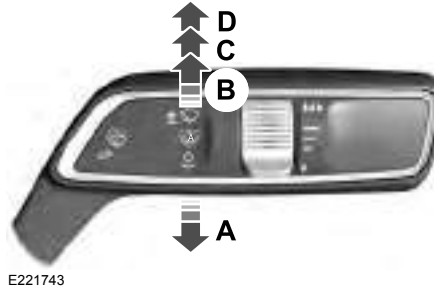

- A Single wipe.
- B Intermittent wipe.
- C Low-speed wipe.
- D High-speed wipe.

Intermittent Wipe

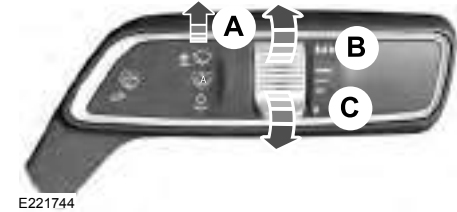

- A Intermittent wipe.
- B Short wipe interval.
- C Long-wipe interval.

Use the rotary control to adjust the intermittent wipe interval.

Note: Make sure you switch the windshield wipers off before entering a car wash.

AUTOWIPERS

Defrost the windshield before you switch the windshield wipers on.

Wipers and Washers

Do not operate the windshield wipers on a dry windshield. This may scratch the glass, damage the wiper blades or cause the wiper motor to overheat. Always use the windshield washers before you switch the windshield wipers on.

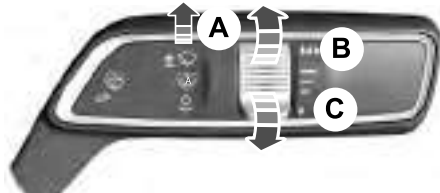

E221744

- A On.
- B High sensitivity.
- C Low sensitivity.

During wet or winter driving conditions where ice, snow or a salty road mist is present, inconsistent or unexpected wiping or smearing may occur. In these conditions, you can do the following:

- Lower the sensitivity of the autowipers to reduce the amount of smearing on the windshield.
- Switch to normal or high-speed wipe.
- Switch autowipers off.

Autowipers uses a rain sensor located in the area around the interior mirror. The wipers will operate when the rain sensor detects water on the windshield. The rain sensor will continue to monitor the amount of water on the windshield and automatically adjust the speed of the wipers.

Use the rotary control to adjust the sensitivity of the autowipers. When you select low sensitivity, the wipers will operate when the sensor detects a large amount of water on the windshield. When you select high sensitivity, the wipers will operate when the sensor detects a small amount of water on the windshield.

Keep the outside of the windshield clean. The rain sensor is very sensitive and the wipers may operate if dirt, mist or insects hit the windshield.

Note: Make sure you switch the windshield wipers off before entering a car wash.

Note: If streaks or smears appear on the windshield, clean the windshield and the wiper blades. If that does not resolve the issue, install new wiper blades. See **Changing the Wiper Blades** (page 314).

Note: If you switch autolamps and autowipers on, the headlamps will automatically turn on when the windshield wipers continuously operate.

Wipers and Washers

WINDSHIELD WASHERS



E221745

Pull the lever toward you to operate the windshield washers. When you release the lever, wiping will continue for a short period of time.

Note: Do not operate the washers when the washer reservoir is empty. This may cause the washer pump to overheat.

Note: Do not operate the windshield washers for more than 10 seconds at a time.

Lighting

LIGHTING CONTROL



E142449

- A Off.
- B Parking lamps, instrument panel lamps, license plate lamps and tail lamps.
- C Headlamp low beam.

Headlamp High Beam

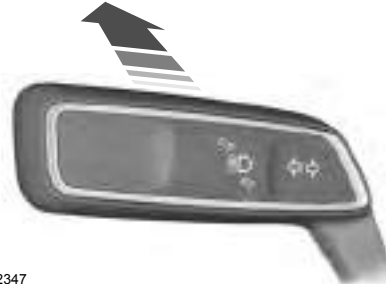

E222347

Push the lever away from you to switch the high beam on.

Push the lever away from you again or pull the lever toward you to switch the high beam off.

Headlamp Flasher

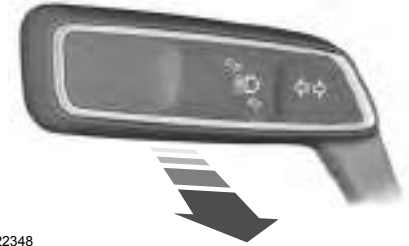

E222348

Slightly pull the lever toward you and release it to flash the headlamps.

AUTOLAMPS (If Equipped)

WARNING



The autolamps switch position may not activate the headlamps in all low visibility conditions, such as daytime fog. Always ensure that your headlamps are switched to auto or on, as appropriate, during all low visibility conditions. Failure to do so may result in a collision.

Lighting

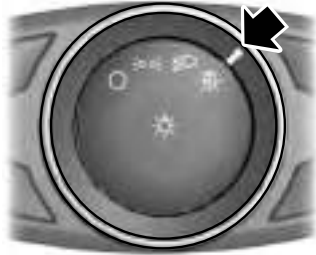

E142451

When the lighting control is in the autolamps position, the headlamps automatically turn on in low light situations or when the wipers activate.

If equipped, the following also activate when the lighting control is in the autolamps position and you switch them on in the information display:

- Configurable daytime running lamps.
- Automatic high beam control.
- Adaptive headlamp control.

The headlamps remain on for a period of time after you switch the ignition off. Use the information display controls to adjust the period of time that the headlamps remain on. See **Information Displays** (page 108).

Note: *With the headlamps in the autolamps position, you cannot switch the high beam headlamps on until the autolamps system turns the low beam headlamps on.*

Windshield Wiper Activated Headlamps

The windshield wiper activated headlamps turn on within 10 seconds when you switch the windshield wipers on and the lighting control is in the autolamps position. They turn off approximately 60 seconds after you switch the windshield wipers off.

The headlamps will not turn on by wiper activation:

- During a mist wipe.
- When the wipers are on to clear washer fluid during a wash condition.
- If the wipers are in intermittent mode.

Note: *If you switch autolamps and autowipers on, the headlamps will automatically turn on when the windshield wipers continuously operate.*

INSTRUMENT LIGHTING DIMMER

Note: *If you disconnect and connect the battery, or fully discharge and charge the battery, the illuminated components will switch to the maximum setting.*

Lighting



E165337

- A Press repeatedly or press and hold to dim.
- B Press repeatedly or press and hold to brighten.

HEADLAMP EXIT DELAY

After you switch the ignition off, you can switch the headlamps on by pulling the direction indicator lever toward you. You will hear a short tone. The headlamps will switch off automatically after three minutes with any door open or 30 seconds after the last door has been closed. You can cancel this feature by pulling the direction indicator toward you again or switching the ignition on.

DAYTIME RUNNING LAMPS

WARNING

 The daytime running lamps system does not activate the rear lamps and may not provide adequate lighting during low visibility driving conditions. Also, the autolamps switch position may not activate the headlamps in all low visibility conditions, such as daytime fog. Make sure the headlamps are switched to auto or on, as appropriate, during all low visibility conditions. Failure to do so may result in a crash.

Type 1 - Conventional (Non-Configurable)

The daytime running lamps turn on when:

1. The ignition is switched to the on position.
2. The transmission is not in park (P) for vehicles with automatic transmissions or the parking brake is released for vehicles with manual transmissions.
3. The lighting control is in the off, parking lamp or autolamps positions.
4. The headlamps are off.

Type 2 - Configurable

Switch the daytime running lamps on or off using the information display controls. See **Information Displays** (page 108).

The daytime running lamps turn on when:

1. They are switched on in the information display. See **Information Displays** (page 108).
2. The ignition is switched to the on position.

Lighting

3. The transmission is not in park (P) for vehicles with automatic transmissions or the parking brake is released for vehicles with manual transmissions.
4. The lighting control is in the autolamps position.
5. The headlamps are off.

The other lighting control switch positions do not activate the daytime running lamps, and you can use them to temporarily override autolamp control.

When switched off in the information display, the daytime running lamps are off in all lighting control switch positions.

AUTOMATIC HIGH BEAM CONTROL (If Equipped)

The system will automatically turn on your high beams if it is dark enough and no other traffic is present. When it detects the headlights of an approaching vehicle, the tail lamps of the preceding vehicle or street lighting, the system will turn off the high beams before they distract other drivers. The low beams remain on.

Note: *If it appears that automatic control of the high beams is not functioning properly, check the windshield in front of the camera for a blockage. A clear view of the road is required for proper system operation. Have any windshield damage in the area of the camera's field-of-view repaired.*

Note: *If the system detects a blockage, for example bird droppings, bug splatter, snow or ice, the system will go into low beam mode until you clear the blockage. A message may also appear in the instrument cluster display noting the front camera is blocked.*

Note: *Typical road dust, dirt and water spots will not affect the performance of the automatic high beam system. However, in cold or inclement weather conditions, you will notice a decrease in the availability of the high beam system, especially at start up. If you want to change the beam state independently of the system, you may switch the high beams on or off using the multifunction switch. Automatic control will resume when conditions are correct.*

Note: *Modification of the vehicle ride height such as using much larger tires, may degrade feature performance.*

A camera sensor, centrally mounted behind the windshield of your vehicle, continuously monitors conditions to decide when to switch the high beams off and on.

Once the system is active, the high beams will switch on if:

- the ambient light level is low enough
- there is no traffic in front of the vehicle
- the vehicle speed is greater than approximately 32 mph (52 km/h).

Lighting

The high beams will switch off if:

- the system detects the headlamps of an approaching vehicle or the tail lamps of a preceding vehicle.
- vehicle speed falls below approximately 27 mph (44 km/h)
- the ambient light level is high enough that high beams are not required
- the system detects severe rain, snow or fog
- the camera is blocked.

Activating the System

Switch the system on using the information display. See **Information Displays** (page 108). Switch the autolamps on. See **Autolamps** (page 85).

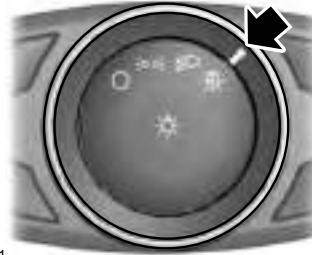

E142451

Manually Overriding the System

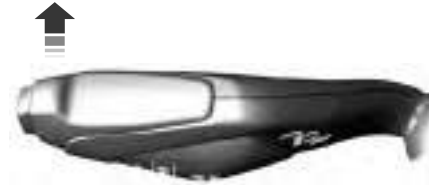

E169254

When the automatic control has activated the high beams, pushing or pulling the stalk will provide a temporary override to low beam.

Use the information display menu to permanently deactivate the system, or turn the lighting control switch from autolamps to headlamps.

ADAPTIVE HEADLAMPS

The headlamp beams move in the same direction as the steering wheel. This provides more visibility when driving around curves.

- A. Without adaptive headlamps
- B. With adaptive headlamps

Lighting

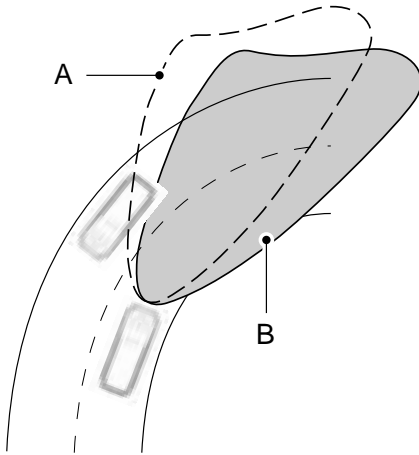

E161714

The system will only work with the lighting control switch in the autolamp position.

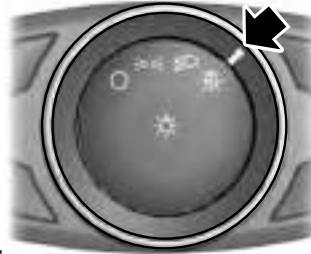

E142451

Note: There may be a delay of up to five seconds before the system will operate when the vehicle is first driven.

Note: The system is only active at speeds above 3 mph (5 km/h).

When the vehicle is started, the lamps track to a predetermined position, then back to center to alert the driver that the system is working properly.

DIRECTION INDICATORS

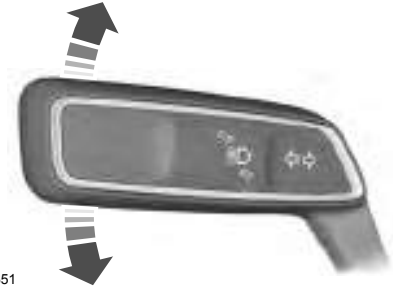

E222351

- To operate the left-hand direction indicator, push the lever down until it stops.
- To operate the right-hand direction indicator, push the lever up until it stops.
- To manually cancel direction indicator operation, push the lever again in either direction.

Lane Change

To indicate a left or right lane change:

Lighting

- Push the lever up or down to the first stop position and release. The direction indicator will flash three times and stop.
- Push the lever up or down to the first stop position and hold. The direction indicator will flash for as long as you hold the lever in this position.

WELCOME LIGHTING

The Lincoln welcome mat projection lights are on the bottom of the exterior mirror housings. They will project an image onto the ground a short distance from your vehicle when welcome lighting or lighted entry turns on.

Note: Moisture, frost and ice build-up or other types of contamination on the surface of the light lens can cause non-permanent distortion or reduced brightness of the image. Do not use abrasive materials to clean the lens.

INTERIOR LAMPS

The lamps switch on when:

- You open any door.
- You press a remote control button.
- You press the all lamps on switch on the front interior lamp.

Front Interior Lamp

Note: The front interior lamp switches are on the overhead console. The exact location of each switch on the overhead console depends upon which roof, sunroof, and window shade features are on your vehicle.

Note: Press the door function switch to switch off when you open any door. The indicator lamp illuminates amber when the door function is off. When the door function is off and you open a door, the courtesy and door lamps stay off. Press the door function switch again to switch back on. The indicator lamp illuminates white when the door function is on. When the door function is on and you open a door, the courtesy and door lamps switch on.

Type 1

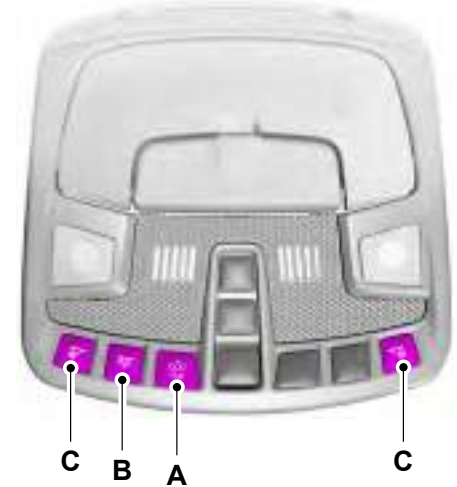

E199032

- A Door function switch.
- B All lamps on switch.
- C Map lamp switches.

Lighting

Type 2



E201073

- A Map lamp switch.
- B Door function switch.
- C All lamps on and off switch.
- D Map lamp switch.

Type 3



E192153

- A All lamps on switch.
- B Door function switch.
- C All lamps off switch.
- D Map lamp switches.

Rear Interior Lamp



E182517

- A. Left-hand side map lamp.
- B. Right-hand side map lamp.

Press the button to switch the lamps on or off.

AMBIENT LIGHTING (If Equipped)

Adjust the ambient lighting using the touchscreen.

Windows and Mirrors

POWER WINDOWS

WARNINGS

 Do not leave children unattended in your vehicle and do not let them play with the power windows. They may seriously injure themselves.

 When closing the power windows, you should verify they are free of obstructions and make sure that children and pets are not in the proximity of the window openings.

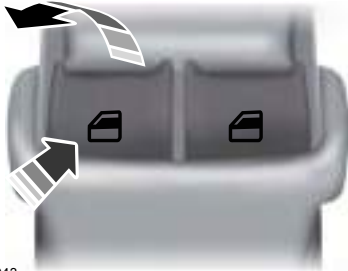

E146043

Note: You may hear a pulsing noise when just one of the windows is open. Lower the opposite window slightly to reduce this noise.

Press the switch to open the window.

Lift the switch to close the window.

One-Touch Down

Press the switch fully and release it. Press again or lift it to stop the window.

One-Touch Up

Lift the switch fully and release it. Press or lift it again to stop the window.

Bounce-Back

The window will stop automatically while closing. It reverses some distance if there is an obstacle in the way.

Overriding the Bounce-Back Feature

WARNING

 When you override the bounce-back feature the window will not reverse if it detects an obstacle. Take care when closing the windows to avoid personal injury or damage to your vehicle.

Pull up the window switch and hold within a few seconds of the window reaching the bounce-back position. The window travels up with no bounce-back protection. The window stops if you release the switch before the window closes fully.

Windows and Mirrors

Window Lock



E144072

Press the control to lock or unlock the rear window controls. It will illuminate when you lock the rear window controls.

Accessory Delay

You can use the window switches for several minutes after you switch the ignition off or until you open either front door.

GLOBAL OPENING AND CLOSING

You can use the remote control to operate the windows with the ignition off.

Note: You can enable or disable this feature in the information display or see an authorized dealer. See **General Information** (page 108).

Note: To operate this feature, accessory delay must not be active.

Opening the Windows

You can only open the windows for a short time after you unlock your vehicle with the remote control. After you unlock your vehicle, press and hold the remote control unlock button to open the windows and vent the moonroof. Release the button once movement starts. Press the lock or unlock button to stop movement.

Closing the Windows

WARNING



When closing the windows and moonroof, you should verify they are free of obstructions and make sure that children and pets are not in the proximity of the window openings.

To close the windows and moonroof, press and hold the remote control lock button. Release the button once movement starts. Press the lock or unlock button to stop movement.

EXTERIOR MIRRORS

Power Exterior Mirrors

WARNING



Do not adjust the mirrors when your vehicle is moving.

Windows and Mirrors



E144073

- A Left-hand mirror.
- B Adjustment control.
- C Right-hand mirror.

To adjust a mirror:

1. Select the mirror you want to adjust. The control illuminates.
2. Adjust the position of the mirror.
3. Press the mirror switch again.

Fold-Away Exterior Mirrors

Push the mirror toward the door window glass. Make sure that you fully engage the mirror in its support when returning the mirror to its original position.

Auto-Folding Mirrors (if Equipped)

The exterior mirrors automatically fold in toward the glass after you place the transmission into park (P), turn off the vehicle, open and close the driver's side door and lock the vehicle. The exterior mirrors automatically unfold and return to their driving position after you unlock the vehicle and open and close the driver's side door.

You can switch this feature on and off through the information display. See **General Information** (page 108).

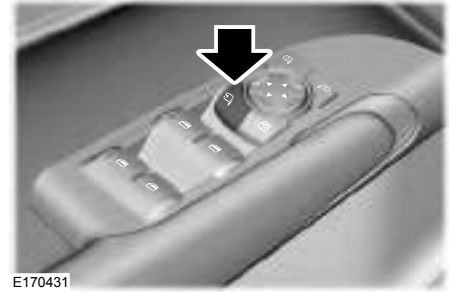

E170431

You can fold the mirrors on demand by pressing the power-folding mirror control located on the door. The control lights and the mirrors fold in toward the glass. Press the control again to unfold the mirrors. The control light turns off.

Note: If you use the power-folding control to fold the mirrors on demand and the auto fold feature is switched on, you must use the control again to unfold them.

Windows and Mirrors

Loose Mirror

If your power-folding mirrors are manually folded, they may not work properly even after you re-position them. You need to reset them if:

- The mirrors vibrate when you drive.
- The mirrors feel loose.
- The mirrors do not stay in the folded or unfolded position.
- One of the mirrors is not in its normal driving position.

To reset the power-fold feature, use the power-folding mirror control to fold and unfold the mirrors. You may hear a loud noise as you reset the power-folding mirrors. This sound is normal. Repeat this process as needed each time the mirrors are manually folded.

Heated Exterior Mirrors

See **Heated Windows and Mirrors** (page 137).

Memory Mirrors

You can save and recall the mirror positions through the memory function. See **Memory Function** (page 145).

Auto-Dimming Feature (If Equipped)

The driver exterior mirror automatically dims when the interior auto-dimming mirror turns on.

Signal Indicator Mirrors

The outer portion of the appropriate mirror housing blinks when you switch on the direction indicator.

Lincoln Welcome Mat

Projection lights, on the bottom of the mirror housings, project an image onto the ground a short distance from the vehicle. See **Lighting** (page 85).

Integrated Blind Spot Mirrors (If Equipped)

WARNING



Objects in the blind spot mirror are closer than they appear.

Blind spot mirrors have an integrated convex mirror built into the upper outboard corner of the exterior mirrors. Their design can increase your visibility along the side of your vehicle.

Check the main mirror first before a lane change, then check the blind spot mirror. If no vehicles are present in the blind spot mirror and the traffic in the adjacent lane is at a safe distance, signal that you intend to change lanes. Glance over your shoulder to verify traffic is clear and carefully change lanes.

Windows and Mirrors

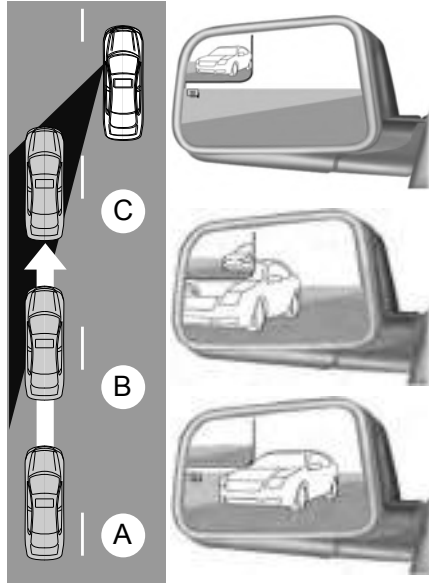

E138665

The image of the approaching vehicle is small and near the inboard edge of the main mirror when it is at a distance. The image becomes larger and begins to move outboard across the main mirror as the vehicle approaches (A). The image transitions from the main mirror and begins to appear in the blind spot mirror as the vehicle approaches (B). The vehicle transitions to your peripheral field of view as it leaves the blind spot mirror (C).

Blind Spot Monitor (If Equipped)

See **Blind Spot Information System** (page 231).

INTERIOR MIRROR

WARNING



Do not adjust the mirror when your vehicle is moving.

Note: Do not clean the housing or glass of any mirror with harsh abrasives, fuel or other petroleum or ammonia-based cleaning products.

You can adjust the interior mirror to your preference. Some mirrors also have a second pivot point. This lets you move the mirror head up or down and from side to side.

Auto-Dimming Mirror

Note: Do not block the sensors on the front and back of the mirror. Mirror performance may be affected. A rear center passenger or raised rear center head restraint may also block light from reaching the sensor.

The mirror will dim automatically to reduce glare when bright lights are detected from behind your vehicle. It will automatically return to normal reflection when you select reverse gear to make sure you have a clear view when backing up.

Windows and Mirrors

SUN VISORS

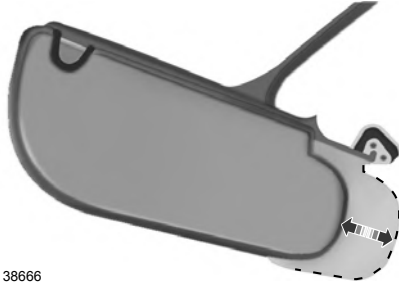

E138666

Rotate the sun visor toward the side window and extend it rearward for extra shade.

Illuminated Vanity Mirror

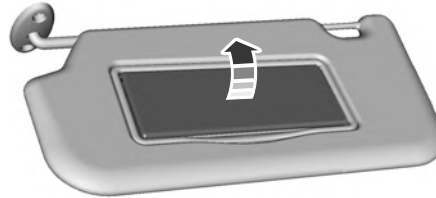

E162197

Lift the cover to switch the lamp on.

SUN SHADES (If Equipped)

Note: Do not try to move the sun shade manually.

The power rear sun shade covers the rear window of the vehicle.



E145986

The control is in the overhead console.

The sun shade has a one-touch up and down feature. Press and release the control to move the sun shade. To stop motion, press the control a second time.

The sun shade automatically retracts when you shift the transmission into **R** (Reverse).

MOONROOF (If Equipped)

WARNINGS



Do not let children play with the moonroof or leave them unattended in the vehicle. They may seriously hurt themselves.

Windows and Mirrors

WARNINGS



When closing the moonroof, you should verify that it is free of obstructions and make sure that children and pets are not in the proximity of the roof opening.

The moonroof controls are located on the overhead console and have a one-touch open and close feature. To stop its movement during one-touch operation, press the control a second time.

Opening and Closing the Moonroof

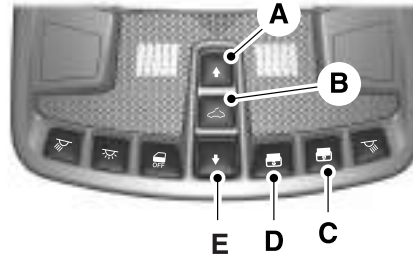

E191272

- A **Moonroof open.** Press and release to open the moonroof. The moonroof stops short of the fully opened position. Press and release the control again to open the moonroof fully.
- B **Moonroof vent.** Press and release to vent the moonroof.
- C **Sunshade open.** Press and release to open the sunshade. The sunshade opens automatically with the moonroof. You can also open the sunshade with the moonroof closed. **Note:** The sunshade stops short of its fully opened position for the comfort of rear passengers. To open the sunshade fully, press the control again.
- D **Sunshade close.** Press and release to close the sunshade. If fully open, the sunshade stops after covering the rear glass panel. Press and release again to fully close the sunshade.
- E **Moonroof close.** Press and release to close the moonroof from either the open or vent positions.

Bounce-Back

The moonroof automatically reverses some distance if an obstacle is detected while closing.

Windows and Mirrors

To override this feature, press and hold the **moonroof close** control within two seconds after the roof comes to a stop following a bounce-back reversal or two successive reversals if equipped with a retractable panoramic roof.

Instrument Cluster

GAUGES

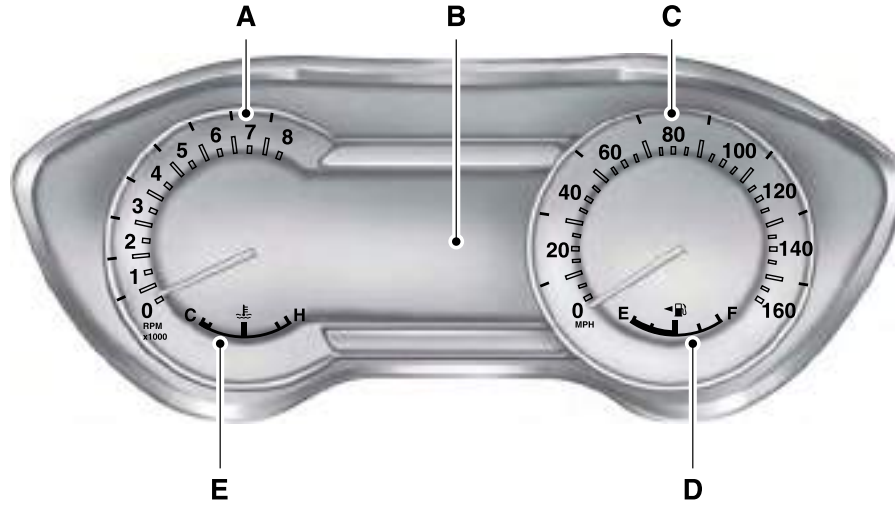

E152749

Instrument Cluster

- A Tachometer
- B Information display
- C Speedometer
- D Fuel gauge
- E Engine coolant temperature gauge

Information Display

Odometer

Located in the bottom of the information display. Registers the accumulated distance your vehicle has traveled.

Trip Computer

See **General Information** (page 108).

Vehicle Settings and Personalization

See **General Information** (page 108).

Fuel Gauge

Note: *The fuel gauge may vary slightly when your vehicle is moving or on a gradient.*

Switch the ignition on. The fuel gauge will indicate approximately how much fuel is left in the fuel tank. The arrow adjacent to the fuel pump symbol indicates on which side of your vehicle the fuel filler door is located.

The needle should move toward F when you refuel your vehicle. If the needle points to E after adding fuel, this indicates your vehicle needs service soon.

After refueling some variability in needle position is normal:

- It may take a short time for the needle to reach full after leaving the gas station. This is normal and depends upon the slope of pavement at the gas station.
- The fuel amount dispensed into the tank is a little less or more than the gauge indicated. This is normal and depends upon the slope of pavement at the gas station.
- If the gas station nozzle shuts off before the tank is full, try a different gas pump nozzle.
- There is a small reserve left in the tank when the fuel gauge reaches empty.

Low Fuel Reminder

A low fuel reminder triggers at 50 mi (80 km) to empty.

Instrument Cluster

Variations:

Note: The low fuel reminder can appear at different fuel gauge positions depending on fuel economy conditions. This variation is normal.

Engine Coolant Temperature Gauge

Indicates engine coolant temperature. At normal operating temperature, the level indicator will be in the normal range. If the engine coolant temperature exceeds the normal range, stop the vehicle as soon as safely possible, switch off the engine and let the engine cool.

WARNING



Never remove the coolant reservoir cap while the engine is running or hot.

WARNING LAMPS AND INDICATORS

The following warning lamps and indicators will alert you to a vehicle condition that may become serious. Some lamps will illuminate when you start your vehicle to make sure they work. If any lamps remain on after starting your vehicle, refer to the respective system warning lamp for further information.

Note: Some warning indicators appear in the information display and function the same as a warning lamp, but do not display when you start your vehicle.

Adaptive Cruise Control (if Equipped)



The speed control system indicator light changes color to indicate what mode the system is in: See **Using Adaptive Cruise Control** (page 216).

On (white light): Illuminates when the adaptive cruise control system is turned on. Turns off when the speed control system is turned off.

Engaged (green light): Illuminates when the adaptive cruise control system is engaged. Turns off when the speed control system is disengaged.

Anti-Lock Braking System



If it illuminates when you are driving, this indicates a malfunction. You will continue to have the normal braking system (without ABS) unless the brake system warning lamp is also illuminated. Have the system checked by your authorized dealer.

Autohold Active



It illuminates when the system holds your vehicle stationary.

Autohold Unavailable



It illuminates when the system is on, but unavailable to hold your vehicle stationary.

Instrument Cluster

Battery



If it illuminates while driving, it indicates a malfunction. Switch off all unnecessary electrical equipment and have the system checked by your authorized dealer immediately.

Blind Spot Monitor (If Equipped)



It will illuminate when you switch this feature off or in conjunction with a message. See **Blind Spot Information System** (page 231). See **Information Messages** (page 114).

Brake System



It will illuminate when you engage the parking brake with the ignition on.

If it illuminates when you are driving, check that the parking brake is not engaged. If the parking brake is not engaged, this indicates low brake fluid level or a brake system malfunction. Have the system checked immediately by your authorized dealer.

WARNING



Driving your vehicle with the warning lamp on is dangerous. A significant decrease in braking performance may occur. It will take you longer to stop your vehicle. Have your vehicle checked by your authorized dealer immediately. Driving extended distances with the parking brake engaged can cause brake failure and the risk of personal injury.

Cruise Control (If Equipped)



It will illuminate when you switch this feature on.

Direction Indicator



Illuminates when the left or right turn signal or the hazard warning flasher is turned on. If the indicators stay on or flash faster, check for a burned out bulb. See **Changing a Bulb** (page 316).

Door Ajar



Displays when the ignition is on and any door is not completely closed.

Electric Park Brake



It will illuminate or flash when the electric parking brake has a malfunction. See **Electric Parking Brake** (page 189).

Engine Coolant Temperature



Illuminates when the engine coolant temperature is high. Stop the vehicle as soon as possible, switch off the engine and let cool. See **Engine Coolant Check** (page 303).

Instrument Cluster

Engine Oil



If it illuminates with the engine running or when you are driving, this indicates a malfunction. Stop your vehicle as soon as it is safe to do so and switch the engine off. Check the engine oil level. See **Engine Oil Check** (page 301).

Note: Do not resume your journey if it illuminates despite the level being correct. Have the system checked by your authorized dealer immediately.

Fasten Seatbelt



It will illuminate and a chime will sound to remind you to fasten your seatbelt. See **Seatbelt Reminder** (page 40).

Front Airbag



If it fails to illuminate when you start your vehicle, continues to flash or remains on, it indicates a malfunction. Have the system checked by your authorized dealer.

Heads Up Display (If Equipped)



A red beam of lights will illuminate on the windshield in certain instances when using adaptive cruise control and/or the collision warning system. It will also illuminate momentarily when you start your vehicle to make sure the display works.

High Beam



It will illuminate when you switch the high beam headlamps on. It will flash when you use the headlamp flasher.

Hood Ajar



Displays when the ignition is on and the hood is not completely closed.

Low Fuel Level



It will illuminate when the fuel level is low or the fuel tank is nearly empty. Refuel as soon as possible.

Low Tire Pressure Warning



It will illuminate when your tire pressure is low. If the lamp remains on with the engine running or when driving, check your tire pressure as soon as possible.

It will also illuminate momentarily when you switch the ignition on to confirm the lamp is functional. If it does not illuminate when you switch the ignition on, or begins to flash at any time, have the system checked by your authorized dealer.

Low Washer Fluid



It will illuminate when the windshield washer fluid is low.

Parking Lamps



It will illuminate when you switch the parking lamps on.

Instrument Cluster

Powertrain Fault



Illuminates when a powertrain or an AWD fault has been detected. Contact your authorized dealer as soon as possible.

Service Engine Soon



If the service engine soon indicator light stays illuminated after the engine is started, it indicates that the On Board Diagnostics system (OBD) has detected a malfunction of the vehicle emissions control system. Refer to On board diagnostics (OBD) in the Fuel and Refueling chapter for more information about having your vehicle serviced. See **Emission Control System** (page 170).

If the light is blinking, engine misfire is occurring which could damage your catalytic converter. Drive in a moderate fashion (avoid heavy acceleration and deceleration) and have your vehicle serviced immediately.

WARNING



Under engine misfire conditions, excessive exhaust temperatures could damage the catalytic converter, the fuel system, interior floor coverings or other vehicle components, possibly causing a fire. Have an authorized dealer service your vehicle immediately.

The service engine soon indicator light illuminates when the ignition is first turned on prior to engine start to check the bulb and to indicate whether the vehicle is ready for Inspection/Maintenance (I/M) testing.

Normally, the service engine soon light will stay on until the engine is cranked, then turn itself off if no malfunctions are present. However, if after 15 seconds the service engine soon light blinks eight times, it means that the vehicle is not ready for I/M testing. See **Emission Control System** (page 170).

Stability Control



It will flash when the system is active. If it remains illuminated or does not illuminate when you switch the ignition on, this indicates a malfunction. During a malfunction the system will switch off. Have the system checked by your authorized dealer immediately. See **Using Stability Control** (page 197).

Stability Control Off



It will illuminate when you switch the system off. It will go out when you switch the system back on or when you switch the ignition off. See **Using Stability Control** (page 197).

Trunk Ajar



Displays when the ignition is on and the trunk is not completely closed.

Instrument Cluster

AUDIBLE WARNINGS AND INDICATORS

Key in Ignition Warning Chime

Sounds when you open the driver's door and you have left the key in the ignition.

Keyless Warning Alert (If Equipped)

Sounds the horn twice when you exit your vehicle with the intelligent access key, after the last door is closed and your keyless vehicle is in RUN, indicating your vehicle is still on.

Headlamps On Warning Chime

Sounds when you remove the key from the ignition and open the driver's door and you have left the headlamps or parking lamps on.

Parking Brake On Warning Chime

Sounds when you have left the parking brake on and drive your vehicle. If the warning chime remains on after you have released the parking brake, have the system checked by an authorized dealer immediately.

Information Displays

GENERAL INFORMATION

WARNING

 Driving while distracted can result in loss of vehicle control, crash and injury. We strongly recommend that you use extreme caution when using any device that may take your focus off the road. Your primary responsibility is the safe operation of your vehicle. We recommend against the use of any hand-held device while driving and encourage the use of voice-operated systems when possible. Make sure you are aware of all applicable local laws that may affect the use of electronic devices while driving.

Various systems on your vehicle can be controlled using the information display controls on the steering wheel. Corresponding information is displayed in the information display.

Information Display Controls



E152750

- Press the up and down arrow buttons to scroll through and highlight the options within a menu.
- Press the right arrow button to enter a sub-menu.
- Press the left arrow button to exit a menu.

- Press and hold the left arrow button at any time to return to the main menu display (escape button).
- Press the OK button to choose and confirm settings or messages.



This icon gives you the ability to switch a feature on or off. A check in the box indicates the feature is enabled, and unchecked indicates the feature is disabled.

Main menu

From the main menu bar on the left side of the information display, you can choose from the following categories:

- Trip 1 & 2
- Fuel Economy
- Driver Assist
- Settings

Scroll up or down to highlight one of the categories and then press the right arrow key or **OK** to enter into that category. Press the left arrow key as needed to exit back to the main menu.

Information Displays

Trip 1 & 2

Press and hold **OK** to reset the currently displayed trip information.

Trip 1 & 2
All value screen (Trip odometer, Average fuel economy, Trip Timer)

- Trip odometer — Shows your accumulated trip distance.
- Average fuel economy — Shows your average fuel economy for a given trip.
- Trip Timer— The timer stops when you switch off your vehicle and restarts when you restart your vehicle.

Fuel Economy

Use the left or right arrow buttons to choose the desired fuel economy display.

Fuel Economy
Instantaneous Fuel Economy
Average MPG

- Instantaneous Fuel Economy: This display shows a visual graph of your instantaneous fuel economy.
- Average MPG — Shows your average fuel economy for a given trip.

Press and hold **OK** to reset your current fuel economy information.

Information Displays

Driver Assist

Use the up or down arrow buttons to choose between different driver assist choices.

Driver Assist		
Traction Control		
Adaptive Steering	Steering in "D"	Sport or Normal
	Steering in "S"	Sport or Normal
Blindspot		
Cross Traffic		
Cruise Control	Adaptive or Normal	
Driver Alert	Driver Alert	
	Driver Alert Display	Driver Alert Display
Intelligent AWD		
Lane Keeping Sys	Mode	Alert, Aid or Alert + Aid
	Intensity	High, Normal or Low
Pre-Collision	Alert Sensitivity	High, Normal or Low
	Active Braking	

Information Displays

Driver Assist
Front Park Aid
Rear Park Aid
Tire Pressure

Settings

Note: Some items are optional and may not appear.

Use the up or down arrow buttons to choose between different driver setting choices.

Note: Some MyKey items will only appear if a MyKey is set.

Settings			
Vehicle	Drive Control	Handling in D	Comfort, Normal or Sport
		Handling in S	Normal or Sport
		Performance in S	Normal or Sport
	Easy Entry/Exit		
	Auto Engine Off		
	Lighting	Adaptive Headlamps	Adaptive Headlamps
			Traffic Setup

Information Displays

Settings		
		Auto Highbeam
	Autolamp Delay	Select time interval
		Daytime Lights
		Welcome Lighting
Locks		Autolock
		Autounlock
		Mislock
	Remote Unlock	All doors or Driver door
		Switches Inhibit
Mirror		Autofold
Neutral Towing		Hold OK to Initialize
Oil Life		Remaining Life XXX% - Hold OK to Reset
Power Decklid		Enable Switch or Disable Switch
Remote Start	Climate Control	Auto or Last Settings
	Front Seats & Wheel	Auto Heated or Off
	Duration	5, 10 or 15 minutes

Information Displays

Settings		
		System
	Windows	Remote
	Wipers	Courtesy Wipe
		Rain Sensing
MyKey	Create MyKey	Hold OK to Create MyKey
	911 Assist	Always On or User Selectable
	Traction Control	Always On or User Selectable
	Max Speed	Choose desired speed or off
	Speed Minder	Choose desired speed or off
	Volume Limiter	
	Do Not Disturb	Always On or User Selectable
	Clear MyKeys	Hold OK to Clear All MyKeys
Display	Distance Unit	Miles & Gallons, L/100km or km/L
	Temperature Unit	°Fahrenheit or °Celsius

Information Displays

Settings		
	Tire Pressure	psi, kPa or BAR
	Language	Choose your applicable setting - Hold OK to Set
	Speedo in km/h	

INFORMATION MESSAGES

Note: Depending on the vehicle options equipped with your vehicle, not all of the messages will display or be available. Certain messages may be abbreviated or shortened depending upon which cluster type you have.

E145981



Press the OK button to acknowledge and remove some messages from the information display. Other messages will be removed automatically after a short time.

Certain messages need to be confirmed before you can access the menus.

Active Park

Message	Action
Active Park Fault	Displayed when the system needs service. Contact your authorized dealer as soon as possible.

Information Displays

Adaptive Cruise Control

Message	Action
Adaptive Cruise Malfunction	Displayed when a radar malfunction is preventing the ACC from engaging. See Using Adaptive Cruise Control (page 216).
Adaptive Cruise Not Available	Displayed when conditions exist such that the adaptive cruise cannot function properly. See Using Adaptive Cruise Control (page 216).
Adaptive Cruise Not Available Sensor Blocked See Manual	Displayed when the radar is blocked because of poor radar visibility due to bad weather or ice/mud/water in front of radar. Driver can typically clean the sensor to resolve. See Using Adaptive Cruise Control (page 216).
Normal Cruise Active Automatic Braking Turned Off	Displayed when the automatic braking has been disabled.
Front Sensor Not Aligned	Displayed when a radar malfunction is preventing the ACC from engaging.
Adaptive Cruise - Driver Resume Control	Displayed when the adaptive cruise has reinstated controls to the driver.
Adaptive Cruise Speed Too Low to Activate	Displays when the vehicle speed is too slow to activate the adaptive cruise.
Adaptive Cruise Shift Down	Displays when the adaptive cruise is automatically adjusting the gap distance and the driver needs to shift the transmission into a lower gear.

Information Displays

Adaptive Headlamps

Message	Action
Check Headlamp System See Manual	Displays when a fault with the system has occurred. Contact an authorized dealer as soon as possible.

AdvanceTrac™

Message	Action
Service AdvanceTrac	Displays when the system detects a malfunction due to a blocked sensor.
AdvanceTrac Off On	Displayed when the traction control has been disabled or enabled by the driver.

Airbag

Message	Action
Occupant Sensor BLOCKED Remove Objects Near Passenger Seat	Displays when the system detects a malfunction due to a blocked sensor.

Information Displays

Alarm

Message	Action
Vehicle Alarm To Stop Alarm, Start Vehicle.	Displays when the alarm has been triggered due to unauthorized entry. See Anti-Theft Alarm (page 76).

Automatic Engine Shutdown

Message	Action
Engine Shuts Off In {seconds to shut off:#0} Seconds	Displays when the engine is getting ready to shut off.
Engine Shut Off For Fuel Economy	Displays when the engine has shut off to help increase fuel economy.
Engine Shuts Off in {seconds to shut off:#0} Seconds Press Ok to Override	Displays when the engine is getting ready to shut off. You can press OK on the left steering wheel button to override the shut down.

Information Displays

AWD

Message	Action
AWD Temporarily Disabled	Displayed when the AWD system has been temporarily disabled to protect itself from overheating.
AWD OFF	Displayed when the AWD system has been automatically disabled to protect itself. This is caused by operating the vehicle with the compact spare tire installed or if the system is overheating.
AWD Restored	The AWD system will resume normal function and clear this message after driving a short distance with the road tire re-installed or after the system is allowed to cool.
AWD Malfunction Service Required	Displayed in conjunction with the Throttle Control/Transmission/AWD light when the AWD system is not operating properly. If the warning stays on or continues to come on, contact your authorized dealer as soon as possible.

Information Displays

Battery and Charging System

Message	Action
Check Charging System	Displayed when the charging system needs servicing. If the warning stays on or continues to come on, contact your authorized dealer as soon as possible.
Low Battery Features Temporarily Turned Off	Displayed when the battery management system detects an extended low-voltage condition. Various vehicle features will be disabled to help preserve the battery. Turn off as many of the electrical loads as soon as possible to improve system voltage. If the system voltage has recovered, the disabled features will operate again as normal.
Turn Power Off To Save Battery	Displayed when the battery management system determines that the battery is at a low state of charge. Turn the ignition off as soon as possible to protect the battery. This message will clear once the vehicle has been started and the battery state of charge has recovered. Turning off unnecessary electrical loads will allow faster battery state-of-charge recovery.

Information Displays

Blind Spot Information and Cross Traffic Alert System

Message	Action
Blindspot System Fault	Displayed when a fault with the system has occurred. Contact your authorized dealer as soon as possible.
Blindspot Not Available Sensor Blocked See Manual	Displayed when the system sensors are blocked. Contact your authorized dealer as soon as possible. See Blind Spot Information System (page 231).
Cross Traffic Vehicle Coming From X	Displayed when the system detects a vehicle. See Blind Spot Information System (page 231).
Cross Traffic Not Available Sensor Blocked See Manual	Displayed when the blind spot information system and cross traffic alert system sensors are blocked. See Blind Spot Information System (page 231).
Cross Traffic System Fault	Displays when a fault with the system has occurred. Contact your authorized dealer as soon as possible.

Doors and Locks

Message	Action
X Door Ajar	Displays when the door(s) listed is not completely closed and the vehicle is moving.
	Displays when the door(s) listed is not completely closed.
Trunk Ajar	Displays when the luggage compartment is not completely closed.
Hood Ajar	Displays when the hood is not completely closed.

Information Displays

Message	Action
Switches Inhibited Security Mode	Displays when the door switches have been disabled.
Child Lock Malfunction Service Required	Displayed when there is a system malfunction with the child locks. Contact your authorized dealer as soon as possible.
Factory Keypad Code {X X X X X}	Displays the factory keypad code after the keypad has been reset. See Keyless Entry (page 71).

Driver Alert

Message	Action
Driver Alert Warning Rest Now	Stop and rest as soon as it is safe to do so.
Driver Alert Warning Rest Suggested	Take a rest soon.

Fuel

Message	Action
Fuel Level Low	Displayed as an early reminder of a low fuel condition.
Check Fuel Fill Inlet	Displayed when the fuel fill inlet may not be properly closed.

Information Displays

Hill Start Assist

Message	Action
Hill Start Assist Not Available	Displays when hill start assist is not available. Contact your authorized dealer. See Auto Hold (page 191).

Keys and Intelligent Access

Message	Action
To START Press Brake	Displayed as a reminder to press the brake while starting the vehicle.
No Key Detected	Displayed if the key is not detected by the system. See Keyless Starting (page 159).
Restart Now or Key is Needed	Displayed when the start/stop button is pressed to shut off the engine and an Intelligent Access key is not detected inside the vehicle.
Run Power Active	Displayed when the vehicle is in the run ignition state.
Starting System Fault	This message is displayed when there is a problem with your vehicle's starting system. See your authorized dealer for service.
Key Program Successful	Displayed during spare key programming, when an intelligent access key is programmed to the system.
Key Program Failure	Displayed during spare key programming, when an intelligent access key has failed to be programmed.

Information Displays

Message	Action
Max Number of Keys Learned	Displayed during spare key programming when the maximum number of keys have been programmed.
Not Enough Keys Learned	Displayed during spare key programming when not enough keys have been programmed.
Key Battery Low Replace Soon	Displays when the key battery is low. Change the battery as soon as possible.
Could Not Program Integrated Key	Displayed when an attempt is made to program a spare key using two existing MyKeys.
Vehicle is ON	Displays to inform the driver that they are exiting the vehicle and the engine is on.

Lane Keeping System

Message	Action
Lane Keeping Sys. Malfunction Service Required	The system has malfunctioned. Contact your authorized dealer as soon as possible.
Front Camera Temporarily Not Available	The system has detected a condition that has caused the system to be temporarily unavailable.
Front Camera Low Visibility Clean Screen	The system has detected a condition that requires the windshield to be cleaned to operate properly.
Front Camera Malfunction Service Required	The system has malfunctioned. Contact your authorized dealer as soon as possible.
Keep Hands on Steering Wheel	Displayed when the system requests the driver to keep their hands on the steering wheel.

Information Displays

Maintenance

Message	Action
Low Engine Oil Pressure	Stop the vehicle as soon as safely possible, turn off the engine. Check the oil level. If the warning stays on or continues to come on with your engine running, contact your authorized dealer as soon as possible.
Change Engine Oil Soon	Displayed when the engine oil life remaining is 10% or less. See Engine Oil Check (page 301).
Oil Change Required	Displayed when the oil life left reaches 0%. See Engine Oil Check (page 301).
Brake Fluid Level Low	Indicates the brake fluid level is low and the brake system should be inspected immediately. See Brake Fluid Check (page 311).
Check Brake System	Displays when the brake system needs servicing. Stop the vehicle in a safe place. Contact your authorized dealer.
Engine Coolant Over Temperature	Displays when the engine coolant temperature is excessively high.
Washer Fluid Level Low	Displays when the washer fluid is low and needs to be refilled.
Power Reduced to Lower Engine Temp	Displays when the engine has reduced power in order to help reduce high coolant temperatures.
Transport / Factory Mode	Displays to indicate that the vehicle is still in Transport or Factory mode. This may not allow some features to operate properly. See your authorized dealer.
See Manual	Informs the driver that the powertrain needs service due to a powertrain malfunction.

Information Displays

MyKey

Message	Action
MyKey not Created	Displayed during key programming when MyKey cannot be programmed.
MyKey Active Drive Safely	Displays when MyKey is active.
Speed Limited to XX MPH/km/h	Displays when starting the vehicle and MyKey is in use and the MyKey speed limit is on.
Near Vehicle Top Speed	Displays when a MyKey is in use and the MyKey speed limit is on and the vehicle speed is approaching 80 mph (130 km/h).
Vehicle at Top Speed of MyKey Setting	Displays when a MyKey is in use and the MyKey speed limit is reached.
Check Speed Drive Safely	Displays when MyKey is active.
Buckle Up to Unmute Audio	Displays when a MyKey is in use and Belt-Minder is activated.
AdvanceTrac On - MyKey Setting	Displays when a MyKey is in use and AdvanceTrac is activated.
Traction Control On - MyKey Setting	Displays when a MyKey is in use and Traction control is activated.
MyKey Park Aid Cannot be Deactivated	Displays when a MyKey is in use and park aid is activated.
Lane Keeping Alert On MyKey Setting	Displayed when the lane keeping aid is on per MyKey settings.

Information Displays

Park Aid

Message	Action
Check Front Park Aid	Displays when the system has detected a condition that requires service. Contact your authorized dealer. See Rear Parking Aid (page 200).
Check Rear Park Aid	Displays when the system has detected a condition that requires service. Contact your authorized dealer. See Rear Parking Aid (page 200).
Front Park Aid On Off	Displays the park aid status.
Rear Park Aid On Off	Displays the park aid status.

Park Brake

Message	Action
To Release: Press Brake and Switch	The electric parking brake is set and a manual release is attempted without the brake pedal being pressed.
Park Brake Use Switch to Release	The electric parking brake is set and an automatic release is attempted but cannot be performed. Perform a manual release.
Release Park Brake	The electric parking brake is set and your vehicle speed exceeds 3 mph (5 km/h). Release park brake before continued driving.
Park Brake Not Applied	The electric parking brake is not fully applied.

Information Displays

Message	Action
Park Brake Not Released	The electric parking brake is not fully released.
Park Brake Maintenance Mode	The electric parking brake system has been put into a special mode that is used to allow service of the rear brakes. Contact an authorized dealer.
Park Brake Limited Function Service Required	The electric park brake system has detected a condition that requires service. Some functionality may still be available. Contact your authorized dealer.
Park Brake Malfunction Service Now	The electric parking brake system has detected a condition that requires service. Contact your authorized dealer.
Park Brake System Overheated	Numerous park brake applies have overheated the system. Wait 2 minutes before attempting to apply again.

Power Steering

Message	Action
Steering Fault Service Now	The power steering system has detected a condition that requires service. See your authorized dealer.
Steering Loss Stop Safely	The power steering system is not working. Stop the vehicle a safe place. Contact your authorized dealer.
Steering Assist Fault Service Required	The power steering system has detected a condition within the power steering system or passive entry or passive start system requires service. Contact your authorized dealer.

Information Displays

Pre-Collision Assist

Message	Action
Pre-Collision Assist Malfunction	Displayed when there is a system malfunction with the collision warning system. The system will be disabled. Contact an authorized dealer as soon as possible.
Pre-Collision Assist Not Available Sensor Blocked	Displayed when the collision warning system radar is blocked because of poor radar visibility due to bad weather, ice, mud or water in front of the radar. Driver can typically clean the sensor to resolve. Contact an authorized dealer as soon as possible.
Pre-Collision Assist Not Available	Displayed when there is a system malfunction with the collision warning system. The system will be disabled. Contact an authorized dealer as soon as possible.

Remote Start

Message	Action
To Drive: Press Brake and Gear Shift Button	Displays as a reminder to apply the brake and push the gear shift button to drive the vehicle after a remote start.

Information Displays

Seats

Message	Action
Memory Recall Not Permitted While Driving	Displays as a reminder that memory seats are not available while driving.
Memory {0} Saved	Displays to show where your memory setting has been saved.

Starting System

Message	Action
To START Press Brake	Displays when starting the vehicle as a reminder to apply the brake.
Cranking Time Exceeded	Displays when the starter has exceeded its cranking time in attempting to start the vehicle.
Engine Start Pending Please Wait	Displays when the starter is attempting to start the vehicle.
Pending Start Cancelled	Displays when the pending start has been cancelled.

Information Displays

Tire Pressure Monitoring System

Message	Action
Tire Pressure Low	Displays when one or more tires on your vehicle have low tire pressure. See Tire Pressure Monitoring System (page 353).
Tire Pressure Monitor Fault	Displays when the tire pressure monitoring system is malfunctioning. If the warning stays on or continues to come on, contact your authorized dealer. See Tire Pressure Monitoring System (page 353).
Tire Pressure Sensor Fault	Displayed when a tire pressure sensor is malfunctioning, or your spare tire is in use. If the warning stays on or continues to come on, contact your authorized dealer as soon as possible. See Tire Pressure Monitoring System (page 353).

Traction Control

Message	Action
Traction Control Off / Traction Control On	Displays when the traction control system has been switched off or on. See Using Traction Control (page 194).
Spinout Detected Hazards Activated	Displays when a spinout has occurred and the hazard are activated.

Information Displays

Transmission

Message	Action
Transmission Malfunction Service Now	See your authorized dealer.
Transmission Overheating Stop Safely	The transmission is overheating and needs to cool. Stop in a safe place as soon as it's possible.
Transmission Over Temperature Stop Safely	The transmission has overheated and needs to cool. Stop in a safe place as soon as it's possible.
Transmission Service Required	See your authorized dealer.
Transmission Too Hot Press Brake	Transmission is getting hot. Stop to let it cool.
Transmission Limited Function See Manual	Displays when the transmission has overheated and has limited functionality. See Automatic Transmission (page 173).
Transmission Warming Up Please Wait	Transmission is too cold. Wait for it to warm up before you drive.
Transmission Not in Park	A reminder to shift into park. In addition, this message is typical after reconnecting or recharging the battery until you cycle the ignition to the on mode. See Changing the 12V Battery (page 312).
Transmission Adjusted	Displays when the transmission has adjusted the shift strategy.
Transmission AdaptMode	Displays when the transmission is adjusting the shift strategy.
Transmission IndicatMode Lockup On	Displays when the transmission shift lever is locked and unable to select gears.
Transmission IndicatMode Lockup Off	Displays when the transmission shift lever is unlocked and free to select gears.

Information Displays

Message	Action
Invalid Gear Selection	Displays when an invalid gear has been selected.
Press Brake Pedal	Displays when the brake pedal needs to be depressed.
Depress Brake to Shift from Park	Displays when the brake pedal needs to be depressed to enable the transmission to shift from park.
Press N again to Enter Stay in Neutral Mode	Displays when the neutral button N needs to be pressed again to enter neutral hold. See Automatic Transmission (page 173).
Stay in Neutral Mode Engaged	Displays when neutral hold is active. See Automatic Transmission (page 173).
Stay in Neutral Tow Engaged See Manual to Disable	Displays when neutral hold is active. See General Information (page 108).
SHIFT SYS FAULT Confirm Park Brake Apply Before Exiting the Vehicle	Displays when there is a system fault and the park brake needs to be depressed before exiting the vehicle. See your authorized dealer.
SHIFT SYS FAULT Cannot Shift Trans Use Park Brake to Secure Vehicle	Displays when there is a system fault and the park brake needs to be depressed before exiting the vehicle. See your authorized dealer.
SHIFT SYS FAULT Service Required	See your authorized dealer.
SHIFT SYS FAULT Vehicle is Shifting to Park	Displays when there is a system fault while the vehicle is shifting to park. See your authorized dealer.
SHIFT SYS FAULT Reverse Unavailable Service Required	Displays when there is a system fault while the vehicle is shifting to reverse. See your authorized dealer.

Information Displays

Message	Action
SHIFT SYS FAULT Drive Unavailable Select S for Drive Service Required	See your authorized dealer.
SHIFT SYS FAULT Neutral Unavailable Service Required	See your authorized dealer.
SHIFT SYS FAULT Sport Unavailable Service Required	See your authorized dealer.
Neutral Tow Engaged Turn Ignition Off for Towing	Displays when neutral tow is active and the ignition needs to be turned off. See Towing the Vehicle on Four Wheels (page 254).
Neutral Tow Engaged Depress Brake and Select Park to Exit Neutral Tow	Displays while attempting to exit neutral tow. The brake pedal needs to be depressed and park button selected to deactivate. See Towing the Vehicle on Four Wheels (page 254).
Neutral Tow Remove Park Brake for Towing	Displays when neutral tow is active and the park brake needs to be released. See Towing the Vehicle on Four Wheels (page 254).
Neutral Tow Disengaged	Displays when neutral tow has been deactivated.

Climate Control

AUTOMATIC CLIMATE CONTROL

Note: You can switch temperature units between Fahrenheit and Celsius. See your SYNC information.

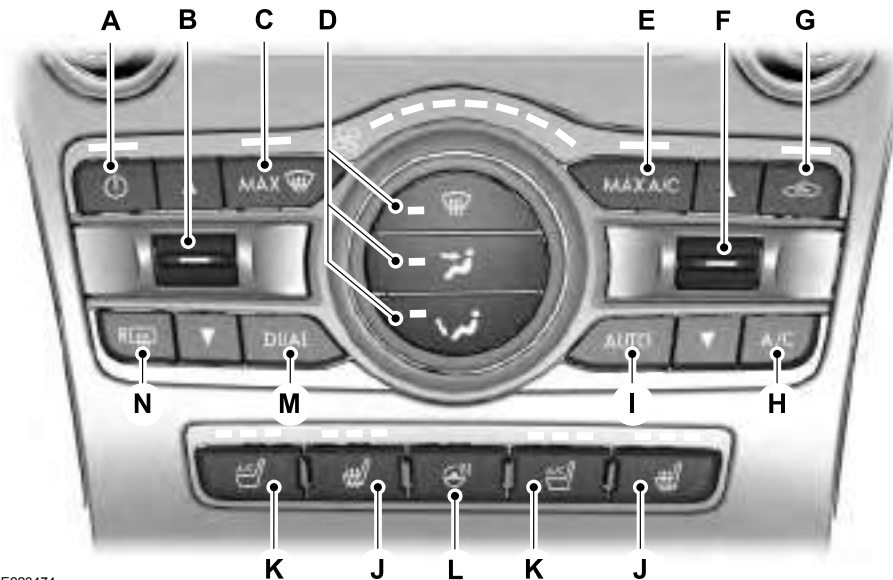

E223474

Climate Control

- A **Power:** Press to switch the system on and off. When the system is off, it prevents outside air from entering the vehicle.
- B **Driver temperature control:** Adjust the temperature setting on the driver side.
- C **MAX defrost:** Press to switch on defrost. Outside air flows through the windshield vents, air conditioning automatically turns on, and fan automatically adjusts to the highest speed. You can also use this setting to defrost and clear the windshield of a thin covering of ice. The heated rear window also automatically turns on when you select maximum defrost.
- D **Air distribution control:** Press to switch airflow from the windshield, instrument panel, or footwell vents on or off. You can distribute air through any combination of these vents.
- E **MAX A/C:** Press to maximize cooling. Recirculated air flows through the instrument panel vents, air conditioning automatically turns on, and the fan automatically adjusts to the highest speed.
- F **Passenger temperature control:** Adjust the temperature setting on the passenger side.
- G **Recirculated air:** Press to switch between outside air and recirculated air. The air currently in the passenger compartment recirculates. This can reduce the time needed to cool the interior and reduce unwanted odors from entering your vehicle.
Note: Recirculated air may also turn on and off automatically in instrument panel or instrument panel and floor airflow modes during hot weather to improve cooling efficiency.
- H **A/C:** Press to switch the air conditioning on or off. Air conditioning cools your vehicle using outside air. To improve the time to reach a comfortable temperature in hot weather, drive with the windows open until you feel cold air through the air vents.
- I **AUTO:** Press to switch on automatic operation. Adjust to select the desired temperature. Fan speed, air distribution, air conditioning operation, and outside or recirculated air are automatically adjusted to heat or cool the vehicle to maintain the desired temperature. You can also switch off dual zone mode by pressing and holding for more than two seconds.
- J **Heated seats:** Press to switch the heated seats on and off. See **Climate Controlled Seats** (page 148).
- K **Climate controlled seats:** Press to switch the cooled seats on and off. See **Climate Controlled Seats** (page 148).
- L **Heated steering wheel:** Press to switch the heated steering wheel on and off.

Climate Control

- M **DUAL:** Press to switch on temperature control for the passenger side of the vehicle. When dual zone is off, passenger temperature settings remain the same as the driver settings.
- N **Heated rear window:** Press to switch the heated rear window on and off. See **Heated Windows and Mirrors** (page 137).

Automatic Fan Settings

The AUTO button illuminates for the following fan settings:

- When three indicators are on, the fan automatically adjusts to the highest speed to reach the selected temperature as quickly as possible.
- When two indicators are on, the fan automatically adjusts to a medium speed to reach the selected temperature with a reduced amount of cabin noise.
- When one indicator is on, the fan automatically adjusts to the lowest speed to reach the selected temperature with the least amount of cabin noise.

Note: The system starts at the previously selected fan setting when AUTO is switched on.

HINTS ON CONTROLLING THE INTERIOR CLIMATE

General Hints

Note: Prolonged use of recirculated air may cause the windows to fog up.

Note: You may feel a small amount of air from the footwell air vents regardless of the air distribution setting.

Note: To reduce humidity build-up inside your vehicle, do not drive with the system switched off or with recirculated air always switched on.

Note: Do not place objects under the front seats as this may interfere with the airflow to the rear seats.

Note: Remove any snow, ice or leaves from the air intake area at the base of the windshield.

Note: To improve the time to reach a comfortable temperature in hot weather, drive with the windows open until you feel cold air through the air vents.

Automatic Climate Control

Note: Adjusting the settings when your vehicle interior is extremely hot or cold is not necessary. The system automatically adjusts to heat or cool the cabin to your selected temperature as quickly as possible. For the system to function efficiently, the instrument panel and side air vents should be fully open.

Note: If you select **AUTO** during cold outside temperatures, the system directs airflow to the windshield and side window vents. In addition, the fan may run at a slower speed until the engine warms up.

Climate Control

Note: If you select **AUTO** during hot outside temperatures, or when the inside of the vehicle is hot, the system automatically uses recirculated air to maximize interior cooling. When the interior reaches the selected temperature, the system automatically switches to using outside air.

Heating the Interior Quickly

1. Select the **AUTO** function.
2. Adjust the temperature function to the desired setting.

Recommended Settings for Heating

1. Select the **AUTO** function.
2. Adjust the temperature function to the desired setting. Use 72°F (22°C) as a starting point, then adjust the setting as necessary.

Cooling the Interior Quickly

1. Select the **MAX A/C** function.

Recommended Settings for Cooling

1. Select the **AUTO** function.

2. Adjust the temperature function to the desired setting. Use 72°F (22°C) as a starting point, then adjust the setting as necessary.

Side Window Defogging in Cold Weather

1. Press the defrost button.
2. Adjust the temperature control to the desired setting. Use 72°F (22°C) as a starting point, then adjust the setting as necessary.

HEATED WINDOWS AND MIRRORS

Note: Make sure the engine is running before operating the heated windows.

Note: Depending on your remote start settings, the heated windows, mirrors and wipers may remain on after remote starting the vehicle.

Heated Rear Window



Press the button to clear the heated rear window of thin ice and fog. The heated rear window will automatically turn off after a short period of time. Press the button again to switch it off.

Note: An indicator on the button illuminates when active.

Note: Do not use razor blades or other sharp objects to clean or remove decals from the inside of the heated rear window. The vehicle warranty does not cover damage caused to the heated rear window grid lines.

Heated Exterior Mirrors (If Equipped)

When you switch the heated rear window on, the heated exterior mirrors will automatically turn on.

Note: Do not remove ice from the mirrors with a scraper or adjust the mirror glass when it is frozen in place.

Note: Do not clean the mirror housing or glass with harsh abrasives, fuel or other petroleum-based cleaning products.

Climate Control

Heated Wiper Park (If Equipped)

When you switch the heated rear window on, the heated wiper park automatically turns on.

CABIN AIR FILTER

Your vehicle is equipped with a cabin air filter, which gives you and your passengers the following benefits:

- It improves your driving comfort by reducing particle concentration.
- It improves the interior compartment cleanliness.
- It protects the climate control components from particle deposits.

You can locate the cabin air filter behind the glove box.

Note: *Make sure you have a cabin air filter installed at all times. This prevents foreign objects from entering the system. Running the system without a filter in place could result in degradation or damage to the system.*

Replace the filter at regular intervals. See **Scheduled Maintenance** (page 495).

For additional cabin air filter information, or to replace the filter, see an authorized dealer.

REMOTE START

The remote start feature allows you to pre-condition the interior of your vehicle. The climate control system works to achieve comfort according to your pre-selected settings.

Note: *You cannot adjust the system during remote start operation. You cannot switch on the displays or indicators during remote start.*

Switch the ignition on to return the system to its previous settings. The following features remain on if they automatically turned on during remote start, or remain off if they did not turn on during remote start.

- Heated seats.
- Cooled seats.
- Heated steering wheel.

- Heated mirrors.
- Heated rear window.

Note: *Passenger heated and cooled seats only remain on during remote start if they were on when you switched the vehicle off.*

You can adjust the default remote start settings using the information display controls. See **Information Displays** (page 108).

Automatic Settings

In hot weather, the system is set to 72°F (22°C). The cooled seats are set to high (if available, and selected to AUTO in the information display).

In moderate weather, the system either heats or cools (based on pre-selected settings). The rear defroster, heated mirrors and heated seats do not automatically switch on.

In cold weather, the system is set to 72°F (22°C). The heated and cooled seats and heated steering wheel are set to high (if available, and selected to AUTO in the information display). The rear defroster and heated mirrors automatically switch on.

Seats

SITTING IN THE CORRECT POSITION

WARNINGS

 Sitting improperly, out of position or with the seatback reclined too far can take weight off the seat cushion and affect the decision of the passenger sensing system, resulting in serious injury or death in the event of a crash. Always sit upright against your seat back, with your feet on the floor.

 Do not recline the seatback as this can cause the occupant to slide under the safety belt, resulting in serious injury in the event of a crash.

 Do not place objects higher than the seatback to reduce the risk of serious injury in the event of a crash or during heavy braking.

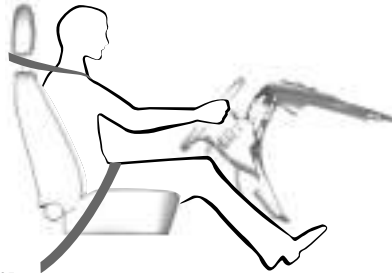

E68595

When you use them properly, the seat, head restraint, safety belt and airbags will provide optimum protection in the event of a crash.

We recommend that you follow these guidelines:

- Sit in an upright position with the base of your spine as far back as possible.
- Do not recline the seatback more than 30 degrees.
- Adjust the head restraint so that the top of it is level with the top of your head and as far forward as possible. Make sure that you remain comfortable.

- Keep sufficient distance between yourself and the steering wheel. We recommend a minimum of 10 in (25 cm) between your breastbone and the airbag cover.
- Hold the steering wheel with your arms slightly bent.
- Bend your legs slightly so that you can press the pedals fully.
- Position the shoulder strap of the safety belt over the center of your shoulder and position the lap strap tightly across your hips.

Make sure that your driving position is comfortable and that you can maintain full control of your vehicle.

HEAD RESTRAINTS

WARNINGS

 Fully adjust the head restraint before you sit in or operate your vehicle. This will help minimize the risk of neck injury in the event of a crash. Do not adjust the head restraint when your vehicle is moving.

Seats

WARNINGS

 The adjustable head restraint is a safety device. Whenever possible, it should be installed and properly adjusted when the seat is occupied. Failure to adjust the head restraint properly could reduce its effectiveness during certain impacts.

 Install the head restraint properly to help minimize the risk of neck injury in the event of a crash.

Note: *Adjust the seatback to an upright driving position before adjusting the head restraint. Adjust the head restraint so that the top of it is level with the top of your head and as far forward as possible. Make sure that you remain comfortable. If you are extremely tall, adjust the head restraint to its highest position.*

Front seat head restraint

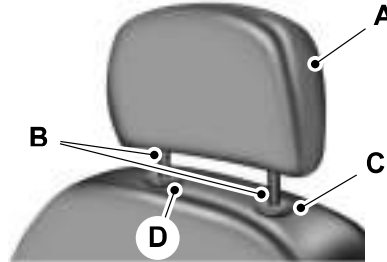

E138642

Rear seat outboard head restraints

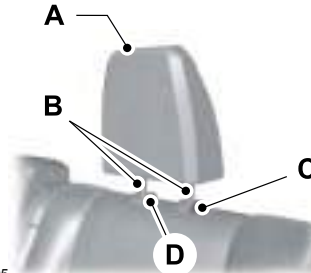

E153105

Rear center head restraint

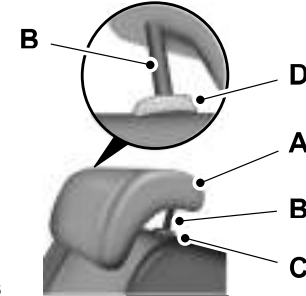

E138645

The head restraints consist of:

- A an energy absorbing head restraint
- B two steel stems
- C guide sleeve adjust and unlock button
- D guide sleeve unlock and remove button

Adjusting the Head Restraint

Raising the Head Restraint

Pull the head restraint up.

Seats

Lowering the Head Restraint

1. Press and hold button C.
2. Push the head restraint down.

Removing the Head Restraint

1. Pull the head restraint up until it reaches its highest position.
2. Press and hold buttons C and D.
3. Pull the head restraint up.

Installing the Head Restraint

Align the steel stems into the guide sleeves and push the head restraint down until it locks.

Tilting Head Restraints

The front head restraints have a tilting feature for extra comfort. To tilt the head restraint, do the following:



E144727

1. Adjust the seatback to an upright driving or riding position.
2. Pivot the head restraint forward toward your head to the desired position.

After the head restraint reaches the forward-most tilt position, pivoting it forward again will then release it to the rearward, untilted position.

POWER SEATS

WARNINGS

 Do not adjust the front seat or seatback while your vehicle is moving. This may result in sudden seat movement, causing the loss of control of your vehicle.

 Do not place cargo or any objects behind the seatback before returning it to the original position.

Seats

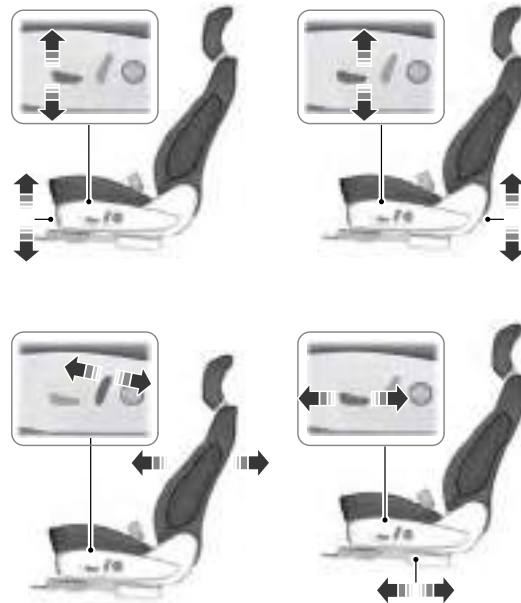

E144632

Seats

Power Lumbar

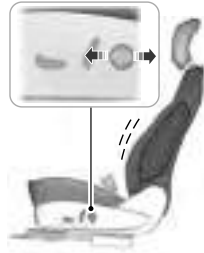

E165608

Four-Way Power Lumbar (If Equipped)

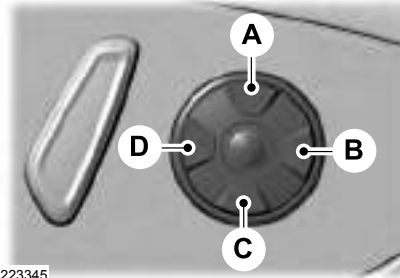

E223345

- A Press to increase upper lumbar only.
- B Press to decrease upper and lower lumbar.
- C Press to increase lower lumbar only.
- D Press to increase upper and lower lumbar.

Multi-Contour Front Seats With Active Motion (If Equipped)

Note: The massage system will turn off after 20 minutes.

Note: The engine must be running or the vehicle must be in accessory mode to activate the seats.

Note: Allow a few seconds for any selection to activate. The seatback and cushion massage cannot function at the same time.

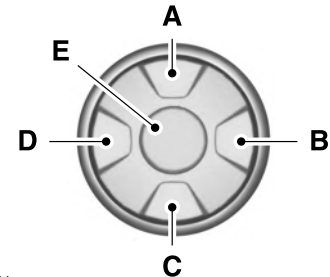

E156301

Seats

	Message mode	Lumbar and bolster mode
A	Back massage intensity adjustment	Upper lumbar
B	Massage intensity decrease and off	Lumbar decrease
C	Cushion massage intensity adjustment	Lower lumbar**
D	Massage intensity increase	Lumbar increase
E	On and off	-

The massage feature will default to an alternating massage mode with back massage intensity adjustment. The lumbar and bolster feature will default to the middle lumbar mode.

** Press C a second time to adjust the back bolster. Press C a third time to adjust the cushion bolster.

You can also adjust this feature through the touchscreen.



Press the Menu Settings icon, then Vehicle. Choose Multi-Contour Seats.

When switched on, the system displays directions for you to adjust the lumbar settings in your seat or to set the massage function.

To access and make adjustments to the lumbar setting:

1. Choose the desired seat to adjust.
2. Press the + or - to adjust the lumbar intensity.

To access and make adjustments to the massage setting:

1. Press the Menu Settings icon, then Vehicle. Choose Multi-Contour Seats.
2. Choose the desired seat to adjust.
3. Press OFF, LO or HI.

Seats

MEMORY FUNCTION (If Equipped)

WARNINGS



Before activating the seat memory, make sure that the area immediately surrounding the seat is clear of obstructions and that all occupants are clear of moving parts.



Do not use the memory function when your vehicle is moving.

This feature automatically recalls the position of the following features:

- Driver seat.
- Power mirrors.
- Power steering column.

The memory control is on the driver door.



E223340

Saving a PreSet Position

1. Adjust the memory features to your desired position.
2. Press and hold the SET button until you hear a single tone.
3. Press the desired preset button until you hear a single tone.

You can save up to two preset memory positions. You can save a memory preset at any time.

Recalling a PreSet Position

Press and release the preset button associated with your desired driving position. The memory features move to the position stored for that preset.

Note: A preset memory position can only be recalled when the ignition is off, or when the transmission is in park (P) or neutral (N) if the ignition is on and the vehicle is not moving.

You can also recall a preset memory position by:

- Pressing the unlock button on your intelligent access key fob if it is linked to a preset position.
- Unlocking the intelligent driver door handle if a linked key fob is present.
- Entering a personal entry code on the Securicode keypad. See **Locks** (page 65).

Note: Using a linked key fob to recall your memory position when the ignition is off moves the seat to the Easy Entry position.

Note: Pressing any active memory feature control - power seat, mirror, or steering column (or any memory button) during a memory recall cancels the operation.

Seats

Linking a PreSet Position to your Remote Control or Intelligent Access Key Foot

Your vehicle can save the preset memory positions for up to two remote controls or intelligent access (IA) keys.

After you have saved your desired memory preset positions:

1. Press and hold the desired preset button for about three seconds until you hear a single tone.
2. Within three seconds, press the lock button on the remote control you are linking.

To unlink a remote control, follow the same procedure – except in step 2, press the unlock button on the remote control.

Note: *If more than one linked remote control or intelligent access key is in range, the memory function moves to the settings of the first key to initiate a memory recall.*

Easy Entry and Exit Feature

If you enable the easy entry and exit feature, it automatically moves the driver seat position rearward up to two inches (five centimeters) when you switch the ignition off.

The driver seat will return to the previous position when you switch the ignition on.

You can enable or disable this feature in the information display. See **Information Displays** (page 108).

REAR SEATS

Note: *Your vehicle may have split seatbacks that you must fold individually.*

Note: *Make sure the center safety belt is unbuckled before folding the seatback.*

To lower the seat back(s) from inside the vehicle, do the following:



E144634

1. Pull the handle to release the seatback.
2. Push the seatback forward.

Seats



E164098

3. Stow the safety belt in the stowage clip. This will prevent the safety belt from getting caught in the seat latch.

When raising the seat back(s), make sure you hear the seat latch into place.

HEATED SEATS

Front Seats

WARNING



People who are unable to feel pain to their skin because of advanced age, chronic illness, diabetes, spinal cord injury, medication, alcohol use, exhaustion or other physical conditions, must exercise care when using the heated seat. The heated seat may cause burns even at low temperatures, especially if used for long periods of time. Do not place anything on the seat that insulates against heat, such as a blanket or cushion. This may cause the heated seat to overheat. Do not puncture the seat with pins, needles or other pointed objects. This may damage the heating element which may cause the heated seat to overheat. An overheated seat may cause serious personal injury.

Do not do the following:

- Place heavy objects on the seat.
- Operate the heated seat if water or any other liquid spills on the seat. Allow the seat to dry thoroughly.
- Operate the heated seats unless the engine is running. Doing so can cause the battery to lose charge.



E146322

Press the heated seat symbol to cycle through the various heat settings and off. More indicator lights indicate warmer settings.

Seats

Rear Seats

WARNING



Persons who are unable to feel pain to the skin because of advanced age, chronic illness, diabetes, spinal cord injury, medication, alcohol use, exhaustion, or other physical conditions, must exercise care when using the seat heater. The seat heater may cause burns even at low temperatures, especially if used for long periods of time. Do not place anything on the seat that insulates against heat, such as a blanket or cushion, because this may cause the seat heater to overheat. Do not puncture the seat with pins, needles, or other pointed objects because this may damage the heating element which may cause the seat heater to overheat. An overheated seat may cause serious personal injury.

Do not do the following:

- Place heavy objects on the seat.
- Operate the seat heater if water or any other liquid is spilled on the seat. Allow the seat to dry thoroughly.
- Operate the heated seats unless the engine is running. Doing so can cause the battery to lose charge.

The rear seat heat controls are located on the rear of the center console.



E146322

Press the heated seat symbol to cycle through the various heat settings and off. More indicator lights indicate warmer settings.

The heated seat module resets at every ignition run cycle. While the ignition is on, press the high or low heated seat switch to enable heating mode. When activated, they will turn off automatically when you turn the engine off.

CLIMATE CONTROLLED SEATS (If

Equipped)

Heated Seats

Seats

WARNING

 People who are unable to feel pain to their skin because of advanced age, chronic illness, diabetes, spinal cord injury, medication, alcohol use, exhaustion or other physical conditions, must exercise care when using the heated seat. The heated seat may cause burns even at low temperatures, especially if used for long periods of time. Do not place anything on the seat that insulates against heat, such as a blanket or cushion. This may cause the heated seat to overheat. Do not puncture the seat with pins, needles or other pointed objects. This may damage the heating element which may cause the heated seat to overheat. An overheated seat may cause serious personal injury.

Do not do the following:

- Place heavy objects on the seat.
- Operate the heated seat if water or any other liquid spills on the seat. Allow the seat to dry thoroughly.
- Operate the heated seats unless the engine is running. Doing so can cause the battery to lose charge.



E146322

Touch the heated seat symbol to cycle through the various heat settings and off. More indicator lights indicate warmer settings.

Cooled Seats

The cooled seats will only function when the engine is running.



E146309

To operate the cooled seats:

Press the cooled seat symbol to cycle through the various cooling settings and off. More indicator lights indicate cooler settings.

If the engine falls below 350 RPM while the cooled seats are on, the feature will turn itself off. You will need to reactivate it.

Climate controlled seat air filter replacement

Your vehicle is equipped with lifetime air filters that are integrated with the seats. Regular maintenance or replacement is not needed.

Seats

REAR SEAT ARMREST



E144635

Fold the armrest down to use the armrest and cupholder. To open the storage lid, pull up on the latch located between the cupholders.

Armrest pass-through

Note: Do not exceed 80 pounds (36 kilograms) of weight on the pass-through door.



E152622

Release the latch, then pull down on the door located in the back of the armrest. You can store cargo of a longer length such as skis or lumber.

Universal Garage Door Opener

HomeLink Wireless Control System

WARNINGS



Make sure that the garage door and security device are free from obstruction when you are programming. Do not program the system with the vehicle in the garage.



Do not use the system with any garage door opener that does not have the safety stop and reverse feature as required by U.S. Federal Safety Standards (this includes any garage door opener manufactured before April 1, 1982). A garage door opener which cannot detect an object, signaling the door to stop and reverse, does not meet current federal safety standards. Using a garage door opener without these features increases the risk of serious injury or death.

Note: Make sure you keep the original remote control transmitter for use in other vehicles as well as for future system programming.

Note: We recommend that upon the sale or lease termination of your vehicle, you erase the programmed function buttons for security reasons. See **Erasing the Function Button Codes**.

Note: You can program a maximum of three devices. To change or replace any of the three devices after it has been initially programmed, you must first erase the current settings. See **Erasing the Function Button Codes**.



E142657

The universal garage door opener replaces the common hand-held garage door opener with a three-button transmitter that is integrated into the driver's sun visor.

The system includes two primary features, a garage door opener and a platform for remote activation of devices within the home. As well as being programmed for garage doors, the system transmitter can be programmed to operate entry gate operators, security systems, entry door locks and home or office lighting.

Additional system information can be found online at www.homelink.com, www.youtube.com/HomeLinkGentex or by calling the toll-free help line on 1-800-355-3515.

In-Vehicle Programming

This process is to program your hand-held transmitter and your in-vehicle HomeLink button.

Note: The programming steps below assume you will be programming HomeLink that was not previously programmed.

Note: Put a new battery in the hand-held transmitter. This will ensure quicker training and accurate transmission of the radio-frequency signal.

Universal Garage Door Opener



E142658

1. With your vehicle parked outside of the garage, turn your ignition to the **on** position, but do not start your vehicle.
2. Hold your hand-held garage door transmitter 2–6 in (5–14 cm) away from the HomeLink button you want to program.
3. Using both hands, simultaneously, press and hold the desired HomeLink button and the hand-held transmitter button. DO NOT release either one until the HomeLink indicator light flashes slowly and then rapidly. When the indicator light flashes rapidly, both buttons may be released. The rapid flashing indicates successful training.

Note: You may need to use a different method if you live in Canada or have difficulties programming your gate operator or garage door opener. See **Gate Operator / Canadian Programming**.

4. Press and hold the HomeLink button you programmed for two seconds, then release. You may need to do this twice to activate the door. If your garage door does not operate, watch the HomeLink indicator light.

If the indicator light stays on, the programming is complete. No further action is needed.

If the indicator light flashes rapidly for 2 seconds and then turns to a constant light, the HomeLink button is not programmed yet. See **Programming Your Garage Door Opener Motor**.

To program additional buttons, repeat Steps 1 – 4.

For questions or comments, please contact HomeLink at www.homelink.com, www.youtube.com/HomeLinkGentex or 1-800-355-3515.

Programming Your Garage Door Opener Motor

Note: You may need a ladder to reach the unit and you may need to remove the cover or lamp lens on your garage door opener.



E142659

1. Press the learn button on the garage door opener motor and then you have 30 seconds to complete the next two steps.
2. Return to your vehicle.

Universal Garage Door Opener



E142658

3. Press and hold the function button you want to program for 2 seconds, then release. Repeat this step. Depending on your brand of garage door opener, you may need to repeat this sequence a third time.

Gate Operator / Canadian Programming

Canadian radio-frequency laws require transmitter signals to “time-out” (or quit) after several seconds of transmission – which may not be long enough for HomeLink to pick up the signal during programming. Similar to this Canadian law, some U.S. gate operators are designed to “time-out” in the same manner.

Note: *If programming a garage door opener or gate operator, it is advised to unplug the device during the “cycling” process to prevent possible overheating.*

1. Press and hold the HomeLink button while you press and release, **every two seconds**, your hand-held transmitter until the HomeLink indicator light changes from a slow to a rapidly blinking light.
2. Release both the HomeLink and hand-held transmitter buttons.
3. Continue programming HomeLink. See **In-Vehicle Programming**.

Erasing the Function Button Codes

Note: *You cannot erase individual buttons.*

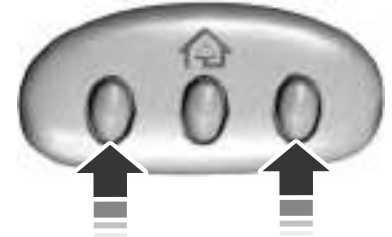

E142660

1. Press and hold the outer two function buttons simultaneously for approximately 20 seconds until the indicator lights above the buttons flash rapidly.
2. When the indicator lights flash, release the buttons. The codes for all buttons are erased.

Reprogramming a Single Button

To program a device to a previously trained button, follow these steps:

1. Press and hold the desired button. Do NOT release the button.

Universal Garage Door Opener

- The indicator light will begin to flash after 20 seconds. Without releasing the button, follow Step 1 in the Programming section.

For questions or comments, contact HomeLink at www.homelink.com, www.youtube.com/HomeLinkGentex or 1-800-355-3515.

Programming to a Genie Intellicode 2 Garage Door Opener

Note: *The Genie Intellicode 2 transmitter must already be programmed to operate with the garage door opener.*

Note: *To program HomeLink to the transmitter you must first put the transmitter into programming mode.*

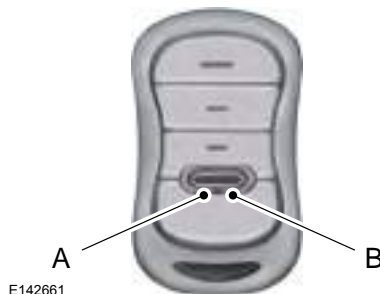

- A. Red indicator light
- B. Green indicator light

- Press and hold one of the buttons on the hand-held transmitter for 10 seconds. The indicator light will change from green to red and green.
- Press the same button twice to confirm the change to programming mode. If done properly the indicator light will appear red.
- Hold the transmitter within 1–3 inches (2–8 centimeters) of the button on the visor you want to program.

- Press and hold both the programmed Genie button on the hand-held transmitter and the button you want to program. The indicator light on the visor will flash rapidly when the programming is successful.

Note: *The Genie transmitter will transmit for up to 30 seconds. If HomeLink does not program within 30 seconds the Genie transmitter will need to be pressed again. If the Genie transmitter indicator light displays green and red, release the button until the indicator light turns off before pressing the button again.*

Once HomeLink has been programmed successfully, the Genie transmitter must be changed out of program mode. To do this:

- Press and hold the previously programmed Genie button on the hand-held transmitter for 10 seconds. The indicator light will change from red to red and green.
- Press the same button twice to confirm the change. If done correctly the indicator light will turn green.

Universal Garage Door Opener

Programming HomeLink to the Genie Intellicode Garage Door Opener Motor

Note: You may need a ladder to access the garage door opener motor.

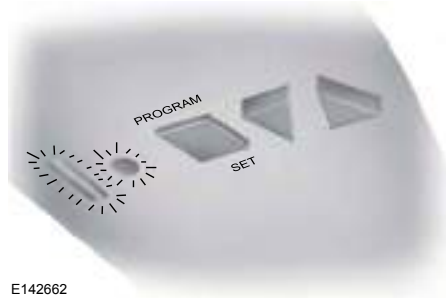

E142662

1. Press and hold the program button on the garage door opener motor until both blue indicator lights turn on.
2. Release the program button. Only the smaller round indicator light should be on.
3. Press and release the program button. The larger purple indicator light will flash.

Note: The next two steps must be completed in 30 seconds.

4. Press and release the Genie Intellicode 2 hand-held transmitter's previously programmed button. Both indicator lights on the garage door opener motor unit should now flash purple.
5. Press and hold the previously programmed button on the visor for 2 seconds. Repeat this step up to 3 times until the garage door moves.

Programming is now complete.

Clearing a HomeLink Device

To erase programming from the three HomeLink buttons press and hold the two outer HomeLink buttons until the indicator light begins to flash. The indicator light will begin flashing in 10 to 20 seconds, at which time both buttons should be released. Programming has now been erased, and the indicator light should blink slowly to indicate the device is in train mode when any of the three HomeLink buttons are pressed.

FCC and RSS-210 Industry Canada Compliance

This device complies with Part 15 of the FCC Rules and with RSS-210 of Industry Canada. Operation is subject to the following two conditions: (1) this device may not cause harmful interference, and (2) this device must accept any interference received, including interference that may cause undesired operation.

Changes or modifications to your device not expressly approved by the party responsible for compliance can void the user's authority to operate the equipment.

Auxiliary Power Points

12 Volt DC Power Point

WARNINGS

 Do not plug optional electrical accessories into the cigar lighter socket. Incorrect use of the cigar lighter can cause damage not covered by the vehicle warranty, and can result in fire or serious injury.

 Do not use a power point for operating a cigar lighter. Incorrect use of the power points can cause damage not covered by the vehicle warranty, and can result in fire or serious injury.

Note: When you switch the ignition on, you can use the socket to power 12 volt appliances with a maximum current rating of 15 amps.

If the power supply does not work after you switch the ignition off, switch the ignition on.

Note: Do not hang any accessory from the accessory plug.

Note: Do not use the power point over the vehicle capacity of 12 volt DC 180 watts or a fuse may blow.

Note: Always keep the power point caps closed when not in use.

Do not insert objects other than an accessory plug into the power point. This will damage the power point and blow the fuse.

Run the vehicle for full capacity use of the power point.

To prevent the battery from running out of charge:

- Do not use the power point longer than necessary when the vehicle is not running.
- Do not leave devices plugged in overnight or when you park your vehicle for extended periods.

Locations

Power points may be in the following locations:

- On the front of the center console.
- Inside the center console.
- On the rear of the center console.

110 Volt AC Power Point (If Equipped)

WARNING

 Do not keep electrical devices plugged in the power point whenever the device is not in use. Do not use any extension cord with the 110 volt AC power point, since it will defeat the safety protection design. Doing so may cause the power point to overload due to powering multiple devices that can reach beyond the 150 watt load limit and could result in fire or serious injury.

Note: The power point will turn off when the ignition is switched off or the battery voltage drops below 11 volts.

Auxiliary Power Points



E194174

To gain access to the outlet contacts, press the plug against the outlet and rotate clockwise.

Use the power point for powering electric devices that require up to 150 watts. It is on the rear of the center console.

When the indicator light on the power point is:

- On: The power point is working, the ignition is on and a device is plugged in.
- Off: The power point is off, the ignition is off or no device is plugged in.
- Flashing: The power point is in fault mode.

The power outlet temporarily turns off power when in fault mode if the device exceeds the 150 watt limit. Unplug your device and switch the ignition off. Switch the ignition back on, but do not plug your device back in. Let the system cool off and switch the ignition off to reset the fault mode. Switch the ignition back on and make sure the indicator light remains on.

Do not use the power point for certain electric devices, including:

- Cathode-ray, tube-type televisions.
- Motor loads, such as vacuum cleaners, electric saws and other electric power tools or compressor-driven refrigerators.
- Measuring devices, which process precise data, such as medical equipment or measuring equipment.
- Other appliances requiring an extremely stable power supply such as microcomputer-controlled electric blankets or touch-sensor lamps.

Storage Compartments

CENTER CONSOLE

Stow items in the cup holder carefully as items may become loose during hard braking, acceleration or crashes, including hot drinks which may spill.

Available console features include:

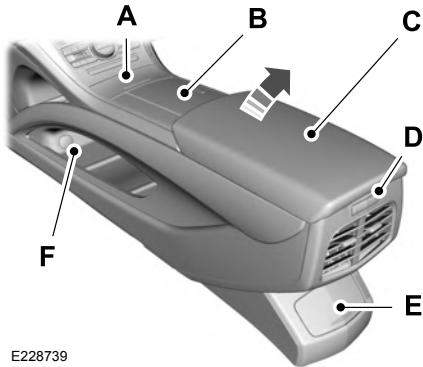

E228739

- A Front storage bin with remote USB port.
- B Cup holders.

- C Storage compartment with auxiliary power point and USB port.
- D Heated rear seats.
- E 110 volt AC power point, auxiliary power point, and charger USB ports.
- F Two auxiliary power points.

Rear Seat Armrest

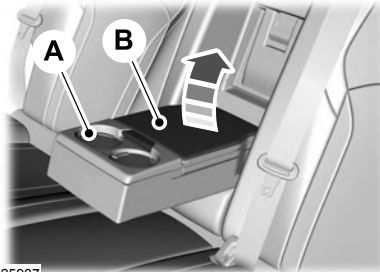

E225987

- A Cup holders.
- B Storage compartment.

OVERHEAD CONSOLE

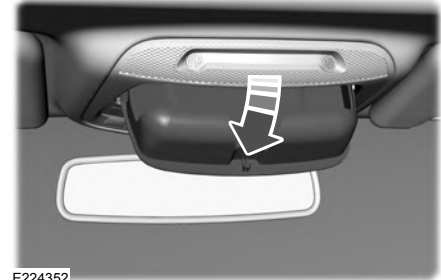

E224352

Press near the rear edge of the door to open it.

Starting and Stopping the Engine

GENERAL INFORMATION

WARNINGS

 Extended idling at high engine speeds can produce very high temperatures in the engine and exhaust system, creating the risk of fire or other damage.

 Do not park, idle or drive your vehicle on dry grass or other dry ground cover. The emission system heats up the engine compartment and exhaust system, creating the risk of fire.

 Do not start the engine in a closed garage or in other enclosed areas. Exhaust fumes can be toxic. Always open the garage door before you start the engine.

 If you smell exhaust fumes inside your vehicle, have your vehicle checked by an authorized dealer immediately. Do not drive your vehicle if you smell exhaust fumes.

If you disconnect the battery, your vehicle may exhibit some unusual driving characteristics for approximately 5 miles (8 kilometers) after you reconnect it. This is because the engine management system must realign itself with the engine. You can disregard any unusual driving characteristics during this period.

The powertrain control system meets all Canadian interference-causing equipment standard requirements regulating the impulse electrical field or radio noise.

When you start the engine, avoid pressing the accelerator pedal before and during operation. Only use the accelerator pedal when you have difficulty starting the engine.

KEYLESS STARTING

Note: *The keyless starting system may not function if the key is close to metal objects or electronic devices such as cellular phones.*

Note: *A valid key must be located inside your vehicle to switch the ignition on and start the vehicle.*

Ignition Modes

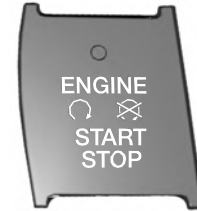

E164319

Starting and Stopping the Engine

The keyless starting system has three modes:

- **Off:** Turns the ignition off.
 - Without applying the brake pedal, press and release the button once when the ignition is in the on mode, or when the vehicle is running but is not moving.
- **On:** All electrical circuits are operational and the warning lamps and indicators illuminate.
 - Without applying the brake pedal, press and release the button once.
- **Start:** Starts the vehicle. The engine may not start when the vehicle starts.
 - Press the brake pedal, and then press the button until the vehicle starts. An indicator light on the button illuminates when the ignition is on and when the vehicle starts.

STARTING A GASOLINE ENGINE

When you start the engine, the idle speed increases, this helps to warm up the engine. If the engine idle speed does not slow down automatically, have your vehicle checked by an authorized dealer.

Before starting the engine, check the following:

- Make sure all occupants have fastened their safety belts.
- Make sure the headlamps and electrical accessories are off.
- Make sure the parking brake is on.
- Put the transmission in **P**.

Note: *Do not touch the accelerator pedal.*

1. Fully press the brake pedal.
2. Press the button.

The system does not function if:

- The key frequencies are jammed.
- The key battery has no charge.

If you are unable to start the engine, do the following:

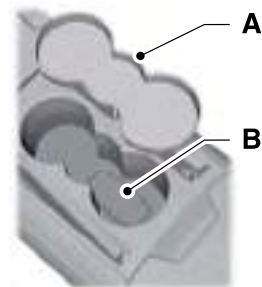

E155835

1. Remove the rubber covering (A) in the cupholder. Place the remote in the backup slot (B) at the bottom of the cupholder.
2. With the key in this position, press the brake pedal, then the START button to switch the ignition on and start your vehicle.

Fast Restart

The fast restart feature allows you to restart the engine within 20 seconds of switching it off, even if a valid key is not present.

Starting and Stopping the Engine

Within 20 seconds of switching the engine off, press the brake pedal and press the button. After 20 seconds have expired, you can no longer restart the engine without the key present inside your vehicle.

Once the engine has started, it remains running until you press the button, even if the system does not detect a valid key. If you open and close a door while the engine is running, the system searches for a valid key. You cannot restart the engine if the system does not detect a valid key within 20 seconds.

Failure to Start

If you cannot start the engine after three attempts, wait 10 seconds and follow this procedure:

1. Fully press the brake pedal.
2. Fully press the accelerator pedal and hold it there.
3. Start the engine.

Note: *You can crank the engine for a total of 60 seconds (without the engine starting) before the starting system temporarily disables. The 60 seconds does not have to be all at once. For example, if you crank the engine three times for 20 seconds each time, without the engine starting, you reached the 60-second time limit. A message appears in the information display alerting you that you exceeded the cranking time. You cannot attempt to start the engine for at least 15 minutes. After 15 minutes, you are limited to a 15-second engine cranking time. You need to wait 60 minutes before you can crank the engine for 60 seconds again.*

Automatic Engine Shutdown

If your vehicle is equipped with a keyless ignition, it has a feature that automatically shuts down the engine if it has been idling for an extended period. The ignition also turns off in order to save battery power. Before the engine shuts down, a message appears in the information display showing a timer counting down from 30 seconds. If

you do not intervene within 30 seconds, the engine shuts down. Another message appears in the information display to inform you that the engine has shut down in order to save fuel. Start your vehicle as you normally do.

Automatic Engine Shutdown Override

Note: *You cannot permanently switch off the automatic engine shutdown feature. When you switch it off temporarily, it turns on at the next ignition cycle.*

You can stop the engine shutdown, or reset the timer, at any point before the 30-second countdown has expired by doing any of the following:

Starting and Stopping the Engine

- You can reset the timer by interacting with your vehicle (such as pressing the brake pedal or accelerator pedal).
- You can temporarily switch off the shutdown feature any time the ignition is on (for the current ignition cycle only). Use the information display to do so. See **Information Displays** (page 108).
- During the countdown before engine shutdown, you are prompted to press OK or RESET (depending on your type of information display) to temporarily switch the feature off (for the current ignition cycle only).

Stopping the Engine When Your Vehicle is Stationary

1. Put the transmission in position **P**.
2. Press the button once.
3. Apply the parking brake.

Note: *This switches off the ignition, all electrical circuits, warning lamps and indicators.*

Note: *If the engine is idling for 30 minutes, the ignition and engine automatically shut down.*

Stopping the Engine When Your Vehicle is Moving

WARNING



Switching off the engine when the vehicle is still moving will result in a loss of brake and steering assistance. The steering will not lock, but higher effort will be required. When the ignition is switched off, some electrical circuits, including air bags, warning lamps and indicators may also be off. If the ignition was turned off accidentally, you can shift into neutral (N) and re-start the engine.

1. Put the transmission in position **N** and use the brakes to bring your vehicle to a safe stop.
2. When your vehicle has stopped, put the transmission in position **P**.
3. Press and hold the button for one second, or press it three times within two seconds.

4. Apply the parking brake.

Guarding Against Exhaust Fumes

WARNING



If you smell exhaust fumes inside your vehicle, have your vehicle checked by your authorized dealer immediately. Do not drive your vehicle if you smell exhaust fumes. Carbon monoxide is present in exhaust fumes. Take precautions to avoid its dangerous effects.

Important Ventilating Information

If you stop your vehicle and then leave the engine idling for long periods, we recommend that you do one of the following:

- Open the windows at least 1 in (2.5 cm).
- Set your climate control to outside air.

Starting and Stopping the Engine

ENGINE BLOCK HEATER (If Equipped)

WARNINGS



Failure to follow engine block heater instructions could result in property damage or serious personal injury.



Do not use your heater with ungrounded electrical systems or two-pronged adapters. There is a risk of electrical shock.



Do not fully close the hood, or allow it to drop under its own weight when using the engine block heater. This could damage the power cable and may cause an electrical short resulting in fire, injury and property damage.

Note: *The heater is most effective when outdoor temperatures are below 0°F (-18°C).*

The heater acts as a starting aid by warming the engine coolant. This allows the climate control system to respond quickly. The equipment includes a heater element (installed in the engine block) and a wire harness. You can connect the system to a grounded 120-volt AC electrical source.

We recommend that you do the following for a safe and correct operation:

- Use a 16-gauge outdoor extension cord that is product certified by Underwriter's Laboratory (UL) or Canadian Standards Association (CSA). This extension cord must be suitable for use outdoors, in cold temperatures, and be clearly marked Suitable for Use with Outdoor Appliances. Do not use an indoor extension cord outdoors. This could result in an electric shock or become a fire hazard.
- Use as short an extension cord as possible.
- Do not use multiple extension cords.
- Make sure that when in operation, the extension cord plug and heater cord plug connections are free and clear of water. This could cause an electric shock or fire.
- Make sure your vehicle is parked in a clean area, clear of combustibles.
- Make sure the heater, heater cord and extension cord are firmly connected.

- Check for heat anywhere in the electrical hookup once the system has been operating for approximately 30 minutes.
- Make sure the system is unplugged and properly stowed before starting and driving your vehicle. Make sure the protective cover seals the prongs of the block heater cord plug when not in use.
- Make sure the heater system is checked for proper operation before winter.

Using the Engine Block Heater

Make sure the receptacle terminals are clean and dry prior to use. Clean them with a dry cloth if necessary.

The heater uses 0.4 to 1.0 kilowatt-hours of energy per hour of use. The system does not have a thermostat. It achieves maximum temperature after approximately three hours of operation. Using the heater longer than three hours does not improve system performance and unnecessarily uses electricity.

Fuel and Refueling

SAFETY PRECAUTIONS

WARNINGS

 Do not overfill the fuel tank. The pressure in an overfilled tank may cause leakage and lead to fuel spray and fire.

 The fuel system may be under pressure. If you hear a hissing sound near the fuel filler inlet, do not refuel until the sound stops. Otherwise, fuel may spray out, which could cause serious personal injury.

 Fuels can cause serious injury or death if misused or mishandled.

 Flow of fuel through a fuel pump nozzle can produce static electricity. This can cause a fire if you are filling an ungrounded fuel container.

 Fuel may contain benzene, which is a cancer-causing agent.

WARNINGS

 When refueling always shut the engine off and never allow sparks or open flames near the fuel tank filler valve. Never smoke or use a cell phone while refueling. Fuel vapor is extremely hazardous under certain conditions. Avoid inhaling excess fumes.

Observe the following guidelines when handling automotive fuel:

- Extinguish all smoking materials and any open flames before refueling your vehicle.
- Always turn off the vehicle before refueling.
- Automotive fuels can be harmful or fatal if swallowed. Fuel such as gasoline is highly toxic and if swallowed can cause death or permanent injury. If fuel is swallowed, call a physician immediately, even if no symptoms are immediately apparent. The toxic effects of fuel may not be visible for hours.

- Avoid inhaling fuel vapors. Inhaling too much fuel vapor of any kind can lead to eye and respiratory tract irritation. In severe cases, excessive or prolonged breathing of fuel vapor can cause serious illness and permanent injury.
- Avoid getting fuel liquid in your eyes. If fuel is splashed in the eyes, remove contact lenses (if worn), flush with water for 15 minutes and seek medical attention. Failure to seek proper medical attention could lead to permanent injury.

Fuel and Refueling

- Fuels can also be harmful if absorbed through the skin. If fuel is splashed on the skin, clothing or both, promptly remove contaminated clothing and wash skin thoroughly with soap and water. Repeated or prolonged skin contact with fuel liquid or vapor causes skin irritation.
- Be particularly careful if you are taking Antabuse or other forms of Disulfiram for the treatment of alcoholism. Breathing gasoline vapors could cause an adverse reaction, serious personal injury or sickness. If fuel is splashed on the skin, wash the affected areas immediately with plenty of soap and water. Consult a physician immediately if you experience any adverse reactions.

FUEL QUALITY

Choosing the Right Fuel

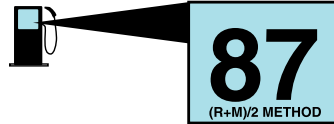

E161513

We recommend regular unleaded gasoline with a minimum pump (R+M)/2 octane rating of 87. Some stations offer fuels posted as regular with an octane rating below 87, particularly in high altitude areas. We do not recommend fuels with an octane rating below 87. To provide improved performance, we recommend premium fuel for severe duty usage such as trailer tow.

Do not use any fuel other than those recommended because they could lead to engine damage that may not be covered by the vehicle Warranty.

Note: Use of any fuel other than those recommended can impair the emission control system and cause a loss of vehicle performance.

Do not use:

- Diesel fuel.
- Fuels containing kerosene or paraffin.
- Fuel containing more than 15% ethanol or E85 fuel.
- Fuels containing methanol.
- Fuels containing metallic-based additives, including manganese-based compounds.
- Fuels containing the octane booster additive, methylcyclopentadienyl manganese tricarbonyl (MMT).
- Leaded fuel (using leaded fuel is prohibited by law).

The use of fuels with metallic compounds such as methylcyclopentadienyl manganese tricarbonyl (commonly known as MMT), which is a manganese-based fuel additive, will impair engine performance and affect the emission control system.

Fuel and Refueling

Do not be concerned if the engine sometimes knocks lightly. However, if the engine knocks heavily while using fuel with the recommended octane rating, contact an authorized dealer to prevent any engine damage.

RUNNING OUT OF FUEL

Avoid running out of fuel because this situation may have an adverse effect on powertrain components.

If you have run out of fuel:

- You may need to cycle the ignition from off to on several times after refueling to allow the fuel system to pump the fuel from the tank to the engine. On restarting, cranking time will take a few seconds longer than normal. With keyless ignition, just start the engine. Crank time will be longer than usual.
- Normally, adding 1 gallon (3.8 liters) of fuel is enough to restart the engine. If the vehicle is out of fuel and on a steep grade, more than 1 gallon (3.8 liters) may be required.
- The service engine soon indicator may come on. For more information on the service engine soon indicator, See **Warning Lamps and Indicators** (page 103).

Refilling With a Portable Fuel Container

WARNINGS



Do not insert the nozzle of portable fuel containers or aftermarket funnels into the capless fuel system. This could damage the fuel system and its seal, and may cause fuel to run onto the ground instead of filling the tank, which could result in serious personal injury.



Do not try to pry open or push open the capless fuel system with foreign objects. This could damage the fuel system and its seal and cause injury to you or others.

Note: *Do not use aftermarket funnels; they will not work with the capless fuel system and can damage it. The included fuel funnel has been specially designed to work safely with your vehicle.*

When filling the vehicle's fuel tank from a portable fuel container, use the funnel included with the vehicle.

Fuel and Refueling

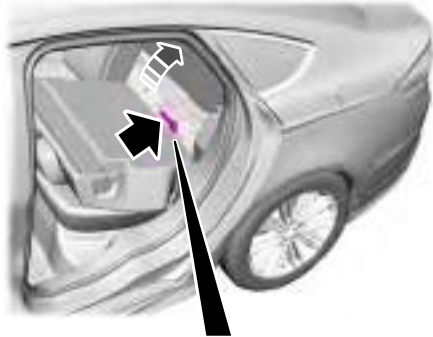

E162864

1. Locate the portable funnel that comes with your vehicle. The funnel is located behind the left-hand side rear seat, under the carpet. Fold down the left-hand side rear seat back. Pull back the piece of carpet to access the funnel.

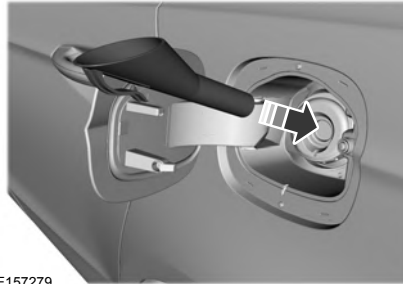

E157279

2. Slowly insert the funnel into the capless fuel system.







E157280

3. Fill the vehicle with fuel from the portable fuel container.

4. When done, clean the funnel or properly dispose of it. Extra funnels can be purchased from your authorized dealer if you choose to dispose of the funnel.

REFUELING

WARNINGS

-  Do not overfill the fuel tank. The pressure in an overfilled tank may cause leakage and lead to fuel spray and fire.
-  Do not try to pry open or push open the capless fuel system with foreign objects. This could damage the fuel system and its seal and cause injury to you or others.
-  Do not remove the fuel pump nozzle from its fully inserted position when refueling.
-  When refueling always shut the engine off and never allow sparks or open flames near the fuel tank filler valve. Never smoke or use a cell phone while refueling. Fuel vapor is extremely hazardous under certain conditions. Avoid inhaling excess fumes.

Fuel and Refueling

WARNINGS

 Wait at least 10 seconds before removing the fuel pump nozzle to allow any residual fuel to drain into the fuel tank.

 Stop refueling when the fuel pump nozzle automatically shuts off for the first time. Failure to follow this will fill the expansion space in the fuel tank and could lead to fuel overflowing.

Note: Your vehicle does not have a fuel filler cap.

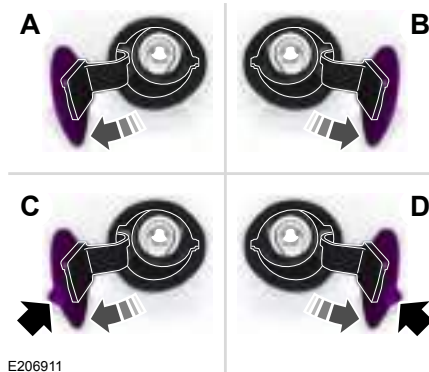

- A Type 1: Left hand side - press the fuel tank filler door to open it.
 - B Type 1: Right hand side - press the fuel tank filler door to open it.
 - C Type 2: Left hand side - pull the fuel tank filler door to open it.
 - D Type 2: Right hand side - pull the fuel tank filler door to open it.
1. Fully open the fuel tank filler door until it engages.

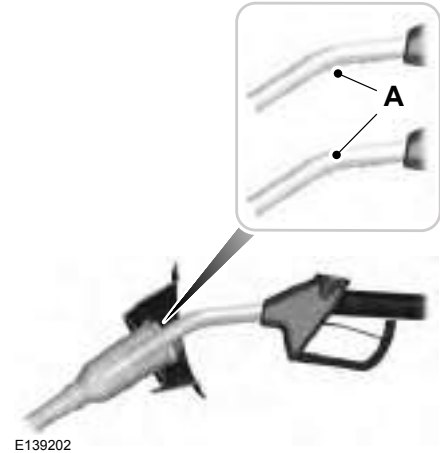

Note: When you insert the correct size fuel pump nozzle a spring loaded inhibitor will open.

2. Insert the fuel pump nozzle up to the first notch on the nozzle A. Keep it resting on the cover of the fuel tank filler pipe opening.

Fuel and Refueling

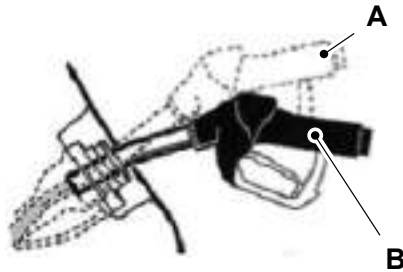

E139203

3. Hold the fuel pump nozzle in the lower position B when refueling. Holding the fuel pump nozzle in the higher position A may affect the flow of fuel and shut off the fuel pump nozzle before the fuel tank is full.

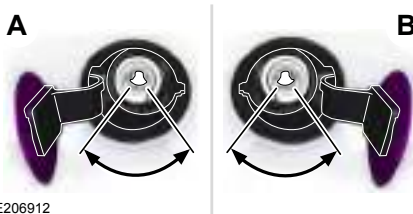

E206912

4. Operate the fuel pump nozzle within the area shown.

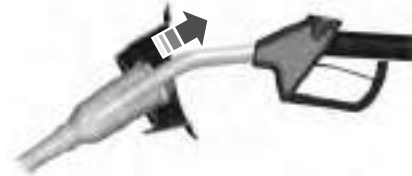

E119081

5. Slightly raise the fuel pump nozzle and then slowly remove it.
6. Fully close the fuel tank filler door.

Note: Do not attempt to start the engine if you have filled the fuel tank with incorrect fuel. Incorrect fuel use can cause damage not covered by the vehicle Warranty. Have your vehicle checked immediately.

FUEL CONSUMPTION

Note: The amount of usable fuel in the empty reserve varies and should not be relied upon to increase driving range. When refueling your vehicle after the fuel gauge indicates empty, you might not be able to refuel the full amount of the advertised capacity of the fuel tank due to the empty reserve still present in the tank.

Empty reserve is the amount of fuel remaining in the tank after the fuel gauge indicates empty. Do not rely on this fuel for driving. The usable capacity of the fuel tank is the amount of fuel that can be put into the tank after the gauge indicates empty. The advertised capacity is the total fuel tank size – it is the combined usable capacity plus the empty reserve.

Filling the Tank

For consistent results when filling the fuel tank:

Fuel and Refueling

- Turn the ignition off before fueling; an inaccurate reading results if the engine is left running.
- Use the same fill rate (low-medium-high) each time the tank is filled.
- Allow no more than two automatic click-offs when filling.

Results are most accurate when the filling method is consistent.

Calculating Fuel Economy

Do not measure fuel economy during the first 1000 miles (1600 kilometers) of driving (this is your engine's break-in period); a more accurate measurement is obtained after 2000 miles - 3000 miles (3200 kilometers - 4800 kilometers). Also, fuel expense, frequency of fill ups or fuel gauge readings are not accurate ways to measure fuel economy.

1. Fill the fuel tank completely and record the initial odometer reading.
2. Each time you fill the tank, record the amount of fuel added.

3. After at least three to five tank fill ups, fill the fuel tank and record the current odometer reading.
4. Subtract your initial odometer reading from the current odometer reading.
5. Calculate fuel economy by dividing miles traveled by gallons used (For Metric: Multiply liters used by 100, then divide by kilometers traveled).

Keep a record for at least one month and record the type of driving (city or highway). This provides an accurate estimate of the vehicle's fuel economy under current driving conditions. Additionally, keeping records during summer and winter show how temperature impacts fuel economy. In general, lower temperatures mean lower fuel economy.

EMISSION CONTROL SYSTEM

WARNINGS



Do not park, idle, or drive your vehicle in dry grass or other dry ground cover. The emission system heats up the engine compartment and exhaust system, which can start a fire.



Exhaust leaks may result in entry of harmful and potentially lethal fumes into the passenger compartment. If you smell exhaust fumes inside your vehicle, have your dealer inspect your vehicle immediately. Do not drive if you smell exhaust fumes.

Your vehicle is equipped with various emission control components and a catalytic converter that will enable your vehicle to comply with applicable exhaust emission standards. To make sure that the catalytic converter and other emission control components continue to work properly:

- Use only the specified fuel listed.
- Avoid running out of fuel.

Fuel and Refueling

- Do not turn off the ignition while your vehicle is moving, especially at high speeds.
- Have the items listed in scheduled maintenance information performed according to the specified schedule.

The scheduled maintenance items listed in scheduled maintenance information are essential to the life and performance of your vehicle and to its emissions system. See **Scheduled Maintenance** (page 495).

If you use parts other than Ford, Motorcraft or Ford-authorized parts for maintenance replacements, or for service of components affecting emission control, such non-Ford parts should be the equivalent to genuine Ford Motor Company parts in performance and durability.

Illumination of the service engine soon indicator, charging system warning light or the temperature warning light, fluid leaks, strange odors, smoke or loss of engine power could indicate that the emission control system is not working properly.

An improperly operating or damaged exhaust system may allow exhaust to enter the vehicle. Have a damaged or improperly operating exhaust system inspected and repaired immediately.

Do not make any unauthorized changes to your vehicle or engine. By law, vehicle owners and anyone who manufactures, repairs, services, sells, leases, trades vehicles, or supervises a fleet of vehicles are not permitted to intentionally remove an emission control device or prevent it from working. Information about your vehicle's emission system is on the Vehicle Emission Control Information Decal located on or near the engine. This decal also lists engine displacement

Please consult your warranty information for complete details.

On-Board Diagnostics (OBD-II)

Your vehicle has a computer known as the on-board diagnostics system (OBD-II) that monitors the engine's emission control system. The system protects the environment by making sure that your vehicle continues to meet government emission standards. The OBD-II system also assists a service technician in properly servicing your vehicle.



When the service engine soon indicator illuminates, the OBD-II system has detected a malfunction. Temporary malfunctions may cause the service engine soon indicator to illuminate.

Examples of temporary malfunctions are:

- the vehicle has run out of fuel—the engine may misfire or run poorly
- poor fuel quality or water in the fuel—the engine may misfire or run poorly
- the fuel fill inlet may not have closed properly. See **Refueling** (page 167).
- driving through deep water—the electrical system may be wet.

Fuel and Refueling

You can correct these temporary malfunctions by filling the fuel tank with good quality fuel, properly closing the fuel fill inlet or letting the electrical system dry out. After three driving cycles without these or any other temporary malfunctions present, the service engine soon indicator should stay off the next time you start the engine. A driving cycle consists of a cold engine startup followed by mixed city/highway driving. No additional vehicle service is required.

If the service engine soon indicator remains on, have your vehicle serviced at the first available opportunity. Although some malfunctions detected by the OBD-II may not have symptoms that are apparent, continued driving with the service engine soon indicator on can result in increased emissions, lower fuel economy, reduced engine and transmission smoothness, and lead to more costly repairs.

Readiness for Inspection/Maintenance (I/M) Testing

Some state/provincial and local governments may have Inspection/Maintenance (I/M) programs to inspect the emission control equipment on your vehicle. Failure to pass this inspection could prevent you from getting a vehicle registration.



If the service engine soon indicator is on or the bulb does not work, you may need to have the vehicle serviced. See On-Board Diagnostics (OBD-II).

Your vehicle may not pass the I/M test if the service engine soon indicator is on or not working properly (bulb is burned out), or if the OBD-II system has determined that some of the emission control systems have not been properly checked. In this case, your vehicle is not ready for I/M testing.

If the vehicle's engine or transmission has just been serviced, or the battery has recently run down or been replaced, the OBD-II system may indicate that the vehicle is not ready for I/M testing. To determine if the vehicle is ready for I/M testing, turn the

ignition key to the on position for 15 seconds without cranking the engine. If the service engine soon indicator blinks eight times, it means that the vehicle is not ready for I/M testing; if the service engine soon indicator stays on solid, it means that the vehicle is ready for I/M testing.

The OBD-II system monitors the emission control system during normal driving. A complete check may take several days. If the vehicle is not ready for I/M testing, you may need to perform the following driving cycle consisting of mixed city and highway driving:

Drive on an expressway or highway for a steady 15 minutes, followed by 20 minutes of stop-and-go driving with at least four 30-second idle periods.

Allow the vehicle to sit for at least eight hours without starting the engine. Then, start the engine and complete the above driving cycle. The engine must warm up to its normal operating temperature. Once started, do not turn off the engine until the above driving cycle is complete. If the vehicle is still not ready for I/M testing, you will have to repeat the above driving cycle.

Transmission

AUTOMATIC TRANSMISSION

WARNINGS



Always set the parking brake fully and make sure you shift the gearshift lever to park (P). Switch the ignition off and remove the key whenever you leave your vehicle.



Do not apply the brake pedal and accelerator pedal simultaneously. Applying both pedals simultaneously for more than a few seconds will limit engine rpm, which may result in difficulty maintaining speed in traffic and could lead to serious injury.

Push Button Shift Transmission

Your vehicle is equipped with an electronic transmission. The shift buttons are located near the middle of the instrument panel. The gears are selected by pressing and releasing the **PRNDS** buttons.



E146223

Every time a gear is selected, the selected button will light up.

Understanding the Positions of your Electronic Transmission

Note: Always come to a complete stop before putting your vehicle into and out of park (P).

Putting your vehicle in gear:

1. Fully press down the brake pedal.
2. Press and release the button on the instrument panel of the gear you want to select.
3. The gearshift button you select will illuminate and the selected gear will appear in the instrument cluster.
4. Release the brake pedal and your transmission will remain in the selected gear.

Transmission

Note: If you attempt to leave your vehicle while it is in gear, the vehicle will automatically shift into park (P). Safety belt and door monitors determine your intent and make the shift for you. During this time, a message will appear in the information display screen prompting you to make the shift. See **Information Messages** (page 114).

Note: To put your vehicle in gear with the door open, perform steps 1-4. See the **Automatic Return to Park** section in this chapter for more information on this feature.

Park (P)

With the transmission in park (P), your vehicle locks the transmission and prevents the front wheels from turning. Always come to a complete stop before putting your vehicle into and out of park (P). An audible chime sounds once you select park (P).

When the ignition is turned off, the vehicle will automatically shift into park (P). If the ignition is turned off while the vehicle is moving, it will first shift into neutral (N) until a slow enough speed is reached. The vehicle will then shift into park (P) automatically.

Automatic Return to Park

Note: This feature will not operate when your vehicle is in Stay in Neutral mode or neutral tow.

Your vehicle has a safety feature that will automatically shift your vehicle into park (P) when any of the following conditions occur:

- You turn the ignition off
- You open the driver's door with your safety belt unlatched
- Your safety belt is unlatched while the driver's door is open

If you turn the ignition off while your vehicle is moving, your vehicle will first shift into neutral (N) until it slows down enough to shift into park (P) automatically.

Note: If you have waited an extended period of time, (2-15 minutes) before starting your vehicle, unlatching your safety belt will cause this feature to activate, even with the driver's door closed.

Note: This feature may not work properly if the door ajar switch is malfunctioning. If your door ajar indicator does not illuminate when you open the driver's door or the indicator illuminates with the driver's door closed. See your authorized dealer.

Reverse (R)

With the transmission in reverse (R), your vehicle will move backward. Always come to a complete stop before shifting into and out of reverse (R).

Neutral (N)

With the transmission in neutral (N), you can start your vehicle and it is free to roll. Hold the brake pedal down while in this position.

Stay in Neutral mode

Stay in Neutral mode allows your vehicle to stay in neutral (N) when you exit the vehicle. Your vehicle must be stationary to enter this mode.

To enter Stay in Neutral mode:

1. Press the neutral (N) button on your shifter assembly.

Transmission

2. A message will appear in your information display screen prompting you to press the neutral (N) button.
3. Press the neutral (N) button again to enter Stay in Neutral mode.

A message will appear in your information display screen when your vehicle has entered Stay in Neutral mode.

Note: During this mode the neutral (N) button will flash continuously and your instrument cluster will display **N** as the selected gear.

Exiting Stay in Neutral mode

To disable Stay in Neutral mode select another gear. See the **Putting the Vehicle in Gear** for instructions on how to do this.

Entering a Carwash

Note: Always put your vehicle in Stay in Neutral mode when entering an automatic car wash. Failure to do this could result in vehicle damage not covered by warranty.

Drive (D)

The normal driving position for the best fuel economy.

Sport (S)

Putting the vehicle in sport (S):

- Provides additional engine braking and extends lower gear operation to enhance performance for uphill climbs, hilly terrain or mountainous areas. This will increase engine RPM during engine braking
- Provides additional lower gear operation through the automatic transmission shift strategy
- Provides gear selection more quickly and at higher engine speeds

SelectShift Automatic™ Transmission

Your SelectShift Automatic transmission gives you the ability to change gears manually.

Paddle Shifters

With your vehicle in drive (D), the paddle shifters provide temporary manual control. They allow you the ability to shift gears quickly, without taking your hands off the steering wheel.

You can achieve extensive manual control by pressing the sport (S) button.

- Pull the right paddle (+) to upshift.
- Pull the left paddle (-) to downshift.



Upshift to the recommended shift speeds according to the following chart:

Transmission

Upshifts when accelerating (recommended for best fuel economy)		
Gear Upshift		mph (km/h)
From	To	
1	2	15 mph (24 km/h)
2	3	25 mph (40 km/h)
3	4	40 mph (64 km/h)
4	5	45 mph (72 km/h)
5	6	50 mph (80 km/h)

The instrument cluster will display your currently selected gear.

The transmission will automatically upshift if your engine speed is too high or downshift if your engine speed is too low.

Note: *The system will stay in manual control until you make another shift button selection. For example, drive (D).*

Brake-Shift Interlock Override

WARNINGS



Do not drive your vehicle until you verify that the brake lamps are working.



When doing this procedure, you need to take the transmission out of park (P) which means your vehicle can roll freely. To avoid unwanted vehicle movement, always fully set the parking brake prior to doing this procedure. Use wheels chocks if appropriate.

WARNINGS



If the parking brake is fully released, but the brake warning lamp remains illuminated, the brakes may not be working properly. Have your vehicle checked as soon as possible.

Note: *See your authorized dealer as soon as possible if this procedure is used.*

Note: *For some markets this feature is disabled.*

Transmission

Note: This feature will only function if your 12-volt battery has power. If vehicle battery voltage is not sufficient, an external 12-volt power source (for example, jumper cables, battery charger or jump pack) may be required to function the interlock override switch.

Use the brake-shift interlock override to move your transmission from the park position in the event of an electrical malfunction. If your vehicle has a dead battery, an external power source will be required.

1. Apply the parking brake and turn your ignition off before performing this procedure.

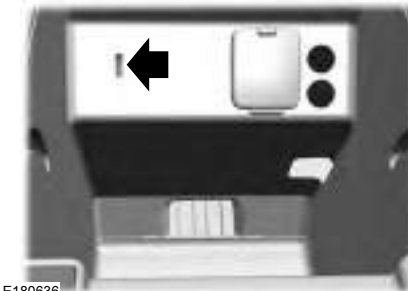

E180636

2. Locate your brake-shift interlock access slot. The slot is located in your center console storage bin. The access slot does not have a label.

Note: Make sure that you correctly identify the access hole as not to damage the media hub.

3. Using a tool, press and hold the brake shift interlock switch. The shift buttons on the instrument panel will flash when your vehicle is in override mode.
4. With the override switch still held, press the neutral button (N) to shift from park.
5. Release the override button.

6. Your vehicle will remain in Stay in Neutral mode for wrecker towing purposes or can be shifted to the desired gear and driven (if possible).
7. Release the parking brake.

Automatic Transmission Adaptive Learning

This feature increases durability and provides consistent shift feel over the life of your vehicle. A new vehicle or transmission may have firm or soft shifts. This operation will not affect function or durability of your transmission and is normal. Over time, the adaptive learning process will fully update transmission operation. Additionally, the strategy must be relearned whenever the battery is disconnected or a new battery is installed.

If Your Vehicle Gets Stuck In Mud or Snow

Note: Do not rock your vehicle if your engine is not at normal operating temperature or damage to your transmission may occur.

Transmission

Note: *Do not rock your vehicle for more than a minute or damage to your transmission and tires may occur, or your engine may overheat.*

Note: *If your vehicle is equipped with AdvanceTrac with Roll Stability Control, it may be beneficial to disengage the AdvanceTrac with Roll Stability Control system while attempting to rock the vehicle.*

If your vehicle gets stuck in mud or snow, you can help rock your vehicle out by shifting between forward and reverse gears, stopping between shifts in a steady pattern. Press lightly on the accelerator in each gear.

All-Wheel Drive (If Equipped)

USING ALL-WHEEL DRIVE (If Equipped)

All-Wheel Drive (AWD) uses all four wheels to power the vehicle. This increases traction, enabling you to drive over terrain and road conditions that a conventional two-wheel drive vehicle cannot. The AWD system is active all the time and requires no input from the operator.

Note: *Your vehicle may be equipped with Dynamic Torque Vectoring. This feature uses all four wheels to power the vehicle and independently controls the torque to each rear wheel. In addition, the system has the ability to over speed the outside rear wheel in a turn. This increases traction and handling performance, allowing the vehicle to travel through road conditions and have path following capability superior to conventional two-wheel drive and AWD vehicles. The Dynamic Torque Vectoring system is active all the time and requires no input from the operator.*

Note: *Your AWD vehicle is not intended for off-road use. The AWD feature gives your vehicle some limited off-road capabilities in which driving surfaces are relatively level, obstruction-free and otherwise similar to normal on-road driving conditions. Operating your vehicle under other than those conditions could subject the vehicle to excessive stress which might result in damage which is not covered under your warranty.*

Note: *When an AWD system fault is present, the warning AWD Malfunction Service Required displays in the information display. The AWD system is not functioning correctly and defaulted to front-wheel drive. When this warning displays, have your vehicle serviced at an authorized dealer.*

Note: *The AWD OFF message may also appear in the information display if the AWD system overheats and defaults to front-wheel drive. This may occur if the vehicle is operated in extreme conditions with excessive wheel slip, such as deep sand. To resume normal AWD function as soon as possible, stop the vehicle in a safe location and stop the engine for at least 10 minutes. After the engine has been restarted and the AWD system has adequately cooled, the AWD OFF message will turn off and normal AWD function returns. If the engine is not stopped, the AWD OFF message turns off when the system cools and normal AWD function returns.*

All-Wheel Drive (If Equipped)

All-Wheel Drive Messages

AWD Messages	Action / Description
AWD OFF	Displays when the system automatically disables to protect itself. This may be caused by operating the vehicle with the compact tire installed, if the system is overheating or if there is an issue with another vehicle system preventing AWD operation. The system resumes normal operation and clears this message after cycling the ignition on and off and driving a short distance with the road tire re-installed, after the system is allowed to cool or after the other vehicle system issues are resolved.
AWD Malfunction Service Required	Displays in conjunction with the powertrain malfunction or reduced power light when the system is not operating properly. If the message stays on or continues to come on, contact your authorized dealer as soon as possible.

All-Wheel Drive (If Equipped)

Operating AWD Vehicles With Spare or Mismatched Tires

WARNING



Only use replacement tires and wheels that are the same size, load index, speed rating and type (such as P-metric versus LT-metric or all-season versus all-terrain) as those originally provided by Ford. The recommended tire and wheel size may be found on either the Safety Compliance Certification Label (affixed to either the door hinge pillar, door-latch post, or the door edge that meets the door-latch post, next to the driver's seating position), or the Tire Label which is located on the B-Pillar or edge of the driver's door. If this information is not found on these labels, then you should contact your authorized dealer as soon as possible. Use of any tire or wheel not recommended by Ford can affect the safety and performance of your vehicle, which could result in an increased risk of loss of vehicle control, vehicle rollover, personal injury and death.

A spare tire of a different size other than the tire provided should never be used. The AWD system may disable automatically and enter front-wheel drive only mode to protect driveline components if a non-full sized tire is installed. This condition may display an AWD OFF message in the information display. If there is an AWD OFF message in the information display from using a non-full sized spare tire, this indicator should turn off after reinstalling the repaired or replaced normal road tire and cycling the ignition off and on. It is recommended to reinstall the repaired or replaced road tire as soon as possible.

Major dissimilar tire sizes between the front and rear axles (for example, 17 inch low profile tires on the front axle and 22 inch high profile tires on the rear axle) could cause the AWD system to stop functioning and default to front-wheel drive or damage the AWD system. However, the AWD system is capable of tolerating any combination of new and worn tires of the same original tire size. For example, using 3 worn tread tires and 1 new tread tire all of the same original tire size, can be tolerated by the AWD system.

Driving In Special Conditions With All-Wheel Drive (AWD)

AWD vehicles are equipped for driving on sand, snow, mud and rough roads and have operating characteristics that are somewhat different from conventional vehicles, both on and off the highway.

When driving at slow speeds in deep sand under high outside temperatures, use a low gear when possible. Lower gear operation will maximize the engine and transmission cooling capability.

Under severe operating conditions, the A/C may cycle on and off to protect overheating of the engine.

Basic operating principles in special conditions

- Drive slower in strong crosswinds which can affect the normal steering characteristics of your vehicle.
- Be extremely careful when driving on pavement made slippery by loose sand, water, gravel, snow or ice.

All-Wheel Drive (If Equipped)

If Your Vehicle Goes Off the Edge of the Pavement

- If your vehicle goes off the edge of the pavement, slow down, but avoid severe brake application, ease the vehicle back onto the pavement only after reducing your speed. Do not turn the steering wheel too sharply while returning to the road surface.
- It may be safer to stay on the apron or shoulder of the road and slow down gradually before returning to the pavement. You may lose control if you do not slow down or if you turn the steering wheel too sharply or abruptly.
- It often may be less risky to strike small objects, such as highway reflectors, with minor damage to your vehicle rather than attempt a sudden return to the pavement which could cause the vehicle to slide sideways out of control or rollover. Remember, your safety and the safety of others should be your primary concern.

If Your Vehicle Gets Stuck

WARNINGS



Always set the parking brake fully and make sure you shift the gearshift lever to park (P). Switch the ignition off and remove the key whenever you leave your vehicle.



If the parking brake is fully released, but the brake warning lamp remains illuminated, the brakes may not be working properly. Have your vehicle checked as soon as possible.



Do not spin the wheels at over 34 mph (55 km/h). The tires may fail and injure a passenger or bystander.

Note: *Do not rock the vehicle if the engine is not at normal operating temperature or damage to the transmission may occur.*

Note: *Do not rock the vehicle for more than a few minutes or damage to the transmission and tires may occur or the engine may overheat.*

If your vehicle gets stuck in mud or snow it may be rocked out by shifting between forward and reverse gears, stopping between shifts, in a steady pattern. Press lightly on the accelerator in each gear.

If your vehicle is equipped with AdvanceTrac® with Roll Stability Control™, it may be beneficial to disengage the AdvanceTrac® with Roll Stability Control™ system while attempting to rock the vehicle.

Emergency Maneuvers

- In an unavoidable emergency situation where a sudden sharp turn must be made, remember to avoid "over-driving" your vehicle (that is, turn the steering wheel only as rapidly and as far as required to avoid the emergency). Excessive steering will result in less vehicle control, not more. Additionally, smooth variations of the accelerator and/or brake pedal pressure should be utilized if changes in vehicle speed are called for. Avoid abrupt steering,

All-Wheel Drive (If Equipped)

acceleration or braking which could result in an increased risk of loss of vehicle control, vehicle rollover and/or personal injury. Use all available road surface to return the vehicle to a safe direction of travel.

- In the event of an emergency stop, avoid skidding the tires and do not attempt any sharp steering wheel movements.
- If the vehicle goes from one type of surface to another (that is, from concrete to gravel) there will be a change in the way the vehicle responds to a maneuver (steering, acceleration or braking). Again, avoid these abrupt inputs.

Sand

Most of the time traction control improves tire traction by managing wheel slip through Brake, Engine, and AWD calibrations. However, during low speed driving, disabling traction control in deep sand can help keep the wheels moving to maintain vehicle momentum.

When driving over sand, try to keep all four wheels on the most solid area of the trail. Avoid reducing the tire pressures but shift to a lower gear and drive steadily through the terrain. Apply the accelerator slowly and avoid spinning the wheels.

Do not drive your vehicle in deep sand for an extended period of time. This could cause the AWD system to overheat and default to front-wheel drive. If this occurs, an AWD OFF message displays in the information display. To resume normal AWD function as soon as possible, stop the vehicle in a safe location and stop the engine for at least 10 minutes. After the engine has been restarted and the AWD system has adequately cooled, the AWD OFF message turns off and normal AWD function returns. In the event the engine is not stopped, the AWD OFF message turns off when the system cools and normal AWD function returns.

When driving at slow speeds in deep sand under high outside temperatures, use L (Low) gear when possible. L (Low) gear operation will maximize the engine and transmission cooling capability.

Under severe operating conditions, the A/C may cycle on and off to protect overheating of the engine.

Avoid excessive speed because vehicle momentum can work against you and cause the vehicle to become stuck to the point that assistance may be required from another vehicle. Remember, you may be able to back out the way you came if you proceed with caution.

Mud and Water

If you must drive through high water, drive slowly. Traction or brake capability may be limited.

When driving through water, determine the depth; avoid water higher than the bottom of the wheel rims (for cars) or the bottom of the hubs (for trucks) (if possible) and proceed slowly. If the ignition system gets wet, the vehicle may stall.

All-Wheel Drive (If Equipped)

Once through water, always try the brakes. Wet brakes do not stop the vehicle as effectively as dry brakes. Drying can be improved by moving your vehicle slowly while applying light pressure on the brake pedal.

Be cautious of sudden changes in vehicle speed or direction when you are driving in mud. Even AWD vehicles can lose traction in slick mud. As when you are driving over sand, apply the accelerator slowly and avoid spinning your wheels. If the vehicle does slide, steer in the direction of the slide until you regain control of the vehicle.

After driving through mud, clean off residue stuck to rotating driveshafts and tires. Excess mud stuck on tires and rotating driveshafts causes an imbalance that could damage drive components.

Note: *Driving through deep water may damage the transmission.*

If the front or rear axle is submerged in water, have the power transfer unit (PTU) or rear axle serviced by an authorized dealer.

Driving on Hilly or Sloping Terrain

Note: *Avoid driving crosswise or turning on steep slopes or hills. A danger lies in losing traction, slipping sideways and possibly rolling over. Whenever driving on a hill, determine beforehand the route you will use. Do not drive over the crest of a hill without seeing what conditions are on the other side. Do not drive in reverse over a hill without the aid of an observer.*

Although natural obstacles may make it necessary to travel diagonally up or down a hill or steep incline, you should always try to drive straight up or straight down.

When climbing a steep slope or hill, start in a lower gear rather than downshifting to a lower gear from a higher gear once the ascent has started. This reduces strain on the engine and the possibility of stalling.

If you do stall out, do not try to turnaround because you might roll over. It is better to back down to a safe location.

Apply just enough power to the wheels to climb the hill. Too much power will cause the tires to slip, spin or lose traction, resulting in loss of vehicle control.



E143949

Descend a hill in the same gear you would use to climb up the hill to avoid excessive brake application and brake overheating. Do not descend in neutral; instead, disengage overdrive or manually shift to a lower gear. When descending a steep hill, avoid sudden hard braking as you could lose control. The front wheels have to be turning in order to steer the vehicle.

All-Wheel Drive (If Equipped)

Your vehicle has anti-lock brakes, therefore apply the brakes steadily. Do not “pump” the brakes.

Driving on Snow and Ice

WARNING



If you are driving in slippery conditions that require tire chains or cables, then it is critical that you drive cautiously. Keep speeds down, allow for longer stopping distances and avoid aggressive steering to reduce the chances of a loss of vehicle control which can lead to serious injury or death. If the rear end of your vehicle slides while cornering, steer in the direction of the slide until you regain control of your vehicle.

Note: *Your vehicle may have original equipment tires designed to optimize the performance of your vehicle in dry or wet summer road conditions. If your vehicle is equipped with such tires, we recommend using a dedicated set (all 4 tires) of winter tires in snow and ice conditions. Do not mix winter tires and performance tires between axles or degraded traction and handling characteristics could result.*

Note: *Excessive tire slippage can cause driveline damage.*

AWD vehicles have advantages over two-wheel drive (2WD) vehicles in snow and ice but can skid like any other vehicle.

Should you start to slide while driving on snowy or icy roads, turn the steering wheel in the direction of the slide until you regain control.

All-Wheel Drive (If Equipped)

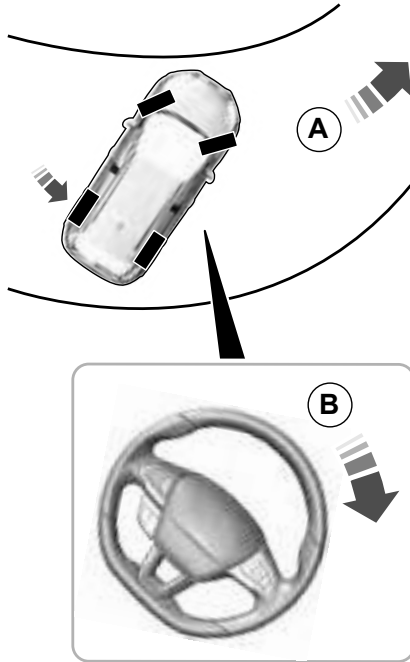

- A Direction of travel.
- B Steering wheel rotation.

Avoid sudden applications of power and quick changes of direction on snow and ice. Apply the accelerator slowly and steadily when starting from a full stop.

Avoid sudden braking as well. Although an AWD vehicle may accelerate better than a two-wheel drive vehicle in snow and ice, it won't stop any faster, because as in other vehicles, braking occurs at all four wheels. Do not become overconfident as to road conditions.

Make sure you allow sufficient distance between you and other vehicles for stopping. Drive slower than usual and consider using one of the lower gears. In emergency stopping situations, apply the brake steadily. Since your vehicle is equipped with a four wheel (ABS), do not "pump" the brakes. See **Hints on Driving With Anti-Lock Brakes** (page 188).

Maintenance and Modifications

The suspension and steering systems on your vehicle have been designed and tested to provide predictable performance whether loaded or empty and durable load carrying capability. For this reason, Ford Motor Company strongly recommends that you do not make modifications such as adding or removing parts (such as lowering kits or stabilizer bars) or by using replacement parts not equivalent to the original factory equipment.

Any modifications to a vehicle that raise the center of gravity can make it more likely the vehicle will rollover as a result of a loss of control. Ford Motor Company recommends that caution be used with any vehicle equipped with a high load or device (such as ladder or luggage racks).

E223901

All-Wheel Drive (If Equipped)

Failure to maintain your vehicle properly may void the warranty, increase your repair cost, reduce vehicle performance and operational capabilities and adversely affect driver and passenger safety. Frequent inspection of vehicle chassis components is recommended if the vehicle is subjected to off-highway usage.

Brakes

GENERAL INFORMATION

Note: Occasional brake noise is normal. If a metal-to-metal, continuous grinding or continuous squeal sound is present, the brake linings may be worn-out. Have the system checked by an authorized dealer. If your vehicle has continuous vibration or shudder in the steering wheel while braking, have it checked by an authorized dealer.

Note: Brake dust may accumulate on the wheels, even under normal driving conditions. Some dust is inevitable as the brake wear and does not contribute to brake noise. See **Cleaning the Alloy Wheels** (page 327).

Note: Depending on applicable laws and regulations in the country for which your vehicle was originally built, your brake lamps may flash during heavy braking. Following this, your hazard lights may also flash when your vehicle comes to a stop.



See **Warning Lamps and Indicators** (page 103).

Wet brakes result in reduced braking efficiency. Gently press the brake pedal a few times when driving from a car wash or standing water to dry the brakes.

Brake Over Accelerator

In the event the accelerator pedal becomes stuck or entrapped, apply steady and firm pressure to the brake pedal to slow the vehicle and reduce engine power. If you experience this condition, apply the brakes and bring your vehicle to a safe stop. Move the transmission to park (P), switch the engine off and apply the parking brake. Inspect the accelerator pedal for any interference. If none are found and the condition persists, have your vehicle towed to the nearest authorized dealer.

Brake Assist

Brake assist detects when you brake rapidly by measuring the rate at which you press the brake pedal. It provides maximum braking efficiency as long as you press the pedal, and can reduce stopping distances in critical situations.

Anti-lock Brake System

This system helps you maintain steering control during emergency stops by keeping the brakes from locking.



This lamp momentarily illuminates when you turn the ignition on. If the light does not illuminate during start up, remains on or flashes, the system may be disabled. Have the system checked by an authorized dealer. If the anti-lock brake system is disabled, normal braking is still effective.



If the brake warning lamp illuminates when you release the parking brake, have the system checked by an authorized dealer.

HINTS ON DRIVING WITH ANTI-LOCK BRAKES

Note: When the system is operating, the brake pedal may pulse and may travel further. Maintain pressure on the brake pedal. You may also hear a noise from the system. This is normal.

Brakes

The anti-lock braking system will not eliminate the risks when:

- You drive too closely to the vehicle in front of you.
- Your vehicle is hydroplaning.
- You take corners too fast.
- The road surface is poor.

ELECTRIC PARKING BRAKE

WARNING



Always set the parking brake and leave your vehicle with the transmission in park (P).

Note: When you apply the electric parking brake in certain conditions, for example on a steep hill, the electric parking brake may reapply the brakes within three to ten minutes. As a result, you may notice various noises when you apply and release the electric parking brake. This is normal and no cause for concern.

The electric parking brake replaces the conventional handbrake. The operating switch is on the instrument panel to the left of the steering wheel.

Applying the electric parking brake

WARNING



The brake system warning lamp will flash when applying the electric parking brake. If the brake system warning lamp continues to flash there could be a problem with your electric parking brake. Have your vehicle checked as soon as possible.

Note: The brake system warning lamp illuminates for 10 seconds if you switch the ignition off after you apply the electric parking brake, or you apply the electric parking brake after you switch the ignition off.

Note: The electric parking brake will not automatically apply. You must apply the electric parking brake using the electric parking brake switch.

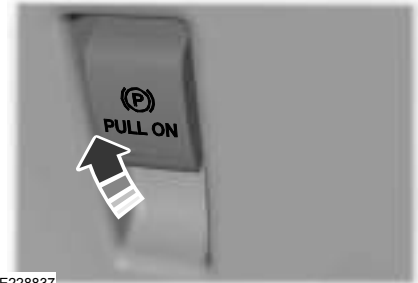

E228837

Pull the switch to apply the electric parking brake.

The brake system warning lamp flashes for about two seconds and then illuminates to confirm that you have applied the electric parking brake. See **Information Displays** (page 108).

Brakes

Applying the electric parking brake when the vehicle is moving

WARNINGS

 Applying the electric parking brake while moving will result in the engagement of the anti-lock braking system. Do not use the electric parking brake system when the vehicle is moving unless the normal brake system is unable to stop the vehicle.

 With the exception of emergency conditions (for example, the brake pedal is broken or is blocked), do not apply the electric parking brake while the vehicle is moving. On bends, or poor road surfaces or weather conditions, emergency braking can cause the vehicle to skid out of control or off the road.

 The brake system warning lamp will flash when applying the electric parking brake. If the brake system warning lamp continues to flash there could be a problem with your electric parking brake. Have your vehicle checked as soon as possible.

If you apply the electric parking brake when your vehicle is moving, the brake system warning lamp illuminates and a warning tone sounds. See **Information Displays** (page 108).

If your vehicle speed is above 4 mph (6 km/h), the braking force is applied as long as you apply the switch. Release or press the switch, or press the accelerator pedal to stop the braking force.

Releasing the electric parking brake

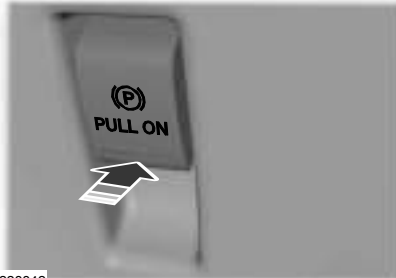

E228842

Release the electric parking brake either manually by pressing the bottom of the switch or automatically.

Manual release

WARNING

 The brake system warning lamp will flash when applying the electric parking brake. If the brake system warning lamp continues to flash there could be a problem with your electric parking brake. Have your vehicle checked as soon as possible.

You can manually release the electric parking brake by:

1. Switching the ignition on.
2. Pressing the brake pedal.
3. Pressing the electric parking brake switch.

When you release the electric parking brake, the brake system warning lamp turns off.

Driving with a Trailer

Depending on the grade and the weight of the trailer, your vehicle and trailer may roll backwards slightly when you start on a slope.

Brakes

To prevent this from happening, do the following:

1. Pull the switch and hold it in this position.
2. Drive your vehicle, then release the switch when you notice that the engine has developed sufficient driving force.

Automatic release - drive away release

Your vehicle automatically releases the parking brake if:

- The driver door is closed.
- The vehicle is accelerated.
- There are no faults detected in the parking brake system.

Note: *If the electric parking brake warning lamp stays illuminated, the electric parking brake will not automatically release. You must release the electric parking brake using the electric parking brake switch.*

The brake system warning lamp will go off to confirm that you have released the electric parking brake.

Note: *The electric parking brake drive away release makes starting on a hill easier. This feature releases the parking brake automatically when the vehicle has sufficient drive force to move up the hill. To assure drive away release when starting uphill, press the accelerator pedal quickly.*

Battery With No Charge

WARNING



You will not be able to apply or release the electric parking brake if the battery is low or has no charge.

If the battery is low or has no charge, use jumper cables and a booster battery.

AUTO HOLD

WARNINGS



The system does not replace the parking brake. When you leave your vehicle, always apply the parking brake.

WARNINGS



You must remain in your vehicle when the system turns on. At all times, you are responsible for controlling your vehicle, supervising the system and intervening, if required. Failure to take care may result in the loss of control of your vehicle, serious personal injury or death.



The system will turn off if a malfunction is apparent. Failure to take care may result in the loss of control of your vehicle, serious personal injury or death.

Auto Hold is a feature that uses your vehicle's brake to hold your vehicle at a stop once your vehicle has reached a standstill condition. For example, Auto Hold can assist you while stopping at traffic lights or while in traffic jams by holding the brake pressure for you once you bring your vehicle to a stop.

Switch Auto Hold off during vehicle or trailer towing.

Brakes

Note: In case of a malfunction in the system while Auto Hold actively holds the vehicle (for example, low power supply), a message appears in the information display. If you see this message, press the brake pedal immediately.

Note: Auto Hold only activates if the system recognizes it is applying enough brake pressure. On a steep hill or incline, you may need to press the brake pedal to activate the Auto Hold system.

Note: When the parking brake automatically applies, the red brake lamp appears. This is normal. When you press the accelerator pedal, the drive away release feature automatically releases the parking brake.

Note: Auto Hold works on all road gradients and in reverse (R).



E227185

Press the Auto Hold button to switch the system on and off. The Auto Hold indicator light illuminates in the Auto Hold button when the system is on.

Note: You can only switch Auto Hold on if you close the door and fasten your safety belt.

Note: Auto Hold turns off every time you power down your vehicle.

When Auto Hold is off, your vehicle behaves the same as a vehicle without Auto Hold.

There is an Auto Hold indicator lamp in the instrument cluster that has two modes, active and unavailable:

AUTO HOLD The Auto Hold (ACTIVE) indicator light illuminates in the information display when the system holds your vehicle stationary. When in active mode, press the brake pedal and the Auto Hold button to switch Auto Hold off.

AUTO HOLD The Auto Hold (UNAVAILABLE) indicator light illuminates in the information display when the system is on but unavailable to hold your vehicle (for example, during Active Park Assist, Car Wash Mode, or when you do not fasten your safety belt).

Using Auto Hold

1. Bring your vehicle to a stop by pressing the brake pedal. After coming to a stop, the green Auto Hold (ACTIVE) indicator lamp illuminates in the information display.
2. Release the brake pedal. The Auto Hold (ACTIVE) indicator light remains illuminated in the information display and Auto Hold will hold your vehicle at a stop.
3. When you press the accelerator pedal, Auto Hold will release the brakes and you will be able to drive off. Once you drive off, the green Auto Hold (ACTIVE) indicator no longer illuminates in the information display.

Note: *The Stop/Start system (if equipped) may stop the engine when you press the brake pedal. If this occurs, it will restart once you press the accelerator pedal. Auto Hold still holds your vehicle at a standstill with the engine off.*

Traction Control

PRINCIPLE OF OPERATION

The traction control system helps avoid drive wheel spin and loss of traction.

If your vehicle begins to slide, the system applies the brakes to individual wheels and, when needed, reduces engine power at the same time. If the wheels spin when accelerating on slippery or loose surfaces, the system reduces engine power in order to increase traction.

USING TRACTION CONTROL

WARNING



The stability and traction control light illuminates steadily if the system detects a failure. Make sure you did not manually disable the traction control system using the information display controls or the switch. If the stability control and traction control light is still illuminating steadily, have the system serviced by an authorized dealer immediately. Operating your vehicle with the traction control disabled could lead to an increased risk of loss of vehicle control, vehicle rollover, personal injury and death.

The system automatically turns on each time you switch the ignition on.

If your vehicle is stuck in mud or snow, switching traction control off may be beneficial as this allows the wheels to spin.

Note: *When you switch traction control off, stability control remains fully active.*

Switching the System Off

When you switch the system off or on, a message appears in the information display showing system status.

You can switch the system off by either using the information display controls or the switch.

Using the Information Display Controls

You can switch this feature off or on in the information display. See **General Information** (page 108).

Using a Switch (If Equipped)

Use the traction control switch on the instrument panel to switch the system off or on.

System Indicator Lights and Messages



The stability and traction control light:

Traction Control

- Temporarily illuminates on engine start-up.
- Flashes when a driving condition activates either of the systems.
- Illuminates if a problem occurs in either of the systems.



The stability and traction control off light temporarily illuminates on engine start-up and stays on when you switch the traction control system off.

Stability Control

PRINCIPLE OF OPERATION

WARNINGS



Vehicle modifications involving braking system, aftermarket roof racks, suspension, steering system, tire construction and wheel and tire size may change the handling characteristics of your vehicle and may adversely affect the performance of the electronic stability control system. In addition, installing any stereo loudspeakers may interfere with and adversely affect the electronic stability control system. Install any aftermarket stereo loudspeaker as far as possible from the front center console, the tunnel, and the front seats in order to minimize the risk of interfering with the electronic stability control sensors. Reducing the effectiveness of the electronic stability control system could lead to an increased risk of loss of vehicle control, vehicle rollover, personal injury and death.

WARNINGS



Remember that even advanced technology cannot defy the laws of physics. It's always possible to lose control of a vehicle due to inappropriate driver input for the conditions. Aggressive driving on any road condition can cause you to lose control of your vehicle increasing the risk of personal injury or property damage. Activation of the electronic stability control system is an indication that at least some of the tires have exceeded their ability to grip the road; this could reduce the operator's ability to control the vehicle potentially resulting in a loss of vehicle control, vehicle rollover, personal injury and death. If your electronic stability control system activates, **SLOW DOWN**.

The system automatically turns on each time you switch the ignition on.

If a fault occurs in either the stability control or the traction control system, you may experience the following conditions:

- The stability and traction control light illuminates steadily.
- The stability control and traction control systems do not enhance your vehicle's ability to maintain traction of the wheels.

If a driving condition activates either the stability control or the traction control system you may experience the following conditions:

- The stability and traction control light flashes.
- Your vehicle slows down.
- Reduced engine power.
- A vibration in the brake pedal.
- The brake pedal is stiffer than usual.
- If the driving condition is severe and your foot is not on the brake, the brake pedal may move as the system applies higher brake force.

The stability control system has several features built into it to help you maintain control of your vehicle:

Stability Control

Electronic Stability Control

The system enhances your vehicle's ability to prevent skids or lateral slides by applying brakes to one or more of the wheels individually and, if necessary, reducing engine power.

Traction Control

The system enhances your vehicle's ability to maintain traction of the wheels by detecting and controlling wheel spin. See **Using Traction Control** (page 194).

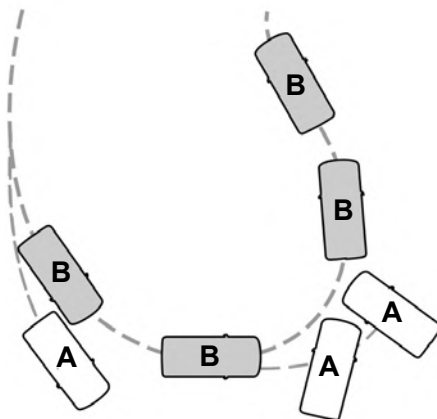

E72903

- A Vehicle without stability control skidding off its intended route.
- B Vehicle with stability control maintaining control on a slippery surface.

USING STABILITY CONTROL

The system automatically turns on each time you switch the ignition on.

The electronic stability control portion of the system disables when the transmission is in reverse (R) or, on some models, if you press and hold the stability control button for more than five seconds when you apply the brakes and the vehicle is at a stop.

You can switch the traction control system off or on independently.

Stability Control

Stability Control and Traction Control Features					
Button Functions	Mode	Stability Control Off Light	Electronic Stability Control	Traction Control System	Collision Warning with Brake Support
Default at start-up	Stability and traction control fully enabled	On during bulb check	Enabled	Enabled	Enabled
Button pressed momentarily	Traction control off	On	Enabled	Disabled	Enabled
Button pressed twice rapidly	Sport mode (if equipped)	On	Enabled with higher threshold target	Enabled with higher threshold target	Disabled
Button pressed and held more than five seconds	Stability and traction control fully disabled	On	Disabled	Disabled	Disabled
Button pressed again after deactivation	Stability and traction control fully enabled	Off	Enabled	Enabled	Enabled

Note: *Stability control fully off can only occur when you put the Active Suspension System (CCD) in sport mode. If you are not in sport mode or change from sport mode to another mode, the stability control enables.*

Note: *Do not use Sport mode on public roadways.*

Your vehicle, if equipped with sport mode allows you to reduce normal stability and traction control system intervention and provide a more spirited driving experience. To enter sport mode, press the stability control button twice rapidly. A message appears in the information display that the system is now in sport mode.

Parking Aids

PRINCIPLE OF OPERATION

WARNINGS

 To help avoid personal injury, please read and understand the limitations of the system as contained in this section. Sensing is only an aid for some (generally large and fixed) objects when moving on a flat surface at parking speeds. Certain objects with surfaces that absorb ultrasonic waves, surrounding vehicle's parking aid systems, traffic control systems, fluorescent lamps, inclement weather, air brakes, and external motors and fans may also affect the function of the sensing system; this may include reduced performance or a false activation.

 To help avoid personal injury, always use caution when in reverse (R) and when using the sensing system.

WARNINGS

 This system is not designed to prevent contact with small or moving objects. The system is designed to provide a warning to assist the driver in detecting large stationary objects to avoid damaging your vehicle. The system may not detect smaller objects, particularly those close to the ground.

 Certain add-on devices such as large trailer hitches, bike or surfboard racks and any device that may block the normal detection zone of the system, may create false beeps.

Note: *Keep the sensors, located on the bumper or fascia, free from snow, ice and large accumulations of dirt. If the sensors are covered, the system's accuracy can be affected. Do not clean the sensors with sharp objects.*

Note: *If your vehicle sustains damage to the bumper or fascia, leaving it misaligned or bent, the sensing zone may be altered causing inaccurate measurement of obstacles or false alarms.*

Note: *The sensing system cannot be turned off when a MyKey is present. See **Principle of Operation** (page 60).*

Note: *If you attach certain add-on devices such as a trailer or bike rack, the rear sensing system may detect that add-on device and therefore provide warnings. It is suggested that you disable the rear sensing system when you attach an add-on device to your vehicle to prevent these warnings.*

The sensing system warns the driver of obstacles within a certain range of your vehicle. The system turns on automatically whenever you switch the ignition on.



You can turn the system on or off by pressing the parking aid button. If your vehicle does not have a parking aid button, the system can be switched off through the information display menu or from the pop-up message that appears once you shift the transmission into reverse (R). See **General Information** (page 108).

If a fault is present in the system, a warning message appears in the information display. See **Information Messages** (page 114).

Parking Aids

REAR PARKING AID

The rear sensors are only active when the transmission is in reverse (R). As your vehicle moves closer to the obstacle, the rate of the audible warning increases. When the obstacle is less than 12 in (30 cm) away, the warning sounds continuously. If the system detects a stationary or receding object farther than 12 in (30 cm) from the corners of the bumper, the tone sounds for only three seconds. Once the system detects an object approaching, the warning sounds again.



E130178

Coverage area of up to 6 ft (1.8 m) from the rear bumper. There may be decreased coverage area at the outer corners of the bumper.

The system detects certain objects while the transmission is in reverse (R) :

- Your vehicle is moving toward a stationary object at a speed of 3 mph (5 km/h) or less.
- Your vehicle is not moving, but a moving object is approaching the rear of your vehicle at a speed of 3 mph (5 km/h) or less.
- Your vehicle is moving at a speed of less than 3 mph (5 km/h) and a moving object is approaching the rear of your vehicle at a speed of less than 3 mph (5 km/h).

The system provides audio warnings only when your vehicle is moving or when your vehicle is stationary and the detected obstacle is less than 12 in (30 cm) away from the bumper.

Obstacle Distance Indicator (If Equipped)

The system provides obstacle distance indication through the information display. The distance indicator displays when the transmission is in reverse (R).

The indicator displays:

- As the distance to the obstacle decreases the indicator blocks illuminate and move towards the vehicle icon.
- If there is no obstacle detected, the distance indicator blocks are grayed out.

FRONT PARKING AID (If Equipped)

The front sensors are active when the transmission is in any position other than park (P) and your vehicle is traveling at low speed.

Parking Aids



E187330

Coverage area of up to 28 in (70 cm) from the front bumper. The coverage area decreases at the outer corners.

When your vehicle approaches an object, a warning tone sounds. When your vehicle moves closer to an object, the warning tone repeat rate increases. The warning tone sounds continuously when an object is 12 in (30 cm) or less from the front bumper.

You can switch the system off through the information display menu or from the pop-up message that appears once you shift the transmission into reverse (R). See **General Information** (page 108). If your vehicle has a parking aid button, you can switch the system off by pressing the button.

Obstacle Distance Indicator (If Equipped)

The system provides obstacle distance indication through the information display.

The indicator displays:

- As the distance to the obstacle decreases the indicator blocks illuminate and move towards the vehicle icon.
- If there is no obstacle detected, the distance indicator blocks are grayed out.

If the transmission is in reverse (R), the front sensing system provides audio warnings when your vehicle is moving and the detected obstacle is moving towards your vehicle. Once the vehicle is stationary, the audio warning will be stopped after 2 seconds. Visual indication is always present in reverse (R).

If the transmission is in drive (D) or any other forward gear (for example, low (L), sport (S) or any forward gear in a manual transmission), the front sensing system provides audio and visual warnings when your vehicle is moving below a speed of 7 mph (12 km/h) and an obstacle is located inside the detection area. Once the vehicle is stationary, the audio warning will be stopped after 2 seconds and the visual indication stops after 4 seconds. If the obstacles detected are within 12 in (30 cm), the visual indication remains on.

If the transmission is in neutral (N), the system provides visual indication only when your vehicle is moving at 7 mph (12 km/h) or below and an obstacle is located inside the detection area. Once your vehicle is stationary, the visual indication will stop after 4 seconds.

Parking Aids

SIDE SENSING SYSTEM (If Equipped)

The side sensing system uses the front and rear side sensors to detect and map obstacles that are near to the sides of your vehicle. The side sensors are active when the transmission is in any position other than park (P).

Note: Obstacles that enter the side detection area without being detected and mapped by the front or rear side sensors will not be detected.



E187810

Coverage area is up to 24 in (60 cm) from the sides of your vehicle.

When the system detects an object close to the side of your vehicle, an audible warning sounds. As the object comes closer to the side of your vehicle, the rate of the audible warning increases. The rate of the audible warning varies depending on whether the obstacle is inside or outside of the driving path of your vehicle.

Obstacle Distance Indicator (If Equipped)

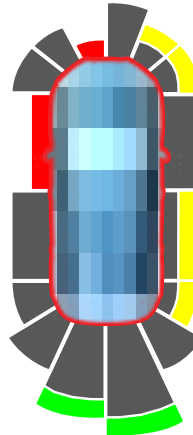

E190459

The system provides obstacle distance indication through the information display.

As the distance to the obstacle decreases, the indicator blocks illuminate and move toward the vehicle icon. If there is no obstacle detected, the distance indicator blocks show greyed out.

When you shift to reverse (R), the side sensing system provides audible and visual distance indication when your vehicle is moving and obstacles are detected within 12 in (30 cm), or when obstacles are detected within 12–24 in (30–60 cm) and are inside the driving path of your vehicle. When you stop your vehicle the audible warning stops after two seconds.

Note: Visual distance indication remains on when the transmission is in reverse (R).

When you shift to drive (D) or any other forward gear, for example, low (L), sport (S) or any forward gear in manual transmission, the side sensing system provides audible and visual distance indication when your vehicle is moving at 7 mph (12 km/h) or below and obstacles are detected within 12 in

Parking Aids

(30 cm), or when obstacles are detected within 12–24 in (30–60 cm) and are inside the driving path of your vehicle. When you stop your vehicle the audible warning stops after 2 seconds and the visual distance indication stops after 4 seconds.

Note: *If the obstacle remains within 12 in (30 cm) visual distance indication remains on.*

If the transmission is in neutral (N), the side sensing system only provides visual distance indication when your vehicle is moving at 7 mph (12 km/h) or below, for example when moving on a slope, and obstacles are detected within 12 in (30 cm). When you stop your vehicle the visual distance indication stops after 4 seconds.

If the side sensing system is not available, the side distance indicator blocks will not be present.

The side sensing system is not available under the following condition:

- If you switch the traction control system off.

The side sensing system may not be available until you have driven approximately the length of your vehicle in order for the system to reinitialize if:

- You switch the ignition on, off and back on.
- Your vehicle remains stationary for over two minutes.
- The anti-lock brake system is activated.
- The traction control system is activated.

ACTIVE PARK ASSIST (If Equipped)

Parallel Parking, Perpendicular Parking, Parallel Park Out Assist

WARNINGS



You must remain in your vehicle when the system turns on. At all times, you are responsible for controlling your vehicle, supervising the system and intervening, if required. Failure to take care may result in the loss of control of your vehicle, serious personal injury or death.

WARNINGS



The sensors may not detect objects in heavy rain or other conditions that cause interference.



Active park assist does not apply the brakes under any circumstances.



At all times, you are responsible for controlling your vehicle, supervising the system and intervening, if required. Failure to take care may result in the loss of control of your vehicle, serious personal injury or death.

The system detects an available parallel or perpendicular parking space and automatically steers your vehicle into the space (hands-free) while you control the accelerator, gearshift and brakes. The system visually and audibly guides you to park your vehicle.

If you are uncomfortable with the proximity to any vehicle or object, you may choose to override the system.

Parking Aids

Parallel Park Out Assist automatically steers your vehicle out of a parallel parking space (hands-free) while you control the accelerator, gearshift and brakes. The system visually and audibly guides you to enter traffic.

Note: *The Blind Spot Information System does not detect traffic alongside or behind your vehicle during a park assist maneuver.*

The system may not correctly operate in any of the following conditions:

- You use a spare tire or a tire significantly worn more than the other tires.
- One or more tires are improperly inflated.
- You try to park on a tight curve.
- Something passes between the front bumper and the parking space (a pedestrian or cyclist).

- The edge of the neighboring parked vehicle is high off the ground (for example, a bus, tow truck or flatbed truck).
- The weather conditions are poor (heavy rain, snow, fog, etc).

Note: *Keep the sensors, located on the bumper or fascia, free from snow, ice and large accumulations of dirt. Covered sensors can affect the system's accuracy. Do not clean the sensors with sharp objects.*

Note: *The sensors may not detect objects with surfaces that absorb ultrasonic waves or cause ultrasonic interference (motorcycle exhaust, truck air brakes or horns).*

Do not use the system if:

- You have attached a bike rack, trailer or other object near the sensors on the front or rear of your vehicle.
- You have attached an overhanging object (surfboard) to the roof.

- A foreign object damages or obstructs the front or rear bumper or side sensors.
- The correct tire size is not in use on your vehicle (for example, a mini-spare tire).

Using Active Park Assist - Parallel Parking



Press the button located on the center console near the gearshift lever or the right side of the center stack once.

When driving at a speed less than 22 mph (35 km/h) the system automatically scans both sides of your vehicle for an available parking space. The system displays a message and a corresponding graphic to indicate it is searching for a parking space. Use the direction indicator to select searching either to the left-hand side or right-hand side of your vehicle. If the direction indicators are not used, the system defaults to the passenger side of your vehicle.

Parking Aids

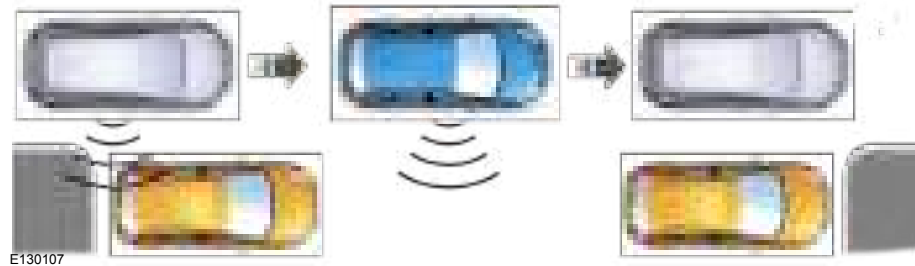

Note: You can also activate the Active Park Assist system after you have already driven partially or completely past a parking space. To do so, press the Active Park button and the system will inform you if you have recently passed a suitable parking space.

When the system finds a suitable space, it displays a message and a tone sounds. Stop your vehicle and follow the instructions on the screen. If your vehicle is moving very slowly, you may need to pull forward a short distance before the system is ready to park.

Note: You must observe that the selected space remains clear of obstructions at all times during the maneuver.

Note: You should drive your vehicle within 5 ft (1.5 m) and as parallel as possible to the other vehicles while passing a parking space.

Note: The system always offers the last detected parking space (for example, if your vehicle detects multiple spaces while you are driving, it offers the last one).

Note: If driven above approximately 22 mph (35 km/h), the system shows a message to alert you to reduce your vehicle speed.

Automatic Steering into Parking Space

Note: If your vehicle speed exceeds approximately 6 mph (10 km/h) or the maneuver is interrupted (driver input), the system switches off and you need to take full control of your vehicle.

When you shift the transmission into reverse (R), with your hands off the wheel (and nothing obstructing its movement), your vehicle steers itself into the space. The system displays instructions to move your vehicle back and forth in the space.

Parking Aids



When you think your vehicle is properly parked, or you hear a solid tone from the parking aid (accompanied by a display message and a chime), bring your vehicle to a complete stop.

When automatic steering is complete, the system displays a message and a tone sounds, indicating that the active park assist process is finished. You are responsible for checking the parking job and making any necessary corrections before leaving your vehicle.

Using Active Park Assist - Perpendicular Parking



Press the button located on the center console near the gearshift lever or the right side of the center stack twice.

The system displays a message and a corresponding graphic to indicate it is searching for a parking space. Use the direction indicator to select searching either to the left-hand side or right-hand side of your vehicle.

Note: *If you do not make a selection the system will default to the passenger's side.*

Parking Aids



When the system finds a suitable space, it displays a message and a tone sounds. Stop your vehicle and follow the instructions on the screen. If your vehicle is moving very slowly, you may need to pull forward a short distance before the system is ready to park.

Note: You must observe that the selected space remains clear of obstructions at all times during the maneuver.

Note: You should drive your vehicle within 5 ft (1.5 m) and as perpendicular as possible to the other vehicles while passing a parking space.

Note: The system always offers the last detected parking space (for example, if your vehicle detects multiple spaces while you are driving, it offers the last one).

Note: If driven above approximately 19 mph (30 km/h), the system shows a message to alert you to reduce your vehicle speed.

Automatic Steering into Parking Space

Note: If your vehicle speed exceeds 6 mph (10 km/h) or the maneuver is interrupted (driver input), the system switches off and you need to take full control of your vehicle.



Parking Aids

When you shift the transmission into reverse (R), with your hands off the wheel (and nothing obstructing its movement), your vehicle steers itself into the space. The system displays instructions to move your vehicle back and forth in the space.

When you think your vehicle is properly parked, or you hear a solid tone from the parking aid (accompanied by a display message and a chime), bring your vehicle to a complete stop.

When automatic steering is complete, the system displays a message and a tone sounds, indicating that the active park assist process is finished. You are responsible for checking the parking job and making any necessary corrections before leaving your vehicle.

Using Active Park Assist - Parallel Park Out Assist



While your vehicle is at rest in a parallel parking space, press the active park assist button.

The system displays a message requesting an indication of direction. Use the direction indicator to signal which side of your vehicle you want to exit the parking space.



Parking Aids

The system determines the clearance to the front and rear of your vehicle and automatically steers your vehicle out of a parallel parking space (hands-free) while you control the accelerator, gearshift and brakes. The system visually and audibly guides you to enter traffic.

After the system has directed your vehicle past the adjacent vehicle or object, it guides you to take control of the steering to complete the exit from the parking spot.

Note: *If the clearance in front of your vehicle allows easy departure, the Parallel Park Out Assist feature might not be available.*

Note: *You are responsible for controlling your vehicle and making sure the path is clear prior to pulling into traffic.*

Troubleshooting the System

The system does not look for a space
The traction control system may be off.
The transmission is in reverse (R). Your vehicle must be moving forward to be able to detect a parking space.

Note: *This system is not intended to assist in exiting perpendicular parking spaces, damages to your vehicle may occur.*

Note: *If your vehicle speed exceeds 3 mph (5 km/h) or the maneuver is interrupted (driver input), the system switches off and you need to take full control of your vehicle.*

Deactivating the Active Park Assist Feature

Manually deactivate the system by:

- Pressing the active park assist button during an active maneuver.
- Grabbing the steering wheel during an active maneuver.

- Driving above approximately 22 mph (35 km/h) for 30 seconds during an active park search.
- Driving above approximately 6 mph (10 km/h) during automatic steering.
- Switching off the traction control system.

Certain vehicle conditions can also deactivate the system, such as:

- Traction control has activated.
- There is an anti-lock brake system activation or failure.

If a problem occurs with the system, a warning message displays accompanied by a tone. Occasional system messages may occur in normal operation. For recurring or frequent system faults, contact an authorized dealer to have your vehicle serviced.

Parking Aids

The system does not offer a particular space
The sensors may be covered (for example, snow, ice or dirt buildup). Covered sensors can affect the system's functionality.
There is not enough room in the parking space for your vehicle to safely park.
There is not enough space for the parking maneuver on the opposite side of the parking space.
The parking space is farther than 5 ft (1.5 m) or closer than 16 in (0.4 m) away.
Your vehicle is going faster than 22 mph (35 km/h) for parallel and 19 mph (30 km/h) for perpendicular parking.

The system does not position the vehicle where I want in the space
Your vehicle is rolling in the opposite direction of the transmission (rolling forward with reverse [R] selected).
An irregular curb along the parking space prevents the system from aligning your vehicle properly.
Vehicles or objects bordering the space may not be positioned correctly.
You pulled your vehicle too far past the parking space.
The tires may not be installed or maintained correctly (not inflated correctly, improper size, or of different sizes).
A repair or alteration has changed detection capabilities.

Parking Aids

The system does not position the vehicle where I want in the space

A parked vehicle has a high attachment (salt sprayer, snowplow or moving truck bed).

The parking space length or position of parked objects changed after your vehicle passed.

The temperature around your vehicle changes quickly (driving from a heated garage into the cold, or after leaving a car wash).

REAR VIEW CAMERA

WARNINGS

 The rear view camera system is a reverse aid supplement device that still requires the driver to use it in conjunction with the interior and exterior mirrors for maximum coverage.

 Objects that are close to either corner of the bumper or under the bumper, might not be seen on the screen due to the limited coverage of the camera system.

 Back up as slow as possible since higher speeds might limit your reaction time to stop your vehicle.

WARNINGS

 Use caution when using the rear video camera and the trunk is ajar. If the trunk is ajar, the camera will be out of position and the video image may be incorrect. All guidelines (if enabled) have been removed when the trunk is ajar.

 Use caution when turning camera features on or off while in reverse (R). Make sure your vehicle is not moving.

The rear view camera system provides a video image of the area behind your vehicle. The image will display in either the rear view mirror or the display in the center of the instrument panel.

During operation, lines will appear in the display that represent your vehicle's path and proximity to objects behind your vehicle.



E152548

The camera is located on the trunk near the high-mount brake lamp.

Parking Aids

Using the Rear View Camera System

The rear view camera system displays what is behind your vehicle when you place the transmission in reverse (R).

The system uses three types of guides to help you see what is behind your vehicle:

- Active guidelines: Show the intended path of your vehicle when reversing.
- Fixed guidelines: Show the actual path your vehicle is moving in while reversing in a straight line. This can be helpful when backing into a parking space or aligning your vehicle with another object behind you.
- Centerline (if applicable): Helps align the center of your vehicle with an object (trailer).

Note: *If the transmission is in reverse (R) and the luggage compartment is ajar, no rear view camera features will display.*

Note: *If the image comes on while the transmission is not in reverse (R), have the system inspected by an authorized dealer.*

Note: *When towing, the camera only sees what you are towing behind your vehicle. This might not provide adequate coverage and you might not see some objects. In some vehicles, the guidelines may disappear once you connect the trailer tow connector.*

The camera may not operate correctly under the following conditions:

- Nighttime or dark areas if the reverse lamps are not operating.
- Mud, water or debris obstructs the camera's view. Clean the lens with a soft, lint-free cloth and non-abrasive cleaner.
- The camera is misaligned due to damage to the rear of your vehicle.

To access any of the rear view camera system settings, make the following selections in the touch screen when the transmission is not in reverse (R):

- Menu > Vehicle > Camera Settings

After changing a system setting, the touch screen shows a preview of the selected features.

Guidelines and the Centerline

Note: *Active guidelines and fixed guidelines are only available when the transmission is in reverse (R).*

Note: *The centerline is only available if Active or Fixed guidelines are on.*

Parking Aids

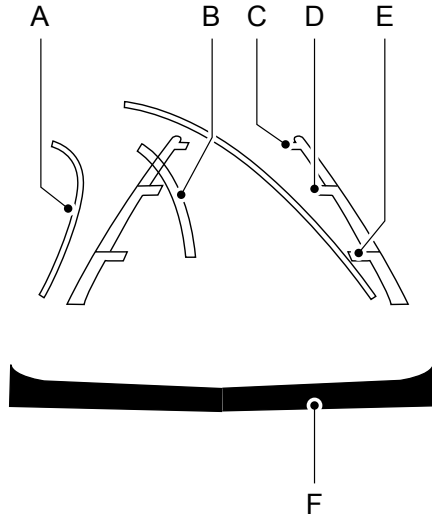

E142436

- A Active guidelines
- B Centerline
- C Fixed guideline: Green zone

- D Fixed guideline: Yellow zone
- E Fixed guideline: Red zone
- F Rear bumper

Active guidelines are only shown with fixed guidelines. To use active guidelines, turn the steering wheel to point the guidelines toward an intended path. If you change the steering wheel position while reversing, your vehicle might deviate from the original intended path.

The fixed and active guidelines fade in and out depending on your steering wheel position. When your steering wheel position is straight, the active guidelines are not visible.

Always use caution while reversing. Objects in the red zone are closest to your vehicle and objects in the green zone are farther away. Objects are getting closer to your vehicle as they move from the green zone to the yellow or red zones. Use the side view mirrors and rear view mirror to get better coverage on both sides and rear of your vehicle.

Enhanced Park Aids

Note: *The reverse sensing system is not effective at speeds above 3 mph (5 km/h) and may not detect certain angular or moving objects.*

The system uses red, yellow and green highlights that appear on top of the video image when the reverse sensing system detects an object. The alert highlights the closest object detected. You can disable the reverse sensing alert if you have enhanced park aids enabled, you will still see the displayed highlighted areas.

Selectable settings for this feature are ON and OFF.

Manual Zoom

WARNING



When manual zoom is on, the full area behind your vehicle is not shown. Be aware of your surroundings when using the manual zoom feature.

Note: *Manual zoom is only available when the transmission is in reverse (R).*

Parking Aids

Note: *Only the centerline shows when you enable manual zoom.*

This allows you to get a closer view of an object behind your vehicle. The zoomed image keeps the bumper in the image to provide a reference. The zoom is only active while the transmission is in reverse (R). When you shift the transmission out of reverse (R), the feature automatically turns off and you must enable it to use it again.

Selectable settings for this feature are ON and OFF.

Rear Camera Delay

When shifting the transmission out of reverse (R) and into any gear other than park (P), the camera image remains in the display until your vehicle speed reaches 5 mph (8 km/h) or until you select a radio button.

Selectable settings for this feature are ON and OFF. The default setting for the rear camera delay is OFF.

Cruise Control

PRINCIPLE OF OPERATION

Cruise control lets you maintain a set speed without keeping your foot on the accelerator pedal. You can use cruise control when your vehicle speed is greater than 20 mph (30 km/h).

USING CRUISE CONTROL

WARNINGS



Do not use cruise control on winding roads, in heavy traffic or when the road surface is slippery. This could result in loss of vehicle control, serious injury or death.



When you are going downhill, your vehicle speed may increase above the set speed. The system will not apply the brakes but a warning displays.

Note: Cruise control will disengage if the vehicle speed decreases more than 10 mph (16 km/h) below the set speed while driving uphill.

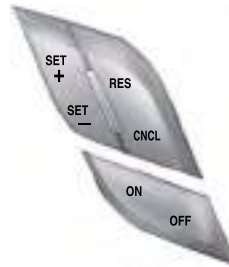

E145976

The cruise controls are on the steering wheel.

Switching Cruise Control On

Press and release **ON**.



The indicator appears in the instrument cluster.

Setting a Speed

1. Drive to desired speed.
2. Press and release **SET+**.
3. Take your foot off the accelerator pedal.

The indicator changes color in the instrument cluster.

Changing the Set Speed

Note: If you accelerate by pressing the accelerator pedal, the set speed will not change. When you release the accelerator pedal, your vehicle returns to the speed that you previously set.

- Press the accelerator or brake pedal until you reach the desired speed. Press and release **SET+**.
- Press and hold **SET+** or **SET-**. Release the control when you reach the desired speed.
- Press and release **SET+** or **SET-**. When you select kph as the display measurement in the information display, the set speed changes in approximately 2 kph increments. When you select mph as the display measurement in the information display, the set speed changes in approximately 1 mph increments.

Cruise Control

Canceling the Set Speed

Press **CNCL** or tap the brake pedal. You will not erase the set speed.

Resuming the Set Speed

Press and release **RES**.

Switching Cruise Control Off

Note: *You will erase the set speed if you switch the system off.*

Press and release **OFF** or switch the ignition off.

USING ADAPTIVE CRUISE CONTROL (If Equipped)

WARNINGS

 Always pay close attention to changing road conditions when using adaptive cruise control. The system does not replace attentive driving. Failing to pay attention to the road may result in a crash, serious injury or death.

WARNINGS

 Adaptive cruise control does not detect stationary or slow moving vehicles below 6 mph (10 km/h).

 Do not use adaptive cruise control on winding roads, in heavy traffic or when the road surface is slippery. This could result in loss of vehicle control, serious injury or death.

 Do not use adaptive cruise control when towing a trailer that has trailer brakes. The auto-brake component of the adaptive cruise control system does not operate the trailer brakes. Using adaptive cruise control when towing a trailer that has trailer brakes may result in the loss of vehicle control, which could result in serious injury.

 Adaptive cruise control is not a crash warning or avoidance system.

 Adaptive cruise control does not detect pedestrians or objects in the road.

 Adaptive cruise control does not detect oncoming vehicles in the same lane.

WARNINGS

 Do not use the system in poor visibility, for example fog, heavy rain, spray or snow.

 Do not use the adaptive cruise control when entering or leaving a highway, on roads with intersections or roundabouts or non-vehicular traffic or roads that are winding, slippery, unpaved, or steep slopes.

 Do not use tire sizes other than those recommended because this can affect the normal operation of the system. Failure to do so may result in a loss of vehicle control, which could result in serious injury.

Note: *It is your responsibility to stay alert, drive safely and be in control of the vehicle at all times.*

The system adjusts your vehicle speed to maintain the set gap between you and the vehicle in front of you in the same lane. You can select four gap settings.

Cruise Control



E222885

The adaptive cruise controls are on the steering wheel.

Switching Adaptive Cruise Control On

Press and release **ON**.



The indicator appears in the information display.

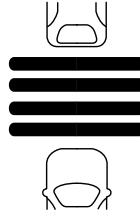

E164805

The current gap setting and set speed also appear in the information display.

Setting the Adaptive Cruise Speed

1. Drive to desired speed.
2. Press and release **SET-**. A green indicator light, the current gap setting and your set speed appear in the information display.
3. Take your foot off the accelerator pedal.

E164805

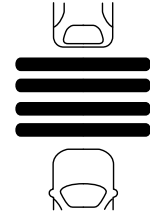

4. A vehicle graphic illuminates if there is a vehicle detected in front of you.

Note: When adaptive cruise control is active, the speedometer may vary slightly from the set speed displayed in the information display.

Setting the Adaptive Cruise Speed When Your Vehicle is Stationary

1. Follow a vehicle to a complete stop.
2. Keep the brake pedal fully pressed.
3. Press and release **RES+**.
4. The set speed automatically adjusts to 20 mph (30 km/h). A green indicator light and the current gap setting appear in the information display.

Cruise Control

Following a Vehicle

WARNINGS



When following a vehicle, your vehicle does not always decelerate quickly enough to avoid a crash without driver intervention. Always apply the brakes when necessary. Failing to do so may result in a crash, serious injury or death.



Adaptive cruise control only warns of vehicles detected by the radar sensor. In some cases there may be no warning or a delayed warning. You should always apply the brakes when necessary. Failure to do so may result in a crash, serious injury or death.

Note: *The brakes may emit noise when applied by the system.*

When a vehicle ahead of you enters the same lane or a slower vehicle is ahead in the same lane, the vehicle speed adjusts to maintain a preset gap distance. A vehicle graphic illuminates in the instrument cluster.

When you are following a vehicle and you switch on your left directional indicator, adaptive cruise control may provide a small temporary acceleration to help you pass.

Your vehicle maintains a consistent gap from the vehicle ahead until:

- The vehicle in front of you accelerates to a speed above the set speed.
- The vehicle in front of you moves out of the lane you are in.
- You set a new gap distance.

The vehicle applies brakes to slow the vehicle to maintain a safe distance from the vehicle in front. The maximum braking which the system can apply is limited. You can override the system by applying the brakes.

If the system predicts that its maximum braking level is insufficient, an audible warning sounds while the system continues to brake. The red warning bar appears on the windshield. You should take immediate action.

Following a Vehicle to a Complete Stop

If your vehicle follows a vehicle to a complete stop and remains stationary for less than three seconds, your vehicle automatically accelerates from a stationary position to follow the vehicle ahead when you release the brake pedal.

If your vehicle follows a vehicle to a complete stop and remains stationary for more than three seconds, you must press and release the **RES+** button or the accelerator pedal to accelerate from a stationary position and follow the vehicle ahead.

Setting the Gap Distance

You can decrease or increase the distance between your vehicle and the vehicle in front by pressing the gap control.

Note: *It is your responsibility to select a gap appropriate to the driving conditions.*

Cruise Control

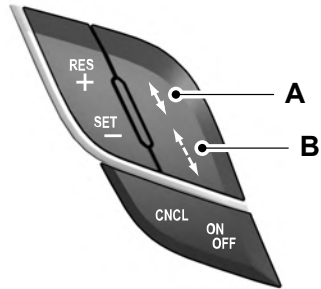

E222822

- A Gap decrease.
- B Gap increase.

E164805

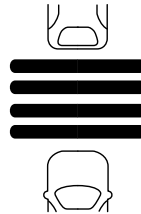

The selected gap appears in the information display as shown by the bars in the graphic. Four gap distance settings are available.

Adaptive cruise control, distance between vehicle settings

Set speed mph (km/h)	Graphic display, bars indicated between vehicles	Time gap, seconds	Distance gap yd (m)	Dynamic behavior
62 (100)	1	1	31 (28)	Sport.
62 (100)	2	1.4	43 (39)	Normal.
62 (100)	3	1.8	55 (50)	Normal.
62 (100)	4	2.2	67 (61)	Comfort.

Each time you start the vehicle, the system selects the last chosen gap setting.

Cruise Control

Overriding the System

WARNING



Whenever the driver presses the accelerator pedal and overrides the system, the system does not automatically apply the brakes to maintain the set distance from any vehicle ahead.

Press the accelerator pedal to override the set speed and gap distance.



When you override the system, the green indicator light illuminates and the lead vehicle graphic does not show in the information display.

The system resumes operation when you release the accelerator pedal. The vehicle speed decreases to the set speed, or a slower speed if following a slower vehicle.

Changing the Set Speed

- Press and release **RES+** or **SET-**. When you select km/h as the display measurement in the information display the set speed changes in approximately 2 km/h increments. When you select mph as the display measurement in the information display the set speed changes in approximately 1 mph increments.
- Press the accelerator or brake pedal until you reach the desired speed. Press and release **SET-**.
- Press and hold **RES+** or **SET-**. Release the control when you reach the desired speed. The set speed changes in approximately 5 mph/10 km/h increments.
- Press the **RES+** or **SET-** button to change the set speed in increments of approximately 1 mph or 2 km/h.
- Hold the **RES+** or **SET-** button to change the set speed in increments of approximately 5 mph or 10 km/h.

The system may apply the brakes to slow the vehicle to the new set speed. The set speed displays continuously in the information display when the system is active.

Canceling the Set Speed

Press and release **CNCL** or tap the brake pedal. The set speed does not erase.

Resuming the Set Speed

Press and release **RES+**. Your vehicle speed returns to the previously set speed and gap setting. The set speed displays continuously in the information display when the system is active.

Note: Only use resume if you are aware of the set speed and intend to return to it.

Automatic Cancellation

Automatic cancellation occurs if:

- The tires lose traction.
- You apply the parking brake.

Cruise Control

Note: *If the engine speed drops too low, the information display indicates low engine speed. Shift to a lower gear (manual transmission only) to avoid automatic cancellation.*

Park Brake Application

Automatic parking brake application and cancellation occurs if:

- You unbuckle the seatbelt and open the door while stopped.
- Holding the vehicle at a stop continuously for more than two minutes.

Hilly Condition Usage

Note: *An audible alarm sounds and the system shuts down if it is applying brakes for an extended period of time. This allows the brakes to cool. The system functions normally again when the brakes cool.*

Select a lower gear during prolonged downhill driving on steep slopes, such as mountainous areas, when the system is active. In such situations, the system needs additional engine braking to reduce the load on the vehicle's regular brake system to prevent the brakes from overheating.

Switching Adaptive Cruise Control Off

Press and release **OFF** when the system is in stand by mode or switch the ignition off.

Note: *You erase the set speed when you switch the system off.*

Detection Issues

WARNING



On rare occasions, detection issues can occur due to the road infrastructures, for example bridges, tunnels and safety barriers. In these cases, the system may brake late or unexpectedly. At all times, you are responsible for controlling your vehicle, supervising the system and intervening, if required.

The radar sensor has a limited field of vision. It may not detect vehicles at all or detect a vehicle later than expected in some situations. The lead vehicle graphic does not illuminate if the system does not detect a vehicle in front of you.

Cruise Control

A



B



C

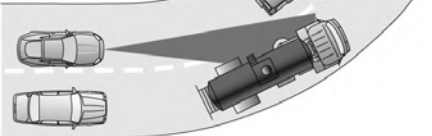

Detection issues can occur:

- A When driving on a different line than the vehicle in front.
- B With vehicles that edge into your lane. The system can only detect these vehicles once they move fully into your lane.
- C There may be issues with the detection of vehicles in front when driving into and coming out of a bend or curve in the road.

In these cases the system may brake late or unexpectedly. The driver should stay alert and intervene when necessary.

If something hits the front end of your vehicle or damage occurs, the radar-sensing zone may change. This could cause missed or false vehicle detections. See an authorized dealer to have the radar checked for proper coverage and operation.

E71621

System Not Available

Conditions that can cause the system to deactivate or prevent the system from activating when requested include:

- A blocked sensor.
- High brake temperature.
- A failure in the system or a related system.
- The system does not detect a lead vehicle while stopped or driving at low speeds.

Blocked Sensor



E145632

Cruise Control

A message appears if something obstructs the sensor's radar signals. The sensor is located behind a cover near the driver side of the lower grille. The system cannot detect

a vehicle ahead and does not function when something obstructs the radar signal.

Note: *You cannot see the sensor, it is behind a fascia panel.*

The following table lists possible causes and actions for this message displaying.

Cause	Action
The surface of the radar in the grille is dirty or obstructed in some way.	Clean the grille surface in front of the radar or remove the object causing the obstruction.
The surface of the radar in the grille is clean but the message remains in the display.	Wait a short time. It may take several minutes for the radar to detect that it is free from obstruction.
Heavy rain or snow is interfering with the radar signals.	Do not use the system in these conditions because it may not detect any vehicles ahead.
Swirling water, or snow or ice on the surface of the road may interfere with the radar signals.	Do not use the system in these conditions because it may not detect any vehicles ahead.
You are in a desert or remote area with no other vehicles and no roadside objects.	Wait a short time or switch to normal cruise control.

Cruise Control

Due to the nature of radar technology, it is possible to get a blockage warning with no actual block. This happens, for example, when driving in sparse rural or desert environments. A false blocked condition either self clears or clears after a you restart your vehicle.

Switching to Normal Cruise Control

WARNING



Normal cruise control does not brake for slower vehicles. Always be aware of which mode you have selected and apply the brakes when necessary.

You can manually change from adaptive cruise control to normal cruise control through the information display.



The cruise control indicator light replaces the adaptive cruise control indicator light if you select normal cruise control. The gap setting does not display, the system does not automatically respond to lead vehicles and automatic braking does not activate.

Driving Aids

DRIVER ALERT (If Equipped)

WARNING



The system is designed to aid the driver. It is not intended to replace your attention and judgment. You are still responsible to drive with due care and attention.

Note: The system will store the on or off setting in the information display menu through ignition cycles.

Note: If enabled in the menu, the system will be active at speeds above 40 mph (64 km/h). When below the activation speed, the information display will inform you that the system is unavailable.

Note: The system works as long as one lane marking can be detected by the camera.

Note: If the camera is blocked or if the windshield is damaged, the system may not function.

Note: The system may not be available in poor weather or other low visibility conditions.

The system automatically monitors your driving behavior using various inputs including the front camera sensor.

If the system detects that your driving alertness is reduced below a certain threshold, the system will alert you using a chime and a message in the information display.

Using Driver Alert

Switching the system on and off

You may switch the system on or off through the information display. See **General Information** (page 108). When activated, the system will monitor your alertness level based upon your driving behavior in relation to the lane markings, and other factors.

System Warnings

Note: The system will not issue warnings below approximately 40 mph (64 km/h).

The warning system is in two stages. At first the system issues a temporary warning that you need to take a rest. This message will only appear for a short time. If the system detects further reduction in driving alertness, another warning may be issued which will remain in the information display for a longer time. Press OK on the steering wheel control to clear the warning.

System Display

When active the system will run automatically in the background and only issue a warning if required. You can view the status at any time using the information display. See **General Information** (page 108).

The alertness level is shown by six steps in a colored bar.

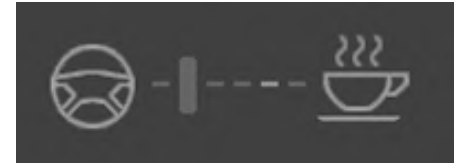

E131358

Driving Aids

The current assessment of your alertness is within a typical range.



E131359

The current assessment of your alertness indicates that you should rest as soon as safely possible.

The status bar will travel from left to right as the calculated alertness level decreases. As the rest icon is approached the color turns from green to yellow to red. The yellow position indicates the first warning is active and the red position indicates the second warning is active.

Note: *If you have recently received a warning; you should consider resting, even if the current assessment is within the typical range.*

Note: *If the camera sensor cannot track the road lane markings or if your vehicle speed drops below approximately 40 mph (64 km/h), the alertness level will change to grey for a short time and the information display will inform you that the system is unavailable.*

Resetting the System

You can reset the system by either:

- Switching the ignition off and on.
- Stopping the vehicle and then opening and closing the driver's door.

LANE KEEPING SYSTEM (If Equipped)

WARNINGS

 Always drive with due care and attention when using and operating the controls and features on your vehicle.

WARNINGS

 At all times, you are responsible for controlling your vehicle, supervising the system and intervening, if required. Failure to take care may result in the loss of control of your vehicle, serious personal injury or death.

 In cold and severe weather conditions the system may not function. Rain, snow and spray can all limit sensor performance.

 Large contrasts in outside lighting can limit sensor performance.

 The system will not operate if the sensor cannot track the road lane markings.

 If damage occurs in the immediate area surrounding the sensor, have your vehicle checked as soon as possible.

Note: *The system works above 40 mph (64 km/h).*

Note: *The system works as long as the camera can detect one lane marking.*

Driving Aids

Note: The system may not function if the camera is blocked or there is damage to the windshield.

Note: When Aid mode is on and the system detects no steering activity for a short period, the system will alert you to put your hands on the steering wheel. The system may detect a light grip or touch on the steering wheel as hands off driving.

The system notifies you to stay in your lane through the steering system and the instrument cluster display when the front camera detects an unintentional drift out of your lane is likely to occur. The system automatically detects and tracks the road lane markings using a camera mounted behind the interior rear view mirror.

Switching the System On and Off

Note: The system on or off setting is stored until it is manually changed, unless a MyKey is detected. If the system detects a MyKey it defaults to on and the mode is set to Alert.

Note: If a MyKey is detected, pressing the button will not affect the on or off status of the system.



Press the button on the steering wheel stalk to switch the system on or off.

System Settings

The system has optional setting menus available. The system stores the last-known selection for each of these settings. You do not need to readjust your settings each time you turn on the system.

Mode: This setting allows you to select which of the system features you can enable.



E165515

Alert only – Provides a steering wheel vibration when the system detects an unintended lane departure.

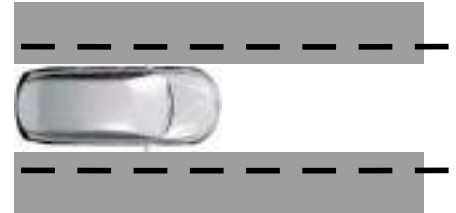

E165516

Aid only – Provides an assistance steering torque input toward the lane center when the system detects an unintended lane departure.

Driving Aids

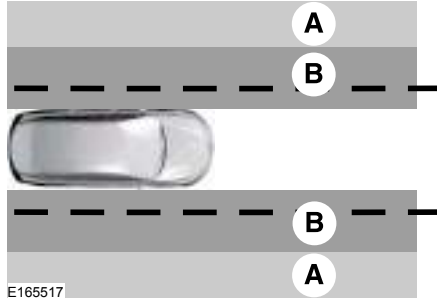

- A Alert
- B Aid

Alert + Aid – Provides an assistance steering torque input toward the lane center. If your vehicle continues drifting out of the lane, the system provides a steering wheel vibration.

Note: *The alert and aid diagrams illustrate general zone coverage. They do not provide exact zone parameters.*

Intensity: This setting affects the intensity of the steering wheel vibration used for the alert and alert + aid modes. This setting does not affect the aid mode.

- Low
- Normal
- High

System Display



When you switch on the system, an overhead graphic of a vehicle with lane markings will display in the information display. If you select aid mode when you switch on the system, a separate white icon will also appear or in some vehicles arrows will display with the lane markings.

When you switch off the system, the lane marking graphics will not display.

While the system is on, the color of the lane markings will change to indicate the system status.

Gray: Indicates that the system is temporarily unable to provide a warning or intervention on the indicated side(s). This may be because:

- Your vehicle is under the activation speed.
- The turn indicator is active.
- Your vehicle is in a dynamic maneuver.
- The road has no or poor lane markings in the camera field-of-view.
- The camera is obscured or unable to detect the lane markings due to environmental conditions (significant sun angles, shadows, snow, heavy rain or fog), traffic conditions (following a large vehicle that is blocking or shadowing the lane), or vehicle conditions (poor headlamp illumination).

See **Troubleshooting** for additional information.

Driving Aids

Green: Indicates that the system is available or ready to provide a warning or intervention, on the indicated side(s).

Yellow: Indicates that the system is providing or has just provided a lane keeping aid intervention.

Red: Indicates that the system is providing or has just provided a lane keeping alert warning.

The system can be temporarily suppressed at any time by the following:

- Quick braking.
- Fast acceleration.
- Using the turn signal indicator.
- Evasive steering maneuver.

Troubleshooting

Why is the feature not available (line markings are gray) when I can see the lane markings on the road?
Vehicle speed is outside the operational range of the feature
Sun is shining directly into the camera lens
Quick intentional lane change
Staying too close to the lane marking
Driving at high speeds in curves
The last Alert warning or Aid intervention occurred a short time ago
Ambiguous lane markings (mainly in construction zones)
Rapid transition from light to dark or vice versa
Sudden offset in lane markings
ABS or AdvanceTrac activation

Driving Aids

Why is the feature not available (line markings are gray) when I can see the lane markings on the road?
--

Camera blockage due to dirt, grime, fog, frost or water on the windshield

Driving too close to the vehicle in front of you
--

Transitioning between no lane markings to lane markings or vice versa

Standing water on the road

Faint lane markings (partial yellow lane markings on concrete roads)
--

Lane width too narrow or too wide

Camera not calibrated after a windshield replacement
--

Driving on tight roads or on uneven roads

Why does the vehicle not come back toward the middle of the lane, as expected, in the Aid or Aid + Alert mode?

High cross winds

Large road crown

Rough roads, grooves, shoulder drop-offs
--

Heavy uneven loading of the vehicle or improper tire inflation pressure

If the tires have been exchanged (including snow tires), or the suspension has been modified
--

Driving Aids

BLIND SPOT INFORMATION SYSTEM

WARNING

 To help avoid injuries, NEVER use the Blind Spot Information System as a replacement for using the interior and exterior mirrors or looking over your shoulder before changing lanes. The Blind Spot Information System is not a replacement for careful driving.

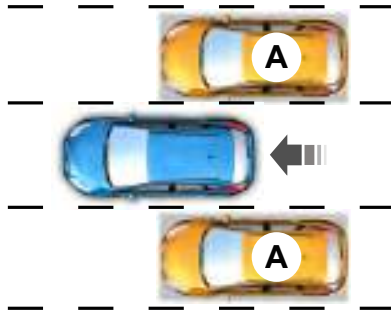

E124788

The Blind Spot Information System is designed to aid you in detecting vehicles that may have entered the blind spot zone (A). The detection area is on both sides of your vehicle, extending rearward from the exterior mirrors to approximately 13 ft (4 m) beyond the bumper. The system is designed to alert you if certain vehicles enter the blind spot zone while driving.

Note: *The Blind Spot Information System does not prevent contact with other vehicles or objects; nor detect parked vehicles, people, animals or infrastructure (fences, guardrails, trees). It's only designed to alert you to vehicles in the blind spot zones.*

Note: *When a vehicle passes quickly through the blind spot zone, typically fewer than two seconds, the system does not trigger.*

Using the System

The Blind Spot Information System turns on when you start the engine and you drive your vehicle forward above 5 mph (8 km/h).

For automatic transmissions, the Blind Spot Information System remains on while the transmission is in drive (D). If shifted into reverse (R) or park (P) the Blind Spot Information System turns off. Once shifted back into drive (D), the Blind Spot Information System turns back on when you drive your vehicle above 5 mph (8 km/h).

For manual transmissions, the Blind Spot Information System is on for all gears except the reverse (R).

Note: *The Blind Spot Information System does not function in reverse (R) or park (P).*

System Lights and Messages



E142442

Driving Aids

The Blind Spot Information System illuminates an amber alert indicator in the outside mirror on the side of your vehicle the approaching vehicle is coming from. When the Blind Spot Information System is alerting on a vehicle and the corresponding turn signal is ON, the Blind Spot Information System alert indicator flashes as an increased warning level.

The alert indicator dims when the system detects nighttime darkness.

Note: *The alert indicator flashes in case of an alert and the turn signal is set to that side at the same time.*

System Sensor Blockage

WARNING



To help avoid injuries, NEVER use the Blind Spot Information System as a replacement for using the interior and exterior mirrors or looking over your shoulder before changing lanes. The Blind Spot Information System is not a replacement for careful driving.

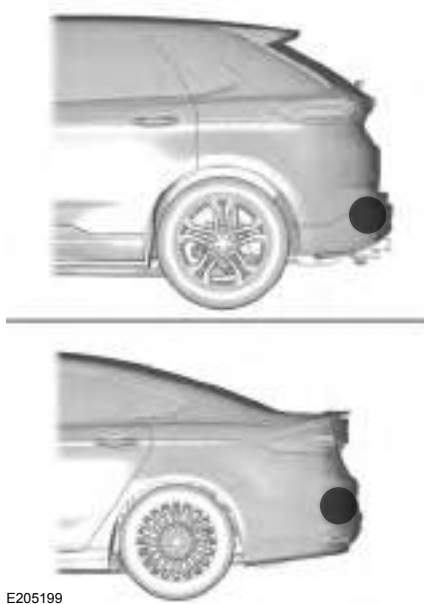

E205199

The system uses radar sensors that are located behind the bumper fascia on each side of your vehicle. Any dirt, mud and snow in front of the sensors and/or driving in heavy rain can cause system degradation. Also, other types of obstructions in front of the sensor can cause system degradation. This is referred to as a 'blocked' condition.

Note: *Do not apply bumper stickers and/or repair compound to these areas, this can cause degraded system performance.*

If the system detects a degraded performance condition, a message warning of a blocked sensor will appear in the information display. Also the BLIS alert indicators will remain ON and BLIS will no longer provide any vehicle warnings. You can clear the information display warning but the alert indicators will remain illuminated.

Driving Aids

A "blocked" condition can be cleared in two ways:

- After the blockage in front of the sensors is removed or the rainfall/snowfall rate decreases or stops, drive for a few minutes in traffic to allow the sensors to detect passing vehicles.
- By cycling the ignition from ON to OFF and then back ON.

Note: *If your vehicle has a tow bar with a factory equipped trailer tow module and it is towing a trailer, the sensors will automatically turn the Blind Spot Information System off. If your vehicle has a tow bar but no factory equipped trailer tow module, it is recommended to turn the Blind Spot Information System off manually. Operating the Blind Spot Information System with a trailer attached will cause poor system performance.*

System Errors

If the system senses a problem with the left or right sensor, the telltale will illuminate and a message will appear in the information display. See **Information Messages** (page 114).

Switching the System Off and On

You can temporarily switch the Blind Spot Information System off in the information display. See **General Information** (page 108). When the Blind Spot Information System switches off, you will not receive alerts and the information display shows a system off message. The telltale in the cluster also illuminates. When you switch the Blind Spot Information System on or off, the alert indicators flash twice.

Note: *The Blind Spot Information System remembers the last selected on or off setting.*

You can also have the Blind Spot Information System switched off permanently at an authorized dealer. Once switched off permanently, the system can only be switched back on at an authorized dealer.

CROSS TRAFFIC ALERT

WARNING



To help avoid personal injury, NEVER use the Cross Traffic Alert system as a replacement for using the interior and exterior mirrors and looking over your shoulder before backing out of a parking space. Cross Traffic Alert is not a replacement for careful driving.

Cross Traffic Alert is designed to warn you of vehicles approaching from the sides when the transmission is in reverse (R).

Using the System

Cross Traffic Alert turns on when you start the engine and you shift into reverse (R). Once shifted out of reverse (R), Cross Traffic Alert turns off.

Note: *Cross Traffic Alert only functions while your transmission is in reverse (R).*

Driving Aids

Cross Traffic Alert is designed to detect vehicles that approach with a speed up to 37 mph (60 km/h). Coverage decreases when

the sensors are partially, mostly or fully obstructed. Reversing slowly helps increase the coverage area and effectiveness.

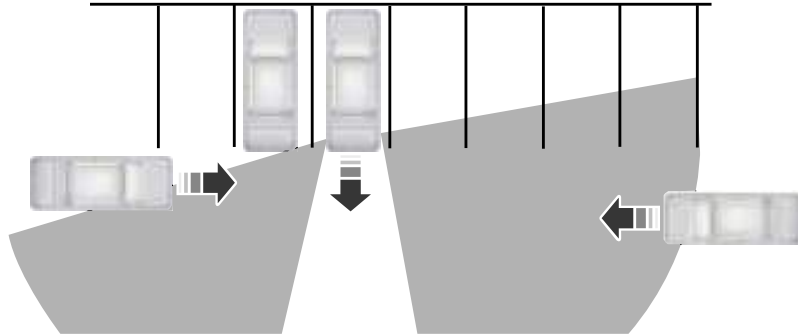

E142440

In this first example, the left sensor is only partially obstructed; zone coverage to the right is nearly maximized.

Driving Aids

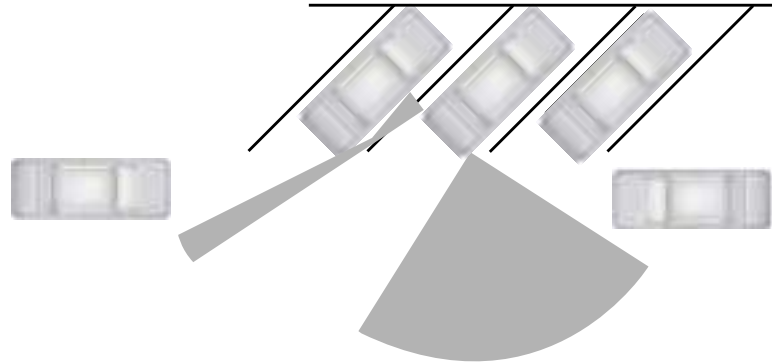

E142441

Zone coverage also decreases when parking at shallow angles. Here, the left sensor is mostly obstructed; zone coverage on that side is severely limited.

Driving Aids

System Lights, Messages and Audible Alerts



E142442

The Cross Traffic Alert illuminates an amber alert indicator in the outside mirror on the side of your vehicle the approaching vehicle is coming from. Cross Traffic Alert also sounds an audible alert and a message appears in the information display indicating a vehicle is coming from the right or left. Cross Traffic Alert works with the reverse sensing system that sounds its own series of tones. See **Rear Parking Aid** (page 200).

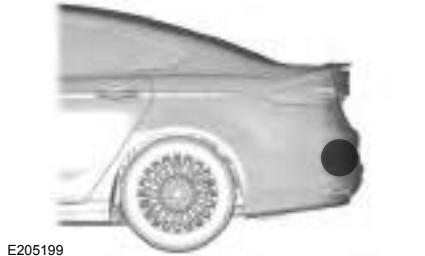

E205199

The system uses radar sensors that are located behind the bumper fascia on each side of your vehicle. Do not allow mud, snow or bumper stickers to obstruct these areas, this can cause degraded system performance. See **Blind Spot Information System** (page 231). If the Blind Spot Information System is blocked, Cross Traffic Alert is also blocked. A corresponding message appears in the information display as soon as you shift the transmission into reverse (R).

System Limitations

Cross Traffic Alert has its limitations; situations such as severe weather conditions or debris build-up on the sensor area may limit vehicle detection.

The following are other situations that may limit the Cross Traffic Alert performance:

- Adjacently parked vehicles or objects obstructing the sensors.
- Approaching vehicles passing at speeds greater than 37 mph (60 km/h).

Driving Aids

- Driving in reverse faster than 7 mph (12 km/h).
- Backing out of an angled parking spot.

False Alerts

Note: *If your vehicle has a tow bar with a factory equipped trailer tow module and it is towing a trailer, the sensors will automatically turn the Cross Traffic Alert off. If your vehicle has a tow bar but no factory equipped trailer tow module, it is recommended to turn the Cross Traffic Alert off manually. Operating Cross Traffic Alert with a trailer attached will cause poor Cross Traffic Alert performance.*

There may be certain instances when there is a false alert by the Cross Traffic Alert system that illuminates the alert indicator with no vehicle in the coverage zone. Some amount of false alerts are normal; they are temporary and self-correct.

System Errors

If Cross Traffic Alert senses a problem with the left or right sensor a message will appear in the information display. See **Information Messages** (page 114).

Switching the System Off and On

You can temporarily switch Cross Traffic Alert off in the information display. See **General Information** (page 108). When you switch Cross Traffic Alert off, you will not receive alerts and the information display will display a system off message.

Note: *The Cross Traffic Alert switches on whenever the ignition is switched on and ready to provide appropriate alerts when the transmission is in reverse (R). Cross Traffic Alert will not remember the last selected on or off setting.*

You can also have Cross Traffic Alert switched off permanently at an authorized dealer. Once switched off permanently, the system can only be switched back on at an authorized dealer.

STEERING

Electric Power Steering

WARNINGS



The electric power steering system has diagnostic checks that continuously monitor the system. If a fault is detected, a message displays in the information display. Stop your vehicle as soon as it is safe to do so. Switch the ignition off. After at least 10 seconds, switch the ignition on and watch the information display for a steering system warning message. If a steering system warning message returns, have the system checked by an authorized dealer.



If the system detects an error, you may not feel a difference in the steering, however a serious condition may exist. Obtain immediate service from an authorized dealer, failure to do so may result in loss of steering control.

Your vehicle has an electric power steering system. There is no fluid reservoir. No maintenance is required.

Driving Aids

If your vehicle loses electrical power while you are driving, electric power steering assistance is lost. The steering system still operates and you can steer your vehicle manually. Manually steering your vehicle requires more effort.

Extreme continuous steering may increase the effort required for you to steer your vehicle. This increased effort prevents overheating and permanent damage to the steering system. You do not lose the ability to steer your vehicle manually. Typical steering and driving maneuvers allow the system to cool and return to normal operation.

Steering Tips

If the steering wanders or pulls, check for:

- Correct tire pressures.
- Uneven tire wear.
- Loose or worn suspension components.
- Loose or worn steering components.
- Improper vehicle alignment.

Note: *A high crown in the road or high crosswinds may also make the steering seem to wander or pull.*

Adaptive Learning

The electronic power steering system adaptive learning helps correct road irregularities and improves overall handling and steering feel. It communicates with the brake system to help operate advanced stability control and accident avoidance systems. Additionally, whenever the battery is disconnected or a new battery installed, you must drive your vehicle a short distance before the system relearns the strategy and reactivates all systems.

PRE-COLLISION ASSIST

WARNINGS



At all times, you are responsible for controlling your vehicle, supervising the system and intervening, if required. Failure to take care may result in the loss of control of your vehicle, serious personal injury or death.

WARNINGS



The system does not detect cyclists, animals, pedestrians at night or vehicles that are driving in a different direction. Failure to take care may result in the loss of control of your vehicle, serious personal injury or death.



The system does not operate during hard acceleration or steering. Failure to take care may lead to a crash or personal injury.



The system may fail or operate with reduced function during cold and severe weather conditions. Snow, ice, rain, spray and fog can adversely affect the system. Keep the front camera and radar free of snow and ice. Failure to take care may result in the loss of control of your vehicle, serious personal injury or death.



In situations where the vehicle camera has limited detection capability, this may reduce system performance. These situations include but are not limited to direct or low sunlight, vehicles at night without tail lights, unconventional vehicle types,

Driving Aids

WARNINGS

pedestrians with complex backgrounds, running pedestrians, partly obscured pedestrians, or pedestrians that the system cannot distinguish from a group. Failure to take care may result in the loss of control of your vehicle, serious personal injury or death.



This system is an extra driving aid. It does not replace your attention and judgment, or the need to apply the brakes. This system does NOT automatically brake your vehicle. If you fail to press the brake pedal when necessary, you may collide with another vehicle.



The system cannot help prevent all crashes. Do not rely on this system to replace driver judgment and the need to maintain a safe distance and speed.

Using the Pre-Collision Assist System

The Pre-Collision Assist system is active at speeds above approximately 3 mph (5 km/h) and pedestrian detection is active at speeds up to 50 mph (80 km/h).



E156130

If your vehicle is rapidly approaching another stationary vehicle, a vehicle traveling in the same direction as yours, or a pedestrian within your driving path, the system is designed to provide three levels of functionality:

1. Alert
2. Brake Support
3. Active Braking

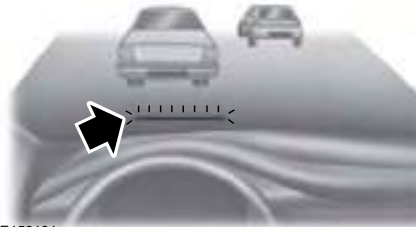

E156131

Alert: When activated, a red warning light flashes, an audible warning chime sounds and a warning message shows in the information display.

Brake Support: The brake support system assists the driver in reducing the collision speed by lightly applying the brakes. If the risk of collision further increases after the warning light illuminates, the brake support prepares the brake system for rapid braking. This may be apparent to the driver. The system does not automatically activate the brakes, but if you press the brake pedal, the system may apply full force, even if the brake pedal is lightly pressed.

Active Braking: Active braking may activate if the system determines that a collision is imminent. The system may help the driver reduce impact damage or avoid the crash completely.

Note: If you perceive Pre-Collision Assist alerts as being too frequent or disturbing, then you can reduce the alert sensitivity, though the manufacturer recommends using the highest sensitivity setting where possible. Setting lower sensitivity would lead to fewer and later system warnings.

Driving Aids

Blocked Sensors

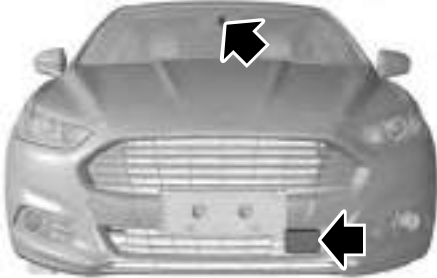

If a message regarding a blocked sensor or camera appears in the information display, the radar signals or camera images are obstructed. The radar sensor is located behind a fascia cover near the driver side of the lower grille. With an obstructed radar, the Pre-Collision Assist system does not function and cannot detect a vehicle ahead. With the front camera obstructed, the

Pre-Collision Assist system does not respond to pedestrians or stationary vehicles and the system performance on moving vehicles reduces. The following table lists possible causes and actions for when this message displays.

E184569

Cause	Action
The surface of the radar in the grille is dirty or obstructed in some way.	Clean the grille surface in front of the radar or remove the object causing the obstruction.
The surface of the radar in the grille is clean but the message remains in the display.	Wait a short time. It may take several minutes for the radar to detect that there is no obstruction.
Heavy rain, spray, snow, or fog is interfering with the radar signals.	The Pre-Collision Assist system is temporarily disabled. Pre-Collision Assist should automatically reactivate a short time after the weather conditions improve.
Swirling water, or snow or ice on the surface of the road may interfere with the radar signals.	The Pre-Collision Assist system is temporarily disabled. Pre-Collision Assist should automatically reactivate a short time after the weather conditions improve.

Driving Aids

Cause	Action
Radar is out of alignment due to a front end impact.	Contact an authorized dealer to have the radar checked for proper coverage and operation.
The windshield in front of the camera is dirty or obstructed in some way.	Clean the outside of the windshield in front of the camera.
The windshield in front of the camera is clean but the message remains in the display.	Wait a short time. It may take several minutes for the camera to detect that there is no obstruction.

Note: *Proper system operation requires a clear view of the road by the camera. Have any windshield damage in the area of the camera's field of view repaired.*

Note: *If something hits the front end of your vehicle or damage occurs, the radar sensing zone may change. This could cause missed or false vehicle detections. Contact an authorized dealer to have the radar checked for proper coverage and operation.*

Note: *If your vehicle detects excessive heat at the camera or a potential misalignment condition, a message may display in the information display indicating temporary sensor unavailability. This message deactivates automatically when operational conditions are corrected (for example, when the ambient temperature around the sensor decreases or the sensor automatically recalibrates successfully).*

DRIVE CONTROL

LINCOLN DRIVE CONTROL

Lincoln Drive Control delivers the Lincoln driving experience through a suite of sophisticated electronic vehicle systems. These systems continuously monitor your driving inputs and the road conditions to optimize ride comfort, steering, handling, powertrain response and sound. You can preset your preferences for these systems within the information display. Lincoln Drive Control will respond to your preferences based on what gear position you select. This provides a single location to control multiple systems performance settings.

Driving Aids

Lincoln Drive Control consists of the following systems:

- Continuously controlled damping dynamically adjusts the shock absorbers stiffness in real time to match the road surface and driver inputs. This system continuously monitors your vehicle's motion (roll, pitch, bounce), suspension position, load, speed, road conditions, and steering to adjust the suspension damping for optimal vehicle control.
- Electronically power-assisted steering adjusts steering effort and feel based on your vehicle speed and your inputs.
- Active noise control utilizes your vehicle electronics to enhance the acoustic experience.
- Electronic stability control and traction control maintain your vehicle control in adverse conditions or high performance driving.
- Electronic throttle control enhances the powertrain response to your inputs.

Using Lincoln Drive Control

You can configure which of the Drive Control modes are active when your vehicle is in drive (D) or in sport (S). The configuration remains active until modified from the main menu on the information display.

These systems have a range of modes which you can choose from in order to customize your ideal driving experience:

- **Comfort** – Provides a more relaxed driving experience, maximizing comfort. Your steering effort decreases and the suspension movement is more fluid. Comfort mode is ideal when you desire enhanced traveling comfort.
- **Normal** – Delivers a balanced combination of comfortable, controlled ride and confident handling. This mode provides an engaging drive experience and a direct connection to the road without sacrificing any of the composure demanded from a luxury vehicle.
- **Sport** – Provides a sportier driving experience. The suspension stiffens, with an emphasis on handling and control. The engine responds more directly to your inputs and takes on a more powerful tone. Sport mode is ideal for use during more spirited driving.

You can change your vehicle's Drive Control settings from the menu on the display screen. See **General Information** (page 108).

Driving Aids

Note: *Not all settings may be available.*

Note: *Lincoln Drive Control has diagnostic checks that continuously monitor the system to ensure proper operation. Certain types of system errors will gray out the mode selections within the information display, preventing you from changing states when the gear position is changed. Other types of errors produce a temporary message in the information display. See **Information Messages** (page 114). If either condition persists for multiple key cycles, have your vehicle checked by an authorized dealer.*

Load Carrying

LOAD LIMIT

Vehicle Loading - with and without a Trailer

This section guides you in the proper loading of your vehicle, trailer, or both. Keep your loaded vehicle weight within its design rating capability, with or without a trailer. Properly loading your vehicle provides maximum return of vehicle design performance. Before you load your vehicle, become familiar with the following terms for determining your vehicle's weight rating, with or without a trailer, from the vehicle's Tire and Loading Information label or Safety Compliance Certification label.

Tire and Loading Label Information

Example:



TIRE AND LOADING INFORMATION

SEATING CAPACITY TOTAL: 5 FRONT: 2 REAR: 3

The combined weight of occupants, and cargo should never exceed • 385 kg or 850 lbs.

TIRE	SIZE	COLD TIRE PRESSURE
FRONT	235/45R18 94V	235 KPA, 34 PSI
REAR	235/45R18 94V	235 KPA, 34 PSI
SPARE	NONE	NONE

SEE OWNERS MANUAL FOR ADDITIONAL INFORMATION



TIRE AND LOADING INFORMATION
RENSEIGNEMENTS SUR LES PNEUS ET LE CHARGEMENT

SEATING CAPACITY / NOMBRE DE PLACES TOTAL: 5 FRONT / AVANT: 2 REAR / ARRIERE: 3

The combined weight of occupants and cargo should never exceed 396 kg or 875 lbs.
Le poids total des occupants et du chargement ne doit jamais dépasser 396 kg ou 875 lb.

TIRE PNEU	SIZE DIMENSIONS	COLD TIRE PRESSURE / PRESSION DES PNEUS A FROID
FRONT AVANT	235/40R19 96V	255 KPA, 37 PSI
REAR ARRIERE	235/40R19 96V	255 KPA, 37 PSI
SPARE DE SECOURS	T125/80R16 97M	415 KPA, 60 PSI

SEE OWNER'S MANUAL FOR ADDITIONAL INFORMATION
VOIR LE MANUEL DE L'USAGER POUR PLUS DE RENSEIGNEMENTS

E198719

Load Carrying

Payload

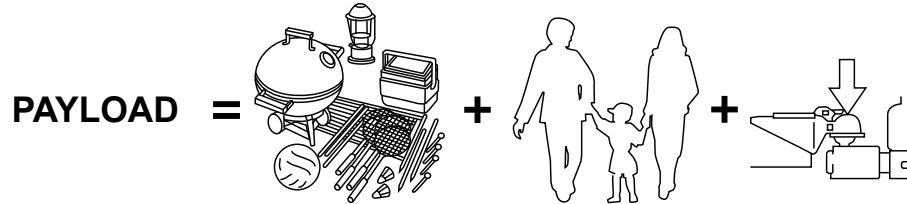

E143816

Payload is the combined weight of cargo and passengers that your vehicle is carrying. The maximum payload for your vehicle appears on the Tire and Loading label. The label is either on the B-pillar or the edge of the driver door. Vehicles exported outside the US and Canada may not have a tire and loading label. Look for “The combined weight of occupants and cargo should never exceed XXX kg OR XXX lb” for maximum payload. The payload listed on the Tire and Loading Information label is the maximum payload for your vehicle as built by the assembly plant. If

you install any additional equipment on your vehicle, you must determine the new payload. Subtract the weight of the equipment from the payload listed on the Tire and Loading label. When towing, trailer tongue weight or king pin weight is also part of payload.

WARNING



The appropriate loading capacity of your vehicle can be limited either by volume capacity (how much space is available) or by payload capacity (how much weight the vehicle should carry). Once you have reached the maximum payload of your vehicle, do not add more cargo, even if there is space available. Overloading or improperly loading your vehicle can contribute to loss of vehicle control and vehicle rollover.

Load Carrying

GAWR (Gross Axle Weight Rating)

GAWR is the maximum allowable weight that a single axle (front or rear) can carry. These numbers are on the Safety Compliance Certification label. The label is located on the door hinge pillar, door-latch post, or the door edge that meets the door-latch post, next to the driver seating position.

The total load on each axle must never exceed its Gross Axle Weight Rating.

GVWR (Gross Vehicle Weight Rating)

GVWR is the maximum allowable weight of the fully loaded vehicle. This includes all options, equipment, passengers and cargo. It appears on the Safety Compliance Certification label. The label is located on the door hinge pillar, door-latch post, or the door edge that meets the door-latch post, next to the driver seating position.

The gross vehicle weight must never exceed the Gross Vehicle Weight Rating.

Safety Compliance Certification Label

Example:

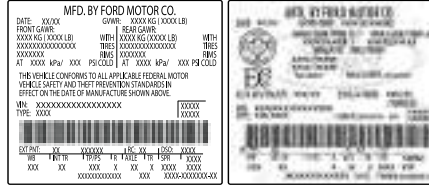

E-108828

WARNING



Exceeding the Safety Compliance Certification label vehicle weight rating limits could result in substandard vehicle handling or performance, engine, transmission and/or structural damage, serious damage to the vehicle, loss of control and personal injury.

Maximum Loaded Trailer Weight

Maximum loaded trailer weight is the highest possible weight of a fully loaded trailer the vehicle can tow. Consult an authorized dealer (or the RV and Trailer Towing Guide available at an authorized dealer) for more detailed information.

GCWR (Gross Combined Weight Rating)

GCWR is the maximum allowable weight of the vehicle and the loaded trailer, including all cargo and passengers, that the vehicle can handle without risking damage. (Important: The towing vehicle's braking system is rated for operation at Gross Vehicle Weight Rating, not at Gross Combined Weight Rating.) Separate functional brakes should be used for safe control of towed vehicles and for trailers where the Gross Combined Weight of the towing vehicle plus the trailer exceed the Gross Vehicle Weight Rating of the towing vehicle.

Load Carrying

The gross combined weight must never exceed the Gross Combined Weight Rating.

Note: For trailer towing information refer to the *RV and Trailer Towing Guide* available at an authorized dealer.

WARNINGS



Do not exceed the GVWR or the GAWR specified on the Safety Compliance Certification label.



Do not use replacement tires with lower load carrying capacities than the original tires because they may lower your vehicle's GVWR and GAWR limitations. Replacement tires with a higher limit than the original tires do not increase the GVWR and GAWR limitations.



Exceeding any vehicle weight rating limitation could result in serious damage to your vehicle, personal injury or both.

Steps for determining the correct load limit:

1. Locate the statement "The combined weight of occupants and cargo should never exceed XXX kg or XXX lb." on your vehicle's placard.
2. Determine the combined weight of the driver and passengers that will be riding in your vehicle.
3. Subtract the combined weight of the driver and passengers from XXX kg or XXX lb.
4. The resulting figure equals the available amount of cargo and luggage load capacity. For example, if the "XXX" amount equals 1,400 lb. and there will be five 150 lb. passengers in your vehicle, the amount of available cargo and luggage load capacity is 650 lb. (1400-750 (5 x 150) = 650 lb.)

5. Determine the combined weight of luggage and cargo being loaded on the vehicle. That weight may not safely exceed the available cargo and luggage load capacity calculated in Step 4.
6. If your vehicle will be towing a trailer, load from your trailer will be transferred to your vehicle. Consult this manual to determine how this reduces the available cargo and luggage load capacity of your vehicle.

Helpful examples for calculating the available amount of cargo and luggage load capacity

Suppose your vehicle has a 1400-pound (635-kilogram) cargo and luggage capacity. You decide to go golfing. Is there enough load capacity to carry you, four of your friends and all the golf bags? You and four friends average 220 pounds (99 kilograms) each and the golf bags weigh approximately 30 pounds (13.5 kilograms) each. The calculation would be: $1400 - (5 \times 220) - (5 \times 30) =$

Load Carrying

$1400 - 1100 - 150 = 150$ pounds. Yes, you have enough load capacity in your vehicle to transport four friends and your golf bags. In metric units, the calculation would be: $635 \text{ kilograms} - (5 \times 99 \text{ kilograms}) - (5 \times 13.5 \text{ kilograms}) = 635 - 495 - 67.5 = 72.5$ kilograms.

Suppose your vehicle has a 1400-pound (635-kilogram) cargo and luggage capacity. You and one of your friends decide to pick up cement from the local home improvement store to finish that patio you have been planning for the past two years. Measuring the inside of the vehicle with the rear seat folded down, you have room for twelve 100-pound (45-kilogram) bags of cement. Do you have enough load capacity to transport the cement to your home? If you and your friend each weigh 220 pounds (99 kilograms), the calculation would be: $1400 - (2 \times 220) - (12 \times 100) = 1400 - 440 - 1200 = -240$ pounds. No, you do not have enough cargo capacity to carry that much weight. In metric units, the calculation would be: $635 \text{ kilograms} - (2 \times 99$

$\text{kilograms}) - (12 \times 45 \text{ kilograms}) = 635 - 198 - 540 = -103$ kilograms. You will need to reduce the load weight by at least 240 pounds (104 kilograms). If you remove three 100-pound (45-kilogram) cement bags, then the load calculation would be: $1400 - (2 \times 220) - (9 \times 100) = 1400 - 440 - 900 = 60$ pounds. Now you have the load capacity to transport the cement and your friend home. In metric units, the calculation would be: $635 \text{ kilograms} - (2 \times 99 \text{ kilograms}) - (9 \times 45 \text{ kilograms}) = 635 - 198 - 405 = 32$ kilograms.

The above calculations also assume that the loads are positioned in your vehicle in a manner that does not overload the front or the rear gross axle weight rating specified for your vehicle on the Safety Compliance Certification label.

Special Loading Instructions for Owners of Pick-up Trucks and Utility-type Vehicles

WARNING



Loaded vehicles may handle differently than unloaded vehicles. Take extra precautions, such as slower speeds and increased stopping distance, when driving a heavily loaded vehicle.

Towing

TOWING A TRAILER

WARNINGS



Do not exceed the GVWR or the GAWR specified on the certification label.



Towing trailers beyond the maximum recommended gross trailer weight exceeds the limit of your vehicle and could result in engine damage, transmission damage, structural damage, loss of vehicle control, vehicle rollover and personal injury.

Note: *There may be electrical items such as fuses or relays that can affect trailer towing operation. See **Fuses** (page 275).*

The load capacity of your vehicle is designated by weight not volume. You may not necessarily be able to use all available space when loading your vehicle or trailer.

Towing a trailer places extra load on the engine, transmission, axle, brakes, tires, and suspension. Inspect these components before, during and after towing.

Load Placement

To help minimize how trailer movement affects the vehicle when driving:

- Load the heaviest items closest to the trailer floor.
- Load the heaviest items in the center of the left and right side trailer tires.

- Load the heaviest items above the trailer axles or just slightly forward toward the trailer tongue. Do not allow the final trailer tongue weight to go above or below 10-15% of the loaded trailer weight.
- Select a ball mount with the correct rise or drop. When both the loaded vehicle and trailer are connected, the trailer frame should be level, or slightly angled down toward the vehicle, when viewed from the side.

When driving with a trailer or payload, a slight takeoff vibration or shudder may be present due to the increased payload weight. Additional information regarding proper trailer loading and setting your vehicle up for towing is located in the Load Carrying chapter. See **Load Limit** (page 244).

You can also find information in the **RV & Trailer Towing Guide** available at your authorized dealer, or online.

Towing

RV & Trailer Towing Guide Online

Website

<http://www.fleet.ford.com/towing-guides/>

RECOMMENDED TOWING WEIGHTS

Note: Do not exceed the trailer weight for your vehicle configuration listed in the chart below.

Note: Be sure to take into consideration trailer frontal area. Do not exceed 12 feet (1.11 meters).

Note: For high altitude operation, reduce the gross combined weight by 2% per 1000 feet (300 meters) starting at the 1000 foot (300 meter) elevation point.

Note: Certain states require electric trailer brakes for trailers over a specified weight. Be sure to check state regulations for this specified weight. The maximum trailer weights listed may be limited to this specified weight, as the vehicle's electrical system may not include the wiring connector needed to activate electric trailer brakes.

Your vehicle may tow a trailer provided the maximum trailer weight is less than or equal to the maximum trailer weight listed for your vehicle configuration on the following chart.

Towing

Powertrain	Maximum trailer weight
2.0L GTDI	1,000 lb (454 kg)
3.0L V6 GTDI	1,000 lb (454 kg)

Calculated with SAE J2807 method.

Towing

ESSENTIAL TOWING CHECKS

Follow these guidelines for safe towing:

- Do not tow a trailer until you drive your vehicle at least 1000 miles (1600 kilometers).
- Consult your local motor vehicle laws for towing a trailer.
- See the instructions included with towing accessories for the proper installation and adjustment specifications.
- Service your vehicle more frequently if you tow a trailer. See your scheduled maintenance information.
- If you use a rental trailer, follow the instructions the rental agency gives you.

You can find information on load specification terms found on the tire label and Safety Compliance label as well as instructions on calculating your vehicle's load in the Load Carrying chapter. See **Load Limit** (page 244).

Remember to account for the trailer tongue weight as part of your vehicle load when calculating the total vehicle weight.

Hitches

Do not use a hitch that either clamps onto the bumper or attaches to the axle.

Distribute the trailer load so 10-15% of the total trailer weight is on the tongue.

Safety Chains

Note: *Never attach safety chains to the bumper.*

Always connect the safety chains to the hook retainers of your vehicle hitch.

To connect the safety chains, cross them under the trailer tongue and allow enough slack for turning tight corners. Do not allow the chains to drag on the ground.

Trailer Brakes

WARNING



Do not connect a trailer's hydraulic brake system directly to your vehicle's brake system. Your vehicle may not have enough braking power and your chances of having a collision greatly increase.

Electric brakes and manual, automatic or surge-type trailer brakes are safe if you install them properly and adjust them to the manufacturer's specifications. The trailer brakes must meet local and federal regulations.

The rating for the tow vehicle's braking system operation is at the gross vehicle weight rating, not the gross combined weight rating.

Separate functioning brake systems are required for safe control of towed vehicles and trailers weighing more than 1500 pounds (680 kilograms) when load.

Trailer Lamps

WARNING



Never connect any trailer lamp wiring to the vehicle's tail lamp wiring; this may damage the electrical system resulting in fire. Contact your authorized dealer as soon as possible for assistance in proper trailer tow wiring installation. Additional electrical equipment may be required.

Towing

Trailer lamps are required on most towed vehicles. Make sure all running lights, brake lights, turn signals and hazard lights are working.

Before Towing a Trailer

Practice turning, stopping and backing up to get the feel of your vehicle-trailer combination before starting on a trip. When turning, make wider turns so the trailer wheels clear curbs and other obstacles.

When Towing a Trailer

- Do not drive faster than 70 mph (113 km/h) during the first 500 miles (800 kilometers).
 - Do not make full-throttle starts.
 - Check your hitch, electrical connections and trailer wheel lug nuts thoroughly after you have traveled 50 miles (80 kilometers).
 - When stopped in congested or heavy traffic during hot weather, place the gearshift in position **P** to aid engine and transmission cooling and to help A/C performance.
- Turn off the speed control with heavy loads or in hilly terrain. The speed control may turn off automatically when you are towing on long, steep grades.
 - Shift to a lower gear when driving down a long or steep hill. Do not apply the brakes continuously, as they may overheat and become less effective.
 - If your transmission is equipped with a Grade Assist or Tow/Haul feature, use this feature when towing. This provides engine braking and helps eliminate excessive transmission shifting for optimum fuel economy and transmission cooling.
 - Allow more distance for stopping with a trailer attached. Anticipate stops and brake gradually.
 - Avoid parking on a grade. However, if you must park on a grade:
 1. Turn the steering wheel to point your vehicle tires away from traffic flow.
 2. Set your vehicle parking brake.
 3. Place the automatic transmission in position **P**.

4. Place wheel chocks in front and back of the trailer wheels. (Chocks not included with vehicle.)

Launching or Retrieving a Boat or Personal Watercraft (PWC)

Note: *Disconnect the wiring to the trailer before backing the trailer into the water.*

Note: *Reconnect the wiring to the trailer after removing the trailer from the water.*

When backing down a ramp during boat launching or retrieval:

- Do not allow the static water level to rise above the bottom edge of the rear bumper.
- Do not allow waves to break higher than 6 inches (15 centimeters) above the bottom edge of the rear bumper.

Exceeding these limits may allow water to enter vehicle components:

- Causing internal damage to the components.
- Affecting driveability, emissions, and reliability.

Towing

Replace the rear axle lubricant anytime you submerge the rear axle in water. Water may contaminate the rear axle lubricant, which is not a normal maintenance inspection item unless there is a possibility of a leak or other axle repair is required.

TOWING THE VEHICLE ON FOUR WHEELS

Emergency Towing

WARNING



If your vehicle has a steering wheel lock make sure the ignition is in the accessory or on position when being towed.

You can flat-tow (all wheels on the ground, regardless of the powertrain/transmission configuration) your disabled vehicle (without access to wheel dollies, car-hauling trailer, or flatbed transport vehicle) under the following conditions:

- Your vehicle is facing forward so you tow it in a forward direction.
- You place the transmission in position **N**. If you cannot place the transmission in position **N**, you may need to override it. See **Transmission** (page 173).
- Maximum speed is 35 mph (56 km/h).
- Maximum distance is 50 miles (80 kilometers).

Recreational Towing

Note: *Put your climate control system in recirculated air mode to prevent exhaust fumes from entering the vehicle. See **Climate Control** (page 134).*

Follow these guidelines if you have a need for recreational (RV) towing. An example of recreational towing would be towing your vehicle behind a motorhome. These guidelines are to make sure you do not damage the transmission during towing.

Vehicles Equipped with a 2.0L Engine

Front-wheel drive (FWD) vehicles **CANNOT** be flat-towed (all wheels on the ground) as vehicle or transmission damage may occur. You must place the front wheels on a two-wheel tow dolly. If you are using a tow dolly, follow the instructions specified by the equipment provider.

All-wheel drive (AWD) vehicles **CANNOT** be flat-towed (all wheels on the ground), as vehicle or transmission damage may occur. It is recommended to tow your vehicle with all four (4) wheels off the ground such as when using a car-hauling trailer. Otherwise, you cannot tow your vehicle.

Towing

Vehicles Equipped with a 3.0L Engine

You can tow your vehicle with all four wheels on the ground using the Neutral Tow feature, or with all four wheels off the ground using a vehicle transport trailer. If you are using a vehicle transport trailer, follow the instruction specified by the equipment provider.

If you tow your vehicle with all four wheels on the ground:

- Tow only in the forward direction.
- Release the parking brake.

Neutral Tow

Enter Neutral Tow mode by doing the following:

1. Put the ignition in accessory mode by pressing the engine START button without pressing the brake pedal.
2. Select the neutral tow option under the vehicle settings menu in the information display. See **General Information** (page 108).
3. Press and hold the OK button to start the neutral tow process.

4. Press the brake pedal and select **N** on the push-button transmission.
5. Turn the ignition off by pressing the engine START button without pressing the brake pedal.

If the process completes successfully:

- the **N** on the push-button transmission blinks slowly
- A confirmation message appears in the information display.

Note: *If the parking brake is applied, a message appears in the information display.*

Note: *Do not exceed 65 mph (105 km/h).*

Note: *Start the engine and allow it to run for five minutes at the beginning of each day and every six hours (or fewer). Shut the engine off and verify that a message appears indicating neutral tow has been engaged, before continuing to tow.*

Exit Neutral Tow mode, make sure the ignition is on (engine can be on or off), press the brake pedal and select **P** on the push-button transmission.

If the process is completed successfully, a message appears indicating that neutral tow has disengaged in both the instrument cluster and push-button transmission display **P**.

Driving Hints

BREAKING-IN

You need to break in new tires for approximately 300 miles (480 kilometers). During this time, your vehicle may exhibit some unusual driving characteristics.

Avoid driving too fast during the first 1000 miles (1600 kilometers). Vary your speed frequently and change up through the gears early. Do not labor the engine.

Do not tow during the first 1000 miles (1600 kilometers).

ECONOMICAL DRIVING

Fuel economy is affected by several things such as how you drive, the conditions you drive under and how you maintain your vehicle.

There are some things to keep in mind that may improve your fuel economy:

- Accelerate and slow down in a smooth, moderate fashion.
- Drive at steady speeds.

- Anticipate stops; slowing down may eliminate the need to stop.
- Combine errands and minimize stop-and-go driving (When running errands, go to the furthest destination first and then work your way back home).
- Close the windows for high-speed driving.
- Drive at reasonable speeds.
- Keep the tires properly inflated and use only the recommended size.
- Use the recommended engine oil.
- Perform all regularly scheduled maintenance.

There are also some things you may want to avoid doing because they reduce your fuel economy:

- Avoid sudden or hard accelerations.
- Avoid revving the engine before turning off the car.
- Avoid long idle periods.
- Do not warm up your vehicle on cold mornings.

- Reduce the use of air conditioning and heat.
- Avoid using speed control in hilly terrain.
- Do not rest your foot on the brake pedal while driving.
- Avoid carrying unnecessary weight.
- Avoid adding particular accessories to your vehicle (e.g. bug deflectors, rollbars/light bars, running boards, ski racks).
- Avoid driving with the wheels out of alignment.

DRIVING THROUGH WATER

WARNING



Do not drive through flowing or deep water as you may lose control of your vehicle.

Note: *Driving through standing water can cause vehicle damage.*

Note: *Engine damage can occur if water enters the air filter.*

Driving Hints

Before driving through standing water, check the depth. Never drive through water that is higher than the bottom of the front rocker area of your vehicle.



E176360

When driving through standing water, drive very slowly and do not stop your vehicle. Your brake performance and traction may be limited. After driving through water and as soon as it is safe to do so:

- Lightly press the brake pedal to dry the brakes and to check that they work.
- Check that the horn works.

- Check that the exterior lights work.
- Turn the steering wheel to check that the steering power assist works.

FLOOR MATS

WARNINGS

 Always use floor mats that are designed to fit the foot well of your vehicle. Only use floor mats that leave the pedal area unobstructed. Only use floor mats that are firmly secured to retention posts so that they cannot slip out of position and interfere with the pedals or impair safe operation of your vehicle in other ways.

 Pedals that cannot move freely can cause loss of vehicle control and increase the risk of serious personal injury.

 Always make sure that the floor mats are properly attached to the retention posts in the carpet that are supplied with your vehicle. Floor mats must be properly secured to both retention posts to make sure mats do not shift out of position.

WARNINGS

 Never place floor mats or any other covering in the vehicle foot well that cannot be properly secured to prevent them from moving and interfering with the pedals or the ability to control the vehicle.

 Never place floor mats or any other covering on top of already installed floor mats. Floor mats should always rest on top of vehicle carpeting surface and not another floor mat or other covering. Additional floor mats or any other covering will reduce the pedal clearance and potentially interfere with pedal operation.

 Check attachment of floor mats on a regular basis. Always properly reinstall and secure floor mats that have been removed for cleaning or replacement.

 Always make sure that objects cannot fall into the driver foot well while the vehicle is moving. Objects that are loose can become trapped under the pedals causing a loss of vehicle control.

Driving Hints

WARNINGS

 Failure to properly follow floor mat installation or attachment instructions can potentially cause interference with pedal operation causing a loss of vehicle control.



E142666

To install floor mats, position the floor mat so that the eyelet is over the retention post and press down to lock in.

To remove the floor mat, reverse the installation procedure.

Roadside Emergencies

ROADSIDE ASSISTANCE

Vehicles Sold in the United States: Getting Roadside Assistance

If you ever need help on the road, the Lincoln Motor Company is there for you with nationwide, 24-hours-a-day, seven-days-a-week assistance.

The service is available:

- Throughout the life of the vehicle for original owners.
- For six years or 68,351 mi (110,000 km) (whichever comes first) within the extended powertrain warranty coverage period for subsequent owners.
- For the coverage period listed on the Roadside Assistance Card included in your Owner's Manual portfolio.

This complimentary Roadside Assistance program is separate from the New Vehicle Limited Warranty, and includes:

- A flat tire change with a good spare (except vehicles supplied with a tire inflation kit).
- Battery jump start.

- Lock-out assistance (key replacement cost is the client's responsibility).
- Fuel delivery — independent service contractors, if not prohibited by state, local or municipal law shall deliver up to 2 gal (8 L) of gasoline or 5 gal (20 L) of diesel fuel to a disabled vehicle. Roadside Assistance limits fuel delivery service to two no-charge occurrences within a 12-month period.
- Winch out — available within 98 ft (30 m) of a paved or county maintained road, no recoveries.
- Towing — independent service contractors, if not prohibited by state, local or municipal law shall tow Lincoln eligible vehicles to the client's selling or preferred dealer within 99 mi (160 km) of the disablement location or to the nearest Lincoln dealer. If a client requests a tow to a selling or preferred dealer that is more than 99 mi (160 km) from the disablement location, the client shall be responsible for any mileage costs in excess of 99 mi (160 km).

Roadside Assistance includes up to \$200 coverage for a towed trailer if the disabled eligible vehicle requires service at the nearest authorized dealer. If the towing vehicle is operational but the trailer is not, then the trailer does not qualify for any roadside services.

Vehicles Sold in the United States: Using Roadside Assistance

United States Lincoln vehicle clients who require Roadside Assistance, call 1-800-521-4140.

If you need to arrange roadside assistance for yourself, Lincoln Motor Company will reimburse a reasonable amount for towing to the nearest Lincoln dealership within 99 mi (160 km). To obtain reimbursement information, United States Lincoln vehicle clients, call 1-800-521-4140. Lincoln Motor Company will ask you to submit your original receipts.

Roadside Emergencies

Vehicles Sold in Canada: Getting Roadside Assistance

To fully assist you should you have a vehicle concern, Lincoln Motor Company offers a complimentary roadside assistance program. This program is eligible within Canada or the continental United States.

This program is separate from the New Vehicle Limited Warranty, but the coverage is concurrent with the powertrain coverage period of your vehicle.

Canadian customers who require roadside assistance, call 1-800-387-5333.

Vehicles Sold in Canada: Using Roadside Assistance

Complete the roadside assistance identification card and place it in your wallet for quick reference.

In Canada, this card is found in the Warranty Guide in the glove compartment of your vehicle.

Vehicles Sold in Canada: Roadside Assistance Program Coverage

The service is available 24 hours a day, seven days a week.

Canadian roadside coverage and benefits may differ from the U.S. coverage.

For complete program coverage details review your warranty guide, contact your dealer, call us in Canada at 1-800-387-9333, or visit our website at www.lincolncanada.com.

HAZARD WARNING FLASHERS

Note: *If used when the vehicle is not running, the battery will lose charge. There may be insufficient power to restart your vehicle.*



The hazard warning button is located on the instrument panel. Use it when your vehicle is creating a safety hazard for other motorists.

- Press the button to turn on the hazard warning function, and the front and rear direction indicators will flash.
- Press the button again to turn them off.

FUEL SHUTOFF

WARNING



Failure to inspect and, if necessary, repair fuel leaks after a collision may increase the risk of fire and serious injury. Ford Motor Company recommends that the fuel system be inspected by an authorized dealer after any collision.

In the event of a moderate to severe collision, this vehicle includes a fuel pump shutoff feature that stops the flow of fuel to the engine. Not every impact will cause a shutoff.

Roadside Emergencies

Should your vehicle shut off after a collision, you may restart your vehicle. For vehicles equipped with a key system:

1. Switch off the ignition.
2. Switch on the ignition.
3. Repeat Steps 1 and 2 to re-enable the fuel pump.

For vehicles equipped with a push button start system:

1. Press the **START/STOP** button to switch off the ignition.
2. Press the brake pedal and press the **START/STOP** button to switch on the ignition.
3. Remove your foot from the brake pedal and press the **START/STOP** button to switch off the ignition.
4. You can either attempt to start the engine by pressing the brake pedal and the **START/STOP** button, or switch on the ignition only by pressing the **START/STOP** button without pressing the brake pedal. Both ways re-enable the fuel system.

Note: *When you try to restart your vehicle after a fuel shutoff, the vehicle makes sure that various systems are safe to restart. Once your vehicle determines that the systems are safe, then the vehicle will allow you to restart.*

Note: *In the event that your vehicle does not restart after your third attempt, contact an authorized dealer.*

JUMP STARTING THE VEHICLE

WARNINGS



Batteries normally produce explosive gases which can cause personal injury. Therefore, do not allow flames, sparks or lighted substances to come near the battery. When working near the battery, always shield your face and protect your eyes. Always provide correct ventilation.

WARNINGS



Keep batteries out of reach of children. Batteries contain sulfuric acid. Avoid contact with skin, eyes or clothing. Shield your eyes when working near the battery to protect against possible splashing of acid solution. In case of acid contact with skin or eyes, flush immediately with water for a minimum of 15 minutes and get prompt medical attention. If acid is swallowed, call a physician immediately.



Use only adequately sized cables with insulated clamps.

Preparing Your Vehicle

Do not attempt to push-start your automatic transmission vehicle.

Note: *Attempting to push-start a vehicle with an automatic transmission may cause transmission damage.*

Note: *Use only a 12-volt supply to start your vehicle.*

Note: *Do not disconnect the battery of the disabled vehicle as this could damage the vehicle electrical system.*

Roadside Emergencies

Park the booster vehicle close to the hood of the disabled vehicle, making sure the two vehicles do not touch.

Connecting the Jumper Cables

WARNINGS

 Do not attach the cables to fuel lines, engine rocker covers, the intake manifold or electrical components as grounding points. Stay clear of moving parts. To avoid reverse polarity connections, make sure that you correctly identify the positive (+) and negative (-) terminals on both the disabled and booster vehicles before connecting the cables.

 Do not attach the end of the positive cable to the studs or L-shaped eyelet located above the positive (+) terminal of your vehicle's battery. High current may flow through and cause damage to the fuses.

 Do not connect the end of the second cable to the negative (-) terminal of the battery to be jumped. A spark may cause an explosion of the gases that surround the battery.

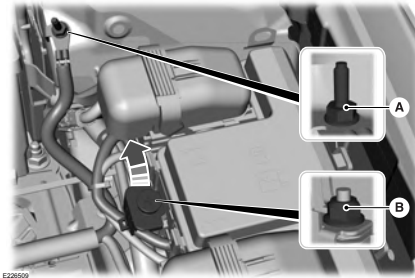

A. Negative prong (-)

B. Positive prong (+)

Note: Remove the red cap from the positive prong (B) on your vehicle before connecting the cables.

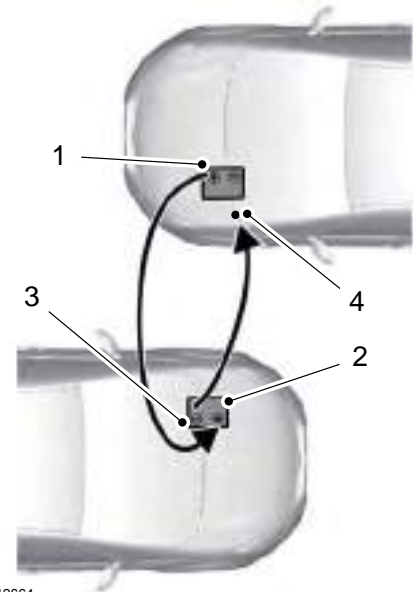

E142664

Note: In the illustration, the bottom vehicle represents the booster vehicle.

Roadside Emergencies

1. Connect the positive (+) jumper cable to the positive (+) terminal of the discharged battery.
 2. Connect the other end of the positive (+) cable to the positive (+) terminal of the booster vehicle battery.
 3. Connect the negative (-) cable to the negative (-) terminal of the booster vehicle battery.
 4. Make the final connection of the negative (-) cable to an exposed metal part of the stalled vehicle's engine, away from the battery and the fuel injection system, or connect the negative (-) cable to a ground connection point if available.
3. Once the disabled vehicle has been started, run both vehicle engines for an additional three minutes before disconnecting the jumper cables.

Removing the Jumper Cables

Remove the jumper cables in the reverse order that they were connected.

Jump Starting

1. Start the engine of the booster vehicle and rev the engine moderately, or press the accelerator gently to keep your engine speed between 2000 and 3000 RPM, as shown in your tachometer.
2. Start the engine of the disabled vehicle.

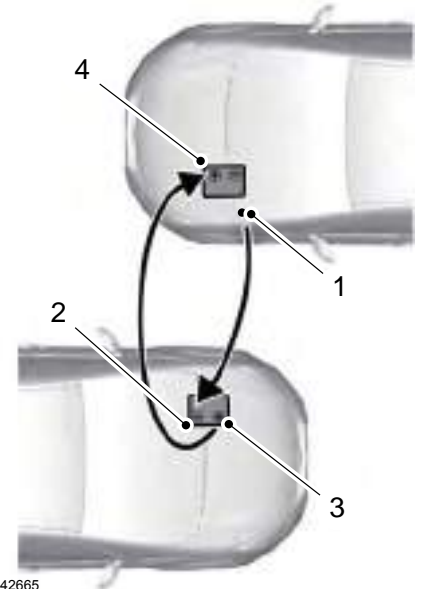

1. Remove the negative (-) jumper cable from the disabled vehicle.

Roadside Emergencies

2. Remove the jumper cable on the negative (-) terminal of the booster vehicle battery.
3. Remove the jumper cable from the positive (+) terminal of the booster vehicle battery.
4. Remove the jumper cable from the positive (+) terminal of the disabled vehicle battery.
5. Allow the engine to idle for at least one minute.

POST-CRASH ALERT SYSTEM

The system flashes the direction indicators and sounds the horn (intermittently) in the event of a serious impact that deploys an airbag (front, side, side curtain or Safety Canopy) or the safety belt pretensioners.

The horn and indicators will turn off when:

- You press the hazard control button.
- You press the panic button on the remote entry transmitter (if equipped).
- Your vehicle runs out of power.

Spinout Detection

If a spinout is detected, the vehicle comes to a stop and the hazard warning flashers come on. A message that states the spinout hazards are activated will appear on the instrument cluster. The message may not appear if your vehicle runs out of power.

Once the hazard warning flashers have been activated, you can turn them off by:

- Pressing the hazard warning flasher button.
- Pressing the remote control unlock button.
- Pressing the remote control panic button.
- Cycling the ignition on and off twice.

TRANSPORTING THE VEHICLE

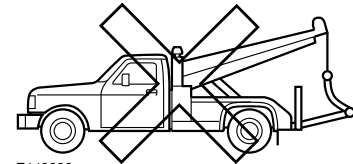
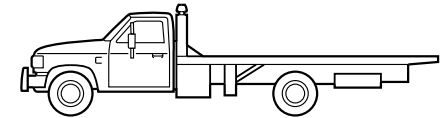
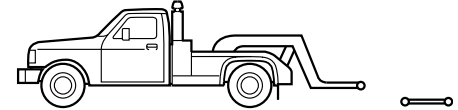

E143886

Roadside Emergencies

If you need to have your vehicle towed, contact a professional towing service, or if you are a member of a roadside assistance program, your roadside assistance service provider.

We recommend the use of a wheel lift and dollies or flatbed equipment to tow your vehicle. Do not tow with a slingbelt. Lincoln Motor Company has not approved a slingbelt towing procedure. Vehicle damage may occur if towed incorrectly, or by any other means.

Lincoln Motor Company produces a towing manual for all authorized tow truck operators. Have your tow truck operator refer to this manual for proper hook-up and towing procedures for your vehicle.

It is acceptable to have your front-wheel drive vehicle towed from the front if using proper wheel lift equipment to raise the front wheels off the ground. When towing in this manner, the rear wheels can remain on the ground.

Front-wheel drive vehicles must have the front wheels placed on a tow dolly when towing your vehicle from the rear using wheel lift equipment. This prevents damage to the transmission.

Towing an all-wheel drive vehicle requires that all wheels be off the ground, such as using a wheel lift and dollies or flatbed equipment. This prevents damage to the transmission, all-wheel drive system and vehicle.

TOWING POINTS

Due to local market requirements in some countries, some vehicles may be equipped with a recovery hook.

Recovery Hook Location

If your vehicle is equipped with a screw-in recovery hook, it is located with the spare tire kit.

Installing the Recovery Hook

There is an installation point for the recovery hook located behind the fascia.

Note: *The screw-in recovery hook has a left-hand thread. Turn it counterclockwise to install it. Make sure that the recovery hook is fully tightened.*

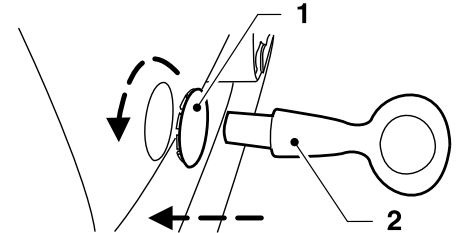

E146284



E188420

Roadside Emergencies

Remove the recovery hook cover by prying it off at the notch with a screwdriver or similar object.

Note: *Use a soft cloth to cover the prying tool. This helps prevent scratch marks to the vehicle's paint.*

Customer Assistance

GETTING THE SERVICES YOU NEED

Warranty repairs to your vehicle must be performed by an authorized dealer. While any authorized dealer handling your vehicle line provides warranty service, we recommend you return to your selling authorized dealer who wants to ensure your continued satisfaction.

Please note that certain warranty repairs require special training and equipment, so not all authorized dealers are authorized to perform all warranty repairs. This means that, depending on the warranty repair needed, you may have to take your vehicle to another authorized dealer.

A reasonable time must be allowed to perform a repair after taking your vehicle to the authorized dealer. Repairs are made using Lincoln or Motorcraft parts, or remanufactured or other parts that are authorized by Lincoln.

Away From Home

If you are away from home when your vehicle needs service, contact the Lincoln Client Relationship Center or use the online resources listed below to find the nearest authorized dealer.

In the United States:

Mailing address

Lincoln Motor Company
Client Relationship Center
P.O. Box 6248
Dearborn, MI 48126

Telephone

1-800-521-4140
TDD for the hearing impaired:
1-800-232-5952

Web Address
www.LincolnOwner.com

These are some of the items that can be found online:

- United States dealer locator by Dealer Name, City, State or ZIP Code.
- Owner Manuals.
- Maintenance Schedules.
- Recalls.
- Lincoln Extended Service Plans.
- Lincoln Original Accessories.
- Service specials and promotions.

In Canada:

Mailing address

Lincoln Client Relationship Centre
Lincoln Motor Company of Canada, Limited
P.O. Box 2000
Oakville, Ontario L6K 1C8

Telephone

1-800-387-9333

Customer Assistance

Web Address
www.LincolnCanada.com

Online Resources

Twitter English

@LincolnMotorCA

Twitter French

@LincolnQC

Instagram

@LincolnMotorCA

Facebook

/LincolnMotorCA

Additional Assistance

If you have questions or concerns, or are unsatisfied with the service you are receiving, follow these steps:

1. Contact your Sales Representative or Service Advisor at your selling or servicing authorized dealer.

2. If your inquiry or concern remains unresolved, contact the Sales Manager, Service Manager or Customer Relations Manager.
3. If you require assistance or clarification on Lincoln Motor Company policies, please contact the Lincoln Client Relationship Center.

In order to help us serve you better, please have the following information available when contacting a Client Relationship Center:

- Vehicle Identification Number.
- Your telephone number (home and business).
- The name of the authorized dealer and city where located.
- The vehicle's current odometer reading.

In some states, you must directly notify Lincoln in writing before pursuing remedies under your state's warranty laws. Lincoln is also allowed a final repair attempt in some states.

In the United States, a warranty dispute must be submitted to the BBB AUTO LINE before taking action under the Magnuson-Moss Warranty Act, or to the extent allowed by state law, before pursuing replacement or repurchase remedies provided by certain state laws. This dispute handling procedure is not required prior to enforcing state created rights or other rights which are independent of the Magnuson-Moss Warranty Act or state replacement or repurchase laws.

IN CALIFORNIA (U.S. ONLY)

California Civil Code Section 1793.2(d) requires that, if a manufacturer or its representative is unable to repair a motor vehicle to conform to the vehicle's applicable express warranty after a reasonable number of attempts, the manufacturer shall be required to either replace the vehicle with one substantially identical or repurchase the

Customer Assistance

vehicle and reimburse the buyer in an amount equal to the actual price paid or payable by the consumer (less a reasonable allowance for consumer use). The consumer has the right to choose whether to receive a refund or replacement vehicle.

California Civil Code Section 1793.22(b) presumes that the manufacturer has had a reasonable number of attempts to conform the vehicle to its applicable express warranties if, within the first 18 months of ownership of a new vehicle or the first 18000 miles (29 000 km), whichever occurs first:

1. Two or more repair attempts are made on the same non-conformity likely to cause death or serious bodily injury OR
2. Four or more repair attempts are made on the same nonconformity (a defect or condition that substantially impairs the use, value or safety of the vehicle) OR
3. The vehicle is out of service for repair of nonconformities for a total of more than 30 calendar days (not necessarily all at one time).

In the case of 1 or 2 above, the consumer must also notify the manufacturer of the need for the repair of the nonconformity at the following address:

Ford Motor Company
16800 Executive Plaza Drive
Mail Drop 3NE-B
Dearborn, MI 48126

You are required to submit your warranty dispute to BBB AUTO LINE before asserting in court any rights or remedies conferred by California Civil Code Section 1793.22(b). You are also required to use BBB AUTO LINE before exercising rights or seeking remedies created by the Federal Magnuson-Moss Warranty Act, 15 U.S.C. sec. 2301 et seq. If you choose to seek redress by pursuing rights and remedies not created by California Civil Code Section 1793.22(b) or the Magnuson-Moss Warranty Act, resort to BBB AUTO LINE is not required by those statutes.

THE BETTER BUSINESS BUREAU (BBB) AUTO LINE PROGRAM (U.S. ONLY)

Your satisfaction is important to Ford Motor Company and to your dealer. If a warranty concern has not been resolved using the three-step procedure outlined earlier in this chapter in the Getting the Services you need section, you may be eligible to participate in the BBB AUTO LINE program.

The BBB AUTO LINE program consists of two parts – mediation and arbitration. During mediation, a representative of the BBB will contact both you and Ford Motor Company to explore options for settlement of the claim. If an agreement is not reached during mediation or you do not want to participate in mediation, and if your claim is eligible, you may participate in the arbitration process. An arbitration hearing will be scheduled so that you can present your case in an informal setting before an impartial person. The arbitrator will consider the testimony provided and make a decision after the hearing.

Customer Assistance

Disputes submitted to the BBB AUTO LINE program are usually decided within forty days after you file your claim with the BBB. You are not bound by the decision, and may reject the decision and proceed to court where all findings of the BBB Auto Line dispute, and decision, are admissible in the court action. Should you choose to accept the BBB AUTO LINE decision, Ford is then bound by the decision, and must comply with the decision within 30 days of receipt of your acceptance letter.

BBB AUTO LINE Application: Using the information provided below, please call or write to request a program application. You will be asked for your name and address, general information about your new vehicle, information about your warranty concerns, and any steps you have already taken to try to resolve them. A Customer Claim Form will be mailed that will need to be completed, signed and returned to the BBB along with proof of ownership. Upon receipt, the BBB will review the claim for eligibility under the Program Summary Guidelines.

You can get more information by calling BBB AUTO LINE at 1-800-955-5100, or writing to:

**BBB AUTO LINE
3033 Wilson Boulevard, Suite 600
Arlington, Virginia 22201**

BBB AUTO LINE applications can also be requested by calling the Ford Motor Company Customer Relationship Center at 1-800-392-3673.

Note: *Ford Motor Company reserves the right to change eligibility limitations, modify procedures, or to discontinue this process at any time without notice and without obligation.*

UTILIZING THE MEDIATION/ARBITRATION PROGRAM (CANADA ONLY)

For vehicles delivered to authorized Canadian dealers. In those cases where you continue to feel that the efforts by Ford of Canada and the authorized dealer to resolve a factory-related vehicle service concern have been unsatisfactory, Ford of Canada participates in an impartial third party mediation/arbitration program administered by the Canadian Motor Vehicle Arbitration Plan (CAMVAP).

The CAMVAP program is a straight forward and relatively speedy alternative to resolve a disagreement when all other efforts to produce a settlement have failed. This procedure is without cost to you and is designed to eliminate the need for lengthy and expensive legal proceedings.

Customer Assistance

In the CAMVAP program, impartial third-party arbitrators conduct hearings at mutually convenient times and places in an informal environment. These impartial arbitrators review the positions of the parties, make decisions and, when appropriate, render awards to resolve disputes. CAMVAP decisions are fast, fair, and final as the arbitrator's award is binding on both you and Ford of Canada.

CAMVAP services are available in all Canadian territories and provinces. For more information, without charge or obligation, call your CAMVAP Provincial Administrator directly at 1-800-207-0685 or visit www.camvap.ca.

GETTING ASSISTANCE OUTSIDE THE U.S. AND CANADA

Before exporting your vehicle to a foreign country, contact the appropriate foreign embassy or consulate. These officials can inform you of local vehicle registration regulations and where to find unleaded fuel.

If you cannot find unleaded fuel or can only get fuel with an anti-knock index lower than is recommended for your vehicle, contact our Customer Relationship Center.

The use of leaded fuel in your vehicle without proper conversion may damage the effectiveness of your emission control system and may cause engine knocking or serious engine damage. Ford Motor Company or Ford of Canada is not responsible for any damage caused by use of improper fuel. Using leaded fuel may also result in difficulty importing your vehicle back into the United States.

If your vehicle must be serviced while you are traveling or living in Asia-Pacific Region, Sub-Saharan Africa, U.S. Virgin Islands, Central America, the Caribbean, and Israel, contact the nearest authorized dealer. If the authorized dealer cannot help you, contact:

FORD MOTOR COMPANY
Customer Relationship Center
1555 Fairlane Drive
Fairlane Business Park #3
Allen Park, Michigan 48101
U.S.A.
Telephone: (313) 594-4857
Fax: (313) 390-0804
Email: expcac@ford.com

For customers in Guam, the Commonwealth of the Northern Mariana Islands (CNMI), America Samoa, and the U.S. Virgin Islands, please feel free to call our Toll-Free Number: (800) 841-FORD (3673).

If your vehicle must be serviced while you are traveling or living in Puerto Rico, contact the nearest authorized dealer. If the authorized dealer cannot help you, contact:

Customer Assistance

FORD MOTOR COMPANY
Customer Relationship Center
1555 Fairlane Drive
Fairlane Business Park #3
Allen Park, Michigan 48101
U.S.A.
Telephone: (800) 841-FORD (3673)
FAX: (313) 390-0804
Email: prcac@ford.com
www.ford.com.pr

If your vehicle must be serviced while you are traveling or living in the Middle East, contact the nearest authorized dealer. If the authorized dealer cannot help you, contact:

FORD MOTOR COMPANY
Customer Relationship Center
1555 Fairlane Drive
Fairlane Business Park #3
Allen Park, Michigan 48101
U.S.A.

Ford: 80004443673

Lincoln: 80004441067

If calling from the UAE: 80004441066

If calling from the Kingdom of Saudi Arabia:
8008443673

If calling from Kuwait: 22280384

FAX: +971 4 3327266
Email: menacac@ford.com
www.me.ford.com

If you buy your vehicle in North America and then relocate to any of the above locations, register your vehicle identification number (VIN) and new address with Ford Motor Company by emailing **expcac@ford.com**.

If you are in another foreign country, contact the nearest authorized dealer. In the event your inquiry is unresolved, communicate your concern with the dealership's Sales Manager, Service Manager or Customer Relations Manager. If you require additional assistance or clarification, please contact the respective Customer Relationship Center as previously listed.

**Customers in the U.S. should call
1-800-392-3673.**

ORDERING ADDITIONAL OWNER'S LITERATURE

To order the publications in this portfolio, contact Helm, Incorporated at:

HELM, INCORPORATED
47911 Halyard Drive
Plymouth, Michigan 48170
Attention: Customer Service

Or to order a free publication catalog, call toll free: 1-800-782-4356

Monday-Friday 8:00 a.m. - 6:00 p.m. EST

Helm, Incorporated can also be reached by their website:

www.helminc.com

(Items in this catalog may be purchased by credit card, check or money order.)

Obtaining a French Owner's Manual

French Owner's Manual can be obtained from your authorized dealer or by contacting Helm, Incorporated using the contact information listed previously in this section.

Customer Assistance

REPORTING SAFETY DEFECTS (U.S. ONLY)



E142557

If you believe that your vehicle has a defect which could cause a crash or could cause injury or death, you should immediately inform the National Highway Traffic Safety Administration (NHTSA) in addition to notifying Ford Motor Company.

If NHTSA receives similar complaints, it may open an investigation, and if it finds that a safety defect exists in a group of vehicles, it may order a recall and remedy campaign. However, NHTSA cannot become involved in individual problems between you, your dealer, or Ford Motor Company.

To contact NHTSA, you may call the Vehicle Safety Hotline toll-free at 1-888-327-4236 (TTY: 1-800-424-9153); go to <http://www.safercar.gov>; or write to:

Administrator

1200 New Jersey Avenue, Southeast
Washington, D.C. 20590

You can also obtain other information about motor vehicle safety from <http://www.safercar.gov>.

REPORTING SAFETY DEFECTS (CANADA ONLY)

If you believe that your vehicle has a defect which could cause a crash or could cause injury or death, you should immediately inform Transport Canada and Ford of Canada.

Transport Canada Contact Information	
Website	www.tc.gc.ca/eng/motorvehiclesafety/safevehicles-defectinvestigations-index-76.htm (English)
Website	www.tc.gc.ca/fra/securiteautomobile/VehiculesSecuritaires-Enquetes-index-76.htm (French)
Phone	1-800-333-0510

Customer Assistance

Ford of Canada Contact Information	
Website	www.ford.ca
Phone	1-800-565-3673

Fuses

FUSE SPECIFICATION CHART

Power Distribution Box

WARNINGS



Always disconnect the battery before servicing high-current fuses.

WARNINGS



To reduce risk of electrical shock, always replace the cover to the power distribution box before reconnecting the battery or refilling fluid reservoirs.

The power distribution box is in the engine compartment. It has high-current fuses that protect your vehicle's main electrical systems from overloads.

If you disconnect and reconnect the battery, you will need to reset some features. See **Changing the 12V Battery** (page 312).

Fuses

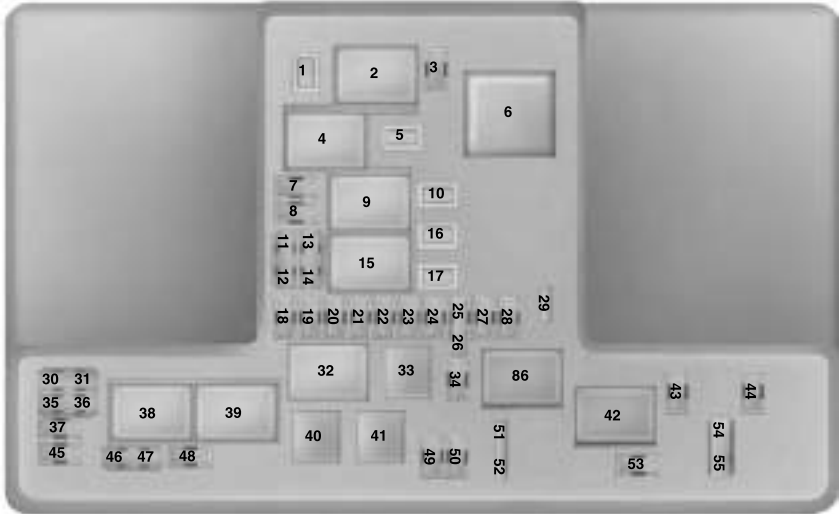

E190797

Fuses

Fuse or relay number	Fuse amp rating	Protected components
1	30A ³	Moonroof.
2	-	Starter relay.
3	15A ¹	Rain sensor.
4	-	Blower motor relay.
5	20A ³	Power point 3 - Back of console.
6	-	Not used.
7	20A ¹	Powertrain control module - vehicle power 1. Powertrain control module power.
8	20A ¹	Powertrain control module - vehicle power 2. Emissions components.
9	-	Powertrain control module relay.
10	20A ³	Power point 1 - driver front.
11	15A ²	Powertrain control module - vehicle power 4. Ignition coils.
12	15A ²	Powertrain control module - vehicle power 3.

Fuses

Fuse or relay number	Fuse amp rating	Protected components
		Non-emissions components.
13	-	Not used.
14	-	Not used.
15	-	Run-start relay.
16	20A ³	Power point 2 - console.
17	-	Not used.
18	20A ¹	Right hand side headlamp ballast.
19	10A ¹	Run-start electronic power assist steering.
20	10A ¹	Run-start lighting. Adaptive cruise control.
21	15A ¹	Run-start transmission control. Transmission oil pump start-stop.
22	10A ¹	Air conditioner clutch solenoid.
23	15A ¹	Run-start: Blind spot information system, Rear view camera, All-wheel drive (3.0L engine), Heads-up display, shifter. Voltage stability module.

Fuses

Fuse or relay number	Fuse amp rating	Protected components
24	-	Not used.
25	10A ²	Run-start anti-lock brake system.
26	10A ²	Run-start powertrain control module.
27	-	Not used.
28	-	Not used.
29	-	Not used.
30	-	Not used.
31	-	Not used.
32	-	Electric fan #1 relay.
33	-	Air conditioner clutch relay.
34	-	Not used.
35	-	Not used.
36	-	Not used.
37	-	Not used.
38	-	Electric fan 2 relay.

Fuses

Fuse or relay number	Fuse amp rating	Protected components
39	-	Electric fan coil 2 and 3 relay.
40	-	Horn relay.
41	-	Not used.
42	-	Fuel pump relay coil.
43	-	Not used.
44	20A ¹	Left hand side headlamp ballast.
45	5A ¹	USB smart charger.
46	-	Not used.
47	-	Not used.
48	-	Not used.
49	-	Not used.
50	20A ¹	Horn.
51	-	Not used.
52	-	Not used.

Fuses

Fuse or relay number	Fuse amp rating	Protected components
53	10A ¹	Multi-contour seats.
54	10A ²	Brake on-off switch.
55	10A ²	Alt sensor.

¹ Micro fuse.

² Dual micro fuse.

³ M-type fuse.

Power Distribution Box - Bottom

There are fuses located on the bottom of the fuse box. To access the bottom of the fuse box, do the following:

Fuses

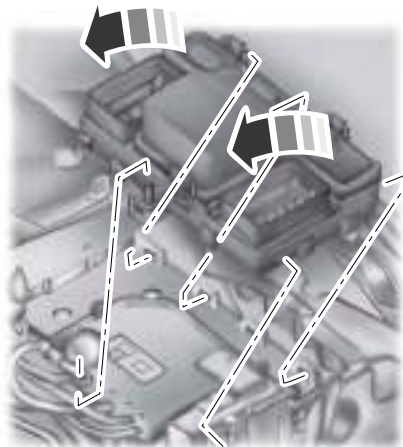

E145983

1. Release the two latches, located on both sides of the fuse box.
2. Raise the inboard side of the fuse box from the cradle.
3. Move the fuse box toward the center of the engine compartment.
4. Pivot the outboard side of the fuse box to access the bottom side.

Fuses

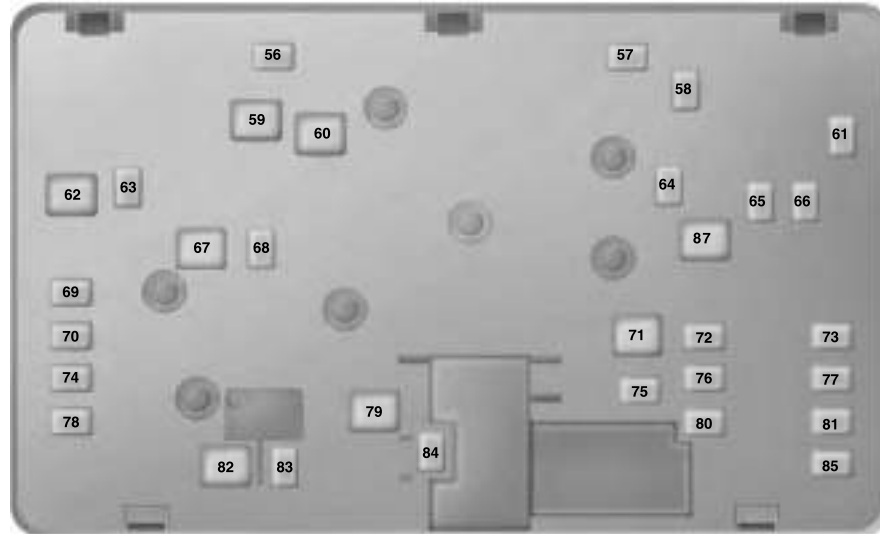

E190798

Fuses

Fuse or relay number	Fuse amp rating	Protected components
56	–	Not used.
57	-	Not used.
58	30A ¹	Fuel pump feed.
59	30A ²	Electric fan 3 (2.0L engine).
	40A ²	Electric fan 3 (3.0L engine).
60	30A ²	Electric fan 1 (2.0L engine).
	40A ²	Electric fan 1 (3.0L engine).
61	-	Not used.
62	50A ²	Body control module 1.
63	25A ¹	Electric fan 2 (2.0L engine).
	30A ¹	Electric fan 2 (3.0L engine).
64	30A ¹	All-wheel drive (torque vectoring).

Fuses

Fuse or relay number	Fuse amp rating	Protected components
65	20A ¹	Front heated seat.
66	15A ¹	Heated wiper park.
67	50A ²	Body control module 2.
68	40A ¹	Heated rear window.
69	30A ¹	Anti-lock brake system valves.
70	30A ¹	Passenger seat.
71	-	Not used.
72	20A ¹	Transmission oil pump.
73	20A ¹	Rear climate controlled seats.
74	30A ¹	Driver seat module.
75	25A ¹	Wiper motor 1.
76	30A ¹	Power decklid module.

Fuses

Fuse or relay number	Fuse amp rating	Protected components
77	30A ¹	Front climate controlled seats.
78	-	Not used.
79	40A ²	Blower motor.
80	25A ¹	Wiper motor 2.
81	40A ¹	Inverter.
82	-	Not used.
83	20A ¹	Transmission Range Control Module shifter.
84	30A ¹	Starter solenoid.
85	30A ¹	Wide open panoramic roof 2.
86	-	Not used.
87	60A ²	Anti-lock brake system pump.

¹ M-type fuse.

² J-type fuse.

Fuses

Passenger Compartment Fuse Panel

The fuse panel is under the instrument panel to the left of the steering column.

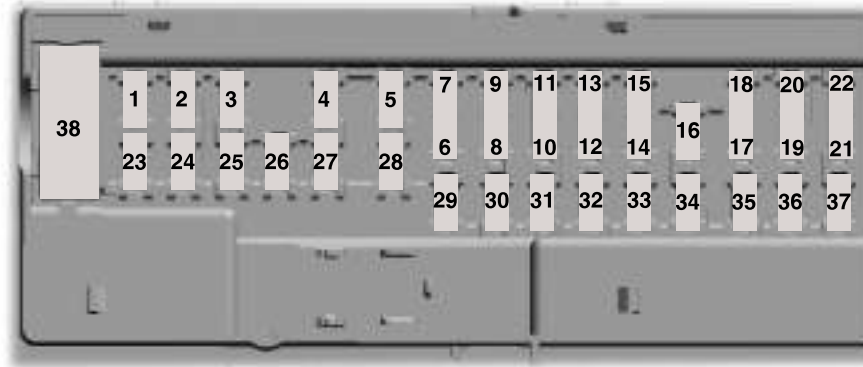

E145984

Fuses

Fuse or relay number	Fuse amp rating	Protected components
1	10A ¹	Lighting (ambient, glove box, vanity, dome, trunk).
2	7.5A ¹	Lumbar.
3	20A ¹	Driver door unlock.
4	5A ¹	Not used (spare).
5	20A ¹	Subwoofer amplifier.
6	10A ²	Not used (spare).
7	10A ²	Not used (spare).
8	10A ²	Not used (spare).
9	10A ²	Rear seat entertainment module.
10	5A ²	Power trunk logic. Keypad. Cellphone passport module.

Fuses

Fuse or relay number	Fuse amp rating	Protected components
11	5A ²	Not used (spare).
12	7.5A ²	Climate control, Gear shift.
13	7.5A ²	Steering wheel column. Cluster. Datalink logic.
14	10A ²	Extended power module.
15	10A ²	Datalink-Gateway module.
16	15A ¹	Trunk release. Child lock.
17	5A ²	Not used (spare).
18	5A ²	Push button stop-start.
19	7.5A ²	Extended power module.
20	7.5A ²	Adaptive headlamps.
21	5A ²	Humidity and in-car temperature sensor.

Fuses

Fuse or relay number	Fuse amp rating	Protected components
22	5A ²	Not used (spare).
23	10A ¹	Delayed accessory (power inverter logic all smart window logic, driver window switch). Rear sunshade. Moonroof. Panoramic roof.
24	20A ¹	Central lock-unlock.
25	30A ¹	Driver door (window, mirror).
26	30A ¹	Front passenger door (window, mirror).
27	30A ¹	Moonroof.
28	20A ¹	Amplifier.
29	30A ¹	Rear driver side door (window).
30	30A ¹	Rear passenger side door (window).
31	15A ¹	Not used (spare).

Fuses

Fuse or relay number	Fuse amp rating	Protected components
32	10A ¹	Voice control. Radio frequency receiver. Display.
33	20A ¹	Radio. Active noise control. CD changer.
34	30A ¹	Run-start bus (fuse #19, 20, 21, 22, 35, 36, 37, circuit breaker).
35	5A ¹	Not used (spare).
36	15A ¹	Continuous control damping suspension module. Auto dimming rear view mirror. Rear heated seats.
37	20A ¹	Heated steering wheel.
38	30A	Not used (spare).

¹ Micro fuse.

² Dual micro fuse.

Fuses

CHANGING A FUSE

Fuses

WARNING



Always replace a fuse with one that has the specified amperage rating. Using a fuse with a higher amperage rating can cause severe wire damage and could start a fire.



E217331

If electrical components in the vehicle are not working, a fuse may have blown. Blown fuses are identified by a broken wire within the fuse. Check the appropriate fuses before replacing any electrical components.

Fuses

Fuse Types

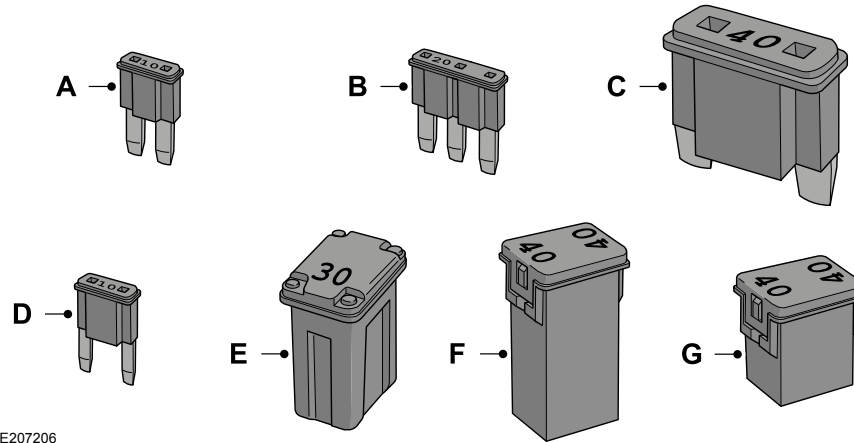

E207206

Callout	Fuse Type
A	Micro 2
B	Micro 3
C	Maxi

Fuses

Callout	Fuse Type
D	Mini
E	M Case
F	J Case
G	J Case Low Profile

Maintenance

GENERAL INFORMATION

Have your vehicle serviced regularly to help maintain its roadworthiness and resale value. There is a large network of authorized dealers that are there to help you with their professional servicing expertise. We believe that their specially trained technicians are best qualified to service your vehicle properly and expertly. They are supported by a wide range of highly specialized tools developed specifically for servicing your vehicle.

If your vehicle requires professional service, an authorized dealer can provide the necessary parts and service. Check your warranty information to find out which parts and services are covered.

Use only recommended fuels, lubricants, fluids and service parts conforming to specifications. Motorcraft® parts are designed and built to provide the best performance in your vehicle.

Precautions

- Do not work on a hot engine.
- Make sure that nothing gets caught in moving parts.
- Do not work on a vehicle with the engine running in an enclosed space, unless you are sure you have enough ventilation.
- Keep all open flames and other burning material (such as cigarettes) away from the battery and all fuel related parts.

Working with the Engine Off

1. Set the parking brake and shift to park (P).
2. Switch off the engine.
3. Block the wheels.

Working with the Engine On

WARNING



To reduce the risk of vehicle damage and/or personal burn injuries, do not start your engine with the air cleaner removed and do not remove it while the engine is running.

1. Set the parking brake and shift to park (P).
2. Block the wheels.

OPENING AND CLOSING THE HOOD



E142457

1. To open the hood, go inside the vehicle and pull the hood release handle located under the left-hand side of the instrument panel.

Maintenance

2. Go to the front of the vehicle and find the secondary release lever, which is located under the front of the hood, near the Lincoln badge.
3. Release the hood latch by pushing the secondary release lever to your left, toward the passenger side of the vehicle.
4. Raise the hood. A gas strut will support the hood.
5. To close the hood, lower the hood and apply closing force to the hood as it drops the last 8 to 11 inches (20 to 30 centimeters).

Note: *Make sure that the hood is closed fully before operating your vehicle. A warning indicator will appear in the information display if not closed properly.*

Maintenance

UNDER HOOD OVERVIEW - 2.0L

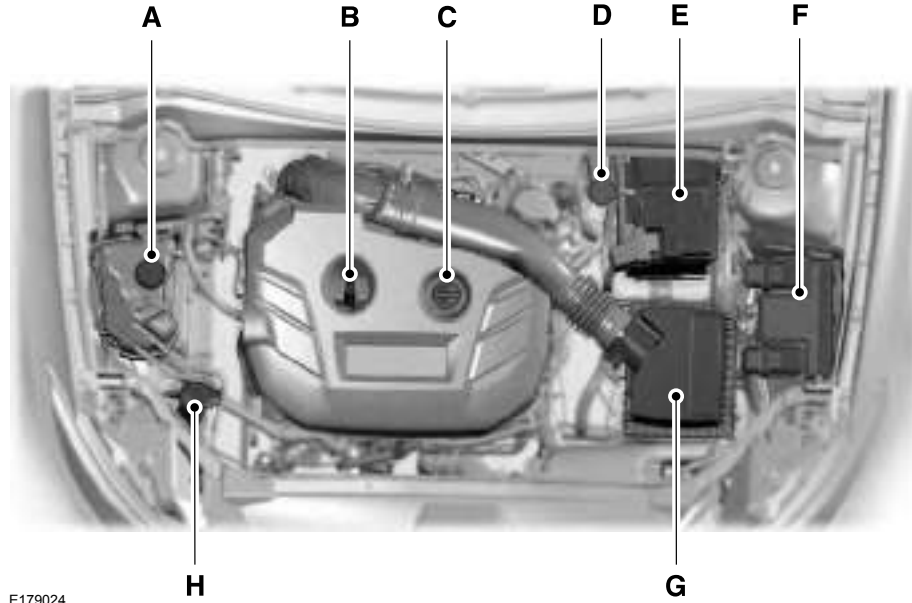

E179024

Maintenance

- A Engine coolant reservoir. See **Engine Coolant Check** (page 303).
- B Engine oil dipstick. See **Engine Oil Dipstick** (page 301).
- C Engine oil filler cap. See **Engine Oil Check** (page 301).
- D Brake fluid reservoir. See **Brake Fluid Check** (page 311).
- E Battery. See **Changing the 12V Battery** (page 312).
- F Engine compartment fuse box. See **Fuses** (page 275).
- G Air filter. See **Changing the Engine Air Filter** (page 319).
- H Washer system fluid reservoir. See **Washer Fluid Check** (page 312).

Maintenance

UNDER HOOD OVERVIEW - 3.0L

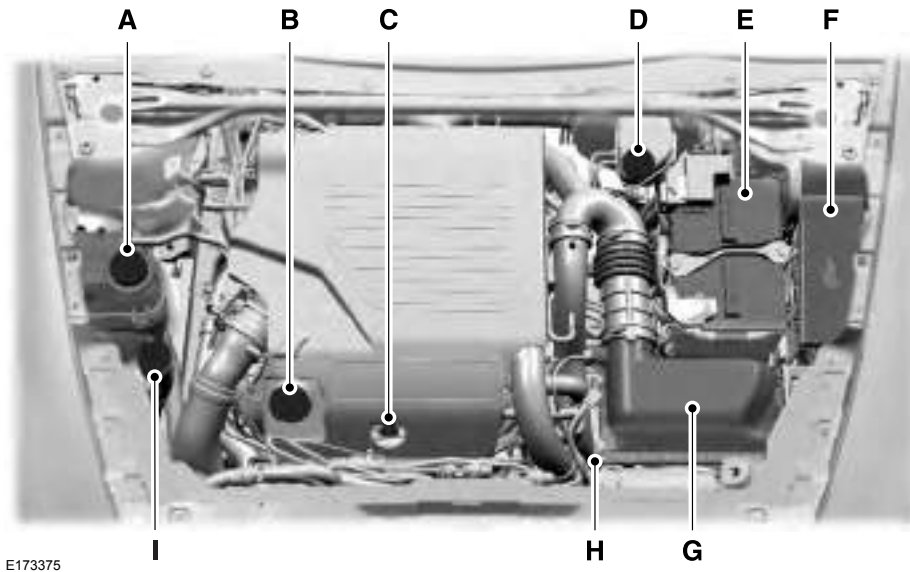

Maintenance

- A. Engine coolant reservoir. See **Engine Coolant Check** (page 303).
- B. Engine oil filler cap. See **Engine Oil Check** (page 301).
- C. Engine oil dipstick. See **Engine Oil Dipstick** (page 301).
- D. Brake fluid reservoir. See **Brake Fluid Check** (page 311).
- E. Battery. See **Changing the 12V Battery** (page 312).
- F. Engine compartment fuse box. See **Fuses** (page 275).
- G. Air filter assembly. See **Changing the Engine Air Filter** (page 319).
- H. Automatic transmission dipstick. See **Automatic Transmission Fluid Check** (page 307).
- I. Washer fluid reservoir. See **Washer Fluid Check** (page 312).

Maintenance

ENGINE OIL DIPSTICK - 2.0L

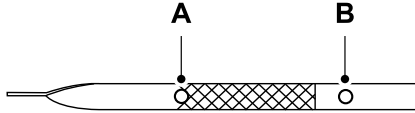

E142462

A MIN
B MAX

ENGINE OIL DIPSTICK - 3.0L

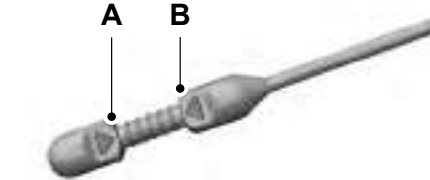

E188072

A Minimum.
B Maximum.

ENGINE OIL CHECK

To check the engine oil level consistently and accurately, do the following:

1. Make sure the parking brake is on. Make sure the transmission is in park (P) or neutral (N).
2. Run the engine until it reaches normal operating temperature.
3. Make sure that your vehicle is on level ground.

4. Switch the engine off and wait 15 minutes for the oil to drain into the oil pan. Checking the engine oil level too soon after you switch the engine off may result in an inaccurate reading.
5. Open the hood. See **Opening and Closing the Hood** (page 295).
6. Remove the dipstick and wipe it with a clean, lint-free cloth. See **Under Hood Overview** (page 297).
7. Replace the dipstick and remove it again to check the oil level. See **Engine Oil Dipstick** (page 301).
8. Make sure that the oil level is between the maximum and minimum marks. If the oil level is at the minimum mark, add oil immediately. See **Capacities and Specifications** (page 374).
9. If the oil level is correct, replace the dipstick and make sure it is fully seated.

Note: Do not remove the dipstick when the engine is running.

Note: If the oil level is between the maximum and minimum marks, the oil level is acceptable. Do not add oil.

Maintenance

Note: *The oil consumption of new engines reaches its normal level after approximately 3,100 mi (5,000 km).*

Adding Engine Oil

WARNING

 Do not remove the filler cap when the engine is running.

Do not use supplemental engine oil additives because they are unnecessary and could lead to engine damage that may not be covered by the vehicle Warranty.



Only use oils certified for gasoline engines by the American Petroleum Institute (API). An oil with this trademark symbol conforms to the current engine and emission system protection standards and fuel economy requirements of the International Lubricants Specification Advisory Committee (ILSAC), comprised of U.S. and Japanese automobile manufacturers.

To top up the engine oil level do the following:

Clean the area surrounding the engine oil filler cap before you remove it.

1. Remove the engine oil filler cap. See **Under Hood Overview** (page 297). Turn it counterclockwise and remove it.
2. Add engine oil that meets the correct specification. See **Capacities and Specifications** (page 374). You may have to use a funnel to pour the engine oil into the opening.
3. Recheck the oil level.
4. If the oil level is correct, replace the dipstick and make sure it is fully seated.

5. Replace the engine oil filler cap. Turn it clockwise until you feel a strong resistance.

Note: *Do not add oil further than the maximum mark. Oil levels above the maximum mark may cause engine damage.*

Note: *Make sure you install the oil filler cap correctly.*

Note: *Soak up any spillage with an absorbent cloth immediately.*

OIL CHANGE INDICATOR RESET

Use the information display controls on the steering wheel to reset the oil change indicator.

Maintenance

From the main menu scroll to:

Message	Action and description
Settings	Press the right arrow button, then from this menu scroll to the following message.
Vehicle	Press the right arrow button, then from this menu scroll to the following message.
Oil Life	Press the right arrow button, then from this menu scroll to the following message.
Hold OK to Reset	Press and hold the OK button until the instrument cluster displays the following message.
	Reset Successful
	When the oil change indicator resets the instrument cluster displays 100%. Remaining Life {00}%

Message	Action and description
	If the instrument cluster displays one of the following messages, repeat the process. Not Reset Reset Cancelled

ENGINE COOLANT CHECK

WARNINGS

 Do not add engine coolant when the engine is hot. Steam and scalding liquids released from a hot cooling system can burn you badly. Also, spilling coolant on hot engine parts can burn you.

 Do not put engine coolant in the windshield washer fluid container. If sprayed on the windshield, engine coolant could make it difficult to see through the windshield.

WARNINGS

 To reduce the risk of personal injury, make sure the engine is cool before unscrewing the coolant pressure relief cap. The cooling system is under pressure. Steam and hot liquid can come out forcefully when you loosen the cap slightly.

 Do not add coolant further than the **MAX** mark.

When the engine is cold, check the concentration and level of the coolant at the intervals listed in the scheduled maintenance information. See **Scheduled Maintenance** (page 495).

Note: Make sure that the coolant level is between the **MIN** and **MAX** marks on the coolant reservoir.

Note: Coolant expands when it is hot. The level may extend beyond the **MAX** mark.

Maintenance

Maintain coolant concentration within 48% to 50%, which equates to a freeze point between -30°F (-34°C) and -34°F (-37°C). Coolant concentration should be checked using a refractometer. We recommend, Robinair® Coolant and Battery Refractometer 75240 (Rotunda tool part number: ROB75240). We do not recommend the use of hydrometers or coolant test strips for measuring coolant concentration.

Note: *Automotive fluids are not interchangeable. Do not use coolant or windshield washer fluid outside of its specified function and vehicle location.*

Note: *Do not use stop leak pellets, cooling system sealants, or non-specified additives as they can cause damage to the engine cooling or heating systems. Resulting component damage may not be covered by the vehicle Warranty.*

Adding Coolant

WARNING



Never remove the coolant reservoir cap while the engine is running or hot.

It is very important to use prediluted coolant meeting the correct specification in order to avoid plugging the small passageways in the engine cooling system. See **Capacities and Specifications** (page 374). Incorrect prediluted coolant use can cause damage not covered by the vehicle Warranty.

If the coolant level is at or below the minimum mark, add prediluted coolant immediately.

To top up the coolant level do the following:

1. Unscrew the cap slowly. Any pressure escapes as you unscrew the cap.
2. Add prediluted coolant meeting the correct specification. See **Capacities and Specifications** (page 367).
3. Add enough prediluted coolant to reach the correct level.
4. Replace the coolant reservoir cap, turn it clockwise until you feel a strong resistance.
5. Check the coolant level in the coolant reservoir the next few times you drive your vehicle.

Note: *During normal vehicle operation, the coolant may change color from orange to pink or light red. As long as the coolant is clear and uncontaminated, this color change does not indicate the coolant has degraded nor does it require the coolant to be drained, the system to be flushed, or the coolant to be replaced.*

Do not mix different colors or types of prediluted coolant in your vehicle. Mixing of prediluted coolant or using an incorrect prediluted coolant may harm the engine or cooling system components and may not be covered by the vehicle Warranty.

In case of emergency, you can add a large amount of water without prediluted coolant in order to reach a vehicle service location. On arrival do the following:

1. Drain the cooling system.
2. Chemically clean the cooling system. We recommend Motorcraft Premium Cooling System Flush.
3. Refill with prediluted coolant as soon as possible.

Maintenance

Water alone, without prediluted coolant, can cause engine damage from corrosion, overheating or freezing.

Do not use the following as a coolant substitute:

- Alcohol.
- Methanol.
- Brine.
- Any coolant mixed with alcohol or methanol antifreeze.

Alcohol and other liquids can cause engine damage from overheating or freezing.

Do not add extra inhibitors or additives to the coolant. These can be harmful and compromise the corrosion protection of the coolant.

Recycled Coolant

We do not recommend the use of recycled coolant as an approved recycling process is not yet available.

Dispose of used engine coolant in an appropriate manner. Follow your community's regulations and standards for recycling and disposing of automotive fluids.

Severe Climates

If you drive in extremely cold climates:

- It may be necessary to increase the coolant concentration above 50%.
- A coolant concentration of 60% provides improved freeze point protection. Coolant concentrations above 60% decrease the overheat protection characteristics of the coolant and may cause engine damage.

If you drive in extremely hot climates:

- It may be necessary to decrease the coolant concentration to 40%.
- A coolant concentration of 40% provides improved overheat protection. Coolant concentrations below 40% decrease the freeze and corrosion protection characteristics of the coolant and may cause engine damage.

Vehicles driven year-round in non-extreme climates should use prediluted coolant for optimum cooling system and engine protection.

Fail-Safe Cooling

Fail-safe cooling allows you to temporarily drive your vehicle before any incremental component damage occurs. The fail-safe distance depends on ambient temperature, vehicle load and terrain.

How Fail-Safe Cooling Works

If the engine begins to overheat, the coolant temperature gauge moves toward the red zone:



A warning lamp illuminates and a message may appear in the information display.



If the engine reaches a preset over-temperature condition, the engine automatically switches to alternating cylinder operation. Each disabled cylinder acts as an air pump and cools the engine.

Maintenance

When this occurs, your vehicle still operates, however:

- Engine power is limited.
- The air conditioning system turns off.

Continued operation increases the engine temperature, causing the engine to completely shut down. Your steering and braking effort increases in this situation.

When the engine temperature cools, you can re-start the engine. Have your vehicle checked as soon as possible to minimize engine damage.

When Fail-Safe Mode Is Activated

WARNINGS



Fail-safe mode is for use during emergencies only. Operate your vehicle in fail-safe mode only as long as necessary to bring your vehicle to rest in a safe location and seek immediate repairs. When in fail-safe mode, your vehicle will have limited power, will not be able to maintain

WARNINGS

high-speed operation, and may completely shut down without warning, potentially losing engine power, power steering assist, and power brake assist, which may increase the possibility of a crash resulting in serious injury.



Never remove the coolant reservoir cap while the engine is running or hot.

Your vehicle has limited engine power when in the fail-safe mode, drive your vehicle with caution. Your vehicle does not maintain high-speed operation and the engine may operate poorly.

Remember that the engine is capable of automatically shutting down to prevent engine damage. In this situation:

1. Pull off the road as soon as safely possible and switch the engine off.
2. If you are a member of a roadside assistance program, we recommend that you contact your roadside assistance service provider.

3. If this is not possible, wait a short period for the engine to cool.
4. Check the coolant level. If the coolant level is at or below the minimum mark, add prediluted coolant immediately.
5. When the engine temperature cools, you can re-start the engine. Have your vehicle checked as soon as possible to minimize engine damage.

Note: *Driving your vehicle without repair increases the chance of engine damage.*

Engine Coolant Temperature Management (If Equipped)

WARNING



To reduce the risk of crash and injury, be prepared that the vehicle speed may reduce and the vehicle may not be able to accelerate with full power until the coolant temperature reduces.

Maintenance

If you tow a trailer with your vehicle, the engine may temporarily reach higher a temperature during severe operating conditions, for example ascending a long or steep grade in high ambient temperatures.

At this time, you may notice the coolant temperature gauge moves toward the red zone and a message may appear in the information display.

You may notice a reduction in vehicle speed caused by reduced engine power. In order to manage the engine coolant temperature. Your vehicle may enter this mode if certain high-temperature and high-load conditions take place. The amount of speed reduction depends on vehicle loading, grade and ambient temperature. If this occurs, there is no need to pull off the road. You can continue to drive your vehicle.

The air conditioning may automatically turn on and off during severe operating conditions to protect the engine from overheating. When the coolant temperature decreases to the normal operating temperature, the air conditioning turns on.

If the coolant temperature gauge moves fully into the red zone, or if the coolant temperature warning or service engine soon messages appear in your information display, do the following:

1. Pull off the road as soon as safely possible and shift the transmission into park **(P)**.
2. Leave the engine running until the coolant temperature gauge needle returns to the normal position. After several minutes, if the temperature does not drop, follow the remaining steps.
3. Switch the engine off and wait for it to cool. Check the coolant level.
4. If the coolant level is at or below the minimum mark, add prediluted coolant immediately.
5. If the coolant level is normal, restart the engine and continue.

AUTOMATIC TRANSMISSION FLUID CHECK

6F35/HF35 transmission (If Equipped)

Note: *Transmission fluid should be checked by an authorized dealer. If required, fluid should be added by an authorized dealer.*

The automatic transmission does not have a transmission fluid dipstick.

Refer to your scheduled maintenance information for scheduled intervals for fluid checks and changes. Your transmission does not consume fluid. However, the fluid level should be checked if the transmission is not working properly, (For example: if the transmission slips or shifts slowly) or if you notice some sign of fluid leakage. See **Scheduled Maintenance** (page 495).

Do not use supplemental transmission fluid additives, treatments or cleaning agents. The use of these materials may affect transmission operation and result in damage to internal transmission components.

Maintenance

6F50/6F55 Transmission (if Equipped)

WARNINGS



The dipstick cap and surrounding components may be hot; gloves are recommended.



Use gloves when moving the air filter assembly. Components will be hot.

Note: *Automatic transmission fluid expands when warmed. To obtain an accurate fluid check, drive the vehicle until it is warmed up (approximately 20 miles [30 kilometers]). If your vehicle has been operated for an extended period at high speeds, in city traffic during hot weather or pulling a trailer, the vehicle should be turned off until normal operating temperatures are reached to allow the fluid to cool before checking. Depending on vehicle use, cooling times could take up to 30 minutes or longer.*

Refer to your scheduled maintenance information for scheduled intervals for fluid checks and changes. Your transmission does not consume fluid. However, the fluid level should be checked if the transmission is not working properly. For example, if the transmission slips or shifts slowly or if you notice some sign of fluid leakage.

1. Drive the vehicle 20 miles (30 kilometers) or until it reaches normal operating temperature
2. Park the vehicle on a level surface and engage the parking brake.
3. With the parking brake engaged and your foot on the brake pedal, start the engine and move the gearshift lever through all of the gear ranges. Allow a minimum of 10 seconds for each gear to engage.
4. Put the gearshift lever in **P** (Park) and leave the engine running.

Note: *You will need to move the air filter assembly to access the transmission dipstick.*

5. Remove the dipstick, wiping it clean with a clean, dry lint free rag. If necessary, refer to Under hood overview in this chapter for the location of the dipstick.
6. Install the dipstick making sure it is fully seated in the filler tube by turning it to the locked position.
7. Remove the dipstick and inspect the fluid level. The fluid should be in the designated areas for normal operating temperature.

Moving the Air Filter Assembly (Accessing the Dipstick)

WARNING



Do not run engine with the air filter disconnected.

Maintenance

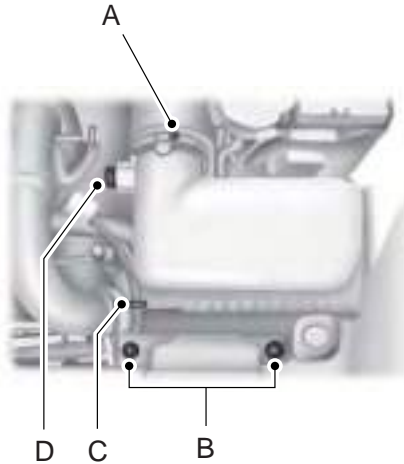

E158839

1. Shut the engine off.
2. Clean the area around the clamp that connects the air filter assembly to the rubber hose (A).



E158840

3. Remove the bolt cover (if equipped).
4. Remove two bolts that attach the air filter assembly to the front of the vehicle (B).
5. Loosen the clamp holding the air filter assembly to the rubber hose (A).
6. Remove the harness retaining clip by pulling up (C). Do not disconnect the sensor (D).
7. Without disconnecting the sensor (D), pull the air filter assembly up to disconnect the air filter assembly from the seated grommets located underneath the air filter assembly.

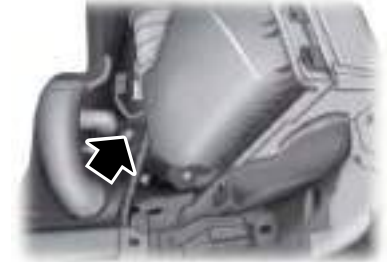

E158841

8. Rotate the air filter assembly 90 degrees counterclockwise and reinstall into the rubber hose.
9. Tighten the clamp (A).
10. The transmission fluid level indicator can now be accessed.

Maintenance

Checking the fluid level

Low fluid level

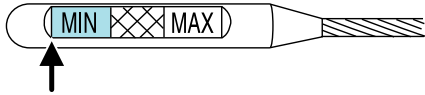

E158842

If the fluid level is below the MIN range of the dipstick, add fluid to reach the hash mark level.

Note: If the fluid level is below the MIN level, do not drive the vehicle. An underfill condition may cause shift or engagement concerns or possible damage.

Correct fluid level

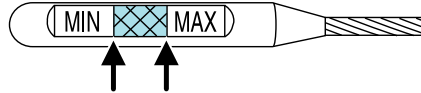

E158843

The transmission fluid should be checked at normal operating temperature 180°F-200°F (82°C-93°C) on a level surface. The normal operating temperature can be reached after approximately 20 miles (30 kilometers) of driving.

The transmission fluid level should be targeted within the cross-hatch area if at normal operating temperature 180°F-200°F (82°C-93°C).

High fluid level

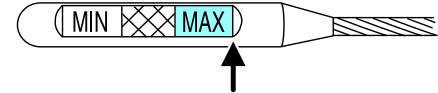

E158844

If the fluid level is above the MAX range of the dipstick, remove fluid to reach the hashmark level.

Note: Fluid level above the MAX level may cause shift or engagement concerns or possible damage. High fluid levels can be caused by an overheating condition. If your vehicle has been operated for an extended period at high speeds, in city traffic during hot weather or pulling a trailer, the vehicle should be turned off until normal operating temperatures are reached. Depending on vehicle use, cooling times could take up to 30 minutes or longer.

Maintenance

Adjusting Automatic Transmission Fluid Levels

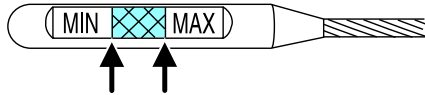

E158845

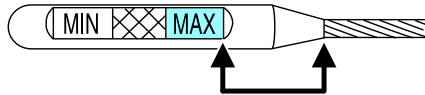

E158846

Before adding any fluid, make sure the correct type is used. The type of fluid used is normally indicated on the dipstick and also in the Technical Specifications section in this chapter.

Note: An overfill condition of transmission fluid may cause shift or engagement concerns or possible damage.

Do not use supplemental transmission fluid additives, treatments or cleaning agents. The use of these materials may affect transmission operation and result in damage to internal transmission components. Reinstall the air filter assembly. After the fluid level has been checked and adjusted as necessary, do the following:

1. Shut the engine off.
2. Loosen the clamp holding the air filter assembly to the rubber hose.
3. Rotate the air filter assembly 90 degrees clockwise without disconnecting the sensor.
4. Seat the air filter assembly back into the grommets by pushing down on the air filter assembly.
5. Tighten the clamp.
6. Install and tighten two bolts that attach air filter assembly to the front of the vehicle.
7. Install the bolt cover (if equipped).

8. Reinstall the harness retaining clip into the front of the air filter assembly.

BRAKE FLUID CHECK

WARNINGS

 Do not use any fluid other than the recommended brake fluid as this will reduce brake efficiency. Use of incorrect fluid could result in the loss of vehicle control, serious personal injury or death.

 Only use brake fluid from a sealed container. Contamination with dirt, water, petroleum products or other materials may result in brake system damage or failure. Failure to adhere to this warning could result in the loss of vehicle control, serious personal injury or death.

 Do not allow the fluid to touch your skin or eyes. If this happens, rinse the affected areas immediately with plenty of water and contact your physician.

Maintenance

WARNINGS

 A fluid level between the **MAX** and **MIN** lines is within the normal operating range and there is no need to add fluid. A fluid level not in the normal operating range could compromise the performance of the system. Have your vehicle checked immediately.

To avoid fluid contamination, the reservoir cap must remain in place and fully tight, unless you are adding fluid.

Only use fluid that meets Ford specifications. See **Capacities and Specifications** (page 367).

WASHER FLUID CHECK

WARNING

 If you operate your vehicle in temperatures below 40°F (5°C), use washer fluid with antifreeze protection. Failure to use washer fluid with antifreeze protection in cold weather could result in impaired windshield vision and increase the risk of injury or accident.

Note: *The front and rear washer systems are supplied from the same reservoir.*

Add fluid to fill the reservoir if the level is low. Only use a washer fluid that meets Ford specifications. See **Capacities and Specifications** (page 367).

State or local regulations on volatile organic compounds may restrict the use of methanol, a common windshield washer antifreeze additive. Washer fluids containing non-methanol antifreeze agents should be used only if they provide cold weather protection without damaging the vehicle's paint finish, wiper blades or washer system.

FUEL FILTER

Your vehicle is equipped with a lifetime fuel filter that is integrated with the fuel tank. Regular maintenance or replacement is not needed.

CHANGING THE 12V BATTERY

WARNINGS

 Batteries normally produce explosive gases which can cause personal injury. Therefore, do not allow flames, sparks or lighted substances to come near the battery. When working near the battery, always shield your face and protect your eyes. Always provide correct ventilation.

 When lifting a plastic-cased battery, excessive pressure on the end walls could cause acid to flow through the vent caps, resulting in personal injury and damage to the vehicle or battery. Lift the battery with a battery carrier or with your hands on opposite corners.

Maintenance

WARNINGS



Keep batteries out of reach of children. Batteries contain sulfuric acid. Avoid contact with skin, eyes or clothing. Shield your eyes when working near the battery to protect against possible splashing of acid solution. In case of acid contact with skin or eyes, flush immediately with water for a minimum of 15 minutes and get prompt medical attention. If acid is swallowed, call a physician immediately.



Battery posts, terminals and related accessories contain lead and lead compounds. Wash hands after handling.

Your vehicle is fitted with a Motorcraft maintenance-free battery which normally does not require additional water.

When a battery replacement is required, you must use a recommended replacement battery that matches the electrical requirements of the vehicle.

Note: *If your vehicle has a battery cover, after cleaning or replacing the battery, make sure you reinstall it.*

Note: *See an authorized dealer for battery access, testing, or replacement.*

To make sure the battery management system works correctly, do not connect an electrical device ground connection directly to the battery negative post. This can cause inaccurate measurements of the battery condition and potential incorrect system operation.

Note: *If you add electrical accessories or components to the vehicle, it may adversely affect battery performance and durability. This may also affect the performance of other electrical systems in the vehicle.*

If you see any corrosion on the battery or terminals, remove the cables from the terminals and clean with a wire brush. You can neutralize the acid with a solution of baking soda and water.

Because your vehicle's engine is electronically-controlled by a computer, some engine control settings are maintained by power from the battery. Some engine computer settings, like the idle trim and fuel trim strategy, optimize the driveability and

performance of the engine. The clock and radio station presets are also maintained in memory by power from the low-voltage battery. These settings are erased when a technician disconnects and connects the low-voltage battery.

To restore the settings, do the following:

Note: *Until you switch the ignition to the on position, you will receive a message in your information display stating that your vehicle is not in park.*

1. Apply the parking brake.
2. Shift into park (P) or neutral (N).
3. Switch off all accessories.
4. Press the brake pedal and start your vehicle.
5. Run the engine until it reaches normal operating temperature. While the engine is warming up, complete the following:
Reset the clock. See **Audio System** (page 386). Reset the power windows bounce-back feature. See **Windows and Mirrors** (page 93). Reset the radio station presets. See **Audio System** (page 386).

Maintenance

6. Allow the engine to idle for at least one minute.
7. Drive the vehicle at least 10 mi (16 km) to completely relearn the idle trim and fuel trim strategy.

Note: If you do not allow the engine to relearn the idle and fuel trim strategy, the idle quality of your vehicle may be adversely affected until the engine computer eventually relearns the idle trim and fuel trim strategy.

Note: Certain features may not operate if the battery monitor system is not reset with a scan tool following a jump start or battery replacement. Normal electrical accessory operation should resume after your vehicle is left undisturbed for 8 hours.

Make sure that you dispose of old batteries in an environmentally friendly way. Seek advice from your local authority about recycling old batteries.

If storing your vehicle for more than 30 days without recharging the battery, we recommend that you disconnect the battery cables to maintain battery charge for quick starting.

CHECKING THE WIPER BLADES



E142463

Run the tip of your fingers over the edge of the blade to check for roughness.

Clean the wiper blades with washer fluid or water applied with a soft sponge or cloth.

CHANGING THE WIPER BLADES

Replace the wiper blades at least annually for optimum performance.

You can improve poor wiper quality by cleaning the wiper blades and the windshield.

Note: Do not hold the wiper blade when lifting the wiper arm.

Note: Make sure that the wiper arm does not spring back against the glass when the wiper blade is not attached.

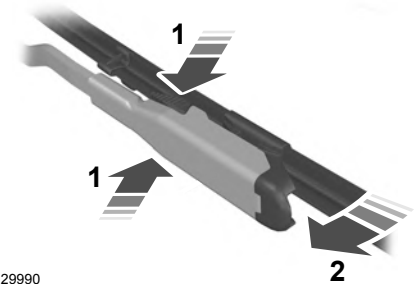

E129990

1. Pull the wiper blade and arm away from the glass. Press the locking buttons together.
2. Slightly rotate the wiper blade.
3. Remove the wiper blade.
4. Install in the reverse order.

Note: Make sure that the wiper blade locks into place.

Maintenance

ADJUSTING THE HEADLAMPS

Vertical Aim Adjustment

The headlamps on your vehicle are properly aimed at the assembly plant. If your vehicle has been in an accident, the alignment of your headlamps should be checked by your authorized dealer.

Headlamp Aiming Target

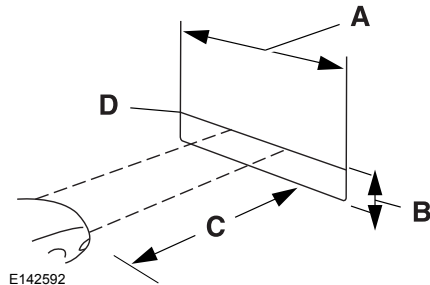

A 8 feet (2.4 meters)

B Center height of lamp to ground

C 25 feet (7.6 meters)

D Horizontal reference line

Vertical Aim Adjustment Procedure

1. Park the vehicle directly in front of a wall or screen on a level surface, approximately 25 feet (7.6 meters) away.
 2. Measure the height of the headlamp bulb center from the ground and mark an 8 foot (2.4 meter) horizontal reference line on the vertical wall or screen at this height.
- Note:** To see a clearer light pattern for adjusting, you may want to block the light from one headlamp while adjusting the other.
3. Turn on the low beam headlamps to illuminate the wall or screen and open the hood.



E142465

4. On the wall or screen you will observe a flat zone of high intensity light located at the top of the right hand portion of the beam pattern. If the top edge of the high intensity light zone is not at the horizontal reference line, the headlamp will need to be adjusted.

Maintenance

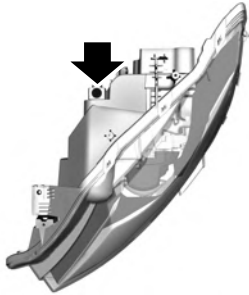

E150095

5. Locate the vertical adjuster on each headlamp. Using a Phillips #2 screwdriver, turn the adjuster either clockwise or counterclockwise in order to adjust the vertical aim of the headlamp. The horizontal edge of the brighter light should touch the horizontal reference line.
6. Close the hood and turn off the lamps.

Horizontal Aim Adjustment

The horizontal aim does not require any adjustment for this vehicle. If a fault occurs, have the system checked by an authorized dealer.

CHANGING A BULB

Lamp Assembly Condensation

Exterior lamps are vented to accommodate normal changes in pressure. Condensation can be a natural by-product of this design. When moist air enters the lamp assembly through the vents, there is a possibility that condensation can occur when the temperature is cold. When normal condensation occurs, a thin film of mist can form on the interior of the lens. The thin mist eventually clears and exits through the vents during normal operation. Clearing time may take as long as 48 hours under dry weather conditions.

Examples of acceptable condensation are:

- Presence of thin mist (no streaks, drip marks or droplets).
- Fine mist covers less than 50% of the lens.

Examples of unacceptable moisture (usually caused by a lamp water leak) are:

- Water puddle inside the lamp.
- Large water droplets, drip marks or streaks present on the interior of the lens.

Take your vehicle to a dealer for service if any of the above conditions of unacceptable moisture are present.

Replacing Bulbs

For replacing bulbs, see your authorized dealer.

BULB SPECIFICATION CHART

Replacement bulbs are specified in the chart below. Headlamp bulbs must be marked with an authorized "D.O.T." for North America to make sure they have the proper lamp performance, light brightness, light pattern, and safe visibility. The correct bulbs will not damage the lamp assembly or void the lamp assembly warranty and will provide quality bulb illumination time.

Maintenance

Function	Trade name
Headlamp high beam - high series	LED
Headlamp high beam - low series	HID
Headlamp low beam - high series	LED
Headlamp low beam - low series	HID
Side marker lamp - front	LED
Park lamp - front	LED
Signature lamp	LED
Daytime running lamp	LED
Turn lamp - front	LED
Tail and brake lamp	LED
Reverse lamp	LED
Turn lamp - rear	LED
Side marker lamp - rear	LED
License plate lamp	LED
Trunk lamp	LED

Maintenance

Function	Trade name
High-mount brake lamp	LED
Side repeater lamp	LED
Glove compartment lamp	LED
Interior lamp	LED

To replace any bulb, see your authorized dealer.

Maintenance

CHANGING THE ENGINE AIR FILTER

WARNING



Do not start the engine with the air filter removed. This can cause damage not covered by the vehicle Warranty and can result in serious injury.

Only use the specified replacement air filter. See **Capacities and Specifications** (page 367).

Change the air filter element at the correct interval. See **Scheduled Maintenance** (page 495).

When changing the engine air filter, do not allow debris or foreign material to enter the air induction system. The engine and turbocharger are susceptible to damage from even small particles.

Note: Failure to use the correct air filter element may result in severe engine damage. Resulting component damage may not be covered by the vehicle Warranty.

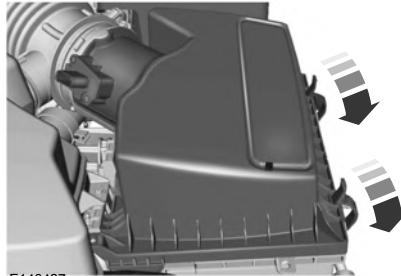

1. Release the clamps that secure the air filter cover to the housing.
2. Carefully lift the air filter housing cover.
3. Remove the air filter element from the air filter housing.
4. Wipe any dirt or debris from the air filter housing and cover to make sure no dirt gets in the engine and that you have a good seal.

5. Install a new air filter element. Be careful not to crimp the filter element edges between the air filter housing and cover. This could cause filter damage and allow unfiltered air to enter the engine if it is not properly seated.
6. Install the air filter housing cover.
7. Engage the clips to secure the air filter housing cover to the air filter housing.

Vehicle Care

GENERAL INFORMATION

vehicle and protect its finishes.

Your Ford or Lincoln authorized dealer has many quality products available to clean your

Materials

Name	Specification
Motorcraft Bug and Tar Remover ZC-42	-
Motorcraft Custom Bright Metal Cleaner ZC-15	-
Motorcraft® Detail Wash ZC-3-A	ESR-M14P4-A
Motorcraft Engine Shampoo and Degreaser (U.S.) ZC-20 (U.S.)	-
Engine Shampoo	-
Motorcraft Leather and Vinyl Cleaner ZC-56	-
Multi-Purpose Cleaner	-
Motorcraft® Premium Windshield Wash Concentrate with Bitterant (U.S.) ZC-32-B2 (U.S.)	WSS-M14P19-A
Professional Strength Carpet and Upholstery Cleaner ZC-54	-
Motorcraft Spot and Stain Remover (U.S.) ZC-14 (U.S.)	-
Motorcraft® Ultra-Clear Spray Glass Cleaner (U.S.)	ESR-M14P5-A

CLEANING PRODUCTS

For best results, use the following products or products of equivalent quality:

Vehicle Care

Name	Specification
ZC-23 (U.S.)	
Motorcraft® Wheel and Tire Cleaner ZC-37-A	-

CLEANING THE EXTERIOR

Wash your vehicle regularly with cool or lukewarm water and a neutral pH shampoo, we recommend Motorcraft Detail Wash.

- Never use strong household detergents or soap, for example dish washing or laundry liquid. These products can discolor and spot painted surfaces.
- Never wash your vehicle when it is hot to the touch, or during strong or direct sunlight.
- Dry your vehicle with a chamois or soft terry cloth towel to eliminate water spotting.

- Immediately remove fuel spillages, bird droppings, insect deposits and road tar. These may cause damage to your vehicle's paintwork or trim over time. We recommend Motorcraft Bug and Tar Remover.
- Remove any exterior accessories, for example antennas, before entering a car wash.

Note: *Suntan lotions and insect repellents can damage painted surfaces. If these substances come in contact with your vehicle, wash the affected area as soon as possible.*

Exterior Chrome Parts

- Apply a high quality-cleaning product to bumpers and other chrome parts. Follow the manufacturer's instructions. We recommend Motorcraft Custom Bright Metal Cleaner.
- Do not apply the cleaning product to hot surfaces. Do not leave the cleaning product on chrome surfaces longer than the time recommended.
- Using other non-recommended cleaners can result in severe and permanent cosmetic damage.

Note: *Never use abrasive materials, for example steel wool or plastic pads as they can scratch the chrome surface.*

Note: *Do not use chrome cleaner, metal cleaner or polish on wheels or wheel covers.*

Vehicle Care

Exterior Plastic Parts

For routine cleaning we recommend Motorcraft Detail Wash. If tar or grease spots are present, we recommend Motorcraft Bug and Tar Remover.

Stripes or Graphics (If Equipped)

Hand washing your vehicle is preferred however, pressure washing may be used under the following conditions:

- Do not use water pressure higher than 2,000 psi (14,000 kPa).
- Do not use water hotter than 179°F (82°C).
- Use a spray with a 40° wide spray angle pattern.
- Keep the nozzle at a 12 in (305 mm) distance and 90° angle to your vehicle's surface.

Note: *Holding the pressure washer nozzle at an angle to the vehicle's surface may damage graphics and cause the edges to peel away from the vehicle's surface.*

Underbody

Flush the complete underside of your vehicle frequently. Keep body and door drain holes free of debris or foreign material.

Under Hood

For removing black rubber marks from under the hood we recommend Motorcraft Wheel and Tire Cleaner or Motorcraft Bug and Tar Remover.

WAXING

Regular waxing is necessary to protect your car's paint from the elements. We recommend that you wash and wax the painted surface once or twice a year.

When washing and waxing, park your vehicle in a shaded area out of direct sunlight. Always wash your vehicle before applying wax.

- Use a quality wax that does not contain abrasives.
- Follow the manufacturer's instructions to apply and remove the wax.

- Apply a small amount of wax in a back-and-forth motion, not in circles.
- Do not allow wax to come in contact with any non-body (low-gloss black) colored trim. The wax will discolor or stain the parts over time.
 - Roof racks.
 - Bumpers.
 - Grained door handles.
 - Side moldings.
 - Mirror housings.
 - Windshield cowl area.
- Do not apply wax to glass areas.
- After waxing, your car's paint should feel smooth, and be free of streaks and smudges.

CLEANING THE ENGINE

Engines are more efficient when they are clean because grease and dirt buildup keep the engine warmer than normal.

Vehicle Care

When washing:

- Take care when using a power washer to clean the engine. The high-pressure fluid could penetrate the sealed parts and cause damage.
- Do not spray a hot engine with cold water to avoid cracking the engine block or other engine components.
- Spray Motorcraft Engine Shampoo and Degreaser on all parts that require cleaning and pressure rinse clean. In Canada, use Motorcraft Engine Shampoo.
- Never wash or rinse the engine while it is hot or running; water in the running engine may cause internal damage.
- Never wash or rinse any ignition coil, spark plug wire or spark plug well, or the area in and around these locations.
- Cover the battery, power distribution box, and air filter assembly to prevent water damage when cleaning the engine.

CLEANING THE WINDOWS AND WIPER BLADES

Car wash chemicals and environmental fallout can result in windshield and wiper blade contamination. Dirty windshield and wipers will result in poor windshield wiper operation. Keep the windshield and wiper blades clean to maintain windshield wiper performance.

To clean the windshield and wiper blades:

- Clean the windshield with a non-abrasive glass cleaner. When cleaning the interior of the windshield, avoid getting any glass cleaner on the instrument panel or door panels. Wipe any glass cleaner off these surfaces immediately.
- For windshields contaminated with tree sap, chemicals, wax or bugs, clean the entire windshield using steel wool (no greater than 0000 grade) in a circular motion and rinse with water.
- Clean the wiper blades with isopropyl rubbing alcohol or windshield washer concentrate.

Note: Do not use razor blades or other sharp objects to clean or remove decals from the inside of the heated rear window. The vehicle warranty does not cover damage caused to the heated rear window grid lines.

CLEANING THE INTERIOR

WARNINGS



Do not use cleaning solvents, bleach or dye on the vehicle's safety belts, as these actions may weaken the belt webbing.



On vehicles equipped with seat-mounted airbags, do not use chemical solvents or strong detergents. Such products could contaminate the side airbag system and affect performance of the side airbag in a collision.

Note: Follow the same procedure for cleaning leather seats when cleaning leather interior. See **Cleaning Leather Seats** (page 326).

Vehicle Care

Note: Do not use household cleaning products or glass cleaners, which can stain and discolor the fabric and affect the flame retardant abilities of the seat materials.

For fabric, carpets, cloth seats, safety belts and seats equipped with side airbags:

- Remove dust and loose dirt with a vacuum cleaner.
- Remove light stains and soil with Motorcraft Professional Strength Carpet & Upholstery Cleaner.

For grease or tar stains:

- Spot clean the area with Motorcraft Spot and Stain Remover (Motorcraft Multi-Purpose Cleaner in Canada).
- If a ring forms on the fabric after spot cleaning, clean the entire area immediately (but do not oversaturate) or the ring will set.

Cleaning Alcantara Microfiber Cloth Fabric (If Equipped)

Note: Alcantara microfiber cloth fabric is made of polyester microfiber with micro-porous polyurethane. Using commercially available fabric cleaners can cause permanent damage.

Note: Do not use commercially available leather and vinyl cleaning products on Alcantara microfiber cloth fabric.

Note: Some vehicles may have Alcantara microfiber cloth fabric on the seats, headliner, floor mats and door panels.

Depending on the type of stain, use water, lemon juice or pure ethyl alcohol when cleaning. For cleaning Alcantara microfiber cloth, refer to the following chart:

Type of Stain	Cleaning Procedure
Fruit juice, jam, jelly, syrup or ketchup.	Use lukewarm water and rinse by dabbing with clean water.
Blood, egg, excrement or urine.	Use cold water and rinse by dabbing with clean water. Avoid warm water because it makes these substances coagulate.
Liquor, alcoholic beverages, wine, beer, cola and tea.	Use lukewarm water. If the color remains, treat with lemon juice and then rinse.

Vehicle Care

Type of Stain	Cleaning Procedure
Indelible pencil, cocoa, chocolate, pastry with cream or chocolate, ice cream or mustard.	Use lukewarm water and rinse by dabbing with clean water.
Vinegar, hair gel, tomato sauce or coffee with sugar.	Use lemon juice, wipe with lukewarm water and rinse by dabbing with clean water.
Dye transfer and all other stains.	Use ethyl alcohol, then dab with water.

CLEANING THE INSTRUMENT PANEL AND INSTRUMENT CLUSTER LENS

WARNING



Do not use chemical solvents or strong detergents when cleaning the steering wheel or instrument panel to avoid contamination of the airbag system.

Note: Follow the same procedure as cleaning leather seats for cleaning leather instrument panels and leather interior trim surfaces. See **Cleaning Leather Seats** (page 326).

Clean the instrument panel and cluster lens with a clean, damp and soft cloth, then use a clean, dry and soft cloth to dry these areas.

- Avoid cleaners or polishes that increase the gloss of the upper portion of the instrument panel. The dull finish in this area helps protect you from undesirable windshield reflection.
- Do not use any household cleaning products or glass cleaners as these may damage the finish of the instrument panel, interior trim and cluster lens.

- Wash or wipe your hands clean if you have been in contact with certain products such as insect repellent and suntan lotion to avoid possible damage to the interior painted surfaces.
- Do not allow air fresheners and hand sanitizers to spill onto interior surfaces. If a spill occurs, wipe off immediately. Your warranty may not cover these damages.

If a staining liquid like coffee or juice has been spilled on the instrument panel or on interior trim surfaces:

1. Wipe up spilled liquid using a clean, soft cloth as quickly as possible.

Vehicle Care

2. Use Motorcraft Premium Leather and Vinyl Cleaner or a commercially available leather cleaning product for automotive interiors. Test any cleaner or stain remover on an inconspicuous area.
3. Alternatively, wipe the surface with a clean, soft cloth and a mild soap and water solution. Dry the area with a clean, soft cloth.
4. If necessary, apply more soap and water solution or cleaning product to a clean, soft cloth and press it onto the soiled area. Allow this to set at room temperature for 30 minutes.
5. Remove the soaked cloth, then with a clean, damp cloth, use a rubbing motion for 60 seconds on the soiled area.
6. Dry the area with a clean, soft cloth.

CLEANING LEATHER SEATS (if

Equipped)

Note: *Follow the same procedure as cleaning leather seats for cleaning leather instrument panels and leather interior trim surfaces.*

For routine cleaning, wipe the surface with a soft, damp cloth and a mild soap and water solution. Dry the area with a clean, soft cloth.

For cleaning and removing stains such as dye transfer, use Motorcraft Premium Leather and Vinyl Cleaner or a commercially available leather cleaning product for automotive interiors.

Note: *Test any cleaner or stain remover on an inconspicuous area.*

You should:

- Remove dust and loose dirt with a vacuum cleaner.
- Clean and treat spills and stains as soon as possible.

Do not use the following products as these may damage the leather:

- Oil and petroleum or silicone-based leather conditioners.
- Household cleaners.
- Alcohol solutions.
- Solvents or cleaners intended specifically for rubber, vinyl and plastics.

REPAIRING MINOR PAINT DAMAGE

Authorized dealers have touch-up paint to match your vehicle's color. Your vehicle color code is printed on a sticker on the front, left-hand side door jamb. Take your color code to your authorized dealer to make sure you get the correct color.

Before repairing minor paint damage, use a cleaner such as Motorcraft Bug and Tar Remover to remove particles such as bird droppings, tree sap, insect deposits, tar spots, road salt and industrial fallout.

Always read the instructions before using cleaning products.

Vehicle Care

CLEANING THE ALLOY WHEELS

Note: Do not apply a cleaning chemical to warm or hot wheel rims and covers.

Note: Some automatic car washes may cause damage to the finish on your wheel rims and covers.

Note: Industrial-strength or heavy-duty cleaners in combination with brush agitation to remove brake dust and dirt, could wear away the clear coat finish over a period time.

Note: Do not use hydrofluoric acid-based or high caustic-based wheel cleaners, steel wool, fuels or strong household detergents.

Note: If you intend parking your vehicle for an extended period after cleaning the wheels with a wheel cleaner, drive your vehicle for a few minutes before doing so. This will reduce the risk of increased corrosion of the brake discs.

Alloy wheels and wheel covers are coated with a clear coat paint finish. To maintain their condition we recommend that you:

- Clean the wheels weekly using Motorcraft Wheel and Tire Cleaner. Apply using manufacturer's instructions.
- Use a sponge to remove heavy deposits of dirt and brake dust accumulation.
- Rinse thoroughly with a strong stream of water when you have completed the cleaning process.
- To remove tar and grease, use Motorcraft Bug and Tar Remover.

VEHICLE STORAGE

If you plan on storing your vehicle for 30 days or more, read the following maintenance recommendations to make sure your vehicle stays in good operating condition.

We engineer and test all motor vehicles and their components for reliable, regular driving. Under various conditions, long-term storage may lead to degraded engine performance or failure unless you use specific precautions to preserve engine components.

General

- Store all vehicles in a dry, ventilated place.
- Protect from sunlight, if possible.
- If vehicles are stored outside, they require regular maintenance to protect against rust and damage.

Body

- Wash your vehicle thoroughly to remove dirt, grease, oil, tar or mud from exterior surfaces, rear-wheel housing and the underside of front fenders.
- Periodically wash your vehicle if it is stored in exposed locations.
- Touch-up exposed or primed metal to prevent rust.
- Cover chrome and stainless steel parts with a thick coat of auto wax to prevent discoloration. Re-wax as necessary when you wash your vehicle.
- Lubricate all hood, door and luggage compartment hinges and latches with a light grade oil.

Vehicle Care

- Cover interior trim to prevent fading.
- Keep all rubber parts free from oil and solvents.

Engine

- Change the engine oil and filter prior to storage because used engine oil contains contaminants which may cause engine damage.
- Start the engine every 15 days for a minimum of 15 minutes. Run at fast idle with the climate controls set to defrost until the engine reaches normal operating temperature.
- With your foot on the brake, shift through all the gears while the engine is running.
- We recommend that you change the engine oil before you use your vehicle again.

Fuel system

- Fill the fuel tank with high-quality fuel until the first automatic shutoff of the fuel pump nozzle.

Cooling system

- Protect against freezing temperatures.
- When removing your vehicle from storage, check coolant fluid level. Confirm that there are no cooling system leaks and that fluid is at the recommended level.

Battery

- Check and recharge as necessary. Keep connections clean.
- If storing your vehicle for more than 30 days without recharging the battery, we recommend that you disconnect the battery cables to maintain battery charge for quick starting.

Note: *It is necessary to reset memory features if battery cables are disconnected.*

Brakes

- Make sure the brakes and parking brake release fully.

Tires

- Maintain recommended air pressure.

Miscellaneous

- Make sure all linkages, cables, levers and pins under your vehicle are covered with grease to prevent rust.
- Move vehicles at least 25 ft (7.5 m) every 15 days to lubricate working parts and prevent corrosion.

Removing Vehicle From Storage

When your vehicle is ready to come out of storage, do the following:

- Wash your vehicle to remove any dirt or grease film build-up on window surfaces.
- Check windshield wipers for any deterioration.
- Check under the hood for any foreign material that may have collected during storage such as mice or squirrel nests.
- Check the exhaust for any foreign material that may have collected during storage.
- Check tire pressures and set tire inflation per the Tire Label.

Vehicle Care

- Check brake pedal operation. Drive your vehicle 15 ft (4.5 m) back and forth to remove rust build-up.
- Check fluid levels (including coolant, oil and gas) to make sure there are no leaks, and fluids are at recommended levels.
- If you remove the battery, clean the battery cable ends and check for damage.

Contact an authorized dealer if you have any concerns or issues.

Wheels and Tires

TIRE SEALANT AND INFLATOR KIT

Note: The temporary mobility kit contains enough sealant compound in the canister for one tire repair only. See your authorized Ford dealer for replacement sealant canisters.

The kit is located under the load floor in the trunk. The kit consists of an air compressor to re-inflate the tire and a canister of sealing compound that will effectively seal most punctures caused by nails or similar objects. This kit will provide a temporary tire repair allowing you to drive your vehicle up to 120 mi (200 km) at a maximum speed of 50 mph (80 km/h) to reach a tire service location.

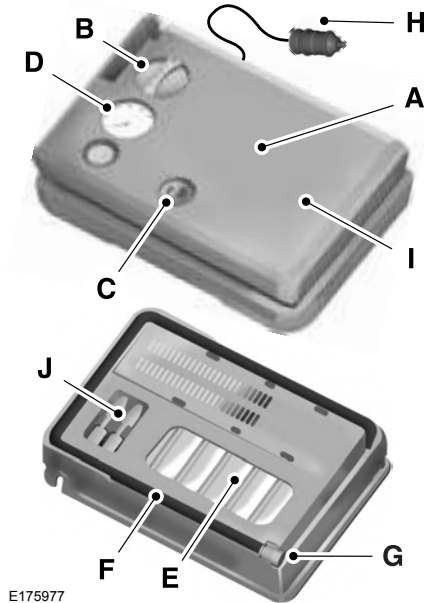

E175977

- A Air compressor (inside)
- B Selector switch
- C On and off button

- D Air pressure gauge
- E Sealant bottle and canister
- F Dual purpose hose: air and repair
- G Tire valve connector
- H Accessory power plug
- I Casing/housing
- J Bike/raft/sports ball adapters

General Information

WARNING



Failure to follow these guidelines could result in an increased risk of loss of vehicle control, injury or death.

Note: Do not use the kit if a tire has become severely damaged. Only punctures located within the tire tread can be sealed with the kit.

Do not attempt to repair punctures larger than ¼ inch (6 millimeters) or damage to the tire's sidewall. The tire may not completely seal.

Wheels and Tires

Loss of air pressure may adversely affect tire performance. For this reason:

Note: Do not drive the vehicle above 50 mph (80 km/h).

Note: Do not drive further than 120 mi (200 km). Drive only to the closest authorized Ford dealer or tire repair shop to have your tire inspected.

- Drive carefully and avoid abrupt steering maneuvers.
- Periodically monitor tire inflation pressure in the affected tire; if the tire is losing pressure, have the vehicle towed.
- Read the information in the Tips for Use of the Kit section to make sure safe operation of the kit and your vehicle.

Tips for Use of the Kit

To ensure safe operation of the kit:

- Read all instructions and cautions fully.
- Before operating the kit, make sure your vehicle is safely off the road and away from moving traffic. Turn on the hazard lights.

- Always set the parking brake to ensure the vehicle doesn't move unexpectedly.
- Do not remove any foreign objects, such as nails or screws, from the tire.
- When using the kit, leave the engine running (only if the vehicle is outdoors or in a well-ventilated area) so the compressor does not drain the vehicle's battery.
- Do not allow the compressor to operate continuously for more than 15 minutes. This will help prevent the compressor from overheating.
- Never leave the kit unattended during operation.
- Sealant compound contains latex. Those with latex sensitivities should use appropriate precautions to avoid an allergic reaction.
- Keep the kit away from children.
- Only use the kit when the ambient temperature is between -22°F (-30°C) and 158°F (70°C).

- Only use the sealing compound before the use-by date. The use-by date is on a label on the sealant canister and can be seen through the rectangular viewing window on the bottom of the compressor. Check the use-by date regularly and replace the canister after four years of non-use.
- Do not store the kit unsecured inside the passenger compartment of the vehicle as it may cause injury during a sudden stop or crash. Always store the kit in its original location.
- After sealant use, the tire pressure monitoring system sensor and valve stem on the wheel must be replaced by an authorized Ford dealer.
- Operating the kit could cause an electrical disturbance in radio, CD, and DVD player operation.



* When inflation only is required for a tire or other objects, the selector must be in the Air position.

Wheels and Tires

What to do when a Tire Is Punctured

A tire puncture within the tire's tread area can be repaired in two stages with the kit:

- In the first stage, the tire will be reinflated with a sealing compound and air. After the tire has been inflated, you will need to drive the vehicle about 3.7 mi (6 km) to distribute the sealant in the tire.
- In the second stage, you will need to check the tire pressure and adjust, if necessary, to the vehicle's specified tire inflation pressure.

First Stage: Reinflating the Tire with Sealing Compound and Air

WARNING

 Do not stand directly beside the tire while the compressor is operating. This could cause personal injury if the tire bursts.

Note: *If the tire does not inflate to the recommended tire pressure within 15 minutes, stop and call roadside assistance.*

WARNINGS

 Watch the sidewall of the tire when inflating. If any cracks, bumps or similar damage appears, switch the compressor off and let the air out by means of the pressure relief valve. Do not continue driving with this tire. This could cause loss of vehicle control.

 Do not run the engine when operating the air compressor unless the vehicle is outdoors or in a well-ventilated area.

Preparation: Park the vehicle in a safe, level and secure area, away from moving traffic.

Turn the hazard lights on. Apply the parking brake and turn the engine off. Inspect the flat tire for visible damage.

Sealant compound contains latex. Use appropriate precautions to avoid any allergic reactions.

Do not remove any foreign object that has pierced the tire. If a puncture is located in the tire sidewall, stop and call roadside assistance.

1. Remove the valve cap from the tire valve.

2. Unwrap the dual purpose hose (black tube) from the back of the compressor housing.
3. Fasten the hose to the tire valve by turning the connector clockwise. Tighten the connection securely.

Wheels and Tires

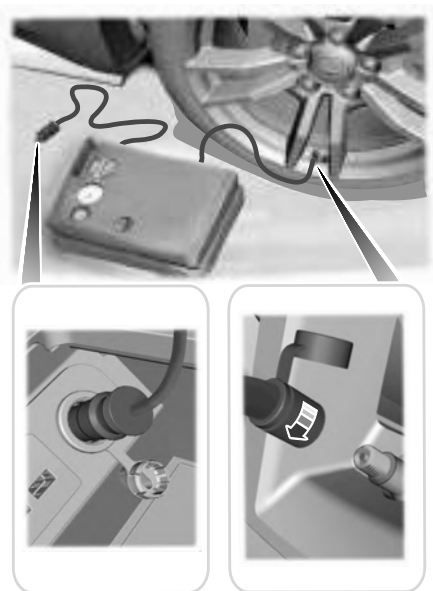

E175979

4. Plug the power cable into the 12-volt power point in the vehicle.

5. Remove the warning sticker found on the casing/housing and place it on the top of the instrument panel or the center of the dash.
6. Start the vehicle leave the engine running so the compressor does not drain the vehicle's battery.

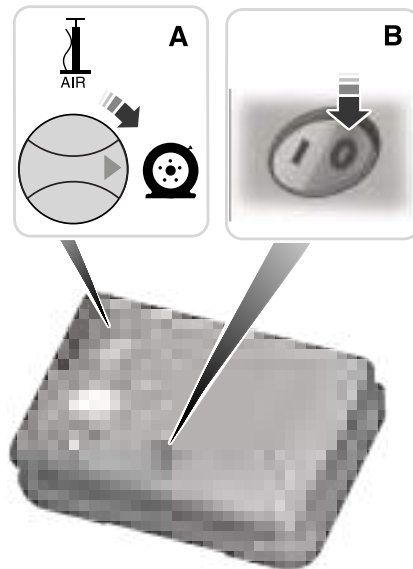

E175981

7. Turn dial (A) clockwise to the sealant position. Turn the kit on by pressing the on/off button (B).

Wheels and Tires

- Inflate the tire to the pressure listed on the tire label located on the driver's door or the door jamb area. The initial air pressure gauge reading may indicate a value higher than the label pressure while the sealing compound is being pumped into the tire. This is normal and should be no reason for concern. The pressure gauge reading will indicate the tire inflation pressure after about 30 seconds of operation. The final tire pressure should be checked with the compressor turned OFF in order to get an accurate pressure reading.

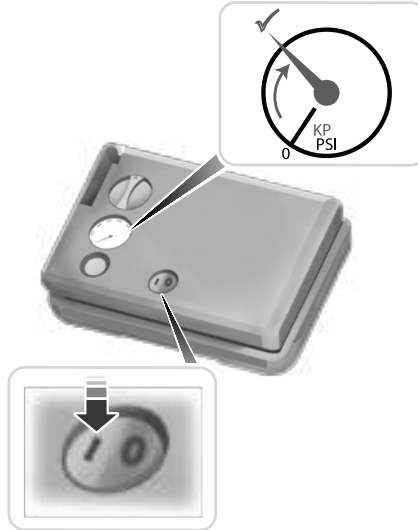

E175982

- When the recommended tire pressure is reached, turn off the kit, unplug the power cable, and disconnect the hose from the tire valve. Re-install the valve cap on the tire valve and return the kit to the stowage area.
- Immediately and cautiously, drive the vehicle 3.7 mi (6 km) to distribute the sealant evenly inside the tire. Do not exceed 50 mph (80 km/h).
- After 3.7 mi (6 km), stop and check the tire pressure. See Second stage: Checking tire pressure.

WARNING

 If you experience any unusual vibration, ride disturbance or noise while driving, reduce your speed until you can safely pull off to the side of the road and call for roadside assistance. Failure to do so could cause you to lose control of your vehicle and increase the risk of personal injury or death.

Wheels and Tires

Note: If you experience any unusual vibration, ride disturbance or noise while driving, do not proceed to the second stage of this operation.

Second Stage: Checking Tire Pressure

If you have injected sealant in the tire and the pressure is below 20 psi (1.4 bar), continue to the next step.

Note: If the tire does not inflate to the recommended tire pressure within 15 minutes, stop and call roadside assistance.

WARNING



The air compressor power plug may be hot after use. Allow it to cool before handling. Failure to do so could result in personal injury.

Check the air pressure of your tires as follows:



E175983

1. Remove the valve cap from the tire valve.
2. Firmly screw the air compressor hose onto the valve stem by turning clockwise.
3. Push and turn the dial clockwise to the air position.
4. If required, turn on the compressor and adjust the tire to the recommended inflation pressure shown on the tire label located on the driver's door or door jamb area. The tire pressure should be checked with the compressor turned OFF in order to get an accurate pressure reading.

5. Remove the hoses, re-install the valve cap on the tire and return the kit to the stowage area.

What to do after the Tire has been Sealed

WARNING



If you experience any unusual vibration, ride disturbance or noise while driving, reduce your speed until you can safely pull off to the side of the road and call for roadside assistance. Failure to do so could cause you to lose control of your vehicle and increase the risk of personal injury or death.

After using the kit to seal your tire, you will need to replace the sealant canister. Sealant canisters and spare parts can be obtained at an authorized Ford dealer. Empty sealant canisters may be disposed of at home. However, canisters still containing liquid sealant should be disposed of by your local authorized Ford dealer or tire dealer, or in accordance with local waste disposal regulation.

Wheels and Tires

Note: After the sealing compound has been used, the maximum vehicle speed is 50 mph (80 km/h) and the maximum driving distance is 120 mi (200 km). The sealed tire should be inspected immediately.

You can check the tire pressure any time within the 120 mi (200 km) by performing the steps listed previously in the Second stage: Checking Tire Pressure procedure.

Removal of the sealant canister from the kit

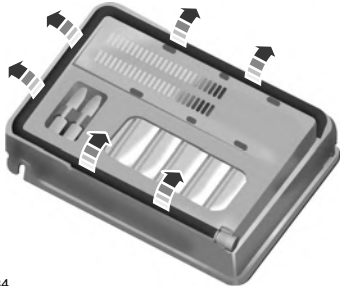

E175984

1. Unwrap the dual purpose hose (black tube) from the compressor housing.



E175985

2. Unwrap the power cord.



E175986

3. Remove the back cover.



E175987

4. Rotate the sealant canister up 90 degrees and pull away from casing/housing to remove.

Installation of the sealant canister to the kit

1. With the canister held perpendicular to the housing, insert the canister nozzle into the connector and push until seated.
2. Rotate the canister 90 degrees down into the housing/casing.

Wheels and Tires



E175988

3. Snap the back cover back into place.

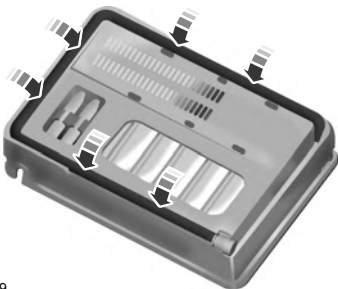

E175989

4. Wrap the dual purpose hose (black tube) around the channel on the bottom of the housing/casing.



E175990

5. Wrap the power cord around the housing and stow the accessory power plug into its storage area.

Note: *If you experience any difficulties with the removal or installation of the sealant canister, consult your authorized Ford dealer for assistance.*

Check and record the sealant compound's use-by date and make sure that it is replaced with a fresh canister after this date. The use-by date is on a label located on the sealant canister and can be seen through the rectangular viewing window on the bottom of the kit. Replace the sealant canister if not used after four years.

TIRE CARE

Important information for 245/40R19 low-profile tires and wheels If your vehicle is equipped with 245/40R19 tires, they are low-profile tires. These tires and wheels are designed to give your vehicle a sport appearance. With low-profile tires, you may notice an increase in road noise and faster tire wear, depending on road conditions and driving styles. Due to their design, low-profile tires and wheels are more prone to road damage from potholes, rough or unpaved roads, car wash rails and curb contact than standard tires and wheels.

Note: *Your vehicle's warranty does not cover these types of damage. Tires should always be kept at the correct inflation pressures and extra caution should be taken when operating on rough roads to avoid impacts that could cause wheel and tire damage.*

Wheels and Tires

Information About Uniform Tire Quality Grading



E142542

Tire Quality Grades apply to new pneumatic passenger car tires. The Quality grades can be found where applicable on the tire sidewall between tread shoulder and maximum section width. For example: **Treadwear 200 Traction AA Temperature A.**

These Tire Quality Grades are determined by standards that the United States Department of Transportation has set.

Tire Quality Grades apply to new pneumatic passenger car tires. They do not apply to deep tread, winter-type snow tires, space-saver or temporary use spare tires, light truck or LT type tires, tires with nominal rim diameters of 10 to 12 inches or limited production tires as defined in Title 49 Code of Federal Regulations Part 575.104 ©)(2).

U.S. Department of Transportation Tire quality grades: The U.S. Department of Transportation requires Ford Motor Company to give you the following information about tire grades exactly as the government has written it.

Treadwear

The treadwear grade is a comparative rating based on the wear rate of the tire when tested under controlled conditions on a specified government test course. For example, a tire graded 150 would wear 1 ½ times as well on the government course as a tire graded 100. The relative performance of tires

depends upon the actual conditions of their use, however, and may depart significantly from the norm due to variations in driving habits, service practices, and differences in road characteristics and climate.

Traction AA A B C

WARNING

 The traction grade assigned to this tire is based on straight-ahead braking traction tests, and does not include acceleration, cornering, hydroplaning or peak traction characteristics.

The traction grades, from highest to lowest are AA, A, B, and C. The grades represent the tire's ability to stop on wet pavement as measured under controlled conditions on specified government test surfaces of asphalt and concrete. A tire marked C may have poor traction performance.

Wheels and Tires

Temperature A B C

WARNING



The temperature grade for this tire is established for a tire that is properly inflated and not overloaded. Excessive speed, underinflation, or excessive loading, either separately or in combination, can cause heat buildup and possible tire failure.

The temperature grades are A (the highest), B and C, representing the tire's resistance to the generation of heat and its ability to dissipate heat when tested under controlled conditions on a specified indoor laboratory test wheel. Sustained high temperature can cause the material of the tire to degenerate and reduce tire life, and excessive temperature can lead to sudden tire failure. The grade C corresponds to a level of performance which all

passenger car tires must meet under the Federal Motor Vehicle Safety Standard No. 139. Grades B and A represent higher levels of performance on the laboratory test wheel than the minimum required by law.

Glossary of Tire Terminology

- **Tire label:** A label showing the original equipment tire sizes, recommended inflation pressure and the maximum weight the vehicle can carry.
- **Tire Identification Number:** A number on the sidewall of each tire providing information about the tire brand and manufacturing plant, tire size and date of manufacture. Also referred to as DOT code.
- **Inflation pressure:** A measure of the amount of air in a tire.
- **Standard load:** A class of P-metric or Metric tires designed to carry a maximum load at set pressure. For example: For P-metric tires 35 psi (2.4 bar) and for Metric tires 36 psi (2.5 bar). Increasing the inflation pressure beyond this pressure will not increase the tire's load carrying capability.
- **Extra load:** A class of P-metric or Metric tires designed to carry a heavier maximum load at 42 psi (2.9 bar). Increasing the inflation pressure beyond this pressure will not increase the tire's load carrying capability.
- **kPa:** Kilopascal, a metric unit of air pressure.
- **PSI:** Pounds per square inch, a standard unit of air pressure.
- **Cold tire pressure:** The tire pressure when the vehicle has been stationary and out of direct sunlight for an hour or more and prior to the vehicle being driven for 1.0 mi (1.6 km).

Wheels and Tires

- **Recommended inflation pressure:** The cold inflation pressure found on the Safety Compliance Certification Label (affixed to either the door hinge pillar, door-latch post, or the door edge that meets the door-latch post, next to the driver's seating position), or Tire Label located on the B-Pillar or the edge of the driver's door.
- **B-pillar:** The structural member at the side of the vehicle behind the front door
- **Bead area of the tire:** Area of the tire next to the rim.
- **Sidewall of the tire:** Area between the bead area and the tread.
- **Tread area of the tire:** Area of the perimeter of the tire that contacts the road when mounted on the vehicle.
- **Rim:** The metal support (wheel) for a tire or a tire and tube assembly upon which the tire beads are seated.

Information Contained on the Tire Sidewall

Both United States and Canada Federal regulations require tire manufacturers to place standardized information on the sidewall of all tires. This information identifies and describes the fundamental characteristics of the tire and also provides a U.S. DOT Tire Identification Number for safety standard certification and in case of a recall.

Information on P Type Tires

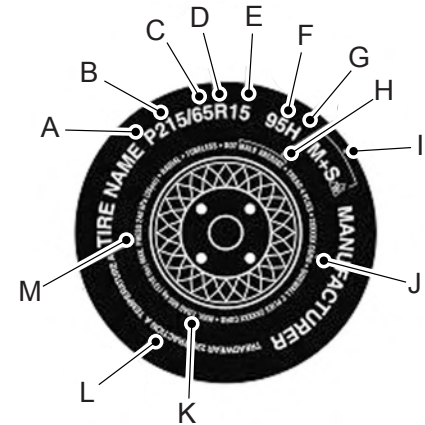

E142543

P215/65R15 95H is an example of a tire size, load index and speed rating. The definitions of these items are listed below. (Note that the tire size, load index and speed rating for your vehicle may be different from this example.)

Wheels and Tires

A. **P:** Indicates a tire, designated by the Tire and Rim Association, that may be used for service on cars, sport utility vehicles, minivans and light trucks. **Note:** If your tire size does not begin with a letter this may mean it is designated by either the European Tire and Rim Technical Organization or the Japan Tire Manufacturing Association.

B. **215:** Indicates the nominal width of the tire in millimeters from sidewall edge to sidewall edge. In general, the larger the number, the wider the tire.

C. **65:** Indicates the aspect ratio which gives the tire's ratio of height to width.

D. **R:** Indicates a radial type tire.

E. **15:** Indicates the wheel or rim diameter in inches. If you change your wheel size, you will have to purchase new tires to match the new wheel diameter.

F. **95:** Indicates the tire's load index. It is an index that relates to how much weight a tire can carry. You may find this information in your owner's manual. If not, contact a local tire dealer.

Note: *You may not find this information on all tires because it is not required by federal law.*

G. **H:** Indicates the tire's speed rating. The speed rating denotes the speed at which a tire is designed to be driven for extended periods of time under a standard condition of load and inflation pressure. The tires on your vehicle may operate at different conditions for load and inflation pressure. These speed ratings may need to be adjusted for the difference in conditions. The ratings range from 81 mph (130 km/h) to 186 mph (299 km/h). These ratings are listed in the following chart.

Note: *You may not find this information on all tires because it is not required by federal law.*

Letter rating	mph (km/h)
M	81 mph (130 km/h)
N	87 mph (140 km/h)
Q	99 mph (159 km/h)
R	106 mph (171 km/h)
S	112 mph (180 km/h)
T	118 mph (190 km/h)
U	124 mph (200 km/h)
H	130 mph (210 km/h)
V	149 mph (240 km/h)

Wheels and Tires

Letter rating	mph (km/h)
W	168 mph (270 km/h)
Y	186 mph (299 km/h)

Note: For tires with a maximum speed capability over 149 mph (240 km/h), tire manufacturers sometimes use the letters ZR. For those with a maximum speed capability over 186 mph (299 km/h), tire manufacturers always use the letters ZR.

H. U.S. DOT Tire Identification Number:

This begins with the letters DOT and indicates that the tire meets all federal standards. The next two numbers or letters are the plant code designating where it was manufactured, the next two are the tire size code and the last four numbers represent the week and year the tire was built. For example, the numbers 317 mean the 31st week of 1997. After 2000 the numbers go to four

digits. For example, 2501 means the 25th week of 2001. The numbers in between are identification codes used for traceability. This information is used to contact customers if a tire defect requires a recall.

I. **M+S or M/S:** Mud and Snow, or

AT: All Terrain, or

AS: All Season.

J. Tire Ply Composition and Material

Used: Indicates the number of plies or the number of layers of rubber-coated fabric in the tire tread and sidewall. Tire manufacturers also must indicate the ply materials in the tire and the sidewall, which include steel, nylon, polyester, and others.

K. **Maximum Load:** Indicates the maximum load in kilograms and pounds that can be carried by the tire. See the Safety Compliance Certification Label (affixed to either the door hinge pillar, door-latch post, or the door edge that meets the door-latch post, next to the driver's seating position), for the correct tire pressure for your vehicle.

L. Treadwear, Traction and Temperature Grades:

Wheels and Tires

- **Treadwear** The treadwear grade is a comparative rating based on the wear rate of the tire when tested under controlled conditions on a specified government test course. For example, a tire graded 150 would wear one and one-half times as well on the government course as a tire graded 100.
- **Traction:** The traction grades, from highest to lowest are AA, A, B, and C. The grades represent the tire's ability to stop on wet pavement as measured under controlled conditions on specified government test surfaces of asphalt and concrete. A tire marked C may have poor traction performance.
- **Temperature:** The temperature grades are A (the highest), B and C, representing the tire's resistance to the generation of heat and its ability to dissipate heat when tested under controlled conditions on a specified indoor laboratory test wheel.

M. Maximum Inflation Pressure: Indicates the tire manufacturers' maximum permissible pressure or the pressure at which the maximum load can be carried by the tire. This pressure is normally higher than the vehicle manufacturer's recommended cold inflation pressure which can be found on the Safety Compliance Certification Label (affixed to either the door hinge pillar, door-latch post, or the door edge that meets the door-latch post, next to the driver's seating position), or Tire Label which is located on the B-Pillar or the edge of the driver's door. The cold inflation pressure should never be set lower than the recommended pressure on the vehicle label.

The tire suppliers may have additional markings, notes or warnings such as standard load or radial tubeless.

Additional Information Contained on the Tire Sidewall for LT Type Tires

Note: *Tire Quality Grades do not apply to this type of tire.*

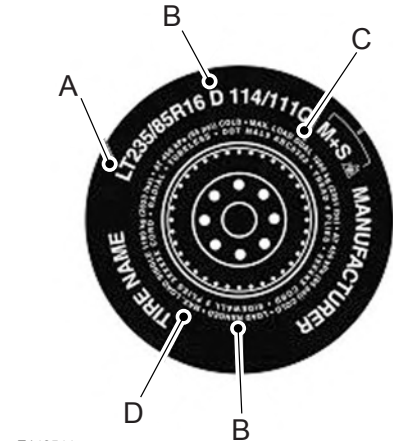

E142544

LT type tires have some additional information beyond those of P type tires; these differences are described below.

A. LT: Indicates a tire, designated by the Tire and Rim Association, that is intended for service on light trucks.

Wheels and Tires

B. Load Range and Load Inflation

Limits: Indicates the tire's load-carrying capabilities and its inflation limits.

C. Maximum Load Dual lb (kg) at psi

(kPa) cold: Indicates the maximum load and tire pressure when the tire is used as a dual; defined as four tires on the rear axle (a total of six or more tires on the vehicle).

D. Maximum Load Single lb (kg) at psi

(kPa) cold: Indicates the maximum load and tire pressure when the tire is used as a single; defined as two tires (total) on the rear axle.

Information on T Type Tires

T145/80D16 is an example of a tire size.

Note: *The temporary tire size for your vehicle may be different from this example. Tire Quality Grades do not apply to this type of tire.*



E142545

T type tires have some additional information beyond those of P type tires; these differences are described below:

A. **T:** Indicates a type of tire, designated by the Tire and Rim Association, that is intended for temporary service on cars, sport utility vehicles, minivans and light trucks.

B. **145:** Indicates the nominal width of the tire in millimeters from sidewall edge to sidewall edge. In general, the larger the number, the wider the tire.

C. **80:** Indicates the aspect ratio which gives the tire's ratio of height to width. Numbers of 70 or lower indicate a short sidewall.

D. **D:** Indicates a diagonal type tire.

R: Indicates a radial type tire.

E. **16:** Indicates the wheel or rim diameter in inches. If you change your wheel size, you will have to purchase new tires to match the new wheel diameter.

Wheels and Tires

Location of the Tire Label

You will find a Tire Label containing tire inflation pressure by tire size and other important information located on the B-Pillar or the edge of the driver's door.

Inflating Your Tires

Safe operation of your vehicle requires that your tires are properly inflated. Remember that a tire can lose up to half of its air pressure without appearing flat.

Every day before you drive, check your tires. If one looks lower than the others, use a tire gauge to check pressure of all tires and adjust if required.

At least once a month and before long trips, inspect each tire and check the tire pressure with a tire gauge (including spare, if equipped). Inflate all tires to the inflation pressure recommended by Ford Motor Company.

You are strongly urged to buy a reliable tire pressure gauge, as automatic service station gauges may be inaccurate. Ford recommends the use of a digital or dial-type tire pressure gauge rather than a stick-type tire pressure gauge.

Use the recommended cold inflation pressure for optimum tire performance and wear. Under-inflation or over-inflation may cause uneven treadwear patterns

WARNING



Under-inflation is the most common cause of tire failures and may result in severe tire cracking, tread separation or blowout, with unexpected loss of vehicle control and increased risk of injury. Under-inflation increases sidewall flexing and rolling resistance, resulting in heat buildup and internal damage to the tire. It also may result in unnecessary tire stress, irregular wear, loss of vehicle control and accidents. A tire can lose up to half of its air pressure and not appear to be flat!

Always inflate your tires to the Ford recommended inflation pressure even if it is less than the maximum inflation pressure information found on the tire. The Ford recommended tire inflation pressure is found on the Safety Compliance Certification Label (affixed to either the door hinge pillar, door-latch post, or the door edge that meets the door-latch post, next to the driver's seating position), or Tire Label which is located on the B-Pillar or the edge of the driver's door. Failure to follow the tire pressure recommendations can cause uneven treadwear patterns and adversely affect the way your vehicle handles

Maximum Inflation Pressure is the tire manufacturer's maximum permissible pressure and the pressure at which the maximum load can be carried by the tire. This pressure is normally higher than the manufacturer's recommended cold inflation pressure which can be found on the Safety Compliance Certification Label (affixed to either the door hinge pillar, door-latch post, or the door edge

Wheels and Tires

that meets the door-latch post, next to the driver's seating position), or Tire Label which is located on the B-Pillar or the edge of the driver's door. The cold inflation pressure should never be set lower than the recommended pressure on the Safety Compliance Certification Label or Tire Label.

When weather temperature changes occur, tire inflation pressures also change. A 10°F (6°C) temperature drop can cause a corresponding drop of 1 psi (0.07 bar) in inflation pressure. Check your tire pressures frequently and adjust them to the proper pressure which can be found on the Safety Compliance Certification Label or Tire Label.

To check the pressure in your tire(s):

1. Make sure the tires are cool, meaning they are not hot from driving even a mile.

Note: *If you are checking tire pressure when the tire is hot, (for example driven more than 1.0 mi (1.6 km), never bleed or reduce air pressure. The tires are hot from driving and it is normal for pressures to increase above recommended cold pressures. A hot tire at or below recommended cold inflation pressure could be significantly under-inflated.*

Note: *If you have to drive a distance to get air for your tire(s), check and record the tire pressure first and add the appropriate air pressure when you get to the pump. It is normal for tires to heat up and the air pressure inside to go up as you drive.*

2. Remove the cap from the valve on one tire, then firmly press the tire gauge onto the valve and measure the pressure.
3. Add enough air to reach the recommended air pressure.

Note: *If you overfill the tire, release air by pressing on the metal stem in the center of the valve. Then recheck the pressure with your tire gauge.*

4. Replace the valve cap.
5. Repeat this procedure for each tire, including the spare.

Note: *Some spare tires operate at a higher inflation pressure than the other tires. For T type mini-spare tires, see the Dissimilar spare wheel and tire assembly information for a description. Store and maintain at 60 psi (4.15 bar). For full-size and dissimilar spare tires, see the Dissimilar spare wheel and tire assembly information for a description. Store and maintain at the higher of the front and rear inflation pressure as shown on the Tire Label.*

6. Visually inspect the tires to make sure there are no nails or other objects embedded that could poke a hole in the tire and cause an air leak.

Wheels and Tires

7. Check the sidewalls to make sure there are no gouges, cuts or bulges.

Inspecting Your Tires and Wheel Valve Stems

Periodically inspect the tire treads for uneven or excessive wear and remove objects such as stones, nails or glass that may be wedged in the tread grooves. Check the tire and valve stems for holes, cracks, or cuts that may permit air leakage and repair or replace the tire and replace the valve stem. Inspect the tire sidewalls for cracking, cuts, bruises and other signs of damage or excessive wear. If internal damage to the tire is suspected, have the tire demounted and inspected in case it needs to be repaired or replaced. For your safety, tires that are damaged or show signs of excessive wear should not be used because they are more likely to blow out or fail.

Improper or inadequate vehicle maintenance can cause tires to wear abnormally. Inspect all your tires, including the spare, frequently, and replace them if one or more of the following conditions exist:

Tire Wear



E142546

When the tread is worn down to 0.08 in (2 mm), tires must be replaced to help prevent your vehicle from skidding and hydroplaning. Built-in treadwear indicators, or wear bars, which look like narrow strips of smooth rubber across the tread will appear on the tire when the tread is worn down to 0.08 in (2 mm).

When the tire tread wears down to the same height as these wear bars, the tire is worn out and must be replaced.

Damage

Periodically inspect the tire treads and sidewalls for damage (such as bulges in the tread or sidewalls, cracks in the tread groove and separation in the tread or sidewall). If damage is observed or suspected have the tire inspected by a tire professional. Tires can be damaged during off-road use, so inspection after off-road use is also recommended.

Wheels and Tires

Age

WARNINGS

 Tires degrade over time depending on many factors such as weather, storage conditions, and conditions of use (load, speed, inflation pressure) the tires experience throughout their lives.

 In general, tires should be replaced after six years regardless of tread wear. However, heat caused by hot climates or frequent high loading conditions can accelerate the aging process and may require tires to be replaced more frequently.

You should replace your spare tire when you replace the road tires or after six years due to aging even if it has not been used.

U.S. DOT Tire Identification Number

Both U.S. and Canada Federal regulations require tire manufacturers to place standardized information on the sidewall of all tires. This information identifies and describes the fundamental characteristics of the tire and also provides a U.S. DOT Tire Identification Number for safety standard certification and in case of a recall.

This begins with the letters DOT and indicates that the tire meets all federal standards. The next two numbers or letters are the plant code designating where it was manufactured, the next two are the tire size code and the last four numbers represent the week and year the tire was built. For example, the numbers 317 mean the 31st week of 1997. After 2000 the numbers go to four digits. For example, 2501 means the 25th week of 2001. The numbers in between are identification codes used for traceability. This information is used to contact customers if a tire defect requires a recall.

Tire Replacement Requirements

Your vehicle is equipped with tires designed to provide a safe ride and handling capability.

WARNINGS

 Only use replacement tires and wheels that are the same size, load index, speed rating and type (such as P-metric versus LT-metric or all-season versus all-terrain) as those originally provided by Ford. The recommended tire and wheel size may be found on either the Safety Compliance Certification Label (affixed to either the door hinge pillar, door-latch post, or the door edge that meets the door-latch post, next to the driver's seating position), or the Tire Label which is located on the B-Pillar or edge of the driver's door. If this information is not found on these labels then you should contact your authorized dealer as soon as possible. Use of any tire or wheel not recommended by Ford can affect the safety and performance of your vehicle, which could result in an increased risk

Wheels and Tires

WARNINGS

of loss of vehicle control, vehicle rollover, personal injury and death. Additionally the use of non-recommended tires and wheels could cause steering, suspension, axle, transfer case or power transfer unit failure. If you have questions regarding tire replacement, contact your authorized dealer as soon as possible.



To reduce the risk of serious injury, when mounting replacement tires and wheels, you should not exceed the maximum pressure indicated on the sidewall of the tire to set the beads without additional precautions listed below. If the beads do not seat at the maximum pressure indicated, re-lubricate and try again.

When inflating the tire for mounting pressures up to 20 psi (1.38 bar) greater than the maximum pressure on the tire sidewall, the following precautions must be taken to protect the person mounting the tire:

WARNINGS

1. Make sure that you have the correct tire and wheel size.
2. Lubricate the tire bead and wheel bead seat area again.
3. Stand at a minimum of 12 ft (3.66 m) away from the wheel and tire assembly.
4. Use both eye and ear protection.

For a mounting pressure more than 20 psi (1.38 bar) greater than the maximum pressure, a Ford dealer or other tire service professional should do the mounting.

Always inflate steel carcass tires with a remote air fill with the person inflating standing at a minimum of 12 ft (3.66 m) away from the wheel and tire assembly.

Important: Remember to replace the wheel valve stems when the road tires are replaced on your vehicle

It is recommended that the two front tires or two rear tires generally be replaced as a pair.

The tire pressure sensors mounted in the wheels (originally installed on your vehicle) are not designed to be used in aftermarket wheels.

The use of wheels or tires not recommended by Ford Motor Company may affect the operation of your tire pressure monitoring system.

If the tire pressure monitoring system indicator is flashing, your system is malfunctioning. Your replacement tire might be incompatible with your tire pressure monitoring system, or some component of the system may be damaged.

Wheels and Tires

Safety Practices

WARNINGS



If your vehicle is stuck in snow, mud or sand, do not rapidly spin the tires; spinning the tires can tear the tire and cause an explosion. A tire can explode in as little as three to five seconds.



Do not spin the wheels at over 34 mph (55 km/h). The tires may fail and injure a passenger or bystander.

Driving habits have a great deal to do with your tire mileage and safety.

- Observe posted speed limits
- Avoid fast starts, stops and turns
- Avoid potholes and objects on the road
- Do not run over curbs or hit the tire against a curb when parking

Highway Hazards

No matter how carefully you drive there is always the possibility that you may eventually have a flat tire on the highway. Drive slowly to the closest safe area out of traffic. This may further damage the flat tire, but your safety is more important.

If you feel a sudden vibration or ride disturbance while driving, or you suspect your tire or vehicle has been damaged, immediately reduce your speed. Drive with caution until you can safely pull off the road. Stop and inspect the tires for damage. If a tire is under-inflated or damaged, deflate it, remove the wheel and replace it with your spare tire and wheel (if provided). If you cannot detect a cause, have the vehicle towed to the nearest repair facility or tire dealer to have the vehicle inspected.

Tire and Wheel Alignment

A bad jolt from hitting a curb or pothole can cause the front end of your vehicle to become misaligned or cause damage to your tires. If your vehicle seems to pull to one side when you're driving, the wheels may be out of alignment. Have an authorized dealer check the wheel alignment periodically.

Wheel misalignment in the front or the rear can cause uneven and rapid treadwear of your tires and should be corrected by an authorized dealer. Front-wheel drive vehicles and those with an independent rear suspension (if equipped) may require alignment of all four wheels.

The tires should also be balanced periodically. An unbalanced tire and wheel assembly may result in irregular tire wear.

Wheels and Tires

Tire Rotation

Note: If your tires show uneven wear ask an authorized dealer to check for and correct any wheel misalignment, tire imbalance or mechanical problem involved before tire rotation.

Note: Your vehicle may be equipped with a dissimilar spare wheel and tire assembly. A dissimilar spare wheel and tire assembly is defined as a spare wheel and tire assembly that is different in brand, size or appearance from the road tires and wheels. If you have a dissimilar spare wheel and tire assembly it is intended for temporary use only and should not be used in a tire rotation.

Note: After having your tires rotated, inflation pressure must be checked and adjusted to the vehicle requirements.

Rotating your tires at the recommended interval (as indicated in the Scheduled Maintenance chapter) will help your tires wear more evenly, providing better tire performance and longer tire life.

Front-wheel drive and all-wheel drive vehicles (front tires on the left side of the diagram)

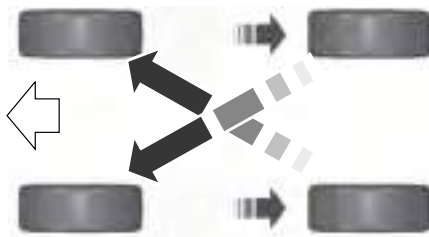

E142547

All vehicles with directional tires (front tires on the left of the diagram)

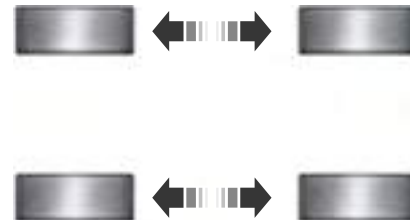

E147237

Sometimes irregular tire wear can be corrected by rotating the tires.

Summer Tires

Your Ford vehicle may be equipped with summer tires to provide superior performance on wet and dry roads. Summer tires do not have the Mud and Snow (M+S or M/S) tire traction rating on the tire side wall. Since summer tires do not have the same traction performance as All-season or Snow tires, Ford does not recommend using summer tires when temperatures drop to approximately 45°F (7°C) or below

Wheels and Tires

(depending on tire wear and environmental conditions) or in snow and ice conditions. Like any tire, summer tire performance is affected by tire wear and environmental conditions. If you must drive in those conditions, Ford recommends using Mud and Snow (M+S, M/S), All-season or Snow tires.

USING SUMMER TIRES

Summer tires provide superior performance on wet and dry roads. Summer tires do not have the Mud and Snow (M+S or M/S) tire traction rating on the tire side wall. Since summer tires do not have the same traction performance as All-season or Snow tires, we do not recommend using summer tires when temperatures drop to approximately 45°F (7°C) or below (depending on tire wear and environmental conditions) or in snow and ice conditions. Like any tire, summer tire performance is affected by tire wear and environmental conditions. If you must drive in those conditions, we recommend using Mud and Snow (M+S, M/S), All-season or Snow tires.

Always store your summer tires indoors at temperatures above 20°F (-7°C). The rubber compounds used in these tires lose flexibility and may develop surface cracks in the tread area at temperatures below 20°F (-7°C). If the tires have been subjected to 20°F (-7°C) or less, warm them in a heated space to at least 40°F (5°C) for at least 24 hours before installing them on a vehicle, or moving the vehicle with the tires installed, or checking tire inflation. Do not place tires near heaters or heating devices used to warm the room where the tires are stored. Do not apply heat or blow heated air directly on the tires. Always inspect the tires after storage periods and before use.

USING SNOW CHAINS

WARNING



Snow tires must be the same size, load index, and speed rating as those originally provided by Ford. Use of any tire or wheel not recommended by Ford can affect the safety and performance of your vehicle, which could result in an increased risk of loss of vehicle control, vehicle rollover, personal injury, and death. Additionally, the use of non-recommended tires and wheels could cause steering, suspension, axle, transfer case, or power transfer unit failure. It is also strongly advised to follow the Ford recommended tire inflation pressure found on the Safety Compliance Certification Label (affixed to either the door hinge pillar, door-latch post, or the door edge that meets the door-latch post, next to the driver's seating position), or Tire Label which is located on the B-Pillar or the edge of the driver door. Failure to follow the tire pressure recommendations can cause uneven treadwear patterns and adversely affect the way your vehicle handles.

Wheels and Tires

The tires on your vehicle may have all-weather treads to provide traction in rain and snow. However, in some climates you may need to use snow chains.

Your vehicle may not be compatible with snow chain or cable usage with the factory-fitted wheels and tires. Only certain chains or snow cables have been approved by Ford as safe for use on your vehicle with the following tire size: 225/55R17. You should only install chains or cables sized at 10 mm or less in dimension as measured on the sidewall of your tire. Not all S-class snow chains meet these restrictions. Chains of this size restriction will include a tensioning device. The chains should be mounted in pairs on the front tires only. If you need to use chains, it is recommended that steel wheels (of the same size and specification) be used, as chains may chip aluminum wheels.

Follow these guidelines when using traction devices:

- If possible, avoid fully loading your vehicle
- Purchase chains or cables from a manufacturer that clearly labels body to tire dimension restrictions.
- When driving with snow chains or cables, do not exceed 30 mph (48 km/h) or the maximum speed recommended by the chain manufacturer; whichever is less.
- Drive cautiously. If you hear the chains or cables rub or bang against the vehicle, stop and retighten them. If this does not work, remove the chains or cables and prevent vehicle damage.
- Remove the chains or cables when they are no longer needed. Do not use the chains or cables on dry roads.
- If a temporary spare tire is mounted on your vehicle, do not use snow chains on the axle with the temporary spare tire.

If you have any questions regarding snow tires or snow chains, please contact your authorized dealer.

TIRE PRESSURE MONITORING SYSTEM

WARNING



The tire pressure monitoring system is not a substitute for manually checking tire pressures. You should periodically check tire pressures using a pressure gauge. Failure to correctly maintain tire pressures could increase the risk of tire failure, loss of control, vehicle rollover and personal injury.



Each tire, including the spare (if provided), should be checked monthly when cold and inflated to the inflation pressure recommended by the vehicle manufacturer on the vehicle placard or tire inflation pressure label. (If your vehicle has tires of a different size than the size indicated on the vehicle placard or tire inflation pressure label, you should determine the proper tire inflation pressure for those tires.)

Wheels and Tires

As an added safety feature, your vehicle has been equipped with a Tire Pressure Monitoring System (TPMS) that illuminates a low tire pressure telltale when one or more of your tires is significantly under-inflated. Accordingly, when the low tire pressure telltale illuminates, you should stop and check your tires as soon as possible, and inflate them to the proper pressure. Driving on a significantly under-inflated tire causes the tire to overheat and can lead to tire failure. Under-inflation also reduces fuel efficiency and tire tread life, and may affect the vehicle's handling and stopping ability.

Please note that the TPMS is not a substitute for proper tire maintenance, and it is the driver's responsibility to maintain correct tire pressure, even if under-inflation has not reached the level to trigger illumination of the TPMS low tire pressure telltale.

Your vehicle has also been equipped with a TPMS malfunction indicator to indicate when the system is not operating properly. The TPMS malfunction indicator is combined with the low tire pressure telltale. When the system detects a malfunction, the telltale will flash for approximately one minute and then remain continuously illuminated. This sequence will continue upon subsequent vehicle start-ups as long as the malfunction exists.

When the malfunction indicator is illuminated, the system may not be able to detect or signal low tire pressure as intended. TPMS malfunctions may occur for a variety of reasons, including the installation of replacement or alternate tires or wheels on the vehicle that prevent the TPMS from functioning properly. Always check the TPMS malfunction telltale after replacing one or more tires or wheels on your vehicle to ensure that the replacement or alternate tires and wheels allow the TPMS to continue to function properly.

The tire pressure monitoring system complies with part 15 of the FCC rules and with RSS-210 of Industry Canada. Operation is subject to the following two conditions: (1) This device may not cause harmful interference, and (2) This device must accept any interference received, including interference that may cause undesired operation.

Changing Tires With a Tire Pressure Monitoring System



E142549

Wheels and Tires

Note: Each road tire is equipped with a tire pressure sensor located inside the wheel and tire assembly cavity. The pressure sensor is attached to the valve stem. The pressure sensor is covered by the tire and is not visible unless the tire is removed. Take care when changing the tire to avoid damaging the sensor

You should always have your tires serviced by an authorized dealer.

Check the tire pressure periodically (at least monthly) using an accurate tire gauge. See *Inflating Your Tires* in this chapter.

Understanding Your Tire Pressure Monitoring System

The tire pressure monitoring system measures pressure in your four road tires and sends the tire pressure readings to your vehicle.



E229422

The low tire pressure warning light will turn on if the tire pressure is significantly low. Once the light is illuminated, your tires are under-inflated and need to be inflated to the manufacturer's recommended tire pressure. Even if the light turns on and a short time later turns off, your tire pressure still needs to be checked.

When Your Temporary Spare Tire is Installed

When one of your road tires needs to be replaced with the temporary spare, the system will continue to identify an issue to remind you that the damaged road wheel and tire assembly needs to be repaired and put back on your vehicle.

To restore the full function of the tire pressure monitoring system, have the damaged road wheel and tire assembly repaired and remounted on your vehicle.

When You Believe Your System is Not Operating Properly

The main function of the tire pressure monitoring system is to warn you when your tires need air. It can also warn you in the event the system is no longer capable of functioning as intended. See the following chart for information concerning your tire pressure monitoring system:

Wheels and Tires

Low tire pressure warning light	Possible cause	Customer action required
Solid warning light	Tire(s) under-inflated	Make sure tires are at the proper pressure. See Inflating your tires in this chapter. After inflating your tires to the manufacturer's recommended pressure as shown on the Tire Label (located on the edge of driver's door or the B-Pillar), the vehicle must be driven for at least two minutes over 20 mph (32 km/h) before the light turns off.
	Spare tire in use	Repair the damaged road wheel and tire assembly and reinstall it on the vehicle to restore system function. For a description on how the system functions, see When your temporary spare tire is installed in this section.
	TPMS malfunction	If the tires are properly inflated and the spare tire is not in use but the light remains on, contact your authorized dealer as soon as possible.
Flashing warning light	Spare tire in use	Repair the damaged road wheel and tire assembly and reinstall it on the vehicle to restore system function. For a description on how the system functions, see When your temporary spare tire is installed in this section.
	TPMS malfunction	If the tires are properly inflated and the spare tire is not in use but the light remains on, contact your authorized dealer as soon as possible.

Wheels and Tires

When Inflating Your Tires

When putting air into your tires (such as at a gas station or in your garage), the tire pressure monitoring system may not respond immediately to the air added to your tires.

It may take up to two minutes of driving over 20 mph (32 km/h) for the light to turn off after you have filled your tires to the recommended inflation pressure

How Temperature Affects Your Tire Pressure

The tire pressure monitoring system monitors tire pressure in each pneumatic tire. While driving in a normal manner, a typical passenger tire inflation pressure may increase about 2 to 4 psi (14 to 28 kPa) from a cold start situation. If the vehicle is stationary overnight with the outside temperature significantly lower than the daytime temperature, the tire pressure may decrease about 3 psi (21 kPa) for a drop of 30°F (17°C) in ambient temperature. This lower pressure value may be detected by the tire pressure monitoring system as being significantly lower than the recommended

inflation pressure and activate the system warning light for low tire pressure. If the low tire pressure warning light is on, visually check each tire to verify that no tire is flat. If one or more tires are flat, repair as necessary. Check the air pressure in the road tires. If any tire is under-inflated, carefully drive the vehicle to the nearest location where air can be added to the tires. Inflate all the tires to the recommended inflation pressure.

CHANGING A ROAD WHEEL

WARNINGS



The use of tire sealant may damage your tire pressure monitoring system and should only be used in roadside emergencies. If you must use a sealant, the Ford Tire Mobility Kit sealant should be used. The tire pressure monitoring system sensor and valve stem on the wheel must be replaced by an authorized dealer after use of the sealant.

WARNINGS



If the tire pressure monitor sensor becomes damaged, it will no longer function. See **Tire Pressure Monitoring System** (page 353).

Note: *The tire pressure monitoring system indicator light will illuminate when the spare tire is in use. To restore the full function of the monitoring system, all road wheels equipped with tire pressure monitoring sensors must be mounted on the vehicle.*

If you get a flat tire while driving, do not apply the brake heavily. Instead, gradually decrease your speed. Hold the steering wheel firmly and slowly move to a safe place on the side of the road.

Have a flat serviced by an authorized dealer in order to prevent damage to the tire pressure monitoring system sensors. See **Tire Pressure Monitoring System** (page 353). Replace the spare tire with a road tire as soon as possible. During repairing or replacing of the flat tire, have an authorized dealer inspect the tire pressure monitoring system sensor for damage.

Wheels and Tires

Dissimilar Spare Wheel and Tire Assembly Information

WARNING



Failure to follow these guidelines could result in an increased risk of loss of vehicle control, injury or death.

If you have a dissimilar spare wheel and tire, then it is intended for temporary use only. This means that if you need to use it, you should replace it as soon as possible with a road wheel and tire assembly that is the same size and type as the road tires and wheels that were originally provided by Ford. If the dissimilar spare tire or wheel is damaged, it should be replaced rather than repaired.

Important Use of Spare Wheel

A dissimilar spare wheel and tire assembly is defined as a spare wheel and tire assembly that is different in brand, size or appearance from the road tires and wheels and can be one of three types:

1. T-type mini-spare.
2. Full-size dissimilar spare with label on wheel.
3. Full-size dissimilar spare without label on wheel.

This spare tire begins with the letter T for tire size and may have Temporary Use Only molded in the sidewall.

This spare tire has a label on the wheel that states: THIS WHEEL AND TIRE ASSEMBLY FOR TEMPORARY USE ONLY.

Driving with a T-type Mini-spare or Full-size Dissimilar Spare With Label on Wheel

Do not:

- Exceed 50 mph (80 km/h).
- Load the vehicle beyond maximum vehicle load rating listed on the Safety Compliance Label.

- Tow a trailer.
- Use snow chains on the end of the vehicle with the dissimilar spare tire.
- Use more than one dissimilar spare tire at a time.
- Use commercial car washing equipment.
- Try to repair the dissimilar spare tire.

Use of the above dissimilar spare wheel at any one wheel location can lead to impairment of the following:

- Handling, stability and braking performance.
- Comfort and noise.
- Ground clearance and parking at curbs.
- Winter weather driving capability.
- Wet weather driving capability.
- All-wheel driving capability (if applicable).

Driving With a Full-size Dissimilar Spare Wheel and Tire Assembly

Do not:

- Exceed 70 mph (113 km/h).
- Use more than one dissimilar spare wheel and tire assembly at a time.

Wheels and Tires

- Use commercial car washing equipment.
- Use snow chains on the end of the vehicle with the dissimilar spare wheel and tire assembly.

Use of the above dissimilar spare wheel at any one wheel location can lead to impairment of the following:

- Handling, stability and braking performance.
- Comfort and noise.
- Ground clearance and parking at curbs.
- Winter weather driving capability.
- Wet weather driving capability.
- All-wheel driving capability.

Give additional caution to the following when driving with the full-size dissimilar spare wheel and tire assembly:

- Towing a trailer.
- Driving vehicles equipped with a camper body.
- Driving vehicles with a load on the cargo rack.

Drive cautiously when using a full-size dissimilar spare wheel and tire assembly and seek service as soon as possible.

Changing a Road Wheel Procedure (If Equipped)

WARNINGS

 When one of the front wheels is off the ground, the transmission alone will not prevent the vehicle from moving or slipping off the jack, even if the transmission is in park (P).

 To help prevent your vehicle from moving when you change a tire, be sure to place the transmission in park (P), set the parking brake and block (in both directions) the wheel that is diagonally opposite (other side and end of the vehicle) to the tire being changed.

 Never get underneath a vehicle that is supported only by a jack. If your vehicle slips off the jack, you or someone else could be seriously injured.

WARNINGS

 Do not attempt to change a tire on the side of the vehicle close to moving traffic. Pull far enough off the road to avoid the danger of being hit when operating the jack or changing the wheel.

 Always use the jack provided as original equipment with your vehicle. If using a jack other than the one provided as original equipment with your vehicle, make sure the jack capacity is adequate for the vehicle weight, including any vehicle cargo or modifications.

Note: *Passengers should not remain in your vehicle when the vehicle is being jacked.*

1. Park on a level surface, set the parking brake and activate the hazard flashers.
2. Place the transmission in park (P) and turn the engine off. For vehicles with a manual transmission, place the transmission in reverse [®]) after the engine is turned off.

Wheels and Tires

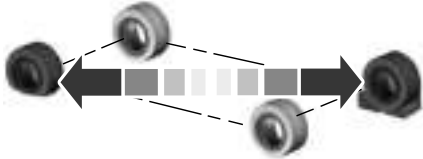

E175447

3. Block both the front and rear of the wheel diagonally opposite the flat tire. For example, if the left front tire is flat, block the right rear wheel.
4. Remove the carpeted wheel cover.
5. Remove the spare tire bolt securing the spare tire by turning it counterclockwise.
6. Remove the spare tire from the spare tire compartment.

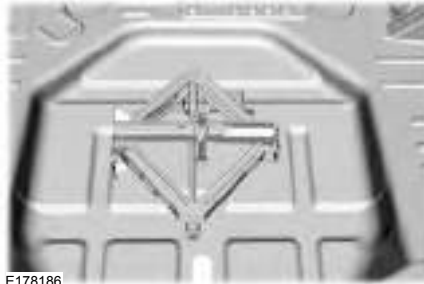

E178186

7. Remove the lug wrench and jack from the spare tire compartment.

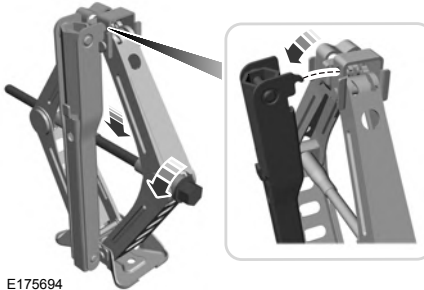

E175694

8. To remove the wrench from the jack, turn the hex nut on the jack counterclockwise. This will lower the jack and loosen the mechanical lock.

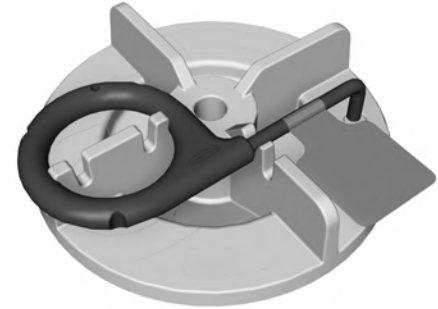

E224246

9. If your vehicle has a wheel trim, use the tool supplied to remove it and access the lug nuts.
10. Loosen each wheel lug nut one-half turn counterclockwise, but do not remove them until the wheel is raised off the ground.

Wheels and Tires



E145908

11. The vehicle jacking points are shown here, and can be identified by the triangle markings on the molding. The triangle marking may be located on the side or the underside of the molding. The jacking points are identified on vehicles without moldings by a pair of arrows on the metal flange pointing to the jacking point between them. Details are depicted on the warning label on the jack.



E174939

12. Place the jack at the jacking point next to the tire you are changing. Turn the jack handle clockwise until the wheel is completely off the ground.
13. Remove the lug nuts with the lug wrench.

14. Replace the flat tire with the spare tire, making sure the valve stem is facing outward. Reinstall the lug nuts until the wheel is snug against the hub. Do not fully tighten the lug nuts until the wheel has been lowered. If you are using the temporary tire, the lug nut washers will not appear to be flush with the rim. This is normal only when using the temporary spare tire.
15. Lower the wheel by turning the jack handle counterclockwise.

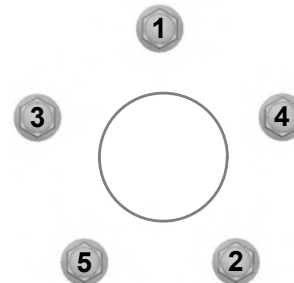

E75442

Wheels and Tires

16. Remove the jack and fully tighten the lug nuts in the order shown. See

Technical Specifications (page 365).

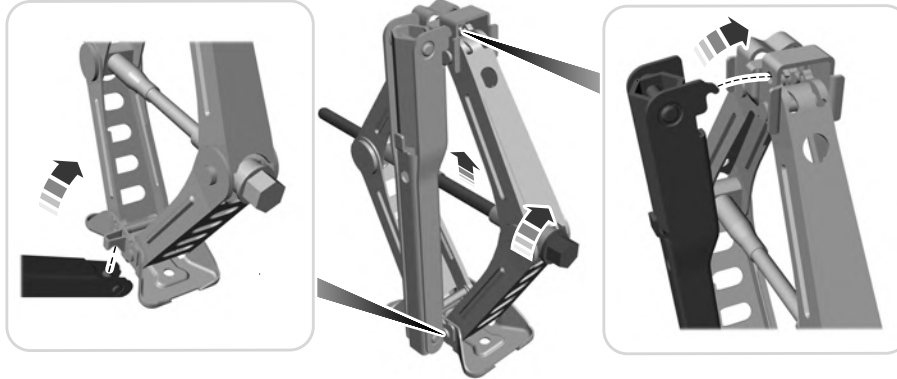

E176165

17. To store the folded wrench on the jack, engage the bracket of the jack base on the wrench feature as shown. Swing the wrench upward and adjust the height of the jack until the pin engages the hole. Tighten the hex nut clockwise by hand until secure.
18. Put the flat tire, jack and lug wrench away. Make sure the jack is fastened securely before you drive.
19. Unblock the wheel.

Wheels and Tires

Stowing the Flat Tire

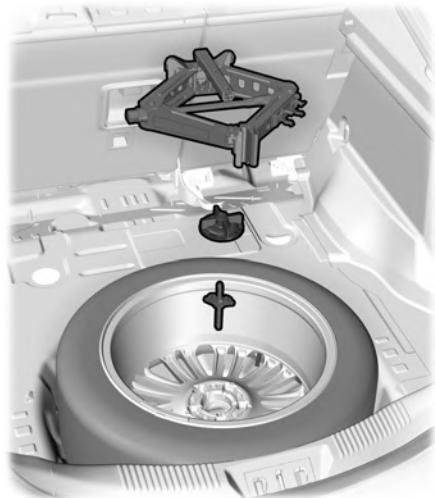

E227869

You can temporarily stow the full-size road wheel in the spare tire compartment.

1. Lift the carpeted wheel cover at an angle to access the spare tire compartment.

2. Place the wheel in the spare tire well with the valve stem facing down.
3. Install the shorter jack retainer bolt to the jack bolt-down bracket through the centre of the wheel. Finally, wind the wheel retainer down to secure the wheel in place.
4. Place the jack and tools back into the spare tire compartment.
5. Replace the carpeted wheel cover.

Stowing the Flat Tire Using the Retainer Strap (If Equipped)

You can temporarily stow the full-size road wheel in the spare tire compartment.

1. Find the flat tire retainer strap tucked inside the jack channel.

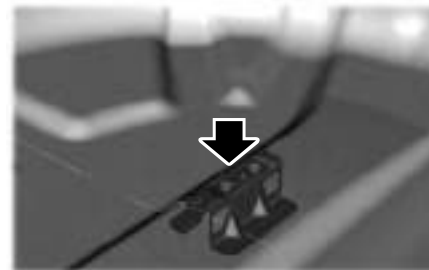

E224480

2. Locate the jack bolt-down bracket. Push the retainer strap through the jack bolt-down bracket.
3. Put the jack and lug wrench away. Make sure the jack is fastened so it does not rattle when you drive.
4. Stow the flat tire on the floor in the cargo area.
5. Weave the retainer strap through the wheel openings.

Wheels and Tires

6. Secure the flat tire by tying a flat knot.



E224479

Wheels and Tires

TECHNICAL SPECIFICATIONS

Wheel Lug Nut Torque Specifications

WARNING



When a wheel is installed, always remove any corrosion, dirt or foreign materials present on the mounting surfaces of the wheel or the surface of the wheel hub, brake drum or brake disc that contacts the wheel. Make sure that any fasteners that attach the rotor to the hub are secured so they do not interfere with the mounting surfaces of the wheel. Installing wheels without correct metal-to-metal contact at the wheel mounting surfaces can cause the wheel nuts to loosen and the wheel to come off while your vehicle is in motion, resulting in loss of control.

Bolt size	lb.ft (Nm)
M14 x 1.5	150 lb.ft (204 Nm)

Torque specifications are for nut and bolt threads free of dirt and rust. Use only Ford recommended replacement fasteners.

Retighten the lug nuts to the specified torque within 100 miles (160 kilometers) after any wheel disturbance (such as tire rotation, changing a flat tire, wheel removal).

Wheels and Tires



A Wheel pilot bore

Inspect the wheel pilot hole and mounting surface prior to installation. Remove any visible corrosion or loose particles.

E145950

Technical Specifications

The tire wheel assembly has already been balanced at the vehicle assembly plant. There are many factors during the vehicle usage that may lead to a tire wheel imbalance. These factors may cause vehicle vibration and increased steering, suspension and tire wear. In this case, the wheel and tire assembly may need to be re-balanced. The maximum **dynamic static** imbalance per wheel balance plane needs to be less than 7g. The tire wheel assembly also needs to be re-balanced after changing the wheel and the tire. Please contact an authorized dealer for service.

Capacities and Specifications

ENGINE SPECIFICATIONS - 2.0L

Engine	2.0L engine
Cubic inches	122
Firing order	1-3-4-2
Ignition system	Coil on plug
Compression ratio	9.3:1
Spark plug gap	0.027-0.031 in. (0.70-0.80 mm)

Capacities and Specifications

Drivebelt Routing

- A Long drivebelt is on first pulley groove closest to engine
- B Short drivebelt is on second pulley groove farthest from engine

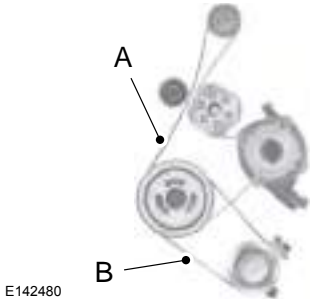

ENGINE SPECIFICATIONS - 3.0L

Engine	3.0L V6 Engine
Cubic inches	180
Firing order	1-4-2-5-3-6
Ignition system	Coil in plug
Compression ratio	9.5:1
Spark plug gap	0.028–0.031 in (0.7–0.8 mm)

Capacities and Specifications

Drivebelt Routing



E221312

MOTORCRAFT PARTS - 2.0L

Component	Motorcraft part number
Air filter element.	FA-1912
Oil filter.	FL-910-S
Battery.	BXT-94RH7-730

Capacities and Specifications

Component	Motorcraft part number
Spark plugs.	SP-537
Cabin air filter.	FP-71
Windshield wiper blade.	WW-2200 (driver side) WW-1900 (passenger side)

We recommend Motorcraft® replacement parts available at your Lincoln dealer or at fordparts.com for scheduled maintenance. These parts meet or exceed Ford Motor Company's specifications and are engineered for your vehicle. Use of other parts may impact vehicle performance, emissions and durability. Your warranty may be void for any damage related to use of other parts.

If a Motorcraft® oil filter is not available, use an oil filter that meets industry performance specification SAE/USCAR-36.

For spark plug replacement, contact an authorized dealer. Replace the spark plugs at the appropriate intervals. See **Scheduled Maintenance** (page 495).

Capacities and Specifications

MOTORCRAFT PARTS - 3.0L

Component	Motorcraft part number
Air filter element	FA-1912
Oil filter	FL-2062
Battery	BXT-94RH7-730
Spark plugs	SP-542
Cabin air filter	FP-71
Windshield wiper blade	WW-2200 (driver side) WW-1900 (passenger side)

We recommend Motorcraft replacement parts available at your Lincoln dealer or at fordparts.com for scheduled maintenance. These parts meet or exceed Ford Motor Company's specifications and are engineered for your vehicle. Use of other parts may impact vehicle performance, emissions and durability. Your warranty may be void for any damage related to use of other parts.

If a Motorcraft oil filter is not available, use an oil filter that meets industry performance specification SAE/USCAR-36.

For spark plug replacement, contact an authorized dealer. Replace the spark plugs at the appropriate intervals. See **Scheduled Maintenance** (page 495).

Capacities and Specifications

VEHICLE IDENTIFICATION NUMBER

The vehicle identification number is located on the left-hand side of the instrument panel.

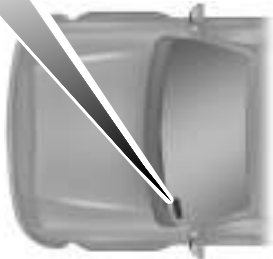

E142476

Please note that in the graphic, XXXX is representative of your vehicle identification number.

The Vehicle Identification Number contains the following information:

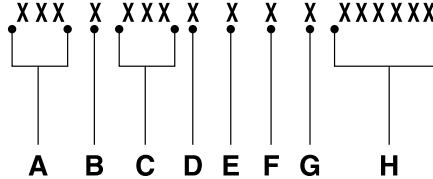

E142477

- A World manufacturer identifier
- B Brake system, Gross Vehicle Weight Rating, Restraint Devices and their locations
- C Make, vehicle line, series, body type
- D Engine type
- E Check digit
- F Model year
- G Assembly plant
- H Production sequence number

VEHICLE CERTIFICATION LABEL

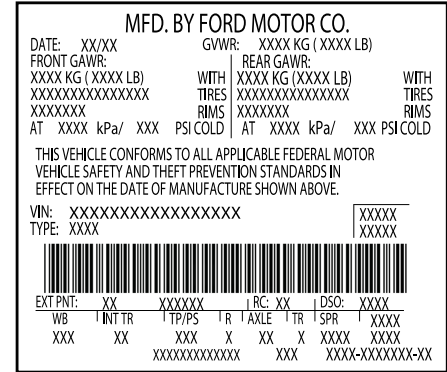

E167469

The National Highway Traffic Safety Administration Regulations require that a Safety Compliance Certification Label be affixed to a vehicle and prescribe where the Safety Compliance Certification Label may be located. The Safety Compliance Certification Label shall be affixed to either the door hinge pillar, the door latch post, or the edge of the door near the door latch, next to the driver's seating position.

Capacities and Specifications

TRANSMISSION CODE DESIGNATION

MFD. BY FORD MOTOR CO.

DATE: XX/XX GVWR: XXXX KG (XXXX LB)
 FRONT GAWR: REAR GAWR:
 XXXX KG (XXXX LB) WITH XXXX KG (XXXX LB) WITH
 XXXXXXXXXXXXXXXX TIRES XXXXXXXXXXXXXXXX TIRES
 XXXXXXXX RIMS XXXXXXXX RIMS
 AT XXXX kPa/ XXX PSI COLD | AT XXXX kPa/ XXX PSI COLD

THIS VEHICLE CONFORMS TO ALL APPLICABLE FEDERAL MOTOR
 VEHICLE SAFETY AND THEFT PREVENTION STANDARDS IN
 EFFECT ON THE DATE OF MANUFACTURE SHOWN ABOVE.

VIN: XXXXXXXXXXXXXXXX XXXXX
 TYPE: XXXX XXXXX



EXT PNT: XX XXXXXX RC: XX DSO: XXXX
 WB INT TR TP/PS R AXLE TR SPR XXXX
 XXX XX XXX X XX X XXXX XXXX
 XXXXXXXXXXXXX X =XXXX-XXXXXXXX-XX



The transmission code is on the Safety Compliance Certification Label. The following table shows the transmission code along with the transmission description.

Description	Code
Six-speed automatic transmission 6F55	C
Six-speed automatic transmission 6FMR	W

Capacities and Specifications

CAPACITIES AND SPECIFICATIONS - 2.0L

Capacities

WARNING



The air conditioning refrigerant system contains refrigerant under high pressure. Only qualified personnel should service the air conditioning refrigerant system. Opening the air conditioning refrigerant system can cause personal injury.

Item	Capacity
Engine oil (with oil filter).	5.7 qt (5.4 L)
Engine coolant.	8.5 qt (8 L)
Brake fluid.	Between MIN/MAX on brake fluid reservoir
Rear differential fluid (All Wheel Drive).	16.0–20.8 fl oz (473–615 ml)
Power Transfer Unit fluid (All Wheel Drive).	15.2 fl oz (450 ml)*
Automatic transmission fluid.	9.0 qt (8.5 L)**
Windshield washer fluid.	Fill as required
Fuel tank (Front Wheel Drive).	16.5 gal (62.5 L)
Fuel tank (All Wheel Drive).	18.0 gal (68.1 L)

Capacities and Specifications

Item	Capacity
A/C refrigerant.	22 oz (0.62 kg)
A/C refrigerant compressor oil.	5.24 fl oz (155 ml)

*Contact an authorized dealer for fluid level checking and filling.

**Approximate dry fill capacity. Actual amount may vary during fluid changes.

Specifications

Materials

Name	Specification
Recommended motor oil (U.S. and Mexico): Motorcraft® SAE 5W-30 Premium Synthetic Blend Motor Oil XO-5W30-QSP	WSS-M2C946-A
Recommended motor oil (Canada): Motorcraft® SAE 5W-30 Super Premium Motor Oil CXO-5W30-LSP12	WSS-M2C946-A
Optional motor oil (U.S. and Mexico): Motorcraft® SAE 5W-30 Full Synthetic Motor Oil XO-5W30-QFS	WSS-M2C946-A
Optional motor oil (Canada): Motorcraft® SAE 5W-30 Synthetic Motor Oil	WSS-M2C946-A

Capacities and Specifications

Name	Specification
CXO-5W30-LFS12	
Engine coolant (U.S. and Mexico): Motorcraft® Orange Prediluted Antifreeze/Coolant VC-3DIL-B	WSS-M97B44-D2
Engine coolant (Canada): Motorcraft® Orange Prediluted Antifreeze/Coolant CVC-3DIL-B	WSS-M97B44-D2
Brake fluid: Motorcraft® DOT 4 Low Viscosity (LV) High Performance Motor Vehicle Brake Fluid PM-20	WSS-M6C65-A2
Rear differential fluid (All Wheel Drive) (U.S. and Mexico): Motorcraft® SAE 80W-90 Premium Rear Axle Lubricant XY-80W90-QL	WSP-M2C197-A
Rear differential fluid (All Wheel Drive) (Canada): Motorcraft® SAE 80W-90 Premium Rear Axle Lubricant CXY-80W90-1L	WSP-M2C197-A
Power Transfer Unit fluid (All Wheel Drive) (U.S. and Mexico): Motorcraft® SAE 75W-140 Synthetic Rear Axle Lubricant XY-75W140-QL	WSL-M2C192-A
Power Transfer Unit fluid (All Wheel Drive) (Canada): Motorcraft® SAE 75W-140 Synthetic Rear Axle Lubricant	WSL-M2C192-A

Capacities and Specifications

Name	Specification
CXY-75W140-1L	
Automatic transmission fluid (U.S. and Mexico): Motorcraft® MERCON LV Automatic Transmission Fluid XT-10-QLVC	WSS-M2C938-A MERCON LV
Automatic transmission fluid (Canada): Motorcraft® MERCON LV Automatic Transmission Fluid CXT-10-LV12	WSS-M2C938-A MERCON LV
Windshield washer fluid (U.S. and Mexico): Motorcraft® Premium Windshield Wash Concentrate with Bitterant ZC-32-B2	WSS-M14P19-A
Windshield washer fluid (Canada): Motorcraft® Premium Quality Windshield Washer Fluid CXC-37-(A, B, D, F)	WSS-M14P19-A
A/C refrigerant (U.S. and Mexico): R-1234yf Refrigerant HS7Z-19B519-AA	WSS-M17B21-A
A/C refrigerant (Canada): R-1234yf Refrigerant HS7Z-19B519-BA	WSS-M17B21-A
A/C refrigerant compressor oil: Motorcraft® R-1234yf Refrigerant PAG Oil	WSS-M2C300-A2

Capacities and Specifications

Name	Specification
YN-35	
Multi-purpose grease: Motorcraft® Multi-Purpose Grease Spray XL-5-A	ESB-M1C93-B
Lock cylinders (U.S. and Mexico): Penetrating and Lock Lubricant XL-1	--
Lock cylinders (Canada): Penetrating Fluid CXC-51-A	--

If you use oil and fluids that do not meet the defined specification and viscosity grade, this may lead to:

- Component damage which is not covered by the vehicle warranty.
- Longer engine cranking periods.
- Increased emission levels.
- Reduced engine performance.
- Reduced fuel economy.
- Degraded brake performance.

We recommend Motorcraft motor oil for your vehicle. If Motorcraft oil is not available, use motor oils of the recommended viscosity grade that meet API SN requirements and display the API Certification Mark for gasoline engines. Do not use oil labeled with API SN service category unless the label also displays the API certification mark.



E142732

Capacities and Specifications

An oil that displays this symbol conforms to current engine, emission system and fuel economy performance standards of the International Lubricants Specification Advisory Committee (ILSAC).

Do not use supplemental engine oil additives because they are unnecessary and could lead to engine damage that may not be covered by your vehicle warranty.

Note: *Ford recommends using DOT 4 Low Viscosity (LV) High Performance Brake Fluid or equivalent meeting WSS-M6C65-A2. Use of any fluid other than the recommended fluid may cause degraded brake performance and not meet the Ford performance standards. Keep brake fluid clean and dry. Contamination with dirt, water, petroleum products or other materials may result in brake system damage and possible failure.*

Note: *Automatic transmissions that require MERCON LV transmission fluid should only use MERCON LV transmission fluid. The use of any other fluid may cause transmission damage.*

CAPACITIES AND SPECIFICATIONS - 3.0L

Capacities

WARNING



The air conditioning refrigerant system contains refrigerant under high pressure. Only qualified personnel should service the air conditioning refrigerant system. Opening the air conditioning refrigerant system can cause personal injury.

Item	Capacity
Engine oil (with oil filter).	6.0 qt (5.7 L)
Engine coolant (Front Wheel Drive).	11.4 qt (10.8 L)
Engine coolant (All Wheel Drive).	11.8 qt (11.2 L)

Capacities and Specifications

Item	Capacity
Brake fluid.	Between MIN/MAX on brake fluid reservoir
Rear differential fluid (All Wheel Drive).	16.0–20.8 fl oz (473–615 ml)
Power Transfer Unit fluid (All Wheel Drive).	15.2 fl oz (450 ml)*
Automatic transmission fluid.	11.6 qt (11 L)**
Windshield washer fluid.	Fill as required
Fuel tank (Front Wheel Drive).	16.5 gal (62.5 L)
Fuel tank (All Wheel Drive).	18.0 gal (68.1 L)
A/C refrigerant.	18 oz (0.51 kg)
A/C refrigerant compressor oil.	5.24 fl oz (155 ml)

*Contact an authorized dealer for fluid level checking and filling.

**Approximate dry fill capacity. Actual amount may vary during fluid changes.

Capacities and Specifications

Specifications

Materials

Name	Specification
Recommended motor oil (U.S. and Mexico): Motorcraft® SAE 5W-30 Premium Synthetic Blend Motor Oil XO-5W30-QSP	WSS-M2C946-A
Recommended motor oil (Canada): Motorcraft® SAE 5W-30 Super Premium Motor Oil CXO-5W30-LSP12	WSS-M2C946-A
Optional motor oil (U.S. and Mexico): Motorcraft® SAE 5W-30 Full Synthetic Motor Oil XO-5W30-QFS	WSS-M2C946-A
Optional motor oil (Canada): Motorcraft® SAE 5W-30 Synthetic Motor Oil CXO-5W30-LFS12	WSS-M2C946-A
Engine coolant (U.S. and Mexico): Motorcraft® Orange Prediluted Antifreeze/Coolant VC-3DIL-B	WSS-M97B44-D2
Engine coolant (Canada): Motorcraft® Orange Prediluted Antifreeze/Coolant CVC-3DIL-B	WSS-M97B44-D2

Capacities and Specifications

Name	Specification
Brake fluid: Motorcraft® DOT 4 Low Viscosity (LV) High Performance Motor Vehicle Brake Fluid PM-20	WSS-M6C65-A2
Rear differential fluid (All Wheel Drive) (U.S. and Mexico): Motorcraft® SAE 80W-90 Premium Rear Axle Lubricant XY-80W90-QL	WSP-M2C197-A
Rear differential fluid (All Wheel Drive) (Canada): Motorcraft® SAE 80W-90 Premium Rear Axle Lubricant CXY-80W90-1L	WSP-M2C197-A
Power Transfer Unit fluid (All Wheel Drive) (U.S. and Mexico) Motorcraft® SAE 75W-140 Synthetic Rear Axle Lubricant XY-75W140-QL	WSL-M2C192-A
Power Transfer Unit fluid (All Wheel Drive) (Canada) Motorcraft® SAE 75W-140 Synthetic Rear Axle Lubricant CXY-75W140-1L	WSL-M2C192-A
Automatic transmission fluid (U.S. and Mexico): Motorcraft® MERCON LV Automatic Transmission Fluid XT-10-QLVC	WSS-M2C938-A MERCON LV
Automatic transmission fluid (Canada): Motorcraft® MERCON LV Automatic Transmission Fluid CXT-10-LV12	WSS-M2C938-A MERCON LV

Capacities and Specifications

Name	Specification
Windshield washer fluid (U.S. and Mexico): Motorcraft® Premium Windshield Wash Concentrate with Bitterant ZC-32-B2	WSS-M14P19-A
Windshield washer fluid (Canada): Motorcraft® Premium Quality Windshield Washer Fluid CXC-37-(A, B, D, F)	WSS-M14P19-A
A/C refrigerant (U.S. and Mexico): R-1234yf Refrigerant HS7Z-19B519-AA	WSS-M17B21-A
A/C refrigerant (Canada): R-1234yf Refrigerant HS7Z-19B519-BA	WSS-M17B21-A
A/C refrigerant compressor oil: Motorcraft® R-1234yf Refrigerant PAG Oil YN-35	WSS-M2C300-A2

Capacities and Specifications

Name	Specification
Multi-purpose grease: Motorcraft® Multi-Purpose Grease Spray XL-5-A	ESB-M1C93-B
Lock cylinders (U.S. and Mexico): Penetrating and Lock Lubricant XL-1	--
Lock cylinders (Canada): Penetrating Fluid CXC-51-A	--

If you use oil and fluids that do not meet the defined specification and viscosity grade, this may lead to:

- Component damage which is not covered by the vehicle warranty.
- Longer engine cranking periods.
- Increased emission levels.
- Reduced engine performance.
- Reduced fuel economy.
- Degraded brake performance.

We recommend Motorcraft motor oil for your vehicle. If Motorcraft oil is not available, use motor oils of the recommended viscosity grade that meet API SN requirements and display the API Certification Mark for gasoline engines. Do not use oil labeled with API SN service category unless the label also displays the API certification mark.



E142732

Capacities and Specifications

An oil that displays this symbol conforms to current engine, emission system and fuel economy performance standards of the International Lubricants Specification Advisory Committee (ILSAC).

Do not use supplemental engine oil additives because they are unnecessary and could lead to engine damage that may not be covered by your vehicle warranty.

Note: *Ford recommends using DOT 4 Low Viscosity (LV) High Performance Brake Fluid or equivalent meeting WSS-M6C65-A2. Use of any fluid other than the recommended fluid may cause degraded brake performance and not meet the Ford performance standards. Keep brake fluid clean and dry. Contamination with dirt, water, petroleum products or other materials may result in brake system damage and possible failure.*

Note: *Automatic transmissions that require MERCON LV transmission fluid should only use MERCON LV transmission fluid. The use of any other fluid may cause transmission damage.*

Audio System

GENERAL INFORMATION

Radio Frequencies and Reception Factors

AM and FM frequencies are established by the Federal Communications Commission (FCC) and the Canadian Radio and Telecommunications Commission (CRTC). Those frequencies are:

- AM: 530, 540-1700, 1710 kHz
- FM: 87.9-107.7, 107.9 MHz

Radio Reception Factors	
Distance and strength	The further you travel from an AM or FM station, the weaker the signal and the weaker the reception.
Terrain	Hills, mountains, tall buildings, bridges, tunnels, freeway overpasses, parking garages, dense tree foliage and thunderstorms can interfere with the reception.
Station overload	When you pass a ground-based broadcast repeating tower, a stronger signal may overtake a weaker one and result in the audio system muting.

CD and CD Player Information

Note: CD units play commercially pressed 4.7 in (12 cm) audio compact discs only. Due to technical incompatibility, certain recordable and re-recordable compact discs may not function correctly when used in Ford CD players.

Note: Do not insert CDs with homemade paper (adhesive) labels into the CD player as the label may peel and cause the CD to become jammed. You should use a permanent felt tip marker rather than adhesive labels on your homemade CDs. Ballpoint pens may damage CDs. Please contact an authorized dealer for further information.

Note: Do not use any irregularly shaped discs or discs with a scratch protection film attached.

Always handle discs by their edges only. Clean the disc with an approved CD cleaner only. Wipe it from the center of the disc toward the edge. Do not clean in a circular motion.

Audio System

Do not expose discs to direct sunlight or heat sources for extended periods.

MP3 and WMA Track and Folder Structure

Audio systems capable of recognizing and playing MP3 and WMA individual tracks and folder structures work as follows:

- There are two different modes for MP3 and WMA disc playback: MP3 and WMA track mode (system default) and MP3 and WMA folder mode.
- MP3 and WMA track mode ignores any folder structure on the MP3 and WMA disc. The player numbers each MP3 and WMA track on the disc (noted by the MP3 or WMA file extension) from T001 to a maximum of T255. The maximum number of playable MP3 and WMA files may be less depending on the structure of the CD and exact model of radio present.

- MP3 and WMA folder mode represents a folder structure consisting of one level of folders. The CD player numbers all MP3 and WMA tracks on the disc (noted by the MP3 or WMA file extension) and all folders containing MP3 and WMA files, from F001 (folder) T001 (track) to F253 T255.
- Creating discs with only one level of folders helps with navigation through the disc files.

If you are burning your own MP3 and WMA discs, it is important to understand how the system reads the structures you create. While various files may be present (files with extensions other than MP3 and WMA), only files with the MP3 and WMA extension are played; other files are ignored by the system. This enables you to use the same MP3 and WMA disc for a variety of tasks on your work computer, home computer and your in-vehicle system.

In track mode, the system displays and plays the structure as if it were only one level deep (all MP3 and WMA files play, regardless of being in a specific folder). In folder mode, the system only plays the MP3 and WMA files in the current folder.

AUDIO UNIT - VEHICLES WITH: PREMIUM AM/FM/CD

WARNING



Driving while distracted can result in loss of vehicle control, crash and injury. We strongly recommend that you use extreme caution when using any device that may take your focus off the road. Your primary responsibility is the safe operation of your vehicle. We recommend against the use of any hand-held device while driving and encourage the use of voice-operated systems when possible. Make sure you are aware of all applicable local laws that may affect the use of electronic devices while driving.

Audio System

Note: The touchscreen system controls most of the audio features. See your SYNC information.

Note: Depending on your vehicle options, your audio display and functions may be different than shown here.

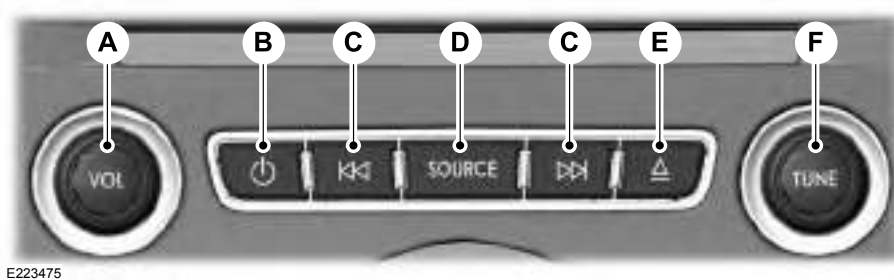

- A **Volume:** Turn to adjust the volume.
- B **Power:** Press to switch the system on and off.
- C **Seek, Fast Forward and Reverse:** In radio mode, select a frequency band and press either button. The system stops at the first station it finds in that direction. In CD mode, press to select the next or previous track. Press and hold to move quickly forward or backward through the current track.
- D **SOURCE:** Press to access different audio modes, for example AM, FM and CD.
- E **Eject:** Eject a CD.
- F **TUNE:** In radio mode, adjust to manually search through the radio frequency band.

Audio System

MEDIA HUB (If Equipped)

You can locate the media hub inside the center console or on the instrument panel.



E211463

See your SYNC information.

GENERAL INFORMATION

WARNING

 Driving while distracted can result in loss of vehicle control, crash and injury. We strongly recommend that you use extreme caution when using any device that may take your focus off the road. Your primary responsibility is the safe operation of your vehicle. We recommend against the use of any hand-held device while driving and encourage the use of voice-operated systems when possible. Make sure you are aware of all applicable local laws that may affect the use of electronic devices while driving.

Getting to Know Your System

The SYNC 3 system allows you to interact with a variety of features using the touchscreen and voice commands. By integrating with your Bluetooth-enabled phone, the touchscreen provides easy interaction with audio, multimedia, climate control, navigation, and your phone's SYNC 3 compatible apps.

Using the Touchscreen

To operate the touchscreen, you can simply touch the item or option that you want to select. The button changes color when you select it.

The SYNC 3 layout allows you to quickly select the feature you wish to use.

SYNC™ 3



E205444

Item	Menu Item	Action and Description
A	Status Bar	This bar displays icons and messages pertaining to current system activities including climate settings, voice commands and phone functions such as text messages.
B	Home	This button is available on the main screens. Pressing it takes you to the home screen view.
C	Clock	This shows the current time. You can set the clock manually or have it controlled by the vehicle's GPS location. See Settings (page 457).
D	Outside Temperature	This displays the current outside temperature.
E	Feature Bar	You can touch any of the buttons on this bar to select a feature.

The touchscreen allows you quick access to all of your comfort, navigation, communication and entertainment options. Using the status and feature bar you can quickly select the feature you want to use.

Note: *Your system is equipped with a feature that allows you to access and control audio features for 10 minutes after you switch the ignition off (and no doors open).*

The Status Bar

Additional icons also display in the status bar depending on market, vehicle options and current operation. If a feature is not active, the icon does not display. Certain icons may move to the left or right depending on what options are active.

SYNC™ 3

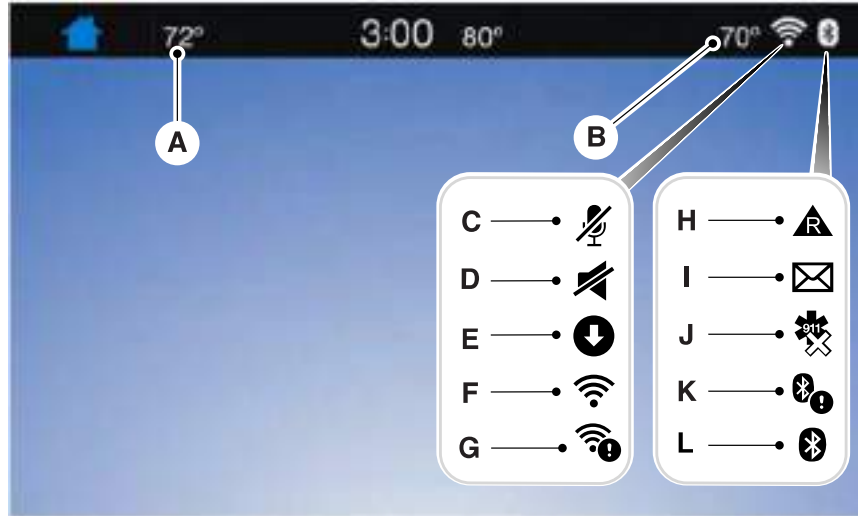

E212809

SYNC™ 3

Callout	Item	Description
A	Driver Temperature	This shows the temperature the driver selects through the climate control system.
B	Passenger Temperature	When the passenger's temperature has been adjusted and is no longer linked to the driver's temperature, it displays here. If Dual is turned off and the temperatures are linked, the passenger's temperature does not display.
C	Microphone Mute	This icon displays when your phone's microphone is muted. A caller cannot hear you.
D	Mute	This icon displays when the audio system is muted.
E	Download	This icon appears when SYNC 3 receives a software update. Pressing the icon shows more details about the new software.
F	Wi-Fi	This icon appears if a Wi-Fi network is connected.
G	Wi-Fi in Range	An available Wi-Fi network is within range.
H	Roaming	This icon displays when your cell phone is roaming.
I	Text Message	This icon displays when you receive a text message on your phone.
J	911 Assist Off	This icon displays when 911 Assist is set to off and your phone is connected to SYNC.
K	Bluetooth Alert	The Bluetooth alert icon displays when there is an active Bluetooth alert.
L	Bluetooth	This icon displays to show an active Bluetooth connection.

Messages may also appear in the status bar to provide you with notifications. You can

select the message to view the associated feature.

Feature Bar

Feature Bar Item	Functions
Audio	Allows you to control the media playing in your vehicle. You can control all audio features including AM, FM and satellite radio, CDs, and media streaming over a Bluetooth device or through a USB connection.
Climate	Allows you to adjust the temperature, fan speed and airflow within the vehicle.
Phone	Allows you to make calls, receive calls, and access the phonebook of your connected device.
Navigation (If equipped)	Allows you to see your vehicle's location on a virtual road map, get driving directions to your destination and find points of interest along your route.

Feature Bar Item	Functions
Apps	Connect and control SYNC 3 compatible apps running on your iPhone or Android device. Also, access built-in additional features such as SiriusXM Traffic and Travel Link (if equipped).
	If your vehicle is a hybrid, plug-in hybrid, or electric this is also where your settings and power information is located.
Settings	You can customize your system with various settings for the touchscreen display, feature preferences, and how you want to interact with your vehicle.

Cleaning the Touchscreen

You can remove fingerprints with a dry, clean, soft cloth.

If dirt or fingerprints are still on the screen, apply a small amount of alcohol to the cloth and try to clean it again.

Note: Do not use detergent or any type of solvent to clean the touchscreen.

Note: Do not pour or spray alcohol onto the touchscreen.

Using Voice Recognition

Using voice commands allows you to keep your hands on the wheel and focus on what is in front of you. The system provides feedback through audible tones, prompts, questions and spoken confirmations depending on the situation and the chosen level of interaction (voice settings).

The system also asks short questions (confirmation prompts) when it is not sure of your request or when there are multiple possible responses to your request.

When using voice commands, words and icons may appear in the status bar indicating the status of the voice command session. See **Using Voice Recognition** (page 408).

Accessing and Adjusting Modes Through Your Vehicle Information Display (If Equipped)

Depending on your vehicle and selected options you may be able to control some of the SYNC 3 features on your information display. The features are visible in the center of the display (A).

SYNC™ 3

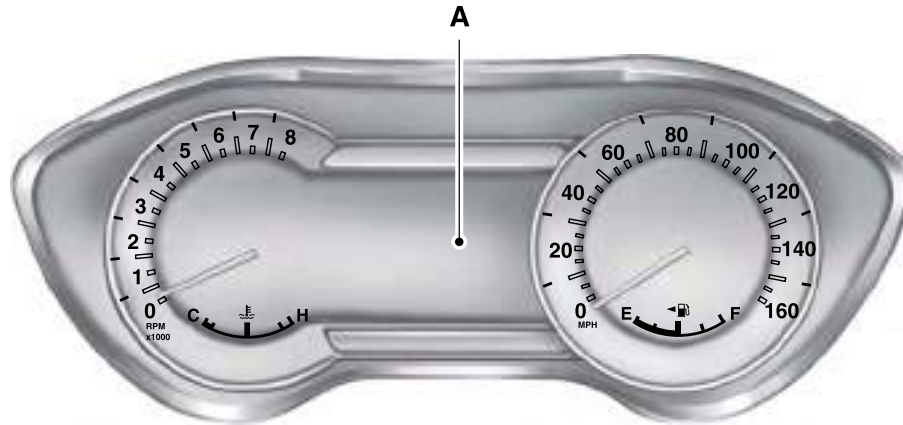

E185883

You can make the following adjustments using the information display SYNC 3 screen:

Option	Information				
Audio	Information for current audio playing.				
	Select source.				
Navigation	View current road and speed limit (if information is available).				
	View current route, next turn, time to your destination (depending on cluster level), distance to destination (depending on cluster level), and ability to cancel route.				
	If you do not have an active navigation route programed, the compass is shown.				
Phone	If you are not on a call, a call can be made by selecting: *				
	Quick dial	All calls	Incoming calls	Outgoing calls	Missed calls
	If you are on a call, the call information is displayed on the information display.				
	If you are receiving a call, you can accept it by selecting OK on the right-hand steering wheel controls.				

* Depending on your vehicle options, all of these choices may not display.

Use the **OK** and arrow buttons on the right side of your steering wheel to scroll through the available modes.

The selection menu expands and different options appear.

- Press the up and down arrows to scroll through the modes.
- Press the right arrow to enter the mode, use the left arrow to exit the mode.

- Press the up and down arrows to make adjustments within the chosen mode.
- Press **OK** to confirm your selection.

Note: If your vehicle is not equipped with navigation, compass appears in the display instead of navigation. If you press the right arrow to go into the compass menu, you can see the compass graphic. The compass displays the direction in which the vehicle is traveling, not true direction (for example, if the vehicle is traveling west, the middle of the compass graphic displays west; north displays to the left of west though its true direction is to the right of west).

Using the Steering Wheel Controls

Depending on your vehicle and option package, you can use different controls on your steering wheel to interact with the touchscreen system in different ways.

VOL: Control the volume of audio output.

Mute: Mute the audio output.

Voice: Press to start a voice session. Press again to stop the voice prompt and immediately begin speaking. Press and hold to end a voice session.

SEEK NEXT:

- While in radio mode, press to seek between memory presets.
- While in USB, Bluetooth Audio or CD mode, press to seek between songs or press and hold to fast seek.

SEEK PREVIOUS:

- While in radio mode, press to seek between memory presets.
- While in USB, Bluetooth Audio or CD mode, press to seek between songs or press and hold to fast seek.

PHONE ACCEPT: Press to answer a call or switch between calls.

PHONE REJECT: Press to end a call or reject an incoming call.

Note: On some models, **SEEK NEXT** may be combined with **PHONE REJECT** and **SEEK PREVIOUS** may be combined with **PHONE ACCEPT**.

M: Touch the control repeatedly to switch between media sources (modes).

See **Steering Wheel** (page 78).

Using Your Bezel Controls

Depending on your vehicle and option package, you may also have these controls on your instrument panel:

- **Power:** Switch the audio system on and off.
- **VOL:** Control the volume of playing audio.
- **Seek** and **Tune:** Use as you normally would in audio modes.
- **Eject:** Eject a CD from the audio system.
- **SOURCE** or **MEDIA:** Press repeatedly to advance through available media modes.
- **SOUND:** Press to access the Sound menu where you can adjust sound and other audio settings.
- **1-6:** Press and hold to store or press to select an AM, FM or SIRIUS memory preset. See **Audio System** (page 386).

- **DISP:** Switch the display on or off. You can also touch the screen to switch the display back on.
- **Temperature, fan and climate control buttons:** Control the temperature, fan speed or settings of the climate control system. See **Climate Control** (page 134).

911 Assist

WARNINGS

 Unless the 911 Assist setting is set on before a crash, the system will not dial for help which could delay response time, potentially increasing the risk of serious injury or death after a crash. setting is set on before a crash, the system will not dial for help which could delay response time, potentially increasing the risk of serious injury or death after a crash.

WARNINGS

 Do not wait for 911 Assist to make an emergency call if you can do it yourself. Dial emergency services immediately to avoid delayed response time which could increase the risk of serious injury or death after a crash. If you do not hear 911 Assist within five seconds of the crash, the system or phone may be damaged or non-functional.

 Always place your phone in a secure location in your vehicle so it does not become a projectile or get damaged in a crash. Failure to do so may cause serious injury to someone or damage the phone which could prevent 911 Assist from working properly.

Note: *The SYNC 911 Assist feature must be set on before the incident.*

Note: *The SYNC 911 Assist feature only operates in the U.S., Canada or in a territory in which 911 is the emergency number.*

Note: *Before setting this feature on, make sure that you read the 911 Assist Privacy Notice later in this section for important information.*

Note: *If any user sets 911 Assist to on or off, that setting applies for all paired phones. If 911 Assist is switched off and the phone is connected to SYNC, an icon displays on the status bar.*

Note: *Every phone operates differently. While SYNC 911 Assist works with most cellular phones, some may have trouble using this feature.*

If a crash deploys an airbag (excluding knee airbags and rear inflatable safety belts [if equipped]) or activates the fuel pump shut-off, your SYNC-equipped vehicle may be able to contact emergency services by dialing 911 through a paired and connected Bluetooth-enabled phone. You can learn more about the 911 Assist feature, by visiting:

Website
<p>owner.lincoln.com www.syncmyride.ca</p>

Website
www.syncmaroute.ca

For important information about airbag deployment and the fuel pump shut-off please see the Supplementary Restraints and Roadside Emergencies sections of your owner manual.

To switch 911 Assist on and off please view the settings information. See **Settings** (page 457).

To make sure that 911 Assist works correctly:

- SYNC must be powered and working properly at the time of the incident and throughout feature activation and use.
- The 911 Assist feature must be set on before the incident.
- You must pair and connect a Bluetooth-enabled and compatible cell phone to SYNC.
- A connected Bluetooth-enabled phone must have the ability to make and maintain an outgoing call at the time of the incident.

- A connected Bluetooth-enabled phone must have adequate network coverage, battery power and signal strength.
- The vehicle must have battery power and be located in the U.S., Canada or in a territory in which 911 is the emergency number.

In the Event of a Crash

Not all crashes will deploy an airbag or activate the fuel pump shut-off (the triggers for 911 Assist). If a connected cell phone sustains damage or loses its connection to SYNC during a crash, SYNC will search for and try to connect to a previously paired cell phone; SYNC will then attempt to call the emergency services.

Before making the call:

- SYNC provides a short window of time (about 10 seconds) to cancel the call. If you fail to cancel the call, SYNC attempts to dial 911.
- SYNC says the following, or a similar message: "SYNC will attempt to call 911, to cancel the call, press Cancel on your screen or press and hold the phone button on your steering wheel."

If you do not cancel the call, and SYNC makes a successful call, a pre-recorded message plays for the 911 operator, and then the occupant(s) in your vehicle is able to talk with the operator. Be prepared to provide your name, phone number and location immediately, because not all 911 systems are capable of receiving this information electronically.

911 Assist May Not Work If

- Your cellular phone or 911 Assist hardware sustains damage in a crash.
- The vehicle's battery or the SYNC system has no power.
- The phone(s) thrown from your vehicle are the ones paired and connected to the system.

911 Assist Privacy Notice

When you switch on 911 Assist, it may disclose to emergency services that your vehicle has been in a crash involving the deployment of an airbag or activation of the fuel pump shut-off. Certain versions or updates to 911 Assist may also be capable of electronically or verbally disclosing to 911 operators your vehicle location or other details about your vehicle or crash to assist 911 operators to provide the most appropriate emergency services. If you do not want to disclose this information, do not switch the feature on.

Safety Information

WARNING



Driving while distracted can result in loss of vehicle control, crash and injury. We strongly recommend that you use extreme caution when using any device that may take your focus off the road. Your primary responsibility is the safe operation of your vehicle. We recommend against the use of any hand-held device while driving and encourage the use of voice-operated systems when possible. Make sure you are aware of all applicable local laws that may affect the use of electronic devices while driving.

- Do not attempt to service or repair the system. Have an authorized dealer check your vehicle.
- Do not operate playing devices if the power cords or cables are broken, split or damaged. Place cords and cables out of the way, so they do not interfere with the operation of pedals, seats, compartments or safe driving abilities.

- Do not leave playing devices in your vehicle during extreme conditions as it could cause them damage. See your device's user guide for further information.
- For your safety, some SYNC 3 functions are speed-dependent. Their use is limited to when your vehicle is traveling at speeds under 3 mph (5 km/h). Make sure that you review your device's manual before using it with SYNC 3.

Speed-restricted Features

Some features of this system may be too difficult to use while your vehicle is moving so they are restricted from use unless your vehicle is stationary.

SYNC™ 3

- Screens crowded with information, such as Point of Interest reviews and ratings, SiriusXM Traffic and Travel Link sports scores, movie times or ski conditions.
- Any action that requires you to use a keyboard is restricted, such as entering a navigation destination or editing information.
- All lists are limited so the user can view fewer entries (such as phone contacts or recent phone call entries).

See the following chart for more specific examples.

Restricted features	
Cellular Phone	Pairing a Bluetooth phone.
	Browsing of list entries is limited for phone contacts and recent phone calls.
System Functionality	Editing the keypad code.
	Enabling Valet Mode.
	Editing settings while the rear view camera or active park assist are active.
Wi-Fi	Editing Wi-Fi settings.
	Editing the list of wireless networks.
	Connecting to a new Wi-Fi network.
Text Messages	Viewing received text messages.

Restricted features	
Navigation	Using the keyboard to enter a destination.
	Demo navigation route.
	Adding or editing Navigation Favorites entries or Avoid Areas.

Creating a SYNC Owner Account

Why do I need a SYNC owner account?

- Essential for keeping up with the latest software and connected features.
- Access to customer support for any questions you may have.
- Maintain account permissions.

Visit the website to sign up and register.

Website
owner.lincoln.com www.syncmyride.ca

Website
www.syncmaroute.ca

Updating Your System

You can choose to download the update onto a USB drive or use Wi-Fi to deliver automatic updates.

USB Updates

To use the USB update you need to log into your owner account and visit the SYNC software update page.

Website
owner.lincoln.com www.syncmyride.ca

Website
www.syncmaroute.ca

The website notifies you if an update is available. You can then select to download the update.

You will need an empty USB drive. Please check the website for minimum requirements. Once you have inserted the USB drive into your computer, choose to start the download. Follow the instructions provided to download the files to the USB drive.

The installation of most files occurs in the background, and does not interrupt your use of the system. Navigation updates cannot be installed in the background, because the files are too large.

To install the update in your vehicle, remove anything that is plugged in the USB ports on the media hub and plug in the USB drive containing the update. When the USB drive is plugged in, the installation should begin immediately. After a successful installation, the update is available the next time the vehicle is started.

Please reference the website for any further actions.

Updating Over Wi-Fi

To update your System over Wi-Fi your vehicle must be within the range of a Wi-Fi access point. Data rates may apply.

To connect your system to Wi-Fi, select:

Menu Item	
Settings	
Wi-Fi	
Available Wi-Fi Networks	You can then select your Wi-Fi network. You may have to enter the security code if the network is secured. The system confirms when it has connected to the network.

You must also give the system permission to update automatically. Upon vehicle delivery, the System asks you if you would like to use the automatic update feature. If you agree to automatic updates, you can press OK to confirm. If this selection does not appear upon vehicle delivery you can access it through the General Settings. See **Settings** (page 457). You can also perform a master reset. See **SYNC™ 3 Troubleshooting** (page 474).

If you would like to switch this feature on later, select:

Menu Item	
Settings	
General	
Automatic System Updates	From this menu, you can enable automatic updates. If you have not done so already, the system prompts you to set up a Wi-Fi connection when you enable this feature.

When Wi-Fi and automatic updates are enabled, your system checks for software updates periodically. If a new version is available, it downloads at that time. Software downloads can take place for up to 30 minutes after you have switched your vehicle off. The updates do not interrupt the normal use of your SYNC 3 system. If a download does not complete for any reason, the

download continues where it left off at the next Wi-Fi connected opportunity. Upon activation of an update, a banner displays on the touchscreen indicating the system update. Select the icon to see more detail. This icon displays for two ignition cycles.

To switch this feature off:

Menu Item	
Settings	
General	
Automatic System Updates	In this menu selection, you can change the selection for automatic updates to OFF.

Support

The SYNC support team is available to help you with any questions you are not able to answer on your own.

Monday-Saturday, 8:30am-8:00pm EST.

United States: 1-800-521-4140.

Canada: 1-800-387-9333.

Times are subject to change due to holidays.

Privacy Information

When you connect a cellular phone to SYNC 3, the system creates a profile within your vehicle that links to that cellular phone. This profile helps in offering you more cellular features and operating more efficiently. Among other things, this profile may contain data about your cellular phone book, text messages (read and unread), and call history, including history of calls when your cell phone was not connected to the system. In addition, if you connect a media device, the system creates and retains an index of supported media content. The system also records a short diagnostic log of approximately 10 minutes of all recent system activity. The log profile and other system data may be used to improve the system and help diagnose any problems that may occur.

The cellular profile, media device index, and diagnostic log remain in your vehicle unless you delete them and are generally accessible only in your vehicle when the cellular phone or media player is connected.

If you no longer plan to use the system or your vehicle, we recommend you perform a Master Reset to erase all stored information. You can find more information about the Master Reset in General Settings. See **Settings** (page 457). System data cannot be accessed without special equipment and access to your vehicle's SYNC 3 module. The Lincoln Motor Company does not access the system data for any purpose other than as described absent consent, a court order, or where required by law enforcement, other government authorities, or other third parties acting with lawful authority. Other parties may seek to access the information independently of The Lincoln Motor Company.

HOME SCREEN

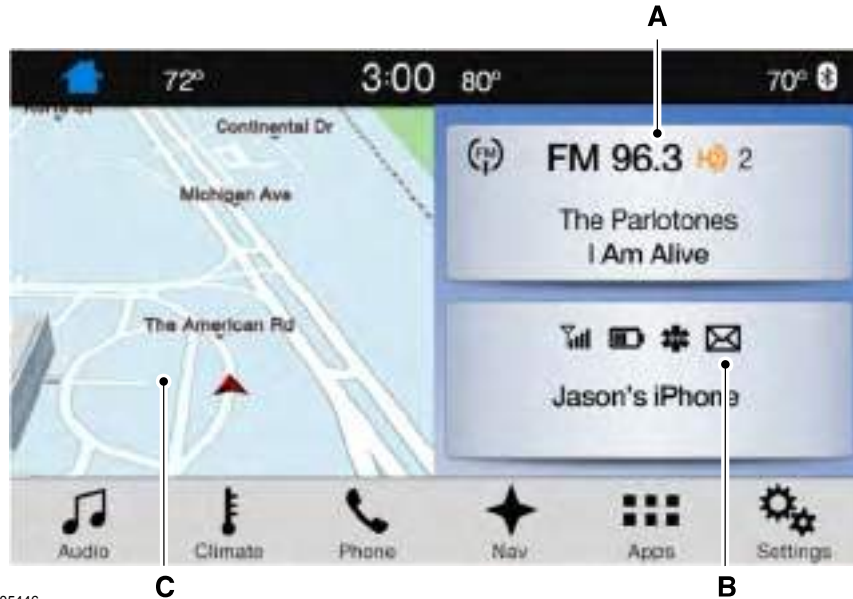

E205446

Item	Tile	Home screen display
A	Audio	Shows the active media source. If your vehicle does not have navigation, this space contains the compass.
B	Phone	The name of the connected phone appears on the screen. The status of the phone features also appear. This includes signal strength, battery charge, 911 assist setting state (On or Off), text messaging and roaming.
C	Navigation	This map displays your current location or current route in real time. When you have navigation active, you also see the next turn and the length of time and distance to your destination. If your vehicle does not have navigation, this space contains the audio information.

If equipped.

You can touch any of the feature displays to access that feature.

Anytime you select the home button, the system returns you to this screen.

USING VOICE RECOGNITION

The SYNC 3 system allows you to use voice commands, to control features like audio and climate controls. By using voice commands, you can keep your hands on the wheel and your eyes on the road.

You can access each feature controlled by SYNC 3 through a variety of commands.



To activate the SYNC 3 voice commands push the voice button on the steering wheel and wait for the prompt.

___ is a dynamic listing, meaning that it can be the name of anything, such as artist, the name of contact or number. The context and the description of the command tell you what to say for this dynamic option.

There are some commands that work for every feature, these commands are:

SYNC™ 3

Voice Command	Action and Description
Main Menu	Brings you to the main menu.
Go back	Returns you to the previous screen.
Cancel	Ends the voice session.
List of Commands	Gives you a list of possible voice commands.
___ List of Commands	You can name any feature and the system gives a list of commands available for the feature. For example, you could say:
	Phone List of Commands
	Navigation List of Commands
Next Page	You can use this command to view the next page of options on any screen where multiple pages of choices are given.
Previous Page	You can use this command to view the previous page of options on any screen where multiple pages of choices are given.
Help	Gives you available commands you can use on the current screen.

Included here are some of the most popular commands for each SYNC 3 feature.

Audio Voice Commands

___ is a dynamic listing, meaning that for audio voice commands it can be the name

of a Sirius channel or a channel number, a radio frequency number, or the name of an artist, album, song or a genre.

To control the media features, press the voice button and when prompted, say:

Voice command	Description
Sirius Channel ___ *	You can say the Sirius channel name or number such as "Sirius channel 16". You can also just say the name of a Sirius station such as "The Pulse".
AM ___ FM ___	Allows you to tune to a specific FM or AM frequency such as "88.7 FM" or "1580 AM".
FM ___ HD ___ *	Allows you to tune to a specific HD frequency such as "88.7 FM HD 1".
Bluetooth Audio	Allows you to listen to music on your Bluetooth-connected device.
USB	Allows you to listen to music on your USB connected device.
Play Genre ___ Play Playlist ___ Play Artist ___ Play Album ___ Play Podcast ___ Play Song ___	For USB audio only, you can say the name of an artist, album, song or a genre to listen to that selection. Your system must finish indexing before this option is available. For example, you could say "Play artist, The Beatles" or "Play song, Penny Lane".

Voice command	Description
Play Audiobook ____	
Browse ____	For USB audio only, you can say the name of an artist, album, or a genre to browse by that selection. Your system must finish indexing before this option is available. For example you can say "Browse The Beatles" or "Browse folk".

* This option may not be available in all markets or may require a subscription.

Climate Voice Commands

You can control the temperature of the vehicle using voice commands.

____ is a dynamic listing, meaning that for climate voice commands it can be the desired degrees for the temperature setting.

To adjust the temperature, say:

Voice command	Description
Climate Set Temperature ____	Adjust the temperature between 59.0°F (15°C)-86.0°F (30°C).
Climate Help	

Phone Voice Commands

Pairing a Phone

You can use voice commands to connect your Bluetooth-enabled phone to the system.

To pair your phone, press the voice button and when prompted, say:

Voice command	Description
Pair Phone	Follow the on-screen instructions to complete the pairing process. See Settings (page 457).

Making Calls

___ is a dynamic listing, meaning that for phone voice commands it can be the name of the contact you wish to call or the digits you want to dial.

Press the voice button and say a command similar to the following:

Voice command	Description
Call ___	Allows you to call a specific contact from your phonebook such as "Call Jenny".
Call ___ at ___	Allows you to call a specific contact from your phonebook at a specific location such as "Call Jenny at Home".
Dial ___	Allows you to dial a specific number such as "Dial 867-5309".

Please make sure that you are saying the contact name exactly as it appears in your contact list.

Once you have provided the digits of the phone number, you can say the following commands:

Voice Command	Description
<0-9>	If the full number was not entered with the first command, you can continue saying the number.
Dial	Tells SYNC 3 to make the phone call.
Delete	Tells SYNC 3 to erase the last block of digits stated.
Clear	Tells SYNC 3 to erase the entire number.

Text Message Voice Commands

To access text message options, press the voice button and say:

Voice command	Description
Listen to Message	
Listen to text message ____	You can say the number of the message you would like to hear.
Reply to Message	

Navigation Voice Commands

You can use any of the following commands to set a destination or find a point of interest.

___ is a dynamic listing, meaning that for navigation voice commands it can be a POI category or an address.

Setting a Destination

You can find an address, a point of interest (POI), or search for points of interest by category:

Voice command	Description
Find an Address	Allows you to enter the address search functionality.
Find a ___	State the name of the POI category you would like to search for such as "Find restaurants".
Find POI	Allows you to enter the POI search functionality.
Find Intersection	Allows you to enter the intersection search functionality.
Destination Nearest ___	State the name of the POI category you would like to search for nearby such as "Destination nearest restaurants".
Destination Previous Destination	Allows you to see a list of your previous destinations.
Destination Home	Allows you to route to your home address.

In addition, you can say these commands when a route is active:

Voice command	Description
Cancel Route	Cancels the current route.
Detour	Allows you to select an alternate route.
Repeat Instruction	Repeats the last guidance prompt.
Show Route	Displays the active route.
Where Am I	Provides current location.
Zoom in	Allows you to zoom in on the map.
Zoom out	Allows you to zoom out from the map.

Mobile App Voice Commands (If Equipped)

The following voice commands are always available:

Voice command	Description
Mobile Apps	SYNC 3 will prompt you to say the name of an app to start it on SYNC 3.
List Mobile Apps	SYNC 3 will list all of the currently available Mobile Apps.
Find New Apps	SYNC 3 will search and connect to compatible app(s) running on your mobile device.

SYNC™ 3

There are also voice commands that you can use when app(s) are connected to SYNC 3:

Voice command	Description
Say the name of an app	At any time, you can say the name of a mobile app to start the mobile app on SYNC 3.
Say the name of an app, followed by help	SYNC 3 will list the available voice commands for the specified app if the app is running on SYNC 3.

SiriusXM Traffic and Travel Link Voice Commands (If Equipped)

SiriusXM Traffic and Travel Link may not be available in all markets. Activation and a subscription are required.

You can say the following commands to access SiriusXM Traffic and Travel Link:

Voice command	Description
Show Traffic	Displays a list of traffic incidents.
Show Weather Map	Displays the current weather map.
Show Fuel Prices	Displays a list of fuel prices.
Show 5 Day Forecast	Displays the 5 day weather forecast.
Help	

Voice Settings Commands

You can say the following commands to access the voice settings:

Voice command	Description
Voice Settings	Allows you to enter the voice settings functionality.
Interaction Mode Standard	Sets standard prompting with longer prompts.
Interaction Mode Advanced	Sets advanced prompting with shorter prompts.
Phone Confirmation On	Allows the system to confirm before making a phone call.
Phone Confirmation Off	The system does not confirm before placing a call.
Voice Command Lists On	The system displays a short list of available commands.
Voice Command Lists Off	The system does not display the list of commands.

Note: Depending on the current climate control settings, the fan speed may automatically go down while issuing voice commands or while making and receiving phone calls via SYNC to reduce the amount of background noise in the vehicle. The fan speed will automatically return to normal operation once the voice session ends. Fan speed can also be adjusted normally during a voice session, simply press fan buttons (or turn fan knob) to increase or decrease fan speed to desired setting.

To disable this automatic fan speed reduction feature during voice sessions, press and hold the climate control AC and Recirculated air buttons simultaneously, release and then increase fan speed within 2 seconds. To re-enable this feature, repeat the above sequence.

ENTERTAINMENT



E205443

SYNC™ 3

Message	Message and description
A	Sources
B	Direct Tune

Message	Message and description
C	Presets

You can access these options using the touchscreen or voice commands.

Sources

Press this button to select the source of media you want to listen to.

Menu item	
AM	
FM	
SIRIUS	*
CD	*
USB	The name of the USB that is plugged in displays here.
Bluetooth Stereo	
Apps	If you have SYNC 3 compatible apps on your connected smart phone, they display here as individual source selections.

* This feature may not be available in all markets and requires an active subscription.

AM/FM Radio

Tuning a Station

You can use the tune or seek controls on the radio bezel to select a station.

To tune a station using the touchscreen, select:

Menu item
Direct Tune

A pop up appears, allowing you to type in the frequency of a station. You can only enter a valid station for the source you are currently listening to.

You can press the backspace button to delete the previously entered number.

Once you have entered the station's call numbers, you can select:

Menu item	Action and description
Enter	Press to begin playing the station you have entered.
Cancel	Press to exit without changing the station.

Presets

To set a new preset, tune to the station and then press and hold one of the memory preset buttons. The audio mutes briefly while the system saves the station and then returns.

There are two preset banks available for AM and three banks for FM. To access additional presets, tap the preset button. The indicator on the preset button shows which bank of presets you are currently viewing.

SIRIUS® Satellite Radio (If Activated)

Note: *This feature may not be available in all markets and requires an active subscription.*



E142593

SIRIUS satellite radio is a subscription-based satellite radio service that broadcasts a variety of music, sports, news, weather, traffic and entertainment programming. Your factory-installed SIRIUS satellite radio system includes hardware and a limited subscription term that begins on the date of sale or lease of your vehicle. See an authorized dealer for availability.

For more information on extended subscription terms (a service fee is required), the online media player and a list of SIRIUS satellite radio channels, and other features, please visit www.siriusxm.com in the United States, www.siriusxm.ca in Canada, or call SIRIUS at 1-888-539-7474.

Note: SIRIUS reserves the unrestricted right to change, rearrange, add or delete programming. This includes canceling, moving or adding particular channels, and its prices, at any time, with or without notice to you. Ford Motor Company shall not be responsible for any such programming changes.

Note: This receiver includes the eCos real-time operating system. eCos is published under the eCos License.

The following buttons are available for Sirius:

Menu item	Action and description	
Browse	Touch this button to see a list of available stations.	
Direct Tune	A pop-up appears, allowing you to type in the call numbers of a station. Once you enter the stations call numbers, you can select:	
	Enter	The system tunes to the station you select.
	Cancel	You exit the pop-up and the current station continues to play.
	You can press the backspace button to delete the previous number.	

Menu item	Action and description	
Replay	Replay audio on the current channel. You can replay approximately 45 minutes of audio as long as you remain tuned to the current station. Changing stations erases the previous audio.	
	Live	When you are in replay mode, you are not able to select a different preset until you return to live audio. Pressing this button returns you to the live broadcast.
ALERT	Save the current song, artist, or team as a favorite. The system alerts you when it plays again on any channel. Selecting this button allows you to enable and edit alerts. See Settings (page 457).	

Memory Presets

To set a preset, tune to the station then press and hold one of the memory preset buttons. The audio mutes briefly while the system saves the station and returns once the station is stored.

There are three preset banks available for SIRIUS. To access additional presets, tap the preset button. The indicator on the preset button shows which bank of presets you are currently viewing.

Satellite Radio Electronic Serial Number (ESN)

You need your ESN to activate, modify or track your satellite radio account. See **Settings** (page 457).

SIRIUS Satellite Radio Reception Factors and Troubleshooting

Potential reception issues	
Antenna obstructions	For optimal reception performance, keep the antenna clear of snow and ice build-up and keep luggage and other materials as far away from the antenna as possible.
Terrain	Hills, mountains, tall buildings, bridges, tunnels, freeway overpasses, parking garages, dense tree foliage and thunderstorms can interfere with your reception.
Station overload	When you pass a ground-based broadcast-repeating tower, a stronger signal may overtake a weaker one and the audio system may mute.
Satellite radio signal interference	Your display may show ACQUIRING... to indicate the interference and the audio system may mute.

Troubleshooting tips		
Message	Cause	Action
Acquiring Signal	Radio requires more than two seconds to produce audio for the selected channel.	No action required. This message should disappear shortly.
Satellite antenna fault SIRIUS system failure	There is an internal module or system failure present.	If this message does not clear shortly, or with an ignition key cycle, your receiver may have a fault. See an authorized dealer for service.
Invalid Channel	The channel is no longer available.	Tune to another channel or choose another preset.

Troubleshooting tips		
Message	Cause	Action
Unsubscribed Channel	Your subscription does not include this channel.	Contact SIRIUS at 1-888-539-7474 to subscribe to the channel, or tune to another channel.
Satellite acquiring signal...	The signal is lost from the SIRIUS satellite or SIRIUS tower to your vehicle antenna.	The signal is blocked. When you move into an open area, the signal should return.
Updating...	Update of channel programming in progress.	No action required. The process may take up to three minutes.
Questions? Call 1-888-539-7474	Your satellite service is no longer available.	Contact SIRIUS at 1-888-539-7474 to resolve subscription issues.
None found. Check channel guide.	All the channels in the selected category are either skipped or locked.	Use the channel guide to turn off the Lock or Skip function on that station.
SIRIUS Subscription updated	SIRIUS has updated the channels available for your vehicle.	No action required.

HD Radio™ Information (If Available)

Note: *This feature may not be available in all markets.*

To activate HD radio, please see the Radio Settings in the Settings Chapter. See **Settings** (page 457).

Note: *HD Radio broadcasts are not available in all markets.*

HD Radio technology is the digital evolution of analog AM/FM radio. Your system has a special receiver that allows it to receive digital broadcasts (where available) in addition to the analog broadcasts, it already receives. Digital broadcasts provide a better sound quality than analog broadcasts with free, crystal-clear audio and no static or distortion. For more information, and a guide to available stations and programming, please visit:

Website
www.hdradio.com

When HD Radio is on and you tune to a station broadcasting HD Radio technology, you may notice the following indicators on your screen:



E142616

The HD logo is grey when acquiring a digital station, and then changes to orange when digital audio is playing. When this logo is available, you may also see Title and Artist fields on-screen.

The multicast indicator appears in FM mode (only) if the current station is broadcasting multiple digital broadcasts. The highlighted numbers signify available digital channels where new or different content is available. HD1 signifies the main programming status and is available in analog and digital broadcasts. Other multicast stations (HD2 through HD7) are only available digitally.

Note: *There is also an additional feature for stations that have more than 1 HD multicast (For example, HD1 or HD2). The HD logo and Radio text appears as a button. Pressing this button allows you cycle through all of the HD stations on that specific frequency. For example, if you are on 101.1 and it has HD1, HD2, HD3, pressing the button repeatedly causes the radio to cycle through the HD stations in a cyclic increasing order.*

When HD Radio broadcasts are active, you can access the following functions:

Message	Action and description
Presets	Allows you to save an active channel as a memory preset. Touch and hold a memory preset slot until the sound returns. There is a brief mute while the radio saves the station. Sound returns when the channel saves. When switching to an HD2 or HD3 memory preset, the sound mutes before the digital audio plays, because the system has to reacquire the digital signal.

Note: *As with any station you save, you cannot access the saved station if your vehicle is outside the station's reception area.*

HD Radio Reception and Station Troubleshooting

Potential reception issues	
Reception area	If you are listening to a multicast station and you are on the fringe of the reception area, the station may mute due to weak signal strength.
	If you are listening to HD1, the system changes back to the analog broadcast until the digital broadcast is available again. However, if you are listening to any of the possible HD2-HD7 multicast channels, the station mutes and stays muted unless it is able to connect to the digital signal again.
Station blending	When the system first receives a station (aside from HD2-HD7 multicast stations), it first plays the station in the analog version. Once the receiver verifies the station is an HD Radio station, it shifts to the digital version. Depending on the station quality, you may hear a slight sound change when the station changes from analog to digital. Blending is the shift from analog to digital sound or digital back to analog sound.

In order to provide the best possible experience, use the contact form to report any station issues found while listening to a station broadcasting with HD Radio

technology. Independent entities own and operate each station. These stations are responsible for ensuring all audio streams and data fields are accurate.

Potential station issues		
Issues	Cause	Action
Echo, stutter, skip or repeat in audio. Increase or decrease in audio volume.	This is poor time alignment by the radio broadcaster.	No action required. This is a broadcast issue.
Sound fading or blending in and out.	The radio is shifting between analog and digital audio.	No action required. The reception issue may clear up as you continue to drive.
There is an audio mute delay when selecting HD2 or HD3, multicast preset or Direct Tune.	The digital multicast is not available until the HD Radio broadcast is decoded. Once decoded, the audio is available.	No action required. This is normal behavior. Wait until the audio is available.
Cannot access HD2 or HD3 multicast channel when recalling a preset or from a direct tune.	The previously stored multicast preset or direct tune is not available in your current reception area.	No action required. The station is not available in your current location.
Text information does not match currently playing audio.	Data service issue by the radio broadcaster.	Fill out the station issue form. *
There is no text information shown for currently selected frequency.	Data service issue by the radio broadcaster.	Fill out the station issue form. *

HD Radio Technology manufactured under license from iBiquity Digital Corp. U.S. and foreign patents. HD Radio and the HD and HD Radio logos are proprietary trademarks of iBiquity Digital Corp. Ford Motor Company and iBiquity Digital Corp. are not responsible for the content sent using HD Radio technology. Content may be changed, added or deleted at any time at the station owner's discretion.

* You can find the form here:

Website
http://www.ibiquity.com/automotive/report_radio_station_experiences

The current audio information appears on the screen.

CD (If equipped)

Once you select this option, the system returns you to the main audio screen.

The following buttons are also available:

Button	Function
Browse	You can use the browse button to select a track.
Repeat	Select this button and a small number one displays to indicate the track is set to repeat. For MP3 CDs, this button allows you to toggle through repeat off, repeat one track (a small number one displays), and repeat current folder (a small folder displays).
Shuffle	Select the shuffle symbol to have the audio on the disk play in random order.

You can use the forward, reverse, pause or play buttons to control the audio playback.

Bluetooth Stereo or USB

Bluetooth Stereo and USB allow you to

access media that you store on your Bluetooth device or USB device such as music, audio books or podcasts.

The following buttons are available for Bluetooth and USB:

Button	Function
Repeat	Pressing the repeat button toggles the repeat setting through three modes: repeat off (button not highlighted), repeat all (button highlighted) and repeat track (button highlighted with a small number one).
Shuffle	Play the tracks in random order.

You can use the forward, reverse, pause or play buttons to control the audio playback.

To get more information about the currently playing track, press the cover art or Info button.

For some devices, SYNC 3 is able to provide 30-second skip buttons when you listen to audio books or podcasts. These buttons allow you to skip forward or backward within a track.

While playing audio from a USB device you can look for certain music by selecting the following:

Button	Function
Browse	If available, displays the list of tracks in the Now Playing playlist.
New Search	This option, which is available under browse, allows you to play all tracks or to filter the available media into one of the below categories.
	Play All

SYNC™ 3

Button	Function
	Playlists
	Artists
	Albums
	Songs
	Genres
	Podcasts
	Audio books
	Composers
A-Z Jump	This button allows you to choose a specific letter to view within the category you are browsing.
Explore Device	If available, this allows you to browse the folders and files on your USB device.

USB Ports



E211463

The USB ports are in the center console or behind a small access door in the instrument panel.

This feature allows you to plug in USB media devices, memory sticks, flash drives or thumb drives, and charge devices if they support this feature.

Select this option to play audio from your USB device.

Apps

The system supports the use of certain audio apps such as iHeartRadio through a USB or bluetooth-enabled device.

Each app gives you different on-screen options depending on the app's content. See **Apps** (page 454).

Supported Media Players, Formats and Metadata Information

The system is capable of hosting nearly any digital media player, including iPod, iPhone, and most USB drives.

Supported audio formats include MP3, WMA, WAV, AAC, and FLAC.

Supported audio file extensions include MP3, WMA, WAV, M4A, M4B, AAC, and FLAC.

Supported USB file systems include: FAT, exFAT, and NTFS.

SYNC 3 is also able to organize the media from your USB device by metadata tags. Metadata tags, which are descriptive software identifiers embedded in the media files, provide information about the file.

If your indexed media files contain no information embedded in these metadata tags, SYNC 3 may classify the empty metadata tags as unknown.

SYNC 3 is capable of indexing up to 50,000 songs per USB device, for up to 10 devices.

CLIMATE

Touch the climate button on the touchscreen to access your climate control features. Depending on your vehicle line and option package, your climate screen may look different from one of the screens shown below. Your screen may not contain all of the features shown.

Note: You can switch temperature units between Fahrenheit and Celsius. See **Settings** (page 457).

SYNC™ 3

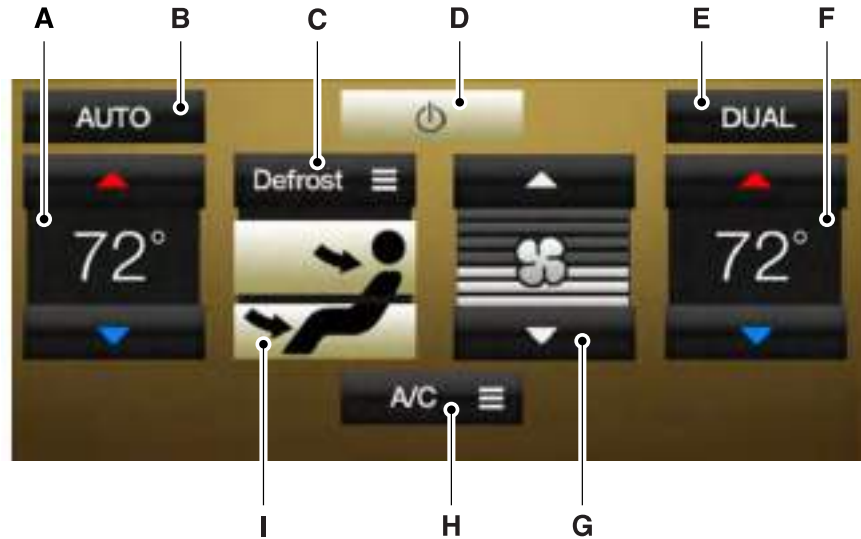

E227323

- A **Driver temperature:** Touch up or down to adjust the temperature.
- B **AUTO:** Touch the button to switch on automatic operation. Select the desired temperature using the temperature control. The system adjusts fan speed, air distribution, air conditioning operation, and selects outside air or recirculated air to heat or cool the vehicle in order to maintain the desired temperature.
- C **Defrost:** A pop up appears on the screen to display the defrost options.
 - MAX Defrost:** Touch the button to maximize defrosting. Air flows through the windshield vents, the fan automatically adjusts to the highest speed and the driver and passenger temperatures are set to HI. You can use this setting to defog or clear a thin covering of ice from the windshield. The heated rear window also automatically turns on when you select MAX Defrost.
 - Defrost:** Distributes air through the windshield defroster vents and demister vents.
 - Heated rear window:** Turns the heated rear window on and off. See **Heated Windows and Mirrors** (page 137).
- D **Power:** Touch the button to switch the system on and off. Switching off the climate control system prevents outside air from entering the vehicle.
- E **DUAL:** This button lights up when the passenger controls are active. To switch the off and link the passenger temperature to the driver temperature, touch the DUAL button.
 - Note:** the passenger side temperature and the DUAL indication automatically turn on when you or your passenger adjust the passenger temperature.
- F **Passenger temperature:** Touch up or down to adjust the temperature.
- G **Fan speed:** Touch up or down to increase or decrease the volume of air that circulates in your vehicle.
 - Note:** You cannot adjust the fan speed when the system is set to AUTO or MAX A/C.
- H **A/C:** A pop-up appears on the screen to display the air conditioning options.

MAX A/C: Touch the button to activate and maximize cooling. The driver and passenger temperatures are set to LO, recirculated air flows through the instrument panel vents, air conditioning automatically turns on and the fan automatically adjusts to the highest speed.

A/C: Touch to switch the air conditioning on or off. Use A/C with recirculated air to improve cooling performance and efficiency.

Note: In certain conditions (for example, Max Defrost), the air conditioning compressor may continue to operate even when you switch the air conditioning A/C button off.

Recirculated air: Touch to switch the recirculated air on or off. When recirculated air is on, it may reduce the amount of time needed to cool down the interior (when used with A/C) and help reduce odors from reaching the interior.

Note: Recirculated air may turn off automatically (or the system may prevent it from turning on) in all airflow modes except MAX A/C to reduce risk of fogging. It may also turn on and off automatically in Panel or Panel/Floor airflow modes during hot weather in order to improve cooling efficiency.

- I **Manual airflow distribution controls:** Select these controls individually, together, or with Defrost to direct the air flow to the area you desire.

Panel: Distributes air through the instrument panel vents.

Floor: Distributes air through the demister vents, floor vents and rear seat floor vents.

PHONE

WARNING



Driving while distracted can result in loss of vehicle control, crash and injury. We strongly recommend that you use extreme caution when using any device that may take your focus off the road. Your primary responsibility is the safe operation of your vehicle. We recommend against the use of any hand-held device while driving and encourage the use of voice-operated systems when possible. Make sure you are aware of all applicable local laws that may affect the use of electronic devices while driving.

Hands-free calling is one of the main features of the system. Once you pair your cell phone, you can access many options using the touchscreen or voice commands. While the system supports a variety of features, many are dependent on your cell phone's functionality.

Pairing Your Cell Phone for the First Time

Pair your Bluetooth-enabled phone with the system before using the functions in hands-free mode.

Switch on Bluetooth on your device to begin pairing. See your phone's manual if necessary.

To add a phone, select:

Menu Item
Add Phone

1. Follow the on-screen instructions.
2. A prompt alerts you to search for the system on your phone.
3. Select your vehicle's make and model as it displays on your phone.
4. Confirm that the six-digit number appearing on your phone matches the six-digit number on the touchscreen.
5. The touchscreen indicates when the pairing is successful.

6. Your phone may prompt you to give the system permission to access information. To check your phone's compatibility, see your phone's manual or visit the website.

Alternatively, to add a phone, select:

Menu Item
Add Phone
Then select:
Discover Other Bluetooth Devices

1. Follow the on-screen instructions.
2. A prompt alerts you to search for the system on your phone.
3. Select your phone's name when it appears on the touchscreen.
4. Confirm that the six-digit number appearing on your phone matches the six-digit number on the touchscreen.
5. The touchscreen indicates when the pairing is successful.

6. Your phone may prompt you to give the system permission to access information. To check your phone's compatibility, see your phone's manual or visit the website.

At a minimum, most cell phones with Bluetooth wireless technology support the following functions:

- Answering an incoming call.
- Ending a call.
- Dialing a number.

- Call waiting notification.
- Caller identification.

Other features, such as text messaging using Bluetooth and automatic phonebook download, are phone-dependent features.

To check your phone's compatibility, see your phone's manual or visit the website:

Websites
owner.lincoln.com

Websites
www.syncmyride.ca www.syncmaroute.ca

Phone Menu

This menu becomes available when a phone is paired and connected.

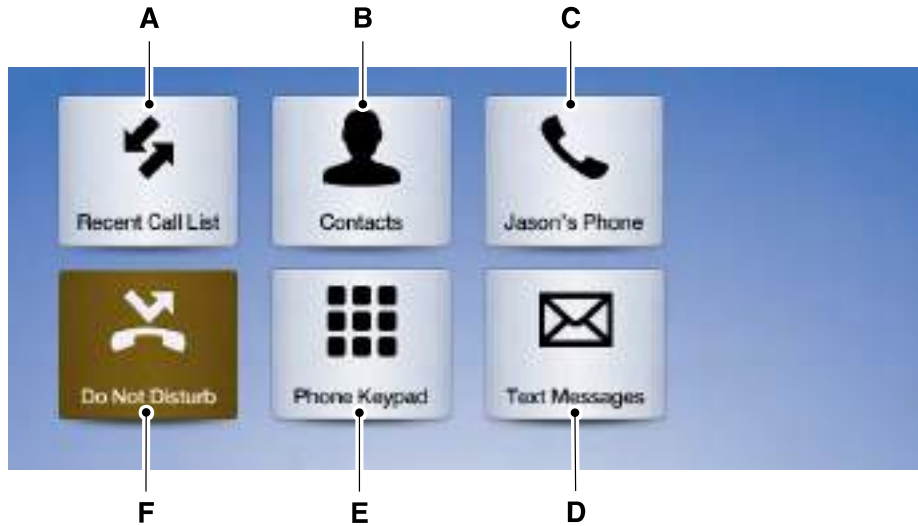

E205447

Item	Menu Item	Action and Description
A	Recent Call List	Displays your recent calls.

Item	Menu Item	Action and Description				
		<p>You can place a call by selecting an entry from this list. You can also sort the calls by selecting the drop down menu at the top of the screen. You can choose:</p> <table border="1"> <tr> <td>All</td> <td>Incoming</td> <td>Outgoing</td> <td>Missed</td> </tr> </table>	All	Incoming	Outgoing	Missed
All	Incoming	Outgoing	Missed			
B	Contacts	<p>All of your contacts from your phone display in alphabetical order.</p> <table border="1"> <tr> <td>A-Z Jump</td> <td>Selecting this button allows you to choose a specific letter to view.</td> </tr> </table>	A-Z Jump	Selecting this button allows you to choose a specific letter to view.		
A-Z Jump	Selecting this button allows you to choose a specific letter to view.					
C	Phone Settings	<p>Displays the name of your phone and takes you to the phone settings options. From this menu, you can pair subsequent devices, set ring tones and alerts. See Settings (page 457).</p>				
D	Text Messages	<p>Displays all recent text messages.</p>				
E	Phone Keypad	<p>Use this keypad to dial in a phone number. Use the backspace button to delete numbers.</p> <table border="1"> <tr> <td>Call</td> <td>Press this button to begin a call.</td> </tr> </table>	Call	Press this button to begin a call.		
Call	Press this button to begin a call.					
F	Do Not Disturb	<p>Touch this button to send all calls directly to your voicemail. New text message notifications are not displayed on the screen and all ringtones and alerts are set to silent.</p>				

Users with phones having voice services may see a button to access the feature. For example, iPhone users see a Siri button. A press and hold of the voice button on the steering wheel also accesses this feature.

Making Calls

There are many ways to make calls from the SYNC 3 system, including using voice commands. See **Using Voice Recognition** (page 408). You can use the touchscreen to place calls as well.

To call a number in your contacts, select:

Menu Item	Action and Description
Contacts	You can then select the name of the contact you want to call. Any numbers stored for that contact display along with any stored contact photos. You can then select the number that you want to call. The system begins the call.

To call a number from your recent calls, select:

Menu Item	Action and Description
Recent Call List	You can then select an entry that you want to call. The system begins the call.

To call a number that is not stored in your phone, select:

Menu Item	Action and Description

Menu Item	Action and Description
Phone Keypad	Select the digits of the number you wish to call.
Call	The system begins the call.

Pressing the backspace button deletes the last digit you typed.

Receiving Calls

During an incoming call, an audible tone sounds. Caller information appears in the display if it is available.

To accept the call, select:

Menu Item
Accept

Note: *You can also accept the call by pressing the phone button on the steering wheel.*

To reject the call, select:

Menu Item
Reject

Note: *You can also reject the call by pressing the phone button on the steering wheel.*

Ignore the call by doing nothing. SYNC 3 logs it as a missed call.

During a Phone Call

During a phone call, the contacts name and number display on the screen along with the call duration.

The phone status items are also visible:

- Signal Strength.
- Battery.
- 911 Assist (United States and Canada Only). See **Settings** (page 457).

You can select any of the following during an active phone call:

Item	
End Call	Immediately end a phone call. You can also press the button on the steering wheel.
Keypad	Press this to access the phone keypad.

Receiving a Text Message

When a new message arrives, an audible tone sounds and the screen displays a pop-up with the caller name and ID, if supported by your cell phone. You can select:

Menu Item	Action and Description
Hear It	Have SYNC 3 read the message to you.
View	View the text on the touchscreen.
Call	To call the sender.
Reply	You can select from 15 preset messages. Press the message that you would like to use and confirm to send the message. SYNC 3 confirms when the message is sent successfully.
Close	To exit the screen.

Item	
Mute	You can switch the microphone off so the caller does not hear you.
Privacy	Transfer the call to the cell phone or back to SYNC 3.

Text Messaging

Note: Downloading and sending text messages using Bluetooth are cell phone-dependent features.

Note: Certain features in text messaging are speed-dependent and not available when your vehicle is traveling at speeds over 3 mph (5 km/h).

Smartphone Connectivity (If Equipped)

The system allows you to use Apple CarPlay and Android Auto to access your phone.

When you use Apple CarPlay or Android Auto, you can:

- Make calls.
- Send and receive messages.
- Listen to music.
- Use your phone's voice assistant.

Apple CarPlay and Android Auto disables some system features.

Most Apple CarPlay and Android Auto features use mobile data.

Apple CarPlay

Apple CarPlay requires an iPhone 5 or newer with iOS 7.1 or newer. We recommend updating to the latest iOS version.

1. Plug your phone into a USB port.
2. Select Apple CarPlay on the touchscreen.

To disable Apple CarPlay on your phone, go to the settings on the touchscreen and select:

Menu Item
Apple CarPlay Preferences
Select the name of your device and then select:
Disable

To return to the system, go to the Apple CarPlay home screen and select the SYNC app.

Android Auto

Android Auto is compatible with most devices with Android 5.0 or newer.

1. Download the Android Auto app to your device from Google Play.
2. Plug your phone into a USB port.
3. Select Android Auto on the touchscreen.

To disable Android Auto on your phone, go to settings on the touchscreen and select:

Menu Item
Android Auto Preferences
Select the name of your device and then select:
Disable

To return to the system, select the speedometer icon in the Android Auto menu bar at the bottom of the touchscreen, and then touch the option to return to SYNC.

NAVIGATION

Your navigation system is comprised of two main features, destination mode and map mode.

Map Mode

Map mode shows advanced viewing comprised of 2D city maps, 3D landmarks and 3D city models (when available). 2D city maps show detailed outlines of buildings, visible land use, landscape features, and detailed railroad infrastructure for the most essential cities around the globe.

3D landmarks appear as clear, visible objects that are typically recognizable and have a certain tourism value.

3D city models are complete 3D models of entire city areas including navigable roads, parks, rivers and rendered buildings. 3D landmarks and city models appear in 3D map mode only. Coverage of these varies and improves with updated map releases.



Select the zoom in icon to see a closer view of the map.



Select the zoom out icon to see a farther away view of the map.

You can adjust the view in preset increments. You can also pinch to zoom in or out of the map.

The information bar tells you the names of streets, cities or landmarks as you hover over them with the crosshair cursor.

You can change your view of the map by tapping on the location indicator icon on the right hand side of the screen. You can choose from the following options:



Heading up (2D map) This always shows the direction of forward travel to be upward on the screen. This view is available for map scales up to 3 mi (5 km).



North up (2D map) always shows the northern direction to be upward on the screen.



3D map mode provides an elevated perspective of the map. Adjust this viewing angle and rotate the map 180 degrees by touching the map twice, and then dragging your finger along the shaded bar with arrows at the bottom of the map.



Re-center the map by pressing this icon whenever you scroll the map away from your vehicle's current location.



Points of Interest (POI) grouping icon: You can choose up to three POI icons to display on the map. If the chosen POIs are located close together or are at the same location a box is used to display a single category icon

instead of repeating the same icon, in order to reduce clutter. When you select the box on the map, a pop-up appears indicating how many POIs are in this location. Select the pop up to see a list of the available POIs. You can scroll through and select POIs from this list.

If your vehicle is low on charge or fuel, station icons automatically display on the map.

Destination Mode

To set a destination, press:

Menu Item	Description
Destination	
Enter a navigation destination in any of the following formats:	
Search	Street Address (number, street, city, state) For example "12 Mainstreet Dearborn MI"
	Partial Address (number, street) if searching in current state (number, street and zip code (or postal code in Canada)) if searching out of state

If you have subscribed to SiriusXM Traffic and Travel Link (where available), traffic flow will be indicated on the map by green (clear), yellow (slowing), and red (stopped) road highlights. Traffic flow is indicated where the information is available and varies across the US.

You can choose to display traffic icons on the map representing twelve different types of incidents. See **Settings** (page 457).

You can set a destination by hovering above a location and selecting:

Button
Start

Menu Item	Description
	<p>You can enter unique addresses that contain door number prefixes with or without the prefix. For example, you could enter "6N340 Fairway Lane" or "340 Fairway Lane".</p>
	<p>City (name or zip code)</p>
	<p>Point of Interest (name or category)</p>
	<p>Intersection (street 1 / street 2) (street 1 and street 2) (street 1 & street 2) (street 1 @ street 2) (street 1 at street 2)</p>
	<p>Latitude and Longitude (##.##### , ##.#####) One to six decimal places are accepted.</p>
	<p>You are given autocomplete options below the address bar to select as you type. If you do not give an exact destination, a menu displays with your possible selections.</p>
Previous Destinations	<p>Collections of your last 40 navigation destinations display here. You can select any option from the list to select it as your destination.</p>

SYNC™ 3

Menu Item	Description
	These locations cannot be deleted individually. To delete them, perform a master reset. See SYNC™ 3 Troubleshooting (page 474).
Home	Select to navigate to your set Home destination. The time it takes to travel from your current location to Home displays. To set your Home, press:
	Home A prompt appears asking if you would like to create a favorite for home. Select:
	Yes Enter a location into the search bar and press:
	Save
Work	Select to navigate to your set Work destination. The time it takes to travel from your current location to Work displays. To set your Work:
	Work A prompt appears asking if you would like to create a favorite for work. Select:
	Yes Enter a location into the search bar and press:
	Save
Favorites	Favorites include any location you have previously saved. To add Favorites:
	Add a Favorite Select this button and enter a location into the destination bar.
	Search Select this option to have the system locate the address you have entered.

SYNC™ 3

Menu Item	Description	
	Save	Select this button when the address you have entered appears on the screen.
	The address saves as a favorite and you see the favorites screen. You can now select this address from the favorites screen.	
Point of Interest (POI) Categories	POI categories that may display (based on market and vehicle configuration):	
	Food	
	Fuel	
	hotel	
	ATM	
	See All	Press to view additional categories. Once you have selected a category, follow the menus to find what you are looking for.
	Inside of these categories you can search by:	
	Nearby	
	Along Route	
	Near Destination	
In a City		

Once you have chosen your destination, press:

Menu Item	Action and Description	
Save	This saves the destination to your favorites.	
Start	This shows you a map of your entire route. You can then choose your route from three different options.	
	Fastest	Uses the fastest moving roads possible.
	Shortest	Uses the shortest distance possible.
	Economical Route	Uses the most fuel-efficient route.
	The time and distance for each route also displays.	
Cancel	On the route screen, you can choose to cancel the current navigation. The system asks for confirmation then returns you to the map mode screen.	

Once you have chosen your destination, press:

Menu Item	Action and Description
Start	<p>The system uses a variety of screens and prompts to guide you to your destination. During Route guidance, you can press the maneuver arrow icon on the map if you want the system to repeat route guidance instructions. When the system repeats the last guidance instruction, it updates the distance to the next guidance instruction, since it detects that the vehicle is moving.</p> <p>The navigation map shows your estimated time of arrival, remaining travel time and the distance to your destination.</p>

Menu Item	Action and Description
	SYNC 3 may not always announce vehicle arrival at the exact point of your destination and you may have to cancel a route manually.

Navigation Menu

In map mode and during active navigation you can access the navigation menu.

During active navigation, touch the bottom of the screen to view the menu and other buttons.

To access the Navigation menu, press:

Button		
Menu		
You can then select:		
Screen View	Full Map	A full screen map displays during navigation.
	Highway Exit Info	Highway exit information displays on the right hand side of the screen during navigation. Points of interest icons display for restaurants, hotels, fuel stations and ATMs when they are present at the exit. You can select the POI icons to receive a listing of specific locations. You can select the POI location as a waypoint or destination if desired.
	Turn List	Only available during an active route. Displays all of the turns on the current route. You can choose to avoid any road on the turn list by selecting the road from the list. A screen then appears and you can press:

Button	
	<p style="text-align: center;">Avoid</p> <p>The system calculates a new route and displays a new turn list.</p>
Traffic List	<p>You can find the SiriusXM Traffic and Travel Link information by pressing this button. This information requires an active subscription to SiriusXM Traffic and Travel Link.</p> <p>When a route is not active, a list of nearby traffic incidents displays (if any are present).</p> <p>When a route is active, you can choose to display a list of traffic nearby or on the route.</p>
Navigation Settings	<p>Press this button to adjust your preferences. See Settings (page 457).</p>
Where Am I?	<p>Provides your current location city, longitude and latitude and the nearest road.</p>
<p>The following are only available on the menu during an active navigation route:</p>	
Cancel Route	<p>The system asks for confirmation and then returns you to the map mode screen.</p>
Mute Guidance	<p>Selecting this option switches off the audio navigation guidance. Press the button again to un-mute guidance.</p>
View Route	<p>Press this to see a map of the full route.</p>
Detour	<p>An alternate route displays in comparison with the current route.</p>
Edit Waypoints	<p>Only available if you have an active waypoint on your route. See Waypoints later in this section for information on how to set waypoints.</p>

Button	
	Use this button to re-order or remove your waypoints.
You can also have the system set the order for you by pressing:	Optimize Order
To return to your route press:	Go

Waypoints

You can add a waypoint to a navigation route as a destination along your route.

To add a waypoint:

1. Select the search icon (magnifying glass) while on an active route. This brings up the destination menu.

2. Set your destination using any of the given methods. Once the destination has been selected, the screen allows you to set the destination as a waypoint by selecting:

Menu Item	
Add Waypoint	The waypoint list then appears and you are able to re-order all of your waypoints by selecting the menu icon on the right hand side of the location. You can select up to five waypoints.
You can also have the system set the order for you by pressing:	Optimize Order
To return to your route, press:	Go

cityseeker (If Equipped)

Note: *cityseeker point of interest (POI) information is limited to approximately 1110 cities (1049 in the United States, 36 in Canada and 15 in Mexico).*



cityseeker

E225487

cityseeker, when available, is a service that provides more information about certain points of interest such as restaurants, hotels and attractions.

When you have selected a point of interest, the location and information appear, such as address, phone number and a star rating.

Press **More Information** to see a photo, a review, a list of services and facilities, the average room or meal price and the web address. This screen displays the point of interest icons.

For restaurants, cityseeker can provide information such as star rating, average cost, review, handicap access, hours of operation, and website address.

For hotels, cityseeker can provide information such as star rating, price category, review, check-in and checkout times, hotel service icons and website address. Hotel service icons include:

- Restaurant
- Business center
- Handicap facilities
- Laundry
- Refrigerator
- 24 hour room service
- Fitness center
- Internet access
- Pool
- Wi-Fi

Attractions include nearby landmarks, amusement parks, historic buildings and more. cityseeker can provide information such as star rating, reviews, hour of operation and admission price.

SiriusXM Traffic and Travel Link

SiriusXM Traffic and Travel Link is available on vehicles equipped with navigation and only in select markets. You must activate and subscribe to receive SiriusXM Traffic and Travel Link information. It helps you locate the best gas prices, find movie listings, get current traffic alerts, view the weather map, get accurate ski conditions and see current sports scores. See **Apps** (page 454).

The system calculates a reasonable efficient route based on available speed limits, traffic, and road conditions. You may know a local short cut that is more efficient at a given time than the route provided by SYNC 3, but you should expect a slight difference in minutes or miles with the SYNC 3 route.

Navigation Map Updates

Annual navigation map updates are available for purchase through your dealership, by calling 1-866-462-8837 in the United States and Canada or 01-800-557-5539 in Mexico. You can also visit:

Website
www.navigation.com/sync

You need to specify the make and model of your vehicle to determine if there is an update available.

HERE is the digital map provider for the navigation application. If you find map data errors, you may report them directly to HERE by going to www.here.com/mapcreator. HERE evaluates all reported map errors and responds with the result of their investigation by e-mail.

Map coverage includes the USA (including Puerto Rico and the US Virgin Islands), Canada and Mexico.

APPS

The system enables voice, steering wheel, and touch screen control of SYNC 3 AppLink enabled smartphone apps. Once an app is running through AppLink, you can control main features of the app through voice commands and steering wheel controls.

Note: Available AppLink enabled apps will vary by market.

Note: You must pair and connect your smartphone via Bluetooth to SYNC 3 to access AppLink.

Note: iPhone users need to connect the phone to the USB port.

Note: For information on available apps, supported smartphone devices and troubleshooting tips please visit:

Websites
owner.lincoln.com www.syncmyride.ca

Websites
www.syncmaroute.ca

Note: Make sure you have an active account for the app that you have downloaded. Some apps will work automatically with no setup. Other apps will want you to configure your personal settings and personalize your experience by creating stations or favorites. We recommend you do this at home or outside of your vehicle.

Note: We encourage you to review the smartphone app's terms of service and privacy policies because Ford is not responsible for your app or its use of data.

Note: AppLink is a native SYNC system feature. Accessing mobile apps through AppLink is only possible when Android Auto or Apple CarPlay are disabled. Some apps may only be accessible in the car through AppLink and others only through Android Auto or Apple CarPlay. Please refer to the Smartphone Connectivity information to disable Android Auto or Apple CarPlay.

Note: In order to use an app with SYNC 3, the App needs to be running in the background of your phone. If you shut down the app on your phone, it shuts down the app on SYNC 3 as well.

Note: If a SYNC 3 AppLink compatible app is not shown in the Apps Domain, make sure the required app is running on the mobile device.

Menu Item	Action and Description
Connect Mobile Apps	SYNC 3 will search and connect to compatible app(s) running on your mobile device.

Enabling SYNC 3 Mobile Apps

In order to enable mobile apps, SYNC 3 requires user consent to send and receive app authorization information and updates using the data plan associated with the connected device.

The connected device sends data to Ford in the United States. The information is encrypted and includes your VIN, SYNC 3 module number, odometer, usage statistics and debugging information. We retain this data for only as long as necessary to provide this service, troubleshoot, and improve products and services and to offer you products and services that may interest you where allowed by law.

Note: You must enable mobile apps for each connected device the first time you select a mobile app using the system.

Note: Ford reserves the right to limit functionality or deactivate mobile apps at any time.

Note: Standard data rates apply. Ford is not responsible for any additional charges you may receive from your service provider, when your vehicle sends or receives data through the connected device. This includes any additional charges incurred due to driving in areas when roaming out of a home network.

You can enable and disable apps through settings. See **Settings** (page 457).

App Permissions

The system organizes the App permissions into groups. You can grant these group permissions individually. You can change a permission group status any time when not driving, by using the settings menu. While in the settings menu, you can also see the data included in each group.

When you launch an app using SYNC 3, the system may ask you to grant certain permissions, for example Vehicle information, Driving characteristics, GPS and Speed, and/or Push notifications. You can enable all groups or none of them during the initial app permissions prompts. The settings menu offers individual group permission control.

Note: You are only prompted to grant permissions the first time you use an app with SYNC 3.

Note: If you disable group permissions, apps will still be enabled to work with SYNC 3 unless you deactivate All Apps in the settings menu.

SiriusXM Traffic and Travel Link (if

Equipped)

WARNING



Driving while distracted can result in loss of vehicle control, crash and injury. We strongly recommend that you use extreme caution when using any device that may take your focus off the road. Your primary responsibility is the safe operation of your vehicle. We recommend against the use of any hand-held device while driving and encourage the use of voice-operated systems when possible. Make sure you are aware of all applicable local laws that may affect the use of electronic devices while driving.

Note: *SiriusXM Traffic and Travel Link may not be available in all markets.*

Note: *In order to use SiriusXM Traffic and Travel Link, your vehicle must have navigation.*

Note: *A paid subscription is required to access and use these features. Go to www.siriusxm.com/travellink for more information.*

Note: *Visit www.siriusxm.com/traffic and click on Coverage map and details for a complete listing of all traffic areas covered by SiriusXM Traffic and Travel Link.*

Note: *Neither Sirius nor Ford is responsible for any errors or inaccuracies in the SiriusXM Traffic and Travel Link services or its use in vehicles.*

When you subscribe to SiriusXM Traffic and Travel Link, it can help you locate the best gas prices, find movie listings, get current traffic alerts, view the current weather map, get accurate ski conditions and see scores to current sports games.

Menu Item	Action and Description
Traffic on Route	Touch these buttons to identify traffic incidents on your route, near your vehicle's current location or near any of your favorite places, if programmed.
Traffic Nearby	
Fuel Prices	Touch this button to view fuel prices at stations close to your vehicle's location or on an active navigation route.
Movie Listings	Touch this button to view nearby movie theaters and their show times, if available.

Menu Item	Action and Description	
Weather	Touch this button to view the nearby weather, current weather, or the five-day forecast for the chosen area.	
	Map	Select to see the weather map, which can show storms, radar information, charts and winds.
	Area	Select to choose from a listing of weather locations.
Sports Info	Touch this button to view scores and schedules from a variety of sports. You can also save up to 10 favorite teams for easier access. The score automatically refreshes when a game is in progress.	
Ski Conditions	Touch this button to view ski conditions for a specific area.	

Sound

Pressing this button allows you to adjust the following:

SETTINGS

Under this menu, you can access and adjust the settings for many of the system features. To access additional settings, swipe the screen left or right.

Sound Settings	
Reset All	Returns Treble, Midrange, and Bass sound settings to factory levels.
Treble	Adjusts the high frequency level.
Midrange	Adjusts the middle frequency level.
Bass	Adjusts the low frequency level.
Balance / Fade	Adjusts the sound ratio from side to side or front to back.
Speed Adaptive Volume	Adjusts the amount the audio system volume increases with speed, or turns the feature off.
Occupancy Mode	Optimizes the sound based on the location of the listeners.
Sound Settings	Stereo
	Surround

Your vehicle might not have all of these features.

Media Player

This button is available when a media device such as a Bluetooth Stereo or USB device is the active audio source. Pressing the button allows you to access the following options for active devices only.

SYNC™ 3

Menu Item	Action and Description		
Podcast Speed	For some Apple devices, SYNC 3 can adjust the playback speed of podcasts. When a podcast is playing, you can choose:		
	Slower	Normal	Faster
Audiobook Speed	For some Apple devices, SYNC 3 can adjust the playback speed of audiobooks. When an audiobook is playing, you can choose:		
	Slower	Normal	Faster
Cover Art Priority	Media Player	Cover art displays from your device's music files. If no cover art for the files exists on the device, then the Gracenote Database provides cover art.	
	Gracenote®	The Gracenote Database supplied cover art is used for your music files. This overrides any cover art from your device.	
Reset Media	Erase the stored media information in order to re-index.		
Gracenote® Database Info	This allows you to view the version level of the Gracenote Database.		
Device Information	This allows you to view the manufacturer and model number of your media device.		

Clock

To adjust the time, select the up and down arrows on either side of the screen. The

arrows on the left adjust the hour and arrows on the right adjust the minute. You can then select AM or PM.

You can adjust the following features:

Menu Item	Action and Description
Clock Format	Select how time displays.
Auto Time Zone Update	When active, the clock adjusts to time zone changes. This feature is only available in vehicles with navigation.
Reset Clock to GPS Time	When selected, the vehicle clock resets to GPS satellite time.

The system automatically saves any updates you make to the settings.

Bluetooth

Pressing this button allows you to access the following:

Menu Item	Action
Bluetooth	On
	Off

You must activate Bluetooth to pair a Bluetooth-enabled device.

The processes of pairing a Bluetooth device is the same as pairing a phone. **See Pairing a Device** in Phone settings for how to pair a device and the available options.

Phone

Pair your Bluetooth-enabled phone with the system before using the functions in hands-free mode.

Switch on Bluetooth on your device to begin pairing. See your phone's manual if necessary.

To add a phone, select:

Menu Item
Add Phone

1. Follow the on-screen instructions.
2. A prompt alerts you to search for the system on your phone.
3. Select your vehicle's make and model as it displays on your phone.
4. Confirm that the six-digit number appearing on your phone matches the six-digit number on the touchscreen.

5. The touchscreen indicates when the pairing is successful.
6. Your phone may prompt you to give the system permission to access information. To check your phone's compatibility, see your phone's manual or visit the website.

Alternatively, to add a phone, select:

Menu Item
Add Phone
Then select:
Discover Other Bluetooth Devices

1. Follow the on-screen instructions.
2. A prompt alerts you to search for the system on your phone.
3. Select your phone's name when it appears on the touchscreen.
4. Confirm that the six-digit number appearing on your phone matches the six-digit number on the touchscreen.

5. The touchscreen indicates when the pairing is successful.
6. Your phone may prompt you to give the system permission to access information. To check your phone's compatibility, see your phone's manual or visit the website.

Other features, such as text messaging using Bluetooth and automatic phonebook download, are phone-dependent features.

Once you have paired a device you can adjust the following options.

To check your phone's compatibility, see your phone's manual or visit the website:

Website
owner.lincoln.com www.syncmyride.ca www.syncmaroute.ca

Once you have paired a device you can adjust the following options.

Menu Item	Action and Description
View Devices	
You can then select:	
Add a Bluetooth Device	You can add a Bluetooth-enabled device by following the steps in the previous table.
You can select a phone by touching the name of the phone on the screen. You then have the following options:	
Connect	Depending on the status of the device, you can select either of these options to interact with the selected device.
Disconnect	
Device Information	Allows you to see phone and device information.
Make Primary	Allows you to select this device to be your preferred device.
Delete	Removes the selected device from the system.

Menu Item	Action and Description
Manage Contacts	
You can then select:	
Automatic Contact Download On/Off	Enable this option to have SYNC 3 periodically re-download your phonebook to keep your contact list up to date.
Sort By:	Choose how you would like the system to display your contacts. You can choose:

SYNC™ 3

Menu Item	Action and Description	
	First Name	Last Name
Re-download Contacts	Select this option to re-download your contact list manually.	
Delete Contacts	Select this option to delete the in vehicle contact list. Deleting the in vehicle list does not erase the contact list on the connected phone.	

Menu Item	Action and Description	
Set Phone Ringtone		
You can then select:		
No Ringtone	No sound plays when a call comes to your phone.	
Use Phone Ringtone	The currently selected ringtone on your phone plays when you receive a call. This option may not be available for all phones. If this option is available, it is the default setting.	
You can also select one of the three available ringers.		

Menu Item	Action and Description
Text Messaging	
You can then select:	
No Alert (Silence)	No sound plays when a message comes to your phone.
You can select one of the three available notification sounds.	
Voice Readout	When enabled, a voice prompt alerts you when you receive a new message.

You can enable and disable the following options as well:

Menu Item	Action and Description
Mute Audio in Privacy	When enabled, vehicle audio (such as radio or apps) is muted for the duration of the phone call even when the phone call is in privacy.
Roaming Warning	When enabled, an alert displays that your phone is roaming when you attempt to place a call.
Low Battery Notification	When enabled, a message displays when the battery on your phone is running low.

911 Assist

Note: *This service is only available in the United States and Canada.*

Select this button to modify the on or off setting for this feature. If the mobile phone's contacts have been downloaded, you can adjust the following option:

Menu Item	Action and Description
Set Emergency Contacts	You can select up to two numbers from your mobile device's phonebook as emergency contacts for quick access at the end of the 911 Assist call process.

Radio

This button is available if a Radio source such as AM or FM is the active media source. Pressing the button allows you to access the following features:

Menu Item	Action and Description
FM HD Radio AM HD Radio (Dependent on current radio source, If Available)	Activation of this feature allows you to listen to HD radio broadcasts.
Radio Text	This feature is available when FM Radio is your active media source. Activate this feature to have the system display radio text.
Autoset Presets (AST)	Refresh
	Selecting this option stores the six strongest stations in your current location to the last preset bank of the currently tuned source.

Navigation

preferences by selecting the following menus.

You can adjust many of the Navigation

Map Preferences

Menu Item	Action and Description	
Map Preferences		
Then select any of the following:		
3D City Model	When this option is active, the system shows 3D renderings of buildings.	
Breadcrumbs	When enabled, your vehicle's previously traveled route displays with white dots.	
POI Icons	Enable this feature to display up to 3 POI icons on the navigation map.	
	Once this feature is activated you can select the icons you want displayed by selecting:	Select POIs
Incident Map Icons	This menu allows you to choose which incident icons you would like to have displayed on the navigation map.	

Route Preferences

Menu Item	Second Level Messages, Actions and Descriptions		
Route Preferences			
Then select any of the following:			
Preferred Route	Choose to have the system display your chosen route type.		
	Shortest	Fastest	Eco
Always Use ___ Route	Bypass route selection in destination programming. The system only calculates one route based on your preferred route setting. When activated, the system uses your selected route type to calculate only one route to the desired destination.		
Use HOV Lanes	The system selects High Occupancy Vehicle or car pool lanes when providing route guidance.		
Automatically Find Parking	The system searches for and displays available parking locations as you approach your destination.		
Eco Time Penalty	Select a level of cost for the calculated Eco Route. The higher the setting, the longer the time allotment is for the route.		
Dynamic Route Guidance	Enable or disable considering traffic information when planning a route. The system can find a faster route based on heavy traffic flow information or detect a Road Closed incident and find a detour route if possible.		

Navigation Preferences

Menu Item	Action and Description
Navigation Preferences	
Guidance Prompts	You can adjust how the system provides prompts.
Then select any of the following:	
Voice and Tones	
Voice Only	
Tones Only	

Mobile Apps

You can enable the control of compatible mobile apps running on your Bluetooth or USB device on SYNC 3. In order to enable mobile apps, SYNC 3 requires user consent to send and receive app authorization information and updates using the data plan associated with the connected device.

The connected devices sends data to Ford in the United States. The encrypted information includes your VIN, SYNC 3 module number, anonymous usage statistics and debugging information. Updates may take place automatically.

Note: *Standard data rates will apply. Ford is not responsible for any additional charges you may receive from your service provider, when your vehicle sends or receives data through the connected device. This includes any additional charges incurred due to driving in areas when roaming out of a home network.*

SYNC™ 3

Menu Item	Action and Description			
Mobile Apps	On	Enable or disable the use of mobile apps on SYNC 3.		
	Off	Disabling mobile apps in the settings menu disables automatic updates and the use of mobile apps on SYNC 3.		
	You can view the status of mobile app permissions in the settings menu.			
Once Mobile Apps is enabled, you have the following options:				
Update Mobile Apps	This provides information on the current state of available app updates.			
	There are three possible statuses:			
	Update Needed	Up-To-Date	Updating Mobile Apps...	
	The system has detected a new app requiring authorization or a general permissions update is required.	No update is required.	The system is trying to receive an update.	
	Request Update		Select this button if an update is required and you want to request this update manually. For example, when your mobile device is connected to a Wi-Fi hotspot, select:	

SYNC™ 3

Menu Item	Action and Description	
	Request Update	
All Apps	Grant or deny permissions to all apps at once.	
There may also be SYNC 3 enabled apps listed under these options.	Grant or deny an individual app particular permissions. App permissions are organized into groups. By pressing the info book icon, you can see which signals are included in each group.	

Note: *Ford and Lincoln are not responsible or liable for any damages or loss of privacy relating to usage of an app, or dissemination of any vehicle data that you approve Ford and Lincoln to provide to an app.*

General

Access and adjust the system settings, voice features, as well as phone, navigation and wireless settings.

Menu Item	
Language	Select to have the touchscreen display in English, Spanish or French.
Distance	Select to display units in kilometers or miles.
Temperature	Select to display units in Celsius or Fahrenheit.
Touch Screen Beep	Select to have the system beep to confirm choices made through the touchscreen.
Automatic System Updates	When you activate this option, the system automatically updates when you have an available Internet connection through a Wi-Fi network or mobile connection.

SYNC™ 3

Menu Item	
About	Information pertaining to the system and its software.
Software Licenses	Documentation of the software license for the system.
Master Reset	Select to restore factory defaults. This erases all personal settings and personal data.

Wi-Fi

You can adjust the following:

Menu Item	Action and Description
Wi-Fi	Enable this option to connect to Wi-Fi for SYNC 3 vehicle software updates.
View Available Networks	This provides you with a list of available Wi-Fi networks within range.
	Clicking on a network from the list allows you to connect or disconnect from that network. The system may require a security code to connect.
	When you click the information button next to a network, more information about the network displays such as the signal strength, connection status and security type.
Wi-Fi Available Notifications	The system alerts you when your vehicle is parked and a Wi-Fi network is within range if SYNC is not already connected.

Ambient Lighting (If Equipped)

Tap a color once to active ambient lighting. This sets the color to the highest intensity.

You can drag the colors up and down to increase or decrease the intensity.

To switch ambient lighting off, press the active color once or drag the active color all the way down to zero intensity.

Camera Settings

To make adjustments using the touchscreen, select:

Message	Action and Description
Camera Settings	
Then select from the following:	
Rear Camera Delay	You can enable or disable this option using the slider.

You can find more information on the rear-view camera system in the parking aids chapter of your owner manual.

Vehicle

Note: *You vehicle may not have all of these features.*

You can select the following features to update their settings.

Door Keypad Code

Select this button to add or erase a personal door keypad code. To add or erase a personal code, you first need to enter the five-digit factory set code. You can find this code on the owner's wallet card in the glove box or from your authorized dealer.

Onboard Modem Serial Number (ESN)

Selecting this button on the settings menu

shows you the ESN number for your system. You need this number for certain registrations such as Satellite Radio.

Display

To make adjustments using the touchscreen, select:

Menu Item	Action and Description	
Brightness	Make the screen display brighter or dimmer.	
Mode	You can select:	
	Auto	The screen automatically switches between day and night modes based on the outside light level.
	Day	The screen displays with a light background to enhance daytime viewing.
	Night	The screen displays with a darker background to make nighttime viewing easier.
	Off	The screen goes black and does not display anything. To switch the screen back on, simply tap the screen.
Auto Dim	Enable this option to automatically dim the display brightness based on ambient lighting conditions.	

Voice Control

You can adjust the voice control settings by selecting the following options.

Menu Item	
Advanced Mode	Enable this option to remove additional voice prompts and confirmations.
Phone Confirmation	Enable this option to have the system confirm a contacts name with you before making a call.
Voice Command List	Enable this option to have the system display a list of available voice commands when the voice button is pressed.

Valet Mode

Valet mode allows you to lock the system. No information is accessible until the system is unlocked with the correct PIN.

When you select valet mode a pop up appears informing you that a four digit code must be entered to enable and disable valet mode. You can use any PIN you chose but you must use the same PIN to disable valet mode. The system asks you to input the code.

Note: *If the system is locked and you cannot remember the PIN, please contact the Customer Relationship Center.*

For Lincoln

United States: 1-800-521-4140

Canada: 1-800-387-9333

To enable valet mode, enter your chosen PIN. The system then asks to confirm your PIN by reentering it. The system then locks.

To unlock the system, enter the same pin number. The system reconnects to your phone and all of your options are available again.

SYNC™ 3 TROUBLESHOOTING

Your SYNC 3 system is easy to use. However, should questions arise, please refer to the tables below.

To check your cell phone's compatibility, visit the Ford or Lincoln website.

Website
owner.lincoln.com www.syncmyride.ca www.syncmaroute.ca

Cell phone issues		
Issue	Possible cause	Possible solution
There is background noise during a phone call.	The audio control settings on your cell phone may be affecting SYNC 3 performance.	Refer to your device's manual about audio adjustments.
During a call, I can hear the other person but they cannot hear me.	Possible cell phone malfunction.	Try switching your cell phone off, resetting it or removing the battery, then try again.
		Make sure that the microphone for SYNC 3 is not set to off. Look for the microphone icon on the phone screen.
During a call, I cannot hear the other person and they cannot hear me.	The system may need to be restarted.	To restart your system, shut down the engine, open and close the door, and then lock the door and wait for 2-3 minutes. Make sure that your SYNC 3 screen is black and the lighted USB port is off.
SYNC 3 is not able to download my phonebook.	This is a cell phone-dependent feature.	Check your cell phone's compatibility.
	Possible cell phone malfunction.	Make sure you allow SYNC 3 to retrieve contacts from your phone. Refer to your cell manual.
		You must switch on your cell phone and the automatic phonebook download feature on SYNC 3.
		Try switching your cell phone off, resetting it or removing the battery, then try again.

SYNC™ 3

Cell phone issues		
Issue	Possible cause	Possible solution
The system says "Phonebook downloaded" but my SYNC 3 phonebook is empty or is missing contacts.	Limitations on your cell phone's capability.	Make sure you allow SYNC 3 to retrieve contacts from your phone. Refer to your cell manual.
		If the missing contacts are stored on your SIM card, move them to your cell phone's memory.
		You must switch on your cell phone and the automatic phonebook download feature on SYNC 3.
I am having trouble connecting my cell phone to SYNC 3.	This is a cell phone-dependent feature.	Check your cell phone's compatibility.
	Possible cell phone malfunction.	Try switching your cell phone off, resetting it or removing the battery, then try again.
		Try deleting your device from SYNC 3 and deleting SYNC from your device, then trying again.
		Always check the security and auto accept prompt settings relative to the SYNC 3 Bluetooth connection on your cell phone.
		Update your cell phone's firmware.
Switch the auto download setting off.		
Text messaging is not working on SYNC 3.	This is a cell phone-dependent feature.	Check your cell phone's compatibility.
	Possible cell phone malfunction.	Try switching your cell phone off, resetting it or removing the battery, then try again.

SYNC™ 3

Cell phone issues		
Issue	Possible cause	Possible solution
	iPhone	<ul style="list-style-type: none"> • Go to your cell phone's Settings. • Go to the Bluetooth Menu. • Press the blue circle to the right of the device named with the your vehicle make and model to enter the next menu. • Turn Show Notifications on. • Disconnect then reconnect your iPhone from the SYNC 3 system to activate this settings update. <p>Your iPhone is now set up to forward incoming text messages to SYNC 3. Repeat these steps for every other SYNC 3 vehicle that you connect. Your iPhone will only forward incoming text messages to SYNC 3 if the iPhone is not unlocked in the messaging application. Replying to text messages using SYNC 3 is not supported by iPhone.</p>

SYNC™ 3

Cell phone issues		
Issue	Possible cause	Possible solution
		Text messages from WhatsApp and Facebook Messenger are not supported.
Audible text messages do not work on my cell phone.	This is a cell phone-dependent feature.	Your cell phone must support downloading text messages through Bluetooth to receive incoming text messages.
	This is a cell phone limitation.	Because each cell phone is different, refer to your device's manual for the specific cell phone you are pairing. In fact, there can be differences between cell phones due to brand, model, service provider and software version.

USB and Bluetooth Stereo issues		
Issue	Possible cause	Possible solution
I am having trouble connecting my device.	Possible device malfunction.	Disconnect the device from SYNC 3. Try switching your device off, resetting it or removing the battery, then reconnect it to SYNC 3.
		Make sure you are using the manufacturer's cable.
		Make sure to correctly insert the USB cable into the device and your vehicle's USB port.
		Make sure that the device does not have an auto-install program or active security settings.

USB and Bluetooth Stereo issues		
Issue	Possible cause	Possible solution
	The device has a lock screen enabled.	Make sure your device is unlocked before connecting it to SYNC 3.
SYNC 3 does not recognize my device when I start my vehicle.	This is a device limitation.	Make sure you are not leaving the device in your vehicle during very hot or cold temperatures.
Bluetooth audio does not stream.	This is a device-dependent feature.	Make sure you connect the device to SYNC 3 and that you have started the media player on your device.
	The device is not connected.	
SYNC 3 does not recognize music that is on my device.	Your music files may not contain the correct artist, song title, album or genre information.	Make sure that all song details are populated.
	The file may be corrupted.	Try replacing the corrupt file with a new version.
	The song may have copyright protection that does not allow it to play.	Some devices require you to change the USB settings from mass storage to media transfer protocol class.
	The file format is not supported by SYNC 3.	Convert the file to a supported format. See Entertainment (page 419).
	The device needs to be re-indexed.	Perform a master reset. See Settings (page 457).
	The device has a lock screen enabled.	Make sure your device is unlocked before connecting it to SYNC 3.

SYNC™ 3

USB and Bluetooth Stereo issues

Issue	Possible cause	Possible solution
When I connect my device, I sometimes do not hear any sound.	This is a device limitation.	Disconnect the device from SYNC 3. Try switching your device off, resetting it or removing the battery, then connect it back to SYNC 3.
		To listen to Apple devices through USB, select AirPlay from the devices Control Center, then select Dock Connector.
		To listen to Apple devices through Bluetooth Stereo, select AirPlay from the devices Control Center, then select SYNC.

Wi-Fi Issues

Issue	Possible cause	Possible solution
Failed connection.	Password error.	Verify password.
	Weak signal.	Check for a poor Wi-Fi signal.
	Multiple Access points within range with the same SSID.	Use a unique name for your SSID, don't use the default name unless it contains a unique identifier, such as part of the MAC address.

SYNC™ 3

Wi-Fi Issues		
Issue	Possible cause	Possible solution
Disconnecting after successful connection.	Weak signal probably due to distance from the hotspot, obstruction or high interference.	Position the vehicle close to the hotspot with the front of the vehicle facing the hotspot direction and remove obstacles if possible. Other Wi-Fi, Bluetooth, microwave and cordless phones may cause interference.
Poor signal seen by Sync despite being near a hotspot.	There may be an obstruction between SYNC 3 and the hotspot.	If the vehicle is equipped with heated windshield, try positioning the vehicle so that the windshield is not facing the hotspot. If you have metallic window tinting but not on the windshield, position the vehicle to face the hotspot. If all windows are tinted, you can open the windows in the direction of the hotspot if that is feasible. Try to remove other obstructions that may impact signal quality such as opening the garage door.
A hotspot is not listed in the list of available networks.	The hotspot was defined as a hidden network.	Please set the network to visible and try again.

SYNC™ 3

Wi-Fi Issues		
Issue	Possible cause	Possible solution
SYNC 3 is not seen when searching for Wi-Fi networks from your phone or other devices.	SYNC 3 does not provide a hotspot.	SYNC 3 currently does not provide a hotspot.
Software download takes too long.	Poor signal strength, too far from the hotspot, hotspot is supporting multiple connections, slow Internet connection or other problems.	Check the signal quality (under network details), if SYNC 3 indicates good or excellent, test with another high-speed equipped hotspot where the environment is more predictable.
SYNC 3 seems to connect with a hotspot and the signal strength is excellent but the software is not being updated.	It is possible that there is no new software. The connected hotspot may be a managed one and it requires either a subscription or agreeing to the terms and conditions.	Test the connection with another device, if the hotspot requires a subscription, you may contact the service provider.

AppLink issues		
Issue	Possible cause(s)	Possible solution(s)
AppLink Mobile Applications: When I select "Connect Mobile Apps," SYNC 3 does not find any applications.	You did not connect an AppLink Compatible phone to SYNC 3.	Make sure you have a compatible smartphone; an Android with OS 2.3 or higher or an iPhone 3GS or newer with iOS 5.0 or higher. Additionally, make sure you pair and connect your phone to SYNC 3 in order to find AppLink-capable apps on your device. iPhone users must also connect to a USB port with an Apple USB cable.
My phone is connected, but I still cannot find any apps.	AppLink-enabled apps are not installed and running on your mobile device.	Make sure you have downloaded and installed the latest version of the app from your phone's app store. Make sure the app is running on your phone. Some apps require you to register or login to the app on the phone before using them with AppLink. Also, some may have a "Ford SYNC" setting, so check the app's settings menu on the phone.
My phone is connected, my app(s) are running, but I still cannot find any apps.	Sometimes apps do not properly close and re-open their connection to SYNC 3, over ignition cycles, for example.	Closing and restarting apps may help SYNC 3 find the application if you cannot discover it inside the vehicle. On an Android device, if apps have an 'Exit' or 'Quit' option, then select it and restart the app. If the app does not have that option, select the phone's settings menu

AppLink issues		
Issue	Possible cause(s)	Possible solution(s)
		and select 'Apps', then find the particular app and choose 'Force stop'. Do not forget to restart the app afterward, then select "Connect Mobile Apps" on SYNC 3.
		On an iPhone with iOS7+, to force close an app, double tap the home button then swipe up on the app to close it. Tap the home button again, then select the app again to restart it. After a few seconds, the app should then appear in SYNC 3's Mobile App's Menu.
My Android phone is connected, my app(s) are running, I restarted them, but I still cannot find any apps.	There is a Bluetooth issue on some older versions of the Android operating system that may cause apps that were found on your previous vehicle drive to not be found again if you did not switch Bluetooth off.	Switch Bluetooth off and then on to reset it on your phone. If you are in your vehicle, SYNC 3 should be able to automatically re-connect to your phone if you press the "Phone" button.

SYNC™ 3

AppLink issues		
Issue	Possible cause(s)	Possible solution(s)
My iPhone is connected, my app is running, I restarted the app but I still cannot find it on SYNC 3.	You may need to reset the USB connection to SYNC 3.	Unplug the USB cable from the phone, wait a moment, and plug the USB cable back in to the phone. After a few seconds, the app should appear in SYNC 3's Mobile Apps Menu. If not, "Force Close" the application and restart it.
I have an Android phone. I found and started my media app on SYNC 3, but there is no sound or the sound is very low.	The Bluetooth volume on the phone may be low.	Increase the Bluetooth volume of the device by using the device's volume control buttons which are most often found on the side of the device.
I can only see some of the AppLink apps running on my phone listed in the SYNC 3 Mobile Apps Menu.	Some Android devices have a limited number of Bluetooth ports that apps can use to connect. If you have more AppLink apps on your phone than the number of available Bluetooth ports, you will not see all of your apps listed in the SYNC 3 mobile apps menu.	Force close or uninstall the apps you do not want SYNC 3 to find. If the app has a "Ford SYNC" setting, disable that setting in the app's settings menu on the phone.

Voice command issues		
Issue	Possible cause	Possible solution
SYNC 3 does not understand what I am saying.	You may be using the wrong voice commands.	Review the cell phone voice commands and the media voice commands at the beginning of their respective sections. Refer to the audio display during an active voice session to find a list of voice commands there.
	You may be speaking too soon or at the wrong time.	Wait for the system to prompt you before you state your command.
SYNC 3 does not understand the name of a song or artist.	You may be using the wrong voice commands.	Review the media voice commands at the beginning of the media section.
	You may not be saying the name exactly as it appears on your device.	Say the song or artist name exactly as it is displayed on your device. For example, say "Play Artist Prince" or "Play song Purple Rain".
		Make sure you are saying the complete title such as "California remix featuring Jennifer Nettles".
	If there are any abbreviations in the name, like ESPN or CNN, you have to spell those: "E-S-P-N" or "C-N-N".	
The song or artist name may have some special characters that are not being recognized by SYNC 3.	Make sure that song titles, artists, album, and playlists names do not have any special characters like *, - or +.	

Voice command issues		
Issue	Possible cause	Possible solution
<p>SYNC 3 does not understand or is calling the wrong contact when I want to make a call.</p>	<p>You may not be saying the name exactly as it appears on your phonebook.</p>	<p>Make sure that you are saying the name exactly as it appears on your phone. For example, if your contact is "Joe Wilson", say "Call Joe Wilson". If your contact name is "Mom", say "Call Mom".</p>
	<p>The contact name may contain special characters.</p>	<p>Make sure that your contact names do not have any special characters like *, - or +.</p>
<p>The SYNC 3 voice control system is having trouble recognizing foreign names stored on my cell phone.</p>	<p>You may not be saying the name exactly as it appears on your phonebook.</p>	<p>SYNC 3 applies the phonetic pronunciation rules of the selected language to the contact names stored on your cell phone.</p> <p>Helpful Hint: You can select your contact manually. Press PHONE. Select the option for phonebook and then contact name. Press the soft-key option to hear it. SYNC 3 will read the contact name to you, giving you some idea of the pronunciation it is expecting.</p>

Voice command issues		
Issue	Possible cause	Possible solution
The SYNC 3 voice control system is having trouble recognizing foreign tracks, artists, albums, genres and playlist names from my media player or USB flash drive.	You may be saying the foreign names using the currently selected language for SYNC 3.	SYNC 3 applies the phonetic pronunciation rules of the selected language to the names stored on your media player or USB flash drive. It is able to make some exceptions for very popular artist names (for example, U2) such that you can always use the English pronunciation for these artists.
The system generates voice prompts and the pronunciation of some words may not be accurate for my language.	SYNC 3 uses text-to-speech voice prompt technology.	SYNC 3 uses a synthetically generated voice rather than pre-recorded human voice.
		SYNC 3 offers several new voice control features for a wide range of languages. Dialing a contact name directly from the phonebook without pre-recording (for example, "call John Smith") or selecting a track, artist, album, genre or playlist directly from your media player (for example, "play artist Madonna").

General		
Issue	Possible cause	Possible solution
The language selected for the instrument cluster and information and entertainment display does not match the SYNC 3 language (phone, USB, Bluetooth audio, voice control and voice prompts).	SYNC 3 does not support the currently selected language for the instrument cluster and information and entertainment display.	SYNC 3 only supports four languages in a single module for text display, voice control and voice prompts. The country where you bought your vehicle dictates the four languages based on the most popular languages spoken. If the selected language is not available, SYNC 3 remains in the current active language.
		SYNC 3 offers several new voice control features for a wide range of languages. Dialing a contact name directly from the phonebook without pre-recording (for example, "call John Smith") or selecting a track, artist, album, genre or playlist directly from your media player (for example, "play artist Madonna").

SYNC 3 System Reset
The system has a System Reset feature that can be performed if the function of a SYNC 3 feature is lost. This reset is intended to restore functionality and will not erase any information previously stored in the system (such as paired devices, phonebook, call history, text messages, or user settings). To perform a System Reset, press and hold the Seek Up (>>) button while pressing and holding the Radio Power button. After approximately 5 seconds the screen will go black. Allow 1-2 minutes for the system reset to complete. You may then resume using the SYNC 3 system.

SYNC™ 3

For additional assistance with SYNC 3 troubleshooting please call or visit the

Lincoln Website.

Lincoln Support	
Customer Relationship Center	United States: 1-800-521-4140
	Canada: 1-800-387-9333
Website	owner.lincoln.com www.syncmyride.ca www.syncmaroute.ca

Accessories

For a complete listing of the accessories that are available for your vehicle, please contact your authorized dealer or visit our online store at:

Web Address (United States)
www.Accessories.Lincoln.com

Web Address (Canada)
www.LincolnCanada.com

Lincoln Motor Company will repair or replace any properly authorized dealer-installed Lincoln Original Accessory found to be defective in factory-supplied materials or workmanship during the warranty period, as well as any component damaged by the defective accessories.

Lincoln Motor Company will warrant your Lincoln accessory through the warranty that provides the greatest benefit:

- 24 months, unlimited mileage.
- The remainder of your new vehicle limited warranty.

Contact an authorized dealer for details and a copy of the warranty.

Exterior Style

- Bumper protectors.
- Side-window deflectors.
- Wheels.

Interior Style

- All-weather floor mats.
- Premium carpeted floor mats.

Lifestyle

- Ash cup (smoker's packages).
- Cargo area protector.
- Cargo net.
- Cargo organizer.
- Roof racks and carriers*.
- Tablet cradle*.

Peace of Mind

- Car covers*.
- Remote start.

- Roadside assistance kit*.
- Vehicle security system.
- Wheel locks.

*Lincoln Licensed Accessory. The accessory manufacturer designs, develops and therefore warrants Lincoln Licensed Accessories, and does not design or test these accessories to Lincoln Motor Company engineering requirements. Contact an authorized Lincoln dealer for the manufacturer's limited warranty details and request a copy of the Lincoln Licensed Accessories product limited warranty from the accessory manufacturer.

Accessories

For maximum vehicle performance, keep the following information in mind when adding accessories or equipment to your vehicle:

- When adding accessories, equipment, passengers and luggage to your vehicle, do not exceed the total weight capacity of the vehicle or of the front or rear axle (GVWR or GAWR as indicated on the Safety Compliance Certification label). Consult an authorized dealer for specific weight information.
- The Federal Communications Commission (FCC) and Canadian Radio Telecommunications Commission (CRTC) regulate the use of mobile communications systems that are equipped with radio transmitters, for example, two-way radios, telephones and theft alarms. Any such equipment installed in your vehicle should comply with the Federal Communications Commission (FCC) and Canadian Radio Telecommunications Commission (CRTC) regulations and should be installed only by an authorized dealer.
- Mobile communications systems may harm the operation of your vehicle, particularly if their manufacturer did not design them specifically for automotive use.
- If you or an authorized Lincoln dealer add any non-Lincoln electrical or electronic accessories or components to your vehicle, you may adversely affect battery performance and durability. In addition, you may also adversely affect the performance of other electrical systems in the vehicle.

Lincoln Protect

PROTECT YOURSELF FROM THE RISING COST OF VEHICLE REPAIRS WITH LINCOLN PROTECT.

Lincoln Protect (U.S. Only)

Lincoln Protect means peace of mind. It's the extended service plan backed by the Lincoln Motor Company, and provides more protection beyond the New Vehicle Limited Warranty coverage.

Lincoln Protect Can Quickly Pay for Itself

One trip to the Service Center could easily exceed the price of your Lincoln Extended Service Plan. With Lincoln Protect you minimize your risk for unexpected repair bills and rising repair costs.

Up to 1000+ Covered Vehicle Components

There are four core Lincoln Protect plans with different levels of coverage. Ask your authorized dealer for details.

1. PremiumCARE - Our most comprehensive coverage. With over 1,000 covered components, this plan is so complete it's probably easier to list what's not covered.

2. ExtraCARE - Covers 113 components, and includes many high-tech items.
3. BaseCARE - Covers 84 components.
4. PowertrainCARE - Covers 29 critical components.

Lincoln Extended Service Plans are honored by all authorized Lincoln dealers in the U.S., Canada and Mexico.

That means you get:

- Reliable, quality service at any Lincoln or Ford dealership.
- Repairs performed by factory trained technicians, using genuine parts.

Rental Car Reimbursement

1st day Rental Benefit

If you bring your car into your dealer for service, we'll give you a loaner to use for the day.

Extended Rental Benefits

If your vehicle is kept overnight for covered repairs, you are eligible for rental car coverage, including bumper to bumper warranty repairs, and Field Service Actions.

Roadside Assistance

Exclusive 24/7 roadside assistance, including:

- Towing, flat-tire change and battery jump starts.
- Out of fuel and lock-out assistance.
- Travel expense reimbursement for lodging, meals and rental car.
- Assistance for taxi, shuttle, rental car coverage and other transportation.

Transferable Coverage

If you sell your vehicle before your Lincoln Protect plan coverage expires, you can transfer any remaining coverage to the new owner. Which should give you and your potential buyer a little more peace of mind.

Lincoln Protect

Less Cost to Properly Maintain Your Vehicle

Lincoln Protect also offers a Premium Maintenance Plan that covers all scheduled maintenance, and selected wear items. The coverage is prepaid, so you never have to worry about the cost of your vehicle's maintenance.

Covered maintenance includes:

- Windshield wiper blades.
- Spark plugs.
- The clutch disc.
- Brake pads and linings.
- Shock absorbers and struts.
- Engine cooling hoses, clamps and o-rings.
- Engine belts.
- Diesel exhaust fluid replenishment.

Interest Free Finance Options

Just a 10% down payment will provide you with an affordable, no interest, no fee payment program allowing you all the security and benefits Lincoln Protect has to offer while paying over time. You are pre-approved with no credit check or hassles. To learn more, call our Lincoln Protect Extended Service Plan specialists at 800-367-3377.

Complete the information below and mail to:

Lincoln Protect Extended Service Plan
P.O. Box 321067
Detroit, MI 48232

EXTENDED SERVICE PLANS (CANADA ONLY)

You can get more protection for your vehicle by purchasing a Lincoln Extended Service Plan. Lincoln Extended Service Plan is the only service contract backed by Lincoln Motor Company of Canada, Limited. Depending on the plan you purchase, Lincoln Extended Service Plan provides benefits such as:

- Rental reimbursement.
- Coverage for certain maintenance and wear items.
- Protection against repair costs after your New Vehicle Limited Warranty Coverage expires.
- Roadside Assistance benefits.

There are several Lincoln Extended Service Plans available in various time, distance and deductible combinations. Each plan is tailored to fit your own driving needs, including reimbursement for towing and rental. When you purchase Lincoln Extended Service Plan, you receive added peace-of-mind protection throughout Canada, the United States and Mexico, provided by a network of participating authorized Lincoln Motor Company dealers.

Note: *Repairs performed outside of Canada, the United States and Mexico are not eligible for Lincoln Extended Service Plan coverage.*

This information is subject to change. For more information, visit your local Lincoln of Canada dealer or www.Lincoln.ca to find the Lincoln Extended Service Plan that is right for you.

Scheduled Maintenance

GENERAL MAINTENANCE INFORMATION

Why Maintain Your Vehicle?

Carefully following the maintenance schedule helps protect against major repair expenses resulting from neglect or inadequate maintenance and may help to increase the value of your vehicle when you sell or trade it. Keep all receipts for completed maintenance with your vehicle.

We have established regular maintenance intervals for your vehicle based upon rigorous testing. It is important that you have your vehicle serviced at the proper times. These intervals serve two purposes; one is to maintain the reliability of your vehicle and the second is to keep your cost of owning your vehicle down.

It is your responsibility to have all scheduled maintenance performed and to make sure that the materials used meet the specifications identified in this owner's manual. See **Capacities and Specifications** (page 367).

Failure to perform scheduled maintenance invalidates warranty coverage on parts affected by the lack of maintenance.

Why Maintain Your Vehicle at Your Dealership?

Factory-Trained Technicians

Service technicians participate in extensive factory-sponsored certification training to help them become experts on the operation of your vehicle. Ask your dealership about the training and certification their technicians have received.

Genuine Ford and Motorcraft® Replacement Parts

Dealerships stock Ford, Motorcraft and Ford-authorized branded re-manufactured replacement parts. These parts meet or exceed our specifications. Parts installed at your dealership carry a nationwide 24-month or unlimited mile (kilometer) parts and labor limited warranty.

If you do not use Ford authorized parts they may not meet our specifications and depending on the part, it could affect emissions compliance.

Convenience

Many dealerships have extended evening and Saturday hours to make your service visit more convenient and they offer one stop shopping. They can perform any services that are required on your vehicle, from general maintenance to collision repairs.

Note: *Not all dealers have extended hours or body shops. Please contact your dealer for details.*

Protecting Your Investment

Maintenance is an investment that pays dividends in the form of improved reliability, durability and resale value. To maintain the proper performance of your vehicle and its emission control systems, make sure you have scheduled maintenance performed at the designated intervals.

Scheduled Maintenance

Your vehicle is equipped with the Intelligent Oil-Life Monitor system, which displays a message in the information display at the proper oil change interval. This interval may be up to one year or 10000 miles (16000 kilometers).

When the oil change message appears in the information display, it is time for an oil change. Make sure you perform the oil change within two weeks or 500 miles (800 kilometers) of the message appearing. Make sure you reset the Intelligent Oil-Life Monitor after each oil change. See **Oil Change Indicator Reset** (page 302).

If your information display resets prematurely or becomes inoperative, you should perform the oil change interval at six months or 5000 miles (8000 kilometers) from your last oil change. Never exceed one year or 10000 miles (16000 kilometers) between oil change intervals.

Your vehicle is very sophisticated and built with multiple, complex, performance systems. Every manufacturer develops these systems using different specifications and performance features. That is why it is important to rely upon your dealership to properly diagnose and repair your vehicle.

Ford Motor Company has recommended maintenance intervals for various parts and component systems based upon engineering testing. Ford Motor Company relies upon this testing to determine the most appropriate mileage for replacement of oils and fluids to protect your vehicle at the lowest overall cost to you and recommends against maintenance schedules that deviate from the scheduled maintenance information.

We strongly recommend the use of only genuine Ford, Motorcraft or Ford-authorized re-manufactured replacement parts engineered for your vehicle.

Additives and Chemicals

This owner's manual and the Ford Workshop Manual list the recommended additives and chemicals for your vehicle. We do not recommend using chemicals or additives not approved by us as part of your vehicle's normal maintenance. Please consult your warranty information.

Oils, Fluids and Flushing

In many cases, fluid discoloration is a normal operating characteristic and, by itself, does not necessarily indicate a concern or that the fluid needs to be changed. However, a qualified expert, such as the factory-trained technicians at your dealership, should inspect discolored fluids that also show signs of overheating or foreign material contamination immediately.

Scheduled Maintenance

Make sure to change your vehicle's oils and fluids at the specified intervals or in conjunction with a repair. Flushing is a viable way to change fluid for many vehicle sub-systems during scheduled maintenance.

It is critical that systems are flushed only with new fluid that is the same as that required to fill and operate the system or using a Ford-approved flushing chemical.

Owner Checks and Services

Make sure you perform the following basic maintenance checks and inspections every month or at six-month intervals.

Check every month
Engine oil level.
Function of all interior and exterior lights.
Tires (including spare) for wear and proper pressure.
Windshield washer fluid level.

Check every six months
Battery connections. Clean if necessary.
Body and door drain holes for obstructions. Clean if necessary.
Cooling system fluid level and coolant strength.
Door weatherstrips for wear. Lubricate if necessary.
Hinges, latches and outside locks for proper operation. Lubricate if necessary.
Parking brake for proper operation.

Scheduled Maintenance

Check every six months
Safety belts and seat latches for wear and function.
Safety warning lamps (brake, ABS, airbag and safety belt) for operation.
Washer spray and wiper operation. Clean or replace blades as necessary.

Multi-Point Inspection

In order to keep your vehicle running right, it is important to have the systems on your vehicle checked regularly. This can help identify potential issues and prevent major problems. We recommend having the following multi-point inspection performed at every scheduled maintenance interval to help make sure your vehicle keeps running great.

Multi-Point inspection	
Accessory drive belt(s)	Hazard warning system operation
Battery performance	Horn operation
Engine air filter	Radiator, cooler, heater and air conditioning hoses
Exhaust system	Suspension components for leaks or damage

Scheduled Maintenance

Multi-Point inspection	
Exterior lamps operation	Steering and linkage
Fluid levels ; fill if necessary	Tires (including spare) for wear and proper pressure **
For oil and fluid leaks	Windshield for cracks, chips or pits
Half-shaft dust boots	Washer spray and wiper operation

Brake, coolant recovery reservoir, automatic transmission and window washer

** If your vehicle is equipped with a temporary mobility kit, check the tire sealant expiration Use By date on the canister. Replace as needed.

Be sure to ask your dealership service advisor or technician about the multi-point vehicle inspection. It is a comprehensive way to perform a thorough inspection of your vehicle. Your checklist gives you immediate feedback on the overall condition of your vehicle.

NORMAL SCHEDULED MAINTENANCE

Intelligent Oil-Life Monitor™

Your vehicle is equipped with an Intelligent Oil-Life Monitor that determines when you should change the engine oil based on how your vehicle is used. By using several important factors in its calculations, the monitor helps reduce the cost of owning your vehicle and reduces environmental waste at the same time.

This means you do not have to remember to change the oil on a mileage-based schedule. Your vehicle lets you know when an oil change is due by displaying a message in the information display.

The following table provides examples of vehicle use and its impact on oil change intervals. It is a guideline only. Actual oil change intervals depend on several factors and generally decrease with severity of use.

Scheduled Maintenance

When to expect the message prompting you to change your oil	
Interval	Vehicle use and example
7500-10000 miles (12000-16000 km)	Normal
	Normal commuting with highway driving No, or moderate, load or towing Flat to moderately hilly roads No extended idling
5000-7499 miles (8000-11999 km)	Severe
	Moderate to heavy load or towing Mountainous or off-road conditions Extended idling Extended hot or cold operation
3000-4999 miles (4800-7999 km)	Extreme
	Maximum load or towing Extreme hot or cold operation

Scheduled Maintenance

Maintenance Intervals

At every oil change interval as indicated by the information display
Change engine oil and filter.**
Rotate the tires.
Perform a multi-point inspection (recommended).
Inspect the automatic transmission fluid level. Consult your dealer for requirements.
Inspect the brake pads, rotors, hoses and parking brake.
Inspect the engine cooling system strength and hoses.
Inspect the exhaust system and heat shields.
Inspect the rear axle and U-joints (AWD only).
Inspect the half-shaft boots.
Inspect the steering linkage, ball joints, suspension, tie-rod ends, driveshaft and U-joints.
Inspect the tires, tire wear and measure the tread depth.
Inspect the wheels and related components for abnormal noise, wear, looseness or drag.

Do not exceed one year or 10000 miles (16000 kilometers) between service intervals.

** Reset the Intelligent Oil-Life Monitor after engine oil and filter changes. See **Engine Oil Check** (page 301).

Scheduled Maintenance

Other maintenance items ¹	
Every 20000 miles (32000 km)	Replace cabin air filter.
Every 30000 miles (48000 km)	Replace engine air filter.
Every 35000 miles (56000 km)	Replace fuel filter (3.0L only).
At 100000 miles (160000 km)	Change engine coolant. ²
Every 100000 miles (160000 km)	Replace spark plugs.
	Inspect accessory drive belt(s). ³

Scheduled Maintenance

Other maintenance items ¹	
Every 150000 miles (240000 km)	Change automatic transmission fluid.
	Replace accessory drive belt(s). ⁴

¹ Perform these maintenance items within 3000 miles (4800 kilometers) of the last engine oil and filter change. Do not exceed the designated distance for the interval.

² Initial replacement at six years or 100000 miles (160000 kilometers), then every three years or 50000 miles (80000 kilometers).

³ After initial inspection, inspect every other oil change until replaced.

⁴ If not replaced within the last 100000 miles (160000 kilometers).

SPECIAL OPERATING CONDITIONS SCHEDULED MAINTENANCE

If you operate your vehicle **primarily** in any of the following conditions, you need to perform extra maintenance as indicated. If you operate your vehicle **occasionally** under any of these conditions, it is not necessary to perform the extra maintenance. For specific recommendations, see your dealership service advisor or technician.

Scheduled Maintenance

Perform the services shown in the following tables when specified or within 3000 miles (4800 kilometers) of the message appearing in the information display prompting you to change your oil.

- **Example 1:** The message comes on at 28751 miles (46270 kilometers). Perform the 30000-mile (48000 kilometer) automatic transmission fluid replacement.

- **Example 2:** The message has **not** come on, but the odometer reads 30000 miles (48000 kilometers) (for example, the Intelligent Oil-Life Monitor was reset at 25000 miles [40000 kilometers]). Perform the engine air filter replacement.

Towing a trailer or using a car-top carrier	
As required	Change engine oil and filter as indicated by information display and perform services listed in the Normal Scheduled Maintenance chart.
Inspect frequently, service as required	Inspect rear axle and U-joints.
Every 30000 miles (48000 km)	See axle maintenance items under Exceptions .
	Change automatic transmission fluid.
Every 60000 miles (96000 km)	Replace spark plugs.

Scheduled Maintenance

Extensive idling or low-speed driving for long distances, as in heavy commercial use (such as delivery, taxi, patrol car or livery)	
As required	Change engine oil and filter as indicated by information display and perform services listed in the Normal Scheduled Maintenance chart.
Inspect frequently, service as required	Replace cabin air filter.
	Replace engine air filter.
Every 30000 miles (48000 km)	Change automatic transmission fluid.
Every 60000 miles (96000 km)	Replace spark plugs.

Operating in dusty or sandy conditions (such as unpaved or dusty roads)	
Inspect frequently, service as required	Replace cabin air filter.
	Replace engine air filter.
Every 5000 miles (8000 km)	Inspect the wheels and related components for abnormal noise, wear, looseness or drag.
	Rotate tires, inspect tires for wear and measure tread depth.
Every 5000 miles (8000 km) or six months	Change engine oil and filter.

Scheduled Maintenance

Operating in dusty or sandy conditions (such as unpaved or dusty roads)	
	Perform multi-point inspection.
Every 30000 miles (48000 km)	Change automatic transmission fluid.

Reset your Intelligent Oil-Life Monitor after engine oil and filter changes. See **Engine Oil Check** (page 301).

Exclusive use of E85 (flex fuel vehicles only)	
Every oil change	If ran exclusively on E85, fill the fuel tank full with regular unleaded fuel.

Exceptions

There are several exceptions to the Normal Schedule:

Rear Axle and PTU Maintenance

The Power Transfer Unit (PTU) and rear axle (AWD only) in your vehicle does not require any normal scheduled maintenance unless the unit shows signs of leakage. Contact an authorized dealer for service.

California Fuel Filter Replacement

If you register your vehicle in California, the California Air Resources Board has determined that the failure to perform this maintenance item does not nullify the emission warranty or limit recall liability before the completion of your vehicle's useful life. Ford Motor Company, however, urges you to have all recommended maintenance services performed at the specified intervals and to record all vehicle service.

Hot Climate Oil Change Intervals

Vehicles operating in the Middle East, North Africa, Sub-Saharan Africa or locations with similar climates using an American Petroleum Institute (API) Certified for Gasoline Engines (Certification mark) oil of SM or SN quality, the normal oil change interval is 3000 miles (5000 kilometers).

If the available API SM or SN oils are not available, then the oil change interval is 1800 miles (3000 kilometers).

Scheduled Maintenance

Engine Air Filter and Cabin Air Filter Replacement

The life of the engine air filter and cabin air filter is dependent on exposure to dusty and

dirty conditions. Vehicles operated in these conditions require frequent inspection and replacement of the engine air filter and cabin air filter.

SCHEDULED MAINTENANCE RECORD

<input type="radio"/> Repair Order #:	<p>Dealer stamp</p>
<input type="radio"/> Distance:	
<input type="radio"/> Engine hours (optional):	
<input type="radio"/> Multi-point inspection (recommended): <input type="checkbox"/>	
<input type="radio"/> Signature:	

Scheduled Maintenance

<input type="radio"/> Repair Order #:	<p>Dealer stamp</p>
<input type="radio"/> Distance:	
<input type="radio"/> Engine hours (optional):	
<input type="radio"/> Multi-point inspection (recommended): <input type="checkbox"/>	
<input type="radio"/> Signature:	

Scheduled Maintenance

<input type="radio"/> Repair Order #:	<p>Dealer stamp</p>
<input type="radio"/> Distance:	
<input type="radio"/> Engine hours (optional):	
<input type="radio"/> Multi-point inspection (recommended): <input type="checkbox"/>	
<input type="radio"/> Signature:	

Scheduled Maintenance

<input type="radio"/> Repair Order #:	<p>Dealer stamp</p>
<input type="radio"/> Distance:	
<input type="radio"/> Engine hours (optional):	
<input type="radio"/> Multi-point inspection (recommended): <input type="checkbox"/>	
<input type="radio"/> Signature:	

Scheduled Maintenance

<input type="radio"/> Repair Order #:	<p>Dealer stamp</p>
<input type="radio"/> Distance:	
<input type="radio"/> Engine hours (optional):	
<input type="radio"/> Multi-point inspection (recommended): <input type="checkbox"/>	
<input type="radio"/> Signature:	

Scheduled Maintenance

<input type="radio"/> Repair Order #:	<p>Dealer stamp</p>
<input type="radio"/> Distance:	
<input type="radio"/> Engine hours (optional):	
<input type="radio"/> Multi-point inspection (recommended): <input type="checkbox"/>	
<input type="radio"/> Signature:	

Scheduled Maintenance

<input type="radio"/> Repair Order #:	<p>Dealer stamp</p>
<input type="radio"/> Distance:	
<input type="radio"/> Engine hours (optional):	
<input type="radio"/> Multi-point inspection (recommended): <input type="checkbox"/>	
<input type="radio"/> Signature:	

Scheduled Maintenance

<input type="radio"/> Repair Order #:	<p>Dealer stamp</p>
<input type="radio"/> Distance:	
<input type="radio"/> Engine hours (optional):	
<input type="radio"/> Multi-point inspection (recommended): <input type="checkbox"/>	
<input type="radio"/> Signature:	

Scheduled Maintenance

<input type="radio"/> Repair Order #:	<p>Dealer stamp</p>
<input type="radio"/> Distance:	
<input type="radio"/> Engine hours (optional):	
<input type="radio"/> Multi-point inspection (recommended): <input type="checkbox"/>	
<input type="radio"/> Signature:	

Scheduled Maintenance

<input type="radio"/> Repair Order #:	<p>Dealer stamp</p>
<input type="radio"/> Distance:	
<input type="radio"/> Engine hours (optional):	
<input type="radio"/> Multi-point inspection (recommended): <input type="checkbox"/>	
<input type="radio"/> Signature:	

Scheduled Maintenance

<input type="radio"/> Repair Order #:	<p>Dealer stamp</p>
<input type="radio"/> Distance:	
<input type="radio"/> Engine hours (optional):	
<input type="radio"/> Multi-point inspection (recommended): <input type="checkbox"/>	
<input type="radio"/> Signature:	

Scheduled Maintenance

<input type="radio"/> Repair Order #:	<p>Dealer stamp</p>
<input type="radio"/> Distance:	
<input type="radio"/> Engine hours (optional):	
<input type="radio"/> Multi-point inspection (recommended): <input type="checkbox"/>	
<input type="radio"/> Signature:	

Scheduled Maintenance

<input type="radio"/> Repair Order #:	<p>Dealer stamp</p>
<input type="radio"/> Distance:	
<input type="radio"/> Engine hours (optional):	
<input type="radio"/> Multi-point inspection (recommended): <input type="checkbox"/>	
<input type="radio"/> Signature:	

Scheduled Maintenance

<input type="radio"/> Repair Order #:	<p>Dealer stamp</p>
<input type="radio"/> Distance:	
<input type="radio"/> Engine hours (optional):	
<input type="radio"/> Multi-point inspection (recommended): <input type="checkbox"/>	
<input type="radio"/> Signature:	

Scheduled Maintenance

<input type="radio"/> Repair Order #:	<p>Dealer stamp</p>
<input type="radio"/> Distance:	
<input type="radio"/> Engine hours (optional):	
<input type="radio"/> Multi-point inspection (recommended): <input type="checkbox"/>	
<input type="radio"/> Signature:	

Scheduled Maintenance

<input type="radio"/> Repair Order #:	<p>Dealer stamp</p>
<input type="radio"/> Distance:	
<input type="radio"/> Engine hours (optional):	
<input type="radio"/> Multi-point inspection (recommended): <input type="checkbox"/>	
<input type="radio"/> Signature:	

Scheduled Maintenance

<input type="radio"/> Repair Order #:	<p>Dealer stamp</p>
<input type="radio"/> Distance:	
<input type="radio"/> Engine hours (optional):	
<input type="radio"/> Multi-point inspection (recommended): <input type="checkbox"/>	
<input type="radio"/> Signature:	

Scheduled Maintenance

<input type="radio"/> Repair Order #:	<p>Dealer stamp</p>
<input type="radio"/> Distance:	
<input type="radio"/> Engine hours (optional):	
<input type="radio"/> Multi-point inspection (recommended): <input type="checkbox"/>	
<input type="radio"/> Signature:	

Scheduled Maintenance

<input type="radio"/> Repair Order #:	<p>Dealer stamp</p>
<input type="radio"/> Distance:	
<input type="radio"/> Engine hours (optional):	
<input type="radio"/> Multi-point inspection (recommended): <input type="checkbox"/>	
<input type="radio"/> Signature:	

Scheduled Maintenance

<input type="radio"/> Repair Order #:	<p>Dealer stamp</p>
<input type="radio"/> Distance:	
<input type="radio"/> Engine hours (optional):	
<input type="radio"/> Multi-point inspection (recommended): <input type="checkbox"/>	
<input type="radio"/> Signature:	

Appendices

END USER LICENSE AGREEMENT

VEHICLE SOFTWARE END USER LICENSE AGREEMENT (EULA)

- You ("You" or "Your" as applicable) have acquired a vehicle having several devices, including SYNC[®] and various control modules, ("DEVICES") that include software licensed or owned by Ford Motor Company and its affiliates ("FORD MOTOR COMPANY"). Those software products of FORD MOTOR COMPANY origin, as well as associated media, printed materials, and "online" or electronic documentation ("SOFTWARE") are protected by international intellectual property laws and treaties. The SOFTWARE is licensed, not sold. All rights reserved.
- The SOFTWARE may interface with and/or communicate with, or may be later upgraded to interface with and/or communicate with additional software and/or systems provided by FORD MOTOR COMPANY.

IF YOU DO NOT AGREE TO THIS END USER LICENSE AGREEMENT ("EULA") DO NOT USE THE DEVICES OR COPY THE SOFTWARE. ANY USE OF THE SOFTWARE, INCLUDING BUT NOT LIMITED TO USE ON THE DEVICES, WILL CONSTITUTE YOUR AGREEMENT TO THIS EULA (OR RATIFICATION OF ANY PREVIOUS CONSENT).

GRANT OF SOFTWARE LICENSE: This EULA grants you the following license:

- You may use the SOFTWARE as installed on the DEVICES and as otherwise interfacing with systems and/or services provide by or through FORD MOTOR COMPANY or its third party software and service providers.

Description of Other Rights and Limitations

- **Speech Recognition:** If the SOFTWARE includes speech recognition component(s), you should understand that speech recognition is an inherently statistical process and that recognition errors are inherent in the process. Neither FORD MOTOR COMPANY nor

its suppliers shall be liable for any damages arising out of errors in the speech recognition process. It is your responsibility to monitor any speech recognition functions included in the system.

- **Limitations on Reverse Engineering, Decompilation and Disassembly:** You may not reverse engineer, decompile, translate, disassemble or attempt to discover any source code or underlying ideas or algorithms of the SOFTWARE nor permit others to reverse engineer, decompile or disassemble the SOFTWARE, except and only to the extent that such activity is expressly permitted by applicable law notwithstanding this limitation or to the extent as may be permitted by the licensing terms governing use of any open source components included with the SOFTWARE.

Appendices

- **Limitations on Distributing, Copying, Modifying and Creating Derivative Works:** You may not distribute, copy, make modifications to or create derivative works based on the SOFTWARE, except and only to the extent that such activity is expressly permitted by applicable law notwithstanding this limitation or to the extent as may be permitted by the licensing terms governing use of any open source components included with the SOFTWARE.
- **Single EULA:** The end user documentation for the DEVICES and related systems and services may contain multiple EULAs, such as multiple translations and/or multiple media versions (e.g., in the user documentation and in the software). Even if you receive multiple EULAs, you are licensed to use only one (1) copy of the SOFTWARE.
- **SOFTWARE Transfer:** You may permanently transfer your rights under this EULA only as part of a sale or transfer of the DEVICES, provided you retain no copies, you transfer all of the SOFTWARE (including all component parts, the media and printed materials, any upgrades, and, if applicable, the Certificate(s) of Authenticity), and the recipient agrees to the terms of this EULA. If the SOFTWARE is an upgrade, any transfer must include all prior versions of the SOFTWARE.
- **Termination:** Without prejudice to any other rights, FORD MOTOR COMPANY may terminate this EULA if you fail to comply with the terms and conditions of this EULA.
- **Internet-Based Services Components:** The SOFTWARE may contain components that enable and facilitate the use of certain Internet-based services. You acknowledge and agree that FORD MOTOR COMPANY, third party software and service suppliers, its affiliates and/or its designated agent may automatically check the version of the SOFTWARE and/or its components that you are utilizing and may provide upgrades or supplements to the SOFTWARE that may be automatically downloaded to your DEVICES.
- **Additional Software/Services:** The SOFTWARE may permit FORD MOTOR COMPANY, third party software and service suppliers, its affiliates and/or its designated agent to provide or make available to you SOFTWARE updates, supplements, add-on components, or Internet-based services components of the SOFTWARE after the date you obtain your initial copy of the SOFTWARE ("Supplemental Components"). SOFTWARE updates may cause you to incur additional charges from your wireless service provider. If FORD MOTOR COMPANY or third party software and services suppliers provide or make available to you Supplemental Components and no other EULA terms are provided along with the Supplemental Components, then the terms of this EULA shall apply. FORD

Appendices

MOTOR COMPANY, its affiliates and/or its designated agent reserve the right to discontinue without liability any Internet-based services provided to you or made available to you through the use of the SOFTWARE.

Appendices

- **Links to Third Party Sites:** The SOFTWARE may provide you with the ability to link to third party sites. The third party sites are not under the control of FORD MOTOR COMPANY, its affiliates and/or its designated agent. Neither FORD MOTOR COMPANY nor its affiliates nor its designated agent are responsible for (i) the contents of any third party sites, any links contained in third party sites, or any changes or updates to third party sites, or (ii) webcasting or any other form of transmission received from any third party sites. If the SOFTWARE provides links to third party sites, those links are provided to you only as a convenience, and the inclusion of any link does not imply an endorsement of the third party site by FORD MOTOR COMPANY, its affiliates and/or its designated agent.
- **Obligation to Drive Responsibly:** You recognize your obligation to drive responsibly and keep attention on the road. You will read and abide with the DEVICES operating instructions particularly as they pertain to safety and you agree to assume any risk associated

with the use of the DEVICES.

UPGRADES AND RECOVERY MEDIA: If the SOFTWARE is provided by FORD MOTOR COMPANY separate from the DEVICES on media such as a ROM chip, CD ROM disk(s) or via web download or other means, and is labeled "For Upgrade Purposes Only" or "For Recovery Purposes Only" you may install one (1) copy of such SOFTWARE onto the DEVICES as a replacement copy for the existing SOFTWARE, and use it in accordance with this EULA, including any additional EULA terms accompanying the upgrade SOFTWARE.

INTELLECTUAL PROPERTY RIGHTS: All title and intellectual property rights in and to the SOFTWARE (including but not limited to any images, photographs, animations, video, audio, music, text and "applets" incorporated into the SOFTWARE), the accompanying printed materials, and any copies of the SOFTWARE, are owned by FORD MOTOR COMPANY, or its affiliates or suppliers. The SOFTWARE is licensed, not sold. You may not copy the printed materials accompanying the SOFTWARE. All title and intellectual property rights in and to the content which

may be accessed through use of the SOFTWARE is the property of the respective content owner and may be protected by applicable copyright or other intellectual property laws and treaties. This EULA grants you no rights to use such content outside its intended use. All rights not specifically granted under this EULA are reserved by FORD MOTOR COMPANY, its affiliates, and third party software and service providers and suppliers. Use of any on-line services which may be accessed through the SOFTWARE may be governed by the respective terms of use relating to such services. If this SOFTWARE contains documentation that is provided only in electronic form, you may print one copy of such electronic documentation.

Appendices

EXPORT RESTRICTIONS: You acknowledge that the SOFTWARE is subject to U.S. and European Union export jurisdiction. You agree to comply with all applicable international and national laws that apply to the SOFTWARE, including the U.S. Export Administration Regulations, as well as end-user, end-use and destination restrictions issued by U.S. and other governments.

TRADEMARKS: This EULA does not grant you any rights in connection with any trademarks or service marks of FORD MOTOR COMPANY, its affiliates, and third party software and service providers.

PRODUCT SUPPORT: Please refer to FORD MOTOR COMPANY instructions provided in the documentation for the DEVICES product support, such as the vehicle owner guide.

Should you have any questions concerning this EULA, or if you desire to contact FORD MOTOR COMPANY for any other reason, please refer to the address provided in the documentation for the DEVICES.

No Liability for Certain Damages: EXCEPT AS PROHIBITED BY LAW, FORD MOTOR COMPANY, ANY THIRD PARTY SOFTWARE OR SERVICES SUPPLIERS, AND THEIR AFFILIATES SHALL HAVE NO LIABILITY FOR ANY INDIRECT, SPECIAL, CONSEQUENTIAL OR INCIDENTAL DAMAGES ARISING FROM OR IN CONNECTION WITH THE USE OR PERFORMANCE OF THE SOFTWARE. THIS LIMITATION SHALL APPLY EVEN IF ANY REMEDY FAILS OF ITS ESSENTIAL PURPOSE. THERE ARE NO WARRANTIES OTHER THAN THOSE THAT MAY BE EXPRESSLY PROVIDED FOR YOUR NEW VEHICLE.

SYNC® Automotive Important Safety Information Read and follow instructions:

- Before using your SYNC® system, read and follow all instructions and safety information provided in this end user manual ("Owner Guide".) Not following precautions found in the Owner Guide can lead to an accident or other serious injuries.

General Operation

- **Voice Command Control:** Certain functions within the SYNC® system may be accomplished using voice commands. Using voice commands while driving helps you to operate the system without removing your hands from the wheel or eyes from the road.
- **Prolonged Views of Screen:** Do not access any function requiring a prolonged view of the screen while you are driving. Pull over in a safe and legal manner before attempting to access a function of the system requiring prolonged attention.
- **Volume Setting:** Do not raise the volume excessively. Keep the volume at a level where you can still hear outside traffic and emergency signals while driving. Driving while unable to hear these sounds could cause an accident.

Appendices

- **Navigation Features:** Any navigation features included in the system are intended to provide turn by turn instructions to get you to a desired destination. Please make certain all persons using this system carefully read and follow instructions and safety information fully.
- **Distraction Hazard:** Any navigation features may require manual (non-verbal) setup. Attempting to perform such set-up or insert data while driving can distract your attention and could cause an accident or other serious injury. Stop the vehicle in a safe and legal manner before attempting these operations.
- **Let Your Judgment Prevail:** Any navigation features are provided only as an aid. Make your driving decisions based on your observations of local conditions and existing traffic regulations. Any such feature is not a substitute for your personal judgment. Any route suggestions made by this system should never replace any local traffic regulations or your personal judgment or knowledge of safe driving practices.
- **Route Safety:** Do not follow the route suggestions if doing so would result in an unsafe or illegal maneuver, if you would be placed in an unsafe situation, or if you would be directed into an area that you consider unsafe. The driver is ultimately responsible for the safe operation of the vehicle and therefore, must evaluate whether it is safe to follow the suggested directions.
- **Potential Map Inaccuracy:** Maps used by this system may be inaccurate because of changes in roads, traffic controls or driving conditions. Always use good judgment and common sense when following the suggested routes.
- **Emergency Services:** Do not rely on any navigation features included in the system to route you to emergency services. Ask local authorities or an emergency services operator for these locations. Not all emergency services such as police, fire stations, hospitals and clinics are likely to be contained in the map database for such navigation features.

Appendices

Your Responsibilities and Assumptions of
Risk

Appendices

- You agree to each of the following:(a) Any use of the SOFTWARE while driving an automobile or other vehicle in violation of applicable law or otherwise driving in an unsafe manner presents a significant risk of distracted driving and should not be attempted under any circumstances;(b) Use of the SOFTWARE at excessive volume poses a significant risk of hearing damage and should not be attempted under any circumstances;(c) The SOFTWARE may not be compatible with new or different versions of an operating system, third party software, or third party services, and the SOFTWARE may potentially cause a critical failure of an operating system, third party software, or third party service.(d) Any third party service accessed by or third party software used with the SOFTWARE (i) may charge an additional fee for access, (ii) may not work correctly, on an uninterrupted basis, or error free, (iii) may change streaming formats or discontinue operation, (iv) may contain adult, profane or offensive content; and (v) may contain inaccurate, false or misleading traffic, weather,

financial or safety information or other content; and (e) Use of the SOFTWARE may cause you to incur additional charges from your wireless service provider (WSP) and any data or minute calculators that may be included in the software program are for reference only, are not warranted in any way and should not be relied upon in anyway.

- When using the SOFTWARE, you agree to be responsible for and assume the entire risk to the items set forth in Section (a) – (e) above.

Disclaimer of Warranty

YOU EXPRESSLY ACKNOWLEDGE AND AGREE THAT USE OF THE DEVICES AND SOFTWARE IS AT YOUR SOLE RISK AND THAT THE ENTIRE RISK AS TO SATISFACTORY QUALITY, PERFORMANCE, COMPATIBILITY, ACCURACY AND EFFORT IS WITH YOU. TO THE MAXIMUM EXTENT PERMITTED BY APPLICABLE LAW, THE SOFTWARE AND ANY THIRD PARTY SOFTWARE OR THIRD-PARTY SERVICES ARE PROVIDED "AS IS" AND "AS AVAILABLE", WITH ALL FAULTS AND

WITHOUT WARRANTY OF ANY KIND, AND FORD MOTOR COMPANY HEREBY DISCLAIMS ALL WARRANTIES AND CONDITIONS WITH RESPECT TO THE SOFTWARE, THIRD PARTY SOFTWARE, AND THIRD-PARTY SERVICES, EITHER EXPRESS, IMPLIED OR STATUTORY, INCLUDING, BUT NOT LIMITED TO, THE IMPLIED WARRANTIES AND/OR CONDITIONS OF MERCHANTABILITY, OF SATISFACTORY QUALITY, OF FITNESS FOR AN ARTICULAR PURPOSE, OF ACCURACY, OF QUIET ENJOYMENT, AND NON-INFRINGEMENT OF THIRD-PARTY RIGHTS. FORD MOTOR COMPANY DOES NOT WARRANT (a) AGAINST INTERFERENCE WITH YOUR ENJOYMENT OF THE SOFTWARE, THIRD PARTY SOFTWARE, OR THIRD-PARTY SERVICES, (b) THAT THE SOFTWARE, THIRD PARTY SOFTWARE, OR THIRD-PARTY SERVICES WILL MEET YOUR REQUIREMENTS, (c) THAT THE OPERATION OF THE SOFTWARE, THIRD PARTY SOFTWARE, OR THIRD-PARTY SERVICES WILL BE UNINTERRUPTED OR ERROR-FREE, (d) OR THAT DEFECTS IN THE SOFTWARE, THIRD PARTY SOFTWARE, OR THIRD-PARTY SERVICES WILL BE CORRECTED. NO ORAL

Appendices

OR WRITTEN INFORMATION OR ADVICE GIVEN BY FORD MOTOR COMPANY OR ITS AUTHORIZED REPRESENTATIVE SHALL CREATE A WARRANTY. SHOULD THE SOFTWARE, THIRD PARTY SOFTWARE, OR THIRD-PARTY SERVICES PROVE DEFECTIVE, YOU ASSUME THE ENTIRE COST OF ALL NECESSARY SERVICING, REPAIR OR CORRECTION. SOME JURISDICTIONS DO NOT ALLOW THE DISCLAIMER OF IMPLIED WARRANTIES OR LIMITATIONS ON APPLICABLE STATUTORY RIGHTS OF A CONSUMER, SO THE ABOVE DISCLAIMER MAY NOT FULLY APPLY TO YOU. THE SOLE WARRANTY PROVIDED BY FORD MOTOR COMPANY SHALL BE FOUND IN THE WARRANTY INFORMATION INCLUDING WITH YOUR OWNER GUIDE. TO THE EXTENT THAT THERE IS ANY CONFLICT BETWEEN THE TERMS OF THIS SECTION AND THE WARRANTY BOOKLET, THE WARRANTY BOOKLET SHALL CONTROL.

Applicable Law, Venue, Jurisdiction

- The laws of the State of Michigan govern this EULA and Your use of the SOFTWARE. Your use of the SOFTWARE may also be subject to other local, state, national, or international laws. Any litigation arising out of or related to this EULA shall be brought and maintained exclusively in a court of the State of Michigan located in Wayne County or in the United States District Court for the Eastern District of Michigan. You hereby consent to submit to the personal jurisdiction of a court in the State of Michigan located in Wayne County and the United States District Court for the Eastern District of Michigan for any dispute arising out of or relating to this EULA.

Binding Arbitration and Class Action Waiver

(a) Application. This Section applies to any dispute EXCEPT IT DOES NOT INCLUDE A DISPUTE RELATING TO COPYRIGHT INFRINGEMENT, OR TO THE ENFORCEMENT OR VALIDITY OF YOUR, FORD MOTOR COMPANY, OR ANY OF

FORD MOTOR COMPANY'S LICENSORS' INTELLECTUAL PROPERTY RIGHTS. Dispute means any dispute, action, or other controversy between You and FORD MOTOR COMPANY, other than the exceptions listed above, concerning the SOFTWARE (including its price) or this EULA, whether in contract, warranty, tort, statute, regulation, ordinance, or any other legal or equitable basis.

(b) Notice of Dispute. In the event of a Dispute, You or FORD MOTOR COMPANY must give the other a "Notice of Dispute", which is a written statement of the name, address, and contact information of the party giving it, the facts giving rise to the dispute, and the relief requested. You and FORD MOTOR COMPANY will attempt to resolve any dispute through informal negotiation within 60 days from the date the Notice of Dispute is sent. After 60 days, You or FORD MOTOR COMPANY may commence arbitration.

Appendices

(c) Small claims court. You may also litigate any dispute in small claims court in your county of residence or FORD MOTOR COMPANY'S principal place of business, if the dispute meets all requirements to be heard in the small claims court. You may litigate in small claims court whether or not You negotiated informally first.

(d) Binding arbitration. If You and FORD MOTOR COMPANY, do not resolve any dispute by informal negotiation or in small claims court, any other effort to resolve the dispute will be conducted exclusively by binding arbitration. You are giving up the right to litigate (or participate in as a party or class member) all disputes in court before a judge or jury. Instead, all disputes will be resolved before a neutral arbitrator, whose decision will be final except for a limited right of appeal under the Federal Arbitration Act. Any court with jurisdiction over the parties may enforce the arbitrator's award.

(e) Class action waiver. Any proceedings to resolve or litigate any dispute in any forum will be conducted solely on an individual basis. Neither you nor FORD MOTOR COMPANY, will seek to have any dispute heard as a class action, as a private attorney general action, or in any other proceeding in which any party acts or proposes to act in a representative capacity. No arbitration or proceeding will be combined with another without the prior written consent of all parties to all affected arbitrations or proceedings.

(f) Arbitration procedure. Any arbitration will be conducted by the American Arbitration Association (the "AAA"), under its Commercial Arbitration Rules. If You are an individual and use the SOFTWARE for personal or vehicle use, or if the value of the dispute is \$75,000 or less whether or not You are an individual or how You use the SOFTWARE, the AAA Supplementary Procedures for Consumer-Related Disputes will also apply. To commence arbitration, submit a Commercial Arbitration Rules Demand for Arbitration form to the AAA. You may request a telephonic or in-person hearing by following the AAA rules. In a

dispute involving \$10,000 or less, any hearing will be telephonic unless the arbitrator finds good cause to hold an in-person hearing instead. For more information, see adr.org or call 1-800-778-7879. You agree to commence arbitration only in your county of residence or FORD MOTOR COMPANY'S principal place of business. The arbitrator may award the same damages to You individually as a court could. The arbitrator may award declaratory or injunctive relief only to You individually, and only to the extent required to satisfy Your individual claim. **Arbitration fees and incentives.**

- i. Disputes involving \$75,000 or less. FORD MOTOR COMPANY will promptly reimburse your filing fees and pay the AAA's and arbitrator's fees and expenses. If you reject FORD MOTOR COMPANY'S last written settlement offer made before the arbitrator was appointed ("last written offer"), your dispute goes all the way to an arbitrator's decision (called an "award"), and the arbitrator awards you more than the last written offer, FORD MOTOR COMPANY will give

Appendices

you three incentives: (1) pay the greater of the award or \$1,000; (2) pay twice your reasonable attorney's fees, if any; and (3) reimburse any expenses (including expert witness fees and costs) that your attorney reasonably accrues for investigating, preparing, and pursuing your claim in arbitration. The arbitrator will determine the amounts.

- ii. Disputes involving more than \$75,000. The AAA rules will govern payment of filing fees and the AAA's and arbitrator's fees and expenses.
- iii. Disputes involving any amount. In any arbitration you commence, FORD MOTOR COMPANY will seek its AAA or arbitrator's fees and expenses, or Your filing fees it reimbursed, only if the arbitrator finds the arbitration frivolous or brought for an improper purpose. In any arbitration FORD MOTOR COMPANY commences, it will pay all filing, AAA, and arbitrator's fees and expenses. It will not seek its attorney's fees or expenses from you in any arbitration. Fees and expenses are not counted in determining how much a dispute involves.

(h) Claims or disputes must be filed within one year. To the extent permitted by law, any claim or dispute under this EULA to which this Section applies must be filed within one year in small claims court (Section c) or in arbitration (Section d). The one-year period begins when the claim or dispute first could be filed. If such a claim or dispute is not filed within one year, it is permanently barred.

(i) Severability. If the class action waiver (Section e) is found to be illegal or unenforceable as to all or some parts of a dispute, then that portion of Section e will not apply to those parts. Instead, those parts will be severed and proceed in a court of law, with the remaining parts proceeding in arbitration. If any other provision of that portion Section e is found to be illegal or unenforceable, that provision will be severed with the remainder of Section e remaining in full force and effect.

Telenav Software End User License Agreement

Please read these terms and conditions carefully before you use the TeleNav Software. Your use of the TeleNav Software indicates that you accept these terms and conditions. If you do not accept these terms and conditions, do not break the seal of the package, launch, or otherwise use the TeleNav Software. TeleNav may revise this Agreement and the privacy policy at any time, with or <http://www.telenav.com> from time to time to review the then current version of this Agreement and of the privacy policy.

1. Safe and Lawful Use

You acknowledge that devoting attention to the TeleNav Software may pose a risk of injury or death to you and others in situations that otherwise require your undivided attention, and you therefore agree to comply with the following when using the TeleNav Software:

- (a) observe all traffic laws and otherwise drive safely;

Appendices

(b) use your own personal judgment while driving. If you feel that a route suggested by the TeleNav Software instructs you to perform an unsafe or illegal maneuver, places you in an unsafe situation, or directs you into an area that you consider to be unsafe, do not follow such instructions;

(c) do not input destinations, or otherwise manipulate the TeleNav Software, unless your vehicle is stationary and parked;

(d) do not use the TeleNav Software for any illegal, unauthorized, unintended, unsafe, hazardous, or unlawful purposes, or in any manner inconsistent with this Agreement;

(e) arrange all GPS and wireless devices and cables necessary for use of the TeleNav Software in a secure manner in your vehicle so that they will not interfere with your driving and will not prevent the operation of any safety device (such as an airbag).

You agree to indemnify and hold TeleNav harmless against all claims resulting from any dangerous or otherwise inappropriate use of the TeleNav Software in any moving vehicle, including as a result of your failure to comply with the directions above.

2. Account Information

You agree: (a) when registering the TeleNav Software, to provide TeleNav with true, accurate, current, and complete information about yourself, and (b) to inform TeleNav promptly of any changes to such information, and to keep it true, accurate, current and complete.

3. Software License

- Subject to your compliance with the terms of this Agreement, TeleNav hereby grants to you a personal, non-exclusive, non-transferable license (except as expressly permitted below in connection with your permanent transfer of the TeleNav Software license), without the right to sublicense, to use the TeleNav Software (in object code form only) in order to access and use the TeleNav Software. This license shall terminate upon any termination or expiration of this Agreement. You agree that you will use the TeleNav Software only for your personal business or leisure purposes, and not to provide commercial navigation services to other parties.

3.1 License Limitations

- **(a)** reverse engineer, decompile, disassemble, translate, modify, alter or otherwise change the TeleNav Software or any part thereof; **(b)** attempt to derive the source code, audio library or structure of the TeleNav Software without the prior express written consent of TeleNav; **(c)** remove from the TeleNav Software, or alter, any of TeleNav's or its suppliers' trademarks, trade names, logos, patent or copyright notices, or other notices or markings; **(d)** distribute, sublicense or otherwise transfer the TeleNav Software to others, except as part of your permanent transfer of the TeleNav Software; or **(e)** use the TeleNav Software in any manner that
 - i. infringes the intellectual property or proprietary rights, rights of publicity or privacy or other rights of any party,
 - ii. violates any law, statute, ordinance or regulation, including but not limited to laws and regulations related to spamming, privacy, consumer and child protection, obscenity or defamation, or

Appendices

iii. is harmful, threatening, abusive, harassing, tortuous, defamatory, vulgar, obscene, libelous, or otherwise objectionable; and (f) lease, rent out, or otherwise permit unauthorized access by third parties to the TeleNav Software without advanced written permission of TeleNav.

4. Disclaimers

- To the fullest extent permissible pursuant to applicable law, in no event will TeleNav, its licensors and suppliers, or agents or employees of any of the foregoing, be liable for any decision made or action taken by you or anyone else in reliance on the information provided by the TeleNav Software. TeleNav also does not warrant the accuracy of the map or other data used for the TeleNav Software. Such data may not always reflect reality due to, among other things, road closures, construction, weather, new roads and other changing conditions. You are responsible for the entire risk arising out of your use of the TeleNav Software. For example but without limitation, you agree not to rely

on the TeleNav Software for critical navigation in areas where the well-being or survival of you or others is dependent on the accuracy of navigation, as the maps or functionality of the TeleNav Software are not intended to support such high risk applications, especially in more remote geographical areas.

- TELENAV EXPRESSLY DISCLAIMS AND EXCLUDES ALL WARRANTIES IN CONNECTION WITH THE TELENAV SOFTWARE, WHETHER STATUTORY, EXPRESS OR IMPLIED, INCLUDING ALL WARRANTIES WHICH MAY ARISE FROM COURSE OF DEALING, CUSTOM OR TRADE AND INCLUDING, BUT NOT LIMITED TO, THE IMPLIED WARRANTIES OF MERCHANTABILITY, FITNESS FOR A PARTICULAR PURPOSE AND NON-INFRINGEMENT OF THIRD PARTY RIGHTS WITH RESPECT TO THE TELENAV SOFTWARE.
- Certain jurisdictions do not permit the disclaimer of certain warranties, so this limitation may not apply to you.

5. Limitation of Liability

- TO THE EXTENT PERMITTED UNDER APPLICABLE LAW, UNDER NO CIRCUMSTANCES SHALL TELENAV OR ITS LICENSORS AND SUPPLIERS BE LIABLE TO YOU OR TO ANY THIRD PARTY FOR ANY INDIRECT, INCIDENTAL, CONSEQUENTIAL, SPECIAL OR EXEMPLARY DAMAGES (INCLUDING IN EACH CASE, BUT NOT LIMITED TO, DAMAGES FOR THE INABILITY TO USE THE EQUIPMENT OR ACCESS DATA, LOSS OF DATA, LOSS OF BUSINESS, LOSS OF PROFITS, BUSINESS INTERRUPTION OR THE LIKE) ARISING OUT OF THE USE OF OR INABILITY TO USE THE TELENAV SOFTWARE, EVEN IF TELENAV HAS BEEN ADVISED OF THE POSSIBILITY OF SUCH DAMAGES. NOTWITHSTANDING ANY DAMAGES THAT YOU MIGHT INCUR FOR ANY REASON WHATSOEVER (INCLUDING, WITHOUT LIMITATION, ALL DAMAGES REFERENCED HEREIN AND ALL DIRECT OR GENERAL DAMAGES IN CONTRACT, TORT (INCLUDING NEGLIGENCE) OR

Appendices

OTHERWISE), THE ENTIRE LIABILITY OF TELENAV AND OF ALL OF TELENAV'S SUPPLIERS SHALL BE LIMITED TO THE AMOUNT ACTUALLY PAID BY YOU FOR THE TELENAV SOFTWARE. SOME STATES AND/OR JURISDICTIONS DO NOT ALLOW THE EXCLUSION OR LIMITATION OF INCIDENTAL OR CONSEQUENTIAL DAMAGES, SO THE ABOVE LIMITATIONS OR EXCLUSIONS MAY NOT APPLY TO YOU.

6. Arbitration and Governing Law

- You agree that any dispute, claim or controversy arising out of or relating to this Agreement or the TeleNav Software shall be settled by independent arbitration involving a neutral arbitrator and administered by the American Arbitration Association in the County of Santa Clara, California. The arbitrator shall apply the Commercial Arbitration Rules of the American Arbitration Association, and the judgment upon the award rendered by the arbitrator may be entered by any court having jurisdiction. Note that there is no judge or jury in an

arbitration proceeding and the decision of the arbitrator shall be binding upon both parties. You expressly agree to waive your right to a jury trial. This Agreement and performance hereunder will be governed by and construed in accordance with the laws of the State of California, without giving effect to its conflict of law provisions. To the extent judicial action is necessary in connection with the binding arbitration, both TeleNav and you agree to submit to the exclusive jurisdiction of the courts of the County of Santa Clara, California. The United Nations Convention on Contracts for the International Sale of Goods shall not apply.

7. Assignment

- You may not resell, assign, or transfer this Agreement or any of your rights or obligations, except in totality, in connection with your permanent transfer of the TeleNav Software, and expressly conditioned upon the new user of the TeleNav Software agreeing to be bound by the terms and conditions of this

Agreement. Any such sale, assignment or transfer that is not expressly permitted under this paragraph will result in immediate termination of this Agreement, without liability to TeleNav, in which case you and all other parties shall immediately cease all use of the TeleNav Software. Notwithstanding the foregoing, TeleNav may assign this Agreement to any other party at any time without notice, provided the assignee remains bound by this Agreement.

8. Miscellaneous

8.1

This Agreement constitutes the entire agreement between TeleNav and you with respect to the subject matter hereof.

8.2

Except for the limited licenses expressly granted in this Agreement, TeleNav retains all right, title and interest in and to the TeleNav Software, including without limitation all related intellectual property rights. No licenses or other rights which are

Appendices

not expressly granted in this Agreement are intended to, or shall be, granted or conferred by implication, statute, inducement, estoppel or otherwise, and TeleNav and its suppliers and licensors hereby reserve all of their respective rights other than the licenses explicitly granted in this Agreement.

8.3

By using the TeleNav Software, you consent to receive from TeleNav all communications, including notices, agreements, legally required disclosures or other information in connection with the TeleNav Software (collectively, "Notices") electronically. TeleNav may provide such Notices by posting them on TeleNav's Website or by downloading such Notices to your wireless device. If you desire to withdraw your consent to receive Notices electronically, you must discontinue your use of the TeleNav Software.

8.4

TeleNav's or your failure to require performance of any provision shall not affect that party's right to require performance at any time thereafter, nor shall a waiver of any breach or default of this Agreement constitute a waiver of any subsequent breach or default or a waiver of the provision itself.

8.5

If any provision herein is held unenforceable, then such provision will be modified to reflect the intention of the parties, and the remaining provisions of this Agreement will remain in full force and effect.

8.6

The headings in this Agreement are for convenience of reference only, will not be deemed to be a part of this Agreement, and will not be referred to in connection with the construction or interpretation of this Agreement. As used in this Agreement, the words "include" and "including" and variations thereof, will not be deemed to be terms of limitation, but rather will be deemed to be followed by the words "without limitation".

9. Other Vendors Terms and Conditions

- The Telenav Software utilizes map and other data licensed to Telenav by third party vendors for the benefit of you and other end users. This Agreement includes end-user terms applicable to these companies (included at the end of this Agreement), and thus your use of the Telenav Software is also subject to such terms. You agree to comply with the following additional terms and conditions, which are applicable to Telenav's third party vendor licensors::

Appendices

9.1 End User Terms Required by HERE North America, LLC

The data (“Data”) is provided for your personal, internal use only and not for resale. It is protected by copyright, and is subject to the following terms and conditions which are agreed to by you, on the one hand, and Telenav (“Telenav”) and its licensors (including their licensors and suppliers) on the other hand.

© 2013 HERE. All rights reserved.

The Data for areas of Canada includes information taken with permission from Canadian authorities, including: © Her Majesty the Queen in Right of Canada, © Queen's Printer for Ontario, © Canada Post Corporation, GeoBase®, © Department of Natural Resources Canada.

HERE holds a non-exclusive license from the United States Postal Service® to publish and sell ZIP+4® information.

©United States Postal Service® 2014. Prices are not established, controlled or approved by the United States Postal Service®. The following trademarks and registrations are owned by the USPS: United States Postal Service, USPS, and ZIP+4

The Data for Mexico includes certain data from Instituto Nacional de Estadística y Geografía.

Terms and Conditions

Permitted Use. You agree to use this Data together with the Telenav Software solely for the internal business and personal purposes for which you were licensed, and not for service bureau, time-sharing or other similar purposes. Accordingly, but subject to the restrictions set forth in the following paragraphs, you agree not to otherwise reproduce, copy, modify, decompile, disassemble, create any derivative works of, or reverse engineer any portion of this Data, and may not transfer or distribute it in any form, for any purpose, except to the extent permitted by mandatory laws.

Restrictions. Except where you have been specifically licensed to do so by Telenav, and without limiting the preceding paragraph, you may not use this Data (a) with any products, systems, or applications installed or otherwise connected to or in communication with vehicles, capable of vehicle navigation, positioning, dispatch, real time route guidance, fleet management or similar applications; or (b) with or in communication with any positioning devices or any mobile or wireless-connected electronic or computer devices, including without limitation cellular phones, palmtop and handheld computers, pagers, and personal digital assistants or PDAs.

Warning. The Data may contain inaccurate or incomplete information due to the passage of time, changing circumstances, sources used and the nature of collecting comprehensive geographic data, any of which may lead to incorrect results.

Appendices

No Warranty. This Data is provided to you “as is,” and you agree to use it at your own risk. Telenav and its licensors (and their licensors and suppliers) make no guarantees, representations or warranties of any kind, express or implied, arising by law or otherwise, including but not limited to, content, quality, accuracy, completeness, effectiveness, reliability, fitness for a particular purpose, usefulness, use or results to be obtained from this Data, or that the Data or server will be uninterrupted or error-free.

Disclaimer of Warranty: TELENAV AND ITS LICENSORS (INCLUDING THEIR LICENSORS AND SUPPLIERS) DISCLAIM ANY WARRANTIES, EXPRESS OR IMPLIED, OF QUALITY, PERFORMANCE, MERCHANTABILITY, FITNESS FOR A PARTICULAR PURPOSE OR NON-INFRINGEMENT. Some States, Territories and Countries do not allow certain warranty exclusions, so to that extent the above exclusion may not apply to you.

Disclaimer of Liability: TELENAV AND ITS LICENSORS (INCLUDING THEIR LICENSORS AND SUPPLIERS) SHALL NOT BE LIABLE TO YOU: IN RESPECT OF ANY CLAIM, DEMAND OR ACTION, IRRESPECTIVE OF THE NATURE OF THE CAUSE OF THE CLAIM, DEMAND OR ACTION ALLEGING ANY LOSS, INJURY OR DAMAGES, DIRECT OR INDIRECT, WHICH MAY RESULT FROM THE USE OR POSSESSION OF THE INFORMATION; OR FOR ANY LOSS OF PROFIT, REVENUE, CONTRACTS OR SAVINGS, OR ANY OTHER DIRECT, INDIRECT, INCIDENTAL, SPECIAL OR CONSEQUENTIAL DAMAGES ARISING OUT OF YOUR USE OF OR INABILITY TO USE THIS INFORMATION, OR THE BREACH OF THESE TERMS OR CONDITIONS, WHETHER IN AN ACTION IN CONTRACT OR TORT OR BASED ON A WARRANTY, EVEN IF TELENAV OR ITS LICENSORS HAVE BEEN ADVISED OF THE POSSIBILITY OF SUCH DAMAGES. Some States, Territories and Countries do not allow certain liability exclusions or damages limitations, so to that extent the above may not apply to you.

Export Control. You shall not export from anywhere any part of the Data or any direct product thereof except in compliance with, and with all licenses and approvals required under, applicable export laws, rules and regulations, including but not limited to the laws, rules and regulations administered by the Office of Foreign Assets Control of the U.S. Department of Commerce and the Bureau of Industry and Security of the U.S. Department of Commerce. To the extent that any such export laws, rules or regulations prohibit HERE from complying with any of its obligations hereunder to deliver or distribute Data, such failure shall be excused and shall not constitute a breach of this Agreement.

Entire Agreement. These terms and conditions constitute the entire agreement between Telenav (and its licensors, including their licensors and suppliers) and you pertaining to the subject matter hereof, and supersedes in their entirety any and all written or oral agreements previously existing between us with respect to such subject matter.

Appendices

Governing Law. The above terms and conditions shall be governed by the laws of the State of Illinois [insert “Netherlands” where European HERE Data is used], without giving effect to (i) its conflict of laws provisions, or (ii) the United Nations Convention for Contracts for the International Sale of Goods, which is explicitly excluded. You agree to submit to the jurisdiction of the State of Illinois [insert “The Netherlands” where European HERE Data is used] for any and all disputes, claims and actions arising from or in connection with the Data provided to you hereunder.

Government End Users. If the Data is being acquired by or on behalf of the United States government or any other entity seeking or applying rights similar to those customarily claimed by the United States government, this Data is a “commercial item” as that term is defined at 48 C.F.R. (“FAR”) 2.101, is licensed in accordance with these End-User Terms, and each copy of Data delivered or otherwise furnished shall be marked and embedded as appropriate with the following “Notice of Use,” and shall be treated in accordance with such Notice:

NOTICE OF USE
CONTRACTOR (MANUFACTURER/ SUPPLIER) NAME: HERE
CONTRACTOR (MANUFACTURER/ SUPPLIER) ADDRESS: c/o Nokia, 425 West Randolph Street, Chicago, Illinois 60606
This Data is a commercial item as defined in FAR 2.101 and is subject to these End- User Terms under which this Data was provided.
© 1987 – 2014 HERE – All rights reserved.

If the Contracting Officer, federal government agency, or any federal official refuses to use the legend provided herein, the Contracting Officer, federal government agency, or any federal official must notify HERE prior to seeking additional or alternative rights in the Data.

Gracenote® Copyright

CD and music-related data from Gracenote, Inc., copyright©

2000-2007 Gracenote. Gracenote Software, copyright © 2000-2007 Gracenote. This product and service may practice one or more of the following U.S. Patents 5,987,525; 6,061,680; 6,154,773; 6,161,132; 6,230,192; 6,230,207; 6,240,459; 6,330,593 and other patents issued or pending. Some services supplied under license from Open Globe, Inc. for U.S. Patent 6,304,523.

Gracenote and CDDB are registered trademarks of Gracenote. The Gracenote logo and logotype, and the "Powered by Gracenote" logo are trademarks of Gracenote.

Gracenote® End User License Agreement (EULA)

This device contains software from Gracenote, Inc. of 2000 Powell Street Emeryville, California 94608 ("Gracenote").

The software from Gracenote (the "Gracenote Software") enables this device to do disc and music file identification and obtain music-related information, including name, artist, track, and title information ("Gracenote Data") from online servers ("Gracenote Servers"), and to perform other

Appendices

functions. You may use Gracenote Data only by means of the intended End User functions of this device. This device may contain content belonging to Gracenote's providers. If so, all of the restrictions set forth herein with respect to Gracenote Data shall also apply to such content and such content providers shall be entitled to all of the benefits and protections set forth herein that are available to Gracenote. You agree that you will use the content from Gracenote ("Gracenote Content"), Gracenote Data, the Gracenote Software, and Gracenote Servers for your own personal, non-commercial use only. You agree not to assign, copy, transfer or transmit the Gracenote Content, Gracenote Software or any Gracenote Data (except in a Tag associated with a music file) to any third party. **YOU AGREE NOT TO USE OR EXPLOIT GRACENOTE CONTENT, GRACENOTE DATA, THE GRACENOTE SOFTWARE, OR GRACENOTE SERVERS, EXCEPT AS EXPRESSLY PERMITTED HEREIN.**

You agree that your non-exclusive licenses to use the Gracenote Content, Gracenote Data, the Gracenote Software, and Gracenote Servers will terminate if you violate these restrictions. If your licenses terminate, you agree to cease any and all use of the Gracenote Content, Gracenote Data, the Gracenote Software, and Gracenote Servers.

Gracenote, respectively, reserve all rights in Gracenote Data, the Gracenote Software, and the Gracenote Servers and Gracenote Content, including all ownership rights. Under no circumstances will either Gracenote become liable for any payment to you for any information that you provide, including any copyrighted material or music file information. You agree that Gracenote may enforce its respective rights, collectively or separately, under this agreement against you, directly in each company's own name.

Gracenote uses a unique identifier to track queries for statistical purposes. The purpose of a randomly assigned numeric identifier is to allow Gracenote to count queries without knowing anything about who you are. For more information, see the web page at www.gracenote.com for the Gracenote Privacy Policy.

THE GRACENOTE SOFTWARE, EACH ITEM OF GRACENOTE DATA AND THE GRACENOTE CONTENT ARE LICENSED TO YOU "AS IS". NEITHER GRACENOTE MAKES ANY REPRESENTATIONS OR WARRANTIES, EXPRESS OR IMPLIED, REGARDING THE ACCURACY OF ANY GRACENOTE DATA FROM THE GRACENOTE SERVERS OR GRACENOTE CONTENT. GRACENOTE COLLECTIVELY AND SEPARATELY RESERVE THE RIGHT TO DELETE DATA AND/OR CONTENT FROM THE COMPANIES' RESPECTIVE SERVERS OR, IN THE CASE OF GRACENOTE, CHANGE DATA CATEGORIES FOR ANY CAUSE THAT GRACENOTE DEEMS SUFFICIENT. NO WARRANTY IS MADE THAT EITHER GRACENOTE CONTENT OR THE GRACENOTE SOFTWARE OR GRACENOTE SERVERS ARE

Appendices

ERROR-FREE OR THAT THE FUNCTIONING OF THE GRACENOTE SOFTWARE OR GRACENOTE SERVERS WILL BE UNINTERRUPTED. GRACENOTE IS NOT OBLIGATED TO PROVIDE YOU WITH ANY ENHANCED OR ADDITIONAL DATA TYPES THAT GRACENOTE MAY CHOOSE TO PROVIDE IN THE FUTURE AND IS FREE TO DISCONTINUE ITS ONLINE SERVICES AT ANY TIME. GRACENOTE DISCLAIMS ALL WARRANTIES EXPRESS OR IMPLIED, INCLUDING, BUT NOT LIMITED TO, IMPLIED WARRANTIES OF MERCHANTABILITY, FITNESS FOR A PARTICULAR PURPOSE, TITLE, AND NON-INFRINGEMENT. NEITHER GRACENOTE WARRANTS THE RESULTS THAT WILL BE OBTAINED BY YOUR USE OF THE GRACENOTE SOFTWARE OR ANY GRACENOTE SERVER. IN NO CASE WILL GRACENOTE BE LIABLE FOR ANY CONSEQUENTIAL OR INCIDENTAL DAMAGES OR FOR ANY LOST PROFITS OR LOST REVENUES FOR ANY REASON WHATSOEVER. © Gracenote 2007.

FCC ID: ACJ-SYNCG3-L

IC: 216B-SYNCG3-L

This device complies with Part 15 of the FCC Rules and with RSS-210 of Industry Canada. Operation is subject to the following two conditions:

- (1) This device may not cause harmful interference, and
- (2) this device must accept any interference received, including interference that may cause undesired operation.

WARNING



Changes or modifications not expressly approved by the party responsible for compliance could void the user's authority to operate the equipment. The term "IC" before the radio certification number only signifies that Industry Canada technical specifications were met.

The antenna used for this transmitter must not be co-located or operating in conjunction with any other antenna or transmitter.

TYPE APPROVALS

RF Certification Logos for Tire Pressure Monitoring Sensor(s)



E207816

Argentina



E207817

Abu Dhabi, Dubai

Appendices



E197509



E202555

Brazil

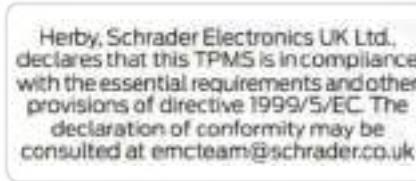

E207818

European Union EU

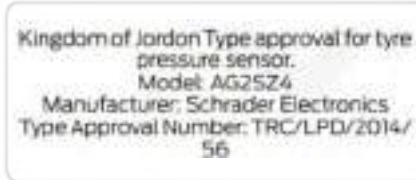

E207819

Jordan



E207820

Malaysia



E197811

Moldova

Appendices



E207821

Morocco



E198001

Philippines



E197844

Serbia



E207822

Singapore



E198002

South Africa

TA-2014/064

Approved



E203899

Appendices

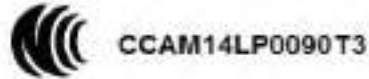

E203679

Taiwan



Schrader Electronics цім стверджує, що обладнання Радіопередавач моделі AG2S24 системи контролю тиску в шині автомобіля відповідає вимогам Технічного регламенту радіоблагоднання і телекомунікаційного кінцевого (термінального) обладнання (Постанова КМУ № 679 від 24 червня 2009 р.) Декларація відповідності знаходиться на сайті Schrader

Electronics та надається за запитом на електронну адресу doc.request@schrader.co.uk

E198009

Ukraine

Index

A		
A/C		
See: Climate Control.....	134	
About This Manual.....	7	
ABS		
See: Brakes.....	188	
ABS driving hints		
See: Hints on Driving With Anti-Lock Brakes.....	188	
Accessories.....	491	
Exterior Style.....	491	
Interior Style.....	491	
Lifestyle.....	491	
Peace of Mind.....	491	
Accessories		
See: Replacement Parts Recommendation.....	13	
ACC		
See: Using Adaptive Cruise Control.....	216	
Active Park Assist.....	203	
Deactivating the Active Park Assist Feature.....	209	
Parallel Parking, Perpendicular Parking, Parallel Park Out Assist.....	203	
Troubleshooting the System.....	209	
Adaptive Headlamps.....	89	
Adjusting the Headlamps.....	315	
Horizontal Aim Adjustment.....	316	
Vertical Aim Adjustment.....	315	
Adjusting the Steering Wheel.....	78	
Power Tilt and Telescope Steering Column.....	78	
AFS		
See: Adaptive Headlamps.....	89	
Airbag Disposal.....	53	
Air Conditioning		
See: Climate Control.....	134	
Air Filter		
See: Changing the Engine Air Filter.....	319	
Alarm		
See: Anti-Theft Alarm.....	76	
All-Wheel Drive.....	179	
Ambient Lighting.....	92	
Anti-Theft Alarm.....	76	
Arming the Alarm.....	77	
Disarming the Alarm.....	77	
Appendices.....	527	
Apps.....	454	
.....	454	
SiriusXM Traffic and Travel Link.....	456	
Audible Warnings and Indicators.....	107	
Headlamps On Warning Chime.....	107	
Key in Ignition Warning Chime.....	107	
Keyless Warning Alert.....	107	
Parking Brake On Warning Chime.....	107	
Audio Control.....	79	
Seek, Next or Previous.....	79	
Audio System.....	386	
General Information.....	386	
Audio Unit - Vehicles With: Premium AM/ FM/CD.....	387	
Auto Hold.....	191	
Using Auto Hold.....	193	
Autolamps.....	85	
Windshield Wiper Activated Headlamps.....	86	
Automatic Climate Control.....	134	
Automatic Fan Settings.....	136	
Automatic High Beam Control.....	88	
Activating the System.....	89	
Manually Overriding the System.....	89	
Automatic Transmission.....	173	
Automatic Transmission Adaptive Learning.....	177	
Brake-Shift Interlock Override.....	176	
If Your Vehicle Gets Stuck In Mud or Snow.....	177	
Push Button Shift Transmission.....	173	
SelectShift Automatic™ Transmission.....	175	
Automatic Transmission Fluid		
Check.....	307	
6F35/HF35 transmission.....	307	
6F50/6F55 Transmission.....	308	
Autowipers.....	82	

Index

Auxiliary Power Points.....	156	California Proposition 65.....	12	Number of MyKeys.....	62
110 Volt AC Power Point.....	156	Capacities and Specifications - 2.0L.....	374	Checking the Wiper Blades.....	314
12 Volt DC Power Point.....	156	Specifications.....	375	Child Restraint and Seatbelt	
Locations.....	156	Capacities and Specifications - 3.0L.....	379	Maintenance.....	41
AWD		Specifications.....	381	Child Restraint Positioning.....	31
See: All-Wheel Drive.....	179	Capacities and Specifications.....	367	Child Safety.....	17
B		Car Wash		General Information.....	17
Battery		See: Cleaning the Exterior.....	321	Child Safety Locks.....	32
See: Changing the 12V Battery.....	312	Center Console.....	158	Left-Hand Side.....	33
Blind Spot Information System.....	231	Rear Seat Armrest.....	158	Right-Hand Side.....	33
Switching the System Off and On.....	233	Changing a Bulb.....	316	Cleaning Leather Seats.....	326
System Errors.....	233	Lamp Assembly Condensation.....	316	Cleaning Products.....	320
Using the System.....	231	Replacing Bulbs.....	316	Cleaning the Alloy Wheels.....	327
Bonnet Lock		Changing a Fuse.....	292	Cleaning the Engine.....	322
See: Opening and Closing the Hood.....	295	Fuses.....	292	Cleaning the Exterior.....	321
Booster Seats.....	28	Changing a Road Wheel.....	357	Exterior Chrome Parts.....	321
Types of Booster Seats.....	29	Changing a Road Wheel Procedure.....	359	Exterior Plastic Parts.....	322
Brake Fluid Check.....	311	Dissimilar Spare Wheel and Tire Assembly		Stripes or Graphics.....	322
Brakes.....	188	Information.....	358	Underbody.....	322
General Information.....	188	Stowing the Flat Tire.....	363	Under Hood.....	322
Breaking-In.....	256	Stowing the Flat Tire Using the Retainer		Cleaning the Instrument Panel and	
Bulb Specification Chart.....	316	Strap.....	363	Instrument Cluster Lens.....	325
C		Changing the 12V Battery.....	312	Cleaning the Interior.....	323
Cabin Air Filter.....	138	Changing the Engine Air Filter.....	319	Cleaning Alcantara Microfiber Cloth	
		Changing the Wiper Blades.....	314	Fabric.....	324
		Checking MyKey System Status.....	62	Cleaning the Windows and Wiper	
		MyKey Distance.....	62	Blades.....	323
		Number of Admin Keys.....	63	Clearing All MyKeys.....	62

Index

Climate.....	432
Climate Control.....	134
Climate Controlled Seats.....	148
Cooled Seats.....	149
Coolant Check	
See: Engine Coolant Check.....	303
Crash Sensors and Airbag Indicator.....	52
Creating a MyKey.....	61
Programming or Changing Configurable	
Settings.....	62
Cross Traffic Alert.....	233
False Alerts.....	237
Switching the System Off and On.....	237
System Errors.....	237
System Lights, Messages and Audible	
Alerts.....	236
System Limitations.....	236
Using the System.....	233
Cruise Control.....	80
Principle of Operation.....	215
Type 1.....	80
Type 2.....	80
Cruise control	
See: Using Cruise Control.....	215
Customer Assistance.....	267

D

Data Recording.....	9
Event Data Recording.....	10
Service Data Recording.....	9
Daytime Running Lamps.....	87
Type 1 - Conventional	
(Non-Configurable).....	87
Type 2 - Configurable.....	87
Direction Indicators.....	90
Lane Change.....	90
Drive Control.....	241
LINCOLN DRIVE CONTROL.....	241
Driver Alert.....	225
Using Driver Alert.....	225
Driver and Passenger Airbags.....	45
Children and Airbags.....	46
Proper Driver and Front Passenger Seating	
Adjustment.....	46
Driver and Passenger Knee Airbags.....	50
Driving Aids.....	225
Driving Hints.....	256
Driving Through Water.....	256
DRL	
See: Daytime Running Lamps.....	87

E

Economical Driving.....	256
Electric Parking Brake.....	189
Applying the electric parking brake.....	189
Applying the electric parking brake when the	
vehicle is moving.....	190
Battery With No Charge.....	191
Releasing the electric parking brake.....	190
Emission Control System.....	170
On-Board Diagnostics (OBD-II).....	171
Readiness for Inspection/Maintenance (I/M)	
Testing.....	172
End User License Agreement.....	527
VEHICLE SOFTWARE END USER LICENSE	
AGREEMENT (EULA)	527
Engine Block Heater.....	163
Using the Engine Block Heater.....	163
Engine Coolant Check.....	303
Adding Coolant.....	304
Engine Coolant Temperature	
Management.....	306
Fail-Safe Cooling.....	305
Recycled Coolant.....	305
Severe Climates.....	305
Engine Immobilizer	
See: Passive Anti-Theft System.....	75

Index

General Maintenance Information.....	495	Heated Windows and Mirrors.....	137	Information Messages.....	114
Multi-Point Inspection.....	498	Heated Exterior Mirrors.....	137	Active Park.....	114
Owner Checks and Services.....	497	Heated Rear Window.....	137	Adaptive Cruise Control.....	115
Protecting Your Investment.....	495	Heated Wiper Park.....	138	Adaptive Headlamps.....	116
Why Maintain Your Vehicle?.....	495	Heating		AdvanceTrac™.....	116
Why Maintain Your Vehicle at Your		See: Climate Control.....	134	Airbag.....	116
Dealership?.....	495	Hints on Controlling the Interior		Alarm.....	117
Getting Assistance Outside the U.S. and		Climate.....	136	Automatic Engine Shutdown.....	117
Canada.....	271	Cooling the Interior Quickly.....	137	AWD.....	118
Getting the Services You Need.....	267	General Hints.....	136	Battery and Charging System.....	119
Away From Home.....	267	Heating the Interior Quickly.....	137	Blind Spot Information and Cross Traffic Alert	
Global Opening and Closing.....	94	Recommended Settings for Cooling.....	137	System.....	120
Closing the Windows.....	94	Recommended Settings for Heating.....	137	Doors and Locks.....	120
Opening the Windows.....	94	Side Window Defogging in Cold		Driver Alert.....	121
		Weather.....	137	Fuel.....	121
H		Hints on Driving With Anti-Lock		Hill Start Assist.....	122
Hazard Warning Flashers.....	260	Brakes.....	188	Keys and Intelligent Access.....	122
Headlamp Adjusting		Home Screen.....	407	Lane Keeping System.....	123
See: Adjusting the Headlamps.....	315	Hood Lock		Maintenance.....	124
Headlamp Exit Delay.....	87	See: Opening and Closing the Hood.....	295	MyKey.....	125
Head Restraints.....	139			Park Aid.....	126
Adjusting the Head Restraint.....	140	I		Park Brake.....	126
Tilting Head Restraints.....	141	In California (U.S. Only).....	268	Power Steering.....	127
Heated Seats.....	147	Information Display Control.....	80	Pre-Collision Assist.....	128
Front Seats.....	147	Information Displays.....	108	Remote Start.....	128
Rear Seats.....	148	General Information.....	108	Seats.....	129
Heated Steering Wheel.....	81			Starting System.....	129
				Tire Pressure Monitoring System.....	130

Index

Traction Control.....	130
Transmission.....	131
Installing Child Restraints.....	19
Child Seats.....	19
Using Lap and Shoulder Belts.....	19
Using Lower Anchors and Tethers for Children (LATCH).....	25
Using Tether Straps.....	27
Instrument Cluster.....	101
Instrument Lighting Dimmer.....	86
Interior Lamps.....	91
Front Interior Lamp.....	91
Rear Interior Lamp.....	92
Interior Luggage Compartment Release.....	73
Interior Mirror.....	97
Auto-Dimming Mirror.....	97
Introduction.....	7
J	
Jump Starting the Vehicle.....	261
Connecting the Jumper Cables.....	262
Jump Starting.....	263
Preparing Your Vehicle.....	261
Removing the Jumper Cables.....	263

K

Keyless Entry.....	71
SECURICODE™ KEYLESS ENTRY KEYPAD.....	71
Keyless Starting.....	159
Ignition Modes.....	159
Keys and Remote Controls.....	54

L

Lane Keeping System.....	226
Switching the System On and Off.....	227
Lighting Control.....	85
Headlamp Flasher.....	85
Headlamp High Beam.....	85
Lighting.....	85
Lincoln Automotive Financial Services.....	12
Lincoln Protect.....	493
EXTENDED SERVICE PLANS (CANADA ONLY).....	494
Lincoln Protect (U.S. Only).....	493
Load Carrying.....	244
Load Limit.....	244
Special Loading Instructions for Owners of Pick-up Trucks and Utility-type Vehicles.....	248

Vehicle Loading - with and without a Trailer.....	244
Locking and Unlocking.....	65
Activating Intelligent Access.....	66
Autolock.....	68
Battery Saver.....	69
Illuminated Entry.....	68
Illuminated Exit.....	68
Locking and Unlocking the Doors with the Key Blade.....	67
Luggage Compartment.....	69
Power Decklid.....	69
Power Door Locks.....	65
Remote Control.....	65
Smart Unlocks for Intelligent Access Keys.....	67
Locks.....	65
Lug Nuts See: Changing a Road Wheel.....	357

M

Maintenance.....	295
General Information.....	295
Media Hub.....	389
Memory Function.....	145
Easy Entry and Exit Feature.....	146

Index

Linking a PreSet Position to your Remote Control or Intelligent Access Key Fob.....	146
Saving a PreSet Position.....	145
Message Center See: Information Displays.....	108
Mirrors See: Heated Windows and Mirrors.....	137
See: Windows and Mirrors.....	93
Mobile Communications Equipment.....	14
Moonroof.....	98
Bounce-Back.....	99
Opening and Closing the Moonroof.....	99
Motorcraft Parts - 2.0L.....	369
Motorcraft Parts - 3.0L.....	371
MyKey Troubleshooting.....	63
MyKey™.....	60
Principle of Operation.....	60
N	
Navigation.....	444
cityseeker.....	453
Destination Mode.....	445
Map Mode.....	444
Navigation Map Updates.....	453
Navigation Menu.....	450
SiriusXM Traffic and Travel Link.....	453
Waypoints.....	452
Normal Scheduled Maintenance.....	499
Intelligent Oil-Life Monitor™.....	499
Maintenance Intervals.....	501
O	
Oil Change Indicator Reset.....	302
Oil Check See: Engine Oil Check.....	301
Opening and Closing the Hood.....	295
Ordering Additional Owner's Literature.....	272
Obtaining a French Owner's Manual.....	272
Overhead Console.....	158
P	
Parking Aids.....	199
Principle of Operation.....	199
Passive Anti-Theft System.....	75
SecuriLock.....	75
PATS See: Passive Anti-Theft System.....	75
Perchlorate.....	12
Personal Safety System™.....	43
How Does the Personal Safety System Work?.....	43
Phone.....	436
During a Phone Call.....	441
Making Calls.....	440
Pairing Your Cell Phone for the First Time.....	436
Phone Menu.....	437
Receiving Calls.....	441
Smartphone Connectivity.....	443
Text Messaging.....	442
Post-Crash Alert System.....	264
Spinout Detection.....	264
Power Door Locks See: Locking and Unlocking.....	65
Power Seats.....	141
Four-Way Power Lumbar.....	143
Multi-Contour Front Seats With Active Motion	143
Power Lumbar.....	143
Power Windows.....	93
Accessory Delay.....	94
Bounce-Back.....	93
One-Touch Down.....	93
One-Touch Up.....	93
Window Lock.....	94
Pre-Collision Assist.....	238
Using the Pre-Collision Assist System.....	239
Protecting the Environment.....	16

Index

Side Airbags.....	49	Starting and Stopping the Engine.....	159	Information Contained on the Tire	
Side Sensing System.....	202	General Information.....	159	Sidewall.....	340
Obstacle Distance Indicator.....	202	Steering.....	237	Temperature A B C.....	339
Sitting in the Correct Position.....	139	Electric Power Steering.....	237	Traction AA A B C.....	338
Snow Chains		Steering Wheel.....	78	Treadwear.....	338
See: Using Snow Chains.....	352	Storage Compartments.....	158	Tire Inflation When Punctured	
Special Notices.....	13	Sunroof		See: Tire Sealant and Inflator Kit.....	330
New Vehicle Limited Warranty.....	13	See: Moonroof.....	98	Tire Pressure Monitoring System.....	353
On Board Diagnostics Data Link		Sun Shades.....	98	Changing Tires With a Tire Pressure	
Connector.....	14	Sun Visors.....	98	Monitoring System.....	354
Special Instructions.....	13	Supplementary Restraints System.....	44	Understanding Your Tire Pressure Monitoring	
Special Operating Conditions Scheduled		Principle of Operation.....	44	System.....	355
Maintenance.....	503	Symbols Glossary.....	7	Tire Repair Kit	
Exceptions.....	506	SYNC™ 3.....	390	See: Tire Sealant and Inflator Kit.....	330
Speed Control		General Information.....	390	Tire Sealant and Inflator Kit.....	330
See: Cruise Control.....	215	SYNC™ 3 Troubleshooting.....	474	First Stage: Reinflating the Tire with Sealing	
Stability Control.....	196	T		Compound and Air.....	332
Principle of Operation.....	196	Technical Specifications		General Information.....	330
Starting a Gasoline Engine.....	160	See: Capacities and Specifications.....	367	Second Stage: Checking Tire Pressure.....	335
Automatic Engine Shutdown.....	161	The Better Business Bureau (BBB) Auto		Tips for Use of the Kit.....	331
Failure to Start.....	161	Line Program (U.S. Only).....	269	What to do after the Tire has been	
Fast Restart.....	160	Tire Care.....	337	Sealed.....	335
Guarding Against Exhaust Fumes.....	162	Glossary of Tire Terminology.....	339	What to do when a Tire Is Punctured.....	332
Important Ventilating Information.....	162	Information About Uniform Tire Quality		Tires	
Stopping the Engine When Your Vehicle is		Grading.....	338	See: Wheels and Tires.....	330
Moving.....	162			Towing a Trailer.....	249
Stopping the Engine When Your Vehicle is				Load Placement.....	249
Stationary.....	162				

Index

Cooling system.....	328	Engine Oil.....	105	Windshield Wipers.....	82
Engine.....	328	Fasten Seatbelt.....	105	Intermittent Wipe.....	82
Fuel system.....	328	Front Airbag.....	105	Wiper Blades	
General.....	327	Heads Up Display.....	105	See: Checking the Wiper Blades.....	314
Miscellaneous.....	328	High Beam.....	105	Wipers and Washers.....	82
Removing Vehicle From Storage.....	328	Hood Ajar.....	105		
Tires.....	328	Low Fuel Level.....	105		
Ventilation		Low Tire Pressure Warning.....	105		
See: Climate Control.....	134	Low Washer Fluid.....	105		
VIN		Parking Lamps.....	105		
See: Vehicle Identification Number.....	372	Powertrain Fault.....	106		
Voice Control.....	80	Service Engine Soon.....	106		
W		Stability Control.....	106		
Warning Lamps and Indicators.....	103	Stability Control Off.....	106		
Adaptive Cruise Control.....	103	Trunk Ajar.....	106		
Anti-Lock Braking System.....	103	Washer Fluid Check.....	312		
Autohold Active.....	103	Washers			
Autohold Unavailable.....	103	See: Cleaning the Exterior.....	321		
Battery.....	104	See: Wipers and Washers.....	82		
Blind Spot Monitor.....	104	Waxing.....	322		
Brake System.....	104	Welcome Lighting.....	91		
Cruise Control.....	104	Wheel Nuts			
Direction Indicator.....	104	See: Changing a Road Wheel.....	357		
Door Ajar.....	104	Wheels and Tires.....	330		
Electric Park Brake.....	104	Technical Specifications.....	365		
Engine Coolant Temperature.....	104	Windows and Mirrors.....	93		
		Windshield Washers.....	84		