



Mercedes-Benz



# S-class Operator's Manual

S 430  
S 500  
S 55 AMG  
S 600

Our company and staff congratulate you on the purchase of your new Mercedes-Benz.

Your selection of our product is a demonstration of your trust in our company name. Further, it exemplifies your desire to own an automobile that will be as easy as possible to operate and provide years of service.

Your Mercedes-Benz represents the efforts of many skilled engineers and craftsmen. To ensure your pleasure of ownership, and for your safety and that of your passengers, we ask you to make a small investment of your time:

- Please read this manual carefully before putting it aside. Then return it to your vehicle where it will be handy for your reference.
- Please abide by the recommendations contained in this manual. They are designed to acquaint you with the operation of your Mercedes-Benz.
- Please abide by the warnings and cautions contained in this manual. They are designed to help improve the safety of the vehicle operator and occupants.

We extend our best wishes for many miles of safe, pleasurable driving.

DaimlerChrysler AG

## Introduction

Product information .....	7
Operator's manual .....	8
Where to find it .....	13
Reporting Safety Defects .....	15

## Instruments and controls

Instruments and controls .....	18
Door control panel .....	20
Overhead control panel .....	21
Dashboard .....	22
Center console .....	24

## Operation

Vehicle keys .....	28
Start lock-out .....	32
General notes on the central locking system .....	33
Central locking system .....	34
Radio frequency and infrared remote control .....	34
KEYLESS-GO .....	38

Opening and closing windows and sliding / pop-up roof from outside .....	45
Panic button .....	47
Mechanical keys .....	47
Doors .....	48
Power closing assist for doors and trunk lid .....	50
Central locking switch .....	50
Automatic central locking .....	52
Emergency unlocking in case of accident .....	52
Trunk .....	53
Trunk lid release switch .....	57
Trunk lid release/close switch .....	58
Trunk lid emergency release .....	61
Antitheft alarm system .....	62
Tow-away alarm .....	64
Easy-entry/exit feature .....	66
Front seat adjustment .....	67
Removal and installation of front seat head restraints .....	72
Lumbar support .....	73

Multicontour backrest .....	73
Seat heater .....	75
Seat ventilation system .....	78
Rear seat head restraints .....	80
Power head restraints, rear .....	81
Power seats, rear .....	82
Seat belts and integrated restraint system .....	84
Seat belts .....	84
Seat belt nonusage warning system .....	85
BabySmart™ airbag deactivation system .....	91
Self-test BabySmart™ without special child seat installed .....	91
Supplemental Restraint System (SRS) .....	92
Emergency tensioning retractor (ETR) .....	93
Airbags .....	94
Safety guidelines for the seat belt, emergency tensioning retractor and airbag .....	100

Infant and child restraint systems .....	102	Malfunction / warning message memory .....	136	Switching the automatic climate control on and off .....	175
Steering wheel adjustment .....	105	Individual settings .....	138	Front center console storage compartment ventilation .....	175
Rear view mirrors .....	106	Setting the audio volume .....	146	Front center console storage compartment ventilation .....	175
Memory function .....	111	Flexible service system (FSS) .....	147	Rear passenger compartment climate control .....	177
Instrument cluster .....	114	Tire inflation pressure monitor .....	150	Power windows .....	181
Multifunction steering wheel, multifunction display .....	120	Engine oil level indicator .....	154	Sliding/pop-up roof .....	184
Trip and main odometer, FSS, tire inflation pressure monitor and engine oil level indicator .....	124	Engine oil consumption .....	155	Interior lighting .....	187
Audio systems .....	125	Exterior lamp switch .....	156	Rear window sunshade .....	190
Radio .....	125	Night security illumination .....	158	Rear door window sunshade .....	191
CD player .....	126	Headlamp cleaning system .....	159	Sun visors .....	191
Cassette player .....	127	Combination switch .....	160	Vanity mirrors .....	192
Telephone .....	128	Hazard warning flasher switch .....	163	Interior .....	193
Telephone book .....	128	Automatic climate control .....	164	Storage compartments and armrests .....	193
Redialing .....	130	Display and controls .....	166	Glove box .....	194
Incoming call .....	132	Basic setting .....	168	Cup holder .....	199
Navigation system .....	133	Special Settings .....	169	Ashtrays .....	201
Distronic (DTR) .....	134	Activated charcoal filter .....	172	Lighter .....	203
Trip computer .....	135	Economy mode .....	173	Parcel net in front passenger footwell .....	204
		Residual engine heat utilization .....	174		

Parcel net in trunk .....	204	Automatic transmission .....	233	Brake assist system	
Telephone, general .....	205	Parking brake .....	242	(BAS) .....	271
Garage door opener .....	206	Driving instructions .....	243	Antilock brake system	
Infrared reflecting		Drive sensibly – Save Fuel .....	243	(ABS) .....	272
windshield .....	210	Drinking and driving .....	243	Electronic stability program	
		Pedals .....	243	(ESP) .....	274
		Power assistance .....	244	Active body control (ABC) .....	278
		Brakes .....	244	Level control system	
		Driving off .....	245	for vehicles	
		Parking .....	246	with Airmatic system .....	279
		Tires .....	247	Level control system	
		Snow chains .....	249	for vehicles	
		Winter driving instructions .....	250	with Active Body Control	
		Block heater .....	251	(ABC) .....	280
		Deep water .....	252	Adaptive damping system	
		Passenger compartment .....	252	(ADS) .....	283
		Traveling abroad .....	252	Parking assist (Parktronic) .....	285
		Cruise control .....	253	What you should know	
		Distronic (DTR) .....	256	at the gas station .....	290
				Check regularly and	
				before a long trip .....	293

## Driving

<b>Instrument cluster display</b>	Malfunction and indicator lamp in the center console ..... 302	LIGHTING SYSTEM ..... 312
Malfunction and indicator lamps in the instrument cluster .....296	AIRBAG OFF indicator lamp .... 302	LIGHT SENSOR ..... 314
On-board diagnostic system .....296	Malfunction and warning messages in the multifunction display ..... 303	ACTIVE BODY CONTROL (ABC) ..... 314
Check engine malfunction indicator lamp .....296	DISPLAY DEFECTIVE ..... 304	TIRE PRESSURE ..... 316
Brake warning lamp .....298	BATTERY/ALTERNATOR ..... 305	ENGINE OIL LEVEL ..... 318
Supplemental restraint system (SRS) indicator lamp .....299	ENTRANCE POSITION ..... 306	CRUISE CONTROL ..... 319
Fuel reserve warning .....299	BRAKE ASSIST ..... 306	KEY ..... 319
ABS malfunction indicator lamp .....300	BRAKE LINING WEAR ..... 307	DOOR .....320
Electronic stability program (ESP) – warning lamp .....301	BRAKE FLUID ..... 307	HOOD .....320
Distronic (DTR) – warning lamp .....301	PARKING BRAKE ..... 308	TELE AID .....321
Seat belt nonusage warning lamp .....302	TRUNK OPEN ..... 308	OIL TEMP. (engine oil temperature) .....321
	ELEC. STABIL. PROG. (Electronic stability program) ..... 309	CHIP-CARD (KEYLESS-GO) .....322
	COOLANT (coolant level) .....310	SELECTOR LEVER .....323
	COOLANT (coolant temperature) ..... 311	TELEPHONE – FUNCTION .....323
		WASHER FLUID .....324
		AIR SPRING (AirMatic) .....325
		DISTRONIC (DTR) .....326

## Practical hints

First aid kit .....	328
Stowing things in the vehicle .....	328
Fuses .....	329
Hood .....	331
Checking engine oil level .....	334
Automatic transmission fluid level .....	335
Active body control (ABC) fluid level .....	335
Coolant level .....	336
Adding coolant .....	336
Windshield and headlamp washer system .....	337
Windshield and headlamp washer fluid mixing ratio .....	337
Spare wheel, vehicle tools, storage compartment .....	338
Vehicle jack .....	339
Wheels .....	340
Tire Replacement .....	340
Rotating wheels .....	341
Spare wheel .....	341

Changing wheels .....	343
Tire inflation pressure .....	348
Battery .....	349
Jump starting .....	351
Towing the vehicle .....	353
Exterior lamps .....	356
Headlamp assembly .....	357
Taillamp assemblies .....	360
Trunk lamp .....	362
Changing batteries in the electronic main key .....	363
Synchronizing remote control .....	365
Changing batteries in the KEYLESS-GO-card .....	366
Emergency engine shut-down .....	368
Fuel filler flap, manual release .....	368
Emergency operation of sliding/pop-up roof .....	369
Replacing wiper blades .....	370
Roof rack .....	371

## Vehicle care

Cleaning and care of the vehicle .....	374
Power washer .....	375
Tar stains .....	376
Paintwork, painted body components .....	376
Engine cleaning .....	376
Vehicle washing .....	376
Ornamental moldings .....	377
Headlamps, taillamps, turn signal lenses .....	377
Cleaning the DISTRONIC system sensor .....	378
Cleaning the parktronic system sensors .....	378
Wiper blades .....	379
Light alloy wheels .....	380
Instrument cluster .....	380
Steering wheel and gear selector lever .....	380
Cup holder .....	380
Seat belts .....	381



Headliner and shelf below rear window .....381  
 Leather upholstery .....381  
 Hard plastic trim items .....381  
 Plastic and rubber parts .....381

**Technical data**

Spare parts service .....384  
 Warranty coverage .....384  
 Identification labels .....385  
 Layout of poly-V-belt drive .....387  
 Technical data .....388  
 Fuels, coolants, lubricants etc. - capacities .....394  
 Engine oils .....396  
 Engine oil additives .....396

Air conditioner refrigerant .....396  
 Brake fluid .....396  
 Premium unleaded gasoline .....397  
 Fuel requirements .....397  
 Gasoline additives .....398  
 Coolants .....398  
 Consumer information .....400

**Index**

Index .....402

### **Product information**

Kindly observe the following in your own best interest:

We recommend using Mercedes-Benz original parts as well as conversion parts and accessories explicitly approved by us for your vehicle model.

We have tested these parts to determine their reliability, safety and their special suitability for Mercedes-Benz vehicles.

We are unable to make an assessment for other products and therefore cannot be held responsible for them, even if in individual cases an official approval or authorization by governmental or other agencies should exist. Use of such parts and accessories could adversely affect the safety, performance or reliability of your vehicle. Please do not use them.

Mercedes-Benz original parts as well as conversion parts and accessories approved by us are available at your authorized Mercedes-Benz Center where you will receive comprehensive information, also on permissible technical modifications, and where proper installation will be performed.

### **Operator's manual**

This Operator's Manual contains a great deal of useful information. We urge you to read it carefully and familiarize yourself with the vehicle before driving.

For your own safety and longer service life of the vehicle, we urge you to follow the instructions and warnings contained in this manual. Ignoring them could result in damage to the vehicle or personal injury to you or others. Vehicle damage caused by failure to follow instructions is not covered by the Mercedes-Benz Limited Warranty.

Your vehicle may have some or all of the equipment described in this manual. Therefore, you may find explanations for optional equipment not installed in your vehicle. If you have any questions about the operation of any equipment, your authorized Mercedes-Benz Center will be glad to demonstrate the proper procedures.

### **Service and warranty information**

The Service and Warranty Information Booklet contains detailed information about the warranties covering your Mercedes-Benz, including:

- New Car Limited Warranty,
- Emission System Warranty,
- Emission Performance Warranty,
- California, Massachusetts, and Vermont Emission Control System Warranty (California, Massachusetts, and Vermont only),
- State Warranty Enforcement Laws (Lemon Laws).

### **Important notice for California retail buyers of Mercedes-Benz automobiles**

Under California law you may be entitled to a replacement of your vehicle or a refund of the purchase price, if Mercedes-Benz USA, LLC or its authorized Mercedes-Benz Center fails to conform the vehicle to its express warranties after a reasonable number of repair attempts during the period of one year or 12 000 miles from original delivery of the vehicle. A reasonable number of repair attempts is presumed for a retail buyer (1) if the vehicle is out of service by reason of repair of substantial nonconformities for a cumulative total of more than 30 calendar days or (2) the same substantial non-conformity has been subject to repair four or more times **and you have at least once directly notified us in writing of the need to repair the non-conformity and have given us an opportunity to perform the repair ourselves. Notifications should be sent to the nearest Mercedes-Benz Regional Office listed in the Service and Warranty Information Booklet.**

### **Maintenance**

The Service Booklet describes all the necessary maintenance work which should be performed at regular intervals.

Always have the Service Booklet with you when you take the vehicle to your authorized Mercedes-Benz Center for service. The service advisor will record each service in the booklet for you.

**Roadside assistance**

The Mercedes-Benz Roadside Assistance Program provides factory trained technical help in the event of a breakdown. Calls to the toll-free Roadside Assistance number:

**1-800-FOR-MERCEdes (in the USA)**  
**1-800-387-0100 (in Canada)**

will be answered by Mercedes-Benz Client Assistance Representatives 24 hours a day, 365 days a year.

For additional information refer to the Mercedes-Benz Roadside Assistance Program brochure in your glove box.

**Change of address or ownership**

If you change your address, be sure to send in the “Change of Address Notice” found in the Service and Warranty Information Booklet, or simply call the Mercedes-Benz Client Assistance Center (in the USA) at 1-800-FOR-MERCEdes, or Customer Service (in Canada) at 1-800-387-0100. It is in your own interest that we can contact you should the need arise.

If you sell your Mercedes, please leave all literature with the vehicle to make it available to the next operator.

If you bought this vehicle used, be sure to send in the “Notice of Purchase of Used Car” found in the Service and Warranty Information Booklet, or call the Mercedes-Benz Client Assistance Center (in the USA) at 1-800-FOR-MERCEdes, or Customer Service (in Canada) at 1-800-387-0100.

### **Operating your vehicle outside the USA or Canada**

If you plan to operate your vehicle in foreign countries, please be aware that:

- Service facilities or replacement parts may not be readily available,
- unleaded gasoline for vehicles with catalytic converters may not be available; the use of leaded fuels will damage the catalysts,
- gasoline may have a considerably lower octane rating, and improper fuel can cause engine damage.

Certain Mercedes-Benz models are available for delivery in Europe under our European Delivery Program. For details, consult your authorized Mercedes-Benz Center or write to:

In the USA:

Mercedes-Benz USA, LLC  
European Delivery Department  
One Mercedes Drive  
Montvale, NJ 07645-0350

In Canada:

Mercedes-Benz Canada, Inc.  
European Delivery Department  
849 Eglinton Avenue East  
Toronto, Ontario M4G 2L5

We continuously strive to improve our product, and ask for your understanding that we reserve the right to make changes in design and equipment. Therefore, information, illustrations and descriptions in this Operator's Manual might differ from your vehicle.

Optional equipment is also described in this manual, including operating instructions wherever necessary. Since they are special-order items, the descriptions and illustrations herein may vary slightly from the actual equipment of your vehicle.

If there are any equipment details that are not shown or described in this Operator's Manual, your authorized Mercedes-Benz Center will be glad to inform you of correct care and operating procedures.

The Operator's Manual and Service Booklet are important documents and should be kept with the vehicle.

### Where to find it

The Operator's Manual is divided into eight sections:

- **Instruments and controls:** An overview of all the controls that can be operated from the driver's seat.
- **Operation:** Information on the vehicle's equipment and its operation.
- **Driving:** Important information on driving.
- **Instrument cluster display:** Displays and indicator lamps on the instrument cluster with brief instructions.
- **Practical hints:** Assistance and instructions in the event of an emergency.
- **Car care:** Instructions on caring for your vehicle.
- **Technical data:** All the important technical data for your vehicle as well as consumer information such as fuels, coolants, lubricants etc. is contained here.
- **Index:** Key terms to help you find a topic quickly.

Other documents may also be supplied, depending on your vehicle's equipment.

Explanation of color used:

Warning notices for the protection of yourself and others appear on red background.



**Problems with your vehicle**

If you should experience a problem with your vehicle, particularly one that you believe may affect its safe operation, we urge you to immediately contact your authorized Mercedes-Benz Center to have the problem diagnosed and corrected if required. If the matter is not handled to your satisfaction, please discuss the problem with the Mercedes-Benz Center management, or if necessary contact us at the following addresses:

In the USA: Client Assistance Center  
Mercedes-Benz USA, LLC  
One Mercedes Drive  
Montvale, NJ 07645-0350

In Canada: Customer Relations Department  
Mercedes-Benz Canada, Inc.  
849 Eglinton Avenue East  
Toronto, Ontario, M4G 2L5

For the USA only:

The following text is published as required of manufacturers under Title 49, Code of U.S. Federal Regulations, Part 575 pursuant to the “National Traffic and Motor Vehicle Safety Act of 1966”.

### **Reporting Safety Defects**

If you believe that your vehicle has a defect which could cause a crash or could cause injury or death, you should immediately inform the National Highway Traffic Safety Administration (NHTSA) in addition to notifying Mercedes-Benz USA, LLC.

If NHTSA receives similar complaints, it may open an investigation, and if it finds that a safety defect exists in a group of vehicles, it may order a recall and remedy campaign. However, NHTSA cannot become involved in individual problems between you, your retailer, or Mercedes-Benz USA, LLC.

To contact NHTSA, you may either call the Auto Safety Hotline toll-free at 1-800-424-9393 (or 366-0123 in Washington, D.C. area) or write to: NHTSA, U.S. Department of Transportation, Washington, D.C. 20590. You can also obtain other information about motor vehicle safety from the Hotline.



## **Instruments and controls**

Instruments and controls .....	18
Door control panel .....	20
Overhead control panel .....	21
Dashboard .....	22
Center console .....	24

**Instruments and controls**



**1** Door control panel, see page 20

**2** Overhead control panel, see page 21

**3** Dashboard, see page 22

**4** Center console, see page 24

## Instruments and controls

20

## Door control panel



- 1 Door handle, pull to open, see page 48
- 2 Memory function (for storing seat, steering wheel, rear view mirror and exterior mirror settings), see page 111
- 3 Seat heater, see page 75  
Seat ventilation, see page 78
- 4 Front seat adjustment, see page 67
- 5 Exterior mirror adjustment, see page 106
- 6 Power windows, see page 181
- 7 Trunk lid release switch, see page 57  
Trunk lid opening/closing system switch, see page 58

### Overhead control panel

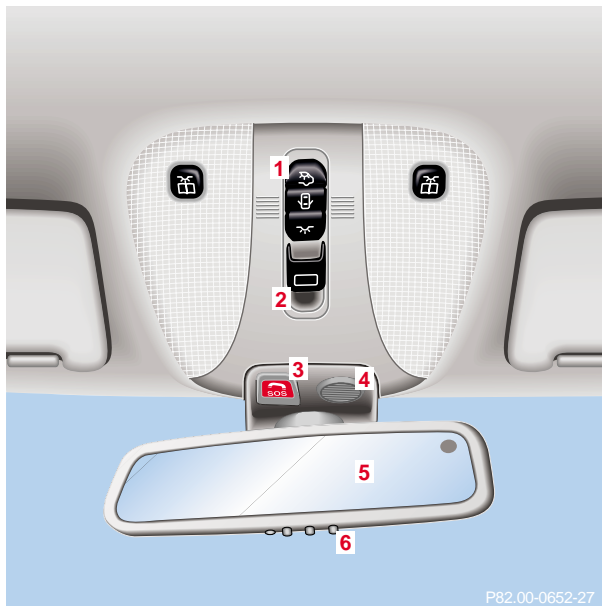

- 1 Interior lighting, see page 187
- 2 Sliding/pop-up roof, see page 184
- 3 Tele Aid (emergency call system), see page 214
- 4 Hands-free microphone for Tele Aid, telephone and voice recognition system
- 5 Rear view mirror, see page 106
- 6 Garage door opener, see page 206



**Dashboard**

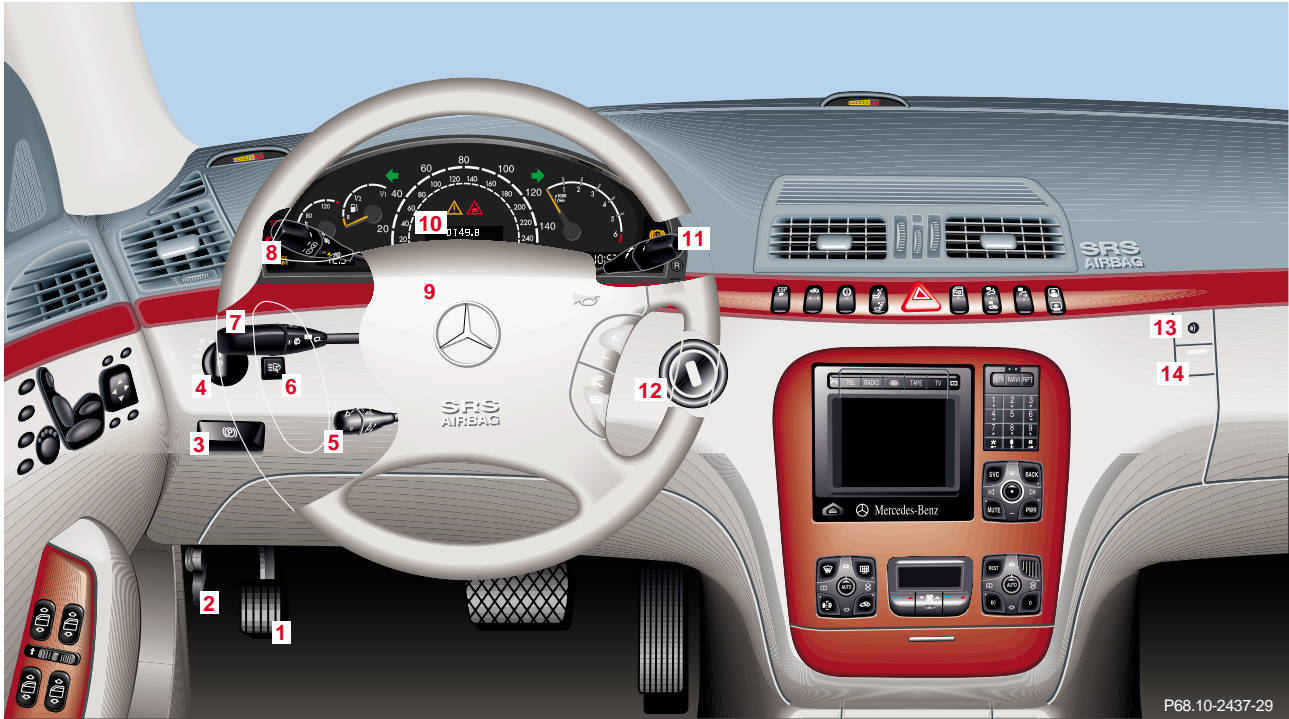

- 1** Parking brake pedal, see page 242
- 2** Hood lock release, see page 331
- 3** Parking brake release, see page 242
- 4** Exterior lamp switch, see page 156
- 5** Easy-entry/exit feature, see page 66  
Steering wheel adjustment, see page 105
- 6** Headlamp washer button, see page 159
- 7** Combination switch, see page 160
- 8** Cruise control switch, see page 253, or  
Distronic (DTR) switch, see page 256
- 9** Multifunction steering wheel, see page 120  
Horn (with electronic key in starter switch  
position 1 or 2)  
Airbag, see page 94
- 10** Instrument cluster, see page 114
- 11** Voice recognition system switch, see separate  
operating instructions
- 12** Starter switch, see page 226
- 13** Glove box lock, see page 194
- 14** Glove box lid release, see page 194

## Instruments and controls

24

## Center console



- 1 ESP (Electronic Stability Program) control switch, see page 274
- 2 ADS (Adaptive Damping System), see page 283  
Level control for vehicles with ABC (Active Body Control), see page 278
- 3 Level control for vehicles with Airmatic, see page 279  
ABC (Active Body Control), see page 278
- 4 Rear seat head restraints, see page 80  
Rear seat head restraints, automatic, see page 81
- 5 Hazard warning flasher switch, see page 163
- 6 Central locking switch, see page 50
- 7 Antitheft Alarm System, see page 62  
Switch for Tow-Away Protection, see page 64
- 8 Parking assist (Parktronic system) deactivation (optional), see page 285
- 9 Rear window sunshade, see page 190
- 10 COMAND system, see separate operating instructions
- 11 Automatic climate control, see page 164  
Rear window defroster, see page 180

- 12** Ashtray, see page 201  
Lighter, see page 203
- 13** Start-/Stop button  
Starter switch for KEYLESS-GO only, see page 228
- 14** Lower storage space, see page 195
- 15** Automatic transmission, see page 233
- 16** AIRBAG OFF indicator lamp, see page 302
- 17** Distronic (DTR) – switch for distance notification function, see page 268.
- 18** Distronic (DTR) – thumbwheel for setting distance, see page 268.

<b>Instruments and controls</b>	<b>Operation</b>	<b>Driving</b>	<b>Instrument cluster display</b>	<b>Practical hints</b>	<b>Car care</b>	<b>Technical data</b>	<b>Index</b>
---------------------------------	------------------	----------------	-----------------------------------	------------------------	-----------------	-----------------------	--------------

Contents - Operation

**Operation**

Vehicle keys .....	28	Trunk lid release/close switch .....	58	Self-test BabySmart™ without special child seat installed .....	91
Start lock-out .....	32	Trunk lid emergency release .....	61	Supplemental Restraint System (SRS) .....	92
General notes on the central locking system .....	33	Antitheft alarm system .....	62	Emergency tensioning retractor (ETR) .....	93
Central locking system .....	34	Tow-away alarm .....	64	Airbags .....	94
Radio frequency and infrared remote control .....	34	Easy-entry/exit feature .....	66	Safety guidelines for the seat belt, emergency tensioning retractor and airbag .....	100
KEYLESS-GO .....	38	Front seat adjustment .....	67	Infant and child restraint systems .....	102
Opening and closing windows and sliding / pop-up roof from outside .....	45	Removal and installation of front seat head restraints .....	72	Steering wheel adjustment .....	105
Panic button .....	47	Lumbar support .....	73	Rear view mirrors .....	106
Mechanical keys .....	47	Multicontour backrest .....	73	Memory function .....	111
Doors .....	48	Seat heater .....	75	Instrument cluster .....	114
Power closing assist for doors and trunk lid .....	50	Seat ventilation system .....	78	Multifunction steering wheel, multifunction display .....	120
Central locking switch .....	50	Rear seat head restraints .....	80	Trip and main odometer, FSS, tire inflation pressure monitor and engine oil level indicator .....	124
Automatic central locking .....	52	Power head restraints, rear .....	81	Audio systems .....	125
Emergency unlocking in case of accident .....	52	Power seats, rear .....	82		
Trunk .....	53	Seat belts and integrated restraint system .....	84		
Trunk lid release switch .....	57	Seat belts .....	84		
		Seat belt nonusage warning system .....	85		
		BabySmart™ airbag deactivation system .....	91		

Radio .....	125	Night security illumination .....	158	Power windows .....	181
CD player .....	126	Headlamp cleaning system .....	159	Sliding/pop-up roof .....	184
Cassette player .....	127	Combination switch .....	160	Interior lighting .....	187
Telephone .....	128	Hazard warning flasher switch .....	163	Rear window sunshade .....	190
Telephone book .....	128	Automatic climate control .....	164	Rear door window sunshade .....	191
Redialing .....	130	Display and controls .....	166	Sun visors .....	191
Incoming call .....	132	Basic setting .....	168	Vanity mirrors .....	192
Navigation system .....	133	Special Settings .....	169	Interior .....	193
Distronic (DTR) .....	134	Activated charcoal filter .....	172	Storage compartments and armrests .....	193
Trip computer .....	135	Economy mode .....	173	Glove box .....	194
Malfunction / warning message memory .....	136	Residual engine heat utilization .....	174	Cup holder .....	199
Individual settings .....	138	Switching the automatic climate control on and off .....	175	Ashtrays .....	201
Setting the audio volume .....	146	Front center console storage compartment ventilation .....	175	Lighter .....	203
Flexible service system (FSS) .....	147	Front center console storage compartment ventilation .....	175	Parcel net in front passenger footwell .....	204
Tire inflation pressure monitor .....	150	Rear passenger compartment climate control .....	177	Parcel net in trunk .....	204
Engine oil level indicator .....	154			Telephone, general .....	205
Engine oil consumption .....	155			Garage door opener .....	206
Exterior lamp switch .....	156			Infrared reflecting windshield .....	210

Instruments and controls	<b>Operation</b>	Driving	Instrument cluster display	Practical hints	Car care	Technical data	Index
-----------------------------	------------------	---------	-------------------------------	-----------------	----------	-------------------	-------

## Central locking system

28

**Vehicle keys and KEYLESS-GO-cards (optional)**

Included with your vehicle are:

- 2 electronic main keys with integrated radio frequency and infrared remote controls plus removable mechanical key.  

The locking tabs for the mechanical key portion of the two electronic main keys are a different color to help distinguish each individual key.
- 1 electronic reserve key without remote control functions, plus removable mechanical key.
- Vehicles with KEYLESS-GO:  
2 KEYLESS-GO-cards without removable mechanical key.

**Warning!**

**When leaving the vehicle always remove the electronic key from the starter switch and take the KEYLESS-GO-card (if so equipped) with you, and lock your vehicle. Do not leave children unattended in the vehicle, or with access to an unlocked vehicle. Unsupervised use of vehicle equipment may cause serious personal injury.**

Vehicles with KEYLESS-GO:

See page 44 on how to use the electronic key together with the KEYLESS-GO-card.

**Important!**

In the case of the loss of a KEYLESS-GO-card, electronic keys or mechanical keys, please, contact an authorized Mercedes-Benz Center or call 1-800-FOR-MERCEdes (in the USA), or 1-800-387-0100 (in Canada) as soon as possible to have the keys or KEYLESS-GO-card deactivated.

### Electronic main key



The electronic main key has an integrated radio frequency and infrared remote control, plus removable mechanical key.

The remote control (1) operates all locks on the vehicle.

The mechanical key (2) works only in the driver's door, trunk, and storage compartment locks.

When using the mechanical key (2) for lock operations, it can be removed by sliding it out of the remote control. To do so, move locking tab (3) to the right and slide the mechanical key (2) in direction of arrow (4).

The remote control transmitter is located in the electronic main key.

The infrared receivers are located in the front door handles.

Note:

Remove the mechanical key from the electronic main key when using valet parking service. To prevent access to trunk or storage compartments lock them separately and retain the mechanical key.

See page 53 for separate locking of trunk and page 194 for locking of glove box.



## Central locking system

30

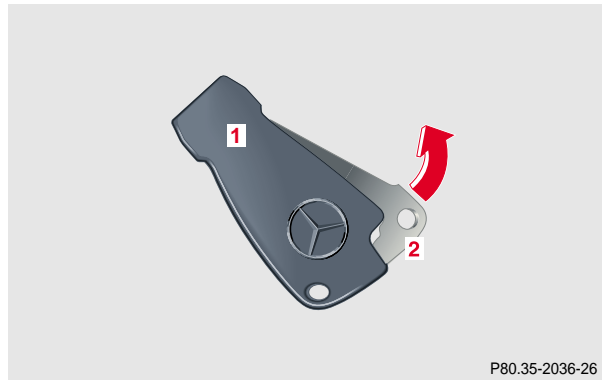
**Electronic reserve key**

The electronic reserve key is without remote control functions, plus removable mechanical key.

The electronic reserve key (1) works only in the starter switch. There are no batteries inside the electronic reserve key.

The mechanical key (2) works only in the driver's door, trunk, and storage compartment locks.

To use the mechanical key (2), remove it from its electronic reserve key (1).

**Note:**

We recommend that you carry the electronic reserve key plus mechanical key with you and keep it in a safe place (e.g. your wallet) so that it is always handy. Never leave the electronic reserve key in the vehicle.

## KEYLESS-GO-card



The KEYLESS-GO-card (1) does not have a removable mechanical key.

The functions of the KEYLESS-GO-card (1) are identical to those of the electronic main key. Carrying the card with you permits the use of the vehicle.

The validity of the KEYLESS-GO-card is checked every time when grasping a door handle or pushing the trunk lid release. Once the KEYLESS-GO-card is recognized outside the vehicle, the doors, trunk lid and fuel filler flap are unlocked, depending on the selected mode (global or selective unlocking mode, see page 43).

Starter switch KEYLESS-GO, see page 228.

Starting and turning off the engine with KEYLESS-GO, see page 231 and page 232.

Note:

In the case of a malfunction in the KEYLESS-GO-system, we recommend that you carry the electronic key plus mechanical key with you and keep them in a safe place so that they are always handy. Never leave the electronic key or a KEYLESS-GO-card in the vehicle.

### Obtaining replacement keys

Your vehicle is equipped with a theft deterrent locking system requiring a special key manufacturing process. For security reasons, replacement keys can only be obtained from your authorized Mercedes-Benz Center.

## Central locking system

32

**Start lock-out****Important!**

Operating with electronic key:

Removing the electronic key from the starter switch activates the start lock-out. The engine cannot be started.

Inserting the electronic key in the starter switch deactivates the start lock-out.

Operating with KEYLESS-GO:

Turning off the engine with the start-/stop button on the gear selector lever activates the start lock-out. For turning off the engine with KEYLESS-GO, see page 232.

Starting the engine with the start-/stop button deactivates the start lock-out, if a valid KEYLESS-GO-card is recognized inside the vehicle. For starting the engine with KEYLESS-GO, see page 231. The engine cannot be started with a KEYLESS-GO-card outside the vehicle.

Note:

In case the engine cannot be started (vehicle's battery is in order), the system is not operational. Contact an authorized Mercedes-Benz Center or call 1-800-FOR-MERCEdes (in the USA), or 1-800-387-0100 (in Canada).

### General notes on the central locking system

If the electronic key is inserted in the starter switch, the vehicle cannot be locked or unlocked with the remote control.

If the vehicle cannot be locked or unlocked:



- Aim transmitter eye at a receiver on either front door handle. Check the batteries of the electronic main key, see page 363, or synchronize the remote control, see page 365.
- Use the mechanical key to unlock the vehicle. To start engine, insert the electronic key in the starter switch. There could be a slight delay until the electronic key can be turned in the starter switch.
- Vehicles with KEYLESS-GO only:  
A KEYLESS-GO-card must be recognized by the system as being outside the vehicle to enable the vehicle to be locked or unlocked (maximum distance between card and doors or trunk is approx. 3 ft. (1 m). Check the location of the KEYLESS-GO-card, see page 38. Check the batteries of the KEYLESS-GO-card, see page 366. The trunk lid will open automatically if a KEYLESS-GO card is detected in the trunk, see page 38.

Note:

If neither the remote control nor KEYLESS-GO system functions, use the mechanical key to unlock or lock the vehicle. To start engine, insert the electronic key in the starter switch. There could be a slight delay until the electronic key can be turned in the starter switch.

### Important!

When unlocking the driver's door with the mechanical key, the exterior lamps will flash and the alarm will sound.

To cancel the alarm, insert the electronic key in the starter switch, or press button  or  on the electronic main key; or with the optional KEYLESS-GO-system, when carrying a KEYLESS-GO-card, by grasping a door handle or pressing the start-/stop button on the gear selector lever.

## Central locking system



34

**Central locking system****Radio frequency and infrared remote control**

The electronic main key has an integrated radio frequency and infrared remote control.

Due to the extended operational range of the remote control, it could be possible to unintentionally lock or unlock the vehicle by pressing the transmit button. If one of the transmit buttons is pressed, the battery check lamp lights up briefly – indicating that the batteries are in order. See page 363 for checking batteries.

The vehicle doors, trunk and fuel filler flap can be centrally locked and unlocked via remote control.

Opening and closing the windows and sliding/pop-up roof and switching on the driver's seat ventilation can only be done with the infrared portion of the remote control. Aim transmitter eye at a receiver (6 or 7), press and hold transmit button  or , see page 45.

With vehicle centrally locked, the trunk can also be opened by using the remote control.

If the electronic key is inserted in starter switch, the vehicle cannot be locked or unlocked, and the trunk lid cannot be opened with the remote control.

**1** Transmit button

Locking



Unlocking



Opening trunk (if not separately locked)

**2** Lamp for battery check (see page 363 for changing batteries if it does not light up briefly)**3** PANIC button**4** Transmitter eye**5** Locking tab for mechanical key

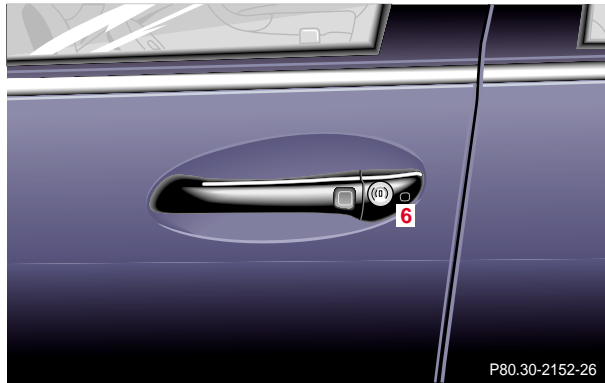

6 Infrared receiver in driver's door handle

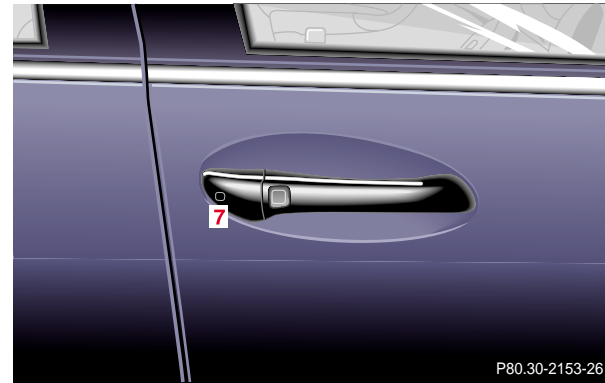

7 Infrared receiver in front passenger door handle

## Central locking system

36

**Locking and unlocking with remote control**

Unlocking:

Press transmit button . All turn signal lamps blink once to indicate that the vehicle is unlocked.

The remote control can be programmed for two kinds of unlocking modes (see below):

Selective unlocking mode –

Press transmit button  once to unlock driver's door and fuel filler flap.

Press transmit button  twice to unlock all doors, fuel filler flap, and trunk.

Global unlocking mode –

Press transmit button  once to unlock all doors, fuel filler flap, and trunk.

Notes:

If the trunk was previously locked separately, it will remain locked, see page 53.

The presently active unlocking mode (selective or global) can only be determined by unlocking the vehicle with the remote control (see below for changing mode).

If within 40 seconds of unlocking with the remote control, neither door nor trunk is opened, the electronic key is not inserted in the starter switch, or the central locking switch is not activated, the vehicle will automatically lock.



Locking:

Press transmit button  once. All turn signal lamps blink three times to indicate that the vehicle is locked. If they do not blink three times, a door or trunk is not properly closed.

Note:

If the vehicle cannot be locked or unlocked by pressing the transmit button, then it may be necessary to change the batteries in the electronic main key (if ok, battery check lamp in electronic main key will light briefly when pressing transmit button) or to synchronize the remote control, see pages 363 and 365.

### Choosing global or selective mode on remote control

Press and hold transmit buttons  and  simultaneously for five seconds to reprogram the remote control. Battery check lamp will blink two times indicating the completed mode change.

### Opening the trunk

The trunk lid will swing open automatically. You should always make sure there is sufficient clearance.

A minimum height clearance of 6 ft. (1.85 m) is required to open the trunk lid.

Press transmit button  until trunk lid is open.

### Important!

Do not place remote control in trunk since trunk is locked when the lid is closed if the vehicle is centrally locked.

Notes:

If the trunk was previously locked separately, it will remain locked, see page 53.

Vehicles with optional remote trunk lid opening/closing system, see page 58:

The switch operated opening/closing procedure can be immediately halted by pressing button  on the electronic main key.



## Central locking system

38

**KEYLESS-GO****Important!**

For the KEYLESS-GO-system to function properly, the operator should observe the following:

- The driver should carry the KEYLESS-GO-card with him/her.
  - To avoid radio transmission interference, never store the KEYLESS-GO-card together with other electronic items (e.g. cellular telephones, other KEYLESS-GO-cards) or metallic objects (e.g. coins, metal foil).
  - To lock or unlock the vehicle, the card must be recognized by the system as being located outside the vehicle. The card must be in close proximity to a door or the trunk lid (approx. 3 ft. [1 m]). To activate the start/stop button function, the KEYLESS-GO-card must be recognized by the system as being located inside the vehicle.
  - If the KEYLESS-GO-card is positioned farther away from the vehicle (e.g. inside clothing or a briefcase) and can no longer be recognized by the system, the vehicle cannot be locked or the engine started via the KEYLESS-GO-system.
- If the KEYLESS-GO-card is removed from the vehicle while the engine is running, or by placing the card in front of the center armrest (see page 195), the message “CHIP-CARD – NOT RECOGNIZED!” will appear repeatedly in the multifunction display, see page 322.  
Find the card or change its present location (e.g. place it on the front passenger seat or insert it in shirt pocket).
  - If the message “CHIP - CARD – NOT RECOGNIZED” is ignored for an extended of time (approx. 15 minutes), the engine could stop by itself during a vehicle stop (e.g. traffic light). The vehicle can then no longer be centrally locked or the engine restarted. You must first find the card or change its present location (e.g. place it on the front passenger seat or insert it in shirt pocket). Start the engine again. See page 228.
  - Do not forget, the engine can be started by anyone with a KEYLESS-GO-card that is left inside the vehicle. Leaving the chip-card behind when exiting and locking the vehicle, the message “CHIP-CARD – STILL IN VEHICLE” appears in the multifunction display, see page 322.

- Opening the driver's door with the engine shut off and no electronic key in the starter switch, the message "CHIP-CARD – DO NOT FORGET" appears as a reminder, see page 322.

**Important!**

In the case of a malfunction in the KEYLESS-GO-system, we recommend that you carry the electronic key plus mechanical key with you and keep them in a safe place so that they are always handy. Never leave the electronic key in the vehicle.

Notes:

The KEYLESS-GO-function also permits closing of windows and sliding/pop-up roof (convenience feature), see page 46.

With the KEYLESS-GO-card in close proximity (approx. 3 ft. [1 m]) of the vehicle, aiming a jet of water at a door handle (e.g. when washing the vehicle) or cleaning snow from a door could lock or unlock the vehicle inadvertently.

To prevent a possible inadvertent lockout, the trunk lid will open automatically if a KEYLESS-GO-card is recognized in the area of the rear shelf or inside the trunk.

Instruments and controls	<b>Operation</b>	Driving	Instrument cluster display	Practical hints	Car care	Technical data	Index
--------------------------	------------------	---------	----------------------------	-----------------	----------	----------------	-------

## Central locking system

40

**Locking and unlocking with KEYLESS-GO-card**

## Unlocking:

Grasp any door handle. All turn signal lamps blink once to indicate that the vehicle is unlocked.

The KEYLESS-GO-card can be programmed for two kinds of unlocking modes (see below):

## Selective unlocking mode –

Grasp driver's door handle to unlock driver's door and fuel filler flap.

Grasping the passenger door or a rear door, centrally unlocks the vehicle.

## Global unlocking mode –

Grasp any door handle to unlock both doors, fuel filler flap, and trunk.

For choosing global or selective mode on KEYLESS-GO-card, see page 43.

## Notes:

The door which was unlocked, can be opened immediately after the audible click. The other door can be opened after its lock button rises up.

If the trunk was previously locked separately, it will remain locked, see page 53.

The presently active unlocking mode (selective or global) can be determined by pressing the button on the KEYLESS-GO-card (see page 43 for changing mode).

If within 40 seconds of unlocking with the KEYLESS-GO-card, neither door nor trunk is opened, the electronic key is not inserted in the starter switch, or the central locking switch is not activated, the vehicle will automatically lock.

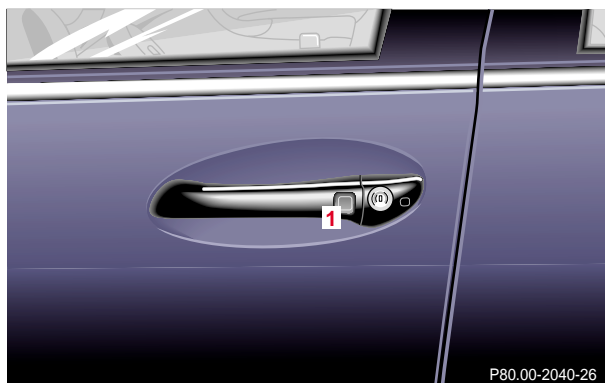

Note:

Locking the vehicle with the door lock button (1) is only possible if a KEYLESS-GO-card is outside the vehicle.

Locking:

Press lock button (1) at any door. All turn signal lamps blink three times to indicate that the vehicle is locked. If they do not blink three times, a door or trunk is not properly closed, or the KEYLESS-GO-card is still in the vehicle. Check the multifunction display, see page 322.

## Central locking system

42



## Unlocking:

Press trunk lid lock (2) to open trunk only.

## Locking:

Press the trunk lid lock button (3). All turn signal lamps blink three times to indicate that the vehicle is locked. If they do not blink three times, a door or trunk is not properly closed or a KEYLESS-GO-card is still in the vehicle. Check the multifunction display, see page 322.

## Notes:

If the trunk was previously locked separately, it will remain locked, see page 53.

The vehicle cannot be centrally unlocked via the trunk lid lock (2).

To prevent a possible inadvertent lockout, the trunk lid will open automatically if a KEYLESS-GO-card is recognized in the area of the rear shelf or inside the trunk.

### Choosing global or selective mode on KEYLESS-GO-card

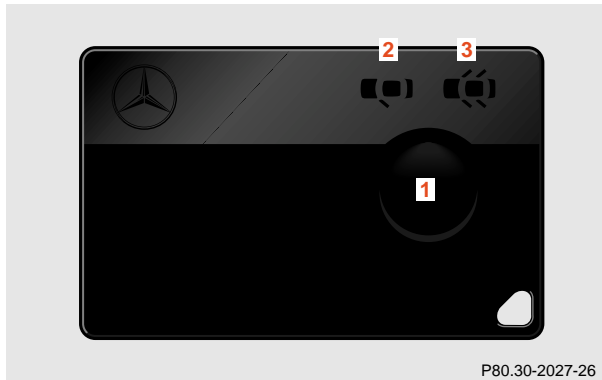

To choose between the selective or global opening mode press and hold button (1) until the indicator lamp at the requested symbol (2) or (3) comes on.

### Checking last KEYLESS-GO-card locking mode

Briefly press button (1). The indicator lamp (2) or (3) lights up in red (vehicle locked) or in green (vehicle unlocked).

## Central locking system

44

**Simultaneous use of electronic key and KEYLESS-GO-card**

When using the electronic key and the KEYLESS-GO-card at the same time, the electronic key overrules the KEYLESS-GO-card.

If the engine is started with the start-/stop button on the gear selector lever, and afterwards the electronic key is inserted in the starter switch, the engine continues to run with the gear selector lever in positions “R”, “N”, “D” plus ranges “4”, “3”, “2”, “1” until it is stopped by using the start-/stop button on the gear selector lever.

If the electronic key is inserted in the starter switch while the gear selector lever is in position “P”, the electronic key takes over. The vehicle operates according to the electronic key position in the starter switch (see page 226), eventually even stopping the engine.

**Warning!**

**When leaving the vehicle always remove the electronic key from the starter switch, take the KEYLESS-GO-card with you, and lock your vehicle. Unsupervised use of vehicle equipment may cause serious personal injury.**

**Opening and closing windows and sliding/pop-up roof from outside (summer opening/convenience feature)**

Aim transmitter eye of remote control at a door receiver.

**Summer opening:  
(Operation with electronic main key)**

The sliding/pop-up roof and all side windows can be opened and the driver's seat ventilation automatically switches on. See page 78 for seat ventilation.

Continue to press transmit button  after unlocking the vehicle.

The windows and sliding/pop-up roof begin to open after approximately 1 second. The driver's seat ventilation automatically switches on. See page 78 for seat ventilation.

To interrupt opening procedure, release transmit button.

**Convenience feature:  
(Operation with electronic main key)**

The sliding/pop-up roof and the side windows can be closed.

Continue to press transmit button  after locking the vehicle.



The windows and sliding/pop-up roof begin to close after approximately 1 second.

To interrupt closing procedure, release transmit button.

Ensure that all side windows and the sliding/pop-up roof are properly closed before leaving the vehicle.

**Warning!**

**Never operate the windows or sliding/pop-up roof if there is the possibility of anyone being harmed by the opening or closing procedure.**

**In case the procedure causes potential danger, the procedure can be immediately halted by releasing the remote control button. To reverse direction of movement press  for opening or  for closing.**



## Central locking system

46

## Note:

If the windows and sliding/pop-up roof cannot be operated automatically by pressing the transmit button of the remote control then it may be necessary to change the batteries in the electronic main key (if ok, battery check lamp in electronic main key will light briefly when pressing transmit button), or to synchronize the remote control, see page 363 and 365.

**Convenience feature  
(Operation with KEYLESS-GO)**

Continue to press lock button on door handle after locking the vehicle.

The windows and sliding/pop-up roof begin to close after approx. 1 second.

To interrupt closing procedure, release lock button. To reverse direction (within 2 seconds after closing), pull and hold door handle. Opening of windows starts and continues for as long as the door handle is held but the door not opened.

Ensure that all side windows and the sliding/pop-up roof are properly closed before leaving the vehicle.

**Warning!**

**Never operate the windows or sliding/pop-up roof if there is the possibility of anyone being harmed by the closing procedure.**

**In case the procedure causes potential danger, the procedure can be immediately halted by releasing the lock button. To reverse direction of movement pull and hold outside door handle.**

### Panic button



To activate press and hold button (1) for at least one second. An audible alarm and blinking exterior lamps will operate for approximately 2<sup>1</sup>/<sub>2</sub> minutes.

To deactivate press button (1) again, or insert electronic key in starter switch.

### Note:

For operation in the USA only: This device complies with Part 15, Subpart C, Section 209 of the FCC Rules. Operation is subject to the following two conditions:

- (1) This device may not cause harmful interference, and
- (2) this device must accept any interference received, including interference that may cause undesired operation.

**WARNING:** Changes or modification not expressly approved by party responsible for compliance could void the user's authority to operate the equipment.

### Mechanical keys

The mechanical keys work only in driver's door, trunk, and storage compartment locks.

### Notes:

The mechanical key does not operate the central locking system or antitheft alarm system.

The fuel filler flap cannot be locked or unlocked with the mechanical key.

If the fuel filler flap cannot be opened, see page 368.

## Central locking system

48

## Doors

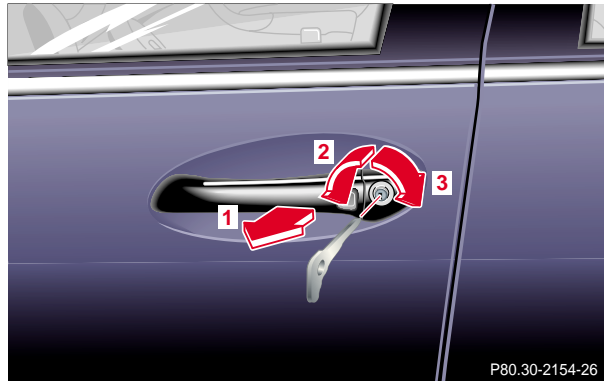

- 1 Opening – pull handle
- 2 Unlocking driver's door
- 3 Locking driver's door

**Important!**

The mechanical key does not operate the central locking system or antitheft alarm system.

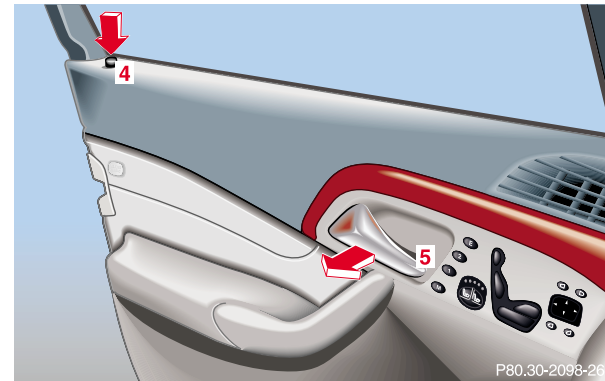

- 4 Individual door from inside:  
Push lock button down to lock.
- 5 Front door from inside:  
Pull handle to unlock.

When you lock the driver's door with the mechanical key, the door lock button should move down.

Each individual door must be locked with the respective door lock button – the driver's door can only be locked when it is closed.

If the vehicle has previously been locked from the outside, opening a door from the inside will trigger the alarm. When opening a front door while the central locking system is in the:

- selective unlocking mode, only that individual door is unlocked. The remaining doors, the trunk and fuel filler flap remain locked.
- global unlocking mode, all doors, the trunk and fuel filler flap are unlocked.

Notes:



In case of a malfunction in the central locking system the doors can be locked and unlocked individually.

To lock, push down lock buttons or turn mechanical key in driver's door lock to position 3. In addition lock the trunk.

To unlock, pull inside door handles or turn mechanical key in driver's door lock to position 2.

Rear doors can only be opened from inside by first pulling up the door lock button.

When unlocking the driver's door with the mechanical key, the exterior lamps will flash and the alarm will sound.

To cancel the alarm, insert the electronic key in the starter switch or press button  or  on the electronic main key.

## Central locking system

50

**Power closing assist for doors and trunk lid**

The doors and the trunk lid close automatically if:

- the doors are positioned against the lock,
- the trunk lid is lowered against the lock.

It is not necessary to slam the door or trunk lid closed, a pneumatic power-assisted mechanism draws doors and trunk lid closed quietly and automatically once the lid or door has been latched. When the pneumatic power-assisted mechanism has stopped, doors and/or trunk can be reopened.

**Warning!**

**To prevent possible personal injury, always keep hands and fingers away from the door or trunk opening when closing a door or the trunk lid. Be especially careful when small children are around.**

**The pneumatic power closing assist mechanism cannot be interrupted once it has been engaged.**

**To prevent personal injury, never actuate the closing assist mechanism by tampering with the door or trunk lid latch.**

**Central locking switch**

- 1 Locking
- 2 Unlocking

The central locking switch is located in the center console.

The doors and trunk can only be locked with the central locking switch, if both front doors are closed.



If the vehicle was previously locked with the central locking switch, while in the selective remote control mode, only the door opened from the inside is unlocked.

If the vehicle was previously locked with the central locking switch, while in the global remote control mode, the complete vehicle is unlocked when a door is opened from the inside.

Notes:

If the vehicle was previously locked with the remote control or the lock button at any door handle (vehicles with KEYLESS-GO), the doors and trunk cannot be unlocked with the central locking switch.

The fuel filler flap cannot be locked or unlocked with the central locking switch.

If the vehicle has previously been locked from the outside, opening a door from the inside will trigger the alarm. To cancel the alarm, insert the electronic key in the starter switch or press button  or  on the electronic main key; or (vehicles with KEYLESS-GO) when carrying the KEYLESS-GO-card, grasp the door handle or press the start-/stop button on the gear selector lever.

### Warning!

**When leaving the vehicle always remove the electronic key from the starter switch, take the KEYLESS-GO-card (if so equipped) with you, and lock your vehicle. Do not leave children unattended in the vehicle, or with access to an unlocked vehicle. Unsupervised use of vehicle equipment may cause serious personal injury.**

## Central locking system

52

**Automatic central locking**

With the automatic central locking system activated, the doors and trunk are locked at vehicle speeds of approximately 9 mph (15 km/h) or more. The fuel filler flap remains unlocked.

The automatic central locking function can be switched on or off. See page 138 for “Individual settings”.

## Notes:

If doors are unlocked with the central locking switch after activating the automatic central locking, and neither door is opened, then the doors remain unlocked even at vehicle speeds of approximately 9 mph (15 km/h) or more.

If a door is opened from the inside at speeds of approximately 9 mph (15 km/h) or less with the automatic central locking activated, the door will again be automatically locked at speeds of approximately 9 mph (15 km/h) or more.

**Important!**

When towing the vehicle, or with the vehicle on a dynamometer test stand, please, note the following:

With the automatic central locking activated and the electronic key in starter switch position 2 (vehicles with KEYLESS-GO: operation position, see page 228), the vehicle doors will lock if the left front wheel as well as the right rear wheel spin at vehicle speeds of approximately 9 mph (15 km/h) or more.

To prevent the vehicle door locks from locking, deactivate the automatic central locking. See page 138 for “Individual settings”.

**Emergency unlocking in case of accident**

The doors unlock automatically a short time after an accident in which an airbag or emergency tensioning retractor deploys (this is intended to aid rescue and exit).

## Trunk

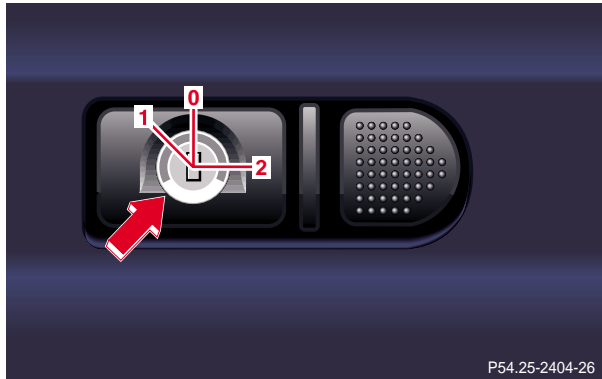

P54.25-2404-26

- 0 Neutral position – push to open (arrow)
- 1 Unlocking
- 2 Separate locking of trunk – remove mechanical key in this position.

The lock is located in the license plate recess.

When the trunk is separately locked, it remains locked when centrally unlocking the vehicle.

To deny any unauthorized person access to the trunk, lock it separately with the mechanical key. Leave only the electronic main key less its mechanical key with the vehicle.

Notes:

In case of a malfunction in the central locking system the trunk can be unlocked individually.

To unlock and open the trunk lid, turn mechanical key to position 1, hold and push to open.



The mechanical key does not operate the central locking system or antitheft alarm system.

When unlocking the trunk with the mechanical key, the exterior lamps will flash and the alarm will sound.



## Central locking system

54

To cancel the alarm, insert the electronic key in the starter switch or press button  or  on the electronic main key or (vehicles with KEYLESS-GO) when carrying the KEYLESS-GO-card, grasp the door handle or press the start-/stop button on the gear selector lever.

If the fuel filler flap cannot be opened, see page 368.

**Important!**

Do not place mechanical key inside trunk, since trunk is locked again when closing the lid if the vehicle has been previously centrally locked.

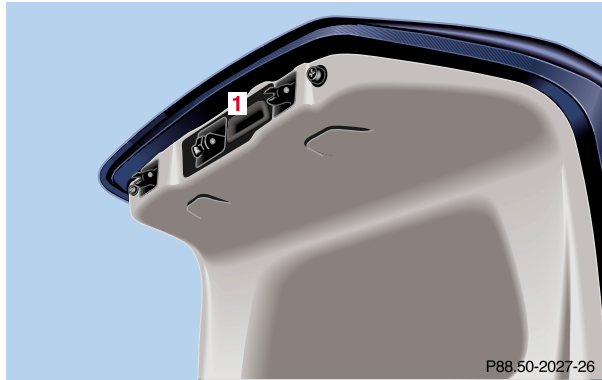

P88.50-2027-26

Vehicles without trunk lid opening/closing system:  
Lower trunk lid using handle (1) and close it with hands placed flat on trunk lid. Please remember to keep your fingers out of the space between the lid and the vehicle.

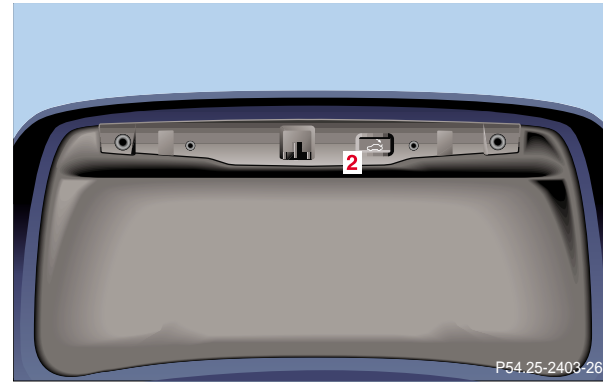

P54.25-2403-26

Vehicles with trunk lid opening/closing system:  
Press trunk lid button (2) briefly. The trunk lid closes automatically.  
The trunk lid can also be closed with the trunk lid opening/closing switch located on the driver's door, see page 58.

## Central locking system

56

**Warning!**

**To prevent possible personal injury, always keep hands and fingers away from the trunk opening when closing the trunk lid. Be especially careful when small children are around.**

**Always be sure persons who might get injured are away from the trunk area when you operate the trunk closing button located on the vehicle door.**

**To interrupt the hydraulic power closing assist mechanism press trunk lid close button (2) inside the trunk lid, push in trunk lid lock or press button  on the electronic main key.**

## Notes:

The automatic closing process is interrupted if the trunk lid is pushed against an object. The trunk lid will reverse slightly and stop. In its final closing stage the hydraulic power closing assist mechanism releases the trunk lid which then drops into the lock by its own weight. Now the trunk lid will stop but not reverse slightly.

Investigate and correct the cause of interruption.

Now press trunk lid button (2) again to close the trunk lid.

In case of a malfunction the trunk lid can be opened and closed manually.

To open, unlock trunk lid with the mechanical key and open lid by hand, see page 53.

To close, lower trunk lid with hands placed flat on trunk lid. Please remember to keep your fingers out of the space between the lid and the vehicle.

Vehicles with KEYLESS-GO:

To prevent a possible inadvertent lockout, the trunk lid will open automatically if a KEYLESS-GO-card is recognized in the area of the rear shelf or inside the trunk.

**Trunk lid release switch**  
(Vehicles without trunk lid opening/closing system)



P54.25-2170-26

The switch is located on the driver's door.

The trunk lid will swing open automatically. You should always make sure there is sufficient clearance.

A minimum height clearance of 6 ft. (1.85 m) is required to open the trunk lid.

To open the trunk, the vehicle must be at standstill. Pull up on switch until trunk lid is open.

The indicator lamp in the switch remains on with trunk lid open.

Notes:

The trunk can also be opened by using the remote control. Press  button.

The trunk lid cannot be opened by the switch or the remote control when previously locked separately with the mechanical key. To open, see page 53.

The trunk lid cannot be opened with the trunk lid release switch when the vehicle was previously locked with the remote control. To unlock vehicle with the remote control, see page 34.

## Central locking system

58

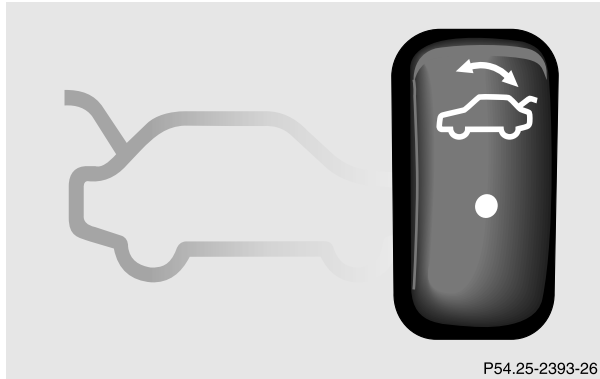
**Trunk lid opening/closing system (optional)**

The switch is located on the driver's door.

The trunk lid will open and close automatically. You should always make sure that there is sufficient clearance.

A minimum height clearance of 6 ft. (1.85 m) is required to open the trunk lid.

To open and close the trunk, the vehicle must be at standstill.

To open trunk lid:

Pull up on switch until trunk lid begins to open. The switch can now be released, the trunk lid opens automatically.

To interrupt the opening process, either pull up on switch, or push in trunk lid lock, or press button  on the remote control.

The indicator lamp in the switch remains on with trunk lid open.

To close trunk lid:

Press upper half of switch until trunk lid is closed and the indicator lamp in the switch goes out.

**Warning!**

**When closing the trunk lid, be sure that there is no danger of anyone being harmed by the closing procedure. Be especially careful when small children are around. Maintain sight of trunk area while operating the door mounted switch.**

**To interrupt the hydraulic power closing assist mechanism release trunk lid release/close switch and pull up to open.**

Notes:

The automatic closing process is interrupted, if the trunk lid is pushed against an object. The trunk lid will reverse slightly and stop. In its final closing stage the hydraulic power closing assist mechanism releases the trunk lid which then drops into the lock by its own weight. Now the trunk lid will stop but not reverse slightly.

Investigate and correct the cause of interruption.

Now press trunk lid opening/closing switch again to close the trunk lid.

In case of a malfunction the trunk lid can be opened and closed manually.

To open, unlock trunk lid with the mechanical key and open lid by hand, see page 53.

To close, lower trunk lid with hands placed flat on trunk lid. Please remember to keep your fingers out of the space between the lid and the vehicle.

The trunk can also be opened by using the remote control. Press  button.

The trunk lid cannot be opened by the switch or the remote control when previously locked separately with the mechanical key. To open, see page 53.

The trunk lid cannot be opened with the trunk lid opening/closing switch when the vehicle was previously locked with the central locking switch. To unlock vehicle with the central locking switch, see page 50.

Vehicles with KEYLESS-GO:

To prevent a possible inadvertent lockout, the trunk lid will open automatically if a KEYLESS-GO-card is recognized in the area of rear shelf or inside the trunk.

## Central locking system

60

**Opening height restriction of trunk lid**

The trunk lid opening height can be restricted when transporting goods on a roof rack (e.g. presence of an MB sport luggage container). When activated, the trunk lid opens to below the roof line of the vehicle.

To activate:

Press upper half of trunk lid opening/closing switch for a minimum of 5 seconds.

To deactivate:

Press upper half of trunk lid opening/closing switch for a minimum of 5 seconds.

Note:

To fully open the trunk lid while opening height restriction activated, deactivate it.

### Trunk lid emergency release

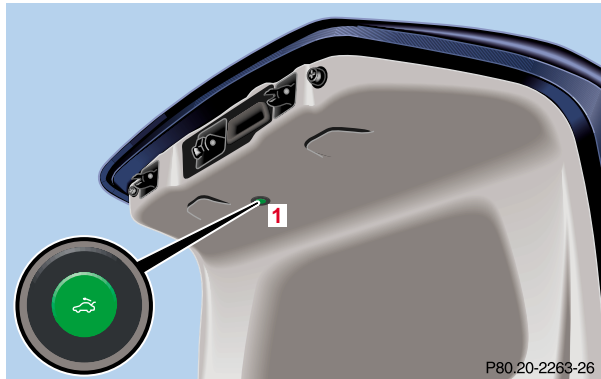

The emergency release button (1) is located in the trunk lid.

Briefly press emergency release button (1).  
All doors, the fuel filler flap, and the trunk unlock; and the trunk lid opens.

Note:

The emergency release button (1) only unlocks and opens the trunk while the vehicle is standing.

#### Important!

The emergency trunk lid release button (1) does not open the trunk lid, if:

- the vehicle battery is discharged or disconnected,
- the trunk lid was previously locked separately with the mechanical key, see page 53.

Illumination of the emergency release button (1):

The button will blink for 30 minutes after opening the trunk.

The button will blink for 60 minutes after closing the trunk.



## Antitheft alarm system

62

**Antitheft alarm system**

**1** Indicator lamp in switch located in center console

The antitheft alarm is automatically armed or disarmed with the remote control or the KEYLESS-GO function, by locking or unlocking the vehicle.

The antitheft alarm is armed within approximately 10 seconds after locking the vehicle with the remote control or the lock button at each door handle (vehicles with KEYLESS-GO).

A blinking lamp (1) indicates that the alarm is armed.

Operation:

Once the alarm system has been armed, the exterior vehicle lamps will flash and an alarm will sound when someone:



- opens a door,
- opens the trunk,
- opens the hood,
- attempts to raise the vehicle.

The alarm will last approximately 2 $\frac{1}{2}$  minutes in form of flashing exterior lamps. At the same time an alarm will sound for 30 seconds. The alarm will stay on even if the activating element (a door, for example) is immediately closed. If the alarm stays on for more than 20 seconds, an emergency call is initiated automatically. See Tele Aid on page 214.

Notes:

We recommend that you carry the electronic reserve key plus mechanical key with you and keep it in a safe place (e.g. your wallet) so that it is always handy. Never leave the flat key in the vehicle.

When you unlock the driver's door with the mechanical key, the exterior lamps will flash and the alarm will sound.

To cancel the alarm, insert the electronic key in the starter switch or press button  or  on the electronic main key; or (vehicles with KEYLESS-GO) when carrying the KEYLESS-GO-card, grasp the door handle or press the start-/stop button on the gear selector lever.

## Tow-away alarm



64

**Tow-away alarm**

The switch is located in the center console.

- 1** Press to switch off
- 2** Indicator lamp

Once the alarm system has been armed, the exterior vehicle lamps will flash and an alarm will sound when someone attempts to raise the vehicle.

The alarm will last approximately 2½ minutes in form of flashing exterior lamps. At the same time an alarm will sound for 30 seconds. The alarm will stay on even if the vehicle is immediately lowered. To cancel the alarm, insert the electronic key in the starter switch or press button  or  on the electronic main key; or (vehicles with KEYLESS-GO) when carrying the KEYLESS-GO-card, grasp the door handle or press the start-/stop button on the gear selector lever.

If the alarm stays on for more than 20 seconds, an emergency call is initiated automatically. See Tele Aid on page 214.

To prevent triggering the tow-away alarm feature, switch off the tow-away alarm before towing the vehicle, or when parking on a surface subject to movement, such as a ferry or auto train.

To do so, turn electronic key in starter switch to position 1 or 0, or remove electronic key from starter switch. Press tow-away alarm switch (1). The indicator lamp (2) illuminates briefly.

Exit vehicle, and lock vehicle with the electronic main key or (vehicles with KEYLESS-GO) the lock button at each door handle.

The tow-away alarm remains switched off until the vehicle is locked again with the electronic main key or the lock button at each door handle (vehicles with KEYLESS-GO), at which time it is automatically reactivated.

## Easy-entry/exit feature

66

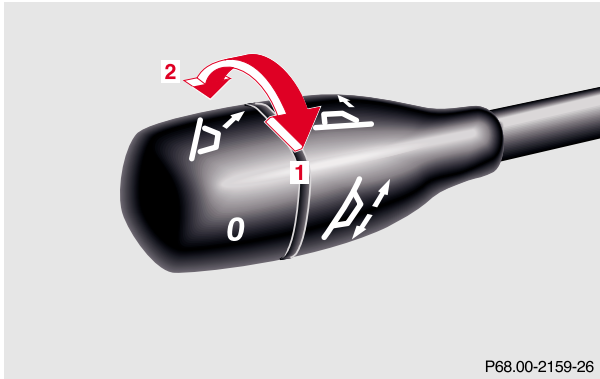
**Easy-entry/exit feature**

The switch is located on the steering column adjustment lever.

Turn the switch in direction:

- 1** to switch on
- 2** to switch off

With the easy-entry/exit feature activated, the steering wheel tilts upwards to allow easier entry into and exit from the vehicle when the driver's door is opened. However, the engine must be turned off.

When the electronic key is inserted in the starter switch or, with a valid KEYLESS-GO-card, when pressing the start-/stop button on the gear selector lever, and if the driver's door is closed, the steering wheel returns to the last position set for it.

**Warning!**

**You must ensure that no one can become trapped or injured by the moving steering wheel when the easy-entry/exit feature is in operation and you open the driver's door or remove the electronic key from the starter switch. Do not leave children unattended in the vehicle, or with access to an unlocked vehicle. Unsupervised use of vehicle equipment may cause serious personal injury.**

## Front seat adjustment

### Warning!

**Do not adjust the driver's seat while driving. Adjusting the seat while driving could cause the driver to lose control of the vehicle.**

**Never ride in a moving vehicle with the seat back reclined. Sitting in an excessively reclined position can be dangerous. You could slide under the seat belt in a collision. If you slide under it, the belt would apply force at the abdomen or neck. That could cause serious or fatal injuries. The seat back and seat belts provide the best restraint when the wearer is in an upright position and belts are properly positioned on the body.**

**Never place hands under seat or near any moving parts while a seat is being adjusted.**

**When leaving the vehicle always remove the electronic key from the starter switch, take the KEYLESS-GO-card (if so equipped) with you, and lock your vehicle.**

**The power seats can also be operated with the driver's or front passenger door open. Do not leave children unattended in the vehicle, or with access to an unlocked vehicle. Unsupervised use of vehicle equipment may cause serious personal injury.**

To operate the front power seat adjustment switches, turn the electronic key in starter switch to position 1 or 2 (with a front door open, the power seats can also be operated with the electronic key removed or in starter switch position 0).

## Seats

68



P54.00-1521-26

The switches are located in each front door.

We recommend to adjust the power seat in the following order:

### 1 Seat adjustment, fore/aft

Press the switch (fore/aft direction) until a comfortable seating position is reached that still allows you to reach the accelerator/brake pedal safely. The position should be as far rearward as possible, consistent with ability to properly operate controls.

Note:

Do not move the front passenger seat completely forward if objects are stored in the parcel net in the front passenger-side footwell. Items in the net may be damaged.

### 2 Press and hold the E button.

When depressed, the exterior mirrors, interior mirror and steering wheel position are preset based on the fore/aft position of the driver's seat.

Only minor personal adjustments, as described below, should then be required.

For steering wheel adjustment, see page 105;

rear view mirror, see page 106;

exterior rear view mirrors, see page 107.

### 3 Seat, up/down

Press the switch (up/down direction) until comfortable seating position with still sufficient headroom is reached.

**4 Seat cushion tilt**

Press the switch in the direction of the arrow until your legs are lightly supported.

**5 Backrest tilt**

Press the switch in the direction of the arrow until your arms are slightly angled when holding the steering wheel.

**6 Seat cushion depth**

Press the switch fore or aft until your legs are supported comfortably.

**7 Head restraint**

The height of the head restraint is adjusted automatically with the seat so that the back of the head is supported approximately at ear level. Adjust the head restraint using the switch if the preset position does not support the back of your head approximately at ear level.

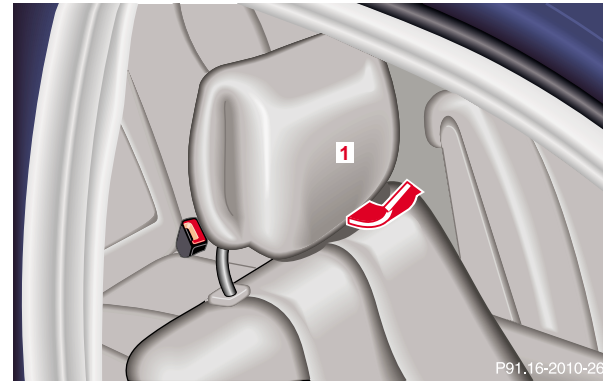

Adjust the head restraint angle (1) by hand. Push or pull the head restraint in direction of arrow.

**Storing seat positions**

The head restraint, steering wheel and rear view mirror position are stored together with the seat position.

See page 111 for notes on the memory function. For recalling a stored seat/head restraint/steering wheel/ and rear view mirror position see page 112.



Instruments and controls	<b>Operation</b>	Driving	Instrument cluster display	Practical hints	Car care	Technical data	Index
--------------------------	------------------	---------	----------------------------	-----------------	----------	----------------	-------

Seats

70

**Important!**

Prior to operating the vehicle, the driver should adjust the seat height for proper vision as well as fore/aft placement and backrest angle to insure adequate control, reach, operation, and comfort. The head restraint should also be adjusted for proper height. See also airbag section on page 94 for proper seat positioning.

In addition, also adjust the steering wheel to ensure adequate control, reach, operation, and comfort.

Both the inside and outside rear view mirrors should be adjusted for adequate rearward vision.

Fasten seat belts. Infants and small children should be seated in a properly secured restraint system that complies with U.S. Federal Motor Vehicle Safety Standard 213 and Canadian Motor Vehicle Safety Standard 213.

All seat, head restraint, steering wheel, and rear view mirror adjustments as well as fastening of seat belts should be done before the vehicle is put into motion.

**Warning!**

Children 12 years old and under must never ride in the front seat, except in a Mercedes-Benz authorized BabySmart™ compatible child seat, which operates with the BabySmart™ system installed in the vehicle to deactivate the passenger-side front airbag when it is properly installed. Otherwise they will be struck by the airbag when it inflates in a crash. If this happens, serious or fatal injury will result.

According to accident statistics, children are safer when properly restrained in the rear seating positions than in the front seating positions. Infants and small children must ride in back seats and be seated in an appropriate infant or child restraint system, which is properly secured with the vehicle's seat belt, fully in accordance with the child seat manufacturer's instructions.

A child's risk of serious or fatal injuries is significantly increased if the child restraints are not properly secured in the vehicle and the child is not properly secured in the child restraint.

### Removal and installation of front seat head restraints



#### Caution!

Do not remove head restraints except when mounting seat covers. Whenever restraints have been removed be sure to reinstall them before driving.

#### Note:

Tilt the backrest rearward for easier removal and installation of the head restraints.

#### To remove:

Press switch (1) upwards and hold until the head restraint is fully extended. Pull head restraint out.

#### To install:

Press switch (1) upwards and hold for about 5 seconds.

Press the head restraint down until it engages.

Adjust head restraint to the desired position.

#### Warning!

**For your protection, drive only with properly positioned head restraints.**

**Adjust head restraint to support the back of the head approximately at ear level.**

**Do not drive the vehicle without the seat head restraints. Head restraints are intended to help reduce injuries during an accident.**

### Lumbar support (optional)



The thumbwheels are located on the sides of the front seats and rear seats.

The seats have an inflatable air cushion built into the backrest to provide additional lumbar support.

Turn the electronic key in starter switch to position 2. The inflation pressure of the air cushion can be continuously varied between position “0” (no pressure) and position “5” (maximum pressure) by changing the pressure regulator (1) setting.

### Multicontour backrest (optional)



Front seats:

The switch clusters are located on the side and near the front of the front seats.

- 1 Lumbar region
- 2 Center section
- 3 Backrest side cushions
- 4 Massage function (PULSE)

## Seats

74



Rear seats:

The switch clusters are located on the sides of the seat.

Some models may be equipped with multicontour seats. These seats have inflatable air cushions built into the backrests to provide additional lumbar and side support.

Turn the electronic key in starter switch to position 2 to operate.

We recommend that you make the basic settings in the following order:

**1 Lumbar region**

**2 Center section**  
(front seats only)

Switches 1 and 2:

Press top of switch and hold; the individual air cushions will be inflated one after the other. Release the switch in the desired position.

Press bottom of switch and hold; the individual air cushions will be deflated one after the other. Release the switch in the desired position.

**3 Backrest side cushions**

The lateral support increases or decreases as you press the button to the right or left. Adjust the side cushions to provide good lateral support.

#### 4 **Massage function (PULSE)**

The multicontour backrest is equipped with a massage function to help prevent fatigue during longer journeys.

The PULSE function inflates and deflates the air cushions in the backrest rhythmically.

An indicator lamp on the switch lights up when the PULSE function is switched on. The PULSE function switches off automatically after approximately 5 minutes.

Note:

If the top cushion is inflated, only the middle air cushion is inflated and deflated.

#### **Seat heater**

The seat heaters can be switched on with the electronic key in starter switch positions 1 or 2.

The buttons are located on each door.

Note:

When in operation, the seat heater consumes a large amount of electrical power. It is not advisable to use the seat heater longer than necessary.

The seat heaters may automatically switch off if too many power consumers are switched on at the same time or if the battery charge is low. In this case, one or both indicator lamps will blink.

The seat heaters switch back on again automatically as soon as sufficient voltage is available.

If the blinking of the indicator lamps is distracting to you, the seat heaters can be switched off.

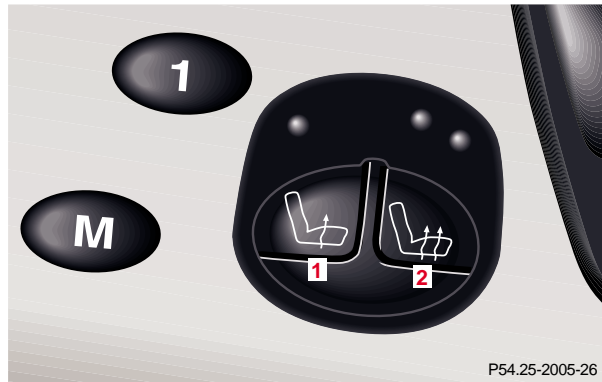
**Vehicles without seat ventilation function:**

Normal heating mode.

Press button (1):

One indicator lamp in the switch lights up.

The seat heater will be automatically switched off after approximately 30 minutes.

Rapid heating mode.

Press button (2):

Both indicator lamps in the switch light up.

The system switches over to normal heating mode automatically after approximately 5 minutes.

Turning off the heater.

Press button (1) or (2) again:

The indicator lamps go out. The seat heater is switched off.

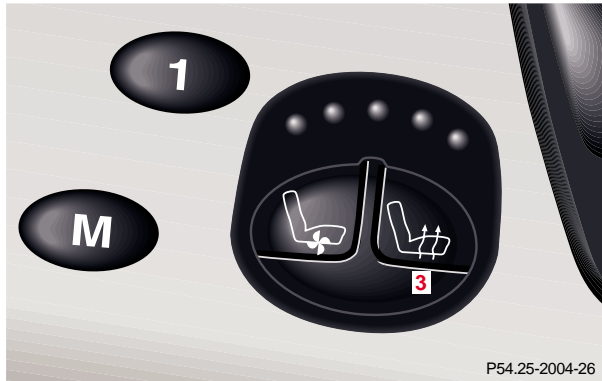

#### **Vehicles with seat ventilation function:**

Rapid heating mode

Press button (3) once.

Both indicator lamps above the button light up.

The system switches over to normal heating mode automatically after approximately 5 minutes.

Normal heating mode

Press button (3) twice:

One indicator lamp above the button lights up.

The seat heater will be automatically switched off after approximately 30 minutes.

Turning off the heater.

Press the button again:

The indicator lamps go out. The seat heater is switched off.



**Seat ventilation system**

The buttons are located on each door.

Seat ventilation can be activated manually with the electronic key in starter switch positions 1 or 2, or by the summer opening function, see page 45.

Notes:

When in operation, the seat ventilation system consumes a large amount of electrical power. It is not advisable to use the seat ventilator longer than necessary.

The seat ventilators may automatically switch off if too many power consumers are switched on at the same time or if the battery charge is low. In this case, one or more indicator lamps will blink.

The seat ventilation switch back on again automatically as soon as sufficient voltage is available.

If the blinking of the indicator lamps is distracting to you, the seat ventilators can be switched off.

The maximum ventilation level (level 3) is automatically selected if the driver's seat ventilation is activated by the summer opening function, see page 45.

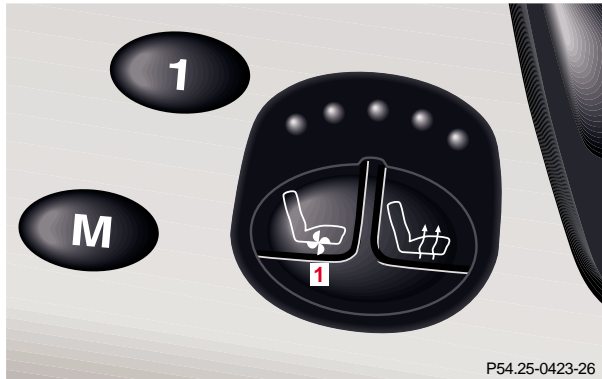

Manual activation:

Turn the electronic key in starter switch to position 1 or 2.

Level 3 ventilation setting (maximum).

Press button (1):

Three blue indicator lamps above the button light up.

The level of ventilation is decreased one step approximately every 10 minutes.

Level 2 ventilation setting (middle).

Press button (1) again:

Two blue indicator lamps above the button light up.

Level 1 ventilation setting (minimum).

Press button (1) again:

One blue indicator lamp above the button lights up.

Turning off the seat ventilation.

Press button (1) again:

The indicator lamps go out. Seat ventilation is switched off.

**Rear seat head restraints**

The switch is located on the center console.

Turn the electronic key in starter switch to position 1 or 2.

Folding head restraints back:

Press the symbol-side on the rocker switch to release the head restraints. The head restraints will fold backward for increased visibility.

Placing head restraints upright:  
Pull the head restraint forward until it locks into position.

Angle of head restraints:

The head restraint angle can be adjusted manually.

**Important!**

For safety reasons, always drive with the rear head restraints in the upright position when the rear seats are occupied.

Keep the area around head restraints clear of articles (e.g. clothing) to not obstruct the folding operation of the head restraints.

### Power head restraints, rear



The switch is located on the center console.

Turn electronic key in starter switch to position 1 or 2.

Activate switch:

- 1 Fold head restraint backwards.
- 2 Place head restraint upright.

### Important!

For safety reasons, always drive with the rear head restraints in the upright position when the rear seats are occupied.

Keep the area around head restraints clear of articles (e.g. clothing) to not obstruct the folding operation of the head restraints.

Notes:

The two outer head restraints fold up or back together. The center head restraint also folds back if there are three head restraints in the rear.

The center head restraint in vehicles with three rear seat positions does not position itself automatically. It must be pulled up by hand until it locks into place.

The head restraints on the two outer seats will position themselves automatically when the seats are occupied (seat belt buckled).

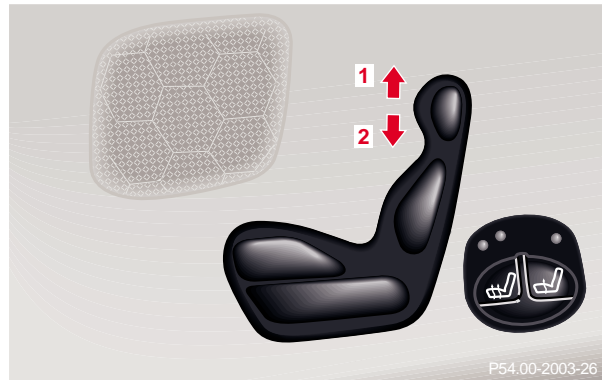
**Power seats, rear**

The switches are located on each rear door.

Activate switch:

- 1** Place head restraint upright
- 2** Fold head restraint backwards

The appropriate outer head restraint can be folded up or back.

The head restraint angle can be adjusted manually.

The seats can be adjusted using the slide switches located in either of the rear doors.

Turn the electronic key in starter switch to position 1 or 2 (with respective door open, that power seat can also be operated with the electronic key removed or in starter switch position 0).

## Seat bench

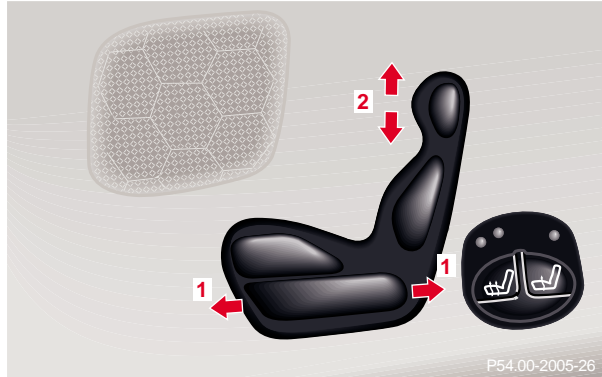

- 1 Fore and aft adjustment**  
The seat cushion moves fore/aft, together with the inclination of the backrest.
- 2 Head restraint**  
Press the switch up or down.  
The head restraints can be placed individually in either upright or fold-down positions.

## Individual seats

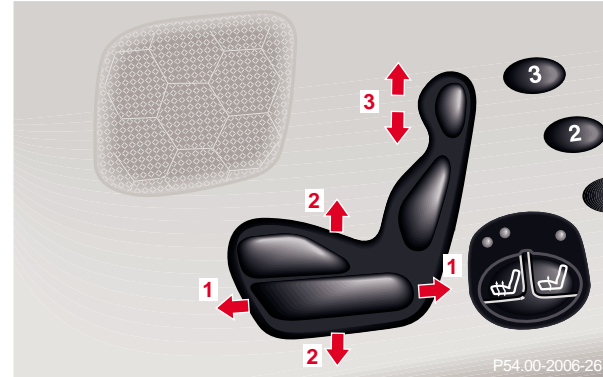

- 1 Fore and aft adjustment**  
The seat cushion moves fore/aft together with the inclination of the backrest.
- 2 Cushion tilt**  
Press the switch up or down.
- 3 Head restraint**  
Press the switch up or down.

## Restraint systems

84

**Seat belts and integrated restraint system**

Your vehicle is equipped with seat belts for all seats, emergency tensioning retractors for all outboard seat belts, dual front airbags, side impact airbags for driver, front and outer rear passengers, and head protective window curtain airbags. Their protective functions are designed to complement one another.

**Seat belts****Important!**

Laws in most states and all Canadian provinces require seat belt use.

All states and provinces require use of child restraints that comply with U.S. Federal Motor Vehicle Safety Standard 213 and Canadian Motor Vehicle Safety Standard 213.

All child restraints systems are designed to be secured in vehicle seats by lap belts or the lap belt portion of a lap-shoulder belt.

For your safety and that of your passengers we strongly recommend their use.

**Warning!**

**Children 12 years old and under must never ride in the front seat, except in a Mercedes-Benz authorized BabySmart™ compatible child seat, which operates with the BabySmart™ system installed in the vehicle to deactivate the passenger-side front airbag when it is properly installed. Otherwise they will be struck by the airbag when it inflates in a crash. If this happens, serious or fatal injury will result.**

**According to accident statistics, children are safer when properly restrained in the rear seating positions than in the front seating positions. Infants and small children must ride in back seats and be seated in an appropriate infant or child restraint system, which is properly secured with the vehicle's seat belt, fully in accordance with the child seat manufacturer's instructions.**

**A child's risk of serious or fatal injuries is significantly increased if the child restraints are not properly secured in the vehicle and the child is not properly secured in the child restraint.**

**Warning!**

Never ride in a moving vehicle with the backrest reclined. Sitting in an excessively reclined position can be dangerous. You could slide under the seat belt in a collision. If you slide under it, the belt would apply force at the abdomen or neck. That could cause serious or even fatal injuries. The backrest and seat belt provide the best restraint when the wearer is in an upright position and the belt is properly positioned on the body.

**Seat belt nonusage warning system**

With the electronic key in starter switch position 2, a warning sounds for a short time if the driver's seat belt is not fastened.

Automatic comfort-fit seat belt:

An automatic comfort-fit feature for all seat belt is activated when the electronic key in the starter switch is turned to position 1 or 2.

The retraction force of the inertia reel is reduced, increasing the level of seat belt comfort.

Note:

For cleaning and care of the seat belts see page 381.



Instruments and controls	<b>Operation</b>	Driving	Instrument cluster display	Practical hints	Car care	Technical data	Index
--------------------------	------------------	---------	----------------------------	-----------------	----------	----------------	-------

Restraint systems

86

**Warning!**

**Failure to wear and properly fasten and position your seat belt greatly increases your risk of injuries and their likely severity in an accident. You and your passengers should always wear seat belts.**

**If you are ever in an accident, your injuries can be considerably more severe without your seat belt properly buckled. Without your seat belt buckled, you are much more likely to hit the interior of the vehicle or be ejected from it. You can be seriously injured or killed.**

**In the same crash, the possibility of injury or death is lessened if you are wearing your seat belt.**

**Warning!**

**Never let more people ride in the vehicle than there are seat belts available. Be sure everyone riding in the vehicle is correctly restrained with a separate seat belt.**

## Fastening seat belts

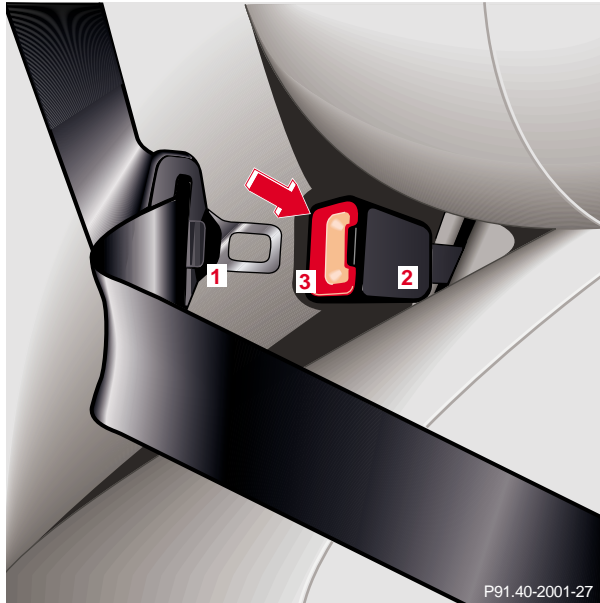

- 1 Latch plate
- 2 Buckle
- 3 Release button

Push the latch plate (1) into the buckle (2) until it clicks. Do not twist the belt. A twisted seat belt may cause injury.

To help avoid severe or fatal injuries, the lap belt should be positioned as low as possible on your hips and not across the abdomen.

### Warning!

**Always fasten your seat belt before driving off. Always make sure your passengers are properly restrained – even those sitting in the rear.**

Tighten the lap portion to a snug fit by pulling shoulder portion up.

## Restraint systems

88

**Operation of seat belts**

The inertia reel stops the belt from unwinding during sudden stops or when quickly pulling on the belt.

The locking function of the reel may be checked by quickly pulling out the belt.

Adjust seat belt so that shoulder portion is located as close as possible to the middle of your shoulder (it should not touch the neck). The height setting for the shoulder portion of the front seat belts is automatically adjusted by the fore/aft movement of the front seat.

Seat moved to front: Belt outlet fully lowered.

Seat moved to rear: Belt outlet fully raised.

**Caution!**

For safety reasons, avoid adjusting the seat or seat back into positions which could affect the correct seat belt positioning.

**Unfastening of seat belts**

Press release button (3) in the belt buckle (2).

Allow the retractor to completely rewind the seat belt by guiding the latch plate (1).

**Warning!**

**USE SEAT BELTS PROPERLY.**

- Seat belts can only work when used properly. Never wear seat belts in any other way than as described in this section, as that could result in serious injuries in case of an accident.
- Each occupant should wear their seat belt at all times, because seat belts help reduce the likelihood of and potential severity of injuries in accidents, including rollovers. The integrated restraint system includes “SRS” (driver airbag, front passenger airbag, side impact airbags, head protection window curtain airbags for side windows), “ETR” (seat belt emergency tensioning retractors), and front knee bolsters. The system is designed to enhance the protection offered to properly belted occupants in certain frontal (front airbags) and side (side impact and window curtain airbags) impacts which exceed preset deployment thresholds.

- Never wear the shoulder belt under your arm, against your neck or off your shoulder. In a crash, your body would move too far forward. That would increase the chance of head and neck injuries. The belt would also apply too much force to the ribs or abdomen, which could severely injure internal organs such as your liver or spleen.
- Never wear belts over rigid or breakable objects in or on your clothing, such as eyeglasses, pens, keys etc., as these might cause injuries.
- Position the lap belt as low as possible on your hips and not across the abdomen. If the belt is positioned across your abdomen, it could cause serious injuries in a crash.
- Each seat belt should never be used for more than one person at a time. Do not fasten a seat belt around a person and another person or other objects.
- Belts should not be worn twisted. In a crash, you wouldn't have the full width of the belt to manage impact forces. The twisted belt against your body could cause injuries.

Instruments and controls	<b>Operation</b>	Driving	Instrument cluster display	Practical hints	Car care	Technical data	Index
--------------------------	------------------	---------	----------------------------	-----------------	----------	----------------	-------

Restraint systems

- Pregnant women should also use a lap-shoulder belt. The lap belt portion should be positioned as low as possible on the hips to avoid any possible pressure on the abdomen.
- Never place your feet on the instrument panel or on the seat. Always keep both feet on the floor in front of the seat.

**Warning!**

**USE CHILD RESTRAINTS PROPERLY.**

Children 12 years old and under must never ride in the front seat, except in a Mercedes-Benz authorized BabySmart™ compatible child seat, which operates with the BabySmart™ system installed in the vehicle to deactivate the passenger front airbag when it is properly installed.

Otherwise they will be struck by the airbag when it inflates in a crash. If this happens, serious or fatal injury will result.

According to accident statistics, children are safer when properly restrained in the rear seating positions than in the front seating positions. Infants and small children must ride in the back seats and be seated in an appropriate infant or child restraint system, which is properly secured with the vehicle's seat belt, fully in accordance with the child seat manufacturer's instructions.

A child's risk of serious or fatal injuries is significantly increased if the child restraints are not properly secured in the vehicle and the child is not properly secured in the child restraint.

Children too big for child restraint systems must ride in back seats using regular seat belts. Position shoulder belt across chest and shoulder, not face or neck. A booster seat may be necessary to achieve proper belt positioning.

### BabySmart™ airbag deactivation system

Special BabySmart™ compatible child seats, designed for use with the Mercedes-Benz system and available at any authorized Mercedes-Benz Center are required for use with the BabySmart™ airbag deactivation system. With the special child seat properly installed, the passenger front airbag will not deploy.

The  indicator lamp located on the center console will be illuminated, except with electronic key removed or in starter switch position 0. The system does not deactivate the door mounted side impact airbag.

### Self-test BabySmart™ without special child seat installed

After turning electronic key in starter switch to position 1 or 2, the  indicator lamp located on the center console comes on for approximately 6 seconds and then extinguishes.

If the indicator lamp should not come on or is continuously lit, the system is not functioning. You must see an authorized Mercedes-Benz Center before seating any child on the front passenger seat. See page 302 for notes on the  indicator lamp.

### Warning!

**The BabySmart™ airbag deactivation system will ONLY work with a special child seat designed to operate with it. It will not work with child seats which are not BabySmart™ compatible.**

**Never place anything between seat cushion and child seat (e.g. pillow), since it reduces the effectiveness of the deactivation system.**

**Follow the manufacturer's instructions for installation of special child seats.**

**The passenger front airbag will not deploy only if the  indicator lamp remains illuminated.**

**Please be sure to check the indicator every time you use the special system child seat. Should the light go out while the restraint is installed, please check installation. If the light remains out, do not use the BabySmart™ restraint to transport children on the front passenger seat until the system has been repaired.**

BabySmart™ is a trademark of Siemens Automotive Corp.

## Restraint systems

92

**Supplemental Restraint System (SRS)**

Airbags are intended as a supplement to seat belts. Airbags alone cannot protect as well as airbags plus seat belts in impacts for which the airbags were designed to operate, and do not afford any protection whatsoever in crashes for which the airbags are not designed to deploy.

The SRS uses two crash severity levels (thresholds) to activate either the emergency tensioning retractor (ETR) or front airbag or both. Activation depends on the direction and severity of the impact exceeding the preset thresholds and whether the seat belt is fastened.

Seat belt fastened

- first threshold exceeded: ETR activates
- second threshold exceeded: airbag also activates

Seat belt not fastened

Front seats:

- first threshold exceeded: airbag activates, not ETR

Rear outer seats:

- first threshold exceeded: ETR activates

Driver and front passenger and rear outer seat systems operate independently of each other.

### **Emergency tensioning retractor (ETR)**

The seat belts for the front and rear outer seats are equipped with emergency tensioning retractors. These tensioning retractors are located in each belt's inertia reel and become operationally ready with the electronic key in starter switch position 1 or 2.

The emergency tensioning retractors are designed to activate only when the seat belts are fastened during frontal impacts exceeding the first threshold of the SRS and in rear impacts exceeding a preset severity level.

They remove slack from the belts in such a way that the seat belts fit more snugly against the body restricting its forward movement as much as possible.

In cases of other frontal impacts, angled impacts, roll-overs, certain side impacts, or other accidents without sufficient frontal or rear impact forces, the emergency tensioning retractors will not be activated. The driver and passengers will then be protected by the fastened seat belts and inertia reel in the usual manner.



## Restraint systems

94

**Airbags****Front airbags**

- 1 Driver airbag
- 2 Front passenger airbag

The most effective occupant restraint system yet developed for use in production vehicles is the seat belt. In some cases, however, the protective effect of a seat belt can be further enhanced by an airbag.

In conjunction with wearing the seat belts, the driver and front passenger airbags can provide increased protection for the driver and front passenger in certain frontal impacts exceeding preset thresholds.

Side impact and head protection window curtain airbags can provide increased protection to belted occupants on the impacted side of the vehicle in side impacts exceeding its preset threshold.

The operational readiness of the airbag system is verified by the indicator lamp "SRS" in the instrument cluster when turning the electronic key in starter switch to position 1 or 2. If no fault is detected, the lamp will go out after approximately 4 seconds; after the lamp goes out, the system continues to monitor the components and circuitry of the airbag system and will indicate a malfunction by coming on again. If the lamp does not

come on at all or if it fails to extinguish after approximately 4 seconds or if it comes on thereafter, a malfunction in the system has been detected.

The following system components are monitored or undergo a self-check: crash-sensor(s), airbag ignition circuits, front seat belt buckles, emergency tensioning retractors, seat sensor.

Initially, when the electronic key is turned from starter switch position 0 to position 1 or 2, malfunctions in the crash sensor are detected and indicated (the “SRS” indicator lamp stays on longer than 4 seconds or does not come on).

Have the system checked at your authorized Mercedes-Benz Center immediately.

In the operational mode, after the indicator lamp has gone out following the initial check, interruptions or short circuits in the airbag ignition circuit and in the driver and front passenger seat belt buckle harnesses, and low voltage in the entire system are detected and indicated.

**Warning!**

**In the event a malfunction of the “SRS” is indicated as outlined above, the “SRS” may not be**

operational. For your safety, we strongly recommend that you visit an authorized Mercedes-Benz Center immediately to have the system checked; otherwise the “SRS” may not be activated when needed in an accident, which could result in serious or fatal injury, or it might deploy unexpectedly and unnecessarily which could also result in injury.

Note:

See page 299 for information on the Supplemental Restraint System (SRS) indicator lamp.

The driver and passenger front airbags are designed to activate only in certain frontal impacts exceeding a preset threshold. The front passenger airbag deploys only if the front passenger seat is occupied and the  indicator lamp on the center console is not illuminated.

Note:

Heavy objects on the front passenger seat can appear to the “SRS” to indicate the presence of an occupant in that seat which causes the passenger front airbag to deploy in a crash exceeding the appropriate threshold.

## Restraint systems

96

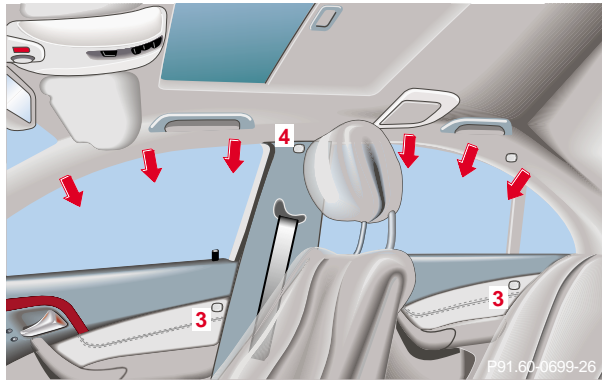
**Side impact airbags, window curtain airbags**

- 3 Side impact airbags
- 4 Window curtain airbags

**Side impact airbags**

The side impact airbags are designed to activate only in certain side impacts exceeding a preset threshold. Only the side impact airbags on the impacted side of the vehicle deploy.

The side impact airbag for the front passenger deploys only if the front passenger seat is occupied.

Side impact airbags operate best in conjunction with a properly positioned and fastened seat belt.

Note:

Heavy objects on front passenger seat can cause the front passenger-side impact airbag to deploy in a crash.

**Window curtain airbag**

The head protection window curtain airbags afford greater protection against injuries to the head and upper body. They fill up in the area between the A and C pillars (see arrows) between the side windows and an occupant's head.

The window curtain airbags are designed to activate only in certain side impacts exceeding a preset threshold. Only the head protection window curtain airbag on the impacted side of the vehicle deploys.

### **Important!**

Airbags are designed to activate only in certain frontal (front airbags) impacts, or side (side impact and head protection window curtain airbags) impacts which exceed preset thresholds.

Only during these types of impacts, if of sufficient severity to meet the deployment thresholds, will they provide their supplemental protection.

The driver and passenger should always wear their seat belts, otherwise it is not possible for the airbags to provide their supplemental protection.

In cases of other frontal impacts, angled impacts, roll-overs, other side impacts, rear collisions, or other accidents, the airbags will not be activated. The driver and passengers will then be protected by the fastened seat belts.

We caution you not to rely on the presence of the airbags in order to avoid wearing your seat belt.

### **Warning!**

Airbags are designed to reduce the potential of injury in certain frontal (front airbags) impacts, or side (side impact and head protection window curtain airbags) impacts which may cause significant injuries, however, no system available today can totally eliminate injuries and fatalities.

The activation of the "SRS" temporarily releases a small amount of dust from the airbags. This dust, however, is neither injurious to your health, nor does it indicate a fire in the vehicle. The dust might cause some temporary breathing difficulty for people with asthma or other breathing trouble. To avoid this, you may wish to get out of the vehicle as soon as it is safe to do so. If you have any breathing difficulty but cannot get out of the vehicle after the airbag inflates, then get fresh air by opening a window or door.

Instruments and controls	<b>Operation</b>	Driving	Instrument cluster display	Practical hints	Car care	Technical data	Index
--------------------------	------------------	---------	----------------------------	-----------------	----------	----------------	-------

## Restraint systems

98

Your vehicle was originally equipped with airbags which are designed to activate in certain impacts exceeding a preset threshold to reduce the potential and severity of injury. It is important to your safety and that of your passenger that you replace deployed airbags and repair any malfunctioning airbags to ensure the vehicle will continue to provide crash protection for occupants.

### Warning!

To reduce the risk of injury when the front airbags inflate, it is very important for the driver and front passenger to always be in a properly seated position and to wear their seat belts.

For maximum protection in the event of a collision always be in normal seated position with your back against the backrest. Fasten your seat belt and ensure that it is properly positioned on your body.

Since the airbag inflates with considerable speed and force, a proper seating and hands on steering wheel position will help to keep you at a safe distance from the airbag. Occupants who are unbelted, out of position or too close to the airbag can be seriously injured by an airbag as it inflates with great force in the blink of an eye:

- Sit properly belted in an upright position with your back against the backrest.
- Adjust the driver's seat as far as possible rearward, still permitting proper operation of vehicle controls. The distance from the center of the driver's breastbone to the center of the airbag cover on the steering wheel must be at least ten inches (25 cm) or more. You should be able to accomplish this by a combination of adjustments to the seat and steering wheel. If you have any problems, please see your authorized Mercedes-Benz Center.
- Do not lean with your head or chest close to the steering wheel or dashboard.
- Keep hands on the outside of steering wheel rim. Placing hands and arms inside the rim can increase the risk and potential severity of hand/arm injury when driver front airbag inflates.

- **Adjust the front passenger seat as far as possible rearward from the dashboard when the seat is occupied.**
- **Occupants, especially children, should never lean their heads in the area of the door where the side airbag inflates. This could result in serious injuries or death should the airbag be triggered. Always sit upright, properly use the seatbelts and appropriate size infant or child restraint system**
- **Children 12 years old and under must never ride in the front seat, except in a Mercedes-Benz authorized BabySmart™ compatible child seat, which operates with the BabySmart™ system installed in the vehicle to deactivate the passenger-side front airbag when it is properly installed. Otherwise they will be struck by the airbag when it inflates in a crash. If this happens, serious or fatal injury can result.**

**Failure to follow these instructions can result in severe injuries to you or other occupants.**

### **Warning!**

**Accident research shows that the safest place for children in an automobile is in the rear seat. Should you choose to place a child 12 years old or under in the front passenger seat of your vehicle, you must properly use a BabySmart™ child restraint which will turn off the passenger side front airbag. BabySmart™ will not, however, turn off the vehicle's side impact airbag.**

**It should be noted that with respect to both front and rear side impact airbags there is a possibility for a side airbag related injury if occupants, especially children, are not properly seated or restrained when next to a side airbag which needs to deploy rapidly in a side impact in order to do its job.**

**To help avoid the possibility of injury, please follow these guidelines: (1) occupants, especially children, should never place their bodies or lean their heads in the area of the door where the side airbag inflates. This could result in serious injuries or death should the side airbag be activated; (2) always sit upright, properly use the seat belts and use an appropriately sized infant or child restraint system for all children 12 years old or under; and (3) always wear seat belts properly.**

Instruments and controls	<b>Operation</b>	Driving	Instrument cluster display	Practical hints	Car care	Technical data	Index
--------------------------	------------------	---------	----------------------------	-----------------	----------	----------------	-------

Restraint systems

If you believe that, even with the use of these guidelines, it would be safer for your rear seat occupants to have both rear door mounted side airbags deactivated, then deactivation can be accomplished upon your written election to do so at your authorized Mercedes-Benz Center at an additional cost. Please contact your local authorized Mercedes-Benz Center or call our Client Assistance Center at 1-800-FOR-MERCEdes (1-800-367-6372) for details.

**Safety guidelines for the seat belt, emergency tensioning retractor and airbag**

**Warning!**

- Damaged seat belts or belts that were highly stressed in an accident must be replaced and their anchoring points must also be checked. Use only belts installed or supplied by an authorized Mercedes-Benz Center.
- Airbags and “ETR’s” are designed to function on a one-time-only basis. An airbag or emergency tensioning retractor (ETR) that was activated must be replaced.
- Do not pass belts over sharp edges.

- Do not make any modification that could change the effectiveness of the belts.
- No modifications of any kind may be made to any components or wiring of the “SRS”. This includes changing or removing any component or part of the “SRS”, the installation of additional trim material, badges etc. over the steering wheel hub, front passenger airbag cover, door trim panels, or door frame trims, and installation of additional electrical/ electronic equipment on or near “SRS” components and wiring. Keep area between airbags and occupants free from objects (e.g. packages, purses, umbrellas, etc.).
- Do not use handles above doors for placing such items as coat hangers etc..
- An airbag system component within the steering wheel gets hot after the airbag has inflated. Do not touch.
- Improper work on the system, including incorrect installation and removal, can lead to possible injury through an unintended activation of the “SRS”.

- In addition, through improper work there is a risk of rendering the “SRS” inoperative or causing unintended airbag deployment. Work on the “SRS” must therefore only be performed by an authorized Mercedes-Benz Center.
- For your protection and the protection of others, when scrapping the airbag unit or emergency tensioning retractor, our safety instructions must be followed. These instructions are available at your authorized Mercedes-Benz Center.

- Given the considerable deployment speed and the textile structure of the airbags, there is the possibility of abrasions or other injuries resulting from airbag deployment.

When you sell your vehicle we strongly urge you to give notice to the subsequent owner that it is equipped with an “SRS” by alerting them to the applicable section in the Operator’s Manual.



Instruments and controls	<b>Operation</b>	Driving	Instrument cluster display	Practical hints	Car care	Technical data	Index
--------------------------	------------------	---------	----------------------------	-----------------	----------	----------------	-------

Restraint systems

**Infant and child restraint systems**

We recommend all infants and children be properly restrained at all times while the vehicle is in motion. All lap-shoulder belts except the driver's seat belt have special seat belt retractors for secure fastening of child restraints.

To activate, pull shoulder belt out completely and let it retract. During the seat belt retraction a ratcheting sound can be heard to indicate that the special seat belt retractor is activated. The belt is now locked.

To deactivate, release seat belt buckle and let seat belt retract completely. The seat belt can again be used in the usual manner

Note:

For child seats with mounting fittings for tether anchorages refer to page 104 (installation of infant and child restraint systems).

**Warning!**

**Never release the seat belt buckle while vehicle is in motion, since the special seat belt retractor will be deactivated.**

**Important!**

The use of infant or child restraints is required by law in all 50 states and all Canadian provinces.

Infants and small children should be seated in an appropriate infant or child restraint system properly secured by a lap-shoulder belt, and that complies with U.S. Federal Motor Vehicle Safety Standard 213 and Canadian Motor Vehicle Safety Standard 213.

A statement by the child restraint manufacturer of compliance with this standard can be found on the instruction label on the restraint and in the instruction manual provided with the restraint.

When using any infant or child restraint system, be sure to carefully read and follow all manufacturer's instructions for installation and use.

Please read and observe warning labels affixed to inside of vehicle and to infant or child restraints.

**Warning!**

Children 12 years old and under must never ride in the front seat, except in a Mercedes-Benz authorized BabySmart™ compatible child seat, which operates with the BabySmart™ system installed in the vehicle to deactivate the passenger front airbag when it is properly installed. Otherwise they will be struck by the airbag when it inflates in a crash. If this happens, serious or fatal injury can result.

According to accident statistics, children are safer when properly restrained in the rear seating positions than in the front seating positions. Infants and small children must ride in back seats and be seated in an appropriate infant or child restraint system, which is properly secured with the vehicle's seat belt, fully in accordance with the child seat manufacturer's instructions.

Infants and small children should never share a seat belt with another occupant. During an accident, they could be crushed between the occupant and seat belt.

Children too big for child restraint systems must ride in back seats using regular seat belts. Position shoulder belt across chest and shoulder, not face or neck. A booster seat may be necessary to achieve proper belt positioning for children from 41 lbs. to the point where a lap/shoulder belt fits properly without one.

When the child restraint is not in use, remove it from the vehicle or secure it with the seat belt to prevent the child restraint from becoming a projectile in the event of an accident.

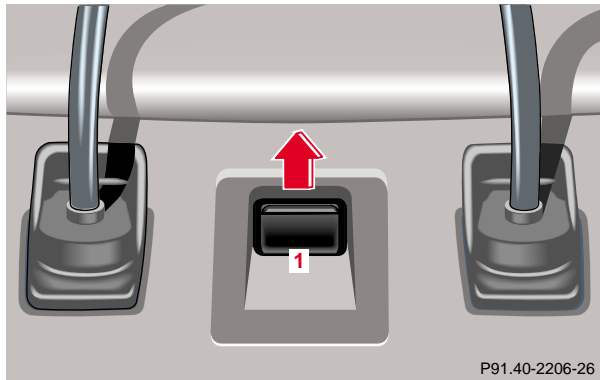
**Installation of infant and child restraint systems**

This vehicle is provided with tether anchorages for a top tether strap at each of the rear seating positions.

Prior to installing a tether strap, remove cover (1) from anchorage ring (2) and store in a convenient place (e.g. glove box).

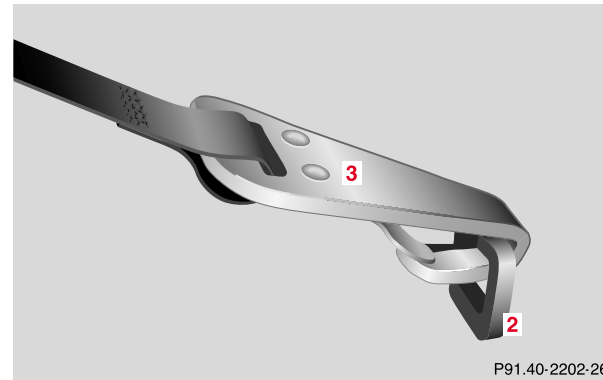

To secure a tether strap to the anchorage, securely fasten the hook (3), which is part of the tether strap, to the anchorage ring (2). For safety, please make sure that the hook has attached to the ring beyond the safety catch, as illustrated.

After removing the tether strap, reinstall the cover (1).

## Steering wheel adjustment

### Warning!

Do not adjust the steering wheel while driving. Adjusting the steering wheel while driving could cause the driver to lose the control of the vehicle.

When leaving the vehicle always remove the electronic key from the starter switch, and take the KEYLESS-GO-card (if so equipped) with you.

The steering wheel adjustment feature can also be operated with the driver's door open. Do not leave children unattended in the vehicle, or with access to an unlocked vehicle. Unsupervised use of vehicle equipment may cause serious personal injury.

To adjust the steering wheel position, turn the electronic key in starter switch to position 1 or 2. With the driver's door open, the steering wheel can also be operated with the electronic key removed or in starter switch position 0. However any adjustment will be cancelled and the steering wheel will return to it's position stored in memory if the driver's door is closed or the electronic key is inserted in the starter switch.

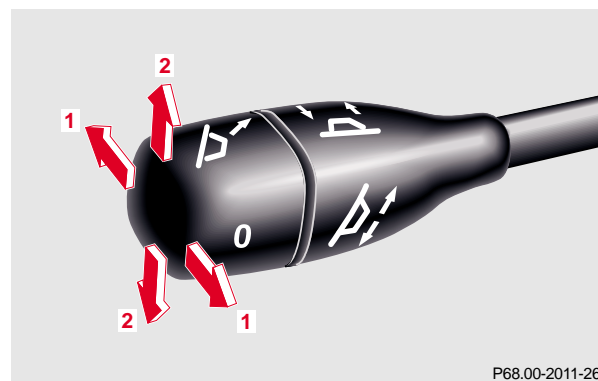

P68.00-2011-26

The stalk is located on the steering column.

### 1 Steering column, lengthen or shorten column

Move the stalk to the front or rear.

### 2 Steering column, height

Move the stalk up or down.

Note:

The steering wheel adjustment can be stored together with the seat and mirror adjustment. See page 111 for notes on the memory function.

## Rear view mirrors

106

**Rear view mirrors****Inside rear view mirror**

Manually adjust the mirror.

**Storing interior rear view mirror positions**

The seat, exterior rear view mirror and steering wheel positions are stored together with the interior rear view mirror position. See page 111 for notes on the memory function.

**Rear view mirror, automatic ant glare**

Ant glare mode:

With the electronic key in starter switch position 2, the mirror reflection brightness responds to changes in light sensitivity.

With the gear selection lever in position "R", or with the interior light switched on, the mirror brightness does not respond to changes in light sensitivity.

Note:

The automatic ant glare function does not react, if incoming light is not aimed directly at sensors in the mirror.

**Warning!**

**In the case of an accident liquid electrolyte may escape the mirror housing when the mirror glass breaks.**

**Electrolyte has an irritating effect. Do not allow the liquid come into contact with eyes, skin, clothing, or respiratory system. In cases it does, immediately flush affected area with water, and seek medical help if necessary.**

## Exterior rear view mirrors



The buttons are located on the driver's door.

### Warning!

Exercise care when using the passenger-side exterior mirror. The mirror surface is convex (outwardly curved surface for a wider field of view). Objects in mirror are closer than they appear. Check your inside rear view mirror or glance over your shoulder before changing lanes.

## Exterior mirror adjustment

Turn the electronic key in starter switch to position 2.

Push button to select mirror to be adjusted:

Driver's side – Push button (1).

passenger-side – Push button (2).

Push the adjustment button (3) up, down, left or right according to the setting desired.

Note:

The exterior rear view mirrors have electrically heated glass. The heater switches on automatically, depending on outside temperature.

## Storing mirror positions in memory

The exterior rear view mirror positions are stored in memory with the seat/head restraint/steering column/interior rear view mirror position and can be recalled when necessary. See page 111 for notes on the memory function.

## Rear view mirrors

108

**Parking position**

The passenger-side exterior mirror can be adjusted and programmed to assist the driver during parking maneuvers (e.g. to observe the curb or other objects close to the vehicle).

With the electronic key in starter switch position 2, and the exterior rear view mirror switch in the passenger-side position, the passenger-side mirror will be turned downward when placing the gear selector lever in "R" reverse.

The mirror position can now be adjusted as desired.

At speeds above approximately 6 mph (10 km/h), upon shifting gear selector lever from "R" Reverse, or upon pressing the driver's side mirror button, the passenger-side mirror will return to its previous position.

To store passenger mirror parking position:

1. Turn electronic key to starter switch position 1 or 2.  
The vehicle must be stationary.
2. Select passenger-side mirror  and adjust the mirror to view the curb.
3. Push the memory button "M" (4).
4. Within 3 seconds push bottom of adjustment button (3).  
The mirror should not move.  
Repeat the memory procedure if the mirror moves.
5. Select driver side mirror. The passenger-side mirror will return to its previous position.

Note:

One stored parking position is available for each of the two electronic main keys or each of the KEYLESS-GO-cards (vehicles with KEYLESS-GO).

### Exterior mirror, electrically folding



The buttons are located on the driver's door.

- 1 Push button to fold both mirrors out.
- 2 Push button to fold both mirrors in.

### Important!

If an exterior mirror housing is forcibly pushed forward (hit from the rear), it must be repositioned manually by applying firm pressure until it snaps back into place.

If an exterior mirror is forcibly pushed rearward (hit from the front), press button (2) to fold mirrors in, then press button (1) to fold mirrors out. Do not force mirror by hand.

Before running the vehicle through an automatic car wash, fold mirrors in, otherwise they might get damaged.

Note:

The mirrors can vibrate if they are not completely folded out.



## Rear view mirrors

110

**Driver's side exterior mirror, antiglare mode****Antiglare mode:**

With the electronic key in starter switch position 2, the mirror reflection brightness responds to changes in light sensitivity.

With the gear selector lever in position "R", or with the interior light switched on, the mirror brightness does not respond to changes in light sensitivity.

**Note:**

The automatic antiglare function does not react, if incoming light is not aimed directly at sensors in the mirror.

**Warning!**

**In the case of an accident liquid electrolyte may escape the mirror housing when the mirror glass breaks.**

**Electrolyte has an irritating effect. Do not allow the liquid come into contact with eyes, skin, clothing, or respiratory system. In cases it does, immediately flush affected area with water, and seek medical help if necessary.**

**Important!**

Electrolyte drops coming into contact with the vehicle paint finish can only be completely removed while in their liquid state, by applying plenty of water.

## Memory function



The memory and stored position buttons are located on the doors.

- 1 Memory button, used to store selected positions which can be retrieved by pressing the buttons (2)
- 2 Stored position buttons

Two sets of seat/head restraint/steering wheel/and rear view mirror positions may be stored into memory.

Together with the driver's seat position you can store the positions for steering wheel, exterior mirrors and rear view mirror.

For the front passenger you can store the seat position.

Two stored positions are available for each of the two electronic main keys or each of the KEYLESS-GO-cards.

## Memory function

112

**Storing positions into memory:**

Driver's seat: with the electronic key in starter switch position 1 or 2 or with the driver's door open and the electronic key inserted in the starter switch.

Front passenger seat and rear seats: with electronic key in starter switch position 1 or 2 or the relevant doors open.

Adjust the seat and multicontour backrest to the desired position. You can also adjust the steering wheel, the exterior mirrors electrically and the interior rear-view mirror by hand for the driver's seat. See page 107 for exterior mirror adjustment and page 105 for steering wheel adjustment.

Push memory button "M", release and push a stored position button "1", or "2" within 3 seconds.

**Recalling positions from memory:**

To recall a seat/head restraint/steering wheel and exterior rear view mirror position, push and hold button "1" or "2" until seat/head restraint/steering wheel and exterior rear view mirror movement has stopped.

The seat/head restraint/steering wheel and exterior rear view mirror movement stops when the button is released.

**Caution!**

Do not operate the power seats using the memory button if the seat backrest is in an excessively reclined position. Doing so could cause damage to front or rear seats.

First move backrest to an upright position.

### **Important!**

Prior to operating the vehicle, the driver should check and adjust if necessary the seat height, seat position fore and aft, and backrest angle to insure adequate control, reach and comfort. The head restraint should also be adjusted for proper height. See also airbag section for proper seat positioning.

In addition, also adjust the steering wheel to ensure adequate control, reach, operation and comfort. Both the inside and outside rear view mirrors should be adjusted for adequate rearward vision.

Fasten seat belts. Infants and small children should be seated in a properly secured restraint system that complies with U.S. Federal Motor Vehicle Safety Standard 213 and Canadian Motor Vehicle Safety Standard 213.

All seat, head restraint, steering wheel, and rear view mirror adjustments as well as fastening of seat belts should be done before the vehicle is put into motion.

### **Warning!**

**Children 12 years old and under must never ride in the front seat, except in a Mercedes-Benz authorized BabySmart™ compatible child seat, which operates with the BabySmart™ system installed in the vehicle to deactivate the passenger-side front airbag when it is properly installed. Otherwise they will be struck by the airbag when it inflates in a crash. If this happens, serious or fatal injury can result.**

**According to accident statistics, children are safer when properly restrained in the rear seating positions than in the front seating positions. Infants and small children must ride in back seats and be seated in an appropriate infant or child restraint system, which is properly secured with the vehicle's seat belt, fully in accordance with the child seat manufacturer's instructions.**

**A child's risk of serious or fatal injuries is significantly increased if the child restraints are not properly secured in the vehicle and the child is not properly secured in the child restraint.**

Instrument cluster

114

Instrument cluster



- 1 Knob for instrument cluster illumination, see page 116
- 2 Engine malfunction indicator lamp, see page 296
- 3 Brake fluid low, parking brake engaged, see page 307
- 4 Supplemental restraint system (SRS) malfunction indicator lamp, see page 299
- 5 Coolant temperature gauge, see page 117
- 6 Outside temperature indicator, see page 117
- 7 Fuel gauge with reserve warning lamp, see page 299
- 8 Left turn signal indicator lamp, see combination switch, see page 160
- 9 Speedometer, see page 118
- 10 Electronic stability program (ESP) warning lamp, system is adjusting to road conditions, see page 301
- 11 Distance warning lamp – vehicles with DISTRONIC (DTR), distance to the vehicle ahead is insufficient, see page 267 and 301.
- 12 Multifunction display, see page 120  
Instrument cluster display, see page 303
- 13 Trip odometer, see page 119 and 124
- 14 Main odometer, see page 124
- 15 Right turn signal indicator lamp, see combination switch, page 160
- 16 Tachometer, see page 119
- 17 Gear range indicator display, see selector lever positions, page 236
- 18 Digital clock  
To set the time, see COMAND operator's manual
- 19 Antilock brake system (ABS) malfunction indicator lamp, see page 300
- 20 High beam headlamp indicator, see exterior lamp switch on page 156, and combination switch on page 160
- 21 Fasten seat belts, see page 302
- 22 Reset button , see pages 116, 119

## Instrument cluster

116

**Activating instrument cluster display**

The instrument cluster is activated by:

- Opening the door<sup>1</sup>.
- Pressing button **R** on the instrument cluster<sup>1</sup>.
- Turning the electronic key in starter switch to position 1 or 2.
- Switching on the exterior lamps.

<sup>1</sup> The instrument cluster is activated for approximately 30 seconds.

**Instrument cluster illumination**

The instrument cluster illumination is dimmed or brightened automatically to suit daylight lighting conditions.

Display illumination, changing basic settings for driving at dusk or in darkness:

Press adjusting knob (1) – the knob will pop out.

Rotate adjusting knob (1) clockwise – instrument lamp intensity increases.

Rotate adjusting knob (1) counterclockwise – instrument lamp intensity decreases.

Push knob back into panel.

Note:

It is not possible to select a basic brightness setting in daylight – the intensity is adjusted automatically.

### Coolant temperature gauge (5)

During severe operating conditions and stop-and-go city traffic, the coolant temperature may rise close to the red marking.

The engine should not be operated with the coolant temperature in the red zone. Doing so may cause serious engine damage which is not covered by the Mercedes-Benz Limited Warranty.

#### Warning!

- **Driving when your engine is badly overheated can cause some fluids which may have leaked into the engine compartment to catch fire. You could be seriously burned.**
- **Steam from an overheated engine can cause serious burns and can occur just by opening the engine hood. Stay away from the engine if you see or hear steam coming from it. Turn off the engine, get out of the vehicle and do not stand near the vehicle until it cools down.**

### Outside temperature indicator (6)

#### Warning!

**The outside temperature indicator is not designed to serve as an Ice-Warning Device and is therefore unsuitable for that purpose. Indicated temperatures just above the freezing point do not guarantee that the road surface is free of ice.**

The temperature sensor is located in the front bumper area. Due to its location, the sensor can be affected by road or engine heat during idling or slow driving. This means that the accuracy of the displayed temperature can only be verified by comparison to a thermometer placed next to the sensor, not by comparison to external displays (e.g. bank signs etc.).

Adaption to ambient temperature takes place in steps and depends on the prevailing driving conditions (stop-and-go or moderate, constant driving) and amount of temperature change.

Note:

The temperature indicator display can be set to read out in either Fahrenheit or Celsius. See page 138.



## Instrument cluster

118

**Speedometer (9)**

When the cruise control is activated, the segments on the speedometer scale between the set speed to the top of the scale are illuminated. Cruise control, see page 253.

When the Distronic (DTR) is activated, one or two segments around the speed stored in memory light up in the speedometer dial. Distronic (DTR), see page 256.

Note:



The speed display is set to read out for

- USA in mph
- Canada in km/h.

### **Trip odometer (13)**

To reset to “0” miles/km:

Activate the instrument cluster if it is not already activated by pressing the **R** button on the instrument cluster.

Press the  or  button on the multifunction steering wheel repeatedly until the trip odometer appears if it is not displayed. See page 124.

Press button **R** on the instrument cluster.

### **Tachometer (16)**

The red marking on the tachometer denotes excessive engine speed.

Avoid this engine speed, as it may result in serious engine damage that is not covered by the Mercedes-Benz Limited Warranty.

To help protect the engine, the fuel supply is interrupted if the engine is operated within the red marking.

Multifunction steering wheel, multifunction display

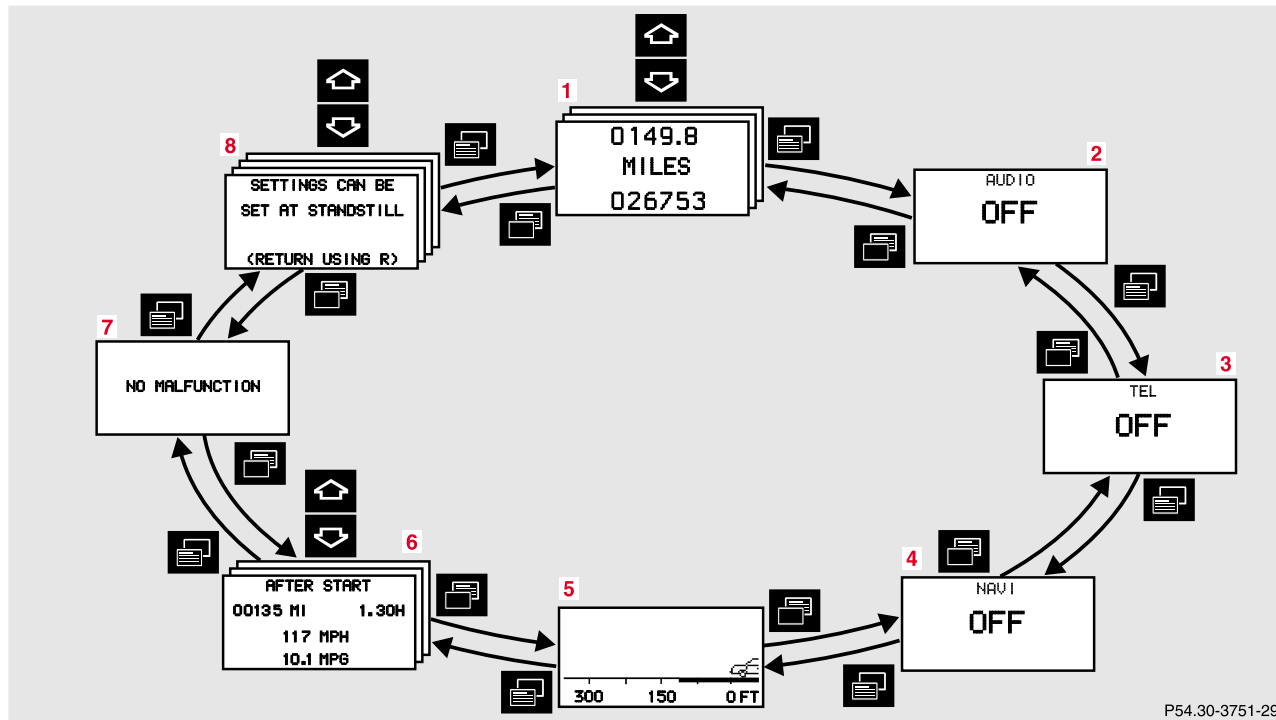



Depending on your vehicle's equipment, you may use the buttons on the multifunction steering wheel to call up, control and set the following systems in the multifunction display:

- 1** Trip odometer and main odometer, see page 119 and page 124  
Flexible service system (FSS), see page 147  
Tire inflation pressure monitor, see page 150  
Engine oil level indicator, see page 154
- 2** Audio systems, see page 125  
Radio, see page 125  
CD player, see page 126  
Cassette player, see page 127
- 3** Telephone, see page 128

- 4** Navigation system, see page 133
- 5** DISTRONIC (DTR), see page 256
- 6** Trip computer, see page 135  
After start  
After reset  
Fuel tank content
- 7** Malfunction message memory, see page 136
- 8** Individual settings, see page 138

Press the  or  button repeatedly until the required system is displayed.

The display advances by one system each time the button is pressed.

You may call up additional displays within some of these categories by pressing the  or  button.

## Multifunction steering wheel, multifunction display

122

**Warning!**

**A driver's attention to the road must always be his/her primary focus when driving.**

**For your safety and the safety of others, selecting features through the multifunction steering wheel should only be done by the driver when traffic and road conditions permit it to be done safely. Programming individual settings in the system can only be made while the vehicle is at standstill.**

**Note:**

The displays in the multifunction display can be set to German, English, French, Italian or Spanish language. See the "TEXT" individual setting on page 138 for instructions on changing the language setting.



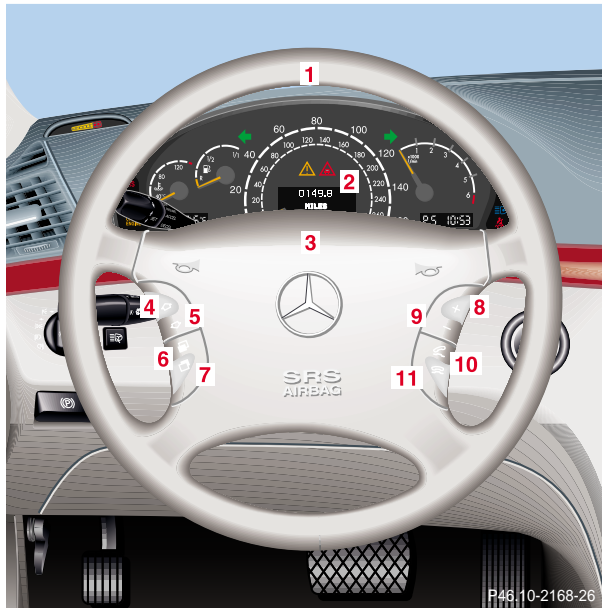





The displays for the audio systems (radio, CD player, cassette player) will appear in English, regardless of the language selected.



- 1 Multifunction steering wheel
- 2 Multifunction display
- 3 Horn pad

Turn the electronic key in starter switch to position 1 or 2.



Press button:

- 4  for next display in system
- 5  for previous display in system
- 6  for next system
- 7  for previous system.
- 8  to increase the volume, see page 146
- 9  to decrease the volume, see page 146
- 10  to dial a telephone number, see page 128
- 11  to end a call

See page 128 for telephone and page 132 for instructions on answering an incoming call.

Press the  or  button repeatedly until the required system is displayed.

The display advances by one system each time the button is pressed.

You may call up additional displays in some systems by pressing the  or  button.

## Multifunction steering wheel, multifunction display

124

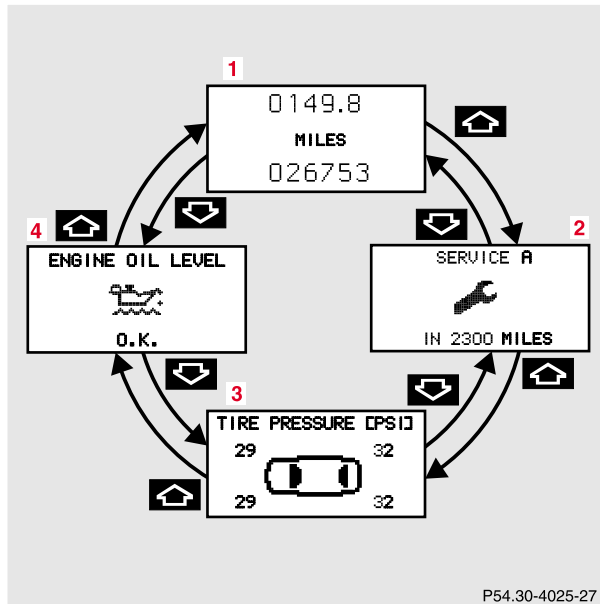
**Trip and main odometer, FSS, tire inflation pressure monitor and engine oil level indicator**

**1** Trip odometer and main odometer  
See page 119 for instructions on resetting the trip odometer.

**2** FSS (Flexible service system), see page 147

**3** Tire inflation pressure monitor, see page 150

**4** Engine oil level indicator, see page 154

Press or button repeatedly until the trip odometer and main odometer display (1) appears.

Press the or button repeatedly until the required display (2, 3, 4, 1) appears.

Pressing the or button displays the next or previous system.

## Audio systems

### Radio

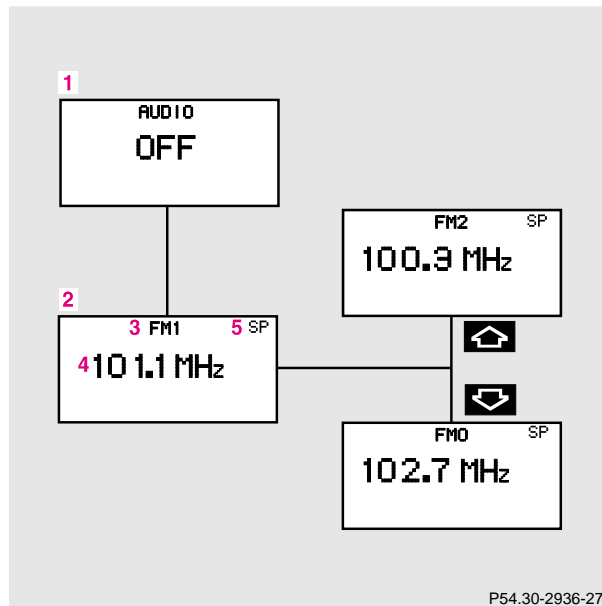

- 1 Audio system is switched off.
- 2 The radio is switched on.
- 3 Wave band setting and memory location number, where appropriate.
- 4 Station name setting or station frequency.
- 5 This only appears when “MEMORY” rather than “FREQUENCY” has been selected in the Individual settings “VEHICLE”. See page 144.

Switch on the radio, see COMAND operator’s manual.

Press the or button repeatedly until display (2) appears.

Press button or repeatedly until the required station or frequency is displayed.

Use the of button to select a stored station or station frequency. This depends on the selection made in the “STATION SEARCH USING” setting menu. See individual settings, page 138

Pressing the or button displays the next or previous system.



## Multifunction steering wheel, multifunction display

126

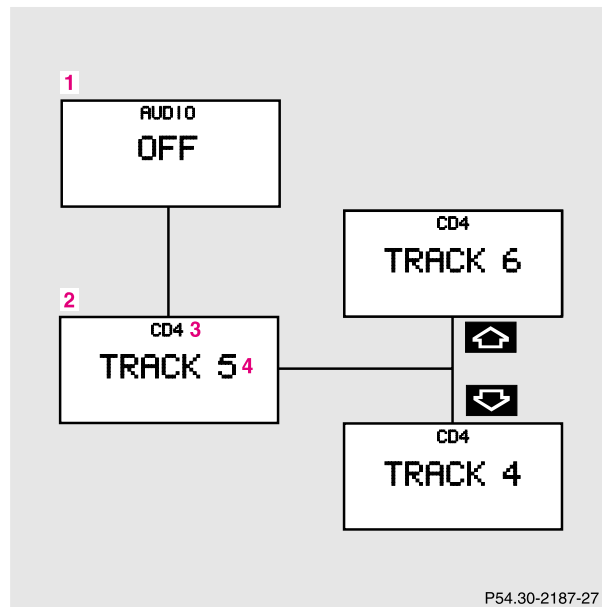

## CD player



- 1 Radio system is switched off.
- 2 The CD player is switched on.
- 3 The number of the CD currently playing is displayed if you are using a CD changer.
- 4 Track number.

Switch on the CD player, see COMAND operator's manual.

Press the  or  button repeatedly until display (2) appears.

Press the  or  button repeatedly until the required track number (4) is displayed.

Pressing the  or  button displays the next or previous system.

Note:

To select a CD from the magazine, press a number on the COMAND system key pad located in the center dashboard.

## Cassette player

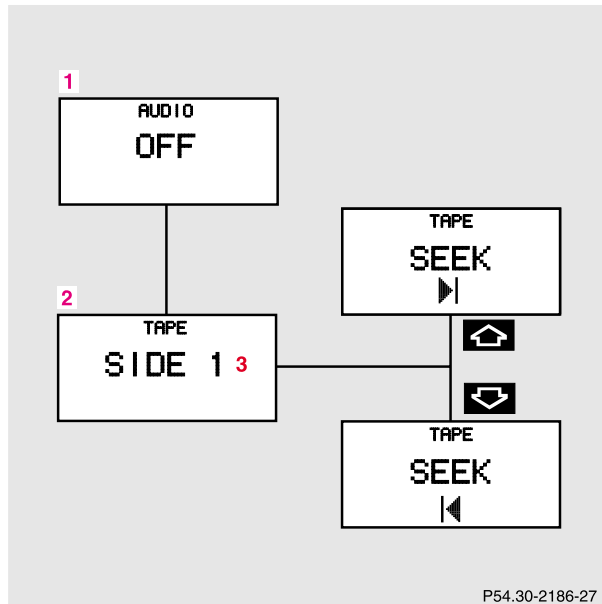

- 1 Audio system is switched off.
- 2 The cassette player is switched on.
- 3 Side being played.

Switch on the cassette player, see COMAND operator's manual.

Press the or button repeatedly until display (2) appears.

Pressing the button fast forwards on to the next track.

Pressing the button rewinds the cassette to the beginning of the current track.

Pressing the or button displays the next or previous system.

Notes:

To select the reverse side of the tape, enter request on the COMAND system located in the center dashboard.

To eject the inserted tape, press "EJT" on the COMAND system located in the center dashboard.

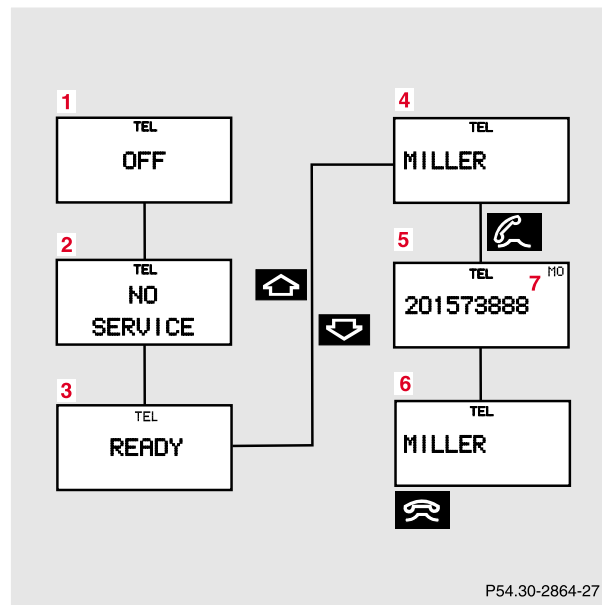

## Multifunction steering wheel, multifunction display

128





**Telephone****Telephone book**

- 1 The telephone is switched off.
- 2 The vehicle is currently outside the transmitter or receiver range.
- 3 The telephone is ready for use.
- 4 Name selected from the telephone book.
- 5 Number for the name selected. Dialing commences.
- 6 Dialing is completed. The name is displayed. The display remains for the duration of the call.
- 7 Memory location number.

The telephone must be switched on.

Press the  or  button repeatedly until the display (3) appears. See the separate telephone instructions manual.

If display (2) appears, no service is available.

Pressing  or  “browses” alphabetically forwards or backwards through the telephone book, providing it was previously downloaded. See telephone operator’s manual for details concerning downloading. Pressing button  or  for longer than a second “browses” rapidly through the telephone book. The name selected appears in the display.

Note:

Press the  button if you do not wish to make a call.

The procedure is cancelled and display (3) appears.

Press the  button when the name you require appears in the display (4). The telephone number (5) is dialed.

The name will be displayed when dialing is completed. Display (6) remains for the duration of the call.

Pressing the  button hangs up and display (3) appears.

Pressing the  or  button displays the next or previous system.

## Multifunction steering wheel, multifunction display

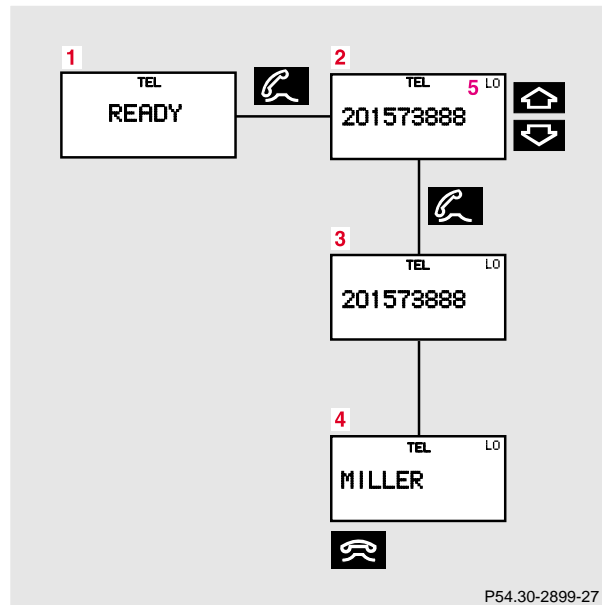

130

## Redialing





- 1** The telephone is ready for use.
- 2** Number or name stored in the redial memory.
- 3** Number in the redial memory – redialing has commenced.
- 4** Dialing is completed and the name stored in the telephone book is displayed or the number dialed will remain displayed if no name has been stored. The display remains for the duration of the call.
- 5** Memory location numbers – the 10 most recently dialed numbers are stored.  
L0, most recently dialed number,  
L1 to L9, previously dialed numbers.

The telephone must be switched on.

Press the  or  button repeatedly until the display (1) appears.

Pressing the  button activates the redial memory and the most recently dialed number is displayed.

Pressing the  or  button “browses” forward or backwards through the redial memory. The number selected appears in the display.

Note:

Press the  button if you do not wish to make a call.

The procedure is cancelled and display (1) appears.

Press the  button when the required number or name appears in the display (2).

The telephone number (3) is dialed.

Once dialing is completed the name (4) is displayed if the name is stored in the telephone book; failing that the number dialed will remain displayed. The display remains for the duration of the call.

Pressing the  button hangs up and display (1) appears.

Pressing the  or  button displays the next or previous system.

**Incoming call**

The telephone must be switched on.

**1** “CALL” – you are being called.

Press the  button to answer the call.

Press the  button to hang up or if you do not wish to answer the incoming call.

## Navigation system

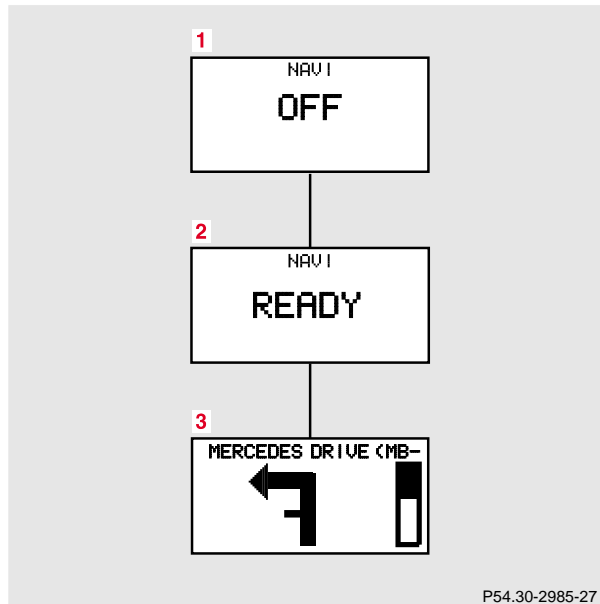

- 1** The navigation system is switched off.
- 2** The navigation system is switched on but no destination has been specified.
- 3** The navigation system is switched on and destination guidance is active.

Press the  or  button repeatedly until the required system is displayed.

See the separate COMAND (Cockpit Management and Data System) instruction manual for notes on the navigation system.

Pressing the  or  button displays the next or previous system.

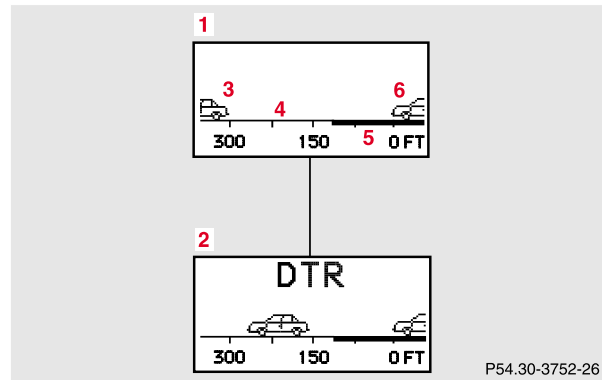

**Distronic (DTR)**

- 1 Disticronic (DTR) is deactivated. The actual distance (4) and the should-be distance (5) to the vehicle in front (3) are displayed.
- 2 Disticronic (DTR) is activated.  
The message “DTR OFF” appears for five seconds when Disticronic is being deactivated.
- 3 Vehicle ahead. Only appears if a vehicle is detected ahead.
- 4 Actual distance to vehicle ahead.
- 5 Should-be distance to vehicle ahead.
- 6 Own vehicle.

Press the  or  button repeatedly until the required system is displayed.

Disticronic (DTR) see page 256.

Pressing the  or  button displays the next or previous system.

## Trip computer

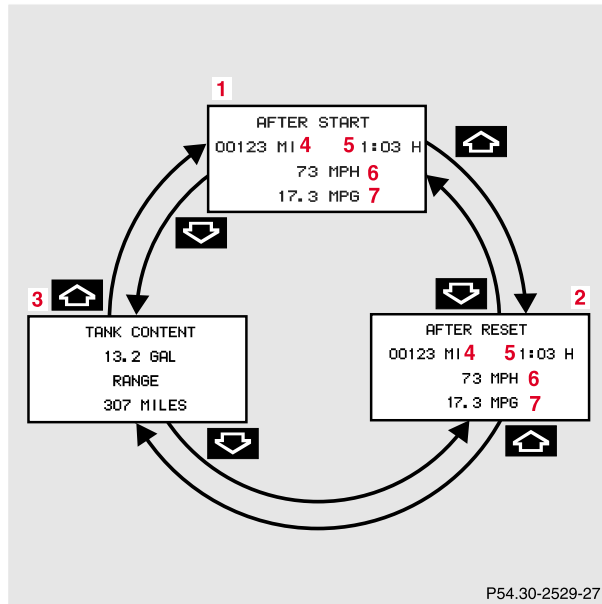

- 1 “AFTER START” – short distance memory
- 2 “AFTER RESET” – long distance memory
- 3 Fuel tank contents and estimated range remaining
- 4 Distance covered “AFTER START” or “AFTER RESET”
- 5 Elapsed time “AFTER START” or “AFTER RESET”
- 6 Average speed “AFTER START” or “AFTER RESET”
- 7 Average fuel consumption “AFTER START” or “AFTER RESET”

Press the button or repeatedly until the display (1, 2 or 3) appears.

Press the or button until the “AFTER START” short distance memory (1), the “AFTER RESET” long distance memory (2) or fuel tank contents and estimated range remaining indicator (3) appears.

Pressing the or button displays the next or previous system.

Note:

The most recently selected display (1, 2 or 3) always appears the next time the trip computer is called up.



## Multifunction steering wheel, multifunction display

136

**Transferring values from the previous journey to the “AFTER START” short distance memory (1):**



The “AFTER START” display will flash until a distance of approximately 1 mile (1.6 km) has been covered or two minutes have elapsed since the engine was restarted. During this period you can incorporate the values for the previous journey by pressing button **R** in the instrument cluster.

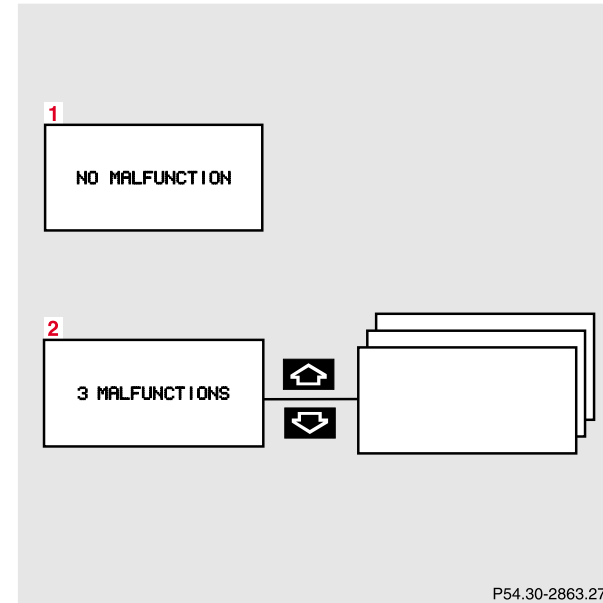

**To reset the short “AFTER START” (1) or long “AFTER RESET” distance memory (2):**

Call up the relevant display (1 or 2) using the  or  button and press the **R** button in the instrument cluster until the values are reset to “0”.

**Malfunction/warning message memory**

- 1 There are no messages stored in the system.
- 2 Number of messages stored in the system.

Press the  or  button repeatedly until the message memory (1 or 2) is displayed.

Press the  or  button if display (2) appears. The stored messages will now be displayed in order.

See page 303 for malfunction and warning messages.

Display (2) will reappear after you have scanned all the malfunction and warning messages.

Should any malfunction or warning messages be stored while driving, they will reappear in the display (2) when the electronic key is in starter switch position 0 or removed from the starter switch.

The malfunction or warning messages will now be displayed for approximately 5 seconds each. Pressing the  button in the instrument cluster displays the next malfunction and warning message immediately.

The message memory will be cleared when the electronic key is turned in the starter switch to position 1 or 2. Should any subsequent faults occur, they will be displayed in the message memory.

Pressing the  or  button displays the next or previous system.

### **Important!**

Malfunction and warning messages are only indicated for certain systems and displayed to a low level of detail. The malfunction and warning messages are simply a reminder with respect to the operation of certain systems and do not replace the driver's responsibility to maintain the vehicle's operating safety by having all required maintenance and safety checks performed on the vehicle and by bringing the vehicle to an authorized Mercedes-Benz Center to address the malfunction and warning messages. See page 303.



## Multifunction steering wheel, multifunction display

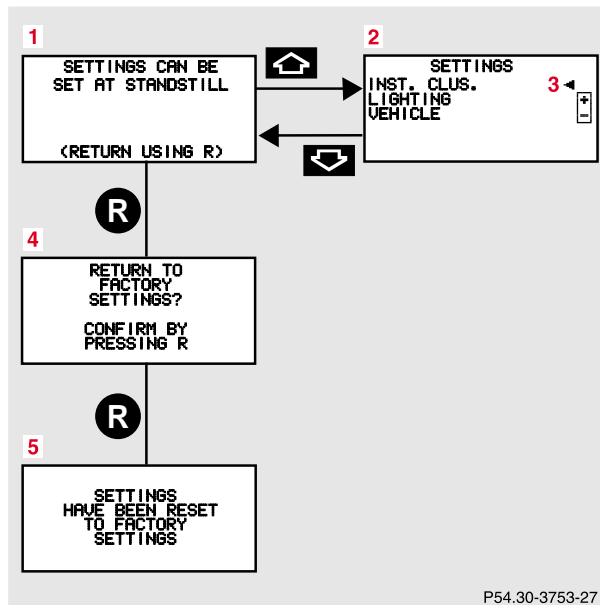

138



## Individual settings



- 1** Preliminary display of the individual settings.
- 2** “SETTINGS” – the requested menu can be called up in this options menu:  
“INSTRUMENT CLUSTER”, see page 140.  
“LIGHTING”, see page 142.  
“VEHICLE”, see page 144.  
These three menus contain additional submenus. Individual settings can be selected in these submenus.
- 3** Selection marker  
Pressing button **+** or **-** on the multifunction steering wheel controls the selection marker.
- 4** See below for instructions on returning the setting menus to the factory settings.
- 5** Acknowledgment

Press the  or  button repeatedly until the individual setting preliminary display (1) appears.

Press the  or  button until the setting menu “SETTINGS” (2) is displayed.

Pressing the  or  button controls the selection marker (3) in setting menu (2).

“INSTRUMENT CLUSTER”, see page 140.

“LIGHTING”, see page 142.

“VEHICLE”, see page 144.

Pressing the  or  button displays the next or previous system.



Notes:

These settings may only be performed with the vehicle at standstill and with the electronic key in starter switch position 1 or 2.

The individual setting preliminary display (1) will appear if you speed up.

The setting menu previously called up will reappear when the vehicle stops, providing no other system has been called up in the meantime.



**To return menu “SETTINGS” (2) to its factory setting:**



- Call up the individual setting preliminary display (1).
- Press the  button in the instrument cluster for approximately 3 seconds. Display (4) will appear.
- Press the  button once more. The menu “SETTINGS” is reset to factory settings, acknowledged by display (5).

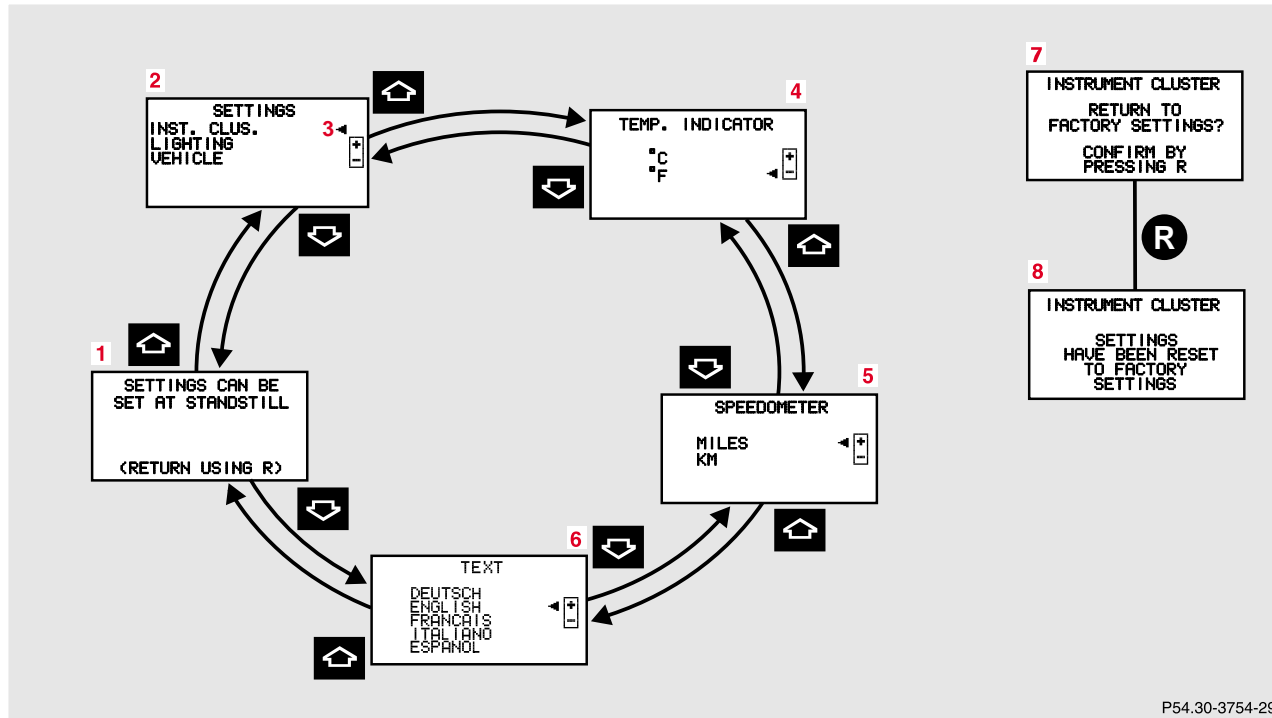

The individual setting preliminary display (1) will appear if you do not press the  button within about 5 seconds. The setting menus will not be reset.



“INSTRUMENT CLUSTER”









- 1 Preliminary display of the individual settings
- 2 “SETTINGS” – the menu “INSTRUMENT CLUSTER” can be called up in this option menu.
- 3 Selection marker  
Pressing button  or  on the multifunction steering wheel controls the selection marker.
- 4 “TEMP. INDICATOR” – the unit set is displayed in the outside temperature display, in the instrument cluster and in the automatic air conditioner display.
- 5 “DISPLAY VALUES IN” – the unit set is displayed in the multifunction display  
  
For setting clock, see separate COMAND operator’s manual.
- 6 “TEXT” – sets the language used in the multifunction display
- 7 Returning the setting menu “INSTRUMENT CLUSTER” to the factory setting.
- 8 Acknowledgment

Press the  or  button repeatedly until the individual setting preliminary display (1) appears.



Press the  or  button until the setting menu “SETTINGS” (2) is displayed.

Press button  or  until the menu “INSTRUMENT CLUSTER” is selected by the selection marker (3).

Press the  or  button until the required display (4 to 6) is displayed. Pressing the  or  button controls the selection marker. The settings made are stored and applied immediately.

The individual setting preliminary display (1) will appear again after you have run through all the setting menus. Pressing the  or  button displays the next or previous system.



**To return menu “INSTRUMENT CLUSTER” (4 to 6) to its factory setting:**

- Call up menu (4 to 6).
- Press the  button in the instrument cluster for approximately 3 seconds. Display (7) will appear.
- Press the  button once more. The menu “INSTR. CLUSTER” is reset to factory settings, acknowledged by display (8).  
The individual setting display “SETTINGS” (2) will appear if you do not press the  button within about 5 seconds. The setting menus will not be reset.



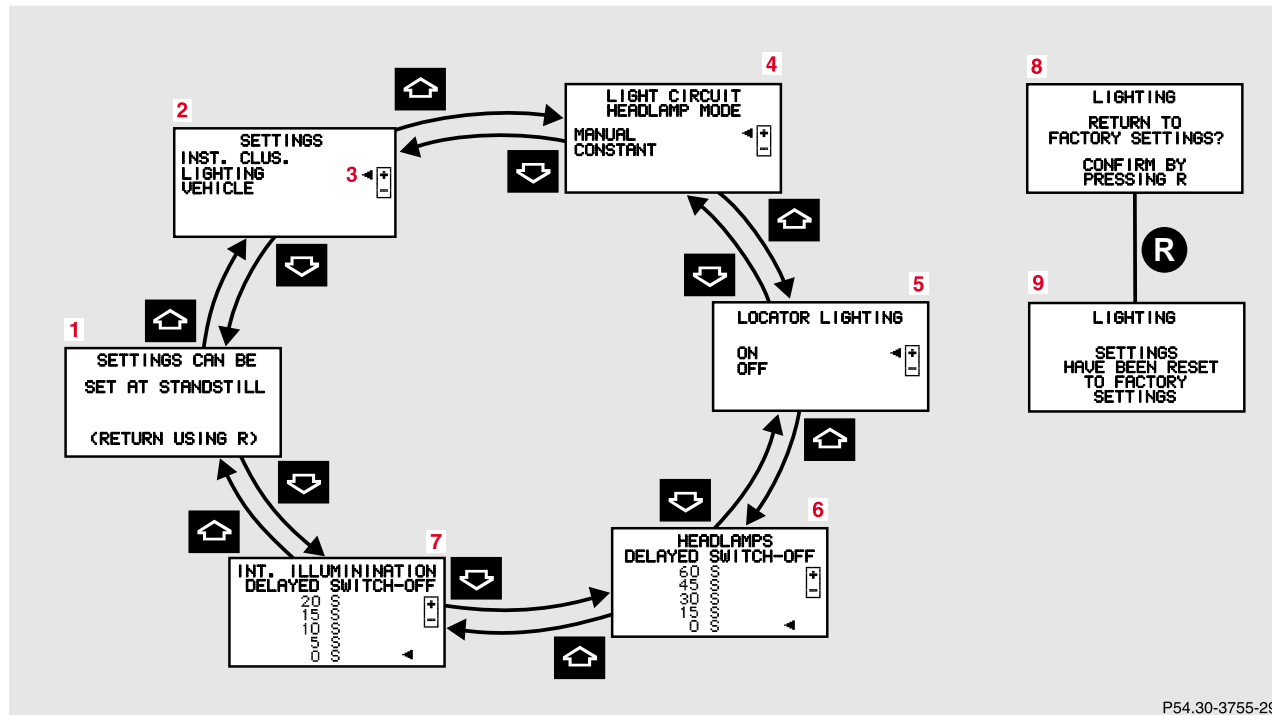



“LIGHTING”









- 1 Preliminary display of the individual settings
- 2 “SETTINGS” – the menu “LIGHTING” can be called up in this option menu.
- 3 Selection marker  
Pressing button  or  on the multifunction steering wheel controls the selection marker.
- 4 “LIGHT CIRCUIT HEADLAMP MODE”<sup>1</sup>, see page 157.
- 5 “LOCATOR LIGHTING”, see page 159.
- 6 “HEADLAMPS DELAYED SWITCH-OFF”, see “Night security illumination” on page 158.
- 7 “INT. ILLUMINATION DELAYED SWITCH-OFF”, see “Interior lighting” on page 187.
- 8 Returning the setting menu “LIGHTING” to the factory setting.
- 9 Acknowledgment



1 Except Canada

Press the  or  button repeatedly until the individual setting preliminary display (1) appears.



Press the  or  button until the setting menu “SETTINGS” (2) is displayed.

Press button  or  until the menu “LIGHTING” is selected by the selection marker (3).

Press the  or  button until the required display (4 to 7) is displayed. Pressing the  or  button controls the selection marker. The settings made are stored and applied immediately.







The individual setting preliminary display (1) will appear again after you have run through all the setting menus. Pressing the  or  button displays the next or previous system.

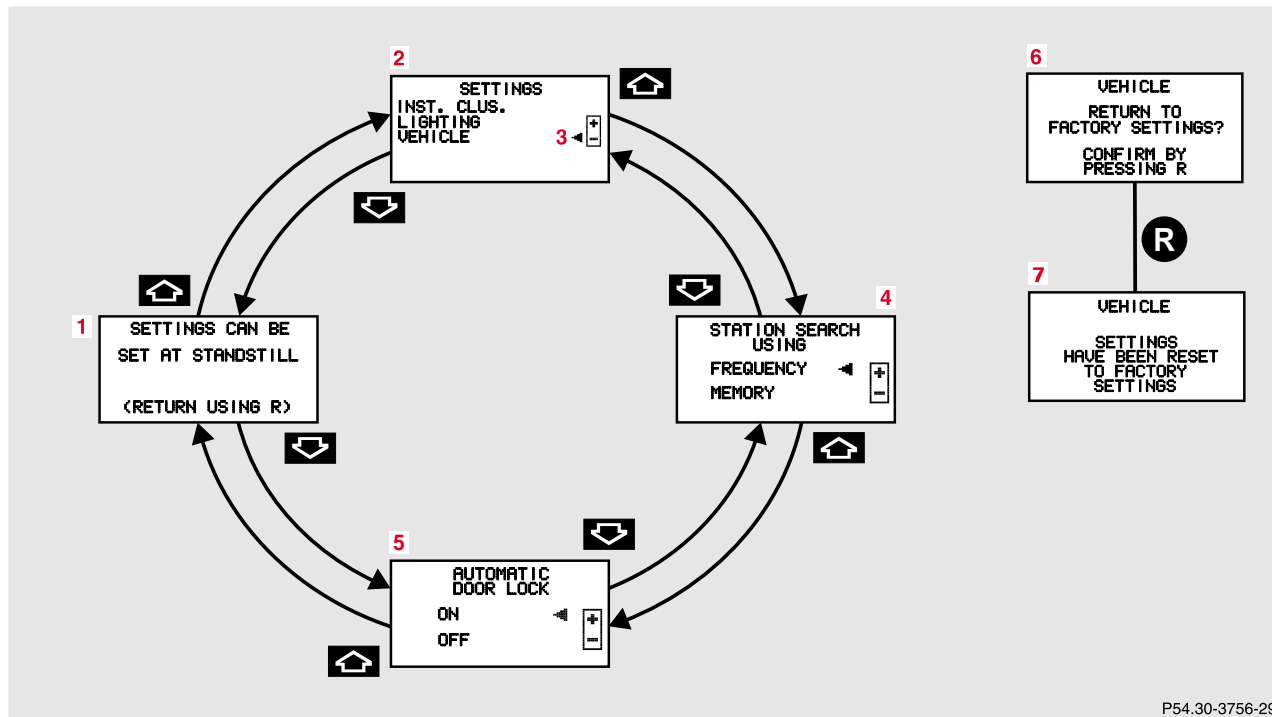

#### To return menu “LIGHTING” (4 to 7) to its factory setting:



- Call up menu (4 to 7).
- Press the  button in the instrument cluster for approximately 3 seconds. Display (8) will appear.
- Press the  button once more. The menu “LIGHTING” is reset to factory settings, acknowledged by display (9).  
The individual setting display “SETTINGS” (2) will appear if you do not press the  button within about 5 seconds. The setting menus will not be reset.



“VEHICLE” (audio and central locking system)









- 1 Preliminary display of the individual settings
- 2 “SETTINGS” – the menu “VEHICLE” can be called up in this option menu
- 3 Selection marker  
Pressing button  or  on the multifunction steering wheel controls the selection marker.
- 4 “STATION SEARCH USING”  
– radio adjustment “FREQUENCY”: use the  or  button to select a frequency.  
– radio adjustment “MEMORY”: use the  or  button to select a stored station (preset memory).
- 5 “AUTOMATIC DOOR LOCK”, see automatic central locking on page 52.
- 6 Returning the setting menu “VEHICLE” to the factory setting.
- 7 Acknowledgment

Press the  or  button repeatedly until the individual setting preliminary display (1) appears.



Press the  or  button until the setting menu “SETTINGS” (2) is displayed.

Press button  or  until the menu “VEHICLE” is selected by the selection marker (3).

Press the  or  button until the required display (4 or 5) is displayed. Pressing the  or  button controls the selection marker. The settings made are stored and applied immediately.

The individual setting preliminary display (1) will appear again after you have run through all the setting menus. Pressing the  or  button displays the next or previous system.

#### To return menu “VEHICLE” (4 and 5) to its factory setting:

- Call up menu (4 or 5).
- Press the  button in the instrument cluster for approximately 3 seconds. Display (6) will appear.
- Press the  button once more. The menu “VEHICLE” is reset to factory settings, acknowledged by display (7).  
The individual setting display “SETTINGS” (2) will appear if you do not press the  button within about 5 seconds. The setting menus will not be reset.

**Setting the audio volume**

You can only adjust the volume of the system currently in use. The volume setting for each system (audio, telephone, navigation and voice recognition system) is stored separately.

Setting button:

 increases the volume.

 reduces the volume.

### Flexible service system (FSS) (service indicator)

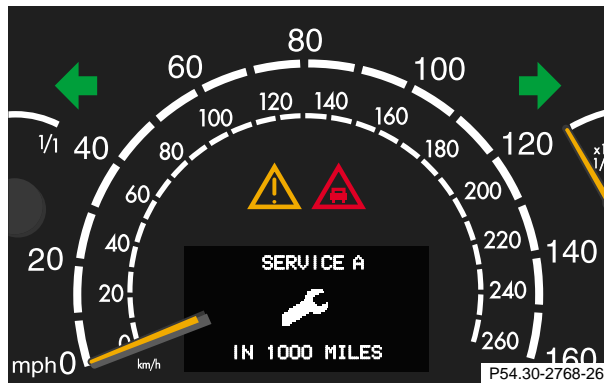

The FSS permits a flexible service schedule that is directly related to the operating conditions of the vehicle.

The symbol  or  appears together with a message in the multifunction indicator prior to the next suggested service.

Depending on operating conditions throughout the year, the next service is calculated and displayed in days or distance remaining.

The message is displayed for approximately 10 seconds when turning the electronic key in starter switch to position 2, or while driving when reaching the service warning threshold.

The symbols and messages indicate the type of service to be performed:

 Service A

 Service B

One of the following messages will appear in the display (e.g. Service A):

“SERVICE A – IN xx DAYS”

“SERVICE A – IN xx MILES” (Canada: KM)

“SERVICE A – EXCEEDED BY xx DAYS”

“SERVICE A – EXCEEDED BY xx MILES” (Canada: KM)

“SERVICE A – PERFORM SERVICE”

The next service due date is displayed either in days or in miles, depending on your driving style.

Once the suggested service term has passed, the symbol and message appear for approximately 30 seconds and a signal sounds every time when turning the electronic key in starter switch to position 2.



## Flexible service system

148



The service indicator disappears automatically after 30 seconds or if button  on the instrument cluster is pressed.

Calling up service indicator manually:

Turn the electronic key in starter switch to position 1.

Call up the trip odometer and main odometer by pressing button  or  on the multifunction steering wheel until the display appears. See page 124.

Press button  or  until the FSS indicator appears.

The next or previous system is displayed by pressing button  or .

**Important!**

The FSS indicator is not an engine oil level indicator. See page 154 for engine oil level indicator.



Note:

When disconnecting vehicle battery for one or more days at a time, such days will not be counted. Any such days not counted by the FSS can be added by your Mercedes-Benz Center.

The interval between services is determined by the type of driving for which the vehicle is used. For example, driving at extreme speeds, and cold starts combined with short distance driving in which the engine does not reach operating normal temperature, reduce the interval between services.

Following a completed A or B service the Mercedes-Benz Center sets the counter mileage to 10 000 miles (Canada: 15 000 km) and 365 days.

The counter can also be set by any individual. To do so:  
Turn the electronic key in starter switch to position 1.

To call up the trip odometer and main odometer, press button  or  on the multifunction steering wheel until the display appears. See page 124.

Press button  or  until the FSS indicator appears.

Press button  on the instrument cluster for approximately 2 seconds.

The multifunction display will show the question: “DO YOU WANT TO RESET SERVICE INTERVAL? – CONFIRM BY PRESSING R”

Press button  on the instrument cluster again to reset the service indicator.

The new service indicator is displayed with the reset distance of 10 000 miles (Canada 15 000 km).

If the FSS counter was inadvertently reset, have a Mercedes-Benz Center correct it.

However you choose to set your reference numbers, the scheduled services as posted in the Service Booklet must be followed to properly care for your vehicle.



## Tire inflation pressure monitor

150

**Tire inflation pressure monitor**

The tire inflation pressure, as selected by the driver, is monitored in all four wheels on the ground. A warning is issued to the driver in the case of a decrease in the inflation pressure in one or more of the tires.



**Warning!**

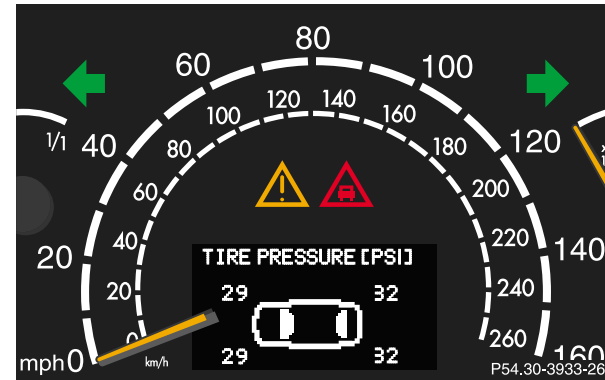

The tire inflation pressure monitor does not indicate a warning for wrongly selected inflation pressures. Always adjust tire inflation pressure according to the label affixed on the fuel filler flap. See page 348 for tire inflation pressure.

The tire inflation pressure monitor is not able to issue a warning due to a sudden loss of pressure (e.g. tire puncture caused by a foreign object). In this case bring vehicle to a halt by carefully applying the service brakes and avoiding abrupt steering maneuvers.

**Inquiry of present tire inflation pressure**

Turn electronic key in starter switch to position 1 or 2.

Press  or  button on the multifunction steering wheel until the display for trip and main odometer appears, see page 124.

Press the  or  button repeatedly until the tire inflation pressure monitor is displayed.

The present tire inflation pressure for each wheel is displayed in multifunction display.

Notes:

Following a tire inflation pressure reactivation process the real tire inflation pressures are displayed only after a few minutes travel time.

Possible differences between readings of a tire pressure gauge of an air hose, e.g. gas station equipment, and the vehicle's multifunction display can occur. The vehicle's multifunction display of the tire inflation pressure monitor is a more precise reading.

#### **Activation of tire inflation pressure monitor**

Activation of tire inflation pressure monitor is necessary if tire inflation pressure is being changed, wheels or tires are replaced, or new wheels are installed on the vehicle.

Tire inflation pressure should be checked and corrected according to the label affixed inside the fuel filler flap. For a detailed description, refer to page 348.

Turn electronic key in starter switch to position 2 (the engine must not be running).

Notes:

When checking the tire inflation pressure of the road wheels, also check the spare tire.

The tire inflation pressure of the spare wheel, mounted or not mounted, is not monitored by the tire inflation pressure monitor.



See page 338 for location of the spare wheel, and page 348 for tire inflation pressure.

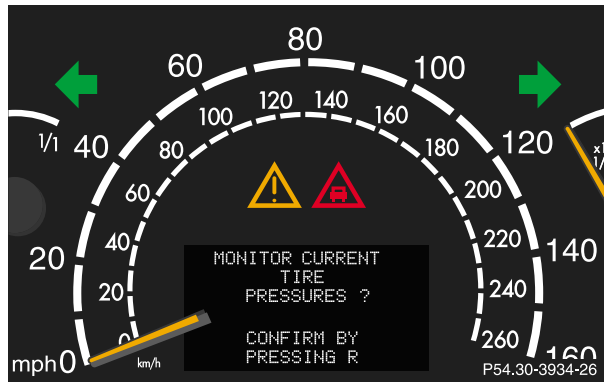

Instruments and controls	<b>Operation</b>	Driving	Instrument cluster display	Practical hints	Car care	Technical data	Index
--------------------------	------------------	---------	----------------------------	-----------------	----------	----------------	-------

## Tire inflation pressure monitor

152



Press  or  button on the multifunction steering wheel until the display for trip and main odometer appears, see page 124.

Press the  or  button repeatedly until the tire inflation pressure monitor appears.

Press and hold button  on the instrument cluster until the message “MONITOR CURRENT TYRE PRESSURES?” appears. Release button .

Press and hold button  on the instrument cluster again until the message “TYRE PRESS. CONTROL - ACTIVATED!” appears.

The tire inflation pressure monitor is now activated and monitors the presently selected tire pressure for all four wheels on the ground.

Repeat above steps if the multifunction display shows the message “TYRE PRESS. CONTROL - REACTIVATE!”.

A multifunction display showing the message “TYRE PRESSURE - CHECK TYRES!” indicates a much too low tire inflation pressure. Check and correct tire inflation pressure again on all wheels, and repeat the tire inflation pressure monitor activation steps listed above.

Notes:

To ensure proper functioning of the tire inflation pressure monitor, the tire inflation pressure should be checked and corrected according to the label affixed inside the fuel filler flap. For a detailed description, refer to page 348.

The message “TYRE PRESS. CONTROL – REACTIVATE” appears if the tire inflation pressure shows an increase of 4.4 psi (0.3 bar) or more. Reactivate the tire inflation pressure monitor.

The tire inflation pressure monitor only functions on wheels equipped with the proper electronic sensors.

Inquire at your authorized Mercedes-Benz Center about retrofitting other than original Mercedes-Benz wheels with electronic sensors.

Transporting a deflated road wheel in the vehicle, e.g. after having a flat, the tire inflation pressure monitor should only be activated once the flat tire and rim are removed from the vehicle. Otherwise the monitor displays the message “TYRE PRESS. CONTROL – CURRENTLY INACTIVE”.

To prevent possible damage to the electronic sensors, have tire changes only performed at an authorized Mercedes-Benz Center.

For malfunction and warning messages, see page 303.

Instruments and controls	<b>Operation</b>	Driving	Instrument cluster display	Practical hints	Car care	Technical data	Index
--------------------------	------------------	---------	----------------------------	-----------------	----------	----------------	-------

## Engine oil level indicator

154

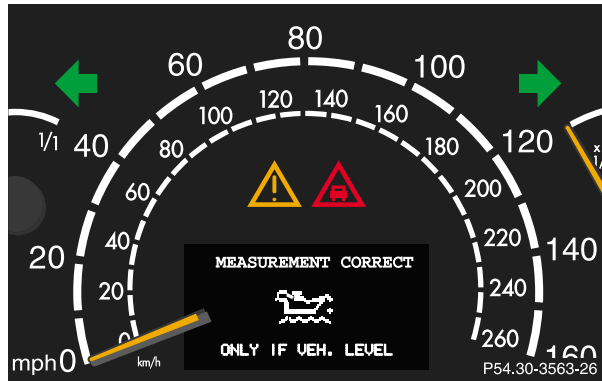
**Engine oil level indicator**

To check the engine oil level, park vehicle on level ground, with engine at normal operational temperature.

Check oil level approximately 5 minutes after stopping the engine, allowing for the oil to return to the oil pan.



The message “PERF. SERV. ON TIME” (perform service [engine oil level check] on time) will be displayed if the required waiting period has not been observed after stopping the engine:





- with engine at operational temperature approximately 5 minutes.

- with engine not at operational temperature up to approximately 30 minutes.

The engine oil level check can be repeated after a short time.

Turn the electronic key in starter switch to position 2.

To call up the trip odometer and main odometer, press button  or  on the multifunction steering wheel until the display appears. See page 124.

Press button  or  on the multifunction steering wheel repeatedly until the “MEASUREMENT CORRECT – ONLY IF VEH. LEVEL” engine oil level indicator appears. This indicator is only a reminder. Measurement can be cancelled by pressing button  or  if the vehicle is not parked on level ground. An incorrect reading will be recorded if you do not cancel the measurement. Move the vehicle to level ground and measure again.

The electronic key in starter switch is not in position 2 if the “ENGINE OIL LEVEL – SWITCH ON IGNITION” message appears.

The “ENGINE OIL LEVEL – MEASURING NOW” message is displayed after approximately 3 seconds.

One of the following messages will subsequently appear on the indicator:

**“ENGINE OIL LEVEL – O.K.”**

No oil needs to be added.

**“ENGINE OIL LEVEL – ADD 1.0 QUART”**

(Canada: 1.0 L)

**“ENGINE OIL LEVEL – ADD 1.5 QUART”**

(Canada: 1.5 L)

**“ENGINE OIL LEVEL – ADD 2.0 QUART”**

(Canada: 2.0 L)

See “Checking engine oil level”, on page 334 for instructions on adding engine oil.

**“ENGINE OIL LEVEL – REDUCE OIL LEVEL”**

Do not overfill the engine.

Excessive oil must be siphoned or drained off. It could cause damage to the engine and catalytic converter not covered by the Mercedes-Benz Limited Warranty.

The “MEASURING NOT POSSIBLE” message will be displayed if a proper oil level check cannot be performed. The engine oil level check can be repeated after a short while.

S 430, S 500 and S 55 AMG only:

Perform the engine oil level check with the dipstick, if it cannot be completed via the multifunction display.

See “Checking engine oil level”, page 334.

In this case we recommend that you have the system checked at a Mercedes-Benz Center.

Notes:

See malfunction and warning messages on page 303 and page 318 if an engine oil level indicator appears in the multifunction display when the engine is running.

The engine oil level cannot be checked while the engine is running. The “ENGINE OIL LEVEL – NOT WHEN ENGINE ON” message will appear.

**Engine oil consumption**

Engine oil consumption checks should only be made after the break-in period. During the break-in period, higher oil consumption may be noticed and is normal. Frequent driving at high engine speeds results in increased consumption.

## Exterior lamp switch

156

## Exterior lamp switch

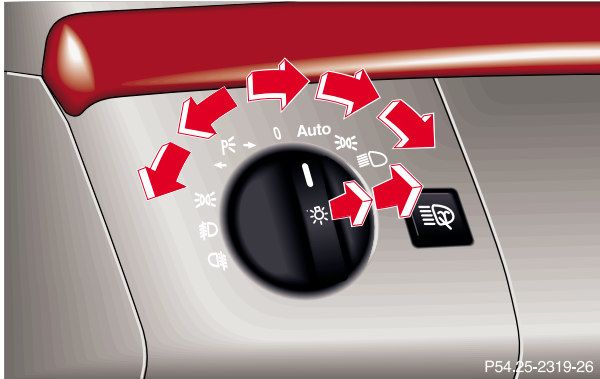

- 0** Off
- AUTO** Automatic headlamp mode, see below.
- P<=>** Parking lamps (also side marker lamps, taillamps, licence plate lamps, instrument panel lamps)  
Canada only: When the engine is running, the low beam is additionally switched on.
- 0<math>\neq</math>** Parking lamps plus low beam or high beam headlamps (combination switch pushed forward).

- P<=>** Standing lamps, right (turn left one stop)
- P<=>** Standing lamps, left (turn left two stops)
- 0<math>\neq</math>** Front fog lamps (pull out one stop) with parking lamps and/or low beam headlamps on. Green indicator in lamp switch comes on.
- 0<math>\neq</math>** Rear fog lamp (pull out to second detent) in addition to the front fog lamps. Yellow indicator in lamp switch comes on.

## Note:

With the electronic key removed and the driver's door open, a warning sounds if the vehicle's exterior lamps (except standing lamps) are not switched off.

Fog lamps will operate with the parking lamps and/or the low beam headlamps on. Fog lamps should only be used in conjunction with low beam headlamps. Consult your State or Province Motor Vehicle Regulations regarding allowable lamp operation.

Fog lamps are automatically switched off when the exterior lamp switch is turned to position **0** or **AUTO**.

**Headlamp mode (HEADLAMPS)**  
(USA only)

The headlamps can be switched on and off manually or automatically, or switched to daytime running lamp mode.

Manual operation:

The low beam headlamps, parking lamps and license plate lamps can be switched on and off with the exterior lamp switch. For exterior lamp switch, see above.

**Warning!**

**The driver is responsible for the operation of the vehicle's lights at all times. The automatic headlamp feature is only an aid to the driver. Switch on the vehicle lights by hand when driving or traffic conditions require you to do so.**

Automatic operation:

With electronic key in starter switch in position 1 turn exterior lamp switch to position **AUTO**.

The parking lamps switch on and off automatically depending on the brightness of the ambient light.

With the engine running and exterior lamp switch in position **AUTO**:

The low beam headlamps, parking lamps and license plate lamps are switched on and off automatically depending on the brightness of the ambient light.

The low beam headlamps, parking lamps and license plate lamps can still be switched on and off manually using the exterior lamp switch.

Note:

The headlamps will not be automatically switched on under foggy conditions.



## Exterior lamp switch

158

**Daytime running lamp mode**

Turn exterior lamp switch to position .

When the engine is running, the low beam headlamps (includes parking lamps and license plate lamps) are automatically switched on.

Canada only:

When shifting from a driving position to position “N” or “P”, the low beam switches off (3 minutes delay).

For nighttime driving the exterior lamp switch should be turned to position  to permit activation of the high beam headlamps.

USA only:

The high beam headlamps can also be activated when driving with the daytime running lamp mode activated and exterior lamp switch in position .

See page 156 for notes on the exterior lamp switch.

To activate the daytime running lamp mode, see “Individual settings” – “LIGHTING” on page 142.

**Night security illumination**

When turning off the engine, the exterior lamps switch on for added illumination, if they were previously switched on (except in daytime running mode). After the last door has been closed the lamp-on time period commences.

The lamp-on time period for night security illumination can be set at several different timed levels from 0 (off) to 60 seconds.

Notes:

Within 10 minutes after closing the last door the night security illumination can be reactivated by opening a door.

See “Individual settings” – “LIGHTING” on page 142 for instructions on how to activate the function.

Deactivating night security illumination temporarily:

Turn the electronic key in starter switch to position 0 then to position 2 and back to position 0 again before getting out of the vehicle. The night security illumination will not be activated when the door is opened.

### Locator lighting

After unlocking the vehicle with the electronic main key during darkness, the fog lamps, parking lamps, taillamps and license plate lamps switch on for a approximately 40 seconds.

The exterior lamps will be switched off when opening the driver's door.

See "Individual settings" - "LIGHTING" on page 142 for instructions on how to activate the function.

### Headlamp cleaning system



Turn the electronic key in starter switch to position 1 or 2.

The headlamps will be cleaned with a high-pressure water jet when you press the headlamp washer button (1).



See page 337 for instructions on filling up the windshield/headlamp washer reservoir.

## Combination switch

160

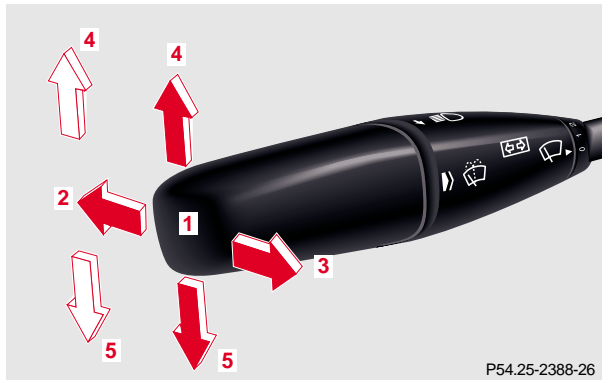
## Combination switch



- 1 Low beam  
(exterior lamp switch position )
- 2 High beam  
(exterior lamp switch position )

- 3 High beam flasher (high beam available independent of exterior lamp switch position)
- 4 Turn signals, right
- 5 Turn signals, left

To signal minor directional changes, such as changing lanes on a highway, move combination switch briefly to the point of resistance only and release. The turn signals blink three times.

To operate the turn signals continuously, move the combination switch past the point of resistance (up or down). The switch is automatically canceled when the steering wheel is turned to a large enough degree.

**Turn signal failure**

If one of the turn signals fails, the turn signal indicator system flashes and sounds at a faster than normal rate.



- 6** Press switch briefly:  
Single wipe without washer fluid  
(select only if windshield is wet).  
Push switch past resistance point:  
Windshield washer system, windshield wipers.  
See page 337 for instructions on filling the  
windshield washer reservoir.
- 7** Windshield wipers

0 Off

I Intermittent wiping

One initial wipe, pauses between wipes are automatically controlled by a rain sensor monitoring the wetness of the windshield. This will not occur with a front door open.

Notes:

With switch in this position, one wipe occurs when turning the electronic key in starter switch from position 0. This will not occur with a front door open.

Do not leave in intermittent setting when vehicle is taken to an automatic car wash or during windshield cleaning. Wipers will operate in presence of water spray at windshield, and wipers may be damaged as a result.

II Normal wiper speed

III Fast wiper speed

## Combination switch

162

**Blocked windshield wipers**

If the windshield wipers become blocked (for example, due to snow), switch off the wipers.

For safety reasons before removing ice or snow, remove electronic key from starter switch. Remove blockage.

Activate combination switch again (electronic key in starter switch position 1).

**Emergency operation of windshield wipers**

In case of windshield wiper malfunction in switch positions I or III, turn combination switch to wiper setting II. Have the system checked at your authorized Mercedes-Benz Center as soon as possible.

**Windshield wipers smear**

If the windshield wipers smear the windshield, even during rain, activate the washer system as often as necessary. The fluid in the washer reservoir should be mixed in the correct ratio.

See page 337 for instructions on filling up the windshield washer reservoir.

**Windshield and headlamp washer fluid mixing ratio**

For temperatures above freezing:

MB Windshield Washer Concentrate "S" and water.

1 part "S" to 100 parts water  
(40 ml "S" to 1 gallon water).

For temperature below freezing:

MB Windshield Washer Concentrate "S" and commercially available premixed windshield washer solvent/antifreeze.

1 part "S" to 100 parts solvent  
(40 ml "S" to 1 gallon solvent).

### Hazard warning flasher switch

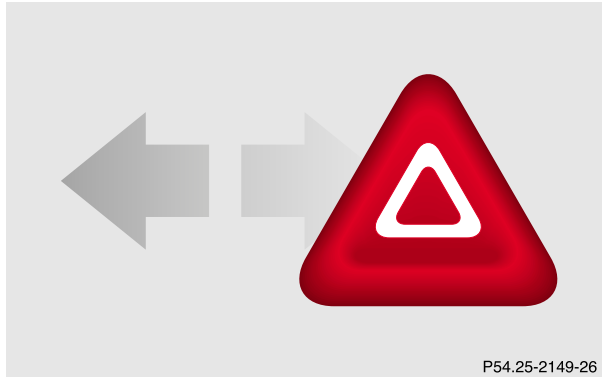

The hazard warning flasher can be activated either manually via the switch located in the dashboard, or it is activated automatically at the time an airbag is deployed.

To activate hazard warning flasher, press switch once. To deactivate, press switch again.

If hazard warning flasher was activated automatically, press switch twice to deactivate.

Note:

With the hazard warning flasher activated, the combination switch in position for either left or right turn, and the electronic key in starter switch position 1 or 2, only the respective left or right side turn signals will operate.

Automatic climate control

164

Automatic climate control

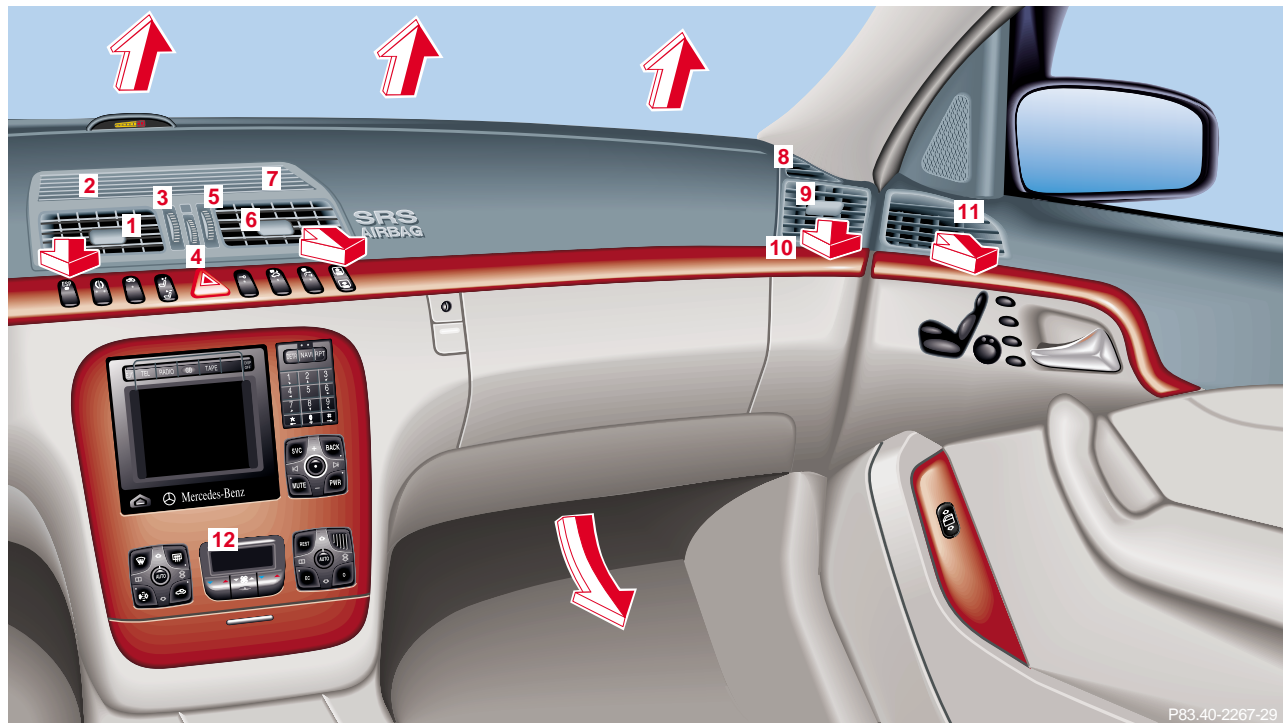

- 1 Center air outlet, left, adjustable
- 2 Fixed air outlet, left
- 3 Air volume control for left center air outlet  
To open: Turn the thumbwheel upward.  
  - : The left center air outlet is fully open.
  - ■: The left center and fixed air outlets are opened.
- 4 Air temperature control  
To lower temperature: Turn thumbwheel towards the blue marking.  
Automatic mode: Turn thumbwheel to position A. The indicator lamp above the thumbwheel will illuminate. The airflow and temperature for the center air outlets are regulated automatically.
- 5 Air volume control for right center air outlet.  
To open: Turn the thumbwheel upward  
  - : The right center air outlet is fully open.
  - ■: The right center and fixed air outlets are opened.

- 6 Center air outlet, right, adjustable
- 7 Fixed air outlet, right
- 8 Side defroster outlet, left and right, fixed
- 9 Side air outlet, left and right, adjustable
- 10 Air volume control for side air outlets  
To open: Turn thumbwheel outwards  
  - : The side air outlet is fully opened.
  - ■: The side and door air outlets are opened.
- 11 Door air outlet, left and right
- 12 Display and controls

Note:

We recommend that the sliders for the air outlets (1, 6, 9) be clicked to the automatic position to provide practically draft free ventilation.



## Automatic climate control

166

## Display and controls



- 1 Defrosting
- 2 Rear window defroster, see page 180
- 3 Residual engine heat utilization, see page 174
- 4 Automatic climate control on/off
- 5 Air distribution, right (automatic, manual operation)
- 6 Economy mode, see page 173
- 7 Temperature control, right

- 8 Air volume (automatic, manual)
- 9 Display

Depending on the ambient light conditions, the figures on the display will be shown as dark figures on a bright background (in daylight), or as bright figures on a dark background (at night).

- 10 Temperature control, left
- 11 Air recirculation, see page 171
- 12 Air distribution, left (automatic, manual operation)
- 13 Activated charcoal filter

**Important!**

This vehicle is equipped with an air conditioning system that uses R-134a (HFC: hydrofluorocarbon) as a refrigerant. Repairs should always be performed by a qualified technician, and refrigerant should be collected in a recovery system for recycling.

### Automatic climate control

The system is always at operational readiness, except when manually switched off.

The automatic climate control only operates with the engine running.

The temperature selector should be left at the desired temperature setting. The temperature selected is reached as quickly as possible.

The system will not heat or cool any quicker by setting a higher or lower temperature.

The desired interior temperature and air distribution can be selected separately for the left and right side of the passenger compartment.

The automatic climate control removes considerable moisture from the air during operation in the cooling mode. It is normal for water to drip on the ground through ducts in the underbody.

The air conditioning will not engage (no cooling) if the economy mode **EC** is selected, see page 173.

### Notes:

Do not obstruct the air flow by placing objects on the air flow-through exhaust slots below the rear window.

Also keep the air intake grill in front of the windshield free of snow and debris.

The storage compartment between the front seats can be ventilated. See page 175 for notes on ventilating the storage space under the armrest in the center console.

The air conditioner switches itself off for its own protection if refrigerant is lost. No cooling will then take place. Economy mode **EC** cannot be switched off. Have the air conditioner checked by a Mercedes-Benz Center should this happen.

### Dust filter

Nearly all dust particles and pollen are filtered out before outside air enters the passenger compartment through the air distribution system.

## Automatic climate control

168

## Basic setting – automatic mode

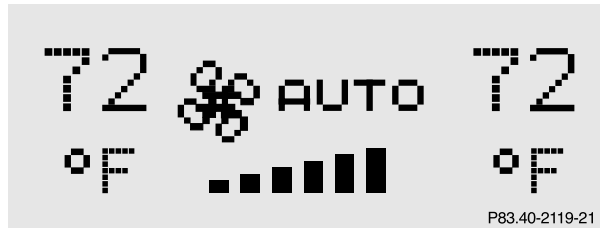

There are three basic settings for the automatic mode:

- Automatic air volume control
- Automatic air outlet control, left and right
- Automatic air outlet control, center, see page 165

We recommend these settings to be used all year round.



Air volume and distribution are controlled automatically.

Set the temperature switches on the left and right to 72°F (22°C). This provides for comfortable conditions in the vehicle.

**Automatic airflow regulation:**

Press the **A** on the air volume switch. The display shows "AUTO".

**Automatic air distribution:**



Press on both **AUTO** knobs until they click in. The ,  and  symbols will no longer be visible.

The economy mode and air recirculation functions will be switched off. The automatic blower will be activated at the same time.

### Special Settings

(use only for short duration)

Air distribution, manual:



Press **AUTO** button. The button pops out, the ,  and  symbols are visible. Turn the button to select the air distribution desired.

 Air from the center, side and door air outlets.

 Air from the center, side, door and windshield air outlets.

 Air from the center, side, door and footwell air outlets.

To return to automatic mode:

Press the **AUTO** button until it clicks in. The ,  and  symbols will no longer be visible.

### Air volume, manual

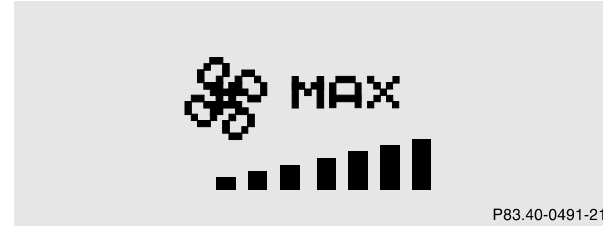



Press the air volume switch up or down. Seven blower speeds can be selected.

## Automatic climate control

170

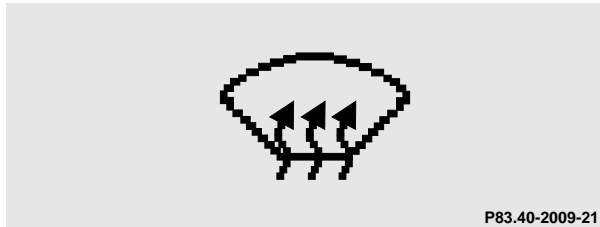
## Defrosting





Press the  button. The display shows .

The fan is set to a higher speed and the warm air is directed to the defroster and windshield air outlets.

Pressing the switch again returns the system to the previous setting.

## Windows fogged on the inside

Switch off the economy mode, if selected: Press button . The indicator lamp in the button will go out.

Switch off air recirculation, if selected: Press button . The indicator lamp in the button will go out.

Adjust left and right air outlets upwards.



Set blower to the maximum blower speed.

Increase temperature setting.

Open the side air outlets and direct them onto the side windows.



### Windshield fogged on the outside

Switch on the windshield wiper.



Press on both **AUTO** buttons until they click in. The ,  and  symbols will no longer be visible.

### Air recirculation



Select air recirculation:

The indicator lamp in the  button is off. Press button  briefly. The indicator lamp in the button illuminates.



To switch off the air recirculation:

The indicator lamp in the  button is on. Press button  briefly. The indicator lamp in the button will go out.

Switching on air recirculation and activating convenience closing:

The indicator lamp in the  button is off. Press button  for more than 2 seconds, the side windows and the sliding/pop-up roof will be closed. The indicator lamp in the button lights up.

Switching off air recirculation and activating convenience opening:

The indicator lamp in the  button is on. Press button  for more than 2 seconds, the side windows and the sliding/pop-up roof return to the position they were in before closing.

A window or the sliding/pop-up roof opened manually after convenience closing will no longer be returned to the position it was in before closing when convenience opening is selected.

The system automatically switches from air recirculation to fresh air:

- after 30 minutes if the outside temperature is above about 40°F (5°C),
- after 5 minutes if the outside temperature is below about 40°F (5°C),
- after 5 minutes if economy mode **EC** is selected.

The system switches automatically to air recirculation at high outside temperatures. A quantity of outside air is added after about 30 minutes.

If the windows should fog up from the inside, switch from recirculated air back to fresh air.

## Automatic climate control

172

**Activated charcoal filter**

An activated charcoal filter markedly reduces bad odors and removes pollutants from air entering the passenger compartment.

To select, press  button. The indicator lamp in the button illuminates.



To cancel, press button. The indicator lamp in the button goes out.

The system switches automatically to the air recirculation mode, if the carbon monoxide (CO) or nitrogen oxides (NO<sub>x</sub>) concentration of the outside air increases beyond a predetermined level.



The automatic air recirculation mode does not function if economy mode  is selected or if the outside temperature has fallen below 40°F (5°C).

The activated charcoal filter should be switched off when windows fog up on the inside, or if the passenger compartment needs to be quickly heated or cooled down.

Switching on the activated carbon filter and activating convenience closing:

The indicator lamp in the  button is off. Press button  for more than 2 seconds, the side windows and the sliding/pop-up roof will be closed. The indicator lamp in the button lights up.

Switching off activated carbon filter and activating convenience opening:

The indicator lamp in the  button is on. Press button  for more than 2 seconds, the side windows and the sliding/pop-up roof return to the position they were in before closing.

A window or the sliding/pop-up roof opened manually after convenience closing will no longer be returned to the position it was in before closing when convenience opening is selected.

### Economy mode

The function of this setting corresponds to the automatic mode. However, because the air conditioning compressor will not engage (fuel savings), it is not possible to air condition in this setting.

Press **EC** button to activate. The indicator lamp in the button illuminates.

Press **EC** button once again to return to the previous setting.

### Important!

In the **EC** mode the windows could fog up on the inside. Switch off **EC** mode.



## Automatic climate control

174

## Residual engine heat utilization



With the engine switched off, it is possible to continue to heat or ventilate the interior for a short while. Air volume and distribution are controlled automatically.

To select:

Turn the electronic key in starter switch to position 1 or 0 or remove it altogether.

Press button **REST**. The display shows “REST”.

This function selection will not activate if the battery level is insufficient.

The function switches off automatically:

- if the electronic key in starter switch is turned to position 2,
- after approximately 30 minutes (if residual engine heat utilization is selected on the optional rear air conditioner: after approximately 15 minutes),
- if the battery voltage drops.

Note:

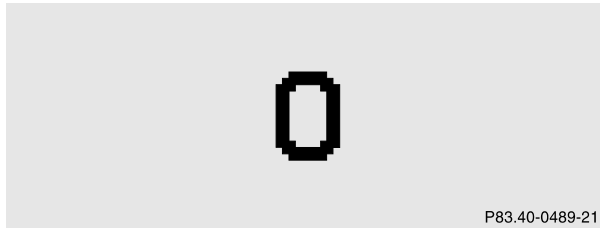

The battery symbol  will appear in the automatic climate control display some time before the residual engine heat utilization is switched off if the battery voltage drops.

### Switching the automatic climate control on and off



To switch off:  
Press button 0. The display shows “0”.

The fresh air supply to the vehicle interior is shut off.  
While driving, use this setting only temporarily,  
otherwise the windshield could fog up.

To switch on:  
Press button 0 or  or at least one of the  buttons so that it pops out and then click it back in.

### Front center console storage compartment ventilation

The front center console compartment has its own air outlet.

To open: Slide the lever up.

To close: Slide the lever down.

The air volume is dependent on the setting of:

- air distribution control,
- air volume control,
- air outlets in the dashboard.

The air temperature is about the same as that of the dashboard air outlets. It cannot be regulated separately.

Note:

The compartment can get very warm due to its confined space. When storing heat sensitive objects in the compartment, close the air outlet while heating the passenger compartment.

Do not allow articles to obstruct the air outlet in the storage compartment.

## Automatic climate control

176

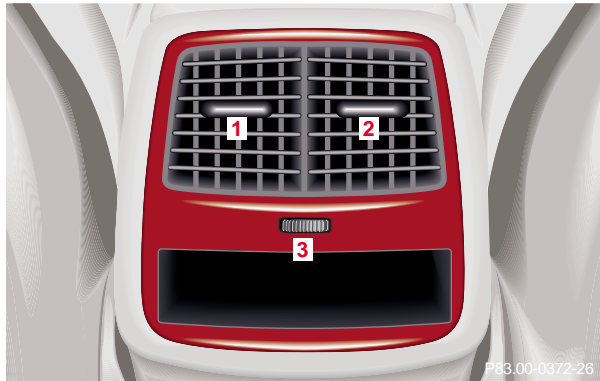
**Rear passenger compartment adjustable air outlets**

- 1** Center air outlet, left
- 2** Center air outlet, right
- 3** Air volume control for center air outlets  
(vehicles without rear air conditioner)  
To open: Turn the wheel to the left.

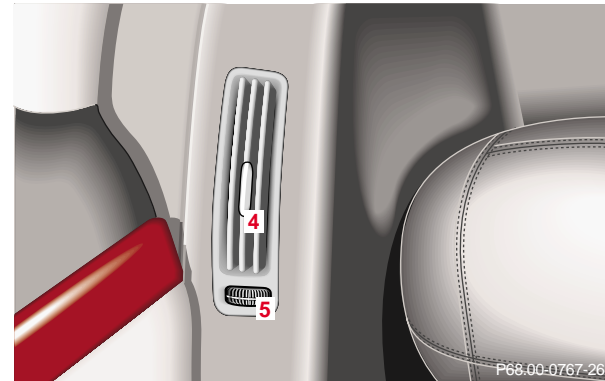

- 4** Rear side air outlet, right and left
- 5** Air volume control for rear side air outlet  
To open: Turn thumbwheel towards the window.

### Rear passenger compartment climate control



- 1** On/off  
Residual engine heat utilization, see page 174.
- 2** Display  
Depending on the ambient light conditions, the figures on the display will be shown as dark figures on a bright background (in daylight) or as, bright figures on a dark background (at night).

- 3** Air distribution up/down
- 4** Temperature control, right
- 5** Air volume (automatic, manual)
- 6** Temperature control, left
- 7** Adjustable rear center air outlet, left
- 8** Adjustable rear center air outlet, right

#### Note:

The rear air conditioner will not cool the air if the **EC** button on the automatic air conditioner is pressed.

The temperature on both sides is automatically set to 72°F (22°C) if the rear seats are not occupied (rear seat belts unbuckled).

## Automatic climate control

178

## Automatic climate control, rear basic setting

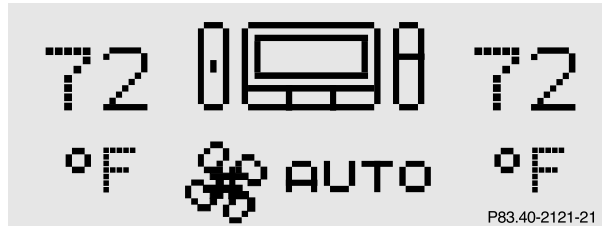

We recommend that automatic mode be selected and that the temperatures on the left and right set to 72°F (22°C). This provides for comfortable conditions in the rear of the vehicle.

Press A on the air volume switch. The display shows "AUTO". Air volume is set automatically.

## Air volume, manual

Press the air volume switch up or down. Seven blower speeds can be selected.

### Controlling the rear air conditioner from the front automatic air conditioner control panel

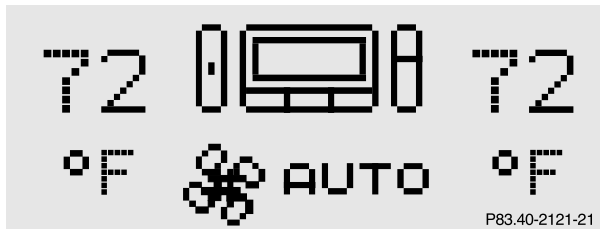

The rear air conditioner can be switched off and the blower and temperature settings can be changed from the automatic air conditioner control panel in the center console.

Press A on the air volume switch and hold until the display illustrated above is shown.

The rear air conditioner can be switched on and off by pressing the 0 button. The blower setting for the rear air conditioner can be controlled with the air volume switch and the temperature setting for the rear air conditioner can be set with the temperature control switches.

The message in the display disappears approximately 4 seconds after the button is pressed for the last time and the automatic air conditioner switches to normal operation.

## Automatic climate control

180

**Rear window defroster**

Turn the electronic key in starter switch to position 2.

To select:

Press the  button in the control panel of the automatic air conditioner. The indicator lamp in the button illuminates.

To cancel:

Press the  button in the control panel of the automatic air conditioner. The indicator lamp in the button goes out.

Note:

Heavy accumulation of snow and ice should be removed before activating the defroster.

The rear window defroster uses a large amount of power. To keep the battery drain to a minimum, turn off the defroster as soon as the rear window is clear.

The defroster is automatically turned off after approximately 6–23 minutes of operation depending on the outside temperature and vehicle speed.

If several power consumers are turned on simultaneously, or the battery is only partially charged, it is possible that the defroster will automatically turn itself off. When this happens, the indicator lamp inside the switch starts blinking.

As soon as the battery has sufficient voltage, the defroster automatically turns itself back on.

## Power windows

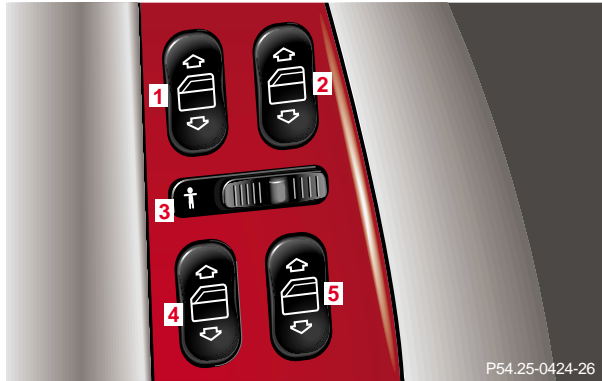

The control panel is located on the driver's door.

Switches for:

- 1 left, front
- 2 right, front
- 3 Switch for rear door window override
- 4 left, rear
- 5 right, rear

There are individual switches in the front passenger door and the rear door for the respective windows.

Turn electronic key in starter switch to position 1 or 2.

Opening the side windows:

Press  on the switch to resistance point.

Closing the side windows:

Press  on the switch to resistance point.



Release switch when window is in desired position.





## Interior equipment

182

**Express opening and closing of windows**

Press  or  on the switch past resistance point and release – window opens or closes completely.

To interrupt procedure, briefly press  or .

If the upward movement of the window is blocked during the closing procedure, the window will stop during the last few inches before closure and open slightly.

When pressing and holding the switch  to close the window, and upward movement of the window is blocked during the last few inches before closure, it will stop but not open slightly.

Note:

The power windows can also be opened and closed using the convenience opening/closing function, see page 45.

**Warning!**

**When closing the windows, be sure that there is no danger of anyone being harmed by the closing procedure.**

**In case of obstruction, the automatic reversal will not operate if a window is being closed by pressing the switch to its resistance point and holding it there, or when using a mechanical key or the electronic key.**

**The closing procedure of door windows can be immediately reversed by either pressing the switch or pressing button  on the electronic main key and holding it, or (vehicle with KEYLESS-GO) when carrying the KEYLESS-GO-card, pull and hold a door handle.**

**When leaving the vehicle, always remove the electronic key from starter switch, take the KEYLESS-GO-card (if so equipped) with you, and lock your vehicle. Do not leave children unattended in the vehicle, or with access to an unlocked vehicle. Unsupervised use of vehicle equipment can cause serious personal injury.**

### Blocking of rear door window operation

If no operation of the rear windows by switch (for instance by children) is desired, slide override switch (3) to the right; the  symbol becomes visible.

Operation of the rear windows with the switches located in the driver's door is still possible.

### Synchronizing power windows

If the power supply was interrupted, (battery disconnected or low), the windows cannot be opened or closed by the express feature.

To resynchronize the express feature, press  side of power window switch until the window is completely closed and hold down for approximately 1 second. Repeat procedure for each window.

The automatic full opening and closing procedure of the windows should now be restored.

## Interior equipment

184

## Sliding/pop-up roof

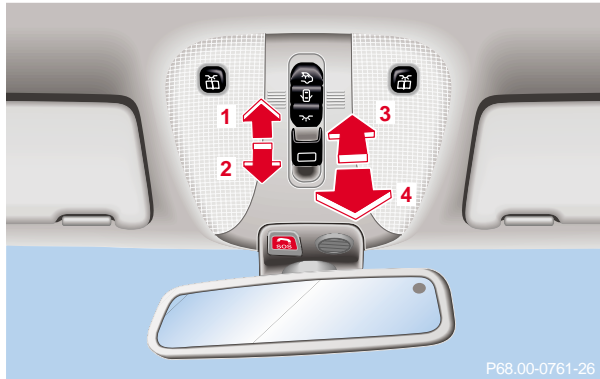

- 1 to slide roof open
- 2 to slide roof closed
- 3 to raise roof at rear
- 4 to lower roof at rear

Turn the electronic key in starter switch to position 1 or 2.

To open, close, raise or lower the sliding/pop-up roof: Move the switch to resistance point in the required direction.

Release the switch when the roof has reached the required position.

**Warning!**

**When closing the sliding/pop-up roof, be sure that there is no danger of anyone being harmed by the closing procedure.**

**When leaving the vehicle, always remove the electronic key from starter switch, take the KEYLESS-GO-card (if so equipped) with you and lock your vehicle. Do not leave children unattended in the vehicle, or with access to an unlocked vehicle. Unsupervised use of vehicle equipment can cause serious personal injury.**

### Opening the sliding/pop-up roof automatically

To select a sunroof opening position, press the switch to resistance point and release it when the sunroof has reached the required position.

The sliding/pop-up roof now opens to the position set if the switch is pressed past resistance point in the “open” direction.

If you wish to change the opening position of the sunroof, move the switch to resistance point in the direction you require.

Stopping the sliding/pop-up roof:  
Move the switch in any direction.

If the movement of the sliding/pop-up roof is blocked during the closing procedure, the sunroof will stop and reopen slightly.

Note:

Opening the sliding/pop-up roof automatically almost fully (less approximately 1 inch [3 cm]), the sunroof must have been opened first by pressing the switch to resistance point and releasing it when the sunroof has reached an almost fully open position.

### Warning!

**When closing the sliding/pop-up roof, be sure that there is no danger of anyone being harmed by the closing procedure.**

**In case of obstruction, the automatic reversal will not operate if the sliding/pop-up roof is being closed by moving the switch to its resistance point and holding it there, or when using the electronic main key or the lock button at each door handle (vehicles with KEYLESS-GO).**

**The closing procedure of the sliding/pop-up roof can be immediately reversed by either moving the switch in any direction, or pressing button  on the electronic main key and holding it; or (vehicles with KEYLESS-GO) when carrying the KEYLESS-GO-card, pull and hold a door handle.**

**When leaving the vehicle, always remove the electronic key from starter switch and take the KEYLESS-GO-card (if so equipped) with you, and lock your vehicle. Do not leave children unattended in the vehicle, or with access to an unlocked vehicle. Unsupervised use of vehicle equipment can cause serious personal injury.**

## Interior equipment

186

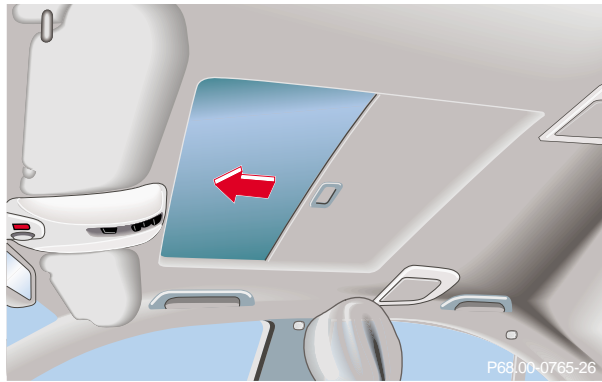

With the roof closed or tilted open, a screen can be slid into the roof opening to guard against sun rays. When sliding the roof open, the screen will also retract.

## Notes:

The sliding/pop-up roof can also be opened and closed using the summer opening/convenience feature, see page 45.

To avoid damaging the seals, do not transport any objects with sharp edges which can stick out of the sliding/pop-up roof.

The sliding/pop-up roof can be opened or closed manually should an electrical malfunction occur, see page 369.

**Synchronizing the sliding/pop-up roof**

The sliding/pop-up roof must be resynchronized if the power supply has been interrupted (battery disconnected or low), the sliding/pop-up roof has been closed manually or the sliding/pop-up roof does not open smoothly or malfunctions.

- Press the switch in the “raise” (3) direction, wait until the sliding/pop-up roof is fully raised at rear and hold the switch for approximately 1 second.

## Interior lighting



### 1 Left front reading lamp

Press the button to switch the reading lamp on or off. The left reading lamp (7) in the interior rear view mirror will be switched on or off.

### 2 Rear interior lights

Press the button to switch the rear passenger compartment lights on/off.

### 3 Right front reading lamp

Press the button to switch the reading lamp on or off. The right reading lamp (8) in the rear view mirror will be switched on or off.

### 4 Door contact switch

Press the rocker switch:

The interior lighting remains switched off, even when centrally unlocking or opening a door or the electronic key is removed from the starter switch.

### 5 To select automatic function:

Press the rocker switch to the center position.

Interior lamps are switched on, and off (soft fade) delayed, when unlocking or locking the vehicle, or when opening or closing a door. However, there will be no (soft fade) delay when the electronic key is in starter switch position 2.

Note:

The time delay for the interior light to switch off after the electronic key is removed from the starter switch can be adjusted in the “Individual settings” – “LIGHTING”. See page 138.

## Interior equipment

188

To prevent the vehicle battery from being discharged with doors open, all interior lamps switch off after approximately 5 minutes.

- 6** Interior lamps, front:  
Press rocker switch in to switch front interior and reading lamps on. The front interior lighting stays on while the rocker switch is pressed in.
- Switching off the front interior lighting:  
Press rocker switch to position (4) or (5).

## Rear reading lamp

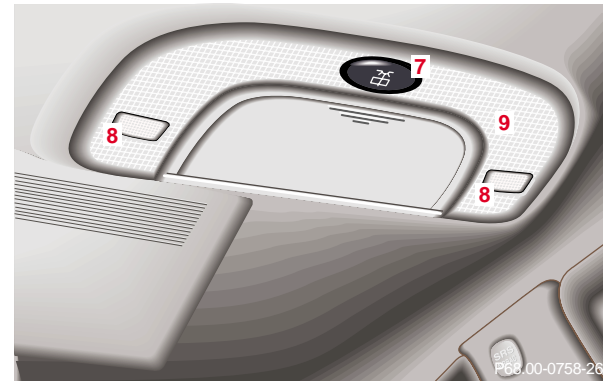

- 7** The rear reading lamps (9) are switched on and off individually with a switch (8) in the respective lamp.

### **Courtesy lighting**

The interior of your vehicle is equipped with various different lighting installations to help you to orient yourself better in the dark.

### **Entrance lamps, exit lamps**

With exterior lamps on or electronic key in starter switch position 1, the lamps in the door trays illuminate.

The lights will remain on for approximately 5 minutes if the electronic key is in starter switch position 0 and exterior lamps are switched off.

### **Footwell lighting**

With exterior lamps on, the footwell is illuminated.

### **Center console lighting**

Turn the electronic key in the starter switch to position 1. The center console is illuminated from the rear-view mirror.

### **Door entry lamps**

The appropriate entry lamp switches on if a door is opened in darkness and if the interior lighting is switched to automatic function.

The entry lamp switches off automatically when the door is closed.



## Interior equipment

190

**Rear window sunshade**

The switch is located on the dashboard above the center display.

Turn the electronic key in starter switch to position 1 or 2.

Press the switch briefly:

- 1** to raise
- 2** to lower

Always raise the sunshade fully for its support against the window frame.

**Warning!**

When operating the rear window sunshade, be sure that there is no danger of anyone being harmed by the raising or lowering procedure.

The raising or lowering procedure can be immediately halted by briefly pressing the upper or lower half of the switch.

Briefly press upper or lower half of the switch again to raise or lower the rear window sunshade completely.

When leaving the vehicle, always remove the electronic key from starter switch, and lock your vehicle. Do not leave children unattended in the vehicle, or with access to an unlocked vehicle. Unsupervised use of vehicle equipment can cause serious personal injury.

### Rear door window sunshade (standard on S 600)

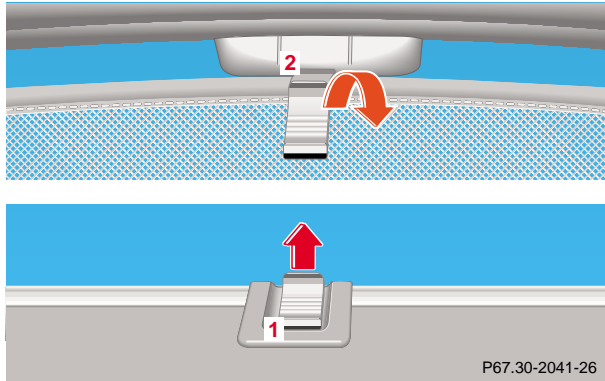

To raise sunshade:  
Pull up on tab (1) and engage in holder (2).

To lower sunshade:  
Disengage tab (1) and guide retraction.

### Sun visors

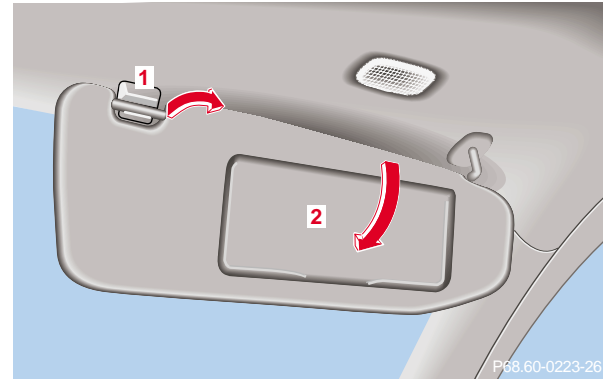

Swing sun visors (2) down to protect against sun glare.  
If sunlight enters through a side window, disengage sun visor (1) from the inner mounting and pivot to the side.

## Interior equipment

192

## Vanity mirrors

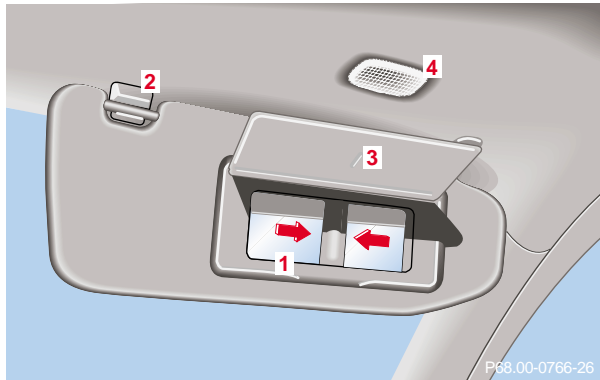
**1** Illuminated vanity mirror

Front seats:

With the visor engaged in its inner mounting (2), the lamp (4) can be switched on by opening the cover (3).

Slide the mirror to the left or right for a normal or magnified image.

Fold the cover down to close the vanity mirror.

**Warning!**

**Do not use the vanity mirror while driving.**

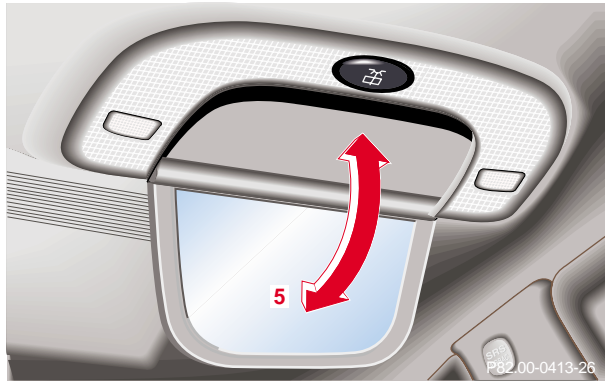

**5** Illuminated vanity mirror

Rear seats:

Touch the cover to lower the mirror. The lamp will switch on automatically.

Close the cover and the lamp will go out.

**Interior**

**Warning!**

To help avoid personal injury during a collision or sudden maneuver, exercise care when stowing things. Put luggage or cargo in the trunk if possible. Do not pile luggage or cargo higher than the seat backs. Do not place anything on the shelf below the rear window.

Luggage nets cannot secure hard or heavy objects.

**Storage compartments and armrests**

**Warning!**

Keep compartment lids closed. This will help to prevent stored objects from being thrown about and injuring vehicle occupants during an accident.

## Interior equipment

194

## Glove box

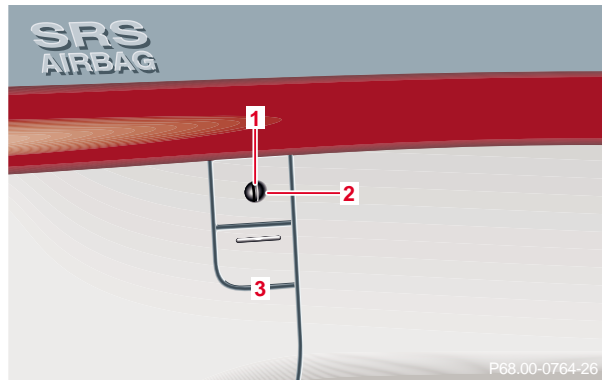

- 1 Unlocked position
- 2 Locked position
- 3 Press to open

The glove box can be locked and unlocked with the mechanical key. See page 29 for instructions on how to remove the mechanical key from the electronic key (e.g. for valet parking service).

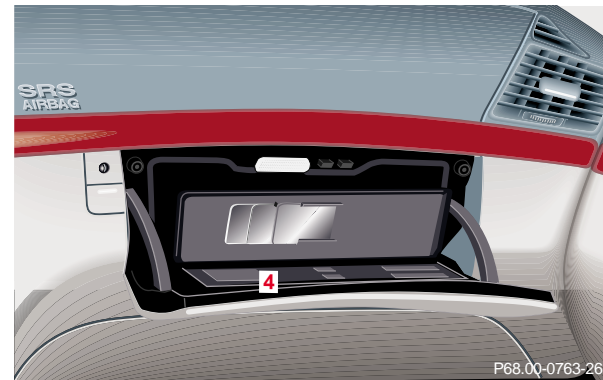

- 4 The glove box lid is equipped with a container (4) for coins and small accessories.

To open, press the marking on the cover.

### Storage compartments in the center console



**5** The storage space is located in the lower portion of the center console.

#### Lower storage space

To open:

Slide the mark on the cover forward.

To close:

Lightly press the mark on the cover forward. The cover closes automatically.

### Storage compartment in front of armrest



**6** Storage compartment in front of armrest

To open:

Touch the top of the cover lightly.

To close:

Lightly push the cover up until it engages in lock.

To remove the insert:

Grasp in the recess and pull out the insert.

## Interior equipment

196

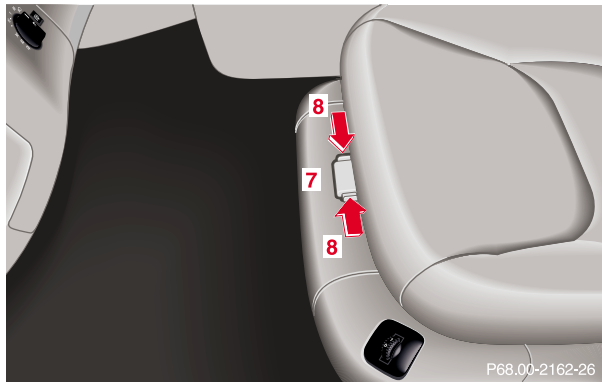
**Storage compartment under the front passenger's seat**

**7** Storage compartment under the front passenger seat

To open:  
Press buttons (8) together and fold the lid down.

To close:  
Fold the lid up until it engages.

### Storage compartment below the front armrest



A coin holder is also located in the storage compartment below the armrest.

### Storage tray in the armrest

To open: Press button (9) and raise the armrest.

To close: Lower the armrest until it engages in lock.

Note:

Vehicles with rear air conditioner:

Do not place any objects in the well under the storage tray.

### Storage space below the armrest

Vehicles without rear air conditioner:

To open: Press button (10) and raise the armrest.

To close: Lower the armrest until it engages in lock.

Note:

The storage compartment can be heated or cooled, see page 175.

The compartment can get very warm due to its confined space. When storing heat sensitive objects in the compartment, close the air outlet while heating the passenger compartment.

Do not obstruct the air outlet in the storage compartment.



## Interior equipment

198

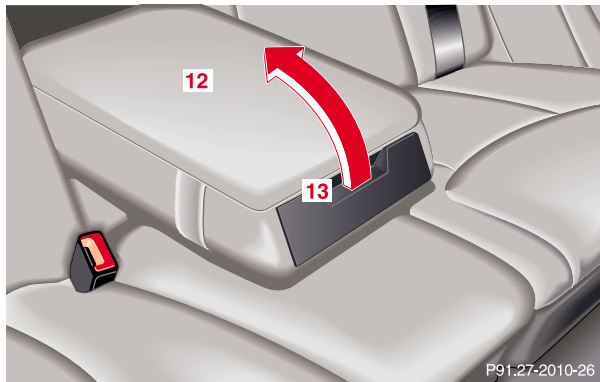
**Armrest with integrated storage compartment  
(rear seat)**

Pull down the armrest (12) by its strap.

To open, press the handle (13) and lift lid.

Before storing the armrest in the backrest, close its storage compartment lid.

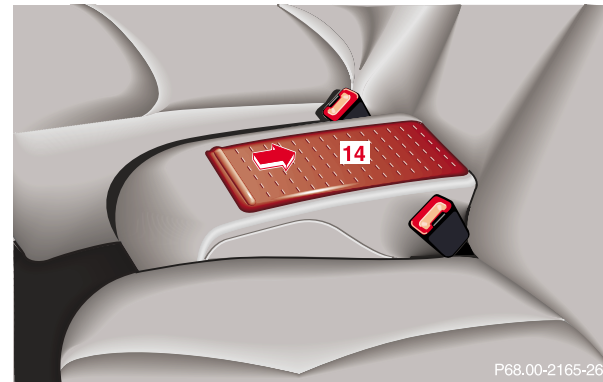
**Storage compartments in the rear passenger  
compartment (Vehicles with individual seats)**

Opening the storage space:

Slide the cover (14) back to open, forward to close.

### Cup holder



1 Cup holder in front seat armrest

To open:  
Fold the cover to the side.

To close:  
Fold the cover back.

#### Warning!

Keep the cup holder closed while traveling. Place only containers that fit into the cup holder to prevent spills. Do not fill containers to a height where the contents could spill during vehicle maneuvers, especially hot liquids.

## Interior equipment

200

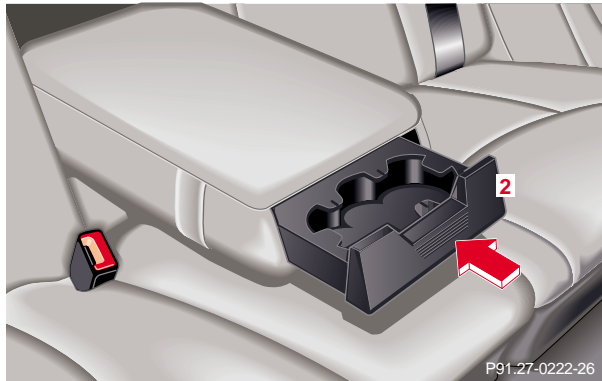

2 Cup holder in rear seat armrest

To open:

Push front of sliding compartment – the cup holder slides out.

To close:

Push the sliding compartment back until it engages.

**Warning!**

**Keep the cup holder closed while traveling. Place only containers that fit into the cup holder to prevent spills. Do not fill containers to a height where the contents could spill during vehicle maneuvers, especially hot liquids.**

## Ashtrays

### Center console

To open:  
Briefly touch the mark on the cover, the ashtray opens automatically.

To remove ashtray insert from center console:

#### Warning!

**Remove front ashtray only with vehicle standing still. With the gear selector lever in position "N", turn off the engine and set the parking brake. Otherwise the vehicle might move as a result of unintended contact with the gear selector lever.**

Prior to removing the ashtray insert, move the gear selector lever to position "N".



Press sliding knob (1) toward the right to eject the insert.

To replace insert:  
Install insert into ashtray frame and push down to engage into place.

## Interior equipment

202

## Rear doors

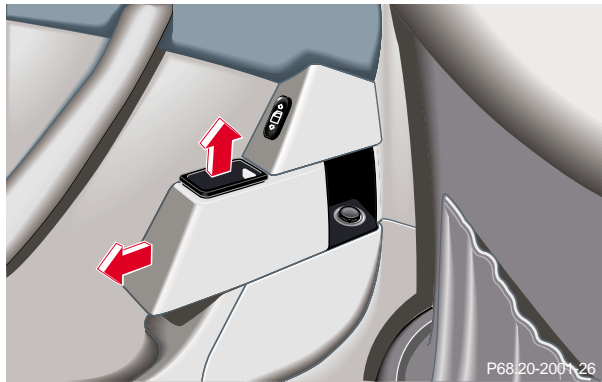

## To open:

Briefly touch the back of the cover, the ashtray slides open automatically.

Briefly press the back of the cover and the ashtray slides back.

## To remove the insert:

Pull the ashtray out slightly and remove the insert.

## To install the insert:

Position the insert and press down while sliding forward.

## Lighter



### 1 Center console lighter

Turn the electronic key in starter switch to position 1 or 2.

Push in lighter in (2); it will pop out automatically when hot.

Note:

The lighter socket can be used to accommodate electrical accessories up to a maximum 85 W.

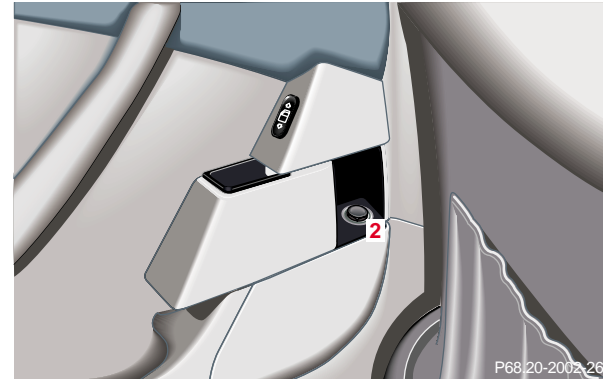

### 2 Rear door lighters

#### Warning!

Never touch the heating element or sides of the lighter, they are extremely hot, hold at knob only.

When leaving the vehicle always remove the electronic key from the starter switch. Do not leave children unattended in the vehicle, or with access to an unlocked vehicle. Unsupervised use of vehicle equipment may cause serious personal injury.

## Interior equipment

204

**Parcel net in front passenger footwell**

A small convenience parcel net is located in the front passenger footwell. It is for small and light items, such as road maps, mail, etc..

**Warning!**

**Do not place heavy or fragile objects, or objects having sharp edges, in the parcel net.**

**In an accident, during hard braking or sudden maneuvers, they could be thrown around inside the vehicle, and cause injury to vehicle occupants.**

**Note:**

With large objects stored in the parcel net do not slide the seat fully forward, it could damage them.

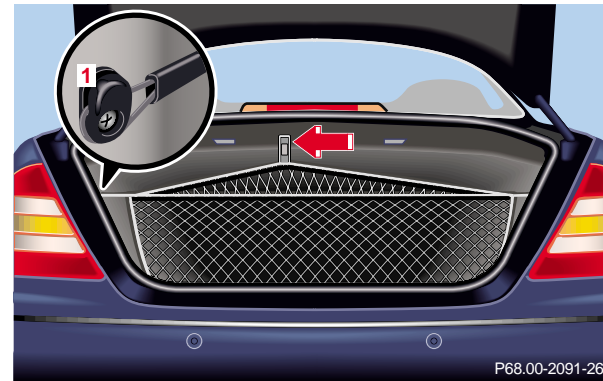
**Parcel net in trunk**

There are hooks (1) on the left and right inside the trunk from which the parcel net is suspended.

The tab (arrow) must point down into the trunk.

The parcel net and hooks are only designed to take light loads in normal driving conditions. They are unable to secure a load in the event of an accident. Observe the weight limit on the tab (arrow).

## Telephone, general

### Warning!

A driver's attention to the road must always be his/her primary focus when driving. For your safety and the safety of others, we recommend that you pull over to a safe location and stop before placing or taking a telephone call. If you choose to use the telephone while driving, please use the hands-free device and only use the telephone when road and traffic conditions permit.

Some jurisdictions prohibit the driver from using a cellular telephone while driving a vehicle.

Bear in mind that at a speed of just 30 mph (approximately 50 km/h), your vehicle is covering a distance of approximately 50 feet (approximately 14 m) every second.

Never operate radio transmitters equipped with a built-in or attached antenna (i.e. without being connected to an external antenna) from inside the vehicle while the engine is running. Doing so could lead to a malfunction of the vehicle's electronic system, possibly resulting in an accident and personal injury.

See separate instruction manual for instructions on how to operate the telephone.



## Garage door opener

206

## Garage door opener

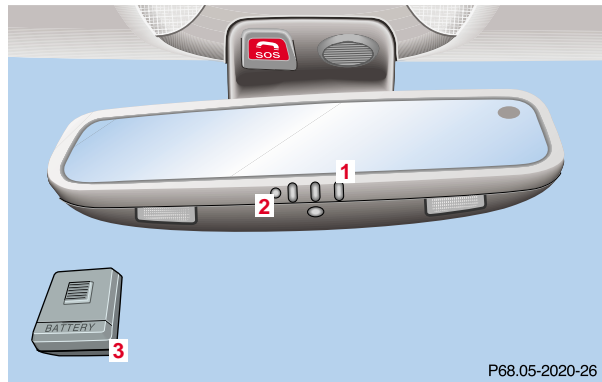

- 1 Signal transmitter keys
- 2 Indicator lamp
- 3 Portable remote control transmitter

The built-in remote control is capable of operating up to three separately controlled objects.

**Warning!**

**When programming a garage door opener, the door moves up or down.**

**When programming or operating the remote control make sure there is no possibility of anyone being harmed by the moving door.**

## Note:

Certain types of garage door openers are incompatible with the integrated opener. If you should experience difficulties with programming the transmitter, contact your authorized Mercedes-Benz Center, or call Mercedes-Benz Client Assistance Center (in the USA only) at 1-800-FOR-MERCEdes, or Customer Service (in Canada) at 1-800-387-0100.

For operation in the USA only: This device complies with Part 15, Subpart C, Section 209 of the FCC Rules. Operation is subject to the following two conditions:

- (1) This device may not cause harmful interference, and
- (2) this device must accept any interference received, including interference that may cause undesired operation.

**WARNING:** Changes or modification not expressly approved by party responsible for compliance could void the user's authority to operate the equipment.

**Programming or reprogramming the integrated remote control:**

1. Turn electronic key in starter switch to position 1 or 2.
2. Hold the end of the hand-held transmitter of the device you wish to train approximately 2 to 5 inches (5 cm to 12 cm) away from the surface of the integrated remote control located on the inside rear view mirror, keeping the indicator lamp in view.

3. Using both hands, simultaneously push the hand-held transmitter button and the desired integrated remote control button. Do not release the buttons until completing step 4.
4. The indicator lamp on the integrated remote control will flash, first slowly and then rapidly. When the indicator lamp flashes rapidly, both buttons may be released (the rapid flashing lamp indicates successful programming of the new frequency signal). To program the remaining two buttons, follow steps 1 through 4.

Note:

If, after repeated attempts, you do not successfully program the integrated remote control device to learn the signal of the hand-held transmitter, the garage door opener could be equipped with the "rolling code feature".

## Garage door opener

208

**Rolling code programming:**

To train a garage door opener (or other rolling code devices) with the rolling code feature, follow these instructions after completing the “Programming” portion of this text. (A second person may make the following training procedures quicker and easier.)

1. Locate training button on the garage door opener motor head unit. Exact location and color of the button may vary by garage door opener brand. If there is difficulty locating the transmitting button, reference to garage door opener operator’s manual.
2. Press “training” button on the garage door opener motor head unit (which activated the “training light”).

**Note:**

Following step 2, there are 30 seconds to initiate step 3.

3. Firmly press and release the programmed integrated remote control transmit button. Press and release same button a second time to complete the training process. (Some garage door openers may require you to do this procedure a third time to complete the training.)
4. Confirm the garage door operation by pressing the programmed button on the integrated remote control transmitter.

**Canadian programming:**

During programming, your hand-held transmitter may automatically stop transmitting. Continue to press and hold the integrated remote control transmitter button (note steps 2 through 4 in the “Programming” portion) while you press and re-press (“cycle”) your hand-held transmitter every two seconds until the frequency signal has been learned. The indicator lamp will flash slowly and then rapidly after several seconds upon successful training.

**Operation of remote control:**

1. Turn electronic key in starter switch to position 1 or 2.
2. Select and press the appropriate button to activate the remote controlled device. The integrated remote control transmitter continues to send the signal as long as the button is pressed – up to 20 seconds.

**Erasing the remote control memory:**

1. Turn electronic key in starter switch to position 1 or 2.
2. Simultaneously holding down the left and right side buttons for approximately 20 seconds, or until the control lamp blinks rapidly, will erase the codes of all three channels.

## Infrared reflecting windshield

210

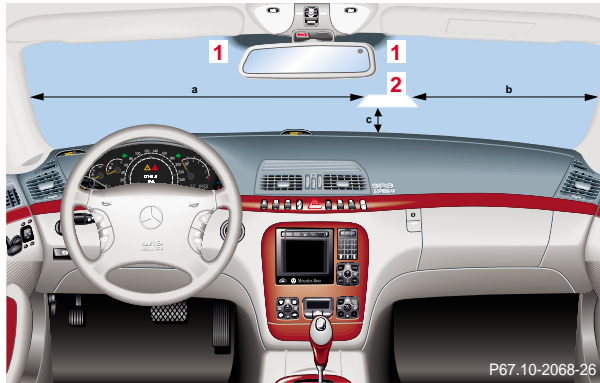
**Infrared reflecting windshield**

- 1** Mounting location for electronic toll collection devices (infrared transparent)
- 2** Infrared transparent area (pass-through for electronic signals)

- a 31.5 in (80 cm)  
b 19.0 in (48 cm)  
c 1.75 in (4.5 cm)

Your vehicle is equipped with infrared reflecting glass which reduces the amount of radiated heat entering the interior through the windows.

The infrared reflecting glass also prevents the transmission of signals through the glass by in-vehicle electronic devices (e.g. electronic toll collection devices).

To allow the use of these devices in the vehicle, two infrared transparent areas (1 and 2) are placed in the windshield.

## Driving

Control and operation of radio transmitters .....	212
The first 1 000 miles (1 500 km) .....	213
Maintenance .....	213
Tele Aid .....	214
Catalytic converter .....	224
Emission control .....	225
Starter switch .....	226
Starter switch - KEYLESS-GO .....	228
Starting and turning off the engine .....	231
Automatic transmission .....	233
Parking brake .....	242

Driving instructions .....	243	Antilock brake system (ABS) .....	272
Drive sensibly - Save Fuel .....	243	Electronic stability program (ESP) .....	274
Drinking and driving .....	243	Active body control (ABC) .....	278
Pedals .....	243	Level control system for vehicles with Airmatic system .....	279
Power assistance .....	244	Level control system for vehicles with Active Body Control (ABC) .....	280
Brakes .....	244	Adaptive damping system (ADS) .....	283
Driving off .....	245	Parking assist (Parktronic) .....	285
Parking .....	246	What you should know at the gas station .....	290
Tires .....	247	Check regularly and before a long trip .....	293
Snow chains .....	249		
Winter driving instructions .....	250		
Block heater .....	251		
Deep water .....	252		
Passenger compartment .....	252		
Traveling abroad .....	252		
Cruise control .....	253		
Distronic (DTR) .....	256		
Brake assist system (BAS) .....	271		

Instruments and controls	Operation	<b>Driving</b>	Instrument cluster display	Practical hints	Car care	Technical data	Index
--------------------------	-----------	----------------	----------------------------	-----------------	----------	----------------	-------

Control and operation of radio transmitters

212

### Control and operation of radio transmitters

#### COMAND, radio and telephone

##### Warning!

Please do not forget that your primary responsibility is to drive the vehicle. Only operate the COMAND (Cockpit Management and Data System), radio or telephone<sup>1</sup> if road and traffic conditions permit.

Bear in mind that at a speed of just 30 mph (approximately 50 km/h), your vehicle is covering a distance of approximately 50 feet (approximately 14 m) every second.

<sup>1</sup> Observe all legal requirements.

#### Telephones and two-way radio

##### Warning!

Never operate radio transmitters equipped with a built-in or attached antenna (i.e. without being connected to an external antenna) from inside the vehicle while the engine is running. Doing so could lead to a malfunction of the vehicle's electronic system, possibly resulting in an accident and personal injury.

Radio transmitters, such as a portable telephone or a citizens band unit should only be used inside the vehicle if they are connected to an antenna that is installed on the outside of the vehicle.

Refer to the radio transmitter operation instructions regarding use of an external antenna.

### The first 1 000 miles (1 500 km)

The more cautiously you treat your vehicle during the break-in period, the more satisfied you will be with its performance later on. Therefore, drive your vehicle during the first 1 000 miles (1 500 km) at moderate vehicle and engine speeds.

During this period, avoid heavy loads (full throttle driving) and excessive engine speeds.

Avoid accelerating by kickdown. It is not recommended to brake the vehicle by manually shifting to a lower gear. We recommend that you select positions “3”, “2” or “1” only at moderate speeds (for hill driving).

After 1 000 miles (1 500 km) speeds may be gradually increased to the permissible maximum.

### Maintenance

Approximately 30 days or 2000 miles (2000 km) prior to the next recommended service, the remaining distance or days are displayed in the multifunction indicator. See Flexible service system (FSS) on page 147.

We strongly recommend that you have your vehicle serviced by your authorized Mercedes-Benz Center, in accordance with the Service Booklet at the times called for by the FSS.

Failure to have the vehicle maintained in accordance with the Service Booklet at the designated times/mileage may result in vehicle damage not covered by the Mercedes-Benz Limited Warranty.



## Tele Aid

### Important!



The initial activation of the Tele Aid system may only be performed by completing the subscriber agreement and placing an acquaintance call using the “SOS” button. Failure to complete either of these steps will result in a system that is not activated. If the system is not activated the indicator lamp in the “SOS” button stays on after turning electronic key in starter switch to position 2 (vehicles with KEYLESS-GO: operating position, see page 228) and the message “TELE AID – NOT ACTIVATED” will be shown in the multifunction display for approx. 10 seconds.



If you have any questions regarding activation, please call the Response Center at 1-800-756-9018 (in the USA) or 1-888-923-8367 (in Canada).

### (Telematic Alarm Identification on Demand)

The Tele Aid system consists of three types of response; automatic and manual emergency, roadside assistance and information.

The Tele Aid system is operational providing that the vehicle’s battery is charged, properly connected, not damaged and cellular and GPS coverage is available.



The speaker volume of a Tele Aid call can be adjusted when using the volume control on the multifunction steering wheel, for raising press button  and for lowering press button .

To activate, press the “SOS” button, the Roadside Assistance button  or the Information button , depending on the type of response required.

Shortly after the completion of your Acquaintance Call, you will receive a user ID and password via first call mail. By visiting [www.mbusa.com](http://www.mbusa.com) and selecting “Tele Aid” (USA only), you will have access to account information, remote door unlock, Info Services’ profile and more.

\* Optional

### System self-check

Initially, after turning the electronic key in starter switch to position 2, malfunctions are detected and indicated (the indicator lamps in the “SOS” button, the Roadside Assistance button  and the Information button  stay on longer than 10 seconds or do not come on). The message “TELE AID – VISIT WORKSHOP” appears for approx. 10 seconds in the multifunction display.

### **Important!**

Always make sure that the indicator lamps in the “SOS” button, in the “Roadside Assistance” button and in the “Information” button do not remain illuminated constantly in red and the message “TELE AID – VISIT WORKSHOP” is not displayed in the multifunction display after the system self check.

If a malfunction is indicated as outlined above, have the system checked at the nearest Mercedes-Benz Center as soon as possible.

### **Emergency calls**

An emergency call is initiated automatically:

- following an accident in which the Emergency Tensioning Retractors (ETR’s) or airbags deploy,
- if the antitheft alarm or the tow away alarm stays on for more than 20 seconds, see pages 62 and 64.

An emergency call can also be initiated manually by opening the cover next to the inside rear view mirror labeled “SOS”, then pressing the button (for longer than 2 seconds) located under the cover. See below for instructions on initiating an emergency call manually.

Once the emergency call is in progress, the indicator lamp in the “SOS” button will begin to flash. The message “EMERGENCY CALL – CONNECTING CALL” appears in the multifunction display. When the connection is established, the message “EMERGENCY CALL – CALL CONNECTED” appears in the multifunction display. All information relevant to the emergency, such as the location of the vehicle (determined by the GPS satellite location system), vehicle model, identification number and color are generated.

A voice connection between the Response Center and the occupants of the vehicle will be established automatically soon after the emergency call has been initiated. When a voice connection is established the audio system mutes and the message “TELE AID – EMERGENCY CALL ACTIVE” appears in the multifunction display. The Response Center will attempt to determine more precisely the nature of the accident provided they can speak to an occupant of the vehicle.

## Tele Aid

216

The Tele Aid system is available if:

- it has been activated and is operational. Activation requires a subscription for monitoring services and cellular air time
- the relevant cellular phone network and GPS signals are available and pass the information on to the response center.

Note:

Location of the vehicle on a map is possible if the vehicle is able to receive signals from the GPS satellite network and pass the information on to the response center.

**Warning!**

**If the indicator lamp in the “SOS” button is illuminated continuously and there was no voice connection to the Response Center established, then the Tele Aid system could not initiate an emergency call (e.g. the relevant cellular phone network is not available). The message “EMERGENCY CALL – CALL FAILED” appears in the multifunction display for approx. 10 seconds.**

**Should this occur, assistance must be summoned by other means.**

### Initiating an emergency call manually

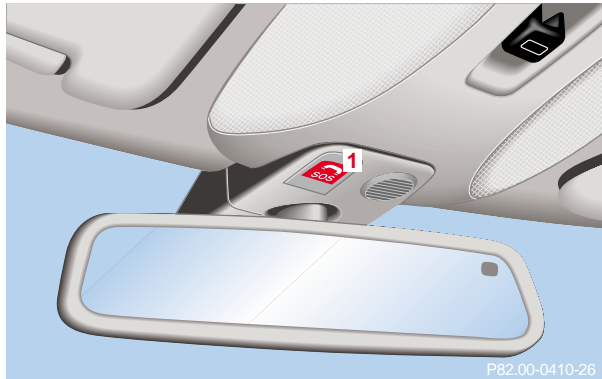

Briefly press on cover (1) – the cover will open.

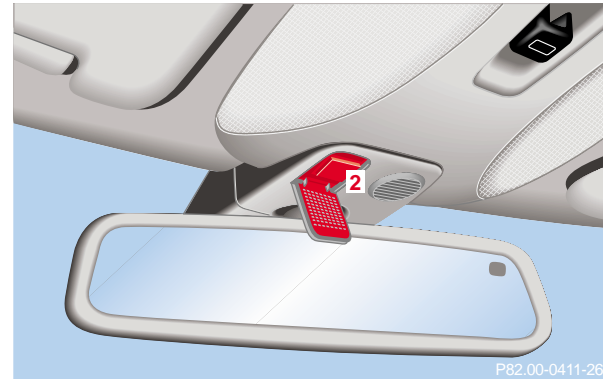

Press the SOS button (2) briefly (for longer than 2 seconds). The indicator lamp in the SOS button (2) will flash until the emergency call is concluded. Wait for a voice connection to the Response Center.

Close the cover (1) after the emergency call is concluded.

**Warning!**

**If you feel at any way in jeopardy when in the vehicle (e.g. smoke or fire in the vehicle, vehicle in a dangerous road location), please do not wait for voice contact after you have pressed the emergency button. Carefully leave the vehicle and move to a safe location. The Response Center will automatically contact local emergency officials with the vehicle's approximate location if they receive an automatic "SOS" signal and cannot make voice contact with the vehicle occupants.**

**Roadside Assistance button **



Located below the center armrest cover is the Roadside Assistance button . Pressing and holding the button (for longer than 2 seconds) will initiate a call to a Mercedes-Benz Roadside Assistance dispatcher. The button will flash while the call is in progress. The message "ROADSIDE ASSISTANCE – CONNECTING CALL" will appear in the multifunction display. When the connection is established, the message "ROADSIDE ASSISTANCE – CALL CONNECTED" appears in the multifunction display. The Tele Aid system will transmit data generating the vehicle identification number, model, color and location (subject to availability of cellular and GPS signals).

A voice connection between the Roadside Assistance dispatcher and the occupants of the vehicle will be established. When a voice connection is established the audio system mutes and the message "TELE AID – ROADSIDE ASSISTANCE CALL ACTIVE" appears in the multifunction display. The nature of the need for assistance can then be described. The Mercedes-Benz Roadside assistance dispatcher will either dispatch a qualified Mercedes-Benz technician or arrange to tow your vehicle to the nearest Mercedes-Benz Center. For services such as labor and/or towing charges may apply. Refer to the Roadside Assistance manual for more information.

These programs are only available in the USA:

- Sign and Drive services: Services such as jump start, a few gallons of fuel or the replacement of a flat tire with the vehicle spare tire are obtainable,
- Remote Vehicle Diagnostics: This function permits the Mercedes-Benz Roadside Assistance dispatcher to download malfunction codes and actual vehicle data.

Notes:

The indicator lamp in the Roadside Assistance button  remains illuminated in red for approx. 10 seconds during the system self-check after turning electronic key in starter switch to position 2 (together with the “SOS” button and the Information button ).

See system self-check on page 214 when the indicator lamp does not light up in red or stays on longer than approximately 10 seconds.

If the indicator lamp in the Roadside Assistance button  is illuminated continuously and there was no voice connection to the Response Center established, then the Tele Aid system could not initiate an Roadside Assistance call (e.g. the relevant cellular phone network is not available). The message “ROADSIDE ASSISTANCE – CALL FAILED” appears in the multifunction display.

Roadside Assistance calls can be terminated using the  button on the multifunction steering wheel.



### Information button

Located below the center armrest cover is the Information button . Pressing and holding the button (for longer than 2 seconds) will initiate a call to the Client Assistance Center. The button will flash while the call is in progress. The message “INFO – CONNECTING CALL” will appear in the multifunction display. When the connection is established, the message “INFO – CALL CONNECTED” appears in the multifunction display. The Tele Aid system will transmit data generating the vehicle identification number, model, color and location (subject to availability of cellular and GPS signals).

A voice connection between the Client Assistance Center representative and the occupants of the vehicle will be established. When a voice connection is established the audio system mutes and the message “TELE AID – INFO CALL ACTIVE” appears in the multifunction display. Information regarding the operation of your vehicle, the nearest Mercedes-Benz Center or Mercedes-Benz USA products and services is available to you.

For more details concerning Tele Aid, please visit [www.mbusa.com](http://www.mbusa.com) and use your ID and password, sent to you separately, to learn more (USA only).

## Notes:

The indicator lamp in the Information button  remains illuminated in red for approx. 10 seconds during the system self-check after turning electronic key in starter switch to position 2 (together with the “SOS” button and the Roadside Assistance button ).

See system self-check on page 214 when the indicator lamp does not light up in red or stays on longer than approximately 10 seconds.

If the indicator lamp in the Information button  is illuminated continuously and there was no voice connection to the Response Center established, then the Tele Aid system could not initiate an Information call (e.g. the relevant cellular phone network is not available). The message “INFO – CALL FAILED” appears in the multifunction display.

Information calls can be terminated using the  button on the multifunction steering wheel.

**Important!**

If the indicator lamps do not start flashing after pressing one of the buttons or remain illuminated (in red) at any time, the Tele Aid system has detected a fault or the service is not currently active, and may not initiate a call. Visit your Mercedes-Benz Center and have the system checked or contact the Response Center at 1-800-756-9018 (in the USA) or 1-888-923-8367 (in Canada) as soon as possible.

## Upgrade Signals

Tele Aid system processes calls using the following priority.

- Automatic emergency – First priority
- Manual emergency – Second priority
- Roadside assistance – Third priority
- Information – Fourth priority

Should a higher priority call be initiated while you are connected, an upgrade (alternating) tone will be heard, and the appropriate indicator lamp will flash. If certain information such as vehicle identification number or client information is not available, the operator may need to retransmit.

During this time you will hear a chirp and voice contact will be interrupted. Voice contact will resume once the retransmission is completed. Once a call is concluded, a chirp will be heard and the appropriate indicator lamp will stop flashing. The COMAND system operation will resume.

**Important!**

If the indicator lamp continues to flash or the system does not reset, contact the Response Center at 1-800-756-9018 (in the USA) or 1-888-923-8367 (in Canada), or Mercedes-Benz Client Assistance at 1-800-FOR-MERCEdes (1-800-367-6372) in the USA or Customer Service at 1-800-387-0100 in Canada.

Notes:

The indicator lamp in the respective button flashes until the call is concluded. Calls can only be terminated by a Response Center or Client Assistance Center representative except Roadside Assistance and Information calls, which can also be terminated by pressing  button on the multifunction steering wheel.

When a Tele Aid call has been initiated, the COMAND system audio is muted and the selected mode (radio, tape or CD) pauses. The optional cellular phone (if installed) switches off. If you must use this phone, the vehicle must be parked. Disconnect the coiled cord and place the call. The navigation system (if engaged) will continue to run. The display in the instrument cluster is available for use and spoken commands are only available by pressing the RPT button on the COMAND unit. A pop-up window will appear in the COMAND display to indicate that a Tele Aid call is in progress.



Instruments and controls	Operation	<b>Driving</b>	Instrument cluster display	Practical hints	Car care	Technical data	Index
--------------------------	-----------	----------------	----------------------------	-----------------	----------	----------------	-------

**Remote door unlock**

In the case you have your vehicle locked unintentionally (e.g. key inside vehicle), and the reserve key is not handy, contact the Mercedes-Benz Response Center at 1-800-756-9018 (in the USA) or 1-888-923-8367 (in Canada). You will be asked to provide your password which you provided when you completed the subscriber agreement.

Then return to your vehicle and press trunk lock for minimum of 20 seconds until the “SOS” button is flashing. The message “EMERGENCY CALL – CALL CONNECTED” appears in the multifunction display.

As an alternative, you may unlock the vehicle via Internet using the ID and password sent to you shortly after the completion of your Acquaintance Call.

The Response Center will then unlock your vehicle with the remote door unlocking feature.

Notes:

The remote door unlock feature is available if the relevant cellular phone network is available.

The SOS button will flash and the message “EMERGENCY CALL – CALL CONNECTED” will appear in the multifunction display to indicate receipt of the door unlock command.

Once the vehicle is unlocked, a Response Center specialist will attempt to establish voice contact with the vehicle occupants.

If the trunk button was pressed for more than 20 seconds before door unlock authorization was received by the Response Center, you must wait 15 minutes before pressing the trunk button again.

### Stolen vehicle tracking services

In the event your vehicle was stolen, report the incident to the police who will issue a numbered incident report. Pass this number on to the Mercedes-Benz Response Center.

The Response Center will then attempt to covertly contact the vehicle's Tele Aid system. Once the vehicle is located, the Response Center will contact the local Law Enforcement and you. The vehicle's location will only be provided to Law Enforcement.

### Info Services (optional, except Canada)

Info Services categories include news, sports, stocks, weather and calendar reminders. Choices can be selected via [www.mbusa.com](http://www.mbusa.com) or by calling 1-800-FOR-MERcedes.

To request Info Services, press the SVC button on the COMAND system, then select "SEND NEW REQUEST FOR INFO SERVICE". "NEW INFO SERVICE REQUEST TRANSMITTED" will appear in the COMAND display and call status messages will appear in the multifunction display.

Once information is available, the message "NEW INFO RECEIVED - READ LATER WHEN STOPPED?" will appear. Select "Yes". With the vehicle stopped in a safe location press SVC, then select "View Info Service of mm.dd.yyyy hh.mm". Messages will be retained for 30 minutes once the ignition is switched off.

### Important!

Tele Aid utilizes the cellular network for communication and the GPS (Global Positioning System) satellites for vehicle location. If either of these signals are unavailable, the Tele Aid system may not function and if this occurs, assistance must be summoned by other means.

### Warning!

**If the indicator lamp in the "SOS" button does not illuminate during or remains illuminated after the system self-check or if the message "TELE AID - VISIT WORKSHOP" appears in the multifunction display, have the system checked at the nearest Mercedes-Benz Center as soon as possible.**

**Catalytic converter**

Your Mercedes-Benz is equipped with monolithic type catalytic converters, an important element in conjunction with the oxygen sensors to achieve substantial control of the pollutants in the exhaust emissions. Keep your vehicle in proper operating condition by following our recommended maintenance instructions as outlined in your Service Booklet.

**Caution!**

To prevent damage to the catalytic converters, use only premium unleaded gasoline in this vehicle.

Any noticeable irregularities in engine operation should be repaired promptly. Otherwise, excessive unburned fuel may reach the catalytic converter causing it to overheat, which could start a fire.

**Warning!**

**As with any vehicle, do not idle, park or operate this vehicle in areas where combustible materials such as grass, hay or leaves can come into contact with the hot exhaust system, as these materials could be ignited and cause a vehicle fire.**

### Emission control

Certain systems of the engine serve to keep the toxic components of the exhaust gases within permissible limits required by law.

These systems, of course, will function properly only when maintained strictly according to factory specifications. Any adjustments on the engine should, therefore, be carried out only by qualified Mercedes-Benz Center authorized technicians. Engine adjustments should not be altered in any way. Moreover, the specified service jobs must be carried out regularly according to Mercedes-Benz servicing requirements. For details refer to the Service Booklet.

### Warning!

**Inhalation of exhaust gas is hazardous to your health. All exhaust gas contains carbon monoxide, and inhaling it can cause unconsciousness and lead to death.**

**Do not run the engine in confined areas (such as a garage) which are not properly ventilated. If you think that exhaust gas fumes are entering the vehicle while driving, have the cause determined and corrected immediately. If you must drive under these conditions, drive only with at least one window fully open.**

## Starter switch

226

## Starter switch

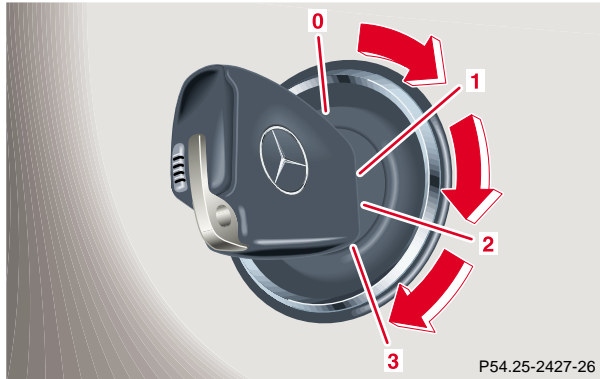

- 0** The electronic key can be withdrawn in this position only. The electronic key can only be removed with the selector lever in position “P”. After removing the electronic key or with the electronic key in starter switch position 0 or 1, the selector lever is locked in position “P”.

- 1** Most electrical consumers can be operated. For detailed information see respective subjects.
- 2** Driving position.  
Gear selector lever is unlocked.
- 3** Starting position.

See page 231 for instructions on starting and stopping the engine.

See page 44 for instructions on the simultaneous use of the electronic key and the KEYLESS-GO-function.

**Warning!**

**When leaving the vehicle always remove the electronic key from the starter switch, take the KEYLESS-GO-card (if so equipped) with you and lock the vehicle. Do not leave children unattended in the vehicle, or with access to an unlocked vehicle. Unsupervised use of vehicle equipment may cause serious personal injury.**

**Important!**

If the electronic key is left in the starter switch position 0 for an extended period of time, it can no longer be turned in the lock. In this case, remove electronic key from starter switch and reinsert.

**Caution!**

To prevent accelerated battery discharge and a possible dead battery, always remove the electronic key from the starter switch. Do not leave the electronic key in starter switch position 0.

## Notes:

A warning sounds when the driver's door is opened with the electronic key in starter switch position 1 or 0.

With the engine at idle speed, the charging rate of the alternator (output) is limited.

It is therefore recommended that you turn off unnecessary electrical consumers while driving in stop-and-go traffic. This precaution helps to avoid draining of the battery.

Unnecessary strain on the battery and charging system may be minimized by turning off the following power consumers, for example:

Heated seats, rear window defroster. In addition, the automatic climate air volume control should be set to the lowest position.

## Starter switch – KEYLESS-GO

228

**Start-/Stop button (vehicles with KEYLESS-GO)**

See page 231 for instructions on starting and turning off the engine.

See page 44 for instructions on the simultaneous use of the electronic key and the KEYLESS-GO-function.

**Warning!**

When leaving the vehicle always take the electronic key and the KEYLESS-GO-card with you, and lock the vehicle. Do not leave children unattended in the vehicle, or with access to an unlocked vehicle. Unsupervised use of vehicle equipment may cause serious personal injury.

Pressing the start-/stop button (1) on the gear selector lever without depressing the brake pedal will sequentially activate the starter switch positions 1 (on) and 2 (operation) and 0 (off).

The engine can be started with the starter switch in any position (on, operation or off), as long as the gear selector lever is in position “P” or “N” and the brake pedal depressed.

“On” position (starter switch position 1, see page 226). Most electrical consumers can be operated. For detailed information see respective subjects.

Operation/driving position (starter switch position 2, see page 226).

All electrical consumers can be operated. Gear selector is unlocked.

“Off” position (electronic key removable from starter switch).

Most electrical consumers cannot be operated. The selector lever is locked in position “P”.

Notes:

For improved recognition of the KEYLESS-GO-card the doors should be closed when pressing the start-/stop button.

The gear selector lever can only be moved with the vehicle battery charged and connected, and the starter switch in the Operation position. With the gear selector lever in position “P”, the brake pedal must also be depressed.

### **Important!**

For the KEYLESS-GO-system to function properly, the operator should observe the following:

- If the KEYLESS-GO-card is positioned farther away from the vehicle (e.g. inside clothing or briefcase), the vehicle cannot be locked (see page 40) or started with the start-/stop button (see page 231).
- If the KEYLESS-GO-card is removed from the vehicle while the engine is running, or by placing the card in front of the center armrest (see page 195), the message “CHIP-CARD – NOT RECOGNIZED!” will appear repeatedly while driving in the multifunction display, see page 322.



Instruments and controls	Operation	<b>Driving</b>	Instrument cluster display	Practical hints	Car care	Technical data	Index
--------------------------	-----------	----------------	----------------------------	-----------------	----------	----------------	-------

Starter switch – KEYLESS-GO

230

- Do not forget, the engine can be started by anyone if a KEYLESS-GO-card is left inside the vehicle.
- To be able to operate the vehicle in the case of a malfunction in the KEYLESS-GO-system (e.g. strong radio frequency disturbance), we recommend that you carry the electronic key plus mechanical key with you and keep them in a safe place so that they are always handy. Never leave the electronic key in the vehicle.
- To avoid radio transmission interference, never store the KEYLESS-GO-card together with other electronic items (e.g. cellular telephones, other KEYLESS-GO-cards) or metallic objects (e.g. coins, metal foil).

Notes:

With the engine at idle speed, the charging rate of the alternator (output) is limited.

It is therefore recommended that you turn off unnecessary electrical consumers while driving in stop-and-go traffic. This precaution helps to avoid draining of the battery.

Unnecessary strain on the battery and charging system may be minimized by turning off the following power consumers, for example:

Heated seats, rear window defroster. In addition, the automatic climate air volume control should be set to the lowest position.

## Starting and turning off the engine

### Before Starting

Ensure that parking brake is engaged and that selector lever is in position “P” or “N”.

### Starting

#### Important!

In areas where temperatures frequently drop below -4°F (-20°C) we recommend that an engine block heater be installed. Your authorized Mercedes-Benz Center will advise you on this subject, see page 251.

Starting the engine with electronic key:

Do not depress accelerator.

Turn electronic key in starter switch to position 2. Briefly turn electronic key in starter switch clockwise to the stop and release. The starter will engage until the engine is running.

If engine will not run, and the starting procedure stops, turn electronic key completely to the left and repeat starting the engine.

After several unsuccessful attempts, have the system checked at the nearest authorized Mercedes-Benz Center.

#### Important!

Due to the installed starter non-repeat feature, the electronic key must be turned completely to the left before attempting to start the engine again.

Starting the engine with KEYLESS-GO:

Note:

For improved recognition of the chip card the doors should be closed when pressing the start-/stop button.

Depress brake pedal during the starting procedure.

Briefly press start-/stop button on gear selector lever. The starter will engage until the engine is running.

If engine will not run, and the starting procedure stops, press start-/stop button on gear selector lever and repeat starting the engine.

After several unsuccessful attempts, have the system checked at the nearest authorized Mercedes-Benz Center.

Instruments and controls	Operation	<b>Driving</b>	Instrument cluster display	Practical hints	Car care	Technical data	Index
--------------------------	-----------	----------------	----------------------------	-----------------	----------	----------------	-------

## Starting and turning off the engine

232

### Turning off

Turning off the engine with electronic key:

Put the selector lever in position “P” and turn the electronic key in the starter switch to position 0 to stop the engine.

The electronic key can only be removed with the selector lever in position “P”.

Turning off the engine with KEYLESS-GO:

Stop the vehicle and put the selector lever in position “P”.

Press start-/stop button on the selector lever until the engine stops. With the driver’s door closed the starter switch is set to the “On” position (starter switch position 1). With the driver’s door opened the starter switch is set to the “Off” position (starter switch position 0, same as electronic key removed from starter switch).

Note:

The engine can only be turned off with selector lever in position “P”. If attempting to turn off the engine while the selector lever is in any other position than “P” a signal sounds and the message “SELECTOR LEVER TO P” appears in the multifunction display as a reminder to move the selector to position “P”.

## Automatic transmission



The automatic transmission selects individual gears automatically, dependent upon

- Selector lever position
- Program mode selector
- Accelerator position
- Vehicle speed

The gear shifting process is continuously adapted, dependent on the driving style, the driving situation and the road characteristics.

### Important!

When parking the vehicle or before working on the vehicle with the engine running, firmly depress the parking brake pedal and shift the selector lever into “P”.

## Automatic transmission

234

**Driving**

The selector lever is automatically locked while in position "P". To move the selector lever out of position "P", the service brake pedal must be firmly depressed before the shift lock will release.

Shift selector lever to the desired position only when the engine is idling normally and the service brake is applied. Do not release the brake until ready to drive. The vehicle may otherwise start creeping when the selector lever is in drive or reverse position.

**Warning!**

**It is dangerous to shift the selector lever out of "P" or "N" if the engine speed is higher than idle speed. If your foot is not firmly on the brake pedal, the vehicle could accelerate quickly forward on in reverse. You could lose control of the vehicle and hit someone or something. Only shift into gear when the engine is idling normally and when your right foot is firmly on the brake pedal.**

**Important!**

After selecting any driving position from "N" or "P", wait a moment to allow the gear to fully engage before accelerating, especially when the engine is cold.

**Accelerator position**

Partial throttle = early upshifting = normal acceleration

Full throttle = later upshifting = rapid acceleration

Kickdown (depressing the accelerator beyond full throttle) = downshifting to a lower gear = maximum acceleration. Once the desired speed is attained, ease up on the accelerator – the transmission shifts up again.

### Stopping

For brief stops, e.g. at traffic lights, leave the transmission in gear and hold vehicle with the service brake.

For longer stops with the engine idling, shift into “N” or “P” and hold the vehicle with the service brake.

When stopping the vehicle on an uphill gradient, do not hold it with the accelerator, use the brake. This avoids unnecessary transmission heat build up.

### Maneuvering

To maneuver in tight areas, e.g. when pulling into a parking space, control the vehicle speed by gradually releasing the brakes. Accelerate gently and never abruptly step on the accelerator.

To rock a vehicle out of soft ground (mud or snow), alternately shift from forward to reverse, while applying slight partial throttle.

Rocking a vehicle free in this manner may cause the ABS or traction system malfunction indicator lamp to come on. Turn off and restart the engine to clear the malfunction indication.

#### Warning!

**Getting out of your vehicle with the selector lever not fully engaged in position “P” is dangerous. Also, when parked on an incline, position “P” alone may not prevent your vehicle from moving, possibly hitting people or objects.**

**Always set the parking brake in addition to shifting to position “P”, see page 242 for parking brake.**

**When parked on an incline, also turn front wheel against curb.**

#### Warning!

**When leaving the vehicle always remove the electronic key from the starter switch, take the KEYLESS-GO-card (if so equipped) with you and lock the vehicle. Do not leave children unattended in the vehicle, or with access to an unlocked vehicle. Children could move the gear selector lever from position “P”, which could result in an accident or serious injury.**

## Automatic transmission

236

## Selector lever position



The current selector lever position is indicated in the gear range indicator display. The automatic gear shifting process can be adapted to specific operating conditions using the selector lever.

**P** Park position

The park position is to be used when parking the vehicle. Engage only with the vehicle stopped. The park position is not intended to serve as a brake when the vehicle is parked. Rather, the driver should always use the parking brake in addition to placing the selector lever in park to secure the vehicle.

Note:

The electronic key can only be removed from the starter switch with the selector lever in position "P". With the electronic key removed, the selector lever is locked in position "P".

With a malfunction in the vehicle's electrical system the selector lever could remain locked in position "P". To unlock the selector lever manually, see page 368.

**R** Reverse gear

Shift to reverse gear only with the vehicle stopped.

Dependent on the program mode selector switch position “S” or “W” the maximum speed in the reverse gear is different. However, it is not possible to change the program mode while in reverse.

#### **N** Neutral

No power is transmitted from the engine to the drive axle. When the brakes are released, the vehicle can be moved freely (pushed or towed). Do not engage “N” while driving except to coast when the vehicle is in danger of skidding (e.g. on icy roads, see page 250 for winter driving instructions).

#### **Important!**

Coasting the vehicle, or driving for any other reason with selector lever in “N” can result in transmission damage that is not covered by the Mercedes-Benz Limited Warranty.

#### **D** Drive

The transmission automatically upshifts through 5th gear. Position “D” provides optimum driving characteristics under all normal operating conditions.

#### **Gear selection for special circumstances**

The transmission gear ranges for special circumstances can be selected by pressing the selector lever to the right or the left with the selector lever in position “D”.

The gear range currently selected is indicated in the instrument cluster display.

Briefly press selector lever in the **–** direction:  
The transmission downshifts, one gear at a time, in the order “4”, “3”, “2”, “1”.

Press and hold selector lever in the **–** direction:  
The selector lever position display will switch to the gear range currently selected by the automatic transmission.

The transmission will only shift down one gear if the gear range currently selected has already shifted to its highest possible gear.

Briefly press selector lever in the **+** direction:  
The transmission will shift from the current gear range to the next higher gear range. If the transmission is already in gear range “D”, an additional upshift of one gear is possible.



## Automatic transmission

238

Press and hold selector lever in the **+** direction:  
The transmission will shift from the current gear  
directly to gear range “D”.

**Warning!**

**On slippery road surfaces, never downshift in order to obtain braking action. This could result in drive wheel slip and reduced vehicle control. Your vehicle's ABS will not prevent this type of loss of control.**

**Important!**

With transmission in gear range “D”, “4” or “3”,  
upshifting from 1st to 2nd to 3rd gear is delayed  
depending on vehicle speed and engine temperature.  
This allows the catalytic converter to heat up more  
quickly to operating temperatures.  
During the brief warm-up period this delayed upshift  
and increased engine noise might be perceived as a  
malfunction. However, neither the engine nor  
transmission are negatively affected by this mode of  
operation.

The delayed upshift is effective with vehicle speeds  
below 31 mph (50 km/h) at partial throttle and engine  
temperatures below 95°F (35°C).

To avoid overrevving the engine when the selector lever  
is moved to a lower gear range, the transmission will not  
shift to a lower gear, if the engine's revolutions per  
minute limit would be exceeded. In this case there will  
be no downshift, even when the vehicle speed reaches  
the engine's rpm limit of that gear, e.g. by applying the  
service brakes.

To prevent the engine from laboring at low RPM when  
driving uphill gradients or with your vehicle heavily  
loaded, the automatic transmission will downshift when  
necessary to maintain engine RPM within the best  
torque range.

Gear ranges:

- 4** Upshift through 4th gear only. Suitable for performance driving.
- 3** Upshift through 3rd gear only. Suitable for moderately steep hills. Since the transmission does not shift higher than 3rd gear, this gear selection will allow use of the engine's braking power downhill.

- 2** Upshift through 2nd gear only. For driving in mountainous regions or under extreme operating conditions. This gear selection will allow use of the engine's braking power when descending steep grades.
- 1** Use this position, which makes maximum use of the engine's braking effect, while descending very steep or lengthy downgrades and only at speeds below 40 mph (60 km/h).

## Automatic transmission

240

## Program mode selector switch



The transmission is provided with a selector switch (1) for Standard “S” and Winter/Wet (snow and ice) “W” program modes.

The program mode currently selected is indicated in the gear range indicator display.

## S Standard mode

Press switch on symbol “S”. Use this mode for all regular driving.

The vehicle starts out in 1st gear.

## Accelerator Operation:

Fast on = depressing the accelerator pedal quickly (not into kickdown position) while driving continuously, rather than depressing the accelerator pedal in the usual manner, will cause the automatic transmission to shift down into a lower gear. This gear shifting process is dependent on the current vehicle speed.

Fast off = there will be no upshift when releasing the accelerator pedal quickly, e.g. using the engine’s braking power during performance driving.

**W** Winter/Wet (snow and ice) mode

Press switch on symbol “W”. The vehicle starts out in 2nd gear, except with selector lever in 1st gear, or with accelerator pedal in kick-down position.

The “W” mode helps to improve traction and driving stability of the vehicle.

The gear shifting process occurs at lower vehicle and engine speeds than in the “S” program mode.

**Caution!**

Never change the program mode when the selector lever is out of position “P”. It could result in a change of driving characteristics for which you may not be prepared.

**Important!**

Always be certain of the program mode selected since the vehicle driving characteristics change with the selection of the program mode.

Dependent on the program mode selector switch position “S” or “W” and the gear selector lever in position “R”, the ratio of power transmission changes.

**Emergency operation  
(Limp home mode)**

If vehicle acceleration worsens or the transmission no longer shifts, the transmission is most likely operating in Limp Home Mode which engages when there is a malfunction of the transmission. This condition may be accompanied by the “CHECK ENGINE” malfunction indicator lamp in the instrument cluster coming on.

In this mode only the 2nd gear or reverse gear can be activated.

To engage 2nd gear or reverse:

1. Stop the vehicle.
2. Move selector lever to position “P”.
3. Turn off the engine.
4. Wait approximately 10 seconds.
5. Restart the engine.
6. Move selector lever to position “D” (for 2nd gear), or move selector lever to position “R” (for reverse gear).

Have the transmission checked at your authorized Mercedes-Benz Center as soon as possible.

## Parking brake

242

**Parking brake**

To engage, firmly depress parking brake pedal. When the electronic key is in starter switch position 2, the brake warning lamp in the instrument cluster should come on brightly.

To release the parking brake, pull handle on instrument panel. The brake warning lamp in the instrument cluster should go out.

A warning sounds and the parking brake warning message (see page 308) appears in the multifunction display, if you start to drive without having released the parking brake.

Also see brake warning lamp on page 298.

**Warning!**

**When leaving the vehicle always remove the electronic key from the starter switch, take the KEYLESS-GO-card (if so equipped) with you and lock the vehicle. Do not leave children unattended in the vehicle, or with access to an unlocked vehicle. Children could release the parking brake, which could result in an accident or serious injury.**

## Driving instructions

### Drive sensibly – Save Fuel

Fuel consumption, to a great extent, depends on driving habits and operating conditions.

To save fuel you should:

- keep tires at the recommended inflation pressures,
- remove unnecessary loads,
- remove roof rack when not in use,
- allow engine to warm up under low load use,
- avoid frequent acceleration and deceleration,
- have all maintenance work performed at regular intervals by an authorized Mercedes-Benz Center.

Fuel consumption is also increased by driving in cold weather, in stop-and-go traffic, on short trips and in hilly country.

## Drinking and driving

### Warning!

**Drinking or taking drugs and driving can be a very dangerous combination. Even a small amount of alcohol or drugs can affect your reflexes, perceptions and judgement.**

**The possibility of a serious or even fatal accident is sharply increased when you drink or take drugs and drive.**

**Please don't drink or take drugs and drive or allow anyone to drive after drinking or taking drugs.**

## Pedals

### Warning!

**Keep driver's foot area clear at all times. Objects stored in this area may impair pedal movement.**

Instruments and controls	Operation	<b>Driving</b>	Instrument cluster display	Practical hints	Car care	Technical data	Index
--------------------------	-----------	----------------	----------------------------	-----------------	----------	----------------	-------

## Driving instructions

244

### Power assistance

#### **Warning!**

**When the engine is not running, the brake and steering systems are without power assistance. Under these circumstances, a much greater effort is necessary to stop or steer the vehicle.**

### Brakes

#### **Warning!**

**After driving in heavy rain for some time without applying the brakes or through water deep enough to wet brake components, the first braking action may be somewhat reduced and increased pedal pressure may be necessary to obtain expected braking effect. Be sure to maintain a safe distance from vehicles in front.**

**Resting your foot on the brake pedal will cause excessive and premature wear of the brake pads.**

**It can also result in the brakes overheating thereby significantly reducing their effectiveness. It may not be possible to stop the vehicle in sufficient time to avoid an accident.**

The condition of the parking brake system is checked each time the vehicle is in the shop for the required maintenance service.

If the parking brake is released and the brake warning lamp in the instrument cluster stays on, the brake fluid level in the reservoir is too low.

Brake pad wear or a leak in the system may be the reason for low brake fluid in the reservoir.

Have the brake system inspected at an authorized Mercedes-Benz Center immediately.

All checks and service work on the brake system should be carried out by an authorized Mercedes-Benz Center.

Install only brake pads and brake fluid recommended by Mercedes-Benz.

#### **Warning!**

**If other than recommended brake pads are installed, or other than recommended brake fluid is used, the braking properties of the vehicle can be degraded to an extent that safe braking is substantially impaired. This could result in an accident.**

**Caution!**

When driving down long and steep grades, relieve the load on the brakes by shifting into a lower gear to use the engine's braking power. This helps prevent overheating of the brakes and reduces brake pad wear.

After hard braking, it is advisable to drive on for some time, rather than immediately parking, so the air stream will cool down the brakes faster.

**Driving off**

Apply the service brakes to test them briefly after driving off. Perform this procedure only when the road is clear of other traffic.

Warm up the engine smoothly. Do not place full load on the engine until the operating temperature has been reached.

When starting off on a slippery surface, do not allow one drive wheel to spin for an extended period with the ESP switched off. Doing so may cause serious damage to the drive train which is not covered by the Mercedes-Benz Limited Warranty.



**Parking****Warning!**

To reduce the risk of personal injury as a result of vehicle movement, before turning off the engine and leaving the vehicle, always:

1. Keep right foot on service brake pedal.
2. Firmly depress parking brake pedal.
3. Move the selector lever to position "P".
4. Slowly release service brake pedal.
5. Turn front wheels towards the road curb.
6. Turn the electronic key to starter switch position 0 and remove, or press start-/stop button (vehicles with KEYLESS-GO).
7. Take the electronic key and the KEYLESS-GO-card (vehicles with KEYLESS-GO) and lock vehicle when leaving.

**Important!**

It is advisable to set the parking brake whenever parking or leaving the vehicle. In addition, move selector lever to position "P".

When parking on hills, always set the parking brake.

## Tires

### Warning!

If you feel a sudden significant vibration or ride disturbance, or you suspect that possible damage to your vehicle has occurred, you should turn on the hazard warning flashers, carefully slow down, and drive with caution to an area which is a safe distance from the roadway.

Inspect the tires and under the vehicle for possible damage. If the vehicle or tires appear unsafe, have it towed to the nearest Mercedes-Benz Center or tire dealer for repairs.

Tread wear indicators (TWI) are required by law. These indicators are located in six places on the tread circumference and become visible at a tread depth of approximately  $\frac{1}{16}$  in (1.5 mm), at which point the tire is considered worn and should be replaced.

The tread wear indicator appears as a solid band across the tread.

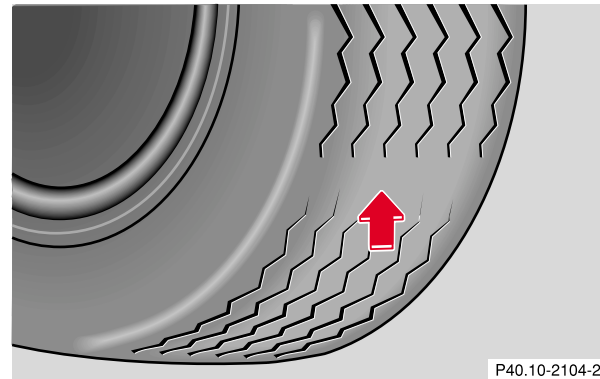

### Warning!

Do not allow your tires to wear down too far. As tread depth approaches  $\frac{1}{16}$  in (1.5 mm), the adhesion properties on a wet road are sharply reduced.

Depending upon the weather and/or road surface (conditions), the tire traction varies widely.

Instruments and controls	Operation	<b>Driving</b>	Instrument cluster display	Practical hints	Car care	Technical data	Index
--------------------------	-----------	----------------	----------------------------	-----------------	----------	----------------	-------

## Driving instructions

Specified tire pressures must be maintained. This applies particularly if the tires are subjected to high loads (e.g. high speeds, heavy loads, high ambient temperatures).

### Warning!

**Do not drive with a flat tire. A flat tire affects the ability to steer or brake the vehicle. You may lose control of the vehicle. Continued driving with a flat tire or driving at high speed with a flat tire will cause excessive heat build-up and possibly a fire.**

### Aquaplaning

Depending on the depth of the water layer on the road, aquaplaning may occur, even at low speeds and with new tires. Reduce vehicle speed, avoid track grooves in the road and apply brakes cautiously in the rain.

## 248

### Tire traction

The safe speed on a wet, snow covered or icy road is always lower than on a dry road.

You should pay particular attention to the condition of the road whenever the outside temperatures are close to the freezing point.

### Warning!

**If ice has formed on the road, tire traction will be substantially reduced. Under such weather conditions, drive, steer and brake with extreme caution.**

We recommend M+S rated radial-ply tires for the winter season for all four wheels to insure normal balanced handling characteristics. On packed snow, they can reduce your stopping distance as compared with summer tires. Stopping distance, however, is still considerably greater than when the road is not snow or ice covered.

### Tire speed rating

S 430, S 500 and S 600 (except Sport Package):

Your vehicle is factory equipped with “H”-rated tires, which have a speed rating of 130 mph (210 km/h).

Vehicles with Sport Package:

Your vehicle is factory equipped with “Y”-rated tires, which have a speed rating of 188 mph (300 km/h).

An electronic speed limiter prevents your vehicle from exceeding a speed of 130 mph (210 km/h).

S 55 AMG:

Your vehicle is factory equipped with “Y”-rated tires, which have a speed rating of 188 mph (300 km/h).

An electronic speed limiter prevents your vehicle from exceeding a speed of 155 mph (250 km/h).

Despite the tire rating, local speed limits should be obeyed. Use prudent driving speeds appropriate to prevailing conditions.

#### Warning!

**Even when permitted by law, never operate a vehicle at speeds greater than the maximum speed rating of the tires.**

**Exceeding the maximum speed for which tires are rated can lead to sudden tire failure causing loss of vehicle control and resulting in personal injury and possible death.**

### Snow chains

Use only snow chains that are tested and recommended by Mercedes-Benz. Your authorized Mercedes-Benz Center will be glad to advise you on this subject.

Chains should only be used on the rear wheels. Follow the manufacturer’s mounting instructions.

Vehicles with Active body control (ABC):

Always select option I or II of the level control system when driving with snow chains, see page 280.

Snow chains should only be driven on snow covered roads at speeds not to exceed 30 mph (50 km/h).

Remove chains as soon as possible when driving on roads without snow.

When driving with snow chains, press the ESP control switch to OFF, refer to page 276.

Instruments and controls	Operation	<b>Driving</b>	Instrument cluster display	Practical hints	Car care	Technical data	Index
--------------------------	-----------	----------------	----------------------------	-----------------	----------	----------------	-------

## Driving instructions

250

### Important!

Use of snow chains is not permissible with tire sizes 245/45 R18 or 275/40 R18.

### Winter driving instructions

The most important rule for slippery or icy roads is to drive sensibly and to avoid abrupt acceleration, braking and steering maneuvers. Do not use the cruise control system under such conditions.

When the vehicle is in danger of skidding, move selector lever to position "N". Try to keep the vehicle under control by corrective steering action.

Road salts and chemicals can adversely affect braking efficiency. Increased pedal force may become necessary to produce the normal brake effect. We therefore recommend depressing the brake pedal periodically when traveling at length on salt-strewn roads. This can bring road salt impaired braking efficiency back to normal. A prerequisite is, however, that this be done without endangering other drivers on the road.

If the vehicle is parked after being driven on salt treated roads, the braking efficiency should be tested as soon as possible after driving is resumed while observing the safety rules in the previous paragraph.

### Warning!

**If the vehicle becomes stuck in snow, make sure that snow is kept clear of the exhaust pipe and from around the vehicle with engine running. Otherwise, deadly carbon monoxide (CO) gases may enter vehicle interior resulting in unconsciousness and death.**

**To assure sufficient fresh air ventilation, open a window slightly on the side of the vehicle not facing the wind.**

### Winter driving

Have your vehicle winterized at your authorized Mercedes-Benz Center before the onset of winter.

- Change the engine oil if the engine contains an oil which is not approved for winter operation. For viscosity (SAE/CCMC class) and filling quantity, see page 396.
- Check engine coolant anticorrosion/antifreeze concentration.
- Additive for the windshield washer and headlamp cleaning system: Add MB Concentrate “S” to a premixed windshield washer solvent/antifreeze which is formulated for below freezing temperatures, see page 337.
- Test battery: Battery capacity drops with decreasing ambient temperature. A well charged battery helps to ensure that the engine can be started, even at low ambient temperatures.

- Tires: We recommend M+S rated radial-ply tires on all four wheels for the winter season. Observe permissible maximum speed for M+S rated radial-ply tires and the legal speed limit.

Note:

In winter operation, the maximum effectiveness of the ABS and ESP can only be achieved with M+S rated radial-ply tires and/or snow chains recommended by Mercedes-Benz. Snow chains maximize performance.

#### Block heater (for Canada only)

The engine is equipped with a block heater.

The electrical cable may be installed at your authorized Mercedes-Benz Center.

## Driving instructions

252

**Deep water****Caution!**

Do not drive through flooded areas or water of unknown depth.

If you must drive through deep water, drive slowly to prevent water from entering the engine compartment or passenger compartment, being ingested by the air intake, possibly causing damage to electrical components or wiring, to engine or transmission that is not covered by the Mercedes-Benz Limited Warranty.

**Passenger compartment****Warning!**

Always fasten items being carried as securely as possible.

In an accident, during hard braking or sudden maneuvers, loose items will be thrown around inside the vehicle, and cause injury to vehicle occupants unless the items are securely fastened in the vehicle.

The trunk is the preferred place to carry objects.

**Traveling abroad**

Abroad, there is a widely-spread Mercedes-Benz service network at your disposal. If you plan to travel into areas which are not listed in the index of your Mercedes-Benz Center directory, you should request pertinent information from your authorized Mercedes-Benz Center.

## Cruise control

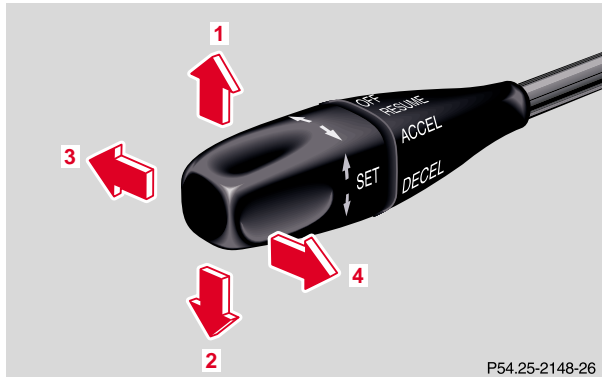

The cruise control allows you to drive in a more relaxed manner, for example over long distances, as it automatically maintains the set speed by actively regulating the throttle setting.

Any given speed above approximately 25 mph (40 km/h) can be maintained with the cruise control by operating the lever.

- 1** Accelerate and set:  
Lift lever briefly to set speed. Hold lever up to accelerate.

- 2** Decelerate and set:  
Depress lever briefly to set speed.  
Hold lever down to decelerate.

Normally the vehicle is accelerated to the desired speed with the accelerator.

Speed is set by briefly pushing the lever to position 1 or 2. The accelerator can then be released.

The selected speed is shown for approximately 5 seconds in the multifunction display, and the corresponding speedometer segments from the selected speed to the vehicle maximum speed are illuminated.

The speed can be increased (e.g. for passing) by using the accelerator. After the accelerator is released, the previously set speed will be resumed automatically.

If a set speed is to be increased or decreased slightly, e. g. to adapt to the traffic flow, hold lever in position 1 or 2 until the desired speed is reached, or briefly tip the lever in the appropriate direction for increases or decreases in 0.6 mph (1 km/h) increments. When the lever is released, the newly set speed remains.



## Driving systems

254

**3** Canceling

To cancel the cruise control, briefly push lever to position 3.

When you step on the brake pedal or the vehicle speed drops below approximately 25 mph (40 km/h), for example when driving upgrade, the cruise control will be canceled.

If the cruise control cancels by itself and remains inoperative until the engine is restarted, have the system checked at your authorized Mercedes-Benz Center as soon as possible.

**4** Resume

If the lever is briefly pushed to position 4 when driving at a speed exceeding approximately 25 mph (40 km/h), the vehicle resumes the speed which was set prior to the cancellation of the cruise control.

The selected speed is shown for approximately 5 seconds in the multifunction display, and the corresponding speedometer segments from the selected speed to the vehicle maximum speed are illuminated.

The last memorized speed is canceled when the electronic key in the starter switch is turned to position 1 or 0.

**Important!**

Moving gear selector lever to position "N" switches the cruise control off.

**Warning!**

**Only use the cruise control if the traffic and weather conditions make it advisable to travel at a steady speed.**

- **The use of cruise control can be dangerous on winding roads or in heavy traffic because conditions do not allow safe driving at a steady speed.**
- **The use of cruise control can be dangerous on slippery roads. Rapid changes in tire adhesion can result in wheel spin and loss of control.**

**The “Resume” function should only be operated if the driver is fully aware of the previously set speed and wishes to resume this particular preset speed.**

Notes:

If the engine does not brake the vehicle sufficiently while driving on a downgrade, the speed you set on the cruise control may be exceeded. In this case the automatic transmission shifts down (max. to 3rd gear) to maintain the set cruise control speed by using the engine’s braking power.

As soon as the grade eases, the automatic transmission shifts up again dependent on the selector lever position.

Nevertheless, in some cases you may have to step on the brake pedal to slow down. In this case the cruise control is switched off.

Use the lever to resume the previously set speed.

The “CRUISE CONTROL ---” message is displayed on the multifunction display when any attempt is made to store speeds below 25 mph (40 km/h) or when an attempt is made to recall a speed when no speed has been stored – the cruise control remains switched off.

See malfunction and warning messages on page 303 if the cruise control has a malfunction.

## Driving systems

256

**Distronic (DTR)  
(optional)**

When activated the DISTRONIC system increases driving convenience, for example over long distances, as it automatically maintains a speed set by the driver by actively regulating the throttle setting. It also maintains within certain limitations a preset distance to a vehicle ahead.

With DISTRONIC switched off, the multifunction display continues to show the distance to the vehicle ahead, if so selected, see page 269.

The distance notification function can be activated separately, see page 267.

In DISTRONIC mode, if the distance sensor detects a slower moving vehicle directly ahead, your vehicle speed will be reduced to the extent permitted by reduced throttle and up to 20% of vehicle braking power, so that you follow that vehicle at a preset distance, see page 268.

Maximum range of detection is approximately 500 ft. (150 m).

Any given speed between 25 mph (Canada: 30 km/h) and 110 mph (Canada: 180 km/h) can be maintained with the DISTRONIC by operating the control lever on the steering column.

**Warning!**

**DISTRONIC is a convenience system, its speed adjustment reduction capability is intended to make cruise control more effective and usable when traffic speeds vary. It is not, however, intended to nor does it replace the need for extreme care. The responsibility for the vehicle speed and the distance to the vehicle ahead, including most importantly brake operation to assure safe stopping distance, rests always with the driver.**

**Warning!**

**DISTRONIC requires familiarity with its operational characteristics. We strongly recommend that you review the following information carefully before operating the system.**

Note:

For operation in the USA only: This device complies with Part 15, Subpart C, Section 209 of the FCC Rules. Operation is subject to the following two conditions:

- (1) This device may not cause harmful interference, and
- (2) this device must accept any interference received, including interference that may cause undesired operation.

Any unauthorized modification to this device could void the user's authority to operate the equipment

### Warning!

**Only use DISTRONIC if the traffic and weather conditions make it advisable to travel at a steady speed.**

**Use of DISTRONIC can be dangerous on winding roads or in heavy traffic because conditions do not allow safe driving at a steady speed.**

**Use of DISTRONIC can be dangerous on slippery roads. Rapid changes in tire adhesion can result in wheel spin and loss of control.**

**DISTRONIC does not act upon adverse sight distance conditions. Do not use DISTRONIC during conditions of fog and heavy rain, snow or sleet.**

**The "Resume" function should only be operated if the driver is fully aware of the previously set speed and wishes to resume this particular preset speed.**

**DISTRONIC does not recognize accordingly and will not react to stationary objects. It is designed and intended only to maintain a set speed and keep a set distance from moving objects in front of it.**

## Driving systems

258

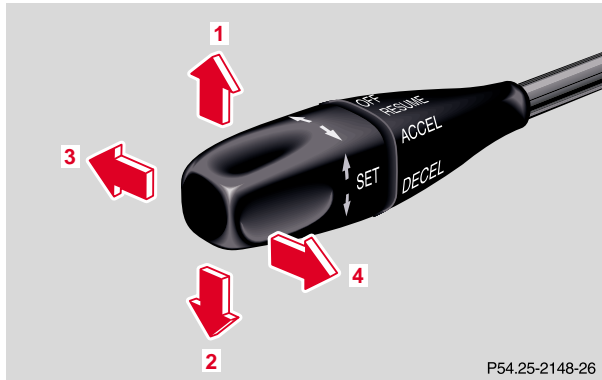

The speed stored in memory is displayed in the multifunction display, and one or two segments around the stored speed light up in the speedometer dial, see page 270.

**1** Accelerate and set:

To increase the speed by 5 mph (Canada: 10 km/h) – briefly lift lever up.

**2** Decelerate and set:

To reduce the speed by 5 mph (Canada: 10 km/h) – briefly depress lever.

**3** Canceling

To cancel Distronic, briefly push lever to position 3. The last set speed remains stored in memory.

**4** Resume

- If the lever is briefly pulled to position 4 when driving at a speed above approximately 25 mph (Canada: 30 km/h), the vehicle resumes the speed which was selected prior to the cancellation of Distronic.
- For minor increases of speeds in increments of 1 mph (Canada: 1 km/h) – briefly pull lever to position 4.

The last memorized speed is canceled when the electronic key in the starter switch is turned to position 1 or 0.

### Activation of Distronic

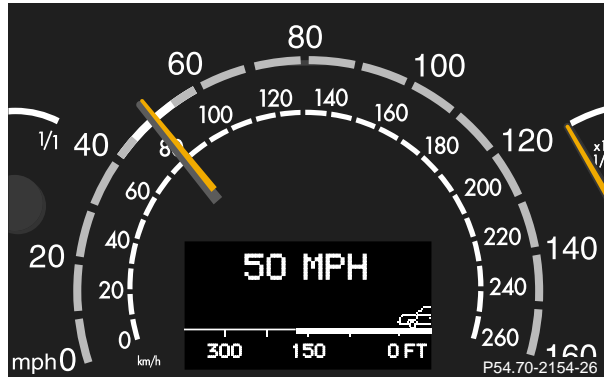

Any given speed above approximately 25 mph (Canada: 30 km/h) can be maintained:

- Normally the vehicle is accelerated to the desired speed with the accelerator.

- Speed is set by briefly moving the control lever to position 1 or 2.

The stored speed is displayed in the multifunction display for approximately 5 seconds (see also page 269), and one or two segments around the stored speed light up on the speedometer dial (see also page 270).

- Remove foot from the accelerator.
- When briefly lifting the control lever to position 1, the vehicle speed will increase in increments of 5 mph (Canada: 10 km/h).

The stored speed is displayed in the multifunction display for approximately 5 seconds (see also page 269), and one or two segments around the stored speed light up on the speedometer dial (see also page 270).

- When briefly lowering the control lever to position 2, the vehicle speed will decrease in increments of 5 mph (Canada: 10 km/h).

The stored speed is displayed in the multifunction display for approximately 5 seconds (see also page 269), and one or two segments around the stored speed light up on the speedometer dial (see also page 270).

## Driving systems

260

- For a more precise setting the speed can be increased in increments of 1 mph (Canada: 1 km/h) by briefly pulling the control lever in direction (4).

**Caution!**

If the driver's foot is not fully removed from the accelerator pedal, the Distronic control system will be overridden and it will not regulate the preset vehicle speed and following distance. The vehicle speed and following distance will be determined only by the accelerator pedal position.

**Warning!**



**Distronic brakes (up to 20% of vehicle braking power) the vehicle to restore the preset distance or to maintain the speed. The brake pedal is automatically retracted as this happens.**

**Keep driver's foot area clear at all times, including the area under the brake pedal. Objects stored in this area may impair pedal movement which could interfere with the braking ability of the Distronic system.**

**Do not place your foot under the brake pedal – your foot could become caught.**

**Invalid attempts to activate**

The multifunction display will show “---” during invalid attempts to activate Distronic:

- below a speed of approximately 25 mph (Canada: 30 km/h),
- while the electronic stability program (ESP) is switched off – ESP warning lamp  in speedometer dial is illuminated, see page 114,
- by moving the distronic control lever in “RESUME” direction (4) when no speed is stored in memory,
- during the initialization and self-test phase after the engine is started – this can take up to 2 minutes,
- while depressing the service brake pedal,
- while the parking brake is set – check  warning lamp (Canada: ) in instrument cluster, see page 114,
- with the gear selector lever in position “P”, “R” or “N” – check gear range indicator display in instrument cluster, see page 114.

### Deactivation of Distronic

Briefly move the distronic control lever in “OFF” direction (3) – the stored speed remains in the memory until the electronic key in the starter switch is turned to position 1 or 0.

Distronic is also deactivated if:

- the service brake pedal is depressed,
- the parking brake is activated,
- the vehicle decelerates to less than approximately 25 mph (Canada: 30 km/h), e.g. while maintaining the distance to the vehicle ahead,

#### Warning!

**The Distronic switches off and releases the brakes when the vehicle decelerates below the minimum speed of 25 mph (Canada: 30 km/h) by operation of the system. At that time, the driver must apply the brakes in order to reduce vehicle speed further or bring it to a stop.**

- the gear selector lever is moved to position “N”,
- the electronic stability program (ESP) is active,
- the electronic stability program (ESP) is switched off manually,
- Model S 55 AMG only:  
the vehicle speed exceeds approximately 160 mph (260 km/h).

Note:

A signal sounds and the message “DTR OFF” appears for 5 seconds in the multifunction display everytime Distronic is deactivated.



## Driving systems

262

## Driving with DISTRONIC activated

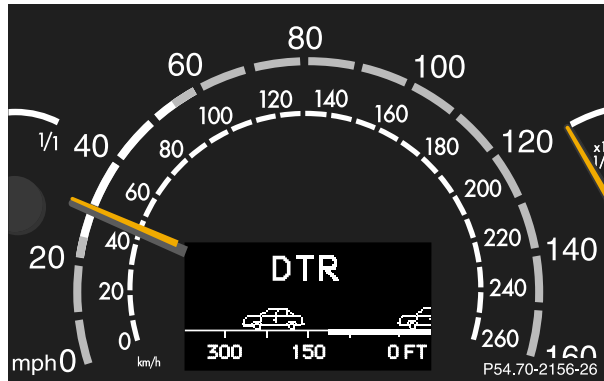

With the electronic key in starter switch position 2, the distance warning lamp 1 in the speedometer dial comes on and goes out with the engine running.

If the distance sensor detects a slower vehicle moving in front, your vehicle speed will be reduced by deceleration and braking of up to 20% of the vehicle braking capacity, so that you follow the vehicle ahead at the preset distance, see page 268. Segments in the speedometer illuminate to indicate the speed range

from the speed of the vehicle in front up to your vehicle's selected speed. See also page 269 for notes on the multifunction displays.

**Warning!**

**DISTRONIC brakes (up to 20% of vehicle braking power) the vehicle to restore the preset distance or to maintain the speed. The brake pedal is automatically retracted as this happens.**

**Keep driver's foot area clear at all times, including the area under the brake pedal. Objects stored in this area may impair pedal movement which could interfere with the braking ability of the DISTRONIC system.**

**Do not place your foot under the brake pedal – your foot could become caught.**

### **Warning!**

A continuous warning sounds and the distance warning lamp in the speedometer dial is illuminated if the Distronic system calculates that the distance to the vehicle ahead and your vehicle's current speed indicate that Distronic will not be capable of slowing the vehicle sufficiently to maintain the preset following distance, which creates a danger of a collision.

Immediately brake the vehicle to increase the distance to the vehicle in front of you. The warning sound is intended as a final caution that you have not interceded with your own braking inputs to avoid a potentially dangerous situation. Do not wait for the operation of the warning signal to intercede with your own braking as that will result in potentially dangerous emergency braking which will not always result an impact being avoided.

**Tailgating increases the risk of an accident.**

The distance warning sound continues until the driver activates the brake pedal, or the preset distance is obtained. As soon as the preset distance is obtained, the distance warning lamp goes out.

### **Caution!**

If the driver's foot is not fully removed from the accelerator pedal, the Distronic control system will be overridden and it will not regulate the preset vehicle speed and following distance. The vehicle speed and following distance is determined only by the accelerator pedal position.

Distronic works on steep uphill and downhill gradients by downshifting gears and applying the brakes to maintain the speed selected by the driver. The transmission will upshift again once the gradient evens out.

The speed can be increased (e.g. for passing) by using the accelerator. After the accelerator is released, the previously set speed will be resumed automatically.

Distronic is deactivated if a vehicle in front causes your vehicle to slow down to less than approximately 25 mph (Canada: 30 km/h). A signal sounds and the message "DTR OFF" appears for 5 seconds in the multifunction display.

**Additional driving hints****Warning!**

Distronic works to maintain the speed selected by the driver unless a moving obstacle proceeding directly ahead of it in the same travel direction is detected (e.g. following another vehicle ahead at a distance set by DISTRONIC). This means that:

- your vehicle can pass another vehicle after you change lanes,
- while in a sharp turn or if the vehicle in front is in a sharp turn, DISTRONIC could lose sight of a vehicle traveling in front of it, then your vehicle could accelerate to the previously selected speed.

DISTRONIC regulates only the distance between your vehicle and those directly ahead, but does not register stationary objects in the roadway, e.g.:

- a stopped vehicle in a traffic jam.
- a disabled vehicle.
- an oncoming vehicle.

**The driver must always be on the alert and observe all traffic and intercede with steering and braking inputs as necessary.**

**Important!**

When starting the engine, DISTRONIC goes through an initialization and self-test phase.

The most likely cause for a malfunctioning system is caused by a dirty sensor (located behind the hood grille), especially at times of snow and ice or heavy rain. In such a case, DISTRONIC will switch off, and the message "DISTRONIC – CLEAN SENSOR!" appears in the multifunction display.

**Warning!**

**DISTRONIC should not be used in snowy or icy road conditions.**

For cleaning and care of the DISTRONIC sensor, see page 378.

The following are some sample situations which may influence the functions of DISTRONIC.

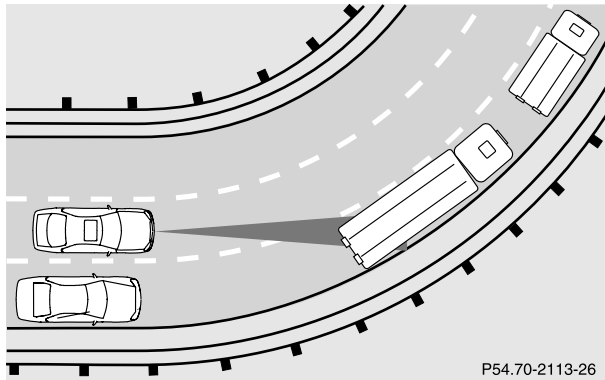

Traveling through turns or bends in the roadway may result in Distronic detecting a moving vehicle traveling in front but not in your lane of travel, causing your vehicle to brake late or unexpectedly. You must be prepared to intercede with accelerator or brake application as necessary.

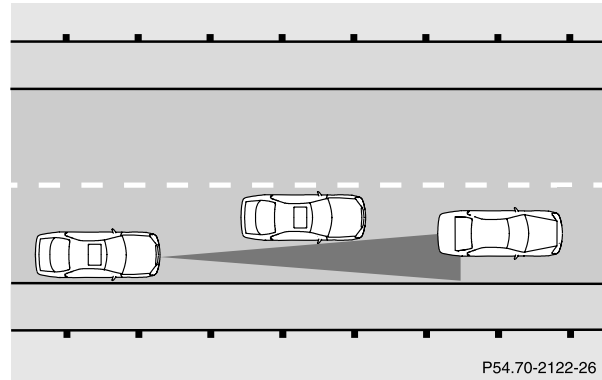

The Distronic system's detection zone is relatively narrow at the start and becomes broader as it senses further from the vehicle. Thus, Distronic may not recognize another vehicle coming into your path close to the front of your vehicle. You must be prepared to intercede with braking or steering as necessary. A vehicle not traveling directly in front of you could cause detection problems, the actual distance to that vehicle really being much shorter.

## Driving systems

266

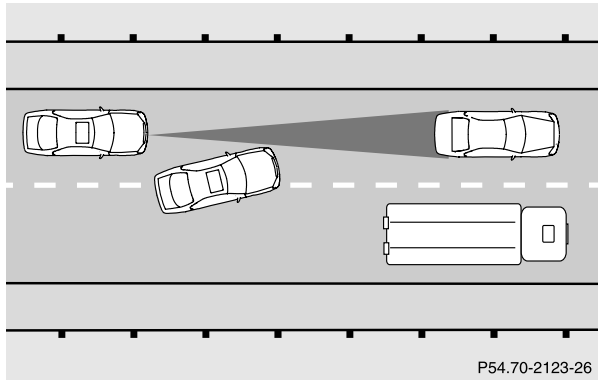

A vehicle changing lanes at close range is only recognized when entering the area scanned by DISTRONIC. You must apply the service brakes to gain sufficient distance to the vehicle ahead.

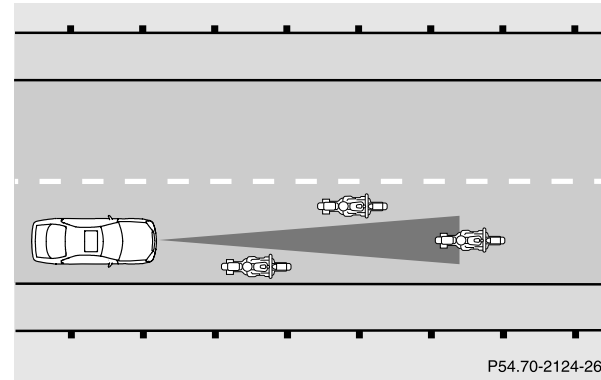

A narrow vehicle (e.g. a motorcycle) is only recognized when entering the area scanned by DISTRONIC. You must apply the service brakes to gain sufficient distance to the vehicle ahead.

### Distance warning function

Even if Distronic is deactivated, the distance to the vehicle ahead continues to be measured, see page 269 for multifunction display.

The Distronic lamp in the speedometer dial illuminates to advise the driver of a situation which under normal braking conditions and dry surfaces should have been addressed by the driver.

The distance notification function can be activated separately, see page 267. It operates when driving at speeds above approximately 25 mph (Canada: 30 km/h).

When recognizing a stationary obstacle or a slower vehicle moving in the vehicle's path and the danger of a collision exists, the distance warning lamp in the speedometer dial lights up and simultaneously a continuous warning sounds.

Note:

Model S 55 AMG only:  
Distance notification function is deactivated if the vehicle speed exceeds approximately 160 mph (260 km/h).

### Important!

With the Distronic switched off, only the distance notification function operates, meaning the vehicle does not slow down.

### Warning!

**If the distance warning lamp in the speedometer dial lights up while driving and a continuous warning sounds, immediate attention on the part of the driver is required.**

**As required by the traffic situation, apply the service brakes and navigate around a possible obstacle. However, do not drive by relying on the distance notification function as that will result in an emergency braking application which, especially depending on road surface conditions and driver reaction, will not always be able to avoid a collision.**

### Important!

Complex driving situations are not always fully recognized by Distronic, which could result in wrong or missing distance warnings.

See page 264 for additional driving hints.

## Driving systems

268

## Distronic settings



- 1 Switch – for distance notification function
- 2 Thumbwheel – for setting distance

Distronic provides a safe following distance range to the vehicle in front. The medium setting is noticeable by a detent in the center position of the thumbwheel (2). If you want to:

- Increase distance – turn thumbwheel (2) towards

- Decrease distance – turn thumbwheel (2) towards

**Warning!**

It is up to the driver to exercise discretion to select the appropriate setting given road conditions, traffic, driver's preferred driving style and applicable laws and driving recommendations for safe following distance.

To switch the distance notification function on or off:

To switch on – press upper half of switch (1). The indicator lamp in the switch lights up.

To switch off – press lower half of the switch (1). The indicator lamp in the switch goes out.

For distance notification function see page 267.

Notes:

With the distance notification function activated, you will still be advised by a continuous audible warning if a potential emergency braking circumstance has been detected, even if Distronic has been deactivated.

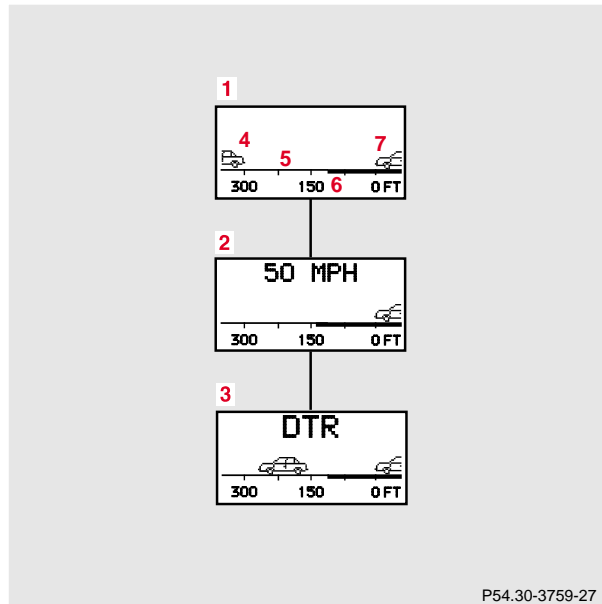

The last selected notification function mode (on/off) will be stored in memory, even when removing the electronic key from the starter switch.

## Multifunction displays



- 1 Distronic is deactivated. The actual distance (5) and the should-be distance (6) to the vehicle ahead (4) are displayed.
- 2 Distronic is activated. The display shows the selected speed for approximately 5 seconds.
- 3 Distronic is activated. The message “DTR OFF” appears for approximately 5 seconds when Distronic is being deactivated.
- 4 Vehicle ahead. Only appears if a vehicle is detected ahead.
- 5 Actual distance to vehicle ahead.
- 6 Should-be distance to vehicle ahead (as calculated by Distronic).
- 7 Own vehicle.

To call up Distronic display:

Press button  or  on the multifunction steering wheel repeatedly until the display (1 or 3) appears.



### Displays in the speedometer dial

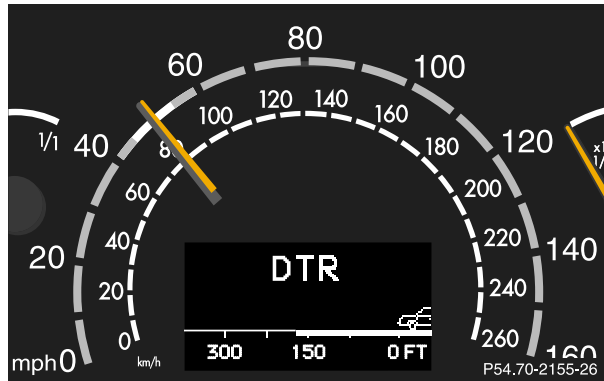

When Distronic system is activated, one or two segments around the speed stored in memory light up in the speedometer dial.

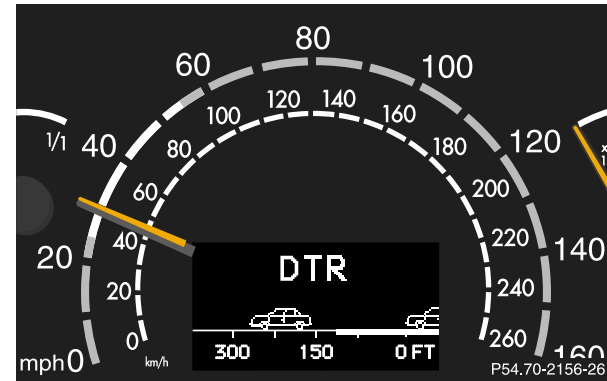

If a vehicle is detected ahead, those segments in the speedometer dial light up that indicate the speed range from the speed of the vehicle in front up to the Distronic stored speed.

When the vehicle in front can no longer be detected, only the segments around the stored speed light up. The vehicle is accelerated to the stored speed.

## Brake assist system (BAS)

### Warning!

**BAS cannot prevent the natural laws of physics from acting on the vehicle, nor can it increase braking efficiency beyond that afforded by the condition of the vehicle brakes and tires or the traction afforded. The BAS cannot prevent accidents, including those resulting from excessive speed in turns, following another vehicle too closely, or aquaplaning. Only a safe, attentive, and skillful driver can prevent accidents. The capabilities of a BAS equipped car must never be exploited in a reckless or dangerous manner which could jeopardize the user's safety or the safety of others.**

The BAS is designed to maximize the vehicle's braking capability during emergency braking maneuvers by having maximum power boost applied to the brakes more quickly in emergency braking conditions than might otherwise be afforded solely by the driver's braking style. This can help reduce braking distances over what ordinary driving and braking style might do. The BAS complements the Antilock Brake System (ABS).

Applying the brakes very quickly results in maximum BAS assistance.

To receive the benefit of the system you must apply continuous full braking power during the stopping sequence. Do not reduce brake pedal pressure.

Once the brake pedal is released, the BAS is deactivated.

If the BAS warning message is displayed, a malfunction has been detected in the system. The brake system functions in the usual manner, but without BAS.

With the ABS malfunctioning, the BAS is also switched off.

If a BAS warning message is displayed, have the BAS checked at your authorized Mercedes-Benz Center as soon as possible.

Instruments and controls	Operation	<b>Driving</b>	Instrument cluster display	Practical hints	Car care	Technical data	Index
--------------------------	-----------	----------------	----------------------------	-----------------	----------	----------------	-------

## Driving systems

272

### Antilock brake system (ABS)

#### Warning!

**Do not pump the brake pedal, rather use firm, steady brake pedal pressure. Pumping the brake pedal defeats the purpose for ABS and significantly reduces braking effectiveness.**

#### Important!

The ABS improves steering control of the vehicle during hard braking maneuvers.

The ABS prevents the wheels from locking up above a vehicle speed of approximately 5 mph (8 km/h) independent of road surface conditions.

At the instant one of the wheels is about to lock up, a slight pulsation can be felt in the brake pedal, indicating that the ABS is in the regulating mode. Keep firm and steady pressure on the brake pedal while experiencing the pulsation.

Continuous steady brake pedal pressure results in applying the advantages of the ABS, namely braking power and ability to steer the vehicle.

In the case of an emergency brake maneuver keep continuous full pressure on the brake pedal. In this manner only can the ABS be most effective.

On slippery road surfaces, the ABS will respond even with light brake pedal pressure because of the increased likelihood of locking wheels. The pulsating brake pedal can be an indication of hazardous road conditions and functions as a reminder to take extra care while driving.

### ABS control

The ABS malfunction indicator lamp  in the instrument cluster comes on with the electronic key in starter switch position 2 and should go out with the engine running.

When the ABS malfunction indicator lamp in the instrument cluster comes on while the engine is running, it indicates that the ABS has detected a malfunction and has switched off. In this case, the brake system functions in the usual manner, but without antilock assistance.

For ABS malfunction indicator lamp, see page 300.

With the ABS malfunctioning, the BAS and ESP are also switched off. Both malfunction indicator lamps come on with the engine running.

If the charging voltage falls below 10 volts, the malfunction indicator lamp comes on and the ABS is switched off. When the voltage is above this value again, the malfunction indicator lamp should go out and the ABS is operational.

If the ABS malfunction indicator lamp stays illuminated, have the system checked at your authorized Mercedes-Benz Center as soon as possible.

### Warning!

**ABS cannot prevent the natural laws of physics from acting on the vehicle, nor can it increase braking or steering efficiency beyond that afforded by the condition of the vehicle brakes and tires or the traction afforded. The ABS cannot prevent accidents, including those resulting from excessive speed in turns, following another vehicle too closely, or aquaplaning. Only a safe, attentive, and skillful driver can prevent accidents. The capabilities of a ABS equipped vehicle must never be exploited in a reckless or dangerous manner which could jeopardize the user's safety or the safety of others.**

### Note:

To alert following vehicles to slippery road conditions you discover, operate your hazard warning flashers as appropriate.

**Electronic stability program (ESP)****Warning!**

**ESP cannot prevent the natural laws of physics from acting on the vehicle, nor can it increase the traction afforded. The ESP cannot prevent accidents, including those resulting from excessive speed in turns, or aquaplaning. Only a safe, attentive, and skillful driver can prevent accidents. The capabilities of an ESP equipped vehicle must never be exploited in a reckless or dangerous manner which could jeopardize the user's safety or the safety of others.**

The ESP enhances directional control and reduces driving wheel spin of the vehicle under various driving conditions.

Over/understeering of the vehicle is counteracted by applying brakes to the appropriate wheel to create a countervailing vehicle movement. Engine torque is also limited. The ESP warning lamp, located in the speedometer dial, starts to flash when ESP is in operation.

**Important!**

If the ESP warning lamp  flashes:

- During take-off apply as little throttle as possible.
- While driving ease up on the accelerator.
- Adapt your speed and driving to the prevailing road conditions.
- Do not switch off the ESP.

**Caution!**

If the vehicle is towed with the front axle raised (see page 353, Towing the vehicle), the engine must be shut off (electronic key in starter switch position 0 or 1). Otherwise, the ESP will immediately be engaged and will apply the rear wheel brakes.

Notes:

The yellow ESP warning lamp  in the speedometer dial comes on with the electronic key in starter switch position 2. It should go out with the engine running.

If the ESP warning message is displayed, a malfunction has been detected in the system. Only partial engine output will be available.

Have the ESP checked at your authorized Mercedes-Benz Center as soon as possible.

For ESP warning message, see page 301.

With the ABS malfunctioning, the ESP is also switched off.

Driving the vehicle with varied size tires will cause the wheels to rotate at different speeds, therefore the ESP may activate (yellow ESP warning lamp in speedometer dial comes on). For this reason, all wheels, including the spare wheel, must have the same tire size.

When testing the parking brake on a brake test dynamometer, the engine must be shut off. Otherwise, the ESP will immediately be engaged and will apply the rear wheel brakes.

In winter operation, the maximum effectiveness of the ESP is only achieved with Mercedes-Benz recommended M+S rated radial-ply tires and/or snow chains.

### Synchronizing ESP

If the power supply was interrupted (battery disconnected or empty), the ESP warning message may be displayed with the engine running.

Turn steering wheel completely to the left and then to the right. The ESP warning message should go out.

## Driving systems

276

## ESP control switch





ESP control switch located on center console.

**1** Press to switch ESP off

ESP warning lamp , located in speedometer dial, comes on.

**2** Press to switch ESP on

ESP warning lamp , located in speedometer dial, goes out.

To improve the vehicle's traction when driving with snow chains, or starting off in deep snow, sand or gravel, switch off ESP by pressing the upper half (1) of the ESP switch. The ESP warning lamp , located in the speedometer dial, is continuously illuminated.

**Warning!**

**When the ESP warning lamp is illuminated continuously, the ESP is switched off.**

**Adapt your speed and driving to the prevailing road conditions.**

With the ESP system switched off, the engine torque reduction feature is cancelled. Therefore, the enhanced vehicle stability offered by ESP is unavailable.

Adapt your speed and driving to the prevailing road conditions.

A portion of the ESP system remains active, even with the switch in the OFF position.

If one drive wheel loses traction and begins to spin, the brake is applied until the wheel regains sufficient traction. The traction control engages at vehicle speeds up to approximately 24 mph (40 km/h), and switches off at 50 mph (80 km/h).

Notes:

Avoid spinning of one drive wheel. This may cause serious damage to the drive train which is not covered by the Mercedes-Benz Limited Warranty.

The ESP warning lamp, located in the speedometer dial, starts to flash at any vehicle speed as soon as the tires lose traction and the wheels begin to spin.

To return to the enhanced vehicle stability offered by ESP: press lower half (2) of the switch (the ESP warning lamp in the speedometer dial goes out).

Vehicles with Distronic (DTR):

With the ESP switched off, the Distronic cannot be switched on. See page 259 for activation of Distronic.

**Warning!**

**ESP should not be switched off during normal driving other than in circumstances described above. Disabling of the system will reduce vehicle stability in standard driving maneuvers.**

**Important!**

If the ESP warning lamp flashes:

- during take-off, apply as little throttle as possible,
- while driving, ease up on the accelerator.



**Active body control (ABC)**

The switch is located on the center console  
Press the switch when the engine is running:

- 1** Suspension for sporty driving style
- 2** Suspension for regular driving style
- 3** Indicator lamp for sporty driving style

The maximum suspension range is selected automatically according to the selected ABC mode (1 or 2), road condition, and driving style.

The selected suspension style is stored in memory, even with the electronic key removed from the starter switch.

**Suspension for regular driving style**

This is the setting for general driving.

The system is set to regular driving mode when the indicator lamp (3) is not illuminated.

Press lower half of switch to change from suspension style for sporty driving to regular driving style.

**Suspension for sporty driving style**

This is the setting for sporty driving.

Press upper half of switch (1) to select suspension style for sporty driving. The indicator lamp (3) comes on.

Note:

See “ACTIVE BODY CONTROL” on page 314 for malfunction and warning messages.

### Level control system for vehicles with Airmatic system

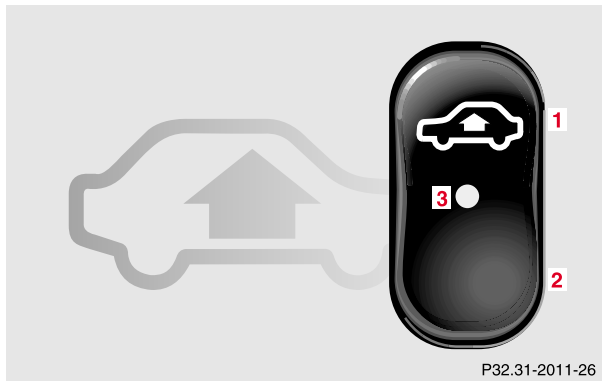

The switch for the ride height adjustment is located on the center console.

Press the switch when the engine is running:

- 1 Raised level
- 2 Normal level
- 3 Indicator lamp

The vehicle ride height in the normal level mode is adjusted automatically according to the vehicle speed. This increases vehicle safety and reduces fuel consumption.

At speeds exceeding approximately 70 mph (110 km/h) the vehicle ride height is reduced to approximately one half inch (15 mm) below the normal level. The vehicle is returned to the normal ride height setting once the speed falls below approximately 35 mph (60 km/h).

#### Normal level

The system is set to normal level when the indicator lamp (3) is not illuminated.

When the raised level ride height returns to the normal level ride height, the indicator lamp (3) goes out.

#### Raised level

To select the raised level mode, press the upper half of the switch (1). The indicator lamp (3) comes on.

Use the raised level setting for rough sections of the road, for example.

The vehicle is raised by approximately  $\frac{3}{4}$  inch (20 mm). The indicator lamp (3) lights up.

## Driving systems

280

The message “AIR SPRING – VEHICLE RISING” appears in the multifunction display. The display switches off when the vehicle is raised.

## Notes:

The raised level setting switches off at speeds exceeding approximately 75 mph (120 km/h), or if vehicle speed is operated between 50 mph (80 km/h) and 75 mph (120 km/h) for approximately 5 minutes. The message “AIR SPRING – LEVEL CANCELLED” appears in the display.

The raised level setting will be stored in memory after the electronic key is removed from the starter switch if you did not drive at the aforementioned speeds.

See “AIR SPRING” on page 325 for malfunction and warning messages.

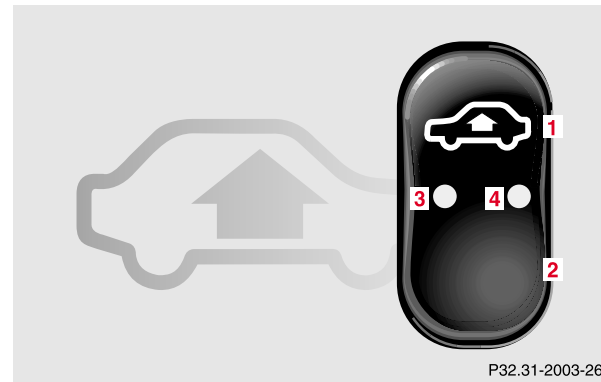
**Level control system for vehicles with Active Body Control (ABC)**

The switch is located on the center console.

Press the switch when the engine is running:

- 1 Raise vehicle chassis
- 2 Lower vehicle chassis
- 3 Indicator lamp
- 4 Indicator lamp

The vehicle chassis ride height is raised or lowered automatically according to the selected setting and to the vehicle speed. This helps to increase vehicle handling safety and lowers fuel consumption.

The selected setting is stored in memory, even with the electronic key removed from the starter switch.

**Warning!**

**To help avoid personal injury, keep hands and feet away from wheel housing area, and stay away from under the vehicle when lowering the vehicle chassis.**

Note:

See “ACTIVE BODY CONTROL” on page 314 for malfunction and warning messages.

**Level control switch positions**

Normal level – indicator lamps (3, 4) are not illuminated. To change from raised level options I or II, press lower half of switch (2) once respectively twice.

Raise level, option I – indicator lamp (3) is illuminated. To change from normal level, press upper half (1) of switch.

To change from raised level, option II, press lower half (2) of switch.

Raised level, option 2 – indicator lamps (3, 4) are illuminated.

To change from normal level or raised level, option I, press upper half (1) of switch once respectively twice.

**Normal level**

Used for normal operation of the vehicle.

Speed dependent lowering of vehicle chassis (approximate values):

- between 0 mph (0 km/h) and 35 mph (60 km/h) – none
- between 35 mph (60 km/h) and 85 mph (140 km/h) – lowered progressively by approximately  $\frac{7}{16}$  inch (11 mm)

Instruments and controls	Operation	<b>Driving</b>	Instrument cluster display	Practical hints	Car care	Technical data	Index
--------------------------	-----------	----------------	----------------------------	-----------------	----------	----------------	-------

## Driving systems

282

### **Raised level, option I**

This setting should be used when road surface conditions are rough and must be used when driving with snow chains mounted.

#### **Important!**

Driving with snow chains requires increased space between tire and wheel housing. Refer to page 249 for driving with snow chains.

Speed dependent lowering of vehicle chassis (approximate values):

- at standstill – raised by approximately  $\frac{3}{4}$  inch (20 mm)
- between 35 mph (60 km/h) and 120 mph (190 km/h) – lowered progressively by approximately one inch (25 mm)

### **Raised level, option II**

This setting should be used when road surface conditions are very rough for increased ground clearance.

Speed dependent lowering of vehicle chassis (approximate values):

- at standstill - raised by approximately one and one eighth inch (30 mm)
- between 0 mph (0 km/h) and 35 mph (60 km/h) - lowered progressively by approximately  $\frac{3}{8}$  inch (10 mm)
- between 35 mph (60 km/h) and 120 mph (190 km/h) – lowered progressively by approximately one inch (25 mm)

### Adaptive damping system (ADS)

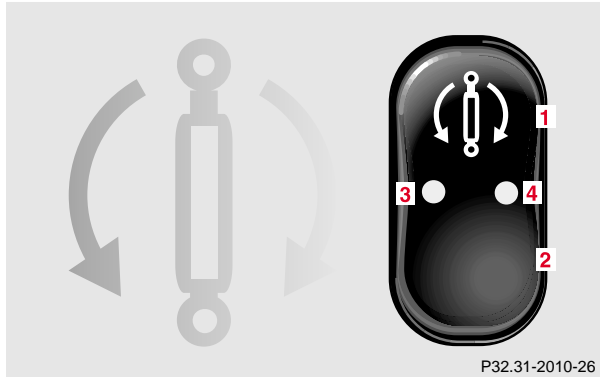

The switch is located on the center console.

Press the switch when the engine is running:

- 1 Firm damping program I and II
- 2 Soft damping program
- 3 Indicator lamp
- 4 Indicator lamp

Depending upon road surface conditions, driving style, and damping program selected, ADS will automatically adjust for optimal ride comfort.

The selected damping mode is stored in memory when removing the electronic key from the starter switch.

The following settings are available:

Soft damping program – indicator lamps (3, 4) are switched off.

Firm damping program I – indicator lamp (3) lights up.

Firm damping program II – indicator lamps (3, 4) light up.

#### Soft damping program

Setting for regular driving.

The soft damping mode is activated when both indicator lamps (3, 4) are switched off.

To change from soft to firm damping mode, press upper half of switch (2) once or twice.

## Driving systems

284

**Firm damping program I**

Setting for sporty driving.

Changing from soft damping program:

Press upper half of switch (1) once. The indicator lamp (3) lights up.

Changing from firm damping program II:

Press lower half of switch (2). The indicator lamp (4) goes out.

**Firm damping program II**

Setting for very sporty driving.

Changing from soft damping:

Press upper half of switch (1) twice. The indicator lamps (3, 4) light up.

Changing from firm damping program I:

Press upper half of switch (1) once. The indicator lamp (4) lights up in addition to indicator lamp (3).

### Parking assist (Parktronic)

The Parktronic system assists the driver during parking maneuvers. It visually and audibly indicates the relative distance between the vehicle and an obstacle.

The front area of the vehicle is monitored when driving forward. When reversing or with the gear selector lever in position “N”, the front as well as the rear areas are monitored.

With the electronic key in starter switch position 2, Parktronic engages automatically at speeds up to approximately 10 mph (15 km/h) and deactivates during higher speeds.

Parktronic can be switched off by a control switch located in the center console. It engages automatically again when starting the engine.

See page 289 for Parktronic switch.

### Warning!

**Parktronic is a supplemental system. It is not intended to nor does it replace the need for extreme care. The responsibility during parking and other critical maneuvers rests always with the driver.**

**Special attention must be paid to objects having smooth surfaces or low silhouettes (e.g. trailer couplings, painted posts, or street curbs). Such objects may not be detected by the system and can damage the vehicle.**

**The operational function of the Parktronic can be affected by dirty sensors, especially at times of snow and ice. See page 378 for notes on cleaning the parktronic system sensors.**

**Interference caused by other ultrasonic signals (e.g. working jackhammers or the air brakes of trucks) can cause the system to send erratic indications, and should be taken into consideration.**



## Parking system

286

## Sensors

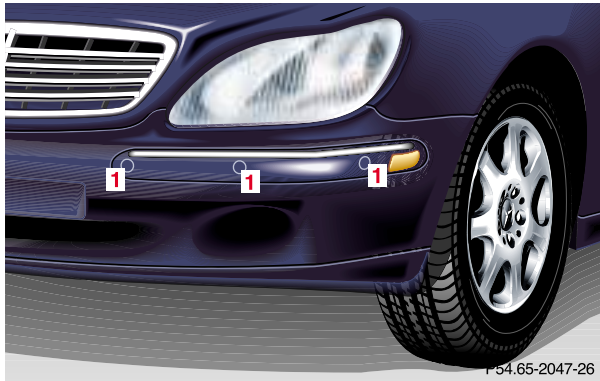

- 1** Sensors located in bumpers  
(front bumper shown)

A total of 10 sensors (1) monitor the vehicle's front and rear areas. Six sensors are located in the front bumper, four sensors in the rear bumper.

For proper operation of the Parktronic always keep the sensors clean, especially at times of snow and ice.

See page 378 for instructions on cleaning the sensors in the bumpers.

## Warning indicators

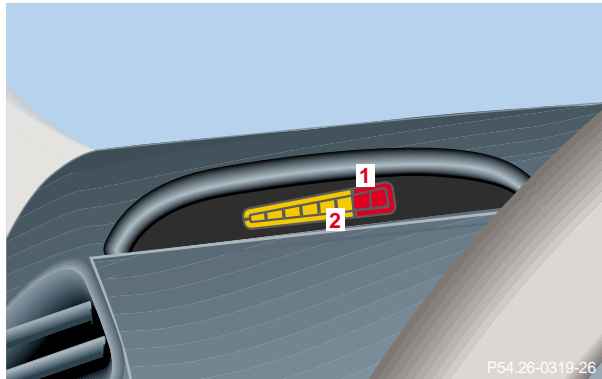

- 1 Frame
- 2 Segments

Visual and audible signals indicate to the driver the relative distance between the vehicle and an obstacle.

Warning indicators for the front area are located above the left and center air outlets in the dashboard.

Warning indicators for the rear area are integrated in the rear headliner.

The frames are illuminated when the Parktronic is engaged.

Each warning indicator has 6 yellow and 2 red segments.

As soon as the sensors detect an obstacle, one or more segments light up, depending on the distance. An intermittent acoustic warning will also sound as the seventh segment lights up and a constant acoustic warning lasting a maximum of 3 seconds will sound for the eighth segment.

## Parking system

288

## Monitoring reach of sensors

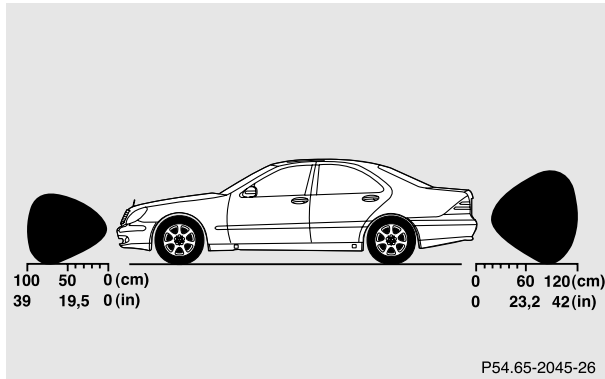

## Front bumper:

Center	approx. 40 in	(100 cm)
Corner	approx. 24 in	(60 cm)

## Rear bumper:

Center	approx. 48 in	(120 cm)
Corner	approx. 32 in	(80 cm)

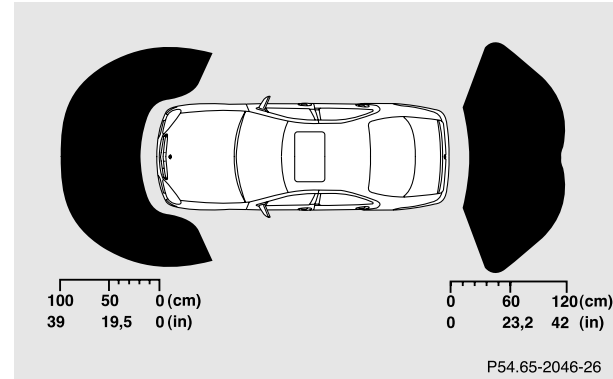

The first yellow segment lights up at these distances. Additional segments light up as the vehicle comes closer to the obstacle.

Minimum distance between vehicle and obstacle at which the system stops indicating:

Front corners	approx. 6 in	(15 cm)
Front center and rear	approx. 8 in	(20 cm)

The obstacle may not be recognized if outside the shaded sensor field, and no longer be indicated when approaching it any closer (warning indicators go out).

### Parktronic malfunction

All red segments of the warning indicators light up, and a warning sounds for 3 seconds, if Parktronic does not function properly.

A dirty sensor could be the reason. See page 378 for instructions on cleaning the sensors in the bumpers.

After cleaning the sensors, turn electronic key in starter switch to position 2. If the defect continues to be displayed, have the system checked at your authorized Mercedes-Benz Center.

### Parktronic switch

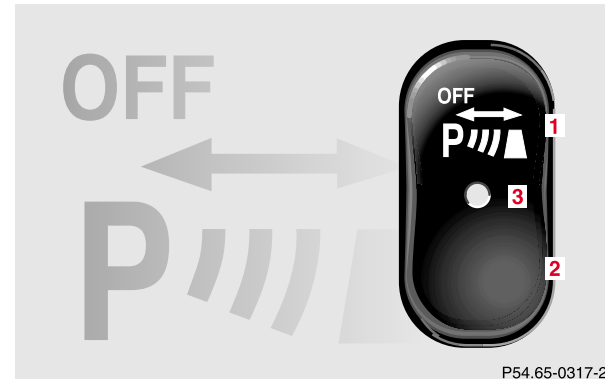

The switch is located on the center console.

- 1 Parktronic switched off
- 2 Parktronic switched on
- 3 Indicator lamp – comes on when Parktronic is switched off

The parktronic system is switched on again when turning the electronic key in starter switch position 2.

## What you should know at the gas station

290

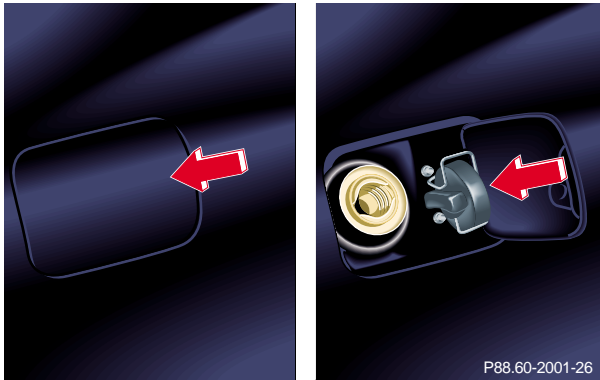
**What you should know at the gas station****Fuel supply****Warning!**

Gasoline is highly flammable and poisonous. It burns violently and can cause serious injury. Whenever you are around gasoline, avoid inhaling fumes and skin contact, extinguish all smoking materials. Never allow sparks, flame or smoking materials near gasoline!

Open flap by pushing near front (arrow). Turn fuel cap to the left and hold on to it until possible pressure in tank has been released, then remove cap. Failure to remove slowly could result in personal injury.

See page 368 for manual release of fuel filler flap.

**Fuel**

To prevent fuel vapors from escaping into open air, fully insert filler nozzle unit.

Only fill fuel tank until the filler nozzle unit cuts out – do not top up or overfill.

**Warning!**

Overfilling of fuel tank may result in creating pressure in the system which could cause a gas discharge such as the gas spraying back out upon removing the filler nozzle which could cause personal injury.

Leaving the engine running and the fuel cap open can cause the “CHECK ENGINE” lamp to illuminate, see page 296 for notes on the “CHECK ENGINE” lamp.

Fuel tank capacity approximately 23.2 US gal (88.0 l).  
This includes approximately 2.9 US gal (11.0 l) reserve.  
Use premium unleaded gasoline:  
S 430, S 500, S 55 AMG  
Posted Octane Index 91 (Average of 96 RON/86 MON).  
S 600:  
Posted Octane Index 93 (Average of 98 RON/88 MON).

### **Engine oil**

Checking oil level, see instructions on pages 154 and 334.

S 430, S 500 and S 55 AMG only:  
Fill quantity between upper and lower dipstick marking level: 2,1 US qt (2.0 l).

Recommended engine oils, see Approved Service Products sheet.

### **Coolant**

For normal replenishing, use water (potable water quality). For further information refer to page 336.

Instruments and controls	Operation	<b>Driving</b>	Instrument cluster display	Practical hints	Car care	Technical data	Index
--------------------------	-----------	----------------	----------------------------	-----------------	----------	----------------	-------

What you should know at the gas station

292

**Tire pressure**

For tire pressure, refer to tire pressure label inside the fuel filler flap. See page 348 for further details.

**Air conditioner**

R-134a refrigerant and special PAG lubricant, refer to “Technical Data”.

**Spark plugs**

Approved spark plugs, refer to “Technical Data”.

**Windshield cleaning**

To prevent damage to the engine hood, the windshield wipers must not be folded forward in parked position.

See page 380 for cleaning the windshield.

**Bulbs**

High and low beams: H7 (55 W),  
 low beam: Xenon (optional)  
 fog lamps: H1 (55 W),  
 turn signal lamps,  
 front 2357 NA (28.5/8.3 W [Yellow]),  
 parking and standing lamps, front: W 5W (5 W)  
 side marker lamps, front: 5 W/4 cp,  
 turn signal lamps, rear: 1156 NA bulb,  
 tail and parking lamp: P 21/4 W,  
 tail, parking and rear fog lamp, driver’s side: P 21/4 W,  
 tail, parking, standing and  
 side marker lamp: R 5 W/4 cp,  
 backup lamps: 21 W/32 cp,  
 license plate lamps: 5 W/4 cp

**Check regularly and before a long trip**

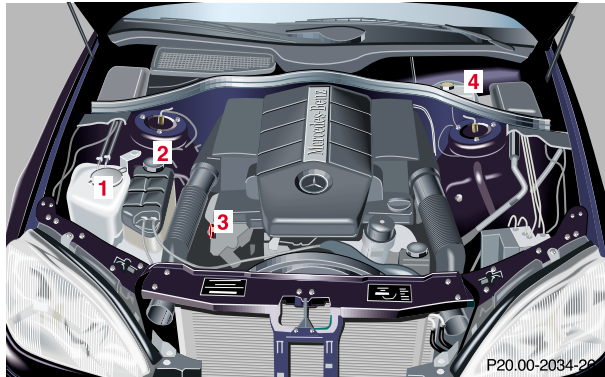

- 1 Windshield washer and headlamp cleaning system**  
For refilling reservoir see page 337.
- 2 Coolant level,**  
see “Adding coolant” on page 336
- 3 Engine oil level,**  
see “Engine oil level checking” on page 154 and 334
- 4 Brake fluid,**  
see “Brake fluid” on page 396

Opening hood, see page 331.

**Vehicle lighting:** Check function and cleanliness. For replacement of light bulbs, see “Exterior lamps” on page 356.

Exterior lamp switch, see page 156.

Check regularly and before a long trip

293

Instruments and controls	Operation	<b>Driving</b>	Instrument cluster display	Practical hints	Car care	Technical data	Index
--------------------------	-----------	----------------	----------------------------	-----------------	----------	----------------	-------





## Instrument cluster display

Malfunction and indicator lamps in the instrument cluster .....	296
On-board diagnostic system .....	296
Check engine malfunction indicator lamp .....	296
Brake warning lamp .....	298
Supplemental restraint system (SRS) indicator lamp .....	299
Fuel reserve warning .....	299
ABS malfunction indicator lamp .....	300
Electronic stability program (ESP) – warning lamp .....	301
Distronic (DTR) – warning lamp .....	301
Seat belt nonusage warning lamp .....	302

Malfunction and indicator lamp in the center console .....	302
AIRBAG OFF indicator lamp ....	302
Malfunction and warning messages in the multifunction display .....	303
DISPLAY DEFECTIVE .....	304
BATTERY/ALTERNATOR .....	305
ENTRANCE POSITION .....	306
BRAKE ASSIST .....	306
BRAKE LINING WEAR .....	307
BRAKE FLUID .....	307
PARKING BRAKE .....	308
TRUNK OPEN .....	308
ELEC. STABIL. PROG. (Electronic stability program) .....	309
COOLANT (coolant level) .....	310
COOLANT (coolant temperature) .....	311

LIGHTING SYSTEM .....	312
LIGHT SENSOR .....	314
ACTIVE BODY CONTROL (ABC) .....	314
TIRE PRESSURE .....	316
ENGINE OIL LEVEL .....	318
CRUISE CONTROL .....	319
KEY .....	319
DOOR .....	320
HOOD .....	320
TELE AID .....	321
OIL TEMP. (engine oil temperature) .....	321
CHIP-CARD (KEYLESS-GO) .....	322
SELECTOR LEVER .....	323
TELEPHONE – FUNCTION .....	323
WASHER FLUID .....	324
AIR SPRING (AirMatic) .....	325
DISTRONIC (DTR) .....	326

### Malfunction and indicator lamps in the instrument cluster

#### General information:

If a bulb in the instrument cluster fails to light up during the bulb self-check when turning the electronic key in steering lock to position 2, have it checked and replaced if necessary.

#### Emission control

Certain systems of the engine serve to keep the toxic components of the exhaust gases within permissible limits required by law.

These systems, of course, will function properly only when maintained strictly according to factory specifications. Any adjustments on the engine should, therefore, be carried out only by authorized Mercedes-Benz Center qualified technicians. Engine adjustments should not be altered in any way. Moreover, the specified service jobs must be carried out regularly according to Mercedes-Benz servicing requirements. For details refer to the Service Booklet.

#### Warning!

**Inhalation of exhaust gas is hazardous to your health. All exhaust gas contains carbon monoxide, and inhaling it can cause unconsciousness and lead to death.**

**Do not run the engine in confined areas (such as a garage) which are not properly ventilated. If you think that exhaust gas fumes are entering the vehicle while driving, have the cause determined and corrected immediately. If you must drive under these conditions, drive only with at least one window fully open.**

#### On-board diagnostic system

##### Check engine malfunction indicator lamp



Engine malfunction indicator lamp. If the "CHECK ENGINE" malfunction indicator lamp comes on when the engine is running, it indicates a malfunction of the fuel management system, emission control system, systems which impact emissions, or the fuel cap is not closed tight (check the fuel cap). If the "CHECK ENGINE" lamp is illuminated continuously and the vehicle is driving normally, you

may still drive the vehicle, however, in all cases, we recommend that you have the system checked at your authorized Mercedes-Benz Center as soon as possible.

If the “CHECK ENGINE” lamp comes on continuously and/or the vehicle is not driving normally (e.g. malfunction of the fuel management system or running out of fuel), serious damage can occur to the emission system. Please contact your authorized Mercedes-Benz Center immediately.

The Sequential Multiport Fuel Injection (SFI) control module monitors emission control components that either provide input signals to or receive output signals from the control module. Malfunctions resulting from interruptions or failure of any of these components are indicated by the “CHECK ENGINE” malfunction indicator lamp in the instrument cluster and are simultaneously stored in the SFI control module.

If the “CHECK ENGINE” malfunction indicator lamp comes on, have the system checked at your authorized Mercedes-Benz Center as soon as possible.

With some exceptions, the control module switches off the “CHECK ENGINE” malfunction indicator lamp if the condition, causing the lamp to come on, no longer exists during three consecutive cycles.

An on-board diagnostic connector is located in the passenger compartment near to the parking brake pedal, allowing the accurate identification of system malfunctions through the readout of diagnostic trouble codes.

Notes:

When running out of fuel, the “CHECK ENGINE” malfunction indicator lamp comes on and the engine possibly switches to its limp-home (emergency operation) mode.

To cancel the limp-home mode, the engine may have to be started three or four times after refueling. The malfunction indicator lamp remains illuminated. Have the system checked at your authorized Mercedes-Benz Center immediately.

## Malfunction and indicator lamps

298

**Brake warning lamp** BRAKE

Except Canada



Canada only

When the brake warning lamp and message appear while the engine is running, this means:

- there is insufficient brake fluid in the reservoir (engine running and parking brake released), or
- the parking brake is set (engine running).

**Warning!**

**Driving with the brake warning lamp illuminated can result in an accident. Have your brake system checked immediately if the brake warning lamp stays on. Don't add brake fluid before checking the brake system. Overfilling the brake fluid reservoir can result in spilling brake fluid on hot engine parts and the brake fluid catching fire. You can be seriously burned.**

**Note:**

If you find that the minimum mark on the brake fluid reservoir is reached, have the brake system checked for brake pad thickness and leaks.

### Supplemental restraint system (SRS) indicator lamp

**SRS** The operational readiness of the airbag system is verified by the indicator lamp “SRS” in the instrument cluster when turning the electronic key in starter switch to position 1 or 2. If no fault is detected, the lamp will go out after approximately 4 seconds; after the lamp goes out, the system continues to monitor the components and circuitry of the airbag system and will indicate a malfunction by coming on again.

#### Warning!

**In the event a malfunction of the “SRS” is indicated as outlined above, the “SRS” may not be operational. For your safety, we strongly recommend that you visit an authorized Mercedes-Benz Center immediately to have the system checked; otherwise the “SRS” may not be activated when needed in an accident, which could result in serious or fatal injury, or it might deploy unexpectedly and unnecessarily which could also result in injury.**

See page 94 for notes on airbags, see page 92 for belt tensioners and page 84 for infant and child seat restraint.

### Fuel reserve warning

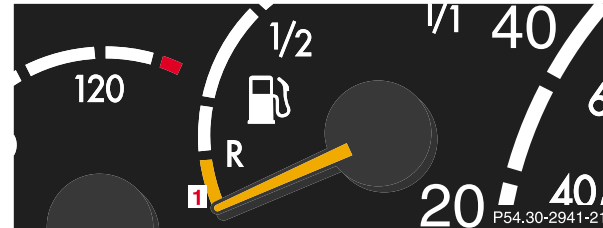

#### 1 Fuel reserve indicator

When the warning lamp (1) comes on after starting the engine, or if it comes on while driving, it indicates that the fuel level is down to the reserve quantity of approximately 2.9 gal (11 liters).

See page 290 for notes on refueling the vehicle.

## Malfunction and indicator lamps

300

**ABS malfunction indicator lamp**

The ABS malfunction indicator lamp in the instrument cluster comes on with the electronic key in starter switch position 2 and should go out with the engine running.

When the ABS malfunction indicator lamp symbol and warning in the instrument cluster remains illuminated while the engine is running, it indicates that the ABS has detected a malfunction and has switched off. In this case, the brake system functions in the usual manner, but without antilock assistance.

A malfunctioning ABS control unit can possibly affect the operation of other systems (e.g. Parktronic, Navigation, Automatic transmission). Be guided accordingly with respect to the use of those systems and have the system checked at your authorized Mercedes-Benz Center as soon as possible.

With the ABS malfunctioning, the BAS and ESP are also switched off. The malfunction indicator lamps and malfunction messages in the multifunction display come on with the engine running.

If the charging voltage falls below 10 volts, the malfunction indicator lamp comes on and the ABS is switched off. When the voltage is above this value again, the malfunction indicator lamp should go out and the ABS is operational.

Have the system checked at your authorized Mercedes-Benz Center as soon as possible.

See page 272 for notes on antilock brake system (ABS).

### Electronic stability program (ESP) – warning lamp



The yellow ESP warning lamp in the speedometer dial comes on with the electronic key in starter switch position 2. It should go out with engine running.

If the ESP malfunction indicator lamp remains illuminated with the engine running, a malfunction has been detected in the system. Pressing the accelerator pedal will require greater effort. Only partial engine output will be available.

See electronic stability program (ESP) on page 274 if the warning lamp lights up or flashes when the vehicle is moving.

### Distronic (DTR) – warning lamp



With the electronic key in starter switch position 2, the distance warning lamp in the speedometer dial comes on and goes out with the engine running.

See Distronic (DTR) system on page 326 for possible malfunction messages.

Note:

The distance warning lamp is without warning function on vehicles without Distronic (DTR).



## Malfunction and indicator lamps

302

**Seat belt nonusage warning lamp**

With the electronic key in starter switch position 2, the seat belt nonusage warning lamp comes on, and a warning sounds for a short time if the driver's seat belt is not fastened.

After starting the engine, the seat belt nonusage warning lamp blinks for a brief period to remind the driver and passengers to fasten seat belts.

**Malfunction and indicator lamp in the center console****AIRBAG OFF indicator lamp**

The  indicator lamp will light up for approximately 6 seconds when you turn the electronic key in starter switch to position 1 or 2.

It does not light up if there is a fault in the system.

The  indicator lamp stays lit as long as a BabySmart™ child seat is properly installed on the front passenger seat. It indicates that the front passenger airbag is switched off.

See page 91 for BabySmart™ airbag and its deactivation system.

### Malfunction and warning messages in the multifunction display

Malfunction and warning messages for the following systems will be displayed immediately in the multifunction display.

They are divided into three categories.

Category C1:

Messages of most immediate priority.

These cannot be cleared from the instrument cluster using the **R** button.

Categories C2 and C3:

Messages of less immediate priority.

These can be cleared from the instrument cluster using the **R** button and are then stored in the malfunction message memory. See page 136

Note:

Certain malfunction and warning messages are accompanied by an audible signal.

Malfunction and warning messages in red are always accompanied by an audible signal.

Temporary messages such as "TRUNK OPEN!" will not be stored in the malfunction message memory.

#### Warning!

**All categories of messages contain important information which should be taken note of and, where malfunction indicated, addressed as soon as possible at an authorized Mercedes-Benz Center.**

**Failure to repair condition noted may cause damage not covered by the Mercedes-Benz Limited Warranty, or result in property damage or personal injury.**

Malfunction and warning messages

**DISPLAY DEFECTIVE (engine control unit)**



Line 1	Line 2	C*
DISPLAY DEFECTIVE	VISIT WORKSHOP!	2

\* C = Category, see page 303

This message is displayed to indicate that the information being relayed by the engine control unit is no longer complete. The display for coolant temperature gauge, tachometer, or the cruise control may have failed.

**DISPLAY DEFECTIVE (several systems)**



Line 1	Line 2	C*
DISPLAY DEFECTIVE	VISIT WORKSHOP!	2

\* C = Category, see page 303

The displays for several systems have failed. Some systems themselves may also have failed.

## BATTERY/ALTERNATOR



Line 1	Line 2	C*
BATTERY/ALTERNATOR	VISIT WORKSHOP!	2

\* C = Category, see page 303

This message indicates a malfunction which must be repaired immediately.

It may indicate that the poly-V-belt has broken. Should this condition occur, the poly-V-belt must be replaced before continuing to operate the vehicle. Otherwise, the engine will overheat due to an inoperative water pump which may result in damage to the engine.

Do not continue to drive the vehicle with this message displayed.

Doing so could result in serious engine damage that is not covered by the Mercedes-Benz Limited Warranty.

## Malfunction and warning messages

306

## ENTRANCE POSITION



Line 1	Line 2	C*
ENTRANCE POSITION	DO NOT DRIVE!	1

\* C = Category, see page 303

Wait until the seat and steering wheel have moved to their driving positions. The display will clear when they have done so.

See also page 66 for easy-entry/exit feature.

## BRAKE ASSIST



Line 1	Line 2	C*
BRAKE ASSIST	VISIT WORKSHOP!	2

\* C = Category, see page 303

A malfunction has been detected in the system. The brake system functions in the usual manner, but without brake assist system (BAS).

See page 271 for notes on the brake assist system (BAS).

## BRAKE LINING WEAR



Line 1	Line 2	C*
BRAKE LINING WEAR	VISIT WORKSHOP!	2

\* C = Category, see page 303

When this message appears during braking, it indicates that the brake pads are worn down.

Have the brake system checked at your authorized Mercedes-Benz Center as soon as possible.

## BRAKE FLUID



Line 1	Line 2	C*
BRAKE FLUID	VISIT WORKSHOP!	2

\* C = Category, see page 303

### Warning!

**Driving with this message displayed can result in an accident. Have your brake system checked immediately. Don't add brake fluid before checking the brake system. Overfilling the brake fluid reservoir can result in spilling brake fluid on hot engine parts and the brake fluid catching fire. You can be seriously burned.**

Malfunction and warning messages

**PARKING BRAKE**



Line 1	Line 2	C*
PARKING BRAKE	RELEASE BRAKE!	1

\* C = Category, see page 303

**TRUNK OPEN**



Line 1	Line 2	C*
TRUNK OPEN!		2

\* C = Category, see page 303

**ELEC. STABIL. PROG.**  
**(Electronic stability program)**



Line 1	Line 2	C*
DISPLAY DEFECTIVE	VISIT WORKSHOP! <sup>1</sup>	2
ELEC. STABIL. PROG.	VISIT WORKSHOP! <sup>2,3,4</sup>	2

\* C = Category, see page 303

- 1 The display or the system is malfunctioning.
- 2 A malfunction has been detected in the system. Pressing the accelerator pedal will require greater effort. Only partial engine output will be available.
- 3 The enhanced vehicle stability offered by ESP and the torque reduction feature are unavailable.
- 4 This message may be displayed if the power supply was interrupted (battery disconnected or empty). Synchronize ESP. See page 275



## Malfunction and warning messages

310

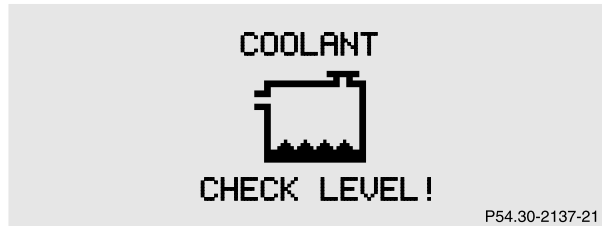
**COOLANT (coolant level)**

Line 1	Line 2	C*
COOLANT	CHECK LEVEL!	2

\* C = Category, see page 303

When this message appears while driving, the coolant level has dropped below the required level. If no leaks are noticeable and the engine temperature does not increase, continue to drive to the nearest service station and have coolant added to the coolant system.

The low engine coolant level warning should not be ignored. Extended driving with the symbol displayed may cause serious engine damage not covered by the Mercedes-Benz Limited Warranty.

In cases of major or frequent minor coolant loss, have the cooling system checked at your authorized Mercedes-Benz Center as soon as possible.

Note:

Do not drive without coolant in the cooling system. The engine will overheat causing major engine damage.

Monitor the coolant temperature gauge while driving, see page 117.

See page 336 for instructions on topping up the coolant.

**Warning!**

**Do not spill antifreeze on hot engine parts. Antifreeze contains ethylene glycol which may burn if it comes into contact with hot engine parts. You can be seriously burned.**

## COOLANT (coolant temperature)

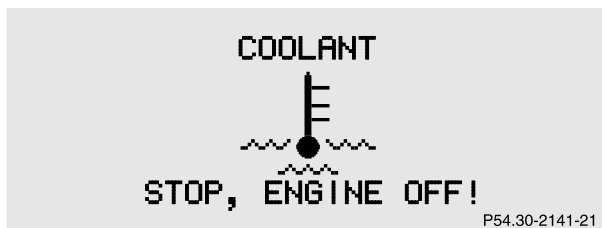

Line 1	Line 2	C*
COOLANT	STOP, ENGINE OFF! <sup>1</sup>	1
COOLANT	VISIT WORKSHOP! <sup>2</sup>	2

\* C = Category, see page 303

- 1 This may indicate that the poly-V-belt has broken. Should this condition occur, the poly-V-belt must be replaced before continuing to operate the vehicle. Otherwise, the engine will overheat due to an inoperative water pump which may result in damage to the engine. Do not continue to drive the vehicle with this message displayed. Doing so could result in serious engine damage that is not covered by the Mercedes-Benz Limited Warranty.
- 2 The cooling fan for the coolant is faulty. Observe the coolant temperature gauge. See page 117

During severe operating conditions and stop-and-go city traffic, the coolant temperature may rise close to the red marking.

The engine should not be operated with the coolant temperature in the red zone. Doing so may cause serious engine damage which is not covered by the Mercedes-Benz Limited Warranty.

### Warning!

**Driving when your engine is badly overheated can cause some fluids which may have leaked into the engine compartment to catch fire. You could be seriously burned.**

**Steam from an overheated engine can cause serious burns and can occur just by opening the engine hood. Stay away from the engine if you see or hear steam coming from it.**

**Turn off the engine, get out of the vehicle and do not stand near the vehicle until it cools down.**

Malfunction and warning messages

**LIGHTING SYSTEM**

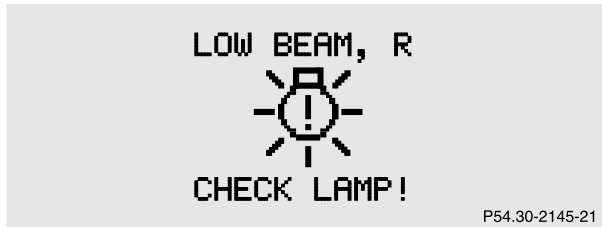

Line 1	Line 2	C*
LOW BEAM,L	CHECK LAMP!	2
LOW BEAM,R	CHECK LAMP!	2
DISPLAY DEFECTIVE	VISIT WORKSHOP! <sup>1</sup>	2
TURN SIGNAL, L	CHECK LAMP!	2
TURN SIGNAL, R	CHECK LAMP!	2
L. TURN SIG. RFLECTR	CHECK LAMP!	2
R. TURN SIG. RFLECTR	CHECK LAMP!	2
TURN SIGNAL F, L	CHECK LAMP!	2

Line 1	Line 2	C*
TURN SIGNAL F, R	CHECK LAMP!	2
BRAKE LIGHT <sup>2</sup>	VISIT WORKSHOP!	2
BRAKE LIGHT, L <sup>3</sup>	CHECK LAMP!	2
BRAKE LIGHT, R <sup>3</sup>	CHECK LAMP!	2
3RD STOP LAMP <sup>3</sup>	CHECK LAMP!	2
HIGH BEAM, L	CHECK LAMP!	2
HIGH BEAM, R	CHECK LAMP!	2
LICENSE PLATE L, L	CHECK LAMP!	2
LICENSE PLATE L, R	CHECK LAMP!	2
	SWITCH OFF LIGHTS!	1
FRONT FOG LAMP, L	CHECK LAMP!	2
FRONT FOG LAMP, R	CHECK LAMP!	2
REAR FOG LAMP	CHECK LAMP!	2
REVERSE LIGHT, L	CHECK LAMP!	2

Line 1	Line 2	C*
REVERSE LIGHT, R	CHECK LAMP!	2
TAIL LIGHT, L	CHECK LAMP! SUBSTITUTE LAMP ON! <sup>4</sup>	2
TAIL LIGHT, R	CHECK LAMP! SUBSTITUTE LAMP ON! <sup>4</sup>	2
SIDELIGHT, L	CHECK LAMP! SUBSTITUTE LAMP ON! <sup>4</sup>	2
SIDELIGHT, R	CHECK LAMP! SUBSTITUTE LAMP ON! <sup>4</sup>	2

In the case of bulb failures in certain lamps, other lamps will substitute. See page 356 for instructions on replacing bulbs.

\* C = Category, see page 303

- 1 The display or the system is malfunctioning.
- 2 The brake lamps are switching on after a delay or are permanently on – visit workshop immediately.
- 3 The brake lamps comprise several light emitting diodes. The warning message will only appear if all light emitting diodes have stopped working.
- 4 Other bulbs will be brought into use as replacements when certain lamps blow.

## Malfunction and warning messages

314

## LIGHT SENSOR



Line 1	Line 2	C*
LIGHT SENSOR	VISIT WORKSHOP!	2

\* C = Category, see page 303

The headlamps will be switched on automatically if the light sensor malfunctions.

The “LIGHT CIRCUIT HEADLAMP MODE” setting menu can be set to “MANUAL” in the individual setting. See page 138. It will then be possible to switch the headlamps on and off using the exterior lamp switch. See page 156 for notes on the exterior lamp switch.

## ACTIVE BODY CONTROL (ABC)



Line 1	Line 2	C*
DISPLAY DEFECTIVE	VISIT WORKSHOP! <sup>1</sup>	2
ACTIVE BODY CONTROL	DRIVE CAREFULLY! <sup>2</sup>	1
ACTIVE BODY CONTROL	STOP, CAR TOO LOW! <sup>3</sup>	1
ACTIVE BODY CONTROL	VISIT WORKSHOP! <sup>4</sup>	2

\* C = Category, see page 303

1 The display or the system is malfunctioning.

2 The capability of the system is restricted.

**Important!**

When the message “ACTIVE BODY CONTROL – DRIVE CAREFULLY!” appears, do not exceed a speed of 50 mph (80 km/h). The vehicle driving characteristics are changed due to a noticeably softer suspension.

In this case visit your Mercedes-Benz Center as soon as possible.

Do not continue to drive if loss of hydraulic fluid or leaks are noticed. Doing so could result in subsequent damage that is not covered by the Mercedes-Benz Limited Warranty.

3 The ABC is defective. Stop the vehicle.  
Press upper half of level control switch, see page 280  
- system selects raised level mode.  
The vehicle chassis is raised depending on the kind of defect.

**Important!**

The wheels may not have sufficient clearance when the steering wheel is turned beyond a certain angle if the “ACTIVE BODY CONTROL – STOP, CAR TOO LOW!” message appears. The front fenders will be damaged if the steering wheel is turned too far. Watch and listen for scraping noises.

Do not exceed a speed of 50 mph (80 km/h).

Visit your Mercedes-Benz Center as soon as possible.

4 The capability of the system is restricted.

**Important!**

When the message “ACTIVE BODY CONTROL – VISIT WORKSHOP!” appears, do not exceed a speed of 50 mph (80 km/h). Visit your Mercedes-Benz Center as soon as possible.

Malfunction and warning messages

**TIRE PRESSURE**



Line 1	Line 2	C*
TIRE PRESSURE	CAUTION TIRE DEFECT! <sup>1</sup>	1
TIRE PRESSURE	CHECK TIRES! <sup>2,3</sup>	1
TIRE PRESSURE	CHECK TIRES! <sup>4</sup>	2
TIRE PRESS. CONTROL	ACTIVATED! <sup>3</sup>	2
TIRE PRESS. CONTROL	ACTIVATION - NOT WHEN ENGINE ON <sup>5</sup>	2
TIRE PRESS. CONTROL	REACTIVATE! <sup>3,6</sup>	3
TIRE PRESS. CONTROL	CURRENTLY INACTIVE! <sup>7</sup>	2
TIRE PRESS. CONTROL	VISIT WORKSHOP! <sup>8</sup>	2

Line 1	Line 2	C*
TIRE PRESSURE, FL	CAUTION TIRE DEFECT! <sup>1</sup>	1
TIRE PRESSURE, FR	CAUTION TIRE DEFECT! <sup>1</sup>	1
TIRE PRESSURE, RL	CAUTION TIRE DEFECT! <sup>1</sup>	1
TIRE PRESSURE, RR	CAUTION TIRE DEFECT! <sup>1</sup>	1
TIRE PRESSURE, FL	CHECK TIRES! <sup>2</sup>	1
TIRE PRESSURE, FL	CHECK TIRES! <sup>4</sup>	2
TIRE PRESSURE, FR	CHECK TIRES! <sup>2</sup>	1
TIRE PRESSURE, FR	CHECK TIRES! <sup>4</sup>	2
TIRE PRESSURE, RL	CHECK TIRES! <sup>2</sup>	1
TIRE PRESSURE, RL	CHECK TIRES! <sup>4</sup>	2
TIRE PRESSURE, RR	CHECK TIRES! <sup>2</sup>	1
TIRE PRESSURE, RR	CHECK TIRES! <sup>4</sup>	2

**Warning!**

**Do not drive with a flat tire. A flat tire affects the ability to steer or brake the vehicle. You may lose control of the vehicle. Continued driving with a flat tire will cause excessive heat build-up and possibly a fire.**

\* C = Category, see page 303.

RL: rear left; FL: front left;

RR: rear right; FR: front right;

- 1 One or more tires deflate rapidly or tire pressure is already below minimum value. Carefully bring the vehicle to a halt, avoiding abrupt steering and braking maneuvers. For reference on changing wheels, see page 340.
- 2 The tire pressure on one or more tires is already below minimum value. Carefully bring the vehicle to a halt, avoiding abrupt steering and braking maneuvers. For reference on changing wheels, see page 343.
- 3 For tire inflation pressure monitor, see page 150.

- 4 Tire pressure in one or more tires is low. Check and correct tire pressure, see page 348.
- 5 The tire pressure monitor cannot be activated with the engine running. Turn off the engine and repeat activation, see page 150.
- 6 When the message appears after starting the engine, the tire inflation pressure on all road wheels should be checked and corrected according to the label affixed inside the fuel filler flap. For tire inflation pressure, see page 348.

The tire inflation pressure monitor must be activated again after the tire inflation pressure has been corrected, see page 150.

- 7 The tire inflation pressure monitor system is unable to monitor the tire pressure due to the presence of several wheel electronics in the vehicle (e.g. a deflated road wheel in the trunk), or nearby radio interference source, or excessive wheel sensor temperatures, or unrecognized wheel sensors mounted.
- 8 The tire inflation pressure monitor is defective or a wheel without proper sensor was installed. Visit your authorized Mercedes-Benz Center.



## Malfunction and warning messages

318

## ENGINE OIL LEVEL



Line 1	Line 2	C*
ENGINE OIL LEVEL	CHECK LEVEL! <sup>1</sup>	2
ENGINE OIL LEVEL	STOP, ENGINE OFF! <sup>2</sup>	1
ENGINE OIL LEVEL	REDUCE OIL LEVEL <sup>3</sup>	2
ENGINE OIL	VISIT WORKSHOP! <sup>4</sup>	2
ENGINE OIL LEVEL	VISIT WORKSHOP! <sup>5</sup>	2

\* C = Category, see page 303.

1 The engine oil level must be checked immediately. See Engine oil level indicator on page 154.

2 There is no oil in the engine. There is a danger of engine damage.

- 3 There is a risk of damaging the engine or catalytic converter. The engine oil level must be checked immediately. See Engine oil level indicator on page 154.
- 4 The engine oil level has dropped to a critical level. Check the engine oil level immediately. See Engine oil level indicator on page 154 and check the engine for visible leakage (loss of oil). Possibility of water in the engine oil. Have the engine oil checked.
- 5 The measuring system is malfunctioning.

When the “ENGINE OIL LEVEL – CHECK LEVEL!” message appears while the engine is running and at operating temperature, the engine oil level has dropped to approximately the minimum mark on the dipstick.

When this occurs, the warning will first come on intermittently and then stay on if the oil level drops further.

If no oil leaks are noted, continue to drive to the nearest service station where the engine oil should be topped to the “full” mark on the dipstick with an approved oil.

The engine oil level warnings should not be ignored. Extended driving with the symbol displayed could result in serious engine damage that is not covered by the Mercedes-Benz Limited Warranty.

## CRUISE CONTROL



Line 1	Line 2	C*
CRUISE CONTROL	VISIT WORKSHOP! <sup>1</sup>	2

\* C = Category, see page 303.

1 Cruise control is malfunctioning.

## KEY

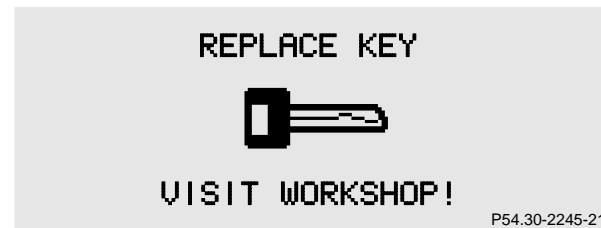

Line 1	Line 2	C*
REPLACE KEY <sup>1</sup>	VISIT WORKSHOP!	2
AUTOM. LIGHT ON	REMOVE KEY!	1

\* C = Category, see page 303.

1 Key needs possibly to be replaced.

Malfunction and warning messages

**DOOR**

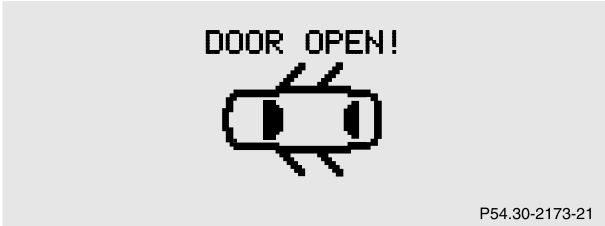

Line 1	Line 2	C*
DOOR OPEN!		1

\* C = Category, see page 303.

**HOOD**



Line 1	Line 2	C*
	ENGINE HOOD OPEN!	2

\* C = Category, see page 303.

See page 331 for hood.

## TELE AID



Line 1	Line 2	C*
TELE AID	VISIT WORKSHOP! <sup>1</sup>	1

\* C = Category, see page 303.

1 The Tele Aid system consists of three types of response; automatic and manual emergency, roadside assistance and information. With this message displayed, one or more functions may not be available.

See page 214 for notes on the Tele Aid.

If a malfunction is indicated as outlined above, have the system checked at the nearest Mercedes-Benz Center as soon as possible.

## OIL TEMP. (engine oil temperature)

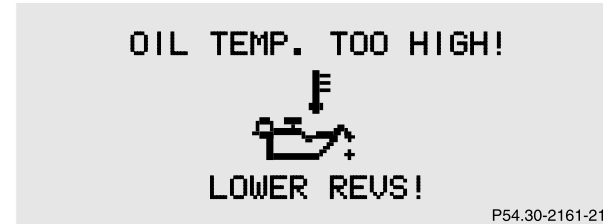

Line 1	Line 2	C*
OIL TEMP TOO HIGH!	LOWER REVS!	2

\* C = Category, see page 303.

There is a danger of engine damage – change to a higher gear or reduce road speed.

Check the engine oil level as soon as the vehicle returns to operating temperature. See Engine oil level indicator on page 154.

## Malfunction and warning messages

322

## CHIP-CARD (KEYLESS-GO)

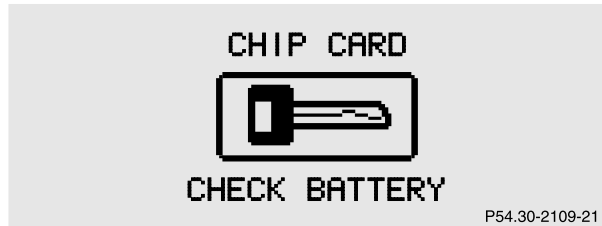

Line 1	Line 2	C*
CHIP-CARD	CHECK BATTERY! <sup>1</sup>	2
CHIP-CARD	NOT RECOGNIZED! <sup>2</sup>	1
CHIP-CARD	NOT RECOGNIZED! <sup>3</sup>	2
CHIP-CARD	STILL IN VEHICLE! <sup>4</sup>	1
CHIP-CARD	DO NOT FORGET! <sup>5</sup>	1

\* C = Category, see page 303.

- 1 Check battery of KEYLESS-GO-card, see page 366.
- 2 The KEYLESS-GO-card cannot be recognized by the running engine (e.g. strong radio-frequency interference) or the card is not in the vehicle.  
Stop immediately and search for the KEYLESS-GO-card or continue to operate the vehicle with the electronic main key, otherwise the vehicle cannot be centrally locked or the engine started again after the engine stops automatically. See page 38.
- 3 The KEYLESS-GO-card was momentarily not recognized. If message repeats, place card in a different position or continue to operate the vehicle with the electronic main key, see page 38.
- 4 A KEYLESS-GO-card left inside the vehicle has been recognized while locking the vehicle from the outside, see page 38.
- 5 The message appears for maximum of 60 seconds each time the driver's door is opened, as long as no electronic main key is in the starter switch. The message appears regardless of the past operation method (electronic main key or KEYLESS-GO-card), see page 38.

**SELECTOR LEVER**  
(Vehicles with KEYLESS-GO only)



Place selector lever in position “P”.  
The message appears when attempting to turn off the engine while the selector lever is in any other position than “P”, see page 232.

**TELEPHONE – FUNCTION**

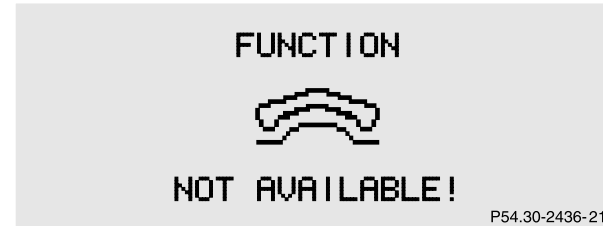

Line 1	Line 2	C*
FUNCTION	NOT AVAILABLE!	3

\* C = Category, see page 303.

The display appears if button  or  on the multifunction steering wheel is pressed and the vehicle is not equipped with a telephone.

## Malfunction and warning messages

324

## WASHER FLUID



Line 1	Line 2	C*
WASHER FLUID	CHECK LEVEL!	3

\* C = Category, see page 303.

When this message appears while the engine is running, the level of the reservoir has dropped to approximately  $\frac{1}{3}$  of the total volume. The reservoir should be refilled with the prescribed mixture of MB Windshield washer concentrate and water or the concentrate and commercially available premixed windshield washer solvent/antifreeze, depending on ambient temperature, at the next opportunity. The reservoir for the windshield and headlamp washer systems is located in the engine compartment.

See windshield and headlamp washer system on page 337 for instructions on topping up the washer fluid.

## AIR SPRING (AirMatic)



Line 1	Line 2	C*
DISPLAY DEFECTIVE	VISIT WORKSHOP! <sup>1</sup>	2
AIR SPRING	STOP, CAR TOO LOW! <sup>2</sup>	1
AIR SPRING	VISIT WORKSHOP! <sup>3</sup>	2

\* C = Category, see page 303

1 The display or the system is malfunctioning.

- 2 The ABC is defective. Stop the vehicle.  
Press upper half of ABC switch, see page 279  
- system selects raised level mode.  
The vehicle chassis is raised depending on the kind of defect.

### Important!

The wheels may not have sufficient clearance when the steering wheel is turned beyond a certain angle if the “AIR SPRING – STOP, CAR TOO LOW!” message appears. The front fenders will be damaged if the steering wheel is turned too far. Watch and listen for scraping noises.

Do not exceed a speed of 50 mph (80 km/h).

Visit your Mercedes-Benz Center as soon as possible.

- 3 Limited function of system.

### Important!

When the message “AIR SPRING – VISIT WORKSHOP” appears, do not exceed a speed of 50 mph (80 km/h).  
Visit your Mercedes-Benz Center as soon as possible



## Malfunction and warning messages

326

## DISTRONIC (DTR)

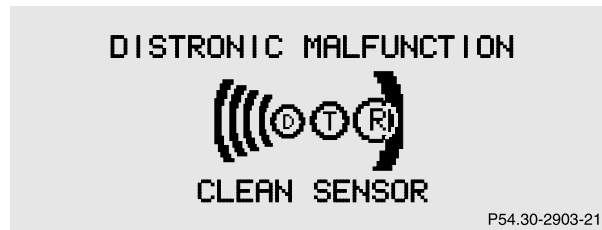

Line 1	Line 2	C*
DISPLAY DEFECTIVE	VISIT WORKSHOP! <sup>1</sup>	2
DISTRONIC	EXTERNAL MALFUNCTION! <sup>2</sup>	2
DISTRONIC MALFUNCTION	CLEAN SENSOR! <sup>3</sup>	2
DISTRONIC	VISIT WORKSHOP! <sup>4</sup>	2

\* C = Category, see page 303.

- 1 The display or the system is malfunctioning.
- 2 Due to the presence of electro-magnetic radiation, the system is presently unavailable.
- 3 DISTRONIC is automatically switched off.  
DISTRONIC sensor in hood grille needs cleaning, see page 378.
- 4 DISTRONIC is defective.

## Practical hints

First aid kit .....	328	Windshield and headlamp washer fluid mixing ratio .....	337	Exterior lamps .....	356
Stowing things in the vehicle .....	328	Spare wheel, vehicle tools, storage compartment .....	338	Headlamp assembly .....	357
Fuses .....	329	Vehicle jack .....	339	Taillamp assemblies .....	360
Hood .....	331	Wheels .....	340	Trunk lamp .....	362
Checking engine oil level .....	334	Tire Replacement .....	340	Changing batteries in the electronic main key .....	363
Automatic transmission fluid level .....	335	Rotating wheels .....	341	Synchronizing remote control .....	365
Active body control (ABC) fluid level .....	335	Spare wheel .....	341	Changing batteries in the KEYLESS-GO-card .....	366
Coolant level .....	336	Changing wheels .....	343	Emergency engine shut-down .....	368
Adding coolant .....	336	Tire inflation pressure .....	348	Fuel filler flap, manual release .....	368
Windshield and headlamp washer system .....	337	Battery .....	349	Emergency operation of sliding/pop-up roof .....	369
		Jump starting .....	351	Replacing wiper blades .....	370
		Towing the vehicle .....	353	Roof rack .....	371

## First aid kit

328

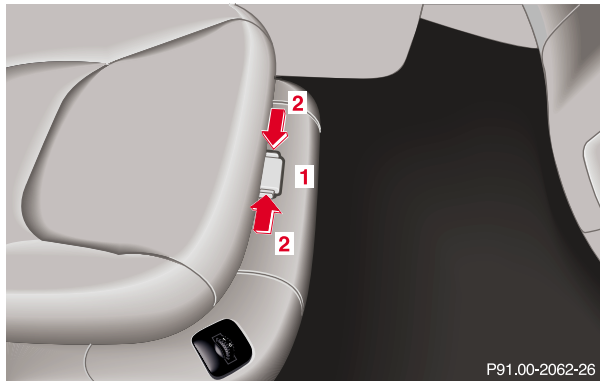
**First aid kit**

The first aid kit is located in the storage space under the front passenger seat.

To open:

Press buttons (2) together and fold the lid (1) down.  
Remove the first aid kit.

To close:

Fold the lid (1) up until it engages.

**Stowing things in the vehicle****Warning!**

To help avoid personal injury during a collision or sudden maneuver, exercise care when stowing things. Put luggage or cargo in the trunk if possible. Do not pile luggage or cargo higher than the seat backs. Do not place anything on the shelf below the rear window.

## Fuses

Most of your vehicle's electrical components are fused with safety fuses. With the exception of the brake lights, all individual lighting system components are electronically fused. Before replacing a blown safety fuse, determine the cause of the short circuit. Always observe amperage and color of fuse.

The circuit for components is protected by a cycled circuit breaker interrupted if too much current is being drawn. The circuit closes automatically after a short time; the circuit is broken again if the malfunction reoccurs.

Always use a new fuse for replacement. Never attempt to repair or bridge a blown fuse.

A fuse chart, spare fuses and a fuse extractor are located in the vehicle tool kit in the luggage bowl under the trunk floor. See page 338 for notes on the vehicle tool kit.

## Fuse boxes in the engine compartment



- 1 Fuse box in engine compartment, left-hand side
- 3 Tabs

## Fuses

330

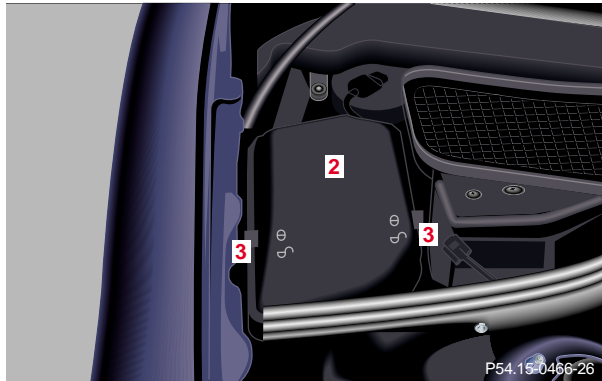

**2** Fuse box in engine compartment, right-hand side

**3** Tabs

To gain access to fuse box:

Slide both tabs (3) on fuse box forward to the  symbol and remove the cover.

To close the fuse box:

Ensure that the sealing rubber is properly positioned when you replace the cover. Press the cover down by hand. Slide both tabs (3) back to the  symbol on the fuse box.

Note:

The fuse box cover must be properly positioned and both tabs pushed forward to prevent moisture entering the fuse box.

#### Auxiliary fuse box below rear seat

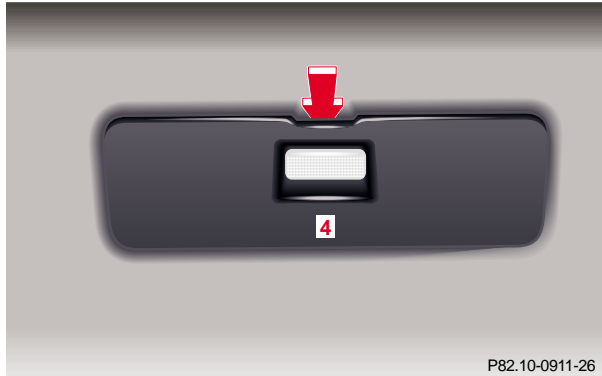

#### 4 Auxiliary fuse box below right rear seat

To open:  
Remove the cover.

To close:  
Press the cover on.

#### Hood

##### Warning!

To help prevent personal injury, stay clear of moving parts when the hood is open and the engine is running. Be sure the hood is properly closed before driving. When closing hood, use extreme caution not to catch hands or fingers.

The radiator fan may continue to run for approximately 30 seconds or even restart after the engine has been turned off. Stay clear from fan blades.

If you see flames or smoke coming from the engine compartment, or if the coolant temperature gauge indicates that the engine is overheated, do not open the hood. Move away from vehicle and do not open the hood until the engine has cooled. If necessary, call a fire department.

## Engine compartment

332

The engine is equipped with a transistorized ignition system. Because of the high voltage it is dangerous to touch any components (ignition coils, spark plug sockets, diagnostic socket) of the ignition system

- with the engine running,
- while starting the engine,
- if ignition is “on” and the engine is turned manually.

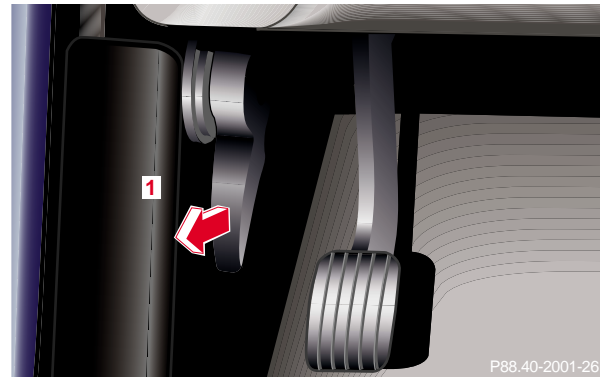

To open:

To unlock the hood, pull release lever (1) under the driver´s side of the instrument panel. At the same time a handle will extend out of the radiator grill.

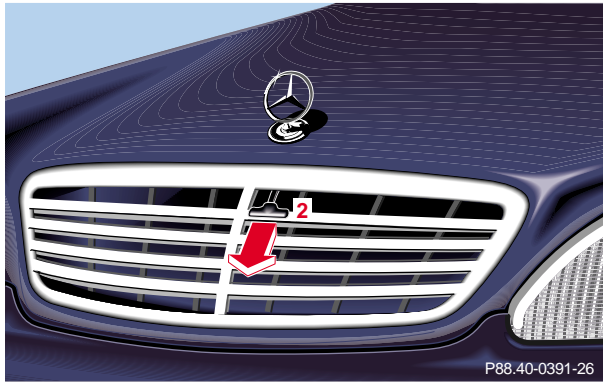

Pull handle (2) to its stop out of radiator grill and open hood (do not pull up on the handle).

Note:

To avoid damage to the windshield wipers or hood, open the hood only with the wipers in the parked position.

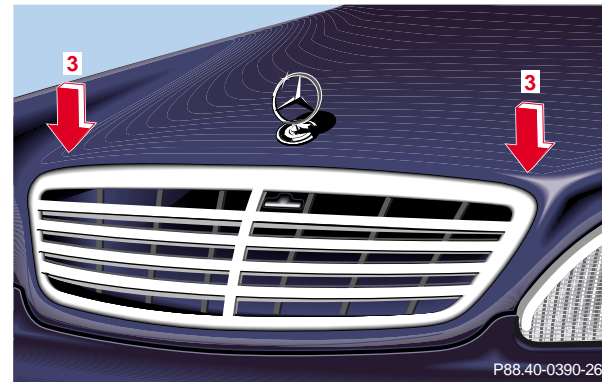

To close:

Lower the hood and let it drop into lock from a height of approximately 1 ft. (30 cm), assisting with hands placed flat on edges of hood (3).

To avoid hood damage, please make sure that hood is fully closed. If not, repeat closing procedure. Do not push down on hood to attempt to fully close it.



## Engine compartment

334

## Checking engine oil level

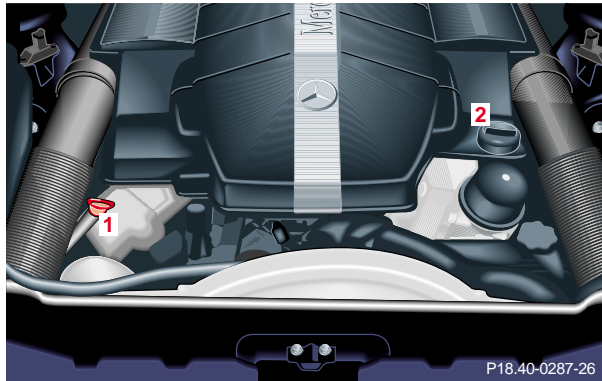

S 500

**1** Dipstick

Model S 600:  
The dipstick is omitted. Engine oil level can be checked via the engine oil level indicator, see page 154.

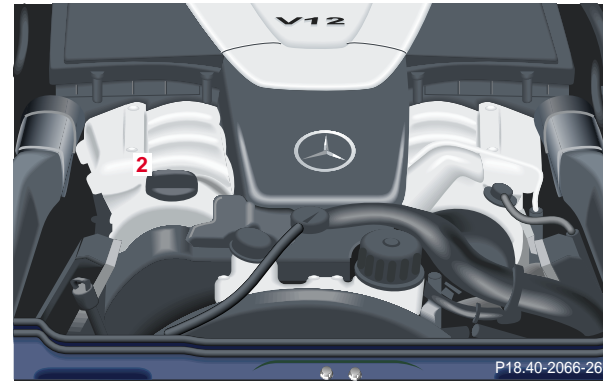
**2** Oil filler cap

S 600

Model S 430, S 500 and S 55 AMG

To check the engine oil level, park vehicle on level ground, with engine at normal operational temperature.

Check engine oil level approximately 5 minutes after stopping the engine, allowing for the oil to return to the oil pan.

The engine oil level can be checked by either the oil dipstick or via the multifunction display in the instrument cluster, see page 154.

Wipe the oil dipstick clean prior to checking the engine oil level. Fully insert dipstick in tube, and remove after three seconds to obtain accurate reading.



The oil level must be between the lower mark (min) and the upper mark (max) on the oil dipstick.

Unscrew the oil filler cap and add oil carefully if you need to top up the oil.

S 430, S 500 and S 55 AMG:

Fill quantity between upper and lower dipstick marking level is approximately 2.1 US qt (2.0 l).

S 600:

Follow the message appearing on the engine oil level indicator display (page 154) as to quantity to be added. Re-install oil filler cap.

Do not overfill the engine. Excessive oil must be drained or siphoned. It could cause damage to engine and catalytic converter not covered by the Mercedes-Benz Limited Warranty.

See Malfunction and warning messages on page 303 if an engine oil level display appears on the multifunction indicator when the engine is running.

Note:

See page 154 for engine oil level indicator.

#### **Automatic transmission fluid level**

The transmission has a permanent fill of automatic transmission fluid.

Regular automatic transmission fluid level checks and changes are not required. For this reason the dipstick is omitted.

If you notice fluid leaks or gear shifting malfunctions, have your authorized Mercedes-Benz Center check the transmission fluid level.

#### **Active body control (ABC) fluid level**

Regular fluid level check is not required.

If you notice fluid leaks or malfunctions, have your authorized Mercedes-Benz Center check the ABC-system.

## Engine compartment

336

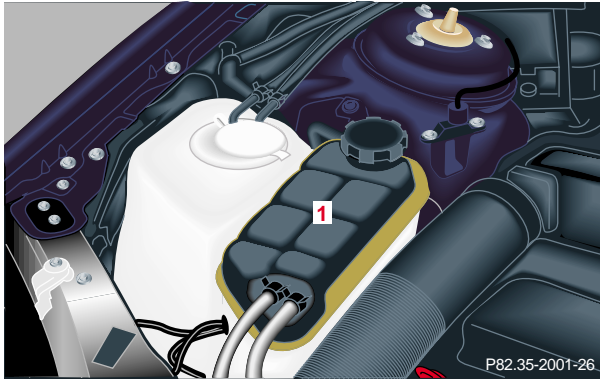
**Coolant level****1** Coolant expansion tank

To check the coolant level, the vehicle must be parked on level ground and the engine stopped.

Check coolant level only when coolant is cold.

The coolant level should reach the black top part of the reservoir.

See page 398 for antifreeze/anticorrosion mixture.

**Adding coolant**

If coolant has to be added, a 50/50 mixture of water and MB anticorrosion/antifreeze should be added.

**Warning!**

- **In order to avoid possibly serious burns:** Use extreme caution when opening the hood if there are any signs of steam or coolant leaking from the cooling system, or if the coolant temperature gauge indicates that the coolant is overheated.
- **Do not remove pressure cap on coolant reservoir if engine temperature is above 194°F (90°C).** Allow engine to cool down before removing cap. The coolant reservoir contains hot fluid and is under pressure.
- **Using a rag, slowly open cap approximately 1/2 turn to relieve excess pressure.** If opened immediately, scalding hot fluid and steam will be blown out under pressure.
- **Do not spill antifreeze on hot engine parts.** Antifreeze contains ethylene glycol which may burn if it comes into contact with hot engine parts.

## Windshield and headlamp washer system

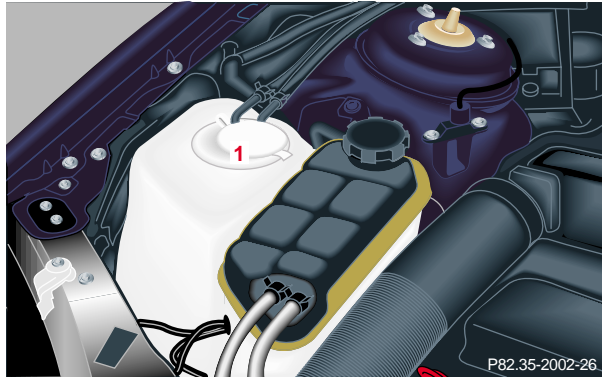

### 1 Windshield and headlamp washer fluid reservoir

The reservoir should be refilled with MB Windshield Washer Concentrate and water (or concentrate commercially available premixed windshield washer solvent/antifreeze, depending on ambient temperatures).

Capacity approximately 7.1 US qt (6.7 l).

### Warning!

Washer solvent/antifreeze is highly flammable. Do not spill washer solvent/antifreeze on hot engine parts, because it may burn. You can be seriously burned.

### Windshield and headlamp washer fluid mixing ratio

For temperatures above freezing:

MB Windshield Washer Concentrate "S" and water.

1 part "S" to 100 parts water  
(40 ml "S" to 1 gallon water).

For temperatures below freezing:

MB Windshield Washer Concentrate "S" and commercially available premixed windshield washer solvent/antifreeze.

1 part "S" to 100 parts solvent  
(40 ml "S" to 1 gallon solvent).

## Spare wheel

338

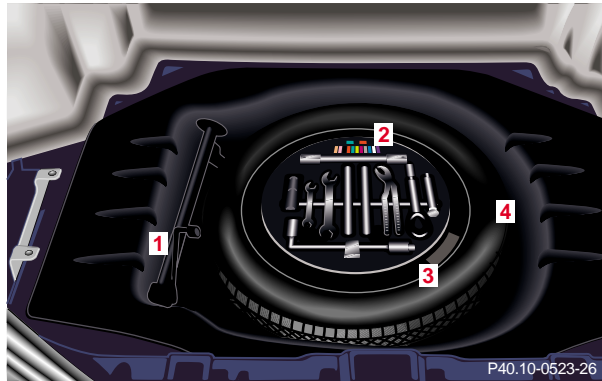
**Spare wheel, vehicle tools, storage compartment**

- 1 Jack
- 2 Luggage bowl with vehicle tool kit, towing eye bolt, fuses, fuse extractor and fuse chart
- 3 Storage tray
- 4 Spare wheel

Lift trunk floor and engage handle in upper edge of trunk.

Always lower trunk floor before closing trunk lid.

To remove the spare wheel:

Take out the vehicle tool kit tray.

Turn the luggage bowl counterclockwise and remove the spare wheel.

To store spare wheel:

Place spare wheel in wheel well and secure it with luggage bowl. Turn luggage bowl clockwise to its stop.

Place vehicle tool kit tray in luggage bowl.

## Vehicle jack



To prepare the jack for use:

Remove the jack from the spare wheel well under the trunk floor, push the crank handle up and turn clockwise until it engages (operational position).

Storing the jack in the trunk:

Retract the jack arm to the base of the jack, push the crank handle up and turn counterclockwise to the end of the stop (storage position).

### Warning!

The jack is designed exclusively for jacking up the vehicle at the jack tubes built into either side of the vehicle. To help avoid personal injury, use the jack only to lift the vehicle during a wheel change. Never get beneath the vehicle while it is supported by the jack. Keep hands and feet away from the area under the lifted vehicle. Always firmly set parking brake and block wheels before raising vehicle with jack.

Do not disengage parking brake while the vehicle is raised. Be certain that the jack is always vertical when in use, especially on hills. Always try to use the jack on level surface. Be sure that the jack arm is fully inserted in the jack tube. Always lower the vehicle onto sufficient capacity jackstands before working under the vehicle.

## Tires, Wheels

340

**Wheels**

Replace rims or tires with the same designation, manufacturer and type as shown on the original part. See your authorized Mercedes-Benz Center for further information.

See your authorized Mercedes-Benz Center for information on tested and recommended rims and tires for summer and winter operation. They can also offer advice concerning tire service and purchase.

**Tire Replacement**

Front and rear tires should be replaced in sets. Rims and tires must be of the correct size and type. For dimensions, see "Technical Data".

We recommend that you break in new tires for approximately 60 miles (100 km) at moderate speed.

It is imperative that the wheel mounting bolts be fastened to a tightening torque of 110 ft.lb. (150 Nm) whenever wheels are mounted.

For rim and tire specifications, refer to "Technical Data".

**Warning!**

**Worn, old tires can cause accidents. If the tire tread is badly worn, or if the tires have sustained damage, replace them.**

**When replacing rims, use only genuine Mercedes-Benz wheel bolts specified for the particular rim type. Failure to do so can result in the bolts loosening and possibly an accident.**

### Rotating wheels

The wheels can be rotated according to the degree of tire wear while retaining the same direction of travel.

Rotating, however, should be carried out as recommended by the tire manufacturer, before the characteristic tire wear pattern (shoulder wear on front wheels and tread center wear on rear wheels) becomes visible, as otherwise the driving properties deteriorate.

Notes:

Thoroughly clean the inner side of the wheels any time you rotate the wheels or wash the vehicle underside.

The use of retread tires is not recommended. Retread tires may adversely affect the handling characteristics and safety of the vehicle.

Dented or bent rims can cause tire pressure loss and damage to the tire beads. For this reason, check rims for damage at regular intervals. The rim flanges must be checked for wear before a tire is mounted. Remove burrs, if any.

Check and ensure proper tire inflation pressure after rotating the wheels. For tire inflation pressure see inside of fuel filler flap and also page 290.

### Spare wheel

**Spare wheel S 430, S 500 and S 600**  
(except Sport Package)

#### Important!

The spare wheel rim is mounted with a full size tire of the same type as on the vehicle, and is fully functional. However, that spare wheel rim is weight optimized and has a limited service life of 12 000 miles (20 000 km) use before a standard wheel rim must replace it.

In the case of a flat tire, you may temporarily use the spare wheel.

Do not operate vehicle with more than one spare wheel mounted.

#### Warning!

**The spare wheel rim is for temporary use only. Use for over a total of 12 000 miles (20 000 km) (aggregate of all uses) may cause wheel rim failure leading to an accident and possible injuries.**



Instruments and controls	Operation	Driving	Instrument cluster display	<b>Practical hints</b>	Car care	Technical data	Index
--------------------------	-----------	---------	----------------------------	------------------------	----------	----------------	-------

## Tires, Wheels

342

### Spare wheel S 55 AMG and Sport Package

S 55 AMG, S 600 with Sport Package:

The spare wheel rim size is 7 1/2 J x 17 H2 with tire size 225/60 R17 98H.

S 430, S 500 with Sport Package:

The spare wheel rim size is 7 1/2 J x 16 H2 with tire size 225/60 R16 98H.

In the case of a flat tire or breakdown, you may temporarily use the spare wheel, while observing the following restrictions:

- Do not exceed vehicle speed of 50 mph (80 km/h).
- Drive to the nearest repair facility to have the flat tire repaired or replaced as appropriate.
- Do not operate vehicle with more than one spare wheel mounted.

For additional information, refer to page 390.

### Warning!

**The spare wheel rim is for temporary use only. Use for over a total of 12 000 miles (20 000 km) may cause wheel rim failure leading to an accident and possible injuries.**

**The dimensions of the spare wheel are different from those of road wheels. As a result, the vehicle handling characteristics change when driving with a mounted spare wheel.**

**The spare wheel should only be used temporarily, and replaced with a regular road wheel as quickly as possible.**

## Changing wheels

### Warning!

The jack is designed exclusively for jacking up the vehicle at the jack tubes built into either side of the vehicle. To help avoid personal injury, use the jack only to lift the vehicle during a wheel change.

Never get beneath the vehicle while it is supported by the jack. Keep hands and feet away from the area under the lifted vehicle. Always firmly set parking brake and block wheels before raising vehicle with jack.

Do not disengage parking brake while the vehicle is raised. Be certain that the jack is always vertical when in use, especially on hills. Always try to use the jack on level surface. Be sure that the jack arm is fully inserted in the jack tube. Always lower the vehicle onto sufficient capacity jackstands before working under the vehicle.

Move vehicle to a level area which is a safe distance from the roadway.

1. Set parking brake and turn on hazard warning flasher.
2. Move selector lever to position "P" and turn off engine.
3. Prevent vehicle from rolling away by blocking wheels with wheel chocks (not supplied with vehicle) or sizable wood block or stone. When changing a wheel on a hill, place chocks on the downhill side blocking both wheels of the other axle. On an level road, place one chock in front of and one behind the wheel that is diagonally opposite to the wheel being changed.

## Tires, Wheels

344

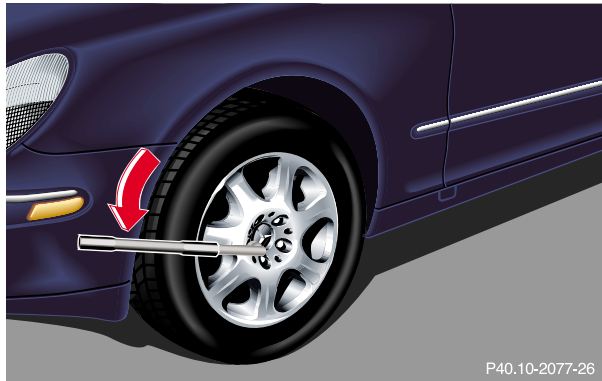

P40.10-2077-26

4. Remove the two-piece wheel wrench from the vehicle tool kit and assemble. Using the wrench, loosen but do not yet remove the wheel bolts.

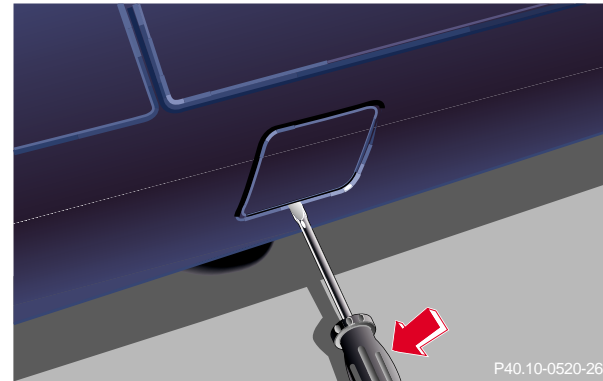

P40.10-0520-26

5. Remove the protective cover from the jack support tube opening by inserting the screwdriver (supplied in the tool kit) in the opening and prying it out.

The tube openings are located directly behind the front wheel housings and in front of the rear wheel housings.



6. Insert jack arm fully into the tube hole up to the stop. Place jack on firm ground. Position the jack so that it is always vertical (plumb-line) as seen from the side (see arrow), even if the vehicle is parked on an incline.
7. Jack up the vehicle until the wheel is clear of the ground. Never start engine while vehicle is raised.



8. Unscrew upper-most wheel bolt and install alignment bolt (1) supplied in the tool kit. Remove the remaining bolts. Keep bolt threads protected from dirt and sand.
9. Remove wheel. Grip wheel from the sides. Keep hands from beneath the wheels.

## Tires, Wheels

346

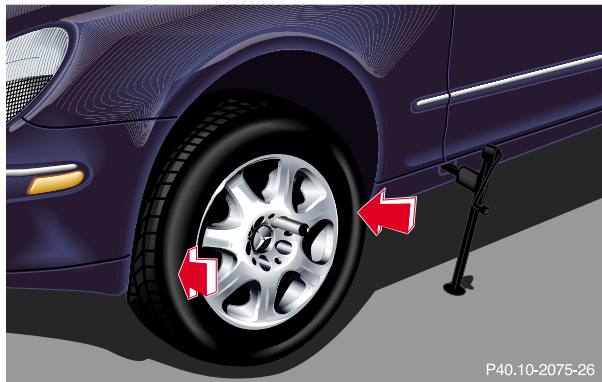

10. Clean contact surfaces of wheel and wheel hub. Install spare wheel on wheel hub. Insert wheel bolts and tighten them slightly.

To avoid paint damage, place wheel flat against hub and hold it there while installing first wheel bolt.

Unscrew the alignment bolt to install the last wheel bolt.



11. Lower vehicle. Remove jack and insert jack tube cover.

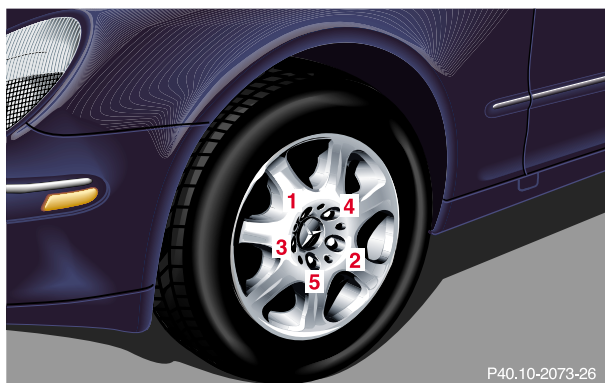

12. Using the wrench, tighten the five bolts evenly, following the sequence illustrated, until all bolts are tight.  
Observe a tightening torque of 110 ft.lb. (150 Nm).

13. Ensure proper tire pressure.

Notes:

Before storing the jack, the jack arm must be lowered almost to the base of the jack.

For proper storage of vehicle jack see page 338.

**Warning!**

Always replace wheel bolts that are damaged or rusted.

Never apply oil or grease to wheel bolts.

Damaged wheel hub threads should be repaired immediately.

Incorrect mounting bolts or improperly tightened mounting bolts can cause the wheel to come off. This could cause an accident. Be sure to use the correct mounting bolts.

**Warning!**

The spare wheel rim is for temporary use only. Use for over a total of 12 000 miles (20 000 km) (aggregate of all uses) may cause wheel rim failure leading to an accident and possible injuries.

The spare wheel should only be used temporarily, and replaced with a regular road wheel as quick as possible.

**S 55 AMG and Sport Package:**

The dimensions of the spare wheel are different from those of the road wheels. As a result, the vehicle handling characteristics change when driving with a mounted spare wheel.

Instruments and controls	Operation	Driving	Instrument cluster display	<b>Practical hints</b>	Car care	Technical data	Index
--------------------------	-----------	---------	----------------------------	------------------------	----------	----------------	-------

Tires, Wheels

**Tire inflation pressure**

A table (see fuel filler flap) lists the tire inflation pressures specified for Mercedes-Benz recommended tires as well as for the varying operating conditions.

**Important!**

Tire pressure changes by approximately 1.5 psi (0.1 bar) per 18°F (10°C) of air temperature change. Keep this in mind when checking tire pressure inside a garage – especially in the winter.

Example:

If garage temperature = approximately +68°F (+20°C) and ambient temperature = approximately +32°F (0°C) then the adjusted air pressure = specified air pressure +3 psi (+0.2 bar).

Tire pressures listed for light loads are minimum values offering high driving comfort. Increased inflation pressures for heavy loads produce favorable handling characteristics with lighter loads and are perfectly permissible. The ride of the vehicle, however, will become somewhat harder.

Tire temperature and pressure increase with the vehicle speed. Tire pressure should therefore only be checked and corrected on cold tires. Correct tire pressure in warm tires only if pressure has dropped below the pressure listed in the table and the respective operating conditions are taken into consideration.

An underinflated tire due to a slow leak (e.g. due to a nail in the tire) may cause damage such as tread separation, bulging etc.. Regular tire pressure checks (including the spare tire) at intervals of no more than 14 days are therefore essential.

If a tire constantly loses air, it should be inspected for damage.

The spare tire should be checked periodically for condition and inflation. Spare tire will age and become worn over time even if never used, and thus should be inspected and replaced when necessary.

**Warning!**

**Do not overinflate tires. Overinflating tires can result in sudden deflation (blowout) because they are more likely to become punctured or damaged by road debris, potholes etc.. Follow recommended inflation pressures.**

**Do not overload the tires by exceeding the specified vehicle capacity weight (as indicated by the label on the driver's door latch post). Overloading the tires can overheat them, possibly causing a blowout.**

**Battery**

**Warning!**

**Failure to follow these instructions can result in severe injury or death.**

**Never lean over batteries while connecting, you might get injured.**

**Battery fluid contains sulfuric acid. Do not allow this fluid to come in contact with eyes, skin or clothing. In case it does, immediately flush affected area with water and seek medical help if necessary.**

**A battery will also produce hydrogen gas, which is flammable and explosive. Keep flames or sparks away from battery, avoid improper connection of jumper cables, smoking etc..**

**Important!**

Battery replacement information:

The maintenance-free battery is located in the trunk under the right-hand wheel well cover panel.

The service life of the battery is dependent on its condition of charge. The battery should always be kept sufficiently charged, in order to last an optimum length of time.



## Battery

350

**Therefore, we strongly recommend that you have the battery charge checked frequently, and corrected if necessary, especially if you use the vehicle less than approximately 200 miles (300 km) per month, mostly for short distance trips, or if it is not used for long periods of time.**

Only charge a battery with a battery charger after the battery has been disconnected from the vehicle's electrical circuit.

Always disconnect the battery negative lead first and connect last.

When removing and connecting the battery, always make sure that all electrical consumers are off and the electronic key is in starter switch position 0. The battery, its filler caps, the vent tube and the opposite plug must always be securely installed when the vehicle is in operation.

While the engine is running the battery terminal clamps must not be loosened or detached, otherwise the generator and other electronic components would be damaged.

Note:

After reconnecting the battery also set the clock (see COMAND operator's manual) resynchronize the front seat head restraints, the express feature of the power windows, the sliding/pop-up roof, and the electronic stability program (see head restraints on page 72, power windows on page 181, and electronic stability program on page 274).

**Battery recycling**

Batteries contain materials that can harm the environment with improper disposal.

Large 12 Volt storage batteries contain lead.

Recycling of batteries is the preferred method of disposal.

Many states require sellers of batteries to accept old batteries for recycling.

## Jump starting

### Warning!

Failure to follow these directions will cause damage to the electronic components, and can lead to a battery explosion and severe injury or death.

Never lean over batteries while connecting or jump starting, you might get injured.

Battery fluid contains sulfuric acid. Do not allow this fluid to come in contact with eyes, skin or clothing. In case it does, immediately flush affected area with water, and seek medical help if necessary.

A battery will also produce hydrogen gas, which is flammable and very explosive. Keep flames or sparks away from battery, avoid improper connection of jumper cables, smoking etc..

Read all instructions before proceeding.

### Important!

A discharged battery can freeze at approximately +14°F (-10°C). In that case, it must be thawed out before jumper cables are used. Attempting to jump start a frozen battery can result in it exploding, causing personal injury.

Jumper cable specifications:

- Minimum cable cross-section of 25 mm<sup>2</sup> or approximately 2 AWG
- Maximum length of 11.5 ft. (3.5 m).

If the battery is discharged, the engine should be started with jumper cables and the (12 V) battery of another vehicle.

Only use 12 V battery to jump start your vehicle. Jump starting with more powerful battery could damage the vehicle's electrical systems, which will not be covered by the Mercedes-Benz Limited Warranty.

The battery is located in the trunk under the right-hand wheel well cover panel.

## Jump starting

352

Proceed as follows:

1. Position the vehicle with the charged battery so that the jumper cables will reach, but never let the vehicles touch. Make sure the jumper cables do not have loose or missing insulation.
2. On both vehicles:
  - Turn off engine and all lights and accessories, except hazard warning flashers or work lights.
  - Apply parking brake and shift selector lever to position "P".

**Important!**

3. Clamp one end of the first jumper cable to the positive (+) terminal of the discharged battery and the other end to the positive (+) terminal of the charged battery. Make sure the cable clamps do not touch any other metal parts.
4. Clamp one end of the second jumper cable to the grounded negative (-) terminal of the charged battery and the final connection to the negative (-) under hood terminal of the disabled vehicle.

**Important!**

5. Start engine of the vehicle with the charged battery and run at high idle. Make sure the cables are not on or near pulleys, fans, or other parts that move when the engine is started. Allow the discharged battery to charge for a few minutes. Start engine of the disabled vehicle in the usual manner.
6. After the engine has started, remove jumper cables by exactly reversing the above installation sequence, starting with the last connection made first. When removing each clamp, make sure that it does not touch any other metal while the other end is still attached.

## Note:

If engine does not run after several unsuccessful starting attempts, have it checked at the nearest authorized Mercedes-Benz Center.

Excessive unburned fuel may damage the catalytic converter.

## Towing the vehicle

### Warning!

**Prior to towing the vehicle with all wheels on the ground, make certain that the electronic key is in starter switch position 2.**

**If the electronic key is left in the starter switch position 0 for an extended period of time, it can no longer be turned in the switch. To unlock, remove electronic key from starter switch and reinsert.**

### Important!

When towing the vehicle, please, note the following:

With the automatic central locking activated and the electronic key in starter switch position 2 (vehicles with KEYLESS-GO: in “On” position, see page 228), the vehicle doors lock if the left front wheel as well as the right rear wheel are turning at vehicle speeds of approximately 9 mph (15 km/h) or more.

To prevent the vehicle door locks from locking, deactivate the automatic central locking. See “VEHICLE” under “Individual settings” on page 144.

**Towing of the vehicle should only be done using the properly installed towing eye bolt. Never attach tow cable, tow rope or tow rod to vehicle chassis, frame or suspension parts.**

### Note:

The selector lever will remain locked in position “P” and the electronic key could not be turned in the starter switch if the battery is disconnected or discharged. See battery on page 349 or jump starting on page 351.

## Towing the vehicle

354

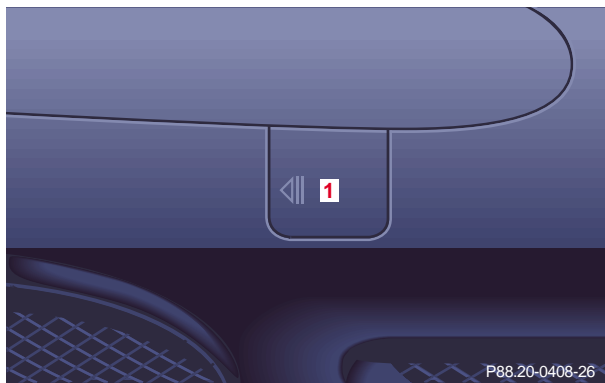
**1** Cover on right side of front bumper

To remove cover:

Press mark on cover in direction of arrow and lift cover off to reveal threaded hole for towing eye bolt. The towing eye bolt is supplied with the tool kit (located in trunk in spare wheel). Screw towing eye bolt in to its stop and tighten with lug wrench.

To reinstall cover:

Fit cover and snap into place.

**2** Cover right side of rear bumper

To remove cover:

Press mark on cover in direction of arrow and lift cover off to reveal threaded hole for towing eye bolt. The towing eye bolt is supplied with the tool kit (located in trunk in spare wheel). Screw towing eye bolt in to its stop and tighten with lug wrench.

To reinstall cover:

Fit cover and snap into place.

We recommend that the vehicle be transported using flat bed equipment. This method is preferable to other types of towing.

**Important!**

**To prevent damage during transport, do not tie down vehicle by its chassis or suspension parts.**

The vehicle may be towed with all wheels on the ground and the selector lever in position “N” for distances up to 30 miles (50 km) and at a speed not to exceed 30 mph (50 km/h). The electronic key must be in starter switch position 2.

To be certain to avoid a possibility of damage to the transmission, however, we recommend the drive shaft be disconnected at the rear axle drive flange for any towing beyond a short tow to a nearby garage.

Do not tow with sling-type equipment. Towing with sling-type equipment over bumpy roads will damage radiator and supports.

Use wheel lift, dolly, or flat bed equipment, with electronic key in starter switch turned to position 0.

**Warning!**

**With the engine not running, there is no power assistance for the braking and steering systems. In this case, it is important to keep in mind that a considerably higher degree of effort is necessary to brake and steer the vehicle.**

Note:

To signal turns while being towed with hazard warning flasher in use, turn electronic key in starter switch to position 2 and activate combination switch for left or right turn signal in usual manner – only the selected turn signal will operate.

Upon canceling the turn signal, the hazard warning flasher will operate again.

**Caution!**

If the vehicle is towed with the front axle raised, the engine must be shut off (electronic key in starter switch position 0 or 1). Otherwise, the ESP will immediately be engaged and will apply the rear wheel brakes.

Switch off the tow-away alarm (see “VEHICLE” under “Individual settings” on page 144) as well as the ESP (see page 274).

## Exterior lamps

### Headlamp adjustment

Correct headlamp adjustment is extremely important. Check and readjust headlamps at regular intervals and when a bulb has been replaced.

#### Warning!

**Bulbs and bulb holders can be very hot. Allow the lamp to cool down before changing a bulb.**

**Halogen lamps contain pressurized gas. A bulb can explode if you:**

- touch or move it when hot,
- drop the bulb,
- scratch the bulb.

**Wear eye and hand protection.**

### Replacing bulbs

#### Warning!

**Because of high voltage in Xenon lamps, it is dangerous to replace the bulb or repair the lamp and its components. We recommend that you have such work done by a qualified technician.**

#### Notes:

To prevent a possible electrical short circuit, switch off lamp prior to replacing a bulb.

When replacing bulbs, install only 12 volt bulbs with the specified watt rating.

When replacing halogen bulbs do not touch glass portion of bulb with bare hands. Use plain paper or a clean cloth.

If the newly installed bulb does not light up, switch the lamp off and on again. If the bulb still does not light up, have the system checked at an authorized Mercedes-Benz Center.

## Headlamp assembly

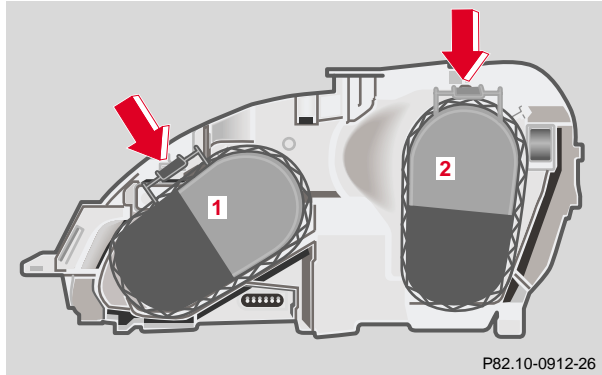

- 1 Headlamp cover for fog lamp, parking and standing lamp, and high beam headlamp
- 2 Headlamp cover for low beam headlamp and turn signal lamp

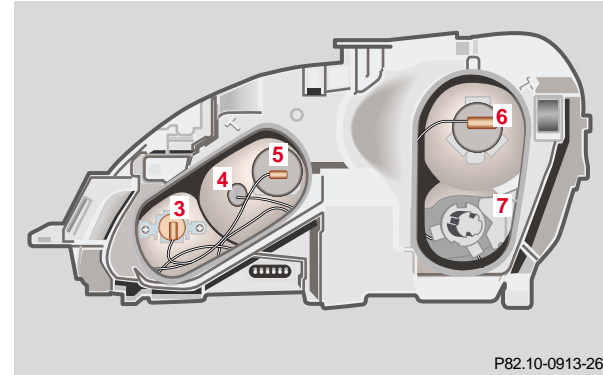

- 3 Bulb socket for fog lamp
- 4 Bulb socket for parking and standing lamp
- 5 Electrical connector for high beam headlamp bulb
- 6 Electrical connector for low beam Halogen type headlamp bulb  
if applicable: for Xenon type headlamp bulb
- 7 Bulb socket for turn signal lamp



## Exterior lamps

358

**Bulbs for high and low beam**

H7 (55 W)

Open hood.

Press the clip together (arrow) and remove headlamp cover (1 or 2).

Pull electrical connector off.

Unclip the retainer spring and take out the bulb.

Insert the new bulb so that the base locates in the recess on the holder.

Clip in retainer springs and plug the connector onto the bulb.

Align headlamp cover (1 or 2) and click into place.

**Xenon (optional)****Bulb for low beam****Warning!**

**Because of high voltage in Xenon lamps, it is dangerous to replace the bulb or repair the lamp and its components. We recommend that you have such work done by a qualified technician.**

**Turn signal lamp**

(2357 NA [28.5/8.3 W] (Yellow))

Open hood.

Press the clip together (arrow) and remove headlamp cover (2).

Twist bulb socket (7) counterclockwise and pull out. Push bulb into socket, turn counterclockwise and remove.

Insert new bulb in socket, push in and twist clockwise. Reinstall bulb socket.

Align headlamp cover (2) and click into place.

### **Front fog lamp**

H1 (55W)

Open hood.

Press the clip together (arrow) and remove headlamp cover (1).

Pull electrical connector off.

Unclip the retainer spring and take out the bulb.

Insert the new bulb so that the base locates in the recess on the holder.

Clip in retainer spring and plug the connector onto the bulb.

Align headlamp cover (1) and click into place.

### **Parking and standing lamp**

W 5W

Open hood.

Press the clip together (arrow) and remove headlamp cover (1).

Twist bulb socket (4) counterclockwise and pull out. Push bulb into socket, turn counterclockwise and remove.

Insert new bulb in socket, push in and twist clockwise. Reinstall bulb socket.

Align headlamp cover (1) and click into place.

## Exterior lamps

360

## Taillamp assemblies

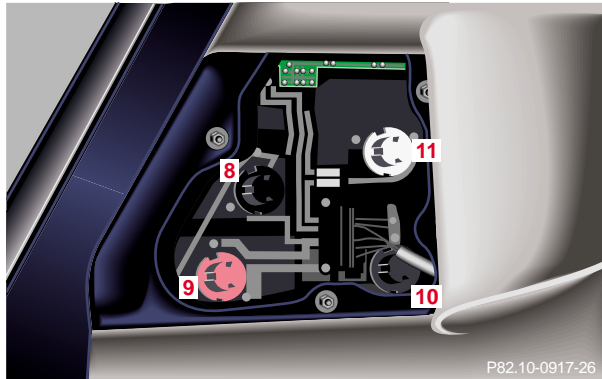

- 8** Black socket:  
Backup lamp (21 W/32 cp bulb)
- 9** Red socket  
Driver's side:  
Taillamp/parking lamp/rear fog lamp  
(P 21/4W bulb)  
passenger-side:  
Taillamp/parking lamp (P 21/4W bulb)
- 10** Grey socket:  
Taillamp/parking lamp/standing lamp/side marker  
(R 5W/4 cp bulb)
- 11** White socket:  
Turn signal lamp (1156 NA bulb [yellow])

Open trunk lid.

Fold trim to the side.

Twist bulb socket counterclockwise and pull out. Push bulb into socket, turn counterclockwise and remove.

Insert new bulb in socket, push in and twist clockwise. Reinstall bulb socket.

Reinstall trim.

### License plate lamp

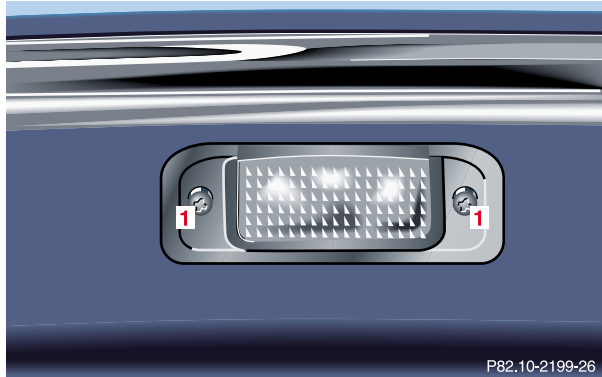

Loosen both securing screws (1), remove lamp and replace tubular lamp (C 5 W/4 cp).

### Stop lamp, High mounted stop lamp, Additional turn signals on the exterior mirror

The stop lamps, the high mounted stop lamp (3rd brake lamp), and the additional turn signals on the exterior mirrors are equipped with LEDs.

Have the system checked at an authorized Mercedes-Benz Center if a malfunction occurs.

## Trunk lamp

362

**Standby bulb function**

The rear fog lamp, dimmed, will act as a replacement lamp, if the bulb in the inner left-hand taillamp stops working.

The inner taillamp acts as a replacement for the right or left-hand bulb of the outer taillamp, if it stops working as a parking lamp.

## Notes:

The multifunction display will indicate that a bulb has failed. See Malfunction and warning messages on page 303.

**Trunk lamp**

The trunk lamp will switch off after approximately 10 minutes if the trunk lid is left open.

## Changing batteries in the electronic main key



- 1 Transmit buttons
- 2 Lamp for battery check and function control

### Checking batteries

If one of the transmit buttons (1) is pressed, the battery check lamp (2) lights up briefly – indicating that the batteries are in order.

Change batteries if the battery check lamp (2) does not light up briefly.



### Changing batteries

Move locking tab (3) in direction of right arrow and remove mechanical key (4, left arrow).

## Electronic main key

364



Insert mechanical key (4) in side opening (5) to open latch. Press briefly (do not use mechanical key as lever) to release battery compartment.

Remove mechanical key from side opening.

Carefully remove battery compartment in direction of arrow (6).

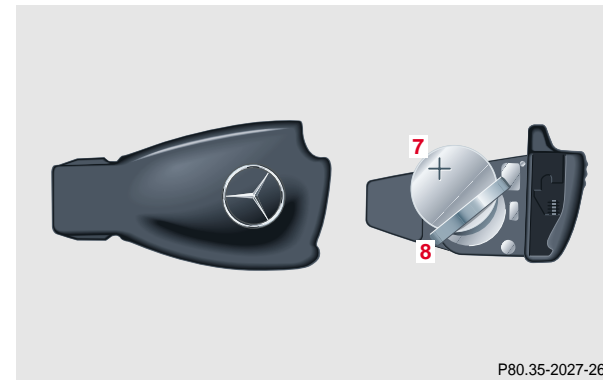

Change batteries (7), inserting new ones under contact spring (8) with plus (+) side facing up.

Return battery compartment into housing until locked in place and slide mechanical key back into electronic main key.

### **Important!**

Batteries contain materials that can harm the environment if disposed of improperly. Recycling of batteries is the preferred method of disposal. For disposal, please follow manufacturer's recommendation on battery package.

Replacement Battery:  
Lithium, type CR 2025 or equivalent.

### **Synchronizing remote control**

The remote control may have to be resynchronized, if the vehicle cannot be locked or unlocked.

To synchronize insert electronic key in starter switch.

The remote control should once again be operational.



## KEYLESS-GO-card

366

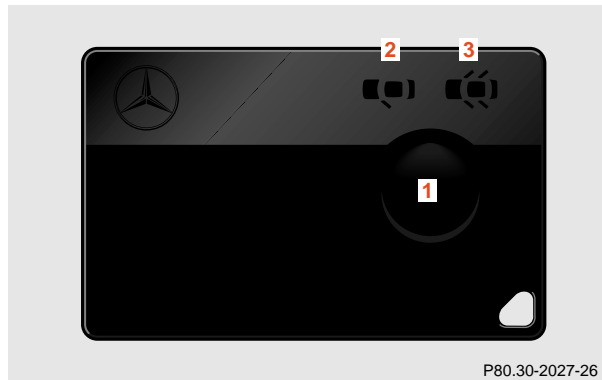
**Changing batteries in the KEYLESS-GO-card****Checking batteries**

Briefly press button (1). The indicator lamp “Unlock driver’s door” (2) or “Global Unlock” (3) should come on red or green.

Change batteries if indicator lamps do not illuminate, see page 367.

## Changing batteries



Pry open cover (1) (e.g. by using a narrow blade screw driver) and remove batteries.

Install new batteries as indicated by the “+” and “-” markings in the KEYLESS-GO-card.

## Important!

Batteries contain materials that can harm the environment if disposed of improperly. Recycling of batteries is the preferred method of disposal. For disposal, please follow manufacturer’s recommendation on battery package.

Replacement batteries:  
Lithium, type CR 2025 or equivalent.

## Emergency engine shut-down

368

**Emergency engine shut-down**

If the engine can no longer be stopped using the electronic key or the start-/stop button (vehicles with KEYLESS-GO), the engine can be turned off by withdrawing two fuses.

For easy removal of fuses use the fuse extractor (supplied with vehicle tool kit) to pull out the fuses marked on the fuse chart as "ENGINE EMERGENCY OFF".

The fuse chart is also located in the vehicle tool kit, see page 338.

For fuses see page 329.

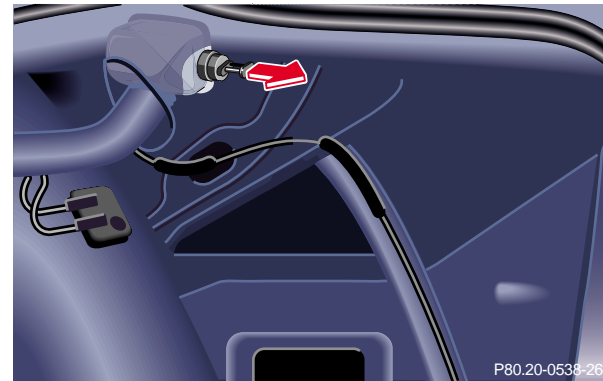
**Fuel filler flap, manual release**

Pull back the trim inside the trunk on the right-hand side. Pull the release knob (arrow) and open the fuel filler flap.

## Emergency operation of sliding/pop-up roof



The sliding/pop-up roof can be opened or closed manually should an electrical malfunction occur.

The sliding/pop-up roof drive is located behind the lens of the left interior overhead light.

Pry off the interior light lens (1) using a screwdriver.



Obtain crank (2) (supplied with vehicle) and insert through hole.

To slide roof closed or to raise the roof at the rear: turn crank clockwise.

To slide the roof open or to lower the roof at the rear: turn crank counterclockwise.

See page 186 for instructions on synchronizing the sliding/pop-up roof after closing manually.

## Replacing wiper blades

370

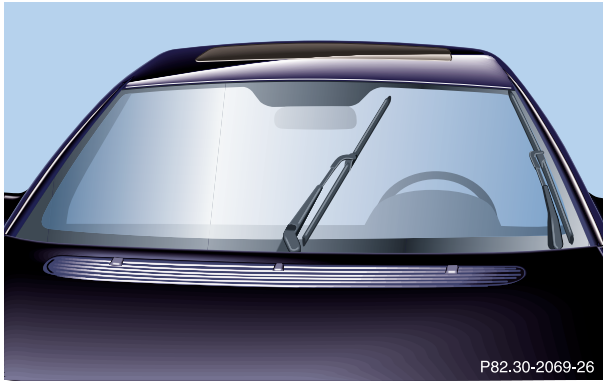
**Replacing wiper blades**

To prevent damage to the hood or the wipers, the wiper arms should only be folded forward while in the position shown above.

- Turn electronic key in starter switch to position 1.
- Turn combination switch to position I, see page 160.
- With wiper arms in position shown above, turn electronic key in starter switch to position 0.

For safety reasons, remove electronic key from starter switch before replacing a wiper blade, otherwise the motor can suddenly turn on and cause injury.

## Notes:

Do not open engine hood with wiper arms folded forward.

Do not allow the wiper arms to contact the windshield glass without a wiper blade inserted. The glass may be scratched or broken.

Make certain that the wiper blades are properly installed. An improperly installed wiper blade may cause windshield damage.

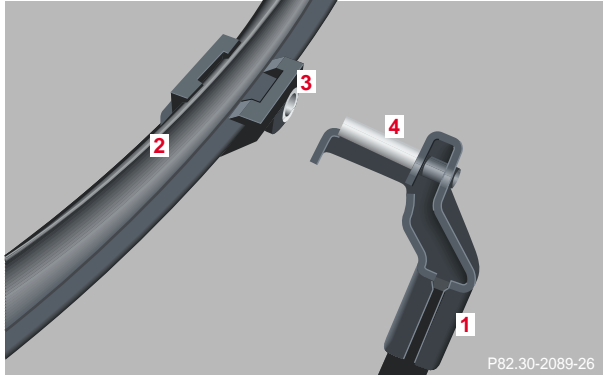

**Removal:**

Fold the wiper arm (1) forward and turn the wiper blade (2) at a right-angle to wiper arm.

Remove wiper blade from wiper arm.

**Installation:**

Install wiper blade onto the wiper arm by inserting pin (4) into take-up (3).

Rotate wiper blade into position parallel to wiper arm.

**Roof rack**

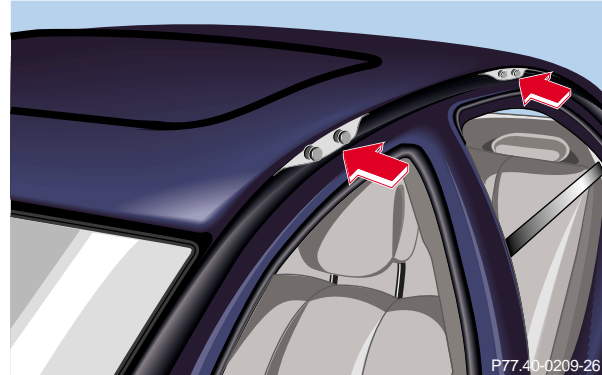

Only mount roof racks to the fastening bolts (see arrows) located under the door weatherstrips.

Use only those roof racks approved by Mercedes-Benz to avoid damage to the vehicle. Follow manufacturer's installation instructions.



## Vehicle care

Cleaning and care of the vehicle .....	374	Headlamps, taillamps, turn signal lenses .....	377	Seat belts .....	381
Power washer .....	375	Cleaning the Distronic system sensor .....	378	Headliner and shelf below rear window .....	381
Tar stains .....	376	Cleaning the parktronic system sensors .....	378	Leather upholstery .....	381
Paintwork, painted body components .....	376	Wiper blades .....	379	Hard plastic trim items .....	381
Engine cleaning .....	376	Light alloy wheels .....	380	Plastic and rubber parts .....	381
Vehicle washing .....	376	Instrument cluster .....	380	Air conditioner refrigerant .....	396
Ornamental moldings .....	377	Steering wheel and gear selector lever .....	380	Brake fluid .....	396
		Cup holder .....	380	Premium unleaded gasoline .....	397
				Fuel requirements .....	397
				Gasoline additives .....	398
				Coolants .....	398
				Consumer information .....	400



Instruments and controls	Operation	Driving	Instrument cluster display	Practical hints	<b>Car care</b>	Technical data	Index
--------------------------	-----------	---------	----------------------------	-----------------	-----------------	----------------	-------

## Cleaning and care of the vehicle

374

### Cleaning and care of the vehicle

#### Warning!

**Many cleaning products can be hazardous. Some are poisonous, others are flammable. Always follow the instructions on the particular container. Always open your vehicle's doors or windows when cleaning the inside.**

**Never use fluids or solvents that are not designed for cleaning your vehicle.**

In operation, your vehicle is subjected to varying external influences which, if gone unchecked, can attack the paintwork as well as the underbody and cause lasting damage.

Such damage is caused not only by extreme and varying climatic conditions, but also by air pollution, road salt, tar, gravel and stone chipping. Grease and oil, fuel, coolant, brake fluid, bird droppings, insects, tree resins etc. should be removed immediately to avoid paint damage. Frequent washing reduces and/or eliminates the aggressiveness and potency of the above adverse influences.

More frequent washings are necessary to deal with unfavorable conditions; for example, near the ocean, in industrial areas (smoke, exhaust emissions), or during winter operation.

You should check your vehicle from time to time for stone chipping or other damage. Any damage should be repaired as soon as possible to prevent the start of corrosion.

In doing so, do not neglect the underside of the vehicle. A prerequisite for a thorough check is a washing of the underbody followed by a thorough inspection. Damaged areas need to be reundercoated.

Your vehicle has been treated at the factory with a wax-base rustproofing in the body cavities which will last for the lifetime of the vehicle. Post-production treatment is neither necessary nor recommended by Mercedes-Benz because of the possibility of incompatibility between materials used in the production process and others applied later.

We have selected car-care products and compiled recommendations which are specially matched to our vehicles and which always reflect the latest technology. You can obtain Mercedes-Benz approved car-care products at your authorized Mercedes-Benz Center.

Scratches, corrosive deposits, corrosion or damage due to negligent or incorrect care cannot always be removed or repaired with the car-care products recommended here. In such cases it is best to seek aid at your authorized Mercedes-Benz Center.

The following topics deal with the cleaning and care of your vehicle and give important “how-to” information as well as references to Mercedes-Benz approved car-care products.

Additional information can be found in the booklet titled “Vehicle Car Guide”.

### **Power washer**

When using a power washer for cleaning the vehicle always observe manufacturers’ operating instructions.

Note:

Vehicles with KEYLESS-GO:

If a door handle is hit by a strong jet of water, and a KEYLESS-GO-card is in close proximity, approx. 3 ft. (approx. 1m), the vehicle could be inadvertently locked or unlocked.

### **Caution!**

Never use a round nozzle to power wash tires. The intense jet of water can result in damage to the tire.

Always replace a damaged tire.

Always keep the jet of water moving across the surface. Do not aim directly at electrical parts, electrical connectors, seals, or other rubber parts.

## Cleaning and care of the vehicle

376

**Tar stains**

Quickly remove tar stains before they dry and become more difficult to remove. A tar remover is recommended.

**Paintwork, painted body components**

Mercedes-Benz approved Paint Care should be applied when water drops on the paint surface do not “bead up”, normally in 3 to 5 months, depending on climate and washing detergent used.

Mercedes-Benz approved Paint Cleaner should be applied if paint surface shows signs of dirt embedding (i.e. loss of gloss).

Do not apply any of these products or wax if your vehicle is parked in the sun or if the hood is still hot.

Use the appropriate MB-Touch-Up Stick for quick and provisional repairs of minor paint damage (i.e. chips from stones, vehicle doors etc.).

**Engine cleaning**

Prior to cleaning the engine compartment make sure to protect electrical components and connectors from the intrusion of water and cleaning agents.

Corrosion protection, such as MB Anticorrosion Wax should be applied to the engine compartment after every engine cleaning. Before applying, all control linkage bushings and joints should be lubricated. The poly-V-belt and all pulleys should be protected from any wax.

**Vehicle washing**

Do not use hot water or wash your vehicle in direct sunlight. Use only a mild car wash detergent, such as Mercedes-Benz approved Car Shampoo.

Thoroughly spray the vehicle with a diffused jet of water. Direct only a very weak spray towards the ventilation intake. Use plenty of water and rinse the sponge and chamois frequently.

Rinse with clear water and thoroughly wipe dry with a chamois. Do not allow cleaning agents to dry on the finish.

Due to the width of the vehicle, prior to running the vehicle through an automatic car wash, fold back the outside mirrors to prevent them from getting damaged.

In the winter, thoroughly remove all traces of road salt as soon as possible.

When washing the underbody, do not forget to clean the inner sides of the wheels.

Note:

Vehicles with KEYLESS-GO:

If a door handle is hit by a strong jet of water, and a KEYLESS-GO-card is in close proximity, approx. 3 ft. (approx. 1m), the vehicle could be inadvertently locked or unlocked.

### **Ornamental moldings**

For regular cleaning and care of very dirty chrome-plated parts, use a chrome cleaner.

### **Headlamps, taillamps, turn signal lenses**

Use a mild car wash detergent, such as Mercedes-Benz approved Car Shampoo, with plenty of water.

To prevent scratches, never apply strong force and use only a soft, non-scratchy cloth when cleaning the lenses. Do not attempt to wipe dirty lenses with a dry cloth or sponge.

## Cleaning and care of the vehicle

378

## Cleaning the DISTRONIC system sensor

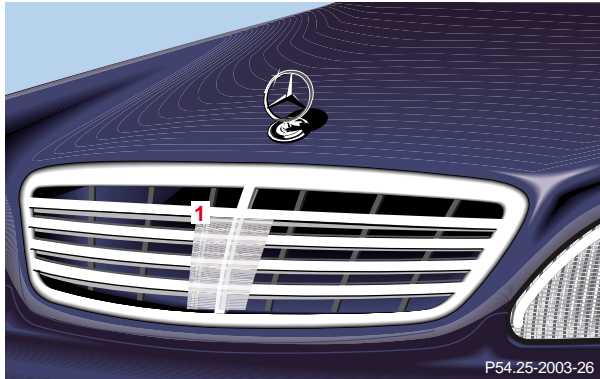

Use a mild car wash detergent, such as Mercedes-Benz approved Car Shampoo, with plenty of water to clean the sensor (1).

To prevent scratches, never apply strong force and only use a soft non-scratchy cloth when cleaning the sensors. Do not attempt to wipe dirty sensors with a dry cloth or sponge.

Note:

Restart the engine after cleaning the sensor (1).

## Cleaning the parktronic system sensors



Use a mild car wash detergent, such as Mercedes-Benz approved Car Shampoo, with plenty of water.

When using a steam cleaner or power washer, aim nozzle only briefly from a minimum distance of 4 in. (10 cm) at sensors (1).

To prevent scratches, never apply strong force and use only a soft, non-scratchy cloth when cleaning the sensors. Do not attempt to wipe dirty sensors with a dry cloth or sponge.

## Wiper blades



To prevent damage to the hood or the wipers, the wiper arms should only be folded forward while in the position shown above.

- Turn electronic key in starter switch to position 1.
- Turn combination switch to position I, see page 161.
- Once the wiper arms are in the position shown above, turn electronic key in starter switch to position 0.

Note:

For safety reasons, remove electronic key from starter switch before cleaning the wiper blades, otherwise the wiper motor can suddenly turn on and cause injury.

- Turn combination switch to position 0, see page 161.

Clean the wiper blade rubber with a clean cloth and detergent solution.

## Cleaning and care of the vehicle

380

**Window cleaning**

Use a window cleaning solution on all glass surfaces. An automotive glass cleaner is recommended.

**Note:**

For safety reasons, switch off wipers and remove electronic key from starter switch before cleaning the windshield, otherwise the wiper motor can suddenly turn on and cause injury.

**Light alloy wheels**

Mercedes-Benz approved Wheel Care should be used for regular cleaning of the light alloy wheels.

If possible, clean wheels once a week with Mercedes-Benz approved Wheel Care, using a soft bristle brush and a strong spray of water.

Follow instructions on container.

**Note:**

Use only acid-free cleaning materials. The acid could lead to corrosion.

**Instrument cluster**

Use a gentle dishwashing detergent or mild detergent for delicate fabrics as a washing solution. Wipe with a cloth moistened in lukewarm solution. Do not use scouring agents.

**Steering wheel and gear selector lever**

Wipe with a damp cloth and dry thoroughly or clean with Mercedes-Benz approved Leather Care.

**Cup holder**

Use a gentle dishwashing detergent or mild detergent for delicate fabrics as a washing solution. Wipe with a cloth moistened in lukewarm solution. Do not use scouring agents.

### Seat belts

The webbing must not be treated with chemical cleaning agents. Use only clear, lukewarm water and soap. Do not dry the webbing at temperatures above 176°F (80°C) or in direct sunlight.

#### Warning!

**Do not bleach or dye seat belts as this may severely weaken them. In a crash they may not be able to provide adequate protection.**

### Headliner and shelf below rear window

Clean with soft bristle brush, or use a dry-shampoo cleaner in case of excessive dirt.

### Leather upholstery

Using aftermarket seat covers or wearing clothing that have the tendency to give off coloring (e.g. when wet etc.) may cause the upholstery to become permanently discolored. By lining the seats with a proper intermediate cover, contact-discoloration will be prevented.

Wipe leather upholstery with a damp cloth and dry thoroughly or clean with Mercedes-Benz approved Leather Care. Exercise particular care when cleaning perforated leather as its underside should not become wet.

### Hard plastic trim items

Pour Mercedes-Benz approved Interior Care onto soft lint-free cloth and apply with light pressure.

### Plastic and rubber parts

Do not use oil or wax on these parts.





## Technical data

Spare parts service .....	384
Warranty coverage .....	384
Identification labels .....	385
Layout of poly-V-belt drive .....	387
Technical data .....	388
Fuels, coolants, lubricants etc. - capacities .....	394

Engine oils .....	396
Engine oil additives .....	396
Air conditioner refrigerant .....	396
Brake fluid .....	396
Premium unleaded gasoline .....	397
Fuel requirements .....	397
Gasoline additives .....	398
Coolants .....	398
Consumer information .....	400

Instruments and controls	Operation	Driving	Instrument cluster display	Practical hints	Car care	Technical data	Index
--------------------------	-----------	---------	----------------------------	-----------------	----------	----------------	-------

## Technical data

384

### Spare parts service

All authorized Mercedes-Benz Centers maintain a stock of original spare parts required for maintenance and repair work. In addition, strategically located parts distribution centers provide quick and reliable parts service.

More than 300 000 different spare parts, for Mercedes-Benz models, are available.

Mercedes-Benz original spare parts are subjected to stringent quality inspections. Each part has been specifically developed, manufactured or selected for and adapted to Mercedes-Benz vehicles.

Therefore, Mercedes-Benz original spare parts should be installed.

### Important!

The use of non-genuine parts and accessories not authorized by Mercedes-Benz could damage the vehicle which damage is not covered by the Mercedes-Benz Limited Warranty or compromise its durability or safety.

### Warranty coverage

Your vehicle is covered under the terms of the “warranties” printed in the Service and Warranty Information booklet and your authorized Mercedes-Benz Center will exchange or repair any defective parts originally installed on the vehicle in accordance with the terms of the following warranties:

1. New vehicle limited warranty
2. Emission system warranty
3. Emission performance warranty
4. California, Massachusetts, and Vermont emission control systems warranty

Replacement parts and accessories are covered by the Mercedes-Benz Spare Parts and Accessories warranties, copies of which are available at any Mercedes-Benz Center.

### Loss of Service and Warranty Information Booklet

Should you lose your Service and Warranty Information booklet, have your authorized Mercedes-Benz Center arrange for a replacement. It will be mailed to you.

## Identification labels



**1** Certification label  
(below driver's door lock latch)

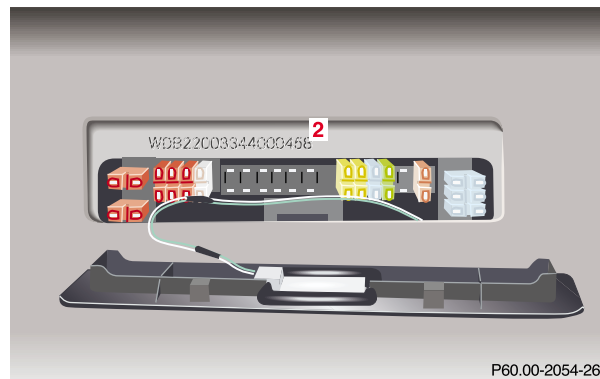

**2** Vehicle Identification Number (VIN)  
(below right rear passenger seat)

## Technical data

386

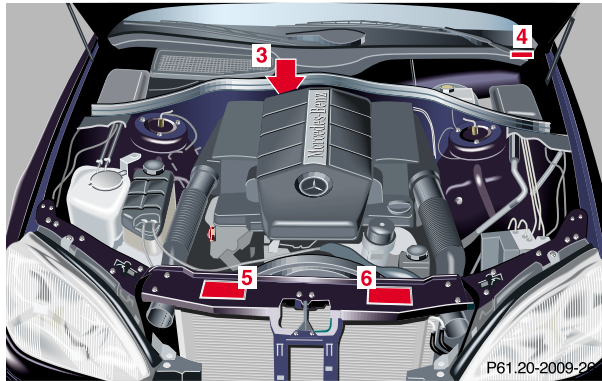

- 3 Engine number
- 4 VIN, visible (lower edge of windshield)
- 5 Emission control label
- 6 Information label, California version  
Vacuum line routing for emission control system

When ordering spare parts, please specify vehicle identification and engine numbers.

### Layout of poly-V-belt drive

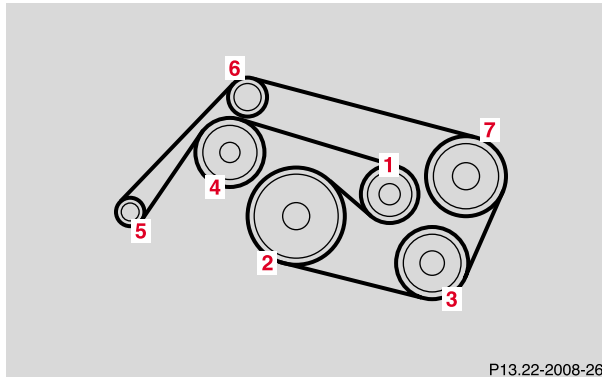

P13.22-2008-26

S 430, S 500, S 55 AMG

- 1 Automatic belt tensioner
- 2 Crankshaft
- 3 Air conditioner compressor
- 4 Coolant pump

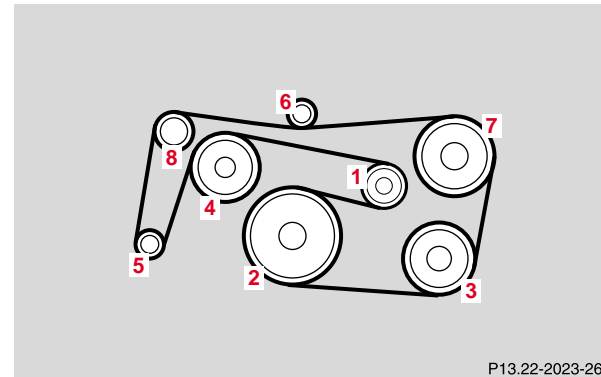

P13.22-2023-26

S 600

- 5 Generator (alternator)
- 6 Idler pulley
- 7 Power steering pump
- 8 Idler pulley (S 600 only)

Technical data

387

Instruments and controls	Operation	Driving	Instrument cluster display	Practical hints	Car care	Technical data	Index
--------------------------	-----------	---------	----------------------------	-----------------	----------	----------------	-------

Instruments and controls	Operation	Driving	Instrument cluster display	Practical hints	Car care	Technical data	Index
--------------------------	-----------	---------	----------------------------	-----------------	----------	----------------	-------

Technical data

388

**Technical data**

<b>Model</b>	<b>S 430</b> (220.070 <sup>1</sup> ) <b>S 430</b> (220.170 <sup>1</sup> )	<b>S 500</b> (220.175 <sup>1</sup> )
<b>Engine</b>	113	113
Mode of operation	4-stroke engine, gasoline injection	4-stroke engine, gasoline injection
No. of cylinders	8	8
Bore	3.54 in (89.90mm)	3.82 in (97.00 mm)
Stroke	3.31 in (84.00 mm)	3.31 in (84.00 mm)
Total piston displacement	260.3 cu. in. (4266 cm <sup>3</sup> )	303.5 cu.in. (4966 cm <sup>3</sup> )
Compression ratio	10:1	10:1
Output acc. to SAE J 1349	275 hp/5750 rpm (205 kW/5750 rpm)	302 hp/5600 rpm (225 kW/5600 rpm)
Maximum torque acc. to SAE J 1349	295 ft-lb (400 Nm) at 3000 rpm	339 ft-lb (460 Nm) at 2700 rpm
Maximum engine speed	6000 rpm	6000 rpm
Firing order	1-5-4-2-6-3-7-8	1-5-4-2-6-3-7-8
Poly-V-belt	2390 mm	2390 mm

<sup>1</sup> The quoted data apply only to the standard vehicle. See an authorized Mercedes-Benz Center for the corresponding data of all special bodies and special equipment.

<b>Model</b>	<b>S 55 AMG (220.175)</b>	<b>S 600 (220.178<sup>1</sup>)</b>
<b>Engine</b>	113	137
Mode of operation	4-stroke engine, gasoline injection	4-stroke engine, gasoline injection
No. of cylinders	8	12
Bore	3.82 in (97.00 mm)	3.31 in (84.00 mm)
Stroke	3.60 in (92.00 mm)	3.43 in (87.00 mm)
Total piston displacement	335.6 cu.in. (5499 cm <sup>3</sup> )	353.6 cu.in. (5786 cm <sup>3</sup> )
Compression ratio	10.5:1	10:1
Output acc. to SAE J 1349	349 hp/5500 rpm (260 kW/5500 rpm)	362 hp/5500 rpm (270 kW/5500 rpm)
Maximum torque acc. to SAE J 1349	391 ft.lb/3000 rpm (530 Nm/3000 rpm)	391 ft.lb/4100 rpm (530 Nm/4100 rpm)
Maximum engine speed	6000 rpm	6000 rpm
Firing order	1-5-4-2-6-3-7-8	1-12-5-8-3-10-6-7-2-11-4-9
Poly-V-belt	2390 mm	2345 mm

<sup>1</sup> The quoted data apply only to the standard vehicle. See an authorized Mercedes-Benz Center for the corresponding data of all special bodies and special equipment.



Instruments and controls	Operation	Driving	Instrument cluster display	Practical hints	Car care	Technical data	Index
--------------------------	-----------	---------	----------------------------	-----------------	----------	----------------	-------

Technical data

390

**Rims – Tires**

**Model**

**S 430, S 500  
(except Sport Package)**

**S 600  
(except Sport Package)**

Rims (light alloy)  
Wheel offset:

7½ J x 16 H 2  
1.81 in (46 mm)

7½ J x 17 H 2  
1.81 in (46 mm)

All season tires:  
Radial-ply tires

225/60 R16 98H

225/55 R 17 97H

Winter tires:  
Radial-ply tires

225/60 R16 98H M+S

225/55 R17 97H M+S

**Spare wheel**

Rim (light alloy)  
Wheel offset:

7½ J x 16 H 2  
2.0 in (51 mm)

7½ J x 17 H 2  
2.0 in (51 mm)

All season tires:  
Radial-ply tires

225/60 R16 98H

225/55 R17 97H

<b>Model</b>	<b>S 430, S 500 (Sport Package)</b>	<b>S 55 AMG S 600 (Sport Package)</b>
Rims front axle (AMG light alloy)	8 <sup>1</sup> / <sub>2</sub> J x 18 H 2	8 <sup>1</sup> / <sub>2</sub> J x 18 H 2
Wheel offset	1.73 in (44 mm)	1.73 in (44 mm)
Rims rear axle (AMG light alloy)	9 <sup>1</sup> / <sub>2</sub> J x 18 H 2	9 <sup>1</sup> / <sub>2</sub> J x 18 H 2
Wheel offset	1.81 in (46 mm)	1.81 in (46 mm)
Radial-ply tires		
Summer tires, front axle:	245/45 R 18	245/45 R 18
Summer tires, rear axle:	275/40 R 18 <sup>1</sup>	275/40 R 18 <sup>1</sup>
<b>Spare wheel</b>		
Rim (light alloy)	7 <sup>1</sup> / <sub>2</sub> J x 16 H 2	7 <sup>1</sup> / <sub>2</sub> J x 16 H 2
Wheel offset:	2.0 in (51 mm)	2.0 in (51 mm)
All season tires:		
Radial-ply tires	225/60 R16 98H	225/55 R17 97Y

<sup>1</sup> Must not be used with snow chains.

Instruments and controls	Operation	Driving	Instrument cluster display	Practical hints	Car care	Technical data	Index
--------------------------	-----------	---------	----------------------------	-----------------	----------	----------------	-------

Technical data

392

**Rims – Winter tires**

<b>Model</b>	<b>S 55 AMG</b>
Rim (light alloy)	7 <sup>1</sup> / <sub>2</sub> J x 17 H 2
Wheel offset	1.81 in (46 mm)
Winter tires:	
Radial-ply tires	225/55 R 17 97 HM+S

**Electrical system**

<b>Model</b>	<b>S 430, S 500</b>	<b>S 55 AMG</b>	<b>S 600</b>
Generator (alternator)	14 V/150 A	14 V/150 A	14 V/150 A
Starter motor	12V/1.7 kW	12V/1.7 kW	12V/2.2 kW
Battery	12V/100 Ah	12V/100 Ah	12V/100 Ah
Spark plugs	Bosch F 8 DPER Beru 14 FGH 8 DPUR X 2 NGK PFR 5 R-11	Bosch F 8 DPER	Beru 14 F 7-DPUR X 2
Electrode gap	0.039 in (1.0 mm)	0.039 in (1.0 mm)	0.041 in (1.05 mm)
Tightening torque	15 – 22 ft.lb (20 – 30 Nm)	15 – 22 ft.lb (20 – 30 Nm)	15 – 22 ft.lb (20 – 30 Nm)

### Weights

Roof load max.	220 lb (100 kg)
Trunk load max.	220 lb (100 kg)

### Main dimensions

Model	S 430 (220.070)	S 430 (220.170), S 500 (220.175)	S 55 AMG (220.173)	S 600 (220.178)
Overall vehicle length	198.3 in (5038 mm)	203.1 in (5158 mm)	203.1 in (5158 mm)	203.1 in (5158 mm)
Overall vehicle width	73.0 in (1855 mm)	73.0 in (1855 mm)	73.0 in (1855 mm)	73.0 in (1855 mm)
Overall vehicle height	56.9 in (1444 mm)	56.9 in (1444 mm)	56.9 in (1444 mm)	56.9 in (1444 mm)
Wheel base	116.7 in (2965 mm)	121.5 in (3085 mm)	121.5 in (3085 mm)	121.5 in (3085 mm)
Track, front	62.0 in (1574 mm)	62.0 in (1574 mm)	62.0 in (1574 mm)	62.0 in (1574 mm)
Track, rear	62.0 in (1574 mm)	62.0 in (1574 mm)	61.8 in (1570 mm)	62.0 in (1574 mm)

Instruments and controls	Operation	Driving	Instrument cluster display	Practical hints	Car care	Technical data	Index
--------------------------	-----------	---------	----------------------------	-----------------	----------	----------------	-------

Fuels, coolants, lubricants etc. - capacities

394

**Fuels, coolants, lubricants etc. - capacities**

Vehicle components and their respective lubricants must match. Therefore use only brands tested and recommended by us. Please refer to the Factory Approved Service Products pamphlet, or inquire at your Mercedes-Benz Center.

	Model	Capacity	Fuels, coolants, lubricants etc.
Engine with oil filter	S 430, S 500	8.5 US qt (8.0 l)	Recommended engine oils
	S 55 AMG	8.0 US qt (7.5 l)	
	S 600	10.0 US qt (9.5 l)	
Automatic transmission		9.6 US qt (9.1 l)	Automatic transmission fluid
Rear axle		1.7 US qt (1.6 l)	Hypoid gear oil SAE 85 W 90
Hydraulic system for adaptive damping system (ADS) or active body control (ABC)		approx. 5.3 US qt (5.0 l)	MB Hydraulic fluid
Power steering		approx. 1.1 US qt (1.0 l)	MB Power steering fluid
Front wheel hubs		approx. 2.1 oz (60 g) each	High temperature roller bearing grease
Brake system		0.7 US qt (0.7 l)	MB Brake fluid (DOT 4+)
Cooling system	S 430, S 500	approx. 12.1 US qt (11.5 l)	MB Anticorrosion/antifreeze
	S 55 AMG	approx. 12.1 US qt (11.5 l)	
	S 600	approx. 12.7 US qt (12.0 l)	

	<b>Model</b>	<b>Capacity</b>	<b>Fuels, coolants, lubricants etc.</b>
Fuel tank including a reserve of		23.2 US gal (88.0 l) 2.9 US gal (11.0 l)	Premium unleaded gasoline: Posted Octane 91 (Avg. of 96 RON/86 MON)
Air conditioner system			R-134a refrigerant and special PAG lubricant
Windshield washer and headlamp cleaning system		7.1 US qt (6.7 l)	MB Windshield washer concentrate <sup>1</sup>

<sup>1</sup> Use MB Windshield Washer Concentrate “S” and water for temperatures above freezing or MB Windshield Washer Concentrate “S” and commercially available premixed windshield washer solvent/antifreeze for temperatures below freezing. Follow suggested mixing ratios, see page 337.

Instruments and controls	Operation	Driving	Instrument cluster display	Practical hints	Car care	Technical data	Index
--------------------------	-----------	---------	----------------------------	-----------------	----------	----------------	-------

Fuels, coolants, lubricants etc. - capacities

**Engine oils**

Engine oils are specifically tested for their suitability in our engines. Therefore, use only engine oils recommended by Mercedes-Benz. Information on recommended brands is available at your authorized Mercedes-Benz Center.

Please follow Service Booklet recommendations for scheduled oil changes. Failure to do so could result in engine damage not covered by the Mercedes-Benz Limited Warranty.

**Engine oil additives**

Do not blend oil additives with engine oil. They may be harmful to the engine operation.

Damage or malfunctions resulting from blending oil additives are not covered by the Mercedes-Benz Limited Warranty.

**Air conditioner refrigerant**

R-134a (HFC) refrigerant and special PAG lubricating oil is used in the air conditioner system.

Never use R-12 (CFC) or mineral-based lubricating oil, otherwise damage to the system will occur.

**Brake fluid**

During vehicle operation, the boiling point of the brake fluid is continuously reduced through the absorption of moisture from the atmosphere. Under extremely hard operating conditions, this moisture content can lead to the formation of bubbles in the system thus reducing the system's efficiency.

The brake fluid must therefore be replaced every two years, preferably in the spring.

It is recommended to use only brake fluid approved by Mercedes-Benz. Your authorized Mercedes-Benz Center will provide you with additional information.

### Premium unleaded gasoline

#### Caution!

To maintain the engine's durability and performance, premium unleaded gasoline must be used. If premium unleaded is not available and low octane fuel is used, follow these precautions:

- have the fuel tank filled only partially with unleaded regular and fill up with premium unleaded as soon as possible,
- avoid full throttle driving and abrupt acceleration,
- do not exceed an engine speed of 3000 rpm, if the vehicle is loaded with a light load such as two persons and no luggage,
- do not exceed  $\frac{2}{3}$  of maximum accelerator pedal position, if the vehicle is fully loaded or operating in mountainous terrain.

### Fuel requirements

Use only Premium unleaded meeting ASTM standard D 439:

The octane number (posted at the pump) must be 91 min. It is an average of both the Research (R) octane number and the Motor (M) octane number:  $(R+M)/2$ . This is also known as ANTI-KNOCK INDEX.

Unleaded gasoline containing oxygenates such as Ethanol, IPA, IBA and TBA can be used provided the ratio of any one of these oxygenates to gasoline does not exceed 10%, MTBE not to exceed 15%.

The ratio of Methanol to gasoline must not exceed 3% plus additional cosolvents.

Using mixtures of Ethanol and Methanol is not allowed. Gasohol, which contains 10% Ethanol and 90% unleaded gasoline, can be used.

These blends must also meet all other fuel requirements such as resistance to spark knock, boiling range, vapor pressure etc..



Instruments and controls	Operation	Driving	Instrument cluster display	Practical hints	Car care	Technical data	Index
--------------------------	-----------	---------	----------------------------	-----------------	----------	----------------	-------

## Fuels, coolants, lubricants etc. - capacities

398

### Gasoline additives

A major concern among engine manufacturers is carbon build up caused by gasoline. Mercedes-Benz recommends the use of only quality gasoline containing additives that prevent the build up of carbon deposits.

After an extended period of using fuels without such additives, carbon deposits can build up especially on the intake valves and in the combustion area, leading to engine performance problems such as:

- warm-up hesitation,
- unstable idle,
- knocking/pinging,
- misfire,
- power loss.

Do not blend other specific fuel additives with fuel. They only result in unnecessary cost, and may be harmful to the engine operation.

Damage or malfunctions resulting from poor fuel quality or from blending specific fuel additives are not covered by the Mercedes-Benz Limited Warranty.

### Coolants

The engine coolant is a mixture of water and anticorrosion/antifreeze, which provides:

- corrosion protection,
- freeze protection,
- boiling protection (by increasing the boiling point).

The cooling system was filled at the factory with a coolant providing freeze protection to approximately -22°F (-30°C) and corrosion protection.

If the antifreeze mixture is effective to -22°F (-30°C), the boiling point of the coolant in the pressurized cooling system is reached at approximately 266°F (130°C).

The coolant solution must be used year round to provide the necessary corrosion protection and increase in the boil-over protection. You should have it replaced every 3 years.

To provide the important corrosion protection, the solution must be at least 45% anticorrosion/antifreeze (equals a freeze protection to approx. -22 °F [-30 °C]). If you use a solution that is more than 55% anticorrosion/antifreeze (freeze protection to approx. -49 °F [-45°C]),

the engine temperature will increase due to the lower heat transfer capability of the solution. Therefore, do not use more than this amount of anticorrosion/antifreeze.

If the coolant level is low, water and MB anticorrosion/antifreeze should be used to bring it up to the proper level (have cooling system checked for signs of leakage).

The water in the cooling system must meet minimum requirements, which are usually satisfied by normal drinking water. If you are not sure about the water quality, consult your authorized Mercedes-Benz Center.

#### Anticorrosion/antifreeze

Your vehicle contains a number of aluminium parts. The use of aluminium components in motor vehicle engines necessitates that anticorrosion/antifreeze coolant used in such engines be specifically formulated to protect the aluminium parts. (Failure to use such anticorrosion/antifreeze coolant will result in a significantly shortened service life.)

Therefore the following product is strongly recommended for use in your vehicle: Mercedes-Benz anticorrosion/antifreeze agent.

Before the start of the winter season (or once a year in the hot southern regions), you should have the anticorrosion/antifreeze concentration checked. The coolant is also regularly checked each time you bring your vehicle to your authorized Mercedes-Benz Center for service.

#### Anticorrosion/antifreeze quantity

Model	Approx. freeze protection	
	- 35°F (- 37°C)	- 49°F (- 45°C)
S 430, S 500, S 55 AMG	6.1 US qt (5.75 l)	6.7 US qt (6.3 l)
S 600	6.3 US qt (6.0 l)	7.0 US qt (6.6 l)

Instruments and controls	Operation	Driving	Instrument cluster display	Practical hints	Car care	Technical data	Index
--------------------------	-----------	---------	----------------------------	-----------------	----------	----------------	-------

Consumer information

**Consumer information**

This has been prepared as required of all manufactures of passenger cars under Title 49, Code of U.S. Federal Regulations, Part 575 pursuant to the “National Traffic and Motor Vehicle Safety Act of 1966”.

**Uniform tire quality grading**

Quality grades can be found where applicable on the tire sidewall between tread shoulder and maximum section width. For example:

Tread wear 200    Traction AA    Temperature A

All passenger car tires must conform to federal safety requirements in addition to these grades.

**Treadwear**

The treadwear grade is a comparative rating based on the wear rate of the tire when tested under controlled conditions on a specified government test course. For example, a tire graded 150 would wear one and one-half (1 1/2) times as well on the government course as a tire graded 100. The relative performance of tires depends upon the actual conditions of their use, however, and

may depart significantly from the norm due to variations in driving habits, service practices and differences in road characteristics and climate.

**Traction**

The traction grades, from highest to lowest are AA, A, B, and C. Those grades represent the tire’s ability to stop on wet pavement as measured under controlled conditions on specified government test surfaces of asphalt and concrete. A tire marked C may have poor traction performance.

**Warning!**

**The traction grade assigned to this tire is based on straightahead braking traction tests, and does not include acceleration, cornering, hydroplaning, or peak traction characteristics.**

## Temperature

The temperature grades are A (the highest), B, and C, representing the tire's resistance to the generation of heat and its ability to dissipate heat when tested under controlled conditions on a specified indoor laboratory test wheel. Sustained high temperature can cause the material of the tire to degenerate and reduce tire life, and excessive temperature can lead to sudden tire failure. The grade corresponds to a level of performance which all passenger car tires must meet under the Federal Motor Vehicle Safety Standard No. 109. Grades B and A represent higher levels of performance on the laboratory test wheel than the minimum required by law.

## Warning!

**The temperature grade for this tire is established for a tire that is properly inflated and not overloaded. Excessive speed, underinflation, or excessive loading, either separately or in combination, can cause excessive heat build up and possible tire failure.**

Instruments and controls	Operation	Driving	Instrument cluster display	Practical hints	Car care	Technical data	Index
--------------------------	-----------	---------	----------------------------	-----------------	----------	----------------	-------

**Index**

**A**

ABS (Antilock brake system) .....	272
Malfunction indicator lamp .....	300
Active body control (ABC) .....	278
Fluid level .....	335
ACTIVE BODY CONTROL (ABC) - malfunction and warning messages .....	314
Adaptive damping system (ADS) .....	283
Adjusting steering wheel .....	105
Air conditioner refrigerant .....	396
Air distribution, manual .....	169
AIR SPRING (AirMatic) - malfunction and warning messages .....	325
Air volume, manual .....	169
Airbag deactivation system .....	91
AIRBAG OFF indicator lamp .....	302
Airbags .....	94
Airmatic system .....	279
Airmatic system (Vehicles with Active Body Control) .....	280
Alarm system .....	62, 64
Anticorrosion/antifreeze .....	251, 336, 394, 398
Antilock brake system (ABS) .....	272
Malfunction indicator lamp .....	300
Antitheft alarm system .....	62
Aquaplaning .....	248
Armrest, rear seat .....	198
Ashtrays .....	201
Center console .....	201
Rear doors .....	202
Audio systems .....	125
Cassette player .....	127
CD Player .....	126
Radio .....	125
Automatic central locking .....	52
Automatic climate control .....	164
Activated charcoal filter .....	172
Adjustable air outlets, rear passenger compartment .....	176
Air distribution, manual .....	169
Air volume, manual .....	169
Basic setting .....	168
Defogging windows .....	170, 171
Defrosting .....	170
Display and controls .....	166
Dust filter .....	167
Economy mode .....	173

Front center console storage compartment ventilation .....	175
Rear window defroster .....	180
Residual engine heat utilization (REST) .....	174
Special settings .....	169
Switching on and off .....	175
Automatic climate control, rear	
Air volume, manual .....	178
Basic setting .....	178
Automatic transmission .....	233
Emergency operation .....	241
Fluid level .....	335
Program mode selector switch .....	240
Selector lever position .....	236

## B

BabySmart™ airbag deactivation system .....	91
Self-test .....	91
BAS (Brake assist system) .....	271
Battery .....	349
Battery recycling .....	350
BATTERY / ALTERNATOR - malfunction and warning messages .....	305
Block heater .....	251

BRAKE ASSIST - malfunction and warning messages .....	306
Brake assist system (BAS) .....	271
Brake fluid .....	244, 293, 298, 394, 396
BRAKE FLUID - malfunction and warning messages .....	307
BRAKE LINING WEAR - malfunction and warning messages .....	307
Brake pad wear .....	307
Brake warning lamp .....	298
Brake fluid low .....	298
Brakes .....	242, 244, 271, 272, 274

## C

Capacities	
Fuels, coolants, lubricants etc. ....	394
Card, KEYLESS-GO .....	28
Catalytic converter .....	224
Center console .....	24
Center console lighting .....	189
Central locking switch .....	50
Central locking system .....	34
Automatic central locking .....	52
Choosing global or selective mode .....	37, 43
Electronic main key .....	29

Instruments and controls	Operation	Driving	Instrument cluster display	Practical hints	Car care	Technical data	Index
--------------------------	-----------	---------	----------------------------	-----------------	----------	----------------	-------

Index

404

Electronic reserve key .....	30	Consumer information .....	400
KEYLESS-GO-card .....	31	Control and operation	
Locking and unlocking .....	36	of radio transmitters .....	212
Locking and unlocking		COOLANT (coolant level) -	
with KEYLESS-GO-card .....	40	malfunction and warning messages .....	310
Mechanical keys .....	30, 47	COOLANT (coolant temperature) -	
Remote control .....	28, 34	malfunction and warning messages .....	311
Simultaneous use of		Coolant level	
electronic main key		Adding .....	336
and KEYLESS-GO-card .....	44	Checking .....	336
Summer opening/convenience feature .....	45	Coolant temperature gauge .....	117
Changing batteries in the		Coolants .....	398
KEYLESS-GO-card .....	366	Anticorrosion/antifreeze quantity .....	399
Changing wheels .....	343	Courtesy lighting .....	189
CHECK ENGINE		Cruise control .....	253
malfunction indicator lamp .....	296	CRUISE CONTROL -	
Check regularly and before a long trip .....	293	malfunction and warning messages .....	319
Checking engine oil level		Cup holder	
Via engine oil level indicator .....	154	In front seat armrest .....	199
Via oil dipstick .....	334	In rear seat armrest .....	200
Child restraint .....	84, 91, 102, 104		
CHIP-CARD (KEYLESS-GO) -		<b>D</b>	
malfunction and warning messages .....	322	Dashboard .....	22
Cleaning and care of the vehicle .....	374	Daytime running lamp .....	158
COMAND, radio and telephone .....	212		
Combination switch .....	160		

Deep water	
Driving instructions .....	252
DISPLAY DEFECTIVE (engine control unit) -	
malfunction and warning messages .....	304
DISPLAY DEFECTIVE (several systems) -	
malfunction and warning messages .....	304
Display illumination .....	116
Distronic (DTR) .....	134, 256
Activation of DISTRONIC .....	259
Additional driving hints .....	264
Cleaning sensor .....	378
Deactivation of DISTRONIC .....	261
Displays in the speedometer dial .....	270
Distance warning function .....	267
DISTRONIC settings .....	268
Driving with DISTRONIC activated .....	262
Invalid attempts to activate .....	260
Multifunction display .....	269
Warning lamp .....	301
DISTRONIC (DTR) -	
malfunction and warning messages .....	326
DOOR -	
malfunction and warning messages .....	320
Door control panel .....	20
Door entry lamps .....	189
Doors	
Power closing assist .....	50
Drinking and driving .....	243
Drive sensibly - Save Fuel .....	243
Driving instructions .....	243
Driving off .....	245
<b>E</b>	
Easy-entry/exit feature .....	66
ELEC. STABIL. PROG. -	
malfunction and warning messages .....	309
Electronic main key .....	29
Changing batteries .....	363
Synchronizing remote control .....	365
Electronic stability program (ESP) .....	274
ESP control switch .....	276
Malfunction and warning messages .....	309
Synchronizing .....	275
Warning lamp .....	301
Emergency call	
See Tele Aid .....	214
Emergency engine shut-down .....	368
Emergency operation of	
sliding/pop-up roof .....	369



<b>Instruments and controls</b>	<b>Operation</b>	<b>Driving</b>	<b>Instrument cluster display</b>	<b>Practical hints</b>	<b>Car care</b>	<b>Technical data</b>	<b>Index</b>
---------------------------------	------------------	----------------	-----------------------------------	------------------------	-----------------	-----------------------	--------------

Index

Emergency tensioning retractor (ETR) .....	93	Warning lamp .....	301
SRS indicator lamp .....	299	ETR (Emergency tensioning retractor) .....	93
Emergency trunk lid release button .....	61	SRS indicator lamp .....	299
Emergency unlocking in case of accident .....	52	Exterior lamp	
Emission control .....	225	malfunction and warning messages .....	312
Emission control label .....	386	Exterior lamp switch .....	156
Engine compartment .....	331	Daytime running lamp mode .....	158
Engine malfunction		Headlamp cleaning system .....	159
CHECK ENGINE		Exterior lamps .....	356
malfunction indicator lamp .....	296	Fog lamps .....	359, 360
Engine oil additives .....	396	Headlamp assembly .....	357
Engine oil consumption .....	155	High mounted stop lamp .....	361
Engine oil level		License plate lamps .....	361
Checking .....	154, 334	Low and high beam .....	358
Warning .....	318	Parking lamps .....	359, 360
ENGINE OIL LEVEL -		Replacing bulbs .....	356
malfunction and warning messages .....	318	Side marker lamps .....	360
Engine oil level indicator .....	154	Standby bulb function .....	362
Engine oils .....	396	Standing lamps .....	359, 360
Entrance lamps, exit lamps .....	189	Stop lamp .....	361
ENTRANCE POSITION -		Taillamp assemblies .....	360
malfunction and warning messages .....	306	Turn signal lamps .....	358, 360, 361
ESP (Electronic stability program) .....	274	Exterior mirror adjustment .....	107
ESP control switch .....	276	Exterior mirror, front passenger side,	
Malfunction and warning messages .....	309	parking position .....	108
Synchronizing .....	275		

Exterior rear view mirrors	
Electrically folding .....	109
Parking position .....	108

## F

First aid kit .....	328
Flexible service system (FSS) .....	147
Footwell lighting .....	189
Front airbags .....	94
Front center console storage	
compartment ventilation .....	175
Front seat adjustment .....	67
Fuel	
Gasoline additives .....	398
Premium unleaded gasoline .....	291, 395, 397
Fuel cap placement warning	
See CHECK ENGINE	
malfunction indicator lamp .....	296
Fuel filler flap, manual release .....	368
Fuel requirements .....	397
Fuel reserve warning .....	299
Fuels, coolants, lubricants etc. - capacities .....	394
Fuses, electrical .....	329

## G

Garage door opener .....	206
Gasoline	
Additives .....	398
Fuel requirements .....	397
Premium unleaded .....	397
General notes on the	
central locking system .....	33
Glove box .....	194

## H

Hazard warning flasher switch .....	163
Head restraints, front seats	
Removal and installation .....	72
Head restraints, rear seat .....	80
Power head restraints .....	81
Headlamp cleaning system .....	159
Headlamp mode (HEADLAMPS) .....	157
Headlights .....	156
Heated seats .....	75
Hood .....	331
HOOD -	
malfunction and warning messages .....	320

**I**

- Identification labels .....385
- Illuminated vanity mirrors ..... 192
- Individual settings ..... 138
  - "INSTRUMENT CLUSTER" ..... 140
  - "LIGHTING" ..... 142
  - "VEHICLE" ..... 144
- Infant and child restraint systems ..... 102
  - Installation ..... 104
- Information call
  - See Tele Aid ..... 214
- Infrared reflecting windshield ..... 210
- Inside rear view mirror ..... 106
- Instrument cluster ..... 114
  - Activating ..... 116
  - Illumination ..... 116
  - Indicator lamps ..... 114, 296
- Instruments and controls ..... 18
- Interior
  - General notes ..... 193
- Interior lighting ..... 187
  - Rear reading lamp ..... 188

**J**

- Jack ..... 339
- Jump starting ..... 351

**K**

- KEY -
  - malfunction and warning messages ..... 319
- KEYLESS-GO ..... 38
  - Changing batteries ..... 366
  - Checking last KEYLESS-GO-card
    - locking mode ..... 43
    - Choosing global or selective mode ..... 43
- KEYLESS-GO-card ..... 28, 31
- Keys, vehicle ..... 28

**L**

- Lamps, exterior
  - Fog lamps ..... 156, 359, 360
  - Headlamps ..... 156, 312, 357, 377
  - License plate lamps ..... 361
  - Parking lamps ..... 156, 359, 360
  - Replacing bulbs ..... 356

Standing lamps .....	156, 359, 360
Stop lamps .....	361
Taillamps .....	156, 312, 360, 377
Turn signal lamps .....	358, 360, 361
Level control system	
Vehicles with Active Body Control (ABC) .....	280
Vehicles with Airmatic system .....	279
LIGHT SENSOR - malfunction and warning messages .....	314
Lighter .....	203
LIGHTING SYSTEM - malfunction and warning messages .....	312
Limp home mode (Automatic transmission) .....	241
Locking and unlocking .....	36, 40
Lumbar support .....	73

## M

Maintenance .....	213
Malfunction and indicator lamps	
In the center console .....	302
In the instrument cluster .....	296
Malfunction and warning message memory .....	136
Malfunction and warning messages	

ACTIVE BODY CONTROL (ABC) .....	314
AIR SPRING (AirMatic) .....	325
BATTERY/ALTERNATOR .....	305
BRAKE ASSIST .....	306
BRAKE FLUID .....	307
BRAKE LINING WEAR .....	307
CHIP-CARD (KEYLESS-GO) .....	322
COOLANT (coolant level) .....	310
COOLANT (coolant temperature) .....	311
CRUISE CONTROL .....	319
DISPLAY DEFECTIVE (engine control unit) .....	304
DISPLAY DEFECTIVE (several systems) .....	304
DISTRONIC (DTR) .....	326
DOOR .....	320
ELEC. STABIL. PROG. .....	309
ENGINE OIL LEVEL .....	318
ENTRANCE POSITION .....	306
HOOD .....	320
KEY .....	319
LIGHT SENSOR .....	314
LIGHTING SYSTEM .....	312
OIL TEMP. (engine oil temperature) .....	321
PARKING BRAKE .....	308
SELECTOR LEVER .....	323

Instruments and controls	Operation	Driving	Instrument cluster display	Practical hints	Car care	Technical data	Index
--------------------------	-----------	---------	----------------------------	-----------------	----------	----------------	-------

Index

410

TELE AID .....	321
TELEPHONE – FUNCTION .....	323
TIRE PRESSURE .....	316
TRUNK OPEN .....	308
WASHER FLUID .....	324
Manual operation of sliding/pop-up roof .....	369
Manual release for fuel filler flap .....	368
Mechanical keys .....	47
Memory .....	105, 106, 107, 111
Recalling .....	112
Storing .....	112
Mirror, exterior	
Adjusting .....	107
Parking position .....	108
Mirror, exterior, rear view .....	107
Mirror, inside, rear view .....	106
Multicontour backrest .....	73
Multifunction display .....	120
Audio systems .....	125
Cassette player .....	127
CD player .....	126
Distronic (DTR) .....	134
Engine oil level indicator .....	124
FSS .....	124
Individual settings .....	138
Malfunction/warning message memory .....	136

Navigation system .....	133
Radio .....	125
Telephone .....	128
Telephone – Incoming call .....	132
Telephone – Redialing .....	130
Telephone book .....	128
Tire inflation pressure monitor .....	124
Trip and main odometer .....	124
Trip computer .....	135
Multifunction steering wheel .....	120
Setting the audio volume .....	146

N

Navigation system .....	133
Night security illumination .....	158

O

OIL TEMP. (engine oil temperature) - malfunction and warning messages .....	321
On-board diagnostic system .....	296
Operator's manual .....	8
Outside temperature indicator .....	117
Overhead control panel .....	21

## P

Panic button .....	47
Parcel net in front passenger footwell .....	204
Parcel net in trunk .....	204
Parking .....	246
Parking assist (Parktronic) .....	285
Malfunction .....	289
Parktronic switch .....	289
Sensors .....	286
Warning indicators .....	287
Parking brake .....	242, 244, 246, 275, 298
PARKING BRAKE - malfunction and warning messages .....	308
Power assistance .....	244
Power closing assist Doors and trunk lid .....	50
Power head restraints, rear .....	81
Power seats, front .....	67
Adjustment .....	67
Lumbar support .....	73
Multicontour backrest .....	73
Seat heater .....	75
Seat ventilation system .....	78
Power seats, rear .....	82
Power windows .....	181

Blocking of rear door window operation .....	183
Express opening and closing .....	182
Opening and closing .....	45
Synchronizing power windows .....	183
Problems with your vehicle .....	14
Product information .....	7

## R

Radio transmitters .....	212
Rain sensor See Intermittent wiping .....	161
Rear door window sunshade .....	191
Rear passenger compartment adjustable air outlets .....	176
Rear passenger compartment climate control .....	177
Rear view mirrors .....	106
Automatic antiglare .....	106
Exterior .....	107
Interior .....	106
Parking position .....	108
Storing mirror positions .....	106, 107
Rear window defroster .....	180
Rear window sunshade .....	190

Instruments and controls	Operation	Driving	Instrument cluster display	Practical hints	Car care	Technical data	Index
--------------------------	-----------	---------	----------------------------	-----------------	----------	----------------	-------

Index

Remote control .....	28, 34						
Battery replacement .....	363						
Removal and installation of							
front seat head restraints .....	72						
Replacing bulbs .....	356						
Replacing wiper blades .....	370						
Reporting Safety Defects .....	15						
Reserve key .....	30						
Residual engine heat utilization (REST) .....	174						
Roadside assistance .....	10						
Roadside assistance call							
See Tele Aid .....	214						
Roof rack .....	371						
<b>S</b>							
Seat belts .....	84						
Fastening .....	87						
Operation .....	88						
Seat belt nonusage warning system .....	85						
Unfastening .....	88						
Warning lamp .....	302						
Seat belts and integrated restraint system .....	84						
Seat heater .....	75						
Seat ventilation system .....	78						
Seats							
Front seat adjustment .....	67						
Lumbar support .....	73						
Multicontour backrest .....	73						
Seat heater .....	75						
Ventilation system .....	78						
SELECTOR LEVER -							
malfunction and warning messages .....	323						
Service indicator							
See Flexible service system (FSS) .....	147						
Setting the audio volume .....	146						
Side impact airbags .....	96						
Simultaneous .....	44						
Simultaneous use of							
electronic main key and							
KEYLESS-GO-card .....	44						
Sliding/pop-up roof .....	184						
Emergency operation .....	369						
Express opening .....	185						
Opening and closing .....	45						
Synchronizing .....	186						
Snow chains .....	249						
SOS-call							
See Tele Aid .....	214						
Spare parts service .....	384						
Spare wheel .....	341						

Special Settings (Automatic climate control) .....	169
SRS (Supplemental Restraint System) .....	92
Indicator lamp .....	299
SRS malfunction .....	94
Standby bulb function .....	362
Start lock-out .....	32
Starter switch .....	226, 228
Starting and turning off the engine .....	231
Steering lock	
See Starter switch .....	226, 228
Steering wheel	
Adjustment .....	105
Easy-entry/exit feature .....	66
Storage compartment in the rear passenger compartment .....	198
Storage compartments and armrests .....	193
Storing mirror positions .....	107
Stowing things in the vehicle .....	328
Sun visors .....	191
Supplemental Restraint System (SRS) .....	92
Indicator lamp .....	299
SRS malfunction .....	94

## T

Tachometer .....	119
Technical data .....	388
Electrical system .....	392
Main dimensions .....	393
Rims and tires .....	390
Weights .....	393
Tele Aid .....	214
Emergency calls .....	215
Information .....	219
Initiating an emergency call manually .....	217
Roadside Assistance .....	218
TELE AID - malfunction and warning messages .....	321
Telephone .....	128
General notes .....	205, 212
Incoming call .....	132
Redialing .....	130
Telephone book .....	128
TELEPHONE - FUNCTION - malfunction and warning messages .....	323
Telephones and two-way radios .....	212



<b>Instruments and controls</b>	<b>Operation</b>	<b>Driving</b>	<b>Instrument cluster display</b>	<b>Practical hints</b>	<b>Car care</b>	<b>Technical data</b>	<b>Index</b>
---------------------------------	------------------	----------------	-----------------------------------	------------------------	-----------------	-----------------------	--------------

**Index**

The first 1 000 miles (1 500 km) .....	213	Trunk lid closing feature .....	55
Tire inflation pressure .....	348	Trunk lamp .....	362
Tire inflation pressure monitor .....	150	Trunk lid	
Inquiry of present tire		Emergency release .....	61
inflation pressure .....	150	Trunk lid release switch .....	57
TIRE PRESSURE -		TRUNK OPEN -	
malfunction and warning messages .....	316	malfunction and warning messages .....	308
Tires		Turn signal failure .....	160
Driving instructions .....	247	Turn signals .....	160
Rims and tires .....	390		
Rotating wheels .....	341	<b>U</b>	
Tire inflation pressure .....	348	Unlocking with KEYLESS-GO-card .....	40
Tire Replacement .....	340		
Tire speed rating .....	249	<b>V</b>	
Tire traction .....	248	Vanity mirrors .....	192
Winter driving instructions .....	250	Vehicle jack .....	339
Tow-away alarm .....	64	Vehicle keys .....	28
Towing the vehicle .....	353	Vehicle tools .....	338
Traveling abroad .....	252		
Trip computer .....	135		
Trip odometer .....	119		
Trunk .....	53		
Opening .....	37		
Power closing assist .....	50		
Release switch .....	57		
Release/close switch .....	58		

## W

Warranty coverage .....	384	Where to find it .....	13
WASHER FLUID -		Window curtain airbags .....	96
malfunction and warning messages .....	324	Windshield and headlamp washer	
Washing the vehicle .....	376	fluid mixing ratio .....	337
What you should know		Windshield and headlamp	
at the gas station .....	290	washer system .....	337
Wheels .....	340	Winter driving .....	251
Changing .....	343	Winter driving instructions .....	250
Light alloy wheels .....	380	Wiper blades, replacing .....	370
Rims and tires .....	390		
Rotating .....	341		
Spare wheel .....	341		



## Service and Literature

Your authorized Mercedes-Benz Center has trained technicians and original Mercedes-Benz parts to service your vehicle properly. For expert advice and quality service, see your authorized Mercedes-Benz Center.

If you are interested in obtaining service literature for your vehicle, please contact your authorized Mercedes-Benz Center. We consider this the best way for you to obtain accurate information for your vehicle.

For further information you can find us on the Mercedes-Benz web-site *www.mbusa.com*.

### **Warning!**

**To help avoid personal injury, be extremely careful when performing any service work or repairs. Improper or incomplete service or the use of incorrect or inappropriate parts or materials may damage the vehicle or its equipment, which may in turn result in personal injury.**

**If you have any question about carrying out some service, turn to the advice of an authorized Mercedes-Benz Center.**

We reserve the right to modify the technical details of the vehicle as given in the data and illustrations of this Operator's Manual. Reprinting, translation and copying, even of excerpts, is not permitted without our prior authorization in writing.

Title illustration no. P00.00-2446-26

Press time 10/31/00

MBUSA/TI

Printed in the U.S.A.

Order No. 6515 213713 Part No. 220 584 81 83 USA Edition B 2001