



# B-Class Electric Drive

Operator's Manual

B-Class Electric Drive Operator's Manual



2425842200

Order no. 65155605 13 Part no. 2425842200 Edition C 2014



Mercedes-Benz

## Symbols

Registered trademarks:

- Bluetooth® is a registered trademark of Bluetooth SIG Inc.
- DTS is a registered trademark of DTS, Inc.
- Dolby and MLP are registered trademarks of DOLBY Laboratories.
- BabySmart™, ESP® and PRE-SAFE® are registered trademarks of Daimler AG.
- HomeLink® is a registered trademark of Johnson Controls.
- iPod® and iTunes® are registered trademarks of Apple Inc.
- Microsoft® and Windows media® are registered trademarks of Microsoft Corporation.
- SIRIUS is a registered trademark of Sirius XM Radio Inc.
- HD Radio is a registered trademark of iBiquity Digital Corporation.
- Gracenote® is a registered trademark of Gracenote, Inc.
- ZAGATSurvey® and related brands are registered trademarks of ZagatSurvey, LLC.

In this Operator's Manual you will find the following symbols:

### **WARNING**

Warning notes make you aware of dangers which could pose a threat to your health or life, or to the health and life of others.

### **Environmental note**

Environmental notes provide you with information on environmentally aware actions or disposal.

 Notes on material damage alert you to dangers that could lead to damage to your vehicle.

 Practical tips or further information that could be helpful to you.

▶ This symbol indicates an instruction that must be followed.

▶ Several of these symbols in succession indicate an instruction with several steps.

(▷ This symbol tells you where you can find more information about a topic.

▷▷ This symbol indicates a warning or an instruction that is continued on the next page.

**Display** This font indicates a display in the multifunction display/COMAND display.

Parts of the software in the vehicle are protected by copyright © 2005 The FreeType Project <http://www.freetype.org>. All rights reserved.

## Publication details

### Internet

Further information about Mercedes-Benz vehicles and about Daimler AG can be found on the following websites:

<http://www.mbusa.com> (USA only)

<http://www.mercedes-benz.ca> (Canada only)

<http://www.mercedes-benz.ca>

### Editorial office

©Daimler AG: Not to be reprinted, translated or otherwise reproduced, in whole or in part, without written permission from Daimler AG.

### Vehicle manufacturer

Daimler AG  
Mercedesstraße 137  
70327 Stuttgart  
Germany

## **Welcome to the world of Mercedes-Benz**

We urge you to read this Operator's Manual carefully and familiarize yourself with the vehicle before driving. For your own safety and a longer vehicle life, follow the instructions and warning notices in this manual.

Ignoring them could result in damage to the vehicle or personal injury to you or others.

Vehicle damage caused by failure to follow instructions is not covered by the Mercedes-Benz Limited Warranty.

The equipment or product designation of your vehicle may vary depending on:

- model
- order
- country specification
- availability

Mercedes-Benz therefore reserves the right to introduce changes in the following areas:

- design
- equipment
- technical features

The equipment in your vehicle may therefore differ from that shown in the descriptions and illustrations.

The following are integral components of the vehicle:

- Operator's Manual
- Maintenance Booklet
- Equipment-dependent supplements

Keep these documents in the vehicle at all times. If you sell the vehicle, always pass all documents on to the new owner.

The technical documentation team at Daimler AG wishes you safe and pleasant motoring.

Mercedes-Benz USA, LLC

Mercedes-Benz Canada, Inc.

A Daimler Company



---

**Index** ..... 4

---

**Introduction** ..... 19

**At a glance** ..... 29

---

**Safety** ..... 39

---

**Opening and closing** ..... 71

---

**Seats, steering wheel and mirrors** .... 85

---

**Lights and windshield wipers** ..... 97

---

**Climate control** ..... 113

---

**Driving and parking** ..... 125

---

**On-board computer and displays** .... 171

---

**Stowage and features** ..... 227

---

**Maintenance and care** ..... 251

---

**Breakdown Assistance** ..... 263

---

**Wheels and tires** ..... 277

---

**Technical data** ..... 307

## 1, 2, 3 ...

**12 V socket**

see Sockets

## A

**ABS (Anti-lock Braking System)**

Display message .....	191
Function/notes .....	63
Important safety notes .....	63
Warning lamp .....	218

**Accident**

Automatic measures after an accident .....	56
--	----

**Activating/deactivating cooling****with air dehumidification .....** 116**Active Parking Assist**

Canceling .....	163
Detecting parking spaces .....	160
Display message .....	210
Exiting a parking space .....	162
Function/notes .....	159
Important safety notes .....	159
Parking .....	161

**ADAPTIVE BRAKE .....** 68**Adaptive Brake Assist**

Display message .....	200
Function/notes .....	65

**Additional speedometer .....** 187**Air bags**

Deployment .....	54
Display message .....	203
Front air bag (driver, front passenger) .....	47
Important safety notes .....	46
Introduction .....	46
Knee bag .....	48
PASSENGER AIR BAG indicator lamps .....	41
Side impact air bag .....	48
Window curtain air bag .....	48

**Air-conditioning system**

see Climate control

**Air vents**

Important safety notes .....	123
Setting .....	123

Setting the center air vents .....	123
Setting the side air vents .....	123
see Climate control	

**Alarm system**

see ATA (Anti-Theft Alarm system)

**Ambient lighting**

Setting the brightness (on-board computer) .....	188
--	-----

**Antenna .....** 23**Anti-lock braking system**

see ABS (Anti-lock Braking System)

**Anti-Theft Alarm system**

see ATA (Anti-Theft Alarm system)

**Ashtray .....** 236**Assistance display (on-board computer) .....** 183**Assistance menu (on-board computer) .....** 183**ASSYST PLUS**

Displaying a service message .....	255
Hiding a service message .....	255
Notes .....	254
Resetting the service interval display .....	255
Service message .....	254
Special service requirements .....	255

**ATA (Anti-Theft Alarm system)**

Activating/deactivating .....	69
Function .....	69
Switching off the alarm .....	69

**ATTENTION ASSIST**

Activating/deactivating .....	184
Display message .....	208
Function/notes .....	166

**Audio menu (on-board computer) ....** 180**Audio system**

see separate operating instructions

**Authorized Mercedes-Benz Center**

see Qualified specialist workshop

**Authorized workshop**

see Qualified specialist workshop

**AUTO lights**

Display message .....	207
see Lights	

**Automatic car wash (care) .....** 256**Automatic headlamp mode .....** 98

## B

<b>Backup lamp</b>	
Changing bulbs .....	106
Display message .....	206
<b>Bag hook</b> .....	232
<b>BAS (Brake Assist System)</b> .....	63
<b>Battery</b>	
Display message .....	215
<b>Battery (SmartKey)</b>	
Checking .....	74
Important safety notes .....	74
Replacing .....	74
<b>Battery (vehicle)</b>	
Charging .....	268
Display message .....	207
Important safety notes .....	265
Jump starting .....	269
<b>Belt</b>	
see Seat belts	
<b>Blind Spot Assist</b>	
Activating/deactivating .....	184
Display message .....	209
Notes/function .....	167
<b>Brake Assist</b>	
see BAS (Brake Assist System)	
<b>Brake fluid</b>	
Display message .....	199
Notes .....	309
<b>Brake lamps</b>	
Changing bulbs .....	106
Display message .....	205
<b>Brakes</b>	
ABS .....	63
Adaptive Brake Assist .....	65
BAS .....	63
Brake fluid (notes) .....	309
Display message .....	191
HOLD function .....	154
Important safety notes .....	148
Maintenance .....	150
Parking brake .....	145
Riding tips .....	148
Warning lamp .....	218
<b>Brake system</b>	
Driving safety systems .....	68

## Breakdown

Towing away .....	271
see Flat tire	

**Brightness control (instrument cluster lighting)** ..... 31

## Bulbs

see Replacing bulbs	
---------------------	--

## C

## Calling up a malfunction

see Display messages	
----------------------	--

## Car

see Vehicle	
-------------	--

## Care

Carpets .....	262
Car wash .....	256
Display .....	260
Exterior lights .....	259
Gear or selector lever .....	261
Interior .....	260
Matte finish .....	258
Notes .....	256
Paint .....	257
Plastic trim .....	260
Power washer .....	257
Rear view camera .....	260
Roof lining .....	262
Seat belt .....	262
Seat cover .....	261
Sensors .....	259
Steering wheel .....	261
Trim pieces .....	261
Washing by hand .....	256
Wheels .....	258
Windows .....	258
Wiper blades .....	259
Wooden trim .....	261

**Cargo compartment cover** ..... 232

**Cargo compartment enlargement** ... 230

Important safety notes .....	230
------------------------------	-----

**Cargo compartment floor**

Height adjustment .....	234
Important safety notes .....	233
Opening/closing .....	233
Stowage well (under) .....	233

**Cargo tie down rings** ..... 231

- Center console**
  - Lower section ..... 35
  - Upper section ..... 34
- Central locking**
  - Automatic locking (on-board computer) ..... 188
  - Locking/unlocking (SmartKey) ..... 72
- Changing bulbs**
  - Brake lamps ..... 106
  - High-beam headlamps ..... 105
  - Low-beam headlamps ..... 104
  - Parking lamps ..... 105
  - Rear fog lamp ..... 106
  - Reversing lamps ..... 106
  - Standing lamps (front) ..... 105
  - Tail lamps ..... 106
  - Turn signals (front) ..... 105
  - Turn signals (rear) ..... 106
- Charge level display** ..... 174
- Charging**
  - see Charging the high-voltage battery
- Charging cable**
  - Connecting ..... 139
  - Controls ..... 138
  - Important safety notes ..... 137
  - Removing ..... 140
  - Storing ..... 138
  - Warming up ..... 137
- Charging the high-voltage battery (important safety notes)** ..... 134
- Child-proof locks**
  - Important safety notes ..... 61
  - Rear doors ..... 62
- Children**
  - In the vehicle ..... 56
  - Restraint systems ..... 57
  - Special seat belt retractor ..... 57
- Child seat**
  - Forward-facing restraint system ..... 60
  - LATCH-type (ISOFIX) child seat anchors ..... 58
  - On the front-passenger seat ..... 60
  - Rearward-facing restraint system .... 60
  - Top Tether ..... 59
- Cigarette lighter** ..... 236
- Climate control**
  - Automatic climate control (dual-zone) ..... 115
  - Auxiliary climate control (on-board computer) ..... 186
  - Controlling automatically ..... 117
  - Convenience opening/closing (air-recirculation mode) ..... 120
  - Cooling with air dehumidification .. 116
  - Defrosting the windows ..... 119
  - Defrosting the windshield ..... 118
  - Immediate pre-entry climate control ..... 122
  - Important safety notes ..... 114
  - Indicator lamp ..... 117
  - Maximum cooling ..... 119
  - Notes on using dual-zone automatic climate control ..... 115
  - Overview of systems ..... 114
  - Pre-entry climate control at departure time ..... 122
  - Pre-entry climate control at time of departure (on-board computer) .. 186
  - Pre-entry climate control via key ... 121
  - Pre-entry climate control via key (on-board computer) ..... 186
  - Problems with cooling with air dehumidification ..... 117
  - Problem with the rear window defroster ..... 120
  - Refrigerant ..... 311
  - Refrigerant filling capacity ..... 311
  - Setting the air distribution ..... 117
  - Setting the airflow ..... 118
  - Setting the air vents ..... 123
  - Setting the temperature ..... 117
  - Switching air-recirculation mode on/off ..... 120
  - Switching on/off ..... 116
  - Switching the rear window defroster on/off ..... 119
  - Switching the ZONE function on/off ..... 118
- Cockpit** ..... 30
  - see Instrument cluster



**COLLISION PREVENTION ASSIST**

- Activating/deactivating the distance warning function ..... 184
- Display message ..... 191
- Operation/notes ..... 64

**Combination switch** ..... 100**Compass**

- Calibrating ..... 249
- Calling up ..... 248
- Setting ..... 249

**Consumption statistics (on-board computer)** ..... 177**Convenience closing feature** ..... 82**Convenience opening/closing (air-recirculation mode)** ..... 120**Convenience opening feature** ..... 82**Coolant**

- Service product ..... 309

**Coolant (engine)**

- Checking the level ..... 253

**Cooling**

- see Climate control

**Copyright** ..... 27**Cornering light function**

- Display message ..... 204

**Crash-responsive emergency lighting** ..... 102**Cruise control**

- Activation conditions ..... 153
- Cruise control lever ..... 152
- Deactivating ..... 154
- Display message ..... 210
- Driving system ..... 152
- Important safety notes ..... 152
- Setting a speed ..... 153
- Storing and maintaining current speed ..... 153

**Cup holder**

- Center console ..... 235
- Important safety notes ..... 234
- see Cup holder

**Customer Assistance Center****(CAC)** ..... 25**Customer Relations Department** ..... 25**D****Dashboard**

- see Cockpit

**Data**

- see Technical data

**Daytime running lamps**

- Display message ..... 206
- Switching on/off (on-board computer) ..... 187
- Switching on/off (switch) ..... 98

**Declarations of conformity** ..... 24**Delayed switch-off**

- Interior lighting ..... 188

**Departure time**

- Setting (on-board computer) ..... 185

**Diagnostics connection** ..... 24**Digital speedometer** ..... 177**DIRECT SELECT lever**

- Transmission ..... 129

**Display**

- High-voltage battery charge level (instrument cluster) ..... 174

**Display (cleaning instructions)** ..... 260**Display messages**

- ASSYST PLUS ..... 254
- Calling up (on-board computer) ..... 190
- Drive system ..... 207
- Driving systems ..... 208
- General notes ..... 190
- Hiding (on-board computer) ..... 190
- Lights ..... 204
- Safety systems ..... 191
- SmartKey ..... 215
- Tires ..... 211
- Vehicle ..... 212

**Distance recorder** ..... 176

- see Odometer

- see Trip odometer

**Distance warning function**

- Activating/deactivating ..... 184
- Function/notes ..... 64
- Warning lamp ..... 225

**Door control panel** ..... 37

**Doors**

Automatic locking (on-board computer) .....	188
Automatic locking (switch) .....	78
Central locking/unlocking (SmartKey) .....	72
Display message .....	214
Emergency locking .....	79
Emergency unlocking .....	79
Important safety notes .....	77
Opening (from inside) .....	77

**Drinking and driving** ..... 147**Driver's door**

see Doors

**Drive system**

Jump-starting .....	269
Starting with the SmartKey .....	127
Switching off .....	145

**Driving abroad**

Mercedes-Benz Service .....	256
-----------------------------	-----

**Driving on flooded roads** ..... 151**Driving safety systems**

ABS (Anti-lock Braking System) .....	63
ADAPTIVE BRAKE .....	68
Adaptive Brake Assist .....	65
BAS (Brake Assist System) .....	63
COLLISION PREVENTION ASSIST ....	64
Distance warning function .....	64
Electronic brake force distribution .....	66
ESP® (Electronic Stability Program) .....	66
ETS (Electronic Traction System) ....	66
Important safety information .....	63
Overview .....	62
RBS .....	68
STEER CONTROL .....	68

**Driving systems**

Active Parking Assist .....	159
ATTENTION ASSIST .....	166
Blind Spot Assist .....	167
Cruise control .....	152
Display message .....	208
HOLD function .....	154
PARKTRONIC .....	155
Rear view camera .....	163

**Driving tips**

Brakes .....	148
Break-in period .....	126
Checking brake lining thickness ....	150
Downhill gradient .....	149
Drinking and driving .....	147
Driving in winter .....	152
Driving on flooded roads .....	151
Driving on wet roads .....	151
Energy .....	147
General .....	147
Hydroplaning .....	151
Icy road surfaces .....	152
Limited braking efficiency on salted roads .....	149
Snow chains .....	280
Wet road surface .....	149

**DVD audio (on-board computer)** ..... 181

**DVD video (on-board computer)** ..... 181

**E****EBD (electronic brake force distribution)**

Display message .....	195
Function/notes .....	66

**E-CELL display** ..... 173**ECO display**

Function/notes .....	148
On-board computer .....	177

**Electric motor number** ..... 308**Electronic Stability Program**

see ESP® (Electronic Stability Program)

**Emergency**

Automatic measures after an accident .....	56
--	----

**Emergency release**

Driver's door .....	79
Vehicle .....	79

**Emergency Tensioning Devices**

Activation .....	54
------------------	----

**Emergency unlocking**

Tailgate .....	80
----------------	----

**Energy**

Driving tips .....	147
--------------------	-----

**Environmental protection**

Note .....	19
------------	----

- ESP® (Electronic Stability Program)**
- Characteristics ..... 67
  - Deactivating/activating ..... 183
  - Deactivating/activating (notes) ..... 67
  - Display message ..... 191
  - ETS ..... 66
  - Function/notes ..... 66
  - General notes ..... 66
  - Important safety information ..... 67
  - Warning lamp ..... 221
- ETS (Electronic Traction System) ..... 66**
- Exterior lighting**
- Setting options ..... 98
- Exterior mirrors**
- Adjusting ..... 93
  - Dipping (automatic) ..... 93
  - Out of position (troubleshooting) ..... 93
  - Storing settings (memory function) ..... 95
  - Storing the parking position ..... 94
- F**
- Flat tire**
- MOExtended tires ..... 264
  - Preparing the vehicle ..... 264
- Floormats ..... 249**
- Fuses**
- Allocation chart ..... 275
  - Before changing ..... 274
  - Fuse box in the engine compartment ..... 275
  - Fuse box in the front-passenger footwell ..... 275
  - Important safety notes ..... 274
- G**
- Garage door opener**
- Clearing the memory ..... 248
  - Important safety notes ..... 245
  - Opening/closing the garage door .. 248
  - Programming (button in the rear-view mirror) ..... 245
- Gear or selector lever (cleaning guidelines) ..... 261**
- Genuine parts ..... 19**
- Glove box ..... 229**
- H**
- Handbrake**
- see Parking brake
- Hazard warning lamps ..... 100**
- Display message ..... 215
- Headlamps**
- Cleaning system (notes) ..... 310
  - Fogging up ..... 101
  - see Automatic headlamp mode
- Head restraints**
- Adjusting ..... 89
  - Adjusting (electrically) ..... 90
  - Adjusting (manually) ..... 89
  - Adjusting (rear) ..... 90
  - Installing/removing (rear) ..... 90
- Heating**
- see Climate control
- High-beam headlamps**
- Changing bulbs ..... 105
  - Display message ..... 205
  - Switching on/off ..... 100
- High voltage**
- see Safety notes
- High-voltage battery**
- Battery care ..... 136
  - Charging (charging station) ..... 140
  - Charging (mains socket) ..... 137
  - Charging cable warming ..... 137
  - Cruise range ..... 136
  - Discharged battery ..... 135
  - Display message ..... 208
  - Energy consumption ..... 136
  - General notes ..... 135
  - Method of operation ..... 135
  - Outside temperatures ..... 135
  - Overvoltage protection ..... 137
  - Problems with the charging process ..... 142
  - Reserve, warning lamp ..... 224
  - Terms of use ..... 137
- High-voltage disconnect device ..... 23**
- Hill start assist ..... 128**
- HOLD function**
- Activating ..... 155
  - Deactivating ..... 155

Display message .....	209
Function/notes .....	154
<b>Hood</b>	
Closing .....	253
Display message .....	214
Important safety notes .....	252
Opening .....	252
<b>Horn</b> .....	30
<b>Hydroplaning</b> .....	151

## I

<b>Ignition lock</b>	
see Key positions	
<b>Immobilizer</b> .....	69
<b>Indicator lamps</b>	
see Warning and indicator lamps	
<b>Indicators</b>	
see Turn signals	
<b>Instrument cluster</b>	
Charge level display .....	31
Overview .....	31
Power display .....	173
Settings .....	187
Warning and indicator lamps .....	32
<b>Instrument cluster lighting</b> .....	172
<b>Interior lighting</b> .....	101
Automatic control .....	102
Delayed switch-off (on-board computer) .....	188
Emergency lighting .....	102
Manual control .....	102
Overview .....	101
Reading lamp .....	101
Setting the brightness of the ambient lighting (on-board computer) .....	188
<b>Internet connection</b>	
Via mobile service module .....	144

## J

<b>Jack</b>	
Storage location .....	264
Using .....	300

## K

<b>Kickdown</b>	
Driving tips .....	131
<b>Knee bag</b> .....	48

## L

<b>Lamps</b>	
see Warning and indicator lamps	
<b>LATCH-type (ISOFIX) child seat anchors</b> .....	58
<b>License plate lamp (display message)</b> .....	205
<b>Lights</b>	
Activating/deactivating the interior lighting delayed switch-off .....	188
Automatic headlamp mode .....	98
Display message .....	204
Hazard warning lamps .....	100
High beam flasher .....	100
High-beam headlamps .....	100
Light switch .....	98
Low-beam headlamps .....	99
Parking lamps .....	99
Rear fog lamp .....	99
Setting the brightness of the ambient lighting (on-board computer) .....	188
Standing lamps .....	100
Switching the daytime running lamps on/off (on-board computer) .....	187
Switching the daytime running lamps on/off (switch) .....	98
Turn signals .....	100
see Interior lighting	
see Lights	
see Replacing bulbs	
<b>Light sensor (display message)</b> .....	207
<b>Loading guidelines</b> .....	228
<b>Locking</b>	
see Central locking	
<b>Locking (doors)</b>	
Automatic .....	78
Emergency locking .....	79
From inside (central locking button) .....	78

- Locking centrally**  
see Central locking
- Locking verification signal (on-board computer)** ..... 188
- Low-beam headlamps**  
Changing bulbs ..... 104  
Display message ..... 204  
Switching on/off ..... 99
- Lumbar support**  
Adjusting the 4-way lumbar support ..... 91
- M**
- M+S tires** ..... 280
- Maintenance**  
see ASSYST PLUS
- Malfunction message**  
see Display messages
- Matte finish (cleaning instructions)** ..... 258
- Maximum charge current**  
Setting (charging cable) ..... 138
- mbrace**  
Call priority ..... 241  
Display message ..... 199  
Downloading destinations (COMAND) ..... 241  
Downloading routes ..... 244  
Emergency call ..... 238  
General notes ..... 237  
Geo fencing ..... 245  
Locating a stolen vehicle ..... 243  
MB info call button ..... 240  
Remote fault diagnosis ..... 243  
Remote vehicle locking ..... 243  
Roadside Assistance button ..... 240  
Search & Send ..... 242  
Self-test ..... 238  
Speed alert ..... 244  
System ..... 238  
Triggering the vehicle alarm ..... 245  
Vehicle remote unlocking ..... 243
- Mechanical key**  
Function/notes ..... 73  
Locking vehicle ..... 79  
Unlocking the driver's door ..... 79
- Memory card (audio)** ..... 181
- Memory function** ..... 95
- Message memory (on-board computer)** ..... 190
- Messages**  
see Display messages
- Mirrors**  
see Exterior mirrors  
see Rear-view mirror  
see Vanity mirror (in the sun visor)
- Mobile phone**  
Menu (on-board computer) ..... 181
- Modifying the programming (SmartKey)** ..... 73
- MOExtended tires** ..... 264
- Mounting wheels**  
Lowering the vehicle ..... 303  
Mounting a new wheel ..... 302  
Preparing the vehicle ..... 300  
Raising the vehicle ..... 300  
Removing a wheel ..... 302  
Securing the vehicle against rolling away ..... 300
- MP3**  
Operation ..... 181  
see separate operating instructions
- Multifunction display**  
Function/notes ..... 176  
Permanent display ..... 187
- Multifunction steering wheel**  
Operating the on-board computer .. 174  
Overview ..... 33
- N**
- Navigation**  
Menu (on-board computer) ..... 179  
see separate operating instructions
- Notes on breaking-in a new vehicle** ..... 126
- O**
- Occupant Classification System (OCS)**  
Conditions ..... 49  
Faults ..... 53

- Operation ..... 49
  - System self-test ..... 51
  - Occupant safety**
    - Automatic measures after an accident ..... 56
    - Children in the vehicle ..... 56
    - Important safety notes ..... 41
    - Pets in the vehicle ..... 62
  - OCS**
    - Conditions ..... 49
    - Faults ..... 53
    - Operation ..... 49
    - System self-test ..... 51
  - On-board computer**
    - Assistance menu ..... 183
    - Audio menu ..... 180
    - Displaying a service message ..... 255
    - Display messages ..... 190
    - E-CELL menu ..... 185
    - Factory settings submenu ..... 189
    - Important safety notes ..... 172
    - Instrument cluster submenu ..... 187
    - Lighting submenu ..... 187
    - Menu overview ..... 176
    - Message memory ..... 190
    - Navigation menu ..... 179
    - Operation ..... 174
    - Service menu ..... 184
    - Settings menu ..... 185
    - Standard display ..... 176
    - Telephone menu ..... 181
    - Trip menu ..... 176
    - Vehicle submenu ..... 188
    - Video DVD operation ..... 181
  - On-board computer (multifunction steering wheel)**
    - Range ..... 178
  - Online access** ..... 143
  - Opening and closing the side trim panels** ..... 105
  - Operating safety**
    - Declaration of conformity ..... 24
  - Operating system**
    - see On-board computer
  - Operator's Manual**
    - Vehicle equipment ..... 20
  - Outside temperature display** ..... 173
  - Overhead control panel** ..... 36
  - Override feature**
    - Rear side windows ..... 62
- ## P
- Paint code number** ..... 308
  - Paintwork (cleaning instructions)** ... 257
  - Panic alarm** ..... 40
  - Parking** ..... 144
    - Important safety notes ..... 144
    - Parking brake ..... 145
    - Position of exterior mirror, front-passenger side ..... 94
    - Rear view camera ..... 163
    - see Active Parking Assist
    - see PARKTRONIC
  - Parking aid**
    - Active Parking Assist ..... 159
    - see Exterior mirrors
    - see PARKTRONIC
  - Parking assistance**
    - see PARKTRONIC
  - Parking brake**
    - Display message ..... 196
    - Electric parking brake ..... 145
    - Warning lamp ..... 223
    - see Parking brake
  - Parking lamps**
    - Switching on/off ..... 99
  - Parking lamps (changing bulbs)** ..... 105
  - PARKTRONIC**
    - Deactivating/activating ..... 157
    - Driving system ..... 155
    - Function/notes ..... 155
    - Important safety notes ..... 155
    - Problem (malfunction) ..... 159
    - Range of the sensors ..... 156
    - Warning display ..... 157
  - PASSENGER AIR BAG**
    - Indicator lamps ..... 41
  - PASSENGER AIR BAG OFF**
    - Problems (malfunction) ..... 203
  - Pets in the vehicle** ..... 62
  - Plastic trim (cleaning instructions)** ..... 260
  - Power display** ..... 173

- Power washers** ..... 257
- Power windows**  
see Side windows
- Program selector button** ..... 131
- Pulling away** ..... 128
- Q**
- Qualified specialist workshop** ..... 24
- R**
- Radar sensor system**  
Activating/deactivating ..... 188  
Display message ..... 209
- Radio**  
Selecting a station ..... 180  
see separate operating instructions
- Radio-wave reception/transmission in the vehicle**  
Declaration of conformity ..... 24
- Range**  
Calling up (on-board computer, luxury multifunction steering wheel) ..... 178  
RANGE PLUS ..... 136
- RANGE PLUS**  
Range ..... 136
- RBS**  
see Recuperative braking system (RBS) ..... 68
- Reading lamp** ..... 101
- READY indicator** ..... 172
- Rear fog lamp**  
Changing bulbs ..... 106  
Display message ..... 206  
Switching on/off ..... 99
- Rear lamps**  
Changing bulbs ..... 106  
see Lights
- Rear seat**  
Folding the backrest forwards/back (vehicles without the EASY-VARIO-PLUS system) ..... 231
- Rear view camera**  
Cleaning instructions ..... 260  
Function/notes ..... 163  
Switching on/off ..... 164
- Rear-view mirror**  
Anti-glare (manual) ..... 93  
Dipping (automatic) ..... 93
- Rear window defroster**  
Problem (malfunction) ..... 120  
Switching on/off ..... 119
- Rear window wiper**  
Replacing the wiper blade ..... 110  
Switching on/off ..... 109
- Recuperative braking system (rbs)** ... 68
- Refrigerant (air-conditioning system)**  
Important safety notes ..... 311
- Remote control**  
Garage door opener ..... 245  
Programming (garage door opener) ..... 245
- Replacing bulbs**  
Important safety notes ..... 102  
Overview of bulb types ..... 103  
Removing/replacing the cover (front wheel arch) ..... 104
- Reporting safety defects** ..... 25
- Reserve**  
High-voltage battery ..... 224
- Restraint system**  
Display message ..... 200  
Introduction ..... 40  
Warning lamp ..... 224  
Warning lamp (function) ..... 41
- Reverse gear**  
Engaging ..... 130
- Reversing feature**  
Side windows ..... 81
- Roadside Assistance (breakdown)** .... 21
- Roof lining and carpets (cleaning guidelines)** ..... 262
- Roof load (maximum)** ..... 311
- Route (navigation)**  
see Route guidance (navigation)
- Route guidance (navigation)** ..... 179

## S

**Safety**

- Children in the vehicle ..... 56
- Child restraint systems ..... 57
- Occupant Classification System (OCS) ..... 49

**Safety notes** ..... 21

**Safety system**

see Driving safety systems

**Seat belts**

- Adjusting the height ..... 44
- center rear-compartment seat ..... 45
- Cleaning ..... 262
- Correct usage ..... 43
- Fastening ..... 44
- Important safety guidelines ..... 42
- Introduction ..... 42
- Releasing ..... 45
- Warning lamp ..... 216
- Warning lamp (function) ..... 45

**Seats**

- Adjusting (electrically) ..... 89
- Adjusting (manually) ..... 88
- Adjusting the 4-way lumbar support ..... 91
- Adjusting the head restraint ..... 89
- Cleaning the cover ..... 261
- Correct driver's seat position ..... 86
- Folding the backrest (rear compartment) forwards/back (vehicles without the EASY-VARIO-PLUS system) ..... 231
- Important safety notes ..... 87
- Seat heating problem ..... 92
- Storing settings (memory function) ..... 95
- Switching seat heating on/off ..... 91

**Selector lever**

see DIRECT SELECT lever

**Sensors (cleaning instructions)** ..... 259

**Service Center**

see Qualified specialist workshop

**Service menu (on-board computer)** ..... 184

**Service products**

- Brake fluid ..... 309
- Important safety notes ..... 309

- Refrigerant (air-conditioning system) ..... 311
- Washer fluid ..... 310

**Settings**

- Factory (on-board computer) ..... 189
- On-board computer ..... 185

**Setting the air distribution** ..... 117

**Setting the airflow** ..... 118

**Setting the maximum charge current (Control system)** ..... 186

**Side impact air bag** ..... 48

**Side marker lamp (display message)** ..... 206

**Side windows**

- Cleaning ..... 258
- Convenience closing feature ..... 82
- Convenience opening feature ..... 82
- Important safety information ..... 81
- Opening/closing ..... 81
- Problem (malfunction) ..... 84
- Resetting ..... 83

**SmartKey**

- Changing the battery ..... 74
- Changing the programming ..... 73
- Checking the battery ..... 74
- Convenience closing feature ..... 82
- Convenience opening feature ..... 82
- Display message ..... 215
- Door central locking/unlocking ..... 72
- Important safety notes ..... 72
- Loss ..... 76
- Mechanical key ..... 73
- Positions (ignition lock) ..... 127
- Problem (malfunction) ..... 76

**SmartKey positions (ignition lock)** .. 127

**Snow chains** ..... 280

**Sockets**

- General notes ..... 237
- Luggage compartment ..... 237
- Rear compartment ..... 237

**Specialist workshop** ..... 24

**Special seat belt retractor** ..... 57

**Speed, controlling**

see Cruise control

**Speedometer**

- Activating/deactivating the additional speedometer ..... 187



- Digital ..... 177
  - In the Instrument cluster ..... 31
  - Selecting the unit of measurement ..... 187
  - see Instrument cluster
  - SRS (Supplemental Restraint System)**
  - see Restraint system
  - Standing lamps**
  - Changing bulbs ..... 105
  - Display message ..... 206
  - Switching on/off ..... 100
  - Starting (vehicle)** ..... 127
  - STEER CONTROL** ..... 68
  - Steering (display message)** ..... 214
  - Steering wheel**
  - Adjusting (manually) ..... 92
  - Buttons (on-board computer) ..... 174
  - Cleaning ..... 261
  - Important safety notes ..... 92
  - Paddle shifters ..... 131
  - Steering wheel paddle shifters** ..... 131
  - Stowage areas** ..... 228
  - Stowage compartments**
  - Armrest (front) ..... 229
  - Armrest (under) ..... 229
  - Center console (rear) ..... 230
  - Cup holders ..... 234
  - Glove box ..... 229
  - Important safety information ..... 228
  - Stowage net ..... 230
  - Under driver's seat/front-passenger seat ..... 230
  - Stowage net** ..... 230
  - Summer tires** ..... 280
  - Sun visor** ..... 235
  - Switching air-recirculation mode on/off** ..... 120
  - Switching off the alarm (ATA)** ..... 69
- T
- Tailgate**
  - Display message ..... 213
  - Emergency unlocking ..... 80
  - Important safety notes ..... 79
  - Opening/closing (from outside) ..... 80
  - Opening dimensions ..... 311
  - Tail lamps**
  - Display message ..... 205
  - see Lights
  - Technical data**
  - Capacities ..... 309
  - Information ..... 308
  - Tires/wheels ..... 303
  - Vehicle data ..... 311
  - Telephone**
  - Accepting a call ..... 182
  - Display message ..... 214
  - Menu (on-board computer) ..... 181
  - Number from the phone book ..... 182
  - Redialing ..... 183
  - Rejecting/ending a call ..... 182
  - Temperature**
  - Outside temperature ..... 173
  - Setting (climate control) ..... 117
  - Theft deterrent systems**
  - ATA (Anti-Theft Alarm system) ..... 69
  - Immobilizer ..... 69
  - Time**
  - see separate operating instructions
  - Tire pressure**
  - Calling up (on-board computer) ..... 284
  - Checking manually ..... 284
  - Display message ..... 211
  - Important safety notes ..... 284
  - Maximum ..... 284
  - Notes ..... 283
  - Recommended ..... 281
  - see Tire pressure
  - Tire pressure monitor**
  - Checking the tire pressure electronically ..... 286
  - Function/notes ..... 284
  - General notes ..... 284
  - Important safety notes ..... 285
  - Restarting ..... 287
  - Warning lamp ..... 226
  - Warning message ..... 286
  - Tires**
  - Aspect ratio (definition) ..... 298
  - Average weight of the vehicle occupants (definition) ..... 296

- Bar (definition) ..... 296
- Changing a wheel ..... 299
- Characteristics ..... 296
- Checking ..... 279
- Curb weight (definition) ..... 298
- Definition of terms ..... 296
- Direction of rotation ..... 299
- Display message ..... 211
- Distribution of the vehicle occupants (definition) ..... 299
- DOT, Tire Identification Number (TIN) ..... 295
- DOT (Department of Transportation) (definition) ..... 296
- GAWR (Gross Axle Weight Rating) (definition) ..... 297
- GVW (Gross Vehicle Weight) (definition) ..... 297
- GVWR (Gross Vehicle Weight Rating) (definition) ..... 297
- Important safety notes ..... 278
- Increased vehicle weight due to optional equipment (definition) ..... 297
- Kilopascal (kPa) (definition) ..... 297
- Labeling (overview) ..... 293
- Load bearing index (definition) ..... 299
- Load index ..... 295
- Load index (definition) ..... 297
- M+S tires ..... 280
- Maximum loaded vehicle weight (definition) ..... 297
- Maximum load on a tire (definition) ..... 298
- Maximum permissible tire pressure (definition) ..... 298
- Maximum tire load ..... 291
- Maximum tire load (definition) ..... 298
- Optional equipment weight (definition) ..... 298
- PSI (pounds per square inch) (definition) ..... 298
- Replacing ..... 299
- Service life ..... 280
- Sidewall (definition) ..... 298
- Speed rating (definition) ..... 297
- Storing ..... 300
- Structure and characteristics (definition) ..... 296
- Summer tires ..... 280
- Temperature ..... 292
- TIN (Tire Identification Number) (definition) ..... 298
- Tire bead (definition) ..... 298
- Tire pressure (definition) ..... 298
- Tire pressures (recommended) ..... 297
- Tire size (data) ..... 303
- Tire size designation, load-bearing capacity, speed rating ..... 293
- Tire tread ..... 279
- Tire tread (definition) ..... 298
- Total load limit (definition) ..... 299
- Traction ..... 292
- Traction (definition) ..... 299
- Tread wear ..... 292
- Uniform Tire Quality Grading Standards ..... 291
- Uniform Tire Quality Grading Standards (definition) ..... 297
- Wear indicator (definition) ..... 299
- Wheel rim (definition) ..... 297
- see Flat tire
- Top Tether** ..... 59
- Towing away**
  - Important safety guidelines ..... 271
  - Installing the towing eye ..... 272
  - Removing the towing eye ..... 273
  - With both axles on the ground ..... 273
  - With the rear axle raised ..... 273
- Tow-starting**
  - Installing the towing eye ..... 272
  - Removing the towing eye ..... 273
- Trailer hitch** ..... 23
- Trailer tow hitch** ..... 23
- Transmission**
  - DIRECT SELECT lever ..... 129
  - Display message ..... 212
  - Drive program ..... 134
  - Driving tips ..... 131
  - Engaging the drive position ..... 130
  - Engaging the park position ..... 129
  - Holding the vehicle stationary on uphill gradients ..... 131
  - Kickdown ..... 131
  - Overview ..... 128

- Program selector button ..... 131
  - Shifting to neutral ..... 130
  - Transmission position display** ..... 129
  - Transmission position display (DIRECT SELECT lever)** ..... 129
  - Transmission positions** ..... 130
  - Trim pieces (cleaning instructions)** ..... 261
  - Trip computer (on-board computer)** ..... 177
  - Trip odometer**
    - Calling up ..... 176
    - Resetting (on-board computer) ..... 177
    - see Trip odometer
  - Trunk**
    - see Tailgate
  - Turn signals**
    - Changing bulbs (front) ..... 105
    - Changing bulbs (rear) ..... 106
    - Display message ..... 204
    - Switching on/off ..... 100
  - Type identification plate**
    - see Vehicle identification plate
- ## U
- Unlocking**
    - Emergency unlocking ..... 79
    - From inside the vehicle (central unlocking button) ..... 78
- ## V
- Vanity mirror (in the sun visor)** ..... 236
  - Vehicle**
    - Correct use ..... 25
    - Data acquisition ..... 26
    - Equipment ..... 20
    - Individual settings ..... 185
    - Limited Warranty ..... 25
    - Loading ..... 288
    - Locking (in an emergency) ..... 79
    - Locking (SmartKey) ..... 72
    - Lowering ..... 303
    - Maintenance ..... 21
    - Parking for a long period ..... 147
    - Raising ..... 300
    - Reporting problems ..... 25
    - Securing from rolling away ..... 300
    - Starting ..... 127
    - Towing (front axle raised) ..... 273
    - Towing away ..... 271
    - Tow-starting ..... 271
    - Transporting ..... 274
    - Unlocking (in an emergency) ..... 79
    - Unlocking (SmartKey) ..... 72
    - Vehicle data ..... 311
  - Vehicle data** ..... 311
  - Vehicle dimensions** ..... 311
  - Vehicle emergency locking** ..... 79
  - Vehicle Homepage**
    - Data protection ..... 143
    - Functions ..... 144
    - General information ..... 143
    - Internet connection ..... 144
  - Vehicle identification number**
    - see VIN
  - Vehicle identification plate** ..... 308
  - Vehicle maintenance**
    - see ASSYST PLUS
  - Vehicle tool kit** ..... 264
  - Video (DVD)** ..... 181
  - VIN** ..... 308
- ## W
- Warning and indicator lamps**
    - ABS ..... 218
    - Brakes ..... 218
    - Distance warning ..... 225
    - ESP® ..... 221
    - ESP® OFF ..... 222
    - Overview ..... 32
    - PASSENGER AIR BAG ..... 41
    - RBS (Recuperative Brake System) ..... 218
    - Restraint system ..... 224
    - Seat belt ..... 216
    - Tire pressure monitor ..... 226
  - Warranty** ..... 20
  - Washer fluid**
    - Display message ..... 214
  - Wheel bolt tightening torque** ..... 303
  - Wheel chock** ..... 300

**Wheels**

Changing a wheel .....	299
Checking .....	279
Cleaning .....	258
Important safety notes .....	278
Interchanging/changing .....	299
Mounting a new wheel .....	302
Mounting a wheel .....	300
Removing a wheel .....	302
Storing .....	300
Tightening torque .....	303
Wheel size/tire size .....	303

**Window curtain air bag**

Display message .....	201
Operation .....	48

**Windows**

see Side windows

**Windshield**

Defrosting .....	118
see Windshield	

**Windshield washer system**

Adding washer fluid .....	254
Notes .....	310

**Windshield wipers**

Display message .....	214
Problem (malfunction) .....	111
Rear window wiper .....	109
Replacing the wiper blades .....	109
Switching on/off .....	108

**Winter driving**

Slippery road surfaces .....	152
Snow chains .....	280

**Winter operation**

General notes .....	280
---------------------	-----

**Winter tires**

M+S tires .....	280
-----------------	-----

**Wiper blades**

Cleaning .....	259
Important safety notes .....	109
Replacing (rear window) .....	110
Replacing (windshield) .....	109

**Wooden trim (cleaning instructions)**

.....	261
-------	-----

**Workshop**

see Qualified specialist workshop

**Z****ZONE function**

Switching on/off .....	118
------------------------	-----

## Protection of the environment

### Note

#### Environmental note

Daimler's declared policy is one of comprehensive environmental protection.

The objectives are for the natural resources that form the basis of our existence on this planet to be used sparingly and in a manner that takes the requirements of both nature and humanity into account.

You too can help to protect the environment by operating your vehicle in an environmentally responsible manner.

Energy consumption and the rate of engine, transmission, brake and tire wear depend on the following factors:

- operating conditions of your vehicle
- your personal driving style

You can influence both factors. You should bear the following in mind:

Operating conditions:

- always make sure that the tire pressures are correct.
- do not carry any unnecessary weight.
- keep an eye on the vehicle's energy consumption.
- remove roof racks once you no longer need them.
- a regularly serviced vehicle will contribute to environmental protection. You should therefore adhere to the service intervals.
- always have service work carried out at a qualified specialist workshop.

Personal driving style:

- drive carefully and maintain a safe distance from the vehicle in front.
- avoid frequent, sudden acceleration and braking.

#### Environmental note

Have a defective high-voltage battery disposed of in an environmentally-responsible

manner. Contact a qualified specialist workshop which has the necessary specialist knowledge and tools to carry out the work required. Mercedes-Benz recommends that you use an authorized Mercedes-Benz Center for this purpose.

## Environmental concerns and recommendations

When prompted to dispose of materials by this Operator's Manual, always try to re-use or recycle them first. Observe the relevant environmental rules and regulations when disposing of materials. In this way you will help to protect the environment.

## Genuine Mercedes-Benz parts

#### Environmental note

Daimler AG also supplies reconditioned major assemblies and parts which are of the same quality as new parts. They are covered by the same Limited Warranty entitlements as new parts.

**!** Air bags and Emergency Tensioning Devices, as well as control units and sensors for these restraint systems, may be installed in the following areas of your vehicle:

- doors
- door pillars
- door sills
- seats
- cockpit
- instrument cluster
- center console

Do not install accessories such as audio systems in these areas. Do not carry out repairs or welding. You could impair the operating efficiency of the restraint systems.

Have aftermarket accessories installed at a qualified specialist workshop.

You could jeopardize the operating safety of your vehicle if you use parts, tires and wheels as well as accessories relevant to safety which have not been approved by Mercedes. This could lead to malfunctions in safety-relevant systems, e.g. the brake system. Use only genuine Mercedes-Benz parts or parts of equal quality. Only use tires, wheels and accessories that have been specifically approved for your vehicle.

Genuine Mercedes-Benz parts are subject to strict quality control. Every part has been specifically developed, manufactured or selected for and adapted to Mercedes-Benz vehicles. Only genuine Mercedes-Benz parts should therefore be used.

More than 300,000 different genuine Mercedes-Benz parts are available for Mercedes-Benz models.

All authorized Mercedes-Benz Centers maintain a supply of genuine Mercedes-Benz parts for necessary service and repair work. In addition, strategically located parts delivery centers provide quick and reliable parts service.

Always specify the vehicle identification number (VIN) when ordering genuine Mercedes-Benz parts (▷ page 308).

## Operator's Manual

### Vehicle equipment

This Operator's Manual describes all models and all standard and optional equipment of your vehicle available at the time of going to print. Country-specific differences are possible. Bear in mind that your vehicle may not feature all functions described here. This also applies to safety-relevant systems and functions. The equipment in your vehicle may therefore differ from that shown in the descriptions and illustrations.

The original purchase agreement lists all systems installed in your vehicle.

Should you have any questions concerning equipment and operation, please consult an authorized Mercedes-Benz Center.

The Operator's Manual and Maintenance Booklet are important documents and should be kept in the vehicle.

## Service and vehicle operation

### Warranty

The Limited Warranty for your vehicle applies in accordance with the warranty terms and conditions in the Service and Warranty Information Booklet.

Your authorized Mercedes-Benz Center will exchange or repair any defective parts originally installed in the vehicle in accordance with the terms of the following warranties:

- New Vehicle Limited Warranty
- State warranty enforcement laws (Lemon Laws)

Replacement parts and accessories are covered by the Mercedes-Benz Parts and Accessories warranties. These are available at any authorized Mercedes-Benz Center.

**i** Should you lose your Service and Warranty Information booklet, have an authorized Mercedes-Benz Center arrange for a replacement. The new Service and Warranty Information booklet will be mailed to you.

## Service and literature

The Limited Warranty for your vehicle applies in accordance with the warranty terms and conditions in the Service and Warranty Booklet. Your authorized Mercedes-Benz Center will exchange or repair any defective parts originally installed in the vehicle in accordance with the terms of the following warranties:

- New Vehicle Limited Warranty
- California, Connecticut, Maine, Massachusetts, New York, Pennsylvania, Rhode

Island and Vermont Emission Control Systems Warranty

- State warranty enforcement laws (lemon laws)

### Maintenance

The Service and Warranty Booklet describes all the necessary maintenance work which should be done at regular intervals.

Always have the Service and Warranty Booklet with you when you bring the vehicle to an authorized Mercedes-Benz Center. The service advisor will record every service for you in the Service and Warranty Booklet.

### Roadside Assistance

The Mercedes-Benz Roadside Assistance Program offers technical help in the event of a breakdown. Calls to the toll-free Roadside Assistance Hotline are answered by our agents 24 hours a day, 365 days a year.

**1-800-FOR-MERCEdes (1-800-367-6372) (USA)**

**1-800-387-0100 (Canada)**

For additional information, refer to the Mercedes-Benz Roadside Assistance Program brochure (USA) or the "Roadside Assistance" section in the Service and Warranty Booklet (Canada). You will find both in the vehicle document wallet.

### Change of address or change of ownership

In the event of a change of address, please send us the "Notification of Address Change" in the Service and Warranty Booklet or simply call the Mercedes-Benz Customer Assistance Center (USA) at the hotline number 1-800-FOR-MERCEdes (1-800-367-6372) or Customer Service Center (Canada) at 1-800-387-0100. This will assist us in con-

tacting you in a timely manner should the need arise.

If you sell your Mercedes, please leave all literature in the vehicle so that it is available to the next owner.

If you have purchased a used car, please send us the "Notification of Used Car Purchase" in the Service and Warranty Booklet or simply call the Mercedes-Benz Customer Assistance Center (USA) at the hotline number 1-800-FOR-MERCEdes (1-800-367-6372) or Customer Service (Canada) at 1-800-387-0100.

### Vehicle operation outside Canada

When you are abroad with your vehicle, observe the following points:

- service facilities or replacement parts may not be readily available.

Some Mercedes-Benz models are available for delivery in Europe through our European Delivery Program. For details, consult an authorized Mercedes-Benz Center or write to one of the following addresses.

#### In the USA

Mercedes-Benz USA, LLC  
European Delivery Department  
One Mercedes Drive  
Montvale, NJ 07645-0350

#### In Canada

Mercedes-Benz Canada, Inc.  
European Delivery Department  
98 Vanderhoof Avenue  
Toronto, Ontario M4G 4C9

### Operating safety

#### Important safety notes

#### WARNING

If you do not have the prescribed service/maintenance work or any required repairs

carried out, this can result in malfunctions or system failures. There is a risk of an accident. Always have the prescribed service/maintenance work as well as any required repairs carried out at a qualified specialist workshop.

### WARNING

If you switch off the ignition while driving, safety-relevant functions are only available with limitations, or not at all. This could affect, for example, the power steering and the brake boosting effect. You will require considerably more effort to steer and brake. There is a risk of an accident.

Do not switch off the ignition while driving.

### WARNING

Modifications to electronic components, their software as well as wiring can impair their function and/or the function of other networked components. In particular, systems relevant to safety could also be affected. As a result, these may no longer function as intended and/or jeopardize the operating safety of the vehicle. There is an increased risk of an accident and injury.

Never tamper with the wiring as well as electronic components or their software. You should have all work to electrical and electronic equipment carried out at a qualified specialist workshop.

If you make changes to electronic components, their software or wiring, the general operating permit for your vehicle may be rendered invalid.

**!** There is a risk of damage to the vehicle if:

- the vehicle becomes stuck, e.g. on a high curb or an unpaved road
- you drive too fast over an obstacle, e.g. a curb or a hole in the road
- a heavy object strikes the undercarriage or parts of the chassis

In situations like this, the body, the undercarriage, chassis parts, wheels or tires

could be damaged without the damage being visible. Components damaged in this way can unexpectedly fail or, in the case of an accident, no longer withstand the strain they are designed to.

In such situations, have the vehicle checked and repaired immediately at a qualified specialist workshop. If on continuing your journey you notice that driving safety is impaired, pull over and stop the vehicle immediately, paying attention to road and traffic conditions. In such cases, visit a qualified specialist workshop.

## Danger of electric shock

All of the vehicle's high-voltage electrical system components are marked with yellow warning stickers which warn you about high voltages. The cables of the vehicle's high-voltage electrical system are orange.



### DANGER

The vehicle's high voltage electrical system is under high voltage. If you modify components in the vehicle's high-voltage electrical system or touch damaged components, you may be electrocuted. The components in the vehicle's high-voltage electrical system may be damaged in an accident, although the damage is not visible. There is a risk of fatal injury.

Following an accident, do not touch any high-voltage components and never modify the vehicle's high-voltage electrical system. Have the vehicle towed away after an accident and the vehicle's high-voltage electrical system checked by a qualified specialist workshop.



When towing a vehicle after an accident, be sure to observe the following sections:

- Transporting the vehicle (> page 274)
- Towing the vehicle with the front axle raised (> page 273)
- Towing a vehicle with both axles on the ground (> page 273)

Read the safety instructions on towing and tow-starting (> page 271).

The ignition must be switched off when carrying out general tasks, such as changing bulbs or checking the coolant level.

### Automatic switching off of the vehicle's high-voltage electrical system

---

If the restraint systems are activated during an accident, the vehicle's high-voltage electrical system is automatically deactivated.

This is to ensure that you do not come into contact with high voltage.

### Automatic protection from switching on of the vehicle's high-voltage electrical system

---

The vehicle's high-voltage electrical system is not activated when the vehicle is started if:

- a serious electrical insulation malfunction is detected in the vehicle's high-voltage electrical system.
- an electrical connection in the vehicle's high-voltage electrical system is disconnected.

### Automatic switching off of the charging process

---

The charging process is deactivated automatically if:

- the high-voltage battery is fully charged.

The charging process is interrupted automatically if:

- a serious electrical insulation malfunction is detected in the vehicle's high-voltage electrical system.
- an electrical connection in the vehicle's high-voltage electrical system is disconnected.

### High-voltage switch-off device

---



Your vehicle is equipped with a high-voltage switch-off device ① which can be used to switch off the vehicle's high-voltage electrical system.

- ❗ The high-voltage system must only be switched off at vehicle standstill by specially trained service engineers. Otherwise the high-voltage system may be damaged.

### Mobile phone antenna

---

- ❗ It is not permitted to retrofit a mobile phone antenna.

### Trailer tow hitch

---

- ❗ Retrofitting a trailer tow hitch is not permissible.

### Warning

---

Vehicles with an electric motor generate much less driving noise than vehicles with internal combustion engines. As a result, when maneuvering or driving at low speeds for example, your vehicle is not heard by other

road users until it is very close, or may not even be heard at all. This is particularly the case if other road users have not yet seen your vehicle but are instead relying on hearing. Drive with particular care, allowing for the possibility that other road users may behave unpredictably.

The vehicle is equipped with a sound generator. At low speeds, an electric vehicle makes less noise than a vehicle with a combustion engine. The sound generator is activated so that other road users can hear your vehicle better. The sound generator is activated at speeds of under 20 mph (30 km/h) and switches off automatically at higher speeds.

### Declarations of conformity

#### Vehicle components which receive and/or transmit radio waves

**USA:** "The wireless devices of this vehicle comply with Part 15 of the FCC Rules. Operation is subject to the two following conditions: 1) These devices may not cause harmful interference, and 2) These devices must accept any interference received, including interference that may cause undesired operation. Changes or modifications not expressly approved by the party responsible for compliance could void the user's authority to operate the equipment."

**Canada:** "The wireless devices of this vehicle comply with Industry Canada license-exempt RSS standard(s). Operation is subject to the following two conditions: (1) These devices may not cause interference, and (2) These devices must accept any interference, including interference that may cause undesired operation of the device."

### Diagnostics connection

#### WARNING

If you connect equipment to the diagnostics connection in the vehicle, it may affect the

operation of the vehicle systems. As a result, the operating safety of the vehicle could be affected. There is a risk of an accident.

Do not connect any equipment to a diagnostics connection in the vehicle.

#### WARNING

Objects in the driver's footwell can restrict the pedal travel or obstruct a depressed pedal. The operating and road safety of the vehicle is jeopardized. There is a risk of an accident.

Make sure that all objects in the vehicle are stowed correctly, and that they cannot enter the driver's footwell. Install the floor mats securely and as specified in order to ensure sufficient clearance for the pedals. Do not use loose floor mats and do not place floor mats on top of one another.

 If equipment on the diagnostics connection is used, the starter battery may discharge.

The diagnostics connection is only intended for the connection of diagnostic equipment at a qualified specialist workshop.

### Routine checks and maintenance service

Bear in mind that you are legally obliged to carry out daily checks and regular inspections at your own responsibility. You can find further information about the individual inspection steps in the Maintenance Booklet.

### Qualified specialist workshop

An authorized Mercedes-Benz Center is a qualified specialist workshop. It has the necessary specialist knowledge, tools and qualifications to correctly carry out the work required on your vehicle. This is especially the case for work relevant to safety.

Observe the notes in the Maintenance Booklet.

Always have the following work carried out at an authorized Mercedes-Benz Center:

- work relevant to safety
- service and maintenance work
- repair work
- alterations, installation work and modifications
- work on electronic components
- work on the drive system

### Correct use

If you remove any warning stickers, you or others could fail to recognize certain dangers. Leave warning stickers in position.

Observe the following information when driving your vehicle:

- the safety notes in this manual
- the Technical Data section in this manual
- traffic rules and regulations
- laws and safety standards pertaining to motor vehicles

### Problems with your vehicle

If you should experience a problem with your vehicle, particularly one that you believe may affect its safe operation, we urge you to contact an authorized Mercedes-Benz Center immediately to have the problem diagnosed and rectified. If the problem is not resolved to your satisfaction, please discuss the problem again with the Mercedes-Benz Center or, if necessary, contact us at one of the following addresses.

#### In the USA

Customer Assistance Center  
Mercedes-Benz USA, LLC  
One Mercedes Drive  
Montvale, NJ 07645-0350

#### In Canada

Customer Relations Department  
Mercedes-Benz Canada, Inc.

98 Vanderhoof Avenue  
Toronto, Ontario M4G 4C9

### Reporting safety defects

USA only:

The following text is reproduced as required of all manufacturers under Title 49, Code of U.S. Federal Regulations, Part 575 pursuant to the National Traffic and Motor Vehicle Safety Act of 1966.

If you believe that your vehicle has a defect which could cause a crash or could cause injury or death, you should immediately inform the National Highway Traffic Safety Administration (NHTSA) in addition to notifying Mercedes-Benz USA, LLC.

If NHTSA receives similar complaints, it may open an investigation, and if it finds that a safety defect exists in a group of vehicles, it may order a recall and remedy campaign. However, NHTSA cannot become involved in individual problems between you, your dealer, or Mercedes-Benz USA, LLC.

To contact NHTSA, you may call the Vehicle Safety Hotline toll-free at 1-888-327-4236 (TTY: 1-800-424-9153); go to <http://www.safercar.gov>; or write to: Administrator, NHTSA, 400 Seventh Street, SW., Washington, DC 20590.

You can also obtain other information about motor vehicle safety from

<http://www.safercar.gov>

### Limited Warranty

- I** Follow the instructions in this manual about the proper operation of your vehicle as well as about possible vehicle damage. Damage to your vehicle that arises from culpable contraventions against these instructions is not covered either by the Mercedes-Benz Limited Warranty or by the New or Used-Vehicle Warranty.

### Data stored in the vehicle

#### Data recording

This vehicle is capable of recording diagnostic information relating to vehicle operation, malfunctions, and user settings. This may include information about the performance or status of various systems, including but not limited to, engine, throttle, steering or brake systems, that is stored and can be read out with suitable devices, particularly when the vehicle is serviced. The data obtained is used to properly diagnose and service your vehicle or to further optimize and develop vehicle functions.

#### COMAND/mbrace

If the vehicle is equipped with COMAND or mbrace, additional data about the vehicle's operation, the use of the vehicle in certain situations, and the location of the vehicle may be compiled through COMAND or the mbrace system.

For additional information please refer to the COMAND User Manual and/or the mbrace Terms and Conditions.

#### Event data recorders

This vehicle is equipped with an event data recorder (EDR). The main purpose of an EDR is to record data that will assist in understanding how a vehicle's systems performed in certain crash or near crash-like situations, such as during air bag deployment or when hitting a road obstacle. The EDR is designed to record data related to vehicle dynamics and safety systems for a short period of time, typically 30 seconds or less.

The EDR in this vehicle is designed to record such data as:

- how various systems in your vehicle are operating
- whether or not the driver and passenger seat belts are fastened

- how far (if at all) the driver is depressing the accelerator and/or brake pedal and
- how fast the vehicle is traveling

This data can help provide a better understanding of the circumstances in which crashes and injuries occur. NOTE: EDR data is recorded by your vehicle only if a non-trivial crash situation occurs; no data is recorded by the EDR under normal driving conditions and no personal data (e.g., name, gender, age, and crash location) are recorded. However, other parties, such as law enforcement, can combine the EDR data with the type of personal identification data routinely acquired during a crash investigation.

To read data recorded by an EDR, special equipment is required, and access to the vehicle or the EDR is needed. In addition to the vehicle manufacturer, other parties that have the special equipment, such as law enforcement, can read the information by accessing the vehicle or the EDR.

EDR data may be used in civil and criminal matters as a tool in accident reconstruction, accident claims, and vehicle safety. Since the Crash Data Retrieval CDR tool that is used to extract data from the EDR is commercially available, Mercedes-Benz USA, LLC ("MBUSA") expressly disclaims any and all liability arising from the extraction of this information by unauthorized Mercedes-Benz personnel.

MBUSA will not share EDR data with others without the consent of the vehicle owners or, if the vehicle is leased, without the consent of the lessee. Exceptions to this representation include responses to subpoenas by law enforcement; by federal, state or local government; in connection with or arising out of litigation involving MBUSA or its subsidiaries and affiliates; or, as required by law.

Warning: The EDR is a component of the Supplemental Restraint System ("SRS") Module. Tampering with, altering, modifying or removing the EDR component may result in a malfunction of the SRS Module and other systems.

State laws or regulations regarding EDRs that conflict with federal regulation are pre-empted. This means that in the event of such conflict, the federal regulation governs. As of February 2013, 13 states have enacted laws relating to EDRs.

### **Information on copyright**

#### **General information**

Information on license for free and open-source software used in your vehicle and its electronic components is available on the following website:

[http://www.mercedes-benz.com/  
opensource](http://www.mercedes-benz.com/opensource)



Cockpit .....	30
Instrument cluster .....	31
Multifunction steering wheel .....	33
Center console .....	34
Overhead control panel .....	36
Door control panel .....	37

## Cockpit



	Function	Page
①	Steering wheel paddle shifters	131
②	Combination switch	100
③	Instrument cluster	31
④	Horn	
⑤	DIRECT SELECT lever	129
⑥	PARKTRONIC warning display	155
⑦	Overhead control panel	36

	Function	Page
⑧	Climate control systems	114
⑨	Ignition lock	127
⑩	Adjusts the steering wheel	92
⑪	Cruise control lever	152
⑫	Electric parking brake	145
⑬	Light switch	98
⑭	Diagnostics connection	24
⑮	Opens the hood	252



## Instrument cluster

## Displays and controls



	Function	Page		Function	Page
①	Speedometer		⑤	Display for the condition of charge of the high-voltage battery	174
②	Multifunction display	176	⑥	Instrument cluster lighting	172
③	Power display	173			
④	E-CELL display	173			

## Warning and indicator lamps















	Function	Page
①	Low-beam head-lamps	99
②	Parking lamps	99
③	High-beam head-lamps	100
④	ESP®	221
⑤	Electric parking brake (red)	223
⑥	Electric parking brake (yellow)	223
⑦	Distance warning	225
⑧	Turn signals	100
⑨	Restraint system	224

	Function	Page
⑩	Seat belt	216
⑪	RBS (Recuperative Brake System)	218
⑫	Rear fog lamp	99
⑬	Drive system	207
⑭	Tire pressure monitor	226
⑮	High-voltage battery reserve	208
⑯	ESP® OFF	221
⑰	ABS	218
⑱	Brakes	218

## Multifunction steering wheel









	Function	Page		Function	Page
①	Multifunction display	176	⑤	  Selects a menu   Selects a submenu or scrolls through lists  Confirms your selection Hides display messages	174 174 174 190
②	Audio/COMAND display (see the separate operating instructions)		⑥	 Back Switches off the Voice Control System (see the separate operating instructions)	174
③	 Switches on the Voice Control System (see the separate operating instructions)				
④	 Rejects or ends a call Exits phone book/redial memory  Makes or accepts a call Switches to the redial memory   Adjusts the volume  Mute	181			

## Center console

## Center console, upper section



	Function	Page
①	Audio system/COMAND; see the separate operating instructions	
②	 Seat heating	91
③	 PARKTRONIC	155
④	 RANGE PLUS	136
⑤	 Hazard warning lamps	100
⑥	 PASSENGER AIR BAG OFF indicator lamp	49
⑦	 Drive program	134
⑧	 Immediate pre-entry climate control	122





## Center console, lower section







	Function	Page
①	Ashtray	236
	Cigarette lighter	236
	Socket	237
	Stowage compartment	228
②	Stowage compartment	228
③	Cup holder	234
④	Stowage compartment	228
⑤	Audio/COMAND controller; see the separate operating instructions	

## Overhead control panel











	Function	Page
①	 Switches the rear compartment interior lighting on/off	102
②	 Switches the right-hand reading lamp on/off	101
③	 Switches the front interior lighting/automatic interior lighting control off	102
④	 MB Info call button (mbrace system)	240
⑤	Rear-view mirror	93

	Function	Page
⑥	Buttons for the garage door opener	248
⑦	 SOS button (mbrace system)	238
⑧	 Roadside Assistance call button (mbrace system)	240
⑨	 Switches the front interior lighting on	102
⑩	 Switches the left-hand reading lamp on/off	101

## Door control panel



	Function	Page		Function	Page
①	Opens the door	77	⑤	 Adjusts the exterior mirrors electrically	93
②	  Unlocks/locks the vehicle	78	⑥	 Opens and closes the side windows	81
③	    Saves the seat and exterior mirror settings	95	⑦	 Activates/deactivates the override feature for the rear power side windows	62
④	Adjusts the seats electrically	89			





Useful information .....	40
Panic alarm .....	40
Occupant safety .....	40
Children in the vehicle .....	56
Pets in the vehicle .....	62
Driving safety systems .....	62
Theft deterrent locking system .....	69

## Useful information

**i** This Operator's Manual describes all models and all standard and optional equipment of your vehicle available at the time of publication of the Operator's Manual. Country-specific differences are possible. Bear in mind that your vehicle may not feature all functions described here. This also applies to safety-relevant systems and functions.

**i** Read the information on qualified specialist workshops: (▷ page 24).

## Panic alarm



▶ **To activate:** press **PANIC** button ① for at least one second.

An alarm sounds and the exterior lighting flashes.

▶ **To deactivate:** press **PANIC** button ① again.

or

▶ Insert the SmartKey into the ignition lock.

## Occupant safety

### Restraint system: introduction

The restraint system reduces the risk of vehicle occupants coming into contact with parts of the vehicle's interior in the event of an accident. The restraint system can also

reduce the forces to which vehicle occupants are subjected during an accident.

The restraint system comprises:

- Seat belt system
- Air bags
- Child restraint system
- Child seat securing systems

The components of the restraint system work in conjunction with each other. They can only deploy their protective function if, at all times, all vehicle occupants:

- have fastened their seat belts correctly (▷ page 43)
- have adjusted their seat and head restraint properly (▷ page 87).

As the driver, you also have to make sure that the steering wheel is adjusted correctly.

Observe the information relating to the correct driver's seat position (▷ page 86).

You also have to make sure that an air bag can inflate properly if deployed (▷ page 46).

An air bag supplements a correctly worn seat belt. As an additional safety device, the air bag increases the level of protection for vehicle occupants in the event of an accident. For example, if, in the event of an accident, the protection offered by the seat belt is sufficient, the air bags are not deployed. When an accident occurs, only the air bags that increase protection in that particular accident situation are deployed. However, seat belts and air bags generally do not protect against objects penetrating the vehicle from the outside.

Information on restraint system operation can be found under "Triggering of the Emergency Tensioning Device and air bags" (▷ page 54).

For more information about children traveling with you in the vehicle and on child restraint systems, see "Children in the vehicle" (▷ page 56).

## Important safety notes

### ⚠ WARNING

Modifications to the restraint system may cause it to no longer work as intended. The restraint system may then not perform its intended protective function and may fail in an accident or trigger unexpectedly, for example. This poses an increased risk of injury or even fatal injury.

Never modify parts of the restraint system. Never tamper with the wiring, the electronic components or their software.

If it is necessary to modify an air bag system to accommodate a person with disabilities, contact an authorized Mercedes-Benz Center for details. USA only: for further information contact our Customer Assistance Center at 1-800-FOR-MERCEDES (1-800-367-6372).

## Restraint system warning lamp

The functions of the restraint system are checked after the ignition is switched on and at regular intervals while the drive system is running. Therefore, malfunctions can be detected in good time.

The  restraint system warning lamp in the instrument cluster lights up when the ignition is switched on. It goes out no later than a few seconds after the drive system is started. The components of the restraint system are in operational readiness.

A malfunction has occurred if the  restraint system warning lamp:

- does not light up after the ignition is switched on
- does not go out after a few seconds with the drive system running
- lights up again while the drive system is running

### ⚠ DANGER

If the restraint system is malfunctioning, individual restraint system components may be triggered unintentionally or might not be trig-

gered at all in the event of an accident with a high rate of vehicle deceleration. This could affect Emergency Tensioning Devices or air bags, for example. The vehicle's high-voltage electrical system may also not be deactivated as intended in the event of an accident. You could suffer an electric shock if you touch the damaged components of the vehicle's high-voltage electrical system. This poses an increased risk of injury or even fatal injury.

Have the restraint system checked and repaired immediately at a qualified specialist workshop. Immediately switch off the ignition and remove the SmartKey from the ignition lock after an accident.

## PASSENGER AIR BAG indicator lamp



PASSENGER AIR BAG OFF indicator lamp ① and PASSENGER AIR BAG ON indicator lamp ② are part of the Occupant Classification System (OCS).

The indicator lamps display the status of the front-passenger front air bag.

- PASSENGER AIR BAG OFF ① lights up: the front-passenger front air bag is deactivated. It will then not be deployed in the event of an accident.
- PASSENGER AIR BAG ON ② lights up: the front-passenger front air bag is enabled. If, in the event of an accident, all deployment criteria are met, the front-passenger front air bag is deployed.

Depending on the person in the front-passenger seat, the front-passenger front air bag must either be disabled or enabled; see the following points. You must make sure of this both before and during a journey.

- **Children in a child restraint system:** whether the front-passenger front air bag is enabled or deactivated depends on the installed child restraint system, and the age and size of the child. Therefore, be sure to observe the notes on the "Occupant Classification System (OCS)" (▷ page 49) and on "Children in the vehicle" (▷ page 56). There you will also find instructions on rearward and forward-facing child restraint systems on the front-passenger seat.
- **All other persons:** depending on the classification of the person in the front-passenger seat, the front-passenger front air bag is enabled or deactivated (▷ page 49). Be sure to observe the notes on "Seat belts" (▷ page 42) and "Air bags" (▷ page 46). There you can also find information on the correct seat position.

## Seat belts

### Introduction

Seat belts are the most effective means of restricting the movement of vehicle occupants in the event of an accident or the vehicle rolling over. This reduces the risk of vehicle occupants coming into contact with parts of the vehicle interior or being ejected from the vehicle. Furthermore, the seat belt helps to keep the vehicle occupant in the best position in relation to the air bag.

The seat belt system comprises:

- Seat belts
- Emergency Tensioning Devices for the front seat belts and the outer seat belts in the rear
- Seat belt force limiters for the front seat belts and the outer seat belts in the rear

If the seat belt is pulled out of the belt outlet quickly or with a jerky movement, the belt retractor locks. The belt strap cannot be extracted any further.

The Emergency Tensioning Device tightens the seat belt in an accident, pulling the belt close against the body. However it does not pull the vehicle occupant back in the direction of the backrest.

The Emergency Tensioning Device does not correct an incorrect seat position or the routing of an incorrectly fastened seat belt.

When triggered, seat belt force limiters help to reduce the force exerted by the seat belt on the vehicle occupant.

The seat belt force limiters for the front seats are synchronized with the front air bags, which absorb part of the deceleration force. This can reduce the force exerted on the vehicle occupants during an accident.

**!** If the front-passenger seat is unoccupied, do not insert the belt tongue into the buckle of the front-passenger seat. This may otherwise lead to the triggering of the Emergency Tensioning Device in the event of an accident, which will then need to be replaced.

### Important safety notes

The use of seat belts and child restraint systems is required by law in:

- all 50 states
- the U.S. territories
- the District of Columbia
- all Canadian provinces

Even where this is not required by law, all vehicle occupants should correctly fasten their seat belts before starting the journey.

#### WARNING

If the seat belt is incorrectly fastened, it cannot protect as intended. Furthermore, an incorrectly fastened seat belt can cause additional injury, for example, in an accident, during braking or when abruptly changing direc-

tion. This poses an increased risk of injury or even fatal injury.

Make sure that all vehicle occupants are seated properly with a correctly fastened seat belt.

### WARNING

The seat belt does not offer the intended level of protection if you have not moved the backrest to an almost vertical position. When braking or in the event of an accident, you could slide underneath the seat belt and sustain abdomen or neck injuries, for example. This poses an increased risk of injury or even fatal injury.

Adjust the seat properly before beginning your journey. Always ensure that the backrest is in an almost vertical position and that the shoulder section of your seat belt is routed across the center of your shoulder.

### WARNING

Persons under 5 ft (1.50 m) in height cannot fasten the seat belt correctly without an additional suitable restraint system. If the seat belt is incorrectly fastened, it cannot protect as intended. Furthermore, an incorrectly fastened seat belt can cause additional injury, for example, in an accident, during braking or an abrupt change of direction. This poses an increased risk of injury or even fatal injury.

For this reason, always secure persons under 5 ft (1.50 m) in height in suitable restraint systems.

If a child younger than 12 years and under 5 ft (1.50 m) in height is traveling in the vehicle:

- always secure the child in a child restraint system suitable for this Mercedes-Benz vehicle. The child restraint system must be appropriate to the age, weight and size of the child
- always observe the instructions and safety notes in the "Children in the vehicle" section of this Operator's Manual (> page 56) in addition to the child

restraint system manufacturer's installation instructions

- be sure to observe the instructions and safety notes on the "Occupant classification system (OCS)" (> page 49)

### WARNING

The seat belts may not perform their intended protective function if:

- they are damaged, modified, extremely dirty, bleach or dyed
- the seat belt buckle is damaged or extremely dirty
- the Emergency Tensioning Devices, belt anchorages or inertia reels have been modified

Seat belts may sustain non-visible damage in an accident, e.g. due to glass splinters. Modified or damaged seat belts may tear or fail, e.g. in an accident. Modified Emergency Tensioning Devices could accidentally trigger or fail to deploy when necessary. This poses an increased risk of injury or even fatal injury.

Never modify the seat belts, Emergency Tensioning Devices, belt anchorages or inertia reels. Make sure that the seat belts are undamaged, not worn out and clean. Following an accident, have the seat belts checked immediately at a qualified specialist workshop.

Only use seat belts that have been approved for your vehicle by Mercedes-Benz. Any such modifications could invalidate the vehicle's general operating permit.

## Proper use of the seat belts

Observe the safety notes on the seat belt (> page 42).

All vehicle occupants must be wearing the seat belt correctly before beginning the journey. Also make sure that all vehicle occupants are always wearing the seat belt correctly while the vehicle is in motion.

When fastening the seat belt, always make sure that:

- the seat belt tongue is only inserted to the belt buckle belonging to that seat.
- the seat belt is tight across your body. Avoid wearing bulky clothing, e.g. a winter coat.
- the seat belt is not twisted.

Only then can the forces which occur be distributed over the area of the belt.

- the shoulder section of the belt is always routed across the center of your shoulder. The shoulder section of the belt must not come into contact with your neck or be routed under your arm. Where possible, adjust the seat belt to the appropriate height.

- the lap belt passes tightly and as low down as possible across your lap.

The lap belt must always be routed across your hip joints and not across your abdomen. This applies particularly to pregnant women. If necessary, push the lap belt down to your hip joint and pull it tight using the shoulder section of the belt.

- the seat belt is not routed across sharp, pointed or fragile objects. If you have such items located on or in your clothing, e.g. pens, keys or eyeglasses, store these in a suitable place.

- only one person is using a seat belt at a time.

Infants and children must never travel sitting on the lap of a vehicle occupant. In the event of an accident, they could be crushed between the vehicle occupant and seat belt.

- objects are never secured with a seat belt if the seat belt is also being used by one of the vehicle's occupants.

Seat belts are only intended to secure and restrain vehicle occupants. Always observe the "Loading guidelines" for securing objects, luggage or loads (▷ page 228).

## Fastening and adjusting the seat belts

Observe the safety notes on the seat belt (▷ page 42) and the notes on correct use of seat belts (▷ page 43).

If the center rear seat belt is being used, also observe the information about the seat belt for the center rear seat (▷ page 45).



- ▶ Adjust the seat (▷ page 86). The seat backrest must be in an almost vertical position.
- ▶ Pull the seat belt smoothly from belt outlet ③.
- ▶ Engage seat belt tongue ② in belt buckle ①.
- ▶ If necessary, pull upwards on the shoulder section of the seat belt to tighten the belt across your body.



The shoulder section of the seat belt must always be routed across the center of the shoulder. Adjust the belt outlet if necessary.

- ▶ **To raise:** slide the belt outlet upwards.  
The belt outlet will engage in various positions.
- ▶ **To lower:** hold belt outlet release ① and slide the belt outlet downwards.
- ▶ Let go of belt outlet release ① in the desired position and make sure that the belt outlet engages.

All seat belts except the driver's seat belt are equipped with a special seat belt retractor to securely fasten child restraint systems in the vehicle. Further information can be found under "Special seat belt retractor" (▷ page 57).

### Seat belt for the center rear seat

If the left-hand rear seat backrest is folded down and back up again, the rear center seat belt may lock. The seat belt can then not be pulled out.

- ▶ **To release the rear center seat belt:** pull the seat belt out approximately 1 in (25 mm) at the belt outlet on the backrest and then release it again.  
The seat belt is retracted and released.

### Releasing seat belts



- ❗ Make sure that the seat belt is fully rolled up. Otherwise, the seat belt or belt tongue will be trapped in the door or in the seat mechanism. This could damage the door, the door trim panel and the seat belt. Damaged seat belts can no longer fulfill their protective function and must be replaced. Visit a qualified specialist workshop.



- ▶ Press release button ①, hold belt tongue ② firmly and guide it back towards belt outlet ③.

### Belt warning for the driver and front passenger

The  seat belt warning lamp in the instrument cluster is a reminder that all occupants must fasten their seat belts. It may light up continuously or flash. In addition, there may be a warning tone.

Regardless of whether the driver's seat belt has already been fastened, the  seat belt warning lamp lights up for six seconds each time the drive system is started. If the front doors are closed and the driver or front-passenger seat belt has not been fastened, the  seat belt warning lamp lights up again after the six seconds. As soon as the driver's and front-passenger seat belts are fastened or a front door is opened again, the  seat belt warning lamp goes out.

If the driver's seat belt is not fastened after the drive system is started, an additional warning tone will sound. The warning tone switches off after six seconds or once the driver's seat belt is fastened.

If the vehicle's speed exceeds 15 mph (25 km/h) once and the driver's and front-passenger seat belts are not fastened, a



warning tone sounds. The warning tone sounds with increasing intensity for 60 seconds or until the driver or front passenger have fastened their seat belts. If the driver or front passenger unfasten their seat belts during the journey, the seat belt warning is activated again.

- **i** For more information on the  seat belt warning lamp, see "Warning and indicator lamps in the instrument cluster, seat belts" (▷ page 216).

## Air bags

### Introduction

The installation point of an air bag can be recognized by the AIR BAG symbol.

An air bag complements the correctly fastened seat belt. It is no substitute for the seat belt. The air bag provides additional protection in applicable accident situations.

Not all air bags are deployed in an accident. The different air bag systems function independently from one another (▷ page 54).

However, no system available today can completely eliminate injuries and fatalities.

It is also not possible to rule out a risk of injury caused by an air bag due to the high speed at which the air bag must be deployed.

### Important safety notes

#### WARNING

If you do not sit in the correct seat position, the air bag cannot protect as intended and could even cause additional injury when deployed. This poses an increased risk of injury or even fatal injury.

To avoid hazardous situations, always make sure that all of the vehicle's occupants:

- have fastened their seat belts correctly, including pregnant women
- are sitting correctly and maintain the greatest possible distance to the air bags
- follow the following instructions

Always make sure that there are no objects between the air bag and the vehicle's occupants.

- Adjust the seats properly before beginning your journey. Always make sure that the seat is in an almost upright position. The center of the head restraint must support the head at about eye level.
- Move the driver's and front-passenger seats as far back as possible. The driver's seat position must allow the vehicle to be driven safely.
- Only hold the steering wheel on the outside. This allows the air bag to be fully deployed.
- Always lean against the backrest while driving. Do not lean forwards or lean against the door or side window. You may otherwise be in the deployment area of the air bags.
- Always keep your feet in the footwell in front of the seat. Do not put your feet on the dashboard, for example. Your feet may otherwise be in the deployment area of the air bag.
- For this reason, always secure persons less than 5 ft (1.50 m) tall in suitable restraint systems. Up to this height, the seat belt cannot be worn correctly.

#### **If a child is traveling in your vehicle, also observe the following notes:**

- Always secure children under 12 years of age and less than 5 ft (1.50 m) in height in suitable child restraint systems.
- Child restraint systems should be installed on the rear seats.



- Only secure a child in a rearward-facing child restraint system on the front-passenger seat when the front-passenger front air bag is deactivated. If the PASSENGER AIR BAG OFF indicator lamp is permanently lit, the front-passenger front air bag is deactivated (▷ page 41).
- Always observe the instructions and safety notes on the "Occupant Classification System (OCS)" (▷ page 49) and on "Children in the vehicle" (▷ page 56) in addition to the child restraint system manufacturer's installation instructions.

**Objects in the vehicle interior may prevent the air bag from functioning correctly.** Before starting your journey and to avoid risks resulting from the speed of the air bag as it deploys, make sure that:

- there are no people, animals or objects between the vehicle occupants and an air bag.
- there are no objects between the seat, door and B-pillar.
- no hard objects, e.g. coat hangers, hang on the grab handles or coat hooks.
- no accessories, such as cup holders, are attached to the vehicle within the deployment area of an air bag, e.g. to doors, side windows, rear side trim or side walls.
- no heavy, sharp-edged or fragile objects are in the pockets of your clothing. Store such objects in a suitable place.

#### WARNING

If you modify the air bag cover or affix objects such as stickers to it, the air bag can no longer function correctly. There is an increased risk of injury.

Never modify an air bag cover or affix objects to it.

#### WARNING

Sensors to control the air bags are located in the doors. Modifications or work not performed correctly to the doors or door paneling, as well as damaged doors, can lead to the

function of the sensors being impaired. The air bags might therefore not function properly any more. Consequently, the air bags cannot protect vehicle occupants as they are designed to do. There is an increased risk of injury.

Never modify the doors or parts of the doors. Always have work on the doors or door paneling carried out at a qualified specialist workshop.

## Front air bags



Driver's air bag ① deploys in front of the steering wheel; front-passenger front air bag ② deploys in front of and above the glove box.

When deployed, the front air bags offer additional head and thorax protection for the occupants in the front seats.

The PASSENGER AIR BAG OFF and PASSENGER AIR BAG ON indicator lamps inform you about the status of the front-passenger front air bag (▷ page 41).

Front-passenger front air bag ② will only deploy if:

- the system, based on the OCS weight sensor readings, detects that the front-passenger seat is occupied (▷ page 49). The PASSENGER AIR BAG ON indicator lamp is lit (▷ page 49)
- the restraint system control unit predicts a high accident severity

### Driver's knee bag



Driver's knee bag ① deploys under the steering column. The driver's knee bag is triggered together with the front air bag.

The driver's knee bag offers additional thigh, knee and lower leg protection for the occupant in the driver's seat.

### Side impact air bags

#### WARNING

Unsuitable seat covers could restrict or even prevent the deployment of the air bags integrated into the seats. Consequently, the air bags cannot protect vehicle occupants as they are designed to do. In addition, the function of the Occupant Classification System (OCS) could be restricted. This poses an increased risk of injury or even fatal injury.

You should only use seat covers that have been approved for the respective seat by Mercedes-Benz.



Side impact air bags ① deploy next to the outer bolsters of the seat backrests.

When deployed, the side impact air bag offers additional thorax and pelvis protection. However, it does not protect the:

- head
- neck
- arms

In the event of a side impact, the side impact air bag is deployed on the side on which the impact occurs.

The side impact air bag on the front-passenger side (front) deploys in the following situations:

- the OCS system detects that the front-passenger seat is occupied or
- the belt tongue is engaged in the belt buckle of the front-passenger seat

If the belt tongue is engaged in the belt buckle, the side impact air bag on the front-passenger side deploys if an appropriate accident situation occurs. In this case, deployment is independent of whether the front-passenger seat is occupied or not.

### Window curtain air bags



Window curtain air bags ① are integrated into the side of the roof frame and deployed in the area from the A-pillar to the C-pillar.

When deployed, the window curtain air bag enhances the level of protection for the head. However, it does not protect the chest or arms.

In the event of a side impact, the window curtain air bag is deployed on the side on which the impact occurs.

If the system determines that they can offer additional protection to that provided by the seat belt, a window curtain air bag may be deployed in other accident situations (▷ page 54).

## Occupant Classification System (OCS)

### Introduction

The Occupant Classification System (OCS) categorizes the person in the front-passenger seat. Depending on that result, the front-passenger front air bag is either enabled or deactivated.

The system does not deactivate:

- the side impact air bag
- the window curtain air bag
- the Emergency Tensioning Devices

### Prerequisites

To be classified correctly, the front passenger must sit:

- with the seat belt fastened correctly
- in an almost upright position with their back against the seat backrest
- with their feet resting on the floor, if possible

If the front passenger does not observe these conditions, OCS may produce a false classification, e.g. because the front passenger:

- transfers their weight by supporting themselves on a vehicle armrest
- sits in such a way that their weight is raised from the seat cushion

If it is absolutely necessary to install a child restraint system on the front-passenger seat, be sure to observe the correct positioning of the child restraint system. Never place objects under or behind the child restraint system, e.g. cushions. The entire base of the child restraint system must always rest on the seat cushion of the front-passenger seat. The

backrest of the forwards-facing child restraint system must, as far as possible, be resting on the backrest of the front-passenger seat.

The child restraint system must not touch the roof or be put under strain by the head restraint. Adjust the angle of the seat backrest and the head restraint position accordingly.

Only then can OCS be guaranteed to function correctly. Always observe the child restraint system manufacturer's installation instructions.

### Occupant Classification System operation (OCS)



- ① PASSENGER AIR BAG OFF indicator lamp
- ② PASSENGER AIR BAG ON indicator lamp

The indicator lamps inform you whether the front-passenger front air bag is deactivated or enabled.

- Turn the SmartKey to position **1** or **2** in the ignition lock.

The system carries out self-diagnostics.

The PASSENGER AIR BAG OFF and PASSENGER AIR BAG ON indicator lamps must light up simultaneously for approximately six seconds.

The indicator lamps display the status of the front-passenger front air bag.

- PASSENGER AIR BAG OFF ① lights up: the front-passenger front air bag is deactiva-

ted. It will then not be deployed in the event of an accident.

- PASSENGER AIR BAG ON ② lights up: the front-passenger front air bag is enabled. If, in the event of an accident, all deployment criteria are met, the front-passenger front air bag is deployed.

If the status of the front-passenger front air bag changes while the vehicle is in motion, an air bag display message appears in the instrument cluster (▷ page 203). When the front-passenger seat is occupied, always pay attention to the PASSENGER AIR BAG ON and PASSENGER AIR BAG OFF indicator lamps. Be aware of the status of the front-passenger front air bag both before and during the journey.

#### WARNING

If the PASSENGER AIR BAG OFF indicator lamp is lit, the front-passenger front air bag is disabled. It will not be deployed in the event of an accident and cannot perform its intended protective function. A person in the front-passenger seat could then, for example, come into contact with the vehicle's interior, especially if the person is sitting too close to the dashboard. This poses an increased risk of injury or even fatal injury.

When the front-passenger seat is occupied, always ensure that:

- the classification of the person in the front-passenger seat is correct and the front-passenger front air bag is enabled or disabled in accordance with the person in the front-passenger seat
- the front-passenger seat has been moved back as far back as possible.
- the person is seated correctly.

Make sure, both before and during the journey, that the status of the front-passenger front air bag is correct.

#### WARNING

If you secure a child in a rearward-facing child restraint system on the front-passenger seat

and the PASSENGER AIR BAG ON indicator lamp is lit up, the front-passenger front air bag may deploy in an accident. The child could be struck by the air bag. This poses an increased risk of injury or even fatal injury.

Make sure that the front-passenger front air bag has been disabled. The PASSENGER AIR BAG OFF indicator lamp must be lit.

If the PASSENGER AIR BAG OFF indicator lamp remains off and/or the PASSENGER AIR BAG ON indicator lamp lights up, do not install a rearward-facing child restraint system on the front-passenger seat. You can find more information on OCS under "Problems with the Occupant Classification System" (▷ page 53).

#### WARNING

If you secure a child in a forward-facing child restraint system on the front-passenger seat and you position the front-passenger seat too close to the dashboard, in the event of an accident, the child could:

- come into contact with the vehicle's interior if the PASSENGER AIR BAG OFF indicator lamp is lit, for example
- be struck by the air bag if the PASSENGER AIR BAG ON is lit up

This poses an increased risk of injury or even fatal injury.

Move the front-passenger seat as far back as possible. Always make sure that the shoulder belt strap is correctly routed from the vehicle belt outlet to the shoulder belt guide on the child restraint system. The shoulder belt strap must be routed forwards and downwards from the vehicle belt outlet. If necessary, adjust the vehicle belt outlet and the front-passenger seat accordingly. Always observe the child restraint system manufacturer's installation instructions.

If OCS determines that:

- the front-passenger seat is unoccupied, the PASSENGER AIR BAG OFF indicator lamp lights up after the system self-test and

remains lit. This indicates that the front-passenger front air bag is deactivated.

- the front-passenger seat is occupied by a child of up to 12 months old in a standard child restraint system, the PASSENGER AIR BAG OFF indicator lamp lights up after the system self-test and remains lit. This indicates that the front-passenger front air bag is deactivated.

But in the case of a 12-month-old child in a standard child restraint system, the PASSENGER AIR BAG ON can light up permanently after the system self-test. This indicates that the front-passenger front air bag is activated. The result of the classification is dependent on, among other factors, the child restraint system and the child's stature. It is recommended that you install the restraint system on a suitable rear seat.

- the front-passenger seat is occupied by a person of smaller stature (e.g. a teenager or small adult), either the PASSENGER AIR BAG ON or PASSENGER AIR BAG OFF indicator lamp lights up and remains lit after the system self-test depending on the result of the classification.
  - If the PASSENGER AIR BAG ON indicator lamp lights up, move the front-passenger seat as far back as possible. Alternatively, a person of smaller stature can sit on a rear seat.
  - If the PASSENGER AIR BAG OFF indicator lamp is lit, a person of smaller stature should not use the front-passenger seat.
- the front-passenger seat is occupied by an adult or a person of a stature corresponding to that of an adult, the PASSENGER AIR BAG ON indicator lamp lights up after the system self-test and remains lit. This indicates that the front-passenger front air bag is activated.

If children are traveling in the vehicle, be sure to observe the notes on "Children in the vehicle" (▷ page 56).

When OCS is malfunctioning, the red  restraint system warning lamp in the instrument cluster and the PASSENGER AIR BAG OFF indicator lamp light up simultaneously. The front-passenger front air bag is deactivated in this case and does not deploy during an accident. Have the system checked by qualified technicians as soon as possible. Consult an authorized Mercedes-Benz Center. The front-passenger seat should only be repaired at an authorized Mercedes-Benz Center.

If the front-passenger seat, the seat cover or the seat cushion is damaged, have the necessary repair work carried out at an authorized Mercedes-Benz Center.

For safety reasons, Mercedes-Benz recommends that you only use seat accessories that have been approved by Mercedes-Benz. If the driver's air bag deploys, this does not mean that the front-passenger front air bag will also deploy. The Occupant Classification System (OCS) categorizes the occupant in the front-passenger seat. Depending on that result, the front-passenger front air bag is either enabled or deactivated.

### System self-test

#### DANGER

If both the PASSENGER AIR BAG OFF and PASSENGER AIR BAG ON indicator lamps do not light up during the system self-test, the system is malfunctioning. The front-passenger front air bag might be triggered unintentionally or might not be triggered at all in the event of an accident with high deceleration. This poses an increased risk of injury or even fatal injury.

In this case the front-passenger seat may not be used. Do not install a child restraint system on the front-passenger seat. Have the Occupant Classification System (OCS) checked and repaired immediately at a qualified specialist workshop.

**⚠ DANGER**

If the PASSENGER AIR BAG OFF indicator lamp remains lit after the system self-test, the front-passenger front air bag is disabled. It will not be deployed in the event of an accident. In this case, the front-passenger front air bag cannot perform its intended protective function, e.g. when a person is seated in the front-passenger seat.

That person could, for example, come into contact with the vehicle's interior, especially if the person is sitting too close to the dashboard. This poses an increased risk of injury or even fatal injury.

When the front-passenger seat is occupied, always ensure that:

- the classification of the person in the front-passenger seat is correct and the front-passenger front air bag is enabled or disabled in accordance with the person in the front-passenger seat
- the person is seated properly with a correctly fastened seatbelt
- the front-passenger seat has been moved back as far back as possible

If the PASSENGER AIR BAG OFF indicator lamp remains lit when it should not, the front-passenger seat may not be used. Do not install a child restraint system on the front-passenger seat. Have the Occupant Classification System (OCS) checked and repaired immediately at a qualified specialist workshop.

**⚠ WARNING**

Objects between the seat surface and the child restraint system could affect OCS operation. This could result in the front-passenger air bag not functioning as intended during an accident. This poses an increased risk of injury or even fatal injury.

Do not place any objects between the seat surface and the child restraint system. The entire base of the child restraint system must always rest on the seat cushion of the front-passenger seat. The backrest of the forwards-

facing child restraint system must, as far as possible, be resting on the backrest of the front-passenger seat. Always comply with the child restraint system manufacturer's installation instructions.

After the system self-test, the PASSENGER AIR BAG OFF or PASSENGER AIR BAG ON indicator lamp display the status of the front-passenger front air bag (> page 49).

For more information about the OCS, see "Problems with the Occupant Classification System" (> page 53).

## Problems with the Occupant Classification System (OCS)

Be sure to observe the notes on "System self-test" (▷ page 51).

Problem	Possible causes/consequences and ► Solutions
<p>The PASSENGER AIR BAG OFF indicator lamp lights up and remains lit, even though the front-passenger seat is occupied by an adult or a person of a stature corresponding to that of an adult.</p>	<p>The classification of the person on the front-passenger seat is incorrect.</p> <ul style="list-style-type: none"> <li>▶ Make sure the conditions for a correct classification of the person on the front-passenger seat are met (▷ page 49).</li> <li>▶ If the PASSENGER AIR BAG OFF indicator lamp remains lit, the front-passenger seat may not be used.</li> <li>▶ Have OCS checked as soon as possible at an authorized Mercedes-Benz Center.</li> </ul>
<p>The PASSENGER AIR BAG OFF indicator lamp does not light up and/or does not stay on.</p> <p>The front-passenger seat is:</p> <ul style="list-style-type: none"> <li>• unoccupied</li> <li>• occupied by the weight of a child up to 12 months old in a child restraint system</li> </ul>	<p>OCS is malfunctioning.</p> <ul style="list-style-type: none"> <li>▶ Make sure there is nothing between the seat cushion and the child seat.</li> <li>▶ Make sure that the entire base of the child restraint system rests on the seat cushion of the front-passenger seat. The backrest of the forward-facing child restraint system must lie as flat as possible against the backrest of the front-passenger seat. If necessary, adjust the position of the front-passenger seat.</li> <li>▶ When installing the child restraint system, make sure that the seat belt is tight. Do not pull the seat belt tight using the front-passenger seat adjustment. This could result in the seat belt and the child restraint system being pulled too tightly.</li> <li>▶ Check for correct installation of the child restraint system.</li> <li>▶ Make sure that no objects are applying additional weight onto the seat.</li> <li>▶ If the PASSENGER AIR BAG OFF indicator lamp remains off and/or the PASSENGER AIR BAG ON indicator lamp lights up, do not install a child restraint system on the front-passenger seat. It is recommended that you install the restraint system on a suitable rear seat.</li> <li>▶ Have OCS checked as soon as possible at an authorized Mercedes-Benz Center.</li> </ul>



## Deployment of Emergency Tensioning Devices and air bags

### Important safety notes

#### WARNING

The air bag parts are hot after an air bag has been deployed. There is a risk of injury.

Do not touch the air bag parts. Have a deployed air bag replaced at a qualified specialist workshop as soon as possible.

#### WARNING

A deployed air bag no longer offers any protection and cannot provide the intended protection in an accident. There is an increased risk of injury.

Have the vehicle towed to a qualified specialist workshop in order to have a deployed air bag replaced.

It is important for your safety and that of your passenger to have deployed air bags replaced and to have any malfunctioning air bags repaired. This will help to make sure the air bags continue to perform their protective function for the vehicle occupants in the event of a crash.

#### WARNING

Pyrotechnic Emergency Tensioning Devices that have been deployed are no longer operational and are unable to perform their intended protective function. This poses an increased risk of injury or even fatal injury.

Therefore, have pyrotechnic Emergency Tensioning Devices which have been triggered immediately replaced at a qualified specialist workshop.

If Emergency Tensioning Devices or air bags are deployed, you will hear a bang, and a small amount of powder may also be released. The  restraint system warning lamp lights up.

Only in rare cases will the bang affect your hearing. The powder that is released generally does not constitute a health hazard, but it may cause short-term breathing difficulties in

people with asthma or other respiratory problems. To avoid this, you may wish to get out of the vehicle or open the windows as soon as it is safe to do so.

Air bags and pyrotechnic Emergency Tensioning Devices (ETDs) contain perchlorate material, which may require special handling and regard for the environment. National guidelines must be observed during disposal. In California, see [www.dtsc.ca.gov/HazardousWaste/Perchlorate/index.cfm](http://www.dtsc.ca.gov/HazardousWaste/Perchlorate/index.cfm).

### Method of operation

During the first stage of a collision, the restraint system control unit evaluates important physical data relating to vehicle deceleration or acceleration, such as:

- duration
- direction
- intensity

Based on the evaluation of this data, the restraint system control unit deploys the Emergency Tensioning Devices during a frontal or rear collision.

An Emergency Tensioning Device can only be deployed, if:

- the ignition is switched on
- the components of the restraint system are operational; see "Restraint system warning lamp" (▷ page 41)
- the belt tongue is engaged in the buckle on the respective front-passenger seat

The Emergency Tensioning Devices in the rear compartment are deployed independently of the lock status of the seat belts.



If the restraint system control unit detects a more severe accident, further components of the restraint system are activated independently of each other in certain frontal collision situations:

- Front air bags and driver's knee bag
- Window curtain air bag, if the system determines that deployment can offer additional protection to that provided by the seat belt

The front-passenger front air bag is activated or deactivated depending on the person on the front-passenger seat. The front-passenger front air bag can only deploy in an accident if the PASSENGER AIR BAG ON indicator lamp is lit. Observe the information on the PASSENGER AIR BAG indicator lamps (▷ page 41).

Your vehicle has two-stage front air bags. During the first deployment stage, the front air bag is filled with propellant gas to reduce the risk of injuries. The front air bag is fully deployed with the maximum amount of propellant gas if a second deployment threshold is reached within a few milliseconds.

The deployment threshold of the Emergency Tensioning Devices and the air bag are determined by evaluating the rate of vehicle deceleration or acceleration which occurs at various points in the vehicle. This process is pre-emptive in nature. Deployment should take place in good time at the start of the collision.

The rate of vehicle deceleration or acceleration and the direction of the force are essentially determined by:

- the distribution of forces during the collision
- the collision angle
- the deformation characteristics of the vehicle
- the characteristics of the object with which the vehicle has collided

Factors which can only be seen and measured after a collision has occurred do not play a decisive role in the deployment of an air bag,

nor do they provide an indication of air bag deployment.

The vehicle can be deformed considerably, without an air bag being deployed. This is the case if only parts which are relatively easily deformed are affected and the rate of deceleration is not high. Conversely, air bags may be deployed even though the vehicle suffers only minor deformation. This is the case if, for example, very rigid vehicle parts such as longitudinal body members are hit, and sufficient deceleration occurs as a result.

If the restraint system control unit detects a side impact or that the vehicle is rolling over, the relevant restraint system components are activated independently of one another depending on the apparent type of accident. If the system determines a need for additional protection for the vehicle occupants, the Emergency Tensioning Devices are deployed.

- Side impact air bag on the side of impact, independently of the Emergency Tensioning Device and the use of the seat belt on the driver's seat

The side impact air bag on the front-passenger side deploys under the following conditions:

- the OCS system detects that the front-passenger seat is occupied or
- the belt tongue is engaged in the belt buckle of the front-passenger seat
- Window curtain air bag on the side of impact, independently of the use of the seat belt and independently of whether the front-passenger seat is occupied
- Window curtain air bags on the driver's and front-passenger side in certain situations when the vehicle rolls over, if the system determines that deployment can offer additional protection to that provided by the seat belt

**i** Not all air bags are deployed in an accident. The different air bag systems work independently of each other.

How the air bag system works is determined by the severity of the accident detected, especially the vehicle deceleration or acceleration and the apparent type of accident:

- frontal collision
- side impact
- rollover

### Automatic measures after an accident

Immediately after an accident, the following measures are implemented, depending on the type and severity of the impact:

- the hazard warning lamps are activated
- the emergency lighting is activated
- the vehicle doors are unlocked
- the front side windows are lowered
- the drive system is deactivated
- vehicles with mbrace: automatic emergency call

## Children in the vehicle

### Important safety notes

Accident statistics show that children secured in the rear seats are safer than children secured in the front-passenger seat. For this reason, Mercedes-Benz strongly advises that you install a child restraint system on a rear seat. Children are generally better protected there.

If a child younger than 12 years and under 5 ft (1.50 m) in height is traveling in the vehicle:

- always secure the child in a child restraint system suitable for Mercedes-Benz vehicles. The child restraint system must be appropriate to the age, weight and size of the child
- be sure to observe the instructions and safety notes in this section in addition to

the child restraint system manufacturer's installation instructions

- be sure to observe the instructions and safety notes on the "Occupant classification system (OCS)" (▷ page 49)

### WARNING

If children are left unsupervised in the vehicle, they could:

- open the doors, thus endangering other people or road users.
- get out and disrupt traffic.
- operate the vehicle's equipment.

Additionally, children could set the vehicle in motion if, for example, they:

- release the parking brake.
- shift the transmission out of park position **P**
- start the vehicle's drive system.

There is a risk of an accident and injury.

When leaving the vehicle, always take the SmartKey with you and lock the vehicle. Never leave children or animals unattended in the vehicle. Always keep the SmartKey out of reach of children.

### WARNING

If persons, particularly children are subjected to prolonged exposure to extreme heat or cold, there is a risk of injury, possibly even fatal. Never leave children unattended in the vehicle.

### WARNING

If the child restraint system is subjected to direct sunlight, parts may get very hot. Children may burn themselves on these parts, particularly on the metal parts of the child restraint system. There is a risk of injury.

If you leave the vehicle, taking the child with you, always ensure that the child restraint system is not exposed to direct sunlight. Protect it with a blanket, for example. If the child restraint system has been exposed to direct sunlight, let it cool down before securing the

child in it. Never leave children unattended in the vehicle.

Always ensure that all vehicle occupants have their seat belts fastened correctly and are sitting properly. Particular attention must be paid to children.

Observe the safety notes on the seat belt (▷ page 42) and the notes on correct use of seat belts (▷ page 43).

A booster seat may be necessary to achieve proper seat belt positioning for children over 41 lbs (18 kg) or until they reach a height where a lap/shoulder belt can be fastened properly without a booster seat.

### Special seat belt retractor

#### WARNING

If the seat belt is released while driving, the child restraint system will no longer be secured properly. The special seat belt retractor is disabled and the inertia reel draws in a portion of the seat belt. The seat belt cannot be immediately refastened. There is an increased risk of injury, possibly even fatal.

Stop the vehicle immediately, paying attention to road and traffic conditions. Reactivate the special seat belt retractor and secure the child restraint system properly.

All seat belts except the driver's seat belt are equipped with a special seat belt retractor. When activated, the special seat belt retractor ensures that the seat belt will not slacken once the child restraint system has been secured.

Installing a child restraint system:

- ▶ Always comply with the child restraint system manufacturer's installation instructions.
- ▶ Pull the seat belt smoothly from the belt outlet.
- ▶ Engage the seat belt tongue in the belt buckle.

Activating the special seat belt retractor:

- ▶ Pull the seat belt out fully and let the inertia reel retract it again. While the seat belt is retracting, you should hear a ratcheting sound. The special seat belt retractor is activated.
- ▶ Push the child seat restraint system down so that the seat belt is tight and does not loosen.

Removing a child restraint system/deactivating the special seat belt retractor:

- ▶ Always comply with the child restraint system manufacturer's installation instructions.
- ▶ Press the release button on the belt buckle, hold the belt tongue firmly and guide it back towards the belt outlet. The special seat belt retractor is deactivated.

### Child restraint system

The use of seat belts and child restraint systems is required by law in:

- all 50 states
- the U.S. territories
- the District of Columbia
- all Canadian provinces

You can obtain further information about the correct child restraint system from any authorized Mercedes-Benz Center.

#### WARNING

If the child restraint system is installed incorrectly on a suitable seat, it cannot protect as intended. The child cannot then be restrained in the event of an accident, heavy braking or sudden changes of direction. There is an increased risk of injury, possibly even fatal.

Make sure that you observe the child restraint system manufacturer's installation instructions and the notes on use. Please ensure, that the base of the child restraint system is always resting completely on the seat cush-

ion. Never place objects, e.g. cushions, under or behind the child restraint system. Only use child restraint systems with the original cover designed for them. Only replace damaged covers with genuine covers.

### WARNING

If the child restraint system is installed incorrectly or is not secured, it can come loose in the event of an accident, heavy braking or a sudden change in direction. The child restraint system could be thrown about, striking vehicle occupants. There is an increased risk of injury, possibly even fatal.

Always install child restraint systems properly, even if they are not being used. Make sure that you observe the child restraint system manufacturer's installation instructions.

You will find further information on stowing objects, luggage or loads under "Loading guidelines" (> page 228).

### WARNING

Child restraint systems or their securing systems which have been damaged or subjected to a load in an accident can no longer protect as intended. The child cannot then be restrained in the event of an accident, heavy braking or sudden changes of direction. There is an increased risk of injury, possibly even fatal.

Replace child restraint systems which have been damaged or subjected to a load in an accident as soon as possible. Have the securing systems on the child restraint system checked at a qualified specialist workshop, before you install a child restraint system again.

Securing systems for the child restraint system are:

- the seat belt system
- the ISOFIX (LATCH-type) securing rings
- the Top Tether anchorages

**i** If it is absolutely necessary to carry a child on the front-passenger seat, be sure to observe the information on the "Occupant Classification System (OCS)" (> page 49). There you will also find information on deactivating the front-passenger front air bag.

All child restraint systems must meet the following standards:

- U.S. Federal Motor Vehicle Safety Standards 213 and 225
- Canadian Motor Vehicle Safety Standards 213 and 210.2

Confirmation that the child restraint system corresponds to the standards can be found on an instruction label on the child restraint system. This confirmation can also be found in the installation instructions that are included with the child restraint system.

Observe the warning labels in the vehicle interior and on the child restraint system.

### LATCH-type (ISOFIX) child seat securing system

#### WARNING

LATCH-type (ISOFIX) child restraint systems do not offer sufficient protective effect for children whose weight is greater than 48 lbs (22 kg) who are secured using the safety belt integrated in the child restraint system. In the event of an accident, a child might not be restrained correctly. This poses an increased risk of injury or even fatal injury.

If the child weighs more than 48 lbs (22 kg), only use LATCH-type (ISOFIX) child restraint systems with which the child is also secured with the vehicle seat belt. Also secure the child restraint system with the Top Tether belt, if available.

Always comply with the manufacturer's installation and operating instructions for the child restraint system used.

Before every trip, make sure that the LATCH-type (ISOFIX) child restraint system is engaged correctly in both LATCH-type (ISOFIX) securing rings

**!** When installing the child restraint system, make sure that the seat belt for the middle seat does not get trapped. The seat belt could otherwise be damaged.



① LATCH-type (ISOFIX) securing rings

► Install the LATCH-type (ISOFIX) child restraint system on both LATCH-type (ISOFIX) securing rings ①.

ISOFIX is a standardized securing system for specially designed child restraint systems on the rear seats. LATCH-type (ISOFIX) securing rings ① for two LATCH-type (ISOFIX) child restraint systems are installed on the left and right rear seats.

Non-LATCH-type (ISOFIX) child seats may also be used and can be installed using the vehicle's seat belt system. Install child seats according to the manufacturer's instructions.

## Top Tether

### Introduction

Top Tether provides an additional connection between a child restraint system, secured with a LATCH-type (ISOFIX) child seat mount, and the rear seat. This helps reduce the risk of injury even further. If the child restraint system is equipped with a Top Tether belt, this should always be used.

## Important safety notes

### WARNING

If the rear seat backrests are not locked, they could fold forwards in the event of an accident, heavy braking or sudden changes of direction. As a result, child restraint systems cannot perform their intended protective function. Rear seat backrests that are not locked can also cause additional injuries, e.g. in the event of an accident. This poses an increased risk of injury or even fatal injury.

Always lock rear seat backrests after installing a Top Tether belt. Observe the lock verification indicator. Adjust the rear seat backrests so that they are in an upright position.

If the rear backrest is not engaged and locked, the red lock verification indicator will be visible (► page 230).

## Top Tether anchorages



The Top Tether anchorages are located on the rear side of the rear seat backrests.

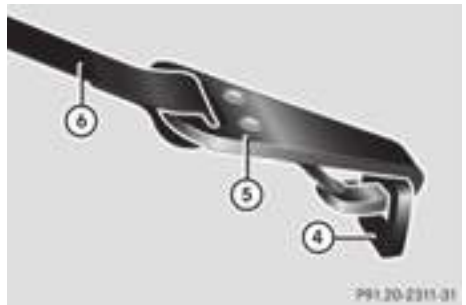

- ▶ Move head restraint ① upwards.
- ▶ Release rear seat backrest ③ and fold it forwards (▷ page 230).
- ▶ Route Top Tether belt ⑥ under head restraint ① between the two head restraint bars.
- ▶ Hook Top Tether hook ⑤ of Top Tether belt ⑥ into Top Tether anchorage ④.

Make sure that:

- Top Tether hook ⑤ is hooked into Top Tether anchorage ④ as shown.
  - Top Tether belt ⑥ is not twisted.
  - Top Tether belt ⑥ is routed between rear seat backrest ③ and cargo compartment cover ② if cargo compartment cover ② is installed.
  - Top Tether belt ⑥ is routed between the rear seat backrest ③ and the cargo net if the cargo net is installed.
- ▶ Swing back rear seat backrest ③ until it engages.  
The red lock verification indicator is no longer visible.
  - ▶ Install the LATCH-type (ISOFIX) child restraint system with Top Tether. Always comply with the child restraint system manufacturer's installation instructions when doing so.
  - ▶ Tension Top Tether belt ⑥. Always comply with the child restraint system manufacturer's installation instructions when doing so.
  - ▶ Move head restraint ① back down again slightly if necessary (▷ page 90). Make sure that you do not interfere with the correct routing of Top Tether belt ⑥.

### Child restraint system on the front-passenger seat

#### General notes

Accident statistics show that children secured in the rear seats are safer than children secured in the front-passenger seat. For this reason, Mercedes-Benz strongly advises

that you install a child restraint system on a rear seat.

If it is absolutely necessary to install a child restraint system to the front-passenger seat, be sure to observe the instructions and safety notes on the "Occupant classification system (OCS)" (▷ page 49).

You can thus avoid the risks that could arise as a result of:

- an incorrectly categorized person in the front-passenger seat
- the unintentional deactivation of the front-passenger front air bag
- the unsuitable positioning of the child restraint system, e.g. too close to the dashboard

#### Rearward-facing child restraint system

If it is absolutely necessary to install a rearward-facing child restraint system on the front-passenger seat, always make sure that the front-passenger front air bag is deactivated. Only if the PASSENGER AIR BAG OFF indicator lamp is permanently lit (▷ page 41) is the front-passenger front air bag deactivated.

Always observe the child restraint system manufacturer's installation and operating instructions.

#### Forward-facing child restraint system

If it is absolutely necessary to install a forward-facing child restraint system on the front-passenger seat, always move the front-passenger seat as far back as possible. The entire base of the child restraint system must always rest on the seat cushion of the front-passenger seat. The backrest of the child restraint system must, as far as possible, lie flat against the backrest of the front-passenger seat. The child restraint system must not touch the roof or be put under strain by the head restraint. Adjust the angle of the seat backrest and the head restraint position accordingly. Always make sure that the shoul-

der belt strap is correctly routed from the vehicle belt sash guide to the shoulder belt guide on the child restraint system. The shoulder belt strap must be routed forwards and downwards from the vehicle belt sash guide. If necessary, adjust the vehicle belt sash guide and the front-passenger seat accordingly.

Always observe the child restraint system manufacturer's installation and operating instructions.

## Child-proof locks

### Important safety notes

#### WARNING

If children are traveling in the vehicle, they could:

- open doors, thus endangering other people or road users
- exit the vehicle and be caught by oncoming traffic
- operate vehicle equipment and become trapped

There is a risk of an accident and injury.

Always activate the child-proof locks and override feature if children are traveling in the vehicle. When leaving the vehicle, always take the key with you and lock the vehicle. Never leave children unattended in the vehicle.

Override feature for:

- Rear doors (▷ page 62)
- Rear side windows (▷ page 62)

#### WARNING

If children are left unsupervised in the vehicle, they could:

- open the doors, thus endangering other people or road users.
- get out and disrupt traffic.
- operate the vehicle's equipment.

Additionally, children could set the vehicle in motion if, for example, they:

- release the parking brake.
- shift the transmission out of park position **P**
- start the vehicle's drive system.

There is a risk of an accident and injury.

When leaving the vehicle, always take the SmartKey with you and lock the vehicle. Never leave children or animals unattended in the vehicle. Always keep the SmartKey out of reach of children.

#### WARNING

If persons, particularly children are subjected to prolonged exposure to extreme heat or cold, there is a risk of injury, possibly even fatal. Never leave children unattended in the vehicle.

#### WARNING

If the child restraint system is subjected to direct sunlight, parts may get very hot. Children may burn themselves on these parts, particularly on the metal parts of the child restraint system. There is a risk of injury.

If you leave the vehicle, taking the child with you, always ensure that the child restraint system is not exposed to direct sunlight. Protect it with a blanket, for example. If the child restraint system has been exposed to direct sunlight, let it cool down before securing the child in it. Never leave children unattended in the vehicle.



## Child-proof locks for the rear doors



You secure each door individually with the child-proof locks on the rear doors. A door secured with a child-proof lock cannot be opened from inside the vehicle. When the vehicle is unlocked, the door can be opened from the outside.

- ▶ **To activate:** press the child-proof lock lever up in the direction of arrow ①.
- ▶ Make sure that the child-proof locks are working properly.
- ▶ **To deactivate:** press the child-proof lock lever down in the direction of arrow ②.

## Override feature for the rear side windows



- ▶ **To activate/deactivate:** press button ①. If indicator lamp is lit, operation of the rear side windows is disabled. Operation is only possible using the switches in the driver's door. If the indicator lamp is off, operation is possible using the switches in the rear compartment.

## Pets in the vehicle

### ⚠ WARNING

If you leave animals unattended or unsecured in the vehicle, they could press buttons or switches, for example.

As a result, they could:

- activate vehicle equipment and become trapped, for example
- activate or deactivate systems, thereby endangering other road users

Unsecured animals could also be flung around the vehicle in the event of an accident or sudden steering or braking, thereby injuring vehicle occupants. There is a risk of an accident and injury.

Never leave animals unattended in the vehicle. Always secure animals properly during the journey, e.g. use a suitable animal transport box.

## Driving safety systems

### Overview of driving safety systems

In this section, you will find information about the following driving safety systems:

- **ABS (Anti-lock Braking System)**  
(▷ page 63)
- **BAS (Brake Assist System)** (▷ page 63)
- **RBS (Recuperative Brake System)**  
(▷ page 68)
- **COLLISION PREVENTION ASSIST** (Adaptive Brake Assist and distance warning signal)  
(▷ page 64)
- **ESP® (Electronic Stability Program)**  
(▷ page 66)
- **EBD (Electronic Brake force Distribution)**  
(▷ page 66)
- **ADAPTIVE BRAKE** (▷ page 68)
- **STEER CONTROL** (▷ page 68)



### Important safety notes

If you fail to adapt your driving style or become distracted, the driving safety systems can neither reduce the risk of accident nor override the laws of physics. Driving safety systems are merely aids designed to assist driving. You are responsible for the distance to the vehicle in front, for vehicle speed and for braking in good time. Always adapt your driving style to suit the prevailing road, weather and traffic conditions and maintain a safe distance from the vehicle in front. Drive carefully.

- i** The driving safety systems described only work as effectively as possible when there is adequate contact between the tires and the road surface. Pay particular attention to the information regarding tires, recommended minimum tire tread depths etc. in the "Wheels and tires" section (▷ page 278). In wintry driving conditions, always use winter tires (M+S tires) and if necessary, snow chains. Only in this way will the driving safety systems described in this section work as effectively as possible.

### ABS (Anti-lock Braking System)

#### General information

ABS regulates brake pressure in such a way that the wheels do not lock when you brake. This allows you to continue steering the vehicle when braking.

The  ABS warning lamp in the instrument cluster lights up when the ignition is switched on. It goes out if the drive system is running.

#### Important safety notes

- i** Observe the "Important safety notes" section for driving safety systems (▷ page 63).

#### WARNING

If ABS is faulty, the wheels could lock when braking. The steerability and braking charac-

teristics may be severely impaired. Additionally, further driving safety systems are deactivated. There is an increased danger of skidding and accidents.

Drive on carefully. Have ABS checked immediately at a qualified specialist workshop.

When ABS is malfunctioning, other systems, including driving safety systems, will also become inoperative. Observe the information on the ABS warning lamp (▷ page 218) and display messages which may be shown in the instrument cluster (▷ page 191).

ABS works from a speed of about 5 mph (8 km/h), regardless of road-surface conditions. ABS works on slippery roads, even if you only brake gently.

#### Braking

- ▶ **If ABS intervenes:** continue to depress the brake pedal vigorously until the braking situation is over.
- ▶ **To make a full brake application:** depress the brake pedal with full force.

If ABS intervenes when braking, you will feel a pulsing in the brake pedal.

The pulsating brake pedal can be an indication of hazardous road conditions, and functions as a reminder to take extra care while driving.

### BAS (Brake Assist System)

#### General information

BAS operates in emergency braking situations. If you depress the brake pedal quickly, BAS automatically boosts the braking force, thus shortening the stopping distance.

#### Important safety notes

- i** Observe the "Important safety notes" section (▷ page 63).

**⚠ WARNING**

If BAS is malfunctioning, the braking distance in an emergency braking situation is increased. There is a risk of an accident.

In an emergency braking situation, depress the brake pedal with full force. ABS prevents the wheels from locking.

**Braking**

- ▶ Keep the brake pedal firmly depressed until the emergency braking situation is over. ABS prevents the wheels from locking.

The brakes will function as usual once you release the brake pedal. BAS is deactivated.

**COLLISION PREVENTION ASSIST****General notes**

COLLISION PREVENTION ASSIST comprises Adaptive Brake Assist and the distance warning signal, which are described in the following.

**Distance warning function****Important safety notes**

- ❗ Observe the "Important safety notes" section for driving safety systems (▶ page 63).

**⚠ WARNING**

The distance warning function does not react:

- to people or animals
- to oncoming vehicles
- to crossing traffic
- when cornering

Thus, the distance warning function cannot provide a warning in all critical situations. There is a risk of an accident.

Always pay careful attention to the traffic situation and be ready to brake.

**⚠ WARNING**

The distance warning function cannot always clearly identify objects and complex traffic situations.

In such cases, the distance warning function may:

- give an unnecessary warning
- not give a warning

There is a risk of an accident.

Always pay careful attention to the traffic situation and do not rely solely on the distance warning function.

**Function**

- ▶ **To activate/deactivate:** activate or deactivate the distance warning function in the on-board computer (▶ page 184).

If the distance warning function is activated, the multifunction display does not display a symbol.

When the distance warning function is deactivated, the  symbol appears in the multifunction display in the assistance graphics display.

The distance warning function can help you to minimize the risk of a front-end collision with a vehicle ahead or reduce the effects of such a collision. If the distance warning function detects that there is a risk of a collision, you will be warned visually and acoustically. The distance warning function cannot prevent a collision without your intervention.

Starting at a speed of around 4 mph (7 km/h), the distance warning function warns you if you rapidly approach a vehicle in front. An intermittent warning tone will then sound, and the  distance warning lamp will light up in the instrument cluster.

- ▶ Brake immediately in order to increase the distance from the vehicle in front.

or

- ▶ Take evasive action provided it is safe to do so.

Due to the nature of the system, particularly complicated but non-critical driving conditions may also cause the system to display a warning.

With the help of the radar sensor system, the distance warning function can detect obstacles that are in the path of your vehicle for an extended period of time.

Up to a speed of around 40 mph (70 km/h), the distance warning function can also react to stationary obstacles, such as stopped or parked vehicles.

If you approach an obstacle and the distance warning function detects a risk of a collision, the system will initially alert you both visually and acoustically.

In particular, the detection of obstacles can be impaired if:

- dirt on the sensors or anything else covering the sensors
- there is snow or heavy rain
- there is interference by other radar sources
- there are strong radar reflections, for example in parking garages
- a narrow vehicle traveling in front, e.g. a motorbike
- a vehicle traveling in front on a different line relative to the center of your vehicle

Following damage to the front end of the vehicle, have the configuration and operation of the radar sensor checked at a qualified specialist workshop. This also applies to collisions at low speeds where there is no visible damage to the front of the vehicle.

### Adaptive Brake Assist

- ❗ Observe the "Important safety notes" section for driving safety systems (> page 63).

#### WARNING

Adaptive Brake Assist cannot always clearly identify objects and complex traffic situations.

In such cases, Adaptive Brake Assist can:

- intervene unnecessarily
- not intervene

There is a risk of an accident.

Always pay careful attention to the traffic situation and be ready to brake. Terminate the intervention in a non-critical driving situation.

#### WARNING

Adaptive Brake Assist does not react:

- to people or animals
- to oncoming vehicles
- to crossing traffic
- to stationary obstacles
- when cornering

As a result, the Adaptive Brake Assist may not intervene in all critical conditions. There is a risk of an accident.

Always pay careful attention to the traffic situation and be ready to brake.

Due to the nature of the system, particularly complicated but non-critical driving conditions may also cause Brake Assist to intervene.

Adaptive Brake Assist provides braking assistance in hazardous situations at speeds above 4 mph (7 km/h). It uses radar sensor technology to assess the traffic situation.

With the help of Adaptive Brake Assist, the distance warning signal can detect obstacles that are in the path of your vehicle for an extended period of time.

As soon as a risk of a collision is detected, Adaptive Brake Assist calculates the braking force necessary to avoid the collision. If you apply the brakes forcefully, Adaptive Brake Assist will automatically increase the braking force to a level suitable for the traffic conditions.

- ▶ Keep the brake pedal depressed until the emergency braking situation is over. ABS prevents the wheels from locking.

The brakes will work normally again if:

- you release the brake pedal.
- there is no longer any danger of a collision.
- there is no longer an obstacle detected in front of your vehicle.

Adaptive Brake Assist is then deactivated.

Up to a speed of approximately 155 mph (250 km/h), Adaptive Brake Assist is capable of reacting to moving objects that have already been detected as such at least once over the period of observation. Adaptive Brake Assist does not react to stationary obstacles.

If Adaptive Brake Assist is not available due to a malfunction in the radar sensor system, the brake system remains available with full brake boosting effect and BAS.

In particular, the detection of obstacles can be impaired if there is:

- there is dirt on the sensors or anything else covering the sensors
- there is snow or heavy rain
- there is interference by other radar sources
- there are strong radar reflections, for example in parking garages
- a narrow vehicle traveling in front, e.g. a motorbike
- a vehicle traveling in front on a different line relative to the center of your vehicle

Following damage to the front end of the vehicle, have the configuration and operation of the radar sensor checked at a qualified specialist workshop. This also applies to collisions at slow speeds where there is no visible damage to the front of the vehicle.

### EBD (electronic brake force distribution)

#### General information

EBD monitors and controls the brake pressure on the rear wheels to improve driving stability while braking.

#### Important safety notes

**i** Observe the "Important safety notes" section for driving safety systems (▷ page 63).

#### WARNING

If EBD is malfunctioning, the rear wheels can lock, e.g. under full braking. This increases the risk of skidding and an accident.

You should therefore adapt your driving style to the different handling characteristics. Have the brake system checked at a qualified specialist workshop.

Observe information regarding indicator and warning lamps (▷ page 218) as well as display messages (▷ page 195).

### ESP® (Electronic Stability Program)

#### General notes

**i** Observe the "Important safety notes" section (▷ page 63).

ESP® monitors driving stability and traction, i.e. power transmission between the tires and the road surface.

If ESP® detects that the vehicle is deviating from the direction desired by the driver, one or more wheels are braked to stabilize the vehicle. The drive system output is also modified to keep the vehicle on the desired course within physical limits. ESP® assists the driver when pulling away on wet or slippery roads. ESP® can also stabilize the vehicle during braking.

### ETS/4ETS (Electronic Traction System)

**i** Observe the "Important safety notes" section (▷ page 63).

ETS traction control is part of ESP®.

ETS brakes the drive wheels individually if they spin. This enables you to pull away and accelerate on slippery surfaces, for example if the road surface is slippery on one side. In

addition, more drive torque is transferred to the wheel or wheels with traction.

ETS remains active when you deactivate ESP®.

### Important safety notes

#### WARNING



If ESP® is malfunctioning, ESP® is unable to stabilize the vehicle. Additionally, further driving safety systems are deactivated. This increases the risk of skidding and an accident.

Drive on carefully. Have ESP® checked at a qualified specialist workshop.

**!** When testing the electric parking brake on a braking dynamometer, switch off the ignition. Application of the brakes by ESP® may otherwise destroy the brake system.

When towing your vehicle with the front axle raised, observe the notes on ESP® (> page 273).

ESP® is deactivated if the  ESP® OFF warning lamp in the instrument cluster lights up continuously when the drive system is running.

If the  ESP® warning lamp and the  ESP® OFF warning lamp are lit continuously, ESP® is not available due to a malfunction. Observe the information on warning lamps (> page 221) and display messages which may be shown in the instrument cluster (> page 191).

**i** Only use wheels with the recommended tire sizes. Only then will ESP® function properly.

### Characteristics of ESP®

#### General information

If the  ESP warning lamp goes out before beginning the journey, ESP® is automatically active.

If ESP® intervenes, the  ESP® warning lamp flashes in the instrument cluster.

If ESP® intervenes:

- ▶ Do not deactivate ESP® under any circumstances.
- ▶ Only depress the accelerator pedal as far as necessary when pulling away.
- ▶ Adapt your driving style to suit the prevailing road and weather conditions.

### Deactivating/activating ESP®

#### Important safety notes

**i** Observe the "Important safety notes" section (> page 63).

You can select between the following states of ESP®:

- ESP® is activated.
- ESP® is deactivated.

#### WARNING

If you deactivate ESP®, ESP® no longer stabilizes the vehicle. There is an increased risk of skidding and an accident.

Only deactivate ESP® in the situations described in the following.

It may be best to deactivate ESP® in the following situations:

- when using snow chains
- in deep snow
- on sand or gravel

**i** Activate ESP® as soon as the situations described above no longer apply. ESP® will otherwise not be able to stabilize the vehicle if the vehicle starts to skid or a wheel starts to spin.

**!** Avoid spinning the driven wheels for an extended period with ESP® deactivated. You could otherwise damage the drivetrain.

### Deactivating/activating ESP®

You can deactivate or activate ESP® via the on-board computer.

► **To deactivate:** (▷ page 183).

The  ESP® OFF warning lamp in the instrument cluster lights up.

► **To activate:** (▷ page 183).

The  ESP® OFF warning lamp in the instrument cluster goes out.

### Characteristics when ESP® is deactivated

If ESP® is deactivated and one or more wheels start to spin, the  ESP® warning lamp in the instrument cluster flashes. In such situations, ESP® will not stabilize the vehicle.

If you deactivate ESP®:

- ESP® no longer improves driving stability.
- the drive system's torque is no longer limited and the driven wheels are able to spin. The spinning of the wheels results in a cutting action for better traction on loose surfaces.
- traction control is still activated.
- ESP® still provides support when you brake.

### ADAPTIVE BRAKE

ADAPTIVE BRAKE enhances braking safety and offers increased braking comfort. In addition to the braking function, ADAPTIVE BRAKE also has the HOLD function (▷ page 154) and hill start assist (▷ page 128). For further information, see "Driving tips" (▷ page 148).

### STEER CONTROL

#### General information

STEER CONTROL helps you by transmitting a noticeable steering force to the steering wheel in the direction required for vehicle stabilization.

This steering assistance is provided in particular if:

- both right wheels or both left wheels are on a wet or slippery road surface when you brake.
- the vehicle starts to skid.

### Important safety notes

If ESP® is malfunctioning, you will not receive steering support from STEER CONTROL. Power steering will, however, continue to function.

### RBS (Recuperative Brake System)

**i** Observe the "Important safety notes" section for driving safety systems (▷ page 63).

RBS converts the kinetic energy when braking into electrical current. The electric motor is used as an alternator during braking. The converted energy is then stored in the high-voltage battery.

If the warning light in the instrument cluster is lit up, there is a motor malfunction or a brake malfunction.

### WARNING

In the event of malfunctions in the RBS, the following may occur:

- the braking performance of the electric motor may be either reduced or not effective
- brake pedal resistance may be lower than usual
- pedal travel may be longer than usual

If you do not make an additional effort to apply the brake yourself, the braking effect may not be sufficient. There is a risk of an accident.

In the event of this malfunction, continue to depress the brake pedal. The brake system is still fully functional.

## Theft deterrent locking system

### Immobilizer

The immobilizer prevents your vehicle from being started without the correct SmartKey.

- ▶ **To activate:** remove the SmartKey from the ignition lock.
- ▶ **To deactivate:** switch on the ignition.

When leaving the vehicle, always take the SmartKey with you and lock the vehicle. Anyone can start the drive system if a valid key has been left inside the vehicle.

**i** The immobilizer is always deactivated when you start the drive system.

If the drive system cannot be started when the starter battery is fully charged, the immobilizer may be faulty. The READY display in the multifunction display does not appear. Contact an authorized Mercedes-Benz Center or call 1-800-FOR-MERCEDES (in the USA) or 1-800-387-0100 (in Canada).

### ATA (anti-theft alarm system)



- ▶ **To arm:** lock the vehicle with the SmartKey.

Indicator lamp ① flashes. The alarm system is armed after approximately 15 seconds.

- ▶ **To disarm:** unlock the vehicle with the SmartKey.

or

- ▶ Insert the SmartKey into the ignition lock.



A visual and an audible alarm are triggered if the alarm system is armed and you open:

- the vehicle with the mechanical key
- a door
- the tailgate
- the hood

- ▶ **To stop the alarm:** insert the SmartKey into the ignition lock.

The alarm is switched off.

or

- ▶ Press the  or  button on the SmartKey.

The alarm is switched off.

The alarm is not switched off, even if you close the open door that triggered it, for example.

**i** If the alarm stays on for more than 30 seconds, the mbrace emergency call system automatically sends a message to the Customer Assistance Center by text message or data connection. The emergency call system sends the message provided that:

- you have subscribed to the mbrace service.
- the mbrace service has been activated properly.
- the necessary mobile phone network is available.





Useful information .....	72
SmartKey .....	72
Doors .....	77
Cargo compartment .....	79
Side windows .....	81

## Useful information

- i** This Operator's Manual describes all models and all standard and optional equipment of your vehicle available at the time of publication of the Operator's Manual. Country-specific differences are possible. Bear in mind that your vehicle may not feature all functions described here. This also applies to safety-relevant systems and functions.
- i** Read the information on qualified specialist workshops: (▷ page 24).

## SmartKey

### Important safety notes

#### WARNING

If children are left unsupervised in the vehicle, they could:

- open the doors, thus endangering other people or road users.
- get out and disrupt traffic.
- operate the vehicle's equipment.

Additionally, children could set the vehicle in motion if, for example, they:

- release the parking brake.
- shift the transmission out of park position **P**
- start the vehicle's drive system.

There is a risk of an accident and injury.

When leaving the vehicle, always take the SmartKey with you and lock the vehicle. Never leave children or animals unattended in the vehicle. Always keep the SmartKey out of reach of children.

#### WARNING

If persons, particularly children are subjected to prolonged exposure to extreme heat or cold, there is a risk of injury, possibly even fatal. Never leave children unattended in the vehicle.

#### WARNING

If you attach heavy or large objects to the SmartKey, the SmartKey could be unintentionally turned in the ignition lock. This could cause the engine to be switched off. There is a risk of an accident.

Do not attach any heavy or large objects to the SmartKey. Remove any bulky key rings before inserting the SmartKey into the ignition lock.



- !** Keep the SmartKey away from strong magnetic fields. Otherwise, the remote control function could be affected. Strong magnetic fields can occur in the vicinity of powerful electrical installations.

Do not keep the SmartKey:

- with electronic devices, e.g. a mobile phone or another SmartKey
- with metallic objects, e.g. coins or metal foil
- inside metallic objects, e.g. a metal case

### SmartKey functions



- ①  To lock the vehicle
- ②  To unlock the vehicle

► **To unlock centrally:** press button ②.

If you do not open the vehicle within approximately 40 seconds of unlocking:

- the vehicle is locked again.
- the theft deterrent locking system is armed again.

► **To lock centrally:** press button ①.

The SmartKey centrally locks/unlocks:



- the doors
- the tailgate
- the charge socket flap



The turn signals flash once when unlocking and three times when locking.

- i** You can also set an audible signal to confirm that the vehicle has been locked. The audible signal can be activated and deactivated using the on-board computer (▷ page 188).





### Changing the settings of the locking system

You can change the settings of the locking system. Then only the driver's door is unlocked when you unlock the vehicle. This is useful if you frequently travel on your own.

- ▶ **To change the setting:** simultaneously press the  and  buttons for approximately 6 seconds until the battery check lamp (▷ page 74) flashes twice.

- i** If the setting of the locking system is changed within the signal range of the vehicle, pressing the  or  button:
- locks or
  - unlocks the vehicle

The SmartKey now functions as follows:

- ▶ **To unlock the driver's door:** press the  button once.
- ▶ **To unlock centrally:** press the  button twice.
- ▶ **To lock centrally:** press the  button.
- ▶ **To restore the factory settings:** simultaneously press the  and  buttons for approximately 6 seconds until the battery check lamp flashes twice (▷ page 74).



### Mechanical key

#### General notes

If the vehicle can no longer be unlocked with the SmartKey, use the mechanical key.

If you use the mechanical key to unlock and open the driver's door, the anti-theft alarm system will be triggered (▷ page 69).

There are several ways to turn off the alarm:

- ▶ Press the  or  button on the SmartKey.

or

- ▶ Insert the SmartKey into the ignition lock.

If you unlock the vehicle using the mechanical key, the charge socket flap will not be unlocked automatically.

- ▶ **To unlock the charge socket flap:** insert the SmartKey into the ignition lock.

#### Removing the mechanical key



- ▶ Push release catch ① in the direction of the arrow and at the same time remove mechanical key ② from the SmartKey.

For further information about:

- unlocking the driver's door (▷ page 79)
- unlocking the cargo compartment (▷ page 80)
- locking the vehicle (▷ page 79)

## SmartKey battery

### Important safety notes

#### WARNING

Batteries contain toxic and corrosive substances. If batteries are swallowed, it can result in severe health problems. There is a risk of fatal injury.



Keep batteries out of the reach of children. If a battery is swallowed, seek medical attention immediately.



The SmartKey batteries contain perchlorate material, which may require special handling and regard for the environment. National guidelines must be observed during disposal. In California, see [www.dtsc.ca.gov/HazardousWaste/Perchlorate/index.cfm](http://www.dtsc.ca.gov/HazardousWaste/Perchlorate/index.cfm).

Mercedes-Benz recommends that you have the batteries replaced at a qualified specialist workshop.

### Checking the battery



- ▶ Press the  or  button. The battery is working properly if battery check lamp ① lights up briefly. The battery is discharged if battery check lamp ① does not light up briefly.
- ▶ Change the battery (▷ page 74).

**i** If the SmartKey battery is checked within the signal reception range of the vehicle, pressing the  or  button:

- locks or
- unlocks the vehicle

**i** You can get a battery at any qualified specialist workshop.

### Replacing the battery

You will need a CR 2025 3 V cell battery.

- ▶ Take the mechanical key out of the SmartKey (▷ page 73).







- ▶ Press mechanical key ② into the opening in the SmartKey in the direction of the arrow until battery tray cover ① opens. When doing so, do not hold cover ① shut.
- ▶ Remove battery tray cover ①.



- ▶ Repeatedly tap the SmartKey against your palm until battery ③ falls out.
- ▶ Insert the new battery with the positive terminal facing upwards. Use a lint-free cloth to do so.

- ▶ Make sure that the surface of the battery is free of lint, grease and other contaminants.
- ▶ Insert the front tabs of battery tray cover ① and then press to close it.
- ▶ Insert the mechanical key into the SmartKey.
- ▶ Check the function of all SmartKey buttons on the vehicle.

## Problems with the SmartKey

Problem	Possible causes/consequences and ► Solutions
<p>You cannot lock or unlock the vehicle using the SmartKey.</p>	<p>The SmartKey battery is discharged or nearly discharged.</p> <ul style="list-style-type: none"> <li>► Try again to lock/unlock the vehicle using the remote control function of the SmartKey. Point the tip of the SmartKey at the driver's door handle from close range and press the  or  button.</li> </ul> <p>If this does not work:</p> <ul style="list-style-type: none"> <li>► Check the SmartKey battery and replace it if necessary (► page 74).</li> <li>► Unlock (► page 79) or lock (► page 79) the vehicle using the mechanical key.</li> </ul> <p>There is interference from a powerful source of radio waves.</p> <ul style="list-style-type: none"> <li>► Try again to lock/unlock the vehicle using the remote control function of the SmartKey. Point the tip of the key at the driver's door handle from close range and press the  /  button.</li> </ul> <p>The SmartKey is faulty.</p> <ul style="list-style-type: none"> <li>► Unlock (► page 79) or lock (► page 79) the vehicle using the mechanical key.</li> <li>► Have the SmartKey checked at a qualified specialist workshop.</li> </ul>
<p>You have lost a SmartKey.</p>	<ul style="list-style-type: none"> <li>► Have the SmartKey deactivated at a qualified specialist workshop.</li> <li>► Report the loss immediately to the vehicle insurers.</li> <li>► If necessary, have the locks changed as well.</li> </ul>
<p>You have lost the mechanical key.</p>	<ul style="list-style-type: none"> <li>► Report the loss immediately to the vehicle insurers.</li> <li>► If necessary, have the locks changed as well.</li> </ul>

Problem	Possible causes/consequences and ► Solutions
The drive system cannot be started using the key.	<p>The on-board voltage is too low.</p> <ul style="list-style-type: none"> <li>► Switch off non-essential consumers, e.g. seat heating or interior lighting, and try to start the drive system again.</li> </ul> <p>If this does not work:</p> <ul style="list-style-type: none"> <li>► Check the starter battery and charge it if necessary (► page 265).</li> </ul> <p>or</p> <ul style="list-style-type: none"> <li>► Jump-start the vehicle (► page 269).</li> </ul> <p>or</p> <ul style="list-style-type: none"> <li>► Consult a qualified specialist workshop.</li> </ul>
The drive system cannot be started using the key.	<p>The steering lock is mechanically blocked.</p> <ul style="list-style-type: none"> <li>► Remove the SmartKey and reinsert it into the ignition lock. While doing this, turn the steering wheel in both directions.</li> </ul>

## Doors

### Important safety notes

#### WARNING

If children are left unsupervised in the vehicle, they could:

- open the doors, thus endangering other people or road users.
- get out and disrupt traffic.
- operate the vehicle's equipment.

Additionally, children could set the vehicle in motion if, for example, they:

- release the parking brake.
- shift the transmission out of park position **P**
- start the vehicle's drive system.

There is a risk of an accident and injury.

When leaving the vehicle, always take the SmartKey with you and lock the vehicle. Never leave children or animals unattended in the vehicle. Always keep the SmartKey out of reach of children.

#### WARNING

If persons, particularly children are subjected to prolonged exposure to extreme heat or

cold, there is a risk of injury, possibly even fatal. Never leave children unattended in the vehicle.

You should preferably place luggage or loads in the cargo compartment. Observe the loading guidelines (► page 228).

### Unlocking and opening doors from the inside



- **To unlock a front door:** pull door handle ②. Locking knob ① pops up. The door is unlocked and can be opened.

- ▶ **To open a front door:** pull door handle ②.
- ▶ **To unlock a rear door:** pull up locking knob ①.  
The door is unlocked and can be opened.
- ▶ **To open a rear door:** pull door handle ②.

You can open a door from inside the vehicle even if it has been locked. You can open the rear doors from inside the vehicle unless they are secured by the child-proof lock (> page 62).

If the vehicle has previously been locked with the SmartKey, opening a door from the inside will trigger the anti-theft alarm system. Switch off the alarm (> page 69).

### Centrally locking and unlocking the vehicle from the inside

You can centrally lock or unlock the vehicle from the inside. This can be useful if you wish to lock the vehicle before pulling away, for example.



- ▶ **To unlock:** press button ①.
- ▶ **To lock:** press button ②.  
The vehicle locks when all the doors and the tailgate are closed.

This does not lock or unlock the charge socket flap.

You cannot unlock the vehicle centrally from the inside if the vehicle has been locked with the SmartKey.

You can open a door from inside the vehicle even if it has been locked. You can open the

rear doors from inside the vehicle unless they are secured by the child-proof lock (> page 62).

If the vehicle has previously been locked with the SmartKey, opening a door from the inside will trigger the anti-theft alarm system. Switch off the alarm (> page 69).

If the vehicle has been locked using the locking button for the central locking, or has been locked automatically, and a door is opened from the inside:

- the vehicle will be fully unlocked if it had previously been fully unlocked
- only the door which has been opened from the inside is unlocked if only the driver's door had been previously unlocked

### Automatic locking feature



- ▶ **To deactivate:** press and hold button ① for about 5 seconds until a tone sounds.
- ▶ **To activate:** press and hold button ② for about 5 seconds until a tone sounds.

**i** If you press one of the two buttons and do not hear a tone, the relevant setting has already been selected.

The vehicle is locked automatically when the ignition is switched on and the wheels are turning.

You could therefore lock yourself out if:

- the vehicle is being pushed.
- the vehicle is being towed.
- the vehicle is on a roller dynamometer.



You can also switch the automatic locking function on and off using the on-board computer (▷ page 188).

### Unlocking the driver's door (mechanical key)

If the vehicle can no longer be unlocked with the SmartKey, use the mechanical key.

If you use the mechanical key to unlock and open the driver's door, the anti-theft alarm system will be triggered (▷ page 69).

- ▶ Take the mechanical key out of the SmartKey (▷ page 73).
- ▶ Insert the mechanical key into the lock of the driver's door as far as it will go.



- ▶ Turn the mechanical key counter-clockwise as far as it will go to position **1**. The door is unlocked.
- ▶ Turn the mechanical key back and remove it.
- ▶ Insert the mechanical key into the SmartKey.

### Locking the vehicle (mechanical key)

If the vehicle can no longer be locked with the SmartKey, use the mechanical key.

- ▶ Open the driver's door.
- ▶ Close the front-passenger door, the rear doors and the tailgate.
- ▶ Press the locking button (▷ page 78).

- ▶ Check whether the locking knobs on the front-passenger door and the rear doors are still visible. Press down the locking knobs manually, if necessary (▷ page 77).
- ▶ Close the driver's door.
- ▶ Take the mechanical key out of the SmartKey (▷ page 73).
- ▶ Insert the mechanical key into the lock of the driver's door as far as it will go.



- ▶ Turn the mechanical key clockwise as far as it will go to position **1**.
  - ▶ Turn the mechanical key back and remove it.
  - ▶ Make sure that the doors and the tailgate are locked.
  - ▶ Insert the mechanical key into the SmartKey.
- i** If you lock the vehicle as described above, the charge socket flap is not locked. The anti-theft alarm system is not armed.

### Cargo compartment

#### Important safety notes

#### WARNING

If persons, particularly children are subjected to prolonged exposure to extreme heat or cold, there is a risk of injury, possibly even fatal. Never leave children unattended in the vehicle.

- !** The tailgate swings upwards and to the rear when opened. Therefore, make sure

that there is sufficient clearance above and behind the tailgate.

- i** The opening dimensions of the tailgate can be found in the "Vehicle data" section (▷ page 311).

You should preferably place luggage or loads in the cargo compartment. Observe the loading guidelines (▷ page 228).

Do not leave the SmartKey in the cargo compartment. You could otherwise lock yourself out.

The tailgate can be:

- opened and closed manually from outside
- unlocked from inside with the mechanical key

### Opening/closing from outside

#### Opening

- ▶ Press the  button on the SmartKey.



- ▶ Pull handle ①.
- ▶ Raise the tailgate.

#### Closing



- ▶ Pull the tailgate down using handle ①.
- ▶ Allow the tailgate to drop into the lock.
- ▶ If necessary, lock the vehicle with the .

### Tailgate emergency release

If the tailgate can no longer be opened from outside the vehicle, use the emergency release on the inside of the tailgate.

- !** The tailgate swings upwards and to the rear when opened. Therefore, make sure that there is sufficient clearance above and behind the tailgate.

- i** The opening dimensions of the tailgate can be found in the "Vehicle data" section (▷ page 311).

You can reach the emergency release via the cargo compartment. Fold the rear backrests forward (▷ page 231).

- ▶ Take the mechanical key out of the SmartKey (▷ page 73).



- ▶ Insert mechanical key ② fully into opening ① in the paneling.
  - ▶ Turn mechanical key ② 90° clockwise.
  - ▶ Push mechanical key ② in the direction of the arrow and open the tailgate.
- i** When you lock the vehicle (▷ page 79), the cargo compartment is also locked.

## Side windows

### Important safety notes

#### WARNING

While closing the side windows, body parts in the closing area could become trapped. There is a risk of injury.

When closing make sure that no parts of the body are in the closing area. If somebody becomes trapped, release the switch or press the switch to open the side window again.

#### WARNING

If children operate the side windows they could become trapped, particularly if they are left unsupervised. There is a risk of injury.

Activate the override feature for the rear side windows. When leaving the vehicle, always take the SmartKey with you and lock the vehicle. Never leave children unsupervised in the vehicle.

### Side window reversing feature

The side windows are equipped with an automatic reversing feature. If a solid object blocks or restricts a side window during the closing process, the side window opens again automatically. However, the automatic reversing feature is only an aid and does not relieve you of the responsibility of paying attention when closing a side window.

#### WARNING

The reversing feature does not react:

- to soft, light and thin objects, e.g. small fingers
- over the last 1/6 in(4 mm) of the closing movement
- during resetting
- when closing the side window again manually immediately after automatic reversing

This means that the reversing feature cannot prevent someone being trapped in these situations. There is a risk of injury.

Make sure that no body parts are in close proximity during the closing procedure. If someone becomes trapped, press the switch to open the side window again.

### Opening and closing the side windows

The switches for all side windows are located on the driver's door. There is also a switch on each door for the corresponding side window. The switches on the driver's door take precedence.



- ① Front left
- ② Front right
- ③ Rear right
- ④ Rear left

**i** When the override feature for the side windows is activated (▷ page 62), the side windows cannot be operated from the rear.

▶ Turn the SmartKey to position **1** or **2** in the ignition lock.

▶ **To open:** press the corresponding switch.

▶ **To open fully:** press the corresponding switch beyond the point of resistance. Automatic operation is started.

▶ **To close:** pull the corresponding switch.

▶ **To close fully:** pull the corresponding switch beyond the pressure point. Automatic operation is started.

▶ **To interrupt automatic operation:** press/pull the corresponding switch again.

**i** If you press/pull the switch beyond the point of resistance, automatic operation is started in the corresponding direction. You can stop automatic operation by pressing/pulling the switch again.

**i** You can continue to operate the side windows after switching off the drive system or removing the key. This function remains active for 5 minutes or until the driver's or front-passenger door is opened.

### Convenience opening

You can ventilate the vehicle before you start driving. To do this, the SmartKey is used to carry out the following functions simultaneously:

- unlock the vehicle
- open the side windows

**i** The convenience opening feature can only be operated using the SmartKey. The SmartKey must be close to the driver's door handle.

▶ Point the tip of the SmartKey at the driver's door handle.

▶ Press and hold the  button until the side windows are in the desired position.

▶ **To interrupt convenience opening:** release the  button.

### Convenience closing feature

#### WARNING

When using the convenience closing feature, parts of the body could be trapped in the closing area when a side window is being closed. There is a risk of injury.

Observe the complete closing procedure when the convenience closing feature is operating. Make sure that no body parts are in close proximity during the closing procedure.

When you lock the vehicle, you can simultaneously:

- close the side windows

**i** The SmartKey must be close to the driver's door handle.

▶ Point the tip of the SmartKey at the driver's door handle.

▶ Press and hold the  button until the side windows are fully closed.

- ▶ Make sure that all the side windows are closed.
- ▶ **To interrupt convenience closing:**  
release the  button.

### Resetting the side windows

You must reset each side window if:

- the side window opens again slightly after being closed fully.
  - the side window can no longer be fully opened or closed.
- ▶ Close all the doors.
  - ▶ Turn the key to position **1** or **2** in the ignition lock.
  - ▶ Pull the corresponding switch on the door control panel until the side window is completely closed (▷ page 81).
  - ▶ Hold the switch for an additional second.

If the side window opens again slightly:

- ▶ Immediately pull the corresponding switch on the door control panel until the side window is completely closed (▷ page 81).
- ▶ Hold the switch for an additional second.
- ▶ If the respective side window remains closed after the button is released, then it has been set correctly. If this is not the case, repeat the steps above again.

### Problems with the side windows

#### WARNING

If you close a side window again immediately after it has been blocked or reset, the side window closes with increased or maximum force. The reversing feature is then not active. Parts of the body could be trapped in the closing area in the process. This poses an increased risk of injury or even fatal injury.

Make sure that no parts of the body are in the closing area. To stop the closing process, release the switch or push the switch again to reopen the side window.

Problem	Possible causes/consequences and ► Solutions
<p>A side window cannot be closed because it is blocked by objects, e.g. leaves in the window guide.</p>	<ul style="list-style-type: none"> <li>► Remove the objects.</li> <li>► Close the side window.</li> </ul>
<p>A side window cannot be closed and you cannot see the cause.</p>	<p>If a side window is obstructed during closing and reopens again slightly:</p> <ul style="list-style-type: none"> <li>► Immediately after the window blocks, pull the corresponding switch again until the side window has closed. The side window is closed with increased force.</li> </ul> <p>If a side window is obstructed again during closing and reopens again slightly:</p> <ul style="list-style-type: none"> <li>► Immediately after the window blocks, pull the corresponding switch again until the side window has closed. The side window is closed without the anti-entrapment feature.</li> </ul>

Useful information .....	86
Correct driver's seat position .....	86
Seats .....	87
Steering wheel .....	92
Mirrors .....	93
Memory functions .....	95

## Useful information

**i** This Operator's Manual describes all models and all standard and optional equipment of your vehicle available at the time of publication of the Operator's Manual. Country-specific differences are possible. Bear in mind that your vehicle may not feature all functions described here. This also applies to safety-relevant systems and functions.

**i** Read the information on qualified specialist workshops: (▷ page 24).

## Correct driver's seat position

**⚠ WARNING**

You could lose control of your vehicle if you do the following while driving:

- adjust the driver's seat, head restraint, steering wheel or mirrors
- fasten the seat belt

There is a risk of an accident.

Adjust the driver's seat, head restraint, steering wheel and mirror and fasten your seat belt before starting the engine.



Observe the safety guidelines on seat adjustment (▷ page 87).

► Make sure that seat ③ is adjusted properly.

Manual seat adjustment (▷ page 88)

Electrical seat adjustment (▷ page 89)

When adjusting the seat, make sure that:

- you are as far away from the driver's air bag as possible.
- you are sitting in a normal upright position.
- you can fasten the seat belt properly.
- you have moved the backrest to an almost vertical position.
- you have set the seat cushion angle so that your thighs are gently supported.
- you can depress the pedals properly.

► Check whether the head restraint is adjusted properly (▷ page 89).

When doing so, make sure that you have adjusted the head restraint so that the back of your head is supported at eye level by the center of the head restraint.

Observe the safety guidelines on steering wheel adjustment (▷ page 92).

► Make sure that steering wheel ① is adjusted properly.

Adjusting the steering wheel (▷ page 92)

When adjusting the steering wheel, make sure that:

- you can hold the steering wheel with your arms slightly bent.
- you can move your legs freely.
- you can see all the displays in the instrument cluster clearly.

Observe the safety guidelines for seat belts (▷ page 42).

► Check whether you have fastened seat belt ② properly (▷ page 44).



The seat belt should:

- fit snugly across your body
  - be routed across the middle of your shoulder
  - be routed in your pelvic area across the hip joints
- ▶ Before starting off, adjust the rear-view mirror and the exterior mirrors (▷ page 93) in such a way that you have a good view of road and traffic conditions.
- ▶ **Vehicles with a memory function:** save the seat and exterior mirror settings (▷ page 95).

## Seats

### Important safety notes

#### WARNING

Children could become trapped if they adjust the seats, particularly when unattended. There is a risk of injury.

When leaving the vehicle, always take the SmartKey with you and lock the vehicle. Never leave children unsupervised in the vehicle.

The seats can still be adjusted when there is no SmartKey in the ignition lock.

#### WARNING

You could lose control of your vehicle if you do the following while driving:

- adjust the driver's seat, head restraint, steering wheel or mirrors
- fasten the seat belt

There is a risk of an accident.

Adjust the driver's seat, head restraint, steering wheel and mirror and fasten your seat belt before starting the engine.

#### WARNING

If you adjust the seat height carelessly, you or other vehicle occupants could be trapped and thereby injured. Children in particular could accidentally press the electrical seat adjust-

ment buttons and become trapped. There is a risk of injury.

While moving the seats, make sure that your hands or other body parts do not get under the lever assembly of the seat adjustment system.

#### WARNING

When you adjust a seat, you or other vehicle occupants could become trapped, e.g. on the seat guide rail. There is a risk of injury.

Make sure when adjusting a seat that no one has any body parts in the sweep of the seat.

#### WARNING

The seat belt does not offer the intended level of protection if you have not moved the backrest to an almost vertical position. When braking or in the event of an accident, you could slide underneath the seat belt and sustain abdomen or neck injuries, for example. This poses an increased risk of injury or even fatal injury.

Adjust the seat properly before beginning your journey. Always ensure that the backrest is in an almost vertical position and that the shoulder section of your seat belt is routed across the center of your shoulder.

#### WARNING

If head restraints are not installed and adjusted correctly, they cannot provide protection as intended. There is an increased risk of injury in the head and neck area, e.g. in the event of an accident or when braking.

Always drive with the head restraints installed. Before driving off, make sure for every vehicle occupant that the center of the head restraint supports the back of the head at about eye level.

**!** To avoid damage to the seats and the seat heating, observe the following information:

- keep liquids from spilling on the seats. If liquid is spilled on the seats, dry them as soon as possible.
- if the seat covers are damp or wet, do not switch on the seat heating. The seat heating should also not be used to dry the seats.
- clean the seat covers as recommended; see the "Interior care" section.
- do not transport heavy loads on the seats. Do not place sharp objects on the seat cushions, e.g. knives, nails or tools. The seats should only be occupied by passengers, if possible.
- when the seat heating is in operation, do not cover the seats with insulating materials, e.g. blankets, coats, bags, seat covers, child seats or booster seats.

**!** Make sure that there are no objects in the footwell under or behind the seats when moving the seats back. There is a risk that the seats and/or the objects could be damaged.

**i** The head restraints in the front and rear seats can be removed.<sup>1</sup>

For more information, contact a qualified specialist workshop.

**i** Further related subjects:

- cargo compartment enlargement (folding down the rear seats) (▷ page 230)

## Adjusting the seats manually



### Seat fore-and-aft adjustment

- ▶ Lift handle ① and slide the seat forwards or backwards.
- ▶ Release lever ③ again. Make sure that you hear the seat engage in position.

### Backrest angle

- ▶ Relieve the pressure on the backrest.
- ▶ Turn handwheel ④ forwards or backwards.

### Seat height

- ▶ Pull handle ③ upwards or push it down repeatedly until the seat has reached the desired height.

### Seat cushion angle

Adjust the angle so that your thighs are lightly supported.

- ▶ Turn handwheel ② forwards or backwards.

<sup>1</sup> Not on vehicles with sports seats or electrically adjustable head restraints.

## Adjusting the seats electrically



- ① Head restraint height<sup>2</sup>
- ② Seat cushion angle
- ③ Seat height
- ④ Seat fore-and-aft adjustment
- ⑤ Backrest angle

**i** You can store the seat settings using the memory function (▷ page 95).

## Adjusting the head restraints

### **⚠ WARNING**

You could lose control of your vehicle if you do the following while driving:

- adjust the driver's seat, head restraint, steering wheel or mirrors
- fasten the seat belt

There is a risk of an accident.

Adjust the driver's seat, head restraint, steering wheel and mirror and fasten your seat belt before starting the engine.

### **⚠ WARNING**

If head restraints are not installed and adjusted correctly, they cannot provide protection as intended. There is an increased risk of injury in the head and neck area, e.g. in the event of an accident or when braking.

Always drive with the head restraints installed. Before driving off, make sure for every vehicle occupant that the center of the head

restraint supports the back of the head at about eye level.

## Adjusting the head restraints manually

### Adjusting the head restraint height



- ▶ **To raise:** pull the head restraint up to the desired position.
- ▶ **To lower:** press release catch ① in the direction of the arrow and push the head restraint down to the desired position.

### Adjusting the fore/aft position of the head restraint



<sup>2</sup> This function is only available on vehicles with electrically adjustable head restraints.

With this function you can adjust the distance between the head restraint and the back of the seat occupant's head.

- ▶ **To adjust forwards:** pull the head restraint forwards in the direction of the arrow until it engages. There are several notches.
- ▶ **To move backwards:** press and hold release button ① and push the head restraint backwards.
- ▶ When the head restraint is in the desired position, release the button and make sure that the head restraint is engaged in position.

### Adjusting the height of the head restraints electrically

- ▶ **To adjust the head restraint height:** slide the switch for head restraint adjustment (▷ page 89) up or down in the direction of the arrow .

### Rear seat head restraints

#### Adjusting the rear seat head restraint height



- ▶ **To raise:** pull the head restraint up to the desired position.
- ▶ **To lower:** press release catch ① and push the head restraint down until it is in the desired position.

### Removing and installing the rear seat head restraints

#### ⚠ WARNING

If head restraints are not installed and adjusted correctly, they cannot provide protection as intended. There is an increased risk of injury in the head and neck area, e.g. in the event of an accident or when braking.

Always drive with the head restraints installed. Before driving off, make sure for every vehicle occupant that the center of the head restraint supports the back of the head at about eye level.

- ❗ Electrically adjustable head restraints cannot be removed and re-installed.

The rear head restraints on the outer seats can be removed and re-installed.



- ▶ Fold the seat backrest slightly forwards in order to remove the head restraint (▷ page 231).
- ▶ **To remove:** pull the head restraint up to the stop.
- ▶ Press release catch ① and pull the head restraint out of the guides.
- ▶ **To re-install:** insert the head restraint so that the notches on the bar are on the left when viewed in the direction of travel.
- ▶ Push the head restraint down until you hear it engage in position.

### Adjusting the 4-way lumbar support

You can adjust the contour of the front seat backrests individually to provide optimum support for your back.



- ① To raise the backrest contour
- ② To soften the backrest contour
- ③ To lower the backrest contour
- ④ To harden the backrest contour

### Switching the seat heating on/off

#### Activating/deactivating

**⚠ WARNING**

Repeatedly switching on the seat heating can cause the seat cushion and backrest pads to become very hot. The health of persons with limited temperature sensitivity or a limited ability to react to excessively high temperatures may be affected or they may even suffer burn-like injuries. There is a risk of injury. Therefore, do not switch the seat heating on repeatedly.



The three red indicator lamps in the button indicate the heating level you have selected. The system automatically switches from level **3** to level **2** after approximately eight minutes.

The system automatically switches from level **2** to level **1** after approximately ten minutes. The system automatically switches off approximately 20 minutes after it is set to level **1**.

- ▶ Turn the SmartKey to position **1** or **2** in the ignition lock (▷ page 127).
  - ▶ **To switch on:** press button ① repeatedly until the desired heating level is set.
  - ▶ **To switch off:** press button ① repeatedly until all the indicator lamps go out.
- i** If the battery voltage is too low, the seat heating may switch off.

## Problems with the seat heating

Problem	Possible causes/consequences and ► Solutions
The seat heating has switched off prematurely or cannot be switched on.	<p>The on-board voltage is too low because too many electrical consumers are switched on.</p> <p>► Switch off electrical consumers that you do not need, such as the rear window defroster or interior lighting.</p> <p>Once the battery is sufficiently charged, the seat heating will switch back on automatically.</p>

## Steering wheel

### Important safety notes

#### ⚠ WARNING

You could lose control of your vehicle if you do the following while driving:

- adjust the driver's seat, head restraint, steering wheel or mirrors
- fasten the seat belt

There is a risk of an accident.

Adjust the driver's seat, head restraint, steering wheel and mirror and fasten your seat belt before starting the engine.

#### ⚠ WARNING

Children could injure themselves if they adjust the steering wheel. There is a risk of injury.

When leaving the vehicle, always take the SmartKey with you and lock the vehicle. Never leave children unsupervised in the vehicle.

### Adjusting the steering wheel

#### ⚠ WARNING

If the steering wheel is unlocked while the vehicle is in motion, it could change position unexpectedly. This could cause you to lose control of the vehicle. There is a risk of an accident.

Before starting off, make sure the steering wheel is locked. Never unlock the steering wheel while the vehicle is in motion.



- ① Release lever
  - ② To adjust the steering wheel height
  - ③ To adjust the steering wheel position (fore-and-aft adjustment)
- Push release lever ① down completely. The steering column is unlocked.
  - Adjust the steering wheel to the desired position.
  - Push release lever ① up completely. The steering column is locked.
  - Check if the steering column is locked. When doing so, try to push the steering wheel up or down or try to move it in the fore-and-aft direction.

## Mirrors

### Rear-view mirror



- ▶ **Anti-glare mode:** flick anti-glare lever ① forwards or back.

### Exterior mirrors

#### Adjusting the exterior mirrors

#### WARNING

The exterior mirror on the front-passenger side reduces the size of the image. Visible objects are actually closer than they appear. This means that you could misjudge the distance from road users traveling behind, e.g. when changing lane. There is a risk of an accident.

For this reason, always make sure of the actual distance from the road users traveling behind by glancing over your shoulder.



- ▶ Turn the SmartKey to position 1 or 2 in the ignition lock (▷ page 127).
- ▶ Press button ① for the left-hand exterior mirror or button ② for the right-hand exterior mirror.  
The indicator lamp in the corresponding button lights up in red.  
The indicator lamp goes out again after some time. You can adjust the selected mirror using adjustment button ③ as long as the indicator lamp is lit.
- ▶ Press adjustment button ③ up, down, or to the left or right until you have adjusted the exterior mirror to the correct position. You should have a good overview of traffic conditions.

The convex exterior mirrors provide a larger field of vision.

The exterior mirrors are automatically heated after starting the vehicle if the rear window defroster is switched on and the outside temperature is low. Heating takes a maximum of 10 minutes.

- ❗ You can also heat up the exterior mirrors manually by switching on the rear window defroster.

#### Exterior mirror pushed out of position

If an exterior mirror has been pushed out of position, proceed as follows:

- ▶ Move the exterior mirror into the correct position manually.  
The mirror housing is engaged again and you can adjust the exterior mirrors as usual (▷ page 93).

#### Automatic anti-glare mirrors

The rear-view mirror and the exterior mirror on the driver's side automatically go into anti-glare mode if:

- the ignition is switched on and
- incident light from headlamps strikes the sensor in the rear-view mirror.



The mirrors do not go into anti-glare mode if reverse gear is engaged or the interior lighting is switched on.

### Parking position for the exterior mirror on the front-passenger side

#### General notes

The "Parking position for the exterior mirror on the front-passenger side" function is only available if the vehicle is equipped with the "Memory package".

#### Setting and storing the parking position

##### Using reverse gear

You can position the front-passenger side exterior mirror in such a way that you can see the rear wheel on that side as soon as you engage reverse gear. You can store this position.



- ▶ Make sure that the vehicle is stationary.
- ▶ Turn the SmartKey to position **2** in the ignition lock (▷ page 127).
- ▶ Press button **②** for the exterior mirror on the front-passenger side.
- ▶ Engage reverse gear.  
The exterior mirror on the front-passenger side moves to the preset parking position.
- ▶ Use adjustment button **③** to adjust the exterior mirror. You should see the rear wheel and the curb in the exterior mirror. The parking position is stored.

- i** If you shift the transmission to another position, the exterior mirror on the front-passenger side returns to the driving position.

#### Using the memory button

You can position the front-passenger side exterior mirror in such a way that you can see the rear wheel on that side as soon as you engage reverse gear. You can store this position. This setting can be stored using memory button **M** **④**.

- ▶ Make sure that the vehicle is stationary.
- ▶ Turn the SmartKey to position **2** in the ignition lock (▷ page 127).
- ▶ Press button **②** for the exterior mirror on the front-passenger side.
- ▶ Use adjustment button **③** to adjust the exterior mirror. You should see the rear wheel and the curb in the exterior mirror.
- ▶ Press memory button **M** **④** and one of the arrows on adjustment button **③** within three seconds.

The parking position is stored if the exterior mirror does not move.

- ▶ If the mirror moves out of position, repeat the steps.

#### Calling up a stored parking position setting

- ▶ Turn the SmartKey to position **2** in the ignition lock (▷ page 127).
- ▶ Adjust the exterior mirror on the front-passenger side with the corresponding button (▷ page 93).
- ▶ Engage reverse gear.  
The exterior mirror on the front-passenger side moves to the stored parking position.



The exterior mirror on the front-passenger side moves back to its original position:

- as soon as you exceed a speed of 9 mph (15 km/h)
- about ten seconds after you have disengaged reverse gear
- if you press button ① for the exterior mirror on the driver's side

## Memory functions

### Storing settings

#### WARNING

If you use the memory function on the driver's side while driving, you could lose control of the vehicle as a result of the adjustments being made. There is a risk of an accident.

Only use the memory function on the driver's side when the vehicle is stationary.

#### WARNING

When the memory function adjusts the seat, you and other vehicle occupants – particularly children – could become trapped. There is a risk of injury.

While the memory function is making adjustments, make sure that no one has any body parts in the sweep of the seat. If somebody becomes trapped, immediately release the memory function position button. The adjustment process is stopped.

#### WARNING

Children could become trapped if they activate the memory function, particularly when unattended. There is a risk of injury.

When leaving the vehicle, always take the SmartKey with you and lock the vehicle. Never leave children unsupervised in the vehicle.

The memory function can be used at any time, e.g. even when the SmartKey isn't in the ignition lock.

With the memory function, you can store up to three different settings, e.g. for three different people.

The following settings are stored as a single memory preset:

- position of the seat, backrest and head restraint
- driver's side: position of the exterior mirrors on the driver's and front-passenger sides



- ▶ Adjust the seat (> page 89).
- ▶ Adjust the exterior mirror on the driver's side (> page 93).
- ▶ Briefly press the **M** memory button and then press storage position button **1**, **2** or **3** within three seconds. The settings are stored in the selected preset position, and a confirmation tone sounds.

### Calling up a stored setting

- ▶ Press and hold the relevant storage position button **1**, **2** or **3** until the seat and exterior mirrors are in the stored position.
-  The setting procedure is interrupted as soon as you release the storage position button.



Useful information .....	98
Exterior lighting .....	98
Interior lighting .....	101
Replacing bulbs .....	102
Windshield wipers .....	108

## Useful information

**i** This Operator's Manual describes all models and all standard and optional equipment of your vehicle available at the time of publication of the Operator's Manual. Country-specific differences are possible. Bear in mind that your vehicle may not feature all functions described here. This also applies to safety-relevant systems and functions.

**i** Read the information on qualified specialist workshops: (▷ page 24).

## Exterior lighting

## General notes

For reasons of safety, Mercedes-Benz recommends that you drive with the lights switched on even during the daytime. In some countries, operation of the headlamps varies due to legal requirements and self-imposed obligations.

## Setting the exterior lighting

## Setting options

Exterior lighting can be set using:

- the light switch
- the combination switch (▷ page 100)
- the on-board computer (▷ page 187)

## Light switch

## Operation

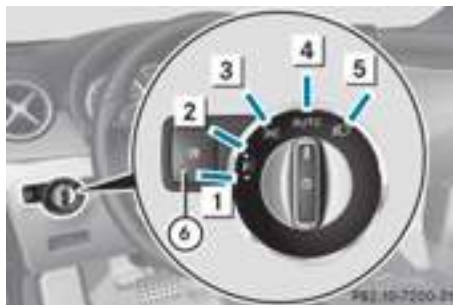

- |          |             |  |
|----------|-------------|--|
| <b>1</b> |             | Left-hand standing lamps                                     |
| <b>2</b> |             | Right-hand standing lamps                                    |
| <b>3</b> |             | Parking lamps, license plate and instrument cluster lighting |
| <b>4</b> | <b>AUTO</b> | Automatic headlamp mode, controlled by the light sensor      |
| <b>5</b> |             | Low-beam/high-beam headlamps                                 |
| <b>6</b> |             | Rear fog lamp  |

If you hear a warning tone when you leave the vehicle, the lights may still be switched on.

► Turn the light switch to **AUTO**.

The exterior lighting (except the parking/standing lamps) switches off automatically if you:

- remove the SmartKey from the ignition lock
- open the driver's door with the SmartKey in position **0** in the ignition lock.

## Automatic headlamp mode

**WARNING**

When the light switch is set to **AUTO**, the low-beam headlamps may not be switched on automatically if there is fog, snow or other causes of poor visibility due to the weather conditions such as spray. There is a risk of an accident.

In such situations, turn the light switch to



The automatic headlamp feature is only an aid. The driver is responsible for the vehicle's lighting at all times.

**AUTO** is the favored light switch setting. The light setting is automatically selected according to the brightness of the ambient light (exception: poor visibility due to weather conditions such as fog, snow or spray):

- SmartKey in position **1** in the ignition lock: the parking lamps are switched on or off automatically depending on the brightness of the ambient light
- With the ignition on: if you have switched on the daytime running lamps function in the on-board computer, the daytime running lamps or the parking lamps and low-beam headlamps are switched on or off automatically depending on the brightness of the ambient light.

► **To switch on automatic headlamp mode:** turn the light switch to **AUTO**.

The daytime running lamps improve the visibility of your vehicle during the day. The daytime running lamps function is required by law in Canada.

When the drive system is switched on and the vehicle is stationary: if you move the DIRECT SELECT lever to position **P**, the daytime running lamps/low-beam headlamps go out after 3 minutes.

When the drive system is switched on, the vehicle is stationary and in high ambient light brightness: if you turn the light switch to **☀**, you turn on the daytime running lamps and parking lamps.

If the drive system is switched on and you turn the light switch to **☀**, the manual settings take precedence over the daytime running lamps.

### Low-beam headlamps

When the ignition is switched on and the light switch is in position **☀**, the parking lamps and low-beam headlamps are switched on. This is the case even if the light sensor does

not detect it is dark. This is a particularly useful function in the event of rain and fog.

► **To switch on the low-beam headlamps:** turn the SmartKey in the ignition lock to position **2** or switch on the ignition.

► Turn the light switch to **☀**. The green **☀** indicator lamp in the instrument cluster lights up.

### Rear fog lamp

The rear fog lamp improves visibility of your vehicle for the traffic behind in the event of thick fog. Please take note of the country-specific regulations for the use of rear fog lamps.

► **To switch on the rear fog lamp:** turn the SmartKey in the ignition lock to position **2** or switch on the ignition.

► Turn the light switch to **☁** or **AUTO**.

► Press the **☁** button.

The yellow **☁** indicator lamp in the instrument cluster lights up.



► **To switch off the rear fog lamp:** press the **☁** button.

The yellow **☁** indicator lamp in the instrument cluster goes out.

**i** For vehicles with Bi-Xenon headlamps or the Intelligent Light System, if the rear fog lamp is switched on, the lower 15 LEDs of the brake lamp in the tail lamp switch off. For right-wheel drive vehicles they only switch off in the left-hand tail lamp, and for left-wheel drive vehicles only in the right-hand tail lamp. This is due to a legal requirement.



### Parking lamps

**!** If the battery has been excessively discharged, the parking lamps or standing lamps are automatically switched off to enable the next engine start. Always park your vehicle safely and sufficiently lit according to legal standards. Avoid the continuous use of the **☀** parking lamps for several hours. If possible, switch on the **☀** right or the **☀** left standing lamp.

- ▶ **To switch on:** turn the light switch to . The green  indicator lamp in the instrument cluster lights up.

### Standing lamps

Switching on the standing lamps ensures the corresponding side of the vehicle is illuminated.

- ▶ **To switch on the standing lamps:** the SmartKey should not be in the ignition lock or it should be in position **0**.
- ▶ Turn the light switch to  (left-hand side of the vehicle) or  (right-hand side of the vehicle).

### Combination switch



#### Turn signal



- ① High-beam headlamps
- ② Turn signal, right
- ③ High-beam flasher
- ④ Turn signal, left

- ▶ **To indicate briefly:** press the combination switch briefly to the pressure point in the direction of arrow ② or ④. The corresponding turn signal flashes three times.
- ▶ **To indicate:** press the combination switch beyond the pressure point in the direction of arrow ② or ④.

### High-beam headlamps

- ▶ **To switch on the high-beam headlamps:** turn the SmartKey in the ignition lock to position **2** or switch on the ignition.
  - ▶ Turn the light switch to  or **AUTO**.
  - ▶ Press the combination switch beyond the pressure point in the direction of arrow ①. In the **AUTO** position, the high-beam headlamps are only switched on when it is dark and the ignition is on.
- The blue  indicator lamp in the instrument cluster lights up when the high-beam headlamps are switched on.
- ▶ **To switch off the high-beam headlamps:** move the combination switch back to its normal position. The blue  indicator lamp in the instrument cluster goes out.

### High-beam flasher

- ▶ **To switch on:** turn the SmartKey in the ignition lock to position **1** or **2**, or switch on the ignition.
- ▶ Pull the combination switch in the direction of arrow ③.

### Hazard warning lamps



The hazard warning lamps automatically switch on if:

- an air bag is deployed or
- the vehicle decelerates rapidly from a speed of above 45 mph (70 km/h) and comes to a standstill.

► **To switch on the hazard warning lamps:** press button ①.

All turn signals flash. If you now switch on a turn signal using the combination switch, only the turn signal lamp on the corresponding side of the vehicle will flash.

► **To switch off the hazard warning lamps:** press button ①.

The hazard warning lamps switch off automatically if the vehicle reaches a speed of above 6 mph (10 km/h) again after a full brake application.

**i** The hazard warning lamps still operate if the ignition is switched off.

### Headlamps fogged up on the inside

The headlamps may fog up on the inside if there is high atmospheric humidity.

► Switch on the lights and drive off. The level of fogging diminishes, depending on the length of the journey and the weather conditions (humidity and temperature).

If the level of fogging does not diminish:



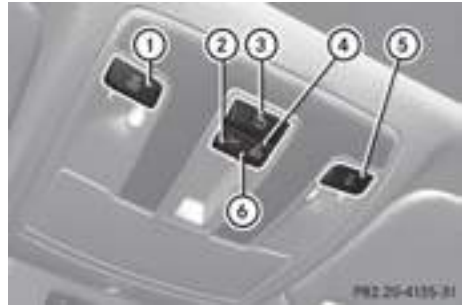

► Have the headlamps checked at a qualified specialist workshop.

## Interior lighting

### Overview of interior lighting



Front overhead control panel

- ①  To switch the left-hand front reading lamp on/off
- ②  To switch the front interior lighting on
- ③  To switch the on/off
- ④  To switch the front interior lighting/automatic interior lighting control off
- ⑤  To switch the right-hand front reading lamp on/off
- ⑥ To switch the automatic interior lighting control on



Rear-compartment overhead control panel (grab handle in the rear compartment)

- ① To switch the reading lamp on/off

## Interior lighting control

### Important notes

The interior lighting functions are automatically deactivated after some time except for when the SmartKey is in position **2** in the ignition lock. This prevents your vehicle's starter battery from discharging.

The brightness of the ambient lighting may be set using the on-board computer (> page 188). If the interior lighting control is switched off, the ambient lighting is also switched off.

### Automatic interior lighting control

▶ **To switch on:** move the switch to center position .

▶ **To switch off:** move the switch to the  position.

The interior lighting automatically switches on if you:

- unlock the vehicle
- open a door
- remove the SmartKey from the ignition lock

The interior light is activated for a short while when the SmartKey is removed from the ignition lock. You can activate this delayed switch-off using the on-board computer (> page 188).

### Manual interior lighting control

▶ **To switch the front interior lighting on:** set the switch to the  position.

▶ **To switch off the interior lighting:** set the switch to the  position or (if the door is closed) to the center position.

▶ **To switch the on/off:** press the  button.

▶ **To switch the reading lamps on/off:** press the  button.

## Crash-responsive emergency lighting

The interior lighting is activated automatically if the vehicle is involved in an accident.

▶ **To switch off the crash-responsive emergency lighting:** press the hazard warning lamp button.

or

▶ Lock and then unlock the vehicle using the SmartKey.

## Replacing bulbs

### Important safety notes

#### Xenon bulbs

#### DANGER

Xenon bulbs carry a high voltage. You can get an electric shock if you remove the cover of the Xenon bulb and touch the electrical contacts. There is a risk of fatal injury.

Never touch the parts or the electrical contacts of the Xenon bulb. Always have work on the Xenon bulbs carried out at a qualified specialist workshop.

You can recognize whether your vehicle is equipped with Xenon bulbs by the following: the cone of light from the Xenon bulbs moves from the top to the bottom and back again when you start the drive system. Before starting the drive system, you must first switch on the lights.

Bulbs and lamps are an important aspect of vehicle safety. You must therefore make sure that these function correctly at all times. Have the headlamp setting checked regularly.

#### Other bulbs

#### WARNING

Bulbs, lamps and connectors can get very hot when operating. If you change a bulb, you could burn yourself on these components. There is a risk of injury.



Allow these components to cool down before changing a bulb.

Do not use a bulb that has been dropped or if its glass tube has been scratched.

The bulb may explode if:

- you touch it
- it is hot
- you drop it
- you scratch it

Only operate bulbs in enclosed lamps designed for that purpose. Only install spare bulbs of the same type and the specified voltage.

Marks on the glass tube reduce the service life of the bulbs. Do not touch the glass tube with your bare hands. If necessary, clean the glass tube when cold with alcohol or spirit and rub it off with a lint-free cloth.

Protect bulbs from moisture during operation. Do not allow bulbs to come into contact with liquids.

There are bulbs other than the Xenon bulbs that you cannot replace. Replace only the bulbs listed (> page 103). Have the bulbs that you cannot replace yourself changed at a qualified specialist workshop.

If you require assistance changing bulbs, consult a qualified specialist workshop.

If the new bulb still does not light up, consult a qualified specialist workshop.

Bulbs and lamps are an important aspect of vehicle safety. You must therefore make sure that these function correctly at all times.

Have the headlamp setting checked regularly.

### Overview: changing bulbs/bulb types

You can replace the following bulbs. The bulb type can be found in the legend.

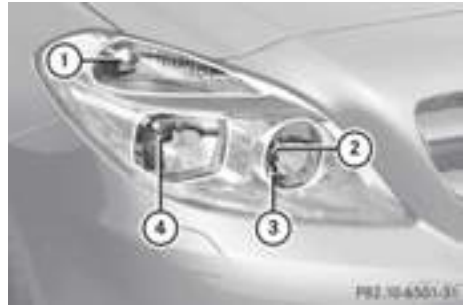

Vehicles with halogen headlamps

- ① Turn signal lamp: 3457
- ② High-beam headlamp: H7 55 W
- ③ Parking lamp/standing lamp: W 5 W LL
- ④ Low-beam headlamp: H7 55 W



Vehicles with Bi-Xenon headlamps

- ① Cornering lamp: H7 55 W

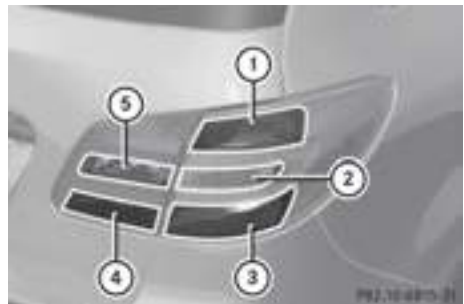

Tail lamps (vehicles with halogen headlamps)

- ① Tail lamp/turn signal lamp/brake lamp: P 21 W
- ② Inoperative
- ③ Side marker lamp: P 21 W

- ④ Rear fog lamp: P 21 W
- ⑤ Backup lamp: W 16 W



Tail lamps (vehicles with Bi-Xenon headlamps)

- ① Turn signal lamp/brake lamp: P 21 W
- ② Rear fog lamp: H 21 W
- ③ Backup lamp: W 16 W



License plate lamp (vehicles with halogen headlamps)

- ① License plate lamp: C 5 W

### Changing the front bulbs

#### Removing and installing the cover in the front wheel housing

You must remove the cover from the front wheel housing before you can change the front bulbs.



- ▶ **To remove:** switch off the lights.
- ▶ Turn the front wheels inwards.
- ▶ Slide cover ① upwards. Cover ① is released.
- ▶ Unclip cover ①.
- ▶ **To install:** clip in cover ①.
- ▶ Push cover ① down. Cover ① is locked.

#### Low-beam headlamps (halogen headlamps)

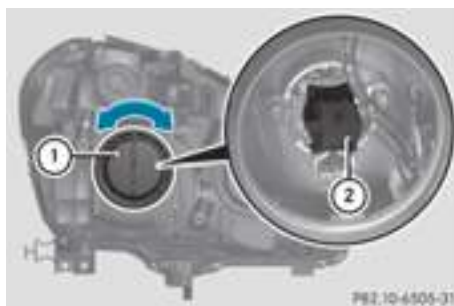

- ▶ Remove the cover in the front wheel housing (▷ page 104).
- ▶ Turn housing cover ① counter-clockwise and remove it.
- ▶ Turn bulb holder ② counter-clockwise and pull out.
- ▶ Take the bulb out of bulb holder ②.
- ▶ Insert the new bulb into bulb holder ②.
- ▶ Insert bulb holder ② and turn it clockwise.

- ▶ Press on housing cover ① and turn it to the right.
- ▶ Replace the cover in the front wheel housing (▷ page 104).

### High-beam headlamps/daytime running lamps (halogen headlamps)



- ▶ Switch off the lights.
- ▶ Open the hood.
- ▶ Turn housing cover ① counter-clockwise and remove it.
- ▶ Turn bulb holder ② counter-clockwise and pull out.
- ▶ Take the bulb out of bulb holder ②.
- ▶ Insert the new bulb into bulb holder ②.
- ▶ Insert bulb holder ② and turn it clockwise.
- ▶ Press on housing cover ① and turn it to the right.
- ▶ Replace the cover in the front wheel housing (▷ page 104).

### Parking lamps/standing lamps (halogen headlamps)

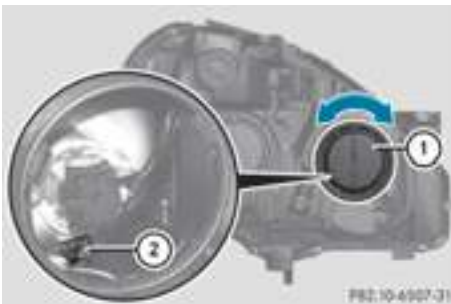

- ▶ Switch off the lights.
- ▶ Open the hood.
- ▶ Turn housing cover ① counter-clockwise and remove it.
- ▶ Pull out bulb holder ②.
- ▶ Take the bulb out of bulb holder ②.
- ▶ Insert the new bulb into bulb holder ②.
- ▶ Insert bulb holder ②.
- ▶ Press on housing cover ① and turn it to the right.

### Turn signals (halogen headlamps)



- ▶ Switch off the lights.
- ▶ Open the hood.
- ▶ Turn bulb holder ① counter-clockwise and pull out.
- ▶ Take the bulb out of bulb holder ①.
- ▶ Insert the new bulb into bulb holder ①.
- ▶ Insert bulb holder ① and turn it clockwise until it engages.

### Changing the rear bulbs

#### Opening and closing the side trim panels

You must open the side trim panel in the cargo compartment before you can change the bulbs in the tail lamps.



Left-hand side trim panel



Right-hand side trim panel

► **To open:** turn release knob ① 90° in the direction of the arrow and remove side trim panel ②.

► **To close:** insert side trim panel ② and turn release knob ① 90° in the opposite direction to the arrow.

## Tail lamps

### Turn signal/tail and brake lamps

- Switch off the lights.
- Open the cargo compartment.
- Open the side trim panel (▷ page 105).

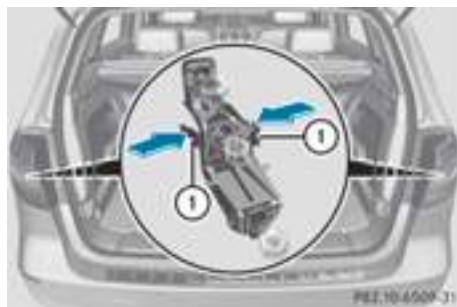

- Press retaining lugs ① simultaneously in the direction of the arrow and pull the bulb holder out.

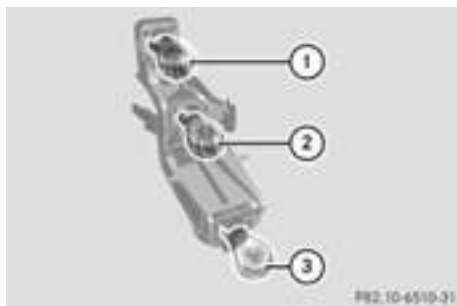

Bulb holder

- ① Turn signal/tail/brake lamps<sup>3</sup>.
- ② Unused bulbs (vehicles without LEDs)
- ③ Side marker lamp (vehicles without LEDs)
- Lightly press the corresponding bulb into the holder, turn it counter-clockwise and remove it from the bulb holder.
- Insert the corresponding new bulb into the bulb holder, press gently and turn it clockwise.
- Attach the bulb holder and press firmly. The retaining lugs on the bulb holder engage audibly.
- Close the side trim panel (▷ page 105).

<sup>3</sup> Vehicles with LEDs: turn signal/brake lamps only

### Backup lamp and rear fog lamp

Due to their location, have the bulbs in the backup lamp and rear fog lamp in the tailgate changed at a qualified specialist workshop.

- ▶ Switch off the lights.
- ▶ Open the tailgate.
- ▶ Insert a screwdriver, for example, into recess ④ on the inside.
- ▶ Pry off and remove the upper section of handle ③.
- ▶ Pull the lower section of handle ① using a sharp, sudden movement to remove it from the trim and then place it to one side.

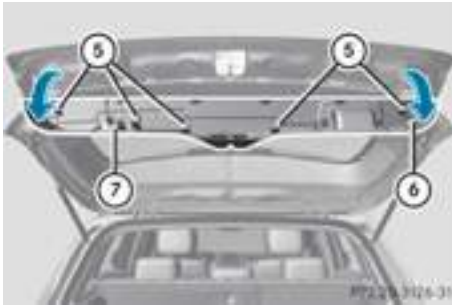

- ▶ Reach under the right-hand side of trim ⑥.
- ▶ Apply a gentle jolting force along the entire length of the trim in order to unclip it.
- ▶ Pull out connector ⑦ of the surround lighting by releasing the latches.
- ▶ Place trim ⑥ to one side.



- ▶ Unclip part of trim ⑧ from the assembly using a sudden, sharp movement, until bulb holder ⑨ is accessible.



- ▶ Remove bulb holder ⑨ using both sides of lever ⑩.

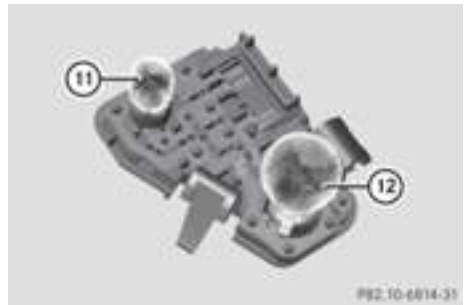

Bulb holder

- ▶ **Rear fog lamp ⑪:** press the bulb gently into holder ⑨, turn it counter-clockwise and remove it from bulb holder ⑨.
- ▶ Insert the new bulb into bulb holder ⑨ and turn it clockwise.
- ▶ **Backup lamp ⑫:** remove the bulb from bulb holder ⑨.
- ▶ Insert the new bulb into bulb holder ⑨.
- ▶ Re-insert bulb holder ⑨ until you hear engage audibly.
- ▶ Position trim ⑧ and engage it in place by tapping it with your hand.
- ▶ Before beginning the installation, check that all the metal clips are inserted in the parts placed to one side: 2 clips ② in the upper part of handle ③ and 5 clips ⑤ in trim ⑥.

- ▶ Unclip part of trim ⑧ from the assembly using a sudden, sharp movement, until bulb holder ⑨ is accessible.

- ▶ If not, remove the missing metal clips from the metal openings in the tailgate and insert them in the appropriate places.
- ▶ Take trim ⑥ and connect plug connector ⑦ to the surround lighting.

**i** The surround lighting only illuminates when the tailgate has been shut and reopened.

- ▶ Position trim ⑥ and engage it in place by tapping it with your hand, starting from the outside.
- ▶ Clip in the lower section of handle ① again.
- ▶ Insert and engage the upper section of handle ③ into lower section ①.

## Windshield wipers

### Switching the windshield wipers on/off

**!** Do not operate the windshield wipers when the windshield is dry, as this could damage the wiper blades. Moreover, dust that has collected on the windshield can scratch the glass if wiping takes place when the windshield is dry.

If it is necessary to switch on the windshield wipers in dry weather conditions, always use washer fluid when operating the windshield wipers.

**!** If the windshield wipers leave smears on the windshield after the vehicle has been washed in an automatic car wash, wax or other residues may be the reason for this. Clean the windshield using washer fluid after washing the vehicle in an automatic car wash.



Combination switch

- 1  0 Windshield wiper off
- 2  ⋯ Intermittent wipe, low (rain sensor set to low sensitivity)
- 3  ⋯⋯ Intermittent wipe, high (rain sensor set to high sensitivity)
- 4  — Continuous wipe, slow
- 5  = Continuous wipe, fast
- 6  Single wipe/  To wipe the windshield using washer fluid

- ▶ Switch on the ignition.
- ▶ Turn the combination switch to the corresponding position.

**!** Vehicles with a rain sensor: if the windshield becomes dirty in dry weather conditions, the windshield wipers may be activated inadvertently. This could then damage the windshield wiper blades or scratch the windshield.

For this reason, you should always switch off the windshield wipers in dry weather.

**Vehicles with a rain sensor:** in the  ⋯ or  ⋯⋯ position, the appropriate wiping frequency is automatically set according to the intensity of the rain. In the  ⋯⋯ position, the rain sensor is more sensitive than in the  ⋯ position, causing the windshield wiper to wipe more frequently.



If the wiper blades are worn, the windshield will no longer be wiped properly. This could prevent you from observing the traffic conditions.

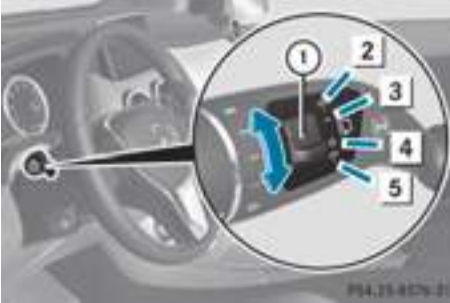

### Switching the rear window wiper on/off



Combination switch

- ①  Switch
  - ②  To wipe with washer fluid
  - ③ **I** To switch on intermittent wiping
  - ④ **0** To switch off intermittent wiping
  - ⑤  To wipe with washer fluid
- ▶ Turn the SmartKey to position **1** or **2** in the ignition lock.
  - ▶ Turn switch ① on the combination switch to the corresponding position. When the rear window wiper is switched on, the icon appears in the instrument cluster.

### Replacing the wiper blades

#### Important safety notes

#### WARNING

If the windshield wipers begin to move while you are changing the wiper blades, you could be trapped by the wiper arm. There is a risk of injury.

Always switch off the windshield wipers and ignition before changing the wiper blades.

- !** To avoid damaging the wiper blades, make sure that you touch only the wiper arm of the wiper.
- !** Never open the hood/tailgate if a wiper arm has been folded away from the windshield/rear window.

Never fold a windshield wiper arm without a wiper blade back onto the windshield/rear window.

Hold the windshield wiper arm firmly when you change the wiper blade. If you release the wiper arm without a wiper blade and it falls onto the windshield/rear window, the windshield/rear window may be damaged by the force of the impact.

Mercedes-Benz recommends that you have the wiper blades changed at a qualified specialist workshop.

### Changing the windshield wiper blades

#### Removing the wiper blades

- ▶ Remove the SmartKey from the ignition lock.
- ▶ Fold the wiper arm away from the windshield.



- ▶ Press both release clips ②.
- ▶ Fold wiper blade ① in the direction of arrow ③ away from wiper arm ④.
- ▶ Remove wiper blade ① in the direction of arrow ⑤.

### Installing the wiper blades



- ▶ Position new wiper blade ① with recess ⑥ on lug ⑤.
- ▶ Fold wiper blade ① in the direction of arrow ③ onto the wiper arm, until retaining clips ② engage in bracket ④.
- ▶ Make sure that wiper blade ① is seated correctly.
- ▶ Fold the wiper arm back onto the windshield.

- ▶ Hold wiper arm ① and press wiper blade ② in the direction of the arrow until it releases.
- ▶ Remove wiper blade ②.

### Installing a wiper blade

- ▶ Place new wiper blade ② onto wiper arm ①.
- ▶ Hold wiper arm ① and press wiper blade ② in the opposite direction to the arrow until it engages.
- ▶ Make sure that wiper blade ② is seated correctly.
- ▶ Position wiper blade ② parallel to wiper arm ①.
- ▶ Fold wiper arm ① back onto the rear window.

### Replacing the rear window wiper blade

#### Removing a wiper blade



- ▶ Remove the SmartKey from the ignition lock.
- ▶ Fold wiper arm ① away from the rear window until it engages.
- ▶ Position wiper blade ② at a right angle to wiper arm ①.



## Problems with the windshield wipers

Problem	Possible causes/consequences and ► Solutions
The windshield wipers are jammed.	<p>Leaves or snow, for example, may be obstructing the windshield wiper movement. The wiper motor has been deactivated.</p> <ul style="list-style-type: none"> <li>► For safety reasons, you should remove the SmartKey from the ignition lock.</li> <li>► Remove the cause of the obstruction.</li> <li>► Switch the windshield wipers back on.</li> </ul>
The windshield wipers fail completely.	<p>The windshield wiper drive is malfunctioning.</p> <ul style="list-style-type: none"> <li>► Select another wiper speed on the combination switch.</li> <li>► Have the windshield wipers checked at a qualified specialist workshop.</li> </ul>
The windshield washer fluid from the spray nozzles no longer hits the center of the windshield.	<p>The spray nozzles are misaligned.</p> <ul style="list-style-type: none"> <li>► Have the spray nozzles adjusted at a qualified specialist workshop.</li> </ul> <p>The spray nozzles are dirty.</p> <ul style="list-style-type: none"> <li>► For safety reasons, you should remove the SmartKey from the ignition lock.</li> <li>► Clean the spray nozzles.</li> </ul>



Useful information .....	114
Overview of climate control systems .....	114
Operating the climate control systems .....	116
Setting the air vents .....	123

### Useful information

- i** This Operator's Manual describes all models and all standard and optional equipment of your vehicle available at the time of publication of the Operator's Manual. Country-specific differences are possible. Bear in mind that your vehicle may not feature all functions described here. This also applies to safety-relevant systems and functions.
- i** Read the information on qualified specialist workshops: (▷ page 24).

### Overview of climate control systems

#### General notes

Observe the settings recommended on the following pages. The windows could otherwise fog up.

To prevent the windows from fogging up:

- switch off climate control only briefly
- switch on air-recirculation mode only briefly
- switch on the cooling with air dehumidification function
- switch on the defrost windshield function briefly, if required

Dual-zone automatic climate control dehumidifies the air and regulates the temperature in the vehicle interior and filters undesirable substances out of the air.

Optimum operation is only achieved with the side windows closed.

- i** Ventilate the vehicle for a brief period during warm weather, e.g. using the convenience opening feature (▷ page 82). This will speed up the cooling process and the desired vehicle interior temperature will be reached more quickly.
- i** The integrated filter filters out most particles of dust and soot and completely filters out pollen. It also reduces gaseous pol-

lutants and odors. A clogged filter reduces the amount of air supplied to the vehicle interior. For this reason, you should always observe the interval for replacing the filter, which is specified in the Maintenance Booklet. As it depends on environmental conditions, e.g. heavy air pollution, the interval may be shorter than stated in the Maintenance Booklet.

- i** It is possible that the dehumidification function of the climate control system may be activated automatically an hour after the SmartKey has been removed. The vehicle is then ventilated for 30 minutes.

## Control panel for dual-zone automatic climate control

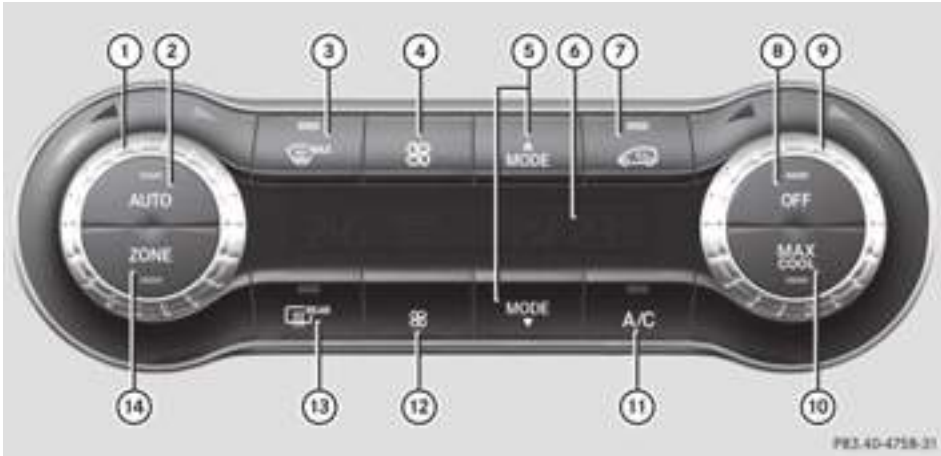

- ① To set the temperature, left (▷ page 117)
- ② To set climate control to automatic (▷ page 117)
- ③ To defrost the windshield (▷ page 118)
- ④ To increase the airflow (▷ page 118)
- ⑤ To set the air distribution (▷ page 117)
- ⑥ Display
- ⑦ To activate/deactivate air-recirculation mode (▷ page 120)
- ⑧ To switch climate control on/off (▷ page 116)
- ⑨ To set the temperature, right (▷ page 117)
- ⑩ To activate/deactivate maximum cooling (▷ page 119)
- ⑪ To switch cooling with air dehumidification on/off (▷ page 116)
- ⑫ To reduce the airflow (▷ page 118)
- ⑬ To switch the rear window defroster on/off (▷ page 119)
- ⑭ To switch the ZONE function on/off (▷ page 118)

### Optimum use of dual-zone automatic climate control

#### Automatic climate control

The following contains instructions and recommendations to enable you to get the most out of your automatic climate control.

- Activate climate control using the **AUTO** and **A/C** buttons. The indicator lamps in the **AUTO** and **A/C** buttons light up.
- Set the temperature to 72 °F (22 °C).
- Only use the "Windshield defrosting" function briefly until the windshield is clear again.
- Only use air-recirculation mode briefly, e.g. if there are unpleasant outside odors or when in a tunnel. The windows could otherwise fog up, since no fresh air is drawn into the vehicle in air-recirculation mode.
- Use the ZONE function to adopt the temperature settings on the driver's side for the front-passenger side as well. The indicator lamp in the **ZONE** button goes out.

## Operating the climate control systems

### Switching climate control on/off

#### General notes

When the climate control is switched off, the air supply and air circulation are also switched off. The windows could fog up. Therefore, switch off climate control only briefly

#### Dual-zone automatic climate control

► Turn the SmartKey to position **2** in the ignition lock.

► **To switch on:** press the **AUTO** button. The indicator lamp in the **AUTO** button lights up. Airflow and air distribution are set to automatic mode.

or

► Press the **OFF** button. The indicator lamp in the **OFF** button goes out. The previously selected settings are restored.

► **To switch off:** press the **OFF** button. The indicator lamp in the **OFF** button lights up.

**i** Dual-zone automatic climate control: switch on climate control primarily using the **AUTO** button.

### Activating/deactivating cooling with air dehumidification

#### General notes

If you deactivate the "Cooling with air-dehumidification" function, the air inside the vehicle will not be cooled. The air inside the vehicle will also not be dehumidified. The windows can fog up more quickly. Therefore, only deactivate the "Cooling with air-dehumidification" function briefly.

The "Cooling with air-dehumidification" function is operational when the vehicle is ready

to drive. The air inside the vehicle is cooled and dehumidified according to the temperature selected.

Condensation may drip from the underside of the vehicle when it is in cooling mode. This is normal and not a sign that there is a malfunction.

#### Activating/deactivating

► **To activate:** press the **A/C** button.

The indicator lamp in the **A/C** button lights up.

► **To deactivate:** press the **A/C** button.

The indicator lamp in the **A/C** button goes out. The "Cooling with air dehumidification" function has a delayed switch-off feature.

**Problems with the "Cooling with air dehumidification" function**

Problem	Possible causes/consequences and ► Solutions
The indicator lamp in the  button flashes three times or remains off. The "Cooling with air dehumidification" function cannot be switched on.	Cooling with air dehumidification has been deactivated due to a malfunction. ► Visit a qualified specialist workshop.

**Setting climate control to automatic**



**General notes**



In automatic mode, the set temperature is maintained automatically at a constant level. The system automatically regulates the temperature of the dispensed air, the airflow and the air distribution.

The automatic mode functions optimally when the "Cooling with air dehumidification" function is activated. If necessary, cooling with air dehumidification can be deactivated.



If you deactivate the "Cooling with air-dehumidification" function, the air inside the vehicle will not be cooled. The air inside the vehicle will also not be dehumidified. The windows can fog up more quickly. Only switch the cooling with air dehumidification function off for short periods.

**Setting climate control to automatic**

- Turn the key to position **3** in the ignition lock.  
The READY indicator is displayed.
- Set the desired temperature.
- **To activate:** press the  button.  
The indicator lamp in the  button lights up. Automatic air distribution and airflow are activated.

- **To switch to manual mode:** press the  or  button.



or

- Press the  or  button.  
The indicator lamp in the  button goes out. Automatic air distribution and airflow are deactivated.

**Setting the temperature**

**Dual-zone automatic climate control**



Different temperatures can be set for the driver's and front-passenger sides.

- Turn the SmartKey to position **2** in the ignition lock (► page 127).
- **To increase/reduce:** turn thumbwheel  ① or  ② counter-clockwise or clockwise (► page 115). Only change the temperature setting in small increments. Start at 72 °F (22 °C).

**Setting the air distribution**

**Dual-zone automatic climate control**

**Air distribution settings**



-  Directs air through the defroster vents
-  Directs air through the center and side air vents
-  Directs air through the footwell air vents

 Directs the airflow through the center and side air vents as well as the defroster vents

 Directs air through the defroster and footwell vents



**i** Regardless of the air distribution setting, airflow is always directed through the side air vents. The side air vents can only be closed if the adjusters are turned clockwise until they engage.

### Setting the air distribution

- ▶ Turn the SmartKey to position **2** in the ignition lock (▷ page 127).
- ▶ Press the  or  button repeatedly until the desired symbol appears in the display.





### Setting the airflow

#### Dual-zone automatic climate control

- ▶ Turn the SmartKey to position **2** in the ignition lock (▷ page 127).
- ▶ **To increase/reduce:** press the  or  button.



### Switching the ZONE function on/off

This function is only available with dual-zone automatic climate control.



- ▶ **To activate:** press the  button.  
The indicator lamp in the  button lights up.  
The temperature setting for the driver's side is not adopted for the front-passenger side.
- ▶ **To deactivate:** press the  button.  
The indicator lamp in the  button goes out.  
The temperature setting for the driver's side is adopted for the front-passenger side.



### Defrosting the windshield

You can use this function to defrost the windshield or to defrost the inside of the windshield and the side windows.



- i** The windshield heating is switched on using the "Windshield defrosting" function.
- i** Only use the "Windshield defrosting" function briefly until the windshield is clear again.
- ▶ Turn the SmartKey to position **3** in the ignition lock (▷ page 127).  
The READY indicator is displayed.
- ▶ **To activate:** press the  button.  
The indicator lamp in the  button lights up.  
The climate control system switches to the following functions:
  - high airflow
  - high temperature
  - air distribution to the windshield and front side windows
  - air-recirculation mode off
  - windshield heating on

**i** The "Windshield defrosting" function automatically sets the blower output to the optimum defrosting effect. As a result, the airflow may increase or decrease automatically after the button is pressed.

- i** You can adjust the blower output manually while the "Windshield defrosting" function is in operation:
  - ▶ Press the  or  button.

- ▶ **To deactivate:** press the  button.  
The indicator lamp in the  button goes out. The previously selected settings are restored. Air-recirculation mode remains deactivated.

or

- ▶ Press the  button.  
The indicator lamp in the  button goes out. Airflow and air distribution are set to automatic mode.





or

- ▶ Turn temperature control ① or ② counter-clockwise or clockwise (▷ page 115).

### MAX COOL maximum cooling

The MAX COOL function is only available in vehicles for the USA.

The MAX COOL function only works when the vehicle is ready to drive.

- ▶ Turn the SmartKey to position **3** in the ignition lock (▷ page 127).  
The READY indicator is displayed.
- ▶ **To activate:** press the  button.  
The indicator lamp in the button lights up.
- ▶ **To activate:** press the  button again.  
The indicator lamp goes out. The previously selected settings are restored.



When you activate MAX COOL, climate control switches to the following functions:

- maximum cooling
- maximum airflow
- air-recirculation mode on



### Defrosting the windows

#### Windows fogged up on the inside

##### Dual-zone automatic climate control

- ▶ Activate the  "Cooling with air dehumidification" function.
- ▶ Activate automatic mode .
- ▶ If the windows continue to fog up, activate the  "Windshield defrosting" function.
- i** You should only select this setting until the windshield is clear again.

#### Windows fogged up on the outside

- ▶ Activate the windshield wipers.
- ▶ Set the air distribution to  or .
- i** You should only select this setting until the windshield is clear again.



### Rear window defroster

#### General notes

The rear window defroster has a high current draw. You should therefore switch it off as soon as the rear window is clear. Otherwise, the rear window defroster switches off automatically after several minutes.

If the battery voltage is too low, the rear window defroster may switch off.

#### Activating/deactivating

- ▶ Turn the SmartKey to position **2** in the ignition lock (▷ page 127).
- ▶ Press the  button.  
The indicator lamp in the  button lights up or goes out.

## Problems with the rear window defroster

Problem	Possible causes/consequences and ► Solutions
The rear window defroster has deactivated prematurely or cannot be activated.	<p>The battery has not been sufficiently charged.</p> <p>► Switch off any consumers that are not required, e.g. reading lamps, interior lighting or the seat heating.</p> <p>When the battery is sufficiently charged, the rear window defroster can be activated again.</p>

### Activating/deactivating air-recirculation mode



#### General notes

You can deactivate the flow of fresh air if unpleasant odors are entering the vehicle from outside. The air already inside the vehicle will then be recirculated.

If you switch on air-recirculation mode, the windows can fog up more quickly, in particular at low temperatures. Only use air-recirculation mode briefly to prevent the windows from fogging up.



#### Activating/deactivating

► Turn the SmartKey to position **2** in the ignition lock.

► **To activate:** press the  button. The indicator lamp in the  button lights up.

**i** Air-recirculation mode is activated automatically at high outside temperatures. When air-recirculation mode is activated automatically, the indicator lamp in the  button is not lit.

Outside air is added after about 30 minutes.

► **To deactivate:** press the  button. The indicator lamp in the  button goes out.

**i** Air-recirculation mode deactivates automatically:

- after approximately 5 minutes at outside temperatures below approximately 41 °F (5 °C)
- after approximately 5 minutes if the cooling with air dehumidification function is deactivated
- after approximately 30 minutes at outside temperatures above approximately 41 °F (5 °C) if the "Cooling with air dehumidification" function is activated

#### Convenience opening/closing using the air-recirculation button

##### WARNING

When using the convenience closing feature, parts of the body could be trapped in the closing area when a side window is being closed. There is a risk of injury.



Observe the complete closing procedure when the convenience closing feature is operating. Make sure that no body parts are in close proximity during the closing procedure.

##### WARNING



During convenience opening parts of the body could be drawn in or become trapped between the side window and window frame. There is a risk of injury.

Make sure that nobody touches the side window during the opening procedure. If someone becomes trapped, press the  switch

immediately to open/close the side window in the door. The side window stops. To continue closing the side window, pull on the  switch.

- ▶ **Convenience closing feature:** press and hold the  button until the side windows are closed. The indicator lamp in the  button lights up. Air-recirculation mode is activated.



If parts of the body are in the closing area during convenience closing, proceed as follows:

- ▶ Press the  button for opening/closing the side windows. The side window stops.
- ▶ To then open the side windows, press the  button again.

or

- ▶ Press and hold the  button again for longer than 2 seconds. The side windows move in the opposite direction.

- ❗ Notes on the automatic reversing feature for the side windows (▷ page 81).

- ▶ **Convenience opening feature:** press and hold the  button until the side windows are opened. The side windows move back to their original positions. The indicator lamp in the  button goes out. Air-recirculation mode is deactivated.

- ❗ If you open the side windows manually after closing them with the convenience closing feature, they will remain in this position when opened using the convenience opening feature.

### Pre-entry climate control via key

Before getting in, the vehicle interior can be briefly warmed or ventilated in advance and the air from the air vents can be pre-cooled.

The high-voltage battery must be sufficiently charged before the pre-entry climate control (via key) can be activated.

### Activating/deactivating the pre-entry climate control (via key)

When the vehicle is unlocked using the SmartKey, the climate control functions are activated.

- ❗ You can activate pre-entry climate control (via the SmartKey) three times in succession. The climate control function will be deactivated after the third time. The **Pre-Entry Climate Ctrl. (Via SmartKey) Available Again After Engine Start** display message appears in the instrument cluster. To activate the pre-entry climate control again, start the drive system.

The pre-cooling climate control function runs for up to 1 minute, the pre-heating climate control function runs for up to 5 minutes.

When the vehicle is pre-cooled, the following functions are activated as necessary:

- Climate control system
- Cooling with air dehumidification
- Blower

When the vehicle is pre-heated, the following functions are activated as necessary:

- Climate control system
- Blower
- Seat heating
- Windshield heating
- Rear window defroster

Pre-entry climate control is automatically switched off when operational readiness mode is requested.

### Activating/deactivating pre-entry climate control (via SmartKey)

You can activate and deactivate pre-entry climate control (via SmartKey) via the on-board computer in the **E-CELL** submenu (▷ page 185).

- ❗ If the condition of charge of the high-voltage battery is below the specified minimum

condition of charge, pre-entry climate control will not be activated even if it has been set.

### Pre-entry climate control at departure time and immediate pre-entry climate control

#### Important safety notes

##### WARNING

If persons, particularly children are subjected to prolonged exposure to extreme heat or cold, there is a risk of injury, possibly even fatal. Never leave children unattended in the vehicle.

#### General notes

Using the "pre-entry climate control at departure time" function, you can cool or heat the vehicle interior prior to the desired departure time.

When using the "pre-entry climate control at departure time" function, the condition of charge of the high-voltage battery must be higher than the specified minimum condition of charge.

The running time of the climate control may be reduced if:

- the vehicle is not connected to an electric power supply
- the high-voltage battery is not fully charged

In certain situations, the desired interior temperature cannot be reached.

When the vehicle is cooled, the following functions are activated as necessary:

- Climate control system
- Cooling with air dehumidification
- Blower

When the vehicle is heated, the following functions are activated as necessary:

- Climate control system
- Blower

- Seat heating
- Windshield heating
- Rear window defroster

"Immediate pre-entry climate control" is automatically switched off when operational readiness mode is requested.

#### Setting the departure time

You can set a departure time for the "pre-entry climate control at departure time". Your vehicle will then be cooled or heated until the desired temperature is reached in time for the set departure time. "Pre-entry climate control at departure time" will be activated a maximum of 50 minutes before departure. If the departure is delayed, the vehicle will be heated or cooled for a further 5 minutes.

You can set the desired departure time in the **E-CELL** submenu on the on-board computer (> page 185).

#### Activating immediate pre-entry climate control

You can activate "immediate pre-entry climate control" even if the vehicle interior is already at the desired temperature. This means that the vehicle interior continues to be cooled or heated, e.g. if the journey is interrupted for up to 50 minutes, and the interior temperature is kept constant. You can only set the desired temperature using the climate control unit. If you do not pre-select a temperature, the last temperature set will be automatically adopted.



The colors of the indicator lamps in the button have the following meanings:

Red Heating activated

Blue Cooling activated

Yellow Pre-entry climate control at departure is preselected

- ▶ **To activate/deactivate "immediate pre-entry climate control":** press button ① on the center console (▷ page 34). The blue or red indicator lamp in the button lights up or goes out.

## Setting the air vents

### Important safety notes

#### WARNING

Very hot or very cold air can flow from the air vents. This could result in burns or frostbite in the immediate vicinity of the air vents. There is a risk of injury.

Make sure that all vehicle occupants always maintain a sufficient distance to the air outlets. If necessary, redirect the airflow to another area of the vehicle interior.

In order to ensure the direct flow of fresh air through the air vents into the vehicle interior, please observe the following notes:

- keep the air inlet between the windshield and the hood free of blockages, such as ice, snow or leaves.
- never cover the air vents or air intake grilles in the vehicle interior.
- i** You can move the adjusters for the air vents vertically or horizontally to set the direction of the airflow.
- i** For optimal climate control in the vehicle, open the air vents completely and set the adjusters to the central position.

### Setting the center air vents



- ▶ **To open the center air vents:** turn the adjuster in one of center air vents ① counter-clockwise.
- ▶ **To close the center air vents:** turn the adjuster in one of center air vents ① clockwise until it engages.

### Setting the side air vents



- ① Side window defroster vent
- ② Side air vent

- ▶ **To open a side air vent:** turn the adjuster in the side air vent ② to the left.
- ▶ **To close a side air vent:** turn the adjuster in the side air vent ② to the right until it engages.



Useful information .....	126
Notes on breaking-in a new vehicle .....	126
Driving .....	126
Transmission .....	128
Charging the high-voltage battery ..	134
Parking .....	144
Driving tips .....	147
Driving systems .....	152

## Useful information

- i** This Operator's Manual describes all models and all standard and optional equipment of your vehicle available at the time of publication of the Operator's Manual. Country-specific differences are possible. Bear in mind that your vehicle may not feature all functions described here. This also applies to safety-relevant systems and functions.
- i** Read the information on qualified specialist workshops: (▷ page 24).

## Notes on breaking-in a new vehicle

### Important safety notes

New and replaced brake pads and discs only reach their optimum braking effect after several hundred kilometers of driving. Compensate for this by applying greater force to the brake pedal.

## Driving

### Important safety notes

#### **WARNING**

Objects in the driver's footwell can restrict the pedal travel or obstruct a depressed pedal. The operating and road safety of the vehicle is jeopardized. There is a risk of an accident.

Make sure that all objects in the vehicle are stowed correctly, and that they cannot enter the driver's footwell. Install the floor mats securely and as specified in order to ensure sufficient clearance for the pedals. Do not use loose floor mats and do not place floor mats on top of one another.

#### **WARNING**

Unsuitable footwear can hinder correct usage of the pedals, e.g.:

- shoes with thick soles
- shoes with high heels
- slippers

There is a risk of an accident.

Wear suitable footwear to ensure correct usage of the pedals.

#### **WARNING**

If you switch off the ignition while driving, safety-relevant functions are only available with limitations, or not at all. This could affect, for example, the power steering and the brake boosting effect. You will require considerably more effort to steer and brake. There is a risk of an accident.

Do not switch off the ignition while driving.

#### **WARNING**

If the parking brake has not been fully released when driving, the parking brake can:

- overheat and cause a fire
- lose its hold function.

There is a risk of fire and an accident. Release the parking brake fully before driving off.

The braking performance of the electric motor using recuperative braking is, in some operating modes, either reduced or not effective:

- when the condition of charge of the high-voltage battery increases
- if the high-voltage battery is not yet at a normal operating temperature
- when driving at speeds close to zero
- in transmission position **N**
- during and after ESP stability control.

If necessary, counteract the reduced regenerative braking effect by applying the brake yourself.



**!** Make sure the charging cable has been disconnected from the vehicle socket before starting a journey. The vehicle or charging cable may otherwise be damaged when you drive off.

**i** Before commencing your journey, ensure that the charging cable required for charging the high-voltage battery is in the vehicle.

### SmartKey positions



- 0** To remove the SmartKey (shift the transmission to position **P**)
  - 1** Power supply for some consumers, such as the windshield wipers
  - 2** Ignition (power supply for all consumers) and drive position
  - 3** Starting the engine
- i** The SmartKey can be turned in the ignition lock even if it is not the correct SmartKey for the vehicle. The ignition is not switched on. The drive system cannot be started.

### Starting the engine

#### Important safety notes

##### **⚠** WARNING

If children are left unsupervised in the vehicle, they could:

- open the doors, thus endangering other people or road users.
- get out and disrupt traffic.
- operate the vehicle's equipment.

Additionally, children could set the vehicle in motion if, for example, they:

- release the parking brake.
- shift the transmission out of park position **P**
- start the vehicle's drive system.

There is a risk of an accident and injury.

When leaving the vehicle, always take the SmartKey with you and lock the vehicle. Never leave children or animals unattended in the vehicle. Always keep the SmartKey out of reach of children.

Vehicles with an electric motor generate much less driving noise than vehicles with internal combustion engines. As a result, your vehicle may not be heard by other road users in certain situations. This can happen, for example, when you are parking and your vehicle is not seen by other road users. This requires you to adopt a particularly anticipatory driving style, as it is necessary to allow for the possibility that other road users may behave erratically.

The vehicle is equipped with a sound generator. The sound generator is activated so that other road users can hear your vehicle better. The sound generator is activated at speeds of under 20 mph (30 km/h) and switches off automatically at higher speeds.

#### Starting procedure

- i** Do not switch the ignition on and off at intervals of less than 3 seconds more than 15 times in succession. If it is switched on

and off more than 16 times, the ignition must remain off for at least 20 seconds. You could otherwise damage the vehicle.

- ▶ Turn the SmartKey to position **3** (▷ page 127) in the ignition lock and release it.

The drive system is started. The system check display appears in the multifunction display.

Once the system check is complete, the **Ready** display appears in the lower multifunction display. The vehicle is ready to drive.

### Pulling away

The vehicle is equipped with a sound generator. At low speeds, an electric vehicle makes less noise than a vehicle with a combustion engine. The sound generator is activated so that other road users can hear your vehicle better. The sound generator is activated at speeds of under 20 mph (30 km/h) and switches off automatically at higher speeds.

- ❗ It is only possible to move the DIRECT SELECT lever from position **P** to the desired selector lever position if you depress the brake pedal. Only then is the parking lock deactivated, at which point the electrical parking brake is released automatically. If the brake pedal is not depressed, the DIRECT SELECT lever can still be moved but the parking lock remains engaged.

- ▶ Depress the brake pedal and keep it depressed.
- ▶ Move the DIRECT SELECT lever to position **D** or **R**.
- ▶ Release the brake pedal.
- ▶ Carefully depress the accelerator pedal. The electric parking brake is automatically released (▷ page 145).

The red **PARK** (USA only) or **(P)** (Canada only) indicator lamp in the instrument cluster goes out.

- ❗ The vehicle locks centrally once you have pulled away. The locking knobs in the doors drop down.

You can open the doors from the inside at any time.

### Hill start assist

Hill start assist will aid you when pulling away on a hill. It holds the vehicle for a short time after you have removed your foot from the brake pedal. This gives you enough time to move your foot from the brake pedal to the accelerator pedal and depress it before the vehicle begins to roll.

#### WARNING

After a short time, hill start assist will no longer brake your vehicle and it could roll away. There is a risk of an accident and injury.

Therefore, quickly move your foot from the brake pedal to the accelerator pedal. Never leave the vehicle when it is held by hill start assist.

- ▶ Take your foot off the brake pedal. The vehicle is then held for about a second.
- ▶ Pull away.

Hill start assist is not active if:

- you are pulling away on a level road or on a downhill gradient.
- the DIRECT SELECT lever is in position **N**.
- the electric parking brake is applied.
- ESP® is malfunctioning.

Further information on holding the vehicle stationary on uphill gradients (▷ page 131).

## Transmission

### Important safety notes

- ❗ Shift the DIRECT SELECT lever to position **P** when the drive system is switched off and the vehicle is stationary. Park position **P** is

engaged and the electric parking brake is applied automatically:

If the DIRECT SELECT lever cannot be engaged in park position **P**, the parking brake is engaged automatically.

Observe the "Important safety notes" section on activating/deactivating ESP® (▷ page 183).

## DIRECT SELECT lever

### Overview of transmission positions

The DIRECT SELECT lever is on the right of the steering column.



**P** Park position with parking lock

**R** Reverse gear

**N** Neutral

**D** Drive

**i** The DIRECT SELECT lever always returns to its original position. The current transmission position **P**, **R**, **N** or **D** appears in the transmission position display (▷ page 176) in the multifunction display.

### Transmission position display

The current transmission position and drive program appear in the multifunction display.



① Transmission position display

② Drive program display

**i** The arrows in the transmission position display show how and into which transmission positions you can shift using the DIRECT SELECT lever.

**!** If the transmission position display in the multifunction display is not working, you should pull away carefully to check whether the desired transmission position is engaged. It is advisable to select transmission position **D**.

### Engaging park position P

**i** You can only engage park position **P** when the vehicle is stationary.

► Push the DIRECT SELECT lever in the direction of arrow **P**.

Transmission position display **P** is shown in the multifunction display.

**i** When you have engaged park position **P**, make sure that the transmission position display shows **P** in the multifunction display.

**i** The transmission shifts into park position **P** automatically if you open the driver's door when the vehicle is stationary or when driving at very low speed with the transmission in position **D** or **R**.

In addition, a warning tone sounds and a display message is shown.

**i** Depressing the brake and pushing the DIRECT SELECT lever up or down disengages the parking lock. The transmission is in **N** neutral.

In order to shift from park position **P** directly into **R** or **D**:

- depress the brake pedal and
- push the DIRECT SELECT lever up or down past the first point of resistance

### Engaging reverse gear R

**!** Only shift into reverse gear **R** when the vehicle is stationary. You could otherwise damage the drive system.

- ▶ When the vehicle is stationary, depress the brake pedal.
- ▶ Push the DIRECT SELECT lever up past the first point of resistance.

### Shifting to neutral N

- ▶ When the vehicle is stationary, depress the brake pedal.
- ▶ Push the DIRECT SELECT lever up or down to the first point of resistance.

When the drive system is switched off, the transmission shifts to **N** automatically.

### Remaining in neutral N

If the transmission is to remain in neutral **N**, for example when washing the vehicle in an automatic car wash with a towing mechanism, observe the following information:

#### WARNING

If children are left unsupervised in the vehicle, they could:

- open the doors, thus endangering other people or road users.
- get out and disrupt traffic.
- operate the vehicle's equipment.

Additionally, children could set the vehicle in motion if, for example, they:

- release the parking brake.
- shift the transmission out of park position **P**
- start the vehicle's drive system.

There is a risk of an accident and injury.

When leaving the vehicle, always take the SmartKey with you and lock the vehicle. Never leave children or animals unattended in the vehicle. Always keep the SmartKey out of reach of children.

- Make sure that the ignition is switched on.
- When the vehicle is stationary, depress the brake pedal and keep it depressed.
- Shift to neutral **N**.
- Release the brake pedal.
- If the electric parking brake is engaged, release it.
- Switch off the ignition and leave the SmartKey in the ignition lock.

### Engaging drive position D

- ▶ When the vehicle is stationary, depress the brake pedal.
- ▶ Push the DIRECT SELECT lever down past the first point of resistance.

### Transmission positions

**P**

#### Park position

This prevents the vehicle from rolling away when stopped. Only move the selector lever to **P** when the vehicle is stationary.

The SmartKey can only be removed when the selector lever is in position **P**. When there is no SmartKey in the ignition lock, the selector lever is locked in position **P**.

**R**

#### Reverse gear

Only move the selector lever to **R** when the vehicle is stationary.

**N****Neutral**

No power is transmitted from the drive system to the drive wheels. Releasing the brakes will allow you to move the vehicle freely.

If ESP® is faulty: only move the selector lever to **N** if the vehicle is in danger of skidding, e.g. on icy roads.

**D****Drive**

For driving forwards

**Driving tips****Holding the vehicle stationary on uphill gradients**

Do not hold the vehicle stationary on uphill gradients by depressing the accelerator pedal. Instead, only ever hold the vehicle stationary on uphill gradients by:

- depressing the brake pedal
- engaging the electric parking brake

**Kickdown**

Use kickdown for maximum acceleration.

- ▶ Depress the accelerator pedal beyond the pressure point.

The needle in the power display points to the boost area (▷ page 173).

- ▶ Ease off the accelerator pedal once the desired speed is reached.

**i** Maximum acceleration is available for a limited time.

**Rocking the vehicle free**

Shifting the transmission repeatedly between gears **D** and **R** may help to free the vehicle if it has become stuck in slush or snow. The vehicle's engine management system limits the speed to a maximum of 5 mph (9 km/h) when shifting back and forth. To shift back and forth between transmission positions **D** and **R**,

move the DIRECT SELECT lever up and down past the point of resistance.

**Program selector button****General notes**

The program selector button allows you to choose between drive programs with different driving characteristics.



Program selector button

<b>E</b> Economy	Comfortable, economical driving style
<b>S</b> Sport	Sporty driving style

- ▶ Press program selector button ①. The selected drive program appears in the multifunction display.

When the ignition is switched on, the driving mode last selected becomes active.

**Steering wheel paddle shifters****Manually adjustable recuperation**

If necessary, counteract the reduced regenerative braking effect by applying the brake yourself.

You can increase or reduce recuperation in overrun mode using the steering wheel paddle shifters. When you remove your foot from the accelerator pedal, recuperation occurs. The electric motor is then used as an alternator and energy is recovered while driving. The

recuperated electrical energy is stored in the high-voltage battery. A higher energy recuperation level means that the vehicle is braked more powerfully.

The various recuperation levels are shown in the transmission position display once **D** has been selected (> page 129).

The following recuperation levels are available in overrun mode:

- no recuperation (**D<sup>+</sup>**, coasting mode)
- moderate recuperation (**D**)
- high recuperation (**D<sup>-</sup>**)
- recuperation depending on the traffic situation (**D<sup>AUTO</sup>**, radar-based)

You can see the intensity of recuperation in overrun mode by reading the recuperation performance value shown in the power display (> page 173).

The transmission shifts into recuperation level **D<sup>AUTO</sup>** each time the ignition is switched on.



- ① Left-hand steering wheel paddle shifter -  
 ② Right-hand steering wheel paddle shifter  
 +

- ▶ **To reduce recuperation:** pull right-hand steering wheel paddle shifter ② towards you.
- ▶ **To increase recuperation:** pull left-hand steering wheel paddle shifter ① towards you.

The various different levels are to be used under the following conditions:

<b>D<sup>+</sup></b>	Driving without much braking and without the presence of obstacles or sharp bends The vehicle retains the maximum possible amount of kinetic energy.
<b>D</b>	Normal driving (standard setting)
<b>D<sup>-</sup></b>	Sporty driving The brake pedal does not need to be used as often because the extent of the deceleration is greater than in <b>D</b> . Energy use when decelerating is considerably higher than when the vehicle is braked with the brake pedal.
<b>D<sup>AUTO</sup></b> (radar-based)	The intensity of recuperation is automatically adjusted to the current traffic situation.

In levels **D** and **D<sup>-</sup>**, deceleration can be controlled in an infinitely variable manner using the accelerator pedal.

The braking performance of the electric motor using recuperative braking is, in some operating modes, either reduced or not effective:

- when the condition of charge of the high-voltage battery increases
- if the high-voltage battery is not yet at a normal operating temperature
- when the vehicle is almost stationary
- in transmission position **N**
- during and after ESP stability control

### RadAR-based recuperation

- ❗ Radar-based recuperation is not a distance control function and therefore can-

not maintain the distance to the vehicle in front.

Maintain a safe distance.

Mercedes-Benz recommends that you activate COLLISION PREVENTION ASSIST as a visual and acoustic aid.

The vehicle uses the sensors of COLLISION PREVENTION ASSIST during radar-based recuperation (**D<sup>AUTO</sup>**). The sensors detect the distance to the vehicle ahead and its speed. The intensity of recuperation is then automatically adjusted to the current traffic situation.

The range can then be increased by storing energy efficiently. Adjustment is infinitely variable from overrun mode (no recuperation) to maximum recuperation.

Examples of radar-based recuperation:

- Approaching a slower vehicle, a decelerating vehicle or when following a vehicle downhill. Your vehicle decelerates slightly and increases recuperation.
- Driving when no vehicle is detected in front or when a vehicle is detected in the far distance or an accelerating vehicle is detected. Your vehicle switches to overrun mode at higher speeds.
- Driving on a steep downhill slope. Acceleration downhill is reduced and recuperation is increased. This is comparable with shifting down when driving downhill.

► **To activate radar-based recuperation:** pull one steering wheel paddle shifter ① or ② towards you and hold for about one second.

► **To deactivate radar-based recuperation:** briefly pull one steering wheel paddle shifter ① or ② towards you.

If you change between radar-based and manual recuperation, the following levels are activated depending on the steering wheel paddle shifter selected:

② Steering wheel paddle shifter +	selects <b>D<sup>+</sup></b> (overrun)
① Steering wheel paddle shifter -	selects <b>D<sup>-</sup></b> (maximum recuperation)

In particular, the function of the radar sensors can be impaired in the case of:

- there is dirt on the sensors or anything else covering the sensors
- there is snow or heavy rain
- there is interference by other radar sources
- there are strong radar reflections, for example in parking garages
- a narrow vehicle traveling in front, e.g. a motorbike
- a vehicle traveling in front on a different line relative to the center of your vehicle

Following damage to the front end of the vehicle, have the configuration and operation of the radar sensor checked at a qualified specialist workshop. This also applies to collisions at slow speeds where there is no visible damage to the front of the vehicle.

**i** If the radar sensor is not available, the system switches automatically to level **D** with moderate recuperation. In this case have the radar sensor checked at a qualified specialist workshop.

### Automatic adjustment of recuperation on downhill gradients

**i** Automatic adjustment of recuperation on downhill gradients is available in level **D<sup>AUTO</sup>** or on vehicles without steering wheel paddle shifters in level **D**.

The vehicle can detect steep downhill gradients. To reduce acceleration downhill and to



charge the high-voltage battery, recuperation is increased steplessly. This is comparable to the engine brake in a combustion engine when you downshift a gear on a downhill gradient.

### Drive program

Drive program **E** is characterized by the following:

- full power output by using kickdown.
- the vehicle pulling away more gently in forward gear unless the accelerator pedal is depressed fully.
- reduced power on the accelerator pedal increases sensitivity. This supports an even and economical driving style.
- the wheels are less likely to spin.

Drive program **S** is characterized by the following:

- the entire power output can be utilized by depressing the accelerator pedal.

## Charging the high-voltage battery

### Important safety notes

#### DANGER

The vehicle's high voltage electrical system is under high voltage. If you modify components in the vehicle's high-voltage electrical system or touch damaged components, you may be electrocuted. The components in the vehicle's high-voltage electrical system may be damaged in an accident, although the damage is not visible. There is a risk of fatal injury.

Following an accident, do not touch any high-voltage components and never modify the vehicle's high-voltage electrical system. Have the vehicle towed away after an accident and the vehicle's high-voltage electrical system checked by a qualified specialist workshop.

#### WARNING

In the event of a vehicle fire, the internal pressure of the high-voltage battery can exceed a critical value. In this case flammable gas escapes through a ventilation valve on the underbody. The gas can ignite. There is a risk of injury.

Leave the danger zone immediately. Secure the danger area at a suitable distance, whilst observing legal requirements.

#### DANGER

If you use incorrectly installed mains sockets or adapters, extension cables or similar to connect the charging cable to a mains socket, this could lead to fires or an electric shock. There is a risk of fatal injury.

To avoid hazardous situations, observe the following:

- Only connect the charging cable to mains sockets that:
  - are installed correctly and
  - have been approved by an electrical specialist.
- For safety reasons, only use the charging cables supplied with the vehicle, or charging cables which have been approved for use with this vehicle.
- Never use a damaged charging cable.
- Do **not** use:
  - Extension cables
  - Cable drums
  - Multiple sockets
- Do not use a socket adapter to connect the charging cable to the mains socket. The only exception is if the adapter has been tested and approved by the manufacturer for charging the high-voltage battery in an electric vehicle.
- Always observe the safety notes in the socket adapter's operating instructions.



The vehicle's high voltage electrical system is under high voltage.

- Do not handle high-voltage components or the orange cables of the vehicle's high-voltage electrical system.
- Do not touch high-voltage components or the orange cables of the high-voltage electrical system when a vehicle has been involved in a crash.
- Do not touch any damaged components or the damaged orange cables of the vehicle's high-voltage electrical system.
- Do not remove the covers of the high-voltage electrical system components that are marked with a warning sticker.

### General notes

#### Method of operation

The vehicle is equipped with a high-voltage battery for driving. The high-voltage battery stores the energy needed to operate the electric motor and releases it again.

The electric motor uses energy that has been stored in the high-voltage battery when pulling away, accelerating and during the journey.

In overrun mode, kinetic energy is converted by means of energy recuperation into electrical energy and stored in the high-voltage battery.

The high-voltage battery can be charged as follows:

- through energy recuperation while the vehicle is in motion
- with the charging cable at a mains socket while the vehicle is stationary
- with the charging cable at a charging station while the vehicle is stationary

The high-voltage battery can be charged in a voltage range from 110 V to 240 V.

- i** If the condition of charge drops to less than 13%, the high-voltage battery reserve indicator lamp lights up in the instrument

cluster. Charge the high-voltage battery as soon as possible.

Below a condition of charge of 5%, the performance of the vehicle is reduced.

The vehicle's high-voltage electrical system switches off at a condition of charge of 0%.

- i** Use of the pre-entry climate control (via key) may mean that the high-voltage battery is not fully charged.

#### Discharged battery

The vehicle's high-voltage electrical system switches off if the high-voltage battery is completely discharged. 30 seconds prior to this, you are informed of the switch-off by the **Battery level too low. Stop and charge immediately** message. This protects the battery from exhaustive discharge.

- i** It is not possible to restart the drive system until after charging.

Do not leave the vehicle parked for longer than 14 days with a high-voltage battery condition of charge below 20%.

You can check the condition of charge in the charge level display (▷ page 174).

Further information on the "Energy flow display" can be found in the "Trip" menu (▷ page 176).

#### High and low outside temperatures

##### Low outside temperatures

The efficiency of the high-voltage battery is significantly reduced at very low outside temperatures. The high-voltage battery is then no longer able to provide the normal electrical power output.

##### High outside temperatures

To prevent damage to the high-voltage battery due to very high outside temperatures, the maximum power output of the high-voltage battery is reduced automatically.

The E-CELL display indicates the maximum amount of power available (▷ page 173).

## Energy consumption and range

This range is reduced by:

- high and low outside temperatures
- the use of air conditioning or heating
- switching on consumers

The battery's physical characteristics are such that leaving the vehicle parked for an extended period at low outdoor temperatures without charging it can lead to:

- a reduction in battery performance
- longer charge times

In extreme cases, this could mean that the vehicle cannot be started. For this reason, connect the charging cable when leaving the vehicle parked for long periods at low outdoor temperatures.

As a result of its basic characteristics, the amount of energy available from the high-voltage battery decreases over the course of its life.

This reduces:

- the maximum range that can be achieved by the vehicle
- the maximum output (acceleration) of the vehicle

You can actively reduce the energy consumption of your vehicle in a number of ways, for example, by:

- an anticipatory driving style
- reducing the use of electrical consumers
- having the vehicle regularly maintained

The charging time of the high-voltage battery may change over the course of its life.

## RANGE PLUS

**i** Using RANGE PLUS shortens the service life of the battery. Therefore, only use RANGE PLUS if, for example:

- long journeys are planned or
- the availability of charging stations at the destination is limited

If you activate RANGE PLUS, the operating window of the battery will be extended at the next charging process. An extended driving range will be available to you for the next journey.

**i** The more often RANGE PLUS is used, the more the extended range is reduced.

Therefore always check the range display before every journey.



- ▶ **To switch on:** press button ①.  
The green Indicator lamp lights up.
- ▶ **To switch off:** press button ①.  
The indicator lamp goes out.

RANGE PLUS switches off automatically if:

- the charging cable is disconnected or
- the charging process is complete

## Notes on battery care

Avoid storing or transporting the vehicle in high temperatures over a long period (e.g. container transport).

If you park the vehicle and leave it stationary for longer periods, connect it to a power supply.

Temperatures below -13 °F (-25 °C) and over 104 °F (40 °C), which affect the vehicle for a period of more than seven days, can cause irreversible damage.

## Conditions of use

Observe the following notes:

- information on exceptions to the high-voltage battery terms of use in the battery rental agreement
- information on exceptions and limitations in warranty documentation and in the related Maintenance Booklet
- maintenance notes for the high-voltage battery in the Maintenance Booklet

## Handling the charging cable and charging cable controls

Do not leave the charging cable controls (▷ page 138) hanging loose from an electrical outlet. Otherwise, this could result in a poor contact with the electrical outlet and malfunctions when charging the vehicle.

To ensure that the brackets within the charging cable controls are not subjected to incorrect loads, observe the following:

- Never lift or carry the controls by the charging cable connector or the mains plug.
- To transport the charging cable, the coiled part can be:
  - wrapped around the controls or
  - secured to the housing of the controls

## Heat generated by the charging cable and connector

Pay attention to the "Important safety notes" (▷ page 134).

During the charging process, the charging cable and connector may heat up.

The charging cable and connector will only heat up within the permissible limiting values, provided that:

- the power supply and the charging cable are not damaged
- the instructions for handling the charging cable and controls on the charging cable are observed

Should the permissible heating temperature limits be exceeded, have the mains power supply checked.

## Protection device against overvoltage

**!** Overvoltage in the mains supply may damage the vehicle. For this reason, the vehicle is equipped with a protection device against overvoltage in the mains supply. This device may be triggered during severe thunderstorms, for example, and may lead to the building's fuse being tripped and an interruption in the power supply. These functions protect the vehicle. After the building fuse is switched on again, the charging process resumes automatically. Following an interruption in the power supply or tripping of the building's fuse, it may take up to 10 minutes for charging to resume automatically.

Switch on the building protection system again after it has been triggered. Otherwise, the charging process cannot be continued. The high-voltage battery will not be charged and you may not be able to drive the vehicle. If other devices are protected by the same protective device, these are switched off as well when the protective device is triggered. Ensure that these other devices are still operational after reactivating the protection device.

## Charging the high-voltage battery via the electrical outlet

### Charging cable

#### Important safety notes

The vehicle is supplied with a single-phase 12 A charging cable. Only use the charging cable included with the vehicle, which has been approved for vehicle use.

Pay attention to the "Important safety notes" (▷ page 134).

**!** Only use the charging cable to charge the high-voltage battery. Do not use the charging cable for other purposes. It may otherwise be damaged.

- i** If you use the supplied 12 A charging cable to charge a high-voltage battery:
- the charge time increases considerably
  - electrical consumption increases considerably

Where possible, charge the high-voltage battery at a charging station (▷ page 140). Only then can certified electrical energy consumption levels be reached.

- i** The charging process can vary depending on the charging station. Therefore, always observe the local information.

Information about charging at a charging station can be found at (▷ page 140).

### Stowing the charging cable

The charging cable can be stowed in a bag in the trunk of the vehicle. To do so, the bag must be secured to the cargo tie-down rings using the retaining strap provided.

### Controls on the charging cable

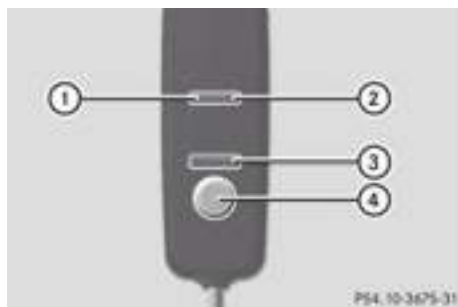

- ① Alternating current status indicator
- ② Control/protection system indicator
- ③ Charge current indicator
- ④ Charge current setting button

When displays ① and ② on the charging cable light up, this means the following:

#### Display ①

Lights up green	The external power supply connection is working properly. The high-voltage battery can be charged.
Flashes red	A malfunction has been detected in the external power supply. The high-voltage battery is recharged as soon as the electricity signal registers normal values.
Lights up red	There is a malfunction. The charging cable must be removed from the electrical outlet and then re-inserted.

#### Display ②

Lights up green	There are no malfunctions. The high-voltage battery can be charged.
Lights up red	There is a malfunction. The high-voltage battery cannot be charged.

- i** For information on problems relating to the charging process, see (▷ page 142).

### Setting the maximum charge current

#### **⚠ WARNING**

If the charge current draw via a mains socket is too high during the charging process, the external electrical system may overheat. There is a risk of fire.

Before beginning the charging process, check the maximum permissible charge current locally. Consult a qualified expert to do so where necessary.

If necessary, adjust your vehicle's settings.

- !** An excessive charge current can blow a fuse or lead to overheating of the external power supply. Check whether the external power supply is compatible with the set

charge current. If necessary, lower the set charge current or use another power socket.

You can set a limit for the values of the charge current used in charging the high-voltage battery. This acts as a means of preventing the power supply from overloading. You can set this limit by using the controls on the charging cable or in the on-board computer's menu. Only set the maximum charge current in the on-board computer menu if there are no charge current settings on the charging cable.

The default standard value is the minimum charge current setting. This corresponds to the minimum available charge current from the power supply.

- i** The value of the maximum setting and the adjustment values may vary depending on the country.

Before charging the high-voltage battery, have the maximum permissible charge current for the relevant power socket checked by an electrician.

- ▶ **To adjust the setting:** press button ④ repeatedly until the desired setting is selected in display ③.
  - Two LEDs are flashing: minimum setting
  - All LEDs are flashing: maximum setting

Information about the charging time  
(▶ page 311)

If, after the charging process, the charging cable is:

- left connected to the power socket, the currently selected values will be used for the next charging process.
- removed from the power socket, the values will be reset to the minimum setting for the next charging process. You may then need to reset the values of the maximum charge current.

- i** If more time than usual is required when charging the high-voltage battery, check the maximum charge current setting using

the controls on the charging cable or in the on-board computer's menu.

### Connecting the charging cable

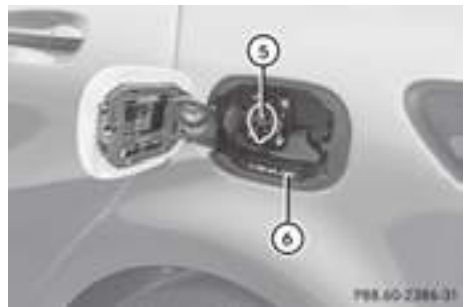
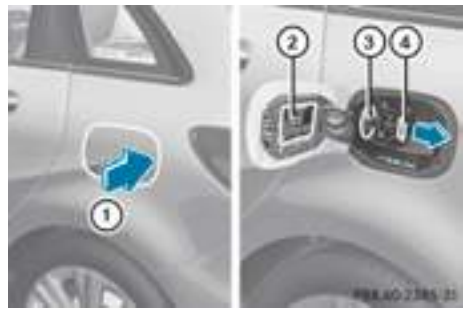

- ① To open the charge socket flap
- ② Tire pressure table
- ③ Vehicle charge socket cover
- ④ Fastener
- ⑤ Vehicle socket
- ⑥ Warning sticker

- ▶ Shift the DIRECT SELECT lever to position P.
- ▶ Switch the ignition off.
- ▶ Press the charge socket flap in the direction of arrow ①. The charge socket flap swings up.
- ▶ Slide fastener ④ to the right. Vehicle charge socket cover ③ is open.
- ▶ Insert the power supply plug into the electrical outlet to the stop.
- ▶ Insert the charging cable connector into vehicle socket ⑤ to the stop. The high-voltage battery is being charged.

- i** The vehicle must not be moved while the charging cable is connected or during charging.
- i** Depending on the temperature, the engine cooling system and battery cooling system may audibly switch on when the charging cable is connected or during the charging process.

### Removing the charging cable

When the charge level display reaches 100%, the battery is fully charged (▷ page 174).

- !** Make sure the charging cable has been disconnected from the vehicle socket before starting a journey. The vehicle or charging cable may otherwise be damaged when you drive off.



When the battery is charged:

- ▶ Press and hold button ⑦ on the charging cable connector and remove the charging cable from vehicle socket ⑤.
- ▶ Close vehicle socket cover ③.
- ▶ Close the charge socket flap.
- ▶ Remove the charging cable from the electrical outlet.
- ▶ Stow the charging cable safely in the vehicle (▷ page 138).

### Charging the high-voltage battery at the charging station

#### General notes

Pay attention to the "Important safety notes" (▷ page 134).

#### Charging communication at a charging station

The charging station first has to be activated before you can charge at a charging station. You can activate the charging station by using an RFID card or via telephone activation. Observe the on-site operator instructions for the charging station.

When the vehicle is connected to the charging station, information and details on technical parameters are exchanged. It can thus take up to 30 seconds for the charging process to begin.

#### Connecting the charging cable

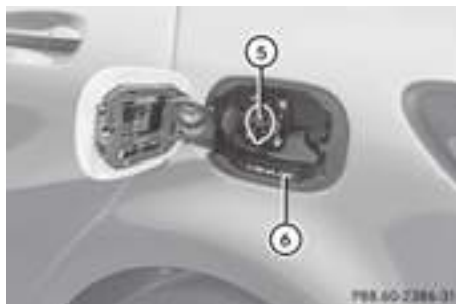

- ① To open the charge socket flap
- ② Tire pressure table

- ③ Vehicle charge socket cover
- ④ Fastener
- ⑤ Vehicle socket
- ⑥ Warning sticker
- ▶ Set the DIRECT SELECT lever to position **P**.
- ▶ Switch the ignition off.
- ▶ Press the charge socket flap in the direction of arrow ①.  
The charge socket flap swings up.
- ▶ Slide fastener ④ to the right.  
Vehicle charge socket cover ③ is open.
- ▶ Insert the charging cable connector into vehicle socket ⑤ to the stop.

**i** The vehicle must not be moved while the charging cable is connected or during charging.

**i** Depending on the temperature, the engine cooling system and battery cooling system may audibly switch on when the charging cable is connected or during the charging process.

### Removing the charging cable

When the charge level display reaches 100%, the battery is fully charged (▷ page 174).

**!** Make sure the charging cable has been disconnected from the vehicle socket before starting a journey. The vehicle or charging cable may otherwise be damaged when you drive off.



When the battery is charged:

- ▶ Press and hold button ⑦ on the charging cable connector and remove the charging cable from vehicle socket ⑤.
- ▶ Close vehicle socket cover ③.
- ▶ Close the charge socket flap.

## Problems with the charging process

Problem	Possible causes/consequences and ► Solutions
The charge socket flap cannot be opened.	<p>The charge socket flap is not unlocked.</p> <p>► Unlock the vehicle (▷ page 72).</p>
	<p>The SmartKey batteries are discharged.</p> <p>► Unlock the vehicle manually using the SmartKey (▷ page 73).</p>
	<p>The charge socket flap is unlocked, but the opening mechanism is jammed.</p> <p>► Lock and unlock the vehicle.</p> <p>If, after that, the opening mechanism is still jammed:</p> <p>► Consult a qualified specialist workshop.</p>
The high-voltage battery is not being charged.	<p>A malfunction has occurred during the initialization of the charging process.</p> <p>► Ensure that the charging cable is connected to the electrical outlet.</p> <p>► Remove the charging cable connector from the vehicle socket and wait 30 seconds; then re-insert it into the vehicle socket.</p> <p>► If the problem persists, consult a qualified specialist workshop.</p>
The high-voltage battery is not charged during the charging process when connected to a power socket.	<p>The electrical outlet is faulty.</p> <p>► Have the electrical outlet checked to test if it is functioning properly.</p> <p>or</p> <p>► Use a different electrical outlet.</p>
The charging cable connector cannot be removed from the vehicle socket.	<p>The snap fastener on the charging cable connector is locked.</p> <p>► Press and hold the button on the charging cable connector. The snap fastener on the vehicle socket is unlocked.</p> <p>► Remove the charging cable connector from the vehicle socket.</p>
	<p>The snap fastener on the charging cable connector is blocked.</p> <p>► Press and hold the button on the charging cable connector.</p> <p>► Try to remove the blockage.</p>



## Online access to the vehicle

### General information

#### WARNING

If you operate information systems and communication equipment integrated in the vehicle while driving, you will be distracted from traffic conditions. You could also lose control of the vehicle. There is a risk of an accident.

Only operate the equipment when the traffic situation permits. If you are not sure that this is possible, park the vehicle paying attention to traffic conditions and operate the equipment when the vehicle is stationary.

You must observe the legal requirements for the country in which you are currently driving when operating integrated information systems and communications equipment.

Only use information systems and communications devices if this is permitted while driving and if the traffic situation permits. You may otherwise be distracted from the traffic conditions, cause an accident and injure yourself and others.

From the "My Mercedes Electric - Vehicle Homepage", you can call up remote query and remote configuration functions for your vehicle. This is possible from an Internet-enabled computer, as well as many modern smartphones.

You can access the "Vehicle Homepage" via your web browser.

The Internet address was not available at the time of going to press. Please call the Mercedes-Benz Customer Assistance Center (USA) at the hotline number **1-800-FOR-MERCEdes (1-800-367-6372)** to obtain the relevant Internet address.

In order to use the "Vehicle Homepage", you must agree to the applicable terms of use.

The contractual periods of mbrace apply to the "Vehicle Homepage". To use the "Vehicle Homepage", you require an activated mbrace access and a separate activation/registration for the "Vehicle Homepage".

Further information about the supported end devices and available languages is available at any authorized Mercedes-Benz Center.

In order to call up the "Vehicle Homepage", the vehicle must be connected to the Internet.

This is possible via the radio module (▷ page 144).

### Notes on data protection

Bear in mind that the "Vehicle Homepage" offers access to your data. Therefore, look after the vehicle verification code (VVC) and your user details carefully.

The vehicle verification code (VVC) is required when you register for the first time on the "Vehicle Homepage". This code is used to link the vehicle and the user access on the "Vehicle Homepage" and enables correct use. You can obtain further information from an authorized Mercedes-Benz Center.

#### Prevent unauthorized persons from accessing this data.

Every person who has access to the information stated can use the functions on the "Vehicle Homepage".

- If you sell your vehicle, you are obliged to delete the vehicle from your personal area on the "Vehicle Homepage". Additionally, you must destroy documents containing the vehicle verification code (VVC).
- If you have bought a used vehicle, it is possible that the previous owner still has access to the "Vehicle Homepage". If in doubt, have a new vehicle verification code (VVC) issued by the Mercedes-Benz Center after purchase. With the new code you can set up the access to your vehicle, as described in the section "Setting up a personal area". There, you may also deactivate the existing access of the previous owner.

## Calling up functions in the "My Mercedes Electric - Vehicle Homepage"

The "My Mercedes Electric - Vehicle Homepage" allows you access to your vehicle's functions using remote query and remote configuration. For example, climate control can be activated using remote configuration which means that it need not be set in the vehicle. Power for the climate control is primarily supplied via the charging cable connected to the mains supply. In this way, the range of the vehicle in most cases is not reduced. If climate control is activated, the battery charge level and thus the range may be reduced. The "Vehicle Homepage" provides you with information all about how to use your vehicle.

If the vehicle is entered in your personal area of the "Vehicle Homepage", you can also access the following functions:

- request the current condition of charge
- program the departure time
- order and activate the "Pre-entry climate control at departure time" function

If the vehicle is charging, the predicted charging time and the predicted range will also be shown.

This data is estimated and may be influenced by the following factors:

- outside temperature
- switched on consumers, e.g. climate control and seat heating
- personal driving style
- road and traffic conditions
- route characteristics

Therefore, allow for a sufficient reserve.

## Connecting the vehicle to the Internet

### Via a radio module

- i** This function is not available in all countries and requires an activated mbrace access.

You can use the "Vehicle Homepage" if the vehicle has a connection to the Internet via a mobile phone. The radio module uses a mobile phone connection and transmits the necessary data by radio. The vehicle automatically recognizes whether a connection to the Internet via the radio module is possible or not. No presets are necessary.

- i** Restrictions in reception are possible if the vehicle is in an underground car park, for example. Restrictions may also occur in areas with poor mobile network coverage.

## Parking

### Important safety notes

#### WARNING

If you release the parking brake on uphill or downhill gradients, the vehicle can begin to move when in park position **P**. There is a risk of an accident.

To avoid hazardous situations:

- prevent the parked vehicle from rolling on uphill or downhill gradients by always applying the parking brake.
- do not park the vehicle on uphill or downhill gradients if the parking brake is malfunctioning.

#### WARNING

If you leave children unsupervised in the vehicle, they could set it in motion by, for example:

- release the parking brake.
- shift the transmission out of park position **P**.
- start the vehicle's drive system.

They could also operate the vehicle's equipment. There is a risk of an accident and injury.

When leaving the vehicle, always take the SmartKey with you and lock the vehicle. Never leave children unsupervised in the vehicle.

**!** While the vehicle is rolling, do not shift the transmission directly from **D** to **R**, from **R** to **D** or directly to **P**.

Do not open the driver's door while the vehicle is in motion. Otherwise, at low speeds in transmission position **D** or **R**, park position **P** is engaged automatically and the electrical parking brake is applied. The transmission could be damaged.

**!** Always secure the vehicle correctly against rolling away. Otherwise, the vehicle or its drivetrain could be damaged.

To ensure that the vehicle is secured against rolling away unintentionally:

- the electric parking brake must be applied.
- the transmission must be in position **P**.
- the key in the ignition lock must be turned to position **0** and removed from the ignition lock.
- on steep uphill or downhill gradients, turn the front wheels towards the curb.

### Switching off the drive system

#### Important safety notes

##### WARNING

If you switch off the ignition while driving, safety-relevant functions are only available with limitations, or not at all. This can affect the power steering and the brake boosting effect, for example. You will require considerably more effort to steer and brake. There is a risk of an accident.

Do not switch off the ignition while driving.

- ▶ Shift the DIRECT SELECT lever to position **P**.
- ▶ Turn the SmartKey to position **0** in the ignition lock and remove it. The immobilizer is activated.

### Electric parking brake

#### General notes

##### WARNING

If you leave children unsupervised in the vehicle, they could set it in motion by, for example:

- release the parking brake.
- shift the transmission out of park position **P**.
- start the vehicle's drive system.

They could also operate the vehicle's equipment. There is a risk of an accident and injury.

When leaving the vehicle, always take the SmartKey with you and lock the vehicle. Never leave children unsupervised in the vehicle.

**i** The function of the electric parking brake and the parking lock is dependent on the on-board voltage. If the on-board voltage is low or if there is a malfunction in the system, it may not be possible to apply the released parking brake or to shift the transmission to the **P** position.

- ▶ If this is the case, only park the vehicle on level ground and secure it to prevent it rolling away.
- ▶ Shift the transmission to position **P**.

It may not be possible to release an applied parking brake if the on-board voltage is low or there is a malfunction in the system. Contact a qualified specialist workshop.

**i** The electric parking brake carries out a function check at regular intervals when the drive system is switched off. The sounds that can be heard while this is occurring are normal.



## Applying/releasing manually

### Applying

- ▶ Push handle ①.

When the electric parking brake is applied, the red **PARK** (USA only) or **(P)** (Canada only) indicator lamp lights up in the instrument cluster.

- i** The electric parking brake can also be applied when the SmartKey is removed.

### Releasing

- ▶ Turn the SmartKey to position **1** or **2** in the ignition lock.

- ▶ Pull handle ①.

The red **PARK** (USA only) or **(P)** (Canada only) indicator lamp in the instrument cluster goes out.

## Applying automatically

When the vehicle's HOLD function is holding the vehicle at a standstill, the electric parking brake is engaged automatically.

In addition, at least one of the following conditions must be fulfilled:

- the drive system is switched off.
- the driver's door is open and the seat belt is not fastened.
- there is a system malfunction.
- the power supply is insufficient.
- the vehicle is stationary for a lengthy period.

The red **PARK** (USA only) or **(P)** (Canada only) indicator lamp in the instrument cluster lights up.

## Releasing automatically

Your vehicle's electric parking brake is automatically released if all of the following conditions are met:

- the vehicle has been started.
- the transmission is in position **D** or **R**.
- the seat belt has been fastened.
- you depress the accelerator pedal.

If the transmission is in position **R**, the tailgate must be closed.

If your seat belt is not fastened, the following conditions must be fulfilled to automatically release the electric parking brake:

- the driver's door is closed.
- you have shifted out of transmission position **P** or you have previously driven faster than 2 mph (3 km/h).

- i** Ensure that you do not depress the accelerator pedal unintentionally. Otherwise the parking brake will be released and the vehicle will start to move.



## Emergency braking

The vehicle can also be braked during an emergency by using the electric parking brake.

- ▶ While driving, push handle ① of the electric parking brake (▷ page 145).

- i** The vehicle is braked for as long as handle ① of the electric parking brake is pressed. The longer electric parking brake handle ① is depressed, the greater the braking force.

During braking:

- a warning tone sounds
- the **Please Release Parking Brake** message appears
- the red  (USA only) or  (Canada only) indicator lamp in the instrument cluster flashes

When the vehicle has been braked to a standstill, the electric parking brake is applied.

### Parking the vehicle for a long period

If you leave the vehicle parked for longer than four weeks, the battery may be damaged by exhaustive discharging.

If you leave the vehicle parked for longer than six weeks, the vehicle may suffer damage as a result of lack of use.

- ▶ Visit a qualified specialist workshop and seek advice.
- ❗ You can obtain information about trickle chargers from a qualified specialist workshop.

## Driving tips

### General notes

### Important safety notes

#### WARNING

If you switch off the ignition while driving, safety-relevant functions are only available with limitations, or not at all. This could affect, for example, the power steering and the brake boosting effect. You will require considerably more effort to steer and brake. There is a risk of an accident.

Do not switch off the ignition while driving.

#### WARNING

If you operate mobile communication equipment while driving, you will be distracted from

traffic conditions. You could also lose control of the vehicle. There is a risk of an accident. Only operate this equipment when the vehicle is stationary.

Observe the legal requirements for the country in which you are driving. Some jurisdictions prohibit the driver from using a mobile phone while driving a vehicle.

If you make a call while driving, always use hands-free mode. Only operate the telephone when the traffic situation permits. If you are unsure, pull over to a safe location and stop before operating the telephone.

Bear in mind that at a speed of only 30 mph (approximately 50 km/h), the vehicle covers a distance of 44 ft (approximately 14 m) per second.

### Drive sensibly – save energy

Observe the following tips to save energy:

- The tires should always be inflated to the recommended tire pressure.
- Remove unnecessary loads.
- Remove roof racks when they are not needed.
- Avoid frequent acceleration or braking.

Energy consumption also increases when driving in low or high outside temperatures, in stop-start traffic, on short journeys and in hilly terrain.

### Drinking and driving

#### WARNING

Drinking and driving and/or taking drugs and driving are very dangerous combinations. Even a small amount of alcohol or drugs can affect your reflexes, perceptions and judgment.

The possibility of a serious or even fatal accident is greatly increased when you drink or take drugs and drive.

Do not drink or take drugs and drive or allow anyone to drive who has been drinking or taking drugs.

### ECO display

The ECO display gives you information on how economical your driving style is. The ECO display assists you in achieving the optimum driving style in terms of consumption, taking the actual and selected conditions into consideration. Your driving style can significantly influence the vehicle's consumption.



ECO display (example: multifunction display)

The ECO display consists of three bars:

- **Acceleration**
- **Constant**
- **Coasting**

The percent value is the average value of the three bars. The three bars and the mean value begin at the value of 50%. A higher percentage indicates a more economical driving style.

The ECO display does not indicate the actual fuel consumption and a fixed percentage count in the ECO display does not indicate a fixed consumption figure.

Apart from driving style, consumption is dependent on many factors such as, e.g.:

- load
- tire pressure
- cold start
- choice of route
- electrical consumers switched on

These factors are not taken into consideration by the ECO display.

The evaluation of your driving style is carried out using the following three categories:

- **Acceleration** (evaluation of all acceleration processes):
  - The bar fills up: moderate acceleration, especially at higher speeds
  - The bar empties: sporty acceleration
- **Constant** (assessment of driving behavior at all times):
  - The bar fills up: constant speed and avoidance of unnecessary acceleration and deceleration
  - The bar empties: fluctuations in speed
- **Coasting** (assessment of all deceleration processes):
  - The bar fills up: anticipatory driving, keeping your distance and early release of the accelerator. The vehicle can coast without use of the brakes.
  - The bar empties: frequent braking

To achieve a higher value in the categories **Acceleration** and **Constant**, drive the vehicle in drive program **E**:

- i** On long journeys at a constant speed, e.g. on the highway, only the bar for **Constant** will change.
- i** The ECO display summarizes the driving characteristics from the start of the journey to its completion. For this reason, the bars change dynamically at the beginning of the journey. On longer journeys, there are fewer changes. For more dynamic changes, carry out a manual reset.

Further information on the ECO display (▷ page 177).

### Braking

#### Important safety notes

##### **WARNING**

If you increase the recuperation level on slippery road surfaces, the drive wheels may lose

their traction. There is an increased danger of skidding and accidents.

Do not increase the recuperation level on slippery road surfaces.

The braking performance of the electric motor using recuperative braking is, in some operating modes, either reduced or not effective:

- when the condition of charge of the high-voltage battery increases
- if the high-voltage battery is not yet at a normal operating temperature
- when driving close to the maximum speed
- when driving at speeds close to zero
- in transmission position **N**
- during and after ESP stability control.

If you do not make an additional effort to apply the brake yourself, the braking effect may not be sufficient. If necessary, counteract the reduced regenerative braking effect by applying the brake yourself.

### Downhill gradients

On long, steep gradients, you must reduce the load on the brakes by selecting maximum recuperation. This helps you to avoid overheating the brakes and wearing them out excessively.

Recuperation allows the vehicle to be decelerated without placing a load on the braking system.

Do not depress the brake pedal continuously while the vehicle is in motion, e.g. causing the brakes to rub by constantly applying light pressure to the pedal. This results in excessive and premature wear to the brake pads.

### Heavy and light loads

#### WARNING

If you rest your foot on the brake pedal while driving, the braking system can overheat. This increases the stopping distance and can even

cause the braking system to fail. There is a risk of an accident.

Never use the brake pedal as a footrest. Never depress the brake pedal and the accelerator pedal at the same time.

- ❗ Depressing the brake pedal constantly results in excessive and premature wear to the brake pads.

If the brakes have been subjected to a heavy load, do not stop the vehicle immediately. Drive on for a short while. This allows the airflow to cool the brakes more quickly.

### Wet roads

If you have driven for a long time in heavy rain without braking, there may be a delayed reaction from the brakes when braking for the first time. This may also occur after the vehicle has been washed or driven through deep water.

You have to depress the brake pedal more firmly. Maintain a greater distance from the vehicle in front.

After driving on a wet road or having the vehicle washed, brake firmly while paying attention to the traffic conditions. This will warm up the brake discs, thereby drying them more quickly and protecting them against corrosion.

### Limited braking performance on salt-treated roads

If you drive on salted roads, a layer of salt residue may form on the brake discs and brake pads. This can result in a significantly longer braking distance.

- Brake occasionally to remove any possible salt residue. Make sure that you do not endanger other road users when doing so.
- Carefully depress the brake pedal and the beginning and end of a journey.
- Maintain a greater distance to the vehicle ahead.



## Servicing the brakes

**!** If the red brake warning lamp lights up in the instrument cluster and you hear a warning tone while the engine is running, the brake fluid level may be too low. Observe additional warning messages in the multi-function display.

The brake fluid level may be too low due to brake pad wear or leaking brake lines.

Have the brake system checked immediately. This work should be carried out at a qualified specialist workshop.

**!** A function or performance test should only be carried out on a 2-axle dynamometer. If you are planning to have the vehicle tested on such a dynamometer, contact an authorized Mercedes-Benz Center to obtain further information first. Otherwise, you could damage the drive train or the brake system.

**!** As the ESP® system operates automatically, the engine and the ignition must be switched off (the SmartKey must be in position **0** or **1** in the ignition lock) if:

- the electric parking brake is tested on a brake dynamometer (for a maximum of ten seconds)
- the vehicle is towed with the front axle raised.

Braking triggered automatically by ESP® may seriously damage the brake system.

All checks and maintenance work on the brake system must be carried out at a qualified specialist workshop. Consult a qualified specialist workshop to arrange this.

Have brake pads installed and brake fluid replaced at a qualified specialist workshop.

If the brake system has only been subject to moderate loads, you should test the functionality of your brakes at regular intervals.

You can find a description of Brake Assist (BAS) on (▷ page 63).

Mercedes-Benz recommends that you only have brake pads/linings installed on your

vehicle which have been approved for Mercedes-Benz vehicles or which correspond to an equivalent quality standard. Brake pads/linings which have not been approved for Mercedes-Benz vehicles or which are not of an equivalent quality could affect your vehicle's operating safety.

Mercedes-Benz recommends that you only use brake fluid that has been specially approved for your vehicle by Mercedes-Benz, or which corresponds to an equivalent quality standard. Brake fluid which has not been approved for Mercedes-Benz vehicles or which is not of an equivalent quality could affect your vehicle's operating safety.

## Checking brake lining thickness

You can measure the brake pad/lining thickness using a test gage. Color-coding (green or red) on the test gage allows you to determine whether the brake pad/lining thickness is still sufficient. The test gage is in the vehicle document wallet in the glove box.



Front wheel





Rear wheel

- ▶ Bring the vehicle and wheels into a suitable position so that you can attach test gage ⑤.
  - ▶ Secure the vehicle against rolling away (> page 144).
  - ▶ Shift the DIRECT SELECT lever to **P**.
  - ▶ Switch off the drive system.
  - ▶ Place test gage ⑤ between the wheel's spokes on brake pad/lining ③.
  - ▶ Hold test gage ⑤ vertically on brake disc ① and slide measuring pin ② onto brake disc ①.
  - ▶ Check which color field ④ the arrow on measuring pin ② is pointing to.
    - Green:** the brake pad/lining thickness is sufficient.
    - Red:** the brake pad/lining thickness is not sufficient. Have the brake pads/lining checked at a qualified specialist workshop.
- i** To avoid an inaccurate measurement:
- make sure you position the wheels suitably
  - do not put the measuring pin on a recess in the brake disc

## Driving on wet roads

### Hydroplaning

If water has accumulated to a certain depth on the road surface, there is a danger of hydroplaning occurring, even if:

- you drive at low speeds.
- the tires have adequate tread depth.

For this reason, in the event of heavy rain or in conditions in which hydroplaning may occur, you must drive in the following manner:

- lower your speed.
- avoid ruts.
- brake carefully.

### Driving on flooded roads

**!** Bear in mind that vehicles traveling in front or in the opposite direction create waves. This may cause the maximum permissible water depth to be exceeded.

Failure to observe these notes may result in damage to the engine, electrical systems and transmission.

**!** Do not drive through flooded areas. Check the depth of any water before driving through it. Drive slowly through standing water. Otherwise, water could enter the vehicle interior or the drive system.

These notes must be observed under all circumstances. Otherwise, the drive system, electrical systems and transmission could be damaged.

If you have to drive on stretches of road on which water has collected, please bear in mind that:

- the maximum permissible fording depth in still water is 10 in (25 cm)
- you should drive no faster than at a walking pace

## Winter driving

### General notes

#### WARNING

If you increase the recuperation level on slippery road surfaces, the drive wheels may lose their traction. There is an increased danger of skidding and accidents.

Do not increase the recuperation level on slippery road surfaces.

At the onset of winter, have your vehicle winterized at a qualified specialist workshop, e.g. at an authorized Mercedes-Benz Center.

Drive particularly carefully on slippery road surfaces. Avoid sudden acceleration, steering and braking maneuvers. Do not use cruise control.

If the vehicle threatens to skid or cannot be stopped when moving at low speed:

- ▶ Shift the DIRECT SELECT lever to position **N**.

The outside temperature indicator is not designed to serve as an ice-warning device and is therefore unsuitable for that purpose. Changes in the outside temperature are displayed after a short delay.

Indicated temperatures just above the freezing point do not guarantee that the road surface is free of ice. The road may still be icy, especially in wooded areas or on bridges. You should pay special attention to road conditions when temperatures are around freezing point.

For more information on driving with snow chains, see (▷ page 280).

For more information on driving with summer tires, see (▷ page 280).

Observe the notes in the "Winter operation" section (▷ page 280).

## Driving systems

### Cruise control

#### Important safety notes

Cruise control maintains a constant road speed for you. In order to avoid exceeding the set speed, it decelerates automatically.

If you fail to adapt your driving style, cruise control can neither reduce the risk of an accident nor override the laws of physics. Cruise control cannot take into account the road, traffic and weather conditions. Cruise control is only an aid. You are responsible for the distance to the vehicle in front, for vehicle speed, for braking in good time and for staying in your lane.

Use cruise control only if road and traffic conditions make it appropriate to maintain a steady speed for a prolonged period. You can set any road speed above 20 mph (30 km/h).

Do not use cruise control:

- in road and traffic conditions which do not allow you to maintain a constant speed e.g. in heavy traffic or on winding roads
- on slippery road surfaces. Braking or accelerating could cause the drive wheels to lose traction and the vehicle could then skid
- when there is poor visibility, e.g. due to fog, heavy rain or snow

If there is a change of drivers, advise the new driver of the speed stored.

#### Cruise control lever

You can operate cruise control with the cruise control lever.



- ① To activate or increase speed
- ② To activate or reduce speed
- ③ To deactivate cruise control
- ④ To activate at the current speed/last stored speed

When you activate cruise control, the stored speed is shown in the multifunction display for 5 seconds.

### Activation conditions

To activate cruise control, all of the following activation conditions must be fulfilled:

- the electric parking brake must be released.
- you are driving faster than 20 mph (30 km/h).
- ESP® must be active, but not intervening.
- the DIRECT SELECT lever must be in position D.

### Storing, maintaining and calling up a speed

#### Storing and maintaining the current speed

You can store the current speed if you are driving faster than 20 mph (30 km/h).

- ▶ Accelerate the vehicle to the desired speed.
- ▶ Briefly press the cruise control lever up ① or down ②.
- ▶ Remove your foot from the accelerator pedal.  
Cruise control is activated. The vehicle automatically maintains the stored speed.

- ❗ Cruise control may be unable to maintain the stored speed on uphill gradients. The stored speed is resumed when the gradient evens out. Cruise control maintains the stored speed on downhill gradients by automatically decelerating the vehicle.

#### Storing the current speed or calling up the last stored speed

##### ⚠ WARNING

If you call up the stored speed and it differs from the current speed, the vehicle accelerates or decelerates. If you do not know the stored speed, the vehicle could accelerate or brake unexpectedly. There is a risk of an accident.

Pay attention to the road and traffic conditions before calling up the stored speed. If you do not know the stored speed, store the desired speed again.

- ▶ Briefly pull the cruise control lever towards you ④.
- ▶ Remove your foot from the accelerator pedal.  
The first time cruise control is activated, it stores the current speed or regulates the speed of the vehicle to the previously stored speed.

#### Setting a speed

Keep in mind that it may take a brief moment until the vehicle has accelerated or braked to the speed set.

- ▶ Press the cruise control lever up ① for a higher speed or down ② for a lower speed.
- ▶ **To adjust the set speed in 1 mph increments (1 km/h increments):** briefly press the cruise control lever up ① or down ② to the pressure point. Every time the cruise control lever is pressed up ① or down ② the last speed stored is increased or reduced.
- ▶ **To adjust the set speed in 5 mph increments (10 km/h increments):** briefly press the cruise control lever up ① or down ② to the pressure point. Every time the cruise control lever is pressed up ① or down ② the last speed stored is increased or reduced.

**i** Cruise control is not deactivated if you depress the accelerator pedal. For example, if you accelerate briefly to overtake, cruise control adjusts the vehicle's speed to the last speed stored after you have finished overtaking.

### Deactivating cruise control

There are several ways to deactivate cruise control:

- ▶ Briefly press the cruise control lever forwards ③.
- or
- ▶ Brake.

Cruise control is automatically deactivated if:

- the vehicle is secured with the electric parking brake
- you are driving at less than 20 mph (30 km/h)
- ESP® intervenes or you deactivate ESP®
- you shift the DIRECT SELECT lever to position **N** while driving

If cruise control is deactivated, you will hear a warning tone. You will see the **Cruise Control Off** message in the multifunction display for approximately 5 seconds.

**i** The last speed stored is cleared when you switch off the drive system.

### HOLD function

#### Important safety notes

#### WARNING

When leaving the vehicle, it can still roll away despite being braked by the HOLD function if:

- there is a malfunction in the system or in the voltage supply.
- the HOLD function has been deactivated by pressing the accelerator pedal or the brake pedal, e.g. by a vehicle occupant.
- the electrical system in the engine compartment, the battery or the fuses have been tampered with.
- the battery is disconnected

There is a risk of an accident.

If you wish to exit the vehicle, always turn off the HOLD function and secure the vehicle against rolling away.

**!** If the HOLD function is activated, the vehicle brakes automatically in certain situations. To prevent damage to the vehicle, deactivate the HOLD function in the following or other similar situations:

- when towing the vehicle
- in the car wash

Deactivating the HOLD function  
(▷ page 155).

### General notes

The HOLD function can assist the driver in the following situations:

- when pulling away, especially on steep slopes
- when maneuvering on steep slopes
- when waiting in traffic

The vehicle is kept stationary without the driver having to depress the brake pedal.

The braking effect is canceled and the HOLD function deactivated when you depress the accelerator pedal to pull away.

### Activation conditions

You can activate the HOLD function if:

- the vehicle is stationary
- the drive system is switched on
- the driver's door is closed or your seat belt is fastened
- the electric parking brake is released
- the transmission position **D**, **R** or **N** is engaged

### Activating the HOLD function



- ▶ Make sure that the activation conditions are met.
- ▶ Depress the brake pedal.
- ▶ Quickly depress the brake pedal further until ① appears in the multifunction display. The HOLD function is activated. You can release the brake pedal.

- ❗ If depressing the brake pedal the first time does not activate the HOLD function, wait briefly and then try again.

### Deactivating the HOLD function

The HOLD function is deactivated automatically if:

- you accelerate and the transmission is in position **D** or **R**.
- the transmission is in position **P**.

- you depress the brake pedal again with a certain amount of pressure until ① disappears from the multifunction display.
- you secure the vehicle using the electric parking brake.

- ❗ After a time, the electric parking brake secures the vehicle and relieves the service brake.

The electric parking brake automatically secures the vehicle if the HOLD function is activated and:

- the driver's door is open and the driver's seat belt is unfastened.
- the drive system is switched off.
- a system malfunction occurs.
- the power supply is not sufficient.

If a malfunction occurs, then the transmission may be shifted into position **P** automatically.

- ❗ If you do not deactivate the HOLD function before you switch off the drive system, you can no longer start the drive system. Deactivate the HOLD function before you switch off the drive system.

## PARKTRONIC

### Important safety notes

PARKTRONIC is an electronic parking aid with ultrasonic sensors. It monitors the area around your vehicle using six sensors in the front bumper and four sensors in the rear bumper. PARKTRONIC indicates visually and audibly the distance between your vehicle and an object.

PARKTRONIC is only an aid. It is not a replacement for your attention to your immediate surroundings. You are always responsible for safe maneuvering, parking and exiting a parking space. When maneuvering, parking or pulling out of a parking space, make sure that there are no persons, animals or objects in the area in which you are maneuvering.

**!** When parking, pay particular attention to objects above or below the sensors, such as flower pots or trailer drawbars. PARKTRONIC does not detect such objects when they are in the immediate vicinity of the vehicle. You could damage the vehicle or the objects.

The sensors may not detect snow and other objects that absorb ultrasonic waves.

Ultrasonic sources such as an automatic car wash, the compressed-air brakes on a truck or a pneumatic drill could cause PARKTRONIC to malfunction.

PARKTRONIC may not function correctly on uneven terrain.

PARKTRONIC is activated automatically when you:

- switch on the ignition
- shift the transmission to position **D**, **R** or **N**
- release the electric parking brake.

PARKTRONIC is deactivated at speeds above 11 mph (18 km/h). It is reactivated at lower speeds.

## Range of the sensors

### General notes

PARKTRONIC does not take objects into consideration that are:

- below the detection range, e.g. people, animals or objects
- above the detection range, e.g. overhanging loads, truck overhangs or loading ramps.



① Example: sensors in the front bumper, right-hand side



Side view



Top view

The sensors must be free from dirt, ice or slush. They can otherwise not function correctly. Clean the sensors regularly, taking care not to scratch or damage them (> page 259).

### Front sensors

Center	Approx. 40 in (approx. 100 cm)
Corners	Approx. 24 in (approx. 60 cm)

## Rear sensors

Center	Approx. 48 in (approx. 120 cm)
Corners	Approx. 32 in (approx. 80 cm)

## Minimum distance

Center	Approx. 8 in (approx. 20 cm)
Corners	Approx. 8 in (approx. 20 cm)

If there is an obstacle within this range, the relevant warning displays light up and a warning tone sounds. If the distance falls below the minimum, the distance may no longer be shown.

## Warning displays

The warning displays show the distance between the sensors and the obstacle. The warning display for the front area is located on the dashboard above the center air vents. The warning display for the rear area is located on the headliner in the rear compartment.



Warning display for the front area

- ① Segments on the left-hand side of the vehicle
- ② Segments on the right-hand side of the vehicle
- ③ Segments showing operational readiness

The warning display for each side of the vehicle is divided into five yellow and two red seg-

ments. PARKTRONIC is operational if yellow segments showing operational readiness ③ light up.

The selected transmission position and the direction in which the vehicle is rolling determine which warning display is active when the drive system is running.

Transmission position	Warning display
<b>D</b>	Front area activated
<b>R, N</b> or the vehicle is rolling backwards	Rear and front areas activated
<b>P</b>	No areas activated

One or more segments light up as the vehicle approaches an obstacle, depending on the vehicle's distance from the obstacle.

From the:

- sixth segment onwards, you will hear an intermittent warning tone for approximately 2 seconds
- seventh segment onwards, you will hear a warning tone for approximately 2 seconds. This indicates that you have now reached the minimum distance.

## Deactivating/activating PARKTRONIC



- ① Indicator lamp
- ② To deactivate/activate PARKTRONIC

If indicator lamp ① lights up, PARKTRONIC is deactivated.

- i** PARKTRONIC is automatically activated when you turn the key to position **2** in the ignition lock.



## Problems with PARKTRONIC

Problem	Possible causes/consequences and ► Solutions
Only the red segments in the PARKTRONIC warning displays are lit. You also hear a warning tone for approximately 2 seconds. PARKTRONIC is deactivated after approximately 5 seconds, and the indicator lamp in the PARKTRONIC button lights up.	PARKTRONIC has malfunctioned and has switched off. ► If problems persist, have PARKTRONIC checked at a qualified specialist workshop.
Only the red segments in the PARKTRONIC warning displays are lit. PARKTRONIC is deactivated after approximately 5 seconds.	The PARKTRONIC sensors are dirty or there is interference. ► Clean the PARKTRONIC sensors (► page 259). ► Switch the ignition back on.
	The problem may be caused by an external source of radio or ultrasound waves. ► See if PARKTRONIC functions in a different location.

### Active Parking Assist

#### General notes

Active Parking Assist is an electronic parking aid with ultrasound. It measures the road on both sides of the vehicle. A parking symbol indicates a suitable parking space. Active steering intervention can assist you during maneuvering and parking. You may also use PARKTRONIC (► page 155).

#### Important safety notes

Active Parking Assist is merely an aid. It is not a replacement for your attention to your immediate surroundings. You are always responsible for safe maneuvering, parking and exiting a parking space. Make sure that no persons, animals or objects are in the maneuvering range.

When PARKTRONIC is switched off, Active Parking Assist is also unavailable.

#### WARNING

The vehicle swings out when parking and in doing so could cross into the opposite lane. This could result in a collision with another road user. There is a risk of an accident.

Pay attention to other road users when parking. Stop the vehicle if necessary or cancel the Active Parking Assist parking procedure.

**!** If unavoidable, you should drive over obstacles such as curbs slowly and not at a sharp angle. Otherwise, you may damage the wheels or tires.

Active Parking Assist may possibly indicate parking spaces which are not suitable for parking, for example:

- where parking or stopping is prohibited
- in front of driveways or entrances and exits
- on unsuitable surfaces

### Parking tips:

- On narrow roads, drive as close to the parking space as possible.
- Parking spaces that are littered or overgrown might be identified or measured incorrectly.
- Parking spaces that are partially occupied by trailer drawbars might not be identified as such or be measured incorrectly.
- Snowfall or heavy rain may lead to a parking space being measured inaccurately.
- Pay attention to the PARKTRONIC (▷ page 157) warning messages during the parking procedure.
- You can intervene in the steering procedure to correct it at any time. Active Parking Assist will then be canceled.
- When transporting a load which protrudes from your vehicle, you should not use Active Parking Assist.
- Never use Active Parking Assist when snow chains are installed.
- Make sure that the tire pressures are always correct. This has a direct influence on the parking characteristics of the vehicle.

### Use Active Parking Assist for parking spaces:

- that are parallel to the direction of travel
- that are on straight roads, not bends
- that are on the same level as the road, e.g. not on the pavement

### Detecting parking spaces

Objects located above the height range of Active Parking Assist will not be detected when the parking space is measured. These are not taken into account when the parking procedure is calculated, e.g. overhanging loads, tail sections or loading ramps of goods vehicles.

#### WARNING

If there are objects above the detection range, Active Parking Assist may turn prematurely.

You may cause a collision as a result. There is a risk of an accident.

If there are objects above the detection range, stop and deactivate Active Parking Assist.

For further information on the detection range (▷ page 156).

Active Parking Assist does not support you with parking spaces parallel to the direction of travel if:

- the parking space is on a curb
- the parking space is apparently blocked, for example by foliage or grass paving blocks
- the range of movement is too small
- the parking space is bordered by an obstacle which is not clearly defined such as a tree or a trailer



- ① Detected parking space on the left
- ② Parking symbol
- ③ Detected parking space on the right

Active Parking Assist is automatically activated when driving forwards. The system is operational at speeds of up to approximately 22 mph (35 km/h). While in operation, the system independently locates and measures parking spaces on both sides of the vehicle.

Active Parking Assist will only detect parking spaces:

- that are parallel to the direction of travel
- that are at least 59 in (1.5 m) wide
- that are at least 39 in (1 m) longer than your vehicle

When driving at speeds below 19 mph (30 km/h), you will see parking symbol as a status indicator in the instrument cluster.

When a parking space has been detected, an

arrow towards the right or the left also appears. By default, Active Parking Assist only displays parking spaces on the front-passenger side. Parking spaces on the driver's side are displayed as soon as the turn signal on the driver's side is activated. This must remain switched on until you acknowledge the use of Active Parking Assist by pressing the  button on the multifunction steering wheel.



A parking space is displayed while you are driving past it, and until you are approximately 50 ft (15 m) away from it.

## Parking

### WARNING

Active Parking Assist merely aids you by intervening actively in the steering. If you do not brake there is a risk of an accident.

Always apply the brakes yourself when maneuvering and parking.

- ▶ Stop the vehicle when the parking space symbol shows the desired parking space in the instrument cluster.
- ▶ Shift the transmission to position **R**. The **Start Park Assist? Yes: OK No: ** message appears in the multifunction display.
- ▶ **To cancel the procedure:** press the  button on the multifunction steering wheel or pull away.
- ▶ **To park using Active Parking Assist:** press the  button on the multifunction steering wheel. The **Park Assist Active Accelerate and Brake Observe Surroundings** message appears in the multifunction display.
- ▶ Let go of the multifunction steering wheel.
- ▶ Back up the vehicle, being ready to brake at all times. Do not exceed a maximum speed of approximately 5 mph (10 km/h) when backing up. Otherwise Active Parking Assist will be canceled.

 In tight parking spaces, you will achieve the best parking results by backing up as far as possible. When doing so, also observe the PARKTRONIC messages.

- ▶ Stop as soon as PARKTRONIC sounds the continuous warning tone, if not before. Maneuvering may be required in tight parking spaces.

The **Park Assist Active Select D Observe Surroundings** message appears in the multifunction display.

- ▶ Shift the transmission to position **D** while the vehicle is stationary. Active Parking Assist immediately steers in the other direction.

The **Park Assist Active Accelerate and Brake Observe Surroundings** message appears in the multifunction display.

 You will achieve the best results by waiting for the steering procedure to complete before pulling away.

- ▶ Drive forwards and be ready to brake at all times.
- ▶ Stop as soon as PARKTRONIC sounds the continuous warning tone, if not before.

The **Park Assist Active Select R Observe Surroundings** message appears in the multifunction display.

Further transmission shifts may be necessary.

As soon as the parking procedure is complete, the **Park Assist Finished** message appears in the multifunction display and you will hear a tone.

Active Parking Assist no longer supports you with steering interventions. When Active Parking Assist is finished, you must steer again yourself. PARKTRONIC is still available.

- ▶ Maneuver if necessary.
- ▶ Always observe the warning messages displayed by PARKTRONIC (▷ page 157).

Parking tips:

- The way your vehicle is positioned in the parking space after parking is dependent

on various factors. These include the position and shape of the vehicles parked in front and behind it and the conditions of the location. It may be the case that Active Parking Assist guides you too far into a parking space, or not far enough into it. In some cases, it may also lead you across or onto the curb. If necessary, you should cancel the parking procedure with Active Parking Assist.



- You can also engage forward gear prematurely. The vehicle redirects and does not drive as far into the parking space. Should a gear be changed too early, the parking procedure will be canceled. A sensible parking position can no longer be achieved from this position.

### Exiting a parking space

In order that Active Parking Assist can support you when you exit the parking space:

- the border of the parking space must be high enough. A curb is too small, for example.
- the border of the parking space must not be too wide. Your vehicle can be maneuvered into a position at a maximum of 45° to the starting position in the parking space.
- a maneuvering distance of at least 3.3 ft (1.0 m) must be available.

Active Parking Assist can only assist you with exiting a parking space if you have parked the vehicle parallel to the direction of travel using Active Parking Assist.

- ▶ Start the drive system.
- ▶ Switch on the turn signal in the direction you will drive out of the parking space.
- ▶ Shift the transmission to position **D** or **R**. The **Start Park Assist? Yes: OK No: ** message appears in the multifunction display.
- ▶ **To cancel the procedure:** press the **** button on the multifunction steering wheel or pull away.

or

- ▶ **To exit a parking space using Active Parking Assist:** press the **** button on the multifunction steering wheel.

The **Park Assist Active Accelerate and Brake Observe Surroundings** message appears in the multifunction display.

- ▶ Let go of the multifunction steering wheel.
- ▶ Reverse the vehicle or drive forwards, being ready to brake at all times. Do not exceed a maximum speed of approximately 6 mph (10 km/h) when exiting a parking space. Otherwise Active Parking Assist will be canceled.
- ▶ Stop when PARKTRONIC sounds the continuous warning tone, if not before.
- ▶ Shift the transmission to position **D** or **R** as required while the vehicle is stationary. Active Parking Assist immediately steers in the other direction. The **Park Assist Active Accelerate and Brake Observe Surroundings** message appears in the multifunction display.

- ▶ **i** You will achieve the best results by waiting for the steering procedure to complete before pulling away.

If you back up after activation, the steering wheel is moved to the straight-ahead position.

- ▶ Drive forwards and back up as prompted by the PARKTRONIC warning displays, several times if necessary.
- ▶ Stop as soon as PARKTRONIC sounds the continuous warning tone, if not before.

Once you have exited the parking space completely, the steering wheel is moved to the straight-ahead position. You hear a tone and the **Park Assist Finished** message appears in the multifunction display. You will then have to steer and merge into traffic on your own. PARKTRONIC is still available.

## Canceling Active Parking Assist

You can cancel Active Parking Assist at any time.

- ▶ Stop the movement of the multifunction steering wheel or steer yourself. Active Parking Assist will be canceled at once. The **Park Assist Canceled** message appears in the multifunction display.

or

- ▶ Press the PARKTRONIC button on the center console (▷ page 157). PARKTRONIC is switched off and Active Parking Assist is immediately canceled. The **Park Assist Canceled** message appears in the multifunction display.

Active Parking Assist is canceled automatically if:

- the electric parking brake is engaged
- transmission position **P** is selected
- parking using Active Parking Assist is no longer possible
- you are driving faster than 6 mph (10 km/h)
- a wheel spins, ESP® intervenes or fails. The  warning lamp lights up in the instrument cluster.

A warning tone sounds. The parking symbol goes out and the **Park Assist Canceled** message appears in the multifunction display.

If Active Parking Assist is canceled, you must steer again yourself.

## Rear view camera

### General notes



Rear view camera ① is in the handle on the tailgate.

The rear view camera is an optical parking and maneuvering aid. It uses guide lines to show the area behind your vehicle in the Audio/COMAND display.

The area behind the vehicle is displayed as a mirror image, as in the rear view mirror.

- ❗ The text shown in the COMAND display depends on the language setting. The following are examples of rear view camera messages in the COMAND display.

Observe the notes on cleaning (▷ page 260).

### Important safety notes

The rear view camera is only an aid. It is not a replacement for your attention to your immediate surroundings. You are always responsible for safe maneuvering, parking and exiting a parking space. When maneuvering or parking, make sure that there are no persons, animals or objects in the area in which you are maneuvering.

Under the following circumstances, the rear view camera will not function, or will function in a limited manner:

- if the tailgate is open
- if there is heavy rain, snow or fog
- at night or in very dark places
- if the camera is exposed to very bright light

- if the area is lit by fluorescent light or LED lighting (the display may flicker)
- if there is a sudden change in temperature, e.g. when driving into a heated garage from the cold
- if the camera lens is dirty or obstructed
- if the rear of your vehicle is damaged. In this case, have the camera position and setting checked at a qualified specialist workshop

The field of vision and other functions of the rear view camera may be restricted due to additional accessories on the rear of the vehicle (e.g. license plate holder, bicycle rack).

### Activating/deactivating the rear view camera

- ▶ **To activate:** make sure that the SmartKey is in position **2** in the ignition lock.
- ▶ Make sure that the "Activation by R gear" setting is active in the audio system/COMAND (see the separate audio system/COMAND operating instructions).
- ▶ Engage reverse gear.  
Guide lines are used to show the area behind the vehicle in the Audio/COMAND display.

**To deactivate:** the rear view camera deactivates if you shift the transmission to **P** or after driving forwards a short distance.

### Displays in the Audio/COMAND display

The rear view camera may show a distorted view of obstacles, show them incorrectly or not at all. The rear view camera does not show objects in the following positions:

- very close to the rear bumper
- under the rear bumper
- in the area immediately above the tailgate handle

**!** Objects not at ground level may appear to be further away than they actually are, e.g.:

- the bumper of a parked vehicle
- the drawbar of a trailer

- the ball coupling of a trailer tow hitch
- the rear section of an HGV
- a slanted post

Use the guidelines only for orientation.

Approach objects no further than the bottom-most guideline.

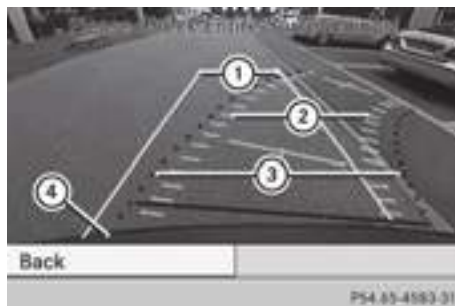

Lanes

- ① White guide line without turning the steering wheel, vehicle width including the exterior mirrors (static)
- ② Yellow lane marking tires at current steering wheel angle, vehicle width to the outer side of the wheels (dynamic)
- ③ Red guide line for the vehicle width including the exterior mirrors, for current steering wheel angle (dynamic)
- ④ Bumper

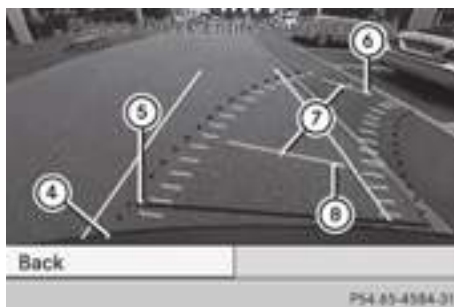

Guide lines

- ④ Bumper
- ⑤ Red guide line at a distance of approximately 10 in (0.25 m) from the rear of the vehicle

- ⑥ Yellow guide line at a distance of approximately 13 ft (4.0 m) from the rear of the vehicle
- ⑦ Vehicle center axle (marker assistance)
- ⑧ Yellow guide line at a distance of approximately 3 ft (1.0 m) from the rear of the vehicle

The lanes and guide lines are only displayed if you have engaged reverse gear.

The distance specifications only apply to objects that are at ground level.



Additional displays on vehicles with PARKTRONIC and COMAND

- ① Front warning display
- ② Additional PARKTRONIC measurement operational readiness indicator
- ③ Rear warning display

Vehicles with PARKTRONIC and COMAND: when PARKTRONIC is operational, the additional measurement operational indicator appears in the COMAND display. If the PARKTRONIC warning displays light up, warning displays ① and ③ in the COMAND display are also active.

### "Reverse parking" function

- Make sure that the rear view camera is activated and the "Reverse parking" function is selected (see the separate operating instructions for the audio system/COMAND).  
The lane and the guide lines are shown.

### Backing up straight into a parking space without turning the steering wheel



- ① White lane with steering wheel straight
- ② Yellow guide line at a distance of approximately 3 ft (1.0 m) from the rear of the vehicle
- ③ Red guide line at a distance of approximately 10 in (0.25 m) from the rear of the vehicle

- Use white lane ① to check whether the vehicle will fit into the parking space.
- Using the white lane as a guide, carefully back up until you reach the end position. Red guide line ③ is then at the end of the parking space. The vehicle is almost parallel in the parking space.

### Reverse perpendicular parking with the steering wheel at an angle

- Drive past the parking space and bring the vehicle to a standstill.





Turning the steering wheel

- ① Red lane indicating the route the vehicle will take with the steering wheel in its current position
- ② Parking space marking

- ▶ While the vehicle is at a standstill, turn the steering wheel in the direction of the parking space until the red lane reaches parking space marking ②.
- ▶ Keep the steering wheel in that position and back up carefully.



Backing up with the steering wheel turned

- ① Red lane indicating the route the vehicle will take with the steering wheel in its current position
- ▶ Stop the vehicle when it is almost exactly in front of the parking space. The white lane should be as close to parallel with the parking space marking as possible.



Driving to the final position

- ① White lane at current steering wheel angle
  - ② Parking space marking
- ▶ Turn the steering wheel to the center position while the vehicle is stationary.

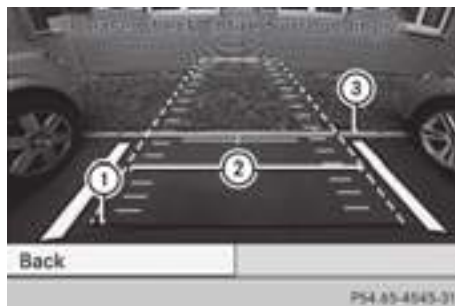

- ① Red guide line at a distance of approximately 10 in (0.25 m) from the rear of the vehicle
  - ② White lane with steering wheel straight
  - ③ End of parking space
- ▶ Back up carefully until you have reached the final position. Red guide line ① is then at end of parking space ③. The vehicle is almost parallel in the parking space.

## ATTENTION ASSIST

### General notes

ATTENTION ASSIST helps you during long, monotonous journeys, such as on highways. It is active in the range between 50 mph (80 km/h) and 112 mph (180 km/h).



If ATTENTION ASSIST detects typical indicators of fatigue or increasing lapses in concentration on the part of the driver, it suggests you take a break.

### Important safety notes

ATTENTION ASSIST is only an aid to the driver. It might not always recognize fatigue or increasing inattentiveness in time or fail to recognize them at all. The system is not a substitute for a well-rested and attentive driver.

ATTENTION ASSIST assesses your level of fatigue or lapses in concentration by taking the following criteria into account:

- your personal driving style, e.g. steering characteristics
- journey details, e.g. time of day and length of journey

The functionality of ATTENTION ASSIST is restricted and warnings may be delayed or not occur at all:



- if the road condition is poor, e.g. if the surface is uneven or if there are potholes
- if there is a strong side wind
- if you have adopted a sporty driving style with high cornering speeds or high rates of acceleration
- if you are predominantly driving slower than 50 mph (80 km/h) or faster than 112 mph (180 km/h)
- if you are currently using COMAND or making a telephone call with it
- if the time has been set incorrectly
- in active driving situations, such as when you change lanes or change your speed

### Warning and display messages in the multifunction display

- ▶ Activate ATTENTION ASSIST using the on-board computer (▷ page 184).

If ATTENTION ASSIST is active, you will be warned no sooner than 20 minutes after your journey has begun. You then hear an

intermittent warning tone twice and the **Attention Assist: Take a Break!** message appears in the multifunction display.

- ▶ If necessary, take a break.
- ▶ Press the  or  button to confirm the message.

On long journeys, take regular breaks in good time to allow yourself to rest properly. If you do not take a break, you will be warned again after 15 minutes at the earliest. The precondition for this is that ATTENTION ASSIST still detects typical indicators of fatigue or increasing lapses in concentration.

ATTENTION ASSIST is reset when you continue your journey and starts assessing your tiredness again if:

- you switch off the drive system.
- you take off your seat belt and open the driver's door, e.g. for a change of drivers or to take a break.

When ATTENTION ASSIST is deactivated, the  symbol appears in the multifunction display in the assistance graphic display.

### Blind Spot Assist

#### General notes

Blind Spot Assist uses a radar sensor system to monitor the areas on both sides of your vehicle. It supports you from a speed of approximately 20 mph (30 km/h). A warning display in the exterior mirrors draws your attention to vehicles detected in the monitored area. If you then switch on the corresponding turn signal to change lanes, you will also receive a visual and audible collision warning. For this purpose, Blind Spot Assist uses sensors in the rear bumper.

## Important safety notes

### WARNING

Blind Spot Assist does not react to:

- vehicles overtaken too closely on the side, placing them in the blind spot area
- vehicles which approach with a large speed differential and overtake your vehicle

As a result, Blind Spot Assist may not give warnings in such situations. There is a risk of an accident.

Always observe the traffic conditions carefully, and maintain a safe lateral distance.

Blind Spot Assist is only an aid. It may fail to detect some vehicles and is no substitute for attentive driving.

### USA only:

This device has been approved by the FCC as a "Vehicular Radar System". The radar sensor is intended for use in an automotive radar system only. Removing, tampering with, or altering the device will void any warranties, and is not permitted by the FCC. Do not tamper with, alter, or use in any non-approved way.

Any unauthorized modification to this device could void the user's authority to operate the equipment.

## Monitoring range of the sensors

In particular, the detection of obstacles can be impaired if:

- there is dirt on the sensors or anything else covering the sensors
- there is poor visibility, e.g. due to fog, heavy rain or snow
- a narrow vehicle traveling in front, e.g. a motorbike or bicycle
- the road has very wide lanes
- the road has narrow lanes
- you are not driving in the middle of the lane
- there are barriers or similar lane borders

Vehicles in the monitoring range are then not indicated.

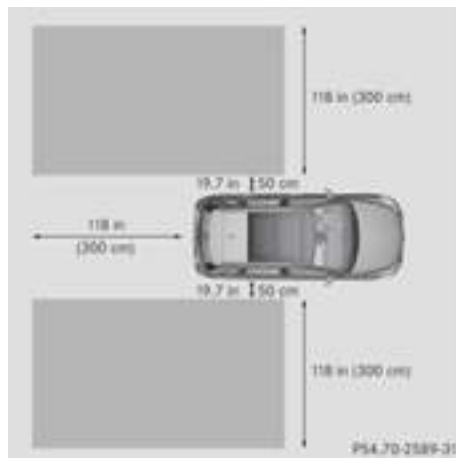

Blind Spot Assist monitors the area up to 10 ft (3.0 m) behind your vehicle and directly next to your vehicle, as shown in the diagram. For this purpose, Blind Spot Assist uses radar sensors in the rear bumper.

If the lanes are narrow, vehicles driving in the lane beyond the lane next to your vehicle may be indicated, especially if the vehicles are not driving in the middle of their lane. This may be the case as soon as the vehicles are driving on the inner side of their lane.

Due to the nature of the system:

- warnings may be issued in error when driving close to crash barriers or similar solid lane borders.
- warnings may be interrupted when driving alongside particularly long vehicles, e.g. trucks, for a prolonged time.

The two sensors for Blind Spot Assist are integrated into the sides of the rear bumper. Make sure that the bumper is free of dirt, ice or slush in the vicinity of the sensors. For example, the radar sensors must not be covered by bicycle racks or overhanging loads. Following a severe impact or in the event of damage to the bumpers, have the function of the radar sensors checked at a qualified spe-

cialist workshop. Blind Spot Assist may otherwise not work properly.

### Warning and indicator lamps

Blind Spot Assist is not active at speeds below approximately 20 mph (30 km/h). Vehicles in the monitoring range are then not indicated.



#### ① Red warning lamp/yellow indicator lamp

When Blind Spot Assist is activated, indicator lamp ① in the exterior mirrors lights up yellow at speeds of up to 20 mph (30 km/h). At speeds above 20 mph (30 km/h), the indicator lamp goes out and Blind Spot Assist is operational.

if a vehicle is detected at speeds of approximately 20 mph (30 km/h), warning lamp ① on the corresponding side lights up red. This warning occurs when a vehicle enters the blind spot monitoring range from behind or from the side. When you overtake a vehicle, the warning only occurs as long as the difference in speed is less than 7 mph (12 km/h). The yellow indicator lamp goes out if reverse gear is engaged. In this event, Blind Spot Assist is no longer active.

The brightness of the warning/indicator lamps is adjusted automatically according to the ambient light.

### Collision warning

If a vehicle is detected in the monitoring range of Blind Spot Assist and you switch on the corresponding turn signal, a double warning tone sounds. Red warning lamp ① flashes. If

the turn signal remains on, vehicles detected are indicated by the flashing of red warning lamp ①. There are no further warning tones.

### Switching on Blind Spot Assist

- ▶ Make sure that Blind Spot Assist is activated in the on-board computer (▷ page 184).
- ▶ Turn the SmartKey to position **2** in the ignition lock.  
Warning lamps ① in the exterior mirrors light up red for approximately 1.5 seconds and then turn yellow.



Useful information .....	172
Important safety notes .....	172
Displays and operation .....	172
Menus and submenus .....	176
Display messages .....	190
Warning and indicator lamps in the instrument cluster .....	216

### Useful information

- i** This Operator's Manual describes all models and all standard and optional equipment of your vehicle available at the time of publication of the Operator's Manual. Country-specific differences are possible. Bear in mind that your vehicle may not feature all functions described here. This also applies to safety-relevant systems and functions.
- i** Read the information on qualified specialist workshops: (▷ page 24).

### Important safety notes

#### WARNING

If you operate information systems and communication equipment integrated in the vehicle while driving, you will be distracted from traffic conditions. You could also lose control of the vehicle. There is a risk of an accident. Only operate the equipment when the traffic situation permits. If you are not sure that this is possible, park the vehicle paying attention to traffic conditions and operate the equipment when the vehicle is stationary.

#### WARNING

If the instrument cluster has failed or malfunctioned, you may not recognize function restrictions in systems relevant to safety. The operating safety of your vehicle may be impaired. There is a risk of an accident.

Drive on carefully. Have the vehicle checked at a qualified specialist workshop immediately.

You must observe the legal requirements for the country in which you are currently driving when operating the on-board computer.

The on-board computer only shows messages or warnings from certain systems in the multifunction display. You should therefore make sure your vehicle is operating safely at all

times. Otherwise, a vehicle that is not operating safely may cause an accident.

If the operating safety of your vehicle is impaired, pull over as soon as it is safe to do so. Contact a qualified specialist workshop.

For an overview, see the instrument panel illustration (▷ page 31).



### Displays and operation

#### Instrument cluster lighting

The lighting in the instrument cluster, in the displays and the controls in the vehicle interior can be adjusted using the brightness control knob.

The brightness control knob is located on the bottom left of the instrument cluster (▷ page 31).

- ▶ Turn the brightness control knob clockwise or counter-clockwise.

If the light switch is set to **AUTO**,  or , the brightness is dependent upon the brightness of the ambient light.

- i** The light sensor in the instrument cluster automatically controls the brightness of the multifunction display.

In daylight, the displays in the instrument cluster are not illuminated.

#### READY indicator



When the drive system is started and the vehicle is ready to drive, READY indicator  appears in the multifunction display. This indicates that the vehicle is operational.

### Outside temperature display

You should pay special attention to road conditions when temperatures are around freezing point.

Bear in mind that the outside temperature display indicates the temperature measured and does not record the road temperature.

The outside temperature display is in the multifunction display (▷ page 176).

Changes in the outside temperature are displayed after a short delay.

### E-CELL display



#### ⚠ WARNING

There is a risk of an accident if you accelerate or overtake when the power output of the drive system is reduced.

You should therefore adapt your driving style and drive particularly carefully. Charge the high-voltage battery at a charge station immediately.

- ▶ Start the drive system (▷ page 127). E-CELL display ① shows the available power of the drive system.

Under normal operating conditions, E-CELL display ① is in the maximum range.

The power output available may deviate from the maximum range in the event of:

- very high or low outside temperatures
- very high performance requirements for a longer period of time

- very low condition of charge of the high-voltage battery
- a malfunction in the drive system

The reduced power output can be improved by charging the high-voltage battery (▷ page 134).

### Power display



Power display ① contains two areas:

- Area above 0  
Here, the current amount of power that the drive system is feeding to the wheels is displayed.
- Area below 0  
Here, the vehicle's recuperative power in overrun mode is displayed.

If the needle for the power display is in the **OFF** position, the vehicle is not ready to drive because:

- the drive system has not yet started
- the charging cable is still connected to the vehicle socket
- there is insufficient power available from the high-voltage battery
- the vehicle's high-voltage electrical system is malfunctioning

When the drive system is started, the needle in the power display moves to position **0**. The display **Ready** appears in the lower multifunction display. The vehicle is ready to drive.

The boost area for maximum acceleration can be reached using kickdown (▷ page 131).

The braking performance of the electric motor using recuperative braking is, in some operating modes, either reduced or not effective:

- when the condition of charge of the high-voltage battery increases
- if the high-voltage battery is not yet at a normal operating temperature
- when the vehicle is almost stationary
- in transmission position **N**
- during and after ESP stability control

If necessary, counteract the reduced regenerative braking effect by applying the brake yourself.

The braking performance of the electric motor using recuperative braking is, in some operating modes, either reduced or not effective:

- when the condition of charge of the high-voltage battery increases
- if the high-voltage battery is not yet at a normal operating temperature
- when the vehicle is almost stationary
- in transmission position **N**
- during and after ESP stability control

If necessary, counteract the reduced regenerative braking effect by applying the brake yourself.

### Charge level display



Condition of charge display ① shows the condition of charge of the high-voltage battery. The charge values are shown as a percentage in the COMAND display (see the separate operating instructions).

The condition of charge of the high-voltage battery has dropped into the reserve range if the drive system is running and:

- the **Drive Battery Reserve Level** message appears in the display
- the indicator lamp in the instrument cluster lights up

**i** Charge the high-voltage battery from a condition of charge of less than 20% at:

- an electrical outlet
- a charging station

### Operating the on-board computer

#### Overview









- ① Multifunction display
- ② Switches on the Voice Control System (see the separate operating instructions)
- ③ Right control panel
- ④ Left control panel
- ⑤ Back button

► **To activate the on-board computer:** turn the SmartKey to position **1** in the ignition lock.







You can control the multifunction display and the settings in the on-board computer using the buttons on the multifunction steering wheel.



### Left control panel

	<ul style="list-style-type: none"> <li>• Calls up the menu and menu bar</li> </ul>
	
	<p><b>Press briefly:</b></p> <ul style="list-style-type: none"> <li>• Scrolls in lists</li> <li>• Selects a submenu or function</li> <li>• In the <b>Audio</b> menu: selects a stored station, an audio track or a video scene</li> <li>• In the <b>Tel</b> (telephone) menu: switches to the phone book and selects a name or telephone number</li> </ul>
	
	<p><b>Press and hold:</b></p> <ul style="list-style-type: none"> <li>• In the <b>Audio</b> menu: selects the previous/next station or selects an audio track or a video scene using rapid scrolling</li> <li>• In the <b>Tel</b> (telephone) menu: starts rapid scrolling through the phone book</li> </ul>
	
	<ul style="list-style-type: none"> <li>• Confirms a selection/display message</li> <li>• In the <b>Tel</b> (Telephone) menu: switches to the telephone book and starts dialing the selected number</li> <li>• In the <b>Audio</b> menu: stops the station search function at the desired station</li> </ul>

### Right control panel

	<ul style="list-style-type: none"> <li>• Rejects or ends a call</li> <li>• Exits phone book/redial memory</li> </ul>
	<ul style="list-style-type: none"> <li>• Makes or accepts a call</li> <li>• Switches to the redial memory</li> </ul>
	<ul style="list-style-type: none"> <li>• Adjusts the volume</li> </ul>
	
	<ul style="list-style-type: none"> <li>• Mute</li> </ul>

### Back button

	<p><b>Press briefly:</b></p> <ul style="list-style-type: none"> <li>• Back</li> <li>• Switches off the Voice Control System (see the separate operating instructions)</li> <li>• Hides display messages/calls up the last <b>Trip</b> menu function used</li> <li>• Exits the telephone book/redial memory</li> </ul>
	<p><b>Press and hold:</b></p> <ul style="list-style-type: none"> <li>• Calls up the standard display in the <b>Trip</b> menu</li> </ul>

## Multifunction display



Multifunction display

- ① Range
- ② Time
- ③ Text field
- ④ Menu bar
- ⑤ Drive program
- ⑥ Permanent display: outside temperature or speed (▷ page 187)
- ⑦ Transmission position (▷ page 129)

► **To show menu bar** ④: press the ◀ or ▶ button on the steering wheel.

Menu bar ④ disappears after a few seconds. Text field ③ shows the selected menu or submenu as well as display messages.

**i** You can set the time using the Audio system or COMAND (see the separate operating instructions).

The following messages may appear in the multifunction display:

- ◀ **P** ▶ Active Parking Assist (▷ page 159)
-  Cruise control (▷ page 152)
- CRUISE** Cruise control (▷ page 152)
- HOLD** HOLD function (▷ page 154)

## Menus and submenus

### Menu overview

Operating the on-board computer (▷ page 174).

Depending on the equipment installed in the vehicle, you can call up the following menus:

- **Trip** menu (▷ page 176)
- **Navi** menu (navigation instructions) (▷ page 179)
- **Audio** menu (▷ page 180)
- **Tel** menu (telephone) (▷ page 181)
- **DriveAssist** menu (assistance) (▷ page 183)
- **Serv.** menu (▷ page 184)
- **Sett** menu (▷ page 185)

The **Audio**, **Navi** and **Tel** menus differ slightly in vehicles with an audio system and in vehicles with COMAND. The examples given in this Operator's Manual apply to vehicles equipped with COMAND.

### Trip menu

#### Standard display



Standard display

- Press the ◀ or ▶ button on the steering wheel to select the **Trip** menu. The **Trip** menu with trip odometer ① and odometer ② is shown.

## Digital speedometer



Digital speedometer

① Digital speedometer

- ▶ Press the ◀ or ▶ button on the steering wheel to select the **Trip** menu.
- ▶ Press the ▲ or ▼ button to select the digital speedometer.

## Trip computer "From Start" or "From Reset"



"From Start" trip computer

- ① Distance
- ② Time
- ③ Average speed
- ④ Average electrical consumption

- ▶ Press the ◀ or ▶ button on the steering wheel to select the **Trip** menu.
- ▶ Press the ▲ or ▼ button to select **From Start** or **From Reset**.

The values in the **From Start** submenu are calculated from the start of a journey whilst the values in the **From Reset** submenu are calculated from the last time the submenu was reset (▷ page 177).

The **From Start** trip computer is automatically reset when:

- the ignition has been switched off for more than 4 hours.
- 999 hours have been exceeded.
- 9,999 miles have been exceeded.

The **From Reset** trip computer is automatically reset if the value exceeds 999 hours or 9999 miles.

## Resetting values

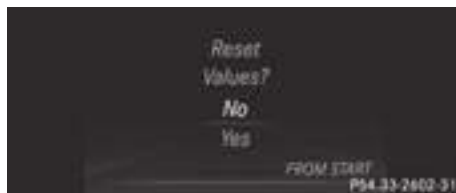

Resetting the "From start" trip computer

You can reset the values of the following functions:





- Trip odometer
  - "From Start" trip computer
  - "From Reset" trip computer
  - ECO display
- ▶ Press the ◀ or ▶ button on the steering wheel to select the **Trip** menu.
  - ▶ Press the ▲ or ▼ button to select the function that you wish to reset.
  - ▶ Press the **OK** button.
  - ▶ Press the ▼ button to select **Yes** and press the **OK** button to confirm.

- ❗ When you reset the values in the "ECO display", the values in the trip computer "From Start" are likewise reset. When you reset the values in the trip computer "From Start", the values in the "ECO display" are likewise reset.

## ECO display



ECO display

- ▶ Press the  or  button on the steering wheel to select the **Trip** menu.
- ▶ Press the  or  button to select **ECO DISPLAY**.





If the ignition remains switched off for longer than 4 hours, the ECO display will be automatically reset.

Further information on the ECO display (> page 148).

### Displaying the range and current consumption



Range and current consumption

- ▶ Press the  or  button on the steering wheel to select the **Trip** menu.
- ▶ Press the  or  button to view the approximate range and current consumption.





The approximate range depends on the condition of charge of the high-voltage battery and your current driving style. If the high-voltage battery condition of charge is low, the display shows a vehicle being charged instead of the approximate range.

The specified values for range depend on the driving program selected and may vary as a result of:

- higher and lower outside temperatures
- the style of driving
- activated electrical consumers

### Energy flow

The energy flow display can be displayed in the multifunction display and in the COMAND display (see separate operating instructions).

- ▶ Press the  or  button on the steering wheel to select the **Trip** menu.
- ▶ Confirm by pressing  on the steering wheel.
- ▶ Use  or  to select **Energy Flow**. The active components are highlighted in the energy flow display.

**i** The energy flow is indicated by arrows. The arrows have a different color depending on the operating state:

- Green: energy recuperation
- White: normal energy consumption
- Red: increased energy consumption

### Drive system switched on when the vehicle is stationary or in overrun mode



The drive system is switched on while the vehicle is stationary. Alternatively, the drive system is switched on while the vehicle is in transmission position **D<sup>+</sup>** or **N**.

The arrows indicating energy flow are not shown.

### Drive system switched off and high-voltage battery being charged



The drive system is switched off. The charging cable is connected and the high-voltage battery is being charged.

The arrows for the energy flow are shown in green.

## Normal driving



The drive system powers the vehicle.

The arrows for the energy flow are shown in white.

## Boost driving mode



The boost mode takes effect if you depress the accelerator pedal quickly.

The arrows for the energy flow are shown in red.

## Energy recuperation mode



The kinetic energy of the vehicle is converted into electrical energy. The high-voltage battery is being charged.

The arrows for the energy flow are shown in green.

## Navigation system menu

### Displaying navigation instructions

- ▶ Switch on the audio system or COMAND (see the separate operating instructions).
- ▶ Press the ◀ or ▶ button on the steering wheel to select the **Navi** menu.

In the **Navi** menu, the multifunction display shows navigation instructions. You can find further information in the separate operating instructions.

### Route guidance not active



Route guidance not active

- ① Direction of travel
- ② Current road

### Route guidance active

#### No change of direction announced



No change of direction announced

- ① Distance to the destination
- ② Distance to the next change of direction
- ③ Current road
- ④ "Follow the road's course" symbol

### Change of direction announced without a lane recommendation



Change of direction announced without a lane recommendation

- ① Road into which the change of direction leads
- ② Distance to change of direction and visual distance display
- ③ Change-of-direction symbol

When a change of direction is announced, you will see symbol ③ for the change of direction and distance graphic ②. The distance indicator shortens towards the top of the display as you approach the point of the announced change of direction.

### Change of direction announced with a lane recommendation

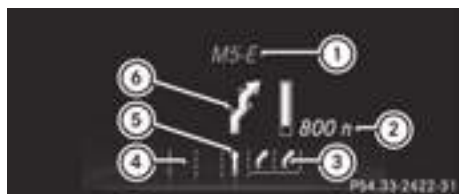

Change of direction announced with a lane recommendation

- ① Road into which the change of direction leads
- ② Distance to change of direction and visual distance display
- ③ New lane during a change of direction
- ④ Uninterrupted lane
- ⑤ Lane recommendation
- ⑥ Change-of-direction symbol

On multilane roads, the system can display lane recommendation ③ for the next change of direction. During the change of direction, additional lanes may be displayed.

Lane recommendations are only displayed if the relevant data is available on the digital map.

### Other status indicators of the navigation system

- : you have reached the destination or an intermediate destination.
- **New Route...** or **Calculating Route:** calculating a new route
- **Off Map** or **Off Mapped Road:** the vehicle position is outside the area of the digital map (off-map position).
- **No Route:** no route could be calculated to the selected destination.

### Audio menu



#### Selecting a radio station





Example: radio station (multifunction display)

- ① Waveband
- ② Channel frequency with memory position

- **i** The memory position is only displayed along with station ② if this has been stored.
- ▶ Switch on the audio system or COMAND and select Radio (see the separate operating instructions).
- ▶ Press the or button on the steering wheel to select the **Audio** menu.
- ▶ **To select a stored station:** briefly press the or button.

- ▶ **To select a station from the station list:** press and briefly hold the  or  button.

If no station list is received:

- ▶ **To select a station using the station search:** press and briefly hold the  or  button.

**i** Information on how to switch wavebands and store stations can be found in the separate operating instructions.

**i** SIRIUS XM satellite radio functions like a normal radio.

You can find further information on operating the satellite radio in the separate operating instructions.







## Operating audio devices or media





Example: CD/DVD changer display (multifunction display)

① Current title

Audio data from various audio devices or media can be played, depending on the equipment installed in the vehicle.

- ▶ Switch on the audio system or COMAND and select audio CD, audio DVD or MP3 mode (see the separate operating instructions).
- ▶ Press the  or  button on the steering wheel to select the **Audio** menu.
- ▶ **To select the next/previous track:** briefly press the  or  button.
- ▶ **To select a track from the track list (rapid scrolling):** press and hold the  or  button until desired track ① has been reached.

If you press and hold  or , the rapid scrolling speed is increased. Not all

audio drives or data carriers support this function.







If track information is stored on the audio device or medium, the multifunction display will show the number and title of the track. The current track does not appear in audio AUX mode (**A**uxiliary audio mode: external audio source connected).

## Video DVD operation



Example: CD/DVD changer display (multifunction display)

① Current scene

- ▶ Switch on COMAND and select video DVD (see the separate operating instructions).
- ▶ Press the  or  button on the steering wheel to select the **Audio** menu.
- ▶ **To select the next/previous scene:** briefly press the  or  button.
- ▶ **To select a scene from the scene list (rapid scrolling):** press and hold the  or  button until desired scene ① has been reached.

## Telephone menu

### Introduction



#### **WARNING**

If you operate information systems and communication equipment integrated in the vehicle while driving, you will be distracted from traffic conditions. You could also lose control of the vehicle. There is a risk of an accident.

Only operate the equipment when the traffic situation permits. If you are not sure that this is possible, park the vehicle paying attention

to traffic conditions and operate the equipment when the vehicle is stationary.

When telephoning, you must observe the legal requirements for the country in which you are currently driving.

- ▶ Switch on the mobile phone and audio system or COMAND (see the separate operating instructions).
- ▶ Establish a Bluetooth® connection to the audio system or COMAND (see the separate operating instructions).
- ▶ Press the  or  button on the steering wheel to select the **Te1** menu.

You will see one of the following display messages in the multifunction display:

- **Please Enter PIN:** the mobile phone has been placed in the mobile phone bracket and the PIN has not been entered.

When you enter your PIN via the mobile phone, the Voice Control System, the audio system or COMAND, the mobile phone searches for a network.

- **Phone READY** or the name of the network provider: the mobile phone has found a network and is ready to receive.
- **Phone No Service:** there is no network available or the mobile phone is searching for a network.

**i** You can obtain further information about suitable mobile phones and connecting mobile phones via Bluetooth®:

- from your authorized Mercedes-Benz Center
- on the Internet at <http://www.mercedes-benz.com/connect>

## Accepting a call



Example: incoming call (multifunction display)

- ▶ Press the  button on the steering wheel to accept an incoming call.

If someone calls you when you are in the **Te1** menu, a display message appears in the multifunction display.







You can accept a call even if you are not in the **Te1** menu.



## Rejecting or ending a call

- ▶ Press the  button on the steering wheel.



You can end or reject a call even if you are not in the **Te1** menu.

## Dialing a number from the phone book



- ▶ Press the  or  button on the steering wheel to select the **Te1** menu.
- ▶ Press the ,  or  button to switch to the phone book.
- ▶ Press the  or  button to select the desired name.

To start scrolling rapidly, press and hold the  or  button for longer than one second.





Rapid scrolling stops when you release the button or reach the end of the list.

- ▶ **If only one telephone number is stored for a name:** press the  or  button to start dialing.



or

- ▶ **If there is more than one number for a particular name:** press the  or  button to display the numbers.









- ▶ Press the  or  button to select the number you want to dial.
- ▶ Press the  or  button to start dialing.

or



- ▶ **If you do not want to make a call:** press the  or  button.

## Redialing

The on-board computer saves the last names or numbers dialed in the redial memory.

- ▶ Press the  or  button on the steering wheel to select the **Te1** menu.
- ▶ Press the  button to switch to the redial memory.
- ▶ Press the  or  button to select the desired name or number.
- ▶ Press the  or  button to start dialing.

or

- ▶ **If you do not want to make a call:** press the  or  button.

## Assistance menu

### Introduction







Example: Assistance menu view options

In the **DriveAssist** menu, you have the following options:

- Displaying the assistance graphic (▷ page 183)
- Deactivating/activating ESP® (▷ page 183)
- Activating/deactivating the distance warning system (▷ page 184)



- Activating/deactivating ATTENTION ASSIST (▷ page 184)
- Activating/deactivating Blind Spot Assist (▷ page 184)

## Displaying the assistance graphic

- ▶ Press the  or  button on the steering wheel to select the **DriveAssist** menu.
- ▶ Press  or  to select **Assistance graphic**.
- ▶ Press the  button.

The assistance graphic can display the status of and information from other driving systems or driving safety systems.

The assistance graphic shows:

- the  symbol, when the rear window wiper (▷ page 109) is activated.
- the  symbol when ATTENTION ASSIST (▷ page 166) is deactivated.

## Deactivating/activating ESP®

- i** Observe the "Important safety notes" section in the description of ESP (▷ page 67).

### WARNING





If you deactivate ESP®, ESP® no longer stabilizes the vehicle. There is an increased risk of skidding and an accident.

Only deactivate ESP® in the situations described in the following.



It may be best to deactivate ESP® in the following situations:

- when using snow chains
- in deep snow
- on sand or gravel

For further information about ESP®, see (▷ page 66).

- ▶ Start the drive system.
- ▶ Press the  or  button on the steering wheel to select the **DriveAssist** menu.
- ▶ Press the  or  button to select **ESP**.





- ▶ Press the **OK** button.  
The current selection is displayed.
- ▶ **To activate/deactivate:** press the **OK** button again.  
ESP® is deactivated if the  warning lamp in the instrument cluster lights up continuously when the drive system is running.

If the  warning lamp and the  warning lamp are lit continuously, ESP® is not available due to a malfunction.

Observe the information on warning lamps (▷ page 221).





Observe the information on display messages (▷ page 191).

### Activating/deactivating the distance warning function

- ▶ Press the  or  button on the steering wheel to select the **DriveAssist** menu.
- ▶ Press  or  to select **Distance Warning**.
- ▶ Press the **OK** button.  
The current selection is displayed.
- ▶ **To activate/deactivate:** press the **OK** button again.  
If the distance warning function is activated, the multifunction display does not display a symbol.  
When the distance warning function is deactivated, the  symbol appears in the multifunction display in the assistance graphics display.

Further information on the distance warning function (▷ page 64).





### Activating/deactivating ATTENTION ASSIST

- ▶ Press the  or  button on the steering wheel to select the **DriveAssist** menu.
- ▶ Press the  or  button to select **ATTENTION ASSIST**.

- ▶ Press the **OK** button.  
The current selection is displayed.
- ▶ **To activate/deactivate:** press the **OK** button again.  
When ATTENTION ASSIST is deactivated, the  symbol appears in the multifunction display in the assistance graphics display.

For further information about ATTENTION ASSIST, see (▷ page 166).

### Activating/deactivating Blind Spot Assist

- ▶ Press the  or  button on the steering wheel to select the **DriveAssist** menu.
- ▶ Press the  or  button to select **Blind Spot Assist**.
- ▶ Press the **OK** button.  
The current selection is displayed.
- ▶ **To activate/deactivate:** press the **OK** button again.

For further information about Blind Spot Assist, see (▷ page 167).

When the **Blind Spot Assist Sensors Deactivated** message is shown, the radar sensor system is deactivated.

- ▶ Switch on the radar sensor system (▷ page 188).

### Maintenance menu



Service menu view options

In the **Serv.** menu, you have the following options:

- Calling up display messages in message memory (▷ page 190)
- Checking the tire pressure electronically (▷ page 286)
- Calling up the service due date (▷ page 254)

## Settings menu

### Introduction



Example: settings menu view

In the **Sett.** menu, you have the following options:

- Changing the E-CELL settings
- Changing the instrument cluster settings
- Changing the light settings
- Changing the vehicle settings
- Restoring the factory settings

### E-CELL menu

#### Departure time

In the **E-CELL** menu you can choose to cool down or heat the vehicle interior for a predefined departure time.

If you have selected Park **P**, the on-board computer displays the expected battery charge time or the RANGE PLUS condition of charge for the departure time set.

Changing the departure time

- ▶ Press the **◀** or **▶** button on the steering wheel to select the **Settings** menu.
- ▶ Press the **▲** or **▼** button on the steering wheel to select the **E-CELL** menu.
- ▶ Press **▲** or **▼** to select **Departure Time**.

- ▶ Press **OK** to confirm.  
You will see the selected setting.
- ▶ Press **▼** or **▲** to select **A**, **B** or **C Change**.
- ▶ Press **◀** or **▶** to select **Departure Time Hours**.
- ▶ Press the **▲** or **▼** button to set the hour.
- ▶ Press **◀** or **▶** to select **Departure Time Minutes**.
- ▶ Press **▲** or **▼** to set the minutes.
- ▶ Press **OK** to confirm.  
After changing from one menu to another, the departure time setting is stored.

Selecting the departure time

- ▶ Press the **◀** or **▶** button on the steering wheel to select the **Settings** menu.
- ▶ Press the **▲** or **▼** button on the steering wheel to select the **E-CELL** menu.
- ▶ Press **▲** or **▼** to select **Departure Time**.
- ▶ Press **OK** to confirm.
- ▶ Press the **▼** or **▲** button to select one of the three departure times or **Timer Off** (no timer active).
- ▶ Press **OK** to confirm.

#### Charging with RANGE PLUS

If you have selected Park **P**, the on-board computer displays the expected battery charge time or the RANGE PLUS condition of charge for the departure time set.

RANGE PLUS charges when:

- you have activated RANGE PLUS via the center console prior to charging and
- the high-voltage battery is fully charged.

If charging is not complete by departure time, the maximum range will **not** be available.



Example:

- Set departure time: 6:41 a.m.
- End time for standard high-voltage battery charging: 6:00 a.m.
- RANGE PLUS condition of charge at 6:41 a.m.: 50%
- The maximum additional range is decreased by 50 percent.

### Pre-entry climate control at time of departure

If you activate the "Rem. Climate Control at departure time" function, the vehicle interior is heated or cooled prior to a desired departure time.

- i** To heat or cool the vehicle interior for a desired departure time, the high-voltage battery must be sufficiently charged. Activate the climate control function primarily when the high-voltage battery is being charged. You must also set a departure time using the **E-CELL** submenu (▷ page 185).

Switching "Pre-entry climate control at departure time" on/off

- ▶ Press the or button on the steering wheel to select the **Settings** menu.
- ▶ Use or to select the **E-CELL** submenu.
- ▶ Press to confirm.
- ▶ Press or to select **Rem. Climate Control At Departure Time**.
- ▶ Press to activate or deactivate. The vehicle interior will then be heated or cooled prior to the predefined departure time.

If a departure time is selected, the yellow indicator lamp lights up on the auxiliary heating button.

You can use the on-board computer to specify up to three departure times in the **E-CELL** submenu. One of the specified departure times may be preselected (▷ page 185).

### Pre-entry climate control (via SmartKey)

Pre-entry climate control (via SmartKey) is switched on temporarily when the vehicle is unlocked using the SmartKey. In order to switch on pre-entry climate control via the SmartKey, the function has to be activated using the on-board computer.

Activating/deactivating pre-entry climate control (via SmartKey)

- ▶ Press the or button on the steering wheel to select the **Settings** menu.
- ▶ Use or to select the **E-CELL** submenu.
- ▶ Press to confirm.
- ▶ Press or to select **Pre-Entry Climate Cont. (Via Key)**.
- ▶ Press to activate or deactivate. If pre-entry climate control (via SmartKey) is activated, pre-entry climate control (via SmartKey) is switched on temporarily when you unlock the vehicle.

### Setting the maximum charge current

Before charging the high-voltage battery, check the maximum permissible charge current for the relevant power socket.

You can set a maximum charge current in the **E-CELL** menu.

It is only necessary to select the maximum charge current if there are no charge current settings on the charging cable.

- i** The maximum charge current values in the on-board computer may deviate from the charging cable values.



Example: changing the charge current

#### ① Setting the maximum charge current

**i** This menu is not available in some countries. In this case, the maximum charge current for the power socket is limited to a fixed level, depending on the country concerned.

- ▶ Press the or button on the steering wheel to select the **Sett.** menu.
- ▶ Use or to select the **E-CELL** submenu.
- ▶ Press the or button to select **Max. Charge Current**.
- ▶ Press to confirm.
- ▶ Press or in the submenu to select desired maximum charge current ①.
- ▶ Press the button on the multifunction steering wheel to confirm.  
The high-voltage battery is charged with the selected maximum charge current.

## Instrument cluster

### Selecting the display unit

You can determine whether the multifunction display shows some messages in miles or kilometers.

- ▶ Press the or button on the steering wheel to select the **Sett** menu.
- ▶ Press the or button to select the **Instrument Cluster** submenu.
- ▶ Press to confirm.

- ▶ Press the or button to select the **Display Unit Speed-/Odometer** function.

You will see the selected setting: **km** or **miles**.

- ▶ Press the button to save the setting.

The selected unit of measurement for distance applies to:

- the digital speedometer in the **Trip** menu
- the odometer and the trip odometer
- the trip computer
- the current consumption and the range
- navigation instructions in the **Navi** menu
- cruise control
- ASSYST PLUS service interval display

### Selecting the permanent display function

You can determine whether the multifunction display permanently shows your speed or the outside temperature.



- ▶ Press the or button on the steering wheel to select the **Sett.** menu.
- ▶ Press the or button to select the **Instrument Cluster** submenu.
- ▶ Press to confirm.
- ▶ Press the or button to select the **Permanent Display:** function.  
You will see the selected setting: **Outside Temperature** or **Speedometer [km/h]**.
- ▶ Press the button to save the setting.

## Lights

### Switching the daytime running lamps on/off

**Canada only:** daytime running lamps are required by law. You cannot set the **Daytime Running Lights** function via the on-board computer.

- ▶ Press the or button on the steering wheel to select the **Sett** menu.
- ▶ Press the or button to select the **Light** submenu.
- ▶ Press to confirm.

- ▶ Press the  or  button to select the **Daytime Running Lights** function. If the **Daytime Running Lights** function has been switched on, the cone of light and the  symbol in the multifunction display are shown in orange.

- ▶ Press the  button to save the setting.

Further information on daytime running lamps (▷ page 98).

### Setting the brightness of the ambient lighting



- ▶ Press the  or  button on the steering wheel to select the **Sett.** menu.

- ▶ Press the  or  button to select the **Light** submenu.

- ▶ Press  to confirm.

- ▶ Press the  or  button to select the **Amb. Light +/-** function.

- ▶ Press the  button to change the settings.

- ▶ Press the  or  button to adjust the brightness to a level from **Off** to **Level 5** (bright).

- ▶ Press the  or  button to save the setting.

### Activating/deactivating the interior lighting delayed switch-off

If you activate the **Interior Lighting Delay** function, the interior lighting remains on for 20 seconds after you remove the key from the ignition lock.

- ▶ Press the  or  button on the steering wheel to select the **Sett** menu.

- ▶ Press the  or  button to select the **Light** submenu.

- ▶ Press  to confirm.

- ▶ Press the  or  button to select the **Interior Lighting Delay** function.

If the **Interior Lighting Delay** function has been switched on, the vehicle interior is displayed in orange in the multifunction display.

- ▶ Press the  button to save the setting.

## Vehicle

### Activating/deactivating the automatic door locking mechanism

- ▶ Press the  or  button on the steering wheel to select the **Sett** menu.

- ▶ Press the  or  button to select the **Vehicle** submenu.

- ▶ Press  to confirm.

- ▶ Press the  or  button to select the **Automatic Door Lock** function.

When the **Automatic Door Lock** function is activated, the vehicle doors are displayed in orange in the multifunction display.

- ▶ Press the  button to save the setting.

If you activate the **Automatic Door Lock** function, the vehicle is centrally locked above a speed of approximately 9 mph (15 km/h).

For further information on the automatic locking feature, see (▷ page 78).

### Activating/deactivating the acoustic locking verification signal

If you switch on the **Acoustic Lock Feedback** function, an acoustic signal sounds when you lock the vehicle.

- ▶ Press the  or  button on the steering wheel to select the **Sett.** menu.

- ▶ Press the  or  button to select the **Vehicle** submenu.

- ▶ Press  to confirm.



- ▶ Press the  or  button to select the **Acoustic Lock** function.

If the **Acoustic Lock** function is activated, the  symbol in the multifunction display lights up orange.



- ▶ Press the  button to save the setting.

### Activating/deactivating the radar sensor system

- ▶ Press the  or  button on the steering wheel to select the **Sett** menu.

- ▶ Press the  or  button to select the **Vehicle** submenu.

- ▶ Press  to confirm.









- ▶ Press the  or  button to select **Radar Sensor (See Oper. Manual)**:. You will see the selected setting: **Enabled** or **Disabled**.

- ▶ Press the  button to save the setting.

If the radar sensor system is switched off, Blind Spot Assist is deactivated (▷ page 167).

### Restoring the factory settings

---

- ▶ Press the  or  button on the steering wheel to select the **Sett** menu.
- ▶ Press the  or  button to select the **Factory setting** submenu.
- ▶ Press  to confirm. The **Reset All Settings?** message appears.
- ▶ Press the  or  button to select **No** or **Yes**.
- ▶ Press  to confirm the selection. If you have selected **Yes**, the multifunction display shows a confirmation message.

For safety reasons, the **Daytime Running Lights** function in the **Light** submenu is only reset if the vehicle is stationary.

## Display messages

### General notes

Display messages appear in the multifunction display.

Display messages with graphic displays may be shown in simplified form in the Operator's Manual and may therefore differ from the multifunction display.



Please respond in accordance with the display messages and follow the additional notes in this Operator's Manual.

Certain display messages are accompanied by an audible warning tone or a continuous tone.

When the ignition is switched off, all display messages are deleted, apart from some high-priority display messages. Once the causes of the high-priority display messages have been rectified, the corresponding display messages are also deleted.

When you stop and park the vehicle, please observe the notes on the HOLD function (> page 154) and parking (> page 144).

### Hiding display messages







- ▶ Press the  or  button on the steering wheel to hide the display message. The display message is cleared.

The multifunction display shows high-priority display messages in red. Some high-priority display messages cannot be hidden.

The multifunction display shows these messages continuously until the causes for the messages have been remedied.

### Message memory

The on-board computer saves certain display messages in the **message memory**. You can call up the display messages:

- ▶ Press the  or  button on the steering wheel to select the **Service** menu. If there are display messages, the multifunction display shows **2 Messages**, for example.
- ▶ Press the  or  button to select the entry, e.g. **2 Messages**.
- ▶ Press  to confirm.
- ▶ Press the  or  button to scroll through the display messages.



## Safety systems

## Display messages



Currently Unavailable See Operator's Manual

## Possible causes/consequences and ► Solutions

ABS (Anti-lock Braking System), ESP® (Electronic Stability Program), BAS (Brake Assist), RBS (Recuperative Brake System), the HOLD function and hill start assist are temporarily unavailable. COLLISION PREVENTION ASSIST may also have failed.

In addition, the , ,  and  warning lamps light up in the instrument cluster.

ATTENTION ASSIST is deactivated.

Possible causes are:

- self-diagnosis is not yet complete.
- the on-board voltage may be insufficient.

 **WARNING**

The braking performance of the electric motor using recuperative braking may be either reduced or not effective. If you do not make an additional effort to apply the brake yourself, the braking effect may not be sufficient. If necessary, counteract the reduced regenerative braking effect by applying the brake yourself.

The brake system continues to function normally, but without the functions listed above. The wheels could therefore lock if you brake hard, for example.

The steerability and braking characteristics may be severely affected. The braking distance in an emergency braking situation can increase.

If ESP® is not operational, ESP® is unable to stabilize the vehicle. There is an increased risk of skidding and an accident.

- Carefully drive a short distance on a suitable stretch of road, making slight steering movements at a speed above 12 mph (20 km/h).

If the display message disappears, the functions mentioned above are available again.

If the display message continues to be displayed:





- Drive on carefully.
- Visit a qualified specialist workshop.



Inoperative See Operator's Manual

ABS, ESP®, BAS, RBS, the HOLD function and hill start assist are not available due to a malfunction.

COLLISION PREVENTION ASSIST may also have failed.

In addition, the , ,  and  warning lamps light up in the instrument cluster.

ATTENTION ASSIST is deactivated.

Display messages	Possible causes/consequences and ► Solutions
	<p data-bbox="356 170 505 196"> <b>WARNING</b></p> <p data-bbox="342 212 1002 355">The braking performance of the electric motor using recuperative braking may be either reduced or not effective. If you do not make an additional effort to apply the brake yourself, the braking effect may not be sufficient. If necessary, counteract the reduced regenerative braking effect by applying the brake yourself.</p> <p data-bbox="342 363 1002 448">The brake system continues to function normally, but without the functions listed above. The wheels could therefore lock if you brake hard, for example.</p> <p data-bbox="342 456 1002 541">The steerability and braking characteristics may be severely affected. The braking distance in an emergency braking situation can increase.</p> <p data-bbox="342 549 1002 616">If ESP® is not operational, ESP® is unable to stabilize the vehicle. There is an increased risk of skidding and an accident.</p> <ul data-bbox="342 624 1002 687" style="list-style-type: none"><li data-bbox="342 624 1002 649">► Drive on carefully.</li><li data-bbox="342 657 1002 687">► Visit a qualified specialist workshop immediately.</li></ul>

## Display messages

## Possible causes/consequences and ► Solutions



Currently Unavailable See Operator's Manual

ESP®, BAS, RBS, the HOLD function and hill start assist are temporarily unavailable.

COLLISION PREVENTION ASSIST may also have failed.

In addition, the , **RBS** and  warning lamps light up in the instrument cluster.

ATTENTION ASSIST is deactivated.

The self-diagnosis function might not be complete, for example.

 **WARNING**

The braking performance of the electric motor using recuperative braking may be either reduced or not effective. If you do not make an additional effort to apply the brake yourself, the braking effect may not be sufficient. If necessary, counteract the reduced regenerative braking effect by applying the brake yourself.

The brake system continues to function normally, but without the functions listed above.

The braking distance in an emergency braking situation can thus increase.

If ESP® is not operational, ESP® is unable to stabilize the vehicle.

There is an increased risk of skidding and an accident.

► Carefully drive a short distance on a suitable stretch of road, making slight steering movements at a speed above 12 mph (20 km/h).

If the display message disappears, the functions mentioned above are available again.

If the display message continues to be displayed:

- Drive on carefully.
- Visit a qualified specialist workshop.

## Display messages



Inoperative See  
Operator's Manual

## Possible causes/consequences and ► Solutions

ESP®, BAS, RBS, the HOLD function and hill start assist are not available due to a malfunction.

COLLISION PREVENTION ASSIST may also have failed.

In addition, the , **RBS** and  warning lamps light up in the instrument cluster.

ATTENTION ASSIST is deactivated.

 **WARNING**

The braking performance of the electric motor using recuperative braking may be either reduced or not effective. If you do not make an additional effort to apply the brake yourself, the braking effect may not be sufficient. If necessary, counteract the reduced regenerative braking effect by applying the brake yourself.

The brake system continues to function normally, but without the functions listed above.

The braking distance in an emergency braking situation can thus increase.

If ESP® is not operational, ESP® is unable to stabilize the vehicle.

There is an increased risk of skidding and an accident.

- Drive on carefully.
- Visit a qualified specialist workshop.

## Display messages



## Possible causes/consequences and ► Solutions



Inoperative See Operator's Manual

EBD (electronic brake force distribution), ABS, ESP®, BAS, RBS, the HOLD function and hill start assist are not available due to a malfunction.

COLLISION PREVENTION ASSIST may also have failed.

In addition, the , **RBS**,  and  warning lamps in the instrument cluster light up and a warning tone sounds.

ATTENTION ASSIST is deactivated.

 **WARNING**

The braking performance of the electric motor using recuperative braking may be either reduced or not effective. If you do not make an additional effort to apply the brake yourself, the braking effect may not be sufficient. If necessary, counteract the reduced regenerative braking effect by applying the brake yourself.

The brake system continues to function normally, but without the functions listed above. The front and rear wheels could therefore lock if you brake hard, for example.

The steerability and braking characteristics may be severely affected. The braking distance in an emergency braking situation can increase.

If ESP® is not operational, ESP® is unable to stabilize the vehicle. There is an increased risk of skidding and an accident.

- Drive on carefully.
- Visit a qualified specialist workshop immediately.

**RBS**

Inoperative See Operator's Manual

RBS (Recuperative Brake System) is unavailable due to a malfunction.











 **WARNING**









The braking performance of the electric motor using recuperative braking may be either reduced or not effective. If you do not make an additional effort to apply the brake yourself, the braking effect may not be sufficient. If necessary, counteract the reduced regenerative braking effect by applying the brake yourself.















The brake system continues to function normally, but without the functions listed above. The front and rear wheels could therefore lock if you brake hard, for example.

Braking efficiency may be impaired.







- Drive on taking extra care.
- Visit a qualified specialist workshop.

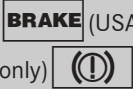

Display messages	Possible causes/consequences and ► Solutions
<p><b>PARK</b> (USA only)  (Canada only)</p> <p>Please Release Parking Brake</p>	<p>The red  (USA only)/ (Canada only) indicator lamp flashes and a warning tone sounds. A condition for automatic release of the electric parking brake is not fulfilled (▷ page 145). You are driving with the electric parking brake applied.</p> <p>► Release the electric parking brake manually.</p> <p>The red  (USA only)/ (Canada only) indicator lamp flashes and a warning tone sounds. You are using the electric parking brake for emergency braking (▷ page 145).</p>
<p><b>PARK</b> (USA only)  (Canada only)</p> <p>Parking Brake See Operator's Manual</p>	<p>The yellow  warning lamp lights up. The electric parking brake is malfunctioning.</p> <p><b>To apply:</b></p> <ul style="list-style-type: none"> <li>► Switch the ignition off.</li> <li>► Press the electric parking brake handle for at least 10 seconds.</li> <li>► Shift the DIRECT SELECT lever to <b>P</b>.</li> <li>► Consult a qualified specialist workshop.</li> </ul> <p>The yellow  warning lamp and the red  (USA only)/ (Canada only) indicator lamp light up. The electric parking brake is malfunctioning.</p> <p><b>To release:</b></p> <ul style="list-style-type: none"> <li>► Switch off the ignition and turn it back on.</li> <li>► Release the electric parking brake manually.</li> </ul> <p>or</p> <ul style="list-style-type: none"> <li>► Release the electric parking brake automatically (▷ page 145).</li> </ul> <p>If the electric parking brake still cannot be released:</p> <ul style="list-style-type: none"> <li>► Do not drive on.</li> <li>► Consult a qualified specialist workshop.</li> </ul>













Display messages	Possible causes/consequences and ► Solutions
	<p>The red  (USA only)/ (Canada only) indicator lamp flashes and the yellow  warning lamp lights up. The electric parking brake is malfunctioning.</p> <p><b>To release:</b></p> <ul style="list-style-type: none"> <li>► Switch off the ignition and turn it back on.</li> <li>► Release the electric parking brake manually.</li> </ul> <p><b>To apply:</b></p> <ul style="list-style-type: none"> <li>► Switch off the ignition and turn it back on.</li> <li>► Apply the electric parking brake manually.</li> </ul> <p>If the red  (USA only)/ (Canada only) indicator lamp continues to flash:</p> <ul style="list-style-type: none"> <li>► Do not drive on.</li> <li>► Secure the vehicle against rolling away (▷ page 300).</li> <li>► Shift the DIRECT SELECT lever to <b>P</b>.</li> <li>► Turn the front wheels towards the curb.</li> <li>► Consult a qualified specialist workshop.</li> </ul>
	<p>The yellow  warning lamp lights up. The red  (USA only)/ (Canada only) indicator lamp flashes for about 10 seconds after the electric parking brake has been applied or released. It then goes out or remains lit. The electric parking brake is malfunctioning.</p> <ul style="list-style-type: none"> <li>► Switch off the ignition and turn it back on.</li> <li>► Apply the electric parking brake.</li> </ul> <p>If it is not possible to engage the electric parking brake:</p> <ul style="list-style-type: none"> <li>► Shift the DIRECT SELECT lever to <b>P</b>.</li> <li>► Visit a qualified specialist workshop.</li> </ul> <p>If it is not possible to release the electric parking brake:</p> <ul style="list-style-type: none"> <li>► Release the electric parking brake automatically (▷ page 145).</li> </ul> <p>If the electric parking brake still cannot be released:</p> <ul style="list-style-type: none"> <li>► Consult a qualified specialist workshop.</li> </ul>

Display messages	Possible causes/consequences and ► Solutions
	<p>The yellow  warning lamp lights up. If you manually apply or release the electric parking brake, the red  (USA only)/ (Canada only) indicator lamp flashes.</p> <p>The electric parking brake is malfunctioning. It is not possible to apply the electric parking brake manually.</p> <ul style="list-style-type: none"> <li>► Shift the transmission to <b>P</b>.</li> <li>► Visit a qualified specialist workshop.</li> </ul>
<p> (USA only)  (Canada only)</p> <p>Parking Brake Inoperative</p>	<p>The yellow  warning lamp lights up. The red  (USA only)/ (Canada only) indicator lamp flashes for about 10 seconds after the electric parking brake has been applied or released. It then goes out or remains lit.</p> <p>The electric parking brake is malfunctioning, e.g. because of overvoltage or undervoltage.</p> <ul style="list-style-type: none"> <li>► Rectify the cause of the overvoltage or undervoltage, e.g. by charging the battery or restarting the drive system.</li> <li>► Engage or release the electric parking brake.</li> </ul> <p>If it remains impossible to apply or release the electric parking brake:</p> <ul style="list-style-type: none"> <li>► Switch off the ignition and turn it back on.</li> <li>► Engage or release the electric parking brake.</li> </ul> <p>If the electric parking brake still cannot be released:</p> <ul style="list-style-type: none"> <li>► Consult a qualified specialist workshop.</li> </ul> <p>The display message is only shown while the vehicle is in motion. The yellow  warning lamp lights up and the red  (USA only)/ (Canada only) indicator lamp flashes.</p> <p>It is not possible to apply the electric parking brake manually.</p> <ul style="list-style-type: none"> <li>► Shift the DIRECT SELECT lever to <b>P</b>.</li> <li>► Visit a qualified specialist workshop.</li> </ul>
<p> (USA only)  (Canada only)</p> <p>Turn On the Ignition to Release the Parking Brake</p>	<p>The red  (USA only)/ (Canada only) indicator lamp lights up.</p> <p>You attempted to release the electric parking brake while the ignition was switched off.</p> <ul style="list-style-type: none"> <li>► Turn the SmartKey to position <b>1</b> in the ignition lock.</li> </ul>



Display messages	Possible causes/consequences and ► Solutions
<p> (USA only)  (Canada only)</p> <p>Check Brake Fluid Level</p>	<p>There is not enough brake fluid in the brake fluid reservoir. In addition, the  (USA only)/ (Canada only) warning lamp lights up in the instrument cluster and a warning tone sounds.</p> <p> <b>WARNING</b></p> <p>The braking effect may be impaired. There is a risk of an accident.</p> <ul style="list-style-type: none"> <li>► Pull over and stop the vehicle safely as soon as possible, paying attention to road and traffic conditions. Do not continue driving under any circumstances.</li> <li>► Secure the vehicle against rolling away (► page 300).</li> <li>► Consult a qualified specialist workshop.</li> <li>► Do not add brake fluid. This does not correct the malfunction.</li> </ul>
<p></p> <p>Check Brake Pad Wear</p>	<p>The brake pads/linings have reached their wear limit.</p> <ul style="list-style-type: none"> <li>► Visit a qualified specialist workshop.</li> </ul>
<p></p> <p>Inoperative</p>	<p>One or more main features of the mbrace system are malfunctioning.</p> <ul style="list-style-type: none"> <li>► Have the mbrace system checked immediately at a qualified specialist workshop.</li> </ul>

Display messages	Possible causes/consequences and ► Solutions
<p>PRE-SAFE Functions Currently Limited See Operator's Manual</p>	<p>Adaptive Brake Assist is temporarily inoperative. Possible causes are:</p> <ul style="list-style-type: none"> <li>• the front bumper is dirty.</li> <li>• function is impaired due to heavy rain or snow.</li> <li>• the radar sensor system is temporarily inoperative, e.g. due to electromagnetic radiation emitted by nearby TV or radio stations or other sources of electromagnetic radiation.</li> <li>• the system is outside the operating temperature range.</li> <li>• the on-board voltage is too low.</li> </ul> <p>When the causes stated above no longer apply, the display message disappears.</p> <p>Adaptive Brake Assist is operational again.</p> <p>If the display message does not disappear:</p> <ul style="list-style-type: none"> <li>► Pull over and stop the vehicle safely as soon as possible, paying attention to road and traffic conditions.</li> <li>► Secure the vehicle against rolling away (▷ page 144).</li> <li>► Clean the front bumper (▷ page 259).</li> <li>► Start the drive system again.</li> </ul>
<p>PRE-SAFE Functions Limited See Operator's Manual</p>	<p>Adaptive Brake Assist is faulty. The distance warning signal may also have failed.</p> <ul style="list-style-type: none"> <li>► Visit a qualified specialist workshop.</li> </ul>
<p> SRS Malfunction Service Required</p>	<p>The restraint system is faulty. The  warning lamp also lights up in the instrument cluster.</p> <p><b>⚠ WARNING</b></p> <p>The air bags or Emergency Tensioning Devices may either be triggered unintentionally or, in the event of an accident, may not be triggered.</p> <p>There is an increased risk of injury.</p> <ul style="list-style-type: none"> <li>► Visit a qualified specialist workshop.</li> </ul> <p>Further information on occupant safety (▷ page 40).</p>

Display messages	Possible causes/consequences and ► Solutions
 <p>Front Left Malfunction Service Required or Front Right Malfunction Service Required</p>	<p>The restraint system has malfunctioned at the front on the left or right. The  warning lamp also lights up in the instrument cluster.</p> <p> <b>WARNING</b></p> <p>The air bags or Emergency Tensioning Devices may either be triggered unintentionally or, in the event of an accident, may not be triggered.</p> <p>There is an increased risk of injury.</p> <p>► Visit a qualified specialist workshop.</p>
 <p>Rear Left Malfunction Service Required or Rear Right Malfunction Service Required</p>	<p>The restraint system has malfunctioned at the rear on the left or right. The  warning lamp also lights up in the instrument cluster.</p> <p> <b>WARNING</b></p> <p>The air bags or Emergency Tensioning Devices may either be triggered unintentionally or, in the event of an accident, may not be triggered.</p> <p>There is an increased risk of injury.</p> <p>► Visit a qualified specialist workshop.</p>
 <p>Rear Center Malfunction Service Required</p>	<p>The restraint system has malfunctioned at the rear center. The  warning lamp also lights up in the instrument cluster.</p> <p> <b>WARNING</b></p> <p>The air bags or Emergency Tensioning Devices may either be triggered unintentionally or, in the event of an accident, may not be triggered.</p> <p>There is an increased risk of injury.</p> <p>► Visit a qualified specialist workshop.</p>
 <p>Left Side Curtain Airbag Malfunction Service Required or Right Side Curtain Airbag Malfunction Service Required</p>	<p>There is a malfunction in the left-hand or right-hand window curtain air bag. The  warning lamp also lights up in the instrument cluster.</p> <p> <b>WARNING</b></p> <p>The left or right window curtain air bag may either be triggered unintentionally or, in the event of an accident, may not be triggered.</p> <p>There is an increased risk of injury.</p> <p>► Visit a qualified specialist workshop.</p>

Display messages	Possible causes/consequences and ► Solutions
<p>Front Passenger Airbag Disabled See Operator's Manual</p>	<p>The front-passenger air bag is deactivated during the journey, even though:</p> <ul style="list-style-type: none"> <li>• an adult or</li> <li>• a person larger than a certain size is occupying the front-passenger seat</li> </ul> <p>If additional forces are applied to the seat, the system may interpret the occupant's weight as lower than it actually is.</p> <p> <b>WARNING</b></p> <p>The front-passenger air bag does not deploy during an accident. There is an increased risk of injury.</p> <ul style="list-style-type: none"> <li>► Pull over and stop the vehicle safely as soon as possible, paying attention to road and traffic conditions.</li> <li>► Secure the vehicle against rolling away (▷ page 300).</li> <li>► Switch the ignition off.</li> <li>► Have the occupant get out of the vehicle.</li> <li>► Keep the seat unoccupied, close the front-passenger door and switch on the ignition.</li> <li>► Observe the PASSENGER AIR BAG OFF indicator lamp in the center console and the multifunction display and check the following:</li> </ul> <p>Seat unoccupied and ignition switched on:</p> <ul style="list-style-type: none"> <li>• the PASSENGER AIR BAG OFF indicator lamp must light up and remain lit. If the indicator lamp is on, OCS has disabled the front-passenger air bag (▷ page 49).</li> <li>• the <a href="#">Front Passenger Airbag Enabled See Operator's Manual</a> or <a href="#">Front Passenger Airbag Disabled See Operator's Manual</a> display messages must not appear in the multifunction display.</li> </ul> <ul style="list-style-type: none"> <li>► Wait for a period of at least 60 seconds until the necessary system checks have been completed.</li> <li>► Make sure that the display messages do not appear in the multifunction display.</li> </ul> <p>If these conditions are fulfilled, the front-passenger seat can be occupied again. Whether the PASSENGER AIR BAG OFF indicator lamp remains lit or goes out depends on how OCS classifies the occupant.</p> <p>If the conditions are not fulfilled, the system is not operating correctly.</p> <ul style="list-style-type: none"> <li>► Visit a qualified specialist workshop immediately.</li> </ul>



Display messages	Possible causes/consequences and ► Solutions
	For further information about the Occupant Classification System, see (▷ page 49).
<p>Front Passenger Airbag Enabled See Operator's Manual</p>	<p>The front-passenger air bag is enabled during the journey, even though:</p> <ul style="list-style-type: none"> <li>• a child, a small adult or an object weighing less than the system's weight threshold is located on the front-passenger seat or</li> <li>• the front-passenger seat is unoccupied</li> </ul> <p>The system may detect objects or forces applying additional weight on the seat.</p> <p> <b>WARNING</b></p> <p>The air bag may deploy unintentionally. There is an increased risk of injury.</p> <ul style="list-style-type: none"> <li>► Pull over and stop the vehicle safely as soon as possible, paying attention to road and traffic conditions.</li> <li>► Secure the vehicle against rolling away (▷ page 300).</li> <li>► Switch the ignition off.</li> <li>► Open the front-passenger door.</li> <li>► Remove the child and the child restraint system from the front-passenger seat.</li> <li>► Make sure that there are no objects on the seat adding to the weight. The system may otherwise detect the additional weight and interpret the seat occupant's weight as greater than it actually is.</li> <li>► Keep the seat unoccupied, close the front-passenger door and switch on the ignition.</li> <li>► Observe the PASSENGER AIR BAG OFF indicator lamp in the center console and the multifunction display and check the following:</li> </ul> <p>Seat unoccupied and ignition switched on:</p> <ul style="list-style-type: none"> <li>• the PASSENGER AIR BAG OFF indicator lamp must light up and remain lit. If the indicator lamp is on, OCS (Occupant Classification System) has disabled the front-passenger air bag (▷ page 49).</li> <li>• the <a href="#">Front Passenger Airbag Enabled See Operator's Manual</a> or <a href="#">Front Passenger Airbag Disabled See Operator's Manual</a> display messages must appear in the multifunction display.</li> </ul>







Display messages	Possible causes/consequences and ► Solutions
	<ul style="list-style-type: none"> <li>► Wait for a period of at least 60 seconds until the necessary system checks have been completed.</li> <li>► Make sure that the display messages do not appear in the multifunction display.</li> </ul> <p>If these conditions are fulfilled, the front-passenger seat can be occupied again. Whether the PASSENGER AIR BAG OFF indicator lamp remains lit or goes out depends on how OCS classifies the occupant.</p> <p>If the conditions are not fulfilled, the system is not operating correctly.</p> <ul style="list-style-type: none"> <li>► Visit a qualified specialist workshop immediately.</li> </ul> <p>For further information about the Occupant Classification System, see (▷ page 49).</p>







## Lights

**i** Display messages about LEDs:



This display message will only appear if all LEDs have failed.

Display messages	Possible causes/consequences and ► Solutions
 <p>Check Left Cornering Light or Check Right Cornering Light</p>	<p>The left or right-hand cornering light is defective.</p> <ul style="list-style-type: none"> <li>► Check whether you are permitted to replace the bulb yourself (▷ page 102).</li> </ul> <p>or</p> <ul style="list-style-type: none"> <li>► Visit a qualified specialist workshop.</li> </ul>
 <p>Check Left Low Beam or Check Right Low Beam</p>	<p>The left or right-hand low-beam headlamp is defective.</p> <ul style="list-style-type: none"> <li>► Check whether you are permitted to replace the bulb yourself (▷ page 102).</li> </ul> <p>or</p> <ul style="list-style-type: none"> <li>► Visit a qualified specialist workshop.</li> </ul>
 <p>Check Rear Left Turn Signal or Check Rear Right Turn Signal</p>	<p>The rear left-hand or rear right-hand turn signal is defective.</p> <ul style="list-style-type: none"> <li>► Check whether you are permitted to replace the bulb yourself (▷ page 102).</li> </ul> <p>or</p> <ul style="list-style-type: none"> <li>► Visit a qualified specialist workshop.</li> </ul>



Display messages	Possible causes/consequences and ► Solutions
 <p>Check Front Left Turn Signal or Check Front Left Turn Signal</p>	<p>The front left-hand or front right-hand turn signal is defective.</p> <ul style="list-style-type: none"> <li>► Check whether you are permitted to replace the bulb yourself (▷ page 102).</li> </ul> <p>or</p> <ul style="list-style-type: none"> <li>► Visit a qualified specialist workshop.</li> </ul>
 <p>Check Left Mirror Turn Signal or Check Right Mirror Turn Signal</p>	<p>The turn signal in the left-hand or right-hand exterior mirror is defective.</p> <ul style="list-style-type: none"> <li>► Visit a qualified specialist workshop.</li> </ul>
 <p>Check Center Brake Lamp</p>	<p>The high-mounted brake lamp is faulty.</p> <ul style="list-style-type: none"> <li>► Visit a qualified specialist workshop.</li> </ul>
 <p>Check Left Brake Lamp or Check Right Brake Lamp</p>	<p>The left or right-hand brake lamp is defective.</p> <ul style="list-style-type: none"> <li>► Check whether you are permitted to replace the bulb yourself (▷ page 102).</li> </ul> <p>or</p> <ul style="list-style-type: none"> <li>► Visit a qualified specialist workshop.</li> </ul>
 <p>Check Left Tail and Brake Lamps or Check Right Tail and Brake Lamps</p>	<p>The left or right-hand tail lamp/brake lamp is defective.</p> <ul style="list-style-type: none"> <li>► Check whether you are permitted to replace the bulb yourself (▷ page 102).</li> </ul> <p>or</p> <ul style="list-style-type: none"> <li>► Visit a qualified specialist workshop.</li> </ul>
 <p>Check Left High Beam or Check Right High Beam</p>	<p>The left or right-hand high beam is defective.</p> <ul style="list-style-type: none"> <li>► Check whether you are permitted to replace the bulb yourself (▷ page 102).</li> </ul> <p>or</p> <ul style="list-style-type: none"> <li>► Visit a qualified specialist workshop.</li> </ul>
 <p>License Plate Lamp</p>	<p>The left or right-hand license plate lamp is defective.</p> <ul style="list-style-type: none"> <li>► Check whether you are permitted to replace the bulb yourself (▷ page 102).</li> </ul> <p>or</p> <ul style="list-style-type: none"> <li>► Visit a qualified specialist workshop.</li> </ul>

Display messages	Possible causes/consequences and ► Solutions
 <p>Rear Fog Lamp</p>	<p>The rear fog lamp is faulty.</p> <ul style="list-style-type: none"> <li>► Check whether you are permitted to replace the bulb yourself (▷ page 102).</li> </ul> <p>or</p> <ul style="list-style-type: none"> <li>► Visit a qualified specialist workshop.</li> </ul>
 <p>Check Front Left Parking Lamp or Check Front Right Parking Lamp</p>	<p>The front left or front right parking or standing lamp is defective.</p> <ul style="list-style-type: none"> <li>► Check whether you are permitted to replace the bulb yourself (▷ page 102).</li> </ul> <p>or</p> <ul style="list-style-type: none"> <li>► Visit a qualified specialist workshop.</li> </ul>
 <p>Backup Light</p>	<p>The backup lamp is defective.</p> <ul style="list-style-type: none"> <li>► Check whether you are permitted to replace the bulb yourself (▷ page 102).</li> </ul> <p>or</p> <ul style="list-style-type: none"> <li>► Visit a qualified specialist workshop.</li> </ul>
 <p>Check Left Tail Lamp or Check Right Tail Lamp</p>	<p>The left or right-hand tail lamp is defective.</p> <ul style="list-style-type: none"> <li>► Check whether you are permitted to replace the bulb yourself (▷ page 102).</li> </ul> <p>or</p> <ul style="list-style-type: none"> <li>► Visit a qualified specialist workshop.</li> </ul>
 <p>Check Front Left Sidemarker Lamp or Check Front Right Sidemarker Lamp</p>	<p>The left or right front side marker lamp is defective.</p> <ul style="list-style-type: none"> <li>► Visit a qualified specialist workshop.</li> </ul>
 <p>Check Rear Left Sidemarker Lamp or Check Rear Right Sidemarker Lamp</p>	<p>The rear left or right side marker lamp is defective.</p> <ul style="list-style-type: none"> <li>► Check whether you are permitted to replace the bulb yourself (▷ page 102).</li> </ul> <p>or</p> <ul style="list-style-type: none"> <li>► Visit a qualified specialist workshop.</li> </ul>
 <p>Check Left Daytime Running Light or Check Right Day-time Running Light</p>	<p>The left or right-hand daytime running lamp is faulty.</p> <ul style="list-style-type: none"> <li>► Check whether you are permitted to replace the bulb yourself (▷ page 102).</li> </ul> <p>or</p> <ul style="list-style-type: none"> <li>► Visit a qualified specialist workshop.</li> </ul>





Display messages	Possible causes/consequences and ► Solutions
 Malfunction See Operator's Manual	The exterior lighting is defective. ► Visit a qualified specialist workshop.
 Auto Lamp Function Inoperative	The light sensor is defective. ► Visit a qualified specialist workshop.
 Switch Off Lights	The lights are still switched on when you leave the vehicle. A warning tone also sounds. ► Turn the light switch to <b>AUTO</b> .



### Drive system



Display messages	Possible causes/consequences and ► Solutions
	The 12 V battery is no longer being charged. ► Do not drive on. ► Do not tow the vehicle. ► Stop the vehicle immediately, paying attention to road and traffic conditions. ► Consult a qualified specialist workshop.
 Check Coolant Level See Operator's Manual	The coolant level is too low. <b>!</b> Avoid making long journeys with too little coolant in the engine cooling system. The engine will otherwise be damaged. ► If the coolant needs topping up more often than usual, have the cooling system checked at a qualified specialist workshop.

## High-voltage battery



Display messages	Possible causes/consequences and ► Solutions
Battery Reserve Level	The charge level of the high-voltage battery has dropped into the reserve range. ► Charge the high-voltage battery.
 Battery Level Too Low. Stop. Charge Immediately	The charge level of the high-voltage battery is so low that it is no longer possible to drive the vehicle. ► Park the vehicle and charge the high-voltage battery.
 Malfunction Visit Workshop	There are malfunctions in the drive system and/or the cooling system. ► Visit an authorized Mercedes-Benz Center.
Without starting engine again, consult workshop	There is a malfunction in the high-voltage electrical system. A warning tone also sounds. ► Do not switch off the drive system. ► Visit an authorized Mercedes-Benz Center immediately.
 Stop Switch Engine Off	There is a serious malfunction in the drive system. A warning tone also sounds. ► Pull over and stop the vehicle safely as soon as possible, paying attention to road and traffic conditions. Do not continue driving under any circumstances. ► Do not tow the vehicle. ► Visit an authorized Mercedes-Benz Center immediately.

## Driving systems

Display messages	Possible causes/consequences and ► Solutions
 Attention Assist: Take a Break!	Based on certain criteria, ATTENTION ASSIST has detected fatigue or a lack of concentration on the part of the driver. A warning tone also sounds. ► If necessary, take a break.  On long journeys, take regular breaks in good time to allow yourself to rest.
 Attention Assist Inoperative	ATTENTION ASSIST is inoperative. ► Visit a qualified specialist workshop.

Display messages	Possible causes/consequences and ► Solutions
<p><b>HOLD</b></p> <p>Off</p>	<p>The HOLD function is deactivated. The vehicle is skidding. A warning tone also sounds.</p> <p>► Reactivate the HOLD function later (▷ page 154).</p> <p>The HOLD function is deactivated. When the brake pedal is firmly depressed, an activation condition is not fulfilled. A warning tone also sounds.</p> <p>► Check the activation conditions for the HOLD function (▷ page 154).</p>
<p>Radar Sensors Deactivated See Operator's Manual</p>	<p>The radar sensor system is deactivated.</p> <p>► Switch on the radar sensor system (▷ page 188).</p>
<p>Blind Spot Assist Currently Unavailable See Operator's Manual</p>	<p>Blind Spot Assist is temporarily inoperative. Possible causes are:</p> <ul style="list-style-type: none"> <li>• the sensors are dirty.</li> <li>• function is impaired due to heavy rain or snow.</li> <li>• the radar sensor system is outside the operating temperature range.</li> <li>• the radar sensor system is temporarily inoperative, e.g. due to electromagnetic radiation emitted by nearby TV or radio stations or other sources of electromagnetic radiation.</li> </ul> <p>The yellow  indicator lamps also light up in the exterior mirrors.</p> <p>When the causes stated above no longer apply, the display message disappears.</p> <p>Blind Spot Assist is operational again.</p> <p>If the display message does not disappear:</p> <ul style="list-style-type: none"> <li>► Pull over and stop the vehicle safely as soon as possible, paying attention to road and traffic conditions.</li> <li>► Secure the vehicle against rolling away (▷ page 300).</li> <li>► Clean the sensors (▷ page 259).</li> <li>► Start the drive system again.</li> </ul>
<p>Blind Spot Assist Inoperative</p>	<p>Blind Spot Assist is defective.</p> <p>The yellow  indicator lamps also light up in the exterior mirrors.</p> <p>► Visit a qualified specialist workshop.</p>

Display messages	Possible causes/consequences and ► Solutions
Park Assist Canceled	<p>The driver's door is open and the driver's seat belt has not been fastened.</p> <ul style="list-style-type: none"> <li>► Repeat the parking process with the seat belt fastened and the driver's door closed.</li> </ul> <p>You have inadvertently touched the multifunction steering wheel while steering intervention was active.</p> <ul style="list-style-type: none"> <li>► While steering intervention is active, make sure that the multifunction steering wheel is not touched unintentionally.</li> </ul> <p>The vehicle has started to skid and ESP<sup>®</sup> has intervened.</p> <ul style="list-style-type: none"> <li>► Use Active Parking Assist again later (▷ page 159).</li> </ul>
Park Assist Inoperative	<p>You have just carried out a large number of turning or parking maneuvers.</p> <p>Active Parking Assist will become available again after approximately 10(▷ page 159).</p> <ul style="list-style-type: none"> <li>► Pull over and stop the vehicle safely as soon as possible, paying attention to road and traffic conditions.</li> <li>► Switch off the drive system and start it again.</li> </ul> <p>If the display message continues to be displayed:</p> <ul style="list-style-type: none"> <li>► Visit a qualified specialist workshop.</li> </ul> <p>PARKTRONIC is defective.</p> <ul style="list-style-type: none"> <li>► Visit a qualified specialist workshop.</li> </ul>
Cruise Control Inoperative	<p>Cruise control is faulty.</p> <p>A warning tone also sounds.</p> <ul style="list-style-type: none"> <li>► Visit a qualified specialist workshop.</li> </ul>
Cruise Control - - - mph	<p>A condition for activating cruise control has not been fulfilled.</p> <p>You have tried to store a speed below 20 mph (30 km/h), for example.</p> <ul style="list-style-type: none"> <li>► If conditions permit, drive faster than 20 mph (30 km/h) and store the speed.</li> <li>► Check the activation conditions for cruise control (▷ page 153).</li> </ul>







Tires	
Display messages	Possible causes/consequences and ► Solutions
Check Tires	<p>The tire pressure in one or more tires has dropped significantly. The wheel position is shown in the multifunction display.</p> <p> <b>WARNING</b></p> <p>With tire pressures which are too low, there is a risk of the following hazards:</p> <ul style="list-style-type: none"> <li>• they may burst, especially as the load and vehicle speed increase.</li> <li>• they may wear excessively and/or unevenly, which may greatly impair tire traction.</li> <li>• the driving characteristics, as well as steering and braking, may be greatly impaired.</li> </ul> <p>There is a risk of an accident.</p> <ul style="list-style-type: none"> <li>► Stop the vehicle without making any sudden steering or braking maneuvers. Pay attention to the traffic conditions as you do so.</li> <li>► Secure the vehicle against rolling away (▷ page 300).</li> <li>► Check the tires and, if necessary, follow the instructions for a flat tire (▷ page 264).</li> <li>► Check the tire pressures and, if necessary, correct the tire pressure.</li> <li>►</li> </ul>
Warning Tire Malfunction	<p>The tire pressure in one or more tires has dropped suddenly. The wheel position is shown in the multifunction display.</p> <p> <b>WARNING</b></p> <p>If you drive with a flat tire, there is a risk of the following hazards:</p> <ul style="list-style-type: none"> <li>• a flat tire affects the ability to steer or brake the vehicle.</li> <li>• you could lose control of the vehicle.</li> <li>• continued driving with a flat tire will cause excessive heat build-up and possibly a fire.</li> </ul> <p>There is a risk of an accident.</p> <ul style="list-style-type: none"> <li>► Stop the vehicle without making any sudden steering or braking maneuvers. Pay attention to the traffic conditions as you do so.</li> <li>► Secure the vehicle against rolling away (▷ page 300).</li> <li>► Check the tires and, if necessary, follow the instructions for a flat tire (▷ page 264).</li> </ul>

Display messages	Possible causes/consequences and ► Solutions
Tire Press. Monitor Currently Unavailable	<p>Due to a source of radio interference, no signals can be received from the wheel sensors. The tire pressure monitor is temporarily malfunctioning.</p> <p>► Drive on. The tire pressure monitor restarts automatically as soon as the problem has been solved.</p>
TirePress. Sensor(s) Missing	<p>There is no signal from the tire pressure sensor of one or several wheels. The pressure of the affected tire is not displayed in the multifunction display.</p> <p>► Have the faulty tire pressure sensor replaced at a qualified specialist workshop.</p>
Tire Pressure Monitor Inoperative No Wheel Sensors	<p>The wheels mounted do not have a suitable tire pressure sensor. The tire pressure monitor is deactivated.</p> <p>► Mount wheels with suitable tire pressure sensors. The tire pressure monitor is activated automatically after driving for a few minutes.</p>
Tire Press. Monitor Inoperative	<p>The tire pressure monitor is faulty.</p> <p>► Visit a qualified specialist workshop.</p>
Please Correct Tire Pressure	<p>The tire pressure is too low in at least one of the tires, or the tire pressure difference between the wheels is too great.</p> <p>► Check the tire pressures at the next opportunity (▷ page 284). ► If necessary, correct the tire pressure. ► Restart the tire pressure monitor (▷ page 287).</p>

### Vehicle





Display messages	Possible causes/consequences and ► Solutions
Shift to 'P' or 'N' to Start Engine	<p>You have attempted to start the engine with the transmission in position <b>R</b> or <b>D</b>.</p> <p>► Shift the transmission to position <b>P</b> or <b>N</b>.</p>
Depress Brake to Start Engine	<p>You have attempted to start the drive system with the transmission in position <b>N</b> without depressing the brake pedal.</p> <p>► Depress the brake pedal.</p>



Display messages	Possible causes/consequences and ► Solutions
To Deselect P or N, Depress Brake and Start Engine	<p>You have attempted to shift the transmission to position <b>R</b> or <b>D</b> without starting the drive system.</p> <ul style="list-style-type: none"> <li>► Start the drive system.</li> <li>► Depress the brake pedal.</li> </ul> <p><b>i</b> It is only possible to shift the transmission from position <b>P</b> to the desired position if you depress the brake pedal. Only then can the parking lock be deactivated. If you do not depress the brake pedal, the DIRECT SELECT lever can still be moved but the parking lock remains engaged.</p>
Apply Brake to Shift from 'P'	<p>You have attempted to move the transmission selector lever to position <b>R</b>, <b>N</b> or <b>D</b> without depressing the brake pedal.</p> <ul style="list-style-type: none"> <li>► Depress the brake pedal.</li> </ul>
Transmission Not in P Risk of Vehicle Rolling Away	<p><b>⚠ WARNING</b></p> <p>The driver's door is open and the transmission is in position <b>R</b>, <b>N</b> or <b>D</b>.</p> <p>A warning tone also sounds.</p> <ul style="list-style-type: none"> <li>► Shift the transmission to position <b>P</b>.</li> <li>► Secure the vehicle against rolling away (▷ page 300).</li> </ul>
Service Required Do Not Shift Gears Visit Dealer	<p>You cannot change the transmission position due to a malfunction. A warning tone also sounds.</p> <p>If transmission position <b>D</b> is selected:</p> <ul style="list-style-type: none"> <li>► Drive to a qualified specialist workshop without shifting the transmission from position <b>D</b>.</li> </ul> <p>If transmission position <b>R</b>, <b>N</b> or <b>P</b> is selected:</p> <ul style="list-style-type: none"> <li>► Do not tow the vehicle.</li> <li>► Consult a qualified specialist workshop.</li> </ul>
Only Shift to 'P' when Vehicle is Stationary	<p>The vehicle is moving.</p> <ul style="list-style-type: none"> <li>► Pull over and stop the vehicle safely as soon as possible, paying attention to road and traffic conditions.</li> <li>► Shift the transmission to position <b>P</b>.</li> </ul>
Reversing Not Possible Service Required	<p>The transmission is malfunctioning. You cannot back up.</p> <ul style="list-style-type: none"> <li>► Visit a qualified specialist workshop.</li> </ul>
	<p>The tailgate is open.</p> <ul style="list-style-type: none"> <li>► Close the tailgate.</li> </ul>

Display messages	Possible causes/consequences and ► Solutions
	<p>The hood is not closed properly.</p> <p> <b>WARNING</b></p> <p>If the hood is not closed properly it may open and block your view when the vehicle is in motion.</p> <p>There is a risk of an accident.</p> <ul style="list-style-type: none"> <li>► Stop the vehicle immediately, paying attention to road and traffic conditions.</li> <li>► Apply the electric parking brake.</li> <li>► Close the hood.</li> </ul>
	<p>At least one door is open. A warning tone also sounds.</p> <ul style="list-style-type: none"> <li>► Close all the doors.</li> </ul>
 <p>Power Steering Malfunction See Operator's Manual</p>	<p>Power assistance for steering is malfunctioning A warning tone also sounds.</p> <p> <b>WARNING</b></p> <p>You will need to use more force to steer.</p> <p>There is a risk of an accident.</p> <ul style="list-style-type: none"> <li>► Check whether you are able to apply the extra force required.</li> <li>► <b>If you are able to steer safely:</b> carefully drive on to a qualified specialist workshop.</li> <li>► <b>If you are unable to steer safely:</b> do not drive on. Contact the nearest qualified specialist workshop.</li> </ul>
<p>Phone No Service</p>	<p>Your vehicle is outside the network provider's transmitter/receiver range.</p> <ul style="list-style-type: none"> <li>► Wait until the mobile phone operational readiness symbol appears in the multifunction display.</li> </ul>
 <p>Check Washer Fluid</p>	<p>The washer fluid level in the washer fluid reservoir has dropped below the minimum.</p> <p> If you do not mix antifreeze with the washer fluid in the winter months, then the washer fluid could freeze in the washer fluid reservoir. In this case, the <b>Check Washer Fluid</b> display message may appear in the multifunction display.</p> <ul style="list-style-type: none"> <li>► Add washer fluid (► page 254).</li> </ul>
<p>Wiper Malfunctioning</p>	<p>The windshield wipers are malfunctioning.</p> <ul style="list-style-type: none"> <li>► Visit a qualified specialist workshop.</li> </ul>





Display messages	Possible causes/consequences and ► Solutions
Hazard Warning Flashers Malfunctioning	The hazard warning lamps are faulty. ► Visit a qualified specialist workshop.
Charger Cable Connected	The charging cable is still connected to the vehicle socket. ► Remove the charging cable from vehicle socket.

SmartKey	
Display messages	Possible causes/consequences and ► Solutions
 Replace Key Battery	The SmartKey batteries are discharged. ► Change the batteries (► page 74).
 Key Not Detected (red display message)	The SmartKey is not in the vehicle. A warning tone also sounds. When you switch off the ignition, you will be unable to start the vehicle. ► Pull over and stop the vehicle safely as soon as possible, paying attention to road and traffic conditions. ► Locate the SmartKey.
	The SmartKey is not detected while driving because a powerful radio transmitter is causing interference. A warning tone also sounds. ► Pull over and stop the vehicle safely as soon as possible, paying attention to road and traffic conditions. ► Insert the SmartKey into the ignition lock and turn it to the desired position (► page 127).
 Key Not Detected (white display message)	You are in the vehicle and the SmartKey currently cannot be detected by the vehicle. ► Change the location of the SmartKey in the vehicle. If the SmartKey still cannot be detected: ► Insert the SmartKey into the ignition lock and turn it to the desired position (► page 127).
 Obtain a New Key	The SmartKey needs to be replaced. ► Visit a qualified specialist workshop.
 Key Does Not Belong to Vehicle	You have put the wrong SmartKey in the ignition lock. ► Use the correct SmartKey.

Display messages	Possible causes/consequences and ► Solutions
 <p>Close Doors to Lock Vehicle</p>	<p>At least one door is open. A warning tone also sounds.</p> <p>► Close all doors and lock the vehicle again.</p>
 <p>Take Your Key from Ignition</p>	<p>The SmartKey is in the ignition lock.</p> <p>► Remove the SmartKey.</p>

## Warning and indicator lamps in the instrument cluster

### Seat belts

Problem	Possible causes/consequences and ► Solutions
 <p>After starting the drive system, the red warning lamp lights up for 6 seconds.</p>	<p>The seat belt warning lamp reminds the driver and front passenger to fasten their seat belts.</p> <p>► Fasten your seat belt (▷ page 42).</p>
 <p>After starting the drive system, the red seat belt warning lamp lights up. In addition, a warning tone sounds for up to 6 seconds.</p>	<p>The driver's seat belt is not fastened.</p> <p>► Fasten your seat belt (▷ page 42). The warning tone ceases.</p>
 <p>After you have started the drive system, the red seat belt warning lamp comes on as soon as the driver's door or the front-passenger door is closed.</p>	<p>The driver or front passenger has not fastened their seat belt.</p> <p>► Fasten your seat belt (▷ page 42). The warning lamp goes out.</p> <p>There are objects on the front-passenger seat.</p> <p>► Remove the objects from the front-passenger seat and stow them in a secure place. The warning lamp goes out.</p>

Problem	Possible causes/consequences and ► Solutions
 <p>The red seat belt warning lamp flashes and an intermittent audible warning sounds.</p>	<p>The driver or front passenger has not fastened their seat belt. The vehicle is being driven faster than 15 mph (25 km/h) or has briefly been driven faster than 15 mph (25 km/h).</p> <ul style="list-style-type: none"><li>► Fasten your seat belt (▷ page 42). The warning lamp goes out and the intermittent warning tone ceases.</li></ul> <p>There are objects on the front-passenger seat. The vehicle is being driven faster than 15 mph (25 km/h) or has briefly been driven faster than 15 mph (25 km/h).</p> <ul style="list-style-type: none"><li>► Remove the objects from the front-passenger seat and stow them in a secure place. The warning lamp goes out and the intermittent warning tone ceases.</li></ul>

## Safety systems

## Problem

 (USA only)

 (Canada only)

The red brake system warning lamp is lit while the drive system is running. A warning tone also sounds.

## Possible causes/consequences and ► Solutions

There is not enough brake fluid in the brake fluid reservoir.

 **WARNING**

The braking effect may be impaired.

There is a risk of an accident.

- Pull over and stop the vehicle safely as soon as possible, paying attention to road and traffic conditions. Do not continue driving under any circumstances.
- Secure the vehicle against rolling away (▷ page 300).
- Do not add brake fluid. Adding more will not remedy the malfunction.
- Consult a qualified specialist workshop.
- Observe the additional display messages in the multifunction display.

 **RBS**

The yellow ABS and RBS warning lamps are on while the drive system is running.

ABS (Anti-lock Braking System) is deactivated due to a malfunction. Therefore, BAS (Brake Assist), COLLISION PREVENTION ASSIST, ESP® (Electronic Stability Program), RBS, the HOLD function and hill start assist are also deactivated, for example. ATTENTION ASSIST is deactivated.

 **WARNING**

The braking performance of the electric motor using recuperative braking may be either reduced or not effective. If you do not make an additional effort to apply the brake yourself, the braking effect may not be sufficient. If necessary, counteract the reduced recuperative braking effect by applying the brake yourself.

The brake system continues to function normally, but without the functions listed above. The wheels could therefore lock if you brake hard, for example.



The steerability and braking characteristics may be severely affected. The braking distance in an emergency braking situation can increase.









If ESP® is not operational, ESP® is unable to stabilize the vehicle. There is an increased risk of skidding and an accident.







- Observe the additional display messages in the multifunction display.
- Drive on carefully.
- Visit a qualified specialist workshop.

If the ABS control unit is malfunctioning, other systems may also not be available, e.g. the navigation system.





Problem	Possible causes/consequences and ► Solutions
<div data-bbox="120 177 165 204"></div> <div data-bbox="176 177 227 204"></div> <p>The yellow ABS and RBS warning lamps are on while the drive system is running.</p>	<p>ABS is temporarily unavailable. BAS, COLLISION PREVENTION ASSIST, ESP<sup>®</sup>, EBD (electronic brake force distribution), the HOLD function and hill start assist are therefore also deactivated, for example.</p> <p>Possible causes are:</p> <ul style="list-style-type: none"> <li>• Self-diagnosis is not yet complete.</li> <li>• The on-board voltage may be insufficient.</li> </ul> <p>ATTENTION ASSIST is deactivated.</p> <p> <b>WARNING</b></p> <p>The braking performance of the electric motor using recuperative braking may be either reduced or not effective. If you do not make an additional effort to apply the brake yourself, the braking effect may not be sufficient. If necessary, counteract the reduced regenerative braking effect by applying the brake yourself.</p> <p>The brake system continues to function normally, but without the functions listed above. The front and rear wheels could therefore lock if you brake hard, for example.</p> <p>The steerability and braking characteristics may be severely affected. The braking distance in an emergency braking situation can increase.</p> <p>If ESP<sup>®</sup> is not operational, ESP<sup>®</sup> is unable to stabilize the vehicle. There is a risk of an accident.</p> <p>► Carefully drive a suitable distance, making slight steering movements at a speed above 12 mph (20 km/h). The functions mentioned above are available again when the warning lamp goes out.</p> <p>If the warning lamp is still on:</p> <ul style="list-style-type: none"> <li>► Observe the additional display messages in the multifunction display.</li> <li>► Drive on carefully.</li> <li>► Visit a qualified specialist workshop.</li> </ul>





Problem	Possible causes/consequences and ► Solutions
<div data-bbox="87 177 196 204" style="border: 1px solid black; padding: 2px; display: inline-block;">  </div> <p>The yellow ABS and RBS warning lamps are on while the drive system is running. A warning tone also sounds.</p>	<p>EBD is malfunctioning. Therefore, ABS, BAS, COLLISION PREVENTION ASSIST, ESP<sup>®</sup>, RBS, the HOLD function and hill start assist are unavailable, for example. ATTENTION ASSIST is deactivated.</p> <p> <b>WARNING</b></p> <p>The braking performance of the electric motor using recuperative braking may be either reduced or not effective. If you do not make an additional effort to apply the brake yourself, the braking effect may not be sufficient. If necessary, counteract the reduced regenerative braking effect by applying the brake yourself.</p> <p>The brake system continues to function normally, but without the functions listed above. The front and rear wheels could therefore lock if you brake hard, for example.</p> <p>The steerability and braking characteristics may be severely affected. The braking distance in an emergency braking situation can increase.</p> <p>If ESP<sup>®</sup> is not operational, ESP<sup>®</sup> is unable to stabilize the vehicle. There is an increased risk of skidding and an accident.</p> <ul style="list-style-type: none"> <li>► Observe the additional display messages in the multifunction display.</li> <li>► Drive on carefully.</li> <li>► Visit a qualified specialist workshop.</li> </ul>

Problem	Possible causes/consequences and ► Solutions
<p>  (USA only)   (Canada only)      </p> <p>The red brake warning lamp, the yellow ESP<sup>®</sup> and ESP<sup>®</sup> OFF warning lamps, the yellow ABS and RBS warning lamps are lit while the drive system is running.</p>	<p>ABS and ESP<sup>®</sup> are malfunctioning. Therefore, BAS, RBS, COLLISION PREVENTION ASSIST, EBD, the HOLD function and hill start assist are also unavailable, for example. ATTENTION ASSIST is deactivated.</p> <p> <b>WARNING</b></p> <p>The braking performance of the electric motor using recuperative braking may be either reduced or not effective. If you do not make an additional effort to apply the brake yourself, the braking effect may not be sufficient. If necessary, counteract the reduced regenerative braking effect by applying the brake yourself.</p> <p>The brake system continues to function normally, but without the functions listed above. The front and rear wheels could therefore lock if you brake hard, for example.</p> <p>The steerability and braking characteristics may be severely affected. The braking distance in an emergency braking situation can increase.</p> <p>If ESP<sup>®</sup> is not operational, ESP<sup>®</sup> is unable to stabilize the vehicle. There is an increased risk of skidding and an accident.</p> <ul style="list-style-type: none"> <li>► Observe the additional display messages in the multifunction display.</li> <li>► Drive on carefully.</li> <li>► Visit a qualified specialist workshop.</li> </ul>
<p>  </p> <p>The yellow ESP<sup>®</sup> warning lamp flashes while the vehicle is in motion.</p>	<p>ESP<sup>®</sup> or traction control has intervened because there is a risk of skidding or at least one wheel has started to spin. Cruise control is deactivated.</p> <ul style="list-style-type: none"> <li>► When pulling away, only depress the accelerator pedal as far as necessary.</li> <li>► Ease off the accelerator pedal while the vehicle is in motion.</li> <li>► Adapt your driving style to suit the road and weather conditions.</li> <li>► Do not deactivate ESP<sup>®</sup>.</li> </ul> <p>For exceptions, see: (► page 67).</p>

Problem	Possible causes/consequences and ► Solutions
 <p>The yellow ESP® OFF warning lamp is lit while the drive system is running.</p>	<p> <b>WARNING</b></p> <p>If ESP® is switched off, ESP® is unable to stabilize the vehicle. There is an increased risk of skidding and an accident.</p> <ul style="list-style-type: none"> <li>► Reactivate ESP®.</li> <li>For exceptions, see: (► page 67).</li> <li>► Adapt your driving style to suit the road and weather conditions.</li> </ul> <p>If ESP® cannot be activated:</p> <ul style="list-style-type: none"> <li>► Have ESP® checked at a qualified specialist workshop.</li> </ul>
   <p>The yellow RBS, ESP® and ESP® OFF warning lamps are lit while the drive system is running.</p>	<p>ESP®, RBS, BAS, COLLISION PREVENTION ASSIST, the HOLD function and hill start assist are not available due to a malfunction. ATTENTION ASSIST is deactivated.</p> <p> <b>WARNING</b></p> <p>The braking performance of the electric motor using recuperative braking may be either reduced or not effective. If you do not make an additional effort to apply the brake yourself, the braking effect may not be sufficient. If necessary, counteract the reduced regenerative braking effect by applying the brake yourself.</p> <p>The brake system continues to function normally, but without the functions listed above.</p> <p>The braking distance in an emergency braking situation can thus increase.</p> <p>If ESP® is not operational, ESP® is unable to stabilize the vehicle. There is an increased risk of skidding and an accident.</p> <ul style="list-style-type: none"> <li>► Observe the additional display messages in the multifunction display.</li> <li>► Drive on carefully.</li> <li>► Visit a qualified specialist workshop.</li> </ul>









Problem	Possible causes/consequences and ► Solutions
  <p>The yellow RBS, ESP<sup>®</sup> and ESP<sup>®</sup> OFF warning lamps are lit while the drive system is running.</p>	<p>ESP<sup>®</sup>, RBS, BAS, the HOLD function and hill start assist are temporarily unavailable. COLLISION PREVENTION ASSIST may also have failed. ATTENTION ASSIST is deactivated. Self-diagnosis is not yet complete.</p> <p> <b>WARNING</b></p> <p>The braking performance of the electric motor using recuperative braking may be either reduced or not effective. If you do not make an additional effort to apply the brake yourself, the braking effect may not be sufficient. If necessary, counteract the reduced regenerative braking effect by applying the brake yourself.</p> <p>The brake system continues to function normally, but without the functions listed above.</p> <p>The braking distance in an emergency braking situation can thus increase.</p> <p>If ESP<sup>®</sup> is not operational, ESP<sup>®</sup> is unable to stabilize the vehicle. There is an increased risk of skidding and an accident.</p> <p>► Carefully drive a suitable distance, making slight steering movements at a speed above 12 mph (20 km/h). The functions mentioned above are available again when the warning lamp goes out.</p> <p>If the warning lamp is still on:</p> <ul style="list-style-type: none"> <li>► Observe the additional display messages in the multifunction display.</li> <li>► Drive on carefully.</li> <li>► Visit a qualified specialist workshop.</li> </ul>
 (USA only)  (Canada only) <p>The red indicator lamp for the electric parking brake flashes or lights up and/or the yellow warning lamp for the electric parking brake lights up.</p>	<ul style="list-style-type: none"> <li>► Observe the additional display messages in the multifunction display.</li> </ul>

Problem	Possible causes/consequences and ► Solutions
 <p>The red restraint system warning lamp is lit while the drive system is running.</p>	<p>The restraint system is faulty.</p> <p> <b>WARNING</b></p> <p>The air bags or Emergency Tensioning Devices may either be triggered unintentionally or, in the event of an accident, may not be triggered.</p> <p>There is an increased risk of injury.</p> <ul style="list-style-type: none"> <li>► Drive on carefully.</li> <li>► Have the restraint system checked at a qualified specialist workshop immediately.</li> </ul> <p>For further information about the restraint system, see (▷ page 40).</p>
 <p>The yellow RBS warning lamp is lit while the drive system is running.</p>	<p>RBS (Recuperative Brake System) is unavailable due to a malfunction.</p> <p> <b>WARNING</b></p> <p>The braking performance of the electric motor using recuperative braking may be either reduced or not effective. If you do not make an additional effort to apply the brake yourself, the braking effect may not be sufficient. If necessary, counteract the reduced regenerative braking effect by applying the brake yourself.</p> <p>The brake system continues to function normally, but without the functions listed above. The front and rear wheels could therefore lock if you brake hard, for example.</p> <p>Braking efficiency may be impaired.</p> <ul style="list-style-type: none"> <li>► Drive on taking extra care.</li> <li>► Visit a qualified specialist workshop.</li> </ul>

### Drive system

Problem	Possible causes/consequences and ► Solutions
 <p>The yellow battery charge warning lamp is on.</p>	<p>The charge level of the high-voltage battery has dropped into the reserve range.</p> <ul style="list-style-type: none"> <li>► Charge the high-voltage battery.</li> </ul>

Driving systems	
Problem	Possible causes/consequences and ► Solutions
 The red distance warning lamp lights up while the vehicle is in motion.	The distance to the vehicle in front is too small for the speed selected. ► Increase the distance.
 The red distance warning lamp lights up while the vehicle is in motion. A warning tone also sounds.	You are approaching a vehicle or a stationary obstacle in your line of travel at too high a speed. ► Be prepared to brake immediately. ► Pay careful attention to the traffic situation. You may have to brake or take evasive action.  For further information about the distance warning function of COLLISION PREVENTION ASSIST (► page 64).

Tires	
Problem	Possible causes/consequences and ► Solutions
 <p>The yellow tire pressure monitor warning lamp (pressure loss/malfunction) is lit.</p>	<p>The tire pressure monitor has detected a loss of pressure in at least one of the tires.</p> <p> <b>WARNING</b></p> <p>With tire pressures which are too low, there is a risk of the following hazards:</p> <ul style="list-style-type: none"> <li>• they may burst, especially as the load and vehicle speed increase.</li> <li>• they may wear excessively and/or unevenly, which may greatly impair tire traction.</li> <li>• the driving characteristics, as well as steering and braking, may be greatly impaired.</li> </ul> <p>There is a risk of an accident.</p> <ul style="list-style-type: none"> <li>► Stop the vehicle without making any sudden steering or braking maneuvers. Pay attention to the traffic conditions as you do so.</li> <li>► Secure the vehicle against rolling away (▷ page 300).</li> <li>► Observe the additional display messages in the multifunction display.</li> <li>► Check the tires and, if necessary, follow the instructions for a flat tire (▷ page 264).</li> <li>► Check the tire pressure (▷ page 284).</li> <li>► If necessary, correct the tire pressure.</li> </ul>
 <p>The yellow tire pressure monitor warning lamp (pressure loss/malfunction) flashes for approximately one minute and then remains lit.</p>	<p>The tire pressure monitor is faulty.</p> <p> <b>WARNING</b></p> <p>The system is possibly unable to recognize or register low tire pressure.</p> <p>There is a risk of an accident.</p> <ul style="list-style-type: none"> <li>► Observe the additional display messages in the multifunction display.</li> <li>► Visit a qualified specialist workshop.</li> </ul>

Useful information .....	228
Loading guidelines .....	228
Stowage areas .....	228
Features .....	234

### Useful information

- i** This Operator's Manual describes all models and all standard and optional equipment of your vehicle available at the time of publication of the Operator's Manual. Country-specific differences are possible. Bear in mind that your vehicle may not feature all functions described here. This also applies to safety-relevant systems and functions.
- i** Read the information on qualified specialist workshops: (▷ page 24).

### Loading guidelines

#### WARNING

If objects, luggage or loads are not secured or not secured sufficiently, they could slip, tip over or be flung around and thereby hit vehicle occupants. There is a risk of injury, particularly in the event of sudden braking or a sudden change in direction.

Always store objects so that they cannot be flung around. Secure objects, luggage or loads against slipping or tipping before the journey.

The handling characteristics of a laden vehicle are dependent on the distribution of the load within the vehicle. Observe the following notes when transporting a load:

- never exceed the maximum permissible gross vehicle mass or the gross axle weight rating for the vehicle (including occupants). The values are specified on the vehicle identification plate on the B-pillar of the driver's door.
- The cargo compartment is the preferred place to carry objects.
- Position heavy loads as far forwards as possible and as low down in the cargo compartment as possible.
- The load must not protrude above the upper edge of the seat backrests.

- Always place the load against the rear or front seat backrests. Make sure that the seat backrests are securely locked into place.
- Always place the load behind unoccupied seats if possible.
- Use the cargo tie-down rings and the parcel nets to transport loads and luggage.
- Use cargo tie-down rings and fastening materials appropriate for the weight and size of the load.
- Hook in the cargo net when loading.
- The maximum load capacity of the stowage well under the cargo compartment floor is 55 lbs (25 kg).
- Secure the load with sufficiently strong and wear-resistant tie-downs. Pad sharp edges for protection.

- !** Do not position the load on one part of the folding cargo compartment floor only. The maximum load capacity of the folding cargo compartment floor is 220 lbs (100 kg). Distribute the weight evenly to avoid damaging the cargo compartment floor. Place a solid board under the load if necessary. Please note that the load on the cargo compartment floor will be increased when the load is lashed down.

### Stowage areas

#### Stowage spaces

### Important safety notes

#### WARNING

If objects in the passenger compartment are stowed incorrectly, they can slide or be thrown around and hit vehicle occupants. There is a risk of injury, particularly in the event of sudden braking or a sudden change in direction.

- Always stow objects so that they cannot be thrown around in such situations.
- Always make sure that objects do not protrude from stowage spaces, parcel nets or stowage nets.
- Close the lockable stowage spaces while driving.
- Stow and secure objects that are heavy, hard, pointy, sharp-edged, fragile or too large in the cargo compartment.

Observe the loading guidelines (▷ page 228).

## Stowage compartments in the front

### Glove box



- ▶ **To open:** pull handle ① and open glove box flap ②.
- ▶ **To close:** fold glove box flap ② upwards until it engages.

**i** There is a pen holder at the top of the glove box flap.

### Stowage compartment in front of the armrest



Vehicles with DIRECT SELECT lever

- ▶ **To open:** press the marking on cover ①.

**i** You can remove the non-slip mat and the insert for cleaning. When removing the insert you will have to overcome some slight resistance.

### Stowage compartment/telephone compartment under the armrest



- ▶ **To open:** on vehicles with moveable armrests, make sure that the armrest is in the rearmost position.

- ▶ Press button ① and fold the armrest up.

**i** Depending on the vehicle's equipment, a USB connection and an AUX IN connection or a Media Interface are installed in the stowage compartment. A Media Interface is a universal interface for portable audio equipment, e.g. for an iPod® or MP3 player (see the separate Audio or COMAND Operating Instructions).

### Stowage compartment under the driver's seat and front-passenger seat

#### WARNING

If you exceed the maximum load for the stowage compartment, the cover may not be able to restrain the items. Items may be thrown out of the stowage compartment and hit vehicle occupants. There is a risk of injury, particularly in the event of sudden braking or a sudden change in direction.

Never exceed the maximum permissible load for the stowage compartment. Stow and secure heavy objects in the cargo compartment.

The maximum permissible load of the stowage compartment is 2.6 lbs (1.2 kg).



- **To open:** pull handle ① up and fold cover ② forwards.

### Stowage space in the rear

#### Stowage compartment in the rear center console



- **To open:** pull down the top of stowage compartment ① by the edge of the handle.

- ⓘ Depending on the vehicle's equipment, there may be an open stowage space above the stowage compartment.

### Stowage nets

Stowage nets are located in the front-passenger footwell and on the back of the driver's and the front-passenger seat.

Observe the loading guidelines (▷ page 228) and the safety notes regarding stowage spaces (▷ page 228).

### Cargo compartment enlargement

#### Important safety notes

#### WARNING

If the rear bench seat/rear seat and seat backrest are not engaged they could fold forwards, e.g. when braking suddenly or in the event of an accident.

- The vehicle occupant would thereby be pushed into the seat belt by the rear bench seat/rear seat or by the seat backrest. The seat belt can no longer offer the intended level of protection and could even cause injuries.
- Objects or loads in the trunk/cargo compartment cannot be restrained by the seat backrest.

There is an increased risk of injury.

Before every trip, make sure that the seat backrests and the rear bench seat/rear seat are engaged.

- ⚠ Before folding the backrest in the rear compartment forwards, make sure that the rear compartment armrest and the cupholder are folded in. They may otherwise be damaged.

Observe the loading guidelines (▷ page 228).



## Cargo compartment enlargement without EASY-VARIO-PLUS system

### Folding the rear seat backrest forward

The left-hand and right-hand rear seat backrests can be folded forwards separately to increase the cargo compartment capacity.



- ▶ Fully insert the backrest head restraints (> page 90).
- ▶ Move the driver's or front-passenger seat forward if necessary.
- ▶ Pull left-hand or right-hand release handle (2) of the seat backrest forwards. Corresponding seat backrest (1) is released.
- ▶ Fold backrest (1) forwards.
- ▶ Move the driver's or front-passenger seat back if necessary.

### Folding the rear seat backrest back



- ▶ Move the driver's or front-passenger seat forward if necessary.
- !** Make sure that the seat belt does not become trapped when folding the rear seat

backrest back. Otherwise, it could be damaged.

- ▶ Fold seat backrest (1) back until it engages. Red lock status indicator (2) is no longer visible.
- ▶ Adjust the head restraints if necessary (> page 90).
- ▶ Move the driver's or front-passenger seat back if necessary.

## Securing cargo

### Cargo tie-down rings

Observe the following notes on securing loads:

- Observe the loading guidelines (> page 228).
- Secure the load using the cargo tie-down rings.
- Distribute the load on the cargo tie-down rings evenly.
- Do not use elastic straps or nets to secure a load, as these are only intended as an anti-slip protection for light loads.
- Do not route tie-downs across sharp edges or corners.
- Pad sharp edges for protection.



- ① Cargo tie-down rings

## Bag hook

### WARNING

The bag hooks cannot restrain heavy objects or items of luggage. Objects or items of luggage could be flung around and thereby hit vehicle occupants when braking or abruptly changing directions. There is a risk of injury. Only hang light objects on the bag hooks. Never hang hard, sharp-edged or fragile objects on the bag hooks.

- ❗ The bag hook can bear a maximum load of 6.6lbs (3kg) and should not be used to secure a load.



① Bag hook

## Cargo compartment cover

### Important safety notes

### WARNING

On its own, the cargo compartment cover cannot secure or restrain heavy objects, items of luggage and heavy loads. You could be hit by an unsecured load during sudden changes in direction, braking or in the event of an accident. There is an increased risk of injury or even fatal injury.

Always store objects so that they cannot be flung around. Secure objects, luggage or loads against slipping or tipping over, e.g. by using tie downs, even if you are using the cargo compartment cover.

- ❗ When loading the vehicle, make sure that you do not stack the load in the cargo compartment higher than the lower edge of the side windows. Do not place heavy objects on top of the cargo compartment cover.

- ❗ When removing and installing the cargo compartment cover, ensure that its end caps do not scrape the light-colored parts of the vehicle.

The cargo compartment cover is located behind the rear bench seat backrest.

### Extending/retracting the cargo compartment cover



- ▶ **To extend:** pull the cargo compartment cover back by grab handle ① and clip it into retainers ② on the left and right.
- ▶ **To retract:** unhook the cargo compartment cover from retainers ② on the left and right and guide it forwards by grab handle ① until it is fully retracted.

## Installing/removing the cargo compartment cover

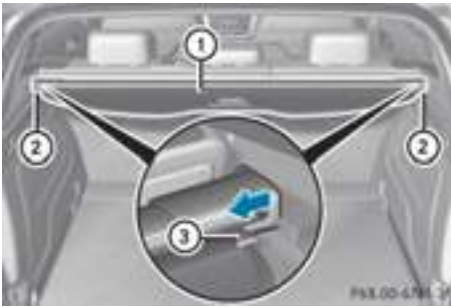

- ▶ **To remove:** make sure that the cargo compartment cover is rolled up.
- ▶ Push in the end cap of cargo compartment cover ① in the direction of the arrow on the right or left side using grip ③.
- ▶ Push cargo compartment cover ① into opposite anchorage ②.
- ▶ Remove cargo compartment cover ① upwards.
- ▶ **To install:** set cargo compartment cover ① on the right or left-hand side in anchorage ②.
- ▶ Push in the opposite end cap of cargo compartment cover ① in the direction of the arrow and insert cargo compartment cover ① into opposite anchorage ②.

## Stowage well under the cargo compartment floor

### Important safety notes

#### WARNING

If you drive when the cargo compartment floor is open, objects could be flung around, thus striking vehicle occupants. There is a risk of injury, particularly in the event of sudden braking or a sudden change in direction.

Always close the cargo compartment floor before a journey.

- ! The maximum load capacity of the stowage well under the cargo compartment floor is 55 lbs (25 kg).

## Opening/closing the cargo compartment floor

Under the trunk floor you can find a folding box.



- ▶ **To open:** open the tailgate.
- ▶ Holding ribbing ②, press handle ① downwards. Handle ① folds up.
- ▶ Swing the cargo compartment floor upwards using handle ① until it rests against the cargo compartment cover.



- ▶ Fold out hook ③ on the underside of the cargo compartment floor.



- ▶ Attach hook (3) to the cargo compartment's upper seal (4).
- ▶ **To close:** detach hook (3) from seal (4).
- ▶ Fasten hook (3) to the bracket on the underside of the cargo compartment floor.
- ▶ Fold the trunk floor down.
- ▶ Press the cargo compartment floor down until it engages.

### Setting the height of the cargo compartment floor

The stowage well under the cargo compartment floor can be increased or decreased in size as necessary. To do this, you can lock the floor at two different heights. The upper catch gives a flat load surface when the rear bench seat is folded forward.



- ▶ **To raise:** using handle (1), lift up cargo compartment floor (2) in the direction of arrow (3) and pull it upwards.
- ▶ Lower cargo compartment floor (2) again. To do this, push the trunk floor away so that it engages in the guide on the upper level. Cargo compartment floor (2) engages in the upper position.
- ▶ **i** Carry out this step using both hands.
- ▶ **To lower:** raise cargo compartment floor (2) slightly using handle (1) and pull it towards you.
- ▶ Lower cargo compartment floor (2) again slowly. Whilst doing so, press the trunk floor into the lower level. Cargo compartment floor (2) engages in the lower position.

## Features

### Cup holder

### Important safety notes

#### WARNING

The cup holder cannot hold a container secure whilst traveling. If you use a cup holder whilst traveling, the container may be flung around and liquid may be spilled. The vehicle occupants may come into contact with the liquid and if it is hot, they may be scalded. You may be distracted from the traffic conditions and you could lose control of the vehicle. There is a risk of an accident and injury.

Only use the cup holder when the vehicle is stationary. Only use the cup holder for containers of the right size. Always close the container, particularly if the liquid is hot.

#### WARNING

If objects in the passenger compartment are stowed incorrectly, they can slide or be thrown around and hit vehicle occupants. There is a risk of injury, particularly in the event of sudden braking or a sudden change in direction.

- Always stow objects so that they cannot be thrown around in such situations.
- Always make sure that objects do not protrude from stowage spaces, parcel nets or stowage nets.
- Close the lockable stowage spaces while driving.
- Stow and secure objects that are heavy, hard, pointy, sharp-edged, fragile or too large in the cargo compartment.

**!** Only use the cup holders for containers of the right size and which have lids. The drinks could otherwise spill.

The stowage compartments in the doors provide space for bottles:

- front: capacity up to 51 fl. oz. (1.5 l)
- rear: capacity up to 17 fl. oz. (0.5 l)

### Cup holder in the front-compartment center console

The cup holder and the rubber mat underneath can be removed for cleaning. Clean them with clean, lukewarm water only.



- **To remove:** carefully pull in upper sections of cup holder ① on the driver's and front-passenger sides until they release.
- Lift the cup holder upwards ② until it can be removed.

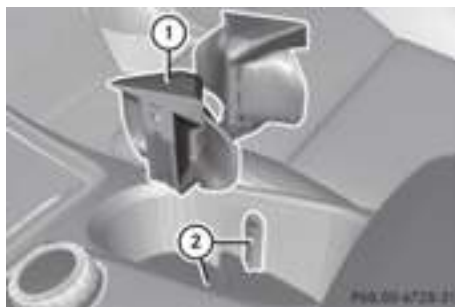

- **To install:** insert cup holder into lateral curved sections ② in the stowage compartment. Insert the cup holder so that the wedge of the upper section of cup holder ① faces forwards.
- Press the cup holder downwards until it engages on the right and left-hand sides.

### Sun visors

#### Overview

#### **⚠ WARNING**

If the mirror cover of the vanity mirror is folded up when the vehicle is in motion, you could be blinded by incident light. There is a risk of an accident.

Always keep the mirror cover folded down while driving.



- ① Mirror light
- ② Bracket
- ③ Retaining clip, e.g. for a car park ticket

- ④ Vanity mirror
- ⑤ Mirror cover

### Vanity mirror in the sun visor

Mirror light ① only functions if the sun visor is clipped into retainer ② and mirror cover ⑤ has been folded up.

### Glare from the side

- ▶ Fold down the sun visor.
- ▶ Pull the sun visor out of retainer ②.
- ▶ Swing the sun visor to the side.
- ▶ **Vehicles with mirror lights:** slide the sun visor horizontally as desired.

## Ashtray

### Front ashtray

**!** The stowage space under the ashtray is not heat resistant. Before placing lit cigarettes in the ashtray, make sure that the ashtray is properly engaged. Otherwise, the stowage space could be damaged.



Example: vehicles with a cover over the stowage compartment

- ▶ **To open:** push the lower section of cover ①.  
The stowage compartment opens.
- ▶ **To remove the insert:** lift insert ③ up ② and out.
- ▶ **To re-install the insert:** press insert ③ into the holder until it engages.

**i** If you remove the ashtray insert, you can use the resulting compartment for stowage.

### Rear-compartment ashtray



- ▶ **To open:** pull cover ③ out by its top edge.
- ▶ **To remove:** pull insert ② by recess ① in the direction of arrow ④ until it audibly releases.
- ▶ Lift insert ② up and out.
- ▶ **To install the insert:** install insert ② from above into the holder and press down until it engages.

## Cigarette lighter

### ⚠ WARNING

You can burn yourself if you touch the hot heating element or the socket of the cigarette lighter.

In addition, flammable materials can ignite if:

- the hot cigarette lighter falls
- a child holds the hot cigarette lighter to objects, for example

There is a risk of fire and injury.

Always hold the cigarette lighter by the knob. Always make sure that the cigarette lighter is out of reach of children. Never leave children unsupervised in the vehicle.

Your attention must always be focused on the traffic conditions. Only use the cigarette



lighter when road and traffic conditions permit.



Example: vehicles with a cover over the stowage compartment

- ▶ Turn the SmartKey to position **2** in the ignition lock (▷ page 127).
- ▶ **To open:** push the lower section of cover **1**.  
The stowage compartment opens.
- ▶ Press in cigarette lighter **2**.  
Cigarette lighter **2** will pop out automatically when the heating element is red-hot.

### 12 V sockets

#### General notes

- ▶ Turn the SmartKey to position **1** in the ignition lock (▷ page 127).

The sockets can be used for accessories with a maximum draw of 180 W (15 A). Accessories include such items as bulbs or chargers for mobile phones.

If the sockets are used for a very long time the battery may discharge.

- i** An emergency cut-out ensures that the on-board voltage does not drop too low. If the on-board voltage is too low, the power to the sockets is automatically cut.

#### Socket in the rear-compartment center console

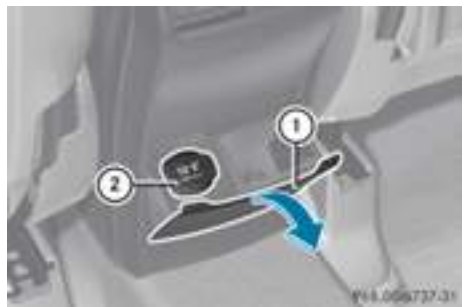

- ▶ Pull cover **1** out by its top edge.
- ▶ Lift up the cover of socket **2**.

#### Socket in the cargo compartment



- ▶ Lift up the cover of socket **1**.

### mbrace

#### General notes

You must have a license agreement to activate the mbrace service. Make sure that your system is activated and operational. To log in, press the MB Info call button. If any of the steps mentioned are not carried out, the system may not be activated.

If you have questions about the activation, contact the following telephone assistance service:

Customer Service at 1-888-923-8367

Shortly after successfully registering with the service, a user ID and password will be sent to you by post.



The system is available if:

- it has been activated and is operational
- the corresponding mobile phone network is available for transmitting data to the Customer Center
- a service subscription is available
- the starter battery is sufficiently charged

- **i** Determining the location of the vehicle on a map is only possible if:
  - GPS reception is available.
  - the vehicle position can be forwarded to the Customer Assistance Center.

### The mbrace system

To adjust the volume during a call, proceed as follows:

- ▶ Press the  or  button on the multifunction steering wheel.

or

- ▶ Use the volume controller of the audio system/COMAND.



The system offers various services, e.g.:



- Automatic and manual emergency call
- Roadside Assistance call
- MB Info call

### System self-test

After you have switched on the ignition, the system carries out a self-diagnosis.

A malfunction in the system has been detected if one of the following occurs:

- The indicator lamp in the SOS button does not come on during the system self-test.
- The indicator lamp in the  Roadside Assistance button does not light up during self-diagnosis of the system.
- The indicator lamp in the  MB Info call button does not light up during self-diagnosis of the system.

- The indicator lamp in one or more of the following buttons continues to light up red after the system self-diagnosis:
  - SOS button
  -  Roadside Assistance call button
  -  MB Info call button
- After the system self-diagnosis, the **Inoperative** or **Service Not Activated** message appears in the multifunction display.

If a malfunction is indicated as outlined above, the system may not operate as expected. In the event of an emergency, help will have to be summoned by other means.

Have the system checked at the nearest authorized Mercedes-Benz Center or call the following telephone assistance service:

Customer Service at 1-888-923-8367

### Emergency call

#### Important safety notes

##### **WARNING**

It can be dangerous to remain in the vehicle, even if you have pressed the SOS button in an emergency if:

- you see smoke inside or outside of the vehicle, e.g. if there is a fire after an accident
- the vehicle is on a dangerous section of road
- the vehicle is not visible or cannot easily be seen by other road users, particularly when dark or in poor visibility conditions

There is a risk of an accident and injury.

Leave the vehicle immediately in this or similar situations as soon as it is safe to do so.

Move to a safe location along with other vehicle occupants. In such situations, secure the vehicle in accordance with national regulations, e.g. with a warning triangle.

You must have a license agreement to activate the mbrace service. Make sure that your system is activated and operational. To register, press the  MB Info call button. If



any of the steps mentioned are not carried out, the system may not be activated.

If you have questions about the activation, contact the following telephone assistance service:

Customer Service at 1-888-923-8367

### General notes

The emergency call is triggered automatically if an air bag is deployed or an Emergency Tensioning Device is triggered.

- ❗ You cannot end an automatically triggered emergency call yourself.

An emergency call can also be initiated manually.

As soon as the emergency call has been initiated, the indicator lamp in the SOS button flashes. The multifunction display shows the **Connecting Call** message.

The audio output is muted.

Once the connection has been made, the **Call Connected** message appears in the multifunction display.

All important information on the emergency is transmitted, for example:

- current location of the vehicle (as determined by the GPS system)
- vehicle identification number
- information on the severity of the accident

After the emergency call has been initiated, a voice connection is automatically established between the Customer Assistance Center and the vehicle occupants.

- If the vehicle occupants respond, the Mercedes-Benz Customer Assistance Center attempts to get more information on the emergency.
- If there is no response from the vehicle occupants, an ambulance is immediately sent to the vehicle.

If no voice connection can be established to the Mercedes-Benz Customer Assistance Center, the system has been unable to initiate an emergency call.

If, for example, the relevant mobile phone network is not available then voice connection cannot be established. The indicator lamp in the SOS button flashes continuously. The **Call Failed** message appears in the multifunction display and must be confirmed. In this case, summon assistance by other means.

### Making an emergency call

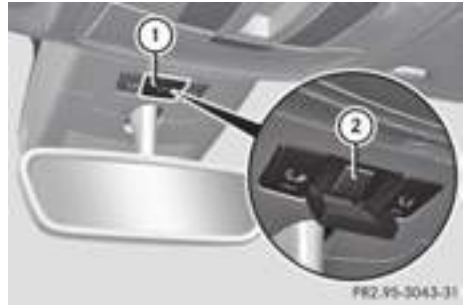

- ▶ **To initiate an emergency call manually:** press cover ① briefly to open.
- ▶ Press SOS button ② briefly. The indicator lamp in SOS button ② flashes until the emergency call is concluded.
- ▶ Wait for a voice connection to the Mercedes-Benz Customer Assistance Center.
- ▶ After the emergency call, close cover ①.

- ❗ If the mobile phone network is unavailable, mbrace will not be able to make the emergency call. If you leave the vehicle immediately after pressing the SOS button, you will not know whether mbrace placed the emergency call. In this case, always summon assistance by other means.

## Roadside Assistance button



- ▶ Press Roadside Assistance button ①. This initiates a call to the Mercedes-Benz Customer Assistance Center. The indicator lamp in Roadside Assistance button ① flashes while the call is active. The multifunction display shows the **Connecting Call** message. The audio output is muted.

If a connection can be made, the **Call Connected** message appears in the multifunction display.

If a mobile phone network and GPS reception are available, the system transfers data to the Mercedes-Benz Customer Assistance Center, for example:

- current location of the vehicle
- vehicle identification number

- ① The audio system or COMAND display indicates that a call is active. During the call, you can change to the navigation menu by pressing the NAVI button on COMAND, for example.

Voice output is not available.

A voice connection is established between the Mercedes-Benz Customer Assistance Center and the vehicle occupants.

From the remote fault diagnosis, the Mercedes-Benz Customer Assistance Center can ascertain the nature of the problem (▶ page 243).

The Mercedes-Benz Customer Assistance Center either sends a qualified Mercedes-

Benz technician or makes arrangements for your vehicle to be transported to the nearest authorized Mercedes-Benz Center.

You may be charged for services such as repair work and/or towing.

Further details are available in your mbrace manual.

- ① If the system has not been able to initiate a Roadside Assistance call:

- the indicator lamp in Roadside Assistance call button ① flashes continuously
- it was not possible to establish a voice connection to the Mercedes-Benz Customer Assistance Center.

This can occur if the relevant mobile phone network is not available, for example.

The **Call Failed** message appears in the multifunction display.

- ▶ **To end a call:** press the  button on the multifunction steering wheel.

or

- ▶ Press the corresponding button for ending a phone call on the audio system or on COMAND.

## MB Info call button



- ▶ Press MB Info call button ①. This initiates a call to the Mercedes-Benz Customer Assistance Center. The indicator lamp in MB Info call button ① flashes while the connection is being made. The multifunction display shows the **Con-**

necting Call message. The audio system is muted.

If a connection can be made, the **Call Connected** message appears in the multifunction display.

If a mobile phone network and GPS reception are available, the system transfers data to the Mercedes-Benz Customer Assistance Center, for example:

- current location of the vehicle
- vehicle identification number

**i** The audio system or COMAND display indicates that a call is active. During the call, you can change to the navigation menu by pressing the NAVI button on COMAND, for example.

Voice output is not available.

A voice connection is established between the Mercedes-Benz Customer Assistance Center and the vehicle occupants.

You receive information about operating your vehicle, about the nearest authorized Mercedes-Benz Center and about other products and services from Mercedes-Benz.

**i** The system has not been able to initiate an MB Info call, if:

- the indicator lamp in MB Info call button  is flashing continuously.
- no voice connection to the Mercedes-Benz Customer Assistance Center was established.

This can occur if the relevant mobile phone network is not available, for example.

The **Call Failed** message appears in the multifunction display.

► **To end a call:** press the  button on the multifunction steering wheel.

or

► Press the corresponding button for ending a phone call on the audio system or on COMAND.

## Call priority

When service calls are active, e.g. Roadside Assistance or MB Info calls, an emergency call can still be initiated. In this case, an emergency call will take priority and override all other active calls.

The indicator lamp of the respective button flashes until the call is ended.

An emergency call can only be terminated by the Mercedes-Benz Customer Assistance Center.

All other calls can be ended by pressing:

- the  button on the multifunction steering wheel
- the corresponding button on the audio system or on COMAND for ending a telephone call

**i** When a call is initiated, the audio system is muted. The mobile phone is no longer connected to COMAND. However, if you want to use your mobile phone, do so only when the vehicle is stationary and in a safe location.

## Downloading destinations in COMAND

### Downloading destinations

**i** The Destination Download function is only possible when:

- the relevant mobile phone network is available and data transfer is possible.
- the vehicle is equipped with a navigation system.

Downloading destinations gives you access to a database with over 15 million points of interest (POIs). These can be downloaded on the navigation system in your vehicle. If you know the destination, the address can be downloaded. Alternatively, you can obtain information on the location of points of interest (POIs)/important destinations in the vicinity.

Furthermore, you can download routes with up to 20 way points.

You are prompted to confirm route guidance to the address entered.

The system calculates the route and subsequently starts the route guidance with the address entered.

- i** If you select **No**, the address can be saved in the address book.

### Route Assistance

This service is part of the mbrace PLUS Package and cannot be purchased separately.

- i** You can use the route assistance function even if the vehicle is not equipped with a navigation system.

Within the framework of this service, you receive a professional and reliable form of navigation support without having to leave your vehicle.

The customer service representative finds a suitable route depending on your vehicle's current position and the desired destination. You will then be guided live through the current route section.

### Search & Send

#### General notes

- i** To use "Search & Send", your vehicle must be equipped with mbrace and a navigation system. Additionally, an mbrace service subscription must be completed.

"Search & Send" is a destination entry service. A destination address which is found on Google Maps® can be transferred via mbrace directly to your vehicle's navigation system.

#### Specifying and sending the destination address

- ▶ Go to the website <http://www.maps.google.com> and enter a destination address into the entry field.
- ▶ **To send the destination address to the e-mail address of your mbrace account:** click on the corresponding button on the website.



- i** Example:

If you select "Send to vehicle" and then "Mercedes-Benz", the destination address will be sent to your vehicle.

- ▶ When the "Send" dialog window appears: Enter the e-mail address you specified when setting up your mbrace account into the corresponding field.
- ▶ Click "Send".

- i** Information on specific commands such as "Address entry" or "Send" can be found on the website.

#### Calling up destination addresses

- ▶ Switch on the ignition. The destination address is loaded into the vehicle's navigation system. A display message appears, asking whether navigation should be started.
- ▶ Select **Yes** by turning  or sliding  to the COMAND controller and press  to confirm. The system calculates the route and subsequently starts the route guidance with the address entered.

- i** If you select **No**, the address can be saved in the address book.

- i** If you have sent more than one destination address, each individual destination must be confirmed separately.

- i** Destination addresses are loaded in the same order as the order in which they were sent.

If you own multiple Mercedes-Benz vehicles with mbrace and activated mbrace accounts:

If multiple vehicles are registered under the same e-mail address, the destination will be sent to all the vehicles.

## Vehicle remote opening

You can use vehicle remote unlocking if you have unintentionally locked your vehicle and a replacement key is not available.

The vehicle can be opened by the Mercedes-Benz Customer Assistance Center.

The vehicle can be immediately remotely unlocked within 4 days of the ignition being turned off. After this time, the remote unlocking may be delayed by 15 to 60 minutes. After 30 days, the vehicle can no longer be opened remotely.

- ▶ Contact the following telephone assistance service:  
Customer Service at 1-888-923-8367  
You will be asked for your password.
- ▶ Return to your vehicle at the time agreed upon with the Mercedes-Benz Customer Assistance Center.

To do this, you will need your identification number and password.

- i** Vehicle remote unlocking is only possible if the relevant mobile phone network is accessible.

## Vehicle remote closing

The remote closing feature can be used when you have forgotten to lock the vehicle and you are no longer nearby.

The vehicle can then be locked by the Mercedes-Benz Customer Assistance Center.

The vehicle can be immediately remotely locked within 4 days of the ignition being turned off. After this time, remote closing may be delayed by 15 to 60 minutes. After 30 days the vehicle can no longer be locked remotely.

- ▶ Contact the following telephone assistance service:  
Customer Service at 1-888-923-8367  
You will be asked for your password.

The next time you are inside the vehicle and you switch on the ignition, the **Doors Locked Remotely** message appears in the multifunction display.

To do this, you will need your identification number and password.

- i** The vehicle valet locking feature is only available when the relevant mobile phone network is accessible and a data connection is possible.

## Stolen vehicle recovery service

If your vehicle has been stolen:

- ▶ Notify the police.  
The police will issue a numbered incident report.
- ▶ This number will be forwarded to the Mercedes-Benz Customer Assistance Center together with your PIN.  
The Mercedes-Benz Customer Assistance Center then tries to locate the system. The Mercedes-Benz Customer Assistance Center contacts you and the local law enforcement agency if the vehicle is located.  
However, only the law enforcement agency is informed of the location of the vehicle.
- i** If the anti-theft alarm system is activated for longer than 30 seconds, the Mercedes-Benz Customer Assistance Center is automatically notified.

## Vehicle remote malfunction diagnosis

With the remote fault diagnosis (Vehicle Health Check), the Customer Assistance Center can provide improved support for problems with your vehicle. During an existing call, vehicle data is transferred to the Customer Assistance Center. The customer service representative can use the received data to decide what kind of assistance is required. You are then, for example, guided to the nearest authorized Mercedes-Benz Center or a recovery vehicle is called.

Vehicle data transfer during an MB Info call or Roadside Assistance call is initiated by the Customer Assistance Center. You will see the **Roadside Assistance Connected** message in the COMAND display. If the vehicle

remote fault diagnosis can be started, the **Request for vehicle diagnosis received. Start vehicle diagnosis?** message appears in the display.

- ▶ Confirm the message with **Yes**.
- ▶ When the **Vehicle diagnosis: Please start ignition** message appears, turn the key to position **2** in the ignition lock (▷ page 127).
- ▶ When the **Please follow the instructions received by phone and move your vehicle to a safe position** message appears, follow the customer service representative's instructions. The message in the display disappears. If you select **Cancel** the remote fault diagnosis is canceled completely. The vehicle operating state check begins. You will see the **Vehicle diagnosis activated.** message.

When the diagnosis is completed, the **Send vehicle diagnostics data (Voice connection may be interrupted during data transfer)** message appears. The vehicle data can now be sent to the Customer Assistance center.

- ▶ Press **OK** to confirm the message. The voice connection with the Customer Assistance Center is terminated. You will see the **Vehicle Diagnosis: Transferring data...** message. The vehicle data is sent to the Customer Assistance Center.

Depending on what the customer service representative agreed with you, the voice connection is re-established after the transfer is complete. If necessary, you will be contacted at a later time by another means, e.g. by e-mail or phone.

Another function of the remote fault diagnosis is the transfer of service data to the Customer Assistance Center. If a service is overdue, the COMAND display shows a message about various special offers at your workshop.

Information on the data stored in the vehicle (▷ page 26).

Information on Roadside Assistance (▷ page 21).

## Downloading routes

---

Downloading routes allows you to transfer and save predefined routes in the navigation system. To do this, an SD memory card must be inserted into the COMAND system. If no SD memory card is inserted, you must insert the card into the card slot on the COMAND system before saving.

A route can be prepared and sent either by a customer service representative or via the mbrace portal on the Internet.

Each route can include up to 20 way points. Once a route has been received by the navigation system, you will see the **<route name> has been saved to memory card. Do you want to start route guidance?** message in the COMAND display. The route is saved to the SD memory card.

- ▶ **To start route guidance:** select **Yes**.

An overview of the route is shown in the display.

- i** If you select **No**, the saved route can be called up later via the navigation menu.

- ▶ Select **Start**. Route guidance is started.

- i** Downloaded and saved data can be called up again in COMAND.

You can find further information in the separate COMAND Operating Instructions.

## Speed alert

---

You can define the upper speed limit, which must not be exceeded by the vehicle.

If this selected speed is exceeded by the vehicle, a message will be sent to the Customer Assistance Center. The Customer Assistance Center then forwards this information to you. You can select the way in which you receive this information beforehand. Possible options

include text message, e-mail or an automated call.

The data you receive contains the following information:

- the location where the speed limit was exceeded
- the time at which the speed limit was exceeded
- the selected speed limit which was exceeded

## Geo fencing

Geo fencing allows you to select areas which the vehicle should not enter or leave. You will be informed if the vehicle crosses the boundaries of the selected areas. You can select the way in which you receive this information beforehand. Possible options include text message, e-mail or an automated call.

The area can be determined as either a circle or a polygon with a maximum of ten corners. You can specify up to ten areas simultaneously. Different settings are possible for each area.

Alternatively, you can trigger an MB Info call and inform the customer service representative that you wish to activate geo fencing.

Currently inactive areas can be activated by text message.

## Triggering the vehicle alarm

With this function, you can trigger the vehicle's panic alarm via text message. An alarm sounds and the exterior lighting flashes. Depending on the setting, the panic alarm lasts 5 or 10 seconds. Afterwards, the alarm switches off.

## Garage door opener

### Important safety notes

#### WARNING

When you operate or program the garage door with the integrated garage door opener, persons in the range of movement of the garage door can become trapped or struck by the garage door. There is a risk of injury.

When using the integrated garage door opener, always make sure that nobody is within the range of movement of the garage door.

### Programming

#### Programming buttons

Pay attention to the "Important safety notes" (> page 245).

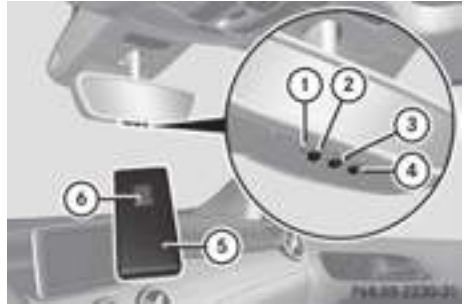

Integrated garage door opener in the rear-view mirror

Garage door remote control (5) is not part of the integrated garage door opener.

- ▶ Before programming for the first time, clear the integrated garage door opener memory (> page 248).
- ▶ Turn the SmartKey to position 2 in the ignition lock.
- ▶ Press and hold button (2), (3) or (4) of the integrated garage door opener. After a short time, indicator lamp (1) lights up yellow.

**i** Indicator lamp (1) lights up yellow as soon as button (2), (3) or (4) is programmed for



the first time. If the selected button has already been programmed, indicator lamp ① lights up yellow after 10 seconds have elapsed.

- ▶ Release button ②, ③ or ④. Indicator lamp ① flashes yellow.
- ▶ Point garage door remote control ⑤ towards buttons ②, ③ or ④ on the rear-view mirror at a distance of 2 to 8 inches (5 to 20 cm).

**i** The required distance between remote control ⑤ and the integrated garage door opener depends on the garage door drive system. Several attempts might be necessary. You should test every position for at least 25 seconds before trying another position.

- ▶ Press and hold button ⑥ on remote control ⑤ until indicator lamp ① lights up green. If indicator lamp ① lights up green or flashes, then programming was successful.
- ▶ Release button ⑥ of remote control ⑤ of the garage door drive.
- ▶ If indicator lamp ① lights up red: repeat the programming procedure for the corresponding button on the rear-view mirror. When doing so, vary the distance between remote control ⑤ and the rear-view mirror.

**i** If the indicator lamp flashes green after successful programming, the garage door system is using a rolling code. After programming, you must synchronize the garage door opener integrated in the rear-view mirror with the receiver of the garage door system.

### Synchronizing the rolling code

Pay attention to the "Important safety notes" (▶ page 245).



Integrated garage door opener in the rear-view mirror

Your vehicle must be within reach of the garage door or gate opener drive. Make sure that neither your vehicle nor any persons/objects are present within the sweep of the door or gate.

- ▶ Turn the SmartKey to position 2 in the ignition lock.
- ▶ Press the programming button of the door or gate drive (see the door or gate drive operating instructions, e.g. under "Programming additional remote controls").
- i** Usually, you now have 30 seconds to initiate the next step.
- ▶ Press previously programmed button ②, ③ or ④ of the integrated garage door opener until the door closes. The rolling code synchronization is then complete.

### Notes on programming the remote control

Canadian radio frequency laws require a "break" (or interruption) of the transmission signals after broadcasting for a few seconds. Therefore, these signals may not last long enough for the integrated garage door opener. The signal is not recognized during programming. Comparable with Canadian law, some U.S. garage door openers also feature a "break".



Proceed as follows:

- if you live in Canada
- if you have difficulties programming the garage door opener (regardless of where you live) when using the programming steps.

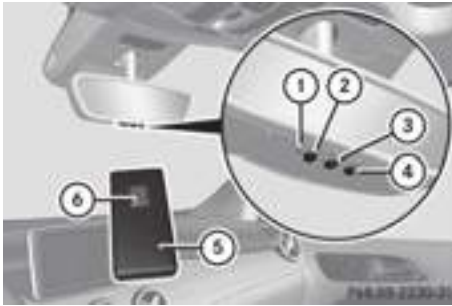

Integrated garage door opener in the rear-view mirror

- ▶ Press and hold button ②, ③ or ④ of the integrated garage door opener. After a short time, indicator lamp ① lights up yellow.
- ▶ Release the button. Indicator lamp ① flashes yellow.
- ▶ Press button ⑥ of remote control ⑤ for 2 seconds, then release it for 2 seconds.
- ▶ Press button ⑥ again and hold for 2 seconds.
- ▶ Repeat this sequence on button ⑥ of remote control ⑤ until indicator lamp ① lights up green. If indicator lamp ① turns red, repeat the process.
- ▶ Continue with the other programming steps (see above).

### Problems when programming

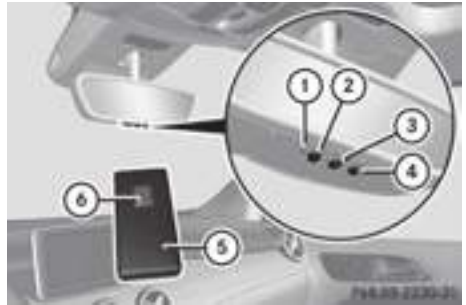

Integrated garage door opener in the rear-view mirror

If you are experiencing problems programming the integrated garage door opener on the rear-view mirror, take note of the following instructions:

- Check the transmitter frequency of garage door drive remote control ⑤. This can usually be found on the back of the remote control. The integrated garage door opener is compatible with devices that have units which operate in the frequency range of 280 to 433 MHz.
- Replace the batteries in garage door remote control ⑤. This increases the likelihood that garage door remote control ⑤ will transmit a strong and precise signal to the integrated garage door opener.
- When programming, hold remote control ⑤ at varying distances and angles from the button which you are programming. Try various angles at a distance between 2 and 12 inches (5 to 30 cm) or at the same angle but at varying distances.
- If another remote control is available for the same garage door drive, repeat the same programming steps with this remote control. Before performing these steps, make sure that new batteries have been installed in garage door drive remote control ⑤.
- Note that some remote controls only transmit for a limited amount of time (the indicator lamp on the remote control goes out).

Press button (6) on remote control (5) again before transmission ends.

- Align the antenna cable of the garage door opener unit. This can improve signal reception/transmission.

### Opening/closing the garage door



Integrated garage door opener in the rear-view mirror

After it has been programmed, the integrated garage door opener performs the function of the garage door system remote control. Please also read the operating instructions for the garage door system.

- ▶ Turn the SmartKey to position **2** in the ignition lock (▷ page 127).
- ▶ Press button (2), (3) or (4) which you have programmed to operate the garage door. Garage door system with a fixed code: indicator lamp (1) lights up green. Garage door system with a rolling code: indicator lamp (1) flashes green.

**i** The transmitter will transmit a signal as long as the button is pressed. The transmission is halted after a maximum of 10 seconds and indicator lamp (1) lights up yellow. Press button (2), (3) or (4) again if necessary.

### Clearing the memory



Integrated garage door opener in the rear-view mirror

Make sure that you clear the memory of the integrated garage door opener before selling the vehicle.

- ▶ Turn the SmartKey to position **2** in the ignition lock (▷ page 127).
- ▶ Press and hold buttons (2) and (4). The indicator lamp initially lights up yellow and then green.
- ▶ Release buttons (2) and (4). The memory of the integrated garage door opener in the rear-view mirror is cleared.

### Compass

#### Calling up the compass

The compass displays in which compass direction the vehicle is currently traveling: **N**, **NE**, **E**, **SE**, **S**, **SW**, **W** or **NW**.



To receive a correct display in rear-view mirror ①, the compass must be calibrated and the magnetic field zone set.

### Setting the compass

- ▶ Determine your position using the following zone maps.



North America zone map

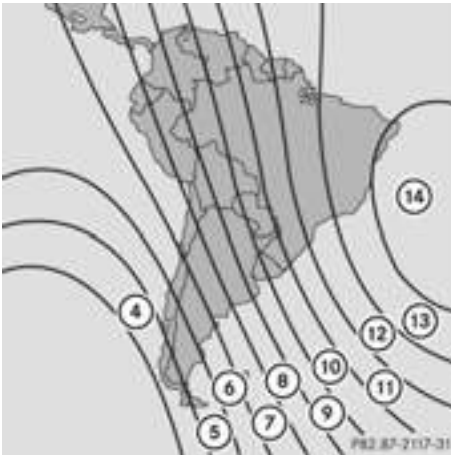

South America zone map

- ▶ Push a round pen into opening ③ (▷ page 248) for approximately 3 seconds. The zone currently selected appears in compass display ② (▷ page 248).
- ▶ **To select the zone:** push a round pen into opening ③ (▷ page 248) until the desired zone is selected. If, after a few seconds, the display in compass display ② (▷ page 248) changes direction, the zone has been selected.

### Calibrating the compass

- ▶ Make sure that there is sufficient space for you to drive in a circle without impeding traffic.

In order to calibrate the compass correctly, do the following:

- calibrate the compass in the open and not in the vicinity of steel structures or high-voltage transmission lines.
- switch off electrical consumers such as the climate control, windshield wipers or rear window defroster.
- close all doors and the tailgate.
- ▶ Switch on the ignition.
- ▶ Push a round pen into opening ③ (▷ page 248) for approximately 6 seconds, until the **C** symbol is shown in compass display ② (▷ page 248).
- ▶ Drive your vehicle in a full circle at approximately 3 mph (5 km/h) to 6 mph (10 km/h). When the calibration has successfully been completed, the current direction is shown in compass display ② (▷ page 248).

### Floor mat on the driver's side

#### WARNING

Objects in the driver's footwell can restrict the pedal travel or obstruct a depressed pedal. The operating and road safety of the vehicle is jeopardized. There is a risk of an accident.

Make sure that all objects in the vehicle are stowed correctly, and that they cannot enter the driver's footwell. Install the floor mats securely and as specified in order to ensure sufficient clearance for the pedals. Do not use loose floor mats and do not place floor mats on top of one another.

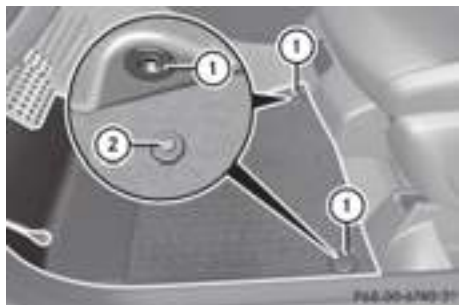

- ▶ Slide the seat backwards.
- ▶ **To install:** place the floor mat in the footwell.
- ▶ Press safety catch knobs ① onto retainers ②.
- ▶ **To remove:** pull the floor mat off retainers ②.
- ▶ Remove the floor mat.

Useful information .....	252
Engine compartment .....	252
Maintenance .....	254
Care .....	256

## Useful information

- i** This Operator's Manual describes all models and all standard and optional equipment of your vehicle available at the time of publication of the Operator's Manual. Country-specific differences are possible. Bear in mind that your vehicle may not feature all functions described here. This also applies to safety-relevant systems and functions.
- i** Read the information on qualified specialist workshops: (▷ page 24).

## Engine compartment

### Hood

#### Important safety notes

#### WARNING

If the hood is unlatched, it may open up when the vehicle is in motion and block your view. There is a risk of an accident. Never unlatch the hood while driving.

#### WARNING

When opening and closing the hood, it may suddenly fall into the closed position. There is a risk of injury to persons within range of movement of the hood.

Open and close the hood only when no one is within its range of movement.

#### WARNING

Opening the hood when the engine is overheated or when there is a fire in the engine compartment could expose you to hot gases or other service products. There is a risk of injury.

Let an overheated engine cool down before opening the hood. If there is a fire in the engine compartment, keep the hood closed and contact the fire department.

#### WARNING

The engine compartment contains moving components. Certain components, such as the radiator fan, may continue to run or start again suddenly when the ignition is off. There is a risk of injury.

If you need to do any work inside the engine compartment:

- switch off the ignition
- never reach into the area where there is a risk of danger from moving components, such as the fan rotation area
- remove jewelry and watches
- keep items of clothing and hair, for example, away from moving parts

#### Opening the hood

#### WARNING

Certain components on the engine may be very hot. When carrying out work on the engine there is a risk of injury.

Where possible, let the engine cool down and touch only the components described in the following.

#### WARNING

When the hood is open and the windshield wipers are set in motion, you can be injured by the wiper linkage. There is a risk of injury.

Always switch off the windshield wipers and the ignition before opening the hood.

- i** Make sure that the windshield wipers are not folded away from the windshield. You could otherwise damage the windshield wipers or the hood.



- ▶ Make sure that the windshield wipers are switched off.
- ▶ Pull release lever ① on the hood. The hood is released.



- ▶ With your hand flat, palm facing down, reach into the gap between the hood and the radiator trim.
- ▶ Press the hood catch lever ② to the left.
- ▶ Raise the hood.



- ▶ Pull support strut ④ out of bracket ⑤.
- ▶ Lift up support strut ④ and insert it into yellow retaining clip ③.

## Closing the hood

- ▶ Raise the hood slightly and, at the same time, remove support strut ④ from yellow retaining clip ③.
- ▶ Swing support strut ④ down and press it into bracket ⑤ until it engages.
- ▶ Lower the hood and let it fall from a height of approximately 8 in (20 cm).
- ▶ Check that the hood has engaged properly. If the hood can be raised slightly, it is not properly engaged. Do not press the hood closed. Open the hood again and close it with a little more force.

## Checking and adding other service products

### Checking coolant level

#### WARNING

The engine cooling system is pressurized, particularly when the engine is warm. When opening the cap, you could be scalded by hot coolant spraying out. There is a risk of injury. Let the engine cool down before opening the cap. Wear eye and hand protection when opening the cap. Open the cap slowly half a turn to allow pressure to escape.

- ❗ The coolant may only be checked and corrected when the engine is cool (coolant temperature below 104 °F (40 °C)). Checking the coolant when the coolant temperature is above 104 °F (40 °C) may result in damage to the engine or to the engine cooling system.





Example

- ▶ Park the vehicle on a level surface. Only check the coolant level when the vehicle is on a level surface and the drive system has cooled down.
- ▶ Turn the SmartKey to position **2** in the ignition lock (▷ page 127).
- ▶ Check the coolant temperature display in the instrument cluster. The coolant temperature must be below 104 °F (40 °C).
- ▶ Turn the SmartKey to position **0** in the ignition lock (▷ page 127).
- ▶ Slowly turn cap ① half a turn counter-clockwise and allow excess pressure to escape.
- ▶ Turn cap ① further counter-clockwise and remove it. If the coolant is at the level of marker bar ③ in the filler neck when cold, there is enough coolant in coolant expansion tank ②.
- ▶ If necessary, add coolant that has been tested and approved by Mercedes-Benz.
- ▶ Replace cap ① and turn it clockwise as far as it will go.

For further information on coolant, see (▷ page 309).

### Windshield washer system

#### WARNING

Certain components on the engine may be very hot. When carrying out work on the engine there is a risk of injury.

Where possible, let the engine cool down and touch only the components described in the following.

#### WARNING

Windshield washer concentrate is highly flammable. If it comes into contact with hot components in the front compartment, it may ignite. There is a risk of fire and injury.

Make sure that no windshield washer concentrate is spilled next to the filler neck.



Example

- ▶ **To open:** pull cap ① upwards by the tab.
- ▶ Add the premixed washer fluid.
- ▶ **To close:** press cap ① onto the filler neck until it engages.

The recommended minimum fluid level in the washer fluid reservoir is 0.26 US gal (1 liter). If the washer fluid level drops below the recommended minimum fluid level of 0.26 US gal (1 liter), a message appears in the multifunction display prompting you to add washer fluid (▷ page 214).

Further information on windshield washer fluid/antifreeze (▷ page 310).

### Maintenance

#### ASSYST PLUS

#### Service messages

The ASSYST PLUS service interval display informs you of the next service due date.



For information on the type of service and service intervals, see the separate Maintenance Booklet.

You can obtain further information from an authorized Mercedes-Benz Center or at <http://www.mbusa.com> (USA only).

The multifunction display shows a service message for several seconds, e.g.:

- Service A in .. Days
- Service A Due
- Service A Exceeded by .. Days

Depending on the operating conditions of the vehicle, the remaining time or distance until the next service due date is displayed.

The letter **A** or **B**, possibly in connection with a number or another letter, indicates the type of service. **A** stands for a minor service and **B** for a major service.

You can obtain further information from an authorized Mercedes-Benz Center.

The ASSYST PLUS service interval display does not take into account any periods of time during which the battery is disconnected.

Maintaining the time-dependent service schedule:

- ▶ Note down the service due date displayed in the multifunction display before disconnecting the battery.

or

- ▶ After reconnecting the battery, subtract the battery disconnection periods from the service date shown on the display.

### Hiding a service message

- ▶ Press the **OK** or **↩** button on the steering wheel.

### Displaying service messages

- ▶ Switch on the ignition.
- ▶ Press the **◀** or **▶** button to select the **Serv.** menu.
- ▶ Press the **▲** or **▼** button to select the **ASSYST PLUS** submenu and confirm by pressing the **OK** button.  
The service due date appears in the multifunction display.

### Information about Service

#### Resetting the ASSYST PLUS service interval display

! If the ASSYST PLUS service interval display has been inadvertently reset, this setting can be corrected at a qualified specialist workshop.

Have service work carried out as described in the Maintenance Booklet. This may otherwise lead to increased wear and damage to the major assemblies or the vehicle.

A qualified specialist workshop, e.g. an authorized Mercedes-Benz Center, will reset the ASSYST PLUS service interval display after the service work has been carried out. You can also obtain further information on maintenance work, for example.

#### Special service requirements

The specified maintenance interval takes only the normal operation of the vehicle into account. Under arduous operating conditions or increased load on the vehicle, maintenance work must be carried out more frequently, for example:

- regular city driving with frequent intermediate stops
- if the vehicle is primarily used to travel short distances
- use in mountainous terrain or on poor road surfaces
- if the engine is often left idling for long periods

Under arduous operating conditions, the tires must be checked more often. Further information can be obtained at a qualified specialist workshop, e.g. an authorized Mercedes-Benz Center.

### Driving abroad

An extensive Mercedes-Benz Service network is also available in other countries. You can obtain further information from any authorized Mercedes-Benz Center.

## Care

### General notes

#### Environmental note

Dispose of empty packaging and cleaning cloths in an environmentally responsible manner.

**!** For cleaning your vehicle, do not use any of the following:

- dry, rough or hard cloths
- abrasive cleaning agents
- solvents
- cleaning agents containing solvents

Do not scrub.

Do not touch the surfaces or protective films with hard objects, e.g. a ring or ice scraper. You could otherwise scratch or damage the surfaces and protective film.

**!** Do not park the vehicle for an extended period straight after cleaning it, particularly after having cleaned the wheels with wheel cleaner. Wheel cleaners could cause increased corrosion of the brake discs and brake pads/linings. For this reason, you should drive for a few minutes after cleaning. Braking heats the brake discs and the brake pads/linings, thus drying them. The vehicle can then be parked.

Regular care of your vehicle is a condition for retaining the quality in the long term.

Use care products and cleaning agents recommended and approved by Mercedes-Benz.

### Exterior care

#### Automatic car wash

##### WARNING

Braking efficiency is reduced after washing the vehicle. There is a risk of an accident. After the vehicle has been washed, brake carefully while paying attention to the traffic conditions until full braking power is restored.

**!** Never clean your vehicle in a Touchless Automatic Car Wash as these use special cleaning agents. These cleaning agents can damage the paintwork or plastic parts.

**!** When washing your vehicle in a tow-through car wash, make sure that the selector lever is in position **N**, otherwise the vehicle could be damaged.

**!** Make sure that:

- the side windows are fully closed.
- the ventilation/heating is switched off (the OFF button has been pressed/the airflow control is set to position **0**).
- the windshield wiper switch is at position **0**.

The vehicle may otherwise be damaged.

You can wash the vehicle in an automatic car wash from the very start.

If the vehicle is very dirty, pre-wash it before cleaning it in an automatic car wash.

After using an automatic car wash, wipe off wax from the windshield and the wiper blades. This will prevent smears and reduce wiping noises caused by residue on the windshield.

#### Washing by hand

In some countries, washing by hand is only allowed at specially equipped washing bays.

Observe the legal requirements in each country.

- ▶ Do not use hot water and do not wash the vehicle in direct sunlight.
- ▶ Use a soft sponge to clean.
- ▶ Use a mild cleaning agent, such as a car shampoo approved by Mercedes-Benz.
- ▶ Thoroughly hose down the vehicle with a gentle jet of water.
- ▶ Do not point the water jet directly towards the air inlet.
- ▶ Use plenty of water and rinse out the sponge frequently.
- ▶ Rinse the vehicle with clean water and dry thoroughly with a chamois.
- ▶ Do not let the cleaning agent dry on the paintwork.

Carefully remove all deposits of road salt as soon as possible when driving in winter.

### Power washers

#### WARNING

The water jet from a circular jet nozzle (dirt blasters) can cause invisible exterior damage to the tires or chassis components. Components damaged in this way may fail unexpectedly. There is a risk of an accident.

Do not use power washers with circular jet nozzles to clean the vehicle. Have damaged tires or chassis components replaced immediately.

- ❗ Always maintain a distance of at least 11.8 in (30 cm) between the vehicle and the power washer nozzle. Information about the correct distance is available from the equipment manufacturer.

Move the power washer nozzle around when cleaning your vehicle.

Do not aim directly at any of the following:

- tires
- door gaps, roof gaps, joints, etc.
- electrical components
- battery
- connectors
- lights
- seals
- trim
- ventilation slots

Damaged seals or electrical components can lead to leaks or failures.

### Cleaning the paintwork

- ❗ Do not affix:

- stickers
- films
- magnetic plates or similar items

to painted surfaces. You could otherwise damage the paintwork.

- ▶ Remove dirt immediately, where possible, while avoiding rubbing too hard.
- ▶ Soak insect remains with insect remover and rinse off the treated areas afterwards.
- ▶ Soak bird droppings with water and rinse off the treated areas afterwards.
- ▶ Remove coolant, brake fluid, tree resin, oils and greases by rubbing gently with a cloth soaked in petroleum ether or lighter fluid.
- ▶ Use tar remover to remove tar stains.
- ▶ Use silicone remover to remove wax.
- ▶ Use a suitable touch-up stick, e.g. MB Touch-Up Stick, to repair slight damage to the paintwork quickly and provisionally.

The following cannot always be completely repaired:

- scratches
- corrosive deposits
- areas affected by corrosion
- damage caused by inadequate care

In such cases, visit a qualified specialist workshop.

If water no longer forms "beads" on the paint surface, use the paint care products recommended and approved by Mercedes-Benz.

This is the case approximately every three to

five months, depending on the climate conditions and the care product used.

If the dirt has penetrated the paint surface or if the paintwork has become dull, then the paintwork should be cleaned. Use the cleaning product Paint Cleaner, which has been approved by Mercedes-Benz.

Do not use these care products in the sun or on the hood while the hood is hot.

### Matte finish care

**!** Never polish the vehicle or the light alloy wheels. Polishing causes the finish to shine.

**!** The following may cause the paint to become shiny and thus reduce the matte effect:

- Vigorous rubbing with unsuitable materials.
- Frequent use of car washes.
- Washing the vehicle in direct sunlight.

**!** Never use paint cleaner, buffing or polishing products, or gloss preserver, e.g. wax. These products are only suitable for high-gloss surfaces. Their use on vehicles with matte finish leads to considerable surface damage (shiny, spotted areas).

Always have paintwork repairs carried out at a qualified specialist workshop.

**!** Do not use wash programs with a hot wax treatment under any circumstances.

Observe these notes if your vehicle has a clear matte finish. This will help you to avoid damage to the paintwork due to incorrect treatment.

These notes also apply to light alloy wheels with a clear matte finish.

- i** The vehicle should preferably be washed by hand using a soft sponge, car shampoo and plenty of water.
- i** Use only insect remover and car shampoo from the range of recommended and approved Mercedes-Benz care products.

### Cleaning the wheels

#### WARNING

The water jet from a circular jet nozzle (dirt blasters) can cause invisible exterior damage to the tires or chassis components. Components damaged in this way may fail unexpectedly. There is a risk of an accident.

Do not use power washers with circular jet nozzles to clean the vehicle. Have damaged tires or chassis components replaced immediately.

**!** Do not use acidic wheel cleaning products to remove brake dust. This could damage wheel bolts and brake components.

**!** Do not park the vehicle for an extended period straight after cleaning it, particularly after having cleaned the wheels with wheel cleaner. Wheel cleaners could cause increased corrosion of the brake discs and brake pads/linings. For this reason, you should drive for a few minutes after cleaning. Braking heats the brake discs and the brake pads/linings, thus drying them. The vehicle can then be parked.

### Cleaning the windows

#### WARNING

You could become trapped by the windshield wipers if they start moving while cleaning the windshield or wiper blades. There is a risk of injury.

Always switch off the windshield wipers and the ignition before cleaning the windshield or wiper blades.

**!** Only fold the windshield wipers away from the windshield when vertical. Otherwise, you will damage the hood.

**!** Do not use dry cloths, abrasive products, solvents or cleaning agents containing solvents to clean the inside of the windows. Do not touch the insides of the windows with hard objects, e.g. an ice scraper or ring.

There is otherwise a risk of damaging the windows.

- ❗ Clean the water drainage channels of the windshield and the rear window at regular intervals. Deposits such as leaves, petals and pollen may under certain circumstances prevent water from draining away. This can lead to corrosion damage and damage to electronic components.
- ▶ Clean the inside and outside of the windows with a damp cloth and a cleaning product that is recommended and approved by Mercedes-Benz.

### Cleaning wiper blades

#### WARNING

You could become trapped by the windshield wipers if they start moving while cleaning the windshield or wiper blades. There is a risk of injury.

Always switch off the windshield wipers and the ignition before cleaning the windshield or wiper blades.

- ❗ Only fold the windshield wipers away from the windshield when vertical. Otherwise, you will damage the hood.
- ❗ Do not pull the wiper blade. Otherwise, the wiper blade could be damaged.
- ❗ Do not clean wiper blades too often and do not rub them too hard. Otherwise, the graphite coating could be damaged. This could cause wiper noise.
- ▶ Fold the windshield wiper arms away from the windshield.
- ▶ Carefully clean the wiper blades with a damp cloth.
- ▶ Fold the windshield wiper arms back again before switching on the ignition.
- ❗ Hold the wiper arm securely when folding back. The windshield could be damaged if the wiper arm smacks against it suddenly.

### Cleaning the exterior lighting

- ❗ Only use cleaning agents or cleaning cloths which are suitable for plastic light lenses. Unsuitable cleaning agents or cleaning cloths could scratch or damage the plastic light lenses.
- ▶ Clean the plastic lenses of the exterior lighting using a wet sponge and a mild cleaning agent, e.g. Mercedes-Benz car shampoo or cleaning cloths.

### Cleaning the mirror turn signals

- ❗ Only use cleaning agents or cleaning cloths that are suitable for plastic lenses. Unsuitable cleaning agents or cleaning cloths could scratch or damage the plastic lenses of the mirror turn signals.
- ▶ Clean the plastic lenses of the mirror turn signals in the exterior mirror housing using a wet sponge or cleaning cloth. Use a mild cleaning agent, e.g. Mercedes-Benz Autoshampoo.

### Cleaning the sensors

- ❗ If you clean the sensors with a power washer, make sure that you keep a distance of at least 11.8 in (30 cm) between the vehicle and the power washer nozzle. Information about the correct distance is available from the equipment manufacturer.



- ▶ Clean sensors ① of the driving systems with water, car shampoo and a soft cloth.

### Cleaning the rear view camera

- ❗ Do not clean the camera lens and the area around the rear view camera with a power washer.



- ▶ Use clear water and a soft cloth to clean camera lens ①.

## Interior care

### Cleaning the display

- ❗ For cleaning, do not use any of the following:

- alcohol-based thinner or gasoline
- abrasive cleaning agents
- commercially-available household cleaning agents

These may damage the display surface. Do not put pressure on the display surface when cleaning. This could lead to irreparable damage to the display.

- ▶ Before cleaning the display, make sure that it is switched off and has cooled down.
- ▶ Clean the display surface using a commercially available microfiber cloth and TFT/LCD display cleaner.
- ▶ Dry the display surface using a dry microfiber cloth.

### Cleaning the plastic trim

#### ⚠ WARNING

Care products and cleaning agents containing solvents cause surfaces in the cockpit to become porous. As a result, plastic parts may come loose in the event of air bag deployment. There is a risk of injury.

Do not use any care products and cleaning agents to clean the cockpit.

- ❗ Do not affix the following to plastic surfaces:

- stickers
- films
- scented oil bottles or similar items

You can otherwise damage the plastic.

- ❗ Do not allow cosmetics, insect repellent or sunscreen to come into contact with the plastic trim. This maintains the high-quality look of the surfaces.

- ▶ Wipe the plastic trim with a damp, lint-free cloth, e.g. a microfiber cloth.
- ▶ **Heavy soiling:** use care and cleaning products recommended and approved by Mercedes-Benz. The surface may change color temporarily. Wait until the surface is dry again.

### Cleaning the steering wheel and gear or selector lever

---

- ▶ Thoroughly wipe with a damp cloth or use leather care agents that have been recommended and approved by Mercedes-Benz.

### Cleaning genuine wood and trim elements

---

- ❗ Do not use solvent-based cleaning agents such as tar remover, wheel cleaners, polishes or waxes. There is otherwise a risk of damaging the surface.
- ❗ Do not use chrome polish on trim pieces. The trim pieces have a chrome look but are mostly made of anodized aluminum and can lose their shine if chrome polish is used. Use a damp, lint-free cloth instead when cleaning the trim pieces. If the chrome-plated trim pieces are very dirty, you can use a chrome polish. If you are unsure as to whether the trim pieces are chrome-plated or not, consult an authorized Mercedes-Benz Center.
- ▶ Wipe the wooden trim and trim pieces with a damp, lint-free cloth, e.g. a microfiber cloth.
- ▶ **Heavy soiling:** use care and cleaning products recommended and approved by Mercedes-Benz.

### Cleaning the seat covers

---

#### General notes

- ❗ Do not use microfiber cloths to clean genuine leather, artificial leather or DINAMICA

covers. If used often, these can damage the cover.

- i Note that regular care is essential to ensure that the appearance and comfort of the covers is retained over time.

#### Genuine leather seat covers

Leather is a natural product.

It exhibits natural surface characteristics, for example:

- differences in the texture
- signs of stretching and marking
- slight nuances of color

These are characteristics of leather and not material defects.

- ❗ To retain the natural appearance of the leather, observe the following cleaning instructions:

- Clean genuine leather covers carefully with a damp cloth and then wipe the covers down with a dry cloth.
- Make sure that the leather does not become soaked. It may otherwise become rough and cracked.
- Only use leather care agents that have been tested and approved by Mercedes-Benz. You can obtain these from a qualified specialist workshop.

#### Seat covers of other materials

- ❗ Observe the following when cleaning:
  - Clean artificial leather covers with a cloth moistened with a solution containing 1% detergent (e.g. dish washing liquid).
  - Clean cloth covers with a microfiber cloth moistened with a solution containing 1% detergent (e.g. dish washing liquid). Rub carefully and always wipe entire seat sections to avoid leaving visible lines. Leave the seat to dry afterwards. Cleaning results depend on the type of dirt and how long it has been there.
  - Clean Alcantara® covers with a damp cloth. Make sure that you wipe entire

seat sections to avoid leaving visible lines.

### Cleaning the seat belts

---

#### **WARNING**

Seat belts can become severely weakened if bleached or dyed. This could cause the seat belts to tear or fail, for instance, in the event of an accident. This poses an increased risk of injury or fatal injury.

Never bleach or dye the seat belts.

- !** Do not clean the seat belts using chemical cleaning agents. Do not dry the seat belts by heating at temperatures above 176 °F (80 °C) or in direct sunlight.
- ▶ Use clean, lukewarm water and soap solution.

### Cleaning the headliner and carpets

---

- ▶ **Headliner:** if it is very dirty, use a soft brush or a cleaning agent recommended and approved by Mercedes-Benz.
- ▶ **Carpets:** use the carpet and textile cleaning agents recommended and approved by Mercedes-Benz.



Useful information .....	264
Where will I find...? .....	264
Flat tire .....	264
12 V battery (vehicle) .....	265
Jump-starting .....	269
Towing .....	271
Fuses .....	274

## Useful information

**i** This Operator's Manual describes all models and all standard and optional equipment of your vehicle available at the time of publication of the Operator's Manual. Country-specific differences are possible. Bear in mind that your vehicle may not feature all functions described here. This also applies to safety-relevant systems and functions.

**i** Read the information on qualified specialist workshops: (▷ page 24).

## Where will I find...?

### Vehicle tool kit

#### General notes

**i** Apart from certain country-specific variations, the vehicles are not equipped with a tire-change tool kit. Some tools for changing a wheel are specific to the vehicle. For more information on which tire changing tools are required and approved to perform a wheel change on your vehicle, consult a qualified specialist workshop.

Tools required for changing a wheel may include, for example:

- Jack
- Wheel chock
- Lug wrench

## Flat tire

### Preparing the vehicle

Your vehicle can be fitted with MOExtended tires (tires with run-flat characteristics) (▷ page 264).

Check if your vehicle is fitted with MOExtended tires. Vehicle preparation is not necessary on vehicles with MOExtended tires. Information on changing/mounting a wheel (▷ page 300).

- ▶ Stop the vehicle on solid, non-slippery and level ground, as far away as possible from traffic.
- ▶ Switch on the hazard warning lamps.
- ▶ Secure the vehicle against rolling away (▷ page 144).
- ▶ If possible, bring the front wheels into the straight-ahead position.
- ▶ Switch off the drive system.
- ▶ Remove the SmartKey from the ignition lock.
- ▶ All occupants must get out of the vehicle. Make sure that they are not endangered as they do so.
- ▶ Make sure that no one is near the danger area while a wheel is being changed. Anyone who is not directly assisting in the wheel change should, for example, stand behind the barrier.
- ▶ Get out of the vehicle. Pay attention to traffic conditions when doing so.
- ▶ Close the driver's door.

### MOExtended tires (tires with run-flat properties)

#### General notes

When using tires with run-flat characteristics, you can continue to drive your vehicle even if there is a total loss of pressure in one or more tires. The affected tire must not show any clearly visible damage.

You can recognize tires with run-flat characteristics by the MOExtended marking which appears on the tire sidewall. You will find this marking next to the tire size designation, the load-bearing capacity and the speed index (▷ page 293).

Tires with run-flat characteristics may only be used in conjunction with an active tire pressure monitor.

### If the pressure loss warning message appears in the multifunction display:

- Observe the instructions in the display messages (> page 211).
- Check the tire for damage.
- If driving on, observe the following notes.

The maximum driving distance is approximately 50 miles (80 km) when the vehicle is partially laden and approximately 18 miles (30 km) when the vehicle is fully laden.

In addition to the vehicle load, the driving distance possible depends upon:

- Speed
- Road condition
- Outside temperature

The driving distance possible in run-flat mode may be reduced by extreme driving conditions/maneuvers, or it can be increased through a moderate style of driving.

The maximum permissible distance which can be driven in run-flat mode is counted from the moment the tire pressure loss warning appears in the multifunction display.

You must not exceed a maximum speed of 50 mph (80 km/h).

**i** When replacing one or all tires, make sure that you use only tires:

- of the size specified for the vehicle and
- marked "MOExtended"

If a tire has gone flat and cannot be replaced with an MOExtended tire, a standard tire may be used as a temporary measure. Make sure that you use the proper size and type (summer or winter tire).

**i** Vehicles featuring tires with run-flat characteristics are not equipped with a TIREFIT kit at the factory. It is therefore recommended that you additionally equip your vehicle with a TIREFIT kit if you mount tires that do not feature run-flat properties, e.g. winter tires. A TIREFIT kit can be obtained from a qualified specialist workshop.

### Important safety notes

#### WARNING

When driving in emergency mode, the driving characteristics deteriorate, e.g. when cornering, accelerating quickly and when braking. There is a risk of an accident.

Do not exceed the stated maximum speed. Avoid abrupt steering and driving maneuvers, and driving over obstacles (curbs, potholes, off-road). This applies in particular to a laden vehicle.

Stop driving in emergency mode if:

- you hear banging noises.
- the vehicle starts to shake.
- you see smoke and smell rubber.
- ESP® is intervening constantly.
- there are tears in the sidewalls of the tire.

After driving in emergency mode, have the wheel rims checked at a qualified specialist workshop with regard to their further use. The defective tire must be replaced in every case.

### 12 V battery (vehicle)

#### Important safety notes

Work on the 12 V battery, such as removal or installation, requires specialist knowledge and the use of special tools. You should therefore have all work involving the battery carried out at a qualified specialist workshop.

**⚠ WARNING**

Work carried out incorrectly on the battery can lead, for example, to a short circuit and thus damage the vehicle electronics. This can lead to function restrictions applying to safety-relevant systems, e.g. the lighting system, ABS (anti-lock braking system) or ESP® (Electronic Stability Program). The operating safety of your vehicle may be restricted. You could lose control of the vehicle, for example:

- braking
- in the event of abrupt steering maneuver and/or when the vehicle's speed is not adapted to the road conditions

There is a risk of an accident.

In the event of a short circuit or a similar incident, contact a qualified specialist workshop immediately. Do not drive any further. You should have all work involving the battery carried out at a qualified specialist workshop.

For further information about ABS and ESP®, see (▷ page 63) and (▷ page 66).

**⚠ WARNING**

Electrostatic build-up can lead to the creation of sparks, which could ignite the highly explosive gases of a battery. There is a risk of an explosion.

Before handling the battery, touch the vehicle body to remove any existing electrostatic build-up.

The highly flammable gas mixture forms when charging the battery as well as when jump-starting.

Always make sure that neither you nor the battery is electrostatically charged. A build-up of electrostatic charge can be caused, for example:

- by wearing clothing made from synthetic fibers
- due to friction between clothing and seats
- if you push or pull the battery across the carpet or other synthetic materials
- if you wipe the battery with a cloth

**⚠ WARNING**

During the charging process, a battery produces hydrogen gas. If a short circuit occurs or sparks are created, the hydrogen gas can ignite. There is a risk of an explosion.

- Make sure that the positive terminal of a connected battery does not come into contact with vehicle parts.
- Never place metal objects or tools on a battery.
- It is important that you observe the described order of the battery terminals when connecting and disconnecting a battery.
- When jump-starting, make sure that the battery poles with identical polarity are connected.
- It is particularly important to observe the described order when connecting and disconnecting the jumper cables.
- Never connect or disconnect the battery terminals while the engine is running.

**⚠ WARNING**

Battery acid is caustic. There is a risk of injury. Avoid contact with the skin, eyes or clothing. Do not inhale any battery gases. Do not lean over the battery. Keep children away from batteries. Wash battery acid immediately with water and seek medical attention.

**♻ Environmental note**

Batteries contain dangerous substances. It is against the law to dispose of them with the household rubbish. They must be collected separately and recycled to protect the environment.



Dispose of batteries in an environmentally friendly manner. Take discharged batteries to a qualified specialist workshop or a special collection point for used batteries.

**!** Have the battery checked regularly at a qualified specialist workshop.

Observe the service intervals in the Maintenance Booklet or contact a qualified specialist workshop for more information.

**!** You should have all work involving the battery carried out at a qualified specialist workshop. In the exceptional case that it is necessary for you to disconnect the battery yourself, make sure that:

- engage gear **P**.
- you switch off the ignition and remove the SmartKey. Make sure the ignition is switched off. Check that all the indicator lamps in the instrument cluster are off. Otherwise, electronic components, such as the alternator, may be damaged.
- you first remove the negative terminal clamp and then the positive terminal clamp. Never swap the terminal clamps. Otherwise, the vehicle's electronic system may be damaged.
- the transmission is locked in position **P** after disconnecting the battery. The vehicle is secured against rolling away. You can then no longer move the vehicle.

The battery and the cover of the positive terminal clamp must be installed securely during operation.

Comply with safety precautions and take protective measures when handling batteries.



Risk of explosion.



Fire, open flames and smoking are prohibited when handling the battery. Avoid creating sparks.



Battery acid is caustic. Avoid contact with skin, eyes or clothing.

Wear suitable protective clothing, especially gloves, apron and face-guard.

Rinse any acid spills immediately with clear water. Contact a physician if necessary.

Wear eye protection.



Keep children away.



Observe this Operator's Manual.



For safety reasons, Mercedes-Benz recommends that you only use batteries which have been tested and approved for your vehicle by Mercedes-Benz. These batteries provide increased impact protection to prevent vehicle occupants from suffering acid burns should the battery be damaged in the event of an accident.

In order for the battery to achieve the maximum possible service life, it must always be sufficiently charged.

Like other batteries, the vehicle battery may discharge over time if you do not use the vehicle. In this case, have the battery disconnected at a qualified specialist workshop. You can also charge the battery with a charger recommended by Mercedes-Benz. Contact a qualified specialist workshop for further information.

Have the battery condition of charge checked more frequently if you use the vehicle mainly for short trips or if you leave it standing idle for a lengthy period. Consult a qualified specialist workshop if you wish to leave your vehicle parked for a long period of time.

Only replace a battery with a battery that has been recommended by Mercedes-Benz.

- i** Remove the SmartKey if you park the vehicle and do not require any electrical consumers. The vehicle will then use very little energy, thus conserving battery power.

**i** If the power supply has been interrupted, e.g. if the battery was discharged, you will have to:

- set the clock (see separate audio system/COMAND operating instructions)

### Charging the battery

#### WARNING

During charging and jump-starting, explosive gases can escape from the battery. There is a risk of an explosion.

Particularly avoid fire, open flames, creating sparks and smoking. Ensure there is sufficient ventilation while charging and jump-starting. Do not lean over a battery.

#### WARNING

Battery acid is caustic. There is a risk of injury. Avoid contact with the skin, eyes or clothing. Do not inhale any battery gases. Do not lean over the battery. Keep children away from batteries. Wash battery acid immediately with water and seek medical attention.

#### WARNING

A discharged battery can freeze at temperatures below freezing point. When jump-starting the vehicle or charging the battery, gases can escape from the battery. There is a risk of an explosion.

Allow the frozen battery to thaw out before charging it or jump-starting.

**!** Only use battery chargers with a maximum charging voltage of 14.8 V.

**!** Only charge the battery using the jump-starting connection point.

The jump-starting connection point is in the engine compartment (▷ page 269).

- ▶ Open the hood.
- ▶ Connect the battery charger to the positive terminal and ground point in the same order as when connecting the donor bat-

tery in the jump-starting procedure (▷ page 269).

If, at low temperatures, the indicator lamps/warning lamps in the instrument cluster do not light up, it is highly likely that the discharged battery has frozen. In this case you may neither jump-start the vehicle nor charge the battery. The service life of a thawed-out battery may be shorter. The starting characteristics can be impaired, particularly at low temperatures. Have the thawed-out battery checked at a qualified specialist workshop.

Only charge the installed battery with a battery charger which has been tested and approved by Mercedes-Benz. A battery charger unit specially adapted for Mercedes-Benz vehicles and tested and approved by Mercedes-Benz is available as an accessory. It permits the charging of the battery in its installed position. Contact an authorized Mercedes-Benz Center for further information and availability. Read the battery charger's operating instructions before charging the battery.

## Jump-starting

For the jump-starting procedure, use only the jump-starting connection point, consisting of a positive terminal and an earth point, in the engine compartment.

### WARNING

Battery acid is caustic. There is a risk of injury.

Avoid contact with the skin, eyes or clothing. Do not inhale any battery gases. Do not lean over the battery. Keep children away from batteries. Wash battery acid immediately with water and seek medical attention.

### WARNING

During charging and jump-starting, explosive gases can escape from the battery. There is a risk of an explosion.

Particularly avoid fire, open flames, creating sparks and smoking. Ensure there is sufficient ventilation while charging and jump-starting. Do not lean over a battery.

### WARNING

During the charging process, a battery produces hydrogen gas. If a short circuit occurs or sparks are created, the hydrogen gas can ignite. There is a risk of an explosion.

- Make sure that the positive terminal of a connected battery does not come into contact with vehicle parts.
- Never place metal objects or tools on a battery.
- It is important that you observe the described order of the battery terminals when connecting and disconnecting a battery.
- When jump-starting, make sure that the battery poles with identical polarity are connected.
- It is particularly important to observe the described order when connecting and disconnecting the jumper cables.
- Never connect or disconnect the battery terminals while the engine is running.

### WARNING

A discharged battery can freeze at temperatures below freezing point. When jump-starting the vehicle or charging the battery, gases can escape from the battery. There is a risk of an explosion. Allow the frozen battery to thaw out before charging it or jump-starting.

**!** Avoid repeated and lengthy starting attempts.

Do not use a rapid-charging device to start the engine.

If, at low temperatures, the indicator lamps/warning lamps in the instrument cluster do not light up, it is highly likely that the discharged battery has frozen. In this case you may neither jump-start the vehicle nor charge the battery. The service life of a thawed-out battery may be shorter. The starting characteristics can be impaired, particularly at low temperatures. Have the thawed-out battery checked at a qualified specialist workshop.

If the 12 V battery is discharged, or after the vehicle has been jump-started, the **Service Required Do Not Shift Gears Visit Dealer** message appears. There is a malfunction in the on-board voltage. Visit a qualified specialist workshop **immediately**.

The drive system cannot be started if the 12 V battery is discharged. This is not dependent on whether the high-voltage battery is charged or not. The vehicle cannot be jump-started if the high-voltage battery is discharged. The high-voltage battery must be charged first.

The drive system can be started using another vehicle.

- Only use batteries with an equal nominal voltage (12 volts).
- Make sure that the battery of the donor vehicle does not have a significantly lower capacity than the discharged battery.
- Use jumper cables with a sufficient cross-section and insulated terminal clamps from a qualified specialist workshop, e.g. an authorized Mercedes-Benz Center.
- Make sure that the two vehicles do not touch.
- Route the jumper cables so that they cannot be caught by rotating components in the engine compartment.
- Do **not** disconnect the discharged battery from the vehicle's electrical system.



- ▶ Switch off the engine of both vehicles.
  - ▶ Shift the transmission to position **P**.
  - ▶ Switch off all electrical consumers.
  - ▶ Remove the battery cover.
  - ▶ Connect positive terminal ② on the vehicle with the flat battery to positive terminal ③ of the donor vehicle using the red jumper cable. Begin with the flat battery.
  - ▶ Connect negative terminal ④ of the donor vehicle to negative terminal ⑤ of the vehicle with the flat battery using the black jumper cable, beginning with donor vehicle's battery ⑥.
  - ▶ Start the engine of the donor vehicle and run it at idling speed.
  - ▶ Switch on the ignition in the vehicle with the flat battery.
  - ▶ If the traction drive cannot be activated immediately, wait for approximately 60 seconds between starting attempts.
- If the drive system does not start, call a breakdown service.



- i** Jumper cables and further information regarding jump-starting can be obtained at any qualified specialist workshop.

## Towing

### Important safety notes

#### WARNING

Functions relevant to safety are restricted or no longer available if:

- the ignition is switched off
- the brake system or the power steering is malfunctioning
- there is a malfunction in the power supply or the vehicle's electrical system

If your vehicle is being towed, much more force may be necessary to steer or brake. There is a risk of an accident.

In such cases, use a tow bar. Before towing, make sure that the steering moves freely.

#### WARNING

When towing or tow-starting another vehicle and its weight is greater than the permissible gross weight of your vehicle, the:

- the towing eye could detach itself
- the vehicle/trailer combination could roll-over.

There is a risk of an accident.

When towing or tow-starting another vehicle, its weight should not be greater than the permissible gross weight of your vehicle.

Information on your vehicle's gross vehicle mass rating can be found in the "Dimensions and weights" section (▷ page 311).

Make sure that no charging cable is plugged in. The parking lock cannot be released if a charging cable is plugged in.

- !** Observe the following points when towing with a tow rope:

- Secure the tow rope on the same side on both vehicles.
- Ensure that the tow cable is not longer than legally permitted. Mark the tow cable in the middle, e.g. with a white cloth (30 x 30 cm). This will make other road users aware that the vehicle is being towed.
- Only secure the tow cable to the towing eye.
- Observe the brake lamps of the towing vehicle while driving. Always maintain a distance so that the tow rope does not sag.
- Do not use steel cables or chains to tow your vehicle. You could otherwise damage the vehicle.

- !** Do not use the towing eyes for recovery purposes as this could damage the vehicle. If in doubt, recover the vehicle with a crane.

- !** If the HOLD function is activated, the vehicle brakes automatically in certain situations. To prevent damage to the vehicle, deactivate the HOLD function in the following or other similar situations:

- when towing the vehicle
- in the car wash

- !** Make sure that the electric parking brake is released. If the electric parking brake is faulty, visit a qualified specialist workshop. Mercedes-Benz recommends that you use an authorized Mercedes-Benz Center for this purpose.

- !** When towing, pull away slowly and smoothly. If the tractive power is too high, the vehicles could be damaged.

**!** The vehicle can be towed a maximum of 30 miles (50km). The towing speed of 30 mph (50 km/h) must not be exceeded. If the vehicle has to be towed more than 30 miles (50km), the entire vehicle must be raised and transported.

**!** Do not tow with sling-type equipment. This could damage the vehicle.

Observe the legal requirements for the relevant countries when towing.

If the vehicle can no longer be driven because of an accident or breakdown, you have the following options:

- transporting the vehicle  
As a rule, you should have the vehicle transported.
- towing the vehicle with a tow rope or tow bar  
Only tow the vehicle in exceptional cases. Observe the following notes.

The vehicle may not be towed and must always be transported if:

- the multifunction display is not working
  - one of more of the following warning lamps is lit up:
    - Drive system
    - 12 V battery
  - one or both of the following display messages have appeared:
    - Stop Switch Engine Off
    - Service Required Do Not Shift Gears Visit Dealer
  - the brake pedal begins to pulsate as the towing procedure commences.
  - you have to tow the vehicle over a longer distance than 30 miles (50 km).
- The battery must be connected and charged. Otherwise, you:
- cannot turn the SmartKey to position **2** in the ignition lock
  - cannot release the electric parking brake
  - cannot shift the transmission to position **N**

**i** The function of the electric parking brake and the parking lock is dependent on the on-board voltage. If the on-board voltage is low or there is a malfunction in the system, it may not be possible to apply the released parking brake or shift the transmission to position **P**.

**i** Switch off non-essential consumers, e.g. the radio.

**i** Disarm the automatic locking feature before the vehicle is towed (> page 188). You could otherwise be locked out when pushing or towing the vehicle.

### Installing/removing the towing eye

#### Installing the towing eye



Example: towing eye mounting covers

- ▶ Remove the towing eye from the stowage space.

The towing eye is located in the stowage well under the trunk floor.

Vehicles with the TIREFIT kit: the towing eye is beneath the tire inflation compressor.

- ▶ Press the mark on cover **1** inwards in the direction of the arrow.

- ▶ Take cover ① off the opening.
- ▶ Screw in the towing eye clockwise as far as it will go and tighten it.

### Removing the towing eye

- ▶ Unscrew the towing eye counter-clockwise.
- ▶ Attach cover ① to the bumper and press until it engages.
- ▶ Place the towing eye in the stowage well under the trunk floor.

### Towing a vehicle with both axles on the ground

Observe the important safety instructions when towing your vehicle with both axles on the ground (▷ page 271).

- ❗ In order to signal a change of direction when towing with the hazard warning lamps switched on, use the combination switch as usual. In this case, only the indicator lamps for the direction of travel flash. After resetting the combination switch, the hazard warning lamp starts flashing again.

The transmission automatically shifts to position **P** when you open the driver's or front-passenger door or when you remove the SmartKey from the ignition lock. In order to ensure that the transmission stays in position **N** when towing the vehicle, you must observe the following points:

- ▶ Make sure that the vehicle is stationary.
- ▶ Turn the SmartKey to position **2** in the ignition lock.
- ▶ Depress and hold the brake pedal.
- ▶ Shift the transmission to position **N**.
- ▶ Release the brake pedal.
- ▶ Release the electric parking brake.
- ▶ Switch on the hazard warning lamps (▷ page 100).
- ▶ Leave the SmartKey in position **2** in the ignition lock.

If the 12 V battery indicator lamp lights up, you must observe the following points:

- ▶ Pull over and stop the vehicle safely as soon as possible, paying attention to road and traffic conditions.
- ▶ Shift the transmission to position **P**.
- ▶ Apply the electric parking brake.

### Towing the vehicle with the front axle raised

Observe the important safety notes when towing your vehicle with the front axle raised (▷ page 271).

- ❗ The ignition must be switched off if the vehicle is being towed with the front axle raised. Otherwise, ESP® may intervene and damage the brake system.
- ▶ Make sure that the vehicle is stationary.
- ▶ Turn the SmartKey to position **2** in the ignition lock.
- ▶ Depress and hold the brake pedal.
- ▶ Shift the transmission to position **P**.
- ▶ Release the brake pedal.
- ▶ Release the electric parking brake.
- ▶ Switch on the hazard warning lamps (▷ page 100).
- ▶ Turn the SmartKey in the ignition lock to position **0** and leave the SmartKey in the ignition lock.

### Towing the vehicle with the rear axle raised

When towing your vehicle with the rear axle raised, it is important that you observe the safety instructions (▷ page 271).

- ❗ The ignition must be switched off if you are towing the vehicle with the rear axle raised. Intervention by ESP® could otherwise damage the brake system.

The transmission automatically shifts to position **P** when you open the driver's or front-passenger door or when you remove the SmartKey from the ignition lock. In order to ensure that the transmission stays in position **N** when towing the vehicle, you must observe the following points:

- ▶ Make sure that the vehicle is stationary.
- ▶ Turn the SmartKey to position **2** in the ignition lock.
- ▶ Depress and hold the brake pedal.
- ▶ Shift the transmission to position **N**.
- ▶ Release the brake pedal.
- ▶ Apply the electric parking brake.
- ▶ Position the front wheels in the straight-ahead position.
- ▶ Switch on the hazard warning lamps (▷ page 100).
- ▶ Turn the SmartKey in the ignition lock to position **0** and leave the SmartKey in the ignition lock.

### Transporting the vehicle

The towing eye can be used to pull the vehicle onto a trailer or transporter for transporting purposes.

- ▶ Turn the SmartKey to position **2** in the ignition lock.
- ▶ When the vehicle is stationary, depress the brake pedal and keep it depressed.
- ▶ Shift the transmission to position **N**.

### As soon as the vehicle has been loaded:

- ▶ Prevent the vehicle from rolling away by applying the electric parking brake.
- ▶ Shift the transmission to position **P**.
- ▶ Turn the SmartKey in the ignition lock to position **0** and remove the SmartKey from the ignition lock.
- ▶ Secure the vehicle.

**!** You may only secure the vehicle by the wheels, not by parts of the vehicle such as

axle or steering components. Otherwise, the vehicle could be damaged.

## Fuses

### Important safety notes

#### WARNING

If you manipulate or bridge a faulty fuse or if you replace it with a fuse with a higher amperage, the electric cables could be overloaded. This could result in a fire. There is a risk of an accident and injury.

Always replace faulty fuses with the specified new fuses having the correct amperage.

- !** Only use fuses that have been approved for Mercedes-Benz vehicles and which have the correct fuse rating for the system concerned. Only use fuses marked with an "S". Otherwise, components or systems could be damaged.

The fuses in your vehicle serve to close down faulty circuits. If a fuse blows, all the components on the circuit and their functions stop operating.

Blown fuses must be replaced with fuses of the same rating, which you can recognize by the color and value. The fuse ratings are listed in the fuse allocation chart.

If a newly inserted fuse also blows, have the cause traced and rectified at a qualified specialist workshop, e.g. an authorized Mercedes-Benz Center.

### Before changing a fuse

- ▶ Secure the vehicle against rolling away (▷ page 144).
- ▶ Switch off all electrical consumers.
- ▶ Turn the SmartKey to position **0** in the ignition lock and remove it (▷ page 127). All indicator lamps in the instrument cluster must be off.

The fuses are located in various fuse boxes:

- Fuse box in the engine compartment on the left-hand side of the vehicle, when viewed in the direction of travel
- Fuse box in the front-passenger footwell

The fuse allocation chart is on the fuse box in the front-passenger footwell (▷ page 275).

### Fuse box in the engine compartment

#### WARNING

When the hood is open and the windshield wipers are set in motion, you can be injured by the wiper linkage. There is a risk of injury. Always switch off the windshield wipers and the ignition before opening the hood.

- ❗ Make sure that no moisture can enter the fuse box when the cover is open.
- ❗ When closing the cover, make sure that it is lying correctly on the fuse box. Moisture seeping in or dirt could otherwise impair the operation of the fuses.



- ▶ Open the hood.
- ▶ Use a dry cloth to remove any moisture from the fuse box.
- ▶ **To open:** unclip hood release cable ④ from the bracket ③.
- ▶ Open retaining clamps ②.
- ▶ Fold up cover ① in the direction of the arrow and remove it.



- ▶ **To close:** check whether the seal is seated correctly in cover ①.
- ▶ Insert cover ① at the back into openings ⑤ on the fuse box.
- ▶ Slide hood release cable ④ to the side and hold if necessary.
- ▶ Fold down cover ①.
- ▶ Clip hood release cable ④ into bracket ③.
- ▶ Hook clamps ② into the fuse box and close.
- ▶ Close the hood.

### Fuse box in the front-passenger footwell

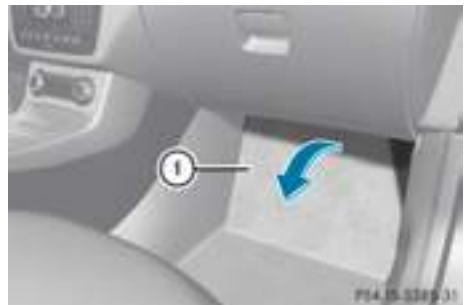

- ▶ **To open:** remove the floor mat from the front-passenger side.
- ▶ Fold out perforated floor covering ① in the direction of the arrow.

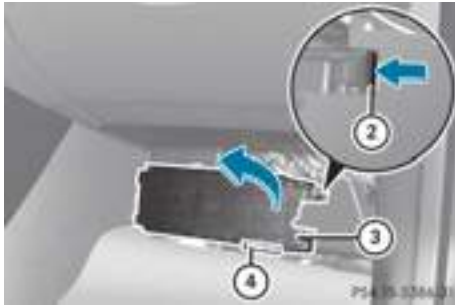

- ▶ To release cover (3), press retaining clamp (2).
- ▶ Fold out cover (3) in the direction of the arrow to the catch.
- ▶ Remove cover (3) forwards.
- ▶ **i** Fuse allocation chart (4) is located on the lower right-hand side of cover (3).
- ▶ **To close:** insert cover (3) on the left-hand side of the fuse box into the retainer. Cover (3) engages in the retainers.
- ▶ Fold down cover (3) until clamps (2) lock audibly.
- ▶ Fold back perforated floor covering (1).

Useful information .....	278
Important safety notes .....	278
Operation .....	278
Winter operation .....	280
Tire pressure .....	281
Loading the vehicle .....	288
Maximum load rating .....	291
Uniform Tire Quality Grading Standards .....	291
Tire labeling .....	293
Definition of terms for tires and loading .....	296
Changing a wheel .....	299
Wheel and tire combinations .....	303

## Useful information

- i** This Operator's Manual describes all models and all standard and optional equipment of your vehicle available at the time of publication of the Operator's Manual. Country-specific differences are possible. Bear in mind that your vehicle may not feature all functions described here. This also applies to safety-relevant systems and functions.
- i** Read the information on qualified specialist workshops: (> page 24).

## Important safety notes

### WARNING

If wheels and tires of the wrong size are used, the wheel brakes or suspension components may be damaged. There is a risk of an accident.

Always replace wheels and tires with those that fulfill the specifications of the original part.

When replacing wheels, make sure to use the correct:

- designation
- model

When replacing tires, make sure to use the correct:

- designation
- manufacturer
- model

### WARNING

A flat tire severely impairs the driving, steering and braking characteristics of the vehicle. There is a risk of accident.

Tires without run-flat characteristics:

- do not drive with a flat tire.
- immediately replace the flat tire with your emergency spare wheel or spare wheel, or consult a qualified specialist workshop.

Tires with run-flat characteristics:

- pay attention to the information and warning notices on MOExtended tires (tires with run-flat characteristics).

Accessories that are not approved for your vehicle by Mercedes-Benz or are not being used correctly can impair the operating safety.

Before purchasing and using non-approved accessories, visit a qualified specialist workshop and ask about:

- suitability
- legal stipulations
- factory recommendations

Information on dimensions and types of wheels and tires for your vehicle can be found (> page 303).

Information on air pressure for the tires on your vehicle can be found:

- on the vehicle's Tire and Loading Information placard on the B-pillar
- on the tire pressure label on the charge socket flap (> page 281)
- under "Tire pressure" (> page 281)

- i** Further information on wheels and tires can be obtained at any qualified specialist workshop.

## Operation

### Information on driving

- If the vehicle is heavily loaded, check the tire pressures and correct them if necessary.
- While driving, pay attention to vibrations, noises and unusual handling characteristics, e.g. pulling to one side. This may indicate that the wheels or tires are damaged. If you suspect that a tire is defective, reduce your speed immediately. Stop the vehicle as soon as possible to check the wheels and tires for damage. Hidden tire damage could also be causing the unusual



handling characteristics. If you find no signs of damage, have the tires and wheels checked at a qualified specialist workshop.

- When parking your vehicle, make sure that the tires do not get deformed by the curb or other obstacles. If it is necessary to drive over curbs, speed humps or similar elevations, try to do so slowly and at an obtuse angle. Otherwise, the tires, particularly the sidewalls, may be damaged.

### Regular checking of wheels and tires

#### WARNING

Damaged tires can cause tire inflation pressure loss. As a result, you could lose control of your vehicle. There is a risk of accident.

Check the tires regularly for signs of damage and replace any damaged tires immediately.

Check the wheels and tires of your vehicle for damage at least once a month, as well as after driving off-road or on rough roads. Damaged wheels can cause a loss of tire pressure. Pay particular attention to damage such as:

- cuts in the tires
- punctures
- tears in the tires
- bulges on tires
- deformation or severe corrosion on wheels

Regularly check the tire tread depth and the condition of the tread across the whole width of the tire (▷ page 279). If necessary, turn the front wheels to full lock in order to inspect the inner side of the tire surface.

All wheels must have a valve cap to protect the valve against dirt and moisture. Do not mount anything onto the valve other than the standard valve cap or other valve caps approved by Mercedes-Benz for your vehicle. Do not use any other valve caps or systems, e.g. tire pressure monitoring systems.

Regularly check the pressure of all the tires particularly prior to long trips. Adjust the tire pressure as necessary (▷ page 281).

The service life of tires depends, among other things, on the following factors:

- driving style
- tire pressure
- distance covered

### Important safety notes on the tire tread

#### WARNING

Insufficient tire tread will reduce tire traction. The tire is no longer able to dissipate water. This means that on wet road surfaces, the risk of hydroplaning increases, in particular where speed is not adapted to suit the driving conditions. There is a risk of accident.

If the tire pressure is too high or too low, tires may exhibit different levels of wear at different locations on the tire tread. Thus, you should regularly check the tread depth and the condition of the tread across the entire width of all tires.

Minimum tire tread depth for:

- Summer tires:  $\frac{1}{8}$  in (3 mm)
- M+S tires:  $\frac{1}{4}$  in (4 mm)

For safety reasons, replace the tires before the legally prescribed limit for the minimum tire tread depth is reached.

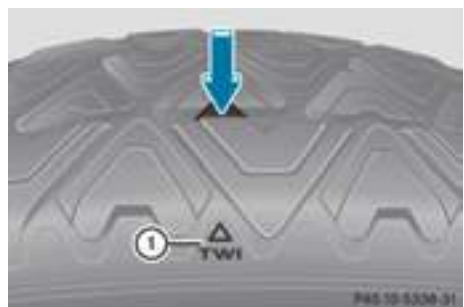

Bar indicator ① for tread wear is integrated into the tire tread.

Treadwear indicators (TWI) are required by law. Six indicators are positioned on the tire tread. They are visible once the tread depth is

approximately  $\frac{1}{16}$  in (1.6 mm). If this is the case, the tire is so worn that it must be replaced.

### Selecting, mounting and replacing tires

- Only mount tires and wheels of the same type and make.

Exception: it is permissible to install a different type or make in the event of a flat tire. Observe the "Tires with run-flat characteristics" section (▷ page 264).

- Only mount tires of the correct size onto the wheels.
- Break in new tires at moderate speeds for the first 60 miles (100 km). The tires only reach their full performance after this distance.
- Do not drive with tires which have too little tread depth, as this significantly reduces the traction on wet roads (hydroplaning).
- Replace the tires after six years at the latest, regardless of wear.

## Winter operation

### General notes

Have your vehicle winterproofed at a qualified specialist workshop at the onset of winter.

Observe the notes in the "Changing a wheel" section (▷ page 299).

### Driving with summer tires

At temperatures below 45 °F (+7 °C), summer tires lose elasticity and therefore traction and braking power. Change the tires on your vehicle to M+S tires. Using summer tires at very cold temperatures could cause cracks to form, thereby damaging the tires permanently. Mercedes-Benz cannot accept responsibility for this type of damage.

### M+S tires

#### WARNING

M+S tires with a tire tread depth of less than  $\frac{1}{8}$  in (4 mm) are not suitable for use in winter and do not provide sufficient traction. There is a risk of an accident.

M+S tires with a tread depth of less than  $\frac{1}{8}$  in (4 mm) must be replaced immediately.

At temperatures below 45 °F (+7 °C), use winter tires or all-season tires. Both types of tire are identified by the M+S marking.

Only winter tires bearing the  snowflake symbol in addition to the M+S marking provide the best possible grip in wintry road conditions. Only these tires will allow driving safety systems such as ABS and ESP® to function optimally in winter. These tires have been developed specifically for driving in snow.

Use M+S tires of the same make and tread on all wheels to maintain safe handling characteristics.

Always observe the maximum permissible speed specified for the M+S tires you have mounted.

Once the winter tires are mounted:

- ▶ Check the tire pressures (▷ page 284).
- ▶ Restart the tire pressure monitor (▷ page 287).

### Snow chains

#### WARNING

If snow chains are mounted on the rear wheels, the snow chains could cause abrasion to the vehicle body or to chassis components. This could cause damage to the vehicle or the tires. There is a risk of an accident.

To avoid hazardous situations:

- never mount snow chains on the rear wheels
- only mount snow chains in pairs on the front wheels.

**!** On some tire sizes there is not enough space for snow chains. To avoid damage to the vehicle or tires, observe the "Wheel and tire combinations" section under "Tires and wheels".

For safety reasons, Mercedes-Benz recommends that you only use snow chains that have been specially approved for your vehicle by Mercedes-Benz, or are of a corresponding standard of quality.

If you intend to mount snow chains, please bear the following points in mind:

- Snow chains may not be mounted on all wheel/tire combinations. Permissible wheel-tire combinations (▷ page 303).
  - Only use snow chains when driving on roads completely covered by snow. Remove the snow chains as soon as possible when you come to a road that is not snow-covered.
  - Local regulations may restrict the use of snow chains. Observe the appropriate regulations if you wish to mount snow chains.
  - Do not exceed the maximum permissible speed of 30 mph (50 km/h).
  - When snow chains are installed, never use Active Parking Assist (▷ page 159).
- i** You may wish to deactivate ESP® (▷ page 67) when pulling away with snow chains installed. You can thereby allow the wheels to spin in a controlled manner, achieving an increased driving force (cutting action).

## Tire pressure

### Tire pressure specifications

#### WARNING

Underinflated or overinflated tires pose the following risks:

- the tires may burst, especially as the load and vehicle speed increase.
- the tires may wear excessively and/or unevenly, which may greatly impair tire traction.
- the driving characteristics, as well as steering and braking, may be greatly impaired.

There is a risk of an accident.

Follow recommended tire inflation pressures and check the pressure of all the tires including the spare wheel:

- monthly, at least
- if the load changes
- before beginning a long journey
- under different operating conditions, e.g. off-road driving

If necessary, correct the tire pressure.

Use a suitable pressure gauge to check the tire pressure. The outer appearance of a tire does not permit any reliable conclusion about the tire pressure. On vehicles equipped with the electronic tire pressure monitor, the tire pressure can be checked in the on-board computer.

The recommended tire pressures for the tires mounted at the factory can be found on the labels described here.

1.) **Tire and Loading Information placard** on the B-pillar on the driver's side of the vehicle (▷ page 288).

The Tire and Loading Information placard contains the recommended tire pressures for cold tires. The recommended tire pressures are valid for the maximum permissible load and up to the maximum permissible vehicle speed.



2.) **Tire pressure table** on the inside of the charge socket flap.

The tire pressure table contains the recommended pressures for cold tires for various operating conditions, i.e. differing load and speed conditions.

**i** Specifications shown in the examples of tire pressure tables are for illustration purposes only. Tire pressure specifications are vehicle-specific and may deviate from the data shown here. Tire pressure specifications applicable to your vehicle are located in your vehicle's tire pressure table.



Example: tire pressure table for all tires permitted for this vehicle by the factory

If a tire size precedes a tire pressure, the tire pressure information following is only valid for that tire size. The load conditions "partially laden" and "fully laden" are defined in the table for different numbers of occupants and amounts of luggage. The actual number of seats may differ.

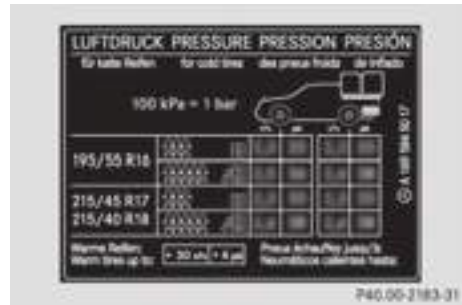

Example: tire pressure table with tire dimensions

Some tire pressure tables show only the rim diameters instead of the full tire size, e.g. **R18**. Rim diameter is part of the tire size and can be found on the tire sidewall (▷ page 293).

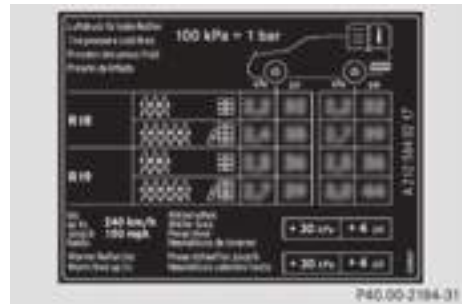

If the tire pressure have been set for light loads and/or low speeds, set them to the higher values:

- if you want to drive with an increased load and/or
- if you want to drive at higher road speeds

**i** The tire pressures for increased loads and/or higher road speeds, shown in the tire pressure table, may have a negative effect on driving comfort.

If the tire pressure is not set correctly, this can lead to an excessive build up of heat and a sudden loss of pressure.

For more information, contact a qualified specialist workshop.

### Important notes on tire pressure

#### WARNING

If the tire pressure drops repeatedly, the wheel, valve or tire may be damaged. Tire pressure that is too low may result in a tire blow-out. There is a risk of an accident.

- Check the tire for foreign objects.
- Check whether the wheel is losing air or the valve is leaking.

If you are unable to rectify the damage, contact a qualified specialist workshop.

#### WARNING

If you fit unsuitable accessories onto tire valves, the tire valves may be overloaded and malfunction, which can cause tire pressure loss. Due to their design, retrofitted tire pressure monitors keep the tire valve open. This can also result in tire pressure loss. There is a risk of an accident.

Only screw the standard valve cap or other valve caps approved by Mercedes-Benz for your vehicle onto the tire valve.

Use a suitable pressure gauge to check the tire pressure. The outer appearance of a tire does not permit any reliable conclusion about the tire pressure.

The tire temperature and pressure increase when the vehicle is in motion. This is dependent on the driving speed and the load.

Therefore, you should only correct tire pressures when the tires are cold.

The tires are cold:

- if the vehicle has been parked with the tires out of direct sunlight for at least 3 hours and
- if the vehicle has not been driven further than 1 mile (1.6 km)

The tire temperature changes depending on the outside temperature, the vehicle speed and the tire load. If the tire temperature changes by 18 °F (10 °C), the tire pressure changes by approximately 10 kPa (0.1 bar/ 1.5 psi). Take this into account when check-

ing the pressure of warm tires. Only correct the tire pressure if it is too low for the current operating conditions. If you check the tire pressure when the tires are warm, the resulting value will be higher than if the tires were cold. This is normal. Do not reduce the tire pressure to the value specified for cold tires. The tire pressure would otherwise be too low. Observe the recommended tire pressures for cold tires:

- on the Tire and Loading Information placard on the B-pillar on the driver's side
- in the tire pressure table on the inside of the fuel filler flap

### Underinflated or overinflated tires

#### Underinflated tires

##### WARNING

Tires with pressure that is too low can overheat and burst as a consequence. In addition, they also suffer from excessive and/or irregular wear, which can severely impair the braking properties and the driving characteristics. There is a risk of an accident.

Avoid tire pressures that are too low in all the tires, including the spare wheel.

Underinflated tires may:

- wear excessively and/or unevenly
- have an adverse effect on energy consumption
- overheat, leading to tire defects
- have an adverse effect on handling characteristics

#### Overinflated tires

##### WARNING

Tires with excessively high pressure can burst because they are damaged more easily by road debris, potholes etc. In addition, they also suffer from irregular wear, which can severely impair the braking properties and the

driving characteristics. There is a risk of an accident.

Avoid tire pressures that are too high in all the tires, including the spare wheel.

Overinflated tires may:

- adversely affect handling
- wear excessively and/or unevenly
- be more likely to become damaged
- have an adverse effect on ride comfort
- increase the braking distance

### Maximum tire pressures

Do not exceed the maximum permissible tire inflation pressure. Always observe the recommended tire pressure for your vehicle when adjusting the tire pressure (▷ page 281).



① Example: maximum permissible tire pressure

**i** The actual values for tires are vehicle-specific and may deviate from the values in the illustration.

### Checking the tire pressures

#### Important safety notes

Observe the "Tire pressure information" section (▷ page 281).

Information on air pressure for the tires on your vehicle can be found:

- on the vehicle's Tire and Loading Information placard on the B-pillar
- on the tire pressure label on the fuel filler flap
- in the "Tire pressure information" section

### Checking tire pressures manually

To determine and set the correct tire pressure, proceed as follows:

- ▶ Remove the valve cap of the tire that is to be checked.
- ▶ Press the tire pressure gauge securely onto the valve.
- ▶ Read the tire pressure and compare it with the recommended value on the Tire and Loading Information placard. The loading information table is on the B-pillar on the driver's side of your vehicle.
- ▶ If necessary, increase the tire pressure to the recommended value (▷ page 281).
- ▶ If the tire pressure is too high, release air by pressing down the metal pin in the valve using the tip of a pen, for example. Then, check the tire pressure again using the tire pressure gauge.
- ▶ Screw the valve cap onto the valve.
- ▶ Repeat these steps for the other tires.

### Tire pressure monitor

#### General notes

If a tire pressure monitor is installed, the vehicle's wheels have sensors that monitor the tire pressures in all four tires. The tire pressure monitor warns you if the pressure drops in one or more of the tires. The tire pressure monitor only functions if the correct sensors are installed on all wheels.

Information on tire pressures is displayed in the multifunction display. After a few minutes of driving, the current tire pressure of each

tire is shown in the **Serv.** menu of the multi-function display.



Example: current tire pressure display

For information on the message display, refer to the "Checking the tire pressure electronically" section (▷ page 286).

### Important safety notes

#### **WARNING**

Each tire, including the spare (if provided), should be checked at least once every two weeks when cold and inflated to the pressure recommended by the vehicle manufacturer on the Tire and Loading Information placard on the driver's door B-pillar or the tire pressure label on the inside of the fuel filler flap. If your vehicle has tires of a different size than the size indicated on the Tire and Loading Information placard or, if available, the tire pressure label, you should determine the proper tire pressure for those tires.

As an added safety feature, your vehicle has been equipped with a tire pressure monitoring system (TPMS) that illuminates a low tire pressure telltale when one or more of your tires are significantly underinflated. Accordingly, when the low tire pressure telltale lights up, you should stop and check your tires as soon as possible, and inflate them to the proper pressure. Driving on a significantly underinflated tire causes the tire to overheat and can lead to tire failure.

Underinflation also reduces fuel efficiency and tire tread life, and may affect the vehicle's handling and stopping ability. Please note that the TPMS is not a substitute for proper tire maintenance, and it is the driver's responsibility to maintain correct tire pressure, even if underinflation has not reached the level to

trigger illumination of the TPMS low tire pressure telltale.

Your vehicle has also been equipped with a TPMS malfunction indicator to indicate when the system is not operating properly. The TPMS malfunction indicator is combined with the low tire pressure telltale. When the system detects a malfunction, the warning lamp will flash for approximately a minute and then remain continuously illuminated. This sequence will be repeated every time the vehicle is started as long as the malfunction exists. When the malfunction indicator is illuminated, the system may not be able to detect or signal low tire pressure as intended.

TPMS malfunctions may occur for a variety of reasons, including the installation of incompatible replacement or alternate tires or wheels on the vehicle that prevent the TPMS from functioning properly. Always check the TPMS malfunction telltale after replacing one or more tires or wheels on your vehicle to ensure that the replacement or alternate Tires and wheels allow the TPMS to continue to function properly.

It is the driver's responsibility to set the tire pressure to that recommended for cold tires which is suitable for the operating situation (▷ page 281). Note that the correct tire pressure for the current operating situation must first be taught-in to the tire pressure monitor. If there is a substantial loss of pressure, the warning threshold for the warning message is aligned to the reference values taught-in. Restart the tire pressure monitor after adjusting the pressure of the cold tires (▷ page 287). The current pressures are saved as new reference values. As a result, a warning message will appear if the tire pressure drops significantly.

The tire pressure monitor does not warn you of an incorrectly set tire pressure. Observe the notes on the recommended tire pressure (▷ page 281).

The tire pressure monitor is not able to warn you of a sudden loss of pressure, e.g. if the



tire is penetrated by a foreign object. In the event of a sudden loss of pressure, bring the vehicle to a halt by braking carefully. Avoid sudden steering movements.

The tire pressure monitor has a yellow warning lamp in the instrument cluster for indicating a pressure loss or malfunction. Whether the warning lamp flashes or lights up indicates whether a tire pressure is too low or the tire pressure monitor is malfunctioning:

- if the warning lamp is lit continuously, the tire pressure on one or more tires is significantly too low. The tire pressure monitor is not malfunctioning.
- if the warning lamp flashes for around a minute and then remains lit constantly, the tire pressure monitor is malfunctioning.





**i** In addition to the warning lamp, a message appears in the multifunction display. Further information can be found on (> page 211).

If the tire pressure monitor is malfunctioning, it may take more than 10 minutes for the tire pressure warning lamp to inform you of the malfunction. When the malfunction has been rectified, the tire pressure warning lamp goes out after a few minutes of driving.

The tire pressure values indicated by the on-board computer may differ from those measured at a gas station with a pressure gauge. The tire pressures shown by the on-board computer refer to those measured at sea level. At high altitudes, the tire pressure values indicated by a pressure gauge are higher than those shown by the on-board computer. In this case, do not reduce the tire pressures.

The operation of the tire pressure monitor can be affected by interference from radio transmitting equipment (e.g. radio headphones, two-way radios) that may be being operated in or near the vehicle.

## Checking the tire pressure electronically

- ▶ Make sure that the SmartKey is in position **2** in the ignition lock (> page 127).
- ▶ Press the  or  button on the steering wheel to select the **Serv.** menu.
- ▶ Press the  or  button to select **Tire Pressure**.
- ▶ Press the  button.

The current tire pressure of each tire is shown in the multifunction display.

If the vehicle has been parked for over 20 minutes, the **Tire pressure will be displayed after driving a few minutes** message appears.

After a teach-in process, the tire pressure monitor automatically detects new wheels or new sensors. As long as a clear allocation of the tire pressure value to the individual wheels is not possible, the **Tire Pressure Monitor Active** message is shown instead of the tire pressure display. The tire pressures are already being monitored.

## Tire pressure monitor warning messages

If the tire pressure monitor detects a pressure loss in a tire, a warning message is shown in the multifunction display and the yellow tire pressure monitor warning lamp comes on.

- If the **Please Correct Tire Pressure** message appears in the multifunction display, the tire pressure in at least one tire is too low. Correct the tire pressure at the next opportunity.
- If the **Check Tires** message appears in the multifunction display, the tire pressure in at least one tire has dropped significantly. Check the tires.
- If the **Warning Tire Malfunction** message appears in the multifunction display, the tire pressure in at least one tire has dropped suddenly. Check the tires.



Observe the instructions and safety notes in the display messages in the "Tires" section (▷ page 211).

- ❗ If the wheel positions are rotated, the tire pressure may be displayed for the wrong positions. This is rectified after a few minutes of driving, and the tire pressures are displayed for the correct positions.

### Restarting the tire pressure monitor

When you restart the tire pressure monitor, all existing warning messages are deleted and the warning lamps go out. The monitor uses the currently set tire pressures as the reference values for monitoring. In most cases, the tire pressure monitor will automatically detect the new reference values after you have changed the tire pressure. However, you can also define reference values manually as described here. The tire pressure monitor then monitors the new tire pressure values.

- ▶ Set the tire pressure to the value recommended for the corresponding driving situation on the Tire and Loading Information placard on the driver's side B-pillar (▷ page 281).

Additional tire pressure values for different operating conditions can also be found on the tire pressure table on the inside of the charge socket flap (▷ page 281).

- ▶ Make sure that the tire pressure is correct on all four wheels.
- ▶ Make sure that the SmartKey is in position 2 in the ignition lock.
- ▶ Press the ◀ or ▶ button on the steering wheel to select the **Serv.** menu.
- ▶ Press the ▲ or ▼ button to select **Tire Pressure**.
- ▶ Press the **OK** button.  
The multifunction display shows the current tire pressure for the individual tires or the **Tire pressure will be displayed**

**after driving a few minutes** message.

- ▶ Press the ▼ button.  
The **Use Current Pressures as New Reference Values** message appears in the multifunction display.

#### If you wish to confirm the restart:

- ▶ Press the **OK** button.  
The **Tire Press. Monitor Restarted** message appears in the multifunction display.

After driving for a few minutes, the system checks whether the current tire pressures are within the specified range. The new tire pressures are then accepted as reference values and monitored.

#### If you wish to cancel the restart:

- ▶ Press the ↵ button.  
The tire pressure values stored at the last restart will continue to be monitored.

### Radio type approval for the tire pressure monitor

Country	Radio type approval number
Brazil	1489-10-4415 Model: MRXMERTX1
Dubai	TRA, Registered NO 0016161/08 TRA, Registered NO ER0076990/11 Dealer NO: DA0047074/10
Morocco	MR5526 ANRT 2010/27/04/2010 MR6706 ANRT 2011/17/11/2011
Philippines	ESD-1105558C
Serbia	И 011 12

Country	Radio type approval number
Singapore	Compliance with IDA Standard N0140-09
South Africa	TA-2008/1068 TA-2011/1370

## Loading the vehicle

### Instruction labels for tires and loads

#### WARNING

Overloaded tires can overheat, causing a blowout. Overloaded tires can also impair the steering and driving characteristics and lead to brake failure. There is a risk of accident.

Observe the load rating of the tires. The load rating must be at least half of the GAWR of your vehicle. Never overload the tires by exceeding the maximum load.



#### ① B-pillar, driver's side

Two instruction labels on your vehicle show the maximum possible load.

- (1) The Tire and Loading Information placard is on B-pillar ① on the driver's side. The Tire and Loading Information placard shows the maximum permissible number of occupants and the maximum permissible vehicle load. It also contains details of the tire sizes and corresponding pressures for tires mounted at the factory.
- (2) The vehicle identification plate is on the B-pillar on the driver's side. The vehicle identification plate informs you of the

gross vehicle weight rating. It is made up of the vehicle weight, all vehicle occupants and the load. You can also find information about the maximum gross axle weight rating on the front and rear axle.

The maximum gross axle weight rating is the maximum weight that can be carried by one axle (front or rear axle). Do not exceed the maximum gross vehicle weight or the maximum gross axle weight rating for the front or rear axle.

### Maximum permissible mass.



- Specification for maximum permissible weight ① is listed on the Tire and Loading Information placard: "The combined weight of occupants and cargo should never exceed XXX kilograms or XXX lbs."

The gross weight of all vehicle occupants, load and luggage must not exceed the specified value.

- ① The specifications shown on the Tire and Loading Information placard in the illustration are examples. The maximum permissible load is vehicle-specific and may deviate from the data shown here. The maximum permissible load that applies for your vehicle can be found on your vehicle's Tire and Loading Information placard.

## Number of seats



Maximum number of seats ① indicates the maximum number of occupants allowed to travel in the vehicle. This information can be found on the Tire and Loading Information placard.

**i** The specifications shown on the Tire and Loading Information placard in the illustration are examples. The number of seats is vehicle-specific and can differ from the details shown. The number of seats in your vehicle can be found on the Tire and Loading Information placard.

## Determining the correct load limit

### Step-by-step instructions

The following steps have been developed as required of all manufacturers under Title 49, Code of U.S. Federal Regulations, Part 575 pursuant to the "National Traffic and Motor Vehicle Safety Act of 1966".

- ▶ **Step 1:** Locate the statement "The combined weight of occupants and cargo should never exceed XXX kg or XXX lbs." on your vehicle's Tire and Loading Information placard.
- ▶ **Step 2:** Determine the combined weight of the driver and passengers that will be riding in your vehicle.
- ▶ **Step 3:** Subtract the combined weight of the driver and passengers from XXX kilograms or XXX lbs.

▶ **Step 4:** The resulting figure equals the available amount of cargo and luggage load capacity. For example, if the "XXX" amount equals 1400 lbs and there will be five 150-lb passengers in your vehicle, the amount of available cargo and luggage load capacity is 650 lbs ( $1400 - 750 (5 \times 150) = 650$  lbs).

▶ **Step 5:** Determine the combined weight of luggage and cargo being loaded on the vehicle. That weight may not safely exceed the available cargo and luggage load capacity calculated in step 4.

**Example: steps 1 to 3**

The following table shows examples of how to calculate total and cargo load capacities with varying seating configurations and different numbers of occupants. The following examples use a maximum load of 1,500 lbs (680 kg). **This is for illustration purposes only.** Make sure you are using the actual load limit for your vehicle stated on your vehicle's Tire and Loading Information placard (▷ page 289).

The greater the combined weight of the occupants, the lower the maximum luggage load.

		Example 1	Example 2	Example 3
Step 1	<b>Combined maximum weight of occupants and load (data from the Tire and Loading Information placard)</b>	1500 lbs (680 kg)	1500 lbs (680 kg)	1500 lbs (680 kg)

		Example 1	Example 2	Example 3
Step 2	<b>Number of people in the vehicle (driver and occupants)</b>	5	3	1
	<b>Distribution of the occupants</b>	Front: 2 Rear: 3	Front: 1 Rear: 2	Front: 1
	<b>Weight of the occupants</b>	Occupant 1: 150 lbs (68 kg) Occupant 2: 180 lbs (82 kg) Occupant 3: 160 lbs (73 kg) Occupant 4: 140 lbs (63 kg) Occupant 5: 120 lbs (54 kg)	Occupant 1: 200 lbs (91 kg) Occupant 2: 190 lbs (86 kg) Occupant 3: 150 lbs (68 kg)	Occupant 1: 150 lbs (68 kg)
	<b>Gross weight of all occupants</b>	750 lbs (340 kg)	540 lbs (245 kg)	150 lbs (68 kg)

		Example 1	Example 2	Example 3
<b>Step 3</b>	<b>Permissible load (maximum gross vehicle weight rating from the Tire and Loading Information placard minus the gross weight of all occupants)</b>	1500 lbs (680 kg) - 750 lbs (340 kg) = 750 lbs (340 kg)	1500 lbs (680 kg) - 540 lbs (245 kg) = 960 lbs (435 kg)	1500 lbs (680 kg) - 150 lbs (68 kg) = 1350 lbs (612 kg)

### Vehicle identification plate

When you have calculated the total load, you should make sure that the gross vehicle weight rating and the gross axle weight rating are not exceeded. Details can be found on the vehicle identification plate on the B-pillar on the driver's side of the vehicle (> page 288).

**Gross Vehicle Weight Rating:** the gross weight of the vehicle, all passengers and the load must not exceed the permissible gross vehicle weight rating.

**Gross Axle Weight Rating (GAWR):** the maximum permissible weight that can be carried by one axle (front or rear axle).

To ensure that your vehicle does not exceed the maximum permissible values, have your loaded vehicle (including driver, occupants, load) weighed on a vehicle weighbridge.

### Maximum load rating

Do not overload the tires by exceeding the specified load limit. The maximum permissible load can be found on the vehicle's Tire and Loading Information placard on the B-pillar on the driver's side (> page 288).



Maximum tire load ① is the maximum permissible weight for which the tire is approved.

- ① The actual values for tires are vehicle-specific and may deviate from the values in the illustration.

## Uniform Tire Quality Grading Standards

### Overview of Tire Quality Grading Standards



Uniform Tire Quality Grading Standards are U.S. government specifications. Their purpose is to provide drivers with uniform reliable information on tire performance data. Tire manufacturers have to grade tires using three performance factors: tread wear ①, tire traction ② and heat resistance ③. These regulations do not apply to Canada. Nevertheless, all tires sold in North America are provided with the corresponding quality grading markings on the sidewall of the tire.

All passenger car tires must conform to the statutory safety requirements in addition to these grades.

Quality grades can be found, where applicable, on the tire sidewall between the tread shoulder and maximum tire width.

**i** The actual values for tires are vehicle-specific and may deviate from the values in the illustration.

For example:

Treadwear	Traction	Temperature
200	AA	A

### Treadwear

The treadwear grade is a comparative rating based on the wear rate of the tire when tested under controlled conditions on a specified U.S. government course. For example, a tire graded 150 would wear one and one-half times as well on the government course as a tire graded 100.

The relative performance of tires depends upon the actual conditions of their use, however, and may depart significantly from the norm due to variations in driving habits, service practices and differences in road characteristics and climate conditions.

### Traction

#### WARNING

The traction grade assigned to this tire is based on straight-ahead braking traction tests, and does not include acceleration, cornering, hydroplaning, or peak traction characteristics.

The traction grades – from highest to lowest – are AA, A, B and C. Those grades represent the tire's ability to stop on wet pavement as measured under controlled conditions on specified government test surfaces of asphalt and concrete. A tire marked C may have poor traction performance.

The safe speed on a wet, snow covered or icy road is always lower than on dry road surfaces.

You should pay special attention to road conditions when temperatures are around the freezing point.

Mercedes-Benz recommends a minimum tread depth of  $\frac{1}{8}$  in (4 mm) for all four winter tires (> page 280) to maintain normal driving characteristics in winter. Winter tires can reduce the braking distance on snow-covered surfaces in comparison with summer tires. The braking distance is still much further than on surfaces that are not icy or covered with snow. Take appropriate care when driving.

**!** Avoid wheelspin. This can lead to damage to the drive train.

### Temperature

#### WARNING

The temperature grade for this tire is established for a tire that is properly inflated and not overloaded. Excessive speed, underinflation, or excessive loading, either separately or in combination, can cause excessive heat build-up and possible tire failure.

The temperature grades are A (the highest), B, and C. They represent the tire's resistance to

the generation of heat and its ability to dissipate heat when tested under controlled conditions on a specified indoor laboratory test wheel. Sustained high temperature can cause the material of the tire to degenerate and reduce tire life, and excessive temperature can lead to sudden tire failure. The grade C corresponds to a level of performance which all passenger car tires must meet under the Federal Motor Vehicle Safety Standard No. 109. Grades B and A represent higher levels of performance on the laboratory test wheel than the minimum required by law.

## Tire labeling

### Overview of tire labeling

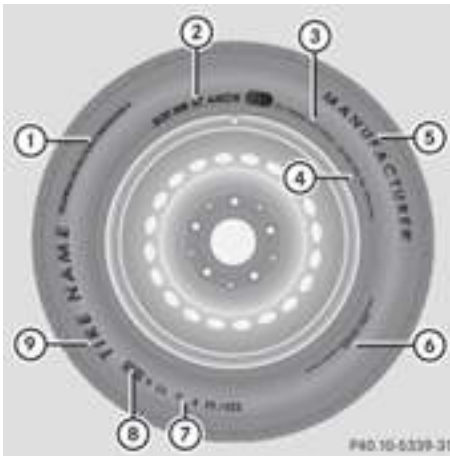

The following markings are on the tire in addition to the tire name (sales designation) and the manufacturer's name:

- ① Uniform tire Quality Grading Standard (▷ page 297)
- ② DOT tire Identification Number (▷ page 295)
- ③ Maximum tire load (▷ page 291)
- ④ Maximum tire pressures (▷ page 284)
- ⑤ Manufacturer
- ⑥ Tire material (▷ page 296)
- ⑦ Tire size designation, load-bearing capacity and speed rating (▷ page 293)

⑧ Load index (▷ page 295)

⑨ Tire name

**i** Tire data is vehicle-specific and may deviate from the data in the example.

### Tire size designation, load-bearing capacity and speed rating



① Tire width

② Nominal aspect ratio in %

③ Tire code

④ Rim diameter

⑤ Load bearing index

⑥ Speed rating

**i** Tire data is vehicle-specific and may deviate from the data in the example.

**General:** depending on the manufacturer's standards, the size imprinted in the tire wall may not contain any letters or may contain one letter that precedes the size description. If there is no letter preceding the size description (as shown above): these are passenger vehicle tires according to European manufacturing standards.

If "P" precedes the size description: these are passenger vehicle tires according to U.S. manufacturing standards.

If "LT" precedes the size description: these are light truck tires according to U.S. manufacturing standards.

If "T" precedes the size description: compact emergency wheels with high tire pressure

that are only designed for temporary use in an emergency.

**Tire width:** tire width ① shows the nominal tire width in millimeters.

**Height-width ratio:** aspect ratio ② is the size ratio between the tire height and tire width and is shown in percent. The aspect ratio is calculated by dividing the tire width by the tire height.

**Tire code:** tire code ③ specifies the tire type. "R" represents radial tires; "D" represents diagonal tires; "B" represents diagonal radial tires.

Optionally, tires with a maximum speed of over 149 mph (240 km/h) may have "ZR" in the size description, depending on the manufacturer (e.g. 245/40 ZR 18).

**Rim diameter:** rim diameter ④ is the diameter of the bead seat, not the diameter of the rim flange. The rim diameter is specified in inches (in).

**Load-bearing index:** load-bearing index ⑤ is a numerical code that specifies the maximum load-bearing capacity of a tire.

Do not overload the tires by exceeding the specified load limit. The maximum permissible load can be found on the vehicle's Tire and Loading Information placard on the B-pillar on the driver's side (▷ page 288).

Example:

Load-bearing index 91 indicates a maximum load of 1,356 lb (615 kg) that the tires can bear. For further information on the maximum tire load in kilograms and pounds, see (▷ page 291).

For further information on the load-bearing index, see "Load index" (▷ page 295).

**Speed rating:** speed rating ⑥ specifies the approved maximum speed of the tire.

#### WARNING

Exceeding the stated tire load-bearing capacity and the approved maximum speed could lead to tire damage or the tire bursting. There is a risk of accident.

Therefore, only use tire types and sizes approved for your vehicle model. Observe the tire load rating and speed rating required for your vehicle.

Regardless of the speed rating, always observe the speed limits. Drive carefully and adapt your driving style to the traffic conditions.

#### Summer tires

Index	Speed rating
Q	up to 100 mph (160 km/h)
R	up to 106 mph (170 km/h)
S	up to 112 mph (180 km/h)
T	up to 118 mph (190 km/h)
H	up to 130 mph (210 km/h)
V	up to 149 mph (240 km/h)
W	up to 168 mph (270 km/h)
Y	up to 186 mph (300 km/h)
ZR...Y	up to 186 mph (300 km/h)
ZR...(..Y)	over 186 mph (300 km/h)
ZR	over 149 mph (240 km/h)

- Tires with a maximum speed of over 149 mph (240 km/h) may have "ZR" in the size description, depending on the manufacturer (e.g. 245/40 ZR18).

The service specification is made up of load-bearing index ⑤ and speed rating ⑥.

- If the size description of your tire includes "ZR" and there are no service specifications, ask the tire manufacturer in order to find out the maximum speed.

If a service specification is available, the maximum speed is limited according to the speed rating in the service specification. Example: 245/40 ZR18 97 Y. In this example, "97 Y" is the service specification. The letter "Y" represents the speed rating. The



maximum speed of the tire is limited to 186 mph (300 km/h).

- The size description for all tires with maximum speeds of over 186 mph (300 km/h) must include "ZR". The service specification must be given in brackets. Example: 275/40 ZR 18 (99 Y). Speed rating "(Y)" indicates that the maximum speed of the tire is over 186 mph (300 km/h). Ask the tire manufacturer about the maximum speed.

#### All-weather tires and winter tires

Index	Speed rating
Q M+S <sup>4</sup>	up to 100 mph (160 km/h)
T M+S <sup>4</sup>	up to 118 mph (190 km/h)
H M+S <sup>4</sup>	up to 130 mph (210 km/h)
V M+S <sup>4</sup>	up to 149 mph (240 km/h)

**i** Not all tires with the M+S marking provide the driving characteristics of winter tires. In addition to the M+S marking, winter tires also have the  snowflake symbol on the tire wall. Tires with this marking fulfill the requirements of the Rubber Manufacturers Association (RMA) and the Rubber Association of Canada (RAC) regarding the tire traction on snow. They have been especially developed for driving on snow.

An electronic speed limiter prevents your vehicle from exceeding a speed of 100mph (160km/h).

The speed rating of tires mounted at the factory may be higher than the maximum speed that the electronic speed limiter permits.

Make sure that your tires have the required speed rating, e.g. when buying new tires. The required speed rating for your vehicle can be found in the "Tires" section (▷ page 303).

Further information about reading tire data can be obtained from any qualified specialist workshop.

<sup>4</sup> Or M+S  for winter tires.

#### Load index



In addition to the load bearing index, load index ① may be imprinted after the letters that identify speed index ⑥ on the sidewall of the tire (▷ page 293).

- If no specification is given: no text (as in the example above), represents a standard load (SL) tire
- XL or Extra Load: represents a reinforced tire
- Light Load: represents a light load tire
- C, D, E: represents a load range that depends on the maximum load that the tire can carry at a certain pressure

**i** Tire data is vehicle-specific and may deviate from the data in the example.

#### DOT, Tire Identification Number (TIN)



Canadian tire regulations prescribe that every manufacturer of new tires or retreader has to imprint a TIN in or on the sidewall.

The TIN is a unique identification number. The TIN enables the tire manufacturers or retreaders to inform purchasers of recalls and other safety-relevant matters. It makes it possible for the purchaser to easily identify the affected tires.

The TIN is made up of manufacturer identification code ②, tire size ③, tire type code ④ and manufacturing date ⑤.

**DOT (Department of Transportation):** tire symbol ① indicates that the tire complies with the requirements of the Canadian transport ministry.

**Manufacturer identification code:** manufacturer identification code ② provides details on the tire manufacturer. New tires have a code with two symbols. Retreaded tires have a code with four symbols.

For further information about retreaded tires, see (▷ page 278).

**Tire size:** identifier ③ describes the tire size.

**Tire type code:** tire type code ④ can be used by the manufacturer as a code to describe specific characteristics of the tire.

**Date of manufacture:** date of manufacture ⑤ provides information about the age of a tire. The first and second positions represent the week of manufacture, starting with "01" for the first calendar week. Positions three and four represent the year of manufacture. For example, a tire that is marked with "3208", was manufactured in week 32 in 2008.

- ① Tire data is vehicle-specific and may deviate from the data in the example.

### Tire characteristics



This information describes the type of tire cord and the number of layers in sidewall ① and under tire tread ②.

- ① Tire data is vehicle-specific and may deviate from the data in the example.

### Definition of terms for tires and loading

#### Tire ply composition and material used

Describes the number of plies or the number of layers of rubber-coated fabric in the tire tread and sidewall. These are made of steel, nylon, polyester and other materials.

#### Bar

Metric unit for tire pressure. 14.5038 pounds per square inch (psi) and 100 kilopascals (kPa) are the equivalent of 1 bar.

#### DOT (Department of Transportation)

DOT marked tires fulfill the requirements of the Canadian Transport Ministry.

#### Normal occupant weight

The number of occupants for which the vehicle is designed multiplied by 68 kilograms (150 lbs).

### Uniform Tire Quality Grading Standards

A uniform standard to grade the quality of tires with regards to tread quality, tire traction and temperature characteristics. The quality grading assessment is made by the manufacturer following specifications from the US government. The ratings are molded into the sidewall of the tire.

### Recommended tire pressures

The recommended tire pressure applies to the tires mounted at the factory.

The Tire and Loading Information placard contains the recommended tire pressure for cold tires, the maximum permissible load and the maximum permissible vehicle speed.

The tire pressure table contains the recommended pressures for cold tires for various operating conditions, i.e. differing load and speed conditions.

### Increased vehicle weight due to optional equipment

The combined weight of all standard and optional equipment available for the vehicle, regardless of whether it is actually installed on the vehicle or not.

### Rim

This is the part of the wheel on which the tire is mounted.

### GAWR (Gross Axle Weight Rating)

The GAWR is the maximum gross axle weight rating. The actual load on an axle must not exceed the gross axle weight rating. The maximum gross axle weight rating can be found on the vehicle identification plate on the B-pillar on the driver's side.

### Speed rating

The speed rating is part of the tire identification. It specifies the speed range for which the tire is approved.

### GVW (Gross Vehicle Weight)

The gross vehicle weight comprises the weight of the vehicle including tools, accessories installed, occupants and luggage. The gross vehicle weight must not exceed the gross vehicle weight rating (GVWR) as specified on the vehicle identification plate on the B-pillar on the driver's side.

### GVWR (Gross Vehicle Weight Rating)

The GVWR is the maximum permitted gross weight of the fully laden vehicle (weight of the vehicle including all accessories, occupants and luggage). The gross vehicle weight rating is specified on the vehicle identification plate on the B-pillar on the driver's side.

### Maximum loaded vehicle weight

The maximum weight is the sum of:

- the curb weight of the vehicle
- the weight of the accessories
- the load limit
- the weight of the factory installed optional equipment

### Kilopascal (kPa)

Metric unit for tire pressure. 6.9 kPa corresponds to 1 psi. Another unit for tire pressure is bar. 100 kilopascals (kPa) are the equivalent of 1 bar.

### Load index

In addition to the load-bearing index, the load index may also be imprinted on the sidewall of

the tire. This specifies the load-bearing capacity more precisely.

### Curb weight

The weight of a vehicle with standard equipment but without passengers and luggage.

### Maximum load rating

Maximum tire load is the maximum permissible weight for which the tire is approved.

### Maximum permissible tire pressure

Maximum permissible tire pressure for one tire.

### Maximum load on one tire

Maximum load on one tire. This is calculated by dividing the maximum axle load of one axle by two.

### PSI (pounds per square inch)

A standard unit of measure for tire pressure.

### Aspect ratio

Relationship between tire height and tire width in percent.

### Tire pressure

This is pressure inside the tire applying an outward force to each square inch of the tire's surface. The tire pressure is specified in pounds per square inch (psi), in kilopascal (kPa) or in bar. The tire pressure should only be corrected when the tires are cold.

### Tire pressure of cold tires

The tires are cold:

- if the vehicle has been parked with the tires out of direct sunlight for at least 3 hours and
- if the vehicle has not been driven further than 1 mile (1.6 km)

### Tread

The part of the tire that comes into contact with the road.

### Bead

The tire bead ensures that the tire sits securely on the wheel. There are several steel wires in the bead to prevent the tire from coming loose from the wheel rim.

### Sidewall

The part of the tire between the tread and the bead.

### Weight of optional extras

The combined weight of those optional extras that weigh more than the replaced standard parts and more than 2.3 kg (5 lbs). These optional extras, such as high-performance brakes, level control, a roof rack or a high-voltage battery, are not included in the curb weight and the weight of the accessories.

### TIN (Tire Identification Number)

This is a unique identifier which can be used by a tire manufacturer to identify tires, for example for a product recall, and thus identify the purchasers. The TIN is made up of the manufacturer's identity code, tire size, tire type code and the manufacturing date.

### Load bearing index

The load bearing index is a code that contains the maximum load bearing capacity of a tire.

### Traction

Traction is the result of friction between the tires and the road surface.

### Treadwear indicators

Narrow bars (tread wear bars) that are distributed over the tire tread. If the tire tread is level with the bars, the wear limit of 1/16 in (1.6 mm) has been reached.

### Occupant distribution

The distribution of occupants in a vehicle at their designated seating positions.

### Total load limit

Nominal load and luggage load plus 68 kg (150 lbs) multiplied by the number of seats in the vehicle.

## Changing a wheel

### Flat tire

You can find information on what to do in the event of a flat tire in the "Flat tire" section (▷ page 264). Information on driving with tires with run-flat characteristics in the event of a flat tire can be found under "Tires with run-flat characteristics" (▷ page 264).

### Rotating the wheels

#### WARNING

Interchanging the front and rear wheels may severely impair the driving characteristics if the wheels or tires have different dimensions.

The wheel brakes or suspension components may also be damaged. There is a risk of accident.

Rotate front and rear wheels only if the wheels and tires are of the same dimensions.

**!** On vehicles equipped with a tire pressure monitor, electronic components are located in the wheel.

Tire-mounting tools should not be used near the valve. This could damage the electronic components.

Only have tires changed at a qualified specialist workshop.

Always pay attention to the instructions and safety notes when changing a wheel (▷ page 299).

The wear patterns on the front and rear tires differ, depending on the operating conditions. Rotate the wheels before a clear wear pattern has formed on the tires. Front tires typically wear more on the shoulders and the rear tires in the center.

If your vehicle's tire configuration allows, you can rotate the wheels according to the intervals in the tire manufacturer's warranty book in your vehicle documents. If no warranty book is available, the tires should be rotated every 3,000 to 6,000 miles (5,000 to 10,000 km), or earlier if tire wear requires. Do not change the direction of wheel rotation.

Clean the contact surfaces of the wheel and the brake disc thoroughly every time a wheel is rotated. Check the tire pressure and reactivate the tire pressure monitor if necessary.

### Direction of rotation

Tires with a specified direction of rotation have additional benefits, e.g. if there is a risk of hydroplaning. You will only gain these benefits if the correct direction of rotation is observed.

An arrow on the sidewall of the tire indicates its correct direction of rotation.

### Storing wheels

Store wheels that are not being used in a cool, dry and preferably dark place. Protect the tires against oil and grease.

### Mounting a wheel

#### Preparing the vehicle

- ▶ Stop the vehicle on solid, non-slippery and level ground.
- ▶ Apply the electric parking brake manually (▷ page 145).
- ▶ Bring the front wheels into the straight-ahead position.
- ▶ Move the DIRECT SELECT lever to **P**.
- ▶ Switch off the drive system.
- ▶ Remove the SmartKey from the ignition lock.
- ▶ If included in the vehicle equipment, remove the tire-change tool kit from the vehicle.
- ▶ Secure the vehicle to prevent it from rolling away.

#### Securing the vehicle to prevent it from rolling away



If your vehicle is equipped with a wheel chock, it can be found in the tire-change tool kit (▷ page 264).

The folding wheel chock is an additional safety measure to prevent the vehicle from

rolling away, for example when changing a wheel.

- ▶ Fold both plates upwards ①.
- ▶ Fold out lower plate ②.
- ▶ Guide the lugs on the lower plate fully into the openings in base plate ③.



Securing the vehicle on level ground

- ▶ **On level ground:** place chocks or other suitable items under the front and rear of the wheel that is diagonally opposite the wheel you wish to change.



Securing the vehicle on slight downhill gradients

- ▶ **On light downhill gradients:** place chocks or other suitable items in front of the wheels of the front and rear axle.

#### Raising the vehicle

##### **WARNING**

If you do not position the jack correctly at the appropriate jacking point of the vehicle, the jack could tip over with the vehicle raised. There is a risk of injury.

Only position the jack at the appropriate jacking point of the vehicle. The base of the jack must be positioned vertically, directly under the jacking point of the vehicle.

- ❗ Position a suitable jack correctly on the intended jacking points. If you fail to position the jack correctly, the vehicle may be damaged.

The jacking points are recesses in the lower door sill. They can only be seen from underneath. There is one located behind each of the front wheel arches and in front of the rear wheel arches.

Position the jack in the jacking points so that when viewed from the side, the jack is in the vertical position.

- ❗ Position a suitable jack only on the jacking points intended for this purpose.

Never position the jack on the high-voltage battery. Do not jack up the vehicle on the high-voltage battery. There is otherwise a risk of damaging the high-voltage battery. Also observe the notes in the "Changing a wheel" section.

#### Observe the following when raising the vehicle:

- to raise the vehicle, only use the vehicle-specific jack that has been tested and approved by Mercedes-Benz. If used incorrectly, the jack could tip over with the vehicle raised.
- the jack is designed only to raise and hold the vehicle for a short time while a wheel is being changed. It is not suited for performing maintenance work under the vehicle.
- avoid changing the wheel on uphill and downhill slopes.
- before raising the vehicle, secure it from rolling away by applying the parking brake and inserting wheel chocks. Do not disengage the parking brake while the vehicle is raised.

- the jack must be placed on a firm, flat and non-slip surface. On a loose surface, a large, load-bearing underlay must be used. On a slippery surface, a non-slip underlay must be used, e.g. rubber mats.
- do not use wooden blocks or similar objects as a jack underlay. Otherwise, the jack will not be able to achieve its load-bearing capacity due to the restricted height.
- make sure that the distance between the underside of the tires and the ground does not exceed 1.2 in (3 cm).
- do not place your hands or feet under the raised vehicle.
- do not lie under the vehicle.
- do not start the electric motor when the vehicle is raised.
- do not open or close the doors or the tailgate when the vehicle is raised.
- make sure that no persons are present in the vehicle when the vehicle is raised.



- Using lug wrench ①, loosen the bolts on the wheel you wish to change by about one full turn. Do not unscrew the bolts completely.





The jacking points are located just behind the wheel housings of the front wheels and just in front of the wheel housings of the rear wheels (arrows).



- ▶ Position jack ③ at jacking point ②.

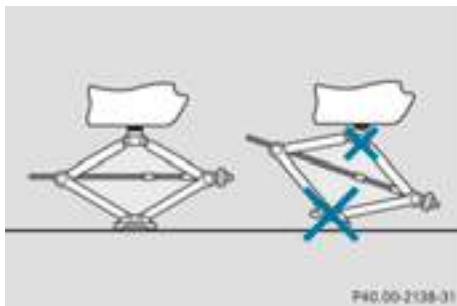

- ▶ Make sure the foot of the jack is directly beneath the jacking point.
- ▶ Turn ratchet wrench ④ until jack ③ sits completely on jacking point ② and the base of the jack lies evenly on the ground.
- ▶ Turn ratchet wrench ④ until the tire is raised a maximum of 1.2 in (3 cm) from the ground.

## Removing a wheel

- ⚠ Do not place wheel bolts in sand or on a dirty surface. The bolt and wheel hub threads could otherwise be damaged when you screw them in.
- ▶ Unscrew the wheel bolts.
- ▶ Remove the wheel.

## Mounting a new wheel

### ⚠ WARNING

Oiled or greased wheel bolts or damaged wheel bolts/hub threads can cause the wheel bolts to come loose. As a result, you could lose a wheel while driving. There is a risk of accident.

Never oil or grease wheel bolts. In the event of damage to the threads, contact a qualified specialist workshop immediately. Have the damaged wheel bolts or hub threads replaced/renewed. Do not continue driving.

### ⚠ WARNING

If you tighten the wheel bolts or wheel nuts when the vehicle is raised, the jack could tip over. There is a risk of injury.

Only tighten the wheel bolts or wheel nuts when the vehicle is on the ground.

Always pay attention to the instructions and safety notes in the "Changing a wheel" section (▶ page 299).

Only use wheel bolts that have been designed for the wheel and the vehicle. For safety reasons, Mercedes-Benz recommends that you only use wheel bolts which have been approved for Mercedes-Benz vehicles and the respective wheel.

- ⚠ To prevent damage to the paintwork, hold the wheel securely against the wheel hub while screwing in the first wheel bolt.





- ▶ Clean the wheel and wheel hub contact surfaces.
- ▶ Place the new wheel on the wheel hub and push it on.
- ▶ Tighten the wheel bolts until they are finger-tight.

### Lowering the vehicle

#### **WARNING**

The wheels could work loose if the wheel nuts and bolts are not tightened to the specified tightening torque. There is a risk of accident. Have the tightening torque immediately checked at a qualified specialist workshop after a wheel is changed.



- ▶ Place the ratchet wrench onto the hexagon nut of the jack so that the letters **AB** are visible.
- ▶ Turn the ratchet wrench until the vehicle is once again standing firmly on the ground.
- ▶ Place the jack to one side.

- ▶ Tighten the wheel bolts evenly in a cross-wise pattern in the sequence indicated (① to ⑤). The specified tightening torque is **96 lb-ft (130 Nm)**.

- ▶ Turn the jack back to its initial position.
- ▶ Stow the jack and the rest of the vehicle tools in the vehicle again.
- ▶ Check the tire pressure of the newly mounted wheel and adjust it if necessary.

Observe the recommended tire pressure (> page 281).

- i** Vehicles with tire pressure monitor: all wheels mounted must be equipped with functioning sensors.

### Wheel and tire combinations

#### General notes

- !** For safety reasons, Mercedes-Benz recommends that you only use tires and wheels which have been approved by Mercedes-Benz specifically for your vehicle.

These tires have been specially adapted for use with the control systems, such as ABS or ESP®, and are marked as follows:

- MO = Mercedes-Benz Original
- MOE = Mercedes-Benz Original Extended (tires featuring run-flat characteristics)
- MO1 = Mercedes-Benz Original (only certain AMG tires)

Mercedes-Benz Original Extended tires may only be used on wheels that have been specifically approved by Mercedes-Benz.

Only use tires, wheels or accessories tested and approved by Mercedes-Benz. Certain characteristics, e.g. handling, vehicle noise emissions or fuel consumption, may otherwise be adversely affected. In addition, when driving with a load, tire dimension variations could cause the tires to come into contact with the bodywork and axle components. This could result in damage to the tires or the vehicle.

Mercedes-Benz accepts no liability for damage resulting from the use of tires, wheels or accessories other than those tested and approved.

Information on tires, wheels and approved combinations can be obtained from any qualified specialist workshop.

- !** Retreaded tires are neither tested nor recommended by Mercedes-Benz, since previous damage cannot always be detected on retreaded tires. As a result, Mercedes-Benz cannot guarantee vehicle safety if retreaded tires are mounted. Do not mount used tires if you have no information about their previous usage.

Overview of abbreviations used in the following tire tables:

- BA: both axles
- FA: front axle
- RA: rear axle

The recommended pressures for various operating conditions can be found:

- on the Tire and Loading Information placard with the recommended tire pressures on the B-pillar on the driver's side
- in the tire pressure table on the inside of the charge socket flap

Observe the notes on recommended tire pressures under various operating conditions (> page 281).

Check tire pressures regularly, and only when the tires are cold. Comply with the maintenance recommendations of the tire manufacturer in the vehicle document wallet.

Notes on the vehicle equipment – always equip the vehicle with:

- tires of the same size on a given axle (left/right)
- with tires of the same type (summer tires, tires with run-flat characteristics, winter tires)

Exception: it is permissible to install a different type or make in the event of a flat

tire. Observe the "Tires with run-flat characteristics" section (> page 264).

- i** The following pages contain information on approved wheel rim and tire sizes for equipping your vehicle with winter tires. Winter tires are not available at the factory as standard equipment or optional extras.

If you want to equip your vehicle with approved winter tires, it may be necessary to obtain wheel rims in the corresponding size. The size of the approved winter tires may differ from the standard tires. This is dependent on the model and the equipment installed at the factory.

The tires and wheel rims, as well as further information, can be obtained at a qualified specialist workshop.

- i** Not all wheel and tire combinations are available at the factory for all countries.

## Tires

### B-Class Electric Drive

	All-weather tires	Alloy wheels
BA	225/50 R17 94 H <sup>5</sup>	7 J x 17 H2 ET 48.5
BA	225/45 R18 95 H <sup>5, 6</sup>	7.5 J x 18 H2 ET 44

<sup>5</sup> Available as MOExtended tires.

<sup>6</sup> Use of snow chains not permitted. Observe the notes in the "Snow chains" section.



<b>Useful information .....</b>	<b>308</b>
<b>Information regarding technical data .....</b>	<b>308</b>
<b>Identification plates .....</b>	<b>308</b>
<b>Service products and filling capaci- ties .....</b>	<b>309</b>
<b>Vehicle data .....</b>	<b>311</b>

## Useful information

**i** This Operator's Manual describes all models and all standard and optional equipment of your vehicle available at the time of publication of the Operator's Manual. Country-specific differences are possible. Bear in mind that your vehicle may not feature all functions described here. This also applies to safety-relevant systems and functions.

**i** Read the information on qualified specialist workshops: (► page 24).

## Information regarding technical data

## General information

**i** The data stated here specifically refers to a vehicle with standard equipment. Consult an authorized Mercedes-Benz Center for the data for all vehicle variants and trim levels.

## Identification plates

## Vehicle identification plate with vehicle identification number (VIN)



► Open the driver's door.  
You will see vehicle identification plate ①.



Example: vehicle identification plate

- ② VIN
- ③ Paint code

**i** The data shown on the vehicle identification plate is used only as an example. This data is different for every vehicle and can deviate from the data shown here. You can find the data applicable to your vehicle on the vehicle identification plate.

## VIN



- Slide the right-hand front seat to its rearmost position.
- Fold up floor covering ① in front of the right-hand front seat.  
You will see VIN ②.

The VIN can also be found on the vehicle identification plate (► page 308).

## Electric motor number

The electric motor number can be found at the bottom of the electric motor. More infor-

mation can be obtained from any authorized Mercedes-Benz Center.

## Service products and filling capacities

### Important safety notes

#### WARNING

Service products may be poisonous and hazardous to health. There is a risk of injury.

Comply with instructions on the use, storage and disposal of service products on the labels of the respective original containers. Always store service products sealed in their original containers. Always keep service products out of the reach of children.

#### Environmental note

Dispose of service products in an environmentally responsible manner.

Service products include the following:

- Lubricants (e.g. engine oil, transmission oil)
- Coolant
- Brake fluid
- Windshield washer fluid
- Climate control system refrigerant

Components and service products must be matched. You should therefore only use products that have been tested and approved by Mercedes-Benz.

Information about tested and approved products can be obtained from an authorized Mercedes-Benz Center or on the Internet at <http://bevo.mercedes-benz.com>.

You can recognize service products approved by Mercedes-Benz by the following inscription on the containers:

- MB-Freigabe (e.g. MB-Freigabe 229.51)
- MB Approval (e.g. MB Approval 229.51)

Other designations or recommendations indicate a level of quality or a specification in accordance with an MB Sheet number (e.g.

MB 229.5). They have not necessarily been approved by Mercedes-Benz.

## Brake fluid

### WARNING

The brake fluid constantly absorbs moisture from the air. This lowers the boiling point of the brake fluid. If the boiling point of the brake fluid is too low, vapor pockets may form in the brake system when the brakes are applied hard. This would impair braking efficiency. There is a risk of an accident.

You should have the brake fluid renewed at the specified intervals.

When handling brake fluid, observe the important safety notes on service products (▷ page 309).

The brake fluid change intervals can be found in the Maintenance Booklet.

Only use brake fluid approved by Mercedes-Benz according to MB Approval 331.0.

Information about approved brake fluid can be obtained at any qualified specialist workshop or on the Internet at: <http://bevo.mercedes-benz.com>.

-  Have the brake fluid regularly replaced at a qualified specialist workshop and the replacement confirmed in the Maintenance Booklet.

## Coolant

### Important safety notes

The coolant is a mixture of water and anti-freeze/corrosion inhibitor. It performs the following tasks:

- corrosion protection
- antifreeze protection
- raising the boiling point

-  When the vehicle is first delivered, it is filled with a coolant mixture that ensures

adequate antifreeze and corrosion protection.

**!** Only add coolant that has been premixed with the desired antifreeze protection. You could otherwise damage the engine.

Further information on coolants can be found in the Mercedes-Benz Specifications for Service Products, MB Specifications for Service Products 310.1, e.g. on the Internet at <http://bevo.mercedes-benz.com>. Or contact a qualified specialist workshop.

**!** Always use a suitable coolant mixture, even in countries where high temperatures prevail.

Otherwise, the engine cooling system is not sufficiently protected from corrosion and overheating.

If antifreeze/corrosion inhibitor is present in the correct concentration, the boiling point of the coolant will be around 266 °F (130 °C).

The antifreeze/corrosion inhibitor concentration in the engine cooling system should:

- be at least 50%. This will protect the engine cooling system against freezing down to approximately -35 °F (-37 °C).
- not exceed 55% (antifreeze protection down to -49 °F (-45 °C)). Heat will otherwise not be dissipated as effectively.

If the vehicle has lost coolant, add equal amounts of water and antifreeze/corrosion inhibitor. Mercedes-Benz recommends an anticorrosion/antifreeze which has been approved for Mercedes-Benz.

**!** The warranty is only valid if you add an antifreeze/corrosion inhibitor which has been approved by Mercedes-Benz and if the recommended mixture ratio is observed.

## Washer fluid

### Important safety notes

#### WARNING

Windshield washer concentrate is highly flammable. If it comes into contact with hot components in the front compartment, it may ignite. There is a risk of fire and injury.

Make sure that no windshield washer concentrate is spilled next to the filler neck.

**!** Only use washer fluid that is suitable for plastic lamp lenses, e.g. MB SummerFit or MB WinterFit. Unsuitable washer fluid could damage the plastic lenses of the headlamps.

**!** Do not add distilled or de-ionized water to the washer fluid container. Otherwise, the level sensor may be damaged.

**!** Only MB SummerFit and MB WinterFit washer fluid should be mixed together. The spray nozzles may otherwise become blocked.

When handling washer fluid, observe the important safety notes on service products (> page 309).

At temperatures above freezing:

- ▶ Fill the washer fluid reservoir with a mixture of water and windshield washer fluid, e.g. MB SummerFit.

Add 1 part MB SummerFit to 100 parts water.

At temperatures below freezing:

- ▶ Fill the washer fluid reservoir with a mixture of water and washer fluid, e.g. MB WinterFit.

Adapt the mixing ratio to the outside temperature.

- Down to 14 °F (-10 °C): mix 1 part MB WinterFit to 2 parts water.
- Down to -4 °F (-20 °C): mix 1 part MB WinterFit to 1 part water.
- Down to -20.2 °F (-29 °C): mix 2 parts MB WinterFit to 1 part water.



- ① Add windshield washer fluid, e.g. MB SummerFit or MB WinterFit, to the washer fluid all year round.

**Climate control system refrigerant**

**Important safety notes**

The climate control system of your vehicle is filled with refrigerant R-134a.

The instruction label regarding the refrigerant type used can be found on the radiator cross member.

- ❗ Only the refrigerant R-134a and the PAG oil approved by Mercedes-Benz may be used. The approved PAG oil may not be mixed with any other PAG oil that is not approved for R-134a refrigerant. Otherwise, the climate control system may be damaged.

Service work, such as topping-up refrigerant or replacing components, may only be carried out by a qualified specialist workshop. All applicable regulations, as well as SAE standard J639, must be adhered to.

Always have all work on the climate control system carried out at an authorized Mercedes-Benz Center.

**Refrigerant instruction label**



Example: refrigerant instruction label

- ① Warning symbol
- ② Refrigerant filling capacity
- ③ Applicable standards

- ④ PAG oil part number
- ⑤ Type of refrigerant

Warning symbol ① advises you about:

- possible dangers
- having service work carried out at a qualified specialist workshop

**Filling capacities**

All models	Capacity
<b>Refrigerant</b>	22.9 ± 0.4 oz (650 ± 10 g)
<b>PAG oil</b>	4.2 oz (120 g)

**Vehicle data**

**General notes**

Please note that for the specified vehicle data:

- the heights specified may vary as a result of
  - tires
  - load
  - condition of the suspension
  - optional equipment
- optional equipment reduces the maximum payload.

**Dimensions and weights**



**Opening dimensions**

① Maximum headroom	75.3 in (1912 mm)
② Opening height	79.5 in (2021 mm)

**Vehicle dimensions**

<b>Vehicle length</b>	171.6 in (4358 mm)
<b>Vehicle height</b>	63.1 in (1604 mm)
<b>Vehicle width including exterior mirrors</b>	79.1 in (2010 mm)
<b>Vehicle width without exterior mirrors</b>	71.3 in (1812 mm)
<b>Wheelbase</b>	106.3 in (2699 mm)
<b>Turning radius</b>	36.1 ft (11.0 m)

**Vehicle weights**

<b>Maximum allowable gross mass</b>	4784 lb (2170 kg)
<b>Maximum trunk load</b>	220 lb (100 kg)
<b>Maximum roof load</b>	165 lb (75 kg)

**High-voltage battery**

<b>Model</b>	Lithium-ion
<b>Energy content</b>	28.0 kWh
<b>Range (according to EPA)</b>	approx. 82 miles (132 km)
<b>Charge time with 110-120 V (12 A)</b>	approx. 28 h

**High-voltage battery**

<b>Charge time with 240 V (32 A)</b>	approx. 5 h
<b>Charge time with 240 V (40 A)</b>	approx. 4 h

The specified values for range depend on the driving program selected and may vary as a result of:

- higher and lower outside temperatures
- the style of driving
- activated electrical consumers