



## OWNER'S MANUAL



i-MiEV

# *Table of contents*

<i>Overview</i>	
<i>General information</i>	
<i>Charging</i>	<b>1</b>
<i>Locking and unlocking</i>	<b>2</b>
<i>Seat and seat belts</i>	<b>3</b>
<i>Instruments and controls</i>	<b>4</b>
<i>Starting and driving</i>	<b>5</b>
<i>For pleasant driving</i>	<b>6</b>
<i>For emergencies</i>	<b>7</b>
<i>Vehicle care and Maintenance</i>	<b>8</b>
<i>Specifications</i>	<b>9</b>

## Instruments and Controls (Driver's area)

E00100105789

LHD

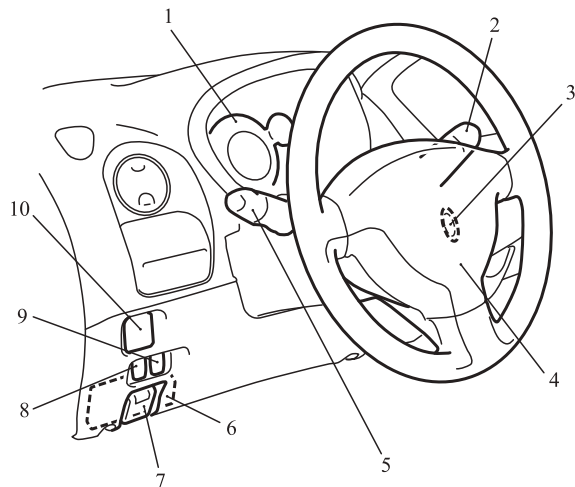

AA5012172

1. Instruments p. 4-02
2. Windscreen wiper and washer switch p. 4-16  
Rear window wiper and washer switch p. 4-17
3. Electric motor switch p. 5-07
4. Supplemental restraint system - airbag (for driver's seat) p. 3-20  
Horn switch p. 4-19
5. Combination headlamps and dipper switch p. 4-11  
Turn-signal lever p. 4-14  
Front fog lamp switch\* p. 4-15  
Rear fog lamp switch p. 4-15
6. Fuses p. 8-20
7. Regular charging opener p. 1-05
8. Headlamp levelling switch p. 4-13
9. Active Stability Control (ASC) OFF switch p. 5-17
10. Electric remote-controlled outside rear-view mirrors switch p. 5-05

RHD

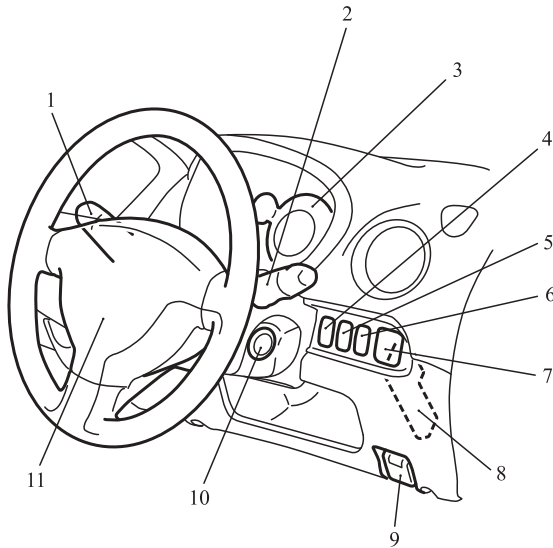

AA5012185

1. Combination headlamps and dipper switch p. 4-11  
Turn-signal lever p. 4-14  
Front fog lamp switch\* p. 4-15  
Rear fog lamp switch p. 4-15
2. Windscreen wiper and washer switch p. 4-16  
Rear window wiper and washer switch p. 4-17
3. Instruments p. 4-02
4. Headlamp levelling switch p. 4-13
5. Active Stability Control (ASC) OFF switch p. 5-17
6. Rear window demister switch p. 4-18
7. Electric remote-controlled outside rear-view mirrors switch p. 5-05
8. Fuses p. 8-20
9. Regular charging opener p. 1-05
10. Electric motor switch p. 5-07
11. Supplemental restraint system - airbag (for driver's seat) p. 3-20  
Horn switch p. 4-19

## Instruments and Controls (Instrument panel)

E00100105792

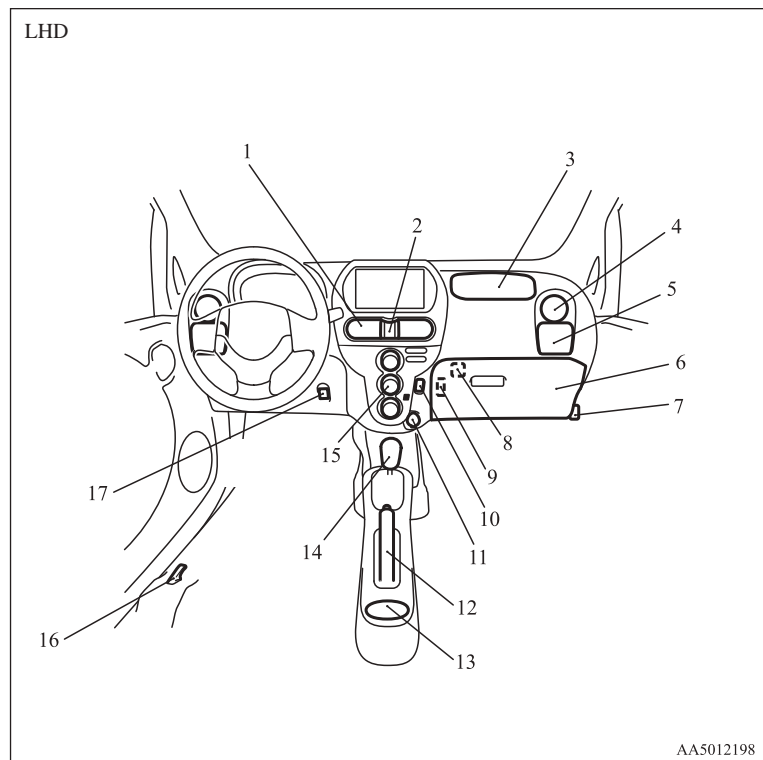

1. Centre ventilators p. 6-02
2. Hazard warning flasher switch p. 4-15
3. Supplemental restraint system - airbag (for front passenger) p. 3-20
4. Side ventilators p. 6-02
5. Cup holder p. 6-15
6. Glove box p. 6-14
7. Bonnet release lever p. 8-07
8. Front passenger's airbag ON-OFF switch p. 3-23
9. Card holder p. 6-14
10. Rear window demister switch p. 4-18
11. Accessory socket p. 6-11
12. Parking brake lever p. 5-03
13. Cup holder p. 6-15
14. Selector lever p. 5-09
15. Air conditioning p. 6-03
16. Quick charging lid opener p. 1-08
17. Heated seat switch\* p. 3-04

RHD

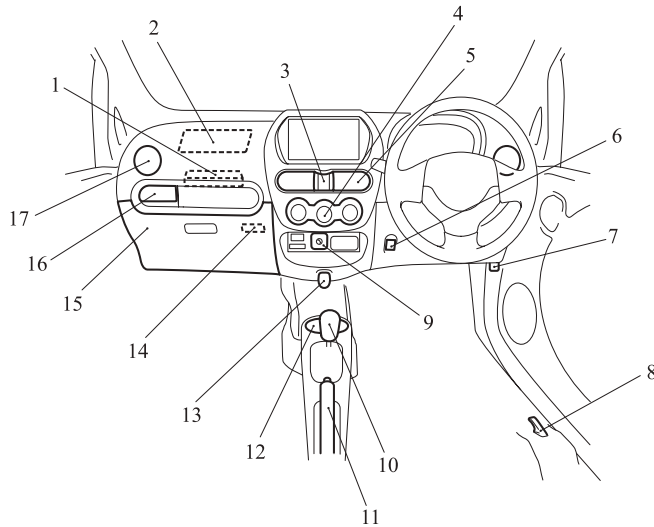

AA5012202

1. Secret box p. 6-14
2. Supplemental restraint system - airbag (for front passenger) p. 3-20
3. Hazard warning flasher switch p. 4-15
4. Air conditioning p. 6-03
5. Centre ventilators p. 6-02
6. Heated seat switch\* p. 3-04
7. Bonnet release lever p. 8-07
8. Quick charging lid opener p. 1-08
9. Front passenger's airbag ON-OFF switch p. 3-23
10. Selector lever p. 5-09
11. Parking brake lever p. 5-03
12. Cup holder p. 6-15
13. Accessory socket p. 6-11
14. Card holder p. 6-14
15. Glove box p. 6-14
16. Cup holder p. 6-15
17. Side ventilators p. 6-02

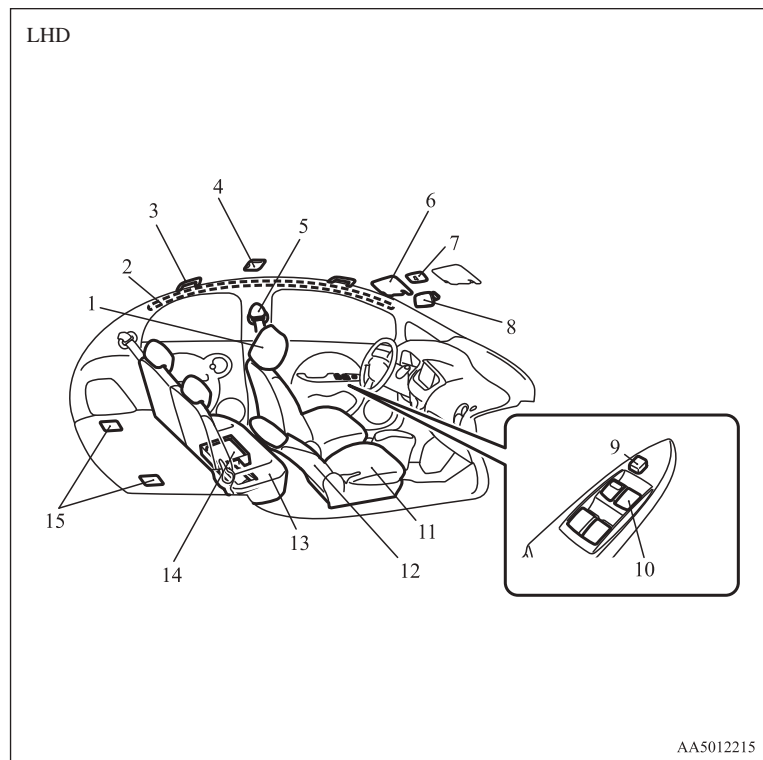

1. Head restraints p. 3-07
2. Supplemental restraint system - curtain airbag p. 3-27
3. Assist grip p. 6-16
4. Room lamp (rear) p. 6-13, 8-24
5. Seat belts p. 3-08
6. Sun visor p. 6-10  
Vanity mirror p. 6-10  
Card holder p. 6-11
7. Map & room lamps (front) p. 6-12, 8-24
8. Inside rear-view mirror p. 5-05
9. Electric window lock switch p. 2-10
10. Electric window control switch p. 2-09
11. Front seat p. 3-03
12. Supplemental restraint system - side airbag (for front seats) p. 3-27
13. Rear seat p. 3-05
14. Tyre repair kit p. 7-04
15. Tether anchorages for child restraint system p. 3-18

RHD

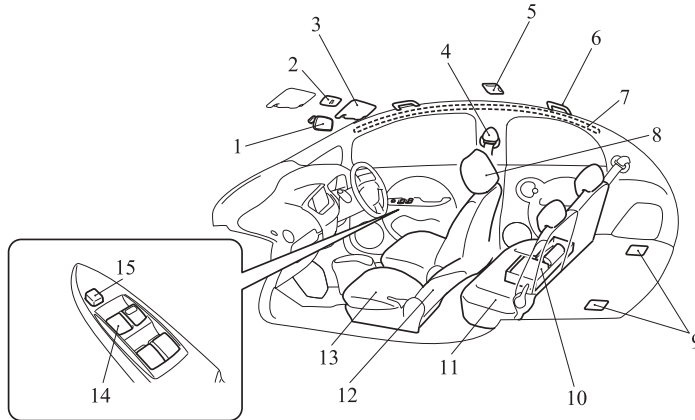

AA5012228

1. Inside rear-view mirror p. 5-05
2. Map & room lamps (front) p. 6-12, 8-24
3. Sun visor p. 6-10  
Vanity mirror p. 6-10  
Card holder p. 6-11
4. Seat belts p. 3-08
5. Room lamp (rear) p. 6-13, 8-24
6. Assist grip p. 6-16
7. Supplemental restraint system - curtain airbag p. 3-27
8. Head restraints p. 3-07
9. Tether anchorages for child restraint system p. 3-18
10. Tyre repair kit p. 7-04
11. Rear seat p. 3-05
12. Supplemental restraint system - side airbag (for front seats) p. 3-27
13. Front seat p. 3-03
14. Electric window control switch p. 2-09
15. Electric window lock switch p. 2-10



## *Electric motor unit room*

E0010080013

1. On board charger/DC-DC converter p. 8-06
2. Inverter p. 8-06
3. Brake electric vacuum pump

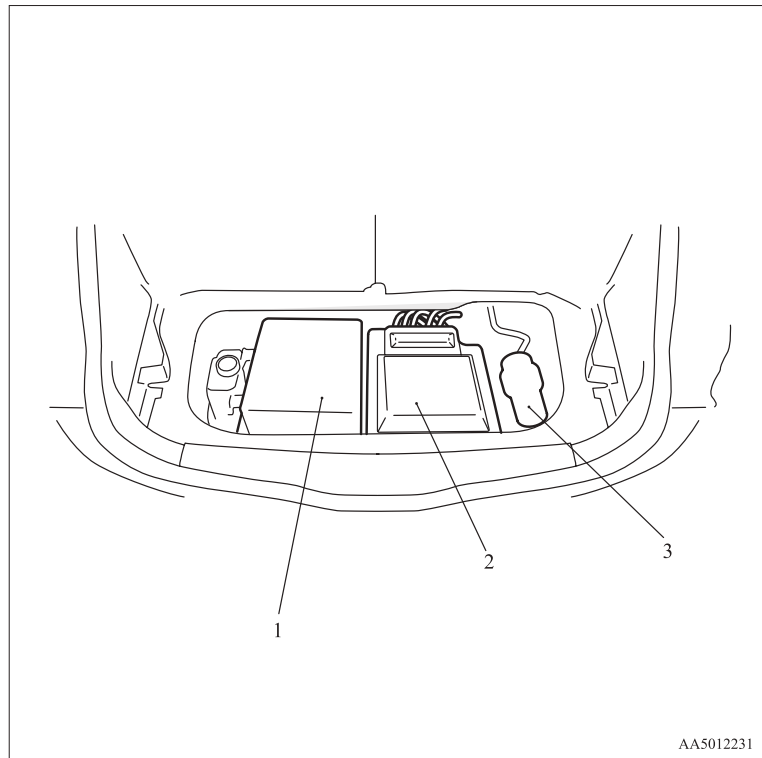

## Outside (Front)

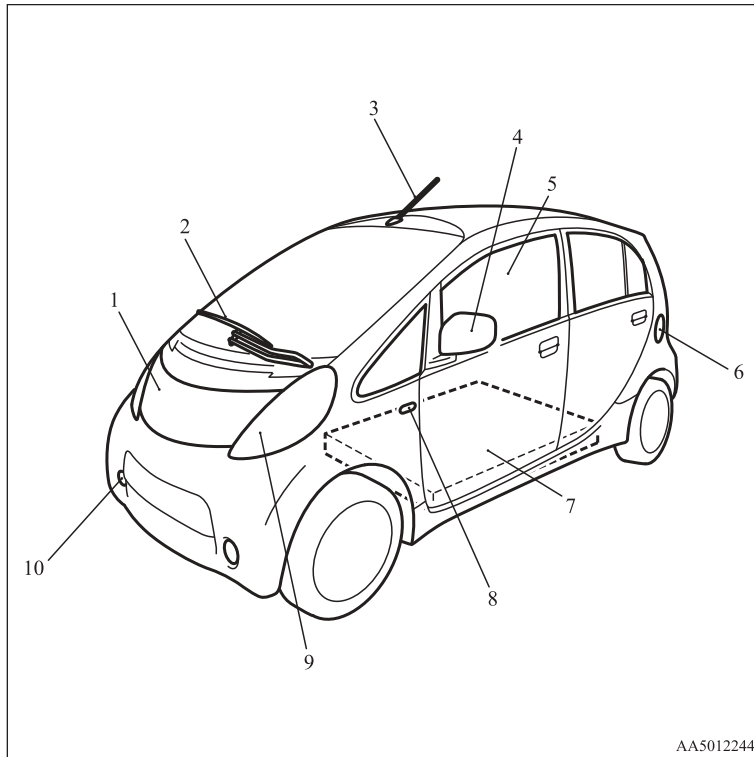

AA5012244

1. Bonnet p. 8-07
2. Windscreen wipers p. 4-16
3. Antenna p. 6-10
4. Outside rear-view mirror p. 5-05
5. Electric window control p. 2-09
6. Quick charging lid p. 1-08
7. Traction battery p. 8-06
8. Side turn-signal lamps/Hazard warning lamps p. 4-09, 8-24, 8-30
9. Headlamps p. 4-11, 8-24, 8-24, 8-30  
Position lamps p. 4-11, 8-24, 8-24, 8-30  
Front turn-signal lamps/Hazard warning lamps p. 4-09, 8-24, 8-24, 8-30
10. Front fog lamps\* p. 4-15, 8-24, 8-31  
Daytime running lamps\* p. 4-13, 8-24, 8-31

## Outside (Rear)

E00100504702

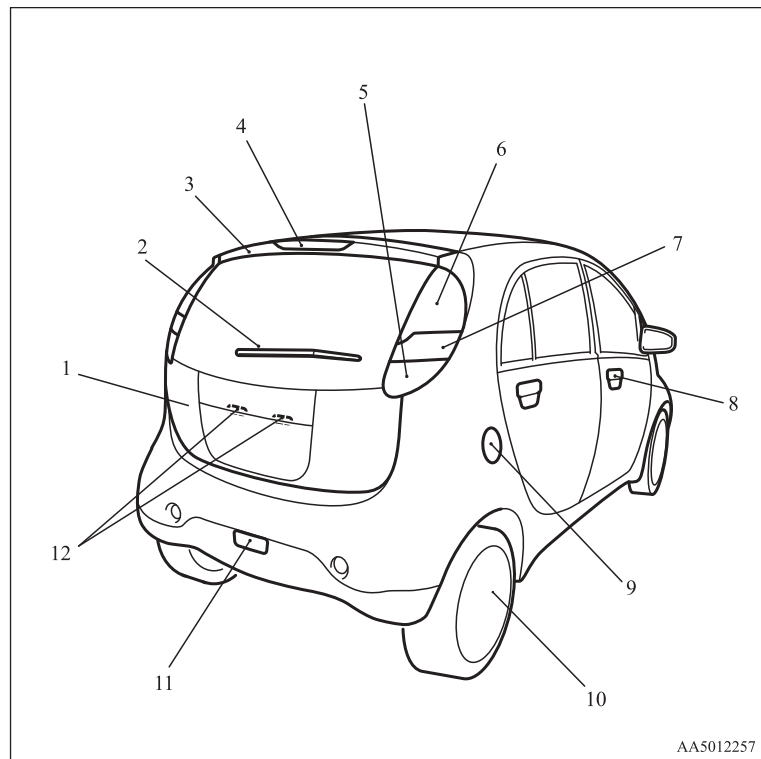

1. Tailgate p. 2-08
2. Rear window wiper p. 4-17
3. Rear spoiler
4. High-mounted stop lamp p. 8-24, 8-34
5. Reversing lamps p. 8-24, 8-33
6. Stop lamps/Tail lamps p. 4-14, 8-24, 8-33
7. Turn-signal lamps/Hazard warning lamps p. 4-14, 4-15, 8-24, 8-33
8. Keyless entry system p. 2-03  
Locking and unlocking the doors p. 2-05
9. Regular charging lid p. 1-05
10. Tyre inflation pressures p. 8-15  
Tyre rotation p. 8-16  
Tyre chains p. 8-17  
Size of tyres and wheels p. 9-05
11. Rear fog lamp p. 4-15, 8-24, 8-32
12. Licence plate lamps p. 4-11, 8-24, 8-34

# *General information*

Familiarizing yourself with i-MiEV.....	02
Installation of accessories.....	03
Modification/alterations to the electrical systems.....	04
Genuine parts.....	04
Disposal information for used batteries.....	04
Cautions and actions to deal with intense heat.....	05
Cautions and actions to deal with intense cold.....	06

## Familiarizing yourself with i-MiEV

E00202600016

This section describes features that the i-MiEV has as an electric vehicle and gives precautions that you should observe. It is important. Please read it carefully.

### Main features

E00202700017

- Energy required for driving is only electricity and fuel supply is not required.
- The traction battery and electric motor unit are mounted outside the passenger compartment. In this way, passenger space is obtained for riding of four adults.
- With the high performance motor, noise and vibration during driving are greatly limited and powerful acceleration can also be obtained.
- With regenerative braking, the traction battery is automatically charged when the accelerator is released.
- The vehicle can be charged from general power outlets (rated AC 220-240 V).
- Charge with the quick charger for i-MiEV is also available.
- The creeping behaviour occurs in i-MiEV like a vehicle with automatic transmission.

### Regenerative braking

It is equivalent to engine braking of an engine vehicle. If you step off the accelerator pedal during driving, motion energy is converted into electric energy using the motor as a power generator. In this conversion, braking force is generated and converted electric energy is charged in the traction battery.

Regenerative braking is stronger in the order of the selector lever position of “C” (COMFORT), “D” (DRIVE), “B” (BRAKE).

Put the selector lever to the “B” (BRAKE) or “C” (COMFORT) position according to the driving condition.

“B”: Strong regenerative braking (For downhill)

“C”: Weak regenerative braking (For long cruising)

### Traction battery

E00202800018

- It is the battery to operate the motor (electric motor unit) and the air conditioning. In addition to the traction battery, i-MiEV has the auxiliary battery to operate lamps, wipers, etc.
- Compact, light-weight lithium ion battery with high energy density is used for the traction battery.
- The lithium ion battery has the following characteristics. Please read this carefully and treat the battery paying attention to the following:

### Characteristics

- It is not necessary to consume the battery completely before charging.
- The capacity is gradually degraded depending on time used and operating conditions.
- The performance may be changed due to the outside temperature. At low temperature, in particular, the cruising range is short and the charging time is long, compared to operation at normal temperature.
- If you store your vehicle at an extremely high or low temperature, the battery capacity may be lowered.
- The battery is gradually discharged without use and the battery charge is lowered.

### Precautions for operation

- Do not store your vehicle with the energy level gauge showing 0 bars. Doing so could damage the traction battery. The battery may have to be replaced depending on the low capacity.
- If you do not use your vehicle for a long time, please charge the traction battery to the full every 3 months so that the energy level gauge may not be 0 bars.
- MITSUBISHI MOTORS collects traction batteries. If you scrap your vehicle, please consult a MITSUBISHI MOTORS Authorized Service Point.

### NOTE

- The progress of the battery capacity loss depends on the vehicle usage and the environment. We recommend to do regular charging from 2 bars or less to charge completely at least once in 3 months. The procedure lets the battery remaining indicator adjusted automatically.

### Cruising range

E00202900019

- Even if the charge level is the same, the cruising range may vary depending on the driving conditions. Since driving at high speed or climbing on a hill requires higher consumption of the traction battery than usual, the cruising range is shortened.
- Since the air conditioning (cooling or heating) consumes power of the traction battery, its operation results in a shorter cruising range. Maintain an appropriate temperature.

- Put the selector lever to the “B” (BRAKE) or “C” (COMFORT) position according to the road condition. To charge the traction battery with appropriate use of regenerative braking can increase the cruising range.

## *Installation of accessories*

E00200301003

We recommend you to consult a MITSUBISHI MOTORS Authorized Service Point.

- The installation of accessories, optional parts, etc., should only be carried out within the limits prescribed by law in your country, and in accordance with the guidelines and warnings contained within the documents accompanying this vehicle.
- Installing electric components incorrectly could lead to a fire. See the “Modification/alterations to the electrical systems” section within this owner’s manual.
- Using a cellular phone or radio set inside the vehicle without an external antenna may cause electrical system interference, which could lead to unsafe vehicle operation.
- Tyres and wheels which do not meet specifications must not be used.  
Refer to the “Specifications” section for information regarding wheel and tyre sizes.

### **Important points!**

Due to large number of accessory and replacement parts of different manufactures available in the market, it is not possible, not only for MITSUBISHI MOTORS, but also for a MITSUBISHI MOTORS Authorized Service Point, to check whether the attachment or installation of such parts affects the overall safety of your MITSUBISHI-vehicle.

Even when such parts are officially authorized, for example by a “general operators permit” (an appraisal for the part) or through the execution of the part in an officially approved manner of construction, or when a single operation permit following the attachment or installation of such parts, it cannot be deduced from that alone, that the driving safety of your vehicle has not been affected.

Consider also that there basically exists no liability on the part of the appraiser or the official. Maximum safety can only be ensured with parts recommended, sold and fitted or installed by a MITSUBISHI MOTORS authorized Service Point (MITSUBISHI MOTORS genuine replacement parts and MITSUBISHI MOTORS accessories). The same also pertains to modifications of MITSUBISHI vehicles with respect to the production specifications. For safety reasons, do not attempt any modifications other than those that follow the recommendations of a MITSUBISHI MOTORS authorized Service Point.

## Modification/alterations to the electrical systems

E00200400414

MITSUBISHI MOTORS CORPORATION has always manufactured safe, high quality vehicles. In order to maintain this safety and quality, it is important that any accessory that is to be fitted, or any modifications carried out which involve the electrical systems, should be carried out in accordance with MITSUBISHI guidelines.

### CAUTION

- If the wires interfere with the vehicle body or improper installation methods are used (protective fuses not included, etc.), electronic devices may be adversely affected, resulting in a fire or other accident.

## Genuine parts

E00200500499

MITSUBISHI MOTORS has gone to great lengths to bring you a superbly crafted automobile offering the highest quality and dependability.

Use MITSUBISHI MOTORS Genuine Parts, designed and manufactured to maintain your MITSUBISHI MOTORS automobile at top performance. MITSUBISHI MOTORS Genuine Parts are identified by this mark and are available at all MITSUBISHI MOTORS Authorized Service Points.

**MITSUBISHI MOTORS  
GENUINE PARTS**

## Disposal information for used batteries

E00201300045

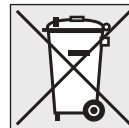

Your vehicle contains batteries and/or accumulators.

Do not mix with general household waste.

For proper treatment, recovery and recycling of used batteries, please take them to applicable collection points, in accordance with your national legislation and the Directives 2006/66/EC. MITSUBISHI MOTORS collects traction batteries. If you scrap your vehicle, please consult a MITSUBISHI MOTORS Authorized Service Point.

By disposing of these batteries correctly, you will help to save valuable resources and prevent any potential negative effects on human health and the environment which could otherwise arise from inappropriate waste handling.

## Cautions and actions to deal with intense heat

- When the vehicle is driven in a high ambient temperature, its air-conditioner performance can be insufficient. Also, using the air conditioner can reduce the vehicle's cruising range.
- When the ambient temperature is approximately 40 °C or higher, the phenomena described below may occur. Please take the described corrective action.

Approx. ambient temperature	Phenomena		Corrective action
Approx. 40 °C to 45 °C	Startup and driving	During quick charging, repeated high-speed driving, or repeated uphill driving, the power down warning lamp* comes on and the motor output is restricted to protect the traction battery or motor (electric motor unit).	Stop the vehicle for a while, avoid quick charging, and wait for the power down warning lamp* to go off.
Approx. 45 °C to 60 °C	Startup and driving	During continued high-speed driving or continued uphill driving, the power down warning lamp* comes on and the motor output is restricted to protect the traction battery or motor (electric motor unit). If you continue driving after the power down warning lamp* has come on, the vehicle may stop when you have driven a few kilometres. (The vehicle stops when the traction battery temperature reaches 60 °C.)	
	Charging and battery	Charging may become impossible. (When the traction battery temperature is 60 °C or higher, charging is limited to protect the traction battery.)	Park in a well-ventilated, shady place.
		The traction battery capacity decreases more quickly, and the cruising range decreases more quickly.	When you park, do so in a well-ventilated, shady place.
Approx. 60 °C or higher	Startup and driving	The power down warning lamp* comes on, and the vehicle may stop. (The vehicle stops when the traction battery temperature reaches 60 °C.)	Park in a well-ventilated, shady place, avoid quick charging, and wait for the power down warning lamp* to go off.
	Charging and battery	Deterioration of the traction battery becomes extremely fast.	Park in a well-ventilated, shady place.

### NOTE

- \*: Refer to "Power down warning lamp" on page 4-11. Illumination of the power down warning lamp does not indicate a malfunction.



### *Cautions and actions to deal with intense cold*

E00203100021

- When the vehicle is driven in a low ambient temperature, its heater performance can be insufficient. Also, using the heater can reduce the vehicle's cruising range.
- When the ambient temperature is approximately -15 °C or lower, the phenomena described below may occur. Please take the described corrective action.

Approx. ambient temperature	Phenomena		Corrective action
Approx. -15 °C or lower	Startup and driving	<ul style="list-style-type: none"> <li>● Motor output is restricted, and the power down warning lamp*1 may come on.</li> <li>● If the traction battery's remaining power is low (approximately 30%), driving performance decreases by approximately 20%.</li> </ul>	Continue driving. (As the traction battery temperature rises, the output restriction will gradually be removed.)
	Charging and battery	<ul style="list-style-type: none"> <li>● Charging times get longer.                             <ul style="list-style-type: none"> <li>• Regular charge: Becomes approximately 2-3 hours longer at -15 °C.</li> <li>• Quick charge: Becomes approximately 2 hours longer at -15 °C.</li> </ul> </li> <li>• Charging times get longer with further reductions in temperature.</li> <li>● Charging may complete with 16 bars of energy level gauge*2 does not go on. Even if charging is completed with 16 bars of energy level gauge come on, the 16th bar may go off early. The lighting bars may decrease with further reductions in temperature.</li> </ul>	When you have finished driving, charge the traction battery before its temperature falls.

Approx. ambient temperature	Phenomena		Corrective action
Approx. -25 °C or lower (including the phenomena of approx. -15 °C or lower)	Startup and driving	<ul style="list-style-type: none"> <li>● Driving performance decreases by approximately 50%.</li> </ul>	Continue driving. (As the traction battery temperature rises, the output restriction will gradually be removed.)
	Charging and battery	<ul style="list-style-type: none"> <li>● Charging may become impossible. (When the traction battery temperature is -25 °C or lower, charging is limited to protect the traction battery.)</li> </ul>	When you have finished driving, charge the traction battery before its temperature falls.
Approx. -30 °C or lower (including the phenomena of approx. -15 °C or lower and -25 °C or lower)	Startup and driving	<ul style="list-style-type: none"> <li>● The ready indicator*<sup>3</sup> does not come on, and startup may not be possible.</li> <li>● In the worst-case scenario, the vehicle may become undrivable (with the energy level gauge and cruising range indications still shown).</li> </ul>	In the daytime, wait for the temperature to rise. When the temperature in the vicinity of the traction battery has risen, start up. (Once you start driving, the traction battery temperature will rise. Provided the traction battery has some power, the vehicle will not stop.)
		<ul style="list-style-type: none"> <li>● Regenerative braking performance may decrease.</li> </ul>	To decelerate, press the brake pedal. (The deterioration in regenerative braking performance is like a deterioration in engine braking in a petrol- or diesel-engine version. If you press the brake pedal, the brakes will work.)

## NOTE

- \*<sup>1</sup>: Refer to “Power down warning lamp” on page 4-11. Illumination of the power down warning lamp does not indicate a malfunction.
- \*<sup>2</sup>: Refer to “Energy level gauge” on page 4-06.
- \*<sup>3</sup>: Refer to “Ready indicator” on page 4-09.



# Charging

Battery.....	1-02
Basic knowledge for charging.....	1-02
EV charging cable.....	1-03
Regular charging (charging method with rated AC 220-240 V outlet).....	1-04
Quick charging (charging method with quick charger).....	1-08

### Battery

E08300100014

There are two types of batteries installed in your vehicle: a traction battery for operating the motor (electric motor unit) and air conditioning as well as an auxiliary battery for starting the electric motor unit and operating the lamps, wipers, etc. This chapter explains charging of the traction battery.

#### NOTE

- The auxiliary battery is automatically charged while the ready indicator is illuminated or during charge for the traction battery. Refer to “Ready indicator” on page 4-09.
- If the auxiliary battery is flat, the electric motor unit cannot be started. Refer to “Emergency starting” on page 7-02.

### Basic knowledge for charging

E08300200015

There are two types of charging: regular charging and quick charging.

Regular charging is performed through the on-board charger using rated AC 220-240 V outlet as the power source.

The rated AC voltage may differ from country to country.

Quick charging is performed with the quick charger compatible with i-MiEV.

#### NOTE

- Repeatedly performing only quick charging may reduce the battery capacity. In usual charge, regular charging is recommended.
- To maintain the capacity of the traction battery, the following is recommended:
  - Fully charge the vehicle in regular charging every two weeks.
  - Do not repeat charging near the full charge level.
- The quick charging gives priority when the regular charging and the quick charging are performed at the same time.  
At this time, the regular charging will be stopped.
- The progress of the battery capacity loss depends on the vehicle usage and the environment.

We recommend to perform normal charging from 2 segments or less to charge completely at least once in 3 months.

The procedure lets the battery remaining indicator adjusted automatically.

### Guideline for charging time

E08300700010

The regular charging time (from 1 bar of energy level gauge to full charge) is different according to the current value.

- 230 V/16 A → about 6 hours
- 230 V/13 A → about 7 hours
- 230 V/10 A → about 8 hours

About 30 minutes with quick charger (About 80 % of full charge)

#### NOTE

- The charging time may vary depending on the battery condition, operation environment of the vehicle and specification of the quick charger.

## EV charging cable

E08301100024

Your vehicle is equipped with the EV charging cable (A) with control box (B).

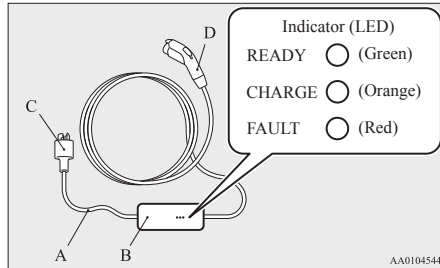

The indicator illuminates/blinks in the following conditions.

- Green: The charging cable plug (C) is inserted into an outlet and the electrical power is provided correctly.
- Orange: The regular charging plug (D) is connected and started charging correctly after the green indicator is illuminated.
- Red (illuminating): A problem is detected in the control box.
- Red (blinking): Electrical leakage or malfunction in the i-MiEV is detected.

### ⚠ WARNING

- If the green or orange indicator does not illuminate or the red indicator blinks or illuminates during regular charging, please contact a MITSUBISHI MOTORS Authorized Service Point.

### ⚠ WARNING

- Do not charge with the EV charging cable banded or rolled. The cable may be heated and resulting in fire.
- Do not alter or disassemble the EV charging cable. Doing so could cause fire, an electric shock or injury.
- Be sure to install the cap to the regular charging plug and store the EV charging cable at a place where the cable is not exposed to water or dust. Entry of foreign matter such as water or dust at the metal terminal of the regular charging plug or charging cable plug may cause fire or malfunction. Contact with metal such as wire or tool may cause fire, an electric shock or malfunction.
- If the EV charging cable, regular charging plug, charging cable plug or outlet shows damage, corrosion or rust, or if loosening is found at the connection, do not perform charging. Doing so could cause fire, an electric shock, or short circuit.
- Pay attention to the following for handling the EV charging cable. Damage to the cable could cause fire, an electric shock, or short circuit.
  - Do not pull with undue force.
  - Do not twist.
  - Do not drag.
  - Do not put an object on top.
  - Do not put the cable close to a heating unit including heater.
  - Do not drop the regular charging plug or do not give strong impact to it.

### ⚠ CAUTION

- Do not charge with the outlet that is smaller than the current value described on the control box.

#### NOTE

- All indicators are illuminated momentarily for confirming operation when the charging cable plug is inserted into an outlet. After that the green indicator is continuously illuminated.
- The orange indicator will go off when the charging is completed. The green indicator is continuously illuminated while the charging plug is inserted into an outlet.

#### Handling and storing the control box

E08301200025

### ⚠ CAUTION

- While charging, it must be prevented being damaged to the control box by the attached rope as shown in the following illustration.

#### NOTE

- Use the hook with load capacity over 4 kg, that weight is the EV charging cable.
- Check the rope has no damage or no loose before use.

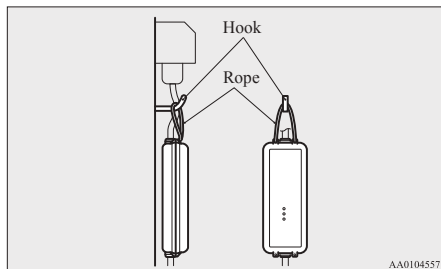

### Cleaning the EV charging cable

E08301300026

1. Gently wipe off with gauze or other soft cloth soaked with a 3 % aqueous solution of neutral detergent.
2. Wipe off all the detergent with a soft cloth dipped in fresh water and thoroughly wrung out.
3. Wipe all moisture off and dry in a shaded, well-ventilated area.

## **⚠ WARNING**

- In cleaning, be sure to remove the charging cable plug and the regular charging plug from the outlet. Do not connect or disconnect the plug with wet hand. Doing so could cause an electric shock.
- Do not have the metal terminal of the regular charging plug and the charging cable plug be exposed to water or neutral detergent. Operation with water could cause fire or an electric shock.

## **⚠ CAUTION**

- Never use benzine, petrol, or other organic solvents, or acid or alkaline solvents. Doing so could cause deformation, discolor, or malfunction. Also, these substances may be present in various cleaners, so check carefully before use.

## **Regular charging (charging method with rated AC 220-240 V outlet)**

E08300900012

## **⚠ WARNING**

- Persons who use electro-medical apparatus such as implantable cardiac pacemaker or implantable cardioverter- defibrillator must check effect from charging with the manufacturer of electro-medical apparatus. Electro-medical apparatus operations could be affected by charging.
- Do not charge with the EV charging cable banded or rolled. Doing so the cable may be heated and this might result in fire.
- Before charging, make sure that there is no foreign matter such as dust at the regular charging connection and the regular charging plug. At this time, do not touch the regular charging connection.
- When the regular charging plug is connected to the charging connection, prevent foreign matter such as water or dust from entering in the connection. Connection with foreign matter such as water or dust may cause fire or an electric shock. Do not perform charging if there might be strong exposure to water at the connection.
- Please observe the following in order to prevent accidents during charging such as electrocution.

## **⚠** WARNING

- Make sure to use the EV charging cable that comes with the vehicle.
- Do not charge another vehicle using the attached EV charging cable. Doing so the cable may be heated and this might result in fire.
- Make sure to use an outlet that is protected from water entering.
- Do not perform charging with the body cover.
- Do not remove and insert plugs with wet hands.
- Do not charge the battery if there is a risk of lightning.
- If abnormal smells are detected or the vehicle produces smoke, quickly stop charging.
- Do not perform charging at a poorly ventilated place with surroundings covered. Keep sparks, cigarettes, and flames away from the auxiliary battery. Flammable gas generated from the auxiliary battery in charging may be filled in a building, resulting in explosion. If charging is inevitably required, ventilate the area well.
- Grasp the regular charging plug when connecting or disconnecting the EV charging cable. Grasping the cable could cause an electric shock, short circuit, and/or fire.

## **⚠** CAUTION

- Do not perform charging from other power source like a generator. Doing so could cause a malfunction.
- During charging, the cooling fans inside the bonnet room may automatically be operated even if the electric motor switch is in the “LOCK” position. Keep your hands away from the cooling fan during charging.

### NOTE

- The on board charger is only for rated AC 220-240 V outlets.
- When connecting or disconnecting the regular charging plug, insert/pull out the plug straight. Also, do not incline or twist the plug. Doing so could cause a bad connection or malfunction.
- Make sure to lock the doors to prevent theft, etc. during charging.

### Charging from rated AC 220-240 V outlet

E0830100023

1. Fully apply the parking brake and place the selector lever to the “P” (PARK) position.
2. Stop the electric devices such as lamps and turn the electric motor switch to the “LOCK” position.

3. Pull the regular charging opener (A) at the bottom left/right of the instrument panel to open the regular charging lid (B) at the right rear side of the vehicle.

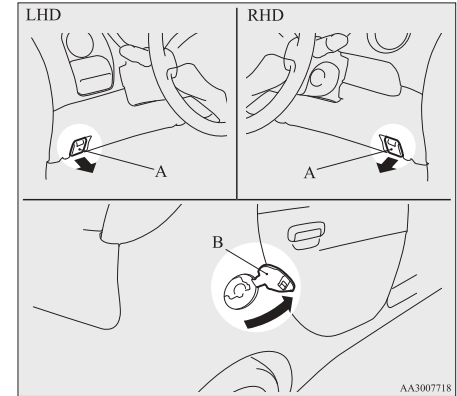

4. Press the tab (C) to open the inner lid (D).

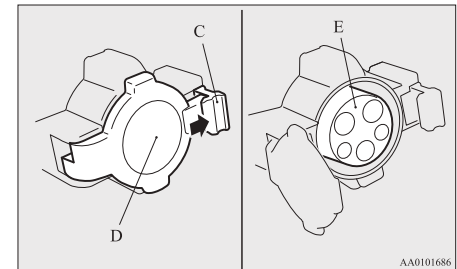



## **⚠ WARNING**

- Do not touch the metal terminal of the regular charging connection (E) and the regular charging plug. Doing so could cause an electric shock and/or malfunction.

## **⚠ CAUTION**

- Do not leave for a long time with the inner lid opened. It becomes impossible to charge if foreign material enters the regular charging connection.

5. Insert the charging cable plug into an outlet.

### NOTE

- The shape of the charging cable plug and outlet may differ from country to country as shown in the illustration.
- Use the following outlets.

## **⚠ WARNING**

- To prevent an electric shock or fire due to electric leak, perform charging using the waterproofed outlet with earthing which is connected to the ground fault interrupter.

## **⚠ WARNING**

- Use the rated AC 220-240 V outlet individually. If a plug adapter is connected at the end of the EV charging cable for use together with other device, the outlet may be overheated, resulting in a fire.

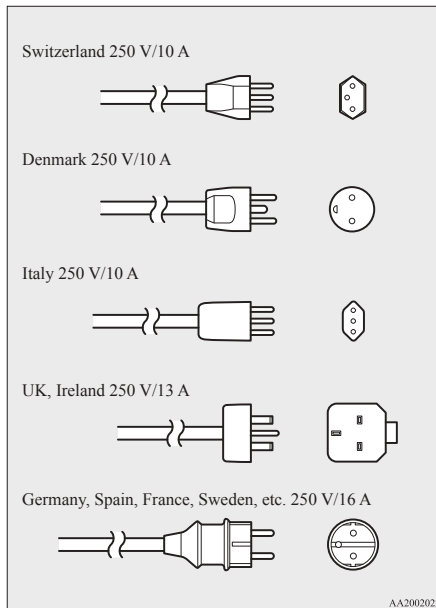

6. Remove the cap (F) on the regular charging plug (G) and make sure that there is no foreign matter such as dust at the end of the regular charging plug and the regular charging connection.

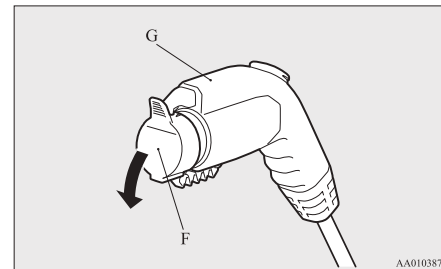

7. Connect the regular charging plug until a click sound is heard without pressing the button (H).

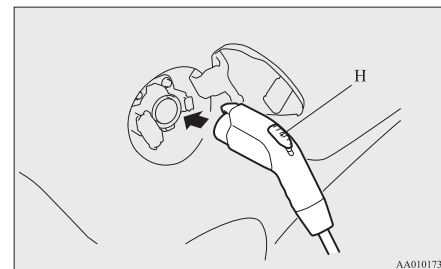

**⚠ CAUTION**

- Do not clasp the top of regular charging plug. It could cause injury to touch the protrusion on the lid.

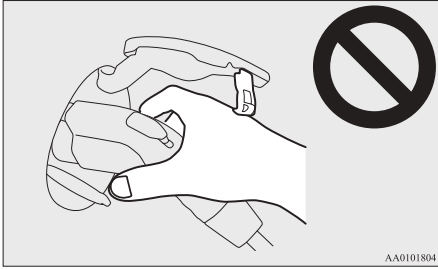

NOTE

- If the electric motor switch is turned to the “START” position with the regular charging plug connected to the regular charging connection, the electric motor unit cannot be started.
8. Make sure that the charging indicator on the instrument cluster is illuminated.

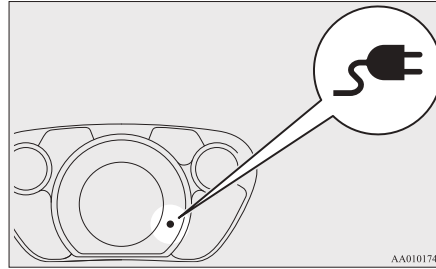

If the charging indicator is not illuminated, charging is not started. Make sure that the regular charging connection and the plug are appropriately connected, and perform charging from Step 5 again.

NOTE

- When the regular charging plug is connected to the charging connection, the charging indicator is blinking. When charging is started, the charging indicator is illuminated.
- The charge level for traction battery can be checked with the energy level gauge (I) on the instrument cluster. Refer to “Energy level gauge” on page 4-06.

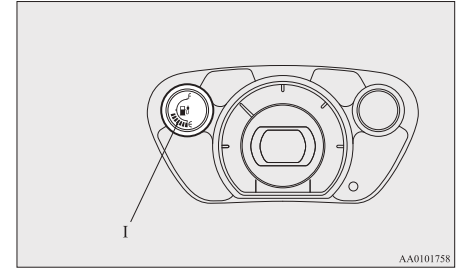

9. Charging is complete when the charging indicator turns off. Pull out the regular charging plug while pressing the button (J).

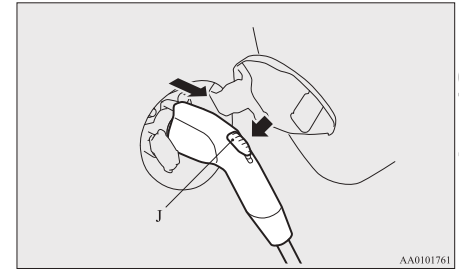

NOTE

- Charging can be stopped half way. In this case, also, pull out the regular charging plug while pressing the button.
10. Close the inner lid and close the regular charging lid.

## Charging

### NOTE

- Make sure that the inner lid is completely closed.  
If the regular charging lid is forcibly closed without completely closing the inner lid, the hinge on the inner lid may be broken.

11. Remove the charging cable plug from the outlet.
12. Install the cap on the regular charging plug.

### **WARNING**

- After charging, be sure to close the inner lid and the regular charging lid completely.  
Be careful that water or dust does not enter in the regular charging connection, inner lid and regular charging plug.  
Entry of water or dust could cause electric leakage, resulting in a fire or electric shock.
- After charging, be sure to disconnect the plug from the outlet.  
If the plug is left connected to the outlet, immersion in water or tampering may cause leakage or an electric shock.

### *Quick charging (charging method with quick charger)*

E08301400027

### **WARNING**

- Be sure to use the quick charger compatible with i-MiEV.  
Use of a non-compatible quick charger may cause fire or malfunction.  
For the quick charger compatible with i-MiEV, consult a MITSUBISHI MOTORS Authorized Service Point.
- For operation of quick chargers, follow the manual of each quick charger.
- Persons who use electro-medical apparatus such as implantable cardiac pacemaker or implantable cardioverter- defibrillator must check effect from charging with the manufacturer of electro-medical apparatus. Electro-medical apparatus operations could be affected by charging.
- Before charging, make sure that there is no foreign matter such as dust at the quick charging connection and the quick charging plug.  
At this time, do not touch the quick charging connection.

### **WARNING**

- When the quick charging plug is connected to the quick charging connection, prevent foreign matter such as water or dust from entering in the connection.  
Connection with foreign matter such as water or dust may cause fire or an electric shock. Do not perform charging if there might be strong exposure to water at the connection.

### **CAUTION**

- During charging, the cooling fans inside the bonnet room may automatically be operated even if the electric motor switch is in the “LOCK” position.  
Keep your hands away from the cooling fan during charging.

### NOTE

- Make sure to lock the doors to prevent theft, etc. during charging.
1. Fully apply the parking brake and move the selector lever to the “P” (PARK) position.
  2. Stop the electric devices such as lamps, air conditioning, etc. and turn the electric motor switch to the “LOCK” position.

3. Pull the quick charging lid opener (A) at the bottom left/right of the driver's seat to open the quick charging lid (B) at the left rear side of the vehicle.

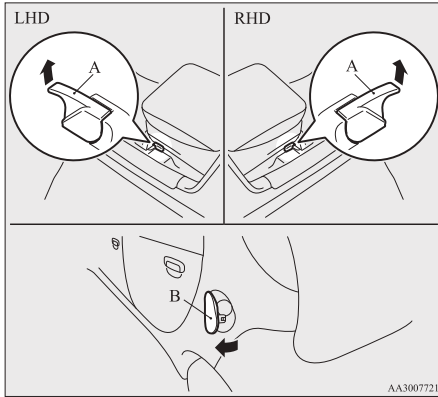

4. Press the tab (C) to open the inner lid (D).

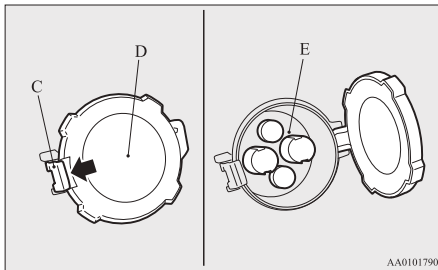

## **⚠ WARNING**

- Do not touch the metal terminal of the quick charging connection (E) and the quick charging plug. Doing so could cause an electric shock and/or malfunction.

## **⚠ CAUTION**

- Do not leave for a long time with the inner lid opened. It becomes impossible to charge if foreign material enters the quick charging connection.

5. Connect the quick charging plug in the quick charging connection to begin charging. For connecting and disconnecting, follow the instruction manual for each quick charger.
6. Make sure that the charging indicator on the instrument cluster is illuminated.

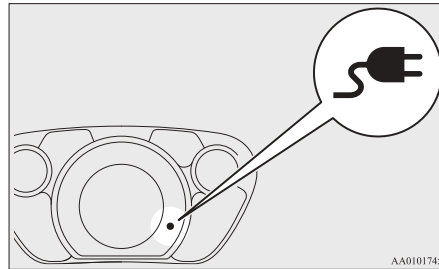

If the charging indicator is not illuminated, charging is not started.

Follow the manual of each quick charger.

### NOTE

- When the regular charging plug is connected to the charging connection, the charging indicator is blinking. When charging is started, the charging indicator is illuminated.
- The charge level for traction battery can be checked with the energy level gauge (F) on the instrument cluster. Refer to “Energy level gauge” on page 4-06.

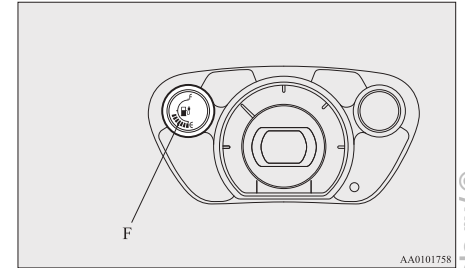

- Operation noise may be heard from the vehicle body during quick charging. This noise comes from operation of the traction battery cooling system, and it is not a malfunction.
- Since the traction battery cooling system uses cool air of the air conditioning, the air conditioning is automatically operated. After quick charging, if the area under the vehicle is wet, transparent and loose, it is dehumidified water from the air conditioning and not a malfunction.

## Charging

7. Charging is complete when the charging indicator turns off.  
Disconnect the quick charging plug according to the manual of the quick charger.

### CAUTION

- **Do not leave the quick charging plug connected to the quick charging connection after charging.**  
Doing so, someone might stumble and it could cause an injury or the quick charging connection might be damaged by playing it.

8. Close the inner lid and close the quick charging lid.

### WARNING

- **After charging, be sure to close the inner lid and the quick charging lid completely. Be careful that water or dust does not enter in the quick charging connection, inner lid and quick charging plug. Entry of water or dust could cause fire, electric shock or short circuit.**

## NOTE

- If the electric motor switch is turned to the “START” position with the quick charging plug connected to the quick charging connection, the electric motor unit cannot be started. Be sure to disconnect the quick charging plug before start.

- Charging may be completed before full charge. This is a control for efficient charge and not a malfunction.  
To achieve full charge, repeat charging from Step 5 again.
- Make sure that the inner lid is completely closed.  
If the quick charging lid is forcibly closed without completely closing the inner lid, the hinge on the inner lid may be broken.

## *Locking and unlocking*

Keys.....	2-02
Electronic immobilizer (Anti-theft starting system).....	2-02
Keyless entry system.....	2-03
Doors.....	2-05
Central door locks.....	2-06
“Child-protection” rear doors.....	2-07
Tailgate.....	2-08
Electric window control.....	2-09

### Keys

E00300102399

Two keys are provided. The key fits all locks. Keep one in a safe place as a spare key.

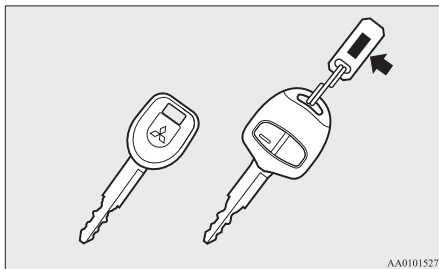

### **⚠ WARNING**

- When taking a key on flights, do not press any switches on the key while on the plane. If a switch is pressed on the plane, the key emits electromagnetic waves, which could adversely affect the plane's flight operation. When carrying a key in a bag, be careful that no switches on the key can be easily pressed by mistake.

### NOTE

- The key number is stamped on the tag as indicated in the illustration. Make a record of the key number and store the key and key number tag in separate places, so that you can order a key in the event the original keys are lost.

- The key is a precision electronic device with a built-in signal transmitter. Please observe the following in order to prevent malfunctioning.

- Do not leave the key anywhere where exposed to direct sunlight, for example on the dashboard.
  - Do not disassemble or modify.
  - Do not excessively bend the key or subject it to strong impacts.
  - Do not expose to water.
  - Keep away from magnetic key rings.
  - Keep away from audio systems, personal computers, TVs, and other equipment that generates a magnetic field.
  - Keep away from devices that emit strong electromagnetic waves, such as cellular phones, wireless devices and high frequency equipment (including medical devices).
  - Do not clean with ultrasonic cleaners or similar equipment.
  - Do not leave the key where it may be exposed to high temperature or high humidity.
- The electric motor unit is designed so that it will not start if the ID code registered in the immobilizer computer and the key's ID code do not match. Refer to the "Electronic immobilizer" section for details and key usage.

### **Electronic immobilizer (Anti-theft starting system)**

E00300201928

The electronic immobilizer is designed to significantly reduce the possibility of vehicle theft. The purpose of the system is to immobilize the vehicle if an invalid start is attempted. A valid start attempt can only be achieved by using a key "registered" to the immobilizer system.

### NOTE

- In the following cases, the vehicle may not be able to receive the registered ID code from the registered key and the electric motor unit may not start.
  - When the key contacts a key ring or other metallic or magnetic object (Type A)
  - When the key grip contacts metal of another key (Type B)

- When the key contacts or is close to other immobilizing keys (including keys of other vehicles) (Type C)

In cases like these, remove the object or additional key from the vehicle key and turn the key back to the “ACC” or “LOCK” position. Then try again to start the electric motor unit. If the electric motor unit does not start, we recommend you to contact your MITSUBISHI MOTORS Authorized Service Point.

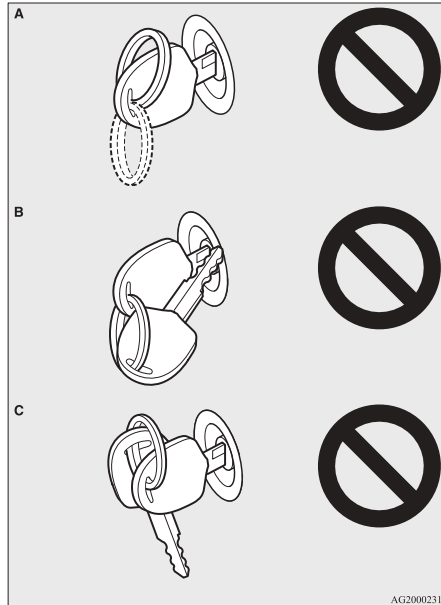

- Two keys are provided. If you lose one of them, order a key from your MITSUBISHI MOTORS Authorized Service Point as soon as possible. To obtain a replacement or extra spare key, take your vehicle and any remaining key to your MITSUBISHI MOTORS Authorized Service Point. All the keys have to be registered in the immobilizer computer unit. The immobilizer can register up to 8 different keys.

### **CAUTION**

- Don't make any alterations or additions to the immobilizer system; alterations or additions could cause failure of the immobilizer.

### *Keyless entry system*

E00300302434

Press the remote control switch, and all doors and the tailgate will be locked or unlocked as desired.

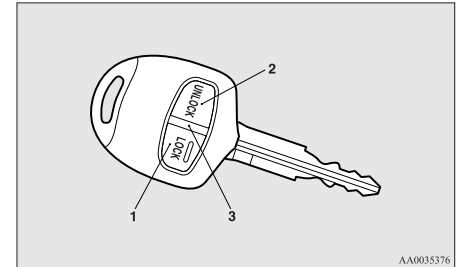

- 1- LOCK switch
- 2- UNLOCK switch
- 3- Indication lamp

#### **To lock**

Press the LOCK switch (1), and all doors and the tailgate will be locked. When they are locked with the room lamp at the middle (•) position or at the “DOOR” position, the room lamp and the turn-signal lamps blink once.

#### **To unlock**

Press the UNLOCK switch (2), and all doors and the tailgate will be unlocked. When unlocked with the room lamp at the (•) position or at the “DOOR” position, the room lamp will be turned on for approximately 15 seconds and the turn-signal lamps will blink twice.



### NOTE

- The indication lamp (3) comes on each time a switch is pressed.
- If the UNLOCK switch (2) is pressed and any of the doors or the tailgate is not opened within approximately 30 seconds, relocking will automatically occur.
- It is possible to modify functions as follows: For further information, please contact your MITSUBISHI MOTORS Authorized Service Point.
  - The time for automatic relocking can be changed.
  - The confirmation function (flashing of the turn-signal lamps) can be set to operate only when the doors and the tailgate are locked or only when the doors and the tailgate are unlocked.
  - The confirmation function (this indicates locking or unlocking of the doors and the tailgate with the flash of the turn-signal lamps) can be deactivated.
  - The number of times the turn-signal lamps are flashed by the confirmation function can be changed.
- The keyless entry system does not operate in the following conditions:
  - The key is left in the key cylinder.
  - The door or the tailgate is open.
- The remote control switch will operate within approximately 4 m from the vehicle. However, the operating range of the remote control switch may change if the vehicle is located near a power station, or radio/TV broadcasting station.
- If either of the following problems occurs, the battery may be exhausted.

- The remote control switch is operated at the correct distance from the vehicle, but the doors and the tailgate are not locked/unlocked in response.
- The indication lamp (3) is dim or does not come on.

For further information, please contact your MITSUBISHI MOTORS Authorized Service Point.

If you replace the battery yourself, refer to “Procedure for replacing the remote control switch battery” on page 2-04.

- If your remote control switch is lost or damaged, please contact your MITSUBISHI MOTORS Authorized Service Point for a replacement remote control switch.
- If you wish to add a remote control switch, we recommend you to contact a MITSUBISHI MOTORS Authorized Service Point.

A maximum of 4 remote control switches are available for your vehicle.

### Operation of the outside rear-view mirrors

E00310800119

#### *To fold*

Within 30 seconds of locking the doors and the tailgate using the LOCK switch (1), press the LOCK switch twice rapidly to fold the outside rear-view mirrors.

#### *To extend*

Within 30 seconds of unlocking the doors and the tailgate using the UNLOCK switch (2), press the UNLOCK switch twice rapidly to return the outside rear-view mirrors to their extended positions.

### Procedure for replacing the remote control switch battery

E00309500129

1. Before replacing the battery, remove static electricity from your body by touching a metal part such as doorknob of the room.
2. Remove the screw (A) from the remote control switch.

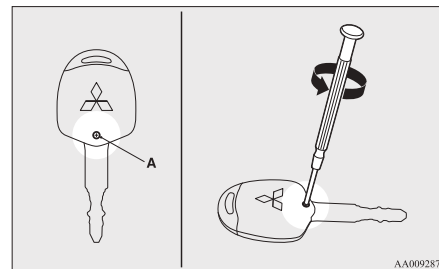

3. With the MITSUBISHI mark facing you, insert the clothcovered tip of a straight blade (or minus) screwdriver into the notch in the remote control switch case and use it to open the case.

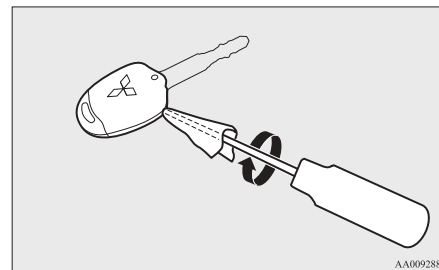

## Doors

E00300402187

### NOTE

- Be sure to perform the procedure with the MITSUBISHI mark facing you. If the MITSUBISHI mark is not facing you when you open the remote control switch case, the switches may come out.

4. Remove the remote control transmitter from the remote control switch case. Then, open the remote control transmitter using the method described in step 2.

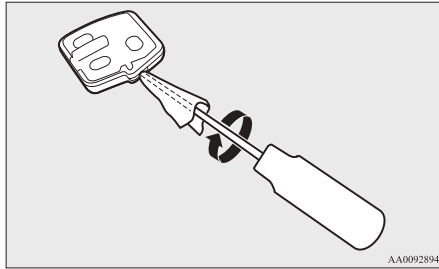

AA0092894

5. Remove the old battery.

6. Install a new battery with the + side (B) down.

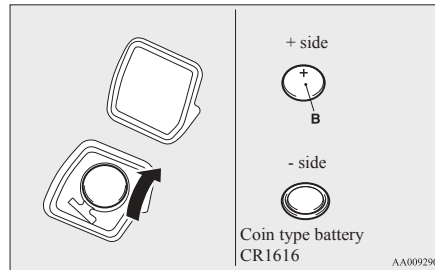

7. Close the remote control transmitter firmly.
8. Place the remote control transmitter in the remote control switch case, then securely close the remote control switch case.
9. Attach the screw (A) removed in step 1.
10. Check the keyless entry system to see that it works.

### NOTE

- You may purchase a replacement battery at an electric appliance store.
- A MITSUBISHI MOTORS Authorized Service Point can replace the battery for you if you prefer.

### **CAUTION**

- When the remote control switch case is opened, be careful to keep water, dust, etc. out. Also, do not touch the internal components.

### **CAUTION**

- Make sure the doors are closed: driving with doors not completely closed is dangerous.
- Never leave children in the vehicle unattended.
- Be careful not to lock the doors while the key is inside the vehicle.

### NOTE

- To prevent the key from being locked inside the vehicle, neither the lock knob on the driver's door nor the key can be used to lock the driver's door when it is open.

### To lock or unlock with the key

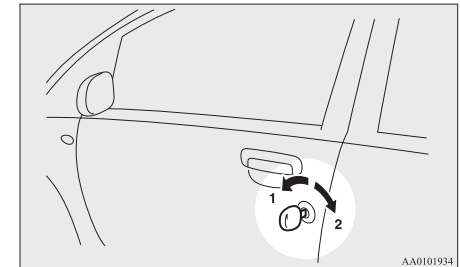

- 1- Lock
- 2- Unlock

## Locking and unlocking

### To lock or unlock from inside the vehicle

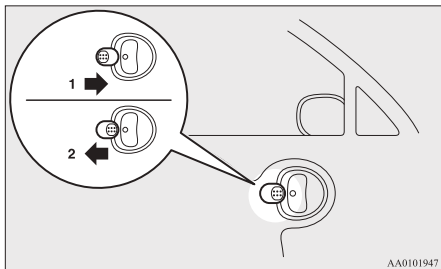

- 1- Lock
- 2- Unlock

Pull the inside door handle towards you to open the door.

#### NOTE

- The driver's door can be opened without using the lock knob by pulling on the inside door handle. Also, all other doors and the tailgate are unlocked at the same time.

### To lock without using the key

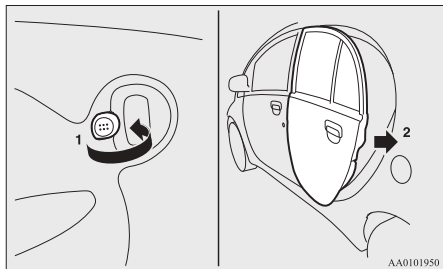

Set the inside lock knob (1) to the locked position, and close the door (2).

#### NOTE

- The driver's door cannot be locked using the inside lock knob while the driver's door is opened.

## Central door locks

E00300801852

#### NOTE

- Each of the doors can be locked or unlocked independently by using the inside lock knob.
- Repeated continuous operation between lock and unlock could activate the central door locking systems built-in protection circuit and prevent the system from operating. If this occurs, wait about 1 minute before operating the inside lock knob or the key.

### Driver's door with key

Using the key on the driver's door locks or unlocks all doors and the tailgate.

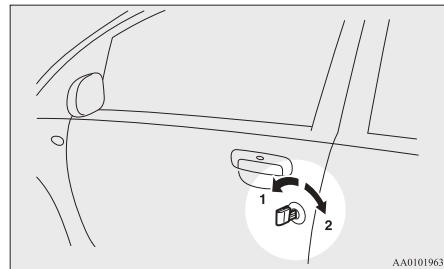

- 1- Lock
- 2- Unlock

### Driver's door with inside lock knob

Using the inside lock knob on the driver's door locks or unlocks all doors and the tailgate.

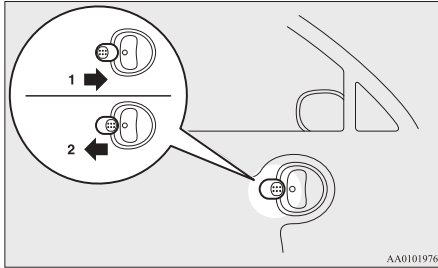

- 1- Lock
- 2- Unlock

### Unlocking doors using selector lever

It is possible to unlock all doors and the tailgate using the selector lever by placing it in the "P" position while the electric motor switch is in the "ON" position.

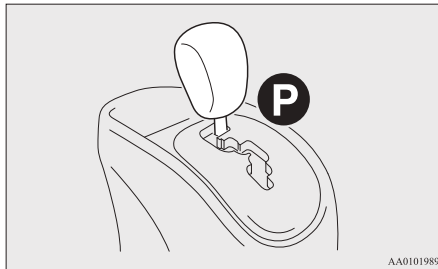

### NOTE

- The vehicle is shipped from the factory with a setting established such that the doors and the tailgate are not unlocked when the selector lever is placed in the "P" position with the electric motor switch in the "ON" position. If you wish to change the setting such that the doors and the tailgate are unlocked, contact your MITSUBISHI MOTORS Authorized Service Point.

### "Child-protection" rear doors

E00300901026

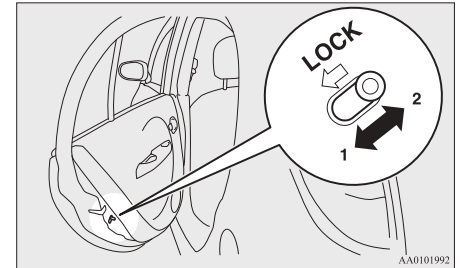

- 1- Lock
- 2- Unlock

Child protection helps prevent the rear doors from being opened accidentally from the inside.

If the lever is set to the locked position, the rear door cannot be opened using the inside handle, but only with the outside handle.

If the lever is set to the "Unlock" position, the child protection mechanism does not function.

### **⚠ CAUTION**

- When driving with a child in the rear seat, please use the child protection to prevent accidental door opening which may cause an accident.

## Tailgate

E00301401161

### **⚠** WARNING

- When opening and closing the tailgate, make sure that there are no people nearby and be careful not to hit your head or pinch your hands, neck, etc.

### 2 To open

After unlocking the tailgate, push the switch (A) and pull up the tailgate.

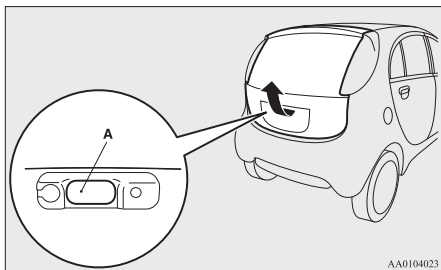

AA0104023

### NOTE

- If you do not open the tailgate immediately after pulling the handle, the tailgate cannot be lifted. If this happens, pull the handle again and lift the tailgate.
- The tailgate cannot be opened when the battery is flat or disconnected.

### To close

Pull the tailgate grip (A) downward as illustrated. Gently push the upper gate from the outside with enough force so that it is completely closed. Always ensure the tailgate is securely closed.

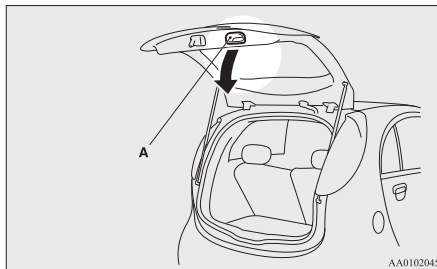

AA0102045

### **⚠** CAUTION

- When closing the tailgate, always ensure your or other person's fingers cannot be caught by the tailgate.

### NOTE

- Gas struts (B) are installed to support the tailgate.  
To prevent damage or faulty operation.
  - Do not hold the gas struts when closing the tailgate.
  - Also, do not push or pull the gas struts.
  - Do not attach any plastic material, tape, etc., to the gas struts.
  - Do not tie string, etc., around the gas struts.
  - Do not hang any object on the gas struts.

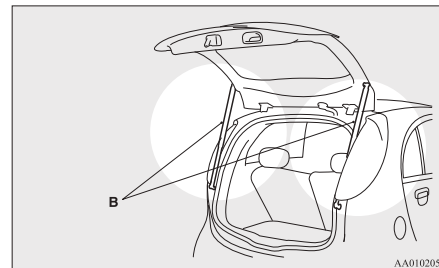

AA0102058

## Electric window control

E00302200550

The electric windows can only be operated with the electric motor switch in the “ON” position.

### **⚠ WARNING**

- Before operating the electric window control, make sure that nothing can get trapped (head, hand, finger, etc.).
- Never leave the vehicle without removing the key.
- Never leave a child (or other person who might not be capable of safe operation of the electric window control) in the vehicle alone.
- The child may tamper with the switch at the risk of its hands or head being trapped in the window.

## Electric window control switch

E00302301705

Each window opens or closes while the corresponding switch is operated.

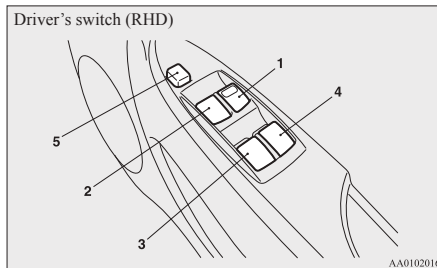
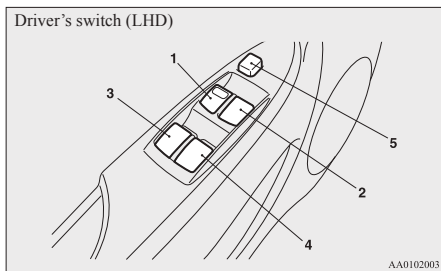

- 1 - Driver's door window
- 2 - Front passenger's door window
- 3 - Rear left door window
- 4 - Rear right door window
- 5 - Lock switch

### **Driver's switches**

The driver's switches can be used to operate all door windows.

A window can be opened or closed by operating the corresponding switch.

Press the switch down to open the window, and pull up the switch to close it.

If the switch for the driver's door window is fully pressed down, the door window automatically opens completely.

If you want to stop the door window movement, pull up the switch.

### **Passenger's switches**

The passenger's switches can be used to operate the corresponding passenger's door windows.

## Locking and unlocking

Press the switch down for opening the door window, and pull up the switch for closing.

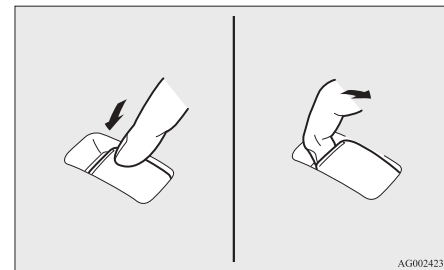

### **NOTE**

- Repeated operation with the electric motor unit stopped will run down the battery. Operate the window switches only while the electric motor unit is running.

### **Lock switch**

E00303101188

When this switch is operated, the passenger's switches cannot be used to open or close the windows and the driver's switch cannot open or close any windows other than the driver's window.

## Locking and unlocking

To unlock, press it once again.

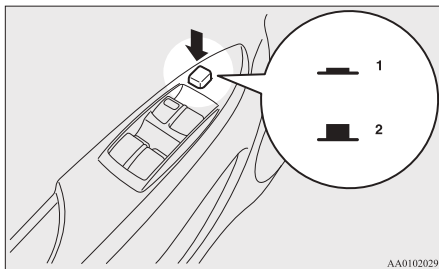

- 1- Lock
- 2- Unlock

### **⚠ WARNING**

- A child may tamper with the switch at the risk of its hands or head being trapped in the window. When driving with a child in the vehicle, please press the window lock switch to disable the passenger's switches.

## Timer function

E00302400927

The door windows can be opened or closed for 30 seconds after the electric motor switch is turned from the "ON" position to the "ACC" or "LOCK" position.

However, once the driver's door or the front passenger's door is opened, the windows cannot be operated.

## *Seat and seat belts*

Seat.....	3-02
Seat adjustment.....	3-03
Front seat.....	3-03
Rear seat.....	3-05
Head restraints.....	3-07
Seat belts.....	3-08
Pregnant women restraint.....	3-10
Seat belt pretensioner system and force limiter system.....	3-11
Child restraint.....	3-11
Seat belt inspection.....	3-20
Supplemental restraint system (SRS) - airbag.....	3-20



## Seat

E00400101869

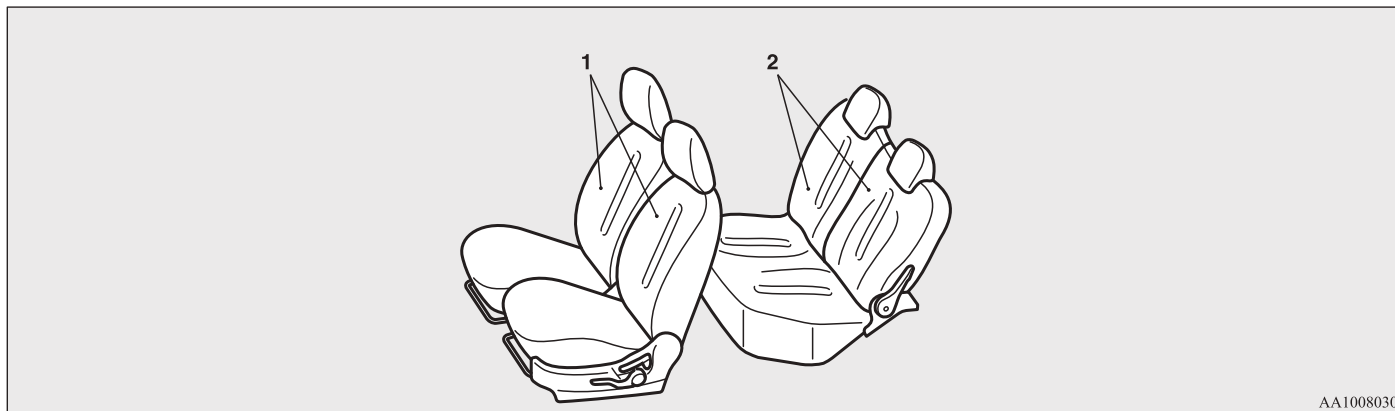

AA1008030

### 1-Front seat

- To adjust forward or backward → p. 3-03
- To recline the seatback → p. 3-04
- To adjust seat height (driver's seat only) → p. 3-04
- Heated seat (driver's seat only)\* → p. 3-04

### 2-Rear seat

- To recline the seatback → p. 3-05
- Folding the seatbacks forward → p. 3-06

## Seat adjustment

E00400300633

Adjust the driver's seat so that you are comfortable and that you can reach the pedals, steering wheel, switches etc. while retaining a clear field of vision.

### **⚠ WARNING**

- Do not attempt to adjust the seat while driving. This can cause loss of vehicle control and result in an accident. After adjustments are made, ensure the seating is locked in position by attempting to move the seat forward and rearward without using the adjusting mechanism.
- Do not allow people or children to ride in any area of your vehicle that is not equipped with seats and seat belts, and make sure that everyone travelling in your vehicle is in a seat and wearing a seat belt, or in the case of a child is strapped in a child restraint.
- To minimize the risk of personal injury in the event of a collision or sudden braking, the seatbacks should always be in the almost upright position while the vehicle is in motion. The protection provided by the seat belts may be reduced significantly when the seatback is reclined. There is greater risk that the passenger will slide under the seat belt, resulting in serious injury, when the seatback is reclined.

### **⚠ CAUTION**

- Make sure the seat is adjusted by an adult or with adult supervision for correct and safe operation.
- Do not place a cushion or the like between your back and the seatback while driving. The effectiveness of the head restraints will be reduced in the event of an accident.
- When sliding the seats, be careful not to catch your hand or foot.

## Front seat

E00400400197

### To adjust forward or backward

E00400500794

Pull the seat adjusting lever and adjust the seat forward or backward to the desired position, and release the adjusting lever.

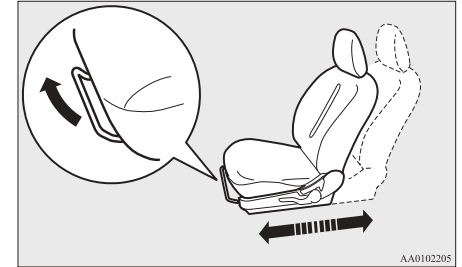

### **⚠ WARNING**

- To ensure the seat is locked securely, try to move the seat forward or backward without using the adjusting lever.

## Seat and seat belts

### To recline the seatback

E00400601008

In order to recline the seatback, lean forward slightly, pull the seatback lock lever up, and then lean backward to the desired position and release the lever. The seatback will lock in that position.

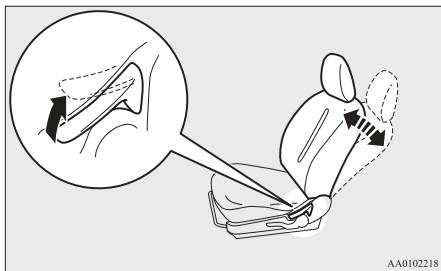

3

### **⚠ CAUTION**

- The reclining mechanism of the seatback is spring loaded, causing it to return to the vertical position when the lock lever is operated. When using the lever, sit close to the seatback or hold it with your hand to control its return motion.

### To adjust seat height (driver's seat only)

E00400701054

To adjust the seat height, operate the lever repeatedly.

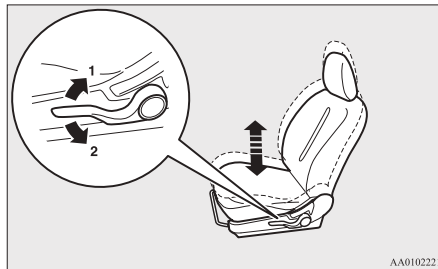

- 1- Raise
- 2- Lower

### Heated seat (driver's seat only)\*

E00401101013

The heated seat can be operated with the electric motor switch in the "ON" position. Operate the switch as indicated by arrows. The indication lamp (A) will illuminate while the heater is on.

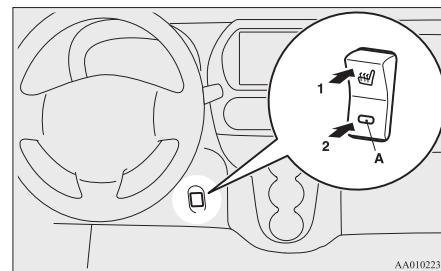

- 1- Heater on.
- 2- Heater off.

### **⚠ CAUTION**

- Switch off the seat heater when not in use.
- Continuous use while the ready indicator is not illuminated can cause the auxiliary battery to run down.
- If the following types of persons use the heated seat, they might become too hot or receive minor burns (red skin, heat blisters, etc.):
  - Elderly or ill people
  - People with sensitive skin
  - Excessively tired people
  - People under the influence of sleep inducing medication, etc.

## **⚠ CAUTION**

- Do not place heavy objects on the seat or stick pins, needles, or other pointed objects into it.
- Do not use a blanket, cushion, or other material with high heat insulation properties on the seat while using the heater; this might cause the heater element to overheat.
- Do not use benzene, kerosene, petrol, alcohol or other organic solvents when cleaning the seat. Doing so could damage not only the seat cover, but also the heater element.
- If water or any other liquid is spilled on the seat, allow it to dry thoroughly before attempting to use the heater.
- Turn the heater off immediately if it appears to be malfunctioning during use.

## *Rear seat*

E0040130053

## **⚠ WARNING**

- When a person sits in the rear seat, pull up the head restraint to a height at which it locks in position. Be sure to make this adjustment before starting to drive. Serious injuries could otherwise be suffered as the result of an impact. Refer to “Head restraints” on page 3-07.

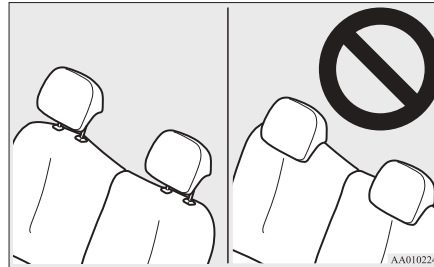

AA0102247

## **⚠ CAUTION**

- Child restraint lower anchorages (A) are provided between the seat cushion and the seatback. Be careful that the lower anchorages may be hot due to heat of the electric motor unit room.

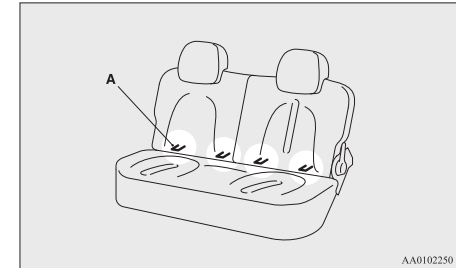

AA0102250

## To recline the seatback

E00401500254

In order to recline the seatback, lean forward slightly, pull the lever, and then lean backward to the desired position and release the lever. The seatback will lock in that position.

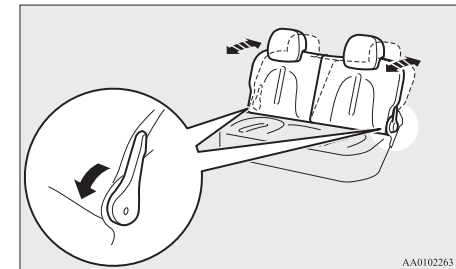

AA0102263

## NOTE

- It is possible to adjust the seatback angle independently on each side.

## Folding the seatbacks forward

E00401600330

Larger objects can be loaded into the vehicle if a seatback is folded forward.

### CAUTION

- Do not stack luggage in the vehicle higher than the seatback height. Also, firmly secure the luggage. Serious accidents could result due to unrestrained objects entering the passenger compartment during sudden braking.

### 3 To fold

Pull the lever, and fold the rear seatbacks forward.

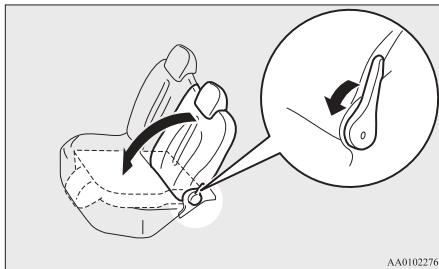

### NOTE

- Do not operate the lever in the wrong direction. Doing so could damage the lever and make it impossible to operate the seatback.

### To replace

1. Raise the seatback until it locks securely into place.
2. Push lightly on the seatback to confirm that it has actually been secured.

## Rear seat cushion

E00401900173

The rear seat cushion can be removed. It is removed when the tyre repair kit stored under the seat cushion is taken out. Use this function when putting the seat covers on, etc.

### To remove

1. Pull the seat stoppers (A) to unlock the seat cushion (B).
2. Lift up the seat cushion and pull it towards you to remove it.

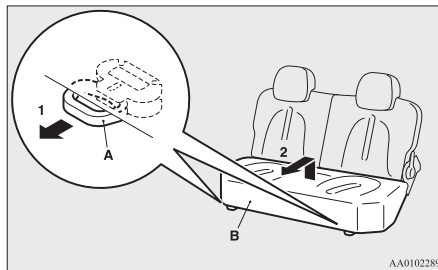

### To install

1. Place the seat belt's buckles on top of the seat cushion.

2. Pushing the seat cushion as far back as possible, press the hooks (A) on the underside of the seat cushion into the right and left stopper installation holes (B) until a click is heard.

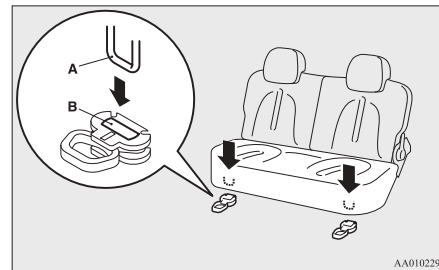

3. After installing the seat cushion, shake it lightly to check that it is properly fixed in position.

## Head restraints

E00403301497

### **⚠ WARNING**

- Driving without the head restraints in place can cause you and your passengers serious injury or death in an accident. To reduce the risk of injury in an accident, always make sure the head restraints are installed and properly positioned when the seat is occupied.
- Never place a cushion or similar device on the seatback. This can adversely affect head restraint performance by increasing the distance between your head and the restraint.

### To adjust height

Adjust the head restraint height so that the centre of the head restraint is as close as possible to eye level to reduce the chances of injury in the event of collision. Any person too tall for the head restraint to reach their seated eye level, should adjust the restraint as high as possible.

To raise the head restraint, move it upward. To lower the restraint, move it downward while pushing the height adjusting knob (A) in the direction of the arrow. After adjustment, push the head restraint downward and make sure that it is locked.

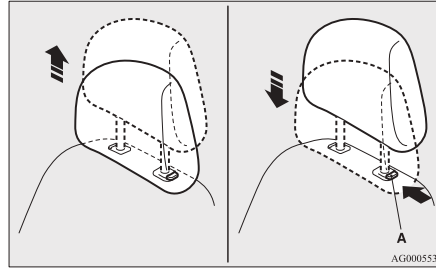

### To remove

Lift the head restraint with the height adjusting knob (A) pushed in.

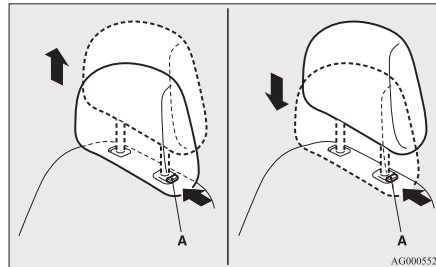

### Installation

Confirm that they are facing the correct direction, and then insert them into the seatback while pressing the height adjusting knob (A) in the direction indicated by the arrow.

### **⚠ CAUTION**

- Confirm that the height adjusting knob (A) is correctly adjusted as shown in the illustration, and also lift the head restraints to ensure that they do not come out of the seatback.

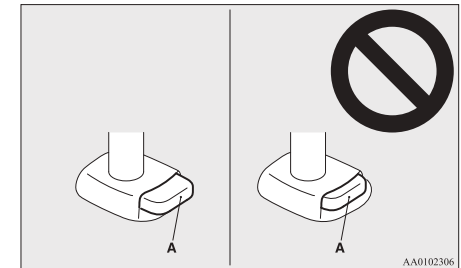

### **⚠ CAUTION**

- The head restraints for the seats differ in shape and size. When installing head restraints, make sure the head restraints are fitted in their respective seats and do not install the head restraints in the wrong direction.

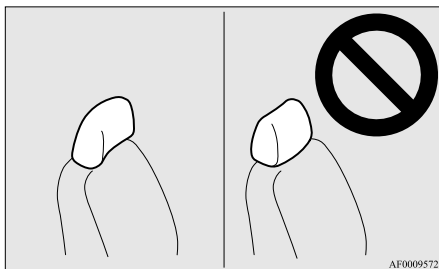

## Seat belts

E00404800636

To protect you and your passengers in the event of an accident, it is most important that the seat belts be worn correctly while driving.

The front seat belts have a pretensioner system. These belts are used the same way as a conventional seat belt.

Refer to “Seat belt pretensioner system and force limiter system” on page 3-11

### **⚠ WARNING**

- Always place the shoulder belt over your shoulder and across your chest. Never put it behind you or under your arm.
- One seat belt should be used by only one person. Doing otherwise can be dangerous.
- The seat belt will provide its wearer with maximum protection if the recliner seatback is placed in fully upright position. When the seatback is reclined, there is greater risk that the passenger will slide under the belt, especially in a forward impact accident, and may be injured by the belt or by striking the instrument panel or seatbacks.
- Seat belts should always be worn by every adult who drives or rides in this vehicle, and by all children who are tall enough to wear seat belts properly. Other children should always use proper child restraint systems.
- Remove any twists when using the belt.

### **⚠ WARNING**

- No modifications or additions should be made by the user which will either prevent the seat belt adjusting devices from operating to remove slack, or prevent the seat belt assembly from being adjusted to remove slack.
- Never hold a child in your arms or on your lap when riding in this vehicle, even if you are wearing your seat belt. To do so risks severe or fatal injury to the child in a collision or sudden stop.
- Always adjust the belt to a snug fit.
- Always wear the lap portion of the belt over your hips.



### 3-point type seat belt (with emergency locking mechanism)

E00404901070

This type of belt requires no length adjustment. Once worn, the belt adjusts itself to the movement of the wearer, but in the event of a sudden or strong shock, the belt automatically locks to hold the wearer's body.

## NOTE

- You can check if the belt locks by pulling it forward quickly.

*To fasten*

1. Pull the seat belt out slowly while holding the latch plate.

## NOTE

- When the seat belts cannot be pulled out in a locked condition, pull the belts once forcefully and then return them. After that, pull the belts out slowly once again.

2. Insert the latch plate into the buckle until a “click” is heard.

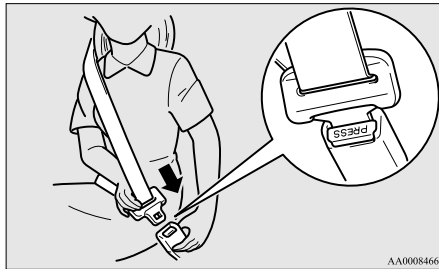

## ⚠ WARNING

- Never wear the lap portion of the belt across your abdomen. During accidents it can press sharply against the abdomen and increase the risk of injury.

## ⚠ WARNING

- The seat belts must not be twisted when worn.

3. Pull the belt slightly to adjust slackness as desired.

*To unfasten*

Hold the latch plate and push the button on the buckle.

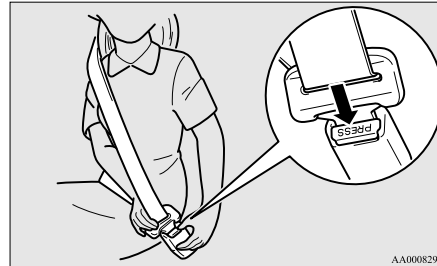

## NOTE

- As the belt retracts automatically, keep holding the latch plate while retracting so that the belt stows slowly. Failure to do this could damage the vehicle.

## Seat belt warning

E00413000025

*Driver's and front passenger's seat belt reminder/warning lamp*

E00414800017

The driver's and front passenger's seat belt warning lamp is located on the instrument panel.

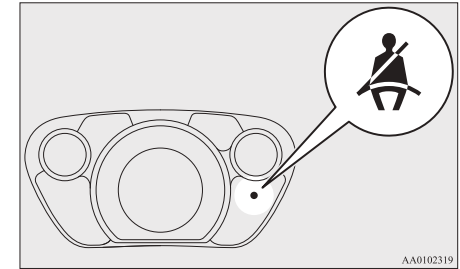

If the electric motor switch is turned to the “ON” position without the driver's or the front passenger's seat belt being fastened, the warning lamp will come on, and the tone will sound for approximately 6 seconds to remind the driver and front passenger to fasten the seat belt.

If the seat belt remains unfastened approximately 1 minute later, the warning lamp will flash and the tone will sound intermittently for approximately 90 seconds when the vehicle is driven.

If the seat belt subsequently remains unfastened, the warning lamp and tone will issue further warnings each time the vehicle starts moving from a stop. And if the passenger unfastens the seat belt while driving, the warning will operate in the same way.

When the seat belt is fastened, the warnings will stop.



## Seat and seat belts

### NOTE

- For the front passenger seat, the warning function works only while a person is sitting on the seat.
- When luggage is placed on the front passenger seat, a sensor in the seat cushion may, depending on the weight and position of the luggage, cause the warning tone to sound and the warning lamp to come on.

### Rear passenger's seat belt warning lamps

E00414900018

The rear passenger's seat belt warning lamps are located on the instrument panel.

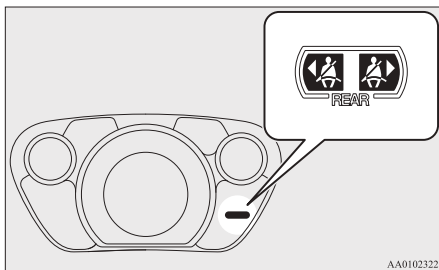

If the electric motor switch is turned to the “ON” position while a seat belt is not fastened, the warning lamp comes on for approximately 30 seconds to remind the rear passenger to fasten the seat belt. If the vehicle is driven with the seat belt still unfastened, the warning lamp comes on for approximately another 30 seconds. (This illumination happens only the first time the vehicle starts moving with the seat belt still unfastened.)

The warning lamp goes off when the seat belt is fastened.

### NOTE

- The warning lamps come on even if no one is sitting on the rear seat.
- If a seat belt is unfastened while the vehicle is being driven, the tone sounds for approximately 1 second and the warning lamp comes on for approximately 30 seconds.
- If the seat belts are initially fastened but a seat belt is unfastened while the vehicle is stationary and the vehicle is then driven with the seat belt still unfastened, the warning lamp comes on again for approximately 30 seconds.

## Pregnant women restraint

E00405600077

### **⚠** WARNING

- Seat belts work for everyone, including pregnant women. Pregnant women should use the available seat belts. This will reduce the likelihood of injury to both the woman and the unborn child. The lap belt should be worn across the thighs and as snug against the hips as possible, but not across the waist. Consult your doctor if you have any additional questions or concerns.

## Seat belt pretensioner system and force limiter system

E00405700166

The driver's seat and front passenger's seat each have a seat belt equipped with a pretensioner system.

### Pretensioner system

E00405801164

The pretensioner system will retract its respective seat belts instantaneously, thus maximizing the seat belt's effectiveness, if there is a frontal impact severe enough to injure the driver and/or front passenger and the electric motor switch is in the "ON" or "START" position.

### WARNING

- To obtain the best results from your pretensioner seat belt, make sure you have adjusted your seat correctly and wear your seat belt properly.

### CAUTION

- Installation of audio equipment or repairs in the vicinity of the pretensioner seat belts or floor console must be performed in line with MITSUBISHI MOTORS guidelines. It is important to do so because the work could affect the pretensioner systems.

### CAUTION

- If you need to scrap the vehicle, please consult a MITSUBISHI MOTORS Authorized Service Point. It is important to do so because unexpected activation of the pretensioner seat belts could cause injuries.

### NOTE

- The pretensioner seat belts will be activated if the vehicle suffers a severe frontal impact, even if the seat belts are not worn.
- The pretensioner seat belts are designed to work only once. After the pretensioner seat belts have been activated, we recommend you have them replaced by a MITSUBISHI MOTORS Authorized Service Point.

### SRS warning lamp

E00405900315

This warning lamp is shared by the SRS airbags and the pretensioner seat belts. Refer to "SRS warning lamp" on page 3-29.

### Force limiter system

E00406000209

In the event of a collision, each force limiter system will effectively absorb the load applied to the seat belt to minimize the impact to the passenger.

## Child restraint

E00406401747

When transporting children in your vehicle, some type of child restraint system should always be used according to the size of the child. This is required by law in most countries.

The regulations concerning driving with children in the front seat may differ from country to country. You are advised to comply with the relevant regulations.

### WARNING

- When possible, put children in the rear seat. Accident statistics indicate that children of all sizes and ages are safer when properly restrained in the rear seat rather than in the front seat.
- Holding a child in your arms is no substitute for a restraint system. Failure to use a proper restraint system can result in severe or fatal injury to the child.
- Each child restraint device or fixing is to be used only by one child.

## Caution for installing the child restraint on vehicles with a front passenger airbag

E00406500318

The label shown here is attached on vehicles with a front passenger airbag.

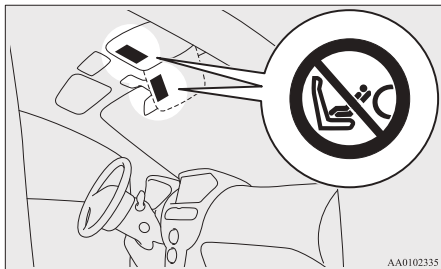

### **⚠ WARNING**

● **Extreme Hazard!**

Do not use a rearward facing child restraint on a seat protected by an airbag in front of it!

Use rearward facing child restraints in the rear seat or turn off the front passenger's airbag ON-OFF switch. (Refer to "To turn an airbag off" on page 3-23)



### **⚠ WARNING**

- A REARWARD FACING CHILD RESTRAINT must NOT be used in the front passenger seat if the front passenger's airbag has not been deactivated. The force of an inflating airbag could kill or cause serious injuries to the child. A rearward facing child restraint must only be used in the rear seat.
- A FORWARD FACING CHILD RESTRAINT should be used in the rear seat whenever possible; if used in the front seat, turn off the front passenger's airbag ON-OFF switch.

## Infants and small children

E00406600999

When transporting infants and small children in your vehicle, follow the instruction given below.

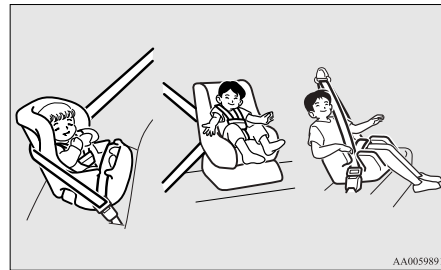

### **Instruction:**

- For small infants, an infant carrier should be used. For small children whose height when seated allows the shoulder belt to lie in contact with the face or the throat, a child seat should be used.
- The child restraint system should be appropriate for the child's weight and height and properly fit in the vehicle. For a higher degree of safety: THE CHILD RESTRAINT SYSTEM SHOULD BE INSTALLED IN THE REAR SEAT.

## NOTE

- Before purchasing a child restraint system, try installing it in the rear seat to make sure there is a good fit. Because of the location of the seat belt buckles and the shape of the seat cushion, it may be difficult to securely install some manufacturer's child restraint systems. If the child restraint system can be pulled forward or to either side easily on the seat cushion after the seat belt has been tightened, choose another manufacturer's child restraint system.

## **WARNING**

- **When installing a child restraint system, refer to the instructions provided by the manufacturer of the restraint system. Failure to do so can result in severe or fatal injury to the child.**
- **After installation, push and pull the child restraint system back and forth, and side to side, to see that it is properly secured. If the child restraint system is not installed securely, it may cause injury to the child or other occupants in case of an accident or sudden stops.**
- **When the child restraint system is not in use, keep your child restraint system secured with the seat belt or remove it from the vehicle in order to prevent it from being thrown around inside the vehicle during an accident.**

Depending on the seating position in the vehicle and the child restraint system that you have, the child restraint can be attached using one of the following two locations:

- To the lower anchorage in the rear seat **ONLY** if the child restraint has ISOFIX mountings (See page 3-18).
- To the seat belt (See page 3-19).

## Older children

E00406700277

Children who have outgrown the child restraint system should be seated in the rear seat and wear combination lap shoulder belt.

The lap portion of the belt should be snug and positioned low on the abdomen so that it is below the top of the hip-bone. Otherwise, the belt could intrude into the child's abdomen during an accident and cause injury.

## Suitability for various ISOFIX positions

E00411400373

Mass group	Size class	Fixture	Vehicle ISOFIX positions
			Rear (Left side/Right side)
Carrycot	F	ISO/L1	X
	G	ISO/L2	X
0 - Up to 10 kg (0-9 months)	E	ISO/R1	X
0+ - Up to 13 kg (0-2 years)	E	ISO/R1	IL* <sup>1</sup> , IL* <sup>2</sup> , #1
	D	ISO/R2	X
	C	ISO/R3	X
I - 9 to 18 kg (9 months-4 years)	D	ISO/R2	X
	C	ISO/R3	X
	B	ISO/F2	IUF
	B1	ISO/F2X	IUF, IL* <sup>3</sup>
	A	ISO/F3	IUF
II & III - 15 to 36 kg (4-12 years)			X

#1: When installing a child restraint system, adjust the front seat in position more than 2 notches forward from the centre of its fore-aft adjustment range.

### CAUTION

- When installing a child restraint system, prevent the head restraint from touching the child restraint system by removing it or adjusting its height.
- When installing a child restraint system, prevent the front seats from touching the child restraint system.  
If the driver's seat touches the child restraint system, install the child restraint system in the rear seat of the passenger's side.

**Definition of characters to be inserted in the table above:**

- IUF- Suitable for ISOFIX forward child restraints systems of universal category approved for use in the mass group.
- IL- Suitable for particular ISOFIX child restraint systems given in the following list (MITSUBISHI MOTORS genuine parts).
- X- ISOFIX position not suitable for ISOFIX child restraint systems in this mass group.

**IL (Genuine part information)**

	Genuine part No.	ECE No.
*1	MZ314393 (Child restraint system), MZ314394 (ISOFIX base)	E1-04301146
*2	MZ314509 (Child restraint system) <sup>#2</sup> , MZ314394 (ISOFIX base)	E1-04301146
*3	MZ313045	E1-04301133

#2: To be available in 2012

**NOTE**

- MITSUBISHI MOTORS Europe B.V. reserves the right to changes without any prior announcement.  
For further information, please contact a MITSUBISHI MOTORS Authorized Service Point.

## Suitability for various seating positions

E00406801028

Mass group		Seating position		
		Front passenger		Rear (Left side/Right side)
		Activated airbag	Deactivated air-bag <sup>#3</sup>	
0	- Up to 10 kg (0-9 months)	X	X	X
0+	- Up to 13 kg (0-2 years)	X	L* <sup>1</sup> , L* <sup>2</sup>	U, L* <sup>1</sup> , L* <sup>2</sup>
I	-9 to 18 kg (9 months-4 years)	X	L* <sup>3</sup> , L* <sup>4</sup>	U, L* <sup>3</sup> , L* <sup>4</sup>
II & III	-15 to 36 kg (4-12 years)	X	L* <sup>5</sup>	U, L* <sup>5</sup>

<sup>#3</sup>: With front passenger's airbag deactivated by means of front passenger's airbag ON-OFF switch

### CAUTION

- When installing a child restraint system, prevent the head restraint from touching the child restraint system by removing it or adjusting its height.
- When installing a child restraint system, prevent the front seats from touching the child restraint system.  
If the driver's seat touches the child restraint system, install the child restraint system in the rear seat of the passenger's side.

#### Definition of characters to be inserted in the table above:

- U- Suitable for "universal" category restraints approved for use in this mass group.
- L- Suitable for particular child restraints in the following list (MITSUBISHI MOTORS genuine parts).
- X- Seat position not suitable for children in this mass group.

**L (Genuine part information)**

	Genuine part No.	ECE No.
*1	MZ314393	E1-04301146
*2	MZ314509 <sup>#4</sup>	E1-04301146
*3	MZ313045	E1-04301133
*4	MZ314451	E1-04301203
*5	MZ314250	E1-04301169

<sup>#4</sup>: To be available in 2012

**NOTE**

- There is no applicable MITSUBISHI MOTORS Genuine Parts to the Mass Group “0-Up to 10 kg”.
- MITSUBISHI MOTORS Europe B.V. reserves the right to changes without any prior announcement.  
For further information, please contact a MITSUBISHI MOTORS Authorized Service Point.



## Installing a child restraint system to the lower anchorage (ISOFIX child restraint mountings) and tether anchorage

E00406900703

### Lower anchorage location

Your vehicle's rear seat is fitted with lower anchorages for attaching a child restraint system with ISOFIX mountings.

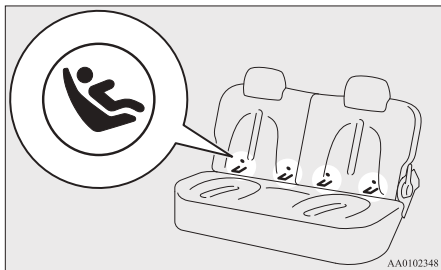

### Tether anchorage locations

There are 2 child restraint anchorage points located on the luggage compartment floor. These are for securing a child restraint system tether strap to each of the 2 rear seating positions in your vehicle.

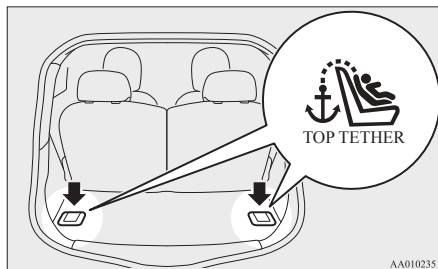

## **⚠ WARNING**

- Child restraint anchorages are designed to withstand only those loads imposed by correctly fitted child restraints. Under no circumstances are they to be used for adult seat belts, harnesses, or for attaching other items or equipment to the vehicle.

### Child restraint system with ISOFIX mountings

The child restraint system is designed only for seats that incorporate lower anchorages. Retain the child restraint system using the lower anchorages.

It is not necessary to retain the child restraint system using the vehicle's seat belts.

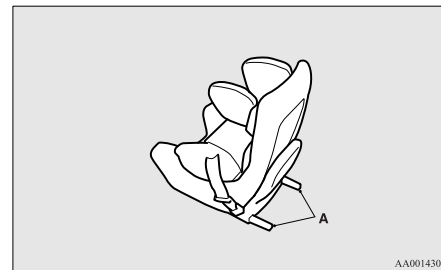

A- Child restraint system connectors

### To install

1. Remove any foreign material in or around the connectors and ensure the vehicle seat belt is in its normal storage position.
2. Open the gap a little between the seat cushion (A) and the seatback (B) with your hand to locate the lower anchorages (C).
3. Push the child restraint system's connectors (D) into the lower anchorages (C) in accordance with the instructions provided by the child restraint system's manufacturer.

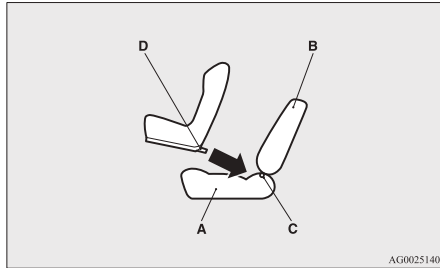

- A- Vehicle seat cushion
- B- Vehicle seatback
- C- Lower anchorage
- D- Connector

If your child restraint system requires the use of a tether strap, fasten the tether strap in accordance with steps 3 through 4.

4. Remove the head restraint from the location in which you wish to install a child restraint.

5. Open the tether anchorage cover (E), and then latch the tether strap hook (F) of the child restraint system to the tether anchorage bracket (G) and tighten the top tether strap hook so it is securely fastened.

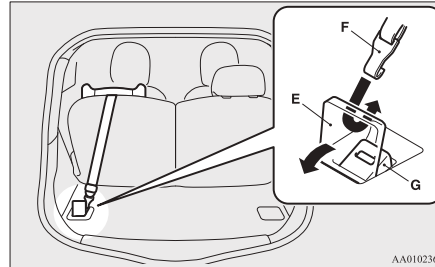

6. Push and pull the child restraint system in all directions to be sure it is firmly secured.

#### To remove

Remove the child restraint system in accordance with the instructions provided by the child restraint system's manufacturer.

## Installing a child restraint system to a 3-point type seat belt (with emergency locking mechanism)

E00408700646

### 3-point type seat belt location

The child restraint system can be fitted by using the 3-point type seat belt at the seating position illustrated below.

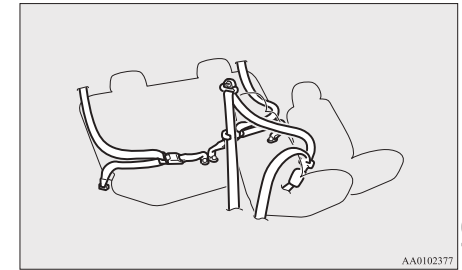

#### Installation:

1. Fasten the seat belt to secure the child restraint system.  
Make sure you hear a "click" when you insert the latch plate in the buckle.
2. Use the locking clip to completely eliminate any slackness.
3. Push and pull the child restraint in all directions to be sure it is secure.

## **⚠** WARNING

- For some types of child restraint, the locking clip (A) should be used to help avoid personal injury during a collision or sudden manoeuvre.

It must be fitted and used in accordance with the child restraint manufacturer's instructions.

The locking clip must be removed when the child restraint is removed.

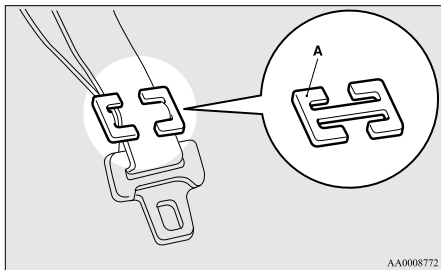

## Seat belt inspection

E00406300576

- Check the belts for cuts, worn or frayed webbing and for cracked or deformed metallic parts. Replace the belt assembly if it is defective.
- A dirty belt should be cleaned with neutral detergent in warm water. After rinsing in water, let it dry in the shade. Do not attempt to bleach or re-dye the belts because this will affect their characteristics.

## **⚠** WARNING

- We recommend you to have all seat belt assemblies including retractors and attaching hardware inspected after any collision. We recommend that seat belt assemblies in use during a collision be replaced unless the collision was minor and the belts show no damage and continue to operate properly.
- Do not attempt to repair or replace any part of the seat belt assemblies; we recommend you to have this work done by a MITSUBISHI MOTORS Authorized Service Point. Incorrect repair or replacement could reduce the effectiveness of the belts and could result in serious injury in the event of a collision.
- Once the pretensioner has been activated, it cannot be re-used. It must be replaced together with the retractor.

## Supplemental restraint system (SRS) - airbag

E00407202026

The information for SRS airbags includes important information concerning the driver's and front passenger's airbags, the side airbags and the curtain airbags.

The SRS driver and front passenger airbags are designed to supplement the primary protection of the driver and front passenger side seat belt systems by providing those occupants with protection against head and chest injuries in certain moderate-to-severe frontal collisions.

The SRS side airbags are designed to supplement properly worn seat belts and provide the driver and front passenger with protection against chest, abdomen and hip injuries in certain moderate-to-severe side impact collisions.

The SRS curtain airbags are designed to supplement properly worn seat belts and provide the driver and passenger with protection against head injuries in certain moderate-to-severe side impact collisions.

The SRS is NOT a substitute for the seat belts. To ensure the maximum protection during all types of collisions and accidents, all occupants, including the passengers as well as the driver, must wear their seat belts.

## How the Supplemental Restraint System works

E00407301600

The SRS includes the following components:

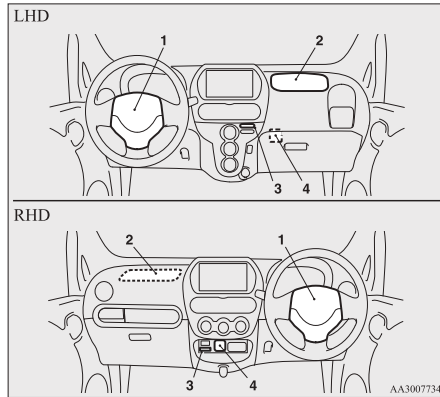

- 1- Airbag module (Driver)
- 2- Airbag module (Passenger)
- 3- Front passenger's airbag OFF indication lamp

### 4- Front passenger's airbag ON-OFF switch

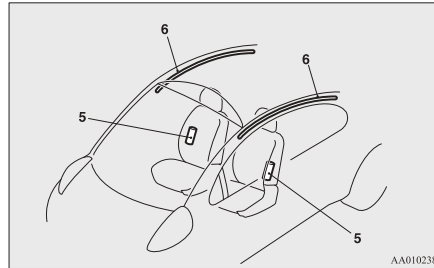

- 5- Side airbag modules
- 6- Curtain airbag modules

The airbags will operate only when the electric motor switch is in the "ON" or "START" position. The airbags deployment produces a sudden, loud noise, and releases some smoke and powder, but these conditions are not injurious, and do not indicate a fire in the vehicle. People with respiratory problems may feel some temporary irritation from chemicals used to produce the deployment; open the windows after airbag deployment, if safe to do so. The airbags deflate very rapidly after deployment, so there is little danger of obscured vision.

## **⚠ CAUTION**

- Airbags inflate at an extremely rapid speed. In certain situations, contact with inflating airbags can result in abrasions, light cuts, bruises, and the like.

## **⚠ WARNING**

- **IT IS VERY IMPORTANT TO BE PROPERLY SEATED.**

A driver or front passenger too close to the steering wheel or instrument panel during airbag deployment can be killed or seriously injured.

Airbags inflate very fast, and with great force.

If the driver and front passenger are not properly seated and restrained, the airbags may not protect you properly, and could cause serious or fatal injuries when it inflates.

- Do not sit on the edge of the seat, or lean head or chest close to the steering wheel or instrument panel. Do not put feet or legs on or against the instrument panel.
- Place all infants and small children in the rear seat and properly restrained using an appropriate child restraint system. The rear seat is the safest place for infants and children.



## **⚠ WARNING**

- Infants and small children should never be unrestrained, stand up against the instrument panel or be held in your arms or on your lap. They could be seriously injured or killed in a collision, including when the airbag inflates. They should be properly seated in the rear seat in an appropriate child restraint system. See the “Child restraint” section of this owner’s manual.



Use rearward facing child restraints in the rear seat or turn off the front passenger’s airbag ON-OFF switch. (Refer to “To turn an airbag off” on page 3-23)

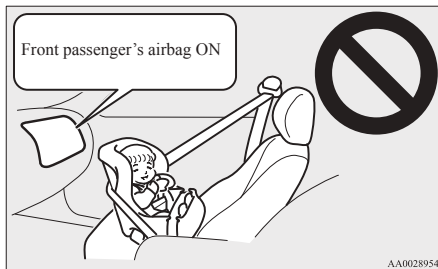

## **⚠ WARNING**

- A REARWARD FACING CHILD RESTRAINT must NOT be used in the front passenger seat if the front passenger’s airbag has not been deactivated. The force of an inflating airbag could kill or cause serious injuries to the child.  
A rearward facing child restraint must only be used in the rear seat.
- A FORWARD FACING CHILD RESTRAINT should be used in the rear seat whenever possible; if they must be used in the front passenger seat, turn off the front passenger’s airbag ON-OFF switch. Failure to do so could kill or cause serious injuries to the child.

## **⚠ WARNING**

- Older children should be seated in the rear seat, properly wearing the seat belt, with an appropriate booster seat if needed.

### Caution for installing the child restraint on vehicles with a front passenger airbag

E00408800474

The label shown here is attached on vehicles with a front passenger airbag.

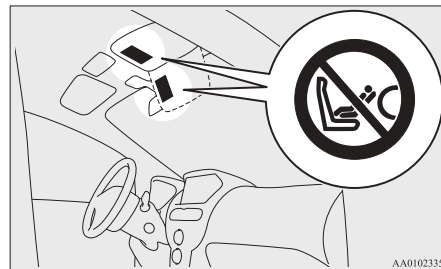

## **⚠ WARNING**

- Extreme Hazard!  
Do not use a rearward facing child restraint on a seat protected by an airbag in front of it!

## Front passenger's airbag ON-OFF switch

E00410100272

The front passenger's airbag ON-OFF switch can be used to disable the front passenger's airbag. If you have a child restraint system that cannot be fitted to any seat other than the front passenger seat, be sure to turn OFF the front passenger's airbag ON-OFF switch before using it. (Refer to "To turn an airbag off" on page 3-23)

The front passenger's airbag ON-OFF switch is located as shown in the illustration.

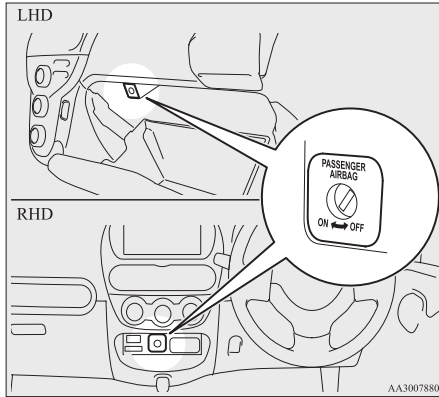

## Front passenger's airbag OFF indication lamp

E00410200316

The front passenger's airbag OFF indication lamp is located as shown in the illustration.

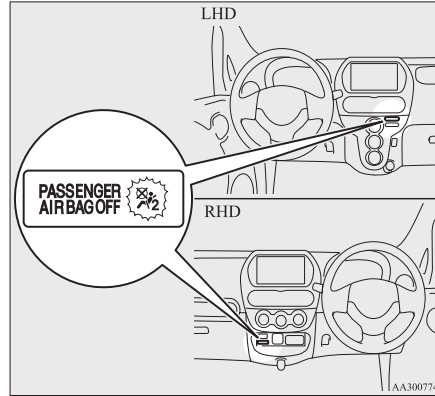

The indication lamp normally comes on when the electric motor switch is turned to the "ON" position, and goes off a few seconds later.

When the front passenger's airbag ON-OFF switch is turned OFF, the indication lamp will stay on to show that the front passenger's airbag is not operational. When the front passenger's airbag ON-OFF switch is turned ON, the indication lamp goes off to show that the front passenger's airbag is operational.

## **⚠ WARNING**

- Do not fit any accessory that makes the indication lamp impossible to see, and do not cover the indication lamp with a sticker. You would not be able to verify the status of the passenger airbag system.

### To turn an airbag off

E00412300076

## **⚠ WARNING**

- To reduce risk of serious or fatal injury:
  - Always remove the key from the electric motor switch before operating the front passenger's airbag ON-OFF switch. Failure to do so could adversely affect the airbag performance.
  - Wait at least 60 seconds to operate the front passenger's airbag ON-OFF switch after turning the electric motor switch to the "LOCK" position. The SRS airbag system is designed to retain enough voltage to deploy the airbag.
  - Always remove the key from the front passenger's airbag ON-OFF switch after operating that switch. Failure to do so could lead to improper position of the front passenger's airbag ON-OFF switch.
  - Do not turn OFF the front passenger's airbag ON-OFF switch except when a child restraint system is fitted to the front passenger seat.

## **⚠** WARNING

- Turn **ON** the front passenger's airbag **ON-OFF** switch immediately after removing a child restraint system from the front passenger seat.
- If the indication lamp does not come on when the front passenger's airbag **ON-OFF** switch is turned **OFF**, do not fit a child restraint system to the front passenger seat. We recommend you to have the system inspected by a **MITSUBISHI MOTORS** Authorized Service Point.
- If the indication lamp remains on when the front passenger's airbag **ON-OFF** switch is turned **ON**, do not allow anyone to sit on the front passenger seat. We recommend you to have the system inspected by a **MITSUBISHI MOTORS** Authorized Service Point.

To turn an airbag off, follow these steps:

1. Insert the key into the front passenger's airbag **ON-OFF** switch, and turn it to the "OFF" position.
2. Remove the key from the key opening of the front passenger's airbag **ON-OFF** switch.

3. Insert the key into the electric motor switch, and turn the electric motor switch to the "ON" position. The front passenger's airbag **OFF** indication lamp will stay on.

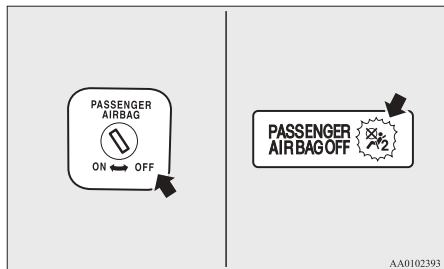

The front passenger's airbag is now deactivated and will not deploy until switched on again.

### Driver's and front passenger's airbag system

E00407400792

The driver's airbag is located under the padded cover in the middle of the steering wheel. The front passenger's airbag is contained in the instrument panel above the glove box.

The driver's airbag and the front passenger's airbag are designed to inflate at the same time even if the passenger seat is not occupied.

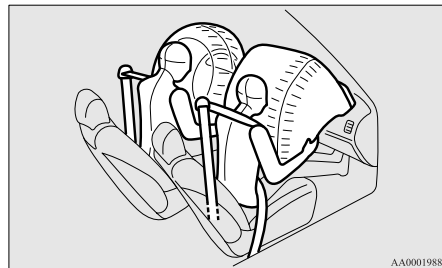

## Deployment of front airbags

E00407501660

### *The front airbags ARE DESIGNED TO DEPLOY when...*

The front airbags are designed to deploy when the vehicle suffers a moderate to severe frontal impact. A typical condition is shown in the illustration.

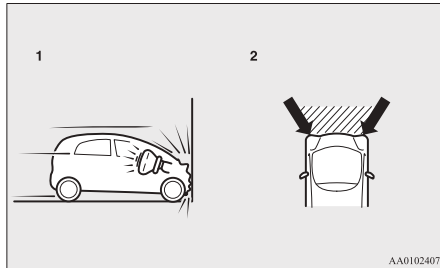

- 1- Head-on collision with a solid wall at a speed of approximately 25 km/h (16 mph) or higher
- 2- Moderate-to-severe frontal impact within the shaded area between the arrows

The front airbags will deploy if the severity of the impact is above the designed threshold level, comparable to an approximately 25 km/h (16 mph) collision when impacting straight into a solid wall that does not move or deform. If the severity of the impact is below the above threshold level, the front airbags may not deploy. However, this threshold speed will be considerably higher if the vehicle strikes an object that absorbs the impact by either deforming or moving (for example, another stationary vehicle, pole or a guard rail).

Because frontal collisions can easily move you out of position, it is important to always properly wear your seat belts. Your seat belts will help keep you a safe distance from the steering wheel and instrument panel during the initial stages of airbag deployment. The initial stage of airbag inflation is the most forceful one, and can possibly cause serious or fatal injuries. Moreover, the seat belts in your vehicle are your primary means of protection in a collision. The airbags are designed to provide additional protection. Therefore, for your safety and the safety of all occupants, be sure to always properly wear your seat belts.

### *The front airbags MAY NOT DEPLOY when...*

With certain types of frontal collisions, the vehicle's body structure is designed to absorb the shock to help protect the occupants from harm. (The vehicle body's front area may deform significantly as it absorbs the impact.) Under such circumstances, the front airbags may not deploy irrespective of the deformation and damage to the vehicle body.

Examples of some typical conditions are shown in the illustration.

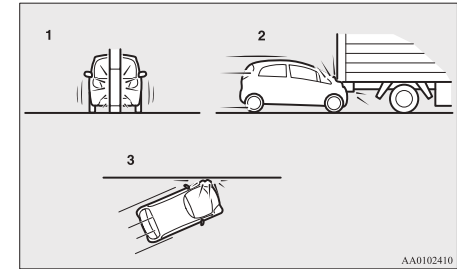

- 1- Collision with a utility pole, tree or other narrow objects.
- 2- Vehicle slides under the rear body of a truck
- 3- Oblique frontal impacts

Because the front airbags do not protect the occupant in all types of frontal collisions, be sure to always properly wear your seat belts.



## Seat and seat belts

**The front airbags ARE NOT DESIGNED TO DEPLOY when...**

The front airbags are not designed to deploy in conditions where they cannot typically provide protection to the occupant. Such conditions are shown in the illustration.

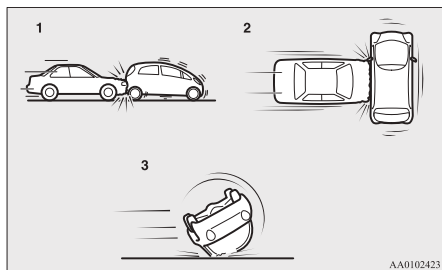

- 1- Rear end collisions
- 2- Side collisions
- 3- Vehicle rolls onto its side or roof

Because the front airbags do not protect the occupant in all types of collisions, be sure to always properly wear your seat belts.

**The front airbags MAY DEPLOY when...**

The front airbags may deploy if the bottom of the vehicle suffers a moderate-to-severe impact (undercarriage damage).

Examples of some typical conditions are shown in the illustration.

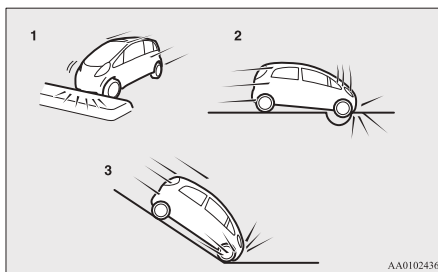

- 1- Collision with an elevated median/island or kerb
- 2- Vehicle travels over a deep hole/pothole
- 3- Vehicle drives down a steep slope and hits the ground

Because the front airbags may deploy in certain types of unexpected impacts as shown in the illustration that can easily move you out of position, it is important to always properly wear your seat belts. Your seat belts will help keep you a safe distance from the steering wheel and instrument panel during the initial stages of airbag deployment. The initial stage of airbag inflation is the most forceful one and can possibly cause serious or fatal injuries if you contact it at this stage.

## **⚠ WARNING**

- Do not attach anything to the steering wheel's padded cover, such as badges or accessories. It might strike and injure an occupant if the airbag inflates.
- Do not set anything on, or attach anything to, the instrument panel above the glove box. It might strike and injure an occupant if the airbag inflates.

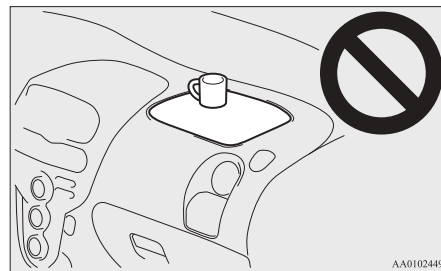

## **⚠ WARNING**

- Do not attach accessories to, or put them in front of, the windscreen. These objects could restrict the airbag inflation, or strike and injure an occupant if the airbags inflate.
- Do not put packages, pets or other objects between the airbags and the driver or front passenger. It could affect airbag performance, or could cause injury when the airbag inflates.

## **⚠ WARNING**

- Right after the airbag inflation, several airbag system components will be hot. Do not touch these components. There is a danger of being burnt.
- The airbag system is designed to work only once. Once the airbags have deployed, they will not work again. They must promptly be replaced, and we recommend you to have the entire airbag system inspected by a MITSUBISHI MOTORS Authorized Service Point.

### Side airbag system

E00407600518

The side airbags (A) are contained in the driver and front passenger seatbacks.

The side airbag is designed to inflate only on the side of the vehicle that is impacted, even with no passenger in the front seat.

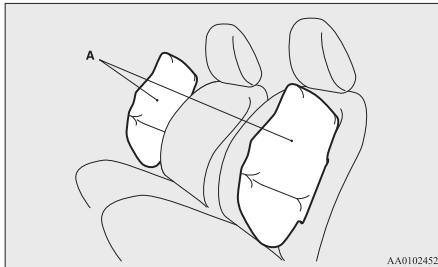

The label shown here is attached to the seatbacks with a side airbag.

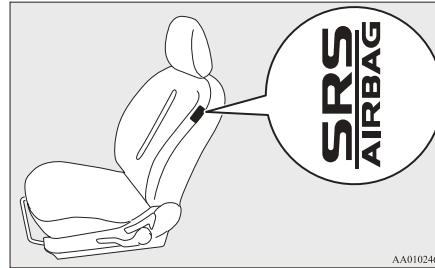

### Curtain airbag system

E00409100562

The curtain airbags are contained in the front pillars and roof side rail. The curtain airbag is designed to inflate only on the side of the vehicle that is impacted, even with no passenger in the front seat or rear seat.

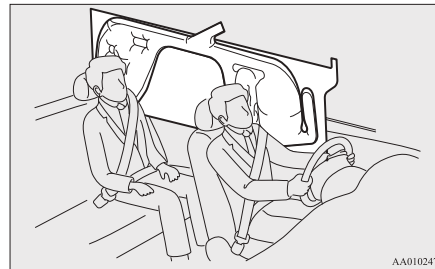

### Deployment of side airbags and curtain airbags

E00407701457

*The side airbags and curtain airbags ARE DESIGNED TO DEPLOY when...*

The side airbags and curtain airbags are designed to deploy when the vehicle suffers a moderate-to-severe side impact to the middle of the passenger compartment.

The typical condition is shown in the illustration.

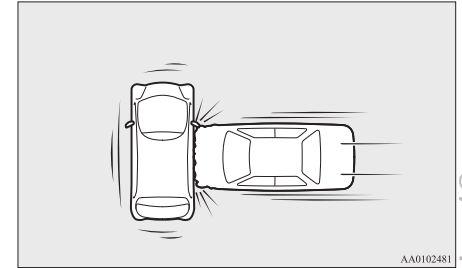

The seat belts in your vehicle are your primary means of protection in a collision. The side airbags and curtain airbags are designed to provide additional protection. Therefore, for your safety and the safety of all occupants, be sure to always properly wear your seat belts.

## Seat and seat belts

### *The side airbags and curtain airbags MAY NOT DEPLOY when...*

With certain types of side collisions, the vehicle's body structure is designed to absorb the shock to help protect the occupants from harm. (The vehicle body's side area may deform significantly as it absorbs the impact.) Under such circumstances, the side airbags and curtain airbags may not deploy irrespective of the deformation and damage to the vehicle body. Examples of some typical conditions are shown in the illustration.

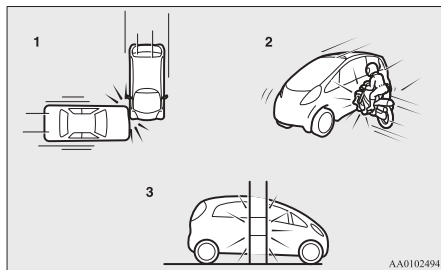

- 1- Side impacts in an area away from the passenger compartment
- 2- Motorcycle or other similar small vehicle collides with the side of vehicle
- 3- Collision with a utility pole, tree or other narrow object

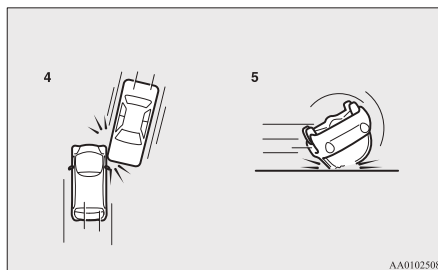

- 4- Oblique side impacts
- 5- Vehicle rolls onto its side or roof

Because the side airbags and curtain airbags do not protect the occupant in all types of side collisions, be sure to always properly wear your seat belts.

### *The side airbags and curtain airbags ARE NOT DESIGNED TO DEPLOY when...*

The side airbags and curtain airbags are not designed to deploy in conditions where they cannot usually provide protection to the occupant. Typical conditions are shown in the illustration.

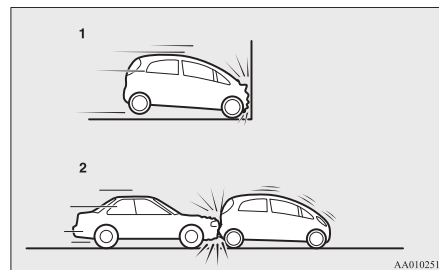

- 1- Head-on collisions
- 2- Rear end collisions

Because the side airbags and curtain airbags do not protect the occupant in all types of collisions, be sure to always properly wear your seat belts.

## **⚠ WARNING**

- The side airbags and curtain airbags are designed to supplement the driver and passenger seat belts in certain side impacts. Seat belts should always be worn properly, and the driver and passenger should sit well back and upright without leaning against the window or door.

**⚠ WARNING**

- The side airbags and curtain airbags inflate with great force. The driver and passenger should not put their arms out the window, and should not lean against the door, in order to reduce risk of serious or possible fatal injury from the deploying side airbags and curtain airbags.

**⚠ WARNING**

- Do not allow any rear seat occupant to hold onto the seatback of either front seat, in order to reduce risk of injury from the deploying side airbags. Special care should be taken with children.
- Do not place any objects near or in front of the seatback of either front seat. They could interfere with proper side airbag inflation, and also could cause injury if thrown free by side airbag deployment.

**⚠ WARNING**

- Do not place stickers, labels or additional trim on the seatback of either front seat. They could interfere with proper side airbag inflation.
- Do not install seat covers on seats with side airbags. Do not re-cover seats that have side airbags. This could interfere with proper side airbag inflation.
- Do not attach a microphone (A) or any other device or object around the part where the curtain airbags (B) activate such as on the windscreen, side door glass, front and rear pillars and roof side or assist grips. When the curtain airbags inflate, the microphone or other device or object will be hurled with great force or the curtain airbags may not activate correctly, resulting in death or serious injury.

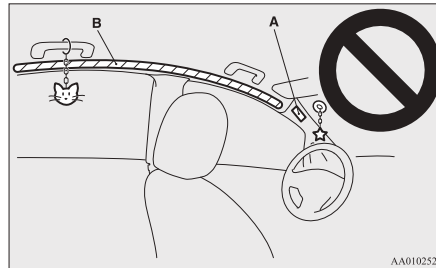
**⚠ WARNING**

- Never install a rearward facing child restraint in the front passenger seat. A forward facing child restraint should be used in the rear seat whenever possible. If a forward facing child restraint must be used in the front passenger seat, adjust the seat to the most rearward position, and ensure that the child stays in the child restraint and away from the door.
- Do not allow the child to lean against or close to the door even if the child is seated in a child restraint system. The child's head should also not be leaned against or be close to the area where the side airbags and curtain airbags are located. It is dangerous if the side airbags and curtain airbags inflate. Failure to follow all of these instructions could lead to serious or fatal injury to the child.
- We recommend work around and on the side airbags and curtain airbags system to be done by a MITSUBISHI MOTORS Authorized Service Point.

**SRS warning lamp**

There is a Supplemental Restraint System ("SRS") warning lamp on the instrument panel. The system checks itself and the lamp tells you if there is a problem. When the electric motor switch is turned to the "ON" or "START" position, the warning lamp should illuminate for several seconds and then should go out. This means the system is ready.

E00407801591

## Seat and seat belts

If an SRS airbag or pretensioner seat belt is not operating properly, the warning lamp comes on and stays on.

The SRS warning lamp is shared by the SRS airbag and the seat belt pretensioner system.

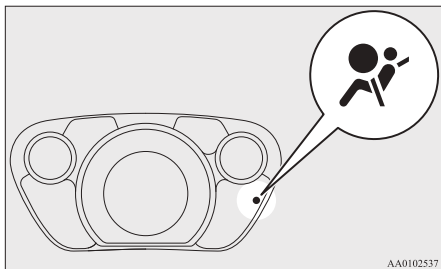

3

### **A** WARNING

- If any of the following conditions occur, the SRS and/or seat belt pretensioners are not working properly, and we recommend you to have it inspected by a MITSUBISHI MOTORS Authorized Service Point immediately.
  - The SRS warning lamp does not illuminate when the electric motor switch is turned “ON”.
  - The SRS warning lamp does not go out after several seconds.
  - The SRS warning lamp illuminates while driving.

## SRS servicing

E00407901550

### **A** WARNING

- We recommend any maintenance performed on or near the components of the SRS to be performed by a MITSUBISHI MOTORS Authorized Service Point. Improper work on the SRS components or wiring could result in inadvertent deployment of the airbags, or could render the SRS inoperative; either situation could result in serious injury.
- Do not modify your steering wheel, seat belt retractor or any other SRS components. For example, replacement of the steering wheel, or modifications to the front bumper or body structure can adversely affect SRS performance and lead to possible injury.
- If your vehicle has sustained any damage, we recommend you to have the SRS inspected to ensure it is in proper working order.
- Do not modify your front seats, centre pillar and centre console. It can adversely affect SRS performance and lead to possible injury. If you found any tear, scratch, crack or damage to the seat fabric near the side airbag, the portion of the front and rear pillars and roof side rail, you should have the SRS inspected by a MITSUBISHI MOTORS Authorized Service Point.

## NOTE

- When you transfer ownership of the vehicle to some other person, we urge you to alert the new owner that it is equipped with the SRS and refer the new owner to the applicable section in this owner's manual.
- If your vehicle has to be scrapped, do this in line with local legislation and contact a MITSUBISHI MOTORS Authorized Service Point to safely dismantle the airbag system.

## *Instruments and controls*

Instruments.....	4-02
Indication and warning lamps.....	4-08
Indication lamps.....	4-09
Warning lamps.....	4-09
Combination headlamps and dipper switch.....	4-11
Headlamp levelling switch.....	4-13
Turn-signal lever.....	4-14
Hazard warning flasher switch.....	4-15
Fog lamp switch.....	4-15
Wiper and washer switch.....	4-16
Rear window demister switch.....	4-18
Horn switch.....	4-19

## Instruments

E00500101251

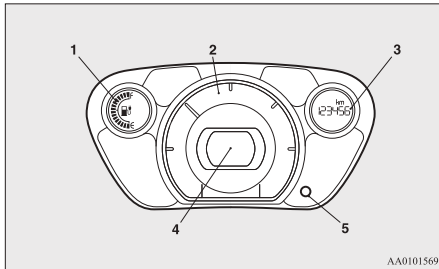

AA0101569

- 1- Energy level gauge
- 2- Energy usage indicator
- 3- Odometer/Tripmeter/Meter illumination control/Service reminder/Cruising range indicator
- 4- Speedometer (km/h or MPH)
- 5- Reset button/Daytime dipper button/Selector button

## Speedometer

E00500201050

When the electric motor switch is in the “ON” position, the speedometer indicates the vehicle speed in kilometers per hour (km/h) (Type 1) or miles per hour (MPH) (Type 2).

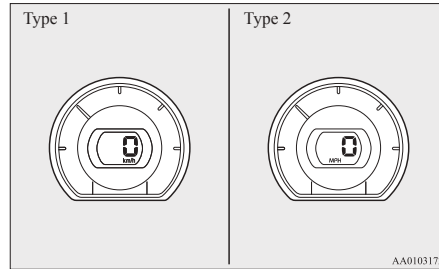

AA0103172

### NOTE

- The display setting can be changed to the preferred units (km or miles) (Type 2). Refer to “Changing the display unit\*” on page 4-02.

### Changing the display unit\*

E00529500026

It is possible to select the speedometer’s display unit.

1. Press the reset button (A) to display the odometer (B). (Refer to “To change the display” on page 4-03.)

2. Keep the reset button pressed for two seconds or longer to change the display unit from MPH to km/h or from km/h to MPH.

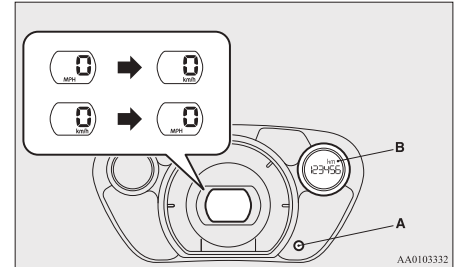

AA0103332

### NOTE

- Once the display unit has changed, keeping the reset button pressed will not cause the display unit to change again.

The display unit for the cruising range will change to match the selected speedometer display unit.

Speedometer	Cruising range
MPH	Miles
km/h	km

### NOTE

- Even if speedometer display unit is changed, the display units for the odometer, tripmeter, and service reminder do not change.

## Energy usage indicator

E00529600014

The consumption power of the electric motor unit and the air conditioning, and charged power of electric energy generated from the regenerative brake are indicated.

When the ready indicator illuminates, the indicating needle moves to the standard position (A) and moves to the left or right according to the use conditions of the vehicle.

[When the indicating needle moves to the right of the standard position]

Indicates consumption power of the electric motor unit and the air conditioning.

The more the needle moves to the right, the more electrical power is being consumed.

[When the indicating needle moves to the left of the standard position]

Indicates charged power of electric energy generated from regenerative braking.

The more the needle moves to the left, the more electric energy is charged.

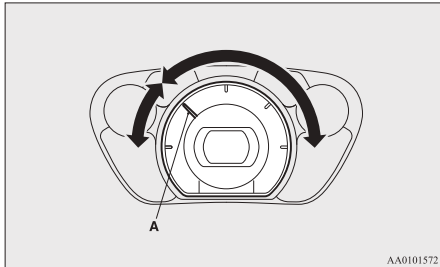

AA0101572

## Odometer/Tripmeter/Meter illumination control/Service reminder/Cruising range indicator

E00500601214

With the electric motor switch in the “ON” position, the odometer, tripmeter, meter illumination control, service reminder and cruising range indicator are displayed.

### To change the display

E00530700015

The display is changed every time the reset button (A) is pressed lightly (less than 1 second).

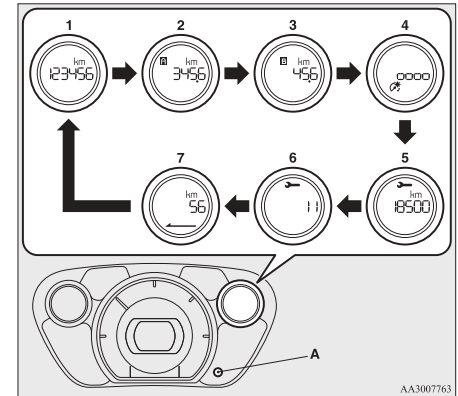

AA3007763

- 1- Odometer
- 2- Tripmeter **A**
- 3- Tripmeter **B**
- 4- Meter illumination control
- 5- Service reminder (Drive distance remaining until next inspection)
- 6- Service reminder (Number of months remaining until next inspection)
- 7- Cruising range indicator

### NOTE

- The cruising range indicator is indicated when the electric motor switch is in the “ON” position.



## Instruments and controls

- If there is no operation for about 10 seconds when the meter illumination control or service reminder is shown, the display returns to the odometer.

### Odometer

E00530800016

The odometer indicates the total distance the vehicle has travelled.

### NOTE

- Even if the electric motor switch is turned to “ACC” or “LOCK”, the odometer will be displayed for about 30 seconds after the reset button is pressed.

### Tripmeter

E00530900017

The tripmeter indicates the distance travelled during a particular trip or period.

There are two tripmeter displays: Tripmeter **A** and **B**.

Tripmeter **A** can be used to measure the distance travelled since the current trip began. At the same time, Tripmeter **B** can be used to measure the distance from an intermediate location.

### NOTE

- Even if the electric motor switch is turned to the “ACC” or “LOCK” position, the tripmeter will be displayed for about 30 seconds after the reset button is pressed.

### To reset the tripmeter

To return the display to “0”, press the reset button (A) for more than 2 seconds. Only the currently displayed value will be reset.

### NOTE

- If the auxiliary battery terminal is removed, the memories for the tripmeter **A** and **B** displays are erased and the displays return to 0.

### Service reminder

E00517700164

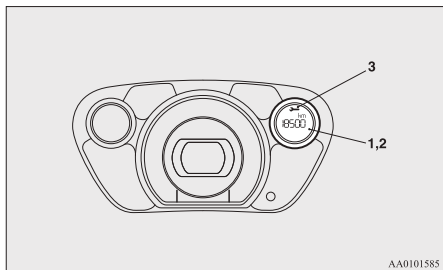

The service reminder shows the driving distance (1) or number of months (2) remaining until the next 12-monthly (20,000 km / 12,500 miles) inspection.

When the next inspection is nearly due, the display shows “-----”.

At this time, a spanner mark (3) is shown for a few seconds whenever the electric motor switch is turned from the “LOCK” position or the “ACC” position to the “ON” position.

### NOTE

- Even if the electric motor switch is turned to the “ACC” or “LOCK” position, the service reminder will be displayed for about 30 seconds after the reset button is pressed.

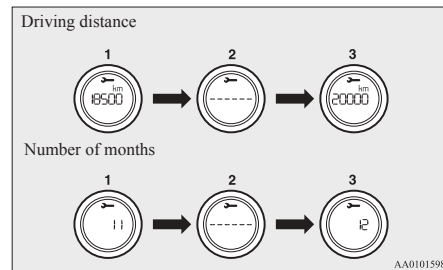

1. The display shows the driving distance or number of months remaining until the next inspection.
2. When the next inspection is nearly due, the display shows “-----”.  
For further information, we recommend you to consult a MITSUBISHI MOTORS Authorized Service Point.  
At this time, a spanner mark is shown for a few seconds whenever the electric motor

switch is turned from the “LOCK” position or the “ACC” position to the “ON” position.

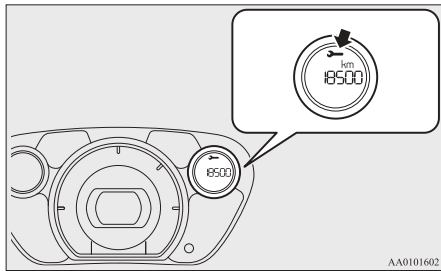

- When the vehicle is inspected at a MITSUBISHI MOTORS Authorized Service Point, the driving distance or number of months remaining until the next inspection will be shown.

**NOTE**

- The indicated distance decreases in steps of 100 km (62 miles). The indicated number of months decreases in steps of one month.
- It is possible to change the settings for the service reminder.  
For further information, we recommend you to consult a MITSUBISHI MOTORS Authorized Service Point.

**Resetting the service reminder**

With the electric motor switch in the “LOCK” position or the “ACC” position, it is possible to reset the spanner mark (A) and “-----” indication (B).

When they have been reset, the driving distance or number of months remaining until the next inspection are shown and the spanner mark (A) is no longer shown every time the electric motor switch is turned from the “LOCK” position or the “ACC” position to the “ON” position.

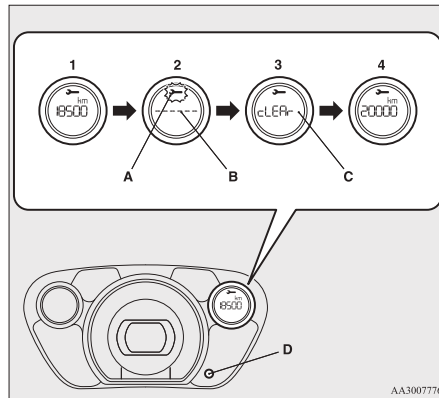

- Push the reset button (D) to view the driving distance or number of months remaining until the next inspection.
- Give the reset button (D) a long push (at least two seconds) to make the spanner mark (A) start flashing. (If you do not touch the reset button for 10 seconds while the spanner mark is flashing, the display will revert to its original indication.)
- Give the reset button (D) a gentle push while the spanner mark is flashing. The “-----” indication (B) will change to “cLEAR” (C).

**CAUTION**

- Daily and periodic inspections and maintenance are your responsibility. Be sure to perform them to help prevent accidents and breakdowns.

**NOTE**

- It is not possible to reset the “-----” indication (B) with the electric motor switch in the “ON” position.
- When a certain distance has been driven and a certain period has elapsed after appearance of the “-----” indication (B), the indication is automatically reset and the number of months until the next periodic inspection is shown.
- If you accidentally reset the display, consult a MITSUBISHI MOTORS Authorized Service Point.

## Instruments and controls

### Daytime dipper button (meter illumination control)

E00529700028

Each time you press the daytime dipper button (2), the brightness of the instruments changes.

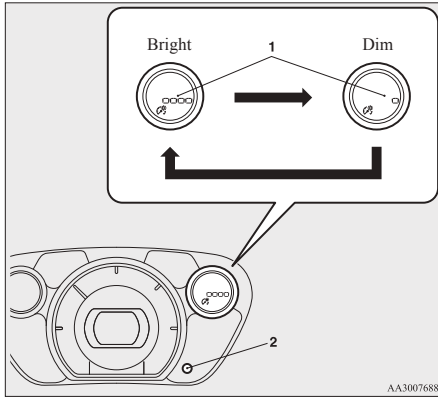

- 1- Brightness display
- 2- Daytime dipper button

### NOTE

- You can adjust to 4 different levels for when the tail lamps are illuminated and 4 for when they are not.
- When the lamp switch is in the “AUTO” position, the meter illumination switches automatically to the adjusted brightness, depending on the brightness outside the vehicle.
- The brightness level of the instruments is stored when the electric motor switch is turned off.

- If you press and hold the button for longer than about 1 second, the brightness automatically scrolls through its different levels, and stops scrolling when you release the button. Select your desired level of brightness.

### Cruising range indicator

E00529900020

This displays the approximate cruising range (how many more kilometres or miles you can drive). When the cruising range becomes short, the indication changes to “---”.

### NOTE

- The cruising range is displayed based on the past drive data. It may vary depending on the driving condition (road condition, driving situation, etc.) and air conditioning operation status.  
For example, the cruising range can be shortened by driving on congested roads, by driving uphill, by repeated hard acceleration, and by use of the air conditioner and heater.  
When the auxiliary battery terminal is disconnected, the power consumption data of the traction battery in the past is deleted. A different value from before may be displayed. Be sure to use the display only for reference.
- When the traction battery is charged, the cruising range is updated. If the charge level is low, the correct value is not displayed.
- On vehicles with speedometer of Type 2, the display setting can be changed to the preferred units (km or miles). Refer to “Changing the display unit\*” on page 4-02.

### Energy level gauge

E00530000018

The energy level gauge indicates the remaining power in the traction battery during charging or when the electric motor switch is in the “ON” position.

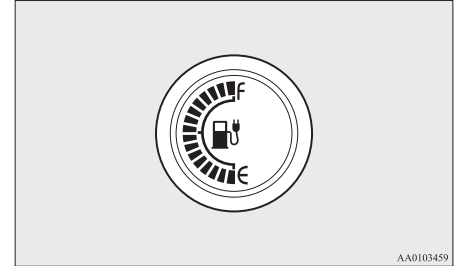

- F- Battery is fully powered.
- E- Charge the battery.

### NOTE

- The charging indicator is also illuminated during charging. Refer to “Charging indicator” on page 4-09.

**Low energy warning indicator**

E00530300011

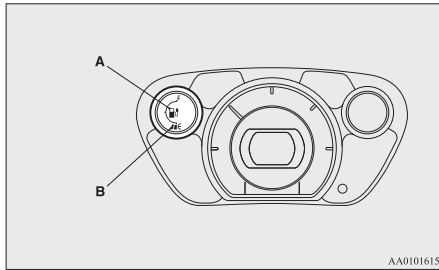

When the electric motor switch is in the “ON” position and the remaining bar of the energy level gauge shows 2 bars or less, the warning indicator (A) and the graduation (B) flash as follows:

When the energy level gauge shows 2 bars: The warning indicator flashes.

When the energy level gauge shows 1 bar: The warning indicator and the graduation flash alternately.

Recharge the traction battery as soon as possible.

**NOTE**

- If the energy level gauge shows 0 bars during use of the air conditioning (cooling or heating), the air conditioning stops operation and the mode is changed to fan only.
- If the energy level gauge shows 0 bars, the power down warning lamp is illuminated to control the output.

- If the energy level gauge shows 2 bars while the traction battery is being charged, the warning indicator flashes. If the energy level gauge shows 1 bar while the traction battery is being charged, the warning indicator and the graduation flash alternately.

## Indication and warning lamps

E00501502044

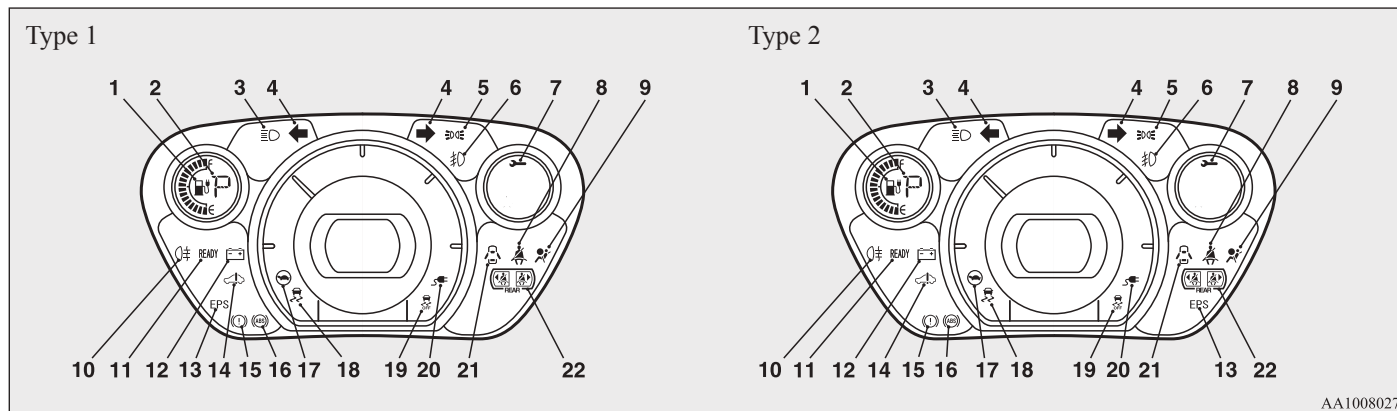

AA1008027

- 1- Low energy warning indicator → p. 4-07
2. Selector lever position indicator → p. 5-10
- 3- High-beam indication lamp → p. 4-09
- 4- Turn-signal indication lamps/Hazard warning indication lamps → p. 4-09
- 5- Position lamp indication lamp → p. 4-09
- 6- Front fog lamp indication lamp\* → p. 4-09
- 7- Service reminder → p. 4-04
- 8- Driver's and front passenger's seat belt warning lamp → p. 3-09
- 9- Supplement Restraint System (SRS) warning lamp → p. 3-29
- 10- Rear fog lamp indication lamp → p. 4-09
- 11- Ready indicator → p. 4-09

- 12- Auxiliary battery charge warning lamp → p. 4-10
- 13- Electric power steering system (EPS) warning lamp → p. 5-15
- 14- Electric motor unit warning lamp → p. 4-11
- 15- Brake warning lamp → p. 4-09
- 16- Anti-lock brake system (ABS) warning lamp → p. 5-14
- 17- Power down warning lamp → p. 4-11
- 18- Active stability control (ASC) indication lamp → p. 5-18
- 19- Active stability control (ASC) OFF indication lamp → p. 5-18
- 20- Charging indicator → p. 4-09
- 21- Door ajar warning lamp → p. 4-10
- 22- Rear passenger's seat belt warnings → p. 3-10

## Indication lamps

E00501600012



### Turn-signal indication lamps/ Hazard warning indication lamps

E00501700374

These indication lamps blink on and off when a turn-signal lamp is operating.

#### NOTE

- If the blinking is too fast, the cause may be a blown lamp bulb or a faulty turn-signal connection.

When the hazard warning lamp switch is pressed, all turn-signal lamps will flash on and off continuously.



### High-beam indication lamp

E00501800072

This indication lamp illuminates when the high-beam is used.



### Front fog lamp indication lamp\*

E00501900132

This indication lamp illuminates while the front fog lamps are on.



### Rear fog lamp indication lamp



E00502000084

This indication lamp illuminates while the rear fog lamp is on.



### Position lamp indication lamp

E00508900102

This lamp illuminates with the lamp switch at “ ” or “ ” position



### Ready indicator

E00530100019

This indicator illuminates when the electric motor switch is turned to “START” and driving becomes possible.



### Charging indicator

E00530200010

This indicator flashes when the regular charging cable or quick charging cable is connected.

After that, the lamp switches to being illuminated when charging starts and goes out when charging is completed.



## Warning lamps

E00502400017

### Brake warning lamp (brake warning buzzer)

E00502502490

This lamp illuminates when the electric motor switch is turned to the “ON” position, and goes off after a few seconds.

Always make sure that the lamp goes off before driving.

With the electric motor switch in the “ON” position, the brake warning lamp illuminates under the following conditions:

- When the parking brake lever has been engaged.
- When the brake fluid level in the reservoir falls to a low level.
- When there is a fault in the brake vacuum pressure system.
- When the brake force distribution function is not operating correctly.

#### Brake warning buzzer

When the brake vacuum pressure is insufficient, a buzzer will sound to alert the driver that braking performance may decrease. If this buzzer should continue to sound, park your vehicle in a safe place and we recommend you to have it checked.

NOTE

- Depressing the brake pedal repeatedly may turn on the brake warning lamp and brake warning buzzer. It is normal if the lamp goes out and the buzzer stops sounding after a few seconds.

**⚠ CAUTION**

- In the situations listed below, brake performance may be compromised or the vehicle may become unstable if brakes are applied suddenly; consequently, avoid driving at high speeds or applying the brakes suddenly. Furthermore, the vehicle should be brought to a stop in a safe location and to have it checked.
  - The brake warning lamp does not illuminate when the parking brake is applied or does not turn off when the parking brake is released.
  - The brake warning lamp remains illuminated during driving.
  - The brake warning lamp and ABS warning lamp are both illuminated at the same time. Refer to “ABS warning lamp” on page 5-14.
  - The brake warning buzzer will not stop sounding.

**⚠ CAUTION**

- The vehicle should be brought to a halt in the following manner when brake performance has deteriorated.
  - Depress the brake pedal harder than usual. Even if the brake pedal moves down to the very end of its possible stroke, keep it pressed down hard.
  - Should the brakes fail, use regenerative braking to reduce your speed and carefully pull the parking brake lever. Depress the brake pedal to operate the stop lamp to alert the vehicles behind you.

NOTE

- Operation sounds of the brake electric vacuum pump may be heard from the electric motor unit room just after the electric motor switch has been turned “ON” or when the brake pedal is depressed. This occurs when the brake electric vacuum pump is operating normally and does not indicate faulty operation.



**Auxiliary battery charge warning lamp**

E00502701219

This warning lamp will illuminate when there is a fault with the charging system of the auxiliary battery.

Normally, when the electric motor switch is turned to the “ON” position, this warning lamp will illuminate. When the electric motor unit is started, the lamp goes out.

**⚠ CAUTION**

- If it illuminates while the ready indicator is illuminated, there is a problem in the charging system. In this case, immediately park your vehicle in a safe place and we recommend you to have it checked.



**Door ajar warning lamp**

E00503300840

This lamp illuminates when either of the doors (also, the tailgate) is not completely closed.

If the vehicle speed exceeds about 8 km/h (5 mph) with a door ajar, the warning lamp will flash 16 times and, at the same time, the buzzer will sound 16 times to notify the driver that a door is ajar.

**⚠ CAUTION**

- Before moving your vehicle, check that the warning lamp is OFF.

## NOTE

- The flashing of the warning lamp and the buzzer can be disabled. For further information, we recommend you to consult a MITSUBISHI MOTORS Authorized Service Point.
- When the driver's door is open, the door ajar warning buzzer does not sound because the electric motor reminder or selector lever reminder sounds.

**Electric motor unit warning lamp**

E00530400012

This warning lamp will illuminate when there is a fault at the high voltage area. Refer to "Service precautions" on page 8-06.

**⚠ CAUTION**

- If the lamp illuminates while driving, immediately park your vehicle in a safe place and we recommend you to have it checked.

**Power down warning lamp**

E00530500013

This warning lamp illuminates at the following cases, and activation of the safety mechanism will limit output.

- When the energy level gauge shows 0 bars
- When the traction battery capacity is not sufficient, the voltage is low or the temperature of the motor (electric motor unit) or traction battery is high or low

## NOTE

- When the power down warning lamp illuminates, avoid sudden acceleration and sudden starting. When the remaining power in the traction battery is low, recharge the traction battery as soon as possible.
- Illumination of the power down warning lamp does not indicate a malfunction.

**Combination headlamps and dipper switch**

E00506002099

**Headlamps**

## NOTE

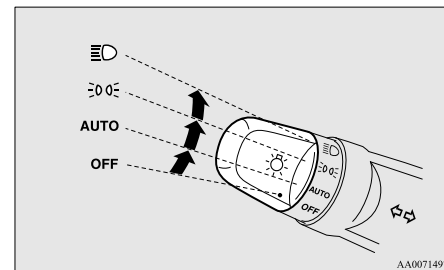

- Do not leave the lamps on for a long time while the ready indicator is not illuminated. A run-down auxiliary battery could result.
- When it rains, or when the vehicle has been washed, the inside of the lens sometimes becomes foggy, but this does not indicate a functional problem. When the lamp is switched on, the heat will remove the fog. However, if water gathers inside the lamp, we recommend you to have it checked.

Rotate the switch to turn on the lamps.





## Instruments and controls

OFF	All lamps off
AUTO	With the electric motor switch in the "ON" position, headlamps, position, tail, licence plate, and instrument panel lamps turn on and off automatically in accordance with outside light level. All lamps turn off automatically when the electric motor switch is turned to the "OFF" position.
	Position, tail, licence plate and instrument panel lamps on
	Headlamps and other lamps go on

### NOTE

- The sensitivity of the automatic on/off control can be adjusted. For further information, please contact your MITSUBISHI MOTORS Authorized Service Point.
- When the headlamps are turned off by the automatic on/off control with the electric motor switch in the "ON" position, the front fog lamps (if so equipped) and rear fog lamps also go off. When the headlamps are subsequently turned back on by the automatic on/off control, the front fog lamps also come on but the rear fog lamp stays off. If you wish to turn the rear fog lamp back on, operate the switch again.
- Do not place anything on the automatic light sensor (A), and do not clean with a glass cleaner.

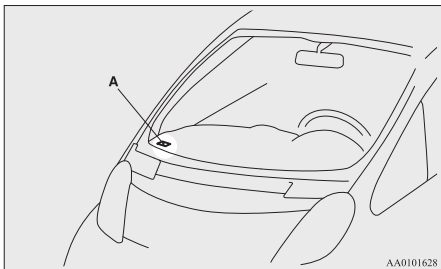

- If the lamps do not turn on or off with the switch in the "AUTO" position, manually operate the switch and we recommend you to have your vehicle checked.

### Lamps (headlamps, fog lamp, etc.) auto-cutout function

E00532700396

- If the key is turned to the "LOCK" or "ACC" position or removed from the electric motor switch, and without opening the driver's door for 3 minutes while the lamp switch in the "OFF" position, the lamps will turn off automatically.
- If the key is turned to the "LOCK" or "ACC" position or removed from the electric motor switch and the driver's door is opened within 3 minutes while the lamp switch is in the "OFF" position, a buzzer will sound to warn the driver that the lamps have not been turned off, and these lamps will automatically turn off.

### NOTE

- The lamp auto-cutout will not function when the lamp switch is in the "OFF" position.
- When the key has been turned to either the "LOCK" or "ACC" position or removed from the electric motor switch with the lamp switch in the "OFF" position, and the lamp switch is returned to the "OFF" position within approximately 3 minutes, the auto-cutout function will not be activated.

### When you want to keep the lamps on

1. Turn the lamp switch in the "OFF" position while the key is in the "LOCK" position.
2. Turn on the lamps with the switch in the "OFF" or "OFF" position again, then the lamps will remain on.

### NOTE

- It is possible to disable the lamp auto-cutout function. For further information, we recommend you to consult MITSUBISHI MOTORS Authorized Service Point.

### Lamp monitor buzzer

E00506100605

If the driver's door is opened when the key is in the "LOCK" or "ACC" position or removed from the electric motor switch while the lamps are on, a buzzer will sound to remind the driver to turn off the lamps.

When the lamp auto-cutout function acts, the buzzer will stop automatically.

## Daytime running lamp\*

E00530600014

The daytime running lamps come on when the ready indicator illuminates and the lamp switch is in the “OFF” or “AUTO” position and the tail lamps are off.

## Dipper (High/Low beam change)

E00506200329

When the lamp switch is in the “

## Headlamp flasher

E00506300199

The high-beams flash when the lever is pulled slightly (2), and will go off when it is released.

When the high-beam is on, the high-beam indication lamp in the instrument cluster will illuminate.

### NOTE

- The high-beams can also flash when the lamp switch is OFF.

- If you turn the lamps off with the headlamps set to high-beam, the headlamps are automatically returned to their low-beam setting when the lamp switch is next turned to the “

## Headlamp levelling switch

E00506400813

The angle of the headlamp beam varies depending on the load carried by the vehicle.

The headlamp levelling switch can be used to adjust the headlamp illumination distance (when the lower beam is illuminated) so that the headlamps' glare does not distract other drivers.

Set the switch according to the following table.

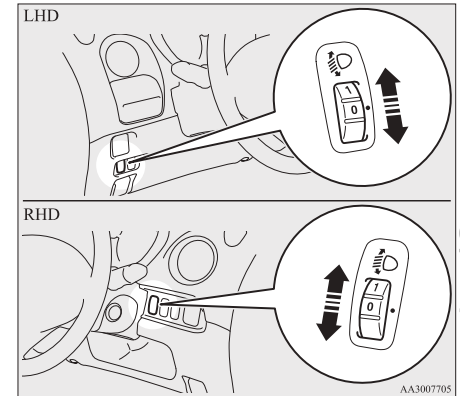

## CAUTION

- Always perform adjustments before driving. Do not attempt to adjust while driving, as it could cause an accident.

## Instruments and controls

### NOTE

- When adjusting the beam position, first put the dial in the “0” position (the highest beam position).

Vehicle condition					
Switch position	“0”	“0”	“1”	“1”	“2”

• 1 person

Full luggage loading

Switch position 0- Driver only/Driver + 1 front passenger

Switch position 1- 4 passengers (including driver)/  
4 passengers (including driver) + Full luggage loading

Switch position 2- Driver + Full luggage loading

## Turn-signal lever

E00506501459

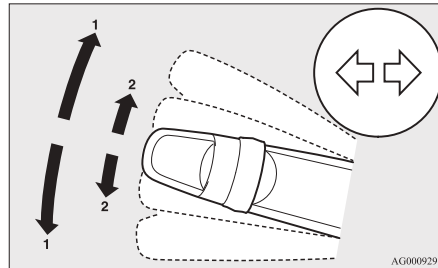

### 1- Turn-signals

When making a normal turn, use position (1). The lever will return automatically when cornering is completed.

### 2- Lane-change signals

When moving the lever to (2) slightly to change a lane, the turn-signal lamps and indication lamp in the instrument cluster will only flash while the lever is operated.

Also, when you move the lever to (2) slightly then release it, the turn-signal lamps and indication lamp in the instrument cluster will flash 3 times.

- Flashing of the turn-signal lamps when the lever is operated with the electric motor switch in the “ACC” position
- The turn-signal lamps 3-flash function for lane changes can be deactivated.
- The time required to operate the lever for the 3-flash function can be adjusted.

### NOTE

- If the lamp flashes unusually quickly, the bulb in a turn-signal lamp may have burned out. We recommend you to have the vehicle inspected.
- It is possible to activate the following functions. For further information, we recommend you to consult a MITSUBISHI MOTORS Authorized Service Point.

## Hazard warning flasher switch

E00506600958

Use the hazard warning flasher switch when the vehicle has to be parked on the road for any emergency. The hazard warning flashers can always be operated, regardless of the position of the electric motor switch.

Push the switch to turn on the hazard warning flashers, all turn-signal lamps flash continuously. To turn them off, push the switch again.

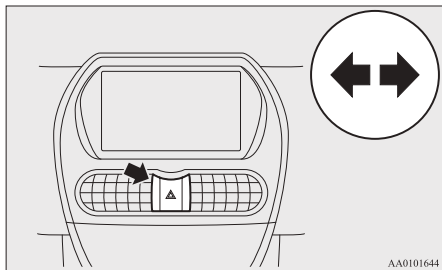

AA0101644

### NOTE

- If the switch is used for a long period while the ready indicator is not illuminated, the auxiliary battery could go flat and it could be impossible to start the electric motor unit.

## Fog lamp switch

### Front fog lamp switch\*

E00506700034

E00508300685

The front fog lamps can be operated while the headlamps or tail lamps are on. Turn the knob in the “ON” direction to turn on the front fog lamps. An indication lamp in the instrument cluster will also come on. Turn the knob in the “OFF” direction to turn off the front fog lamps. The knob will automatically return to its original position when you release it.

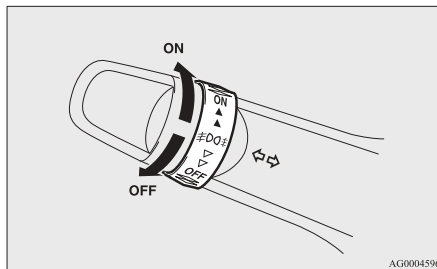

AG0004596

### NOTE

- The front fog lamps are automatically turned off when the headlamps or tail lamps are turned off. To turn the front fog lamps on again, turn the knob in the “ON” direction after turning on the headlamps or tail lamps.
- Do not use fog lamps except in conditions of fog, otherwise excessive lamp glare may temporarily blind oncoming vehicle drivers.

## Rear fog lamp switch

E00508400569

The rear fog lamp can be operated when the headlamps or front fog lamps (if so equipped) turn on. An indication lamp in the instrument cluster comes on when the rear fog lamp is turned on.

[Vehicle without front fog lamps]

Turn the knob once in the “ON” direction to turn on the rear fog lamp. To turn the rear fog lamp off, turn the knob once in the “OFF” direction. The knob will automatically return to its original position when you release it.

[Vehicle with front fog lamps]

Turn the knob once in the “ON” direction to turn on the front fog lamps. Turn the knob once more in the “ON” direction to turn on the rear fog lamp. To turn the rear fog lamp off, turn the knob once in the “OFF” direction. Turn the knob once more in the “OFF” direction to turn off the front fog lamps. The knob will automatically return to its original position when you release it.

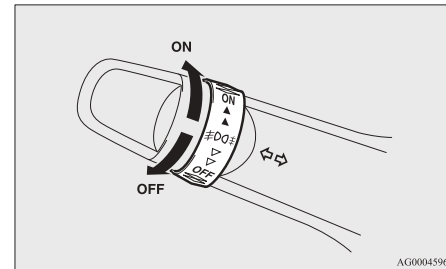

AG0004596

NOTE

- The rear fog lamp is automatically turned off when the headlamps or front fog lamps (if so equipped) are turned off.
- To turn the rear fog lamp on again, turn the knob once in the “ON” direction after turning on the headlamps. (Vehicle without front fog lamps)
- To turn the rear fog lamp on again, turn the knob twice in the “ON” direction after turning on the headlamps. (Vehicle with front fog lamps)

### Wiper and washer switch

E00507101667

#### **⚠ CAUTION**

- **If the washer is used in cold weather, the washer fluid sprayed against the glass may freeze, which may hinder visibility. Warm the glass with the defroster or rear window demister before using the washer.**

### Windscreen wipers

E00516900534

The windscreen wipers can be operated with the electric motor switch in the “ON” or “ACC” position.

If the blades are frozen to the windscreen or rear window, do not operate the wipers until the ice has melted and the blades are freed, otherwise the wiper motor may be damaged.

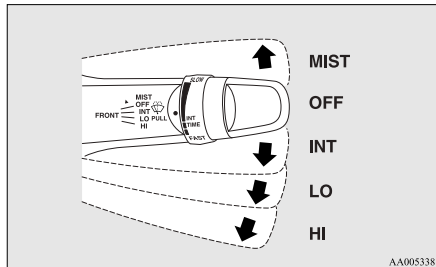

- MIST- Misting function  
The wipers will operate once.
- OFF- Off
- INT- Intermittent (Speed sensitive)
- LO- Slow
- HI- Fast

#### To adjust intermittent intervals

With the lever in the “INT” (speed-sensitive) position, the intermittent intervals can be adjusted by turning the knob (A).

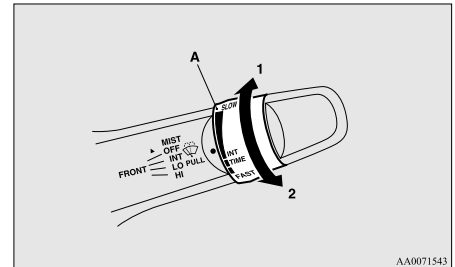

- 1- Fast
- 2- Slow

NOTE

- The speed-sensitive-operation function of the windscreen wipers can be deactivated. For further information, we recommend you to consult a MITSUBISHI MOTORS Authorized Service Point.

### Misting function

The wipers will operate once if the wiper lever is raised to the “MIST” position and released. This operation is useful when it is drizzling, etc. The wipers will continue to operate while the lever is held in the “MIST” position.

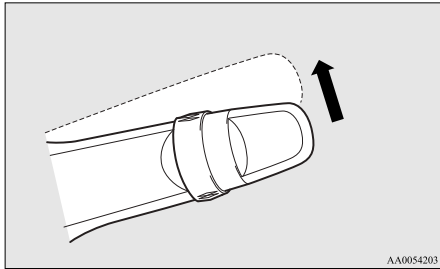

### Windscreen washer

The washer fluid will be sprayed onto the windscreen by pulling the lever towards you. The wipers operate automatically several times while the washer fluid is being sprayed.

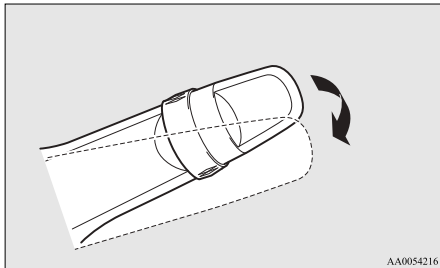

## CAUTION

- If the washer is used in cold weather, the washer fluid sprayed against the glass may freeze resulting in poor visibility. Heat the glass with the defroster or demister before using the washer.

### Rear window wiper and washer

E00507301223

The rear window wiper and washer switch can be operated with the electric motor switch in the “ON” or “ACC” position.

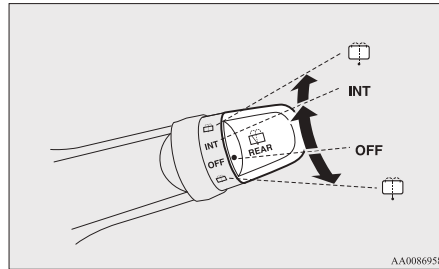

INT

- The wiper operates continuously for several seconds then operates intermittently at intervals of about every 8 seconds.

OFF



- Off
- The washer fluid will be sprayed onto the rear window when the knob is turned fully in either direction. The wipers operate automatically several times while the washer fluid is being sprayed.

### NOTE

- To ensure a clear rearward view, the wiper performs several continuous operations when the reverse gear is engaged while the switch is in the “INT” position. Following this continuous operation, the wiper will automatically switch to intermittent operation.
- It is possible to activate the following functions. For further information, we recommend you to consult a MITSUBISHI MOTORS Authorized Service Point.
  - Adjustment of the interval for intermittent operation
  - Changing intermittent wiper operation to continuous wiper operation

## Precautions to observe when using wipers and washers

E00507600131

- If the moving wipers become blocked by ice or other deposits on the glass, the motor may burn out even if the wiper switch is turned to OFF. If obstruction occurs, park your vehicle in a safe place, turn off the electric motor switch, and clean the deposits from the glass so that the wipers operate smoothly.
- Do not use the wipers when the glass is dry. They may scratch the glass surface and the blades wear out prematurely.
- Before using the wipers in cold weather, check that the wiper blades are not frozen onto the glass. The motor may burn out if the wipers are used with the blades frozen onto the glass.
- Avoid using the washer continuously for more than 20 seconds. Do not operate the washer when the fluid reservoir is empty. Otherwise, the motor may burn out.
- Periodically check the level of washer fluid in the reservoir and refill if required. During cold weather, add a recommended washer solution that will not freeze in the washer reservoir. Failure to do so could result in loss of washer function and frost damage to the system components.

## Rear window demister switch

E00507901216

The rear window demister switch can be operated when the ready indicator illuminates.

Push the switch to turn on the rear window demister. It will be turned off automatically in about 20 minutes. To turn off the demister within about 20 minutes, push the switch again.

The indication lamp (A) will illuminate while the demister is on.

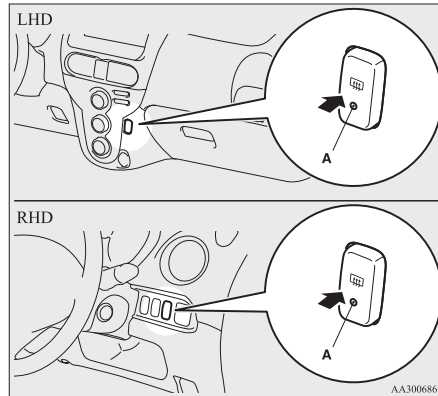

### NOTE

- Since the demister requires a significant amount of power, stop the demister as soon as the window is demisted.

- If your vehicle is equipped with heated mirrors, when the rear window demister switch is pressed, the outside rear-view mirrors are defogged or defrosted. Refer to “Heated mirror” on page 5-07.
- The demister switch is not to melt snow but to clear mist. Remove snow before use of the demister switch.
- When cleaning the inside of the rear window, use a soft cloth and wipe gently along the heater wires, being careful not to damage the wires.
- Do not allow objects to touch the inside of the rear window glass, damaged or broken wires may result.

## *Horn switch*

E00508000318

Press the steering wheel on or around the “” mark.

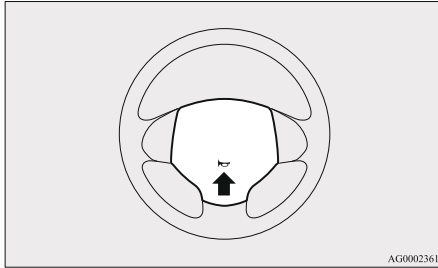





## *Starting and driving*

Economical driving.....	5-02
Driving, alcohol and drugs.....	5-02
Safe driving techniques.....	5-03
Parking brake.....	5-03
Parking.....	5-04
Inside rear-view mirror.....	5-05
Outside rear-view mirrors.....	5-05
Electric motor switch.....	5-07
Steering wheel lock.....	5-08
Starting the electric motor unit.....	5-08
Transmission.....	5-09
Driving the vehicle.....	5-11
Inspection and maintenance following rough road operation.....	5-12
Braking.....	5-12
Brake assist system.....	5-13
Anti-lock brake system (ABS).....	5-14
Electric power steering system (EPS).....	5-15
Active stability control (ASC).....	5-16
Cargo loads.....	5-19
Trailer towing.....	5-20

## Economical driving

E00600101092

For economical driving, there are some technical requirements that have to be met. In order to achieve longer life of the vehicle and the most economical operation, we recommend you to have the vehicle checked at regular intervals in accordance with the service standards.

## Starting and acceleration

Avoid driving with the accelerator pedal is pushed way down, such as for unnecessarily sudden starts, acceleration and deceleration. Smoothly depress the accelerator pedal.

Observe the speed limit and keep the speed as constant as possible while driving.

## Idling

Parking for a long period with the ready indicator illuminated will shorten the cruising range.

## Speed

At higher vehicle speed, more traction battery is consumed. Avoid driving at full speed. Even a slight release of the accelerator pedal will save a significant amount of traction battery.

## Tyre inflation pressure

Check the tyre inflation pressures at regular intervals. Low tyre inflation pressure increases road resistance. In addition, low tyre pressures adversely affect tyre wear and driving stability.

## Cargo loads

Do not drive with unnecessary articles in the luggage compartment.

## Air conditioning

Too much cooling/heating can affect the cruising range, so maintain an appropriate temperature to extend the cruising range.

## Driving, alcohol and drugs

E00600200070

Driving after drinking alcohol is one of the most frequent causes of accidents.

Your driving ability can be seriously impaired even with blood alcohol levels far below the legal minimum. If you have been drinking, don't drive. Ride with a designated non-drinking driver, call a cab or a friend, or use public transportation. Drinking coffee or taking a cold shower will not make you sober. Similarly, prescription and nonprescription drugs affect your alertness, perception and reaction time. Consult with your doctor or pharmacist before driving while under the influence of any of these medications.

### **WARNING**

- **NEVER DRINK AND DRIVE.**  
Your perceptions are less accurate, your reflexes are slower and your judgment is impaired.

## Safe driving techniques

E00600300635

Driving safety and protection against injury cannot be fully ensured. However, we recommend that you pay extra attention to the following:

### Seat belts

Before starting the vehicle, make sure that you and your passengers have fastened your seat belts.

### Floor mats

#### **⚠ WARNING**

- Keep floor mats clear of the pedals by correctly laying floor mats that are suitable for the vehicle.

To prevent the floor mats from slipping out of position, securely retain them using the hook etc.

Note that laying a floor mat over a pedal or laying one floor mat on top of another can obstruct pedal operation and lead to a serious accident.

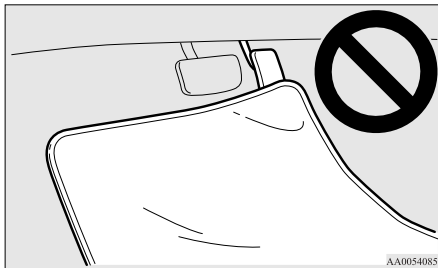

AA0054085

## Carrying children in the vehicle

- Never leave your vehicle unattended with the key and children inside the vehicle. Children may play with the driving controls and this could lead to an accident.
- Make sure that infants and small children are properly restrained in accordance with the laws and regulations, and for maximum protection in case of an accident.
- Prevent children from playing in the luggage compartment. It is quite dangerous to allow them to play there while the vehicle is moving.

## Loading luggage

When loading luggage, be careful not to load above the height of seats. This is dangerous not only because rearward vision will be obstructed, but also the luggage may be projected into the passenger compartment under hard braking.

## Parking brake

E00600501647

To park the vehicle, first bring it to a complete stop, fully apply the parking lever sufficiently to hold the vehicle.

## To apply the parking brake

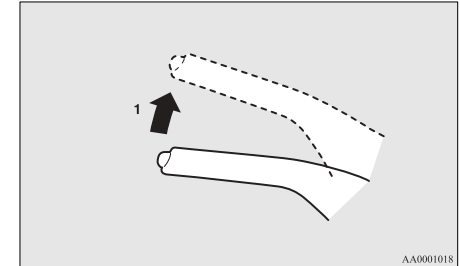

AA0001018

- 1- Firmly depress and hold the brake pedal, then pull the lever up without pushing the button at the end of hand grip.

#### **⚠ CAUTION**

- When you intend to apply the parking brake, firmly press the brake pedal to bring the vehicle to a complete stop before pulling the parking brake lever. Pulling the parking brake lever with the vehicle moving could make the rear wheels lock up, thereby making the vehicle unstable. It could also make the parking brake malfunction.

## Starting and driving

### NOTE

- Apply sufficient force to the parking brake lever to hold the vehicle stationary after the foot brake is released.
- If the parking brake does not hold the vehicle stationary after the foot brake is released, have your vehicle checked immediately.

## To release the parking brake

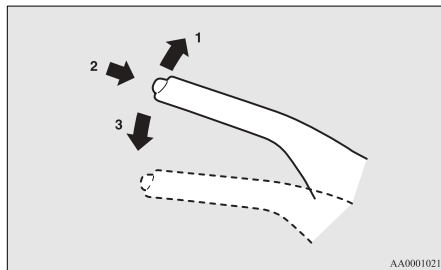

- 1- Firmly depress and hold the brake pedal, then pull the lever up slightly.
- 2- Push the button at the end of hand grip.
- 3- Lower the lever fully.

## **⚠ CAUTION**

- Before driving, be sure that the parking brake is fully released and the brake warning lamp is off. If a vehicle is driven without releasing the parking brake, the brake will be overheated, resulting in ineffective braking and possible brake failure.

## **⚠ CAUTION**

- If the brake warning lamp does not extinguish when the parking brake is fully released, the brake system may be malfunctioning. Have your vehicle checked immediately. For details, refer to “Brake warning lamp” on page 4-09.

## Parking

E00600601534

To park the vehicle, fully engage the parking brake, and then move the selector lever to the “P” (PARK) position.

### Parking on a hill

To prevent the vehicle from rolling, follow these procedures:

#### *Parking on a downhill slope*

Turn the front wheels towards the kerb and move the vehicle forward until the kerb side wheel gently touches the kerb.

Apply the parking brake and place the selector lever into the “P” (PARK) position.

If necessary, apply chocks to the wheels.

#### *Parking on an uphill slope*

Turn the front wheels away from the kerb and move the vehicle back until the kerb side wheel gently touches the kerb.

Apply the parking brake and place the selector lever into the “P” (PARK) position.

If necessary, apply chocks to the wheels.

### NOTE

- Be sure to apply the parking brake before moving the selector lever to the “P” (PARK) position. If you move the selector lever to the “P” (PARK) position before applying the parking brake, it may be difficult to disengage the selector lever from the “P” (PARK) position when you next drive the vehicle, requiring application of a strong force to the selector lever to move it from the “P” (PARK) position.

## Parking with the electric motor unit running

Never leave the electric motor unit running while you take a short sleep/rest.

### **⚠ WARNING**

- Leaving the electric motor unit running risks injury or death from accidentally moving the selector lever.

## Do not keep the steering wheel fully turned for a long time

More effort could be required to turn the steering wheel. Refer to “Electric power steering system (EPS)” on page 5-15.

## When leaving the vehicle

Always carry the key and lock all doors and the tailgate when leaving the vehicle unattended. Always try to park your vehicle in a well lit area.

## Inside rear-view mirror

E00600800672

Adjust the rear-view mirror only after making any seat adjustments so you have a clear view to the rear of the vehicle.

### **⚠ WARNING**

- Do not attempt to adjust the rear-view mirror while driving. This can be dangerous. Always adjust the mirror before driving.

Adjust the rear-view mirror to maximize the view through the rear window.

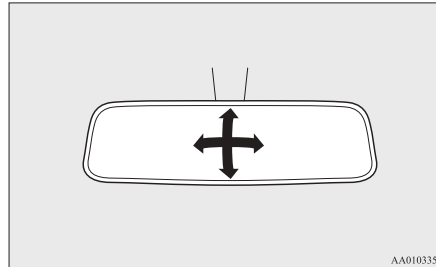

AA0103358

## Outside rear-view mirrors

E00600900628

### To adjust the mirror position

E00601000655

The outside rear-view mirrors can be operated when the electric motor switch is in the “ON” or “ACC” position.

### **⚠ WARNING**

- Do not attempt to adjust the rear-view mirrors while driving. This can be dangerous. Always adjust the mirrors before driving.
- Your vehicle is equipped with convex type mirrors. Please take into consideration, that objects you see in the mirror will look smaller and farther away compared to a normal flat mirror. Do not use this mirror to estimate distance of following vehicles when changing lanes.

## Starting and driving

1. Place the lever (A) to the same side as the mirror you wish to adjust.

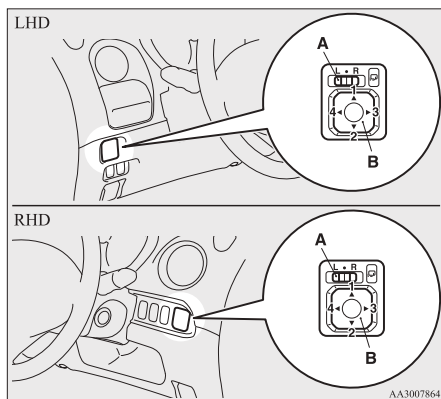

L- Left outside mirror adjustment  
R- Right outside mirror adjustment

2. Press the switch (B) to the left, right, up or down to adjust the mirror position.
  - 1- Up
  - 2- Down
  - 3- Right
  - 4- Left
3. Return the lever (A) back to the middle position (•).

## Retracting and extending the outside mirrors

E00601100669

The outside mirror can be folded in towards the side window to prevent damage when parking in narrow areas.

## **⚠ CAUTION**

- Do not drive the vehicle with the mirror folded in. The lack of rearward visibility normally provided by the mirror could lead to an accident.

With the electric motor switch in the “ON” or “ACC” position, push the mirror retractor switch to retract the mirrors.

Push it again to extend the mirrors to their original positions.

After turning the electric motor switch to the “LOCK” position, it is possible to retract and extend the mirrors using the mirror retractor switch for about 30 seconds.

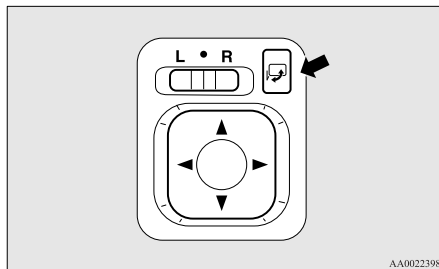

## **⚠ CAUTION**

- It is possible to retract and extend the mirrors by hand. After retracting a mirror using the mirror retractor switch, however, you should extend it by using the switch again, not by hand. If you extended the mirror by hand after retracting it using the switch, it would not properly lock in position. As a result, it could move because of the wind or vibration while you are driving, taking away your rearward visibility.

## NOTE

- Be careful not to get your hands trapped while a mirror is moving.
- The mirrors can be retracted or extended with the keyless entry system remote control switch. Refer to “Keyless entry system” on page 2-03.
- If you move a mirror by hand or it moves after hitting a person or object, you may not be able to return it to its original position using the mirror retractor switch. If this happens, push the mirror retractor switch to place the mirror in its retracted position and then push the switch again to return the mirror to its original position.
- When freezing has occurred and mirrors fail to operate as intended, please refrain from repeated pushing of the retractor switch as this action can result in burn-out of the mirror motor circuits.

## Heated mirror\*

E00601200514

To demist or defrost the outside rear-view mirrors, press the rear window demister switch.

The indication lamp (A) will illuminate while the demister is on.

The heater will be turned off automatically in about 20 minutes.

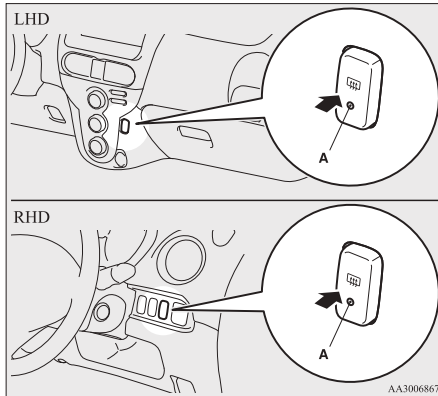

### NOTE

- Since the demister requires a significant amount of power, stop the demister as soon as the window is demisted.

## Electric motor switch

E00629400013

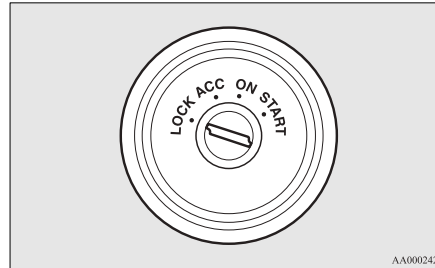

### LOCK

The steering wheel is locked. The key can only be inserted and removed in this position.

### ACC

The ready indicator is not illuminated, but the audio system and other electric devices can be operated.

### ON

The electric motor unit is running, and all the vehicle's electrical devices can be operated.

### START

The electric motor unit operates. After the electric motor unit has started, release the key and it will automatically return to the "ON" position.

### NOTE

- Your vehicle is equipped with an electronic immobilizer.

To start the electric motor unit, the ID code which the transponder inside the key sends must match the one registered in the immobilizer computer. Refer to "Electronic immobilizer (Anti-theft starting system)" on page 2-02.

## To remove the key

E00629500014

1. Set the selector lever to the "P" (PARK) position.
2. Turn the key to the "LOCK" position and remove it.

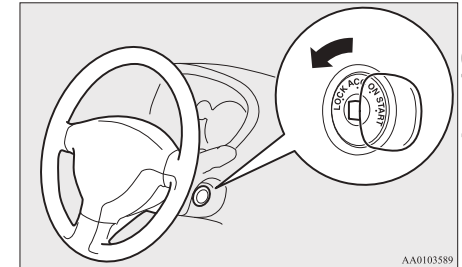



## **⚠ CAUTION**

- If the ready indicator goes out while driving, the brake servomechanism will cease to function and braking efficiency will deteriorate. Also, the power steering system may not operate, the steering wheel feels heavy when turning it.
- When the ready indicator has turned off, turn the electric motor switch to the “LOCK” position. Leaving the electric motor switch in the “ON” or “ACC” position and using electrical devices such as the audio system for a long time could cause the auxiliary battery to go flat and prevent the electric motor unit from being started.

## Steering wheel lock

E00601500692

### To lock

Remove the key at the “LOCK” position. Turn the steering wheel until it is locked.

### To unlock

Turn the key to the “ACC” position while moving the steering wheel slightly right and left.

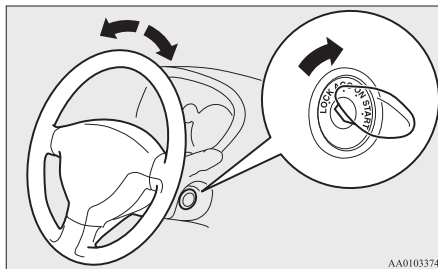

AA0103374

## **⚠ CAUTION**

- Remove the key when leaving the vehicle. In some countries, it is prohibited to leave the key in the vehicle when parked.

## Starting the electric motor unit

E00629300012

## **⚠ CAUTION**

- Never attempt to start the electric motor unit by pushing or pulling the vehicle.

The starting procedure is as follows:

1. Insert the key in the electric motor switch and fasten the seat belt.
2. Make sure the parking brake is applied.
3. Depress and hold the brake pedal.
4. Make sure the selector lever is in the “P” (PARK) position.

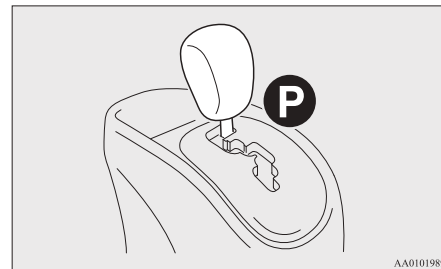

AA0101989

### NOTE

- The electric motor unit will not start unless the selector lever is in the “P” (PARK) position.

- Press the brake pedal with your right foot. Turn the electric motor switch fully, keep it in the “START” position for one to two seconds, and slowly return it to its original position. When you hear the startup sound and the ready indicator comes on, startup of the electric motor unit is complete.

**NOTE**

- If the ready indicator does not illuminate, return the electric motor switch to the “LOCK” position once. After a while, turn it to the “START” position to start the electric motor unit.
- To prevent a careless start, your vehicle is equipped with electric motor reminder. Refer to “Electric motor reminder” on page 5-09.

**Electric motor reminder**

E00630700029

If the driver’s door is opened while the key is in the “ON” position, the electric motor reminder buzzer sounds intermittently to remind the key is in the electric motor switch.

**Selector lever reminder**

E00630800017

If the driver’s door is opened while the selector lever is placed into the other positions from the “P” (PARK) position while the electric motor switch is on, the selector lever reminder buzzer sounds in the interval shorter than electric motor reminder buzzer.

**Transmission**

E00603200677

**Selector lever operation**

E00603301037

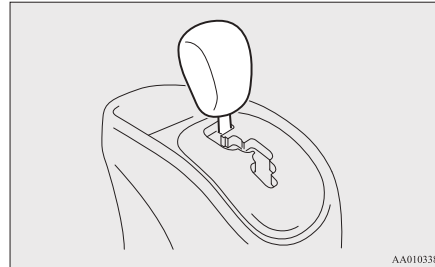

AA0103387

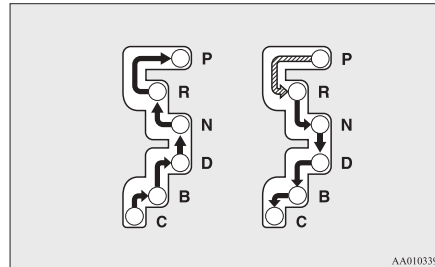

AA0103390

	While depressing the brake pedal, move the selector lever through the gate.
	Move the selector lever through the gate.

**WARNING**

- Always depress the brake pedal when shifting the selector lever into the other position from the “P” (PARK) or “N” (NEUTRAL) position. Never put your foot on the accelerator pedal while shifting the selector lever from the “P” (PARK) or “N” (NEUTRAL) position.

**NOTE**

- To avoid erroneous operation, move the selector lever firmly into each position and briefly hold it there. Always check the position shown by the selector lever position display after moving the selector lever.
- If the brake pedal is not depressed and held, the shift-lock device activates to prevent the selector lever from being moved from the “P” (PARK) position.

## Starting and driving

### Selector lever position indicator

E0060340028

When the electric motor switch is turned to the "ON" position, the position of the selector lever is indicated on the instrument cluster.

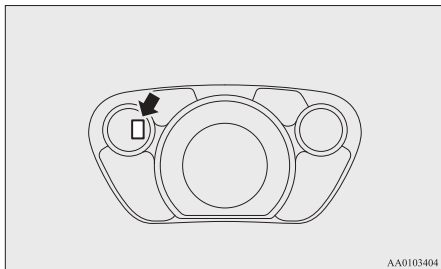

AA0103404

### When the selector lever position indicator blinks

E00629600031

When the selector lever position indicator blinks while you are driving, there could be a malfunction in the transmission system.

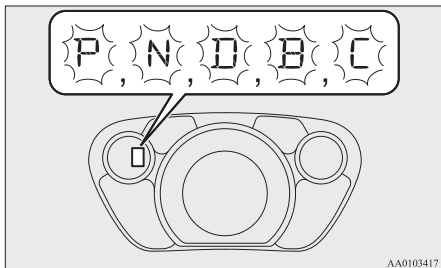

AA0103417

### **A** CAUTION

- If the selector lever position indicator blinks while you are driving, it is likely that a safety device is operating because of a malfunction in the transmission system. We recommend you to have your vehicle inspected as soon as possible.
- The selector lever position indicator warning function does not operate with the selector lever in the "R" (REVERSE) position.

### Selector lever positions

E00603800644

#### "P" PARK

This position locks the transmission to prevent the vehicle from moving. The electric motor unit can be started in this position.

#### "R" REVERSE

This position is to back up.

### **A** CAUTION

- Never shift into the "P" (PARK) or "R" (REVERSE) position while the vehicle is in motion to avoid transmission damage.

#### "N" NEUTRAL

It should only be used when the vehicle is stationary for an extended length of time during driving, such as in a traffic jam.

### **A** WARNING

- Never move the selector lever to the "N" (NEUTRAL) position while driving. A serious accident could occur since you could accidentally move the lever into the "P" (PARK) or "R" (REVERSE) position or you will lose regenerative braking.
- On a gradient, the electric motor unit should be started in the "P" (PARK) position, not in the "N" (NEUTRAL) position.
- Always keep your right foot on the brake pedal when shifting into or out of "N" (NEUTRAL), to minimize the risk of loss of control.

#### "D" DRIVE

This position is for normal driving. Regenerative braking is automatically applied when necessary, depending on road conditions.

### **A** CAUTION

- Never shift into the "D" (DRIVE) position from the "R" (REVERSE) position while the vehicle is in motion to avoid transmission damage.

#### "B" BRAKE

This position gives stronger regenerative braking than the "D" (DRIVE) position. It increases the vehicle's usability on hills and enables more energy-efficient driving. It is intended for downhill driving.

**⚠ WARNING**

- Avoid sudden regenerative braking when driving on wet or icy roads. Using sudden regenerative braking under these conditions could cause the vehicle to skid, resulting in a serious accident.

## NOTE

- When the traction battery level is nearly full or the traction battery temperature is low, the regenerative braking performance may be weakened. In this case, drive the vehicle at a low speed.

**“C” COMFORT**

This position gives weaker regenerative braking than the “D” (DRIVE) position. It enables relaxed driving in circumstances in which you do not accelerate or decelerate much (for example, suburban driving). It is intended for long cruising.

**Driving the vehicle**

E00629700016

**Operation of the transmission**

E00629800020

**⚠ CAUTION**

- Before selecting a position with the electric motor unit running and the vehicle stationary, fully depress the brake pedal to prevent the vehicle from creeping. The vehicle will begin to move as soon as the transmission is engaged, the brakes should only be released when you are ready to drive away.
- Depress the brake pedal with the right foot at all times. Using the left foot could cause driver movement delay in case of an emergency.
- Operating the accelerator pedal while the other foot is resting on the brake pedal will affect braking efficiency and may cause premature wear of brake pads.

**Waiting**

E00630900018

For short waiting periods, such as at traffic signals the vehicle can be left in selector lever position and held stationary with the service brake.

For longer waiting periods with the electric motor unit running, place the selector lever in the “N” (NEUTRAL) position and apply the parking brake, while holding the vehicle stationary with the service brake.

**⚠ CAUTION**

- Never hold the vehicle stationary while in transmission on a hill with the accelerator, always apply the parking brake and/or service brake.

**Parking**

E00631000016

To park the vehicle, first bring it to a complete stop, fully engage the parking brake, and then move the selector lever to the “P” (PARK) position. If you are going to leave the vehicle unattended, always switch off the electric motor unit and carry the key.

## NOTE

- On a slope, be sure to apply the parking brake before moving the selector lever to the “P” (PARK) position. If you move the selector lever to the “P” (PARK) position before applying the parking brake, it may be difficult to disengage the selector lever from the “P” (PARK) position when you next drive the vehicle, requiring application of a strong force to the selector lever to move it from the “P” (PARK) position.

## Inspection and maintenance following rough road operation

E00606700383

After operating the vehicle in rough road conditions, be sure to perform the following inspection and maintenance procedures:

- Check that the vehicle has not been damaged by rocks, gravel, etc.
- Carefully wash the vehicle with water. Drive the vehicle slowly while lightly depressing the brake pedal in order to dry out the brakes. If the brakes still do not function properly, we recommend you to have the brakes checked as soon as possible.
- Remove the insects, dried grass, etc. clogging the radiator core.
- Check the inside of the vehicle. If water entry is found, dry the carpet etc.
- Inspect the headlamps, If the headlamp bulb is flooded with water, we recommend you to have it drained.

## Braking

E00607001830

All the parts of the brake system are critical to safety. We recommend you to have the vehicle checked at regular intervals according to the service booklet.

### CAUTION

- **Avoid driving habits that cause heavy braking and never “ride” the brakes by resting your foot on the brake pedal while driving. It causes brake overheating and fading.**

### Brake system

The service brake is divided into two brake circuits. And your vehicle is equipped with power brakes. If one brake circuit fails, the other is available to stop the vehicle. If you should lose the power assist for some reason, the brakes will still work. In these situations, even if the brake pedal moves down to the very end of its possible stroke or resists being depressed, keep depressing the brake pedal down harder and further than usual; stop driving as soon as possible and have the brake system repaired.

### WARNING

- **Do not turn off the electric motor unit while your vehicle is in motion. If you turn off the electric motor unit while driving, the power assistance for the braking system will stop working and your brakes will not work effectively.**

### WARNING

- **If the power assist is lost or if either brake hydraulic system stops working properly, have your vehicle checked immediately.**

### Warning lamp

The brake warning lamp illuminates to indicate a fault in the braking system. Refer to “Brake warning lamp” on page 4-09.

### When brakes are wet

Check the brake system while driving at a low speed immediately after starting, especially when the brakes are wet, to confirm they work normally. A film of water can be formed on the brake discs or brake drums and prevent normal braking after driving in heavy rain or through large puddles, or after the vehicle is washed. If this occurs, dry the brakes out by driving slowly while lightly depressing the brake pedal.

### When driving downhill

It is important to take advantage of regenerative braking by shifting to the “B” (BRAKE) position while driving on steep downhill roads in order to prevent the brakes from overheating.

**⚠ WARNING**

- Do not leave any objects near the brake pedal or let a floor mat slide under it; doing so could prevent the full pedal stroke that would be necessary in an emergency. Make sure that the pedal can be operated freely at all times. Make sure the floor mat is securely held in place.

**Brake pad and linings**

- Avoid hard braking situations. New brakes need to be broken-in by moderate use for the first 200 km (125 miles).
- The disc brakes are provided with a warning device which emits a shrieking metallic sound while braking if the brake pads have reached their wear limit. If you hear this sound, have the brake pads replaced immediately.

**⚠ WARNING**

- Driving with worn brake pads will make it harder to stop, and can cause an accident.

**Brake assist system**

E00627000174

The brake assist system is a device assisting drivers who cannot depress the brake pedal firmly when it is necessary to do so (such as in emergency stop situations) and provides greater braking force.

If the brake pedal is depressed suddenly, the brakes will be applied with more force than usual.

**⚠ CAUTION**

- The brake assist system is not a device designed to exercise braking force greater than its capacity. Make sure to always keep a sufficient distance between vehicles in front of you without relying too much on the brake assist system.

**NOTE**

- Once the brake assist system is operational, it maintains great braking force even if the brake pedal is lightly released. To stop its operation, completely remove your foot from the brake pedal.
- The brake assist system may become operational when the brake pedal is fully depressed even if it has not been depressed suddenly.

- When the brake assist system is in use, you may feel as if the depressed brake pedal is soft, the pedal moves in small motions in conjunction with the sound of the ABS operation, or the vehicle body and the steering wheel vibrate. This occurs when the brake assist system is operating normally and does not indicate faulty operation. Continue to firmly depress the brake pedal.
- You may hear an operation noise when the brake pedal is depressed suddenly while stationary. This does not indicate a malfunction and the brake assist system is operating normally.

## Anti-lock brake system (ABS)

E00607101394

The anti-lock brake system (ABS) helps prevent the wheels from locking during braking. This helps maintain vehicle drivability and steering wheel handling.

### Driving hints

- Always keep a safe distance from the vehicle in front of you. Even if your vehicle is equipped with ABS, leave a greater braking distance when:
  - Driving on gravel or snow-covered roads.
  - Driving with tyre chains installed.
  - Driving on uneven road surfaces.
- Operation of ABS is not restricted to situations where brakes are applied suddenly. This system may also prevent the wheels from locking when you drive over manholes, steel roadwork plates, road markings, or any uneven road surface.
- When the ABS is activated, you may feel the brake pedal pulsation and the vibrations of the vehicle body and steering wheel. It may also feel as if the pedal resists being pressed. **In this situation, simply hold the brake pedal down firmly. Do not pump the brake, which will result in reduced braking performance.**
- An operation noise may be emitted from the bonnet room in the following situations. The sound is associated with checking the operations of the anti-lock brake system. At this time, you may feel a shock from the brake pedal if you depress it. These do not indicate a malfunction.
  - When the electric motor switch is turned to the “ON” position.

- When the vehicle is driven for a while after the electric motor is turned on.
- The ABS can be used after the vehicle has reached a speed over approximately 10 km/h (6 mph). It stops working when the vehicle slows below approximately 5 km/h (3 mph).

### ⚠ CAUTION

- **The ABS cannot prevent accidents. It is your responsibility to take safety precautions and to drive carefully.**
- **To prevent failure of the ABS, be sure wheels and tyres are of the specified size and the same type.**
- **Do not install any aftermarket limited-slip differential (LSD) on your vehicle. The ABS may stop functioning properly.**

### ABS warning lamp

E00607201207

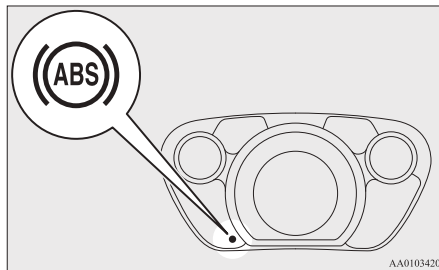

If there is a malfunction in the system, the ABS warning lamp will come on.

Under normal conditions, the ABS warning lamp only comes on when the electric motor switch is turned to the “ON” position and goes off a few seconds later.

### ⚠ CAUTION

- **Any of the following indicates that the ABS is not functioning and only the standard brake system is working. (The standard brake system is functioning normally.) If this happens, we recommend you to have your vehicle inspected as soon as possible.**
  - When the electric motor switch is turned to the “ON” position, the warning lamp does not come on or it remains on and does not go off.
  - The warning lamp comes on while driving

### If the warning lamp illuminates while driving

E00607301338

#### *If only the ABS warning lamp illuminates*

Avoid hard braking and high-speed driving. Stop the vehicle in a safe place, put the selector lever to the “P” (PARK) position and turn off the electric motor unit.

Restart the electric motor unit and check to see whether the lamp goes out after a few minutes driving; if it then remains off during driving, there is no problem.

However, if the warning lamp does not disappear, or if it comes on again when the vehicle is driven, we recommend you to have the vehicle checked.

***If the ABS warning lamp and brake warning lamp illuminate at the same time***

The ABS and brake force distribution function may not work, so hard braking could make the vehicle unstable.

Avoid hard braking and high-speed driving. Stop the vehicle in a safe place and we recommend you to have it checked.

**NOTE**

- The warning lamp may be illuminated when the electric motor unit is started while the auxiliary battery voltage is low, but this is not an ABS malfunction.  
When the traction battery is charged, the auxiliary battery is charged at the same time, and the warning lamp will go out.  
If the warning lamp does not go out or illuminates from time to time even after the battery is charged, have the vehicle inspected at a MITSUBISHI MOTORS Authorized Service Point.

**After driving on icy roads**

E00618800176

After driving on snowy or icy roads, remove any snow and ice which may have be left around the wheels. Be careful not to damage the wheel speed sensors (A) or the cables located at each wheel.

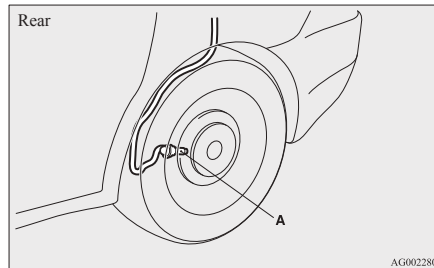
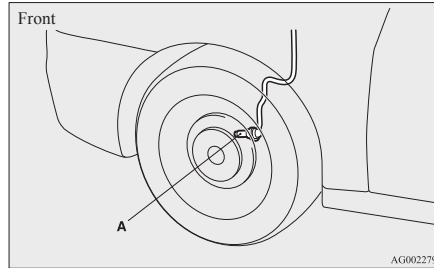

***Electric power steering system (EPS)***

E00629200079

The electric power steering system (EPS) uses an electric motor to assist the turning of the steering wheel.

**NOTE**

- During repeated full-lock turning of the steering wheel (for example, while you are manoeuvring the vehicle into a parking space), a protection function may be activated to prevent overheating of the power steering system. This function will make the steering wheel gradually harder to turn. In this event, limit your turning of the steering wheel for a while. When the system has cooled down, the steering action will return to normal.
- If you turn the steering wheel while the vehicle is stationary with the headlamps on, the headlamps may become dim. This behaviour is not abnormal. The headlamps will return to their original brightness after a short while.



## Electric power steering system warning lamp

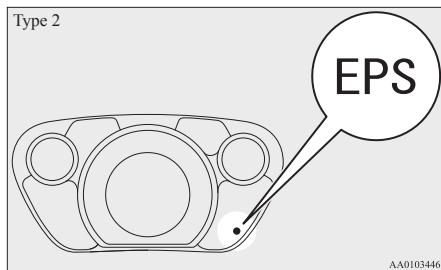
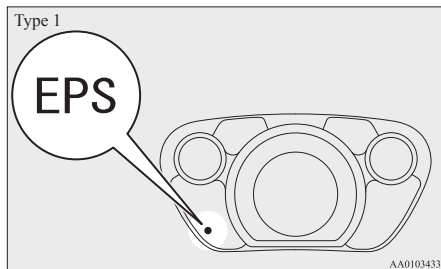

If there is a malfunction in the system, the warning lamp will come on.

Under normal conditions, the warning lamp comes on when the electric motor switch is turned to the "ON" position and goes off a few seconds later.

### **⚠ CAUTION**

- If the warning lamp appears during driving, it may become harder to turn the steering wheel.

#### *If the warning lamp appears while driving*

1. Stop the vehicle in a safe place, put the selector lever to the "P" (PARK) position and turn off the electric motor unit.
2. Restart the electric motor unit to check whether the warning lamp goes out; if it then remains off, there is no problem.

If the warning lamp does not go out, or it appears again while driving, we recommend you to have your vehicle inspected.

### *Active stability control (ASC)*

E00616700386

The Active Stability Control (ASC) takes overall control of the anti-lock brake system, traction control function and stability control function to help maintain the vehicle's control. Please read this section in conjunction with the page on the anti-lock brake system, traction control function and stability control function.



Anti-lock brake system (ABS) → p. 5-14

Traction control function → p. 5-17

Stability control function → p. 5-17

### **⚠ CAUTION**

- Do not over-rely on the ASC. Even the ASC cannot prevent the natural laws of physics from acting on the vehicle. This system, like any other system, has limits and cannot help you to maintain traction and control of the vehicle in all circumstances. Reckless driving may lead to accidents. It is the driver's responsibility to drive carefully. This means taking into account the traffic, road and environmental conditions.
- Be sure to use the same specified type and size of tyre on all 4 wheels. Otherwise, the ASC may not work properly.
- Do not install any aftermarket limited-slip differential (LSD) on your vehicle. The ASC may stop functioning properly.

When the ASC is deactivated, the  indication lamp will turn on. To reactivate the ASC, momentarily press the “ASC OFF” switch; the  indication lamp is turned off.

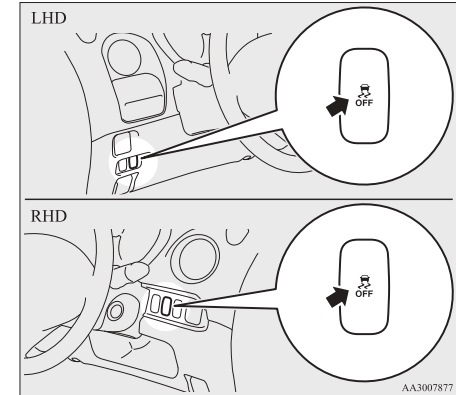

## NOTE

- An operation noise may be emitted from the bonnet room in the following situations. The sound is associated with checking the operations of the ASC. At this time, you may feel a shock from the brake pedal if you depress it. These do not indicate a malfunction.
  - When the electric motor switch is turned to the “ON” position.
  - When the vehicle is driven for a while after the electric motor is turned on.
- When the ASC is activated, you may feel a vibration in the vehicle body or hear a whining sound from the bonnet room. This indicates that the system is operating normally. It does not indicate a malfunction.
- When the anti-lock brake system warning lamp is illuminated, the ASC is not active.

## Traction control function

E0061900087

On slippery surfaces, the traction control function prevents the drive wheels from spinning excessively, thus helping the vehicle to start moving from a stopped condition. It also provides sufficient driving force and steering performance as the vehicle turns while pressing the acceleration pedal.

### CAUTION

- When driving a vehicle on a snowy or icy road, be sure to install snow tyres and drive the vehicle at moderate speeds.

## Stability control function

E00619100088

The stability control function is designed to help the driver maintain control of the vehicle on slippery roads or during rapid steering manoeuvres. It works by controlling the electric motor unit output and the brake on each wheel.

## NOTE

- The stability control function operates at speeds of about 15 km/h (9 mph) or higher.

## “ASC OFF” switch

E00619200496

The ASC is automatically activated when the electric motor switch is turned to the “ON” position. You can deactivate the system by pressing down the “ASC OFF” switch for 3 seconds or longer.

### CAUTION

- For safety reasons, the “ASC OFF” switch should be operated when your vehicle is stopped.
- Be sure to keep the ASC on while driving in normal circumstances.

## Starting and driving

### NOTE

- When moving out of mud, sand or fresh snow, pressing the accelerator pedal may not allow the electric motor speed to increase. In such situations, temporarily turning off the ASC with the “ASC OFF” switch will make it easier to move out your vehicle.
- Using the “ASC OFF” switch turns off both the stability control function and the traction control function.
- If you continue to press the “ASC OFF” switch after the ASC is turned off, the “mis-taken operation protection function” will activate and the ASC will turn back on.

### ASC indication lamp or ASC OFF indication lamp

E00619300556



ASC indication lamp  
The indication lamp will blink when the ASC is operating.





ASC OFF indication lamp  
This indication lamp will turn on when the ASC is turned off with the “ASC OFF” switch.

### CAUTION

- When the  indication lamp blinks, ASC is operating, which means that the road is slippery or that your vehicle’s wheels are beginning to slip. If this happens, drive slower with less accelerator input.

### If the indication lamp illuminates while driving

E00631100017

If an abnormal condition occurs in the system, the  indication lamp and  indication lamp will turn on.

### CAUTION

- The system may be malfunctioning. Stop the vehicle in a safe place, put the selector lever to the “P” (PARK) position and turn off the electric motor unit. Restart the electric motor unit and check whether the indication lamp goes out. If they go out, there is no abnormal condition. If they do not go out or appear frequently, it is not necessary to stop the vehicle immediately, but we recommend you to have your vehicle inspected.

## Towing

E00624400089

### CAUTION

- When towing the vehicle with only the front wheels raised off the ground, do not place the electric motor switch in the “ON” position. Placing the electric motor switch in the “ON” position could cause the ASC to operate, resulting in an accident.

Note that the correct towing method depends on the vehicle’s drive configuration. For details, refer to “Towing” on page 7-10.

## Cargo loads

E00609901413

### Cargo load precautions

#### CAUTION

- Do not load cargo or luggage higher than the top of the seatback. Be sure that your cargo or luggage cannot move once your vehicle is moving. Having the driver's vision blocked, and your cargo being thrown inside the cabin if you suddenly have to brake can cause a serious accident or injury.
- Load heavy cargo or luggage in the front of the vehicle. If the load in the back of the vehicle is too heavy, steering may become unstable.

### Loading a roof carrier

#### CAUTION

- Use a roof carrier that properly fits your vehicle. Do not load luggage directly onto the roof.  
For installation, refer to the instruction manual accompanying the roof carrier.
- When attaching/removing the roof carrier and loading/removing luggage, do not apply excessive pressure on a single point. Depending on how and where the force is applied, this may cause dents on the vehicle roof.

#### NOTE

- We recommend you to use a genuine MITSUBISHI roof carrier.

### Roof carrier precautions

#### CAUTION

- Make sure that the weight of the luggage does not exceed the allowable roof load (43 kg).  
If the allowable roof load is exceeded, this may cause damage to the vehicle.  
The roof load is the total allowable load on the roof (the weight of the roof carrier plus the weight of luggage placed on the roof carrier).
- When luggage is loaded onto the vehicle, please make sure to drive slowly and avoid excessive manoeuvres such as sudden braking or quick turning.  
In addition, place the luggage on the carrier so that its weight is distributed evenly with the heaviest items on the bottom. Do not load items that are wider than the roof carrier.  
The additional weight on the roof could raise the vehicle's centre of gravity and affect vehicle handling characteristics.  
As a result, driving errors or emergency manoeuvres could lead to a loss of control and result in an accident.

#### CAUTION

- Before driving and after travelling a short distance, always check the load to make sure it is securely fastened to the roof carrier.  
Check periodically during your travel that the load remains secure.

#### NOTE

- To prevent wind noise, remove the roof carrier when not in use.
- Remove the roof carrier before using an automatic car wash.
- Be sure that adequate clearance is maintained for raising the tailgate when installing a roof carrier.

## *Trailer towing*

E0061000244

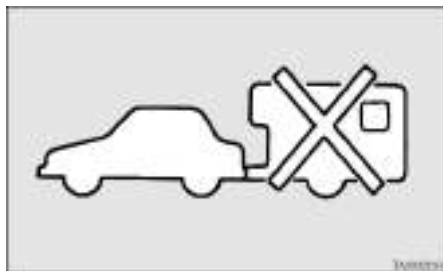

### **⚠** ***WARNING***

- Do not use this vehicle for trailer towing. It may cause an accident or damage the vehicle.

## *For pleasant driving*

Ventilators.....	6-02
Air conditioning.....	6-03
Important operation tips for the air conditioning.....	6-09
Air purifier.....	6-09
Antenna.....	6-10
Sun visors.....	6-10
Accessory socket.....	6-11
Interior lamps.....	6-12
Storage spaces.....	6-14
Cup holder.....	6-15
Assist grips.....	6-16

## Ventilators

E00700100911

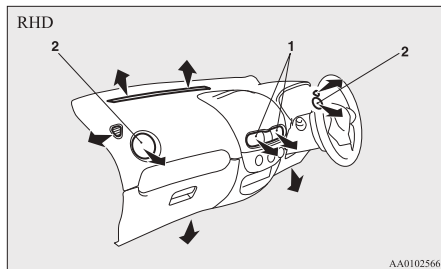
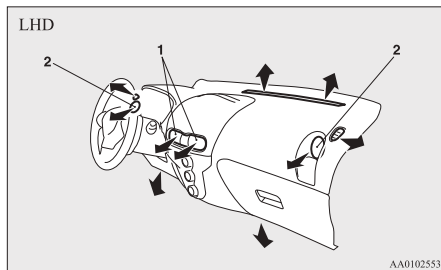

- 1- Centre ventilators
- 2- Side ventilators

### NOTE

- Do not place beverages on top of the instrument panel. If they splash into the air conditioning ventilators, they could damage the system.

## Air flow and direction adjustments

E00700200879

### Centre ventilators

Move the knob (A) and ventilator to adjust.

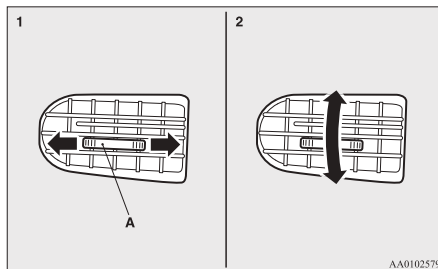

- 1- Left-right adjustment
- 2- Up-down adjustment

### Side ventilators

When the dimple (A) is pressed, the ventilators open. To close the ventilators, press the dimple (B) on the opposite side.

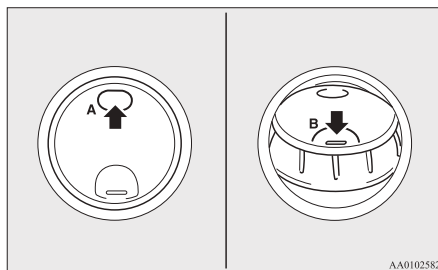

### NOTE

- The cool air from the ventilators may appear as a mist. This is due to moist air being suddenly cooled by the air conditioning. This will clear after a few moments.
- Be careful not to spill drinks, etc., into the ventilators. Doing so might cause the air conditioning not to function normally.

### Mode selection dial

E00726500362

To change the amount of air flowing from the ventilators, turn the mode selection dial.

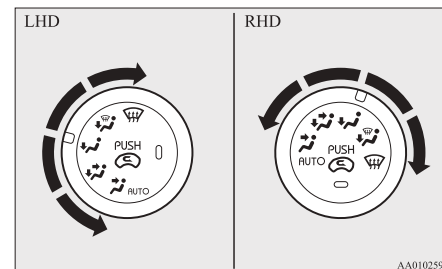

### Face position

Air flows only to the upper part of the passenger compartment.

### Foot/face position

Air flows to the upper part of the passenger compartment, and flows to the leg area.

### Foot position

Air flows mainly to the leg area.

**Foot/demister position**

Air flows to the leg area, the windscreen and the door windows.

**Demister position**

Air flows mainly to the windscreen and the door windows.

**“AUTO” position**

The ventilators change to the following positions according to the position of the temperature control dial.

Refer to “Temperature control dial” on page 6-04.

Temperature control dial position		Ventilator
Between “C” and middle (•)		: Upper part of the passenger compartment
Middle (•)	Set the dial to middle (•) from the “C” side	: Upper part of the passenger compartment
	Set the dial to middle (•) from the “H” side	: Leg area
Between middle (•) and “H”	Near middle (•)	: Leg area
	Near “H”	: Leg area, windscreen and door windows

**CAUTION**

- When using the mode selection dial between the “” and “” positions, prevent fogging by pressing the air selection switch to select outside air. (Refer to “Air selection switch” on page 6-04.)

**NOTE**

- With the mode selection dial between the “” and “” positions, the air flows mainly to the upper part of the passenger compartment. With the mode selection dial between the “” and “” positions, the air flows mainly to the leg area.
- With the mode selection dial between the “” and “” positions, the air flows mainly to the windscreen and door windows.

**Air conditioning**

E00700500465

The air conditioning can only be used when the ready indicator is illuminated.

**NOTE**

- If the energy level gauge is at 0 bar, the vehicle interior cannot be cooled/heated even though the dial or switch is operated. Furthermore, the demist performance is also reduced. Refer to “Energy level gauge” on page 4-06.

**Control panel**

E00700600567

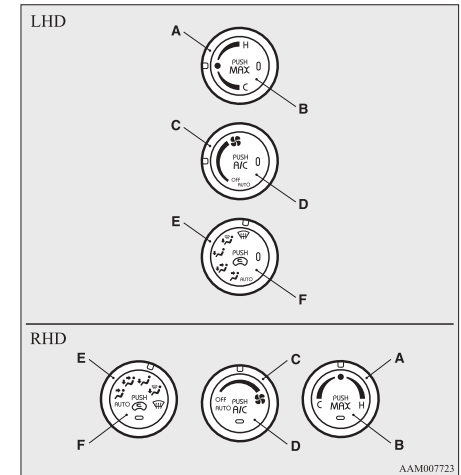

A- Temperature control dial



## For pleasant driving

- B- MAX switch
- C- Blower speed selection dial
- D- Air conditioning switch
- E- Mode selection dial
- F- Air selection switch

### NOTE

- There is an interior air temperature sensor (G) in the illustrated position. Never place anything over the sensor, since doing so will prevent it from functioning properly.

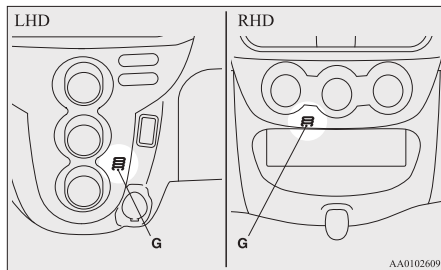

AA0102609

## 6 Blower speed selection dial

E00700700281

Select the blower speed by turning the blower speed selection dial clockwise or anticlockwise. Turn the dial clockwise to increase the air flow and anticlockwise to decrease the air flow.

When the dial is set to the “AUTO” position, the air flow is adjusted automatically according to the temperature of the interior and the position of the temperature control dial.

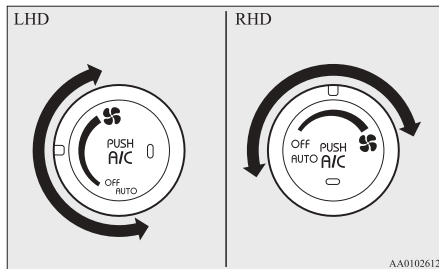

AA0102612

## Temperature control dial

E00700900401

Turn the temperature control dial clockwise or anticlockwise.

When the dial is set to the middle (•) position, only uncooled and unheated air will flow.

When the dial is moved to the middle (•) position when using cooling or heating, the cooling or heating stops.

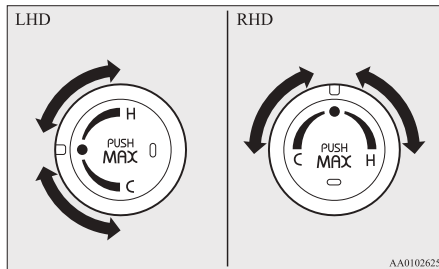

AA0102625

### NOTE

- When the dial is moved from the middle (•) position to the left while the air conditioning is not operating, the air temperature will not change.
- When the dial is moved to the middle (•) position and then to the left while the air conditioning is operating, the air conditioning is operated again.
- When the temperature control dial is set to the “C” position, the air selection changes automatically to the recirculation position and the air conditioning operates. When the dial is moved thereafter, the air conditioning continues to operate and the air selection setting returns to the setting before the dial was set to the “C” position.

## Air selection switch

E00701300747

To change the air selection, simply press the air selection switch.

- Outside air: Indication lamp (A) is OFF  
Outside air is introduced into the passenger compartment.

- Recirculated air: Indication lamp (A) is ON  
Air is recirculated inside the passenger compartment.

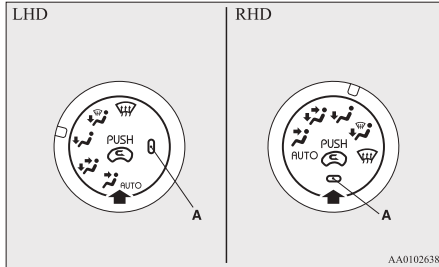

### Air conditioning switch (Air conditioning)

E00701500954

Push the switch to turn the air conditioning on, the indication lamp (A) will come on.

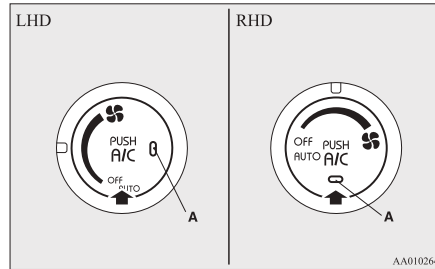

When the switch is pressed again, the operation returns to the mode before pressing the switch.

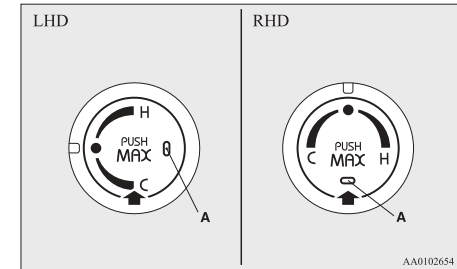

## CAUTION

- Normally, use the outside position to keep the windscreen and side windows clear and quickly remove fog or frost from the windscreen.  
If high cooling performance is desired, or if the outside air is dusty or otherwise contaminated use the recirculation position. Switch to the outside position periodically to increase ventilation so that the windows do not become fogged up.
- Use of the recirculation position for extended time may cause the windows to fog up.

Push the switch again to switch it off.

### MAX switch

E00765300017

When the blower speed selection dial is not OFF and the MAX switch is pressed, the indication lamp (A) illuminates and cooling/heating performance and the air conditioning setting is changed according to the temperature control dial position.

**When the temperature control dial is set between the middle (•) and the “H” position**  
The heating capability is the maximum.

**When the temperature control dial is in the middle (•) position**  
The air flow is the maximum.

**When the temperature control dial is set between the “C” and the middle (•) position**  
The air conditioning automatically operates and the cooling capability is the maximum.

### NOTE

- When the blower speed selection dial or temperature control dial is operated with the indication lamp illuminated, the indication lamp goes out and the selected function overrides others.  
Other functions return to the mode before pressing the MAX switch.

## For pleasant driving

- When the air conditioning is operated with the MAX switch, the air conditioning does not stop if the function is cancelled.
- Do not use the cooling/heating function with the MAX switch for a long time. Since the power consumption is larger than cooling/heating not using the MAX switch, the cruising range is shortened.

## Operating the air conditioning system

E00701800465

### Heating

1. Set the mode selection dial to the “” position.
2. Set the selection switch (A) to the outside position.
3. Turn the temperature control dial clockwise or anticlockwise to the desired temperature between the middle (•) and “H” position.
4. Select the desired blower speed.

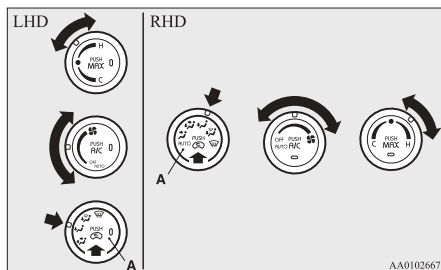

### NOTE

- When the blower speed selection dial is set to the “AUTO” position, the air flow is adjusted automatically according to the temperature of the interior and the position of the temperature control dial.

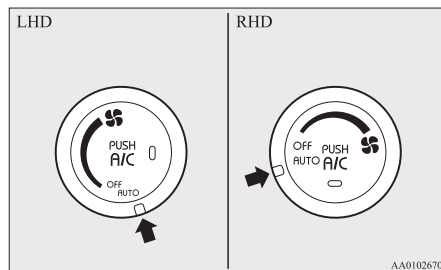

### Quick heating

1. Set the mode selection dial to the “” position.
2. Set the air selection switch (A) to the outside position.
3. Turn the temperature control dial clockwise or anticlockwise to the desired position and “H” position.
4. Turn the blower speed selection dial to any position other than “OFF” position.
5. Press the MAX switch (B).

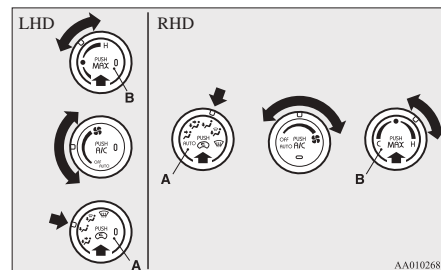

### NOTE

- Do not use the heating function with the MAX switch for a long time. Since the power consumption is larger than heating not using the MAX switch, the cruising range is shortened.

### Cooling

E00701900714

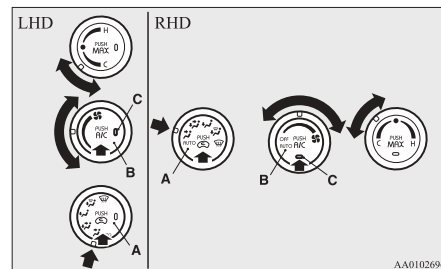

1. Set the mode selection dial to the “” position.

2. Set the air selection switch (A) to the outside position.
3. Turn the temperature control dial clockwise or anticlockwise to the desired temperature between the middle (•) and “C” position.
4. Select the desired blower speed.
5. Push the air conditioning switch (B).
6. When the air conditioning is operating, the switch indication lamp (C) illuminates.

### **CAUTION**

- If the outside air is dusty or otherwise contaminated, or if high-cooling performance is desired, set the air selection switch to the recirculation position and the temperature control dial all the way to the left. Switch to the outside position periodically to increase ventilation so that the windows do not become fogged up.

### NOTE

- When the blower speed selection dial is set to the “AUTO” position, the air flow is adjusted automatically according to the temperature of the interior and the position of the temperature control dial.

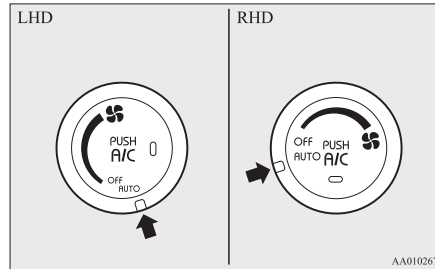

### Quick cooling

E00765400018

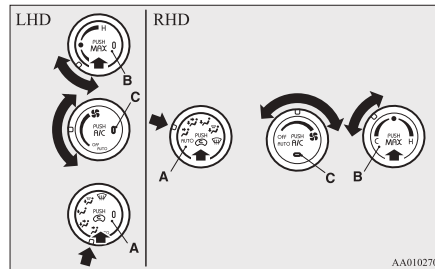

1. Set the mode selection dial to the “MAX” position.
2. Set the air selection switch (A) to the recirculation position.
3. Turn the temperature control clockwise or anticlockwise between the middle (•) and “C” position.
4. Turn the blower speed selection dial to any position other than “OFF” position.
5. Press the MAX switch (B).  
The air conditioning automatically operates and the indication lamp (C) illuminates.

### NOTE

- Do not use the cooling function with the MAX switch for a long time. Since the power consumption is larger than cooling not using the MAX switch, the cruising range is shortened.

### Demisting of the windscreen and door windows

E00702100830

### **CAUTION**

- For safety, make sure you have a clear view through all the windows.

Use the mode selection dial (“MAX” or “H”) to remove frost or mist from the windscreen or door windows.

## For pleasant driving

### For ordinary demisting

Perform the following settings to prevent misting of the windscreen and door windows, and to heat the leg area.

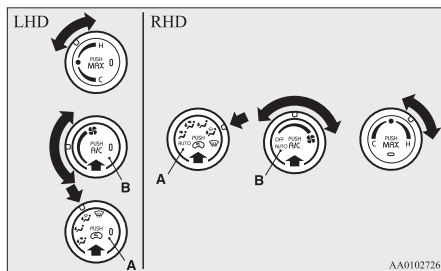

1. Set the air selection switch (A) to the outside position.
2. Set the mode selection dial to the “MAX” position.
3. Turn the temperature control dial clockwise or anticlockwise to the desired temperature between the middle (•) and “H” position.
4. Select the desired blower speed.
5. Push the air conditioning switch (B).

### For quick demisting

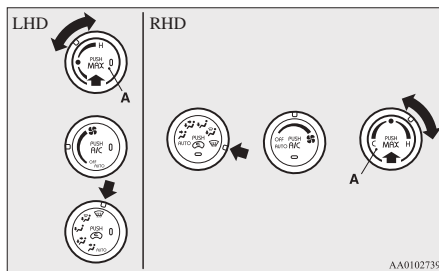

1. Set the mode selection dial to the “MAX” position.
2. Turn the temperature control dial clockwise or anticlockwise to the desired temperature between the middle (•) and “H” position.
3. Press the MAX switch (A).

### NOTE

- When the mode selection dial is in the “MAX” position, the system operates automatically and outside air is set automatically.
- To demist effectively, direct the air flow from the side ventilators towards the door windows.
- Do not set the temperature control dial to the max. cool position. Cool air will blow against the window glasses and prevent demisting.
- Since demisting or defrosting with the MAX switch consumes the power greatly, stop the switch after demisting or defrosting. Use for a long time may shorten the cruising range.

### Introduction of outside air

E00702200424

To introduce air into the vehicle during hot weather, follow these procedures:

1. Set the mode selection dial to any position other than “MAX” position.
2. Turn the temperature control dial to the middle (•) position.
3. Set the air selection switch (A) to the outside position.
4. Select the desired blower speed.

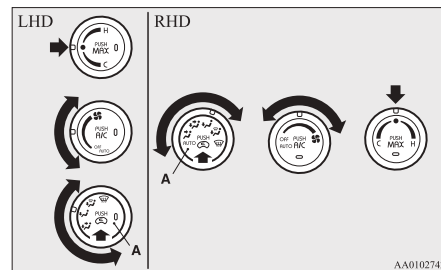

### NOTE

- When the temperature control dial is turned to the middle (•) position while the air conditioning is operating, the air conditioning turns off.

## Important operation tips for the air conditioning

E00708301020

- Park the vehicle in the shade.  
Parking in the hot sun will make the vehicle inside extremely hot, and it will require more time to cool the interior.  
If it is necessary to park in the sun, open the windows for the first few minutes of air conditioning operation to expel the hot air.
- Close the windows when the air conditioning is in use.  
The entry of outside air through open windows will reduce the cooling efficiency.
- Too much cooling is not good for the health. Keep the difference between the vehicle interior temperature and outside temperature to 5 to 6 °C.
- When operating the system, make sure the air intake, which is located in front of the windscreen, is free of obstructions such as leaves and snow. Leaves collected in the air-intake plenum may reduce air flow and plug the plenum water drains.
- Too much cooling/heating can affect the cruising range, so maintain an appropriate temperature to extend the cruising range.

### Air conditioning system refrigerant and lubricant recommendations

If the air conditioning seems less effective than usual, the cause might be a refrigerant leak. We recommend you to have the system inspected.

The air conditioning system in your vehicle must be charged with the refrigerant HFC-134a and the lubricant POE MA68EV.

Use of any other refrigerant or lubricant will cause severe damage which will result in the need to replace your vehicle's entire air conditioning system. The release of refrigerant into the atmosphere is not recommended.

The new refrigerant HFC-134a in your vehicle will not harm the ozone layer.

We recommend you to recover and recycle the refrigerant for reuse.

### During a long period of disuse

The air conditioning should be operated for at least five minutes each week, even in cold weather. This is to prevent the compressor from seizing and to maintain the air conditioning in the best operating condition.

## Air purifier

E00708400561

An air filter has been incorporated into the air conditioning so that pollen and dust are cleaned from the air.

Replace the air filter periodically as its ability to clean the air will be reduced as it collects pollen and dirt. For the maintenance interval, refer to the "SERVICE BOOKLET".

### NOTE

- Operation in certain conditions such as driving on a dusty road and frequent use of the air conditioning can lead to reduction of service life of the filter. When you feel that the air flow is lower than normal or when the windscreen or windows start to fog up easily, replace the air filter.  
We recommend you to have it checked.

## For pleasant driving

### Antenna

E00710500673

When listening to the radio, fully raise the antenna up.

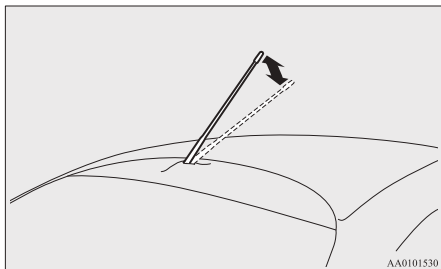

### To remove

Turn the pole (A) anticlockwise.

### To install

Screw the pole (A) clockwise into the base (B) until it is securely retained.

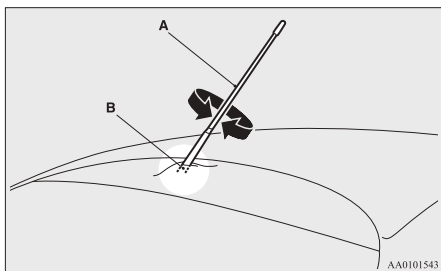

### NOTE

- Be sure to remove the roof antenna in the following cases:
  - When entering a place with low clearance.
  - When using an automatic car wash.
  - When placing a car cover over the vehicle.

### Sun visors

E00711201179

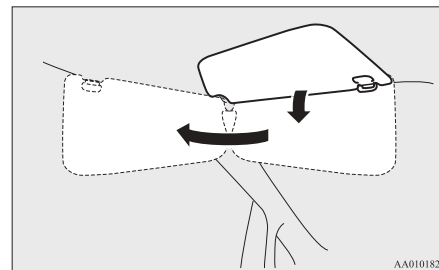

- 1- To eliminate front glare
- 2- To eliminate side glare

### Vanity mirror

E00731900247

A vanity mirror is fitted to the back of the sun visor.

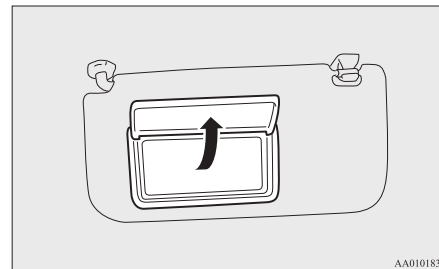

## Card holder

E00732000232

Cards can be slipped into the holder (A) on the back of the sun visor.

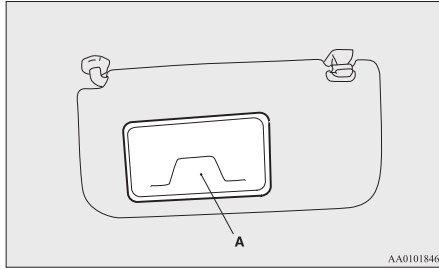

AA0101846

## Accessory socket

E00711601388

To use a plug-in type accessory, open the lid, and insert the plug in the accessory socket. The accessory socket can be used while the electric motor switch is in the "ON" or "ACC" position.

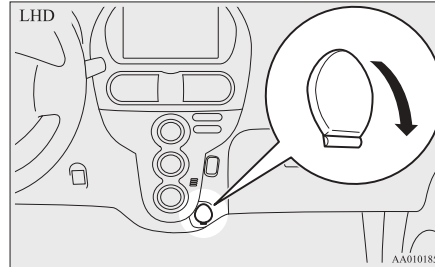

AA0101859

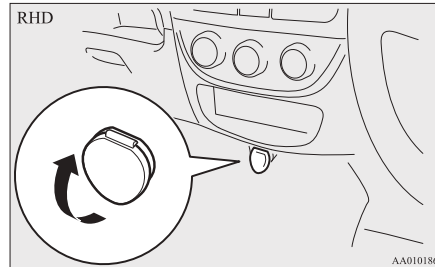

AA0101862

## CAUTION

- Long use of the electric appliance when the ready indicator is not illuminated may run down the auxiliary battery.
- When the accessory socket is not in use, be sure to close the lid, because the socket might become clogged by foreign material and be short-circuited.

## CAUTION

- Be sure to use a "plug-in" type accessory operating at 12 V and at 120 W or less.



## Interior lamps

E00712001220

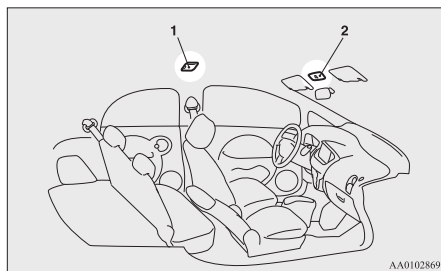

- 1- Room lamp (rear)
- 2- Map & room lamps (front)

### NOTE

- If you leave the lamps on when the ready indicator is not illuminated, you will run down the auxiliary battery. Before you leave the vehicle, make sure that the lamps are turned off.

## Map & room lamps (front)

E00717300609

### Room lamp

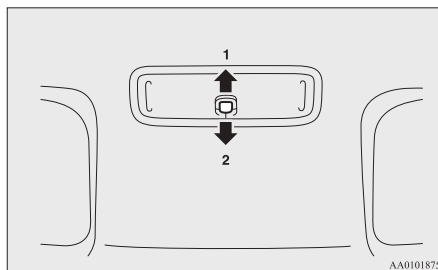

### 1- (DOOR)

- The lamp illuminates when a door or the tailgate is opened. It goes off about 15 seconds after the door or tailgate is closed (delayed off function). However, the lamp goes off immediately in the following cases:
  - When the electric motor switch is turned to the “ON” position.
  - When the central door lock function is used to lock the vehicle.
  - When the remote control switch of the keyless entry system is used to lock the vehicle.
- If the lamp is left switched on with the electric motor switch in the “LOCK” or “ACC” position and a door or the tailgate is opened, it goes off automatically after approximately 30 minutes. The lamp will illuminate again after it automatically goes off in the following cases:

- When the electric motor switch is turned to the “ON” position.
- When the remote control switch of the keyless entry system is operated.
- When any of the doors or the tailgate is opened after all doors and the tailgate are closed.

### NOTE

- When the key is removed while the doors and tailgate are closed, the lamp is illuminated and after about 15 seconds it goes off.
- The time until the lamp goes off (delayed off) can be adjusted. For details, please consult a MITSUBISHI MOTORS Authorized Service Point.
- The auto cut-out function can be deactivated. For details, please consult a MITSUBISHI MOTORS Authorized Service Point.

### 2-

The lamp stays off regardless of whether the doors and tailgate are open or closed.

### Map lamps

E00765200058

Regardless of the position of the room lamp switch, when the lens is pressed, the lamp on the side that was pressed will illuminate. Press the lens again to turn off the lamp.

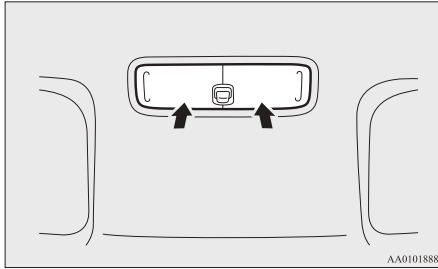

### Room lamp (rear)

E00712300385



#### 1- (ON)

The lamp illuminates regardless of whether the doors and tailgate are open or closed.

#### 2- (\*)

- The lamp illuminates when a door or the tailgate is opened. It goes off about 15 seconds after the door or tailgate is closed (delayed off function).

However, the lamp goes off immediately in the following cases:

- When the electric motor switch is turned to the “ON” position.
  - When the central door lock function is used to lock the vehicle.
  - When the remote control switch of the keyless entry system is used to lock the vehicle.
- If the lamp is left switched on with the electric motor switch in the “LOCK” or “ACC” position and a door or the tailgate is opened, it goes off automatically after approximately 30 minutes.

The lamp will illuminate again after it automatically goes off in the following cases:

- When the electric motor switch is turned to the “ON” position.
- When the remote control switch of the keyless entry system is operated.
- When any of the doors or the tailgate is opened after all doors and the tailgate are closed.

#### NOTE

- When the key is removed while the doors and tailgate are closed, the lamp is illuminated and after about 15 seconds it goes off.
- The time until the lamp goes off (delayed off) can be adjusted. For details, please consult a MITSUBISHI MOTORS Authorized Service Point.

- The auto cut-out function cannot be operated when the room lamp switch is in the “ON” position.

Also, this function can be deactivated. For details, please consult a MITSUBISHI MOTORS Authorized Service Point.

#### 3- (OFF)

The lamp goes off regardless of whether the doors and tailgate are open or closed.

## Storage spaces

E00713101752

### **⚠ CAUTION**

- Never leave lighters, cans of carbonated drink, and spectacles in the cabin when parking the vehicle in hot sunshine. The cabin will become extremely hot, so lighters and other flammable items may catch fire and unopened drink cans (including soft drink or beer cans) may rupture. Also, spectacles with plastic lenses or materials could deform or crack.
- Keep the lids of storage spaces closed while driving the vehicle. A lid or the contents of a storage space could otherwise cause injuries.

### NOTE

- When leaving your vehicle, do not leave valuables in the storage spaces.

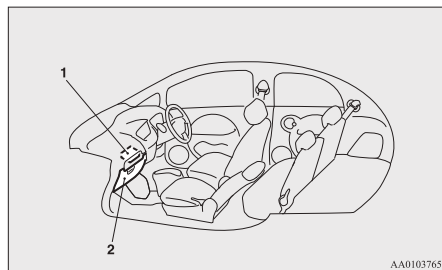

- 1- Secret box (RHD vehicles only)
- 2- Glove box

## Glove box

E00726200242

To open, pull the lever (A).

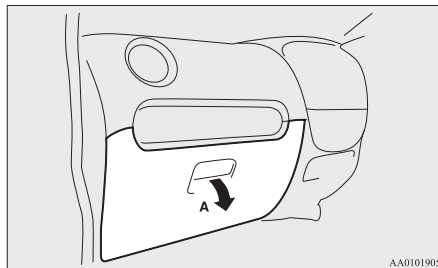

## Card holder

E00765500019

There is a card holder inside the glove box.

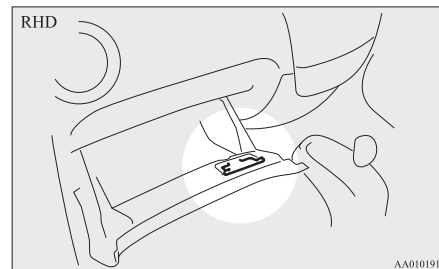
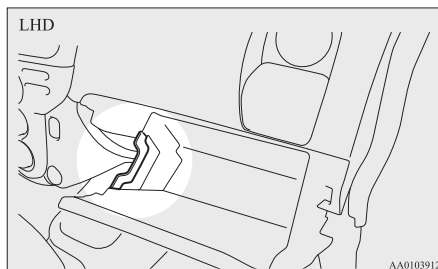

## Secret box (RHD vehicles only)

E00724900056

The secret box is located on the upper part of the glove box.

To use the box, open the lid.

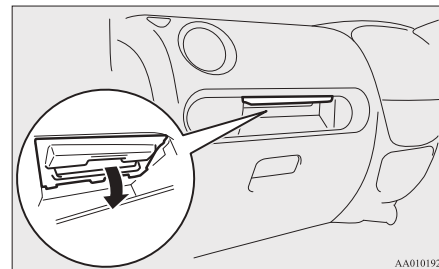

## Cup holder

E00714500974

### **CAUTION**

- Do not drink beverages while driving. This is distracting and could cause an accident.
- Beverages can be spilled owing to vibration or other movement during vehicle operation. Be careful not to get scalded by a hot beverage if it is spilled.

### LHD vehicles

#### Type 1

The cup holder is located behind the parking brake lever.

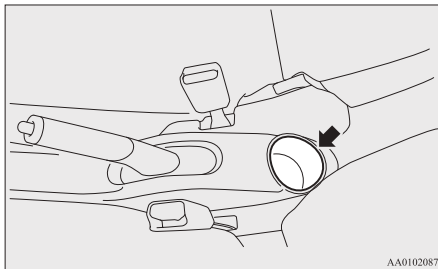

#### Type 2

Tip the cup holder towards you to use it.

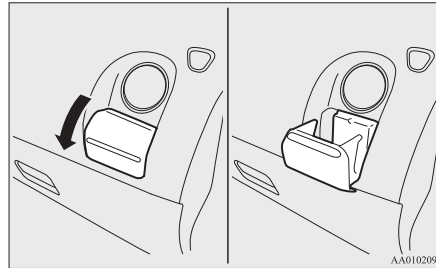

#### NOTE

- When not using the holder, push the holder to stow it away.
- Do not put your hand on the cup holder while getting in or out of the vehicle. The cup holder could break.
- Never place anything other than a cup or drink can in the cup holder.

### RHD vehicles

#### Type 1

The cup holder is located in front of the floor console.

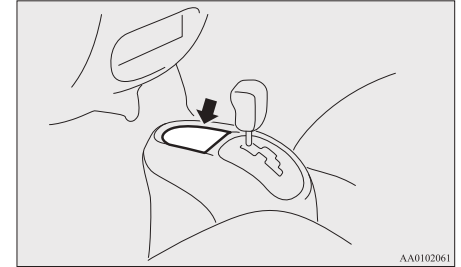

#### Type 2 (Passenger's side only)

To use the cup holder, pull it out.

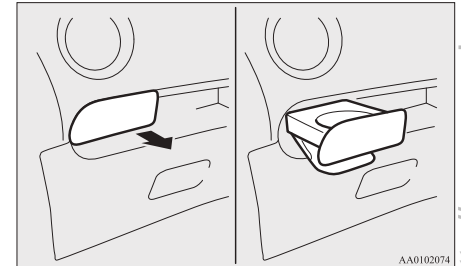

#### NOTE

- When not using the holder, push the holder to stow it away.

## *Assist grips*

E00732800272

The assist grips (located above the doors on the headliner) are not designed to support body weight. They are intended for use only while seated in the vehicle.

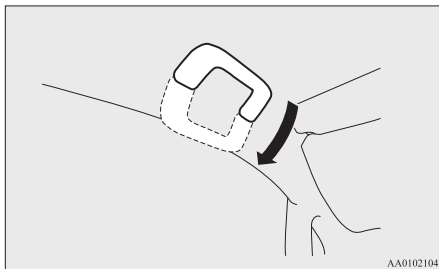

### **⚠ CAUTION**

- Do not use the assist grips when getting in-to or out of the vehicle. The assist grips could detach causing you to fall.

## *For emergencies*

If the vehicle breaks down.....	7-02
Emergency starting.....	7-02
Tyre repair kit.....	7-04
Towing.....	7-10
Operation under adverse driving conditions.....	7-12

## If the vehicle breaks down

E00800101296

If the vehicle breaks down on the road, move it to the shoulder and use the hazard warning flashers and/or the warning triangle etc. Refer to “Hazard warning flasher switch” on page 4-15.

## If the ready indicator goes out while driving

Vehicle operation and control are affected if the ready indicator goes out while driving. Before moving the vehicle to a safe area, be aware of the following:

- The brake booster may become inoperative and the pedal effort will increase. Press down the brake pedal harder than usual.
- The power steering system may not operate, the steering wheel feels heavy when turning it.

## Emergency starting

E00800502659

If the electric motor unit cannot be started because the auxiliary battery is weak or dead, the battery from another vehicle can be used with jumper cables to start the electric motor unit.

### **WARNING**

- To start the electric motor unit by using jumper cables from another vehicle, perform the correct procedures according to the instruction below. Incorrect procedures could result in a fire or explosion or damage to the vehicles.

### **CAUTION**

- The electric motor unit cannot be started by pulling or pushing the vehicle.
- Always wear protective eye goggles when working near the battery.
- Keep the battery out of the reach of children.

1. Get the vehicles close enough so the jumper cables can reach, but be sure the vehicles aren't touching each other.

### **CAUTION**

- Check the other vehicle. It must have a 12-volt battery.  
If the other system isn't 12-volt, shorting can damage both vehicles.

2. Turn off all lamps, heater and other electrical loads.
3. Set the parking brake firmly on your vehicle and move the selector lever into the “P” position.
4. Set the parking brake firmly on another vehicle. Put an A/T in “P” (PARK) or a M/T in “N” (Neutral).
5. Turn the ignition switch or the electric motor switch to the “LOCK” position.

### **WARNING**

- Perform step 5 on both vehicles beforehand. Make sure that the cables or your clothes cannot be caught by the fan or drive belt. Personal injury could result.

6. Remove the battery cover, and then make sure auxiliary battery electrolyte is at the proper level.  
Refer to “Auxiliary battery” on page 8-12.

### **WARNING**

- If electrolyte fluid is not visible, or appears to be frozen, Do Not Attempt Jump Starting!  
A battery might rupture or explode if the temperature is below the freezing point or if it is not filled to the proper level.

7. Connect one end of one jumper cable to the positive (+) terminal of the discharged battery (A), and the other end to the positive (+) terminal of the booster battery (B).

Connect one end of the other jumper cable to the negative (-) terminal of the booster battery, and the other end to the designated location of the vehicle with the discharged battery at the point farthest from the battery.

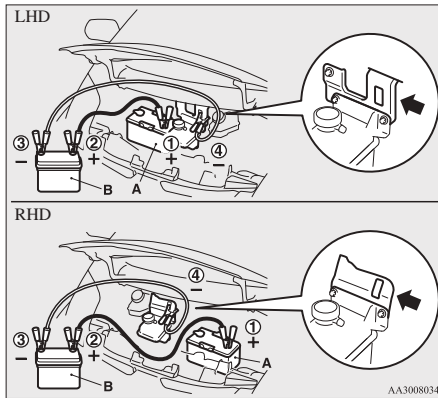

## **⚠ WARNING**

- Make sure you observe the following order when connecting the cables: ①→②→③→④
- Make sure you make connection ④ to the correct designated location (as shown in the illustration). If the connection is made directly to the negative (-) side of the discharged battery, flammable gases generated from the battery might catch fire and explode.

## **⚠ WARNING**

- When connecting the jumper cables, do not connect the positive (+) cable to the negative (-) terminal. Otherwise sparks might cause explosion of the battery.

## **⚠ CAUTION**

- Take care not to get the jumper cable caught in the cooling fan or other rotating part in the bonnet room or engine compartment.
  - Use the proper cables suitable for the battery size to prevent overheating of the cables.
  - Check the jumper cables for damage and corrosion before use.
8. Start the engine in the vehicle which has the booster battery, let the engine idle a few minutes, then start the electric motor unit in the vehicle with the discharged battery.

9. Check that the ready indicator illuminates.

[When the ready indicator illuminates]  
Stop the engine of another vehicle, disconnect the cables in the reverse order and charge the auxiliary battery for more than 30 minutes.

After the auxiliary battery is charged, continue the process from step 16.

[When the ready indicator does not illuminate]  
Both the auxiliary battery and the traction battery have gone flat at the same time. Charge the auxiliary battery and the traction battery by the following procedures (from steps 10 to 14).

10. Keep connecting the jumper cable to each vehicle, turn the electric motor switch of your vehicle to the "LOCK" position.

## NOTE

- The jumper cable needs to be connected to the auxiliary battery when you start charging the traction battery because the on board charger etc. operate with a power source of auxiliary battery.
11. Charge the traction battery by regular charging. (Refer to "Regular charging" on page 1-04.)
12. When the charging indicator on the instrument cluster is illuminated, stop the engine of another vehicle, disconnect the cables in the reverse order.



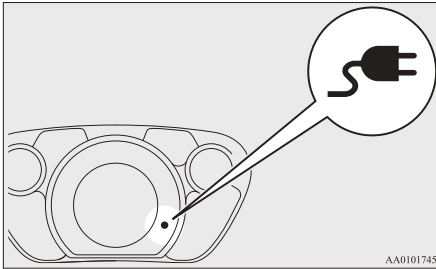

NOTE

- When the regular charging plug is connected to the charging connection, the charging indicator is blinking. When charging is started, the charging indicator is illuminated.
- The auxiliary battery is automatically charged while charging the traction battery.

13. Charge the traction battery for more than 1 hour.
14. Disconnect the charging cable.  
(Refer to “Regular charging” on page 1-04.)
15. Turn the electric motor switch to the “START” position, make sure that the ready indicator on the instrument cluster is illuminated.  
If the ready indicator does not illuminate, perform the procedure again from step 7.  
If charging cannot be performed, consult a MITSUBISHI MOTORS Authorized Service Point.
16. Refit the battery cover. (Refer to “Auxiliary battery” on page 8-12.)

**⚠ WARNING**

- Do not charge the auxiliary battery using an external battery charger while the auxiliary battery is mounted in the vehicle. Doing so could cause the auxiliary battery to catch fire and explode and could result in damage to the vehicle.
- Keep sparks, cigarettes, and flames away from the auxiliary battery because the battery may produce an explosion.
- Use adequate ventilation when charging or using the auxiliary battery in an enclosed space.
- Remove all the caps before charging the auxiliary battery.
- Electrolyte is corrosive diluted sulphuric acid.

If electrolyte (battery acid) comes into contact with your hands, eyes, clothes and the painted surface of your vehicle, it should be thoroughly flushed with water. If electrolyte gets in your eyes, flush them with water immediately and thoroughly, and get prompt medical attention.

NOTE

- If the electric motor unit is started without fully charging the auxiliary battery, it might cause the anti-lock brake warning lamp to illuminate. Refer to “Anti-lock brake system (ABS)” on page 5-14.

*Tyre repair kit*

E00800901311

This kit enables emergency repair of a small puncture in the tread area of a tyre that has run over a nail, screw, or similar object.

**Storage**

The tyre repair kit is stowed under the rear seat cushion. The storage location of the tyre repair kit should be remembered in case of an emergency.

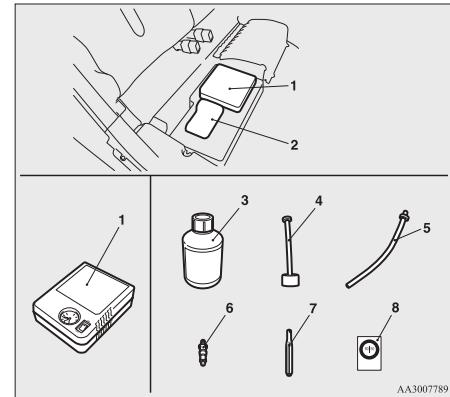

- 1- Tyre compressor
- 2- Tyre repair set
- 3- Tyre sealant bottle
- 4- Filler hose
- 5- Extension hose  
(This hose is used for removal of sealant. It is not used in emergency puncture repair.)
- 6- Valve insert (spare)
- 7- Valve remover
- 8- Speed restriction sticker

**To remove**

1. Remove the rear seat cushion. Refer to “Rear seat cushion” on page 3-06.
2. Remove the screws (A), and remove the cover (B).

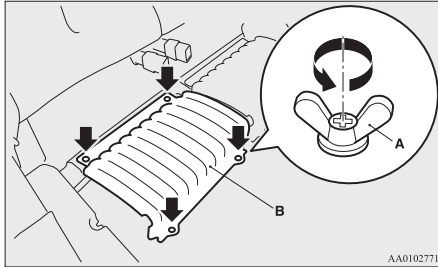

3. Take out the tyre repair kit.

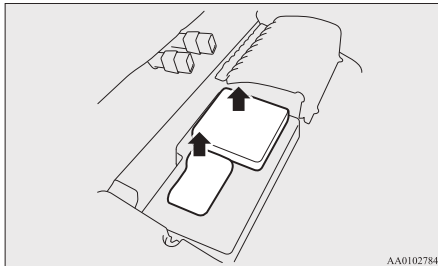
**To install**

Perform the removal steps in reverse.

**How to use the tyre repair kit**

E00802200324

### **⚠ CAUTION**

- The tyre sealant can cause health damage if swallowed. If you accidentally swallow it, drink as much water as possible and immediately consult a doctor.
- If the tyre sealant gets in your eyes or on your skin, rinse with lots of water. If you still sense an abnormality, consult a doctor.
- Consult a doctor immediately if any allergic reactions occur.
- Do not allow children to touch the tyre sealant.
- Do not breathe in the vapours of tyre sealant.

**NOTE**

- The tyre sealant cannot be used in any of the situations listed below. If any of these situations occurs, please contact a MITSUBISHI MOTORS Authorized Service Point or another specialist.
  - The tyre sealant's expiry date has passed. (The expiry date is shown on the bottle label.)

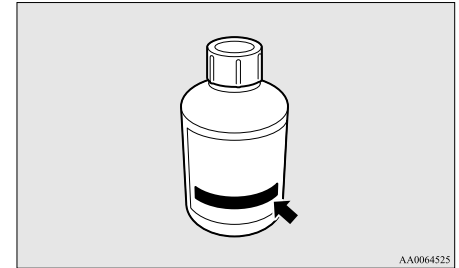

- More than one tyre is punctured.
- The puncture hole has a length or width of 4 mm or more.
- The tyre is punctured in the side wall (A), not in the tread (B).

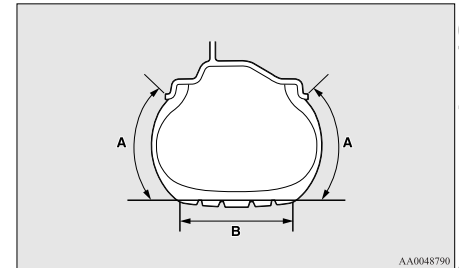

- The vehicle has been driven with the tyre almost completely flat.
- The tyre has completely slipped over the wheel rim and has come off the wheel.
- The wheel is damaged.

## For emergencies

- Use the tyre sealant only at ambient temperatures of -30 °C to + 60 °C.
- Effect an adequate repair without pulling out the object (nail, screw, etc.) that is stuck in the tyre.
- Do not use the tyre sealant if the tyre has been damaged by being driven when insufficiently inflated (e.g. bumps, cuts, cracks etc. on the tyre).
- Wipe tyre sealant off the paintwork immediately with a damp cloth.
- Immediately wash clothes contaminated with tyre sealant.

Before repairing a tyre, first stop your vehicle in a safe, flat location.

1. Park the vehicle on level and stable ground.
2. Set the parking brake firmly.
3. Move the selector lever to the “P” (PARK) position and turn the electric motor switch to the “LOCK” position.
4. Turn on the hazard warning flashers and set up a warning triangle, flashing signal lamp, etc., at an adequate distance from the vehicle, and have all your passengers leave the vehicle.
5. Take out the tyre sealant bottle and the compressor.
6. Shake the tyre sealant bottle well.

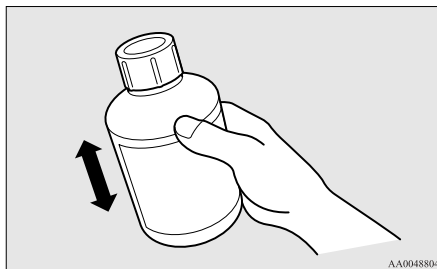

### NOTE

- In cold conditions (when the ambient temperature is 0 °C or lower), thickening of the tyre sealant can make the tyre sealant hard to squeeze out of the bottle. Warm the bottle inside the vehicle.
7. Take the cap (C) off the tyre sealant bottle (D). Do not remove the seal (E). Screw the filler hose (F) onto the bottle (D). As you screw the filler hose onto the bottle, the seal will break, allowing the sealant to be used.

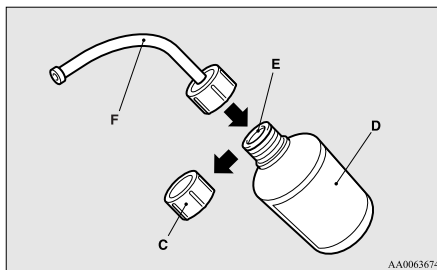

## **⚠ CAUTION**

- If you shake the bottle after screwing on the hose, sealant may spray out of the hose.

8. Take the valve cap (G) off the tyre valve (H), then press the valve remover (I) onto the valve as illustrated. Allow all of the air in the tyre to escape.

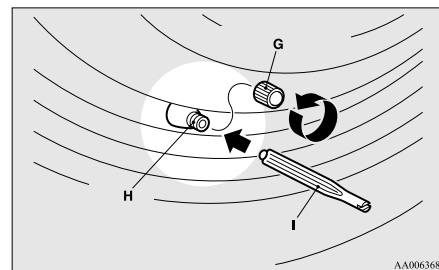

9. Remove the valve insert (J) by turning it anti-clockwise using the valve remover (I). Put the removed valve insert in a clean place so it does not get dirty.

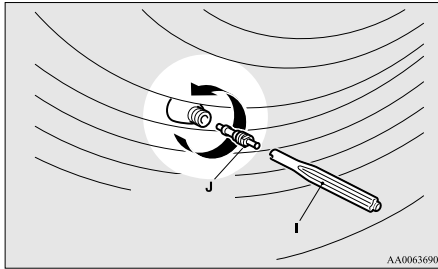

**CAUTION**

- If there is any air left in the tyre when you remove the valve insert, the valve insert may fly out and injure you. Make sure the tyre contains no air before removing the valve insert.

10. Remove the plug (K) from the free end of the hose (L). Press the hose onto the valve (H).

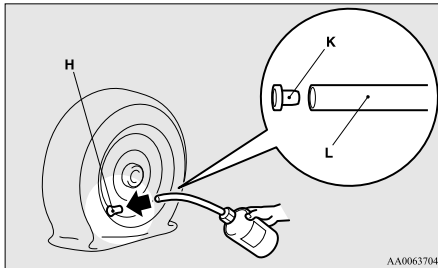

11. Holding the sealant bottle upside-down, squeeze it again and again to inject all of the sealant into the tyre.

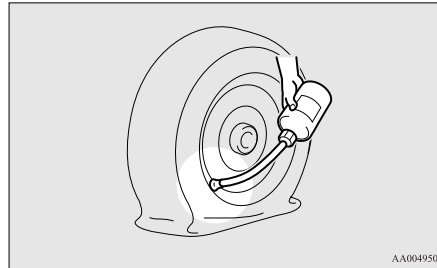

NOTE

- When injecting the sealant, position the valve away from the bottom, i.e., away from the point where the tyre touches the ground. If the valve is near the point where the tyre touches the ground, the sealant may not go in to the tyre easily.

12. After injecting the sealant, pull the hose off the valve, remove any residual sealant from the valve, rim and/or tyre.

Fit the valve insert (J) into the valve (H), and screw the valve insert securely into place using the valve remover (I).

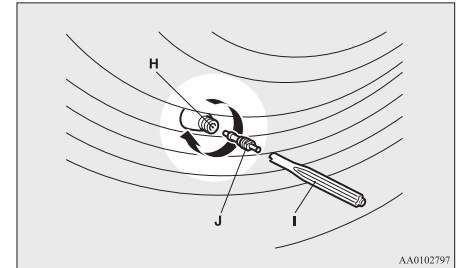

NOTE

- When removing and screwing in the valve insert using the valve remover, turn the valve insert by hand. Using a tool to turn the valve remover could damage it.

13. Pull out the compressor hose (M) from the side of the tyre compressor, and then securely attach the hose to the tyre valve (H).

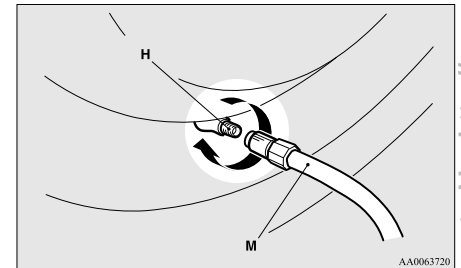

## For emergencies

- Place the compressor (N) with its air pressure gauge (O) on top. Pull out the compressor's power cord (P), insert the plug on the cord into the accessory socket (Q), and then turn the electric motor switch to the "ACC" position. Turn ON the compressor switch (R) and inflate the tyre to the specified pressure.

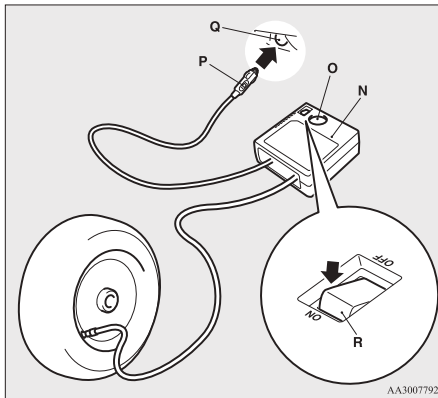

### **⚠ CAUTION**

- The supplied compressor is designed only for inflation of passenger vehicle tyres.
- The compressor is designed to run on a vehicle's 12 V power supply. Do not connect it to any other power source.
- The compressor is not waterproof. If you use it in rain, make sure water does not get on it.

### **⚠ CAUTION**

- Any sand or dust sucked into the compressor could make the compressor break down. Do not place the compressor directly on any sandy or dusty surface when using it.
- Do not disassemble or modify the compressor. Also, do not subject the air pressure gauge to shock. It could malfunction.

- Check and adjust the tyre pressure with reference to the air pressure gauge on the compressor. If you overinflate the tyre, release air by loosening the hose's end fitting. (Refer to "Tyre inflation pressures" on page 8-15.) If there is a gap between the tyre and wheel because the tyre has moved inward from the wheel rim, press the periphery of the tyre towards the wheel to close the gap before running the compressor. (With no gaps, the tyre pressure will rise.)

### **⚠ CAUTION**

- Be careful not to get your fingers trapped between the tyre and wheel as the tyre inflates.
- The surface of the compressor will get hot while the compressor is running. Do not keep the compressor running continuously for more than 10 minutes. After using the compressor, wait for the compressor to cool before using it again.

### **⚠ CAUTION**

- If the compressor becomes sluggish or hot while operating, it is overheating. Immediately place the switch in the OFF position and let the compressor cool down for at least 30 minutes.

#### NOTE

- If the tyre pressure does not rise to the specified level within 10 minutes, the tyre may be so severely damaged that the tyre sealant cannot be used to effect an emergency repair. Please contact a MITSUBISHI MOTORS Authorized Service Point or another specialist in this event.

- Turn OFF the compressor switch, then pull the power cord plug out of the socket.

#### NOTE

- Simply putting sealant and air into the tyre using the tyre repair kit does not seal the puncture hole. Air will leak through the puncture hole until the emergency repair procedure is completed (through step 19 of these instructions).

- When you have inflated the tyre to the specified pressure, stow the compressor, bottle, and other items in the vehicle and promptly start driving the vehicle so that the tyre sealant can spread evenly in the tyre. Drive with great care. Do not exceed a speed of 80 km/h (50 mph). Observe local speed limits.

**⚠ CAUTION**

- If you sense any abnormality while driving, stop the vehicle and contact a MITSUBISHI MOTORS Authorized Service Point or another specialist. Otherwise the tyre pressure may drop before the emergency repair procedure is completed, rendering the vehicle unsafe.

## NOTE

- Driving faster than 80 km/h (50 mph) can make the vehicle vibrate.
18. After driving for 10 minutes or 5 km (3 miles), check the tyre pressure using the air pressure gauge on the compressor. (Refer to “Tyre inflation pressures” on page 8-15.) If the tyre pressure is not sufficient, inflate the tyre to the specified pressure again and drive the vehicle carefully without exceeding a speed of 80 km/h (50 mph).

**⚠ CAUTION**

- If the tyre pressure is lower than the minimum permitted pressure (1.3 bar {130 kPa}), the tyre cannot successfully be repaired with the tyre sealant. Do not drive the vehicle any further. Contact a MITSUBISHI MOTORS Authorized Service Point or another specialist.

19. After driving for 10 minutes or 5 km (3 miles), check the tyre pressure using the air pressure gauge on the compressor. (Refer to “Tyre inflation pressures” on page 8-15.)

If the tyre pressure has apparently not dropped, the emergency repair procedure is complete. You must still not exceed a speed of 80 km/h (50 mph). Observe local speed limits.

**⚠ CAUTION**

- Be sure to check the tyre pressure for confirmation that the emergency repair procedure is complete.

## NOTE

- If the tyre pressure has dropped below the specified level when you check it at the end of the repair procedure, do not drive the vehicle any further. Contact a MITSUBISHI MOTORS Authorized Service Point or another specialist.
- In cold conditions (when the ambient temperature is 0 °C or lower), the time and driving distance necessary until completion of the repair can be longer than in warmer conditions, meaning that the tyre pressure can drop below the specified level even when you have inflated the tyre a second time and subsequently driven the vehicle. If this happens, inflate the tyre to the specified pressure once more, drive for about 10 minutes or 5 km (3 miles), then check the tyre pressure again. If the tyre pressure has again dropped below the specified level, stop driving the vehicle and contact a MITSUBISHI MOTORS Authorized Service Point or another specialist.

20. Affix the speed restriction sticker (R) to the three-diamond mark on the steering wheel. Then immediately drive with great care to a MITSUBISHI MOTORS Authorized Service

Point or another specialist and have tyre repair/replacement performed.

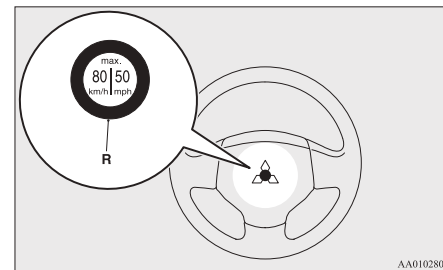
**⚠ CAUTION**

- Do not affix the sticker anywhere except the specified position on the pad of the steering wheel. Affixing the sticker in an incorrect position could prevent the SRS airbag from working normally.

## NOTE

- Please give the empty sealant bottle to your MITSUBISHI MOTORS Authorized Service Point when you purchase new sealant or dispose of the sealant bottle according to national regulations for the disposal of chemical waste.

## For emergencies

- A tyre in which puncture sealant has been used should ideally be replaced with a new one. If you wish to have such a tyre properly repaired for reuse, please contact a MITSUBISHI MOTORS Authorized Service Point or another specialist. Note that a proper repair is impossible following an emergency repair if the puncture hole cannot be located.
- Wipe away any sealant that gets on the wheel. Provided the valve is replaced with a new one, the wheel can be reused.
- The manufacturer is unable to guarantee that all tyre punctures can be repaired with the tyre repair kit, in particular cuts or perforations with a diameter of more than 4 mm or away from the tyre's tread. The manufacturer is not liable for damage sustained through improper use of the tyre repair kit.
- The manufacturer is not liable for damage sustained through re-use of any tyre in which tyre sealant has been used.

## Towing

E00801503549

### If your vehicle needs to be towed

If you need to tow your vehicle, we recommend that you contact a MITSUBISHI MOTORS Authorized Service Point or a commercial tow truck service.

In the following cases, transport the vehicle using a tow truck.

- The ready indicator illuminates but the vehicle does not move, or an abnormal noise is produced.
- Inspection of the vehicle's underside reveals that oil or some other fluid is leaking.

If a wheel gets stuck in a ditch, do not try to tow the vehicle. Please contact your MITSUBISHI MOTORS Authorized Service Point or a commercial tow truck service for assistance.

Only when you cannot receive a towing service from a MITSUBISHI MOTORS Authorized Service Point or commercial tow truck service, tow your vehicle carefully in accordance with the instructions given in "Emergency towing" in this part.

The regulations concerning towing may differ from country to country. It is recommended that you obey the regulations of the area where you are driving your vehicle.

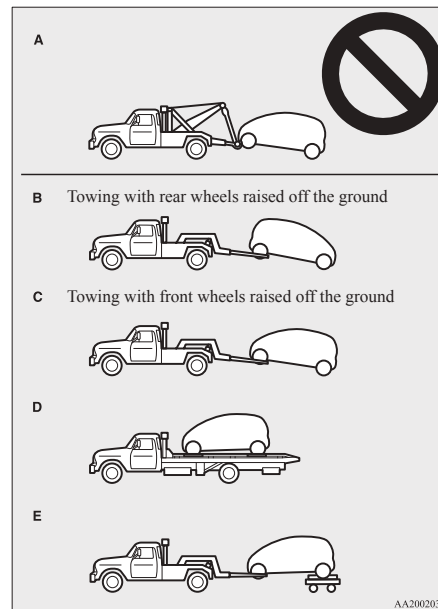

## Towing the vehicle by a tow truck

### **⚠ CAUTION**

- This vehicle must not be towed by a tow truck using sling lift type equipment (Type A) as illustrated. Using a sling lift will damage the bumper and front end.
- If the transmission is malfunctioning or damaged, transport the vehicle with the driving wheels on a carriage (Type B, D or E) as illustrated.
- If you tow the vehicle with only the front wheels or only the rear wheels raised off the ground (Type B or C) after starting the electric motor unit, the Active Stability Control (ASC) system may operate, resulting in an accident.
- If you tow the vehicle with the driving wheels on the ground (Type C) as illustrated, make sure that the towing speed and distance given below are never exceeded, causing damage to the transmission.

Towing speed: 30 km/h (19 mph)  
Towing distance: 30 km (19 miles)

For the towing speed and the towing distance, follow the local driving laws and regulations.

### *Towing with rear wheels raised off the ground (Type B)*

Place the selector lever in the “N” (NEUTRAL) position.

Turn the electric motor switch to the “ACC” position and secure the steering wheel in a straight-ahead position with a rope or tie-down strap.

### *Towing with front wheels raised off the ground (Type C)*

Release the parking brake.

Place the selector lever in the “N” (NEUTRAL) position.

Turn the electric motor switch to the “ACC” position.

### Emergency towing

If towing service is not available in an emergency, your vehicle may be temporarily towed by a rope secured to the towing hook.

In case of your vehicle is to be towed by another vehicle, pay careful attention to the following points.

### *If your vehicle is to be towed by another vehicle*

1. The front towing hook (A) is located as shown in the illustration. Secure the tow rope to the front towing hook.

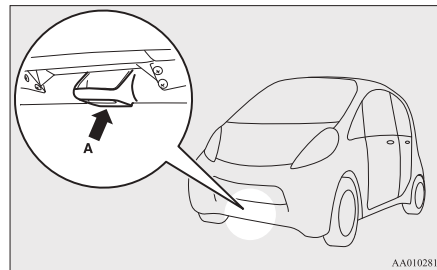

### NOTE

- Using any part other than the designated towing hook (A) could result in damage to the vehicle body.

- Using a wire rope or metal chain can result in damage to the vehicle body. It is best to use a non-metallic rope. If you use a wire rope or metal chain, wrap it with cloth at any point where it touches the vehicle body.
- Take care that the tow rope is kept as horizontal as possible. An angled tow rope can damage the vehicle body.

2. Start the electric motor unit.

If the electric motor unit does not start, turn the electric motor switch to the “ACC” position.

### **⚠ CAUTION**

- If the vehicle is towed with the electric motor switch in the “ON” position without starting the electric motor unit, the auxiliary battery may be flat during towing. In this case, the brake performance may be very poor. Steering is also very heavy. Therefore, start the electric motor unit as much as possible for towing.
- Do not leave the electric motor switch in the “LOCK” position. The steering wheel will lock, causing loss of control.

3. Place the selector lever in the “N” (NEUTRAL) position.
4. Turn on the hazard warning lamps if required by law. (Follow the local driving laws and regulations.)
5. During towing make sure that close contact is maintained between the drivers of both vehicles, and that the vehicles travel at low speed.



## CAUTION

- The person in the vehicle being towed must pay attention to the brake lamps of the towing vehicle and make sure the rope never becomes slack.
- Avoid sudden braking, sudden acceleration and sharp turning; such operation could cause damage to the towing hooks or the tow rope. People in the vicinity could be injured as a result.
- When towing or being towed down a long slope, the brakes may overheat reducing the effectiveness. In this situation, have your vehicle transported by a tow truck.
- When the vehicle is to be towed by another vehicle with all wheels on the ground, make sure that the towing speed and distance given below are never exceeded, causing damage to the transmission.

Towing speed: 30 km/h (19 mph)  
Towing distance: 30 km (19 miles)

For the towing speed and the towing distance, follow the local driving laws and regulations.

### 7 Towing another vehicle

Your vehicle cannot be used to tow another vehicle.

## Operation under adverse driving conditions

E00801702717

### On a flooded road

- Do not drive on a flooded road. If you drive on a flooded road, not only the electric motor unit stops but also a failure like electric leakage or short circuit may occur. If you inevitably had to run on a flooded road and the vehicle was exposed to water, be sure to have your vehicle inspected by a MITSUBISHI MOTORS Authorized Service Point.
- If there is water on the brakes after driving through puddles or washing the vehicle, resulting in temporarily ineffective brakes. In such cases, lightly depress the brake pedal to see if the brakes operate properly. If they do not, lightly depress the pedal several times while driving in order to dry the brake pads.
- When driving in rain or on a road with many puddles a layer of water may form between the tyres and the road surface.

This reduces a tyre's frictional resistance on the road, resulting in loss of steering stability and braking capability.

To cope with this, observe the following items:

- (a) Drive your vehicle at slow speed.
- (b) Do not drive on worn tyres.
- (c) Always maintain the specified tyre inflation pressures.

### On a snow-covered or frozen road

- When driving on a snow-covered or frozen road, it is recommended that you use snow tyres or tyre chains. Refer to the "Snow tyres" and "Tyre chains" sections.
- Avoid high-speed driving, sudden acceleration, sudden braking, and sharp turns.
- Depressing the brake pedal during travel on snowy or icy roads may cause tyre slippage and skidding. Tyres may slip if the ability of the tyres to grip the road surface lessens. This may make it more difficult to stop the vehicle with normal braking operations. For vehicles with an anti-lock brake system (ABS), firmly depress and hold down the brake pedal.
- Allow extra distance between your vehicle and the vehicle in front of you, and avoid sudden braking.
- Accumulation of ice on the braking system can cause the wheels to lock. Pull away from a standstill slowly after confirming safety around the vehicle.

## CAUTION

- Do not press the accelerator pedal rapidly. If the wheels break free of the ice, the vehicle could suddenly start moving and possibly cause an accident.

### On a bumpy or rutted road

Drive as slow as possible when driving on bumpy or rutted roads.

**⚠ CAUTION**

- The impact on tyres and/or wheels when driving on a bumpy or rutted road can damage the tyre and/or wheel.
- The vehicle's body, bumper, muffler and other parts may be damaged if the vehicle is:
  - driven over a step (for example, at the entrance or exit of a parking lot);
  - parked too closely against a kerb or parking block, or by the side of a road with kerbstones;
  - driven on a steep slope;



## *Vehicle care and Maintenance*

Vehicle care precautions.....	8-02
Cleaning the interior of your vehicle.....	8-02
Cleaning the exterior of your vehicle.....	8-03
Service precautions.....	8-06
Bonnet.....	8-07
Coolant/Hot water heater fluid.....	8-09
Washer fluid.....	8-11
Brake fluid.....	8-11
Auxiliary battery.....	8-12
Tyres.....	8-14
Wiper blades.....	8-17
General maintenance.....	8-19
For cold and snowy weather.....	8-20
Fusible links.....	8-20
Fuses.....	8-20
Replacement of lamp bulbs.....	8-23

## Vehicle care precautions

E08400100015

In order to maintain the value of your vehicle, it is necessary to perform regular maintenance using the proper procedures.

Always maintain your vehicle in compliance with environmental pollution control regulations.

Carefully select the materials used for washing, etc., to be sure that they do not contain corrosives. If in doubt, we recommend you to consult a specialist for selection of these materials.

### CAUTION

- **Cleaning products can be dangerous. Always follow the instructions of the cleaning product supplier.**
- **To avoid damage, never use the following to clean your vehicle:**
  - Petrol
  - Paint Thinner
  - Benzine
  - Kerosene
  - Turpentine
  - Naphtha
  - Lacquer Thinner
  - Carbon Tetrachloride
  - Nail Polish Remover
  - Acetone

## Cleaning the interior of your vehicle

E08400200016

After cleaning the interior of your vehicle with water, cleaner or similar, wipe and dry in a shady, well-ventilated area.

### CAUTION

- **Do not use organic substances (solvents, benzene, kerosene, alcohol, petrol, etc.) or alkaline or acidic solutions. These chemicals can cause discolouring, staining or cracking of the surface. If you use cleaners or polishing agents, make sure their ingredients do not include the substances mentioned above.**

## Plastic, vinyl leather, fabric and flocked parts

E08400300017

1. Gently wipe off with a sponge, gauze or other soft cloth soaked with a 3% aqueous solution of neutral detergent.
2. Dip cloth in fresh water and wring it out well. Using this cloth, wipe off the detergent thoroughly.

## NOTE

- Do not use cleaners, conditioners, and protectants containing silicones or wax. Such products, when applied to the instrument panels or other parts, may cause reflections on the windscreen and obscure vision. Also, if such products get on the switches of the electrical accessories, it may lead to failure of these accessories.

## Upholstery

E08400400018

1. To maintain the value of your new vehicle, handle the upholstery carefully and keep the interior clean. Use a vacuum cleaner and brush to clean the seats. If stained, vinyl and synthetic leather should be cleaned with an appropriate cleaner. Cloth fabrics can be cleaned with either upholstery cleaner or a 3% aqueous solution of neutral detergent in lukewarm water.
2. Clean the carpeting with a vacuum cleaner and remove any stains with carpet cleaner. Oil and grease can be removed by lightly dabbing with a clean colourfast cloth and stain remover.

## Genuine leather

E08400500019

1. Gently wipe off with gauze or other soft cloth soaked with a 5 % aqueous solution of neutral detergent.
2. Dip cloth in fresh water and wring it out well. Using this cloth, wipe off the detergent thoroughly.
3. Apply leather protecting agent to the genuine leather surface.

## NOTE

- If genuine leather is wet with water or is washed in water, wipe off water as quickly as possible with a dry, soft cloth. If left damp, mildew may grow.
- The genuine leather surface may be damaged if a nylon brush or synthetic fibre is rubbed hard against it.
- Organic solvents such as benzine, kerosene, alcohol and petrol, acid or alkaline solvents may discolour the genuine leather surface. Be sure to use neutral detergents.
- Remove dirty patches or oil substances quickly as they can stain genuine leather.
- The genuine leather surface may harden and shrink if it is exposed to direct sun for long hours. When your vehicle is parked, place it in the shade as much as possible.

## Cleaning the exterior of your vehicle

E0840060010

If the following is left on your vehicle, it may cause corrosion, discolouration and stains, wash the vehicle as soon as possible.

- Seawater, road deicing products.
- Soot and dust, iron powder from factories, chemical substance (acids, alkalis, coal-tar, etc.).
- Droppings from birds, carcasses of insects, tree sap, etc.

## Washing

E0840070011

Chemicals contained in the dirt and dust picked up from the road surface can damage the paint coat and body of your vehicle if left in prolonged contact. Frequent washing and waxing is the best way to protect your vehicle from this damage. This will also be effective in protecting it from environmental elements such as rain, snow, salt air, etc.

Do not wash the vehicle in direct sunlight. Park the vehicle in the shade and spray it with water to remove dust. Next, using an ample amount of clean water and a car washing brush or sponge, wash the vehicle from top to bottom.

Use a mild car washing soap if necessary. Rinse thoroughly and wipe dry with a soft cloth. After washing the vehicle, carefully clean the joints and flanges of the doors, bonnet and other sections where dirt is likely to remain.

## WARNING

- Do not wash the vehicle while charging the traction battery.  
Doing so could cause fire or an electric shock.
- Before washing the vehicle, make sure that the charging lid and the inner lid are completely closed.  
If the lid is open, the charging unit is exposed to water, resulting in fire or an electric shock.
- Do not pour water inside the electric motor unit room. Doing so could cause fire or an electric shock.
- When washing the vehicle, turn the electric motor switch to the “LOCK” position.
- Do not use a high pressure washing machine to clean the underneath of the vehicle.  
Doing so might cause the electric motor unit problem or malfunction.
- When washing the underside of your vehicle or wheel, be careful not to injure your hands.
- Refrain from excessively using a car wash as its brushes may scratch the paint surface, causing it to lose its gloss. Scratches will be especially visible on darker coloured vehicles.
- Never spray or splash water on the electrical components in the bonnet room.  
Exercise caution also when washing the underbody; be careful not to spray water into the bonnet room.
- Some types of hot water washing equipment apply high pressure and heat to the

## **WARNING**

vehicle. They may cause heat distortion and damage to the vehicle resin parts and may result in flooding of the vehicle interior.

Therefore;

- Maintain a distance of approx. 70 cm or more between the vehicle body and the washing nozzle.
- When washing around the door glass, hold the nozzle at a distance of more than 70 cm and at right angles to the glass surface.
- After washing the vehicle, drive the vehicle slowly while lightly depressing the brake pedal several times in order to dry out the brakes.  
Leaving the brakes wet could result in reduced braking performance. Also, there is a possibility that they could freeze up or become inoperative due to rust, rendering the vehicle unable to move.
- When using an automatic car wash, pay attention to the following items, referring to the operation manual or consulting a car wash operator. If the following procedure is not followed, it could result in damage to your vehicle.

- The outside mirrors are retracted.
- The antenna is removed.
- The wiper arms are secured in place with tape.
- If your vehicle is equipped with a rear spoiler, consult a car wash operator before using the car wash.

### *During cold weather*

Salt and other chemicals spread on the roads in some areas in winter can have a harmful effect on the vehicle body. You should therefore wash the vehicle as often as possible in accordance with our care-instructions. It is recommended to have a preservative applied and the underfloor protection checked before and after the cold weather season. After washing your vehicle, wipe off all water-drops from the rubber parts around the doors to prevent the doors from freezing.

### NOTE

- To prevent freezing of the weatherstripping on the doors, bonnet, etc., they should be treated with silicone spray.

### Waxing

E0840080012

Waxing the vehicle will help prevent the adherence of dust and road chemicals to the paintwork. Apply a wax solution after washing the vehicle, or at least once every three months to assist displacing of water. Do not wax your vehicle in direct sunlight. You should wax after the surfaces have cooled.

## **CAUTION**

- Waxes containing high abrasive compounds should not be used. Such waxes remove rust and stains effectively from the paintwork but they are harmful to the lustre on the painted surface and the plated surface.  
Further, they are harmful to glossy surfaces such as grille, garnish, mouldings, etc.

## **CAUTION**

- Do not use petrol or paint thinners to remove road tar or other contamination to the painted surface.
- Do not apply wax to sections that have a black mat paint coating, as doing so could cause uneven discolouration, spots or stains. If wax gets on such areas, wipe it off using lukewarm water and a soft cloth.

### Polishing

E0840090013

The vehicle should only be polished if the paintwork has become stained or lost its lustre. Do not polish parts with a mat coating and the plastic bumpers. Doing so could cause stains or damage the finish.

### Damaged paint

E0840100011

Small cracks and scratches in the paint coat should be touched up as soon as possible with MITSUBISHI touch-up paint to prevent corrosion. Check body areas facing the road or the tyres carefully for damage to the paint caused by gravels, etc. The paint code number for your vehicle can be found on the vehicle information code plate. (Refer to "Vehicle information code plate" on page 9-02.)

### Cleaning plastic parts

E08401100012

Use a sponge or chamois leather.

If a car wax adheres on a grey or black rough surface of the bumper, moulding or lamps, the surface becomes white. In such a case, wipe it off using lukewarm water and soft cloth or chamois leather.

## CAUTION

- Do not use a scrubbing brush or other hard tools as they may damage the plastic part surface.
- Do not use wax containing compound (polishing powder) which may damage the plastic part surface.
- Do not bring the plastic parts into contact with petrol, light oil, brake fluids, greases, paint thinners, and sulphuric acid (battery electrolyte) which may crack, stain or discolour the plastic parts. If they touch the plastic parts, wipe them off with soft cloth, chamois or the like and an aqueous solution of neutral detergent then immediately rinse the affected parts with water.

## Chrome parts

E08401200013

In order to prevent spots and corrosion of chrome parts, wash with water, dry thoroughly, and apply a special protective coating. This should be done more frequently in winter.

## Aluminium wheels

E08401300014

1. Remove dirt using a sponge while sprinkling water on the vehicle.
2. Use neutral detergent on any dirt that cannot be removed easily with water. Rinse off the neutral detergent after washing the vehicle.
3. Dry the vehicle thoroughly using a chamois leather or a soft cloth.

## CAUTION

- Do not use a brush or other hard implement on the wheels. Doing so could scratch the wheels.
- Do not use any cleaner that contains an abrasive substance or is acidic or alkaline. Doing so could cause the coating on the wheels to peel or become discoloured or stained.
- Do not directly apply hot water using a steam cleaner or by any other means.
- Contact with seawater and road deicer can cause corrosion. Rinse off such substances as soon as possible.

## Window glass

E08401400015

The window glass can normally be cleaned using only a sponge and water.

Glass cleaner can be used to remove oil, grease, insect carcasses, etc. After washing the glass, wipe it dry with a clean, dry, soft cloth. Never use a cloth that is used for cleaning a painted surface to clean a window. Wax from the painted surface could get on the glass and lower glass transparency and visibility.

## NOTE

- To clean the inside of the rear window, always use a soft cloth and wipe the window glass along the demister heater element so as not to cause damage.

## Wiper blades

E08401500016

Use a soft cloth and glass cleaner to remove grease, dead insects, etc., from the wiper blades. Replace the wiper blades when they no longer wipe properly. (Refer to page 8-17.)

## Bonnet room

E08401600017

Clean the bonnet room at the beginning and end of winter. Pay particular attention to flanges, crevices and peripheral parts where dust containing road chemicals and other corrosive materials might collect.

If salt and other chemicals are used on the roads in your area, clean the engine compartment at least every three months.

Never spray or splash water on the electrical components in the bonnet room, as this may cause damage.

Do not bring the nearby parts, the plastic parts and so on into contact with sulphuric acid (battery electrolyte) which may crack, stain or discolour them. If they are in contact, wipe off with soft cloth, chamois or the like and an aqueous solution of neutral detergent then immediately rinse the affected parts with plenty of water.



## Service precautions

E08401700018

Adequate care of your vehicle at regular intervals serves to preserve the value and appearance as long as possible.

Maintenance items as described in this owner's manual can be performed by the owner.

We recommend you to have the periodic inspection and maintenance performed by a MITSUBISHI MOTORS Authorized Service Point or another specialist.

In the event a malfunction or a problem is discovered, we recommend you to have it checked and repaired. Follow the instructions and cautions for each of the various procedures.

### **⚠ WARNING**

- Do not touch any components in the electric motor unit room other than the reserve tank. There are no components requiring inspection other than the reserve tank. Never remove or disassemble the component which generates high voltage, high voltage wire (orange) and its connector. Doing so could result in serious injury that may risk your life.

These components are affixed with the label indicating precautions for handling. Follow the instructions on the label.

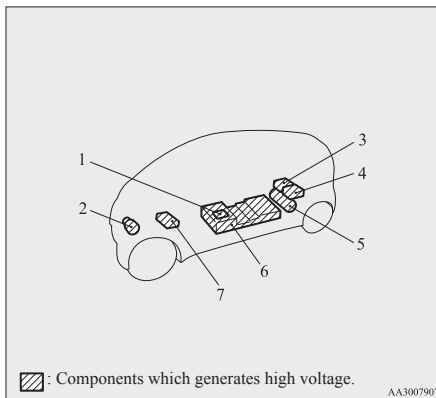

- 1- Service plug
- 2- Air conditioner compressor
- 3- Inverter
- 4- On board charger/DC-DC converter
- 5- Electric motor (Electric motor unit)
- 6- Traction battery
- 7- Heater

### **⚠ WARNING**

- Never touch the service plug (A) under the front seat. Doing so could result in serious injury that may risk your life, including an electric shock. The service plug (A) is used to shut off high voltage from the traction battery for repair of the vehicle at a MITSUBISHI MOTORS Authorized Service Point or another specialist.

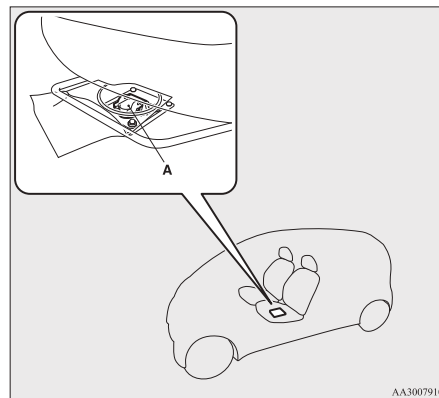

### **⚠ WARNING**

- When checking or servicing the inside of the bonnet room and coolant reserve tank, make sure the electric motor unit is switched off and has had a chance to cool down.
- If it is necessary to do work in the bonnet room with the electric motor running, be especially careful that your clothing, hair, etc., does not become caught by the fan, or other moving parts.
- The fan can turn on automatically even if the electric motor is not running. Turn the electric motor switch to the "LOCK" position to be safe while you work in the bonnet room.
- Do not smoke, cause sparks or allow open flames around the auxiliary battery.

**⚠ WARNING**

- Be extremely cautious when working around the auxiliary battery. It contains poisonous and corrosive sulphuric acid.
- Improper handling of components and materials used in the vehicle can endanger your personal safety. We recommend you to consult a specialist for necessary information.

**⚠ CAUTION**

- The components inside the electric motor unit room might be very hot to touch. To avoid being burnt, make sure all components have sufficiently cooled before beginning an inspection. These components are affixed with the label indicating precautions for handling. Follow the instructions on the label.
- When replacing the auxiliary battery, remove the connected positive (+) and negative (-) terminals after turning the electric motor switch to the “LOCK” position and waiting at least 1 minute. If the auxiliary battery terminal is removed just after the electric motor switch is turned to the “LOCK” position, this may cause damage to components of the electric motor unit.

**Bonnet**

E0840200018

**To open**

1. Pull the release lever towards you to unlock the bonnet.

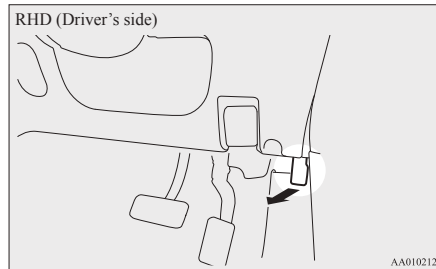
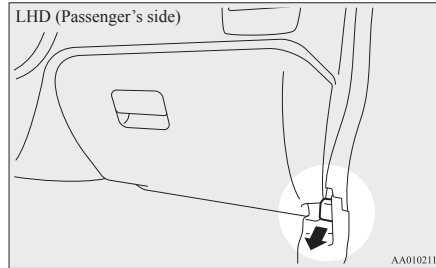

2. Raise the bonnet while pressing the safety lock (A).

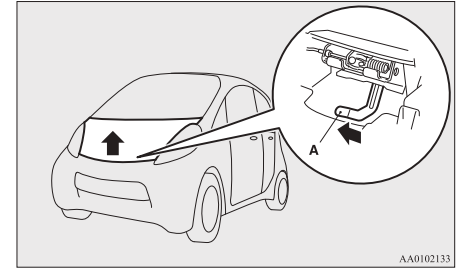

**NOTE**

- Only open the bonnet when the wipers are in the parked position. In any other position, the wipers could damage the paint or bonnet.
3. Support the bonnet by inserting the support bar (B) into its slot on the underside of the bonnet arm (C).

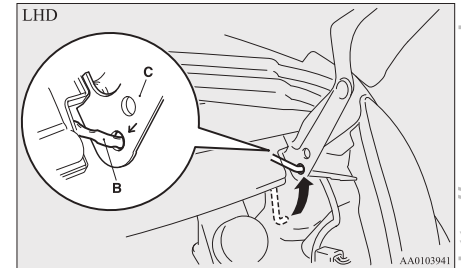

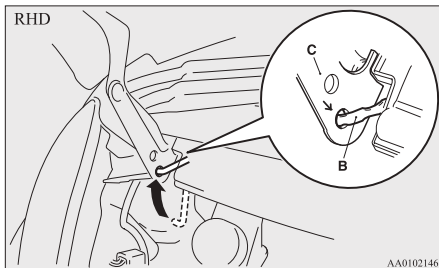

### **⚠ CAUTION**

- Note that the support bar may disengage the bonnet if the open bonnet is lifted by a strong wind.
- After inserting the support bar into the slot, make sure the bar supports the bonnet securely from falling down on to your head or body.

### To close

1. While supporting the bonnet, remove the support bar from the bonnet arm hole and secure it to the clip.
2. Slowly lower the bonnet to a position about 30 cm above the closed position, then let it drop.

3. Make sure the bonnet is securely locked by softly lifting the centre of the bonnet.

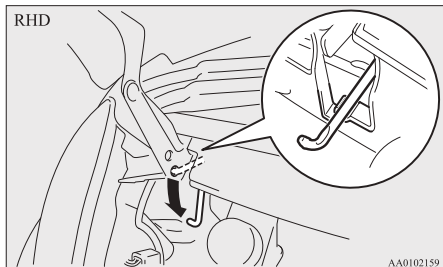
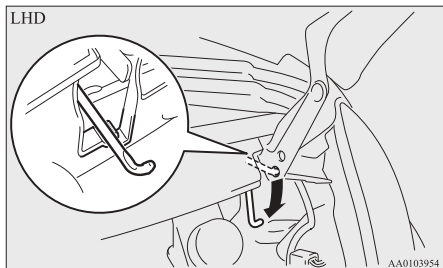

### NOTE

- If this does not close the bonnet, release it from a slightly higher position.
- Do not press down the bonnet hard with a hand as it may damage the bonnet.

### **⚠ CAUTION**

- Be careful that hands or fingers are not trapped when closing the bonnet.
- Before driving, make sure that the bonnet is securely locked. An incompletely locked bonnet can suddenly open while driving. This can be extremely dangerous.

## Coolant/Hot water heater fluid

E08402100019

### To check the coolant level

#### Coolant

1. Open the tailgate.

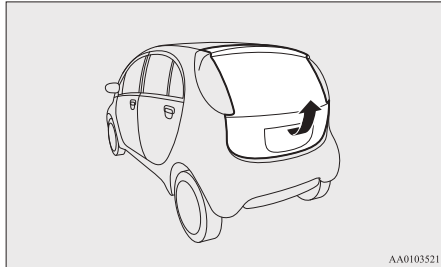

2. Peel off the Velcro fastener (A) to remove the luggage floor carpet (B).

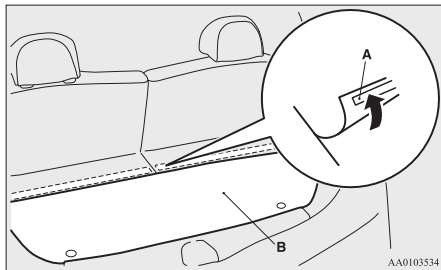

#### NOTE

- A heat insulating material is attached to the luggage floor carpet. To remove the luggage floor carpet, grab and lift up both the carpet floor carpet, grab and lift up both the carpet fabric and the heat insulating material.
3. Turn the 4 screws on the front and rear of the electric motor unit room lid (C) anticlockwise to loosen and remove them, and then remove the electric motor unit room lid (C).

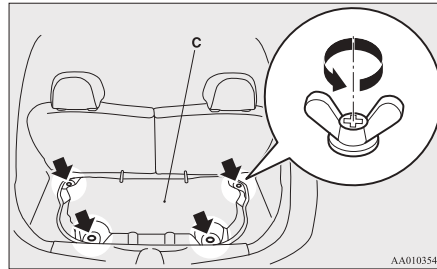

#### NOTE

- When laying the electric motor unit room lid on the ground, leave the underside of the lid with the rubber surface facing up. If the underside is facing downward rubbish and other foreign material could get on the rubber surface and prevent proper reinstallation of the electric motor unit room lid.
4. Check the coolant level in the reservoir tank (D).

While the motor is cold, the coolant level must always be between the “FULL” and “LOW” marks.

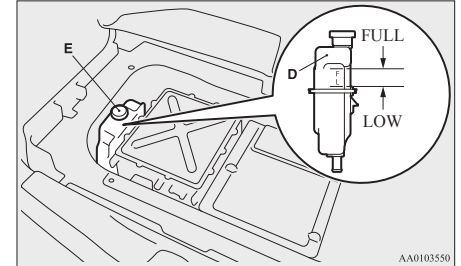

5. Refit the electric motor unit room lid and the luggage floor carpet by following the removal procedures in reverse.

#### Hot water heater fluid

A transparent reserve tank (A) is located in the bonnet room.

The coolant level in this tank should be kept between the “FULL” and “LOW” marks when measured while the electric motor is cold.

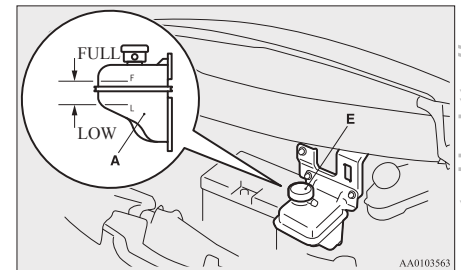

### To add coolant

The cooling system is a closed system and normally the loss of coolant should be very slight. A noticeable drop in the coolant level could indicate leakage. If this occurs, we recommend you to have the system checked as soon as possible.

If the level should drop below the “LOW” level on the reserve tank, open the reserve tank cap (E) and add coolant.

### **WARNING**

- Do not open the reserve tank cap (E) while it is hot. The coolant system is under pressure and any hot coolant escaping could cause severe burns.

### *Anti-freeze*

The coolant contains an ethylene glycol anti-corrosion agent. Some parts of the electric motor are cast aluminium alloy, and periodic changing of the electric motor coolant is necessary to prevent corrosion of these parts.

Use “DIA QUEEN SUPER LONG LIFE COOLANT PREMIUM” or equivalent\*.

\*: similar high quality ethylene glycol based non-silicate, non-amine, non-nitrate and non-borate coolant with long life hybrid organic acid technology

MITSUBISHI Genuine Coolant has excellent protection against corrosion and rust formation of all metals including aluminium and can avoid blockages in the radiator, heater, etc.

Because of the necessity of this anti-corrosion agent, the coolant must not be replaced with plain water even in summer. The required concentration of anti-freeze differs depending on the expected ambient temperature.

Above -35 °C: 50 % concentration of anti-freeze

Below -35 °C: 60 % concentration of anti-freeze

### **CAUTION**

- Do not use alcohol or methanol anti-freeze or any engine coolants mixed with alcohol or methanol anti-freeze. The use of an improper anti-freeze can cause corrosion of the aluminium components.
- Do not use water to adjust the concentration of coolant.
- Concentrations exceeding 60 % will result in a reduction of both the anti-freeze and cooling performance.
- Do not top up with water only. Water by itself reduces the rust-protective and anti-freeze qualities of the coolant and has a lower boiling point. It can also cause damage to the cooling system if it should freeze. Do not use tapwater, as it can cause corrosion and rust formation.

### **During cold weather**

If the temperatures in your area drop below freezing, there is the danger that the coolant in the electric motor, on board charger/DC-DC converter or radiator could freeze and cause severe damage to the electric motor, on board charger/DC-DC converter and/or radiator. Add a sufficient amount of anti-freeze to the coolant to prevent it from freezing.

The concentration should be checked before the start of cold weather and anti-freeze added to the system if necessary.

## Washer fluid

E08402200010

Check if the fluid level is between the “FULL” and “1/2” on the washer fluid reservoir.

If the level is low, replenish the container with washer fluid.

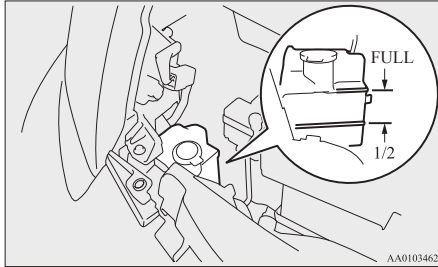

### NOTE

- The washer fluid container serves the windscreen, rear window.

### During cold weather

To ensure proper operation of the washers at low temperatures, use a fluid containing an anti-freezing agent.

## Brake fluid

E08406100017

### To check the fluid level

The brake fluid level must be between the “MAX” and “MIN” marks on the reservoir.

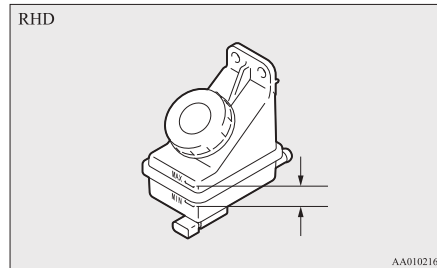
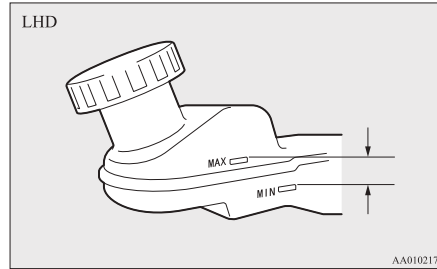

The brake fluid level is monitored by a float. When the brake fluid level falls below the “MIN” mark, the brake fluid warning lamp lights up.

The fluid level falls slightly with wear of the brake pads, but this does not indicate any abnormality.

The brake fluid in the master cylinder should be checked when doing other work under the bonnet. The brake system should also be checked for leakage at the same time.

If the brake fluid level falls markedly in a short length of time, it indicates leaks from the brake system.

If this occurs, we recommend you to have the vehicle checked.

### Fluid type

Use brake fluid conforming to DOT3 or DOT4 from a sealed container. The brake fluid is hygroscopic. Too much moisture in the brake fluid will adversely affect the brake system, reducing the performance.

## CAUTION

- Take care in handling brake fluid as it is harmful to the eyes, may irritate your skin and also damage painted surfaces.
- Use only the specified brake fluid. Do not mix or add different brands of brake fluid to prevent chemical reactions. Do not let any petroleum-based fluid touch, mix with, or get into the brake fluid. This will damage the seals.
- Keep the reservoir tank cap closed to prevent the brake fluid from deteriorating except maintenance.
- Clean the filler cap before removing and close the cap securely after maintenance.

## Auxiliary battery

E08402300011

The condition of the auxiliary battery is very important to keep the vehicle's electrical system working properly. Regular inspection and care are especially important in cold weather.

### Removing and installing the auxiliary battery upper cover

E08402400012

#### To remove

1. Turn the plastic nut (A) anticlockwise, and then remove the auxiliary battery upper cover (B).

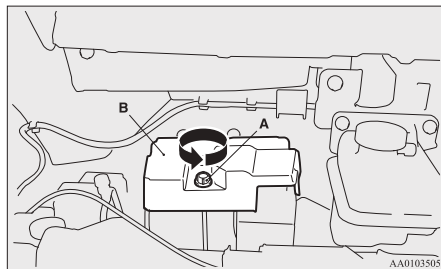

#### NOTE

- Be careful not to lose the removed plastic nut.

#### To install

1. Install the auxiliary battery upper cover (B) onto the auxiliary battery, and then push the plastic nut (A) in the direction shown by the arrows to secure the cover.

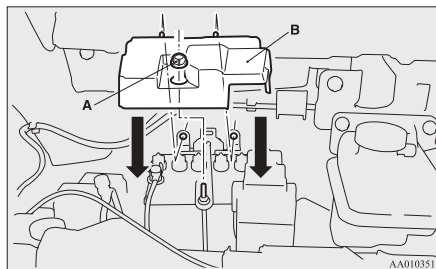

### **⚠ CAUTION**

- Be sure to install the auxiliary battery upper cover. Otherwise, the battery electrolyte may spill and cause a malfunction.
- When installing the auxiliary battery upper cover and plastic nut do not touch the cooling fan or other moving parts in the bonnet room.  
Be especially careful that the cables, your clothing or hair, etc., do not get caught in the cooling fan or other moving parts.

#### NOTE

- Be sure to install the plastic nut in the correct direction.

### Checking auxiliary battery electrolyte level

E08402500013

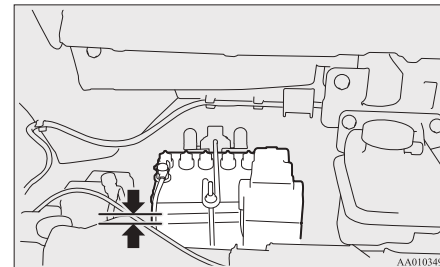

Before checking the auxiliary battery electrolyte level, remove the auxiliary battery's upper cover.

The electrolyte level must be between the specified limit on the outside of the auxiliary battery. Replenish with distilled water as necessary.

The inside of the auxiliary battery is divided into several compartments; remove the cap from each compartment and fill to the upper mark. Do not top up beyond the upper mark because spillage during driving could cause damage.

Check the electrolyte level at least once every 4 weeks, depending on the operating conditions.

If the auxiliary battery is not used, it will discharge by itself with time.

Check it once every four weeks and charge with low current if necessary.

## During cold weather

E08402600014

The capacity of the auxiliary battery is reduced at low temperatures. This is an inevitable result of its chemical and physical properties. This is why a very cold auxiliary battery, particularly one that is not fully charged will only deliver a fraction of the starting current which is normally available.

We recommend you to have the auxiliary battery checked before the start of cold weather and, if necessary, have it charged or replaced.

This does not only ensure reliable starting, but an auxiliary battery which is kept fully charged also has a longer life.

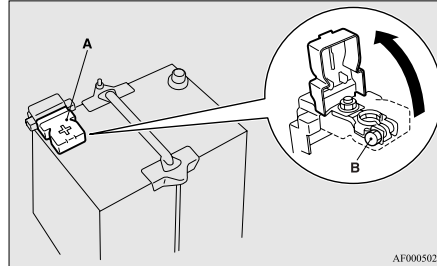

## Disconnection and connection

E08402700015

To disconnect the auxiliary battery cable, stop the electric motor unit, first disconnect the negative (-) terminal and then the positive (+) terminal. When connecting the auxiliary battery, first connect the positive (+) terminal and then the negative (-) terminal.

### NOTE

- Open the terminal cover (A) before disconnecting or connecting the positive (+) terminal of the auxiliary battery.
- Loosen the nut (B), and then disconnect the auxiliary battery cable from the positive (+) terminal.

## ⚠ WARNING

- Keep sparks, cigarettes, and flames away from the auxiliary battery because the auxiliary battery could explode.
- When installing the auxiliary battery, start connection with the positive (+) terminal. If connection is started from the negative (-) terminal, sparks will occur if the positive (+) terminal touches any other parts, and this may cause the auxiliary battery to explode.
- The auxiliary battery electrolyte is extremely caustic. Do not allow it to come in contact with your eyes, skin, clothing, or the painted surfaces of the vehicle. Spilt electrolyte should be flushed immediately with ample amounts of water. Irritation to eyes or skin from contact with electrolyte requires immediate medical attention.
- Ventilate when charging or using the auxiliary battery in an enclosed space.

## ⚠ CAUTION

- Keep it out of reach of children.
- When replacing the auxiliary battery, remove the connected positive (+) and negative (-) terminals after turning the electric motor switch to the "LOCK" position and waiting at least 1 minute. If the auxiliary battery terminal is removed just after the electric motor switch is turned to the "LOCK" position, this may cause damage to components of the electric motor unit.
- Never short-circuit the auxiliary battery. This could cause it to overheat and be damaged.
- If the auxiliary battery is to be quick-charged, first disconnect the battery cables.
- In order to prevent a short circuit, be sure to disconnect the negative (-) terminal first.
- Always wear protective eye goggles when working near the auxiliary battery.
- Do not bring the nearby parts, the plastic parts and so on into contact with sulphuric acid (battery electrolyte) which may crack, stain or discolour them. If they are in contact, wipe off with soft cloth, chamois or the like and an aqueous solution of neutral detergent then immediately rinse the affected parts with plenty of water.



### NOTE

- Keep the terminals clean. After the auxiliary battery is connected, apply terminal protection grease. To clean the terminals, use lukewarm water.
- Check to see if the auxiliary battery is securely installed and cannot be moved during travel. Also check each terminal for tightness.
- When the vehicle is to be left unused for a long period of time, remove the auxiliary battery and store it in a place where the battery fluid will not freeze. The auxiliary battery should be stored only in a fully charged condition.
- It is necessary to adjust the electronic controlled unit when the auxiliary battery is removed for a long period of time. Consult a MITSUBISHI MOTORS Authorized Service Point.

## Tyres

E08402800016

### **WARNING**

- **Driving with tyres that are worn, damaged or improperly inflated can lead to loss of control or blowout of the tyres which can result in a collision with serious or fatal injury.**

## Tyre inflation pressures

E08402900017

Tyre size	Front	Rear
145/65R15 72S	2.5 bar (36 psi) [250 kPa]	—
175/55R15 77V	—	2.5 bar (36 psi) [250 kPa]

Check the tyre inflation pressure of all the tyres while they are cold; if insufficient or excessive, adjust to the specified value. After the tyre inflation pressure has been adjusted, check the tyres for damage and air leaks. Be sure to put caps on the valves.

## Wheel condition

E0840300015

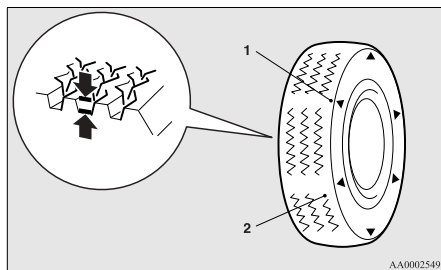

- 1- Location of the tread wear indicator  
2- Tread wear indicator

Check the tyres for cuts, cracks and other damage. Replace the tyres if there are deep cuts or cracks. Also check each tyre for pieces of metal or pebbles. The use of worn tyres can be very dangerous because of the greater chance of skidding or hydroplaning. The tread depth of the tyres must exceed 1.6 mm in order for the tyres to meet the minimum requirement for use.

Tread wear indicators will appear on the surface of the tyre as the tyre wears, thereby indicating that the tyre no longer meets the minimum requirement for use. When these wear indicators appear, the tyres must be replaced with new ones.

## **⚠ CAUTION**

- Always use tyres of the same size, same type, and same brand, and which have no wear differences. Using tyres of different size, type, brands or degree of wear, will increase the differential oil temperature, resulting in possible damage to the driving system. Further, the drive train will be subjected to excessive loading, possibly leading to oil leakage, component seizure, or other serious faults.

## Replacing tyres and wheels

E08403100016

## **⚠ CAUTION**

- Avoid using different size tyres from the one listed and the combined use of different types of tyres, as this can affect driving safety. Refer to “Tyres and wheels” on page 9-05.
- Even if a wheel has the same rim size and offset as the specified type of wheel, its shape may prevent it from being fitted correctly. We recommend you to consult a specialist before using wheels that you have.

## Tyre rotation

E08403200017

Because the front and rear tyres and wheels are not the same size, front and rear tyre rotation is not possible.

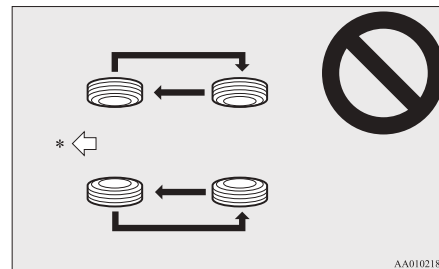

\*: Front

## **⚠ WARNING**

- Rotating tyres would compromise the stability and drivability of the vehicle and could lead to a serious accident.

## Snow tyres

E08403300018

The use of snow tyres is recommended for driving on snow and ice. To preserve driving stability, mount snow tyres of the same size and tread pattern on wheels.

A snow tyre that is worn down more than 50% is no longer appropriate to use.

Snow tyres which do not meet specifications must not be used.

## Wiper blades

E08403500010

If the blades are frozen to the windscreen or rear window, do not operate the wipers until the ice has melted and the blades are freed, otherwise the wiper motor may be damaged.

### NOTE

- When replacing the front wiper with a wiper for use in cold regions, it is necessary to adjust the washer nozzle spray positions. Always contact your MITSUBISHI MOTORS Authorized Service Point when replacing the front wiper with a wiper for use in cold regions.
- When removing snow and frost, be careful not to damage the washer nozzles (A) attached to the wiper arm.

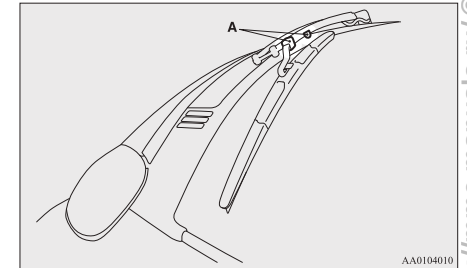

## Wiper blade rubber replacement

### Windscreen wiper blades

1. Lift the wiper arm off the windscreen.
2. Pull the wiper blade until its stopper (A) disengages from the hook (B) as indicated direc-

## CAUTION

- Observe permissible maximum speed for your snow tyres and the legal speed limit.

### NOTE

- The laws and regulations concerning snow tyres (driving speed, required use, type, etc.) vary. Find out and follow the laws and regulations in the area you intend to drive.
- If flange nuts are used on your vehicle, change to tapered nuts when steel wheels are used.

## Tyre chains

E08403400019

If tyre chains have to be used, ensure that they are fitted only on the drive wheels (rear) in accordance with the manufacturer's instructions.

Use only tyre chains which are designed for use with the tyres mounted on the vehicle: use of the incorrect size or type of chain could result in damage to the vehicle body.

Contact a MITSUBISHI MOTORS Authorized Service Point before putting on tyre chains. The max. chain height is as follows.

Tyre size	Wheel size	Max chain height [mm]
175/55R15 77V	15 x 5 J	14 mm

When driving with tyre chains on the tyres, do not drive faster than 50 km/h (30 mph). When you reach roads that are not covered in snow, immediately remove the tyre chains.

## CAUTION

- Practice fitting the chains before you need them. Don't expect help from other people in the cold.
- Choose a clear straight stretch of road where you can pull over and still be seen while you are fitting the chains.
- Do not fit chains before you need them. This will wear out your tyres and the road surface.
- After driving around 100-300 metres, stop and retighten the chains.
- Drive carefully and do not exceed 50 km/h (30 mph). Remember that preventing accidents is not the purpose of tyre chains.
- An aluminium wheel can be damaged by a tyre chain while driving. When fitting a tyre chain on an aluminium wheel, take care that no part of the chain and fitting can be brought into contact with the wheel.
- When installing or removing the tyre chains, take care that hands and other parts of your body are not injured by the sharp edges of the vehicle body.

### NOTE

- The laws and regulations concerning the use of tyre chains vary. Always follow local laws and regulations.
- In most countries, it is prohibited by law to use tyre chains on roads without snow.

## Vehicle care and Maintenance

tion by the arrow (C) on the hook. Pull the wiper blade to remove it.

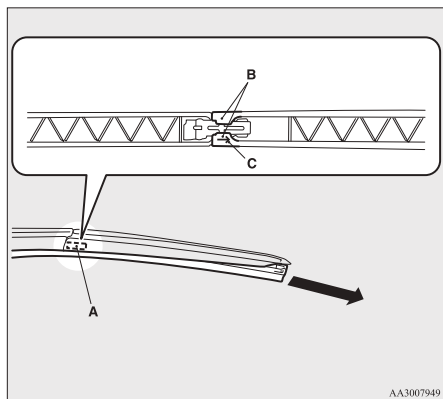

### NOTE

- Do not let the wiper arm drop onto the wind-screen. This could damage the glass.

3. Attach the retainers (D) to a new wiper blade. Refer to the illustration to ensure that the retainers are correctly aligned as you attach them.

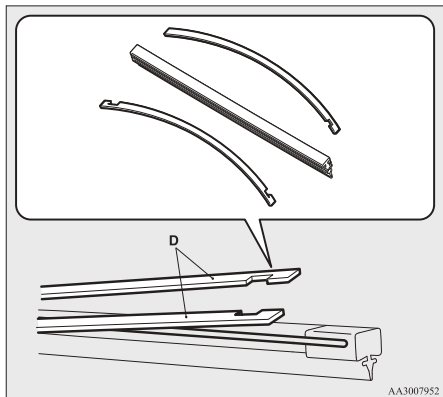

4. Insert the wiper blade into the arm, starting with the opposite end of the blade from the stopper. Make sure the hook (B) is fitted correctly in the grooves in the blade.

### NOTE

- If a retainer is not supplied with the new wiper blade, use the retainer from the old blade.

5. Push the wiper blade until the hook (B) engages securely with the stopper (A).

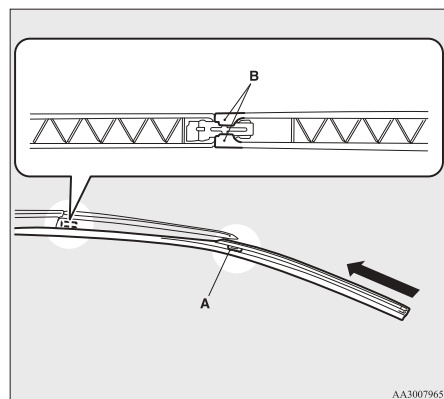

### Rear window wiper blades

1. Lift the wiper arm off the window glass.
2. Pull the wiper blade downward to disengage it from the stopper (A) at the end of the wiper arm. Pull the wiper blade further to remove it.
3. Slide a new wiper blade through the hook (B) on the wiper arm.

## General maintenance

E08403600011

### Coolant and oil leakage

Look under the body of your vehicle to check for coolant and oil leakage.

### Exterior and interior lamp operation

Operate the combination lamp switch to check that all lamps are functioning properly.

If the lamps do not illuminate, the probable cause is a blown fuse or defective lamp bulb. Check the fuses first. If there is no blown fuse, check the lamp bulbs.

For information regarding the inspection and replacement of the fuses and the bulbs, refer to "Fuses" on page 8-20 and "Replacement of lamp bulbs" on page 8-23.

If the fuses and bulbs are all OK, we recommend you to have your vehicle checked and repaired.

### Meter, gauge and indicator/warning lamps operation

Start the electric motor unit and check the operation of all instruments, gauges and indication and warning lamps.

If there is anything wrong, we recommend you to have your vehicle inspected.

### Hinges and latches lubrication

Check all latches and hinges, and, if necessary, have them lubricated.

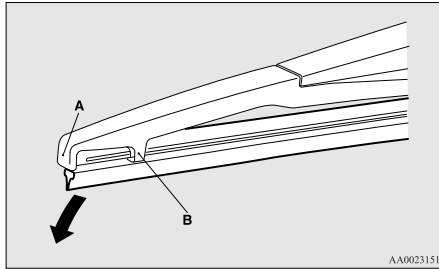

AA0023151

#### NOTE

- Do not allow the wiper arm to fall onto the window glass; it could damage the glass.

4. Firmly insert the retainer (C) into the groove (D) in the wiper blade. Refer to the illustration to ensure that the retainers are correctly aligned as you insert them into the groove.

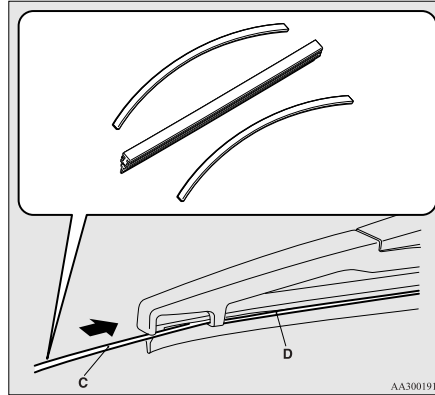

AA3001918

#### NOTE

- If a retainer is not supplied with the new wiper blade, use the retainer from the old blade.

## For cold and snowy weather

E08403700012

### Ventilation slots

The ventilation slots in front of the windscreen should be kept clear of leaves or brushed clear after heavy snowfall, so that the operation of the heating and ventilation systems will not be impaired.

### Weatherstripping

To prevent freezing of the weatherstripping on the doors, bonnet, etc., they should be treated with silicone grease.

### Additional equipment

It is a good idea to carry a shovel or a short-handled spade in the vehicle during the winter so that you can clear away snow if you get stranded. A small hand-brush for sweeping snow off the vehicle and a plastic scraper for the windscreen and rear window are also useful.

## Fusible links

E08403800013

The fusible links will melt to prevent a fire if a large current attempts to flow through certain electrical systems.

In case of a melted fusible link, we recommend you to have your vehicle inspected.

For the fusible links, please refer to "Passenger compartment fuse location table" on page 8-21 and "Bonnet room fuse location table" on page 8-22.

### **⚠ WARNING**

- **Fusible links must not be replaced by any other device. Failing to fit the correct fusible link may result in fire in the vehicle, property destruction and serious or fatal injuries at any time.**

## Fuses

E08403900014

### Fuse block location

E08404000012

To prevent damage to the electrical system due to shortcircuiting or overloading, each individual circuit is provided with a fuse.

There are fuse blocks in the passenger compartment and in the bonnet room.

### NOTE

- Spare fuses are not provided. Please purchase it from a MITSUBISHI MOTORS Authorized Service Point or other locations.

### Passenger compartment

The fuse block in the passenger compartment is located in front of the driver's seat at the position shown in the illustration.

Press the tab (A) and remove the fuse cover (B).

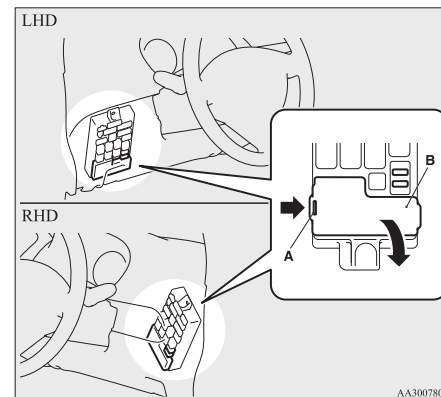

AA3007806

**Bonnet room**

In the bonnet room, the fuse block is located as shown in the illustration. Press the tab (A) and remove the cover.

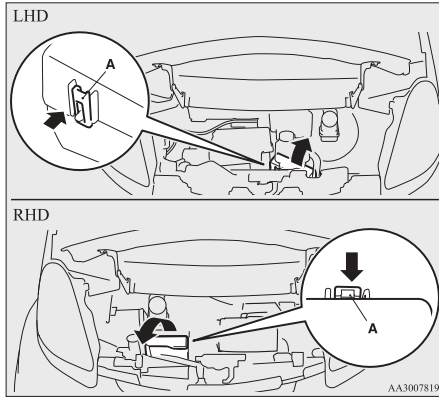

**Fuse load capacity**

E08404100013

The fuse capacity and the names of electrical systems protected by the fuses are indicated on the fuse block cover.

**Passenger compartment fuse location table**

E08404200014

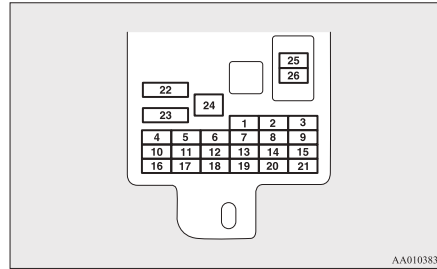

No.	Symbol	Electrical system	Capacities
1		Tail lamp (left)	7.5 A
2		Cigarette lighter/Accessory socket	15 A
3	—	—	—
4		Starter	7.5 A
5		Audio system amp	20 A
6	—	—	—
7		Tail lamp (right)	7.5 A
8		Outside rear-view mirrors	7.5 A
9		Control unit (Electric motor unit)	7.5 A

\*: Fusible link

No.	Symbol	Electrical system	Capacities
10		Control unit	7.5 A
11		Rear fog lamp	10 A
12		Central door lock	15 A
13		Room lamp	10 A
14		Rear window wiper	15 A
15		Gauge	7.5 A
16		Relay	7.5 A
17		Heated seat	20 A
18	OPTION	Option	10 A
19		Heated door mirror	7.5 A
20		Windscreen wiper	20 A
21		Reversing lamps	7.5 A
22		Demister	30 A
23		Heater	30 A
24		Auxiliary battery	30 A*
25		Radio	10 A
26		Electronic controlled unit	15 A

\*: Fusible link

● Some fuses may not be installed on your vehicle, depending on the vehicle model or specifications.



## Vehicle care and Maintenance

- The table above shows the main equipment corresponding to each fuse.

### Bonnet room fuse location table

E08404300015

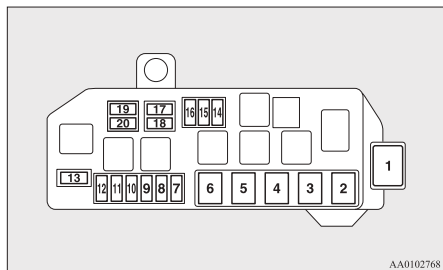

AA0102768

No.	Symbol	Electrical system	Capacity
1	—	—	—
2		Auxiliary battery	30 A*
3		Electric motor switch	40 A*
4		Radiator fan motor	40 A*
5		Electric window control	40 A*
6		Brake electric vacuum pump	30 A*
7		Electric motor unit control	15 A
8	STOP	Stop lamps	15 A

\*: Fusible link

No.	Symbol	Electrical system	Capacity
9		Front fog lamps	15 A
10		Water pump (Electric motor unit)	15 A
11		Charge	10 A
12		Hazard warning flasher	10 A
13		Horn	10 A
14		Daytime running lamps	10 A
15		Traction battery cooling fan motor	15 A
16		Water pump (Air conditioning)	10 A
17		Headlamp low beam (right)	20 A
18		Headlamp low beam (left)	20 A
19		Headlamp high-beam (right)	10 A
20		Headlamp high-beam (left)	10 A

\*: Fusible link

- Some fuses may not be installed on your vehicle, depending on the vehicle model or specifications.
- The table above shows the main equipment corresponding to each fuse.

### Identification of fuse

E08404400016

Capacity	Colour
7.5 A	Brown
10 A	Red
15 A	Blue
20 A	Yellow
30 A	Green (fuse type) / Pink (fusible link type)
40 A	Green (fusible link type)

### Fuse replacement

E08404500017

1. Before replacing a fuse, always turn off the electrical circuit concerned and turn the electric motor switch to the "LOCK" position.
2. Remove the fuse puller (A) from the inside of the fuse cover in the passenger compartment.

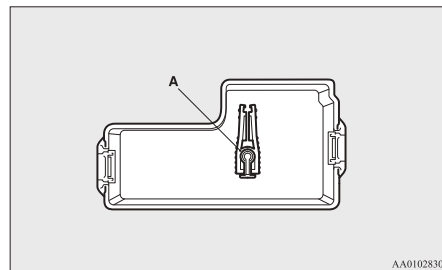

AA0102830

3. Referring to the fuse load capacity table, check the fuse pertaining to the problem.

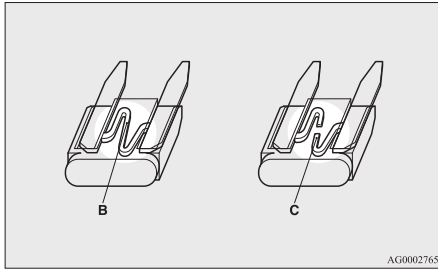

B- Fuse is OK  
C- Blown fuse

### **⚠ CAUTION**

- If the newly inserted fuse blows again after a short time, we recommend you to have the electrical system checked to find the cause and rectify it.
- Never use a fuse with a capacity larger than that specified or any substitute, such as wire, foil, etc.; doing so will cause the circuit wiring to heat up and this could cause fire.

### **Replacement of lamp bulbs**

E08404600018

Before replacing a bulb, ensure the lamp is off. Do not touch the glass part of the new bulb with your bare fingers; the skin oil left on the glass will evaporate when the bulb gets hot and the vapour will condense on the reflector and dim the surface.

### **⚠ CAUTION**

- Bulbs are extremely hot immediately after being turned off. When replacing a bulb, wait for it to cool sufficiently before touching it. You could otherwise be burnt.

#### NOTE

- If any system does not function but the fuse corresponding to that system is normal, there may be a fault in the system elsewhere. We recommend you to have your vehicle checked.

4. Insert a new fuse of the same capacity by using the fuse puller into the same place at the fuse block.

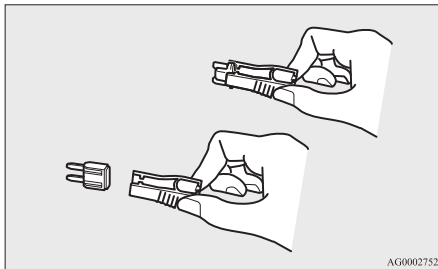

AG0002752

#### NOTE

- If you are unsure of how to carry out the work as required, we recommend you to consult a specialist.
- Be careful not to scratch the vehicle body when removing a lamp or lens.
- When it rains or when the vehicle has been washed, the inside of the lens sometimes becomes foggy. This is the same phenomenon as when window glass mists up on a humid day, and does not indicate a functional problem.

When the lamp is switched on, the heat will remove the fog. However, if water gathers inside the lamp, we recommend you to have the lamp checked.

### **Bulb capacity**

E08404700019

When replacing a bulb, use a new bulb with the same wattage and colour.

Outside

E08404800010

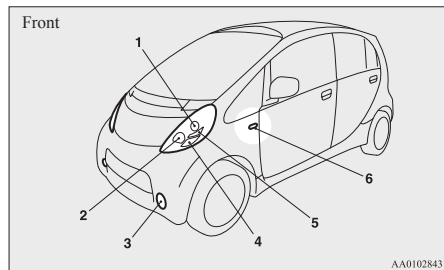

- 1- Headlamps, low beam: 55 W (H11)
  - 2- Headlamps, high-beam: 60 W (HB3)
  - 3- Front fog lamps\*: 35 W (H8)  
Daytime running lamps\*: 13 W (P13W)
  - 4- Front turn-signal lamps: 21 W (W21W)
  - 5- Position lamps: 5 W (W5W)
  - 6- Side turn-signal lamps: 5 W (WY5W)
- \*: if so equipped  
Codes in parentheses indicate bulb types.

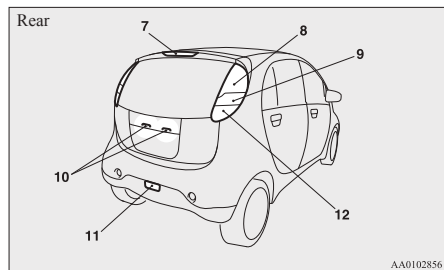

- 7- High-mounted stop lamp: 5 W (W5W)
  - 8- Stop and tail lamps
  - 9- Rear turn-signal lamps: 21 W (WY21W)
  - 10- Licence plate lamps: 5 W (W5W)
  - 11- Rear fog lamp: 21 W (W21W)
  - 12- Reversing lamps: 21 W (W21W)
- Codes in parentheses indicate bulb types.

NOTE

- The stop and tail lamps use LEDs rather than bulbs.  
For repair and replacement, we recommend you to contact a MITSUBISHI MOTORS Authorized Service Point.

Inside

E08404900011

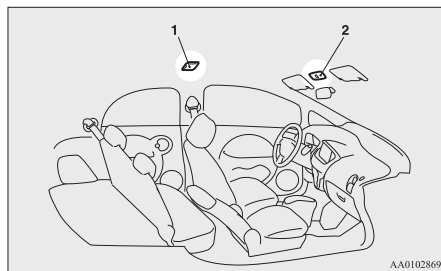

- 1- Room lamp (rear): 8 W
- 2- Room lamp (front) & map lamps: 8 W

Removing and installing the headlamp unit

E08405000022

Bulbs for headlamps, position lamps or front turn-signal lamps are replaced by removing the entire headlamp unit from the vehicle.

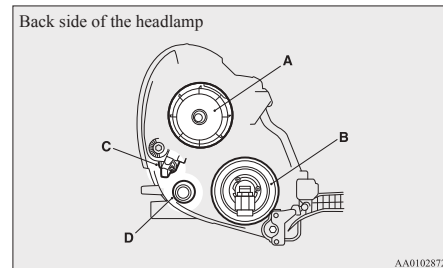

- A- Headlamp (low beam)
- B- Headlamp (high-beam)
- C- Position lamp
- D- Front turn-signal lamp

Refer to the following section for replacement.  
Headlamps (low beam) → p. 8-28  
Headlamps (high-beam) → p. 8-29  
Position lamps → p. 8-30  
Front turn-signal lamps → p. 8-30

Use the following steps to remove the headlamp unit.

To remove

1. Open the bonnet. Refer to “Bonnet” on page 8-07.
2. Press the tab (A) to remove the connector (B).

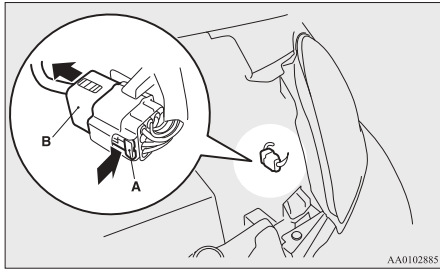

AA0102885

**NOTE**

- When removing the connector for the left headlamp, do not forget to unhook the headlamp wiring from the wiring bracket (C).

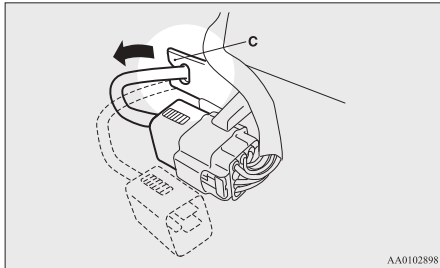

AA0102898

3. Insert a straight blade (or minus) screwdriver with a cloth over its tip at the edge of the work hole cover (D) on the deck garnish (E) and pry gently to remove the cover.

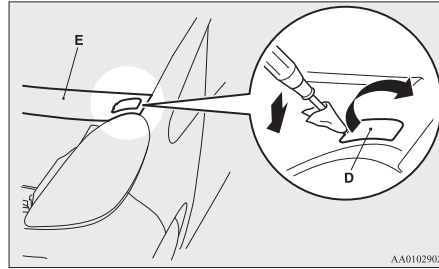

AA0102902

4. Loosen the fixing bolt (F) until the head of the bolt touches the deck garnish (E).

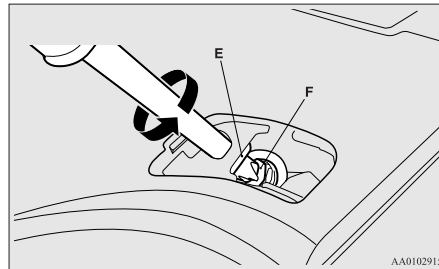

AA0102915

**NOTE**

- Do not loosen the bolt more than necessary. Doing so could cause the bolt to fall off.

5. Insert a straight blade (or minus) screwdriver to remove the 2 clips holding down the bumper.

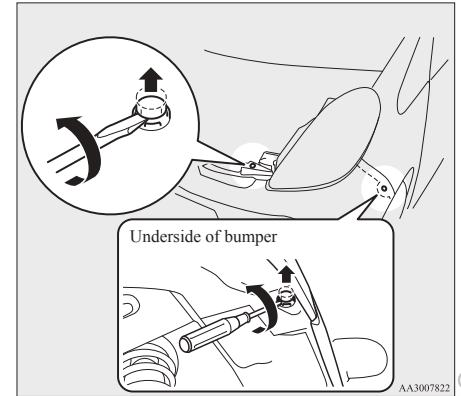

AA3007822

6. Slowly lift up the bumper and disconnect the joint between the bumper and fender.

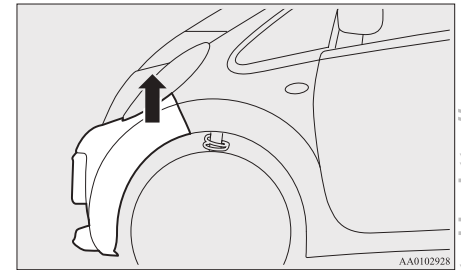

AA0102928

## Vehicle care and Maintenance

### NOTE

- When disconnecting the joint, be careful not to damage surrounding parts.

7. While keeping the bumper flipped up, remove the side fixing bolt (G).

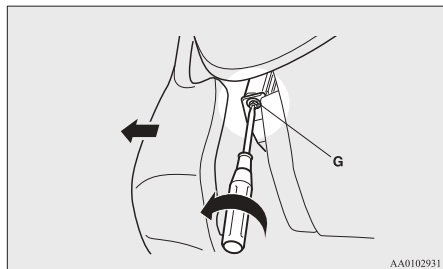

8. Remove the front fixing bolt (H).

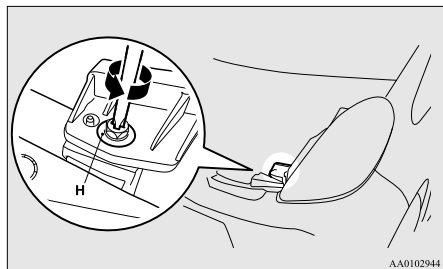

9. As shown in the illustration, shift the entire headlamp unit upward and then unlatch the tab (I) on the upper part of the headlamp to remove it from the vehicle.

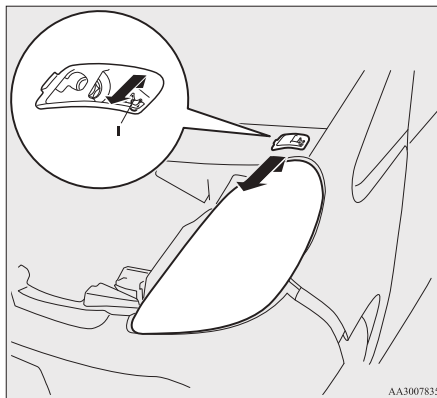

### NOTE

- Do not force the headlamp off the vehicle as doing so could damage the tab.

### To install

The mounting brackets on the headlamps are engraved with the numbers ① to ③. Install each branch in the order of the assigned numbers.

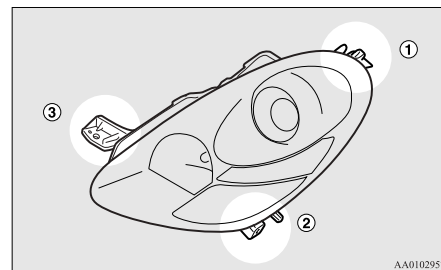

1. As shown in the illustration, insert the cut out area (A) on mounting bracket ① on to the bolt (B) remaining on the vehicle body, and latch the tab (C) on the fixture hole (D) to install the entire headlamp unit to the vehicle body.

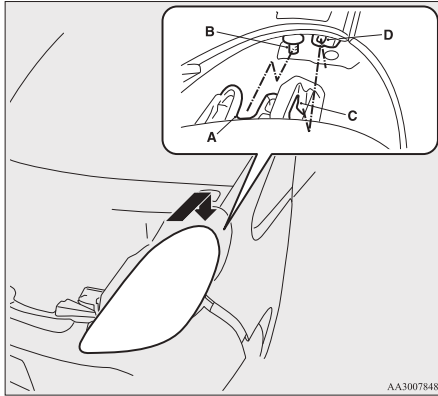

2. Make sure that the tip (F) of the mounting bracket ② is hooked on the body edge (G).

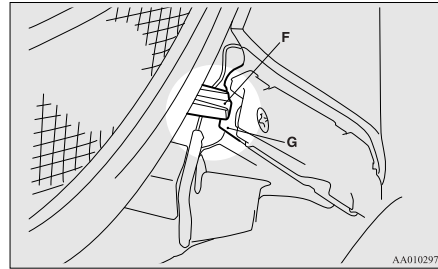

4. Firmly tighten the headlamp mounting bolts in the following order: ① to ③.

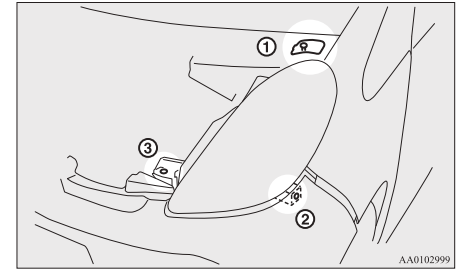

NOTE

- Use the work hole (E) on the deck garnish to confirm that the tab (C) on the upper part of the headlamp is firmly fixed in place.

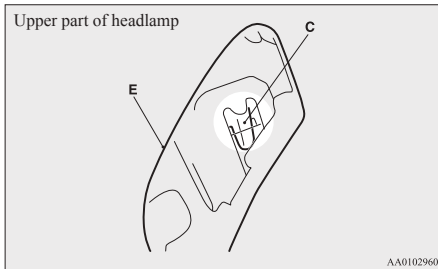

3. Make sure that the pin (H) is inside the hole on the mounting bracket ③.

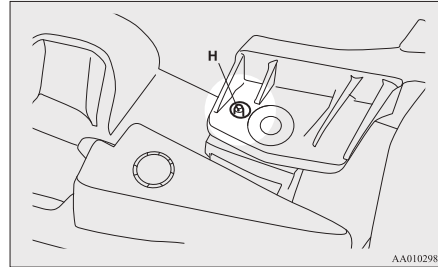

5. After pressing down on the bumper and fender joint from above to fit it in, fix it in place with the clip.

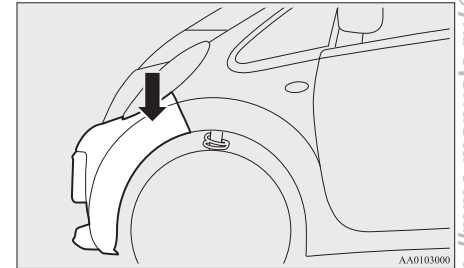

NOTE

- Secure the bumper clip by first inserting it into the mounting hole and then pressing the centre (I) of the clip in.

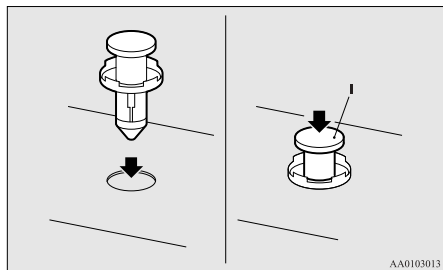

AA0103013

6. Firmly insert the connector (J).

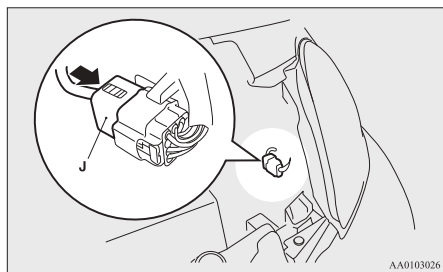

AA0103026

**NOTE**

- When inserting the connector for the left headlamp, do not forget to hook the headlamp wiring in the wiring bracket (K).

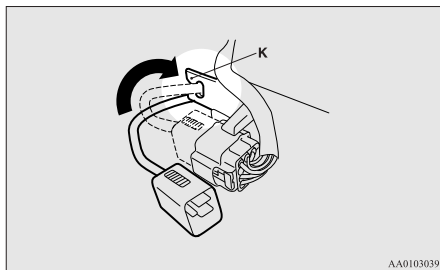

AA0103039

7. Firmly install the cover (L) on the deck garnish.

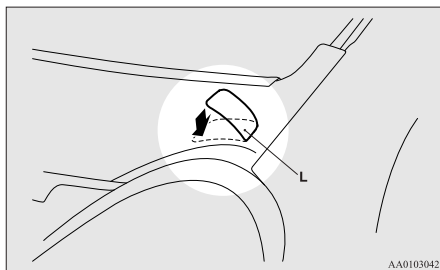

AA0103042

## Headlamps (low beam)

E08405100010

1. Turn the cap (A) anticlockwise to remove it.

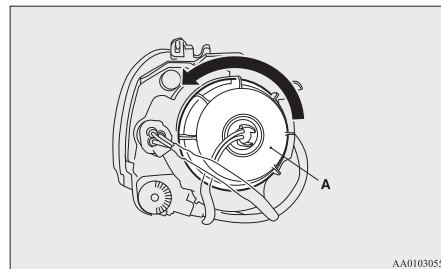

AA0103055

2. Turn the socket (B) anticlockwise to remove it.

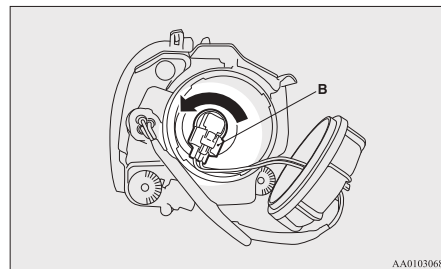

AA0103068

3. While pulling up the tab (C), pull out the bulb (D).

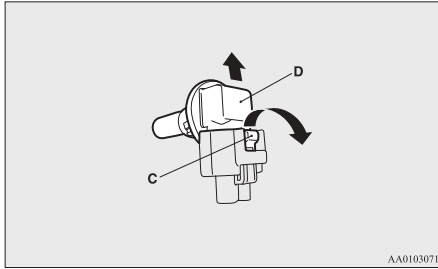

4. To install the bulb, perform the removal steps in reverse.

### **⚠ CAUTION**

- Handle the halogen lamp bulb with care. The gas inside the halogen lamp bulb is highly pressurized, so dropping, knocking, or scratching a halogen lamp bulb can cause it to shatter.
- Never hold the halogen lamp bulb with a bare hand, dirty glove, etc. The oil from your hand could cause the bulb to break the next time the headlamps are operated. If the glass surface is dirty, it must be cleaned with alcohol, paint thinner, etc., and refit it after drying it thoroughly.

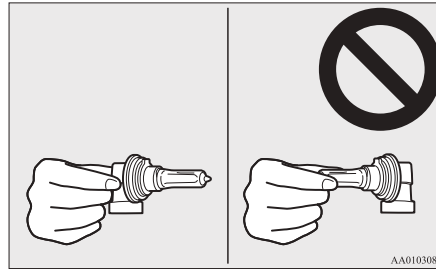

### Headlamps (high-beam)

E08405200011

1. Turn the socket (A) anticlockwise to remove it.

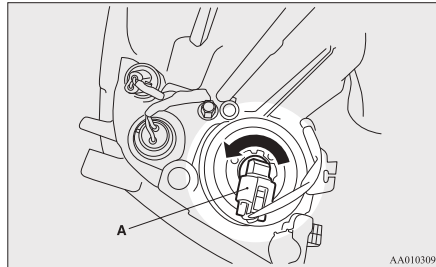

2. While holding down the tab (B), pull out the bulb (C).

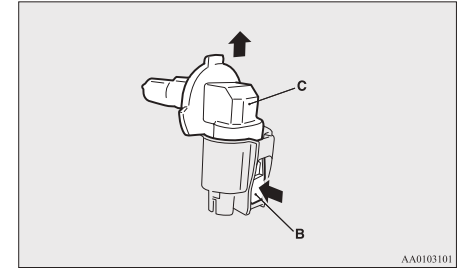

3. To install the bulb, perform the removal steps in reverse.

### **⚠ CAUTION**

- Handle halogen lamp bulbs with care. The gas inside halogen lamp bulbs is highly pressurized, so dropping, knocking, or scratching a halogen lamp bulb can cause it to shatter.
- Never hold the halogen lamp bulb with a bare hand, dirty glove, etc. The oil from your hand could cause the bulb to break the next time the headlamps are operated. If the glass surface is dirty, it must be cleaned with alcohol, paint thinner, etc., and refit it after drying it thoroughly.



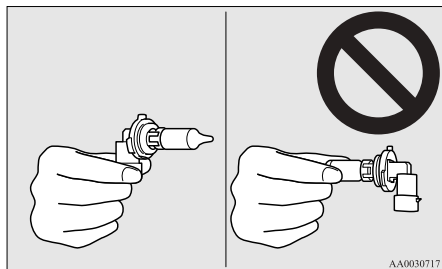

### Position lamps

E08405300012

1. Turn the socket (A) anticlockwise to remove it.

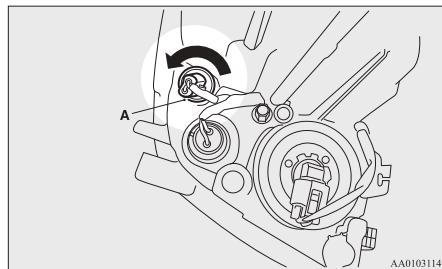

2. Pull the bulb out of the socket.

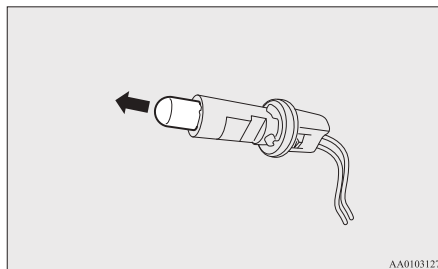

3. To install the bulb, perform the removal steps in reverse.

### Front turn-signal lamps

E08405400013

1. Turn the socket (A) anticlockwise to remove it.

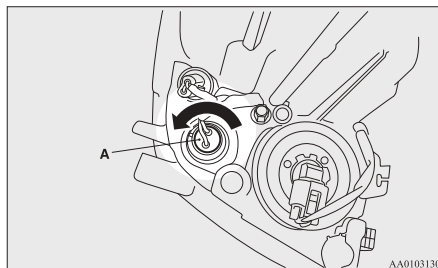

2. Pull the bulb out of the socket.

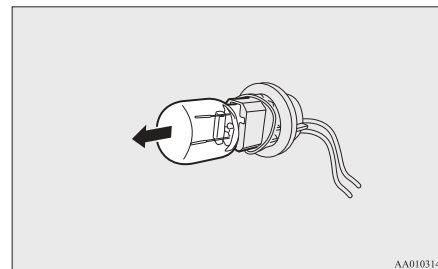

3. To install the bulb, perform the removal steps in reverse.

### Side turn-signal lamps

E08405500014

1. To remove a side turn-signal lamp, insert a straight blade (or minus) screwdriver with a cloth over its tip at the end of the lamp near the rear of the body and use it to gently lever the lamp out of the body.

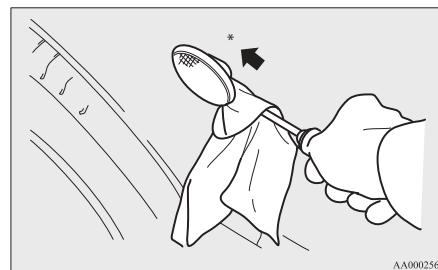

\*: Front of the vehicle

- Remove the socket and bulb assemblies by turning it anticlockwise.

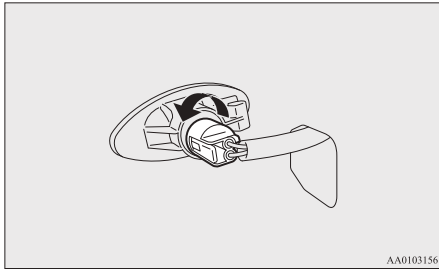

- Pull the bulb out of the socket.

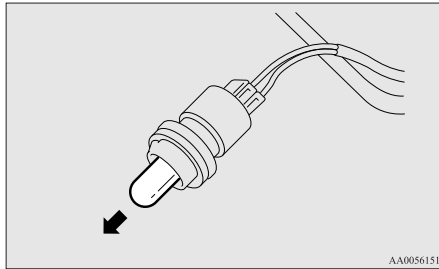

- To install the bulb, perform the removal steps in reverse.

**NOTE**

- When installing the lamp assembly, push in the end facing the front of the vehicle first.

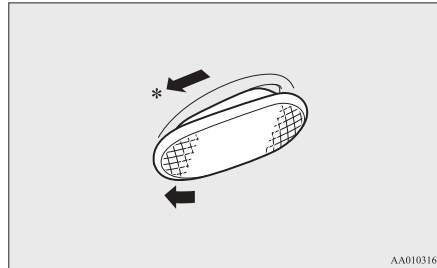

\*: Front of the vehicle

**Front fog lamps\* / Daytime running lamps\***

E08405600015

- To create enough work space, turn the steering wheel all the way in the same direction to the side you wish to replace.
- Remove the clips (A) by a screwdriver, then lift the cover (B).

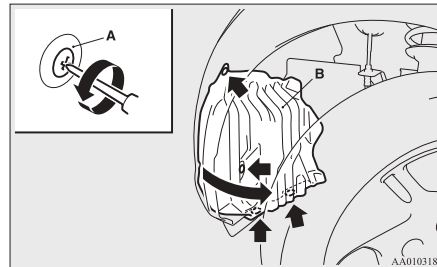

- Turn the socket (C or D) anticlockwise to remove it.

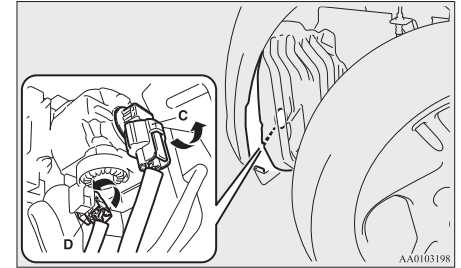

C- Front fog lamp

D- Daytime running lamp

- While holding down the tab (E), pull out the bulb (F).

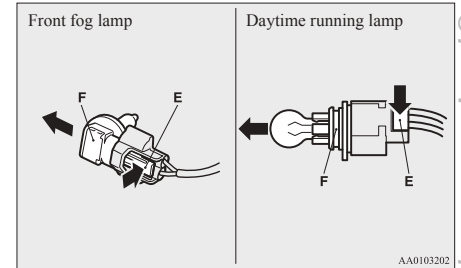

- To install the bulb, perform the removal steps in reverse.

**⚠ CAUTION**

- Handle the halogen lamp bulb with care. The gas inside a halogen lamp bulb is highly pressurized, so dropping, knocking, or scratching a halogen lamp bulb can cause it to shatter.
- Never hold the halogen lamp bulb with a bare hand, dirty glove, etc. The oil from your hand could cause the bulb to break the next time the fog lamps are operated. If the glass surface is dirty, it must be cleaned with alcohol, paint thinner, etc., and refit it after drying it thoroughly.

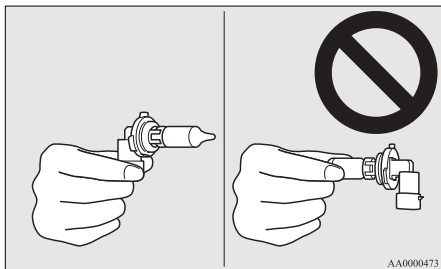

AA0000473

**Rear fog lamp**

E08405700016

1. When removing the lamp unit (A), push it towards the left side of the vehicle body.

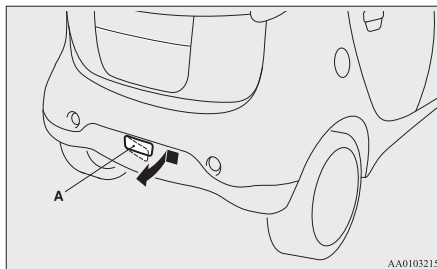

AA0103215

2. Remove the socket (B) and bulb assembly by turning it anticlockwise.

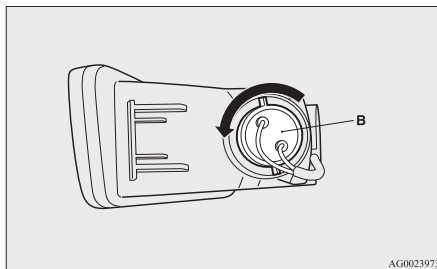

AG0023973

3. Pull the bulb out of the socket.

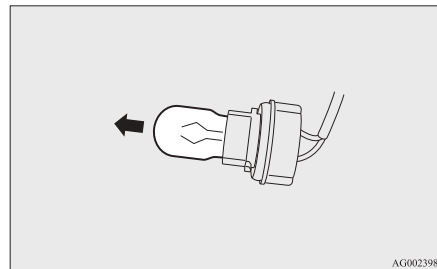

AG0023986

4. To install the bulb, perform the removal steps in reverse.

**NOTE**

- If the wiring harness is pulled off the harness guides (C) on the lamp unit while replacing the bulb, make sure to secure the wiring harness to the harness guides.

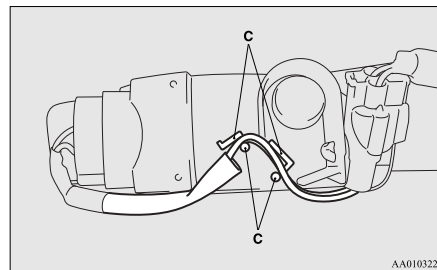

AA0103228

- When installing the lamp unit, first insert the tab (D) into the groove (E) on the body, and then push on the lamp unit to fit it into place.

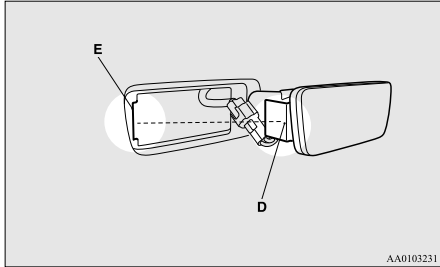

### Rear combination lamps

E08405800017

1. Open the tailgate. (Refer to “Tailgate” on page 2-08.)
2. Remove the screws (A) that hold the lamp unit and remove the lamp unit.

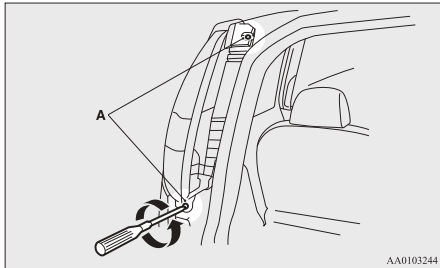

3. Move the lamp unit towards the rear of the vehicle and remove the pins (B) of the lamp unit from the vehicle.

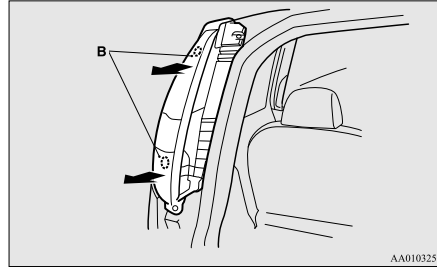

4. Turn the socket anticlockwise to remove it.

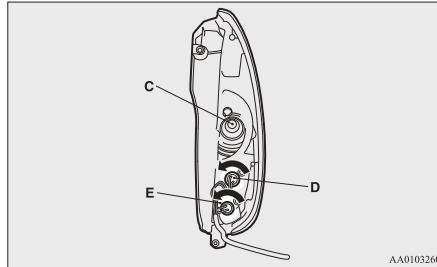

C- Stop and tail lamp (LED) - cannot be replaced  
 D- Rear turn-signal lamp  
 E- Reversing lamp

### NOTE

- The stop and tail lamps use LEDs rather than bulbs. For repair and replacement, we recommend you to contact a MITSUBISHI MOTORS Authorized Service Point.

5. Pull the bulb out of the socket.

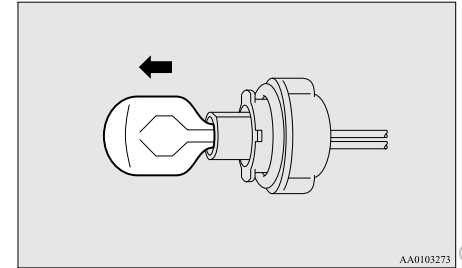

6. To install the bulb, perform the removal steps in reverse.

## High-mounted stop lamp

E08406000016

1. Remove the mounting screws (A) and remove the lamp unit.

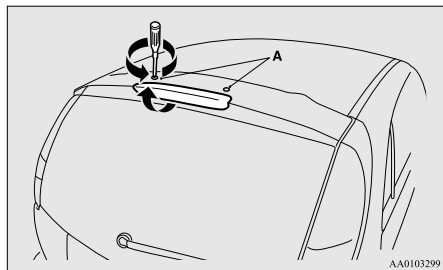

2. Turn the socket anticlockwise to remove it.

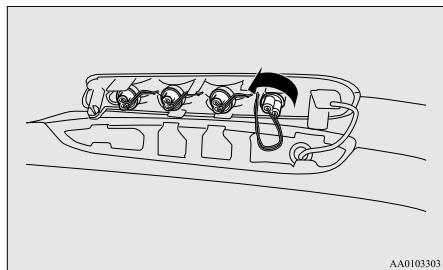

3. Pull the bulb out of the socket.

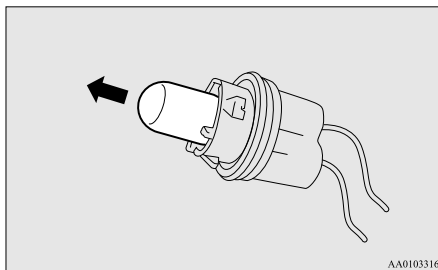

4. To install the bulb, perform the removal steps in reverse.

### NOTE

- When installing the lamp unit, make sure not to bend the washer fluid hose (B).

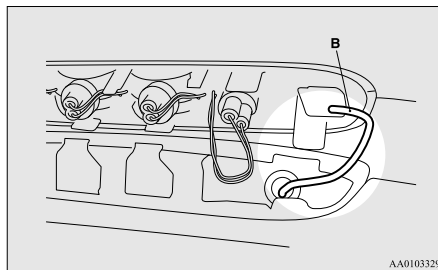

## Licence plate lamps

E08405900018

1. When removing the lamp unit (A), push it towards the left side of the vehicle body.

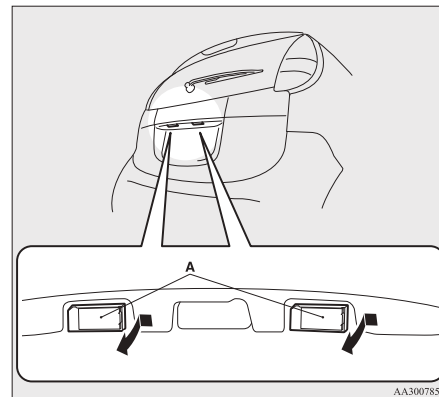

2. Use a straight blade (or minus) screwdriver with a cloth over its tip to gently pry up the tab (B) and remove the lens.

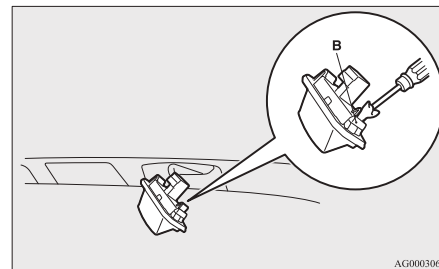

3. Pull the bulb out of the socket.

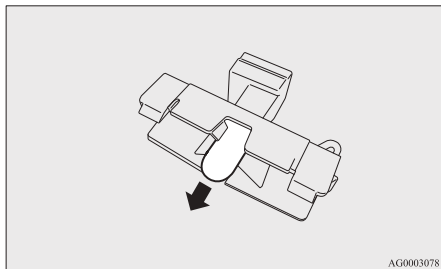

4. To install the bulb, perform the removal steps in reverse.

#### NOTE

- When installing the lamp, insert tab (C) first then align and insert tab (D).

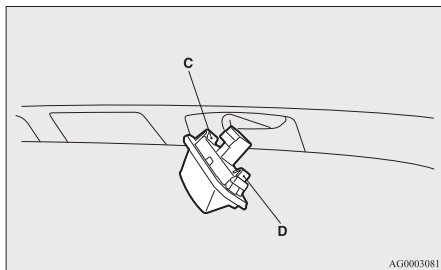



# *Specifications*

Vehicle labeling.....	9-02
Vehicle dimensions.....	9-03
Electric motor specifications.....	9-04
Low voltage electrical system.....	9-04
Tyres and wheels.....	9-05
Electric energy consumption.....	9-06
Refill capacities.....	9-07



## Vehicle labeling

E01100102899

### Vehicle identification number

The vehicle identification number is stamped in the location shown in the illustration.

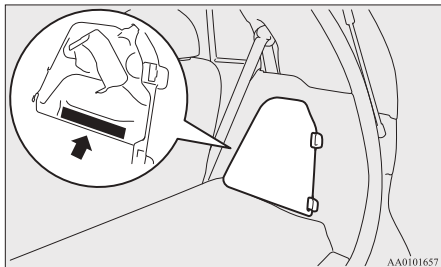

### Vehicle information code plate

The vehicle information code plate is riveted as shown in the illustration.

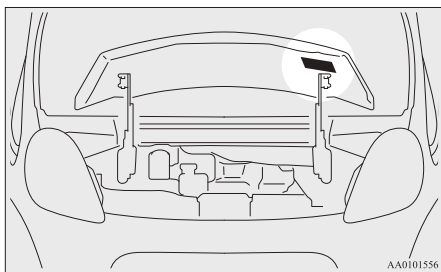

The plate shows model code, engine model, transmission model and body colour code, etc. Please use this number when ordering replacement parts.

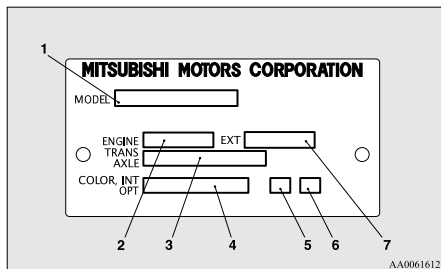

- 1- Model code
- 2- Engine model code
- 3- Transmission model code
- 4- Body colour code
- 5- Interior code
- 6- Option code
- 7- Exterior code

### Electric motor number

The electric motor number is stamped on the flange of the electric motor frame as shown in the illustrations.

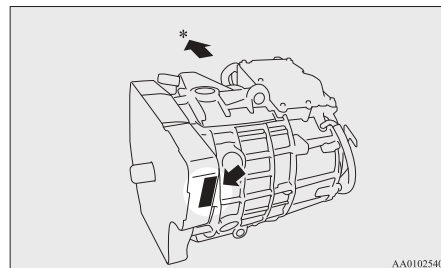

\*: Front of the vehicle

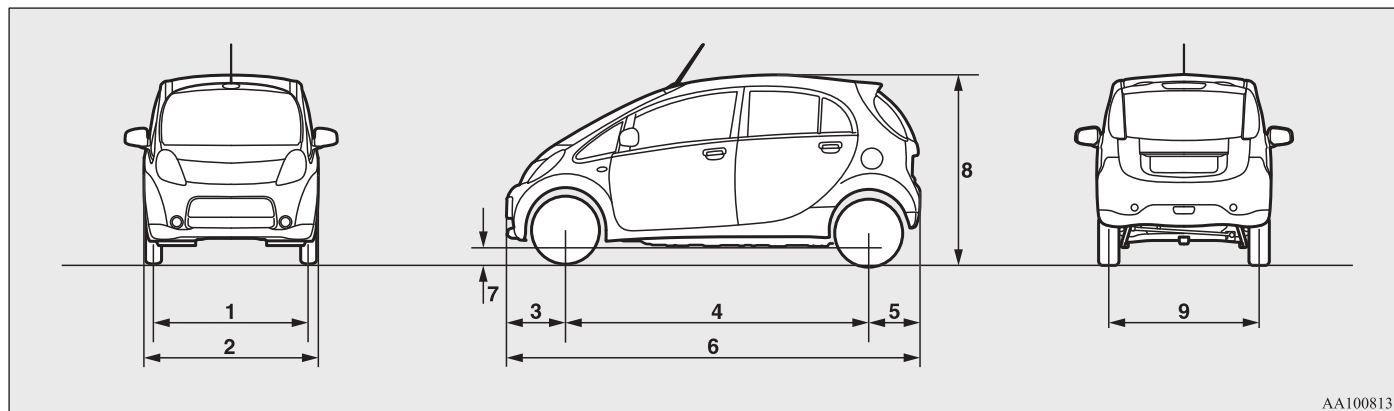
*Vehicle dimensions*

AA1008131

1	Front track	1,310 mm
2	Overall width	1,475 mm
3	Front overhang	500 mm
4	Wheel base	2,550 mm
5	Rear overhang	425 mm
6	Overall length	3,475 mm
7	Ground clearance (unladen)	150 mm
8	Overall height (unladen)	1,610 mm
9	Rear track	1,270 mm
Minimum turning radius		4.5 m

## Specifications

### *Electric motor specifications*

E01100602458

Electric motor model	Y4F1
Maximum output (ECE net)	49 kW/2,500 to 8,000 r/min
Maximum torque	180 Nm/0 to 2,000 r/min
Maximum 30 minutes power (ECE net)	35 kW

### *Low voltage electrical system*

E01100802232

Voltage		12 V
Auxiliary battery	Type (JIS)	34B19L (S)
	Capacity (5HR)	27Ah

*Tyres and wheels*

E01100902884

Item		Front	Rear
Tyre		145/65R15 72S	175/55R15 77S
Wheel	Size	15x4J	15x5J
	Offset	35 mm	

## NOTE

- Contact your MITSUBISHI MOTORS Authorized Service Point for details on the combination used on your vehicle.

*Electric energy consumption*

E01101800017

Item	Combined
Electric energy consumption [NEDC]*	135 Wh/km
Electric range (Cruising range) [NEDC]*	150 km (93 miles)

\*: NEDC stands for New European Driving Cycle. The values of electric energy consumption and electric range are based on ECE R101. These values vary depending on driving style, road and traffic conditions, ambient temperature, use of air conditioners and so forth.

## NOTE

- The results given do not express or imply any guarantee of the electric energy consumption of the particular vehicle. The vehicle itself has not been tested and there are inevitably differences between individual vehicles of the same model. In addition, this vehicle may incorporate particular modifications. Furthermore, the driver's style and road and traffic conditions, as well as the extent to which the vehicle has been driven and the standard of maintenance, will all affect its electric energy consumption.
- All mentioned values are referring to a new, driven in vehicle.
- The consumption, but mainly the driving distance depends on the condition of the traction battery.
- Parameters on traction battery are depending on temperature, climate, charging and charging history and age of the traction battery etc.
- A bigger influence as known by combustion engine are the energy consumptive consumers of the vehicle like heating, air conditioning, etc.

## Refill capacities

E01101303576

Bonnet room

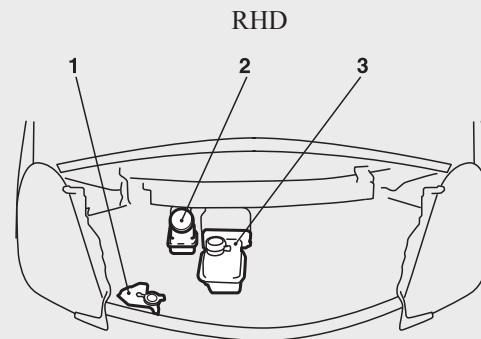
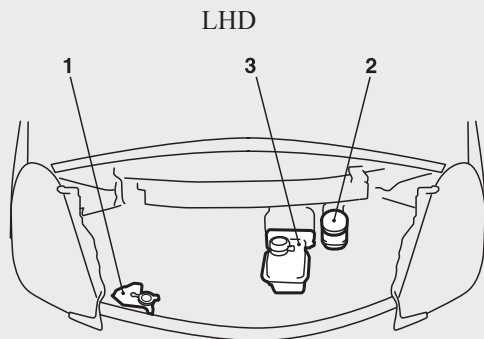

Electric motor unit room (under the floor of the luggage area)

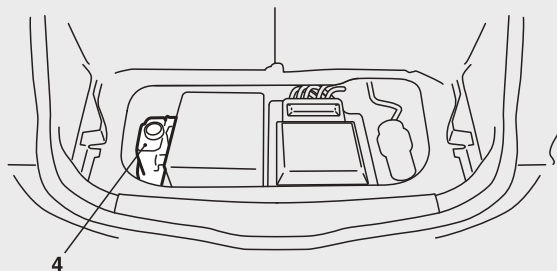

AA5012169

## Specifications

No.	Item		Quantity	Lubricants
1	Washer fluid		1.9 litres	—
2	Brake fluid		As required	Brake fluid DOT 3 or DOT 4
3	Hot water heater fluid	LHD	1.9 litres [includes 0.4 litre in the reserve tank]	DIA QUEEN SUPER LONG LIFE COOLANT PREMIUM or equivalent*
		RHD	1.7 litres [includes 0.4 litre in the reserve tank]	
4	Coolant		5.1 litres [includes 1.1 litres in the reserve tank]	
5	Transmission oil		0.75 litre	DIA QUEEN ATF SP III
6	Refrigerant (air conditioning)		305 - 345 g	HFC-134a

\*: similar high quality ethylene glycol based non-silicate, non-amine, non-nitrate and non-borate coolant with long life hybrid organic acid technology

---

**A**

---

Accessory (Installation) 03  
 Accessory socket 6-11  
 Active stability control (ASC) 5-16  
 Additional equipment 8-20  
 Air conditioning  
   Important operation tips for the air conditioning 6-09  
 Air purifier 6-09  
 Airbag 3-20  
 Antenna 6-10  
 Anti-lock brake system (ABS) 5-14  
   Warning lamp 5-14  
 Assist grips 6-16  
 Auxiliary battery 8-12  
   Specification 9-04  
 Auxiliary battery charge warning lamp 4-10

---

**B**

---

Basic knowledge for charging 1-02  
 Battery  
   Auxiliary battery 8-12  
   Auxiliary battery charge warning lamp 4-10  
   Discharged battery (Emergency starting) 7-02  
   Disposal information for used batteries 04  
   Traction battery 02  
 Bonnet 8-07  
 Brake assist system 5-13  
 Brake  
   Anti-lock brake 5-14  
   Braking 5-12  
   Fluid 8-11,9-07  
   Parking brake 5-03  
   Warning lamp 4-09  
 Bulb capacity 8-23

---

**C**

---

Capacities 9-07  
 Card holder 6-11,6-14  
 Cargo loads 5-19  
 Central door locks 2-06  
 Charging indicator 4-09  
 Charging  
   Guideline for charging time 1-02  
   Quick charging 1-08  
   Regular charging 1-04  
 Child restraint 3-11  
 Child-protection rear doors 2-07  
 Cleaning  
   Exterior of your vehicle 8-03  
   Interior of your vehicle 8-02  
   Plastic, vinyl leather, etc. 8-02  
 Cold  
   Cautions and actions to deal with intense cold 06  
 Combination headlamps and dipper switch 4-11  
 Coolant 8-09,9-07  
 Cruising range 02,9-06  
 Cruising range indicator 4-03,4-06  
 Cup holder 6-15

---

**D**

---

Daytime running lamps 4-13  
   Bulb capacity 8-24  
   Replacement 8-31  
 Demister (rear window) 4-18  
 Dimensions 9-03  
 Dipper (High/Low beam change) 4-13  
 Door ajar warning lamp 4-10  
 Doors  
   Central door locks 2-06  
   Child-protection 2-07

Lock and unlock 2-05  
 Driving the vehicle 5-11  
 Driving, alcohol and drugs 5-02

---

**E**

---

Economical driving 5-02  
 Electric motor switch 5-07  
 Electric motor unit  
   Warning lamp 4-11  
 Electric motor  
   Number 9-02  
   Specifications 9-04  
 Electric power steering system (EPS) 5-15  
 Electric window control 2-09  
   Driver's switches 2-09  
   Lock switch 2-09  
   Passenger's switches 2-09  
   Timer function 2-10  
 Electronic immobilizer (Anti-theft starting system) 2-02  
 Emergency starting 7-02  
 Energy level gauge 4-06  
 Energy usage indicator 4-03  
 EV charging cable 1-03  
 Exterior and interior lamp operation 8-19

---

**F**

---

Fluid capacities and lubricants 9-07  
 Fluid  
   Brake fluid 8-11,9-07  
   Coolant 8-09  
   Hot water heater fluid 8-09,9-07  
   Washer fluid 8-11,9-07  
 For cold and snowy weather 8-20  
 Front fog lamps  
   Bulb capacity 8-24  
   Indication lamp 4-09



## Alphabetical index

Replacement 8-31  
Switch 4-15  
Front room lamp  
Bulb capacity 8-24  
Front seat 3-03  
Front turn-signal lamps  
Bulb capacity 8-24  
Replacement 8-30  
Fuel  
Modification/alterations to the electrical systems 04  
Fuses 8-20  
Fusible links 8-20

---

### G

---

Gauges 4-02,4-08  
General maintenance 8-19  
General vehicle data 9-03  
Genuine parts 04  
Glove box 6-14

---

### H

---

Hazard warning flasher switch 4-15  
Hazard warning indication lamps 4-09  
Head restraints 3-07  
Headlamp levelling switch 4-13  
Headlamps  
Bulb capacity 8-24  
Headlamp flasher 4-13  
Replacement 8-24,8-28,8-29  
Switch 4-11  
Heat  
Cautions and actions to deal with intense heat 05  
Heated mirror 5-07  
Heated seat 3-04  
High-beam indication lamp 4-09

High-mounted stop lamp  
Bulb capacity 8-24  
Replacement 8-34  
Hinges and latches lubrication 8-19  
Horn switch 4-19  
Hot water heater fluid 8-09,9-07

---

### I

---

i-MiEV 02  
Cruising range 02  
Main features 02  
Traction battery 02  
If the vehicle breaks down 7-02  
Indication and warning lamps 4-08  
Indication lamps 4-09  
Inside rear-view mirror 5-05  
Inspection and maintenance following rough road operation 5-12  
Instruments 4-02  
Intense cold  
Cautions and actions 06  
Intense heat  
Cautions and actions 05  
Interior lamps 6-12

---

### J

---

Jump starting (Emergency starting) 7-02

---

### K

---

Keyless entry system 2-03  
Keys 2-02

---

### L

---

Labeling 9-02  
Lamp monitor buzzer 4-12

Lamps (headlamps, fog lamp, etc.) auto-cutout function 4-12  
Licence plate lamps  
Bulb capacity 8-24  
Replacement 8-34  
Low voltage electrical system 9-04  
Lubricants 9-07

---

### M

---

Map lamps 6-12,6-13  
Bulb capacity 8-24  
Meter illumination control 4-03,4-06  
Mirror  
Inside rear-view mirror 5-05  
Outside rear-view mirrors 5-05  
Modification/alterations to the electrical systems 04

---

### O

---

Odometer 4-03,4-04  
Oil  
Transmission oil 9-07  
Operation under adverse driving conditions 7-12  
Outside rear-view mirrors 5-05

---

### P

---

Parking 5-04  
Parking brake 5-03  
Position lamps  
Bulb capacity 8-24  
Indication lamp 4-09  
Replacement 8-30  
Power down warning lamp 4-11  
Precautions to observe when using wipers and washers 4-18  
Pregnant women restraint 3-10

## Puncture

Tyre repair kit 7-04

---

**Q**

---

Quick charging 1-08

---

**R**

---

Ready indicator 4-09

Rear combination lamps

Bulb capacity 8-24

Replacement 8-33

Rear fog lamp

Bulb capacity 8-24

Indication lamp 4-09

Replacement 8-32

Switch 4-15

Rear room lamp

Bulb capacity 8-24

Rear seat 3-05

Rear turn-signal lamps

Bulb capacity 8-24

Replacement 8-30,8-33

Rear window demister switch 4-18

Rear-view mirror

Inside 5-05

Outside 5-05

Refill capacities 9-07

Regenerative braking 02

Regular charging 1-04

Replacement of lamp bulbs 8-23

Reversing lamps

Bulb capacity 8-24

Replacement 8-33

Roof carrier precaution 5-19

Room lamp (front) 6-12

Room lamp (rear) 6-13

---

**S**

---

Safe driving techniques 5-03

Seat belt 3-08

Child restraint 3-11

Force limiter 3-11

Inspection 3-20

Pregnant women restraint 3-10

Pretensioner 3-11

Seat belt reminder/warning lamp (for driver and front passenger) 3-09

Warning lamp (for rear passenger) 3-10

Seats

Adjustment 3-03

Front seat 3-03

Head restraints 3-07

Heated seat 3-04

Rear seat 3-05

Secret box 6-14

Selector lever 5-09

Service precaution 8-06

Service reminder 4-03,4-04

Side turn-signal lamps

Bulb capacity 8-24

Replacement 8-30,8-33

Snow tyres 8-16

Specifications 9-02

Speedometer 4-02

Starting the electric motor unit 5-08

Steering wheel lock 5-08

Stop lamps

Bulb capacity 8-24

Replacement 8-33

Storage spaces 6-14

Glove box 6-14

Secret box 6-14

Sun visors 6-10

Supplemental restraint system 3-20

Servicing 3-30

Warning lamp 3-29

---

**T**

---

Tail lamps

Bulb capacity 8-24

Replacement 8-33

Tailgate 2-08

Towing 7-10

Traction battery 02

Transmission 5-09

Driving the vehicle 5-11

Selector lever 5-09

Selector lever position indicator 5-10

Tripmeter 4-03,4-04

Turn-signal indication lamps 4-09

Turn-signal lever 4-14

Tyre repair kit 7-04

Tyres 8-14

Inflation pressures 8-15

Size (tyre and wheel) 9-05

Snow tyres 8-16

Tread wear indicators 8-16

Tyre chains 8-17

Tyre repair kit 7-04

Tyre rotation 8-16

---

**V**

---

Vanity mirror 6-10

Vehicle care precautions 8-02

Vehicle dimensions 9-03

Vehicle identification number 9-02

Vehicle information code plate 9-02

Vehicle labeling 9-02

Ventilators 6-02

---

**W**

---

- Warning lamps 4-09
- Washer
  - Fluid 8-11,9-07
  - Switch 4-16,4-17
- Washing 8-03
- Waxing 8-04
- Weatherstripping 8-20
- Wheel
  - Specification 9-05
- Wiper
  - Rear window 4-17
  - Windscreen 4-16
  - Wiper blades 8-17

**OMRON**

OMRON Corporation  
3-3-1 NISHIZAKA, OHSU, KUMAKI-CITY,  
AICHI 464-0862, JAPAN  
PHONE: 81-564-264116  
FAX: 81-564-264334

## DECLARATION OF CONFORMITY

We, **OMRON Corporation, AUTOMOTIVE ELECTRONIC COMPONENTS COMPANY** hereby declare, at our sole responsibility, that the following product conforms to the Essential Requirements of the Radio and Telecommunications Terminal Equipment Directive 1999/5/EC, in accordance with the tests conducted to the appropriate requirements of the relevant standards, as listed herewith.

**Product** : Keyless Entry System for vehicle

**Model/ Type Number** : G8C-930M, G8C-931M, G8C-932M for receiver and immobilizer  
: G8D-571M-A for transmitter

Directive and Standards used as appropriate : **Radio** : EN 300 220-1 V2.1.1  
EN 300 220-2 V2.1.2  
EN 300 330-1 V1.3.2 <sup>\*)</sup>  
EN 300 330-2 V1.3.1 <sup>\*)</sup>  
**EMC** : EN 301 489-1 V1.8.1 <sup>\*)</sup>  
EN 301 489-1 V1.6.1 <sup>\*)</sup>  
EN 301 489-3 V1.4.1  
**Safety** : EN 60065:2002+Amd.1:2006+Amd.11:2008 <sup>\*)</sup>  
EN 60065:2002+Amd.1:2006 <sup>\*)</sup>

<sup>\*)</sup> except G8C-931M

<sup>\*)</sup> except G8D-571M-A <sup>\*)</sup> only G8D-571M-A

Year of affixing CE marking : 2010

Signature : *Fumio Hayashi*

Name : Fumio Hayashi

Title and position : Manager  
DEVELOPMENT STRATEGY DEPT.  
DEVELOPMENT & DESIGN DIV.

Date : March 24, 2010

# CE 1731











