

OUTLANDER
OWNER'S MANUAL
2003



Table of contents

Overview

Quick index

<i>General information</i>	1
<i>Seat and restraint systems</i>	2
<i>Features and controls</i>	3
<i>Driving safety</i>	4
<i>Comfort controls</i>	5
<i>For emergencies</i>	6
<i>Vehicle care and maintenance</i>	7
<i>Customer assistance/Reporting safety defects</i>	8
<i>Specifications</i>	9

Instruments and controls

Fog light switch (if so equipped) P.3-64

Combination headlights and dimmer switch P.3-61
Turn signal lever P.3-63

Supplemental restraint system-air bag (for driver's seat) P.2-35
Turn switch P.3-70

Electric remote controlled outside mirror switch P.3-26



Instrument panel light dimmer control dial P.3-65

Brake pedal release lever P.3-4

Personal box P.3-79
Fuses P.7-31

Instrument cluster P.3-53

Wiper and washer switch P.3-66
Rear window wiper and washer switch P.3-68

4 cruise control lever P.3-46

Ignition switch P.3-27

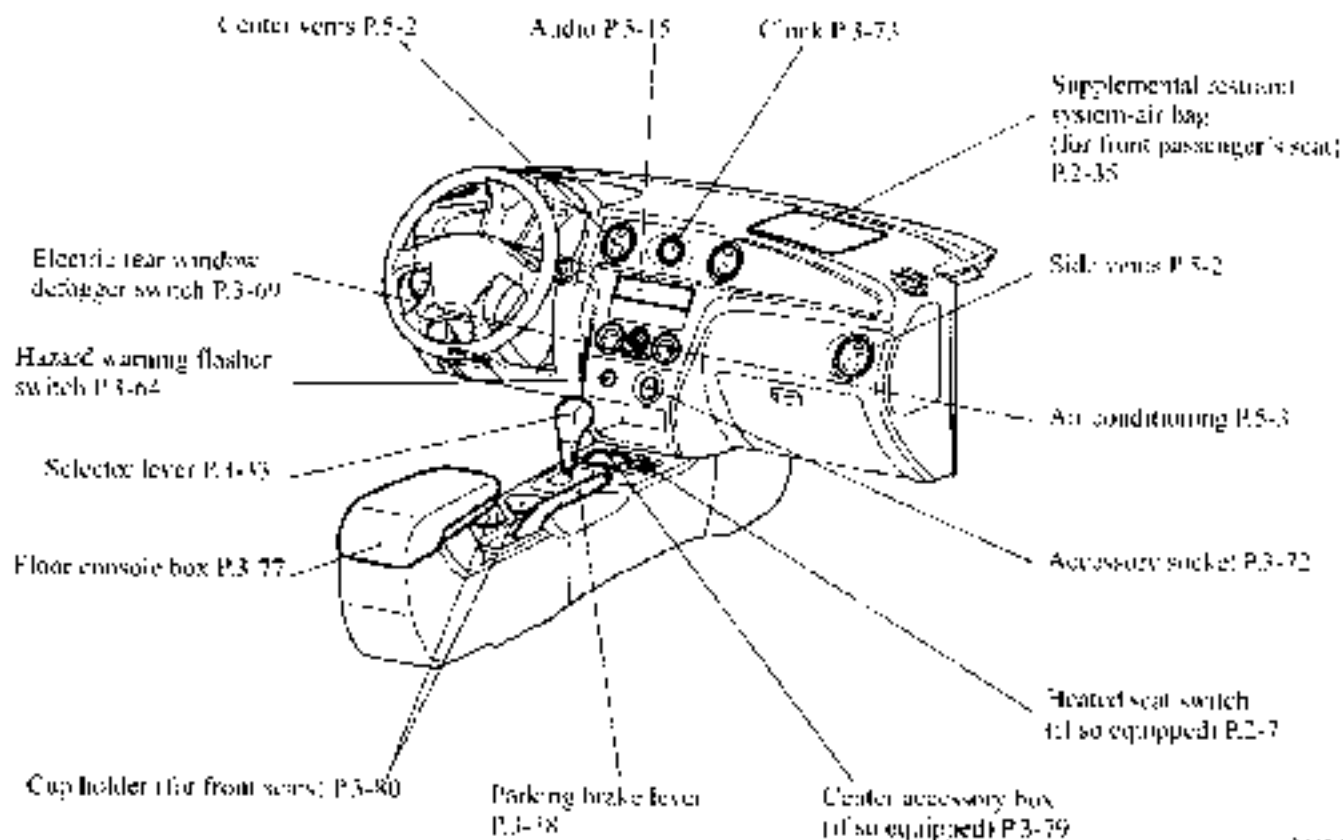

Interior

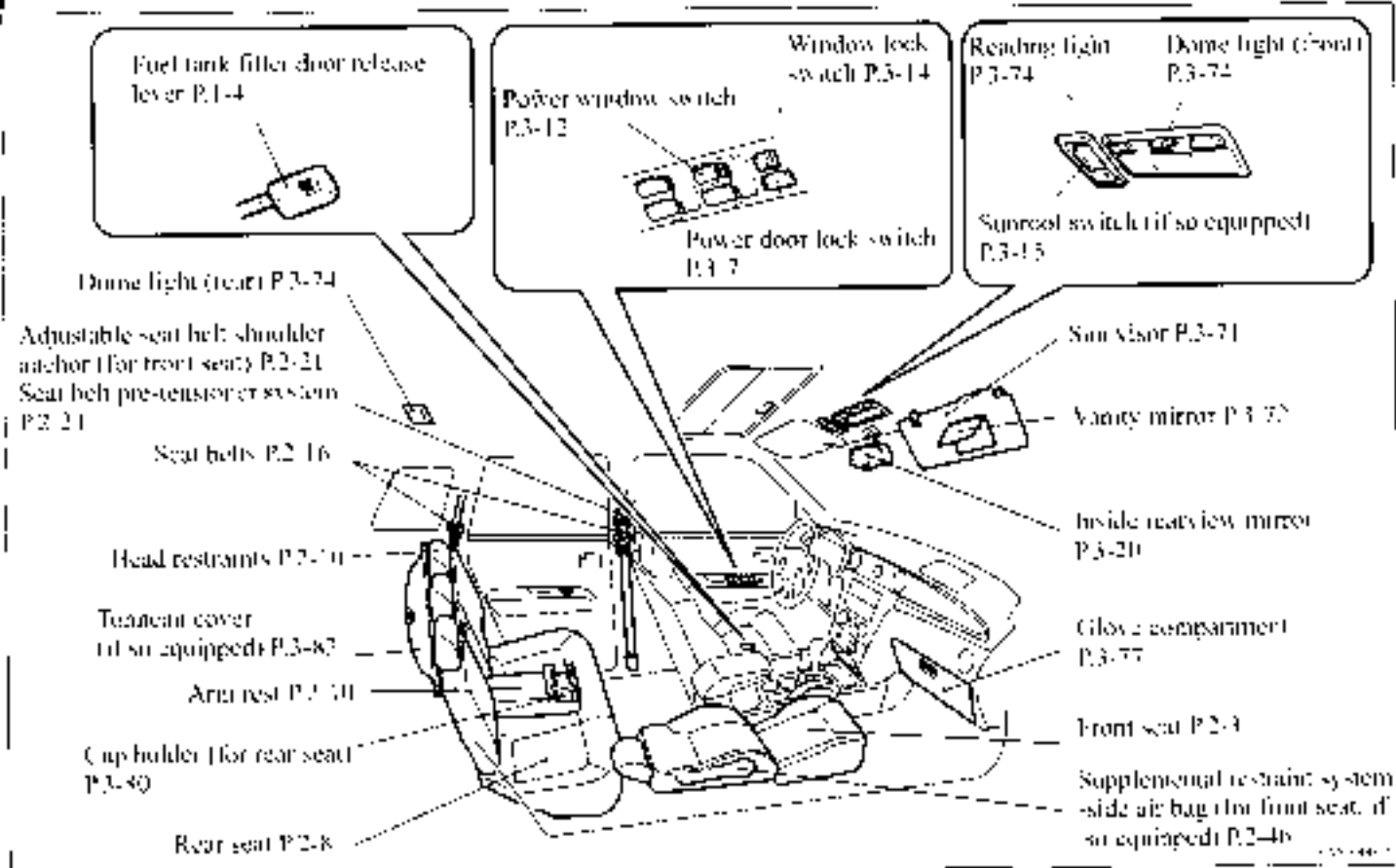

Luggage area

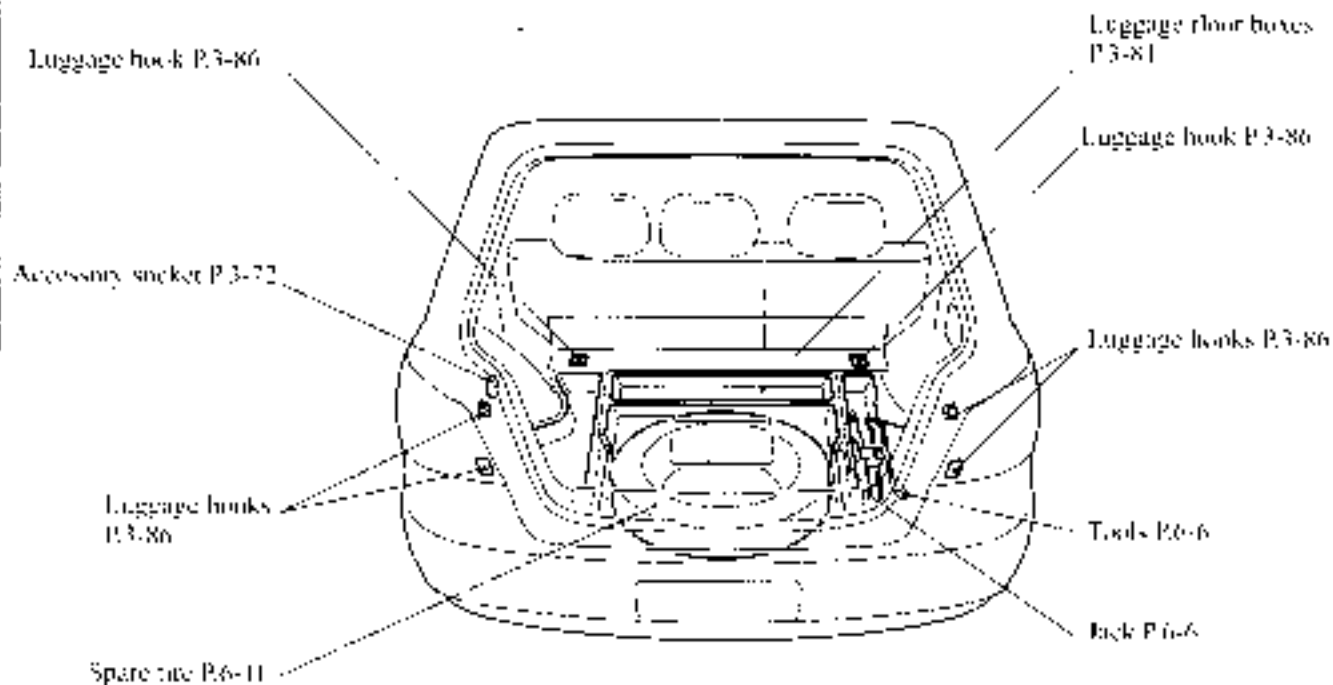

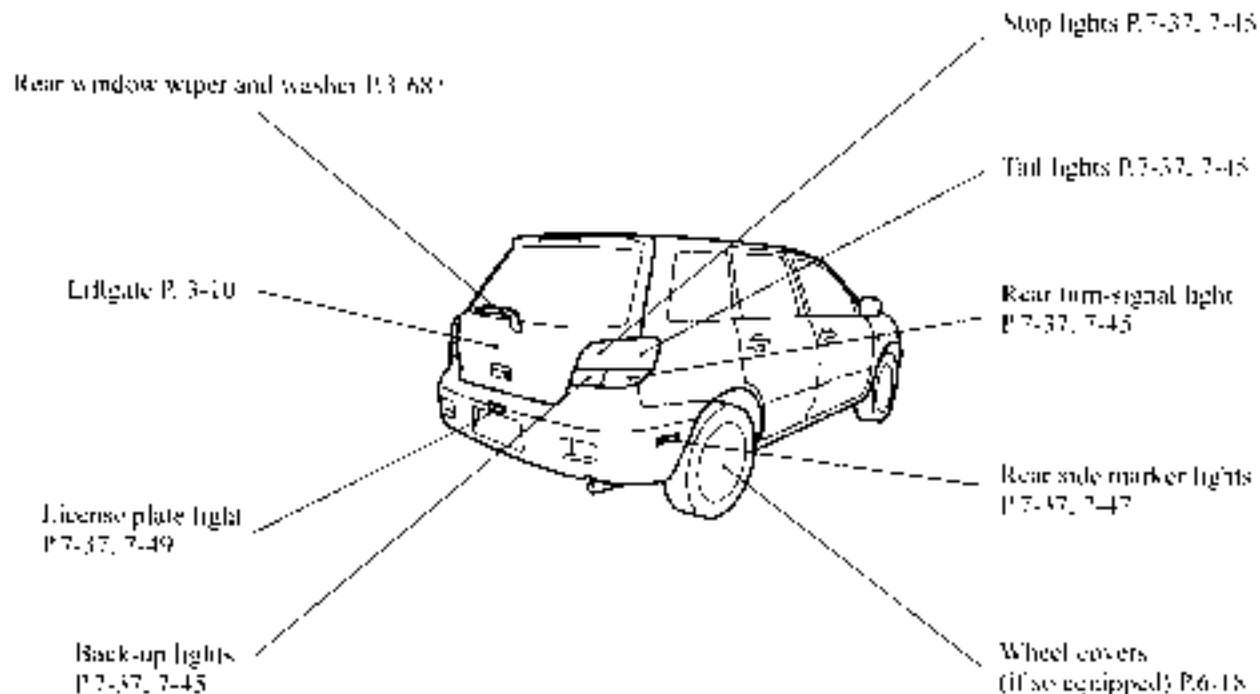





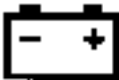

If this warning light comes on or flashes while you're driving...

P. 3-59

NOTE

- These warning lights will come on for a few seconds for a bulb check when the ignition key is first turned to "ON."

Warning light	Do this	Ref. page
 Charging system warning light	<ul style="list-style-type: none"> ● Park your vehicle in a safe place and stop the engine. Contact an authorized Mitsubishi dealer for assistance. 	P. 3-59
 Oil pressure warning light	<ul style="list-style-type: none"> ● Park your vehicle in a safe place and stop the engine, then check the engine oil level. If the light comes on while the engine oil level is normal, have the system checked at an authorized Mitsubishi dealer as soon as possible. 	P. 3-60
BRAKE or  Brake warning light	<ul style="list-style-type: none"> ● If this light comes on while driving, check to see that the parking brake is fully released. ● If this light stays on after releasing the parking brake, stop and check the brake fluid level. ● If the brake fluid level is correct, contact an authorized Mitsubishi dealer for assistance. 	P. 3-58
A/T TEMP Automatic transaxle oil temperature warning light	<ul style="list-style-type: none"> ● Park your vehicle in a safe place. Idle the engine until the warning light goes off. If the light does not go off, have the system checked at an authorized Mitsubishi dealer as soon as possible. 	P. 3-55

Warning light	Do this	Ref. page
<p>SERVICE ENGINE SOON or </p> <p>Malfunction indicator light ("SERVICE ENGINE SOON" or "Check engine light")</p>	<ul style="list-style-type: none"> ● Although your vehicle will usually be drivable and not need towing, have the engine system checked at an authorized Mitsubishi dealer as soon as possible. If the vehicle is not drivable, contact Emergency Roadside Service (ERS), an authorized Mitsubishi dealer, or local towing company for assistance. 	P.3-39
<p>ANTI LOCK or </p> <p>Anti-lock braking system warning light (if so equipped)</p>	<ul style="list-style-type: none"> ● Park your vehicle in a safe place and stop the engine. Test the system as described on page 3-43. ● If the light does not go out after the test, or if it comes on again, it is not necessary to stop the vehicle immediately but we recommend that you have the system checked at an authorized Mitsubishi dealer as soon as possible. ● When this light comes on, the anti-lock braking system is not functioning and only the ordinary braking system is functioning. 	P.3-43
<p>SRS</p> <p>SRS air bag warning light</p>	<ul style="list-style-type: none"> ● It is not necessary to stop the vehicle immediately, but we recommend that you have the air bag system checked at an authorized Mitsubishi dealer as soon as possible. 	P.2-52
<p></p> <p>"N" indicator light in the instrument cluster flashes slowly</p>	<ul style="list-style-type: none"> ● Have the automatic transaxle checked at an authorized Mitsubishi dealer as soon as possible. 	P.3-35

If you hear this sound...

P. 5-6-1



P. 5-6-2



Sound	Do this	Ref. page
Constant buzzer when the driver's door is opened.	<p>"Key reminder buzzer" A buzzer will sound if the driver's door is opened while the ignition key is in the "LOCK" or "ACC" position. Remove the key to stop the buzzer. OR</p> <p>"Headlight reminder buzzer" A buzzer will sound if the driver's door is opened when the ignition key is in the "LOCK" or "ACC" position. This buzzer will also sound if the ignition key is removed while the lights are on. Turn the lights off. The buzzer will stop automatically when the lights are automatically turned off. (See page 3-61 for auto-cutoff function.)</p>	<p>P. 5-7</p> <p>P. 5-6.2</p>

Quick Index

Sound	Do this	Ref. page
Metallic squeal when you press the brake pedal while driving.	"Brake pad wear alarm" The brake pads are worn down to the serviceable limit. Have the brake pads replaced at an authorized Mitsubishi dealer.	P.3-42

If this problem occurs...

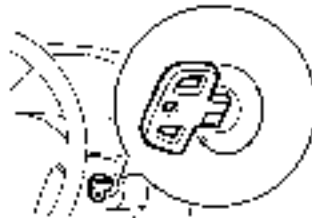
No. 1000

Problem	Do this	Ref. Page
<p>Cannot turn the key.</p> 	<p>From "LOCK" to "ACC" Turn the key while toggling the steering wheel in either direction.</p> <p>From "ACC" to "LOCK" Check the position of the selector lever. The key cannot be removed unless the selector lever is set to the "P" (PARK) position.</p>	P. 1-77
<p>Cannot shift the selector lever from the "P" (PARK) position. The windows are fogged in.</p>	<p>Shift the selector lever while pressing the brake pedal. Check that the ignition key is in the "ON" position.</p>	P. 3-33
	<ol style="list-style-type: none"> 1. Set the mode selection dial to the "OFF" or "ON" position. 2. Turn on the blower. 	P. 5-22
<p>The engine does not start. The lights do not come on. The lights are dim. The horn does not work. The horn sound is weak.</p>	<p>Have the battery checked. Recharge or replace as needed.</p>	P. 7 P. 7-16

Problem	Do this	Ref. page
<p>The engine coolant temperature gauge indicator is at the "H" (hot) position. Steam comes out of the engine compartment.</p> 	<p>The engine is overheated. Carefully stop the vehicle in a safe place.</p>	<p>P. 5</p>
<p>The vehicle is stuck in sand, mud, or snow.</p>	<p>Move the selector lever rhythmically between "Sport Mode" and "R" (REVERSE) positions, while pressing lightly on the accelerator pedal.</p>	<p>P. 25</p>

⚠ WARNING

- When attempting to rock your vehicle out of a stuck position, be sure that no one is near the vehicle. The rocking motion may cause the vehicle to suddenly lurch forward or backward, possibly injuring bystanders.
 - Avoid revving the engine or spinning the wheels. Prolonged efforts to free a stuck vehicle may result in overheating and transaxle failure.
- If the vehicle remains stuck after several rocking attempts, have a towing service pull the vehicle out.

Problem	Do this	Ref. page
The brakes are not functioning properly after crossing a puddle or stream.	Dry out the brakes by driving slowly while lightly pressing the brake pedal.	P 3-20
The automatic transaxle does not shift when accelerating and/or the vehicle does not easily begin to move.	There may be a problem in the automatic transaxle. Have the vehicle inspected by an authorized Mitsubishi dealer. Shift the lever into 2nd gear of the sport mode when starting the vehicle. If the vehicle is on a level road, shift the lever back to "D" (DRIVE) position.	P 3-38
<p data-bbox="119 344 319 369">A tire is punctured</p> 	<ol style="list-style-type: none"> <li data-bbox="478 448 1197 476">1. Park the vehicle in a safe place where the surface is flat and level. <li data-bbox="478 481 925 509">2. Replace the flat tire with the spare tire. 	P 15-14

General information

Fuel selection	1- 2
Filling the fuel tank	1- 4
Installation of accessories	1- 6
Modification/alterations to the electrical or fuel systems	1- 7
Mitsubishi genuine parts	1- 8
Used engine oils safety instructions	1- 8

Fuel selection

Your vehicle is designed to use unleaded gasoline only. It is equipped with a fuel filler pipe especially designed to accept only a small diameter unleaded gasoline dispensing nozzle.

⚠ WARNING

- Gasoline is highly flammable and explosive. You could be burned or seriously injured when handling it. When refueling your vehicle, always turn the engine off and keep away from flames, sparks, and smoking materials. Always handle fuel in well-ventilated outdoor areas.

⚠ CAUTION

- Using leaded gasoline in your vehicle will damage the engine, catalytic converter, and the oxygen sensors. Also, using leaded gasoline is illegal, and will void your warranty coverage of the engine, catalytic converter, and oxygen sensors.

Gasoline additives

Many fuel suppliers add detergents to their gasoline to minimize fuel injector fouling and to control intake valve deposits. These detergent gasolines are highly recommended for use in your vehicle. They help keep your engine in tune and your emission control system working properly.

Octane requirement

Your vehicle is designed to operate on unleaded gasoline having a minimum octane rating of 87 [(MON+RON)/2] or 91 RON.

MON: Motor Octane Number

RON: Research Octane Number

Oxygenated gasoline

Gasoline sold at some service stations may contain oxygenates such as ethanol, methanol, and MTBE (Methyl Tertiary Butyl Ether), although they may not be identified by those names. Oxygenates are required in some areas of the country. Fuels blended with these oxygenates may be used in your vehicles.

Ethanol (Gasohol)

A mixture of 10% ethanol (grain alcohol) and 90% unleaded gasoline may be used in your vehicle, provided the octane rating is at least as high as that recommended for unleaded gasoline.

Methanol

Do not operate your vehicle on gasoline containing methanol (wood alcohol). The use of this type of alcohol can result in vehicle performance problems and could damage critical fuel system parts.

MTBE (Methyl Tertiary Butyl Ether)

A mixture of unleaded gasoline and 15% or less MTBE may be used in your vehicle provided the octane rating is at least as high as that recommended for unleaded gasoline.

Fuel containing more than 15% MTBE may cause reduced vehicle performance, vapor lock, or difficulty in starting.

Reformulated gasoline

Many areas of the country require the use of cleaner burning fuel referred to as "Reformulated Gasoline".

Reformulated gasolines contain oxygenates, and are specially blended to reduce vehicle emissions and improve air quality.

Mitsubishi strongly supports the use of reformulated gasolines. Properly blended reformulated gasolines should have no adverse effects on vehicle performance or the durability of engine and fuel system components.

MMT

MMT is a manganese-containing metallic additive that is blended into some gasolines to increase the octane number. Gasolines blended with MMT offer no performance advantage over gasolines of the same octane number that do not contain MMT. Gasolines blended with MMT may adversely affect the spark plug and emission systems.

Mitsubishi Motors Corporation recommends using gasolines without MMT.

Sulfur in gasoline

Your vehicle may have been designed to meet California low emission standards based on clean burning low sulfur gasoline. Gasoline sold outside of California is allowed to have higher sulfur levels that may affect the performance of your vehicle's catalytic converter. This may cause the engine malfunction indicator light ("SERVICE ENGINE SOON" or "Check engine light") to come on.

Seeing this light while operating on high sulfur gasoline does not necessarily mean your emission control system is malfunctioning. If this happens, your authorized Mitsubishi dealer may recommend that you try using a different brand of unleaded

gasoline having a lower sulfur content to determine if the problem is fuel related.

NOTE

- Poor quality gasoline can cause problems such as difficulty in starting, stalling, engine noise and hesitation. If you experience these problems, try another brand and/or grade of gasoline.

If the engine malfunction indicator light ("SERVICE ENGINE SOON" or "Check engine light") is flashing, have the system checked as soon as possible at an authorized Mitsubishi dealer.

Filling the fuel tank

SAFARI 4x4

⚠ WARNING

- Gasoline is highly flammable and explosive. You could be burned or seriously injured when handling it. When refueling your vehicle, always turn the engine off and keep away from flames, sparks, and smoking materials. Always handle fuel in well-ventilated outdoor areas.

Fuel tank capacity

15.7 gal (59.5 L)

Refueling

1. Before filling with fuel, stop the engine.
2. The fuel tank filler is located on the rear driver side of your vehicle.

The fuel tank filler door can be opened from inside the vehicle with the fuel tank filler door release lever located at the left side of the driver's seat.

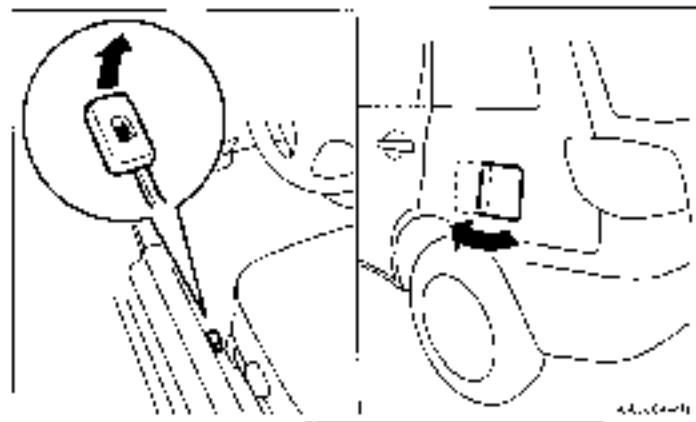

3. Open the fuel tank filler pipe by slowly turning the cap counterclockwise.

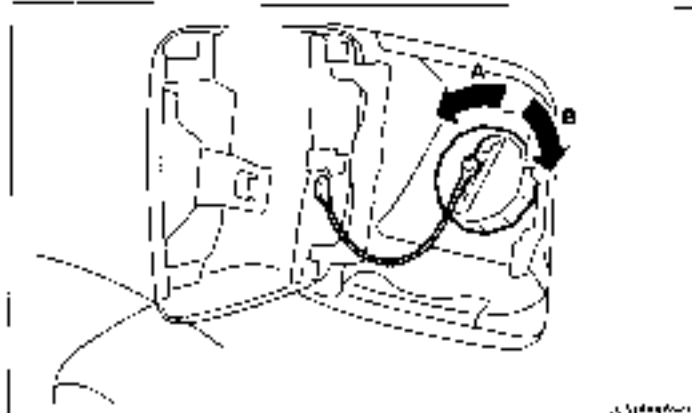

- A- Remove
B- Close

⚠ CAUTION

- Since the fuel system may be under pressure, remove the fuel tank filler pipe cap slowly. This relieves any pressure or vacuum that might have built up in the fuel tank. If the cap is venting vapor or if you hear a hissing sound, wait until it stops before removing the cap. Otherwise, fuel may spray out, injuring you or others.

4. To fill with fuel correctly depends mainly on correct handling of the fuel filler nozzle. Do not hit the nozzle. Insert the nozzle in the tank port as far as it goes.

⚠ CAUTION

- Your vehicle can only be operated using unleaded gasoline. Serious engine and catalytic converter damage will result if leaded gasoline is filled into these vehicles, and consequently, this must never be attempted.

5. When the nozzle stops automatically, move it half way out of the filler pipe. After the second automatic stop, do not try to add more fuel.

⚠ CAUTION

- To avoid fuel spillage and overfilling, do not "top-off" the fuel tank.

6. To close, turn the fuel tank filler pipe cap slowly clockwise until you hear clicking sounds, then gently push the fuel tank filler door closed.

⚠ CAUTION

- If you need to replace the fuel tank filler pipe cap, use only the cap specified for your model vehicle.

NOTE:

- If the fuel tank filler pipe cap is not tight while driving, the malfunction indicator light ("SERVICE ENGINE SOON" or "Check engine light") may come on when the onboard diagnostic (OBD) system performs a self-check. Always tighten the fuel tank filler pipe cap until you hear at least 3 clicks. The indicator light will go off after driving several times. If the indicator light does not go off, contact your authorized Mitsubishi dealer as soon as possible.

Installation of accessories

⚠ CAUTION

- Before any electrical or electronic accessories are installed, consult an authorized Mitsubishi dealer.

- The installation of accessories, optional parts, etc., should only be carried out within the limits prescribed by law, and in accordance with the guidelines and warnings contained within the documents accompanying this vehicle. Only Mitsubishi approved accessories should be fitted to your vehicle.
- Improper installation of electrical parts could cause fire. Refer to the "Modification Alteration to the electrical or fuel systems" section within this owner's manual.
- Using a cellular phone or radio set inside the vehicle without an external antenna may cause electrical system interference, which could lead to unsafe vehicle operation.
- Tires and wheels which do not meet specifications must not be used. Refer to the "Specifications" section for information regarding wheel and tire sizes.

⚠ WARNING

- If you use a cellular phone while driving, keep your attention on your driving, in order to reduce risk of accidents. Refer to state and local laws for cellular phone usage regulations.

Important point!

Due to the large number of accessory and replacement parts of different manufacturers in the market, it is not possible for an authorized Mitsubishi dealer to check whether the attachment or installation of non-Mitsubishi genuine parts affects the driving safety of your Mitsubishi-vehicle.

Modification/alterations to the electrical or fuel systems

Mitsubishi has always manufactured safe, high quality vehicles. In order to maintain this safety and quality, it is important that any accessory that is to be fitted, or any modifications carried out which involve the electrical or fuel systems, should be carried out in accordance with Mitsubishi guidelines.

⚠ CAUTION

- Please consult an authorized Mitsubishi dealer concerning any such fitment or modification. If the wires interfere with the vehicle body or improper installation methods are used (protective fuses not included, etc.), electronic devices may be adversely affected, resulting in a fire or other accident.

Mitsubishi genuine parts

MS-00000007

Mitsubishi Genuine Parts are designed and manufactured to meet high standards of performance, and are recommended for all of your maintenance needs. Also available from your Mitsubishi Motors dealer are a wide variety of accessories to personalize your new vehicle. Each Mitsubishi vehicle has a selection of Mitsubishi authorized accessories to choose from to tailor your new vehicle to your own personal preference. Your Mitsubishi Motors dealer's Parts Manager has information on various audio systems, protection items, as well as interior and exterior accessories available for your specific model.

Used engine oils safety instructions

MS-00000007

WARNING

- Prolonged and repeated contact may cause serious skin disorders, including dermatitis and cancer.
- Avoid contact with the skin as far as possible and wash thoroughly after any contact.
- Keep out of reach of children.

Seat and restraint systems

Seats	2- 2
Seats and restraint systems	3- 3
Front seats	2- 3
Rear seats	2- 8
Head restraints	2- 10
Making a flat seat	2- 12
Seat belts	2- 16
Pregnant women restraint	2- 23
Seat belt pre-tensioner system and force-limiter system	2- 24
Child restraints	2- 25
Maintenance and inspection of seat belts	2- 34
Supplemental Restraint System (SRS)-air bag	2- 35

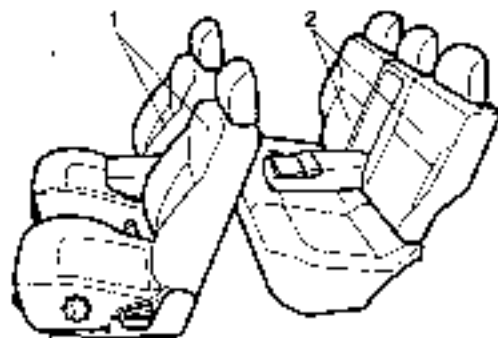
Seats**1 - Front seat**

- To adjust the seat forward or backward → P.2-4
- To adjust the seatback → P.2-5
- To adjust the seat height (Driver's side only) → P.2-6
- To adjust the lumbar support (Driver's side only, if so equipped) → P.2-6
- Heated seats (if so equipped) → P.2-7

2 - Rear seat

- To adjust the seatbacks → P.2-8
- Fold down the rear seatbacks → P.2-9
- Arm rest → P.2-10

Seats and restraint systems

2-2-1000

Your vehicle has seat belts and other features that help protect you and your passengers in an accident.

Seat belts are the most important safety device. When worn properly, seat belts can reduce the chance of serious injury or death in various types of crashes. For added protection during a severe frontal collision, your vehicle has a Supplemental Restraint System (SRS) with air bags for the driver and front seat passenger. The seats, head restraints, and door locks also are safety equipment, which must be used correctly.

Always check the following before you drive:

- That everyone in your vehicle is properly wearing their seat belt.
- That infants and small children are properly secured in appropriate child restraints in the rear seat.
- That all doors are fully closed and locked.
- That seatbacks are upright, with head restraints properly adjusted.

No safety equipment can prevent all injuries or deaths that could occur in a severe collision. You can help reduce the risk of injury by making sure that all your passengers follow the instructions in this manual.

Front seats

2-2-1000

Make sure the driver's seat is positioned as far back as possible to a position that still enables you to fully apply the pedals, easily control the steering wheel and safely operate the vehicle. Make sure you have a clear view out front.



2-2-1000

Seats and restraint systems

2008-2010

Your vehicle has seat belts and other features that help protect you and your passengers in an accident.

Seat belts are the most important safety device. When worn properly, seat belts can reduce the chance of serious injury or death in various types of crashes. For added protection during a severe frontal collision, your vehicle has a Supplemental Restraint System (SRS) with air bags for the driver and front seat passenger. The seats, head restraints, and door locks also are safety equipment, which must be used correctly.

Always check the following before you drive:

- That everyone in your vehicle is properly wearing their seat belt.
- That infants and small children are properly secured in appropriate child restraints in the rear seat.
- That all doors are fully closed and locked.
- That seatbacks are upright, with head restraints properly adjusted.

No safety equipment can prevent all injuries or deaths that could occur in a severe collision. You can help reduce the risk of injury by making sure that all your passengers follow the instructions in this manual.

Front seats

2008-2010

Make sure the driver's seat is positioned as far back as possible to a position that still enables you to fully apply the pedals, easily control the steering wheel and safely operate the vehicle. Make sure you have a clear view out front.

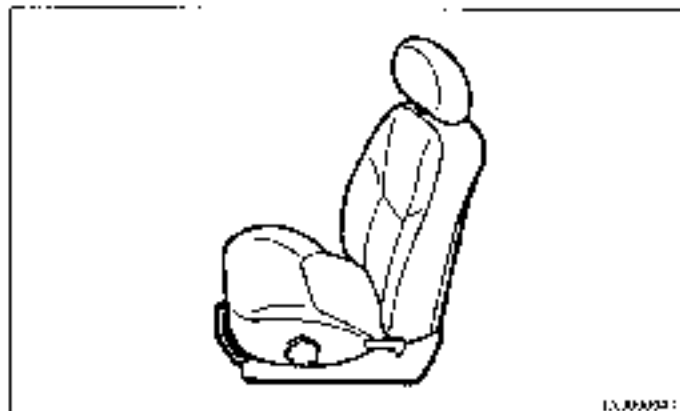

10-00000-1

⚠ WARNING

- Do not attempt to adjust the seat while driving. This can be dangerous.
- After adjusting the seat, make sure that it is securely locked into position.
- The seat must be adjusted by an adult. A child will not be able to lock it properly.
- In order to reduce the risk to passengers of serious or fatal injury in a collision, especially from the front passenger air bag, move the front passenger seat as far back as possible. Children 12 years old and under should ride restrained in the rear seat. Children in rear-facing child restraints **MUST** ride in the rear seat.
- In order to reduce the risk to the driver of serious or fatal injury in an accident, especially from the driver's air bag, move the driver's seat as far back as possible, while still maintaining good frontal visibility and good control of the steering wheel, accelerator and brake pedals.

To adjust the seat forward or backward

Pull the seat adjusting lever up and slide the seat forward or backward to the desired position. Release the adjusting lever to lock the seat in place.

**⚠ WARNING**

- To make sure that the seat is securely locked, try to move it forward or backward without using the adjusting lever.

To adjust the seatback

To adjust the seatback, lean forward slightly, gently pull the seatback lock lever up, then lean backward to a comfortable position and release the lever. The seatback will lock in place.

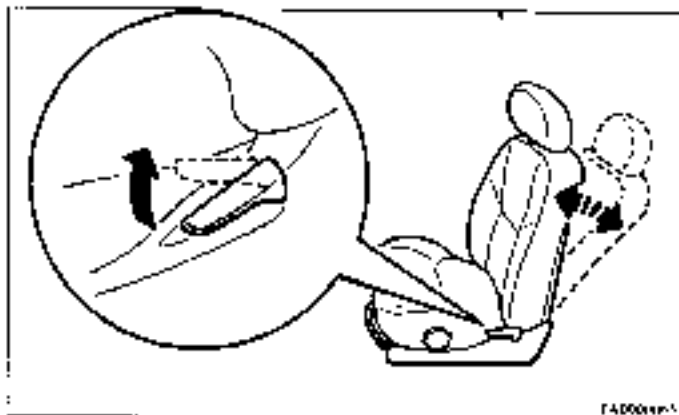

⚠ WARNING

- To reduce the risk of severe or fatal personal injury in the event of a collision or sudden stop, both the driver and all passenger seatbacks should always be kept in the upright position whenever the vehicle is in motion.

The seat belts cannot protect you if the seatbacks are reclined. The more the seatback is reclined, the more the seat belts will not be properly positioned against your body and/or the risk you will slide under the belt in an accident, resulting in severe or fatal injury.

2

⚠ CAUTION

- To return the seatback to its original position, pull the seatback lock lever. When pulling this lever, sit close to the seatback or hold it with your hand to control its return motion.

To adjust the seat height (Driver's side only)

Turn the dial to raise or lower the whole seat cushion.

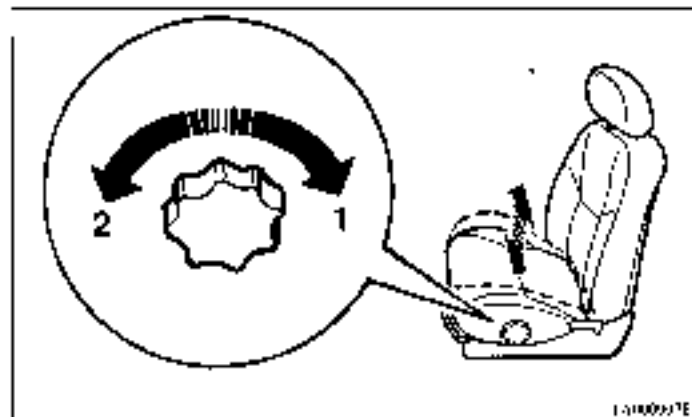

- 1- Raise
- 2- Lower

To adjust the lumbar support (Driver's side only) (if so equipped)

A lumbar support is included in the seatback of the driver's seat.

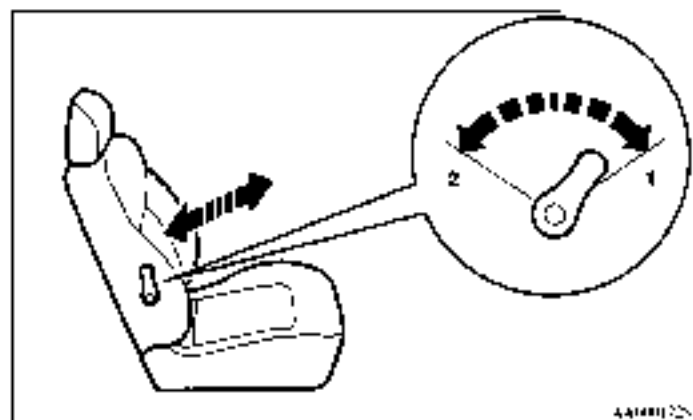

- 1- Strong
- 2- Weak

Heated seats (if so equipped)

The heated seats can be operated when the ignition key is in the "ON" position.

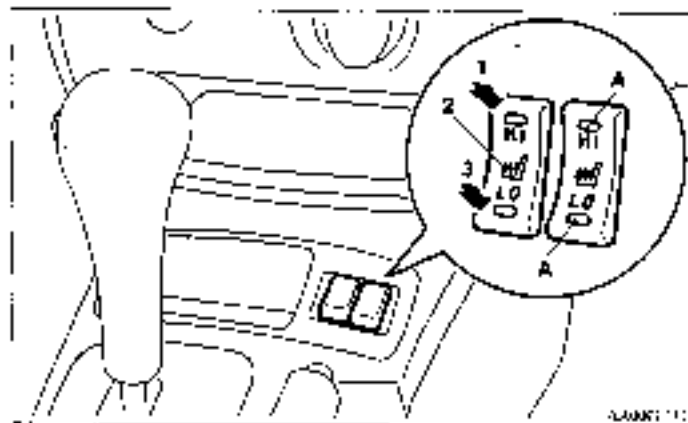

- 1- Heater high (for quick heating)
- 2- Heater off
- 3- Heater low (to keep the seat warm)

The indicator light (A) will illuminate while the heater is on.

⚠ CAUTION

- Switch off the seat heaters when not in use. Operate the heaters at high for quick heating. After the seat has become warm, set the heater to low to keep it warm. Slight variations in the seat temperature may be felt while using the heated seats. This is caused by the operation of the heater's internal thermostat and does not indicate a malfunction.
- If the following types of persons use the heated seats, they might become too hot or receive minor burns (red skin, heat blisters, etc.):
- Children, elderly persons, ill persons
 - Person with sensitive skin
 - Excessively fatigued persons
 - Persons under the influence of alcohol or sleep-inducing medication (cold medicine, etc.)

⚠ CAUTION

- Do not place heavy objects on the seat or stick pins, needles, or other pointed objects into it.

Do not use a blanket, cushion, or other material with high heat insulation properties on the seat while using the heater; doing so could cause the heater element to overheat.

When cleaning the seat, do not use benzene, gasoline, alcohol, or other organic solvents; doing so could damage not only the surface of the seat, but also the heater.

If water or any other liquid is spilled on the seat, allow it to dry thoroughly before attempting to use the heater. Turn the heater off immediately if it appears to be malfunctioning during use.

Rear seats

VA010011

To adjust the seatbacks

To adjust the seatback, lean forward slightly, gently pull the seatback lock knob, then lean backward to a comfortable position and release the knob. The seatback will lock in place.

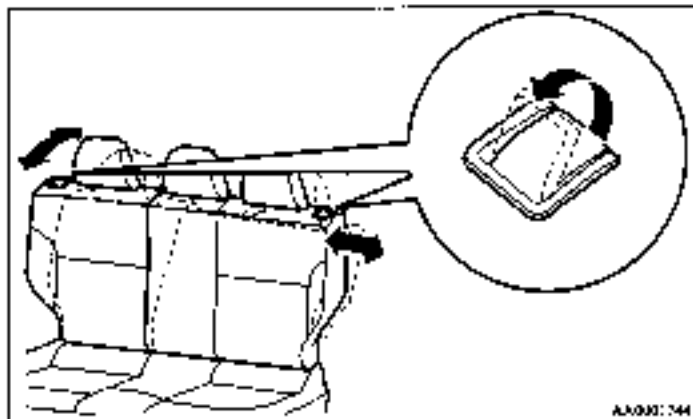

AA001744

Fold down the rear seatbacks

SAAB0401-1

The rear seatbacks can be folded forward to provide additional luggage compartment space.

Push the left and/or right release knobs, and fold the rear seatbacks forward.

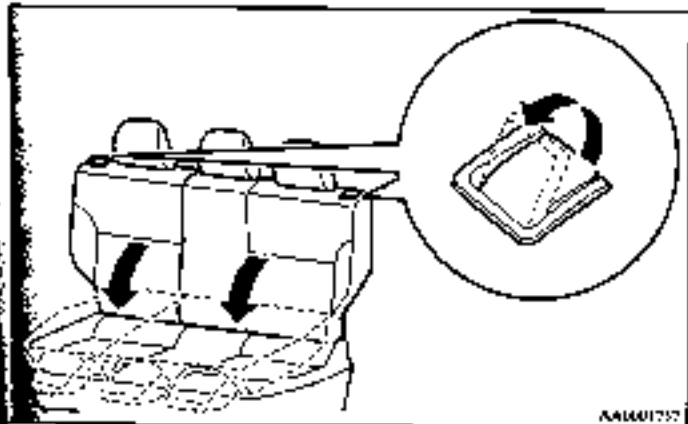

AA1401757

NOTE

- Confirm that the seatback locks securely when it is returned.

⚠ WARNING

- The luggage compartment in the rear of the vehicle should never be used as a play area for children. Children should always be seated in the rear seat in an appropriate child restraint with the seat belts fastened when the vehicle is in motion. Be sure that the rear seatbacks are in their fully upright position and locked in place.

⚠ CAUTION

- Do not load luggage higher than the top of the seatback. Be sure that luggage is firmly secured. Otherwise, restricted rear vision or the luggage being thrown inside the passenger compartment during sudden braking could result in a serious accident or injury.

NOTE

- You can store the tonneau cover in the luggage floor box when not in use. Refer to the "Tonneau cover" on page 3-83.

Seat and restraint systems

Arm rest

Tilt the arm rest down for use as shown.
The arm rest includes a cup holder.

2-0020000-00

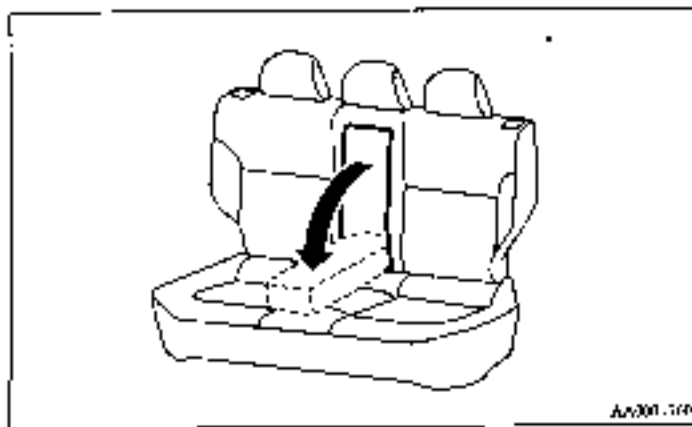

A0001100

Head restraints

2-0020000-00

Padded head restraints for the seats may reduce the risk of a whiplash injury if your vehicle is hit from the rear.

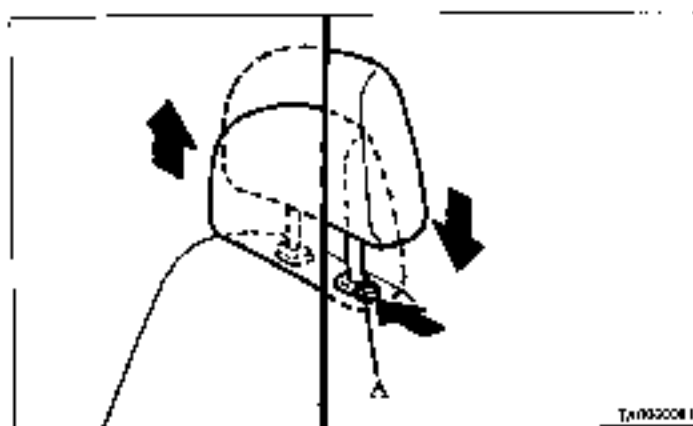

T0020001

Adjustment of the head restraint height

To reduce the risk of injury in the event of a collision, adjust the head restraint height so that the center of the restraint is as close as possible to your eye level when seated. Any person too tall for the restraint to reach their eye level when seated should raise the restraint as high as possible.

- To raise the restraint, pull it straight up.
- To lower the restraint, push down on it while pressing the lock knob (A) in the direction shown by the arrow.
- After adjusting the height, push down on the restraint to make sure that it is locked in position.

⚠ WARNING

- Failure to have the head restraints properly mounted and adjusted may increase the chance of injury in the event of a collision.
- A cushion or similar device should not be placed on the seatback as it may increase the distance between your head and the head restraint and reduce the effectiveness of the restraint.

To remove

To remove the head restraints, press the lock knob (A) in the direction shown by the arrows. Then pull the head restraints up and out of the seatbacks.

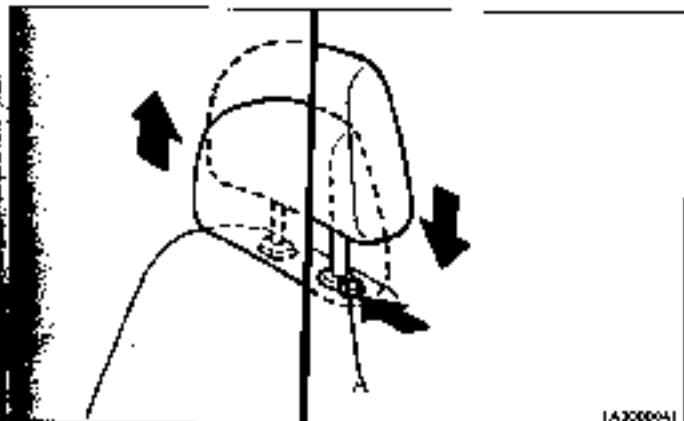
**To install**

To install the head restraints, first check that they are facing in the right direction as shown in the illustration, then insert them into the seatback. Push the head restraints down while pressing the lock knob until the restraints lock into place. Check that the lock knobs are extended out as shown in the illustration. Then pull the head restraints up to make sure that they will not come out of the seatback.

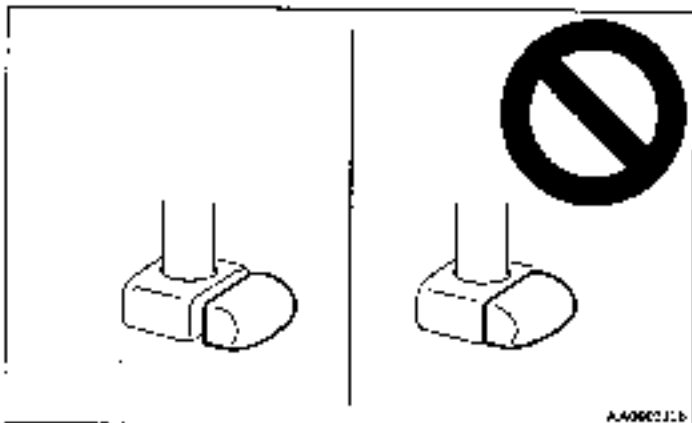
**⚠ WARNING**

- Driving without the head restraints can lead to a serious injury to you and your passengers in an accident. Always have them mounted and properly adjusted before operating your vehicle. Failure to do so will increase the risk of injury in a collision.

Making a flat seat

AA2001711

The entire interior of the vehicle may be used for sleeping accommodations by removing the head restraints and fully reclining all the seats, when the vehicle is stopped.

⚠ WARNING

- Never drive with passengers or cargo on the flat seat. This is extremely dangerous and can cause severe or fatal injury in a collision or if heavy braking is required.

⚠ CAUTION

- Adjust the seats when the vehicle is stopped in a safe place.
- Seat should be adjusted only by adults to avoid accidents.
- When sliding the seats, be careful not to catch your hand or leg.
- Do not walk around on top of the seats after they have been laid flat because the footing is uneven. It is safest to move about on your hands and knees.
- To ensure the seats are locked securely, attempt to move them back and forth.
- Do not jump on or drop heavy objects on the seatbacks.

⚠ CAUTION

- To raise the seatback, firmly place your hand on the seatback, pull the seatback lock knob up, and raise the seatback slowly. (Refer to "To adjust the seatback" on pages 2-5 and 2-8.) Never have a child do this operation.

A flat seat in which the rear seat reclines

AA2001711

1. Remove the head restraints from the front seats. (Refer to the "Head restraints" on page 2-10.)

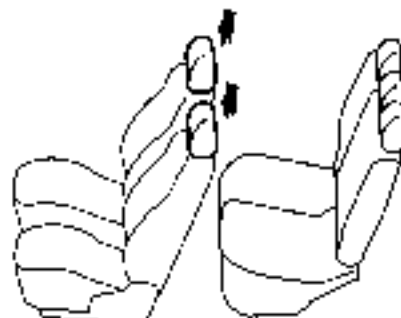

AA2001711

2. Slide the front seats fully forward, then push their seatbacks backward to achieve a flat surface.

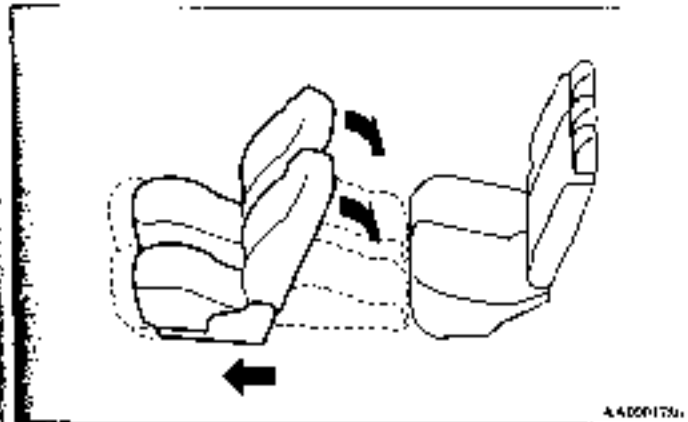

3. Push the rear seatbacks backward.

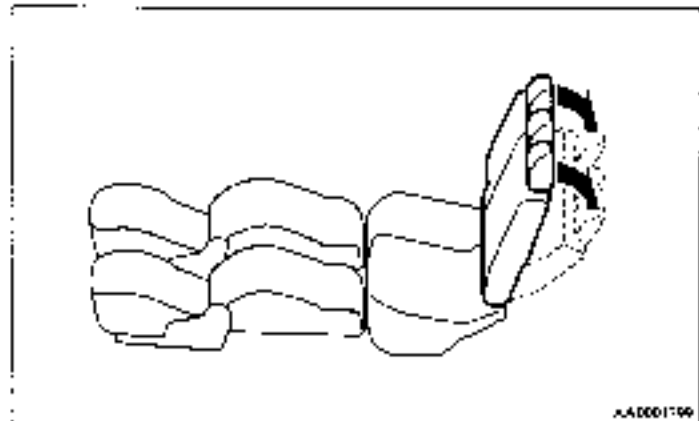

2

Seat and restraint systems

4. To return the seats to the normal position, reverse the above procedure.

2

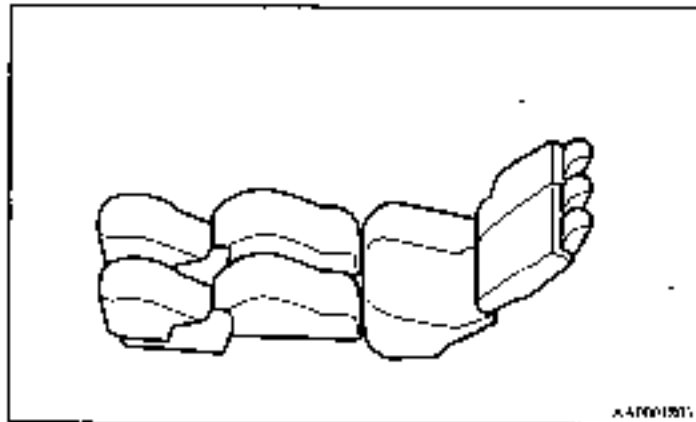

A flat seat in which the rear seat tilts forward

A-1000187

1. Remove the head restraints from the rear seats. Then push the rear seatbacks forward.

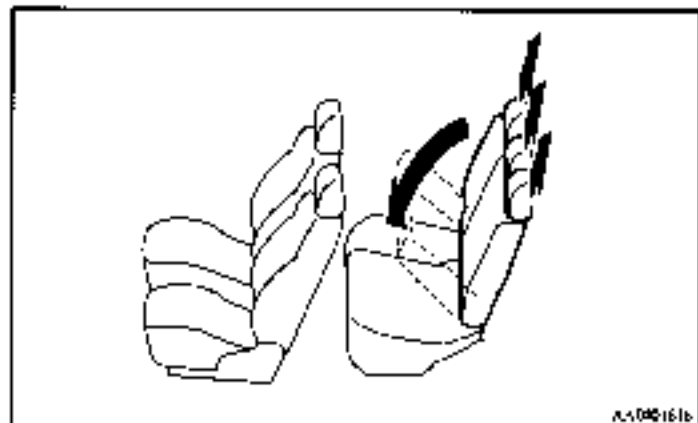

2. Remove the head restraints from the front seats.
(Refer to the "Head restraints" on page 2-11.)

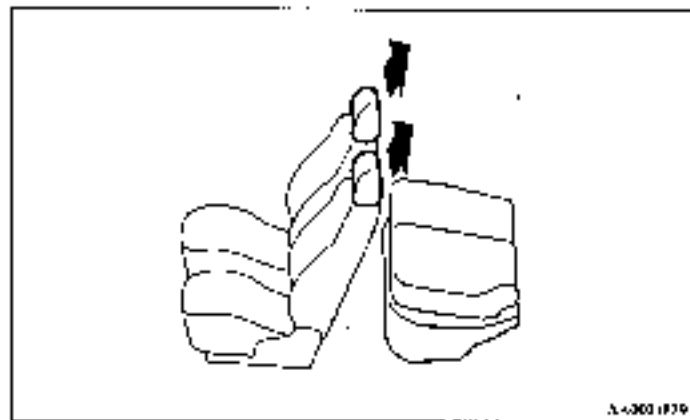

3. Push the seatbacks of the front seats backward to achieve a flat surface, then slide the front seats backward until their seatbacks touch the rear seats.

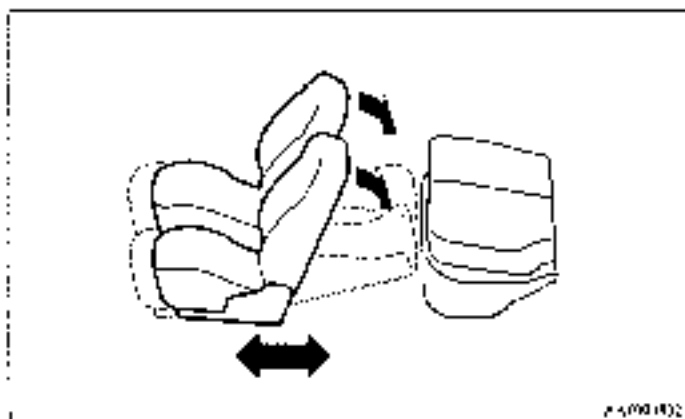

Seat and restraint systems

- To return the seats to the normal position, reverse the above procedure.



AA0001645

Seat belts

W 0000001

Seat belts are installed in your vehicle for the protection of the driver and passengers.

Always use the seat belts. In an accident, injury to the driver and passengers can be reduced if the seat belts are properly used.

NOTE

- Legislation in your driving area may require seat belt usage. But even if it is not required by law, seat belts should always be used.

⚠ WARNING

- Lock all doors before driving to reduce the risk of injury or ejection in a collision.
- Seat belts must always be worn by every adult who drives or rides in your vehicle, and by all children who are large enough to wear seat belts properly.
- Never use one seat belt for more than one person.
- Never carry more people in your vehicle than there are seat belts.
- Always adjust the seat belt for a snug fit.
- Always place the shoulder belt over your shoulder and across your chest. Never put it behind you or under your arm.
- Always wear the lap belt as low as possible across your hips, not around your waist.

⚠ WARNING

- No modifications or additions should be made by the user which will either prevent the seat belt adjusting devices from operating to remove slack, or prevent the seat belt assembly from being adjusted to remove slack.
- To reduce the risk to the driver of a serious or fatal injury in a collision, especially from a deploying driver air bag, always properly wear your seat belt and adjust the driver's seat as far back as possible to a position that still allows you to maintain a clear view out front and have good control of the steering wheel, brake, accelerator, and vehicle controls.
- To reduce the risk to a front seat passenger of a severe or fatal injury from a deploying air bag, make sure the passenger always wears their seat belts properly, that they remain seated all the way back and upright in their seat, and that their seat is moved as far back as possible. Refer to "Supplemental Restraint System (SRS)- air bag" on page 2-35.
- Never hold an infant or child in your arms or on your lap when riding in this vehicle, even if you are wearing your seat belt. Also never place any part of the seat belt you are wearing around an infant or child. This would create a risk of severe or fatal injury to your child in a collision or sudden stop.
- Children 12 years old and under should always ride in the rear seat, properly restrained. This reduces their risk of serious or fatal injury in a collision, especially from the deployment of a front passenger air bag. Refer to "Child restraints" on page 2-25.

⚠ WARNING

- Any child who is too small to properly wear a seat belt must be properly restrained in an appropriate child restraint system. To reduce their risk of severe or fatal injury in a collision, especially from the deployment of a front passenger air bag, children should be seated only in the rear seat. Infants **MUST** be in a rear-facing child safety seat that **MUST ONLY** be used in the rear seat.

UNIBELT restraint system

All seats are equipped with a UNIBELT system which uses one combined lap-and-shoulder belt with an emergency locking retractor.

This system is designed to provide both comfort and safety. It permits full extension and automatic retraction of the belts during normal vehicle operation. A sensing device inside the belt retractor is designed to lock the retractor in the event of a sudden change in the vehicle's motion.

NOTE:

- For instructions on how to install a child restraint system, see "Installing a child restraint system to a UNIBELT" on page 2-31.

UNIBELT instructions

1000000000

2

- 1 Sit in your vehicle in a normal correct posture. To reduce the risk of a severe or fatal injury caused by an inflating air bag, adjust the driver's seat as far back as possible to a position that still allows you to fully apply the pedals, easily control the steering wheel and safely operate your vehicle. The front passenger seat should also be moved as far back as possible. Refer to "Supplemental Restraint System (SRS)- air bag" on page 2-35. Also refer to "To adjust the seat forward or backward" on page 2-4.

Everyone riding in your vehicle should sit and remain seated all the way back in their seat with their back resting straight against the upright seatback.



1470001111

⚠ WARNING

- To reduce the risk of severe or fatal personal injury in the event of a collision or sudden stop, both the driver and all passenger seatbacks should always be kept in the upright position whenever the vehicle is in motion.

The seat belts' ability to protect you will be significantly reduced the more the seatback is reclined. The more the seatback is reclined, the more the seat belts will not be properly positioned against your body and/or the risk you will slide under the belt in an accident and be severely or fatally injured.

2. Grasp the metal tongue and slide it up the webbing so that it easily pulls across your body. With practice, this will become an automatic one-handed motion.



3. Pull the seat belt out slowly while holding the metal tongue. The belt will not lock if you stop or hesitate, so relax and continue to "buckle-up". Push the metal tongue into the buckle until you hear a "click". Pull up on the belt to be sure the metal tongue is locked securely in the buckle.

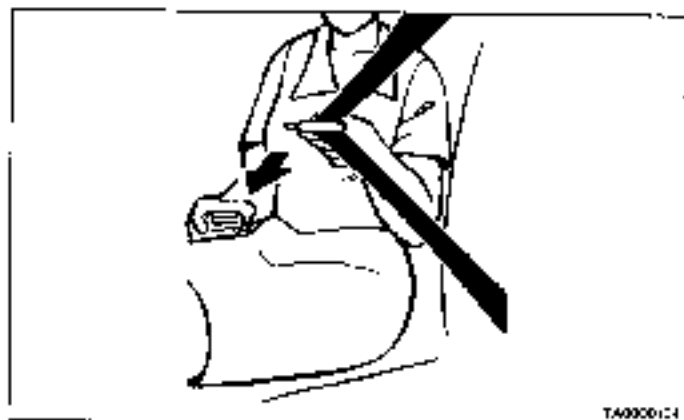

NOTE:

- If the seat belt locks up and cannot be pulled out, pull it once with force and let it retract all the way. Then, pull the belt out slowly once again.

Seat and restraint systems

4. Pull up on the shoulder portion of the belt to take up any extra slack in the lap portion of the belt. The shoulder belt portion will keep enough slack for comfort whenever you return to your normal seated position. If the shoulder belt portion is too tight, pull out 6 to 8 inches of webbing by pulling down on the shoulder belt. Then release the belt and let it return against your chest.

2



NOTE

- If anyone wearing a seat belt causes their belt to fully extend out of the retractor by moving either their upper body or the belt itself, the retractor may switch to its Automatic Locking Retractor (ALR) child restraint installation mode (see page 2-31). The belt will lock when in this position and prevent further movement. If this happens, the retractor can be switched back to its Emergency Locking Retractor (ELR) mode by unlatching the buckle and letting the belt fully retract. Then put the seat belt

back on, repeating steps 1 through 4.

⚠ WARNING

- Be sure the lap belt portion fits snugly and is worn as low as possible across the hips, not around the waist. Failure to do this will increase the risk of severe or fatal injury in a collision.
- Be sure the seat belt webbing is not twisted when worn.

5. The shoulder belt portion will allow regular movement under normal conditions. The belt will lock in the event of an abrupt change in the vehicle's motion.



- h To release the belt, push the button on the buckle. The belt retracts automatically, so hold the tongue when the belt is released and while it retracts. If the belt does not fully return to its stowed position, pull the shoulder belt down slightly, then release it quickly.

Adjustable seat belt shoulder anchor (front seats)

The seat belt shoulder anchor position can be adjusted for greater comfort.

To move the anchor down, press the lock knob (A). To move the anchor up, simply slide the anchor up to the desired position (there is no need to press the lock knob).

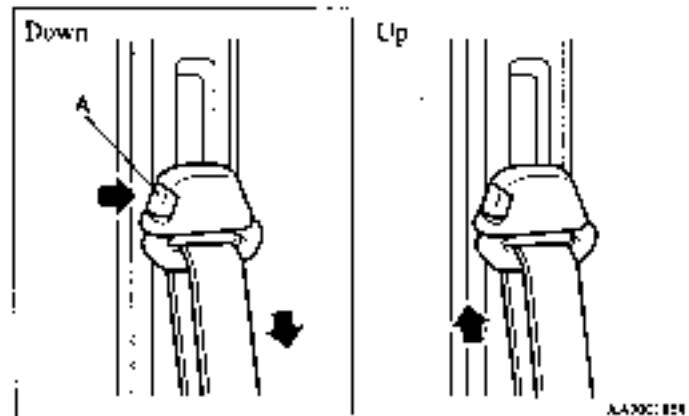

⚠ WARNING

- To reduce the risk of injury in a collision, adjust the shoulder belt anchor so that the shoulder belt is positioned across the center of your shoulder without touching your neck. The belt should not be able to fall off your shoulder. If the shoulder belt anchor is not properly adjusted, the shoulder belt cannot protect you properly.
- Adjust the shoulder belt anchor only when the vehicle is not in motion.
- Make sure the anchor is securely locked in position after adjusting it.

Rear seat belt storage

When the seat belt is not in use, store it as shown in the illustration.

The openings in the front and rear of the holder (A) can be used for storage.

2

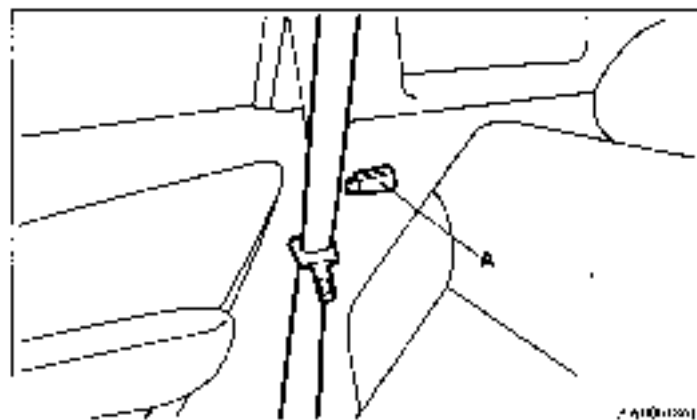

Store the outboard second or third seat belt webbing in the clip slot (B) and the metal tongue in the slot (C) as shown in the illustration.

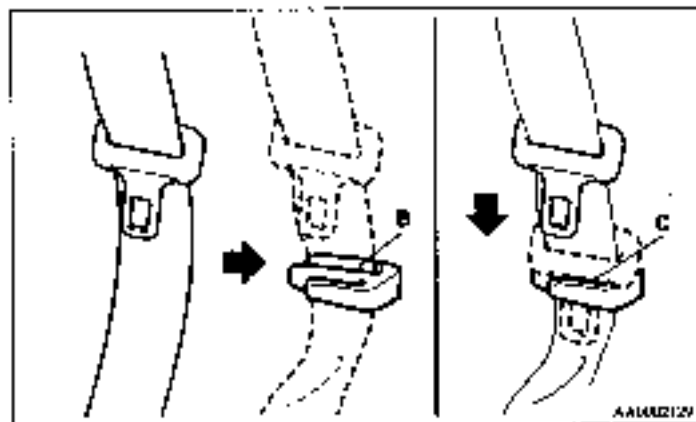

Seat belt extender

FA000015

If the seat belt is too short, even when fully extended, a seat belt extender is available from your dealer. The extender may be used for either of the front seats.

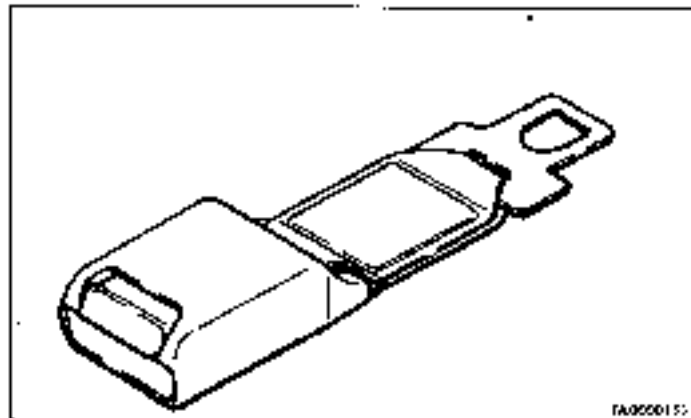

FA000015

⚠ WARNING

- The extender should only be used if the existing belt is not long enough.
Anyone who can use the standard seat belt should not use an extender. Unnecessary use of the extender could result in serious personal injury in a collision.
- When not required, the extender must be removed and stowed because its unnecessary use may deactivate the seat belt locking mechanism.

Pregnant women restraint

FA000017

⚠ WARNING

- Mitsubishi Motors Corporation recommends that pregnant women use the available LNI-BELT. This will reduce the likelihood of injury to both the woman and the unborn child. The lap belt should be worn as snug and as low as possible across the hips, NOT across the waist.
Consult your doctor if you have any questions or concerns.

2

Seat belt pre-tensioner system and force-limiter system

The driver's seat and front passenger's seat each have a seat belt equipped with a pre-tensioner system.

Pre-tensioner system

The driver's and front passenger's seats are provided with a seat belt pre-tensioner system which actuates simultaneously with the deployment of the front air bags in a moderate-to-severe frontal collision.

In certain moderate-to-severe frontal collisions, the seat belt pre-tensioner retracts the seat belt instantaneously to hold the occupant tightly in the seat, making the seat belt and air bag work more effectively.

The pre-tensioner (A) is inside the seat belt's retractor.

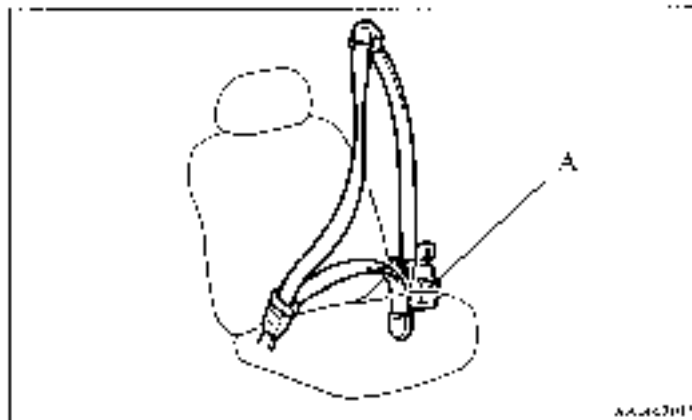

Fasten and use the pre-tensioner seat belt system the same way as conventional seat belts.

When the seat belt pre-tensioner activates, some smoke is released and a loud noise will be heard. The smoke is not harmful, but care should be taken not to intentionally inhale it, as it may cause some temporary irritation to people with breathing problems.

The pre-tensioner activates whenever a strong impact is applied at the front of the vehicle, even if the seat belt is not worn. The seat belt pre-tensioners may not activate in certain frontal collisions, even though the vehicle may be severely damaged. Such non-activation does not mean that something is wrong with the seat belt pre-tensioner system, but rather that the collision forces were not severe enough to activate it.

⚠ WARNING

- After the seat belt pre-tensioner activates, several seat belt pre-tensioner system components will be hot. Do not touch the seat belt retractor after activation.
- The seat belt pre-tensioner system is designed to work only once. After the seat belt pre-tensioners have been activated, they will not work again. They must promptly be replaced and the entire seat belt pre-tensioner system inspected by an authorized Mitsubishi dealer.
- If the vehicle is involved in a collision, be sure to have each seat belt system checked and, if necessary, replaced by an authorized Mitsubishi dealer.

SRS warning light

The same warning lamp is shared by the SRS air bags and the pre-tensioner seat belts. Refer to the "SRS warning light" on page 2-51.

Force-limiter system

In the event of a collision, each force-limiter system will effectively absorb the force applied in the seat belt so as to minimize the impact to the passenger.

Child restraints

When transporting infants or small children in your vehicle, an appropriate child restraint system should always be used. This is required by law in most states.

Child restraints specifically designed for infants and small children are offered by several manufacturers. Choose only a child restraint system with a label certifying that it complies with Federal Motor Vehicle Safety Standard 213 (FMVSS 213) or Motor Vehicle Restraint Systems and Booster Cushions Safety Regulations (RSSRL).

The child restraint system should be appropriate for your child's weight and height, and should properly fit your vehicle's seat.

All children should be restrained in the restraint device that offers the maximum protection for their size and age.

Be sure to check for other local, state, or provincial requirements for child size and age that may vary from the recommendations listed below.

- Children less than 1 year and children less than 20 pounds (9 kg) **MUST** ride in a rear-facing child safety seat that **MUST ONLY** be used in the rear seat.
- Children older than 1 year who weigh less than 40 pounds (18 kg) or who are less than 40 inches (100 cm) tall should be in a forward-facing restraint in the rear seat.
- Children who weigh more than 40 pounds (18 kg) or who are more than 40 inches (100 cm) tall, regardless of age, should use a booster seat in the rear seat until the lap/shoulder belt fits properly.

⚠ WARNING

- All children 12 years old and under should be seated in the rear seat, and properly restrained. Accident statistics show that children of all sizes and ages are safer when properly restrained in the rear seat, rather than in the front seat.
- Any child who is too large to use a child restraint should ride in the rear seat and wear the lap and shoulder belt properly, with the shoulder belt over the shoulder and across the chest, not across the neck, and with the lap belt low on the child's hips, not across the stomach. If necessary, a booster seat should be used for proper seat belt fit. Follow the booster seat manufacturer's instructions. Only use a booster seat that is certified as complying with Federal Motor Vehicle Safety Standards or Motor Vehicle Restraint Systems and Booster Cushions Safety Regulations.

⚠ WARNING

- Never hold an infant or child in your arms or on your lap when riding in this vehicle, even if you are wearing your seat belt. Also never place any part of your seat belt around an infant or child. This would risk severe or fatal injury to the infant or child in a collision or sudden stop.



NAD02174

⚠ WARNING

- Your vehicle is also equipped with a front passenger air bag.
- **REAR-FACING CHILD RESTRAINTS** must NOT be used in the front passenger seat as it places an infant too close to the passenger air bag. The force of an inflating air bag could kill or cause serious injuries to the child. Rear-facing child restraints must only be used in the rear seat.

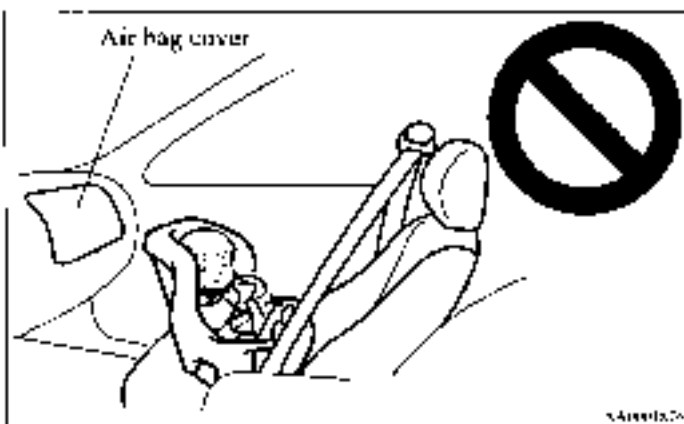
**⚠ WARNING**

- **FRONT-FACING CHILD RESTRAINTS** should always be used in the rear seat whenever possible. If one must be used in the front passenger seat, move the seat to the full rear position and make sure the child stays in the child seat properly restrained. Failure to do so could kill or cause serious injury to the child.



⚠ WARNING

- It is important to use an approved rear-facing infant restraint until the infant is one year old (unless the infant outgrows the seat sooner). This allows the infant's neck and spine to develop enough to support the weight of their head in the event of a collision.
- When installing a child restraint system, follow the instructions provided by the manufacturer and follow the directions in this manual. Failure to do so can result in severe or fatal injury to your child in a collision or sudden stop.
- After installation, push and pull the child restraint system back and forth, and side to side, to see that it is firmly secured. If the child restraint system is not installed securely, it may cause injury to the child or other occupants in the event of a collision or sudden stop.
- When not in use, keep your child restraint system secured with the seat belt, or remove it from the vehicle, in order to prevent it from being thrown inside the vehicle during an accident.

NOTE

- Before purchasing a child restraint system, try installing it in the rear seat to make sure there is a good fit. Because of the location of the seat belt buckles and the shape of the seat cushion, it may be difficult to securely install some manufacturer's child restraint systems. If the child restraint system can be pulled forward or to either side easily on the seat cushion after the seat belt has been tightened, choose another manufacturer's child restraint system.
- Depending on the seating position in the vehicle and the child restraint system that you have, the child restraint can be attached using one of the following 2 methods:
- To the lower anchorage in the rear seat ONLY if the child restraint complies with Federal Motor Vehicle Safety Standard 225 or Canadian Motor Vehicle Safety Standard 210.1 or 210.2 (See page 2-29).
 - To the LATCH (See page 2-31).

Installing a new child restraint system to the lower anchorage

Your vehicle's rear seat is fitted with lower anchorages for attaching a new child restraint system that complies with Federal Motor Vehicle Safety Standard 225 or Canadian Motor Vehicle Safety Standard 210.1 or 210.2.

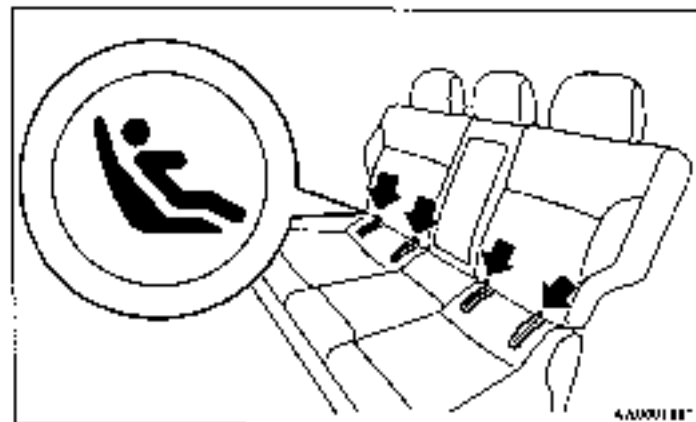

NOTE

- The marks on the seatback show the location of the lower anchorage points.

New child restraint system that complies with Federal Motor Vehicle Safety Standard 225 or Canadian Motor Vehicle Safety Standard 210.1 or 210.2

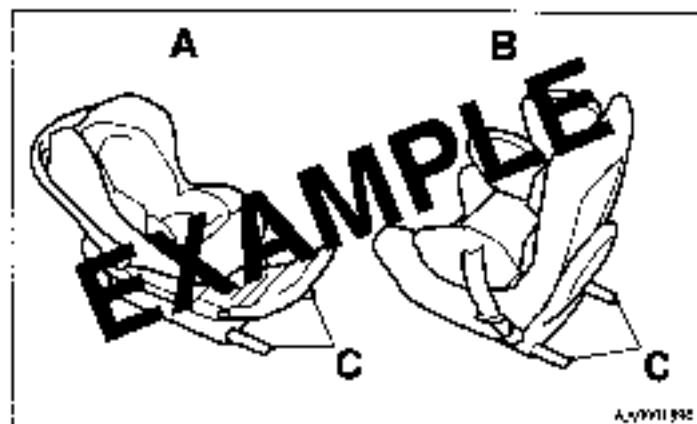

- A- Rear-facing child restraint
- B- Forward-facing child restraint
- C- Child restraint system connectors
(These are only examples.)

Installation

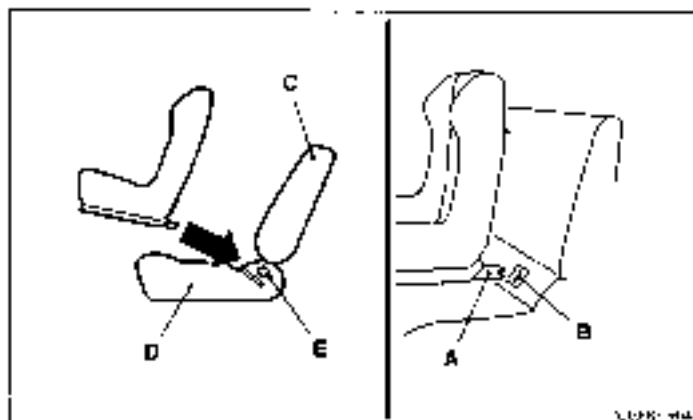

- A- Connector
 B- Slit
 C- Vehicle seatback
 D- Vehicle seat cushion
 E- Lower anchorage

1. Push the child restraint system's connectors (A) into the slit (B) in accordance with the instructions provided by the child restraint system's manufacturer.
2. If your child restraint system requires the use of a top tether strap, refer to "Tether anchors for child restraint systems" on page 2-33.
3. Push and pull the child restraint system in all directions to be sure it is firmly secured.

NOTE

- For a new child restraint system that complies with Federal Motor Vehicle Safety Standard 225 or Canadian Motor Vehicle Safety Standard 210.1 or 210.2, it is not necessary to secure the child restraint system using the vehicle's seat belt.

⚠ WARNING

- If there is any foreign material in or around the connectors, remove it before installing the child restraint system. Also, make sure the seat belt is away from, not looped through or otherwise interferes with the child restraint system. If foreign matter is not removed and/or the seat belt interferes with the child restraint system, the child restraint system will not be secured properly and could move forward in the event of sudden braking or a collision, seriously injuring the child and possibly other vehicle occupants.
- When the vehicle is moving, do not adjust the seat where the child restraint system is installed.

Installing a child restraint system to a UNIBELT (With emergency/automatic locking mechanism)

The UNIBELT at the front passenger and rear seat positions can be converted from normal Emergency Locking Retractor (ELR) mode to Automatic Locking Retractor (ALR) mode. It must be converted to the ALR mode when installing a child restraint system.

Children 12 years old and under should always be restrained in the rear seat, whenever possible, although the front passenger seat belt can also be converted to ALR mode.

⚠ WARNING

- Before placing an infant or child in a child restraint system, be absolutely certain you converted the retractor from the ELR mode to the ALR mode. The ALR mode will keep the child restraint system tightly secured to the seat.

Failure to convert the retractor to the ALR mode may allow the child restraint system to move forward during sudden braking or in a collision, seriously injuring the child or other occupants.

Installation:

- 1 Place the child restraint system in the rear seating position as shown in the illustration.

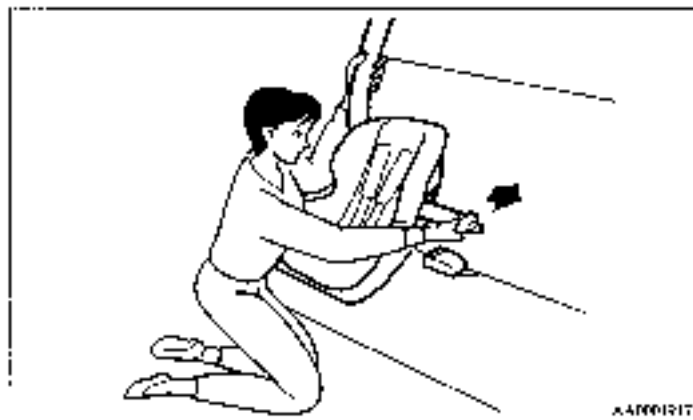

Seat and restraint systems

- 2 Route the unbelt through the child restraint system according to the child restraint system manufacturer's instructions. Then insert the unbelt latch plate into the buckle. Make sure you hear a "click" when you insert the latch plate into the buckle.

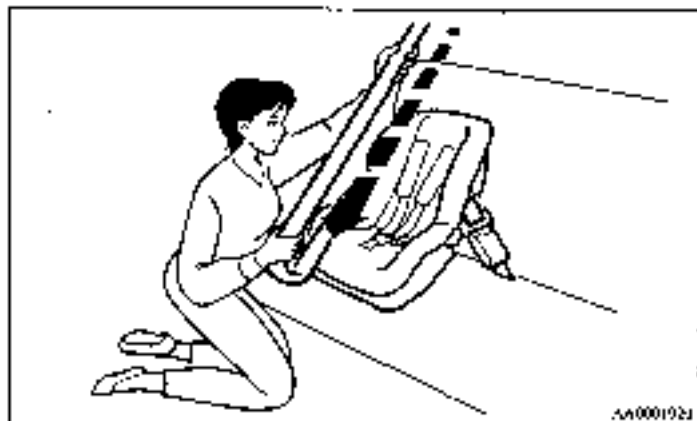

- 3 To activate the ALR mode, slowly pull the shoulder part of the belt all the way out of the retractor until it stops. Then let the belt feed back into the retractor.
- 4 After the belt has retracted, tug on it. If the belt is locked, you will not be able to pull it out. If you can pull the belt out, it is not locked and not in the ALR mode. You will need to repeat steps 3 and 4.

- 5 After confirming that the belt is locked, grab the shoulder part of the belt near the buckle and pull up to remove any slack from the lap part of the belt. Remember, if the lap belt portion is not tight, the child restraint system will not be secure. It may help to put your weight on the child restraint system and/or push on its seatback while pulling up on the belt (see illustration).

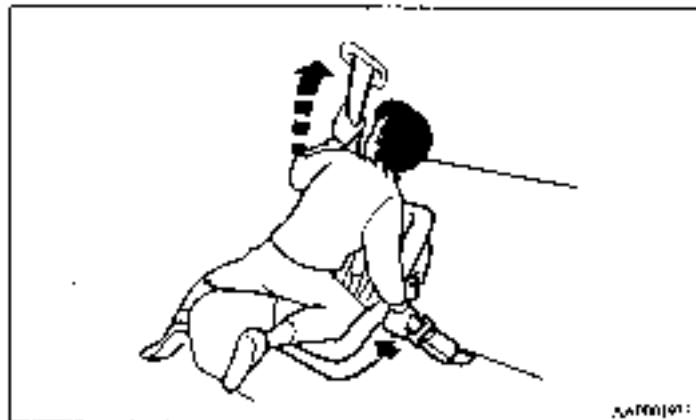

- 6 If your child restraint system requires the use of a top tether strap, refer to "Tether anchors for child restraint systems" on page 2-33.
- 7 Before putting your child in the restraint, push and pull the restraint in all directions to be sure it is firmly secure. Do this before each use. If the child restraint system is not firmly secure, repeat steps 1 through 7.

8. To remove a child restraint system from the vehicle and deactivate the ALR mode, remove the child from the restraint. Unlatch the buckle. Then remove the belt from the restraint and let the belt fully retract.

Tether anchors for child restraint systems

In compliance with the Federal Motor Vehicle Safety Standards or Canadian Motor Vehicle Safety Standards, your vehicle has 3 attachment points on back of the rear seatbacks. These are for securing a child seat tether strap to each of the 3 rear seating positions in your vehicle.

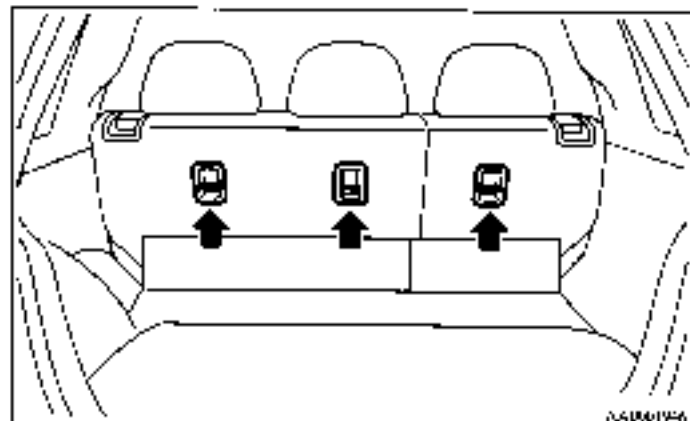

Tether anchor strap installation

Latch the tether strap hook (A) of the child seat to the tether anchor bar (B) and tighten the top tether strap hook so it is securely fastened.

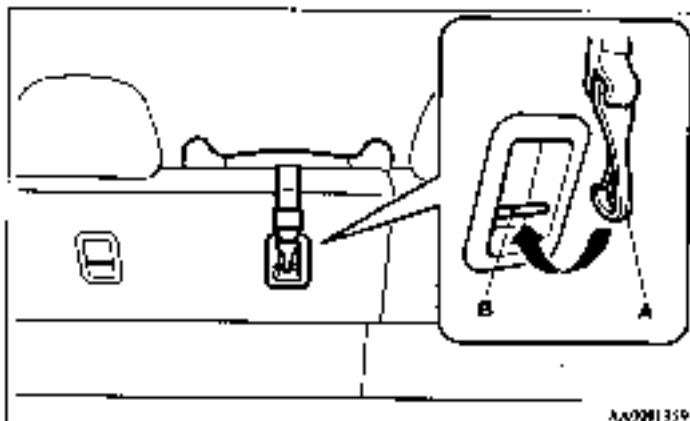

⚠ WARNING

- Child restraint tether anchorages are designed to withstand only those loads from correctly fitted child restraint systems. Under no circumstances are they to be used for adult seat belts, or harnesses, or for attaching other items or equipment to the vehicle.

Children who have outgrown child restraint systems

Children who have outgrown a child restraint system should be seated in the rear seat and wear the UNIBELT. If the shoulder belt crosses their face or neck, and/or the lap belt crosses their stomach, a commercially available booster seat must be used to raise the child so that the shoulder belt crosses their shoulder and the lap belt remains positioned low across their hips. The booster seat should fit the vehicle seat and have a label certifying compliance with Federal Motor Vehicle Safety Standards or Motor Vehicle Restraint Systems and Booster Cushions Safety Regulations.

⚠ WARNING

- Children who are not buckled up securely, or who ride in a vehicle with unlocked doors, can be thrown out of the vehicle or otherwise seriously or fatally injured in the event of a collision.
- A child should never be left unattended in, or unsupervised around, your vehicle. When you leave the vehicle, always take the child out as well.
- Children can die from heat stroke if trapped inside the vehicle, especially on hot days.
- Keep your vehicle locked and the trunk closed when not in use. Keep your vehicle keys away from children.

Maintenance and inspection of seat belts

The seat belt webbing may be cleaned with a hydrocarbon dry cleaning solution or with mild soap or detergent solution. Allow the belts to dry in the shade. Do not allow them to retract until completely dry. Do not attempt to bleach or re-dye the belts. The color may rub off and the webbing strength could be affected.

Regularly check your seat belt buckles and their release mechanisms for positive engagement and release of the latch plate. Check the retractors for automatic locking when in the Automatic Locking Retractor mode. Refer to "Installing a child restraint system to a UNIBELT (with emergency-automatic locking mechanism)" on page 2-34.

Check that the anchor mounting bolts are tight. The entire seat belt assembly should be replaced if the webbing shows any obvious cuts, tears, increase in thickness in any section of the webbing from broken fibers, or severe fading from sunlight. All of these conditions indicate a weakening of the belt.

⚠ WARNING

- All seat belt assemblies, including retractors and attaching hardware, should be inspected by an authorized Mitsubishi dealer after any collision. We recommend that all seat belt assemblies that were used in a collision be replaced unless the collision was VERY minor and the belts show no damage and continue to operate properly.

Do not attempt to repair or replace any part of the seat belt assemblies. This work should be done by an authorized Mitsubishi dealer. Failure to have an authorized Mitsubishi dealer perform the work could reduce the effectiveness of the belts and could result in a serious or fatal injury in a collision.

Supplemental Restraint System (SRS)-air bag

This vehicle is equipped with a Supplemental Restraint System (SRS), which includes air bags for the driver and front passenger and seat belt pretensioner for driver and front passenger. The SRS air bag is designed to supplement the primary protection of the driver and front passenger side seat belt systems by providing those occupants with protection against head and chest injuries in certain moderate to severe frontal collisions. The SRS side air bag (if so equipped) is also designed to supplement the seat belts and provide the driver and front passenger with protection against chest injuries in certain moderate to severe side impact collisions.

The SRS is NOT a substitute for the seat belts. For maximum protection in all types of crashes and accidents, seat belts must ALWAYS be worn by everyone who drives or rides in this vehicle (with infants and small children in an appropriate child restraint in the rear seat, and older children buckled in the rear seat). Refer to "Child restraints" on page 2-25.

⚠ WARNING

- **IT IS VERY IMPORTANT TO ALWAYS WEAR YOUR SEAT BELT PROPERLY EVEN WITH AN AIR BAG.**

- Seat belts help keep the driver and front passenger properly positioned. This reduces the risk of injury in all collisions, and reduces the risk of serious or fatal injuries when the air bags inflate.

During sudden braking just before a collision, an unrestrained or improperly restrained driver or front passenger can move forward into direct contact with, or within close proximity to, the air bag when it begins to inflate.

The beginning stage of air bag inflation is the most forceful and can cause serious or fatal injuries if the occupant comes in contact with the air bag at this time.

- Seat belts reduce the risk of injury in rollovers, side or rear impact collisions, and in lower-speed frontal collisions, because the air bags are not designed to inflate in those situations.
- Seat belts reduce the risk of being thrown from your vehicle in a collision or rollover.

⚠ WARNING

- **IT IS VERY IMPORTANT TO BE PROPERLY SEATED.**

A driver or front passenger sitting too close to the steering wheel or instrument panel during air bag deployment can be killed or seriously injured.

Air bags inflate very quickly and with great force. If the driver and front passenger are not properly seated and restrained, the air bag may not provide the proper protection, and could cause serious or fatal injuries when it inflates.

- Before driving, adjust the driver's seat as far back as possible without affecting your ability to be in complete control of the vehicle.
- Before driving, adjust the front passenger seat as far back as possible.
- Make sure all vehicle occupants are always properly restrained using the available seat belts.
- With the seat belts properly fastened, the driver and front passenger should sit well back in their seats and remain upright without leaning against the window or door.

⚠ WARNING

- Do not sit on the edge of the seat or lean your head or chest close to the steering wheel or the instrument panel. Do not put your feet or legs on or against the instrument panel.

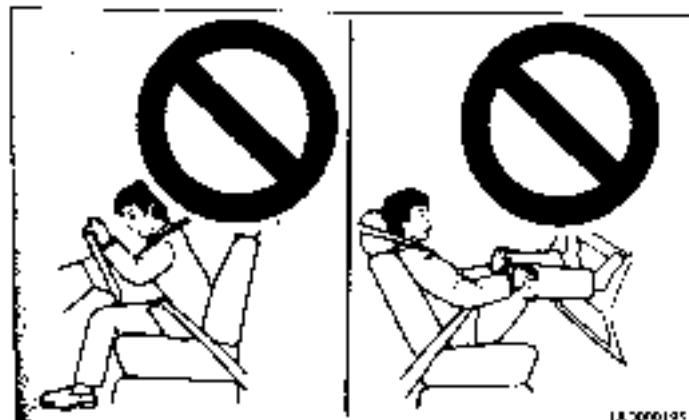
**⚠ WARNING**

- Seat all infants and children 12 years of age and under in the rear seat, properly restrained in an appropriate child restraint system.

⚠ WARNING

- Infants and small children should never ride unrestrained, or lean against the instrument panel. They should never ride held in your arms or on your lap. They could be seriously injured or killed in a collision, especially when the air bags inflate. Children should be properly seated in the rear seat in an appropriate child restraint system. Refer to "Child restraints" on page 2-25.

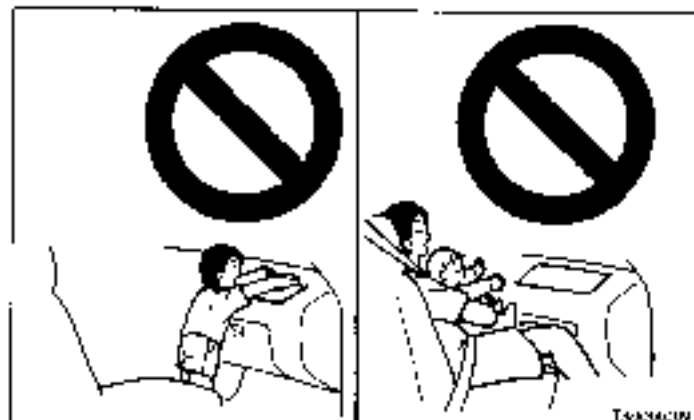

⚠ WARNING

- **REAR-FACING CHILD RESTRAINTS** must NOT be used in the front passenger seat as it places an infant too close to the passenger air bag. The force of an inflating air bag could kill or cause serious injuries to the child. Rear-facing child restraints must only be used in the rear seat.

2

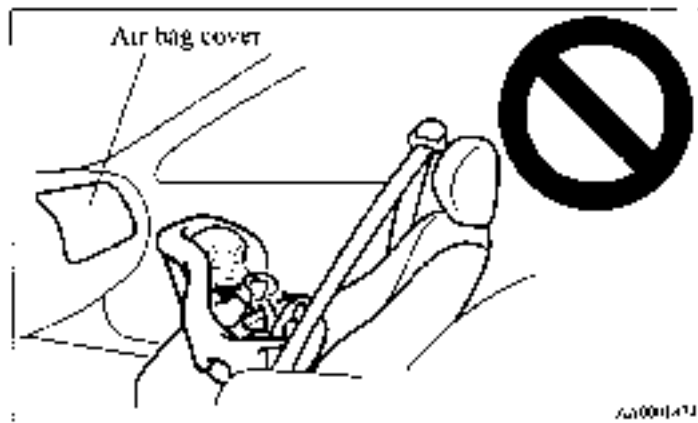

⚠ WARNING

- **FRONT-FACING CHILD RESTRAINTS** should be used in the rear seat whenever possible. If they must be used in the front passenger seat, move the seat to the full rear position. Failure to do so could kill or cause serious injuries to the child.



⚠ WARNING

- Older children, up to and including 12 years old, should be seated in the rear seat with their seat belt properly worn, and with an appropriate booster seat if needed.

How the Supplement Restraint System works

The SRS includes the following components:

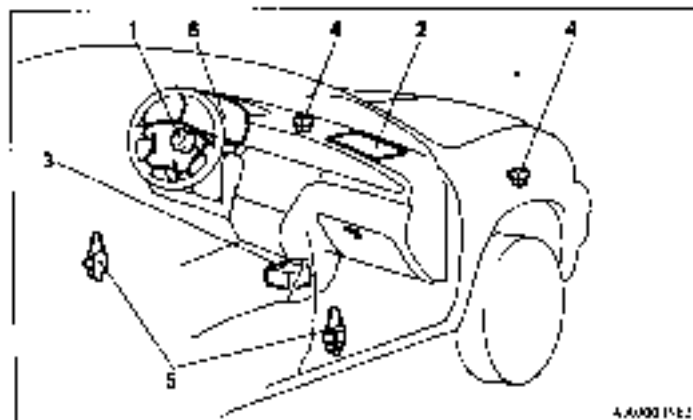

- 1- Air bag module (Driver)
- 2- Air bag module (Passenger)
- 3- Air bag control unit
- 4- Front impact sensor
- 5- Seat belt pre-tensioners
- 6- SRS warning light

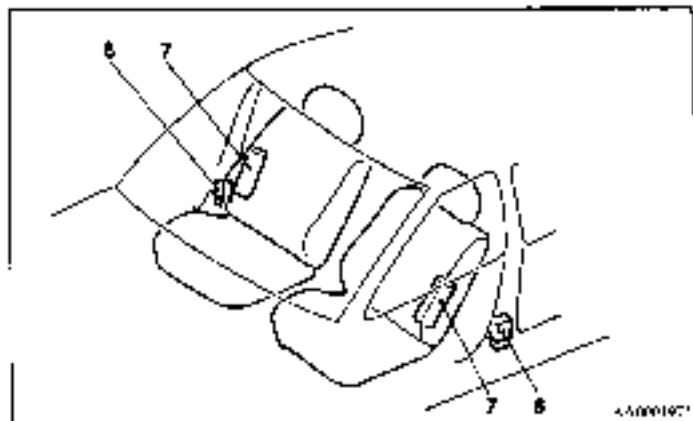

- 7- Side air bag modules (if so equipped)
- 8- Side impact sensors (if so equipped)

The air bag control unit monitors the readiness of the electronic parts of the system whenever the ignition switch is in the "ON" or "START" position. These include all of the items listed above and all related wiring.

The air bags will operate only when the ignition switch is in the "ON" or "START" position.

When an impact sensor detects a front or side impact of sufficient force, it automatically ignites materials in the module inflator which generate gas and inflates the appropriate air bag(s).

Deployment of an air bag produces a sudden, loud noise and releases some smoke and powder. This is not dangerous and

Seat and restraint systems

does not indicate a fire in the vehicle. People with breathing problems may feel some temporary irritation from the chemicals used to inflate the bags. You may open the windows after the air bags inflate if it is safe to do so.

After deployment, the air bags deflate very rapidly, so there is little danger of not being able to see. The time between the sensors first detecting an impact and the air bags deflating after deployment is shorter than a blink of an eye.

Driver's and passenger's front air bag system

The driver's air bag is located under the padded cover in the middle of the steering wheel. The front passenger air bag is contained in the instrument panel above the glove compartment. The driver's air bag and the front passenger's air bag are designed to deploy at the same time.

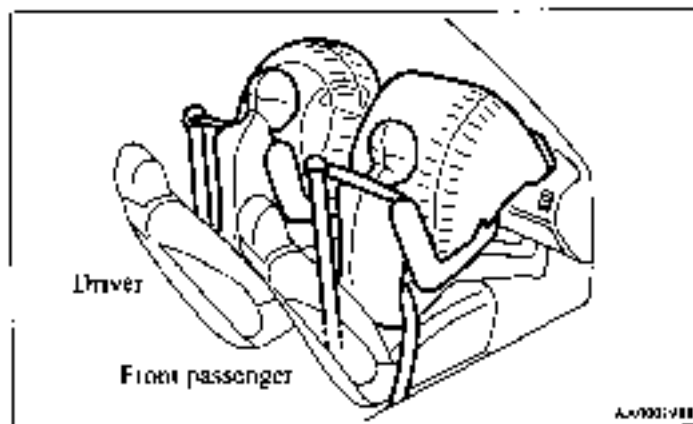

CAUTION

- Air bags inflate very quickly and with great force. In certain situations, contact with an inflating air bag may cause small cuts, abrasions, and bruises.

Deployment of front air bags

The front air bags ARE DESIGNED TO DEPLOY in a...

Head-on collision with a solid wall at speeds of approx. 15mph (25 km/h) or higher

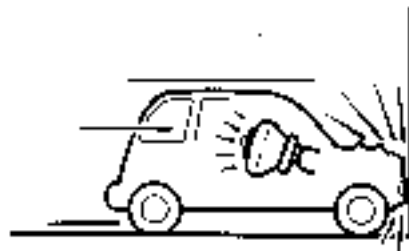

Moderate to severe frontal impact within the shaded area between the arrows



The front air bags are designed to deploy when the vehicle suffers a moderate to severe frontal impact. A typical condition is shown in the illustration on the left.

The front air bags are designed to deploy only in certain moderate to severe frontal collisions within the shaded area between the arrows in the illustration on the right.

The front air bags will deploy if the force of the impact to the vehicle's main structure is above a specific minimum level. The minimum level is an approximately 15 mph (25 km/h) frontal collision straight into a solid wall that does not move, bend or deform. If the force of the impact to the vehicle's main structure is below this minimum level, the front air bags may not deploy. However, this minimum speed will be considerably

higher if the vehicle hits something that absorbs the impact by either bending or moving (for example, another stationary vehicle, a pole or a guard rail).

Because frontal collisions can easily move you out of position, it is important to always wear your seat belts properly. They will help keep you a safe distance from the steering wheel and instrument panel in a collision when the air bag begins to inflate. The beginning stage of air bag inflation is the most forceful, and can possibly cause serious or fatal injuries if a safe distance from the air bag is not maintained during a collision. Also, the seat belts in your vehicle are your primary means of protection in a collision. The SRS (Supplemental Restraint System) air bags are designed to provide additional

Seat and restraint systems

protection. Therefore, for your safety and the safety of all occupants, be sure to always wear your seat belts properly.

The front air bags **MAY NOT DEPLOY** in a ...

With certain types of frontal collisions, the vehicle's body structure is designed to absorb the shock to help protect the occupants from harm. (The vehicle body's front area may bend significantly as it absorbs the impact.) In these situations, the front air bags may not deploy in spite of what may appear to be major damage to the vehicle body. Some typical situations are shown in the illustrations.

Because the front air bags do not protect the occupant in all types of frontal collisions, be sure to always wear your seat belts properly.

Collision with a utility pole, tree or other narrow object

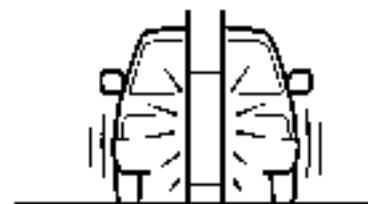

Collision where the vehicle slides under the rear body of a truck

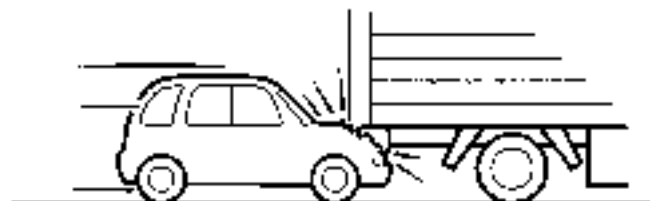

Oblique frontal impact

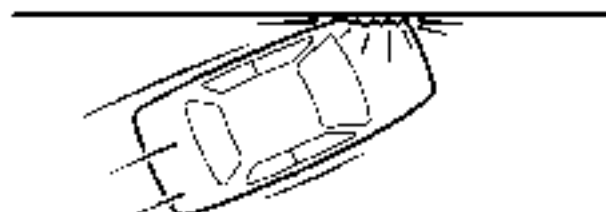

AAJ000057

The front air bags ARE NOT DESIGNED TO DEPLOY in a ...

The front air bags are not designed to deploy in situations where they cannot normally provide protection to the occupants.

These situations are shown in the illustrations.

Because the front air bags do not protect the occupants in all types of frontal collisions, be sure to always wear your seat belts properly.

Rear end collision



Side collision

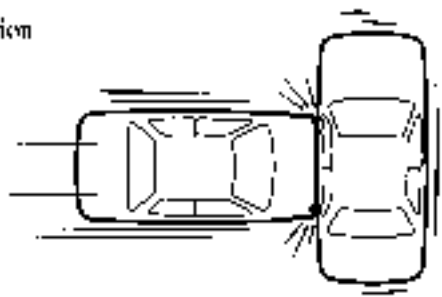

Vehicle rolls onto its side or roof



The front air bags *MAY DEPLOY* in a ...

The front air bags may deploy if the underside of the vehicle suffers a moderate to severe impact (undercarriage damage). Some typical situations are shown in the illustrations.

Because the front air bags may deploy in certain types of unexpected impacts, as shown in the illustrations, that could easily move you out of position, it is important to always wear your seat belts properly. Your seat belts will help keep you a safe distance from the steering wheel and instrument panel when the air bag begins to inflate. The beginning stage of air bag inflation is the most forceful and can cause severe or fatal injuries if you come in contact with the air bag at that time.

Collision with an elevated median/island or curb



Vehicle travels over a deep hole/pothole



Vehicle drives down a steep slope and hits the ground

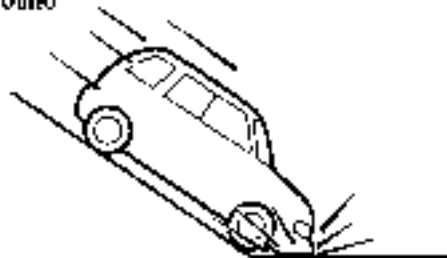

A4200075

⚠ WARNING

- Do not attach anything to the steering wheel's padded cover, such as trim material, badges, etc. These could strike and injure an occupant if the air bag inflates.

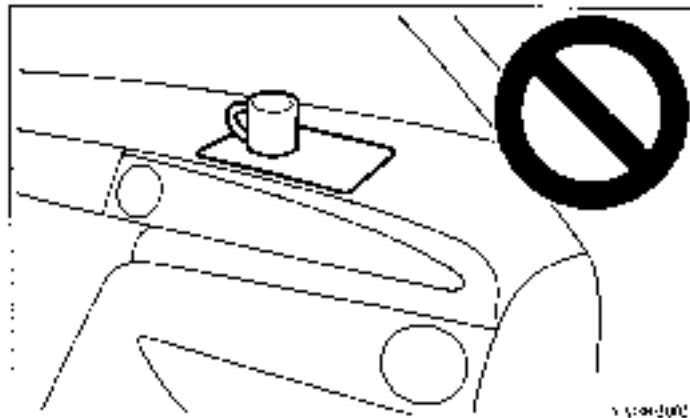
**⚠ WARNING**

- Do not set anything on, or attach anything to, the instrument panel above the glove compartment. Such items could strike and injure an occupant if the air bag inflates.

⚠ WARNING

- Do not attach accessories to, or put them in front of, the windshield. They could restrict the air bag inflation, or strike and injure an occupant, when the air bag inflates.
- Do not put packages, pets or other objects between the air bags and either the driver or the front passenger. This could affect air bag performance, or could cause severe or even fatal injury when the air bag inflates.
- Right after air bag inflation, several parts of the air bag system will be hot. Do not touch them. You could be burned.
- The air bag system is designed to work only once. After the air bags deploy, they will not work again. They must promptly be replaced and the entire air bag system inspected by an authorized Mitsubishi dealer.

Seat and restraint systems

Side air bag system (if so equipped)

The side air bags (A) are contained in the driver and front passenger seat backs.

SAFARI

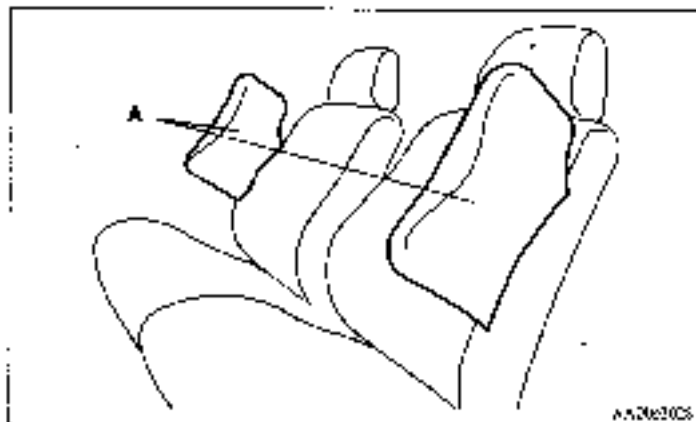

A label is attached to the seat backs in vehicles with side air bags.

The side air bag is designed to inflate only on the side of the vehicle that is hit.

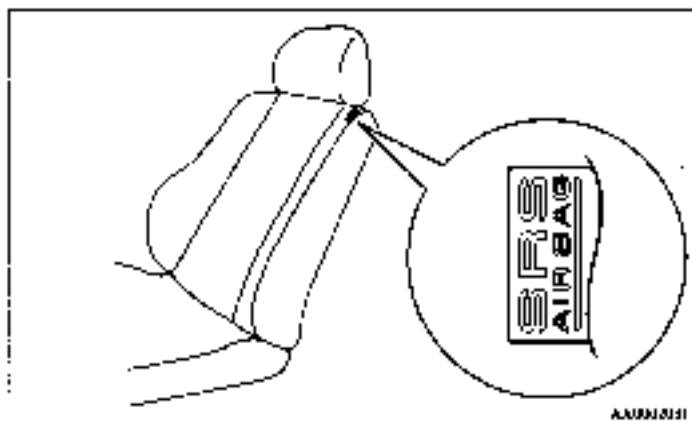

Deployment of side air bags

Figure 2-1

The side air bag IS DESIGNED TO DEPLOY in a ...

A side air bag is designed to deploy when the vehicle suffers a moderate to severe side impact to the middle of the passenger compartment.

The typical situation is shown in the illustration.

Moderate to severe impact to the middle of the vehicle body's side structure

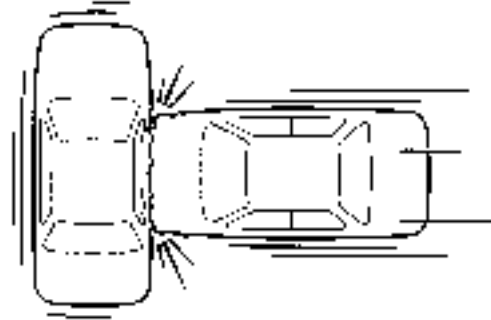

4-4002544

The seat belts in your vehicle are your primary means of protection in a collision. The SRS (Supplemental Restraint System) side air bags are designed to provide additional protection. Therefore, for your safety and the safety of all occupants, be sure to always wear your seat belts properly.

Seat and restraint systems

*The side air bag **MAY NOT DEPLOY** in a ...*

With certain types of side collisions, the vehicle's body structure is designed to absorb the impact to help protect the occupants from harm. (The vehicle body's side area may bend significantly as it absorbs the impact.) In these situations, the side air bag may not deploy, even though there may be major damage to the vehicle body. Examples of some typical situations are shown in the illustrations.

2 Because the side air bags do not protect the occupant in all types of side collisions, be sure to always wear your seat belts properly.

Side impact in an area away from the passenger compartment

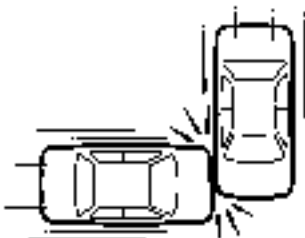

Motorcycle or other similar small vehicle collision with the side of vehicle



Collision with a utility pole, tree or other narrow object



1.6.2.9.0134

The side air bag MAY NOT DEPLOY in an ...

Oblique side impact

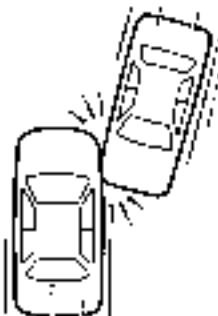

Vehicle rolls onto its side or roof



AAJ1890271

The side air bags ARE NOT DESIGNED TO DEPLOY in a ...

The side air bags are not designed to deploy in situations where they will not provide protection to the occupants. Typical situations are shown in the illustrations.

Because the side air bags do not protect the occupants in all types of collisions, be sure to always wear your seat belts properly.

Head-on collision



Rear end collision



AAJ100061

⚠ WARNING

- The side air bags are designed to supplement the driver and front passenger seat belts in certain side impacts. Seat belts should always be worn properly, and the driver and front passenger should sit well back and upright in their seats without leaning against the window or door.

⚠ WARNING

- The side air bag inflates with great force. In order to reduce the risk of serious or possibly fatal injury when the air bag is inflating, the driver and front passenger should not put their arms out the windows or lean against the doors.

2



⚠ WARNING

- In order to reduce the risk of injury from a deploying side air bag, do not allow any rear seat passengers to hold onto the back of either front seat. Special care should be taken with children.
- Do not place any objects near or around the front of either front seatback. Such objects could interfere with proper side air bag inflation, and could also cause injury if thrown by the deployment of the side air bag.
- Do not place stickers, labels or additional trim on the back of either front seat. It could interfere with proper side air bag inflation.
- Do not install seat covers on seats with side air bags. Do not re-cover the seats that have side air bags. Covers could interfere with proper side air bag inflation.

⚠ WARNING

- Never install a rear-facing child restraint in the front passenger seat. Rear-facing child restraints **MUST ONLY** be used in the rear seat. Forward-facing child restraints should also be used in the rear seat. If a forward-facing child restraint must be used in the front passenger seat, move the seat as far back as possible, and make sure that the child stays in the child restraint and away from the door.

Do not allow the child to lean against or close to the passenger door, even if the child is seated in a child restraint system. The child's head should also not lean against or be close to the section of the seatback where the side air bag is located. It is dangerous if the side air bag inflates. Failure to follow all of these instructions could lead to serious or fatal injury to the child.

- Work done around and on the side air bag system components should only be done by an authorized Mitsubishi dealer. Improper work methods could cause an accidental side air bag deployment, or could make a side air bag inoperable. Either of these situations could result in serious injury.

SRS warning light

NA0010010

There is a Supplemental Restraint System (SRS) warning light on the instrument panel. The system checks itself each time the ignition is turned on and the light indicates if there is a problem.

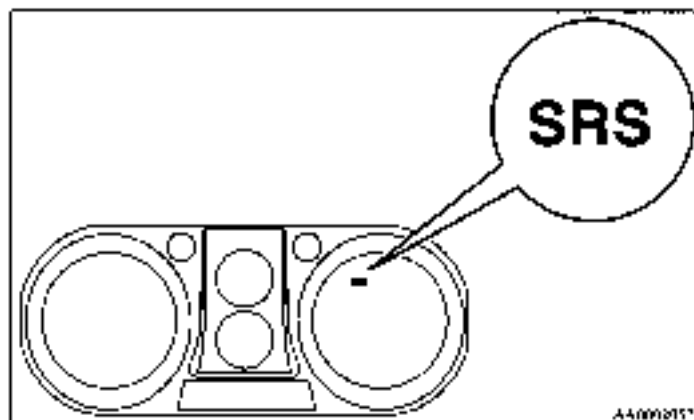

When the ignition key is turned to the "ON" or "START" position, the warning light should come on for several seconds and then go out. This means the system is working properly. The SRS warning light is shared by the driver's air bag, the front passenger's air bag, the optional side air bags, and the seat belt pre-tensioner.

The air bags will operate only when the ignition switch is in the "ON" or "START" position.

⚠ WARNING

- If any of following conditions occur, the SRS is not working properly and you should immediately have it inspected by an authorized Mitsubishi dealer:
 - The SRS warning light does not come on when you start the vehicle.
 - The SRS warning light does not go out after several seconds.
 - The SRS warning light comes on while driving.

SRS servicing

NA0010010

The entire SRS must be inspected by an authorized Mitsubishi dealer 10 years after the vehicle's manufacture date as shown on the certification label located on the driver's door sill.

⚠ WARNING

- Any maintenance performed on or near the components of the SRS should be performed only by an authorized Mitsubishi dealer. Do not permit anyone else to do service, inspection, maintenance or repair on any SRS components or wiring. Similarly, no part of the SRS should ever be handled, removed or disposed by anyone except an authorized Mitsubishi dealer.
Improper work methods on the SRS components or wiring could result in an accidental air bag deployment or could make the SRS inoperable. Either of these situations could result in serious injury.

⚠ WARNING

- Do not modify your steering wheel or any other SRS component or related vehicle part. For example, replacement of the steering wheel, or modifications to the front bumper or body structure can negatively affect SRS performance and may lead to possible injury.
- If your vehicle has received any front-end damage, you should have the SRS inspected by an authorized Mitsubishi dealer to make sure it is in proper working order.
- On vehicles with side air bags, do not modify your front seats, center pillar or center console. Such modifications can adversely affect SRS performance and may lead to possible injury. Also, if you discover any tear or open seam in the seat fabric near the side air bag, have the seat inspected by an authorized Mitsubishi dealer.
- On vehicles with side air bags, if your vehicle has received any damage on either side, you should have the SRS inspected by an authorized Mitsubishi dealer to make sure it is in proper working order.

NOTE

- When you transfer ownership of the vehicle to another person, we urge you to alert the new owner that it is equipped with the SRS and refer that owner to the applicable sections in this owner's manual.
- If you decide to junk or scrap your vehicle, we urge you to first take it to an authorized Mitsubishi dealer so that the SRS can be made safe for disposal.

Caution label

Passenger restraint warning/caution labels for the SRS are located in the vehicle as shown in the illustration.

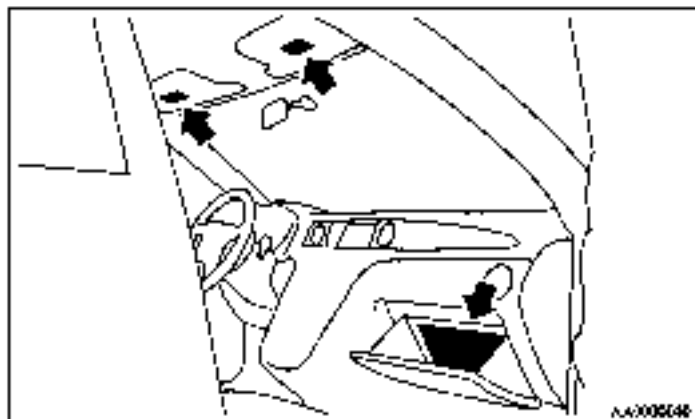

Features and controls

Break-in recommendations	3- 2	Warning lights	3- 58
Keys	3- 2	Combination headlights and dimmer switch	3- 61
Keyless entry system (if so equipped)	3- 5	Turn signal lever	3- 63
Door locks (manual)	3- 6	Hazard warning flasher switch	3- 64
Power door locks	3- 7	Eng light switch (if so equipped)	3- 65
"Child-protection" rear door locks	3- 9	Instrument panel light dimmer control	3- 65
Liftgate	3- 10	Wiper and washer switch	3- 66
Power windows	3- 12	Electric rear window defogger switch	3- 69
Sunroof (if so equipped)	3- 15	Horn switch	3- 70
Parking brake	3- 18	Sun visors	3- 71
Steering wheel tilt lock lever	3- 19	Vanity mirror	3- 72
Inside rearview mirror	3- 20	Accessory socket	3- 73
Outside rearview mirrors	3- 25	Cluck	3- 73
Ignition switch	3- 27	Interior lights	3- 74
Steering wheel lock	3- 29	Accessories	3- 76
Starting	3- 30	Clove confinement	3- 77
Automatic transaxle	3- 32	Floor console box	3- 77
All-wheel drive operation	3- 40	Personal box	3- 79
Service brake	3- 42	Center accessory box (if so equipped)	3- 79
Anti-lock braking system (if so equipped)	3- 43	Cup holder	3- 80
Power steering system	3- 45	Luggage floor boxes	3- 81
Cruse control	3- 46	Tonnent cover (if so equipped)	3- 83
Instrument cluster	3- 53	Luggage hooks	3- 86
Indicator and warning light package	3- 57		
Indicator lights	3- 58		

Break-in recommendations

Advanced automobile manufacturing techniques permit you to operate your new vehicle without requiring a long break-in period of low-speed driving.

However, you can add to the future performance and economy of your vehicle by observing the following precautions during the first 300 miles (500 km).

Drive your vehicle at moderate speeds during the break-in period.

- Avoid revving the engine.
- Avoid rough driving such as fast starts, sudden acceleration, prolonged high-speed driving, and sudden braking. These would have a detrimental effect on the engine and also cause increased fuel and oil consumption, which could result in malfunction of the engine components. Be particularly careful to avoid full acceleration while in low gear.
- Do not overload the vehicle. Observe the seating capacity (See "Cargo loads precautions" on page 4-7.)
- Refrain from towing a trailer or other vehicle. (See "Trailer towing" on page 4-10.)

Keys

Two keys are provided. The keys fit all locks. Keep one in a safe place as a spare key.

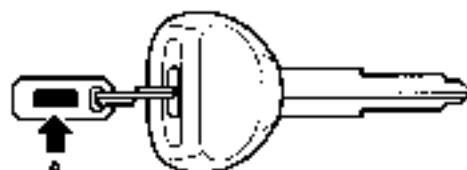

NOTE:

- The key number (A) is stamped on the key number plate as shown in the illustration. Make a record of your key number and store the key and key number in separate places so that you can order a replacement from your authorized Mitsubishi dealer if the original keys are lost.

Keyless entry system (if so equipped)

Press the remote control transmitter to lock or unlock the doors and the liftgate.

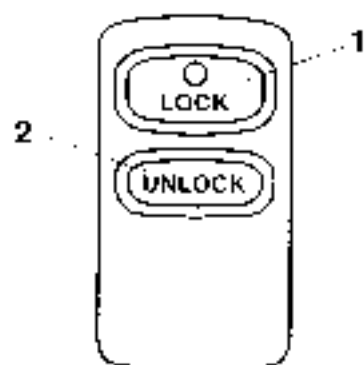

To lock

Press the LOCK button (1) to lock all the doors and the liftgate. When they are locked with the dome light in the "●" (down) position, the dome light will blink twice. The turn signal lights will also blink twice and the horn will sound once.

To unlock

Press the UNLOCK button (2) to unlock the driver's door only. Press the UNLOCK button one more time to unlock all the doors and the liftgate. When the driver's door only or all doors and the liftgate are unlocked with the dome light in the "●" (down) position, the

dome light will turn on for 17 seconds. The turn signal lights will also blink once.

Confirmation function

The keyless entry system confirmation functions (turn the horn and turn signal lights on or off) can each be turned on or off as desired. This is done with the key removed from the ignition switch.

Horn deactivation/reactivation

The confirmation function can be set in the following three ways.

Each time the confirmation function is set, a buzzer will sound to tell you the condition of the confirmation function.

- One buzzer: The horn will sound if the doors and the liftgate are locked with the keyless entry system. The horn will sound regardless of whether the doors and the liftgate are locked or unlocked.
- Two buzzers: The horn will not sound, even if the doors and the liftgate are locked with the keyless entry system.
- Three buzzers: The horn will sound if the doors and the liftgate are already locked and the keyless entry system is used again. In this mode, the horn will only sound when the keyless entry LOCK button is pressed again to reconfirm that the doors and the liftgate are locked.

- 1 Press the LOCK button (1) for 4 to 10 seconds and press the UNLOCK button (2) during this time.
- 2 Release the LOCK and UNLOCK buttons within 10 seconds of pressing the UNLOCK button in step 1.

Turn signal light deactivation/reactivation

The confirmation function from the turn signal lights warning when the doors and the liftgate are locked or unlocked can be turned on or off separately.

A buzzer will sound once when the function has been turned on, and twice if it has been turned off.

1. Press the UNLOCK button (2) for 1 to 10 seconds and press the LOCK button (1) during this time.
2. To turn the function on or off when the doors and the liftgate are locked, release the LOCK button (1) within 10 seconds of pressing it in step 1 and then release the UNLOCK button (2).
3. To turn the function on or off when the doors and the liftgate are unlocked, release the UNLOCK button (2) within 10 seconds of pressing the LOCK button (1) in step 1 and then release the LOCK button (1).

NOTE:

- The keyless entry system does not work if the key is in the ignition.
- The remote control transmitter can be used from about 40 feet (12m) away. However, this distance may change if your vehicle is near a TV transmitting tower, a power station, or a radio station.
- If the UNLOCK button (2) is pressed when all doors and the liftgate are closed, and no doors and the liftgate are opened within about 30 seconds, the doors and the liftgate will automatically relock.
- If the doors and the liftgate do not lock or unlock after you press the LOCK or UNLOCK button on the remote control transmitter, the battery in the remote control transmitter may need to be replaced.

- Do not leave the remote control transmitter where it may be exposed to heat caused by direct sunlight.
- If you lose your remote control transmitter, please contact an authorized Mitsubishi dealer for a replacement.
- If you wish to obtain an additional remote control transmitter, please contact an authorized Mitsubishi dealer. A maximum of 4 remote control transmitters can be programmed for your vehicle.

CAUTION

- The remote control transmitter is a precision electronic device. Therefore:
 - Avoid impact to the remote control transmitter.
 - Keep the remote control transmitter dry.
 - Do not take the remote control transmitter apart.

NOTE:

- Your keyless entry system operates on a radio frequency subject to Federal Communications Commission (FCC) Rules for vehicles sold in U.S.A. and Industry Canada Rules for vehicles sold in Canada. This device complies with Part 15 of the FCC Rules and ICES-700 of the Industry Canada Rules. Operation is subject to the following two conditions:
 - This device may not cause harmful interference.
 - This device must accept any interference, including interference that may cause undesirable operation.

⚠ CAUTION

- Changes or modifications not expressly approved by the manufacturer for compliance could void the user's authority to operate the equipment.

Procedure for replacing the remote control transmitter battery

1. Remove the remote control transmitter case mounting screw (A) and open the case.

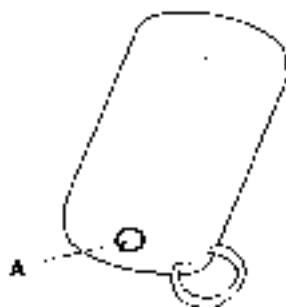

2. Remove the old battery.
3. Install a new battery with the + side (B) down.

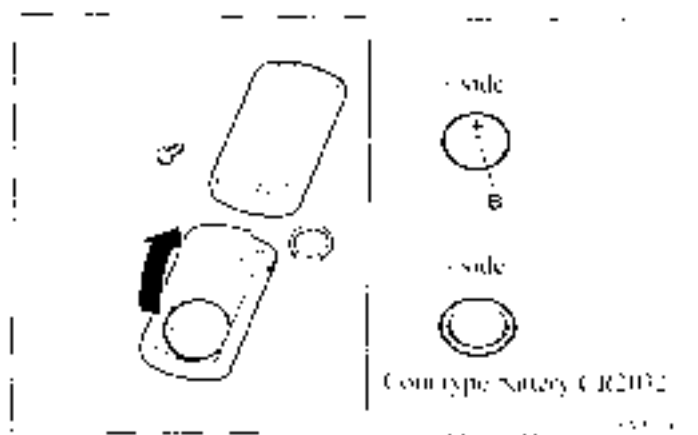

4. Close the remote control transmitter case. Make sure the mounting screw is tightened.
5. Check the keyless entry system to see that it works.

NOTE:

- You may purchase a battery at a receiving appliance store.
- Your authorized Mitsubishi dealer can replace the battery for you, if you prefer.

⚠ CAUTION

- When the remote control transmitter case is opened, be careful to keep water, dust, etc. out. Also, do not touch the internal components.

Door locks (manual)

To lock or unlock the door with the key

Turn the key toward the front of the vehicle to lock the door. After checking that the door is locked, turn the key back to the center and to remove it.

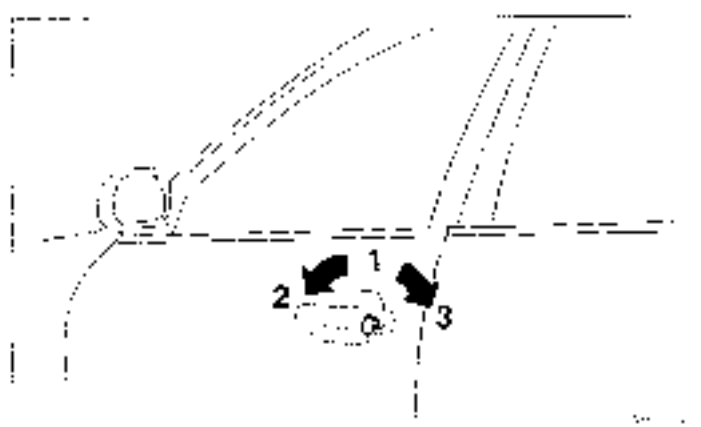

1. Insert or remove the key
2. Lock
3. Unlock

To lock or unlock the door from the inside

Move the lock knob to the lock position (so that the red mark cannot be seen) to lock the door.

All doors should be kept locked while driving.

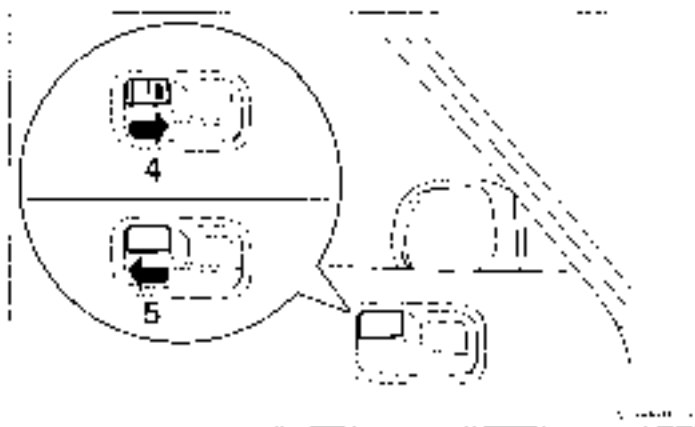

4. Lock
5. Unlock

The driver's door can be unlocked without using the lock knob by pulling on the inside door handle.

⚠ WARNING

- Make sure all the doors are closed. Driving without all the doors being tightly closed is very dangerous.
- Never leave a child unattended in your vehicle.

To lock the door without using the key

1. Move the inside lock knob to the locked position.
2. Be sure the keys are not inside the vehicle. Close the door.

**Key reminder buzzer**

If you open the driver's door while the ignition key is in the "LOCK" or "ACC" position, a buzzer will sound, reminding you to remove the key.

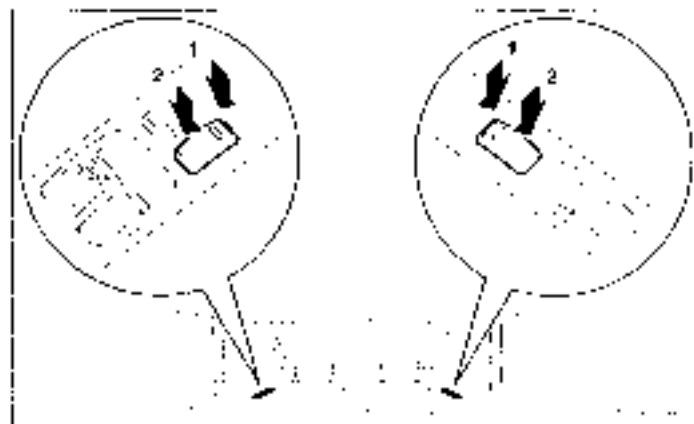
Power door locks**Locking and unlocking with the power door lock switch**

- ↑ Lock
- ↓ Unlock

All of the doors and the liftgate can be locked or unlocked by pressing the power door lock switch on the driver's or the front passenger's door.

Locking and unlocking with the key



- 1 Lock
2 Unlock

Using the key to lock or unlock the driver's or front passenger's door will automatically lock or unlock all of the doors and the luggage.

- Turn the key in the driver's door lock once in the unlock (up) direction, and the driver's door will be unlocked. Turn the key again in the unlocking direction, and all doors and the luggage will be unlocked.

NOTE

- Repeated continuous operation between lock and unlock could activate the power door locking system's hold-on protection circuit and prevent the system from operating. If this occurs, wait about one minute before operating the inside lock knob or the key.

Liftgate

⚠ WARNING

- It is dangerous to drive with the liftgate open since carbon monoxide (CO) gas can enter the cabin. CO is an invisible, odorless gas that can cause unconsciousness and even death.

⚠ CAUTION

- Do not stand behind the exhaust pipe when loading and unloading luggage. Heat from the exhaust could lead to burns.

NOTE:

- Locking or unlocking of the driver's door or the front passenger's door by using the key or keyless entry system of well equipped cars also locks/unlocks the liftgate.

To lock or unlock the liftgate with the key

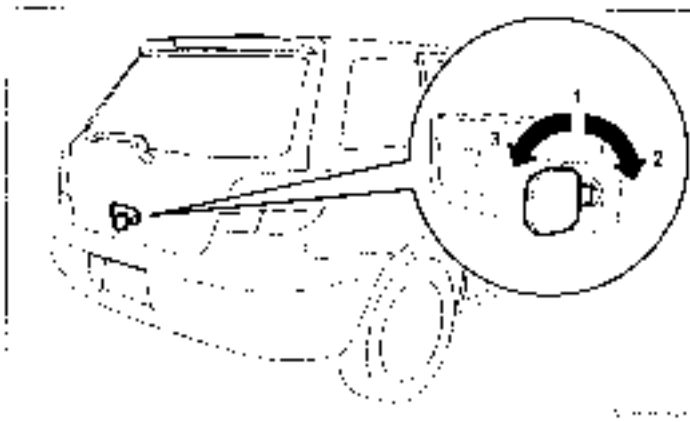

1- Insert and remove the key

2- Lock

3- Unlock

To open

Pull the liftgate handle upwards to open the liftgate.

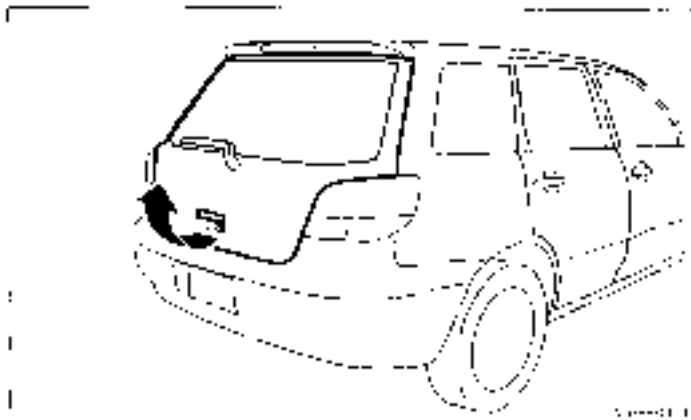
**⚠ CAUTION**

- Make sure there is no one standing nearby when opening the liftgate.

To close

Pull the liftgate grip (A) downward as illustrated and release it before the liftgate closes completely. Gently slam the liftgate from the outside so that it is completely closed.

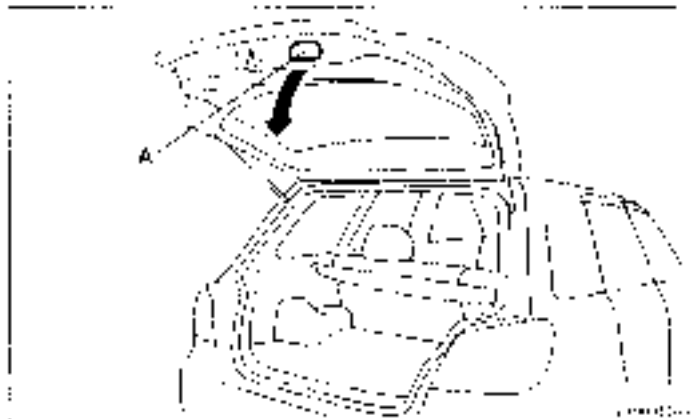
**⚠ WARNING**

- To avoid injuring your hand or arm, do not attempt to close the liftgate without releasing the liftgate grip.
- Before starting the vehicle, be sure to confirm that the liftgate is latched. If the liftgate opens while driving the vehicle, objects stored in the luggage area could fall out into the road.

NOTE

- Gas struts (B) are installed in the locations illustrated in order to support the lidgate. Please observe the following in order to prevent damage or faulty operation:
 - Do not attach any plastic material, tape, etc., to the gas struts.
 - Do not tie string, etc., around the gas struts.
 - Do not pull on the gas struts when closing the lidgate or hang items from the gas struts.



Power windows

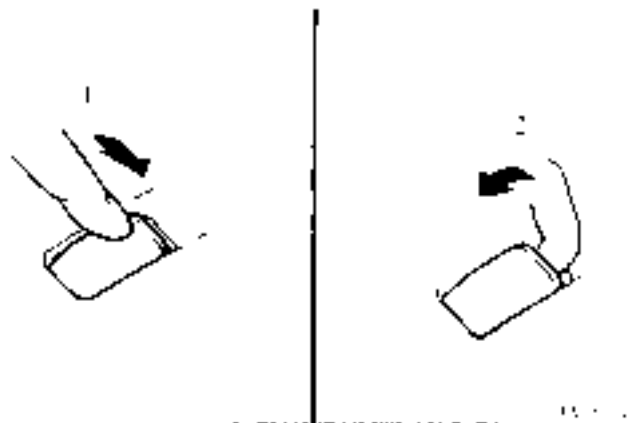

- 1: Open (down)
- 2: Close (up)

NOTE

- Never try to operate the main switch and sub-switch in different directions at the same time. This will freeze the window in position.
- Operating the power windows repeatedly with the engine stopped will run down the battery. Use the window switches while the engine is running.

⚠ WARNING

- Before operating the power windows, make sure that nothing can be trapped (head, hands, fingers, etc.) in the window.
- Never leave the vehicle without removing the key.
- Never leave a child alone in the vehicle.

Main switch

The main switch located on the driver's door can be used to operate all the door windows.

The windows will move while the switch is pressed and stop when the switch is released.

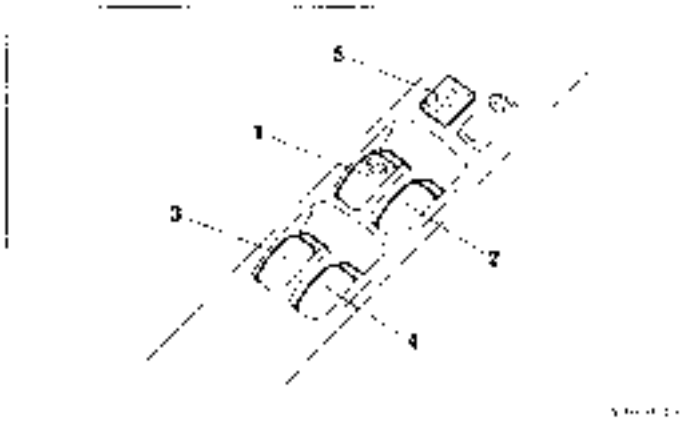

- 1- Driver's door window switch
 (to open the driver's door window all the way, you do not need to hold the switch down for the entire time.)
- 2- Front passenger door window switch
- 3- Left rear door window switch
- 4- Right rear door window switch
- 5- Window lock switch

Sub switch

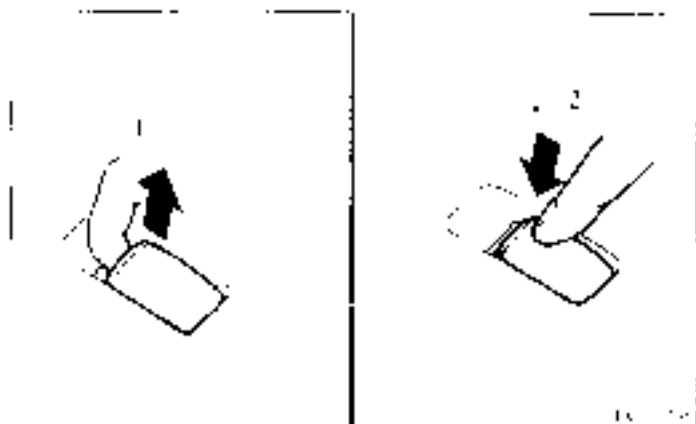

- 1 - Close
- 2 - Open

Each sub-switch can be used for its own passenger door window, unless the driver's window lock switch is activated.

NOTE

- The rear door windows open only half way.

Power window timer function

The power windows can be run up or down when the ignition key is in the "ON" position.

The door windows can be opened or closed for a 30-second period after the ignition key is turned to the "OFF" position.

However, once the driver's door or the front passenger's door is opened, the power windows cannot be operated.

Lock switch

When this switch is in the lock mode, the passenger door switches cannot be used to open or close the door windows, and the main switch will open or close only the driver's door window. To unlock the switch press it again.

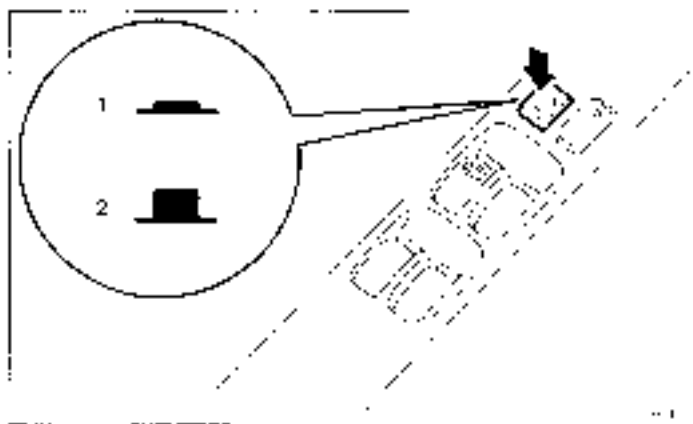

- 1 - Lock
- 2 - Unlock

⚠ WARNING

- Before driving with a child in the vehicle, be sure to lock the window switch to make it inoperative. Children tampering with the switch could easily trap their hands or heads in the window.

Sunroof (if so equipped)

The sunroof can be opened and closed with the ignition key in the "ON" position.

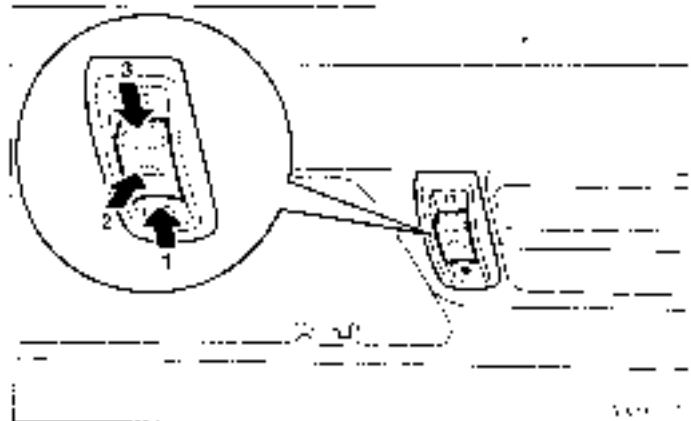
**To open**

The sunroof automatically opens completely if the switch (3) is pressed.

To stop the tilting sunroof, press the switch (2) or (3).

To close

The sunroof closes while the switch (3) is pressed.

To tilt up

When the switch (1) is pressed, the rear sunvisor raises for ventilation.

NOTE:

- When the sunroof is tilted up, the sunshade is automatically opened slightly.

To tilt down

Press the switch (3).

Sunroof timer function

The sunroof can be operated when the ignition key is in the "ON" position. The sunroof can be opened or closed for a 30-second period after the ignition switch is turned off. However, once the driver's door or the front passenger's door is opened, the sunroof cannot be operated until the ignition switch is turned on again.

Safety mechanism

If a hand or head is trapped in the closing sunroof opening, the safety mechanism will cause the sunroof to re-open automatically. The opened sunroof will become operational after a few seconds.

If the safety mechanism is activated 5 or more times consecutively, manual closing of the sunroof will be aborted. To return the sunroof to normal operation:

1. Press switch (3) repeatedly, setting the sunroof in the tilt up position.
2. Once the tilt up position has been reached, press and hold switch (3) for at least 3 seconds.
3. Press switch (2) again to fully close the sunroof.

Features and controls

- After pressing the switch (1) to perform full opening, press the switch (3) to fully close the sunroof.

NOT:

- Do not stop the sunroof before it is completely opened or closed in steps 3 and 4 above. If this should happen repeat the process from step 1.

⚠ CAUTION

- The safety mechanism is deactivated just before the sunroof closes. This allows the sunroof to close completely. Therefore be especially careful that fingers are not trapped in the sunroof opening.

- The sunroof should now operate in the normal manner.

Sunshade

The sunshade can be opened or closed manually while the sunroof is closed.

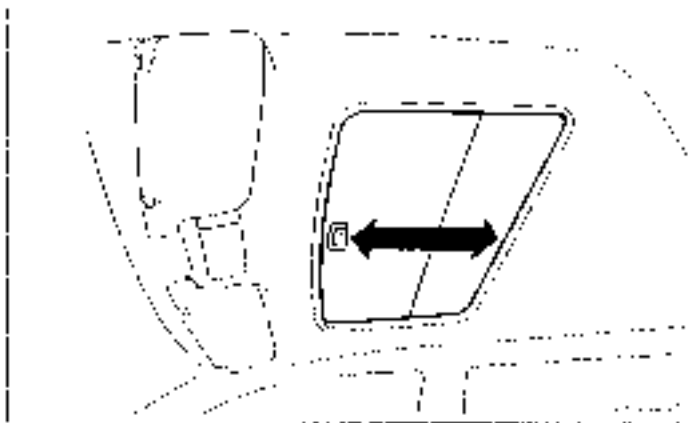

⚠ CAUTION

- Do not attempt to close the sunshade when the sunroof is opened.
- Be careful that hands are not trapped when closing the sunshade.

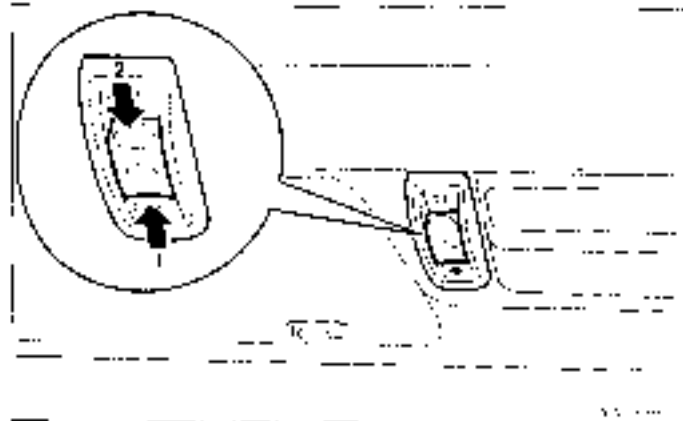
**To open**

When switch (1) is pressed, the sunshade will open along with the sunroof.

To close

When switch (2) is pressed, the sunshade will close along with the sunroof.

NOTE

- If the sunroof is stopped midway, the sunshade will not close along with the sunroof. In such a situation, press switch (1) to fully open the sunroof and then press switch (2).
- When the sunroof is tilted up, the sunshade is automatically raised slightly.
- Be sure to tilt down the sunroof before closing the sunshade.

⚠ WARNING

- Do not stick your head, hands or anything else in the sunroof opening.
- Before operating the sunroof, make sure that nothing can be trapped (head, hands, fingers, etc.).
- Never leave a child (or other person who is incapable of safely operating the sunroof switch) alone in the vehicle.

NOTE

- When leaving the vehicle unattended, be sure to close the sunroof and remove the ignition key.
- Do not try to operate the sunroof if it is frozen closed after snowfall or during extreme cold.
- Do not sit on or place heavy luggage on the sunroof or roof opening edge.
- Do not apply any force that may cause damage to the sunroof.
- Release the switch when the sunroof has reached a completely open or completely closed position.
- If the sunroof does not operate when the sunroof switch is operated, release the switch and check whether something is trapped by the sunroof. If nothing is trapped, have the sunroof checked at an authorized Mitsubishi dealer.
- Be careful when tilting up the sunroof if a ski carrier or a roof carrier is installed. Depending on the model of ski carrier or roof carrier, the sunroof may contact the carrier when the sunroof is tilted up.
- Be sure to close the sunroof completely when washing the vehicle or when leaving the vehicle.

Features and controls

- Do not put any wax on the weatherstrip (black rubber) around the sunroof opening. If it is waxed, the weatherstrip cannot maintain a weatherproof seal with the sunroof.
- After washing the vehicle or after rain, be sure to wipe off any water that is on the sunroof before operating it.
- Operating the sunroof repeatedly with the engine turned off will run down the battery. Operate the sunroof while the engine is running.

Parking brake

To set

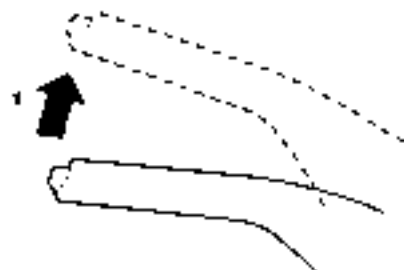

1. Pull the lever up without pushing the button at the end of the hand grip.
When the parking brake is set and the ignition key is in the "ON" position, the brake warning lamp in the instrument cluster will come on.
Before driving, be sure to release the parking brake.

To release



- 1- Lift the lever up slightly
- 2- Press and hold in the end of the hand grip
- 3- Push the lever downward.

CAUTION

- If you drive your vehicle without first releasing the parking brake, the brakes will overheat. This will cause poor braking and possible brake failure.

Steering wheel tilt lock lever

To adjust the steering wheel up or down, move the tilt lock lever upward or downward while raising or lowering the steering wheel to the desired level.

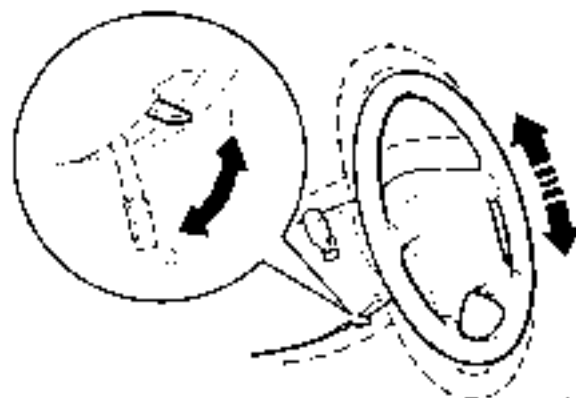

- 1- Locked
- 2- Released

⚠ WARNING

- After adjusting, make sure the lock lever is secured in the locked (1) position.
- Do not attempt to adjust the steering wheel while driving. This can be dangerous.
- When releasing the tilt lock lever (moving it to the UNLOCK position (2)), be sure to hold the steering wheel firmly. Otherwise, the steering wheel may slip down too suddenly.

Inside rearview mirror

Adjust the inside rearview mirror only after making any seat adjustments so as to have a clear view to the rear of the vehicle.

⚠ WARNING

- Do not attempt to adjust the inside rearview mirror while driving. This can be dangerous.
Be sure to adjust the mirror before driving.

Inside day/night rearview mirror (if so equipped)

Adjust the inside mirror to maximize the view through the rear window.

Make this adjustment while the day/night knob (A) is in the daytime position (1).

To reduce glare from other vehicles' headlights, switch the lever to the night position (2).

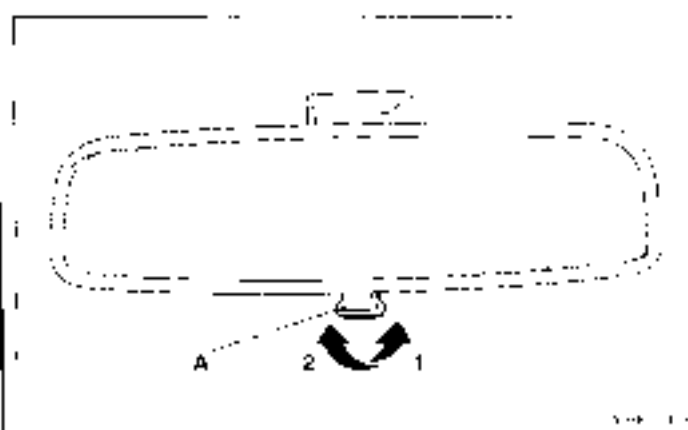
**Electrochromic inside rearview mirror with compass and temperature display (if so equipped)**

The mirror also includes a display in the upper right corner of the mirror face. This can be used as a compass or to indicate outside air temperature.

Electrochromic mirror operation

Make sure the indicator (A) is on. If it's not, press the "DIM" button for about 15 seconds. When on, the mirror automatically dims to the proper level to minimize glare from lights behind you after dark.

To turn the mirror off, press and hold the "DIM" button for about 15 seconds. The indicator will turn off.

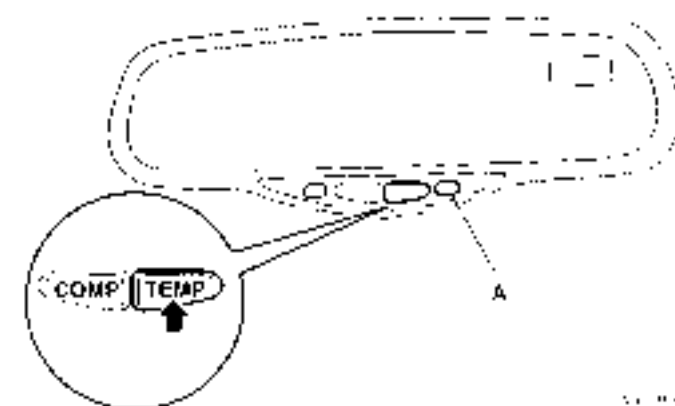

3

Features and controls

To test the electrochromic mirror operation:

1. Cover the forward-facing light sensor (B) on the back of the mirror with a black cloth.

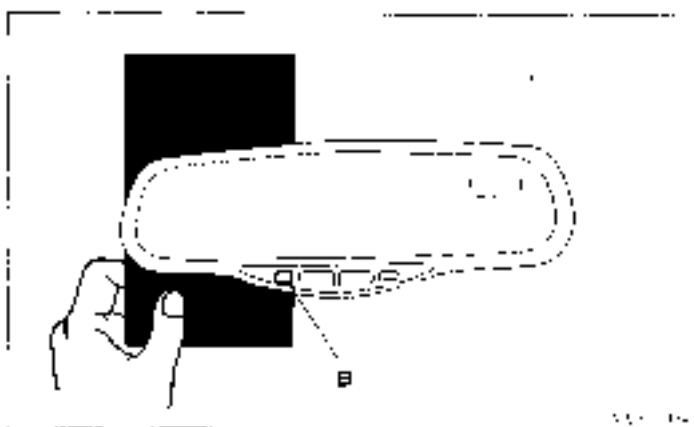

2. While in a well-lit area, make sure light strikes the sensor on the front of the mirror, simulating glare from vehicles behind you.
The mirror will dim within 2 minutes.

Outside temperature

Press the "TEMP" button. The outside temperature will be displayed.

Pressing the "TEMP" button a second time will turn off the display.

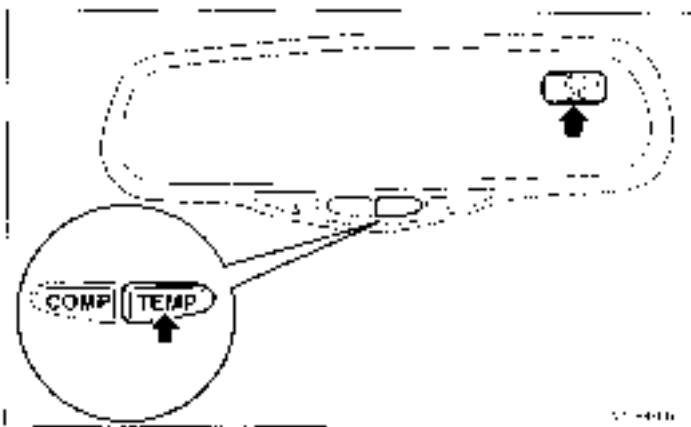

NOTE:

- To alternate the temperature reading between Fahrenheit and Celsius, press the "TEMP" button for 3 seconds until the display blinks "F" and "C". Press the "TEMP" button to toggle between the Fahrenheit and Celsius readings. After 3 seconds of inactivity, the display will return to the temperature reading.
- The outside temperature can be displayed from 50°F (-10°C) to 140°F (60°C).
- If the outside temperature drops below about 37°F (3°C), "R.F." displays for about 1 minute.

- The outside temperature display may differ from the actual temperature due to surrounding conditions, driving conditions, etc.
- If an error message ("SC") or "CH" displays, have the system checked at an authorized Mitsubishi dealer.

Compass operation

Press the "COMP" button. The visual display is now in compass mode and the vehicle's directional heading (N, NE, E, SE, S, SW, W and NW) will be displayed.

Pressing the "COMP" button a second time will turn off the visual display.

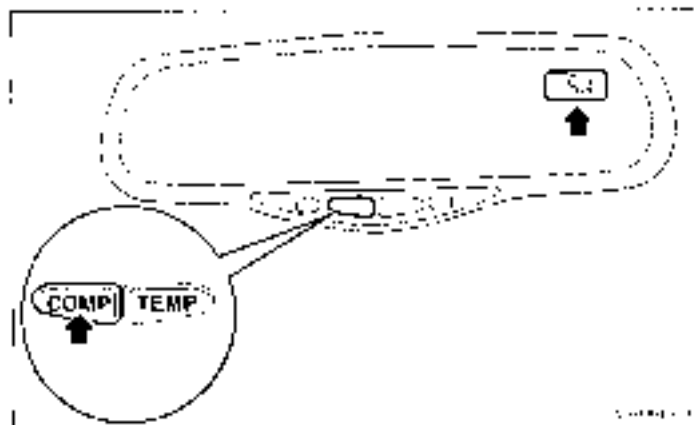

Compass variance

Under certain circumstances, such as during a long distance cross-country trip, it will be necessary to adjust for compass variance.

Compass variance is the difference between car's magnetic north and true geographic north. If not adjusted to account for compass variance, your compass could give false readings.

To adjust for compass variance:

1. Press the "COMP" button for more than 3 seconds. The current zone number will appear in the display.

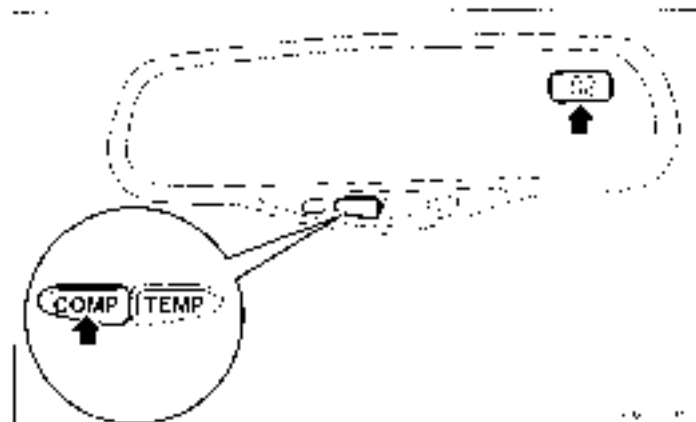

3

Features and controls

2. Find your current location and variance zone number on the zone map.



- The compass may not indicate the correct compass point in the following places shown below. In these cases, the correct direction will be displayed when the vehicle returns to a place where the earth's magnetic field is stable.
 - Vehicles in tunnels or parked in buildings.
 - Expressways, near railroads, underneath railroad cables, or near subways.
 - Near transformer stations or high voltage power lines.
 - Dip or down a steep hill.

Compass calibration

Calibrate the compass as follows.

If the display reads "C", there may be a strong magnetic field interfering with the compass. In this case, the compass may need calibration.

3. Press the "COMP" button until the new zone number appears in the display.

After you stop pressing the button in, the display will show a compass direction within a few seconds.

NOTE

- Do not attach ski racks, antennas, or any other object to the vehicle by means of a magnet. Such magnets will affect the operation of the compass.
- If the compass deviates from the correct indication soon after repeated adjustment, have the compass checked at an authorized Mitsubishi dealer.



Drive the vehicle in a circle at about 5 mph (8 km/h) or less into the display reads a direction.

You can also calibrate the compass by driving your vehicle on your everyday routine and after several turns the compass will become calibrated and will display a direction.

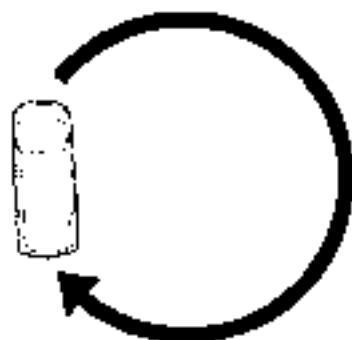

Cleaning of the mirror

When cleaning the mirror, use a paper towel or similar material dampened with glass cleaner. Do not spray glass cleaner directly on the mirror as that may cause the liquid cleaner to enter the mirror housing.

Outside rearview mirrors

Adjust the outside rearview mirrors only after making any seat adjustments so as to have a clear view to the rear of the vehicle.

⚠ WARNING

- Do not attempt to adjust the outside rearview mirrors while driving. This can be dangerous. Be sure to adjust the mirrors before driving.
- Your passenger's side mirror is convex. The objects you see in the mirror will look smaller and farther away than they appear in a regular flat mirror. Do not use this mirror to estimate the distance of vehicles following you when changing lanes.

To adjust the mirror position

Electric remote-controlled outside mirrors

The outside rearview mirrors can be adjusted when the ignition key is in the "ON" or "ACC" position.

Move the lever (A) to the same side as the mirror you wish to adjust.

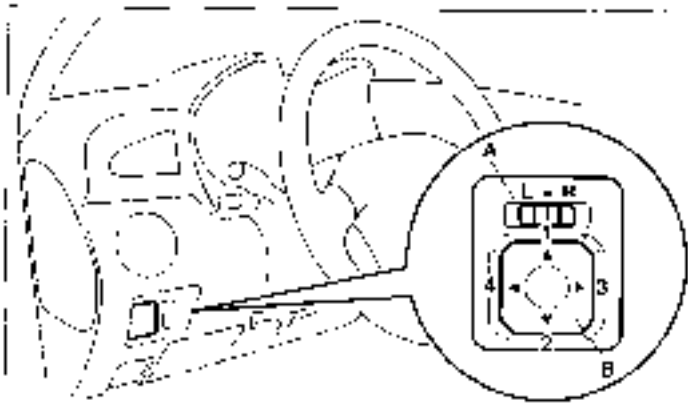

- L - Left outside mirror adjustment
- R - Right outside mirror adjustment

Press the switch (B) to adjust the mirror position.

- 1 - Up
- 2 - Down
- 3 - Right
- 4 - Left

NOTE:

- After adjusting, return the lever to the "OFF" position.

To fold the mirror

The outside mirror can be folded in towards the side window to prevent damage when parking in tight locations.

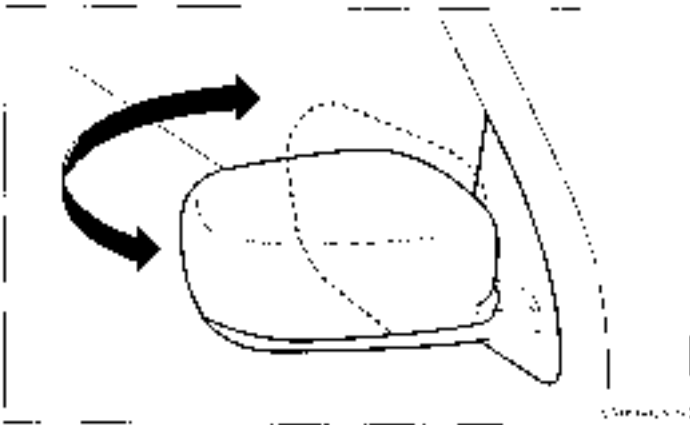

Heated mirrors (if so equipped)

When the rear window defogger switch is pressed, the outside rearview mirrors are defogged or defrosted. Current will flow through the heater element inside the mirrors, thus clearing away frost or condensation.

Ignition switch



LOCK

The engine is off and the steering wheel is locked. The key can be inserted and removed only when the switch is in this position.

ACC

Allows operation of electrical accessories with the engine off.

ON

The engine runs and all accessories can be used.

START

Engages the starter. After the engine starts, release the key and it will return automatically to the "ON" position.

Your vehicle is equipped with ignition switch illumination. The ignition switch will be illuminated.

- When the driver's door is opened until 30 seconds after door is closed. When the ignition switch is set to the "ON" position, it will go off even before 30 seconds.
- When you get out of the vehicle and remove the ignition key it will remain illuminated for about 30 seconds.

If your vehicle is equipped with Daytime Running Lights, when the ignition key is in the "ON" position, the high beam of the headlight will illuminate dimly. (Refer to "Combination headlights and dimmer switch" on page 3-81.)

To remove the key

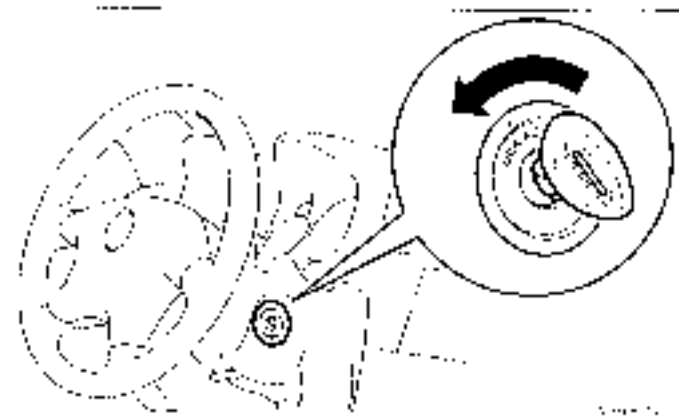

First set the selector lever to the "P" (PARK) position, and then turn the key to the "LOCK" position and remove it.

NOTE

- The key cannot be removed unless the selector lever is set in the "P" (PARK) position.

CAUTION

- If the engine is turned off while driving, the power brake booster will stop functioning and braking efficiency will be reduced. Also, the power steering system will not function and it will require greater effort to manually steer the vehicle.
- Do not leave the key in the "ON" position for a long time when the engine is not running. This will cause the battery to run down.

CAUTION

- Do not turn the key to the "START" position when the engine is running. It will damage the starter motor.

Key reminder buzzer

If the driver's door is opened while the ignition key is in the "LOCK" or "ACC" position, a warning buzzer will sound.

Steering wheel lock

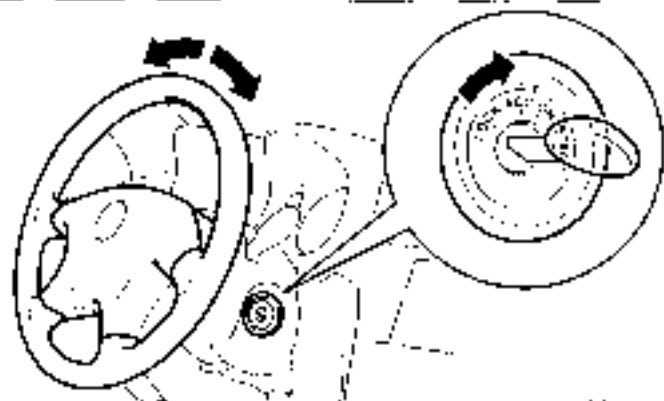

To lock

Remove the key at the "LOCK" position
turn the steering wheel until it is locked

To unlock

Turn the key to the "ACC" position while moving the steering wheel slightly.

⚠ CAUTION

- Remove the key when leaving the vehicle.
- If your vehicle needs to be towed, turn the key to the "ACC" position to unlock the steering wheel.

NOTE:

- If the front wheels are turned, the anti-theft lock may sometimes make it difficult to turn the key from "LOCK" to "ACC". Firmly turn the steering wheel to the left or to the right as you turn the key.

Starting

Tips for starting

- Do not operate the starter motor continuously for longer than 15 seconds as this could run the battery down or damage the starter motor. If the engine does not start, turn the ignition switch back to the "LOCK" position, wait a few seconds, and then try again. Trying repeatedly with the engine or starter motor still turning will damage the starter mechanism.
- If the engine will not start because the battery is weak or discharged, refer to "Jump-starting the engine" on page 6-14 for instructions.
- The engine is warmed up enough for driving when the coolant temperature gauge indicator starts to move. A longer warm-up period will only consume extra fuel.

⚠ WARNING

- Never run the engine in a closed or poorly ventilated area any longer than is needed to move your vehicle out of the area. Carbon monoxide gas, which is odorless and extremely poisonous, could build up and cause serious injury or death.

⚠ CAUTION

- Do not push-start the vehicle.
- Do not run the engine at high rpm or drive at high speeds until the engine has had a chance to warm up.

⚠ CAUTION

- Release the ignition key as soon as the engine starts. Otherwise, the starter motor will be damaged.

NOTE

- After replacing the battery, the electronic control system data for the engine will be erased. As a result, the engine speed may become unstable. If the engine speed becomes unstable, initial engine adjustments will need to be performed. (Refer to "What to do if the engine speed becomes unstable after the battery is replaced" on page 6-25.)

Starting the engine

Your vehicle is equipped with an electronically controlled fuel injection system, which automatically controls the release of fuel. There is usually no need to depress the accelerator pedal when starting the engine.

The starter should not be run for more than 15 seconds at a time.

To prevent battery drain, wait a few seconds between attempts to restart the engine.

Normal conditions

to start your vehicle.

Make sure all occupants are properly seated with seat belts fastened.

1. Insert the ignition key.
2. Press and hold the brake pedal down with your right foot.
3. Set the selector lever in the "P" (PARK) position.
4. Turn the ignition key to the "ON" position and make certain that all warning lights are functioning properly before starting the engine.
5. Turn the ignition key to the "START" position without pressing the accelerator pedal. Release the key when the engine starts.

NOTE

- Muff noises may be heard on engine start-up. These will disappear as the engine warms up.

At extremely cold ambient temperature

If the engine won't start, press the accelerator pedal about half-way down while cranking the engine. Release the accelerator pedal when the engine starts.

▲ CAUTION

- When starting the engine, make sure that you hold the brake pedal down. During very cold weather, if you start the engine with your foot on the accelerator pedal, switch to the brake pedal as soon as the engine has started.

Startability of automatic transaxle vehicle with ambient temperature of -31 °F (-35 °C) or lower

When the ambient temperature is -31 °F (-35 °C) or lower, it may not be possible to start from a standstill even with the shift lever in the "D" (DRIVE) position.

This phenomenon occurs because the transaxle has not warmed up sufficiently; it does not indicate a fault. If it occurs, place the shift lever in the "P" (PARK) position and let the engine idle for at least 10 minutes.

The transaxle will warm up, and you will be able to start normally.

Do not leave the vehicle during warm-up operation.

Flooded engine

If the engine has flooded during starting, just run the starter for 5 to 6 seconds while holding down the accelerator pedal. Release the ignition key (return to "ON" position) and the accelerator pedal. Wait a moment, then without depressing the accelerator pedal, turn the ignition key to the "START" position for another 5 to 6 seconds. Release the ignition key if the engine starts. Repeat as necessary. Contact your Mitsubishi dealer for assistance.

Automatic transaxle

Designed for the most efficient control and equipped with self-adjusting capabilities, the electronically controlled transaxle used in your vehicle selects the most favorable gear for each type of driving and road condition.

DRIVING UPHILL

The transaxle may not shift to a higher gear if the computer determines your current speed would be affected.

For smoother vehicle performance, if you release the throttle while climbing a steep hill, the transaxle may not shift. This is normal, because the computer will be controlling the shifting. After reaching the top of the hill, your normal gear shift operation will resume.

DRIVING DOWNHILL

When traveling down steep grades and using the brakes, the computer may automatically select a lower gear. This helps engine braking efforts, reducing your need to use the brakes.

⚠ CAUTION

- The electronically controlled transaxle system is strictly intended to provide supplementary functions. When driving downhill under certain conditions, when the automatic transaxle is cold immediately after starting, no automatic downshift may be made. The driver should shift down to a lower gear (3rd gear or 2nd gear), which will permit the engine to begin braking.

NOTE

- During the break-in period or immediately after reconnecting the battery, your vehicle may not shift as smoothly. This does not indicate a faulty transaxle. Shifting will become smoother once the transaxle has been shifted several times by the electronic control system.

Selector lever operation

The transaxle has 4 forward gears and 1 reverse gear. The individual gears are selected automatically, depending on the position of the gear selector lever, the speed of the vehicle and the position of the accelerator pedal. The selector lever has 2 "gates", the main gate (1) and the manual gate (2).

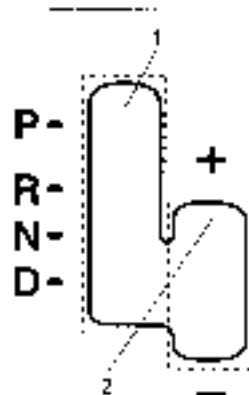

In the main gate, the selector lever has 4 positions, and is equipped with a lock button (A) to prevent inadvertent selection of the wrong gear.

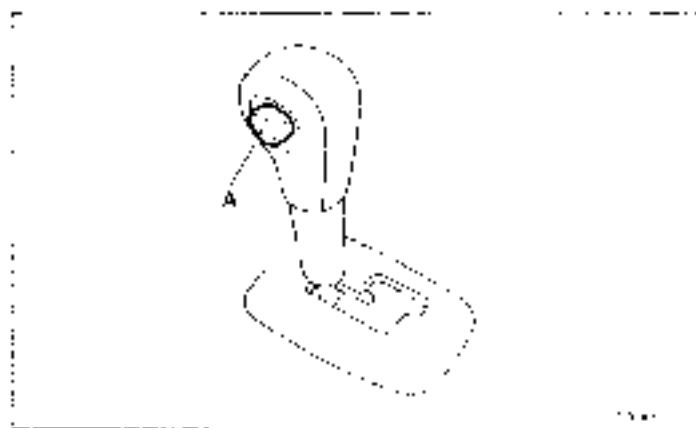

NOTE:

- For information on manual gate operation, please refer to "Sports mode" on page 3-36.

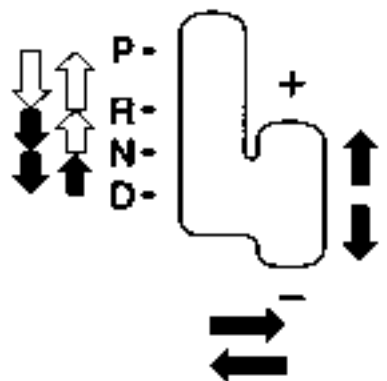

⚠ WARNING

- Always press the brake pedal when shifting the selector lever into a gear from the "N" (NEUTRAL) position. When beginning to drive, do not shift the selector lever from the "N" (NEUTRAL) position while pressing the accelerator pedal. This will cause the vehicle to "jump" forward or backward.

NOTE

- If the brake pedal is not depressed and held, the shift-lock device activates to prevent the selector lever from being moved from the "P" (PARK) position.



The lock button must be pushed while the brake pedal is pressed to move the selector lever.



The lever will move without pushing the lock button.



The lock button must be pushed to move the lever.

⚠ WARNING

- If the lock button is always pressed when using the selector lever, the lever may be accidentally shifted into the "P" (PARK) or "R" (REVERSE) position. Do not press the lock button when making shifts shown by ↓ in the illustration.

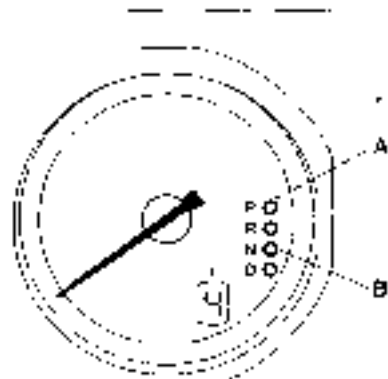
Selector lever position lights¹ "N" indicator light

A- Selector lever position indicator light

When the ignition key is turned to the "ON" position, the indicator light in the instrument panel comes on to show the position of the selector lever (ie "PARK", "DRIVE", "REVERSE" etc).

B- "N" indicator light

When the "N" indicator light flashes with the "D" (DRIVE) position or "Sports Mode" is selected, the automatic transaxle safety device may be malfunctioning.

Have your vehicle inspected by an authorized Mitsubishi dealer as soon as possible.

Automatic transaxle oil temperature warning light

The automatic transaxle oil temperature warning light comes on when the automatic transaxle fluid temperature becomes abnormally high. Normally the warning light comes on when the ignition key is turned to the "ON" position and then will go out after a few seconds.

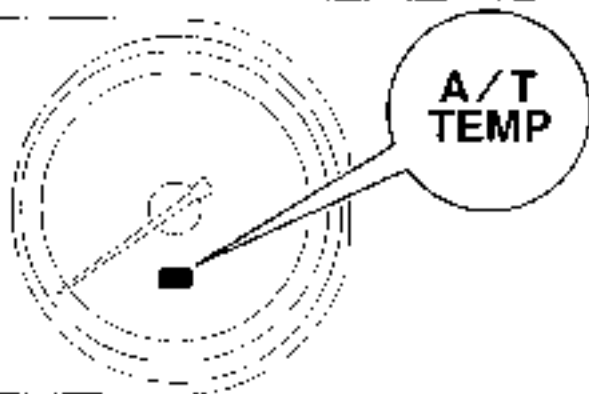

If the light comes on, reduce the engine speed and stop the vehicle in a safe area. Then set the selector lever to "P" (PARK) position and idle the engine until the warning light goes off. When the warning light goes off, resume normal driving. If the warning light does not go off, have your vehicle inspected at an authorized Mitsubishi dealer.

Selector lever positions (Main gate)

"P" PARK

This position locks the transaxle to prevent the vehicle from moving. The engine can be started from the "PARK" position.

"R" REVERSE

Move the lever to this position only after the vehicle has come to a complete stop.

CAUTION

- Never shift into the "P" (PARK) or "R" (REVERSE) position while the vehicle is in motion. If the lever is shifted into the "P" or "R" position while the vehicle is in motion, the transaxle may be damaged.

"N" NEUTRAL

At this position, the transaxle is disengaged. It is the same as the neutral position on a manual transaxle and should be used when the vehicle is not moving for an extended length of time during driving, such as in a traffic jam.

WARNING

- Never move the selector lever to the "N" (NEUTRAL) position while driving since you could accidentally slip it into the "P" (PARK) or "R" (REVERSE) position, damaging the transaxle.

WARNING

- To prevent the vehicle from rolling when stopped on a slope, the engine should be started in the "P" (PARK) position, not in "N" (NEUTRAL).
- Always keep your foot on the brake pedal when the vehicle is in "N" (NEUTRAL), or when shifting into or out of "N" (NEUTRAL), to prevent rolling.

"D" DRIVE

This position is used for most city and highway driving. Engine shifting and braking are done automatically as needed, depending on road conditions.

NOTE:

- For information on manual gate operation, please refer to "Sports mode" on page 3-36.

Sports mode

Whether the vehicle is stationary or in motion, sports mode is selected by pushing the selector lever from the "D" position into the manual gate. To return to "D" range operation, push the selector lever back into the main gate.

In sports mode, gear shifts can be made rapidly simply by moving the selector lever backward and forward. Sports mode allows gear shifts with the accelerator pedal depressed.

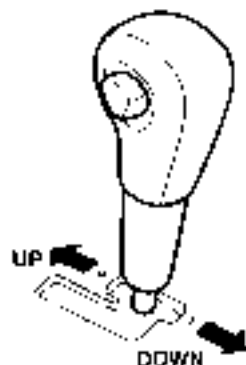
Manual gate**- (UP)**

Push the lever forward once to shift up one gear.

- (DOWN)

Pull the lever backward once to shift down one gear.

⚠ CAUTION

- Upward shifts do not take place automatically in sports mode. The driver must make upward shifts in accordance with prevailing road conditions, making sure the engine rpm remains below the red zone on the tachometer.

⚠ CAUTION

- By rapidly moving the selector lever backwards (DOWN) twice, it is possible to skip one gear (i.e., 3rd to 1st or 4th to 2nd). Since sudden engine deceleration or acceleration can cause a loss of traction, downshifts must be made carefully in accordance with the vehicle's speed.

NOTE

- In sports mode, only the 4 forward gears can be selected. To reverse or park the vehicle, move the selector lever to the "R" (REVERSE) or "P" (PARK) position in the main gate.
- To maintain the required levels of vehicle performance and safety, the system may not execute certain gear shifts when the selector lever is operated, such as 0th gear at low speed.
- In sports mode, downward shifts are made automatically when the vehicle slows down. When the vehicle stops, 1st gear is automatically selected.
- When pulling away from a standstill on a slippery road, push the selector lever forward to the - (UP) position. This causes the transaxle to select 2nd gear, which is better for safe driving on slippery roads. Push the selector lever to the - (DOWN) side to shift back to 1st gear.
- Move the selector lever gently between the manual and main gates and between positions in the manual gate. Excessive force could damage the selector lever.
- When sports mode is selected, the "S" indicator light goes on.

Sports mode indicator lights

In sports mode, the currently selected gear is indicated by the light shown on the instrument panel.

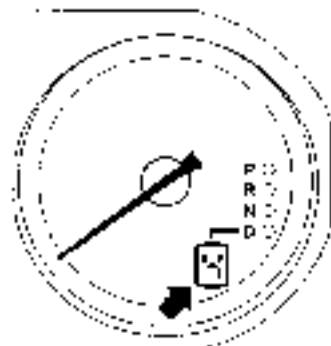

Operation of the automatic transaxle

⚠ CAUTION

- Before selecting a gear with the engine running and the vehicle stationary, fully depress the brake pedal to prevent the vehicle from creeping. The vehicle will begin to move as soon as the gear is engaged, especially when the engine speed is high. At fast idle or with the air conditioning operating, the brakes should only be released when you are ready to drive away.

⚠ CAUTION

- Depress the brake pedal with the right foot at all times. Using the left foot could cause driver movement delay in case of an emergency.
- To prevent sudden acceleration, never run the engine at high rpm when shifting from the "P" (PARK) or "N" (NEUTRAL).
- Operating the accelerator pedal while the other foot is resting on the brake pedal will affect braking efficiency and may cause premature wear of brake pads. Do not rest the engine with brake pedal pressed. This can damage the transaxle.

Passing acceleration

To gain extra acceleration in "D" (DRIVE) position (when passing another vehicle) push the accelerator to the floor. The automatic transaxle will automatically downshift.

NOTE

- In sports mode (downshift) does not take place when the accelerator is depressed all the way to the floor.

Waiting

For short waiting periods, such as at traffic lights, the vehicle can be left in gear and held stationary with the service brake. For longer waiting periods with the engine running, the selector lever should be placed in the "N" (NEUTRAL) position.

⚠ CAUTION

- To avoid transaxle overheating, never try to keep your vehicle stationary on a hill by using the accelerator pedal. Always apply the parking brake and/or service brake.
- Unexpected acceleration may occur if the selector lever is in a position other than "P" (PARK) or "N" (NEUTRAL).
Prior to moving off after having stopped the vehicle, make sure that the selector lever is in "D" (DRIVE) position or "Sports mode" position.

Parking

To park the vehicle, first bring it to a complete stop, fully engage the parking brake, and then move the selector lever to the "P" (PARK) position.

When the automatic transaxle makes no speed change

If the transaxle does not change speeds while driving, or your vehicle does not pick up enough speed when starting on an uphill slope, it may be that there is something unusual happening in the transaxle, causing a safety device to activate. Have your vehicle checked at an authorized Mitsubishi dealer as soon as possible.

- 1 If your vehicle has difficulty moving uphill, shift the selector lever into 2nd gear of the sports mode.
This method might not work depending on the type of transaxle malfunction.
- 2 Once the vehicle is moving on a level road, move the selector lever back to "D" (DRIVE).

NOTE

- When the "N" indicator light in the instrument panel flashes, it means that there is an abnormal condition in the transaxle. Refer to the "Indicator light" on page 3-35.

All-wheel drive operation

Full-time all-wheel drive vehicles are propelled by engine power distributed constantly and appropriately to all four wheels.

Not only does this ensure better handling on dry, paved roads but also permits better traction when driving on slippery, wet or snow-covered roads and when towing out of mud.

Driving

- Avoid driving the vehicle through areas where the tires may get stuck in deep sand or mud. Continuous spinning of the tires once the vehicle is stuck will place excessive loading on the drive train and could seriously damage your vehicle.
- The stopping distance of a full-time all-wheel drive vehicle is similar to that of a front-wheel drive vehicle. When driving on a snow-covered road or a slippery, muddy surface, make sure that you keep a sufficient distance between your vehicle and the one ahead of you.

Driving through water

If the electrical circuits become wet, further operation of the vehicle will be impossible, therefore avoid driving through water unless absolutely necessary. If driving through water is unavoidable, use the following procedure.

Check the depth of the water (max. 7.9 inches/200 mm) is permitted and the geographical features before attempting to drive. Drive slowly at no more than 3 mph (5 km/h) to avoid creating excessive water splashing.

⚠ CAUTION

- **Do not attempt to drive through water at a place where the water is more than about 7.9 inches (200 mm) deep and do not change gears while driving through water.**
Frequent driving through water can adversely affect the life span of the vehicle; consult an authorized Mitsubishi dealer and take the necessary measures to prepare, inspect, and repair the vehicle.
- **After driving through water, apply the brakes to be sure they are functioning properly. If the brakes are wet and not functioning properly, dry them out by driving slowly while lightly depressing the brake pedal.**
Inspect each part of the vehicle carefully.

Inspection and maintenance following rough road operation

After operating the vehicle in rough road conditions, be sure to perform the following inspection and maintenance procedures.

- Check that the vehicle has not been damaged by rocks, gravel, etc.
- Carefully wash the vehicle with water.
Drive the vehicle slowly while lightly depressing the brake pedal in order to dry out the brakes. If the brakes still do not function properly, contact an authorized Mitsubishi dealer as soon as possible to have the brake checked.
- Remove the insects, dried grass, etc. clogging the radiator core.

- After driving through water, check the engine, transaxle, and differential oil. If the oil or grease is milky or cloudy because of water contamination, it must be replaced with new oil.
- Check the inside of the vehicle. If ingress of water is found, dry the carpet etc.
- Inspect the headlights. If the headlight bulb is flooded with water, have the bulb drained off at an authorized Mitsubishi dealer.
- Have an authorized Mitsubishi dealer replace grease in the wheel bearings.

Tires and disc wheels

- Since the driving torque is always applied to all four wheels, the performance of the full-time all-wheel drive vehicle is greatly affected by the condition of the tires. All four tires should be of the same size and type.
 - Use the specified tires and disc wheels for all four wheels.
 - When replacement of the tires or disc wheels is necessary, replace all of them.
 - When a temporary spare tire has been installed, replace it with a standard tire as soon as possible.
 - Rotate the tires and check the tire pressure at regular intervals.

Towing

- The full-time all-wheel drive vehicle cannot be towed by an ordinary tow truck. Make sure that the vehicle is towed with its four wheels raised off the ground. (Refer to the section entitled "Towing.")

Jacking up

- While a full-time all-wheel drive vehicle is being raised on a jack, never start the engine or turn the tires. The turning of the tires could cause the vehicle to slip off the jack.

Service brake

Brake pedal

Use of the brake can cause weakening, resulting in poor brake response and premature wear of the brake linings. When driving down a long or steep hill, use engine braking by shifting the transaxle into a lower gear of the sports mode.

⚠ WARNING

- Do not leave any objects near the brake pedal or let a floor mat slide under it; doing so could prevent the full pedal stroke that would be necessary in an emergency. Make sure that the pedal can be operated freely at all times. Make sure the floor mat is securely held in place.

⚠ CAUTION

- It is important not to drive the vehicle with your foot resting on the brake pedal when braking is not required. This practice can result in very high brake temperatures, premature lining wear, and possible damage to the brakes.

Power brakes

Your vehicle is equipped with power brakes for more braking force with less brake pedal effort.

Your brakes are designed to operate at full capacity even if the power assist is not being used.

If the power assist is not being used, the effort needed to press the brake pedal is greater.

If you should lose the power assist for some reason, the brakes will still work.

If the power brake unit or either of the two brake hydraulic systems stops working properly, the rest of the brake system will still work, but the vehicle will not slow down as quickly.

You will know this has happened if you find you need to press the brake down farther or harder when slowing down or stopping, or if the Brake warning light comes on.

⚠ WARNING

- Never coast downhill with the engine OFF. Keep the engine running whenever your vehicle is in motion. If you turn off the engine while driving, the power brake booster will stop working and your brakes will not work as well.
- If the power assist is lost or if either brake hydraulic system stops working properly, take your vehicle to an authorized Mitsubishi dealer immediately.

Brake pad wear alarm

The disc brakes have an alarm that makes a metallic squeal when the brake pads have worn down enough to need service.

If you hear this sound, have the brake pads replaced at an authorized Mitsubishi dealer.

⚠ WARNING

- Driving with worn brake pads will make it harder to stop, and can cause an accident.

Anti-lock braking system (if so equipped)

The anti-lock braking system helps prevent the wheels from locking up when braking. This helps you keep control of your vehicle and its direction, and shortens braking distances.

Driving hints

- When using the anti-lock brakes (stabilized braking), steering is slightly different from normal driving conditions. Use the steering wheel carefully.
- Always keep a safe distance from the vehicle in front of you. If your vehicle is equipped with the anti-lock braking system, leave a greater braking distance when:
 - Driving on gravel or snow-covered roads
 - Driving on uneven road surfaces
- The anti-lock braking system is only used where brakes are applied suddenly. This system may also prevent the wheels from locking when you drive over curbs, steel manhole plates, road markings, or any uneven road surface.
- When the anti-lock braking system is in use, you may feel the brake pedal vibrating and hear a unique sound. It may also feel as if the pedal resists being pressed.

In this situation, simply hold the brake pedal down firmly. Do not pump the brake, which will result in reduced braking performance.

⚠ CAUTION

- **To prevent failure of the anti-lock braking system, be sure all 4 wheels and tires are the same size and the same type.**

Anti-lock braking system warning light

This light comes on in the event of a malfunction in the anti-lock braking system. It will also come on as a self check for a few seconds when the ignition key is turned to the "ON" position. Always make sure that the light goes out before beginning to drive.

⚠ CAUTION

- **If the anti-lock braking system warning light comes on and stays on after starting the engine or while driving, it means that the anti-lock braking system is not working and that only the standard brake system is available. (The standard brake system will still work properly.) If this happens, take your vehicle to an authorized Mitsubishi dealer.**

⚠ CAUTION

- **The anti-lock braking system cannot prevent accidents. It is your responsibility to take safety precautions and to drive carefully.**

If the warning light illuminates while driving

- Since there is always a risk of your vehicle becoming unstable if you apply the brakes suddenly, be sure to brake gently and do not attempt high-speed driving. Be sure to stop the vehicle in a safe place. Test the system by restarting the engine and driving at a speed of about 12 mph (20 km/h) or higher.
- If the light goes out, there is no abnormal condition. If the light does not go out after driving as instructed here, or if it comes on again, the anti-lock braking system is not functioning. Only the ordinary braking system is functioning. If this happens, take your vehicle to an authorized Mitsubishi dealer and have the system checked.

NOTE

- If the light remains lit after the engine is started, it indicates that only the normal brake system, not the anti-lock braking system, is functioning.

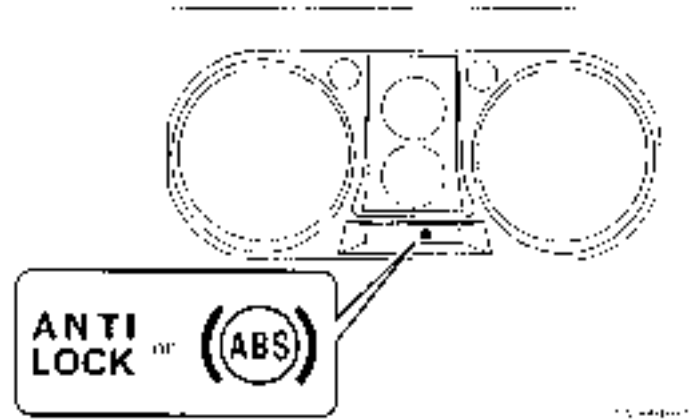

NOTE

- After your vehicle is driven a short distance after starting the engine, you will hear a whining sound and the sound of a motor operating coming from the engine compartment. These are the normal sounds the anti-lock braking system makes when performing a self-check. It does not indicate a malfunction.
- The anti-lock braking system can be used after the vehicle has reached a speed over approximately 6 mph (10 km/h). It stops working when the vehicle slows below approximately 1 mph (5 km/h).
- After driving on snow or icy roads, remove any snow and ice which may have be left around the wheels. On vehicles that have an anti lock braking system, be careful not to damage the wheel speed sensors (AF) or the cables located at each wheel.

Power steering system

The power steering system has mechanical steering capability in case the power assist is lost. If the hydraulic pressure is interrupted for some reason (such as engine stalling), you will still be able to steer your vehicle.

If the power assist is lost, you will notice it takes much more effort to steer and that there is much more "free play" in the steering wheel. If this happens, take your vehicle to an authorized Mitsubishi dealer.

⚠ WARNING

- Never turn off the engine while the vehicle is moving, or your ability to steer the vehicle may be seriously reduced.

3

⚠ CAUTION

- Do not leave the steering wheel turned all the way in one direction. This will prevent the power steering pump from getting enough lubrication and could damage it.

Front

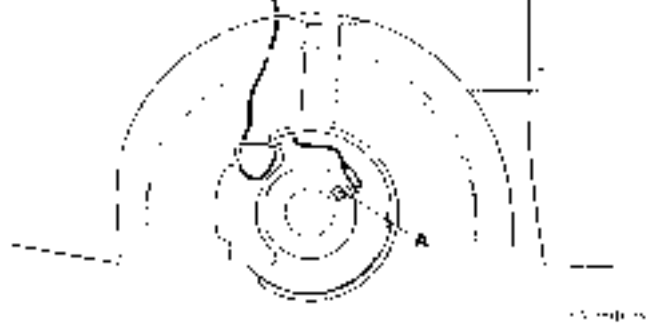

Rear

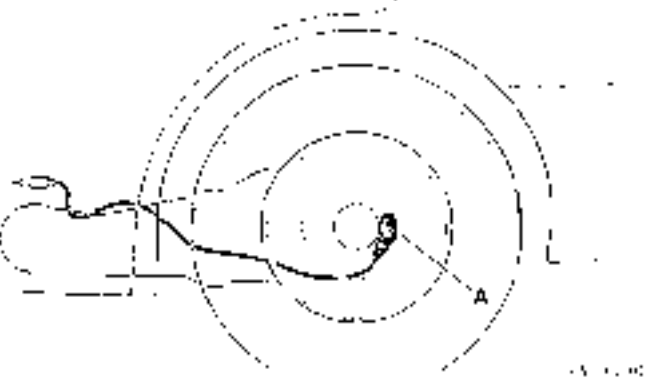

Cruise control

Cruise control is an automatic speed control system. It lets you keep the same driving speed. Cruise control can be used at speeds of 25 mph (40 km/h) or more. It is especially useful for freeway driving. Cruise control does not work at speeds below about 25 mph (40 km/h).

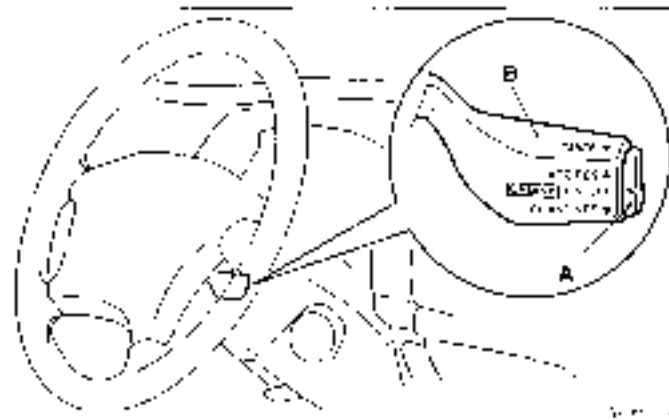

A - Main switch

B - Cruise control lever

⚠ CAUTION

- For safety reasons, the main switch (A) should be set to the "OFF" position when you are not using the cruise control system.

⚠ CAUTION

- Cruise control is not recommended when driving conditions will not allow you to stay at the same speed, such as in heavy traffic or on roads that are winding, icy, snow-covered, wet, or slippery, or on a steep downhill.

NOTE

- Cruise control may not be able to keep your speed on uphills or downhills.
- Your speed may drop on a steep uphill. You may have to use the accelerator if you want to stay at your set speed.
- Your speed may increase to more than the set speed on a steep downhill. You must use the brake to control your speed. If your speed increases too much, turn off the cruise control. (Refer to the section "To deactivate" on page 3-31.)

Cruise control indicator light

This light will come on when the cruise control main switch is "ON".

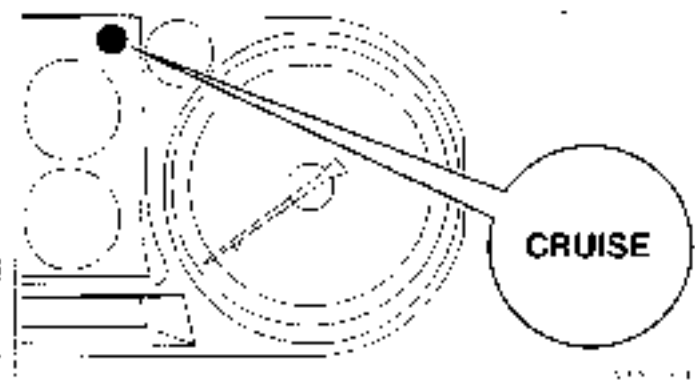

To activate

1. Momentarily push in the main switch (A) at the end of the cruise control lever.

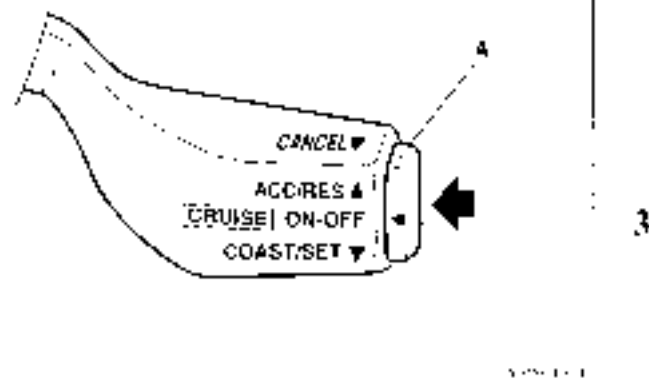

- 3 Pull the lever (B) down while driving at the desired speed.

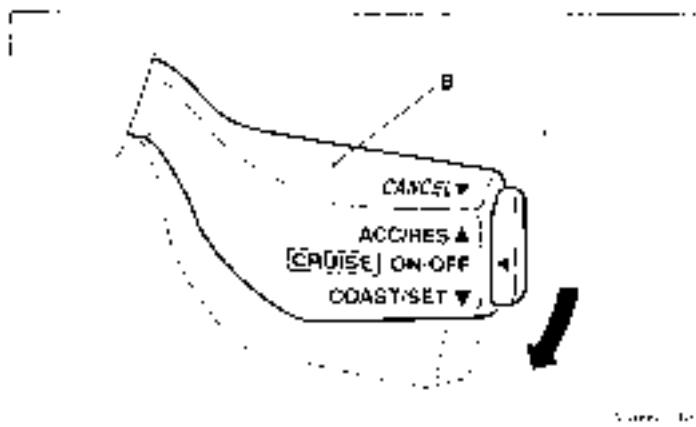

NOTE:

- If the main switch is on when the ignition key is turned off, cruise control will be on automatically the next time you start the engine. The "CRUISE" indicator will also be on. You will need to reset the speed however, if you want to use cruise control.

To increase the set speed

There are 2 ways to increase the set speed.

Cruise control lever

Pull the cruise control lever up and hold it. Your speed will then gradually increase.

When you reach your desired speed, release the switch. Your cruising speed is now set.

To increase your speed in small amounts, pull the cruise control lever up for less than 1 second and release it. Each time you pull the lever up, your vehicle will go about 1 mph (1.6 km/h) faster.

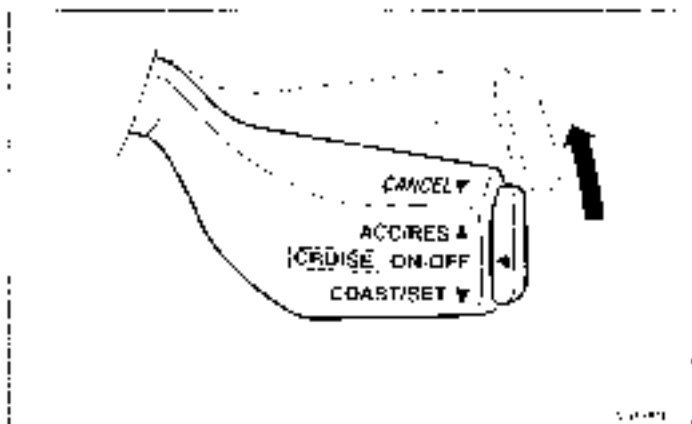

Accelerator

Press the accelerator pedal to reach your desired speed. Pull the cruise control lever down for a moment, then release it.

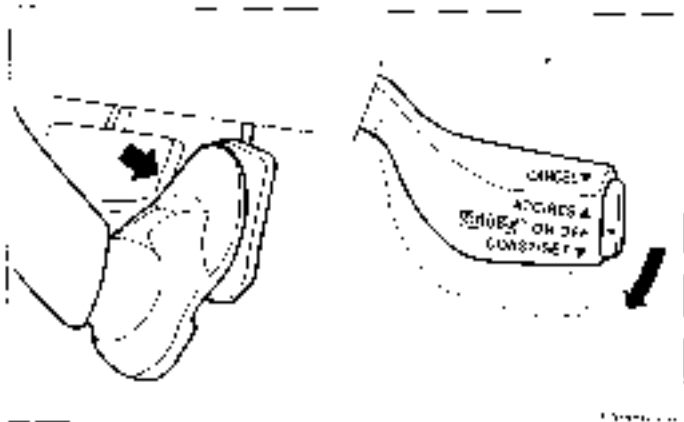
**To decrease the set speed**

There are 2 ways to reduce the set speed.

Cruise control lever

Put the cruise control lever down and hold it while driving at the set speed, and you will slow down coast gradually. When your desired low speed is reached, release the lever.

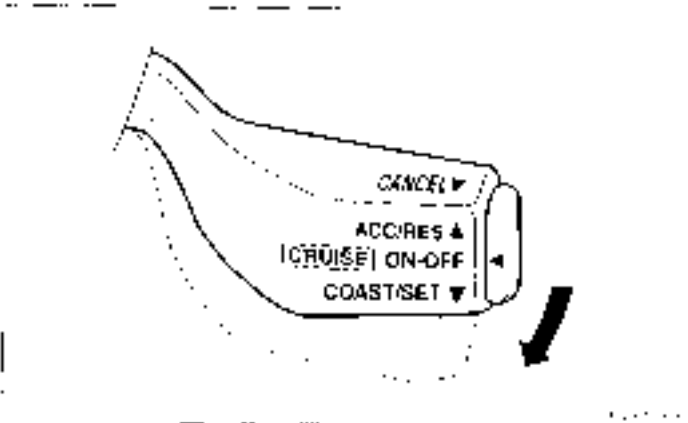

To slow down in small amounts, press the cruise control lever down for less than 1 second and release it. Each time you press the lever down, your vehicle will slow down by about 1 mph (1.6 km/h).

Features and controls

Brake pedal

Press the brake pedal, which disengages the cruise control, then pull the cruise control lever down momentarily to set a new desired cruise speed.

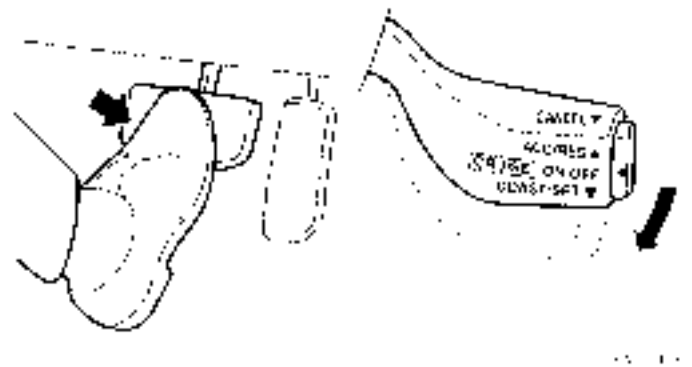

To accelerate for passing

Press the accelerator pedal as you would normally. When you release the pedal, the cruise control will return to your set speed.

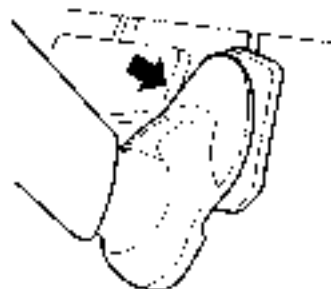

To deactivate

The cruise control can be turned off as follows:

1. Push the main switch (A) at the end of the lever (Map switch OFF)
2. Pull the cruise control lever (B) toward you.

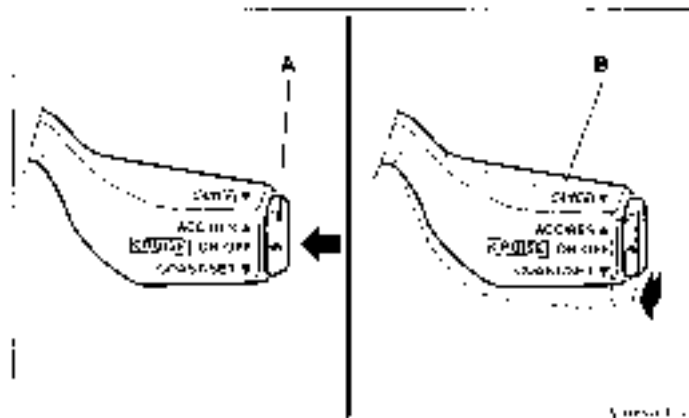

The cruise control can be turned off automatically in any of the following ways:

1. By slightly tapping the brake pedal or pressing down on it to slow your speed.
2. By moving the selector lever to "N" (NEUTRAL).
3. When your speed slows to 10 mph (15 km/h) or more below the set speed because of a hill, etc.
4. When your speed slows to 7.5 mph (10 km/h) or less.

⚠ WARNING

- Although the cruise control can be turned off by moving the selector lever to the "N" position, never move the selector lever to the "N" position while driving. You would have no engine braking and could cause a serious accident.

To resume the set speed

If the speed memory has not been erased, resume the previously set speed by pulling the cruise control lever up while driving at a speed of 25 mph (40 km/h) or higher.

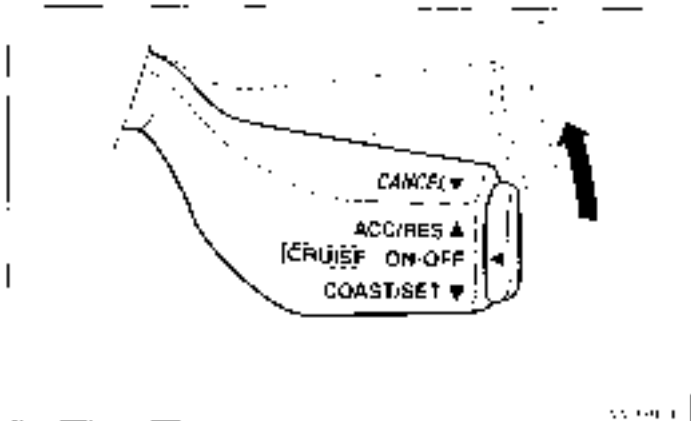

Under either of the following conditions, however, using the switch does not allow you to resume the previously set speed. In these situations, repeat the speed setting procedure:

- The ignition key is turned OFF
- The main switch is turned OFF

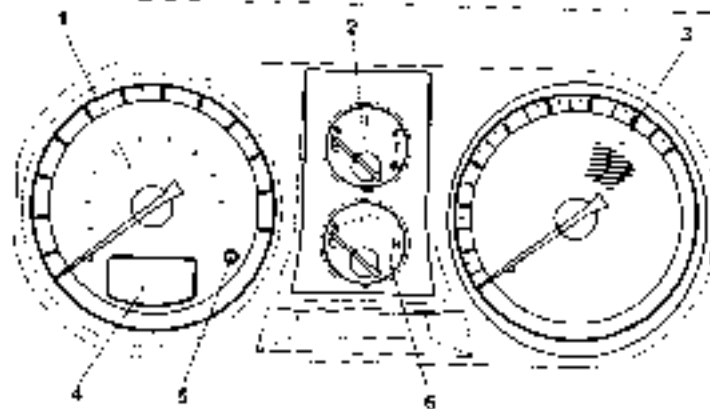
Instrument cluster

- 1 Speedometer
- 2 Fuel gauge
- 3 Tachometer
- 4 Odometer/Trip odometer
- 5 Trip odometer reset button
- 6 Engine coolant temperature gauge

Speedometer

The speedometer shows your vehicle's speed.

Tachometer

The tachometer shows engine revolutions per minute. This allows the driver to determine the most efficient gear range and engine speed combinations.

This gauge also assists in evaluating engine performance.

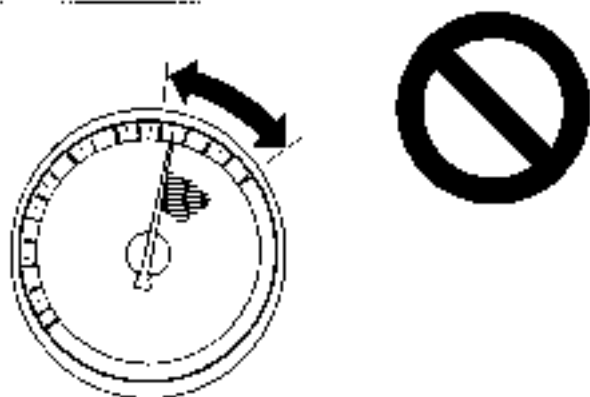

Figure 1-4

CAUTION

- The red zone indicates an engine speed beyond the range of safe operation.

Select the correct gear to control the engine speed so that the tachometer indicator does not enter the red zone.

Odometer/Trip odometer

When the ignition switch is in the "ON" position, an "ODO" and "TRIP" indicator is displayed.

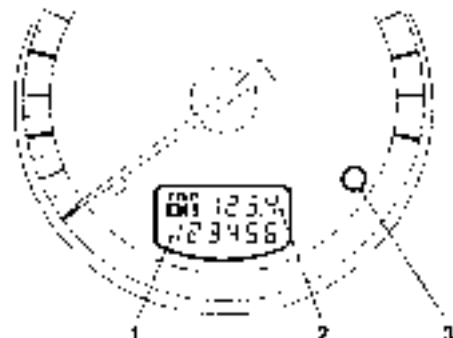

Figure 1-5

- 1 Odometer
- 2 Trip odometer
- 3 Reset button

ODO-Odometer

The odometer shows the total distance the vehicle has traveled.

TRIP-Trip odometer

The trip odometer shows the distance traveled since the last time it was reset.

Every time the reset button (3) is pressed lightly (less than one second), the indicators are changed.

There are two trip odometer displays: **A** and **B**.

TRIP **A** can be used to measure the distance traveled since the current trip began.

At the same time, TRIP **B** can be used to measure the distance from a second location.

To zero the counter, press and hold the reset button for more than one second. Only the currently displayed value will be reset.

If TRIP **A** is displayed, for example, only TRIP **A** will be reset.

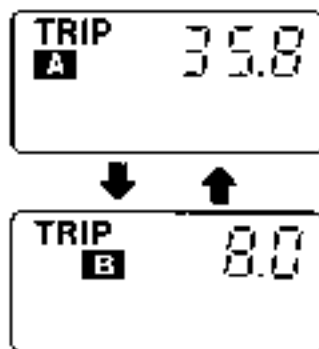

NOTE

- Both TRIP **A** and TRIP **B** can measure trips up to 999.9 miles/kilometers.
- If the battery is disconnected for a long time, both of these displays will be reset to "0".

Fuel gauge

This gauge shows the amount of fuel in the fuel tank when the ignition key is turned to the "ON" position.

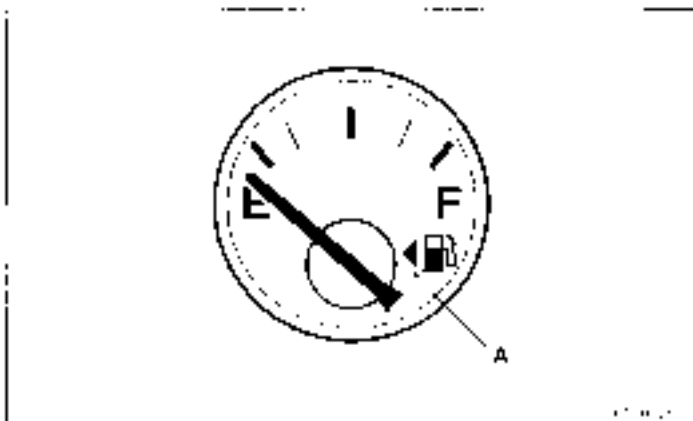

CAUTION

- Do not drive with an extremely low fuel level. Running out of gas could cause damage to the catalytic converter.

NOTE

- It takes a little time after refueling for the gauge to register the newly added fuel.

Fuel lid mark

The arrow (A) indicates that the fuel tank filler door is located on the left side of the vehicle (Refer to "Filling the fuel tank" on page 1-4).

Low-fuel warning light

The warning light comes on when the fuel tank is getting low. Refuel as soon as possible.

CAUTION

- Do not drive with an extremely low fuel level. Running out of gas could cause damage to the catalytic converter.

NOTE:

- On inclines or curves, due to the movement of fuel in the tank, the low-fuel warning light may come on earlier than usual.

Engine coolant temperature gauge

This gauge shows the engine coolant temperature. If the temperature is low when the ignition key is turned to the "ON" position, the indicator will remain at the "C" (cold) post, or until the engine begins to warm up.

The indicator will normally stay near the center while driving, but may rise slightly in stop-and-go traffic or when the engine is under a heavy load.



CAUTION

- Take care to keep the engine operating temperature within the normal range while driving. If the indicator enters the "H" (hot) position, the engine is overheating (Refer to "Engine overheating" on page 6-5).

Indicator and warning light package

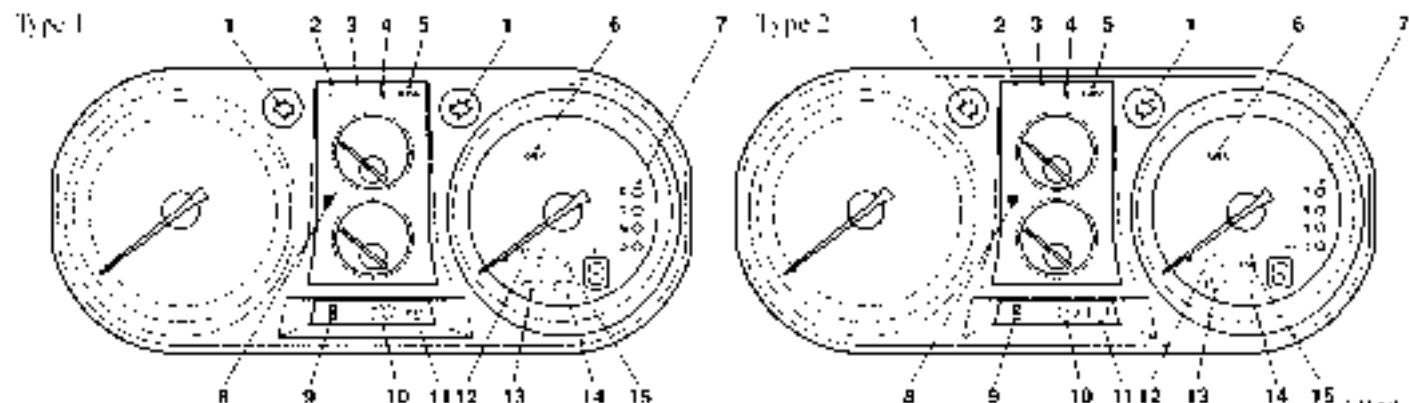

- 1 Turn signal indicator - hazard warning light
- 2 Front fog light indicator (if so equipped)
- 3 High beam indicator
- 4 Seat belt reminder warning light
- 5 Cruise control indicator → Page 3-47
- 6 Supplemental Restraint System (SRS) warning light → Page 2-57
- 7 Automatic transaxle position indicator → Page 3-35
- 8 Low tire warning light → Page 3-56
- 9 Deceleration warning light
- 10 Anti-lock braking system warning light (if so equipped) → Page 3-43
- 11 Brake warning light

- 12 Malfunction indicator light (SERVICE ENGINE SOON or "Check engine" light)
- 13 Oil pressure warning light
- 14 Charging system warning light
- 15 Automatic transaxle oil temperature warning light → Page 3-35

NOTE:

- For full information concerning the indicator or warning lights, marked by the symbol "→ Page XX", refer to the specified pages. For other indicators and warning lights, refer to the appropriate pages.

Indicator lights

Turn signal indicators/hazard warning lights

The arrows will flash in time with the corresponding external turn signals when the turn signal lever is used.

Both arrows will flash when the hazard warning flasher switch is pressed.

NOTE

- If the indicator light flashes faster than usual or if the indicator light stays on without flashing, check for a malfunctioning turn signal light bulb or faulty turn signal connection.

High beam indicator

A blue light comes on when the headlights are on high beam.

Front fog light indicator (if so equipped)

This indicator comes on while the front fog lights are on.

Warning lights

Brake warning light

This light comes on when the ignition key is turned to the "ON" position (engine off).

When the engine is started, the light should go off. But when the parking brake is used or when the brake fluid falls below the prescribed level, the light will come on again.

Before driving your vehicle, release the parking brake fully and make sure that the brake warning light has gone out.

CAUTION

- If the brake warning light does not come on when you use the parking brake, or if it does not go out when you release the brake, contact an authorized Mitsubishi dealer immediately.

If the brake warning light comes on while driving, it could mean reduced braking performance. Park your vehicle in a safe place using the following procedures:

1. If, when using the brake pedal, braking is weak, press your foot harder against the brake pedal.
2. If braking is weak, use engine braking by shifting the transmission into a lower gear to slow the vehicle. Then slowly pull the parking brake lever, while depressing on the brake pedal.

⚠ CAUTION

- Applying the parking brake suddenly is dangerous because the rear wheels can lock.

Malfunction indicator light ("SERVICE ENGINE SOON" or "Check engine light")

This light is a part of the onboard diagnostic (OBD) system which monitors the emissions, engine, and automatic transaxle control systems. If a problem is detected in one of these systems, this light comes on. Although your vehicle will usually be drivable and not need towing, have the system checked as soon as possible at an authorized Mitsubishi dealer.

This light will also come on for about 20 seconds when the ignition key is turned to the "ON" position. If it does not go out after about 20 seconds, take the vehicle to an authorized Mitsubishi dealer.

⚠ CAUTION

- Driving for a long time with the malfunction indicator on may cause more damage to the emission control system. This could also affect fuel economy and drivability.
- If this light does not come on when the ignition key is turned to the "ON" position, have the system checked at an authorized Mitsubishi dealer.

⚠ CAUTION

- If the light comes on while the engine is running, avoid driving at high speeds. During vehicle operation with the light on, the vehicle may not accelerate when you depress the accelerator pedal. When the vehicle is stationary with the light on, you must depress the brake pedal more firmly than usual since the engine idling speed is higher than usual and the vehicle with an automatic transaxle has a stronger tendency to creep forward.

NOTE

- Do not disconnect the battery cable when the Malfunction indicator light ("SERVICE ENGINE SOON" or "Check engine light") is on. The engine electronic control module stores critical OBD information (especially exhaust emission data) which may be lost if the battery cable is disconnected while the malfunction indicator light is on. This will make it difficult to diagnose the cause of future problems.
- If the fuel tank filler tube cap is not on tight, the light may come on. Make sure you tighten this cap every time you add fuel. Turn the fuel tank filler tube cap clockwise and you hear at least 3 clicks.

Charging system warning light

This light comes on in the event of a malfunction in the charging system or when the ignition key is turned to the "ON" position (engine off). When the engine is started, the light should

Features and controls

count. Check to make sure that the light has gone out before driving.

⚠ CAUTION

- If the charging light stays on after the engine has started, the battery charging system may be malfunctioning. In this case, take your vehicle to an authorized Mitsubishi dealer and have the system checked.

Oil pressure warning light

This light comes on when the engine oil pressure is below normal. If the light stays on while driving, stop the engine as soon as possible. Do not run the engine until the cause of the low oil pressure is corrected.

⚠ CAUTION

- If this light comes on when the engine oil level is not low, have your vehicle checked at an authorized Mitsubishi dealer.
- This warning light does not show the amount of oil in the crankcase. This can only be determined by checking the oil level with the dipstick with the engine turned off.

Seat belt reminder/warning light

When the ignition key is turned to the "ON" position, the warning light will come on and the buzzer will sound for about 10

seconds. When the driver's seat belt is fastened, the warning light will go off and the buzzer will stop.

⚠ WARNING

- In order to reduce the risk of serious or fatal injury in an accident, always wear your own seat belt. Do not allow anyone to ride in your vehicle unless he or she is also seated and wearing a seat belt. Children should additionally be restrained in a secure child restraint system.

Door-ajar warning light

This light comes on when any door or lid/gate is open or not completely closed.

⚠ CAUTION

- Before driving, make sure that the door-ajar warning light is off.

NOTE

- On vehicles with keyless entry system, the light remains on for a certain period and then goes out automatically to prevent complete discharge of the battery. Refer to "Interior light auto-cutout function (door light) and other lights" on page 376.

Combination headlights and dimmer switch

Headlights

Rotate the switch to operate the lights.

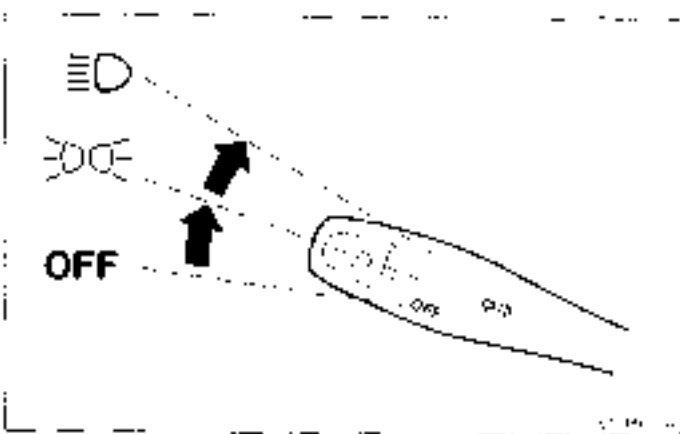

OFF	All lights off
	Parking, tail, front and rear side marker lights, license plate and instrument panel lights on
	Headlights and other lights on

NOTE

- Do not leave the headlights and other lights on for a long period of time when the engine is not running. The battery will run down.

- When it rains, or when the vehicle has been washed, the inside of the lens sometimes becomes foggy. This is the same as when window glass fogs up on a humid day, and does not indicate a problem. When the light is switched on, the heat will dry out the fog. However, if water collects inside the light, have it checked by an authorized Mitsubishi dealer.

Daytime running lights (if so equipped)

When the ignition switch is in the "ON" position and the light switch is set to the "OFF" position, the head lights' light beams are eliminated dimly.

The tail lights do not come on with the daytime running lights. When it starts to get dark, promptly switch on the headlights.

Light auto-cutout function (headlights and other lights)

- If the ignition key is turned to "LOCK" or "ACC" position and the driver's door is opened with the light switch in the "PARKING" or "OFF" position, the lights automatically turn off.
 - If the driver's door is opened after the key is removed from the ignition switch, a high-pitched constant buzzer will sound to remind you to turn off the lights.
 - If the driver's door is opened with the key in the ignition switch, a low-pitched beep will sound to remind you to remove the key.
- If the ignition key is turned to "LOCK" or "ACC" position with the driver's door closed and the light switch in the "PARKING" or "OFF" position, the lights will stay on for about 5 minutes and then turn off automatically.

FEATURES and controls

NOTE

- The light auto-cutout function can be deactivated. For detailed information, please contact your authorized Mitsubishi dealer.

When you want to keep the lights on:

If the light switch is turned to the "LOCK" or "ACC" position again after the engine is turned off, the 3 minutes auto-cutout function described above will not work. The lights (the parking lights, tail lights and license plate lights) will stay lit and will not turn off automatically.

NOTE

- If your vehicle is equipped with a keyless entry system, the light auto-cutout function can be reprogrammed ON (or approximately 30 seconds after you leave the vehicle). For detailed information, please contact your authorized Mitsubishi dealer.

If the light auto-cutout function is reprogrammed, the 30 seconds auto-cutout function can be activated using the following steps:

1. After turning the ignition key to the "LOCK" or "ACC" position, set the light switch to the "OFF" position.
2. Put the light switch back to the "LOCK" or "ACC" position again.

3. Get out of the vehicle and cause the driver's door

NOTE

- When the driver's door is opened, the buzzer emits a high-pitched continuous sound if the key has been removed and emits a low-pitched sound if the key is in the ignition switch.

The buzzer stops sounding when the driver's door is closed.

4. The lights will automatically turn off after 30 seconds.

NOTE

- If the driver's door is not opened and closed, the lights will automatically turn off after about 3 minutes.

Headlight reminder buzzer

If the driver's door is opened with the key in the "LOCK" or "ACC" position while the lights are on, the buzzer will sound to remind you to turn off the lights. The lights will turn off automatically and so will the buzzer. Or you can turn the light switch to the "OFF" position to stop the buzzer.

Dimmer (high/low beam change)

To change the headlights from high beam to low beam and vice versa, pull the turn signal lever to the switch the headlights to low beam as a courtesy whenever there are oncoming vehicles or when there is traffic moving ahead of you. An illuminated blue light in the instrument cluster indicates when the headlights are on high beam.

Headlight flasher

You can flash the high beams by pulling the lever gently toward you (2). The lights will go back to normal when you let go. While the high beam is on, you will see a blue light on the instrument panel.

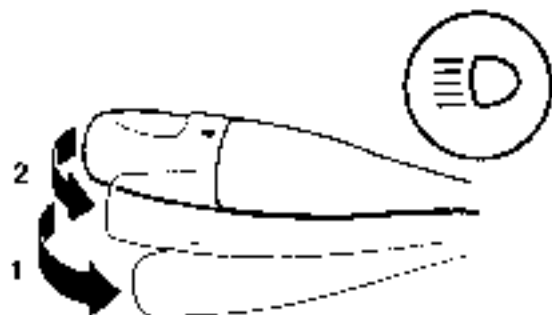

NOTE

- The headlights can also flash when the light switch is OFF.
- If you turn the lights off with the head lights set to high beam illumination, the headlights are automatically returned to their low-beam setting when the light switch is next turned to the "OFF" position.

Turn signal lever

When changing lanes, or to making a gradual turn, hold the lever in the "lane change" position (1). It will return to the neutral position when you let go. Use the full position (2) when making a normal turn. The lever will return to the neutral position when the turn is complete. There may be times when the lever does not return to the neutral position. This usually happens when the steering wheel is turned only slightly. You can easily return the lever by hand.

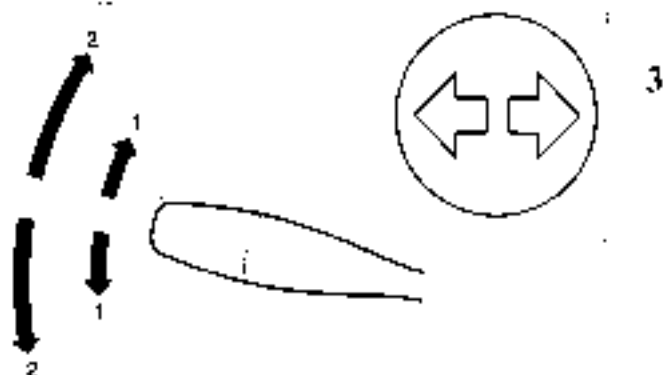

Features and controls

A light in the instrument panel flashes to show when the front and rear turn signal lights are working properly.

If this light flashes faster than usual, check for a burned-out lamp bulb or faulty connection in the system.

If the panel light does not come on when the lever is moved, check for a faulty fuse or a burned-out bulb in the panel.

NOTE

- Replace burned-out bulbs and fuses promptly.

Hazard warning flasher switch

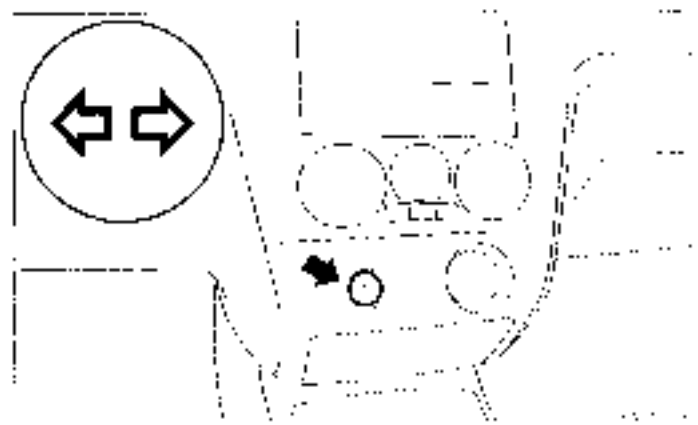

If you press the flasher switch, the front and rear turn signals will flash intermittently, and so will the hazard warning light. This is an emergency warning system and should not be used when the vehicle is in motion, except for emergencies.

If you need to leave your vehicle, the flashers will keep working after the ignition key is removed.

NOTE

- If you keep the flashers on for several hours, the battery will run down. This could make it difficult or impossible to restart your vehicle.

Fog light switch (if so equipped)

The fog lights illuminate only when the headlights are on low beam. Press the switch to illuminate. Press the switch again to turn the lights off.

The indicator light in the instrument cluster will illuminate when the fog lights are on.

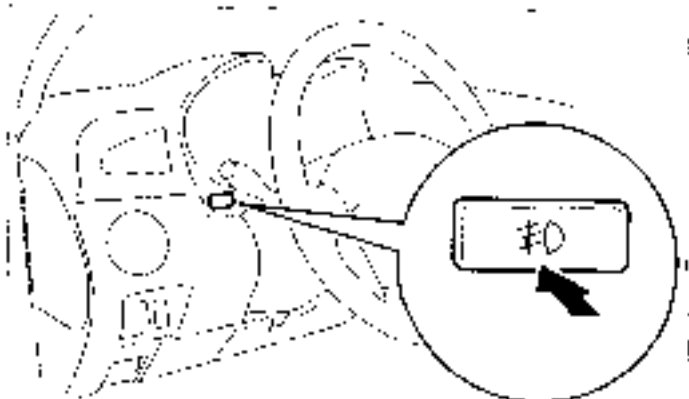
**NOTE:**

- If the headlights are switched to high beam, the fog lights will go out; they will illuminate again when the headlights are switched back to low beam.
- If the light switch is returned to the "OFF" or "AUTO" position while the front fog lights are illuminated, they will automatically turn off. They can be turned back on again by returning the light switch back to "ON" position, and pressing the front fog light switch once again.

Instrument panel light dimmer control

The brightness of the instrument panel lights can be adjusted by turning this knob while the light switch is in the "OFF" or "AUTO" position.

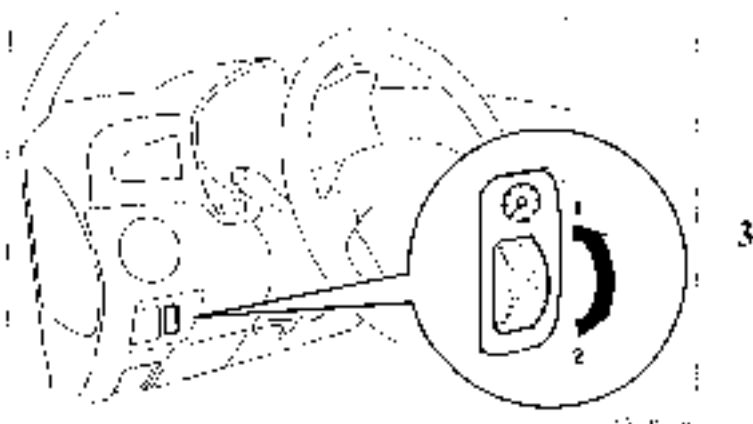

1- High

2- Dark

Wiper and washer switch

Windshield wipers

The windshield wipers wipe when the wiper lever is moved as shown in the illustration and the ignition key is in the "ON" or "ACC" position.

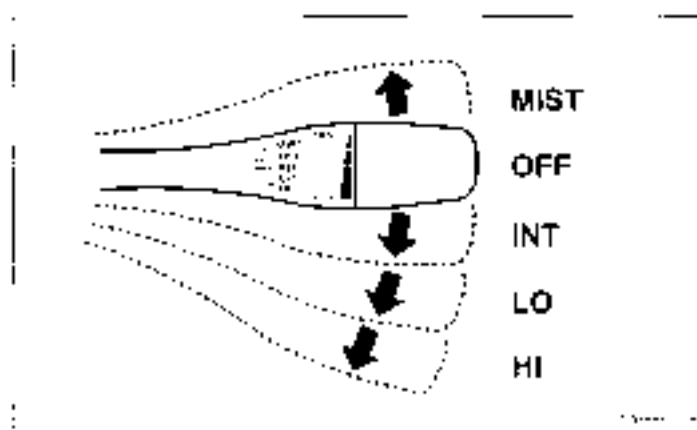

- MIST** Mist/moist function.
The wipers will wipe once only.
- OFF** Off.
- INT** Speed sensitive intermittent operation.
The wiper speed will change with the speed of the vehicle.
- LO** Slow.
- HI** Fast.

NOTE

- If your vehicle is equipped with keyless entry, the speed-sensitive feature of the windshield wipers can be turned off.
For further information, please contact your authorized Mitsubishi dealer.

To adjust intermittent intervals

With the lever in the "INT" (speed-sensitive) position, the wiper speed can be adjusted by turning the knob (A).

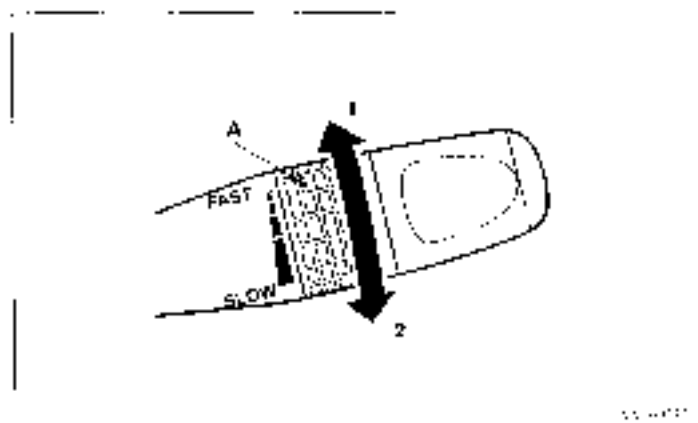

- 1- Fast
2- Slow

Misting function

Move the lever in the direction of the arrow and release, and the wipers will operate once.

Use this function when you are driving in mist or drizzle.

If the lever is held in the upward position (MIST), the wipers continue operating until the lever is released.

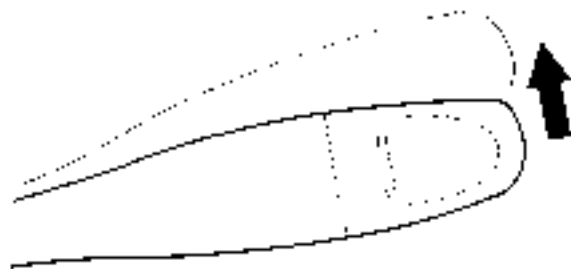
**Windshield washer**

To turn on the windshield washer, pull the lever toward you with the ignition key in either the "ON" or "ACC" position.

The wipers will wipe automatically several times when the washer fluid is sprayed.

To turn off the spray, release the lever.

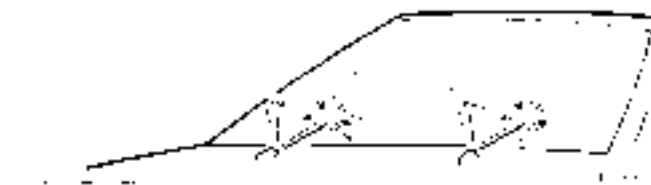
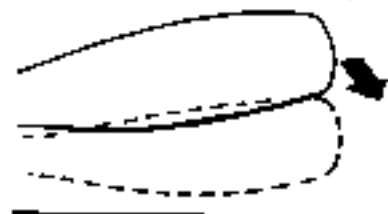

Features and controls

Rear window wiper and washer

The rear window wiper and washer can be operated when the ignition key is in the "ON" or "ACC" position.

Turn the knob to operate the rear window wiper.

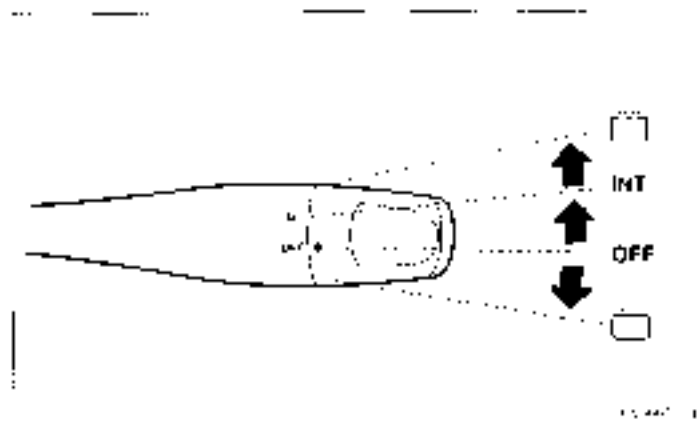

15-247-1

OFF - ON

INT - The wiper operates continuously for several seconds then operates intermittently at intervals of about 3 seconds.

CONT - Washer fluid will be sprayed onto the rear window glass while the knob is turned fully in either direction. When the washer fluid is sprayed, the wiper will automatically operate 3-4 times.

NOTE

- To ensure a clear rearward view, the wiper performs a number of continuous operations either when the switch is moved to the "INT" position or when the shift lever is moved to the "R" (REVERSE) position while the switch is in the "INT" position.

Following this continuous operation, the wiper will automatically switch to intermittent operation.

- The washer fluid reservoir is located in the engine compartment. Check the fluid level regularly and refill if necessary. (See "Washer fluid" on page 144.)

Precautions to observe when using wipers and washers

CAUTION

- If the washer is used in cold weather, the washer fluid sprayed onto the glass might freeze, blocking your view. Heat the glass with the defroster before using the washer.

NOTE

- Do not use the wipers when the windshield is dry. This could scratch the glass and wear the wiper blades prematurely.
- Before using the wipers in cold weather, check to be sure that the wiper blades are not frozen to the windshield or rear window. Using the wipers while the blades are frozen could cause the wiper motor to burn out.

- If the wipers become blocked by ice or other deposits on the glass, the motor may still burn out even if the wiper switch is OFF. If deposits form on the windshield, park your vehicle in a safe place, turn off the engine, and clear the glass so that the wipers can operate smoothly.
- Avoid using the washer for more than 20 seconds at a time. Do not operate the washer when the fluid reservoir is empty or the pump is dry.
- During cold weather, add a recommended washer solution that will not freeze in the washer reservoir. Otherwise the washer may not work or may be damaged.
- Replace the wiper blades when they are worn. Use the proper size replacement blades. If you have questions, ask your authorized Mitsubishi dealer.

Electric rear window defogger switch

The electric rear window defogger can be used with the ignition key in the "ON" position.

The indicator light will come on when you press the electric rear window defogger switch. Electric current will flow through the heating wires on the rear window to help clean away moisture or frost.

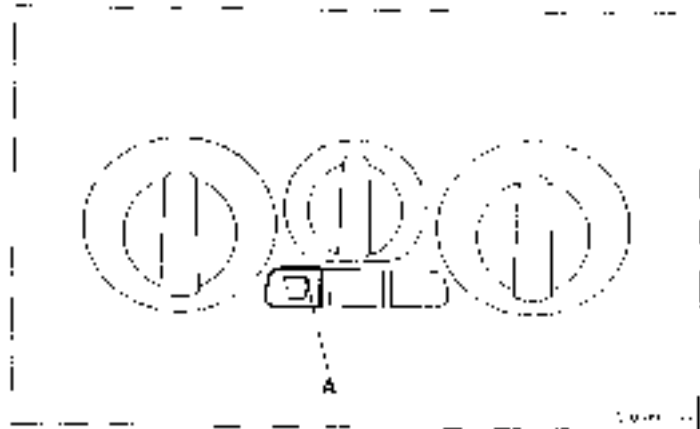

After about 20 minutes of operation, the system will shut off automatically.

To switch the defogger OFF before 20 minutes have passed, press the switch again. The indicator will go out and the defogger will turn off.

If you need the defogger for more than 20 minutes, press the switch again. This will add 20 more minutes.

⚠ CAUTION

- The rear window defogger is not designed to melt snow. Remove any snow manually before using the rear window defogger.
- Use the rear window defogger only after the engine has started and is running. Be sure to turn the defogger switch off immediately after the window is clear to save on battery power.
- Do not place stickers, tape, or other items that are attached with adhesive over the grid wires on the rear window.
- When cleaning the inside rear window, use a soft cloth and wipe lightly over the grid wires.

NOTE

- If your vehicle is equipped with heated mirrors, mist can also be removed from the outside rear-view mirrors when the rear window defogger switch is pressed. (Refer to "Electric remote-controlled outside mirrors" on page 3-26.)

Horn switch

To honk the horn, press the "HORN" mark on the steering wheel.



Sun visors

- 1 Fold the sun visor downward (1) to reduce front glare while driving. To reduce side glare, turn the visor to the side (2).

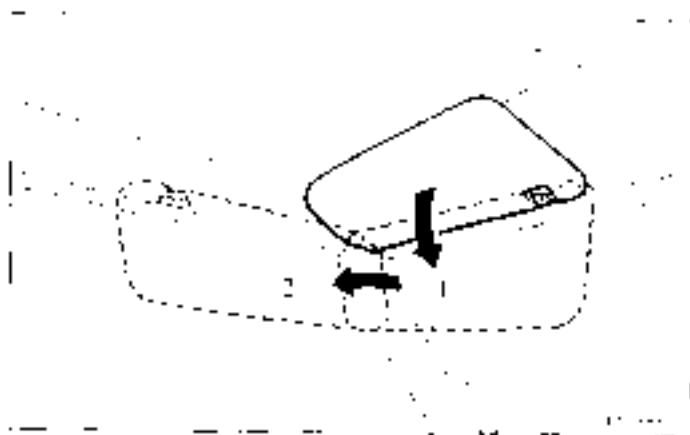
**Card holder**

Cards such as charge cards or business cards can be slipped into the front (A) or back (B) of the lids of the driver's and passenger's side carry-overseats.

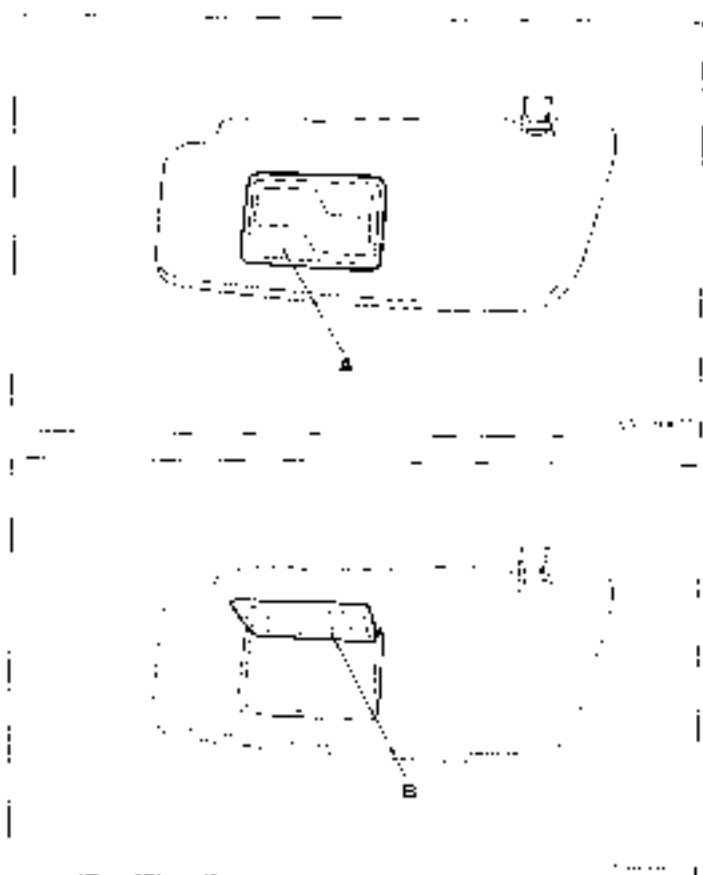

Vanity mirror

The vanity mirrors are located on the back of the driver's and passenger's side sun visor.



3

Accessory socket

To use a "plug in" type accessory, open the cover located on the instrument panel and the left side wall of the rear luggage area, then insert the plug in the socket.

The accessory can be operated when the ignition key is in either the "ON" or "ACC" position.

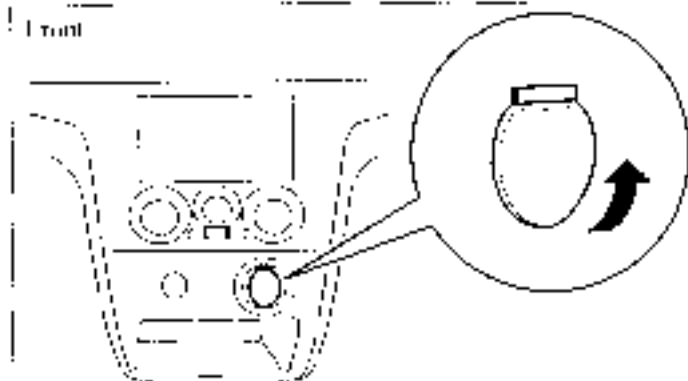

3

Rear

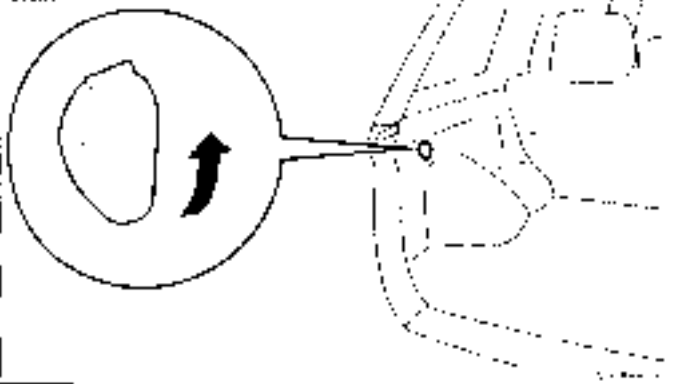

⚠ CAUTION

- Be sure to use a "plug-in" type accessory operating at 12V and at 120W or less.
When using both sockets at the same time, make sure the total power consumption of the electrical accessories does not exceed 120W at 12V.
Also be aware that using electronic equipment with the engine off may run the battery down.
- When the accessory socket is not in use, be sure to close the socket cover. This will prevent the socket from becoming clogged and short circuiting.

Clock

The clock indicates the time regardless of the ignition switch position.

To set the time

Set the time by pressing the various buttons as described below.

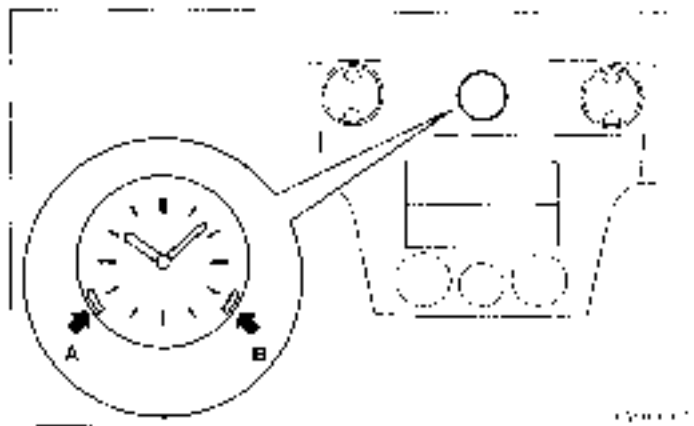

A: Turn clock back

B: Turn clock forward

The hands will start turning more rapidly if the button is held down.

NOTE

- If the battery cables are disconnected during repairs or for any other reason, reset the clock to the correct time after they are reconnected.

Interior lights

Dome light/reading lights

Dome light

The dome light can be turned on by sliding the dome light switch.

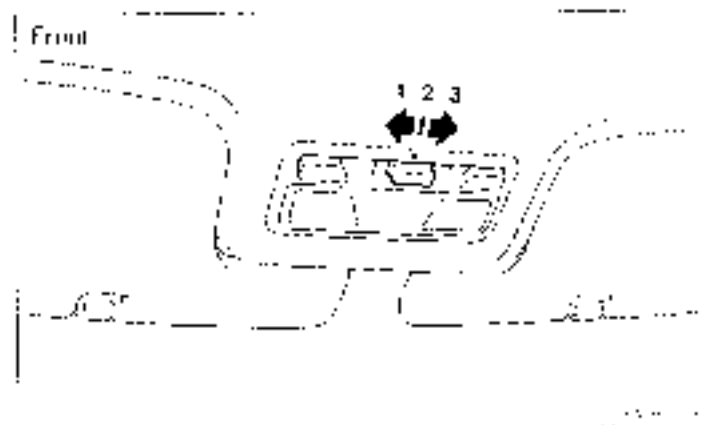

Key

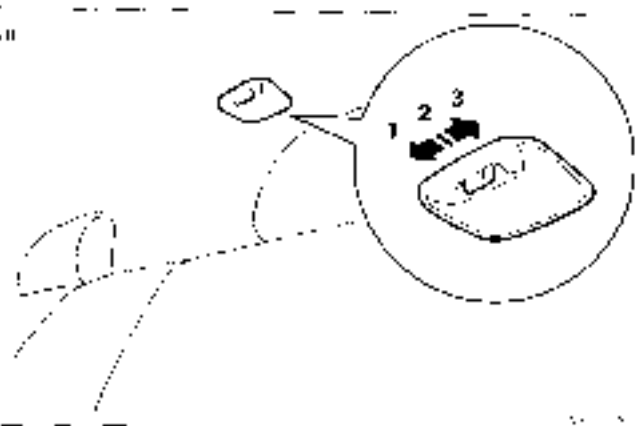

NOTE: The dome light goes off.

NOTE: The dome light comes on when any door or trunk is opened. When all the doors (including the liftgate) are closed, the dome light is dimmed gradually for 30 seconds then goes out. However, the light goes on immediately without being dimmed if:

- The ignition switch is turned ON.
- All the doors (including the liftgate) are locked using the key in the driver's door, the power door lock switch, or the remote control switch from the keyless entry system (if so equipped).

NOTE:

- If the master key is removed with the doors and the liftgate closed, the dome light comes on and then goes out.
- If your vehicle is equipped with keyless entry, you can reprogram it during period. For further information, please contact your authorized Mitsubishi dealer.

NOTE: The dome light comes on.

Reading lights

Push the reading light switch (A) to turn on the light. This light produces a spot beam for convenient use as a map light.

Push the reading light switch again to turn the light off.

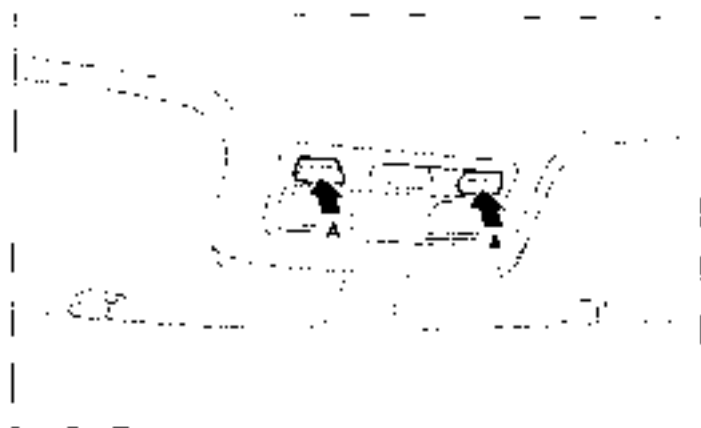

Features and controls

NOTE

- If the reading light is left on with the ignition switch in the "LOCK" position, the lights goes off automatically after approximately 30 minutes to prevent the battery from turning down.

Interior light auto-cutout function (dome light and other lights)

If any of the interior lights are left on with the ignition switch in the "LOCK" position, the lights goes off automatically after approximately 30 minutes to prevent the battery from running down.

The lights come on again if the ignition key is turned to the "ON" or "ACC" position, any door or liftgate is opened and closed, or the keyless entry system is operated.

NOTE

- If your vehicle is equipped with keyless entry, the interior light auto-cutout function can be turned off.
For further information, please contact your authorized Mitsubishi dealer.

Accessory boxes

Convenient storage space is located throughout the vehicle.

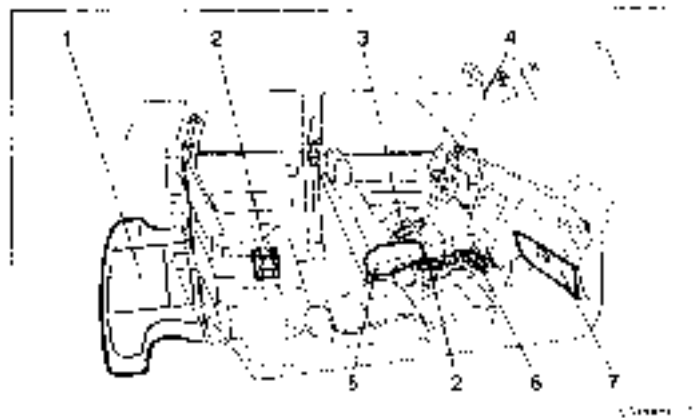

1. Luggage (trunk) box
2. Cup holder
3. Disc pocket
4. Personal box
5. Floor mats box
6. Center accessory box (if so equipped)
7. Glove compartment

Glove compartment

To open the glove compartment, pull the lever (A).

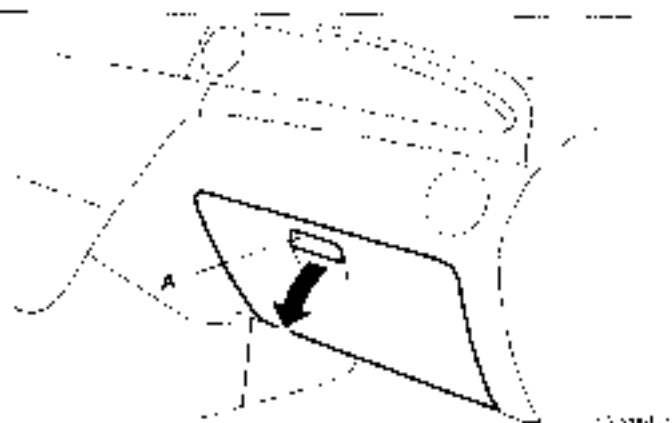

⚠ WARNING

- An open glove compartment door can cause a serious injury to the front passenger in an accident, even if the passenger is wearing his/her seat belt. Always keep the glove compartment door closed when driving.

Floor console box

Upper and lower boxes are located inside the floor console box.

The floor console box can also be used as an arm rest.

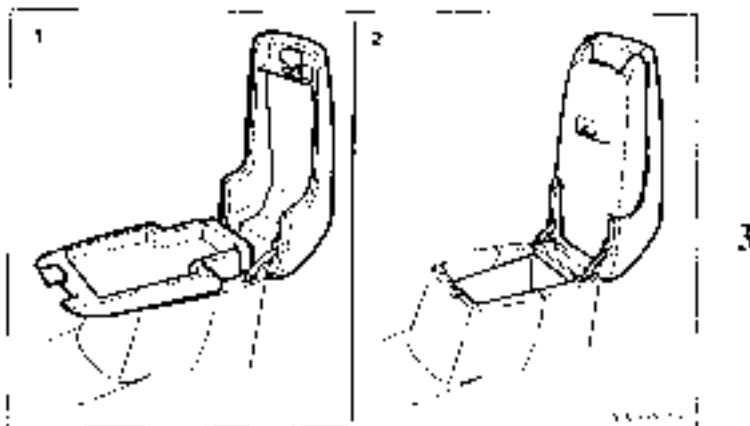

1. Upper box
2. Lower box

Features and controls

Upper box

To open the upper box, lift the left release lever (A) and raise the lid.

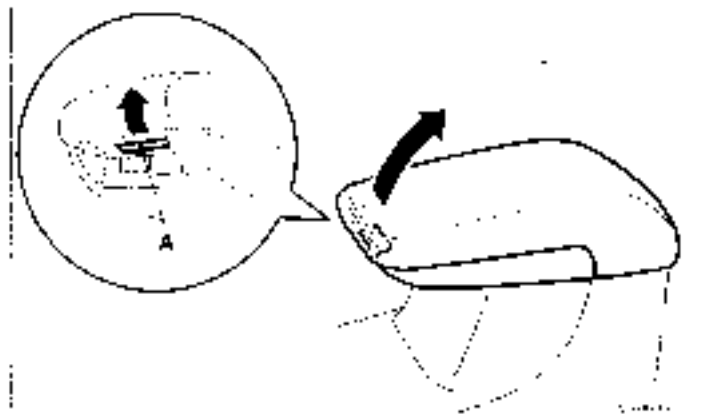

Lower box

To open the lower box, lift the right release lever (B) and raise the lid.

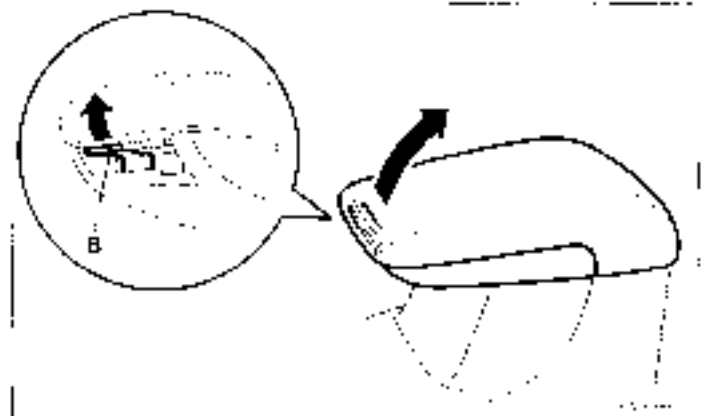

Personal box

To open this box, pull the lid (A).

**Center accessory box (if so equipped)**

To open this box, raise the lid (A).

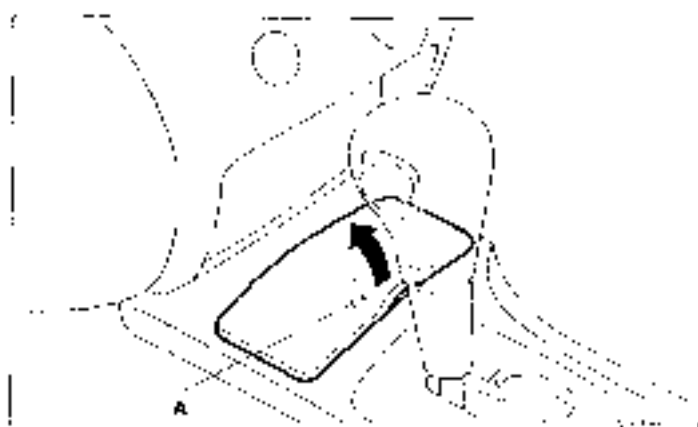

3

Cup holder

For the front seat

The cup holder is located in front of the floor console.
The cup holder is designed for holding cups or drink-cans securely in its holes.

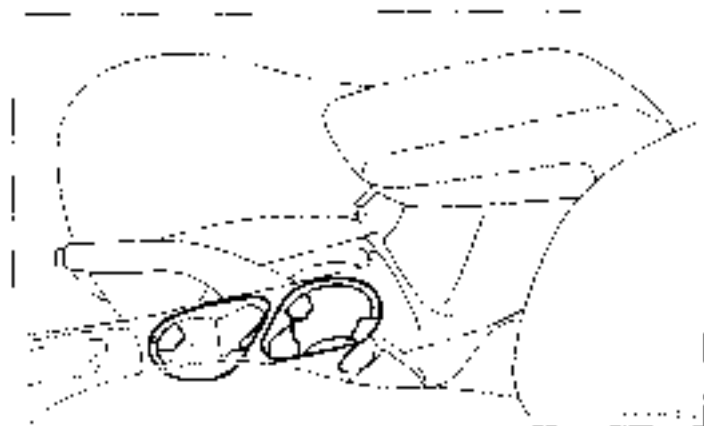

▲ CAUTION

- Do not drink beverages while driving your vehicle. This is distracting and could cause a collision.

For the rear seat

This cup holder is located in the rear seat arm rest.

1. Pull the rear arm rest down to use the cup holder.

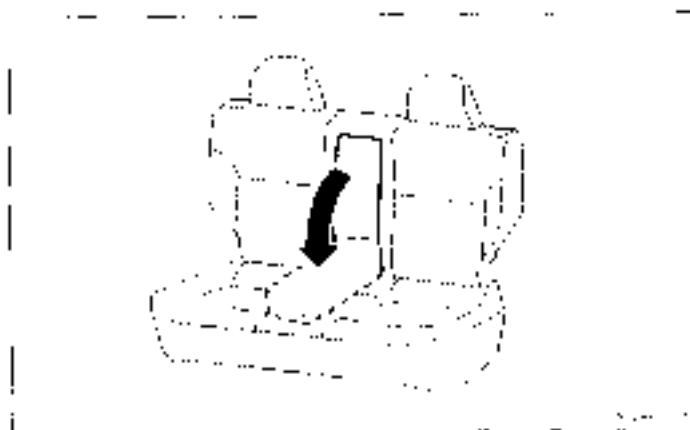

2. Open the lid (A) while folding the side face of the lid with your hand.

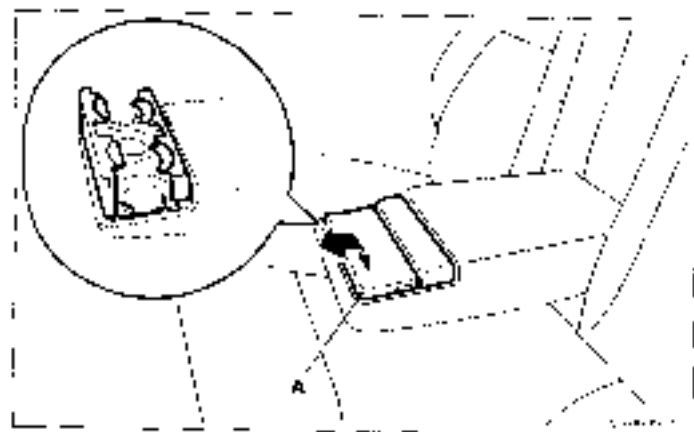

Luggage floor boxes

The box for keeping articles is formed inside the luggage compartment.

To use the box, raise the luggage floor beam.

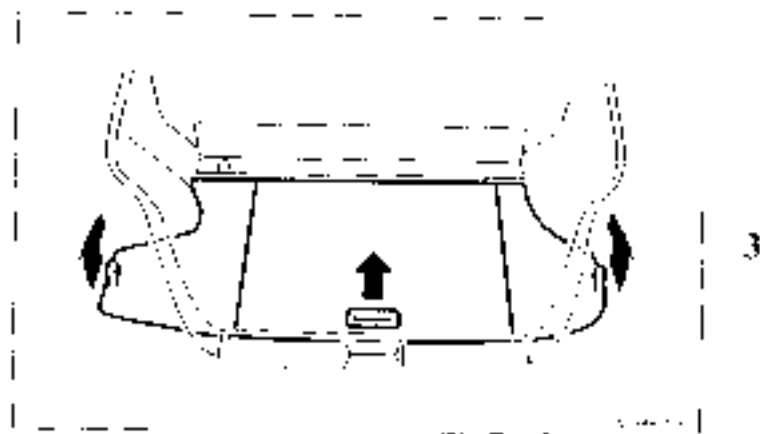

Features and controls

Base boxes can be used for storing tools and jacks (A) for example:



NOTE:

- When placing items in the luggage floor box or taking items out, you can keep the floor board raised by attaching the hook (B) to the weatherstrip as shown.

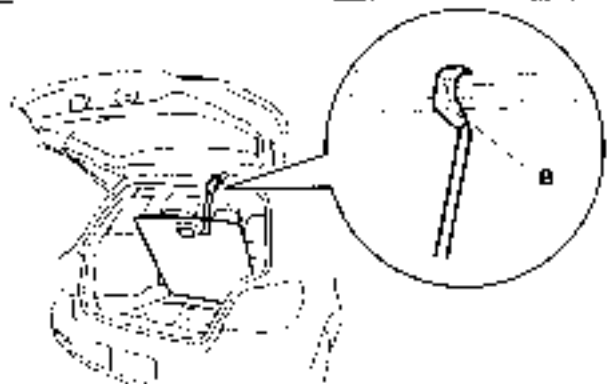

- The hook can be stowed as shown when it is not being used.

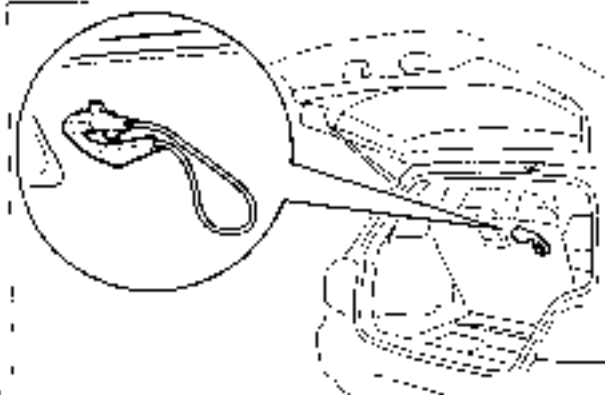

Tonneau cover (if so equipped)

1. Draw out the spring-loaded cover and insert it in the mounting groove (A).

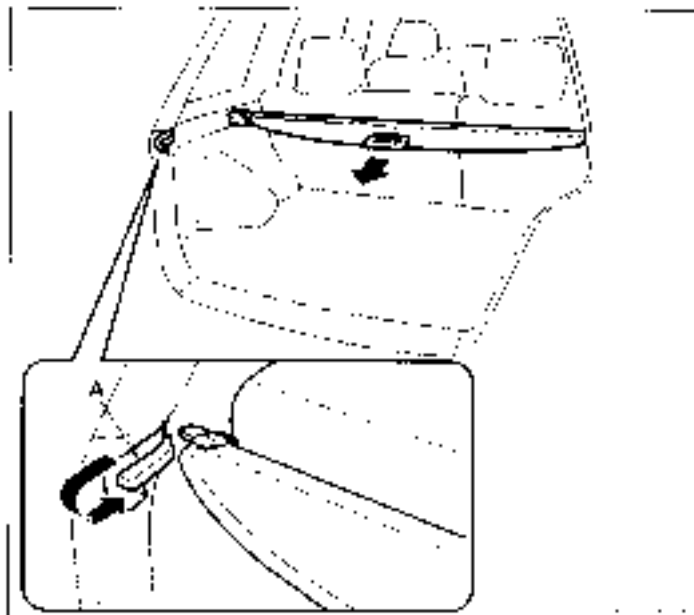

2. Remove the cover from the mounting groove, and the cover will be pulled back into the retracted position.

NOTE

- Do not place anything on the tonneau cover.

To change position

There are three installation holes (A) for the tonneau cover.

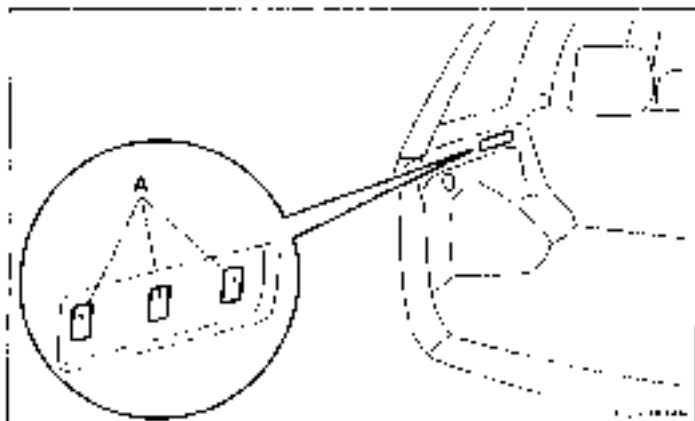

1. Move one of the sliders (B) toward the inside of the vehicle and fit the protruding portion (C) into the installation hole that is to be used. Move the opposite slider in the same fashion.

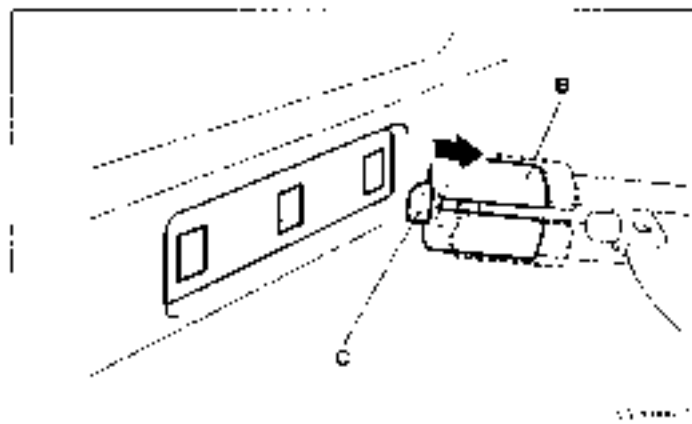

2. After changing the position, gently shake the entire tonneau cover to make sure it is securely retained.

NOTE

- If the rear seatback touches the tonneau cover, move the tonneau cover rearward. The tonneau cover could break if it supports the seatback of the rear seat.

To remove

1. Roll back the tonneau cover.
2. Move one of the sliders (B) toward the inside of the vehicle and lift it to remove the tonneau cover.

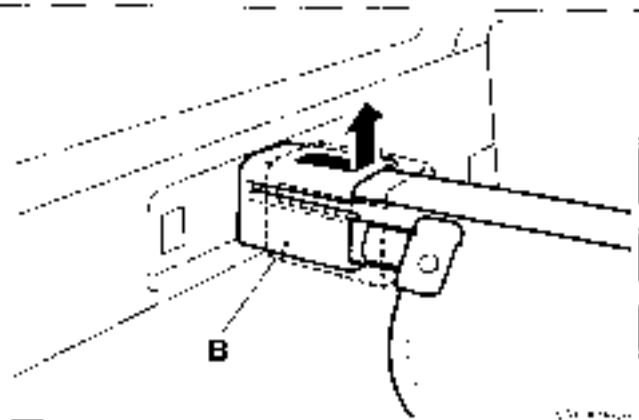

To fit the tonneau cover, follow the removal steps in reverse. Gently shake the entire tonneau cover after fitting it to make sure it is securely retained.

To store

You can store the tonneau cover in the luggage floor box when not in use.

1. Remove the luggage floor board.
2. Push the slider on each side of the box (D) in the luggage floor box.

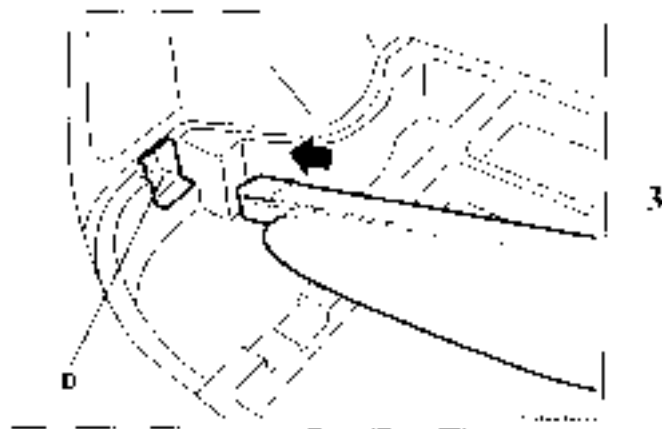

3. Return the luggage floor board to its original position

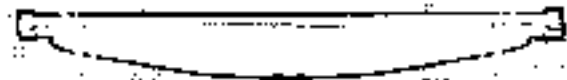

Luggage hooks

⚠ CAUTION

- Do not load the luggage higher than the top of the seatback.
Be sure that luggage is firmly secured.
Restricted rear vision or flying objects entering the passenger compartment during sudden braking could result in a serious accident.

There are hooks on the front and the side of the luggage area for use in securing luggage.

Floor

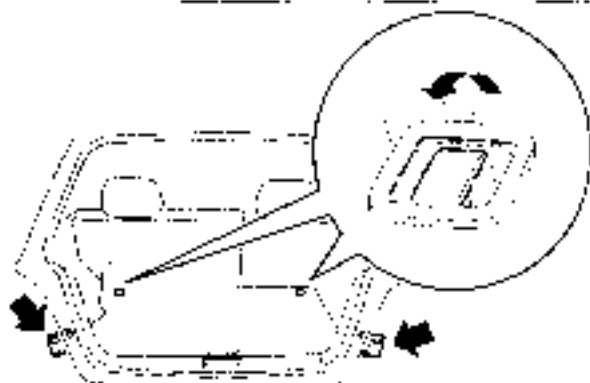

NOTE:

- Do not hang the heavy luggage crate that about 6.6 pound (3 kg) on the hook (Side). Doing so could damage the hook.

Side

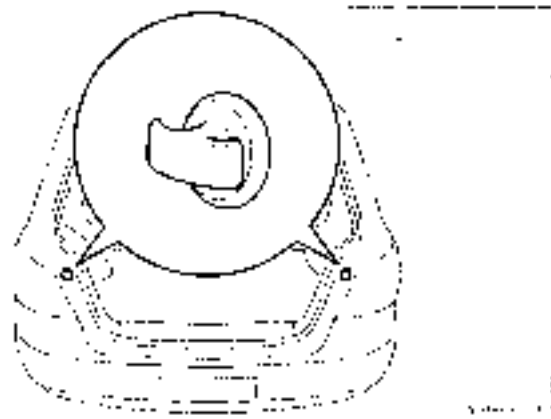

Driving safety

Fuel economy	4- 1
Driving, alcohol and drugs	4- 2
Vehicle preparation before driving	4- 3
Safe driving techniques	4- 3
Off-pavement driving	4- 4
Driving during cold weather	4- 5
Braking	4- 6
Parking	4- 6
Cargo loads	4- 7
Trailer towing	4- 10

Fuel economy

Fuel economy is dependent on many factors. Your personal driving habits can have a significant effect on your fuel use. Several recommendations for achieving the greatest fuel economy are listed below.

- When pulling away from traffic lights or stop signs, accelerate slowly and smoothly.
- When parked for even a short period, do not idle the engine. Shut it off.
- Plan your trips to avoid unnecessary stops.
- Keep your tires inflated to the recommended pressures.
- For freeway driving, maintain a speed of approximately 50 mph (80 km/h) when traffic, roadway and weather conditions safely permit.
- Keep your air filter clean and your vehicle lubricated according to the recommendations in this manual.
- Keep your vehicle "tuned up".
An out of tune engine wastes fuel and costs money.
- Do not overload your vehicle.

Driving, alcohol and drugs

Drunk driving is one of the most frequent causes of accidents. Your driving ability can be seriously impaired even with blood alcohol levels far below the legal minimum. If you have been drinking, don't drive. Ride with a designated non-drinking driver, call a cab or a friend, or use public transportation. Drinking coffee or taking a cold shower will not make you sober.

Similarly, prescription and nonprescription drugs affect your alertness, perception and reaction time. Consult with your doctor or pharmacist before driving while under the influence of any of these medications.

▲ WARNING

● NEVER DRINK AND DRIVE.

Your perceptions are less accurate, your reflexes are slower and your judgment is impaired.

Vehicle preparation before driving

For a safer and more enjoyable trip, always check for the following:

Seat belts and seats

- Before starting the vehicle, make certain that you and all passengers are seated and wearing their seat belts properly (with children in the rear seat, in appropriate restraints), and that all the doors and liftgate are locked.
- Move the driver's seat as far backward as possible, while still keeping good visibility, and good control of the steering wheel, brakes, acceleration, and controls. Check the instrument panel indicators for any possible malfunction.
- Move the front passenger seat as far back as possible.
- Make sure that infants and small children are properly restrained, in accordance with the laws and regulations, and for maximum protection in case of an accident.

Defrosters

Check these by selecting the defroster mode, and set the Blower switch on high. You should be able to feel the air blowing against the windshield.

(Refer to "Defrosting or defogging the windshield and floor windows" on page 5-17.)

Tires

Check all the tires for heavy tread wear or uneven wear patterns. Look for stones, nails, glass, or other objects stuck in the tread. Look for any tread cuts or sidewall cracks. Check the wheel nuts for tightness, and the tires (including spare tires) for proper pressure. Keep them at the recommended tire inflation pressures. Replace your tires before they are heavily worn out.

Lights

Have someone watch while you turn all the exterior lights on and off. Also check the turn signals and high-beam indicators on the instrument panel.

Fluid leaks

Check the ground under the vehicle after parking overnight, for fuel, water, oil, or other leaks. Make sure all the fluid levels are correct. Also, if your car smells fuel, you need to find out why immediately and have it fixed.

Safe driving techniques

Even this vehicle's safety equipment and your safest driving cannot guarantee that you can avoid an accident or injury. However, if you give extra attention to the following areas, you can better protect yourself and your passengers:

- Drive defensively. Be aware of traffic, road and weather conditions. Leave plenty of stopping distance ahead of your vehicle.
- Before changing lanes, check your mirrors and flash your turn signal light.
- While driving, watch the behavior of other drivers, bicyclists, and pedestrians.
- During an emergency stop, switch on the hazard warning flasher.
- Always obey applicable laws and regulations. Be a polite and alert driver. Always leave room for unexpected events, such as sudden braking.
- If you plan to drive in another country, obey their vehicle registration laws and make sure you will be able to get the right fuel.

On pavement driving

WARNING

- **Utility vehicles have a significantly higher rollover rate than other types of vehicles. Avoid abrupt maneuvers and excessive speed. Always buckle up.**

Utility vehicles have higher ground clearance and a narrower track which enables them to perform in a wide variety of off-road situations. Because of the higher ground clearance, these vehicles have a higher center of gravity, which makes them handle differently than ordinary vehicles when driving on pavement. These differences also make utility vehicles handle differently than ordinary vehicles. They are not designed to maneuver or corner at the same speed on pavement as conventional 2 wheel drive cars any more than hot-rodging sports cars are designed to perform satisfactorily under off-road conditions.

Always drive safely and steer the vehicle carefully. Avoid operating the vehicle in a manner that might require sharp turns or abrupt maneuvers. As with other vehicles of this type, failure to operate this vehicle correctly can result in loss of control or vehicle rollover.

In a rollover crisis, an unbelted person is significantly more likely to die than a person wearing a seat belt. Before starting the vehicle, always make certain that you and all your passengers are properly wearing their seat belts (with children in the rear seat, in appropriate restraints).

Driving during cold weather

- Check the battery, including terminals and cables. During extremely cold weather, the battery will not be as strong. Also, the battery power level may drop because more power is used for cold starting and driving. Before driving the vehicle, check to see if the engine runs at the proper speed and if the headlights are as bright as normally. Change or replace the battery if necessary. During extreme cold weather, it is possible that a very low battery could freeze.

⚠ WARNING

- The battery gives off explosive hydrogen gas. Any spark or flame can cause the battery to explode, which could cause serious or fatal injuries. Always wear protective clothes and a face mask when working with your battery, or let a skilled mechanic do it.

- Warm the engine sufficiently. After starting the engine, allow a short warm-up time to distribute oil to all cylinders. Then drive your vehicle slowly. Stay at low speeds at first so that the transaxle, transfer case and rear axle oil have time to spread to all the lubrication points.

- Check the engine antifreeze.

If there is not enough coolant because of a leak or from engine overheating, add high-quality ethylene glycol anti-freeze and water. The recommended blend is about 50% water and 50% anti-freeze. Use a higher concentration (not over 60%) when the outside temperature is -11 to -35 °C or lower. When the engine is working very hard (for example, during mountain driving and/or when the outside temperature is high), use a 50% concentration. This blend will provide adequate protection from corrosion and boiling.

⚠ WARNING

- Never open the radiator cap when the radiator is hot. You could be seriously burned.

Braking

All the parts of the brake system are critical to safety. Have the vehicle serviced by an authorized Mitsubishi dealer at regular intervals according to the "WARRANTY AND MAINTENANCE MANUAL".

When brakes are wet

Check the brake system while driving at a low speed immediately after starting, especially when the brakes are wet, to confirm they work normally.

A film of water can be formed on the brake discs or brake drums and prevent normal braking after driving in heavy rain or through large puddles, or after the vehicle is washed. If this occurs, try the brakes out by driving slowly while lightly depressing the brake pedal.

When driving downhill

It is important to take advantage of the engine braking by shifting to a lower gear while driving on steep downhill roads in order to prevent the brakes from overheating.

Parking

Parking on a hill

When parking on a hill, set the parking brake, and turn the front wheels toward the curb on a downhill, or away from the curb on an uphill.

If necessary, apply chocks to wheels.

Be sure that the parking brake is firmly set when parked and that the selector lever is in the "P" (PARK) position.

When parking on a hill it is important to set the parking brake before moving the selector lever to the "P" (PARK) position.

This prevents loading the parking brake against the transaxle gear. When this happens, it is difficult to move the selector lever out of the "P" (PARK) position.

Parking with the engine running

Never leave the engine running while you take a short sleep rest. Also, never leave the engine running in a closed or poorly ventilated place. Leaving the engine running risks injury or death from accidentally moving the selector lever or the accumulation of toxic exhaust fumes in the passenger compartment.

Where you park

Do not park in a place where there are inflammable objects such as dry grass, leaves, etc. because the exhaust system produces very high temperatures. This may cause a fire.

Your front bumper can be damaged if you scrape it over curbs or parking stop blocks. Be careful when traveling up or down steep slopes where your bumper can scrape the road.

When leaving the vehicle

Always remove the key from the ignition switch and lock all doors and liftgate when leaving the vehicle unattended.

Always try to park your vehicle in a well lit area.

Cargo loads**Cargo loads precautions**

The load your vehicle can safely carry is shown on the tire inflation pressure label (A).

DO NOT EXCEED the Gross Vehicle Weight Rating and Gross Axle Weight Rating numbers listed on the safety certificate or label (B) as the guide for passengers and/or cargo weight.

The maximum passenger and/or cargo weights that your vehicle can carry are printed on the tire inflation pressure label.

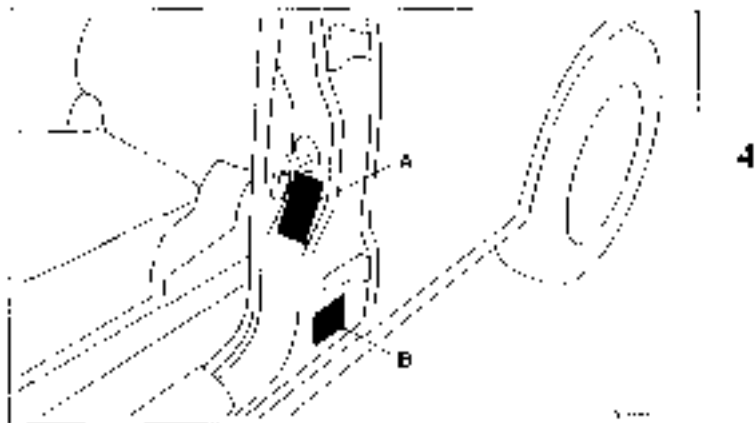

⚠ CAUTION

- Do not load cargo or luggage higher than the top of the seatback. Be sure that your cargo or luggage cannot move once your vehicle is moving. Having either the rear view blocked, or your cargo being thrown inside the cabin if you suddenly have to brake can cause a serious accident or injury.
- Load heavy cargo or luggage in the front of the vehicle. If the load in the back of the vehicle is too heavy, steering may become unstable.

Loading a roof carrier (if so equipped)

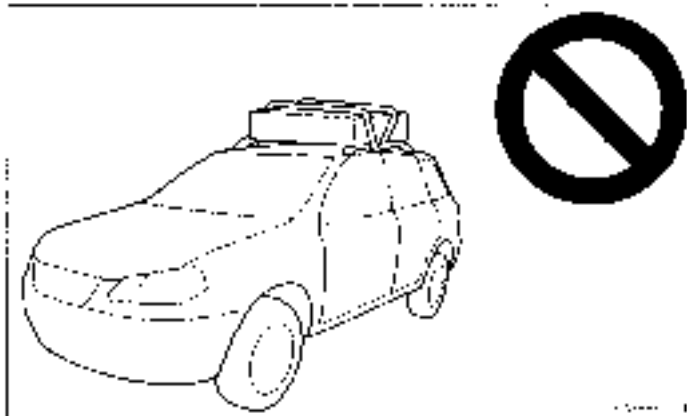

⚠ CAUTION

- Do not load luggage directly onto the roof. Use a roof carrier that properly fits your vehicle. For installation, refer to the instruction manual accompanying the roof carrier.

Roof drip moulding (if so equipped)

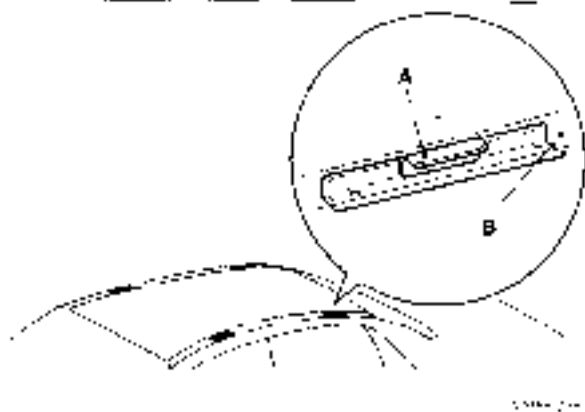

When installing the roof carrier, use the brackets (A). The brackets are located under each roof drip moulding (B).

NOTE

- Use a genuine Mitsubishi roof carrier, since the brackets to be used are of special shape. For details, consult a nearby authorized Mitsubishi dealer.

Roof carrier precaution

⚠ CAUTION

- Make sure that the weight of the luggage does not exceed the allowable roof load.

If the allowable roof load is exceeded, this may cause damage to the vehicle.

The roof load is the total allowable load on the roof (the weight of the roof carrier plus the weight of luggage placed on the roof carrier).

For specific figures, please refer to the "Maximum roof load" on page 9-5.

- When luggage is loaded onto the vehicle, please make sure to drive slowly and avoid excessive maneuvers such as sudden braking or quick turning.

In addition, place the luggage on the carrier so that its weight is distributed evenly with the heaviest items on the bottom. Do not load items that are wider than the roof carrier.

The additional weight on the roof could raise the vehicle's center of gravity and affect vehicle handling characteristics.

As a result, driving errors or emergency maneuvers could lead to a loss of control and result in an accident.

▲ CAUTION

- Before driving and after traveling a short distance, always check the load to make sure it is securely fastened to the roof carrier.
Check periodically during your travel that the load remains secure. If the load is not secure, it could fall from the vehicle and damage your vehicle, another vehicle or create road hazard.

NOTE

- To prevent wind noise or turbulence or gas mileage, remove the roof carrier when not in use.
- Before using an automatic car wash, check with the attendant to determine if the roof carrier should be removed.
- Be sure that adequate clearance is maintained for raising the sunroof and/or liftgate when installing a roof carrier. (For vehicle with sunroof.)

Trailer towing

Towing a trailer will adversely affect handling, performance, braking, durability and driving economy (fuel consumption, etc.).

When you do, be sure to use proper equipment and allow cautious steering and braking for safety driving.

▲ CAUTION

- Do not use improper equipment, or you will lose control of the vehicle, resulting in serious injury to passengers or vehicle malfunction not covered by your warranty. For details, please contact your authorized Mitsubishi dealer.

Weight limits

Never exceed the maximum trailer weight (TW), maximum tongue weight (TB), Gross Vehicle Weight Rating (GVWR) and Gross Axle Weight Rating (GAWR).

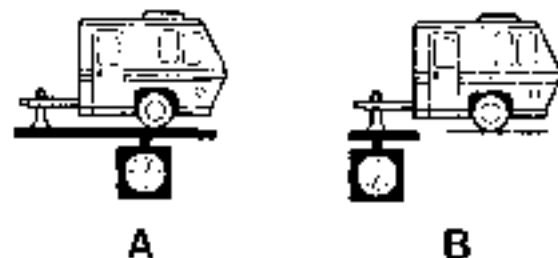

Maximum trailer weight

Recommendations for towing up to this limit are as follows:

Total Trailer Weight	Trailer Brake requirements
Up to 1,000 lbs. (453 kg)	Trailer brakes not required
1,000 lbs. (453 kg) to 2,000 lbs. (907 kg)	Trailer brakes required

Maximum tongue weight

The tongue weight of any trailer is important because it affects the total or gross weight of your vehicle.

The Gross Vehicle Weight Rating (GVWR) includes the curb weight of the vehicle, any cargo you may carry in it, and the

people who will be riding in the vehicle. And if you will tow a trailer, you must add the tongue weight to the GVWR because your vehicle will be carrying that weight, too. See "Vehicle weights" on page 9-5 for more information about your vehicle's maximum load capacity.

Do not exceed the maximum tongue weight for your vehicle.

	Maximum tongue weight
With trailer brake	150 lbs. (68 kg)
Without trailer brake	100 lbs. (45 kg)

After you've loaded your trailer, weigh the trailer and then the tongue, separately, to see if the weights are proper. If not, you may redistribute the weight properly by moving some items around in the trailer.

Gross Vehicle Weight Rating (GVWR) and Gross Axle Weight Rating (GAWR)

The GVWR and GAWRs are printed on the certification label which is riveted on the door sill on the driver's side. Refer to the section "Vehicle loading" on page 9-2.

Trailer hitches

Use a proper hitch and ball, and make sure it is installed at a height that is compatible with the trailer.

Use a good equalizing hitch which uniformly distributes the trailer tongue load throughout the frame.

Keep the trailer tongue load at 10% of the loaded trailer weight for dead weight hitches. Tongue loads can be adjusted by proper distribution of the load in the trailer. This can be checked by separately weighing the loaded trailer and then the tongue.

⚠ WARNING

- If you make any holes in the body of your vehicle for installing a trailer hitch, be sure to seal the holes later when you remove the hitch. If you don't seal them, deadly carbon monoxide (CO) from your exhaust can enter your vehicle. Refer to the "Exhaust system" on page 7-29.

NOTE:

- Mitsubishi recommends that a sway control is used whenever you are towing, to improve towing stability. For details, please consult your authorized Mitsubishi dealer.

Safety chains

A safety chain must always be used between the towing vehicle and the trailer. Leave sufficient slack in the chain for turns.

The chain should cross under the trailer tongue to prevent the tongue from dropping to the ground in case it becomes damaged or separated.

For correct safety chain procedures, consult your authorized Mitsubishi dealer.

⚠ CAUTION

- Never tow a trailer without using a safety chain securely attached to both the trailer and the vehicle. If damage occurs to the coupling unit or hitch ball, there is possible danger of the trailer wandering over into another lane.

Maintenance when trailer towing

Your vehicle will need service more often when you are towing a trailer. Refer to the "WARRANTY AND MAINTENANCE MANUAL". Especially important in trailer operation are automatic transaxle fluid, engine oil, rear axle oil, belt, cooling system and brake system. Each of these is covered in this manual. For details, please refer to the "Vehicle care and maintenance" section.

Check periodically to see that all hitch nuts and bolts are tight.

Operating hints

⚠ WARNING

- If you have a rear window open and you tow a trailer with your vehicle, carbon monoxide gas which you cannot see or smell could come into your vehicle. It can cause unconsciousness or death. Refer to the "Exhaust system" on page 7-29.

To maximize your safety when towing a trailer:

- Have your exhaust system inspected for leaks, and make necessary repairs before starting on your trip.
- Keep the rear windows closed.
- If exhaust does come into your vehicle through a window or another opening, drive with your front, main heating or cooling system on and with the blower on any speed. This will bring fresh, outside air into your vehicle. Do not use recirculation because it only recirculates the air inside your vehicle. Refer to the "Changing the air selection" on page 5-8.

Driver preparation

Towing a trailer requires a certain amount of experience. Before setting out for the open road, you'll want to get to know your trailer. Acquaint yourself with the feel of handling and braking with the added weight of the trailer. And always keep in mind that the vehicle you are driving is now a good deal larger and not nearly as responsive as your vehicle is without a trailer.

Vehicle preparation

Before you start, check the trailer hitch, safety chains, tires and mirror adjustment.

Tires

Be sure your vehicle's tires are inflated to the proper limit for cold tires. You'll find these numbers on the tire inflation pressure label at the sill or the driver's door.

Refer to the section "Vehicle labeling" on page 9-2.

Following distance

Stay at least twice as far behind the vehicle ahead as you would when driving your vehicle without a trailer. This can help you avoid situations that require heavy braking and sudden turns.

Passing

You'll need more passing distance up ahead when you're towing a trailer. And, because you're a good deal longer, you'll need to go much farther beyond the passed vehicle before you can return to your lane.

Backing up

Hold the bottom of the steering wheel with one hand. Then, to move the trailer to the left, just move that hand to the left. To move the trailer to the right, move your hand to the right. Always back up slowly and, if possible, have someone guide you.

Making turns

⚠ CAUTION

- Making sharp turns while towing a trailer could cause the trailer to come in contact with the vehicle. Your vehicle could be damaged. Avoid making sharp turns while towing a trailer.

When you're turning with a trailer, make wider turns than normal to help prevent the trailer from striking shoulders, curbs, road signs, trees or other objects.

Avoid jerky or sudden maneuvers. Signal well in advance.

Overheating

Towing a trailer puts additional burden on the engine and transaxle, which may cause overheating. Following are some suggestions to reduce overheating:

Overheating Situation	<u>Solution</u>
Air conditioning on	Turn off
Highway speeds	Reduce speed
Going up hills	Select lower gear
Stop-and-go city traffic	When stopped, shift transaxle to neutral and idle engine at higher speed

When towing at high altitudes, engine coolant and automatic transaxle oil will overheat at a lower temperature than at normal altitudes.

If you turn your engine off immediately after towing at high altitude on steep uphill grades, your vehicle may show signs similar to overheating. To avoid this, let the engine run while

parked (preferably on level ground) with the automatic transaxle in "P" (PARK) position for a few minutes before turning the engine off.

- If the needle in the engine coolant temperature gauge approaches the overheating zone (refer to the "Engine overheating" on page 6-5).
- If the automatic transaxle oil temperature warning light illuminates, refer to the "Automatic transaxle oil temperature warning light" on page 3-35.

Driving on hills

Reduce speed and shift to a lower gear before you start down a long or steep downgrade. If you don't shift down, overusing the brakes can cause reduced brake efficiency.

You can tow in "D" (DRIVE) position. You may want to shift the transaxle to 3rd gear or a lower gear under heavy loads or hilly conditions.

Parking

Always place chocks or blocks under both the vehicle and trailer wheels when parking. Apply the parking brake firmly. Move the selector lever to the "P" (PARK) position. Avoid parking on a hill with a trailer, but if it cannot be avoided, do so only after performing the following:

1. Apply the brakes and keep them applied.
2. Have someone place chocks or blocks under both the vehicle and trailer wheels.
3. When the chocks or blocks are in place, release your brakes slowly until the chocks or blocks absorb the load.
4. Apply the parking brake firmly.
5. Move the selector lever to the "P" (PARK) position and turn off the engine.

When restarting on a hill parking on a hill:

1. Make sure the selector lever is in the "P" (PARK) position, and start the engine. Be sure to keep the brake pedal depressed.
2. Move the selector lever to the 2nd gear (1st gear or "R" (REVERSE) position).
3. Release the parking brake and brake pedal and slowly pull or back away from the chocks or blocks. Stop and apply your brakes.
4. Have someone retrieve the chocks or blocks.

Comfort controls

Vents	5- 2
Manual air conditioning	5- 3
Important operating tips for the air conditioning	5- 11
AM/FM electronically tuned radio with CD player	5- 15
Error codes	5- 25
Handling of compact discs	5- 23
Antenna	5- 29
General information about your radio	5- 10

Vents

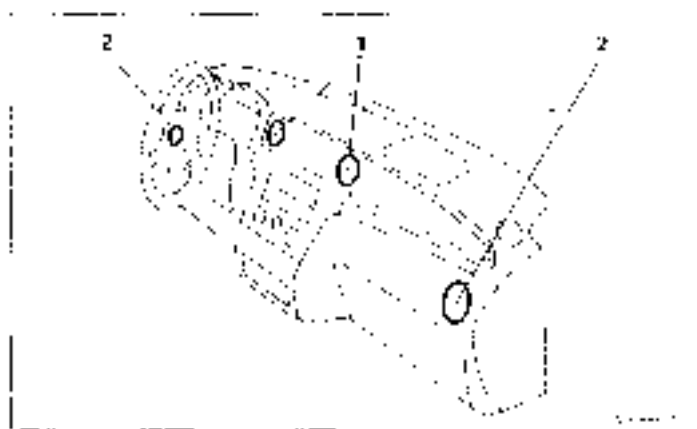

- 1 Center vents
- 2 Side vents

Air flow and direction adjustments

Push the section of the vent door (A) open or up

Close the vents by the pushing the section of the door (B)

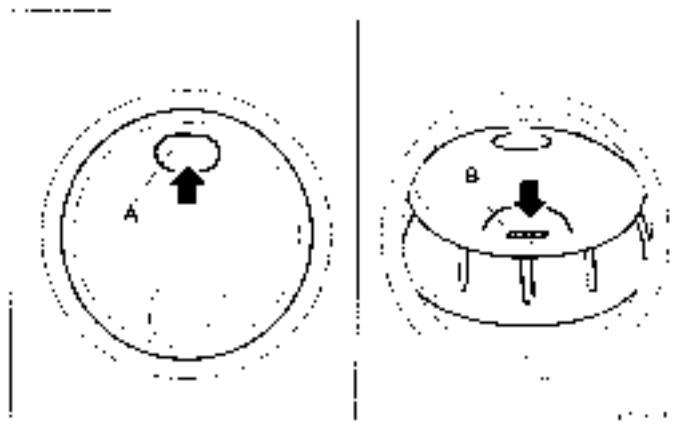

Change the direction of the airflow by turning the vents inset:

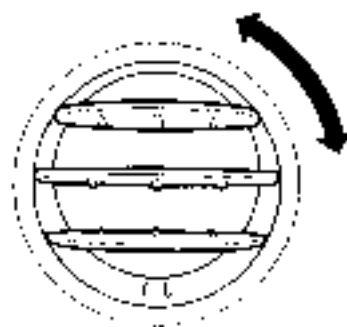

NOTE:

- On rare occasions, air from the vents of an air-conditioned vehicle may be foggy. This is only moisture cooling suddenly and does not indicate a problem.

Manual air conditioning

Control panel

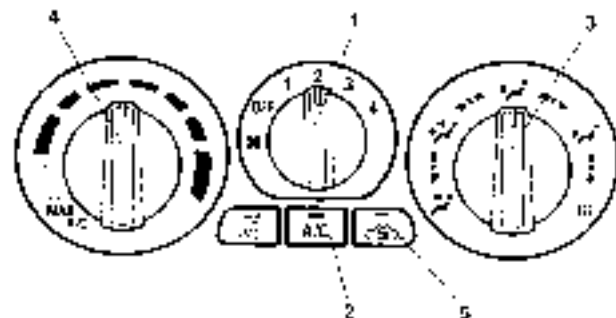

- 1 Blower speed selection dial
- 2 Air conditioning switch
- 3 Mode selection dial
- 4 Temperature control dial
- 5 Air selection switch

Comfort controls

Changing the blower speed

The blower may be run (when the ignition key is in the ON position) at 4 different speeds. Select the best speed to fit your needs. When the blower speed selection dial is set to the OFF position, all air-driven airflow will stop.



Changing the temperature

Turn the temperature control dial clockwise to make the air warmer. Turn it counter-clockwise to make the air cooler.

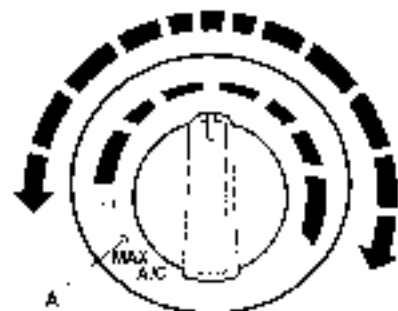

NOTE:

- While the engine coolant temperature is low, the temperature of the air from the heater will be cool/cold until the engine warms up even if you have selected warm air with the dial.
- For maximum air flow to use the 'MAX A/C' position (A); see 'For quick cooling' on page 5-11.

Changing the mode selection

To change the amount of air flowing from the vents, turn the mode selection dial.



These symbols are used in the next several illustrations to demonstrate the quantity of air coming from the vents.

- Small amount of air from the vents
- Medium amount of air from the vents
- Large amount of air from the vents

Face position

Air flows only to the upper part of the passenger compartment.

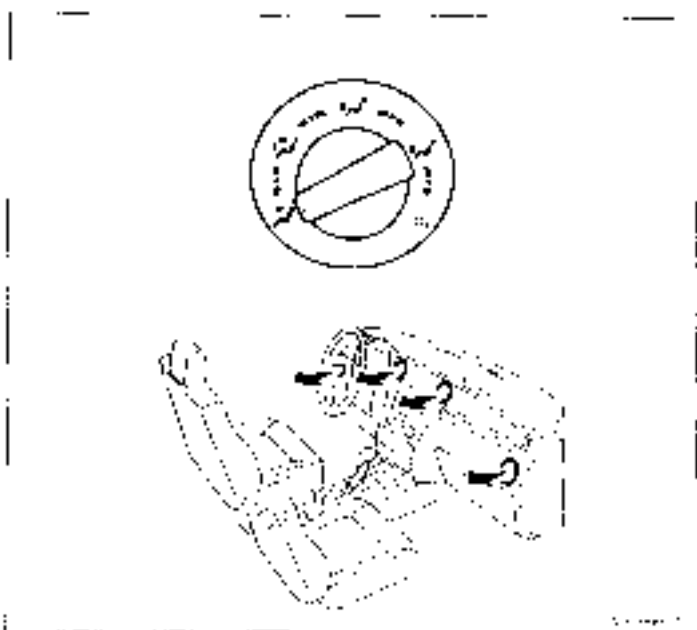

Comfort controls

Foot/face position

Air flows to the upper part of the passenger compartment and flows to the leg area

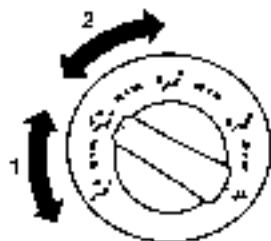

* If so equipped *

NOT

- When the dial is set in position (1), air flows mostly to the upper part of the passenger compartment. In position (2) air flows mostly to the leg area.

Foot position

Air flows mainly to the leg area



* If so equipped *

Foot/defroster position

Air flows to the leg area, the windshield and the door windows

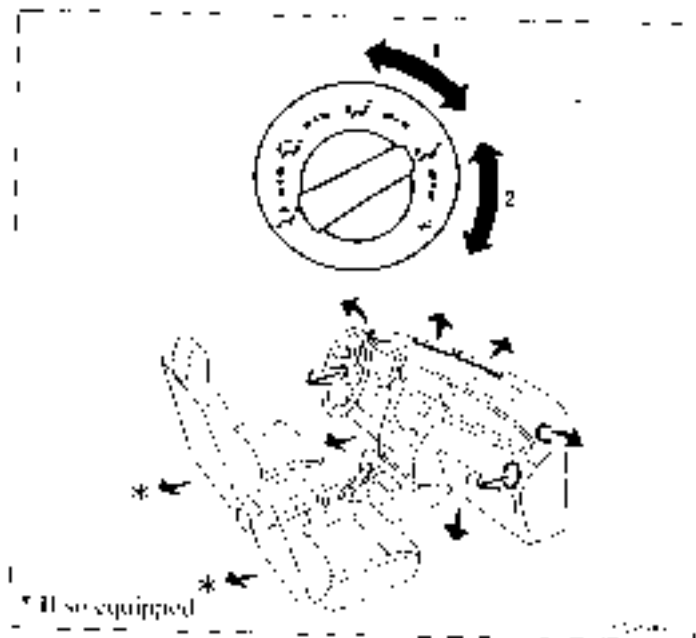

Defroster position

Air flows mainly to the windshield and the door windows

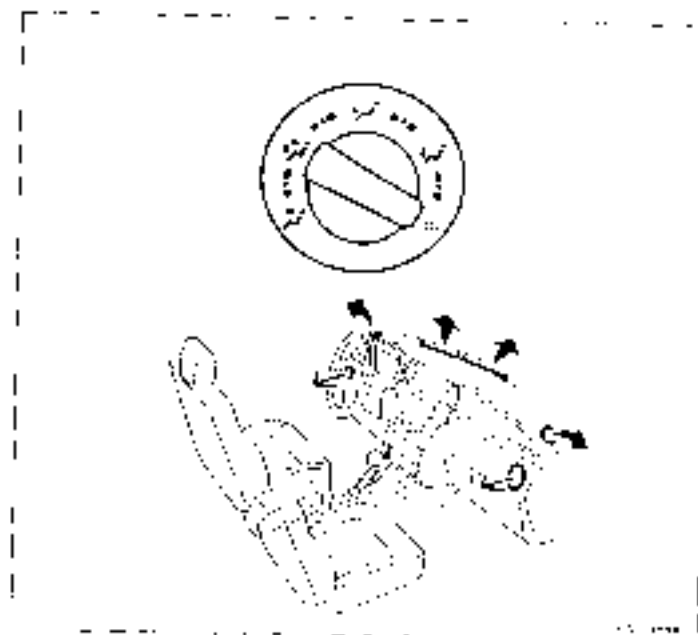

NOTE:

- With the dial set to position (1) air flows mostly to the leg area. In position (2), air flows mostly to the windshield

Changing the air selection

Normally, use the outside position to keep the wind-shield and side windows clear and to quickly remove fog or frost from the windshield.

When the air conditioning turns on, the air selection will be controlled automatically.

When the air conditioning turns off, the air selection automatically goes back to the outside position.

The air selection indicator shows the selected position.

To change the air selection, simply press the air selection switch (A).

- Outside air indicator light is OFF
- Recirculated air indicator light is ON

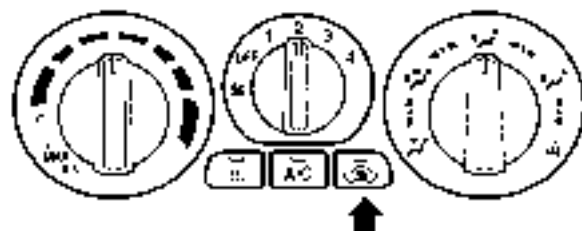

If the outside air is dusty or contaminated in some way, use the recirculation position. Switch to the outside position every now and then to keep the windows from fogging up.

CAUTION

- Using recirculated air for a long time may cause the windows to fog up.

NOTE

- While the mode selection dial is set to the "OFF" or "ON" position, the air conditioning compressor will run automatically. The outside air position will also be selected automatically. In this case, the air conditioning indicator will not change. This is done for optimum performance.
- When the temperature control dial is set to the "MAX A/C" position, the air selection will be automatically set to the recirculation position.
- If the temperature dial is set to any position other than "MAX A/C", outside air will always be used when the ignition switch is turned on.

Air conditioning switch

The air conditioning can only be used while the engine is running.

Push the switch, and the air conditioning compressor will turn on. The air conditioning indicator (A) will come on.

Push the switch again and the air conditioning compressor will stop and the indicator goes off.

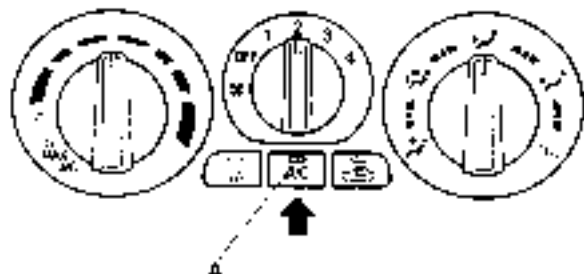
**CAUTION**

- Using the air conditioning slightly increases the engine idle speed. Therefore, make sure your foot is firmly on the brake pedal when shifting the transaxle into drive.

NOTE

- If a problem is detected in the air conditioning compressor, the air conditioning indicator (A) blinks. Press the air conditioning switch once to turn it off, then once more to turn it back on. If the air conditioning indicator (A) does not blink, there is no problem. If it does blink, have it checked at an authorized Mitsubishi dealer.
- Sometimes, for example after using a high-pressure car wash, the condenser can get wet with water, and the air conditioning indicator (A) blinks temporarily. In this case there is nothing wrong. Wait for a while, press the air conditioning switch once to turn the system off, then once more to turn it back on. Once the water evaporates the blinking will stop.

Operating the air conditioning system

Heating

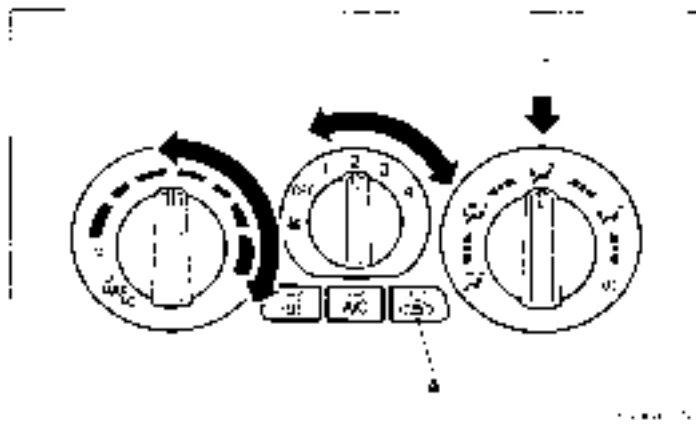

5

Set the mode selection dial to the "HEAT" position and set the air selection switch (A) to the outside position. Turn the temperature control dial clockwise or counterclockwise to the desired temperature. Select the desired blower speed.

NOTE

- For maximum heat, set the blower speed at the 3rd position.

Cooling

For ordinary cooling

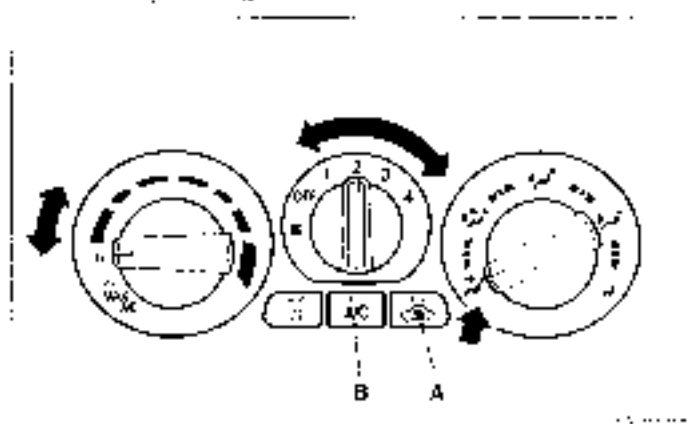

1. Set the mode selection dial to the "COOL" position.
2. Set the air selection switch (A) to the outside position.
3. Push the air conditioning switch (B).
4. Change the temperature by turning the control dial clockwise or counterclockwise.
5. Set the desired blower speed.

NOTE

- If the outside air is dusty or contaminated in some way, set the air selection switch (A) to the recirculation position (C) to save outside air from time to time for good ventilation.

- To cool the leg areas, set the mode selection dial to the "❄️" position.
- When the air conditioning operates with the air selection switch (A) in the outside position, the system automatically determines whether to continue using outside air or to perform recirculation. If the outside air temperature is high, the system selects recirculation to achieve rapid cooling and causes the air selection indicator in the switch to dimminate. Press the air selection switch (A) to return to outside air introduction.

For quick cooling

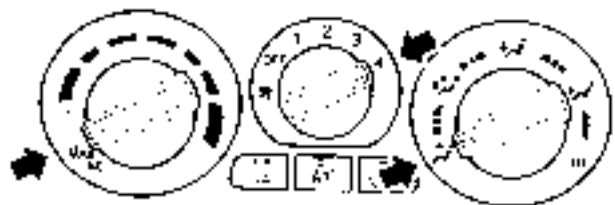

1. Set the mode selection dial to the "❄️" position.
2. Set the temperature control dial to the "MAX AC" position.
3. Set the blower speed to the highest position.

NOTE:

- When the temperature control dial is set to the "MAX AC" position, the air conditioning compressor will run automatically and the light will come on. The recirculation position will be selected automatically. In this case, you cannot turn the air conditioning off or select the outside position.
- When the temperature control dial is set to a position other than "MAX AC", the air selection will automatically change to outside air. The air conditioning will revert to the previous condition in which the "MAX AC" position was not selected.

Comfort controls

Combination of unheated air and heated air

Set the mode selection dial to the positions shown in the illustration and set the air selection switch (A) to the outside position.

The air flow will be directed to the leg area and the upper part of the passenger compartment. Set the desired blower speed. Warm air flows to the leg area and unheated or slightly warm air (depending on temperature settings) flows to the upper part of the passenger compartment.

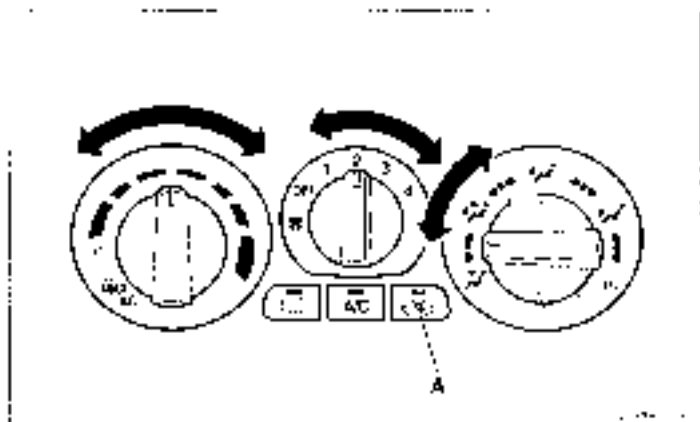

Defrosting or defogging the windshield and door windows

CAUTION

- For safety, make sure you have a clear view through all the windows.

To remove frost or fog from the windshield and door windows, use the mode selection dial (OFF or OFF) .

For ordinary defrosting

To keep the windshield and door windows unblocked and to keep the key area heated (when driving in rain or snow):

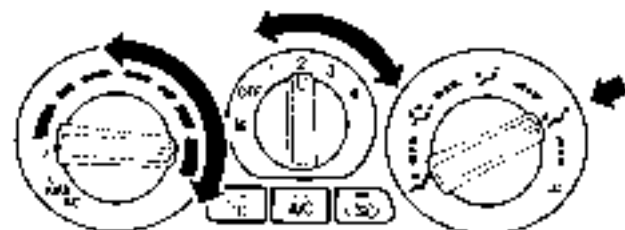

1. Set the mode selection dial to the "snow" position.
2. Set your desired blow speed by turning the blower speed selection dial.
3. Set your desired temperature by turning the temperature control dial.

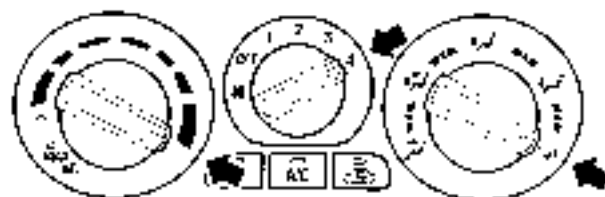
For quick defrosting

1. Set the mode selection dial to the "snow" position.
2. Set the blower to the maximum speed.
3. Set the temperature to the highest position.

NOTE

- When the mode selection dial is set to the "snow" or "snow" position, the air conditioning compressor runs automatically. The outside air position will be selected automatically. (In this case, the air conditioning display will not change.) This is done for optimum performance.
- When the "snow" or "snow" position is selected, you cannot turn the air conditioning off or use the recirculation position. This prevents the windows from fogging up.

Comfort controls

- To defog quickly, direct the air flow from the side vents toward the front windows.
- When defrosting, do not set the temperature control dial near the “MAX A/C” position. This would blow cool air on the window glass and fog it up.

Important operating tips for the air conditioning

- 1 Park the vehicle in the shade whenever possible. Parking in the hot sun makes the vehicle interior extremely hot which then requires more time to cool. If it is necessary to park in the sun, open the windows for the first few minutes of air conditioning to expel the hot air.
- 2 Afterwards, keep the windows closed when the air conditioning is in use. The entry of outside air through open windows will reduce cooling efficiency.
- 3 When using the air conditioning, make sure the air intake, which is located in front of the windshield, is free of obstructions such as leaves. Leaves collected in the air intake chamber may reduce air flow and plug the water drains.

Air conditioning system refrigerant and lubricant recommendations

If the air conditioning seems less effective than usual, the cause might be a refrigerant leak.

Have the system inspected by your authorized Mitsubishi dealer.

▲ CAUTION

- The air conditioning system in your vehicle must be charged with the refrigerant HFC-134a and the lubricant SUN-PAG56.

Use of any other refrigerant or lubricant will cause severe damage and may require replacing your vehicle's entire air conditioning system.

The release of refrigerant into the atmosphere is not recommended.

The new refrigerant HFC-134a in your vehicle is designed not to harm the earth's ozone layer. However, it may contribute slightly to global warming.

It is recommended that the old refrigerant be saved and recycled for future use.

During a long period of disuse

The air conditioning should be operated for at least five minutes each week, even in cold weather. This includes the quick defrosting mode. Operating the air conditioning system weekly maintains lubrication of the compressor internal parts and maintain the air conditioning in the best operating condition.

AM/FM electronically tuned radio with CD player

The audio system can only be used when the ignition switch is in the "ON" or "ACC" position.

NOTE:

- The Mitsubishi genuine CD autochanger can be connected and run by a switch in this audio system. Refer to "Accessories" in page 5-22.
- To listen to the audio system while the engine is not running, turn the ignition key to the "ACC" position.
- If a cellular phone is used inside the vehicle, it may create noise from the audio equipment. This does not mean that anything is wrong with your audio equipment. Either use the cellular phone another time or turn off the audio equipment.
- In case of a disturbance to the equipment (by foreign objects, water, stuck or other etc.), immediately turn off the audio system and have it checked at an authorized Mitsubishi dealer. Never try to repair it yourself. Avoid using the audio system until it is inspected by a qualified person.
- In the event the audio system is damaged by foreign objects, water, or fire, have the system checked by a certified Mitsubishi technician.

Volume and tone control panel

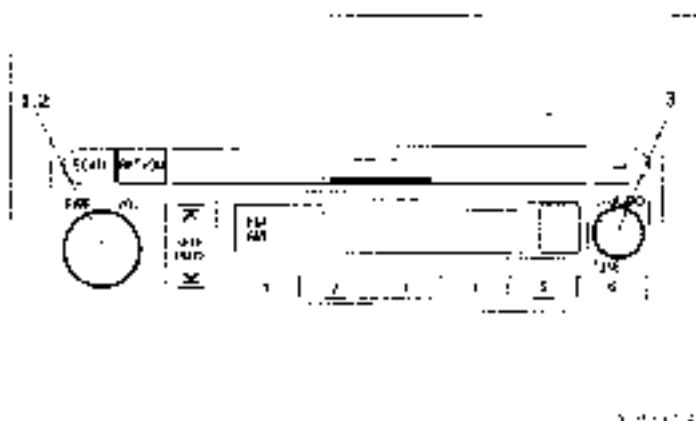

1. PWR (Power) switch
2. VOL (Volume control) knob
3. MUTE button
4. TONE knob

To adjust the volume

VOL (Volume control)

Turn the VOL knob (2) clockwise to increase the volume; counter-clockwise to decrease the volume. The status will be displayed in the display.

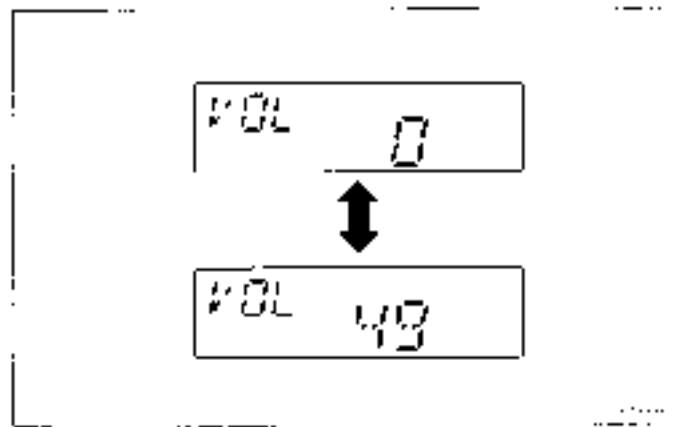

NOTE

- The volume control mode will shut off automatically if either the radio or CD is selected, or if no adjustment is made within about 2 seconds.

To adjust the tone

Press the **AT DIAL TUNE** switch (V) repeatedly to select the tone or balance control to change. The order is: **BAS** → **TRE** → **FREQ** → **BAL** → **Radio adjust mode off**.

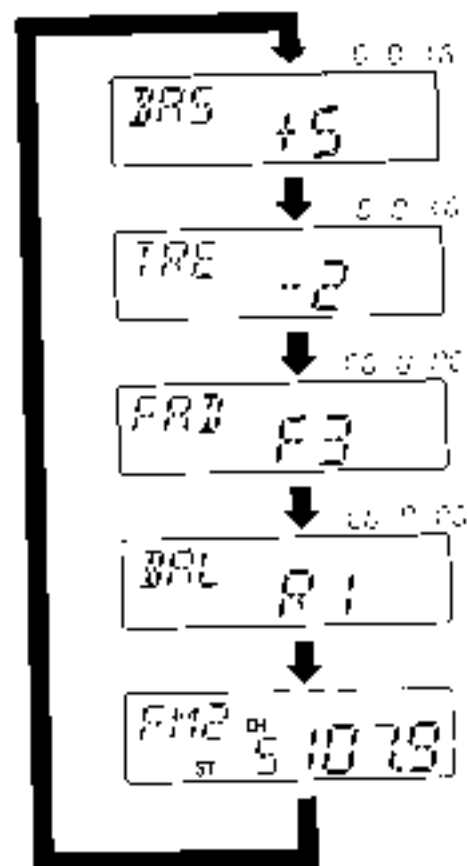

Control controls

2. Turn the **AD-DBT (TBM)** switch (5) either clockwise or counterclockwise to change the tone balance setting.

Mode	Adjusting operation	
	Clockwise	Counterclockwise
BAS	Increase	Decrease
TRE	Increase	Decrease
FAD	Emphasize on the rear speakers	Emphasize on the front speakers
BAL	Emphasize on the right speakers	Emphasize on the left speaker

BAS (Bass tone control)

To select the desired bass level.

TRE (Treble tone control)

To select the desired treble level.

FAD (Front/rear balance control)

To balance the volume from the F (front) and the R (rear) speakers.

BAL (Left/right balance control)

To balance the volume from the L (left) and the R (right) speakers.

NOTE

- When set to "M", it will keep.
- The audio adjust mode will automatically shut-off when either the radio or CD is selected, or if no adjustment is made within about 7 seconds.

Radio control panel and display

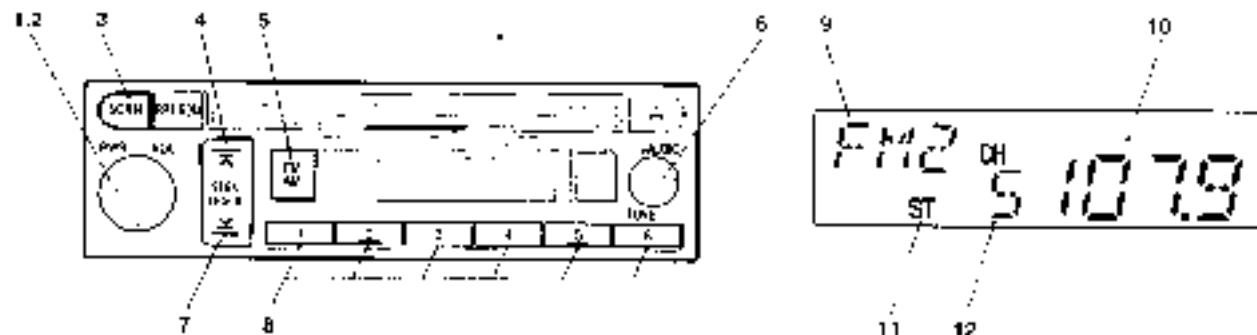

- 1- FWR (On/off) switch
- 2- VOL (Volume control) knob
- 3- SCAN button
- 4- SLK (Up/seek) button
- 5- AM/FM/CAM/FM selection button
- 6- TUNE switch
- 7- SLK/DSK (Up/seek) button
- 8- Memory select buttons
- 9- AM/FM/CAM/FM/FM2 operators
- 10- Frequency display
- 11- ST (Stereo) indicator
- 12- Preset memory number display

To listen to the radio

1. Press the PWR switch (1) or AM/FM button (5) to turn on the radio.
Press the PWR switch again to switch it off.
2. Press the AM/FM button (5) to select the desired band: AM/FM (FM2).
3. Press the SEEK button (4 or 7) or one of the Memory select buttons (8) to tune to a station.
Refer to "Automatic tuning", "Manual tuning" or "To enter frequencies into the memory".

Automatic tuning

1. After pressing the SEEK button (4 or 7), release the button, and reception of the selected station will begin.
2. Press the SCAN button (3), and the radio will tune consecutively to each available station for about 5 seconds per station. If you want to stop searching, press the SCAN button again.
The frequency display of the current station blinks once per second during SCAN.

Manual tuning

The frequency changes every time the AM/FM button (5) is turned. Turn the switch to select the desired station.

To enter frequencies into the memory

As many as 6 AM and 12 FM stations can be entered into the memory.

To store a frequency in the memory, follow these steps:

1. Press the SEEK button (4 or 7) or turn the AM/FM switch (5) to tune to the frequency you wish to keep in the memory.
2. Press one of the Memory select buttons (8) until it beeps. The sound will be momentarily interrupted while the frequency is being entered into the memory. The number of the button matching the entry in the memory, as well as the frequency, are displayed.

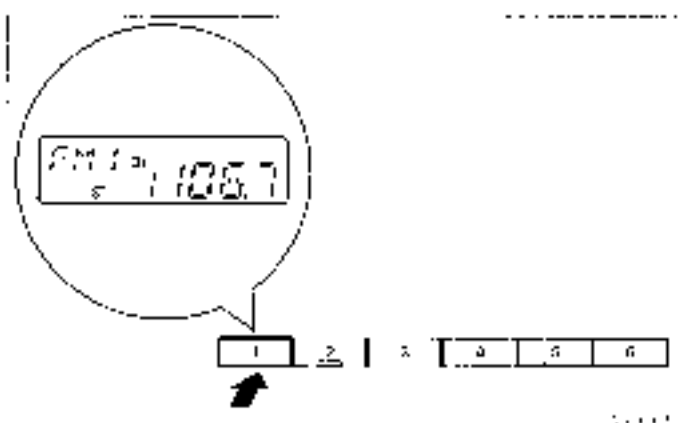

3. The preset memory setting is instructed by pressing the button and then releasing it within about 2 seconds.

NOTE

- Disconnecting the battery cables erases all the frequencies stored in the memory.

CD control panel and display

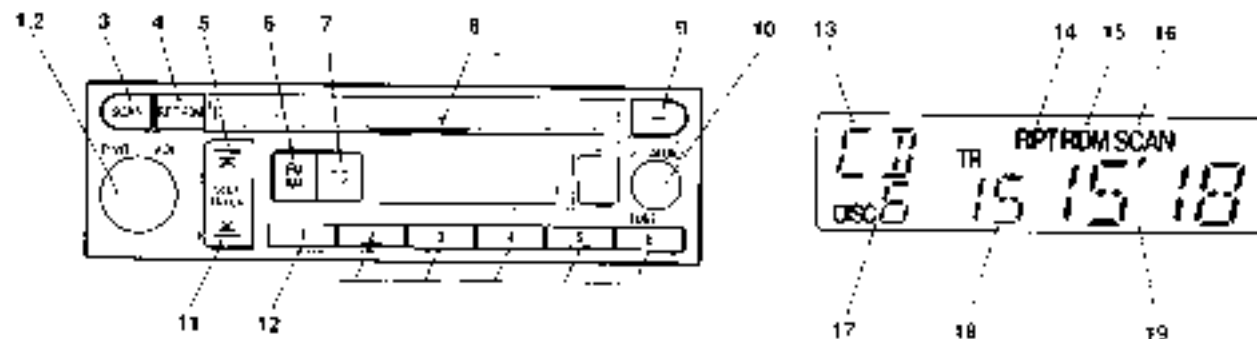

- 1- PWR (Power) switch
- 2- VOL (Volume) control knob
- 3- SCAN button
- 4- RPT/RDM (Repeat/Random) button
- 5- TRW K (Track) button
- 6- AMEM/AMEM (Memory) button
- 7- CD-CD mode change over button
- 8- Disc loading slot
- 9- CD EJECT button
- 10- AUTOHOLD switch
- 11- TRW K (Track) down button
- 12- DISC select buttons
- 13- CD indicator
- 14- RPT (Repeat mode) indicator
- 15- RDM (Random mode) indicator

- 16- SCAN indicator
 - 17- DISC indicator
 - 18- TRW K indicator
 - 19- Track play time display
- * Operates when equipped with a CD autochanger

To listen to a CD

With a CD player

1. Insert the disc with the label facing up.
When a disc is inserted, the CD indicator (CD) will come on and the CD player will begin playing even if the radio is being used. The CD player will also start playback when the CD button (7) is pressed with a disc in the player even if the radio is being used.

NOTE

- If the system is equipped with a CD autochanger, the system switches between the CD player mode and the CD autochanger mode each time the CD button (7) is pressed.
2. To adjust the volume and tone, refer to the section "To adjust the volume" on page 5-16 and "To adjust the tone" on page 5-17.
 3. For vehicles equipped with 4 speakers, when a 3-inch compact disc is used, the adapter is not needed for playback. Insert the disc in the center of the disc-sliding slot. For a vehicle with 6 speakers, 3-inch compact discs cannot be used without an adapter. If a 3-inch compact disc is inserted, it will be ejected automatically. Forcing a 3-inch compact disc into the slot could cause a fault. Consult an authorized Mitsubishi dealer if you wish to play 3-inch compact discs.
 4. For information concerning the handling of compact discs, refer to the section "Handling of compact discs" on page 5-27.

With a CD autochanger

1. Press the CD button (7) and the CD autochanger mode will be selected, starting playback. Each time the CD button is pressed, the CD autochanger switches to a new disc.
2. To adjust the volume and tone, refer to the section "To adjust the volume" on page 5-16 and "To adjust the tone" on page 5-17.
3. To stop the CD player, turn off the power by pressing the PWR switch (11) or switch to the radio mode by pressing the AM/FM button (6).
4. For information concerning the handling of compact discs, refer to the section "Handling of compact discs" on page 5-27.

To select a desired disc (CD autochanger only)

To select another disc with the CD autochanger, press the DISC select buttons (12) to choose the desired disc number.

To fast forward/reverse the disc

To fast forward or reverse, use either the AUDIO FFM switch (10) or the TRACK button (5 or 11).

Fast forward

You can fast forward by turning the AUDIO FFM switch (10) clockwise, or by holding down the **A** side of the TRACK button (5) for more than about 1 second.

Fast reverse

You can fast reverse by turning the AUDIO FFM switch (10) counter-clockwise, or by holding down the **M** side of the TRACK button (11) for more than about 1 second.

NOTE

- Turning the AUDIO FFM switch (10) quickly will not increase the speed of the fast forward/reverse process.

To select a desired track

You can select by using the TRACK button (5 or 11).

Track up

Press the **X** side of the TRACK button (5) until the desired track is reached.

The TRACK indicator (18) will display the number of tracks selected.

Track down

Press the **M** side of the TRACK button (11) until the desired track is reached.

The TRACK indicator (18) will display the number of tracks selected.

NOTE

- Pressing the **M** side of the TRACK button once during the song will cause the CD to restart playing from the beginning of the song.

To repeat the same track or change the order of tracks for playback

Press the RPT (RDM) button (2) to select RPT → RDM → RPT (RDM) mode(s).

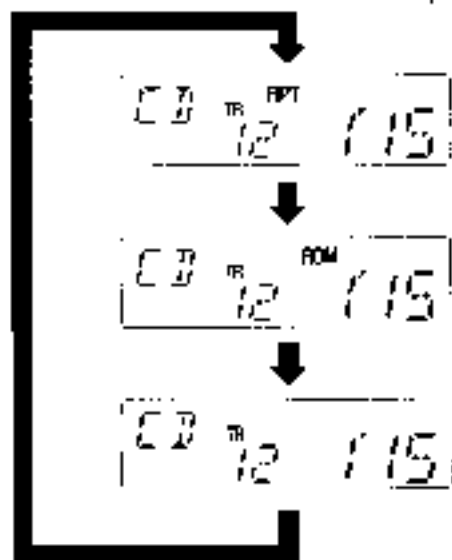

To repeat the same track

Select the RPT mode, and the RPT indicator (2) will come on. You can listen to the same track repeatedly.

To change the order of tracks for playback

Select the RDM mode, and the RDM indicator (1) will come on.

CD player

Tracks are randomly played for playback.

CD autochanger

Tracks are randomly played for playback from all discs loaded in the autochanger.

To find the start of each track on a disc for playback

Press the SCAN button (3). The SCAN indicator (1) will light and the player will playback the first 10 seconds of each track. To exit the SCAN mode, press the button again.

NOTE

- Once all songs on the disc have been scanned, playback on the CD will restart from the beginning of the song that was playing when scanning started.
- The SCAN mode will be unlocked when the radio or CD operation is selected, and a track will start playing.

To eject a disc (CD player only)

Press the eject button (9) is pressed, the disc automatically stops and is ejected. The system automatically switches to radio mode.

Error codes

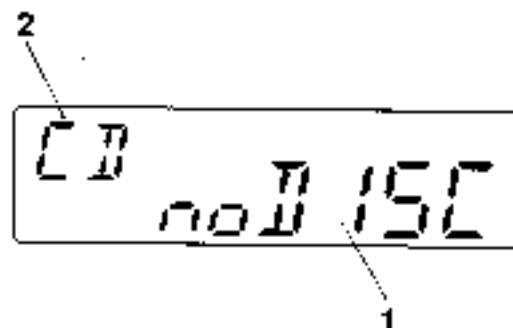

If an error code (1) and a faulty player (2) appears in the frequency display, look at the affected player's instruction manual and take action in accordance with the table below.

Error codes	Cause	Solution
E1	No magazine in charger.	Insert magazine into the charger.
NO DISC	No disc inside	Insert disc.
E1-D1	Player or charger is excessively hot inside. (Playback is temporarily disabled.)	Allow all equipment to cool off. When the temperature lowers to normal, the error code will disappear and playback will automatically resume.

Error codes	Cause	Solution
P-01 P-02	Faulty disc (most likely)	Insert several other discs. If the error code appears only with certain discs, the problem may be due to scratches and/or dirt on the discs. Return from using any damaged discs. If the error code appears with all discs, the problem may be due to condensation on dirt inside the equipment. Wait several hours and re-again. If the error code still appears with all discs, please have the equipment inspected by an authorized Mitsubishi dealer.
P-03 P-	Faulty equipment (most likely)	Have the equipment inspected by an authorized Mitsubishi dealer.

Handling of compact discs

- Use only the type of compact discs that have the mark shown in the illustration below. (Playback of CDR discs may cause problems. CD-RW discs cannot be played.)



- The use of special shaped or low-quality compact discs such as those shown below will damage the CD player.

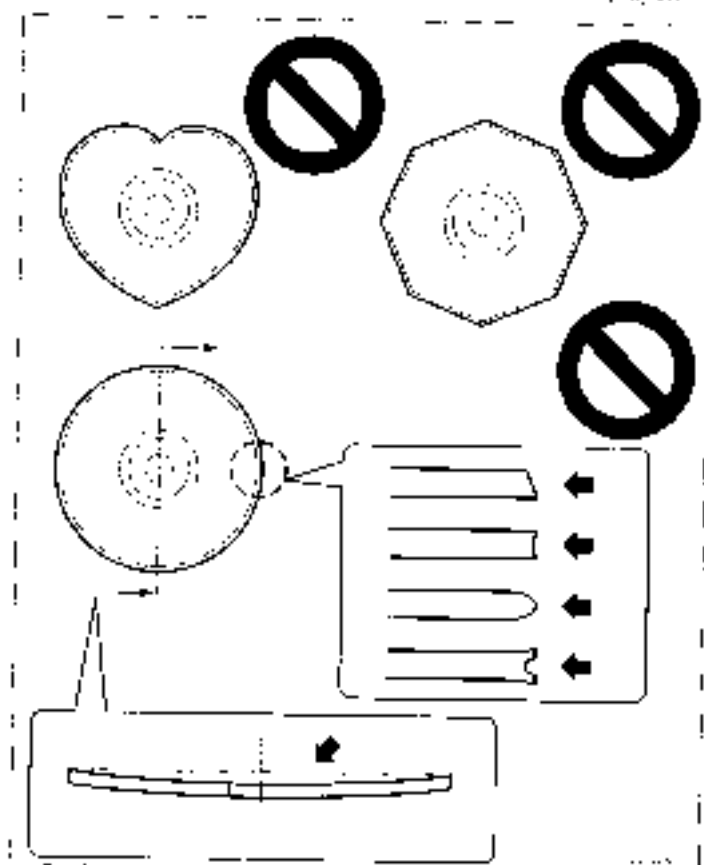

Comfort controls

- When the temperature suddenly rises, such as right after the heater is turned on in cold weather, moisture can condense on the disc or in the player. This could prevent the CD player from operating. In this case, wait until the moisture has had time to dry out.
- When the CD player is subjected to violent vibrations, such as during off-road driving, the tracking may not work.
- When storing compact discs, always store them in their separate cases. Never place compact discs in direct sunlight, or in any place where the temperature or humidity is high.
- Never touch the flat surface of the disc where there isn't a label. This will damage the disc surface and could affect the sound quality. When handling a compact disc, always hold it by the outer edge and the center hole.

- To clean a disc, use a soft, clean, dry cloth. Wipe directly from the center hole toward the outer edge. Do not wipe in a circle. Never use any chemicals such as benzene, paint thinner, a disc spray cleaner, or an anti-static agent on the disc.



Figure 5-1

- Do not use a ball point pen, felt pen, pencil, etc. to write on the label surface of the disc, and do not attach any other labels, seals, etc.

CD player laser warning

⚠ WARNING

- Operating the CD player in a manner other than specifically instructed herein may result in hazardous radiation exposure.

Do not remove the cover and attempt to repair the CD player by yourself. There are no user serviceable parts inside. In case of malfunction, contact an authorized dealer.

Antenna**Whip antenna**

To remove the whip antenna, unscrew it by turning it counter-clockwise.

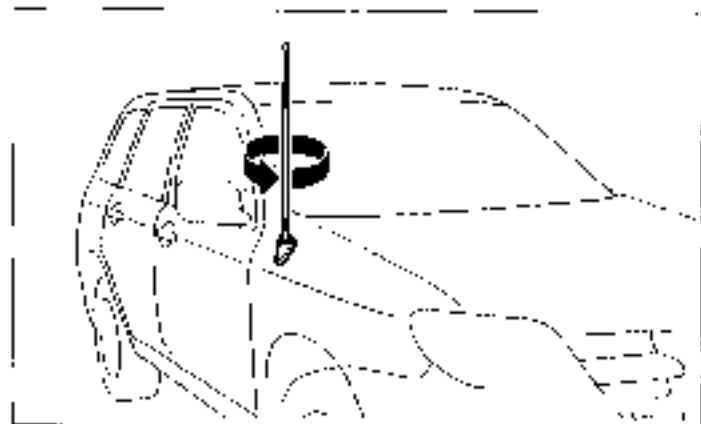
**NOTE:**

- Be sure to put down the whip antenna in the following cases:
 - When entering a place with low clearance.
 - When going into an automatic car wash.
 - When placing a car cover over the vehicle.

General information about your radio

Your vehicle's radio receives both AM and FM stations. The quality of your reception is affected by distance, obstacles, and signal interference.

Your radio complies with Part 15 of Federal Communications Commission (FCC) Rules (for vehicles sold in U.S.A.) and with RSS 210 of Industry Canada Rules (for vehicles sold in Canada). Operation is subject to the following conditions:

- The device may not cause harmful interference.
- This device must accept any interference, including interference that may cause undesirable operation.

CAUTION

- Changes or modifications not expressly approved by the party responsible for compliance could void the user's authority to operate the equipment.

Signal transmission

FM signals do not follow the earth's surface nor are they reflected by the upper atmosphere. For this reason, FM broadcasts cannot be received over long distances. AM signals follow the earth's surface and are reflected by the upper atmosphere. For this reason, AM broadcasts can be received over longer distances.

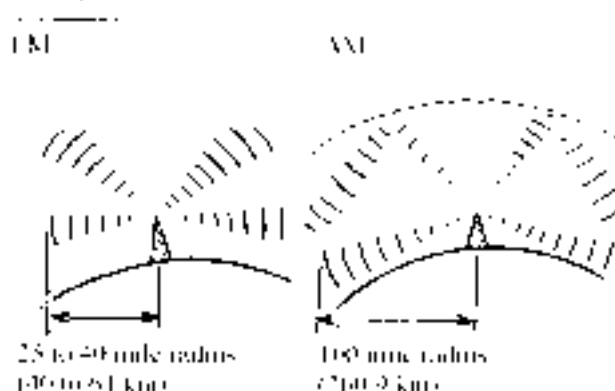

Weak reception (fading)

Because of the limited range of FM signals and the way FM waves transmit, you may experience weak or fading FM reception. When the broadcast is blocked by mountains or similar obstructions, reception can be disturbed.

Reflection

The reason why one can hear FM but not AM in parking garages, under bridges etc. is that FM signals, unlike AM signals, are reflected by solid objects such as buildings, etc.

Because FM signals are easily reflected by buildings, this can also cause reception disturbances.

The direct signal from the broadcast station reaches the antenna slightly before the reflected signal. This time difference may cause some reception disturbance or flutter.

This problem occurs primarily in urban areas.

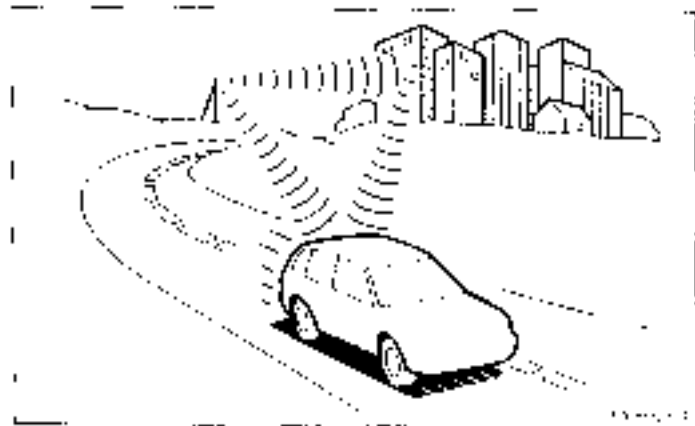

Cross modulation

If one listens to a weak station and is in the vicinity of another strong station, both stations might be received simultaneously.

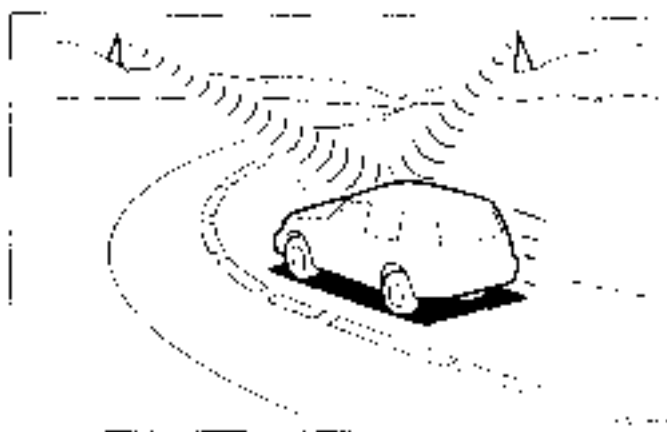

FM stereo reception

Stereo reception requires a high quality broadcast signal. This means that types of disturbances mentioned previously become more marked and the reception range is somewhat diminished during stereo reception.

Causes of disturbances

FM reception is affected by the electrical systems of vehicles in the vicinity, especially those without an electronic noise suppression device. The disturbance is even greater if the station is weak or poorly tuned.

FM reception is not as sensitive to electrical disturbances as AM. AM reception is sensitive to electrical disturbances, such as power lines, lightning and other types of similar electrical phenomena.

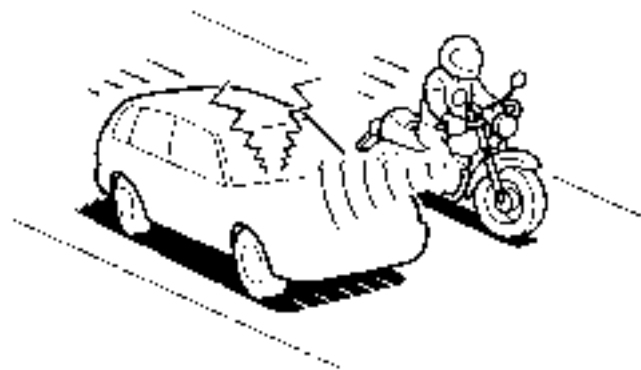

Fig. 12-10

For emergencies

If the vehicle breaks down	6- 2
Jump-starting the engine	6- 2
engine overheating	6- 5
Jack and tools	6- 6
lacking up the vehicle	6- 9
Spare tire	6-11
How to change a tire	6-14
Towing	6-19
What to do if the engine speed becomes unstable after the battery is replaced	6-25
Operation under adverse driving conditions	6-25

If the vehicle breaks down

If your vehicle breaks down on the road, move to the shoulder and turn on the hazard warning flashers. If there is no shoulder, or the shoulder is not safe, drive to the right lane slowly, with the hazard lights flashing, until you come to a safe stopping place. Keep the flashers on long.

If the engine stops/fails

If the engine stops, there will be no power to the steering and brakes, making these difficult to use.

- The brake booster will not work, so the brakes will not grip well. The brake pedal will be harder to press than usual.
- Since there is no power steering, the steering wheel will be hard to turn. Turning the steering wheel requires more effort than usual.

When the engine fails at an intersection

Get help from your passengers, bystanders, etc. to push the vehicle and move it to a safe zone.

Jump-starting the engine

If the engine cannot be started because the battery is weak or dead, you can start it with the battery from another vehicle using jumper cables.

⚠ WARNING

- When using jumper cables to start a vehicle, follow the procedures and be very cautious.

⚠ CAUTION

- Do not try to start your vehicle by pushing or towing. Vehicles with automatic transmissions cannot be started this way. Pushing or towing a vehicle that has a manual transaxle may overheat and damage the catalytic converter. Also, there is more risk of an accident when a vehicle is being pushed or towed.

1. Take off any metal jewelry such as watch bands or bracelets that might make an accidental electrical contact.
2. Position the vehicles close enough together so that the jumper cables can reach, but be sure the vehicles are not touching each other.

⚠ CAUTION

- Check the other vehicle. It must have a 12-volt battery. If the other system isn't 12-volt, both systems can be damaged.

- 5 You could be injured if the vehicles move. Set the parking brake firmly on each vehicle. Put an automatic transaxle in "P" (PARK) or a manual transaxle in "N" (Neutral). Turn the ignition key to the "LOCK" position.

▲ WARNING

- Turn the ignition key to the "LOCK" position on both vehicles. Make sure that the cables or your clothes cannot be caught by the fan or drive belt. Personal injury could result.

NOTE

- Turn off all lights, heater, and other electrical loads. This will avoid sparks and help save both batteries.
1. Make sure your battery electrolyte is at the proper level (Refer to "Batteries" on page 7-10.)

▲ WARNING

- If the electrolyte fluid is not visible, or looks frozen, **DO NOT ATTEMPT JUMP STARTING!** The battery might split open or explode if the temperature is below the freezing point or if it is not filled to the proper level.

- 5 Connect one end of one jumper cable to the positive (+) terminal of the discharged battery (A), and the other end to the positive (+) terminal of the booster battery (B).

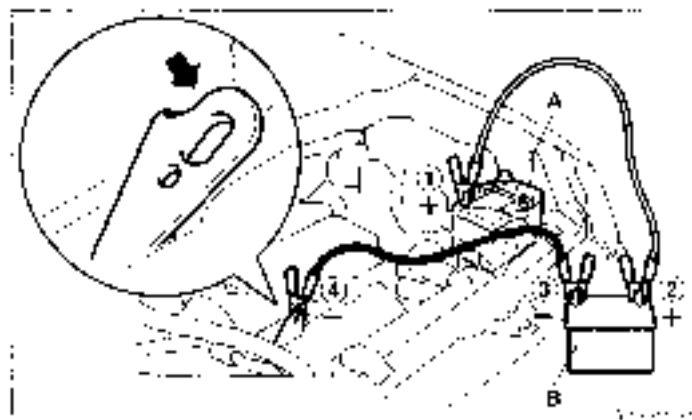

NOTE

- Remove the terminal cover before connecting the jumper cable to the positive terminal of the battery.
- Use the proper cables suitable for the battery size. Otherwise heat damage to the cables could result.
- Check the jumper cables for damage and corrosion before use.

6. Contact one end of the other jumper cable to the negative (-) terminal of the booster battery (H1) and the other end to the engine block of the vehicle with the low battery (V) at the point farthest from the battery.

⚠ WARNING

- Be sure to follow the proper order when connecting the batteries, of: 1 → 2 → 3 → 4.
- Make sure that the connection 4 is made to the engine properly. If the connection is directly made to the negative side of the battery, the flammable gases from inside the battery might catch fire and explode, causing personal injury.
- When connecting the jumper cable, do not connect the positive (+) cable to the negative (-) terminal. Otherwise sparks can make the battery explode.

⚠ CAUTION

- Make sure that the jumper cable will not be caught in the cooling fan or other moving parts in the engine compartment.

7. Start the engine in the vehicle providing the boost. Let the engine idle a few minutes, then start the engine in the vehicle with the low battery.

8. After the engine is started, disconnect the cables in the reverse order from the way you connected them.

⚠ WARNING

- Charging your battery while it is still in your vehicle might cause the battery to catch fire and explode. If you have to charge it while in the vehicle, disconnect the negative terminal.
- Keep sparks, cigarettes and flames away from the battery because the battery may explode.
- Keep your work area well vented when charging or using the battery in an enclosed space.
- Remove all the caps before charging the battery.
- Electrolyte (battery acid) is corrosive diluted sulphuric acid. If electrolyte comes in contact with your hands, eyes, clothes, or the painted surface of your vehicle, thoroughly flush with water. If electrolyte gets in your eyes, flush them immediately and thoroughly with water, and get prompt medical attention.
- Always wear protective clothing and goggles when working near the battery.
- Keep the battery out of the reach of children.

If your vehicle has anti-lock brakes

If you drive your vehicle with a low battery charge, after the engine has been started by using jumper cables, the engine may misfire. This can cause the anti-lock braking system warning light to blink on and off. This is only due to the low battery voltage. It is not a problem with the brake system. If this happens, fully charge the battery and ensure the charging system is operating properly.

Engine overheating

If the engine coolant temperature gauge indicator moves to the "H" (hot) position (red zone), the engine may be overheated. If this happens:

1. Stop the vehicle in a safe place. Turn on the hazard warning flashers.
2. With the engine still running, carefully raise the engine hood to vent the engine compartment.

NOTE:

- Check that the cooling fan is running. If the fan is not running, stop the engine immediately and contact an authorized Mitsubishi dealer for assistance.
- 3. If you see steam or spray coming from under the hood, turn off the engine.
- 4. If you do not see steam or spray coming from under the hood, leave the engine on until the temperature indicator on the instrument panel moves below the red zone. When it is in the middle of the normal zone, you can start driving again. If the indicator stays in the red zone, turn off the engine.

6

 WARNING

- Before raising the engine hood, check to see if there is steam or spray coming from under the hood. Steam or spray coming from an overheated engine could seriously scald you. Do not open the hood until there is no steam or spray.

For emergencies

5. When you do not see any more steam or spray, open the hood. Look for obvious leaks, such as a split radiator hose. Be careful as components will be hot. Any leak source must be repaired.
6. If there is no obvious leak source, check the coolant level in the reserve tank. If there is none, or if it is too low, slowly add coolant.
7. If the reserve tank needs coolant, you will probably also need to add coolant to the radiator. Do not loosen or remove the radiator cap until the engine has cooled down.

⚠ WARNING

- Removing the radiator cap could scald you with escaping hot water or steam. When checking the radiator level, cover the cap with a cloth before trying to remove it. Turn it slowly counterclockwise, without pressing down, to the first notch. The pressure in the system will then be let out. When the pressure is **COMPLETELY LET OUT**, press down and keep turning the cap counterclockwise until it will come off.

8. Start the engine, and slowly add coolant, up to the bottom of the filler neck. Use plain water if you have to, and replace it with the right coolant as soon as possible.
9. Replace the radiator cap and tighten it fully. Check the temperature indicator. You can drive when the indicator returns to the normal zone.
10. Have your vehicle checked by your authorized Mitsubishi dealer.

Jack and tools

Storage

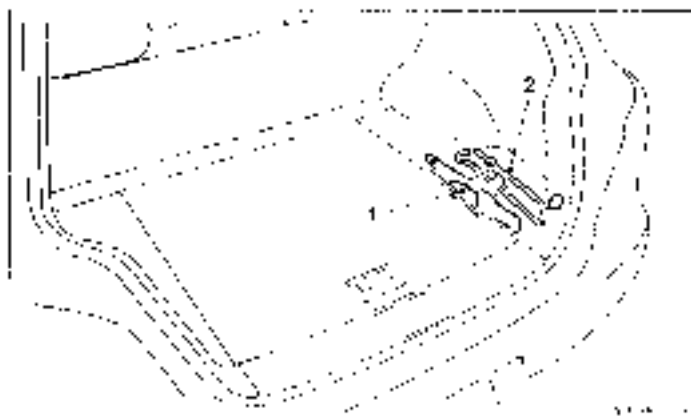

- 1- Jack
- 2- Tools

The jack and tools are stored beneath the luggage floor board of the luggage compartment.

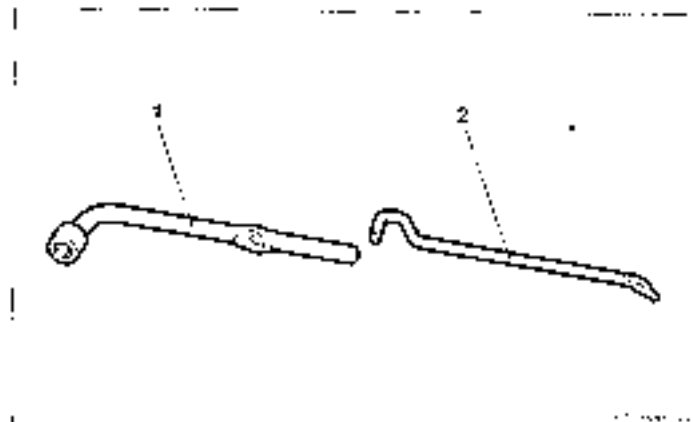
Tools

1- Wheel nut wrench

2- Bar

Jack*To remove*

- 1- Pull up the belt (A) to remove the right-hand suspension head (B)

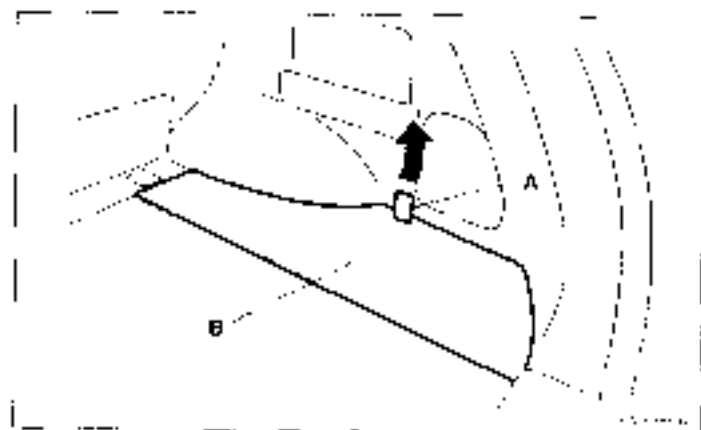

For emergencies

2. Take out the jack from its designated position

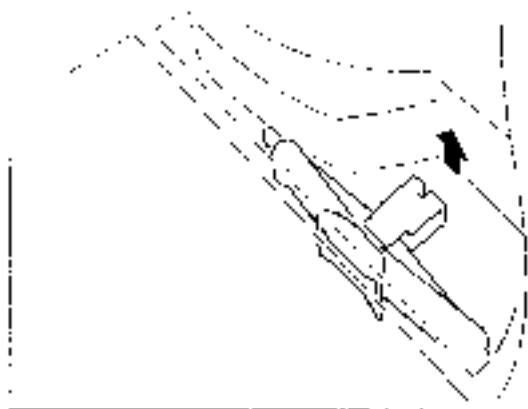

To store

1. Retract the jack, then return it to its original position

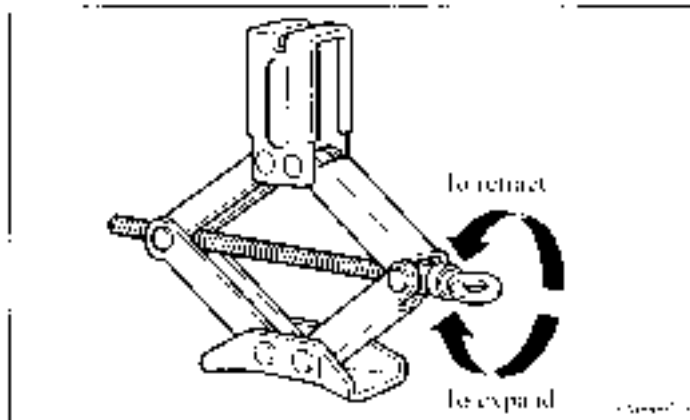

2. Return the luggage floor board to its original position

Jacking up the vehicle

1. Park the vehicle on level and stable ground.
2. Turn on the hazard flashers and turn the ignition key to the "LOCK" position.
3. Set the parking brake firmly, move the selector lever to the "P" (PARK) position.
4. Set up a warning triangle, flashing signal light, etc., at an adequate distance from the vehicle, and have all your passengers leave the vehicle.
5. To prevent the vehicle from falling when it is raised on the jack, place a chuck or block (A) in the tire that is diagonally opposite from the tire (B) you are changing.

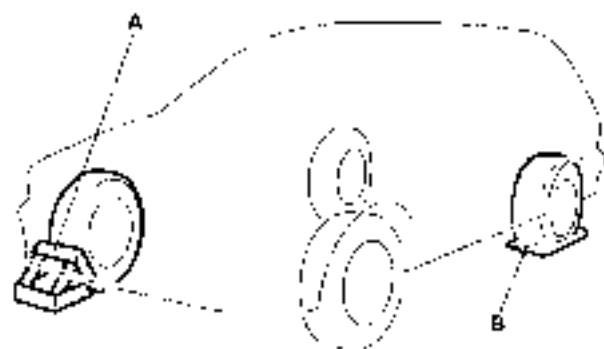

⚠ WARNING

- Be sure to apply a chuck to the correct tire when jacking up the vehicle. If the vehicle moves while jacked up, the jack could slip out of position, leading to an accident.

NOTE:

- The chuck shown in the illustration does not come with your vehicle. It is recommended that you keep one in the vehicle for use if needed.
 - If a chuck is not available, use a stone or any other object that is large enough to hold the wheel in position.
6. Place the jack under one of the jacking points (1) shown in the illustration. Use the jacking point closest to the tire you wish to change.

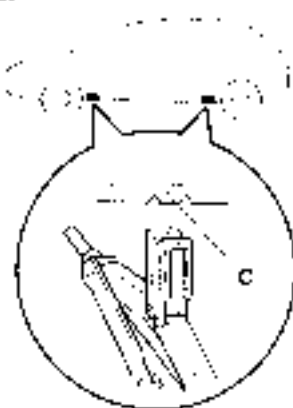

⚠ WARNING

- Set the jack only at the positions shown here. If the jack is set at a wrong position, it could dent your vehicle or the jack might fall over and cause personal injury.
- Do not use the jack on a tilted or soft surface. Otherwise, the jack might slip and cause personal injury. Always use the jack on a flat, hard surface. Before setting the jack, make sure there are no sand or pebbles under the jack base.

7. Rotate the jack by hand until the flange portion (D) fits in the groove (E) on the top of the jack.

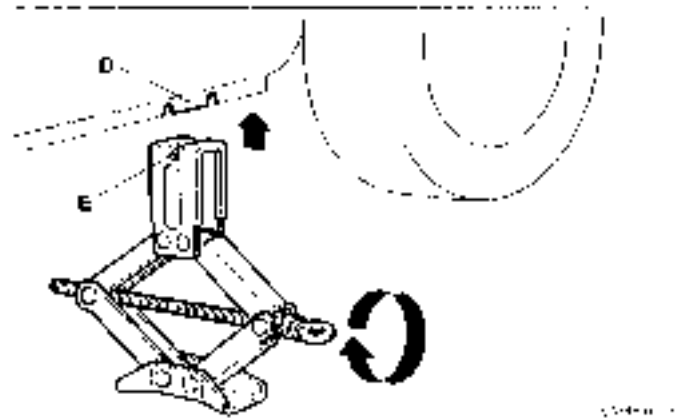

8. Remove the wheel nut wrench and bar from the luggage compartment (refer to "Jack and tools" on page 6-6).

9. Insert the bar (F) into the wheel nut wrench (G). Then put the end of the bar into the shaft's jack end, as shown in the illustration. Slowly rotate the wheel nut wrench until the tire is raised slightly off the ground.

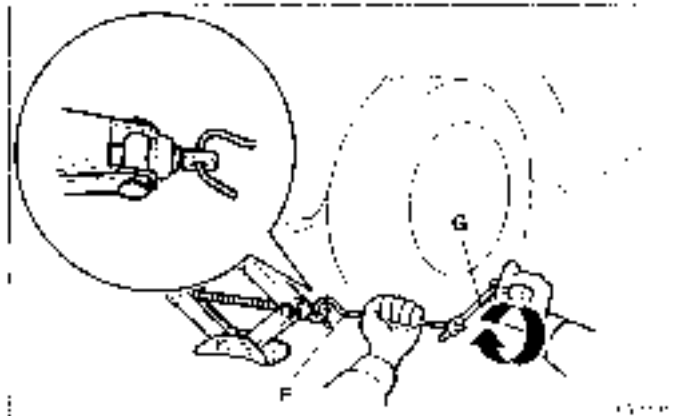

⚠ WARNING

- Stop jacking up the vehicle as soon as the tire is raised off the ground. It is dangerous to raise the vehicle any higher.
- Do not get under your vehicle while using the jack.
- Do not bump the raised vehicle or leave it sitting on the jack for a long time. Both are very dangerous.
- Do not use a jack except the one that came with your vehicle.
- The jack should not be used for any purpose other than to change a tire.

⚠ WARNING

- No one should be in your vehicle when using the jack.
- Do not start or run the engine while your vehicle is on the jack.
- Do not turn the raised wheel. The tires still on the ground could turn and make your vehicle fall off the jack.

*Spare tire***Compact spare tire**

The compact spare tire is designed to save space in the luggage compartment. Its lighter weight makes it easier to use if a flat tire occurs.

⚠ CAUTION

- While the compact spare tire is stowed, the pressure should be checked regularly and kept at the listed pressure.
Driving without enough tire pressure can lead to an accident. If you have no choice but to drive with a low tire, keep your speed down and fill the tire to the correct pressure [60 psi (420 kPa)] as soon as possible.
- The compact spare tire should only be used temporarily. Replace or repair the original tire as soon as possible, and return the spare to the luggage compartment.
If your vehicle has aluminum type wheels, you can use the same wheel nuts on the compact spare tire wheel.
- Do not go over 50 mph (80 km/h) when driving with the compact spare tire.
- Avoid fast starting and braking with a compact spare tire.

⚠ CAUTION

- Do not drive through automatic car washes and over obstacles that could possibly damage the underside of your vehicle. Because the tire is smaller than the original tire, there is less clearance between the ground and your vehicle.
- Because the compact spare tire is designed only for your vehicle, do not use it on any other vehicle.
- Do not put the compact spare tire on a different wheel, and do not put standard tires, snow tires, wheel covers or trim rings on the compact spare wheel. Otherwise, you could damage these parts or other parts on your vehicle.
- Do not use snow chains with your compact spare tire. Because of the smaller tire size, a snow chain will not fit properly. Using a chain could cause damage to your vehicle and loss of the chains.
- The compact spare tire pressure should be checked once a month while the tire is stowed.

To remove

1. Lift up the luggage floor board, then attach the hook (A) as shown in the illustration.
The hook is stored in the back of the luggage floor board.

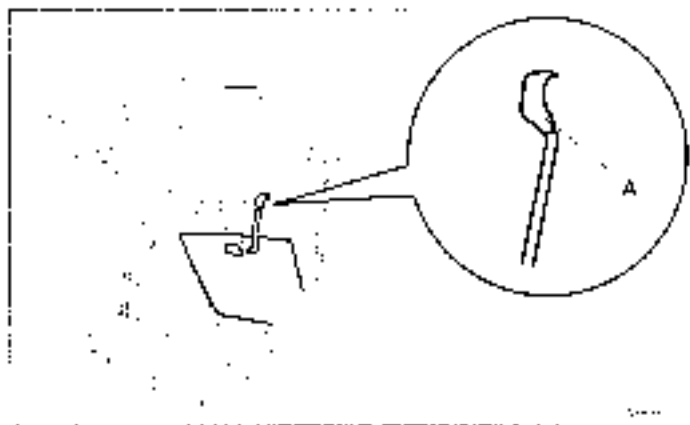

2. Raise the luggage floor box and fit the back end in the notch (B).

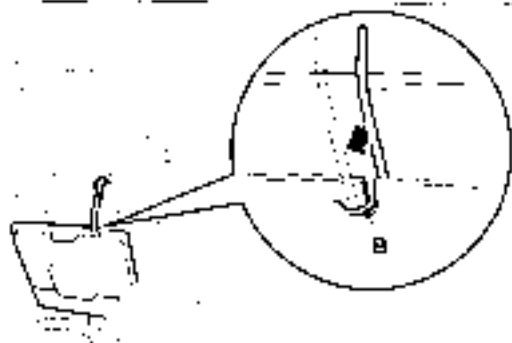

3. To remove the spare tire, remove the installation bolt with the wheel nut wrench (D) by turning it counter-clockwise.

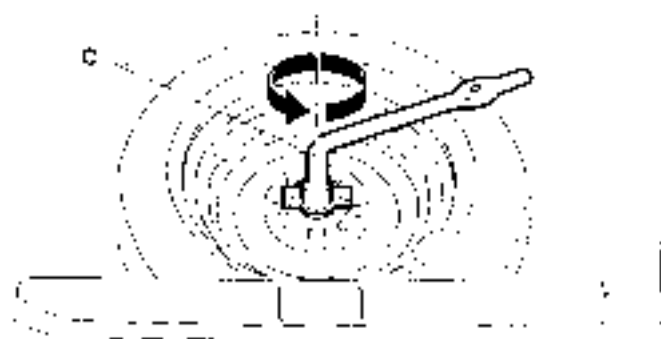

To install

To install the spare tire, tighten the bolt firmly with the wheel nut wrench (D) by turning it clockwise until the spare tire can not move.

How to change a tire

Before changing a tire, first stop your vehicle on a safe, flat location.

1. Park the vehicle on level and stable ground.
2. Turn on the hazard flashers and turn the ignition key to the "LOCK" position.
3. Set the parking brake firmly, move the selector lever to the "P" (PARK) position.
4. Set up a warning triangle, flashing signal light, etc., at an adequate distance from the vehicle, and have all your passengers leave the vehicle.
5. To prevent the vehicle from rolling when it is raised on the jack, place a chuck or block (A) at the tire that is diagonally opposite from the tire (B) you are changing.

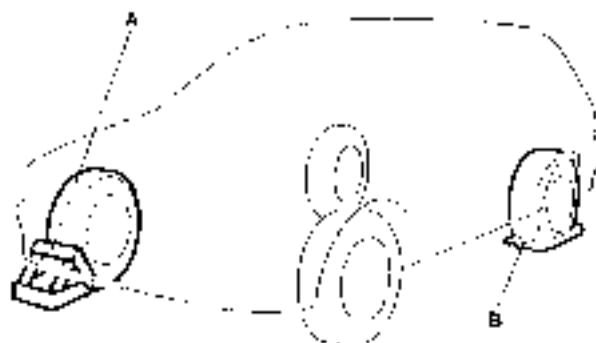

⚠ WARNING

- Be sure to apply a chuck to the correct tire when jacking up the vehicle. If the vehicle moves while jacked up, the jack could slip out of position, leading to an accident.

NOTE

- The chuck shown in the illustration does not come with your vehicle. It is recommended that you keep one in the vehicle for use if needed.
 - If a chuck is not available, use a stone or any other object that is large enough to hold the wheel in position.
6. Get the spare wheel, jack, and wheel nut wrench ready.

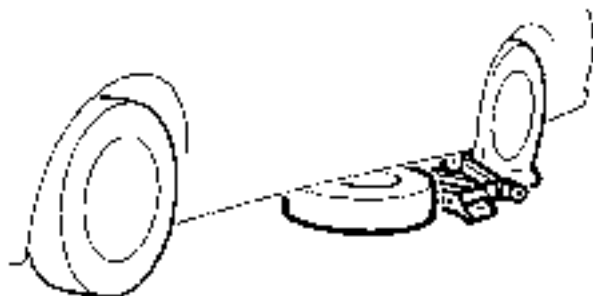

NOTE

- Put the spare wheel under the vehicle, away from the jack. This makes it safer if the jack slips out of position.

7. On vehicles with wheel covers, first remove the covers (Refer to the "Wheel covers" section). Then loosen the wheel nuts with the wheel nut wrench. Do not remove the wheel nuts yet.

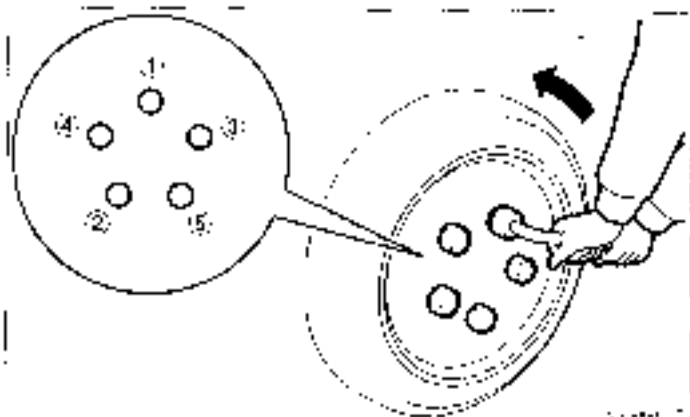

8. Refer to the "Lacking up the vehicle" section to find the closest jacking point to the flat tire. Then position the jack and raise the vehicle until the tire is slightly off the ground.
9. Remove the wheel nuts with the wheel nut wrench, then take the wheel off.

⚠ CAUTION

- Handle the wheel cover carefully when changing the tire, to avoid scratching the wheel surface, causing it to wear out early.

10. Clean out any mud, etc. on the hub surface (C), hub bolts (D) or if the installation holes (E) on the wheel, and then mount the spare tire.

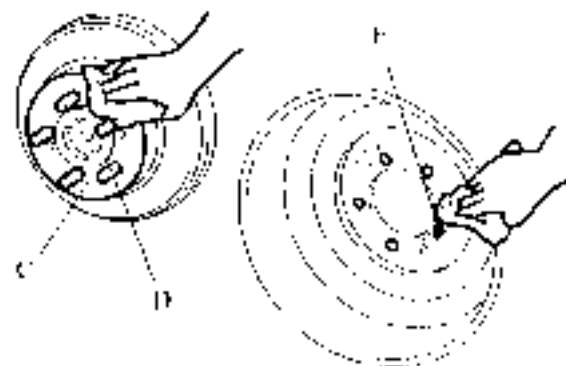

For emergencies

- 11 On vehicle with steel wheels, install the wheel nuts (tapered nuts) with their tapered ends facing inward, then tighten by hand until the wheel is no longer loose.

Vehicle with steel wheels

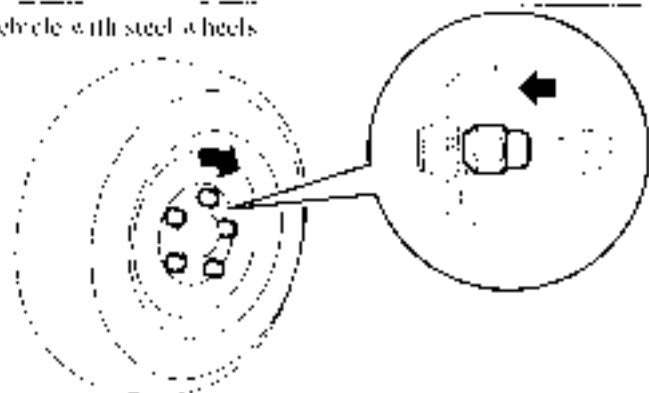

On vehicles with aluminum wheels, temporarily tighten the wheel nuts (flange nuts) until their flange sector comes in contact with the wheel, and it is no longer loose.

Vehicle with aluminum wheels

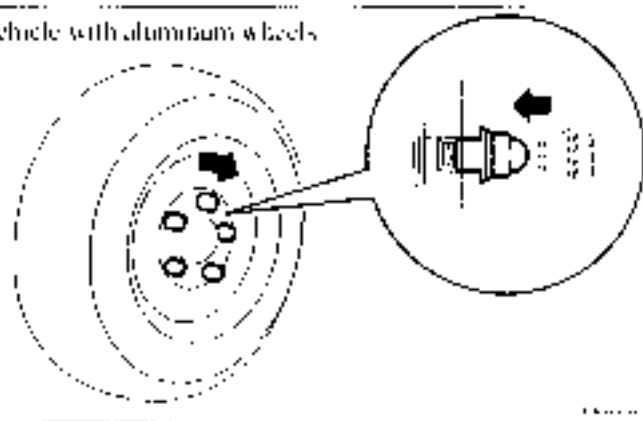

⚠ CAUTION

- Never apply oil to either the wheel bolts or the nuts or they will tighten too much.

NOTE:

- Flange nuts can be temporarily used on the steel wheel but return to the original wheel and tire as soon as possible.
- If all four wheels are changed to steel wheels, use tapered nuts.

12. Lower the vehicle slowly and then tighten the nuts in the order shown in the illustration until each nut has been tightened to the torque listed here:

88 to 108 N·m (65 to 80 ft-lb)

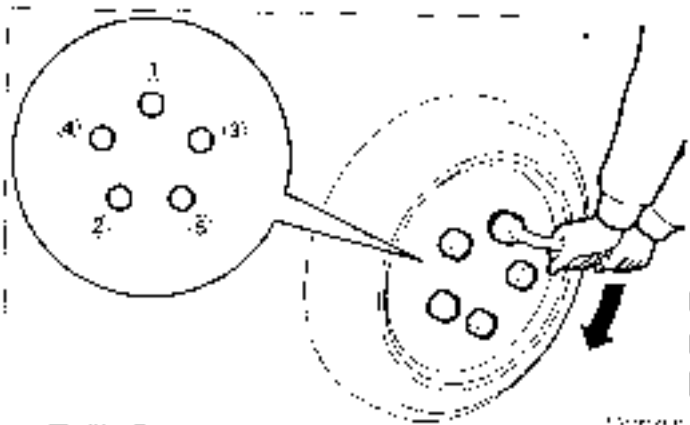

⚠ CAUTION

- Never use your foot or a pipe extension for extra force in the wheel nut wrench. If you do so, you will tighten the nut too much.

13. Lower and remove the jack, then store the jack, flat tire, and chock. Have your damaged tire repaired as soon as possible.

14. Check your tire inflation pressure. The correct pressures are shown on the door label. See the illustration.

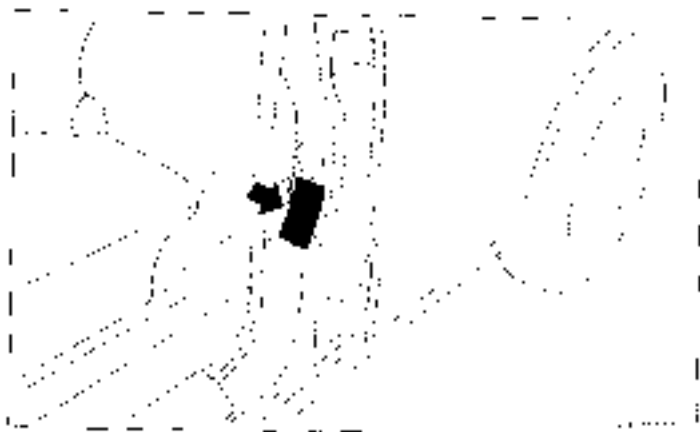

⚠ CAUTION

- The tire pressure should be periodically checked and maintained at the specified pressure while the tire is stowed.
- The compact spare tire is to be used only temporarily when the standard tire is damaged. Repair the damaged tire as soon as possible and use it to replace the compact spare tire.
- After changing the tire and driving the vehicle about 620 miles (1000 km), retighten the wheel nuts to make sure that they have not come loose.
- If the steering wheel vibrates when driving after changing the tire, have the tire checked for balance at your nearest authorized Mitsubishi dealer.

⚠ CAUTION

- Do not mix one type of tire with another or use a different size from the one listed. This would cause early wear and poor handling.

Wheel covers (if so equipped)

To remove

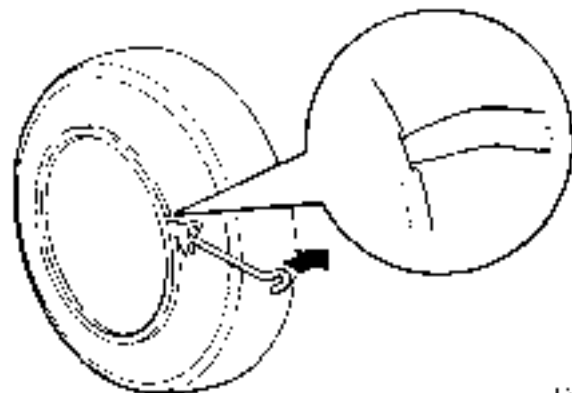

6

Wrap the tip of the bar with a cloth, insert it deeply into the notch provided in the wheel cover, and pry the cover away from the wheel.

Using the same procedure at the other wheel cover notches, work the wheel cover away from the wheel to remove it completely.

NOTE:

- The wheel cover is made of plastic. Be careful when prying it off.

⚠ CAUTION

- Trying to remove the wheel cover with only your bare hands can seriously injure your fingers.

To install

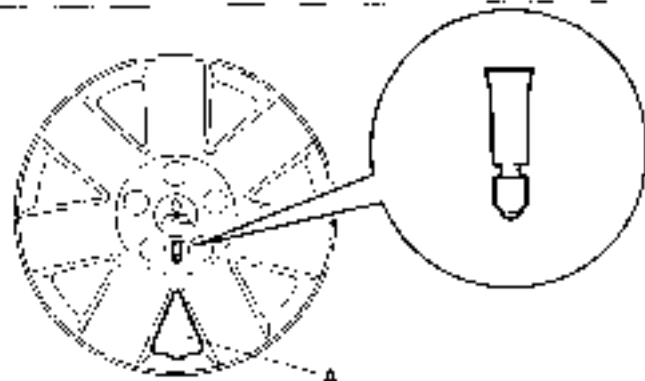

Line up the wheel nuts with the wheel cover mounting holes and line up the air valve with the valve opening (AV) on the wheel cover.

Then pound around the outer edge of the wheel cover with your hand to secure it in place.

Towing

NOTE

- The tire wheel cover is marked with a symbol on the reverse side that shows the air valve location. Before installing the wheel cover to the wheel, make sure that the opening with the symbol mark is correctly aligned with the air valve.

If your vehicle needs to be towed

If towing is necessary, we recommend you to have it done by your Mitsubishi dealer or a commercial tow truck service.

In the following cases, transport the vehicle using a tow truck.

- The engine runs but the vehicle does not move or abnormal noise is produced.
- Out of automatic transaxle fluid.

Only when you cannot receive a towing service from a Mitsubishi dealer or commercial tow truck service, tow your vehicle carefully in accordance with the instructions given in "Emergency towing" in this part.

There may be local regulations concerning towing in your area. It is recommended that you obey the regulations of the area where you are driving your vehicle.

A



B Do not tow all-wheel drive vehicles with this style.



C Do not tow all-wheel drive vehicles with this style.



D



E



Towing the vehicle by a tow truck

⚠ CAUTION

- This vehicle must not be towed by a tow truck using sling lift type equipment (Type A) as illustrated. Using a sling lift will damage the bumper and front end.
- Do not tow all-wheel drive vehicles with the front or rear wheels on the ground (Type B or Type C) as illustrated. This could result in the driving system damage or vehicle may jump at the carriage. If you tow all-wheel drive vehicles, use Type D or E equipment.
- If the transaxle is malfunctioning or damaged, transport the vehicle with the driving wheels on a carriage (Type C, D or E) as illustrated.
- If you tow the vehicles with an automatic transaxle with the driving wheels on the ground (Type B) as illustrated, make sure that the towing speed and distance given below are never exceeded, causing the transaxle damage.
Towing speed: 31 mph (50 km/h)
Towing distance: 18 miles (30 km)

Towing with front wheels off the ground (Type C)

Release the parking brake.

Place the selector lever in the "N" (NEUTRAL) position.

Towing with rear wheels off the ground (Type B)

Place the selector lever in the "N" (NEUTRAL) position. Turn the ignition key to the "ACC" position and secure the steering wheel in a straight-ahead position with a rope or tie-down strap.

Never place the ignition key in the "LOCK" position when towing.

Emergency towing

If towing service is not available in an emergency, your vehicle may be temporarily towed by a cable or chain secured to the towing hook.

If your vehicle is to be towed by another vehicle, or if your vehicle tows another vehicle, pay careful attention to the following points:

If your vehicle is to be towed by another vehicle

- The front towing hook (A) is located as shown in this diagram. Secure the tow rope to the front towing hook. Remove the cover (C) at the center of the front bumper on the bottom side before towing the vehicle.

**NOTE:**

- Towing the vehicle without removing the cover causes the tow rope to interfere with the bumper, resulting in possible damage or deformation of the bumper.
- Do not use the tie-down hook (B) in towing. This hook is provided only for the purpose of transporting the vehicle itself.
- Use any part other than the designated towing hook (A) could be all damage to vehicle body.

For entrapment:

- Using a wire rope or metal chain can result in damage to the vehicle body. It is best to use a non-metallic rope. If you use a wire rope or metal chain, wrap it with cloth at a turning point where it reaches the vehicle body.
 - Use care that the tow rope is kept as horizontal as possible. An angled tow rope can damage the vehicle body.
 - Never attempt to tow out a ditched vehicle, because the tow rope cannot be kept horizontal.
7. Remove each of the three clips (D) by inserting a straight blade (or similar) screwdriver into the clip groove and levering it toward the vehicle body. Remove the cover. When the job is finished, refit the cover by following the tentative steps in reverse.

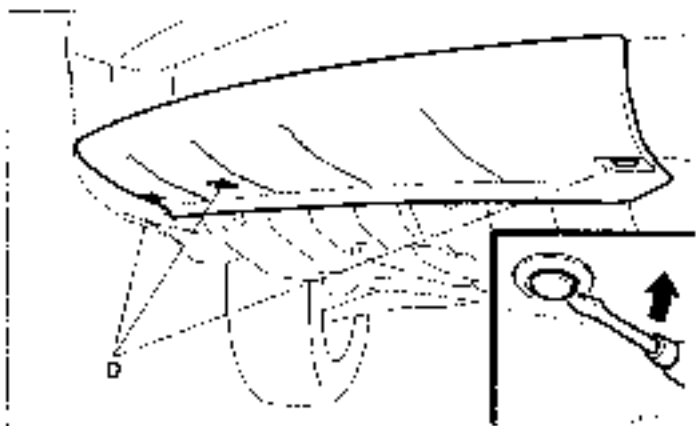

3. Keep the engine running.

If the engine is not running, turn the ignition key to the "ACC" or "ON" position to unlock the steering wheel.

⚠ CAUTION

- When the engine is not running, the brake booster and power steering pump do not operate. This means higher brake depression force and higher steering effort are required. Therefore, vehicle operation is more difficult than usual.
- Do not leave the key in the "LOCK" position or do not remove the ignition key from the ignition switch while driving. The steering wheel will lock, causing loss of control.

1. Place the selector lever in the "R" (REVERSE) position.
3. Turn on the hazard warning lamps, if required by law (follow the local driving laws and regulations).
6. During towing, make sure that close contact is maintained between the drivers of both vehicles, and that the vehicles travel at low speed.

⚠ WARNING

- To prevent entry of exhaust gas from the towing vehicle, set your air selection switch to the recirculation position.

CAUTION

- Avoid sudden braking, sudden acceleration and sharp turning; such operation could cause damage to the towing hooks or the tow rope. People in the vicinity could be injured as a result.
- When going down a long slope, the brakes may over-heat, reducing effectiveness.
- If you tow the vehicle with an automatic transaxle with the driving wheels on the ground, make sure that the towing speed and distance given below are never exceeded, causing the transaxle damage.
Towing speed: 31 mph (50 km/h)
Towing distance: 18 miles (30 km)

If your vehicle tows another vehicle

- 1 Remove each of the two clips (1) by inserting a straight blade (or pin) into the clip groove and levering it toward the candle body.
Remove the cover.
When the tow is finished, refit the cover by following the removal steps in reverse.

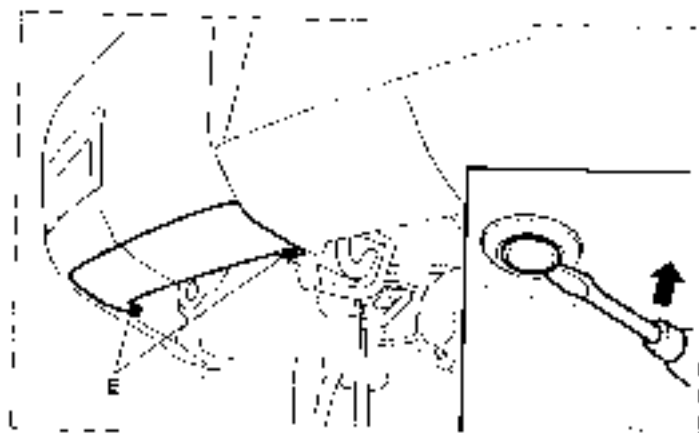

Fire emergencies

- The rear towing hook (F) is located as shown in the illustrations. Secure the tow rope to the rear towing hook.

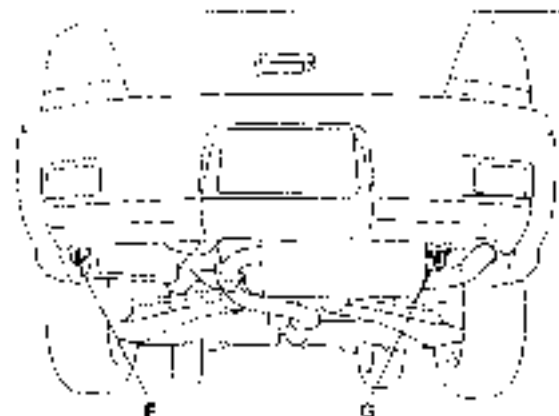

NOTE:

- Do not use the tie-down hook (G) for towing. This hook is provided only for the purpose of transporting the vehicle itself.
- Using any part other than the designated towing hook (F) could result in damage to vehicle body.

NOTE:

- Your vehicle should only be used to tow another vehicle if the weight of the other vehicle is less than your vehicle.

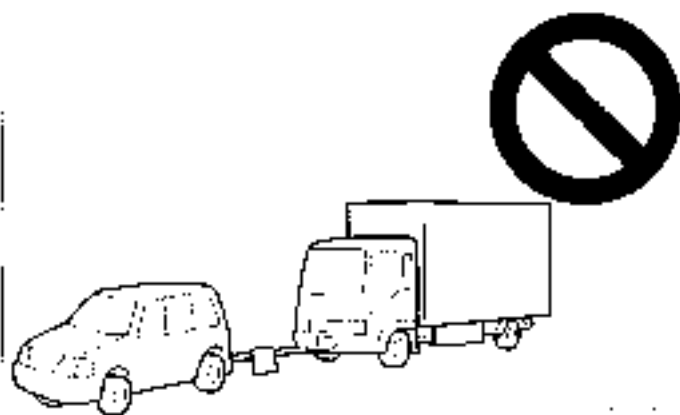

What to do if the engine speed becomes unstable after the battery is replaced

If the engine speed becomes unstable after the battery is replaced, reset the engine using the following method:

1. Stop the vehicle in a safe place.
2. Place the selector lever in the "P" (PARK) position. Stop the engine.
3. Restart the engine.
4. Turn off the air conditioning.
5. Allow the engine to warm up until the needle on the engine coolant temperature gauge stabilizes near the center of the gauge.
6. Stop and restart the engine.
7. Allow the engine to idle for approximately 10 minutes.
8. When the engine speed stabilizes, the resetting procedure is complete.

NOTE

- If the engine speed remains unstable after the resetting procedure has been performed, have the vehicle inspected by an authorized Mitsubishi dealer.

Operation under adverse driving conditions

If your vehicle becomes stuck in sand, mud or snow

If your vehicle becomes stuck in snow, sand, or mud, it can often be moved by a rucking motion. Move the selector lever rhythmically between "Sports mode" and "R" (REVERSE) position, while pressing lightly on the accelerator pedal.

Do not race the engine nor spin the wheels. Constant efforts to free a stuck vehicle can cause overheating and transaxle failure. Let the engine idle for a few minutes to cool the transaxle before trying again.

If your vehicle is still stuck after several rucking attempts, call for help.

WARNING

- When trying to ruck your vehicle out of a stuck position, make sure that there are no people nearby. The rucking motion can make your vehicle suddenly lurch forward or backward, and injure any bystanders.

6

On wet roads

CAUTION

- Avoid flooded roads. Water is often deeper than it looks, and you could be seriously hurt by driving into flood water.

CAUTION

- When driving in rain, on water-covered roads, or through a car wash, water could get into the brake discs and make them fail temporarily. In such cases, lightly press the brake pedal to see if they are working properly. If they are not, press the pedal lightly several times while driving to dry the brake pads or linings, then check them again.
- When driving in rain, a layer of water may form between the tires and the road surface (aquaplaning). This loosens your tires' grip on the road, making it difficult to steer or brake properly. When driving on a wet road:
 - Drive your vehicle at a safe speed.
 - Do not drive on worn tires.
 - Always keep the tires at the correct inflation pressures.

On snowy or icy roads

- When driving on a road covered with snow or ice, use snow tires. There may be state or local regulations about using snow tires and chains. Always check the regulations in your local area before using them. Refer to the section entitled "Snow tires" on page 7-22 and "Tire chains" on page 7-23.
- Drive slowly. Do not make sudden starts or stops, sharp turns, or slam on the brakes.

- Pressing the brake pedal when driving on snowy or icy roads can make your tires slip and skid. When a skid occurs, take your foot off the accelerator. Steer gently into the skid. If your vehicle is equipped with an anti-lock braking system (ABS), brake by pressing the brake pedal firmly and keep it depressed. If your vehicle is not equipped with an anti-lock braking system (ABS), pump the brake pedal with short rapid puls each time fully applying and fully releasing for greatest effect.
- Allow extra distance between your vehicle and the vehicle in front of you and avoid sudden braking.

Vehicle care and maintenance

Service precautions	7- 2	Fuse links	7- 30
Catalytic converter	7- 3	Fuses	7- 31
Engine hood	7- 4	Replacement of light bulbs	7- 3
View of the engine compartment	7- 6	Vehicle care precautions	7- 51
Lighten oil and oil filter	7- 6	Cleaning the inside of your vehicle	7- 51
Engine coolant	7- 9	Cleaning the outside of your vehicle	7- 52
Air cleaner filter	7- 11		
Automatic transaxle fluid	7- 12		
Transfer oil (All-wheel drive models)	7- 13		
Rear axle oil (All-wheel drive models)	7- 14		
Washer fluid	7- 14		
Brake fluid	7- 15		
Power steering fluid	7- 16		
Battery	7- 16		
Tires	7- 18		
Brake pedal free play	7- 23		
Parking brake lever stroke	7- 24		
Wiper blades	7- 25		
Emission-control system maintenance	7- 25		
General maintenance	7- 27		
For cold and snowy weather	7- 30		

Service precautions

Taking regular care of your vehicle will preserve its value and appearance as long as possible.

You can do some of the maintenance work yourself, and the rest should only be performed by an authorized Mitsubishi dealer.

If you discover a malfunction or other problem, have it corrected by an authorized Mitsubishi dealer.

This section describes the maintenance inspections that you can do yourself, if you so desire. Follow the instructions and precautions for each procedure.

⚠ WARNING

- When checking or servicing the inside of the engine compartment, be sure the engine is stopped and has had a chance to cool down.
- If you need to work in the engine compartment with the engine running, be especially careful that your clothing, hair, etc. does not get caught in the fan, drive belts, or other moving parts.
- The fan can turn on automatically even if the engine is not running. Turn the ignition key to the "LOCK" position and remove the key to be safe while you work in the engine compartment.
- Do not smoke or allow open flames around fuel or the battery. The fumes are flammable.
- Be extremely careful when working around the battery. It contains poisonous and corrosive sulfuric acid.

⚠ WARNING

- Do not get under your vehicle while it is on a jack. Always use properly rated automotive jack stands.
- Handling your vehicle's parts and materials in the wrong way can injure you. Ask an authorized Mitsubishi dealer if you have questions.

Catalytic converter

The catalytic converter requires you to use unleaded fuel only. Leaded gasoline will destroy the emission-control effectiveness of the converter.

Normally, the catalytic converter does not require maintenance. However, it is important to keep the engine properly tuned for the converter to continue to work properly.

⚠ CAUTION

- **Damage to the catalytic converter can result if your vehicle is not kept in proper operating condition. If the engine malfunctions or misfires, or if your vehicle performance suffers, have it serviced promptly. Running your vehicle when it is overheated may result in damage to the converter and vehicle.**

⚠ WARNING

- **Do not park or run your vehicle in areas where combustible materials such as dry grass or leaves can come in contact with a hot exhaust. Since a fire could occur.**
- **Do not put undercoat paint on the catalytic converter.**

To reduce the possibility of catalytic converter damage:

- Use UNLEADED GASOLINE ONLY of the type of recommendation or "fuel selection".
- Do not drive with an extremely low fuel level. Running out of gas could damage the catalytic converter.
- Do not try to start the engine by pushing or towing the vehicle. If the battery is weak or out of power, use jumper cables to properly start the engine.
- Do not idle the engine with any spark plug wires disconnected or removed, such as when performing diagnostic tests.
- Do not idle the engine for a long time if it is idling roughly or otherwise obviously malfunctioning.
- To prevent the catalytic converter from being damaged from unburned gas, do not race the engine when turning off the ignition switch.
- Stop driving the vehicle if you think the performance is less than normal, the engine is running ably or there is any other engine trouble, such as with the ignition, etc. If you are not able to stop driving immediately, slow down and drive for only a short time. Have an inspection made by an authorized Mitsubishi dealer as soon as possible.
- In unusual situations involving major engine problems, a bearing or/por may indicate severe and abnormal catalytic converter overheating. If this occurs, stop in a safe place, shut the engine off and let the vehicle cool. Once the engine is cool, immediately take your vehicle to a dealer for service.

Engine hood

To open

Use the engine hood release lever located under the instrument panel near the driver's door to unlatch the engine hood.

Pull the lever toward you to release the engine hood latch.

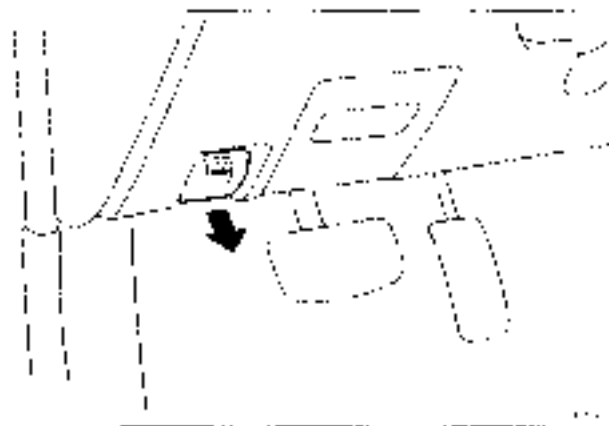

Release the safety lever and lift the engine hood.

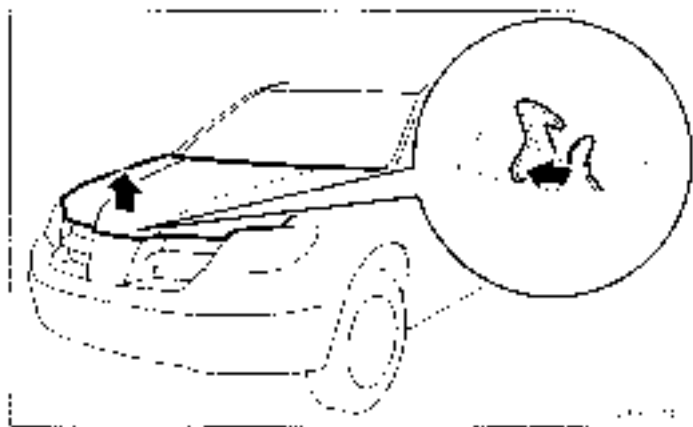

NOTE

- To prevent damage to the engine hood and wipers, make sure the wipers are at resting position when you open the engine hood.

⚠ WARNING

- Never use the release lever to unlatch the engine hood while the vehicle is in motion.
- Do not drive your vehicle unless the engine hood is locked.

Support the engine hood with the hood prop. Insert the hood prop securely in the opening under the hood marked with an arrow.

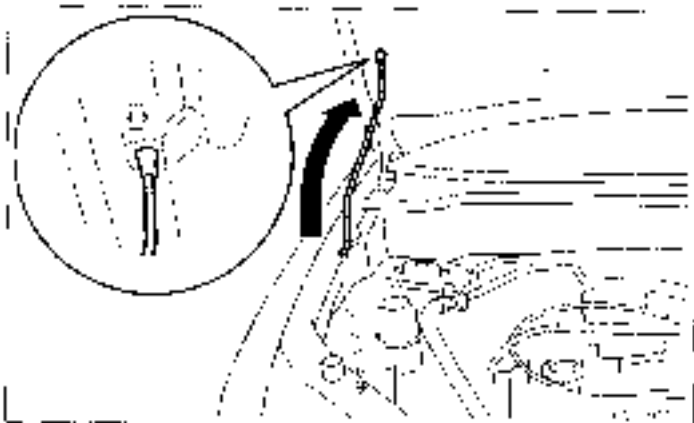

⚠ CAUTION

- Always insert the support prop into the hole specially made for it. Propping the engine hood at any other place could cause the prop to slip out and lead to an accident.
- The hood prop can fall out if the hood is lifted by a strong wind.

To close

Detach the prop from the engine hood and put it back in its retainer.

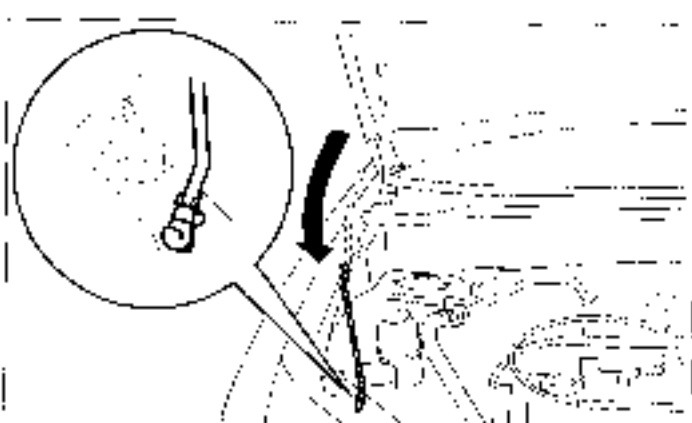

Slowly lower the engine hood about 17 inches (430 mm), then let it drop from its own weight.

NOTE

- If the hood does not close the engine hood properly, drop it again from a slightly higher position.

⚠ CAUTION

- Be careful not to trap your hands or fingers when closing the engine hood.

View of the engine compartment



1000000

- 1 Engine oil level dipstick
- 2 Air cleaner filter
- 3 Brake fluid
- 4 Windshield washer fluid reservoir
- 5 Power steering fluid reservoir
- 6 Engine oil filler cap
- 7 Reservoir cap
- 8 Antifreeze/wash fluid level dipstick
- 9 Engine coolant reservoir
- 10 Battery

NOTE:

- Those items that need to be regularly checked (engine oil, engine coolant, brake fluid, etc.) are colored in white for easy recognition.

Engine oil and oil filter

To check and refill engine oil

It is normal for an engine to use oil. You may need to add oil between the recommended oil change intervals. Before starting the engine, check the engine oil level. Refill if necessary.

To check the oil level, remove the dipstick, wipe it off, and gently insert it all the way into the crankcase. Slowly remove it again. The oil level must not go above the line on the dipstick.

If the level does not reach the line, which shows the smallest amount of oil required, remove the oil filter cap on the engine valve cover, and fill to within the "Add oil" range.

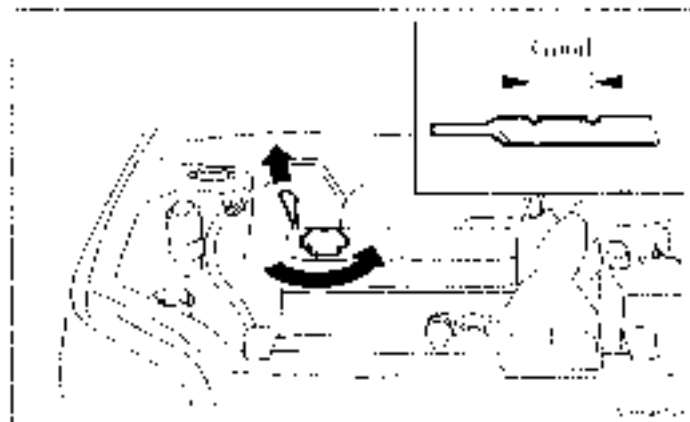

⚠ CAUTION

- Overfilling the crankcase will cause oil aeration and loss of oil pressure, which could damage the engine.

⚠ WARNING

- Used engine oil is poisonous, and can damage your skin. Don't let used oil touch your skin and wash thoroughly after working with it.
- Keep used oil out of the reach of children.

Engine oil identification mark

Mitsubishi recommends using only engine oils with the ILSAC certification symbol on the front of the container.

ILSAC certification symbol

If you cannot find oils with the ILSAC certification symbol, use an API classification SJ, SJ/CD oil that is labeled Energy Conserving.

This mark appears on the top of the oil container and tells you three important things about the oil.

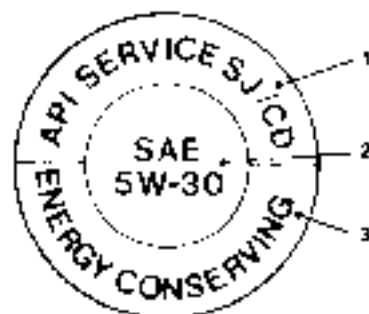
API service symbol

1. The top portion shows the quality of the oil.
2. The center portion shows the SAE grade (SAE oil viscosity).
3. The lower portion shows if the oil is ENERGY CONSERVING.

Recommended engine oil viscosity

Use engine oil with the proper thickness for the outdoor temperatures where you will be driving.



SAE 10W-30 engine oil is best for the outdoor temperature range shown in the above chart.

You are strongly encouraged to use SAE 10W-20 engine oils to help starting in cold temperatures and for improved fuel economy.

To replace the oil filter

The oil filter should be replaced at the time or mileage specified by the "WARRANTY AND MAINTENANCE MANUAL".

Only use high quality replacement filters on this vehicle. The manufacturer's specifications for Genuine Mitsubishi oil filters require that the filter can withstand a pressure of 256 psi (18 MPa). A Genuine Mitsubishi oil filter is the best replacement filter.

Follow the installation instructions printed on the filter.

Engine coolant

To check the coolant level

The coolant reserve tank lets you quickly see when you need to add coolant. To check the coolant level, remove the dipstick with reserve tank lid (A), wipe it off, and gently insert it all the way into the reserve tank. Slowly remove it again. When the engine is cold, the level in the reserve tank should be between the "F" (FULL) and "L" (LOW) marks on the dipstick. The radiator usually stays full so there is no reason to remove the radiator cap (B) except when you check the coolant freeze point or replace the antifreeze coolant.

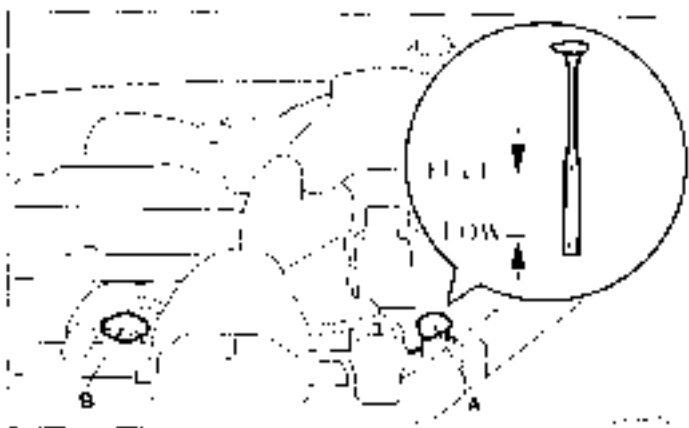

To add coolant

Use Mitsubishi Genuine Coolant or an equivalent.

Mitsubishi Genuine Coolant provides excellent protection against corrosion and rust formation on all metals, including aluminum, and prevents clogs in the radiator, heater, cylinder head, engine block, etc.

If you need to add coolant often, or if the level in the reserve tank does not drop when the engine cools, the cooling system should be pressure-tested for leaks. Take your vehicle to an authorized Mitsubishi dealer for testing.

⚠ CAUTION

- Do not use alcohol or methanol antifreeze or any engine coolants that contain them. Using the wrong antifreeze can corrode aluminum parts.
- When you need to add coolant to the reserve tank, use at least a 50% concentration of ethylene-glycol antifreeze in water. Do not overfill. Use a higher concentration (not over 60%) when the outside temperature is $\leq 31^{\circ}\text{F}$ ($\leq 5^{\circ}\text{C}$) or lower. When the engine is working very hard (for example, during mountain driving and/or when the outside temperature is high), use a 50% concentration. You can check the concentration level with a gauge from an automotive supply store, or your authorized Mitsubishi dealer or service station can check it for you. Use only high quality ethylene-glycol antifreeze coolant that is made to prevent corrosion of all cooling system metals.

⚠ CAUTION

- Do not top off the tank with plain water only. Water by itself boils at a lower temperature and does not stop rust or freezing. If the water freezes, it will damage your cooling system. Do not use tapwater. It can cause corrosion and rust.

Radiator cap

The radiator cap must be tight sealed to prevent losing coolant which may result in engine damage. Only use a Genuine Mitsubishi Parts radiator cap, or an approved equivalent.

⚠ WARNING

- Wait for the engine to cool down before opening the radiator cap. Otherwise hot steam or boiling coolant could spray up from the radiator and scald you.

Points to remember

- Do not overfill the reserve tank.
- Your vehicle uses a special radiator cap that stays sealed and lets the coolant flow from the reserve tank back to the radiator when the engine cools down. If you need to change the cap, use the exact same kind.
- Check the coolant freeze point in the radiator with the proper gauge, and only when it is safe. If you add anti-freeze, the contents of the reserve tank must be protected against freezing.
- Keep the front of the radiator clean. If your vehicle has air conditioning, keep the front of the condenser clean.

- If the temperature of the engine coolant does not rise after the engine is warmed-up, take your vehicle to an authorized Mitsubishi dealer to have the thermostat checked, and replaced if necessary.

Air cleaner filter

The air cleaner filter will get dirty and dusty from use and not filter properly. Replace it with a new filter using the schedule in the "WARRANTY AND MAINTENANCE MANUAL".

- 1. Unlump the cover (resonator).

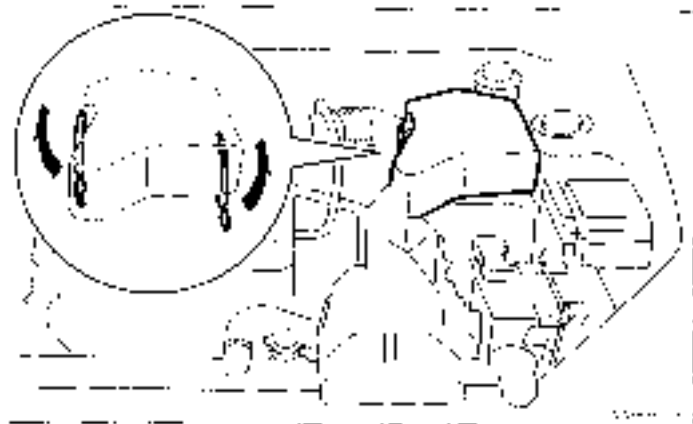

- 2. Unlump and take out the air cleaner filter.

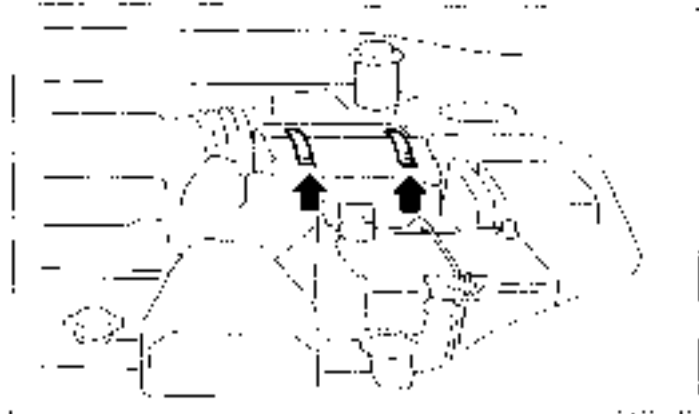

After replacing the air cleaner filter, put the cover (resonator) back on in its original position.

NOTE

- Genuine Mitsubishi Parts are recommended when replacing the air cleaner filter.

⚠ CAUTION

- Take care not to scratch the engine air flow sensor when removing the air cleaner cover.

Automatic transaxle fluid

The automatic transaxle should be maintained and serviced by an authorized Mitsubishi dealer to obtain the best performance and longest life. It is important that the transaxle fluid is kept at the correct level.

To check the fluid level

The fluid level should be checked when the engine temperature gauge shows the engine is warmed up and the fluid in the transaxle is heated to its normal working temperature. Driving with the wrong fluid level will rapidly wear out the transaxle and destroy the fluid.

Procedure for checking the fluid level

- 1 With the parking brake set and the engine idling, select each gear momentarily, ending with the selector lever in the "P" (PARK) position.
- 2 The fluid level should be at the HOT mark, but never above the HOT mark when the engine is warmed up. Add or drain fluid to get to the correct level.
- 3 Make certain that the dipstick cap is installed properly to keep dirt and water out of the transaxle.

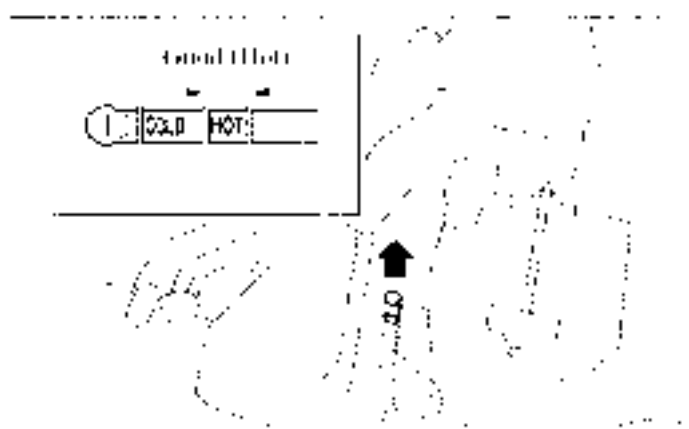

⚠ WARNING

- Transaxle fluid is extremely flammable and poisonous. Do not spill fluid when adding or draining.

Recommended fluid

Use only MITSUBISHI ATF-SP-II transaxle fluid to ensure optimum transaxle performance.

Special additives

Mitsubishi Motors Corporation does not recommend the addition of any fluid additives to the transaxle.

Transfer oil (All-wheel drive models)

Whenever the transfer oil level is checked, add oil to bring up the proper level, if necessary. Fill or change the oil according to the table.

Recommended oil

Lubricant	Hypon gear oil API classification GL-5
Viscosity range	SAE 90

Rear axle oil (All-wheel drive models)

Whenever the oil level is checked, add the oil to maintain the proper level.

Fill or change oil according to the table.

Recommended oil

Lubricant	Hypoid gear oil, API classification GL-5 or Higher
Anticipated temperature range	Viscosity range
Above +10 F (+3 C)	SAE 90
	SAE 85W-90
	SAE 80W-90
+10 F to +30 F (+3 C to +34 C)	SAE 80W
	SAE 75W-90
Below +30 F (+34 C)	SAE 75W

Washer fluid

The windshield and rear window washer fluid reservoir is in the engine compartment.

Check the washer fluid level at regular intervals and add washer fluid to reservoir if necessary.

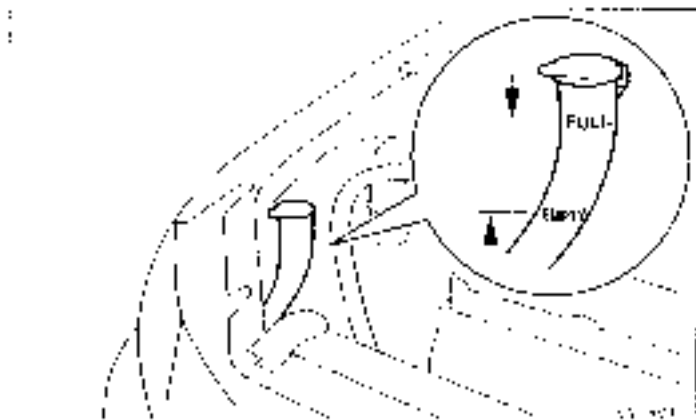

When freezing weather is anticipated, flush out the water in the reservoir by operating the pump. Fill the reservoir with windshield antifreeze (not radiator antifreeze), and operate the system for a few seconds to flush out the residual water.

Brake fluid

CS-107-00

To check the fluid level

Check the brake fluid level in the reservoir.

The brake fluid level must be between the "MAX" and "MIN" marks on the reservoir.

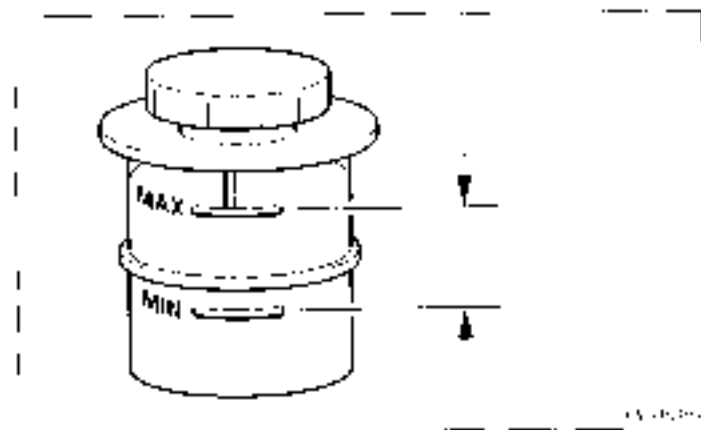

CS-107-00

The fluid level falls slightly with wear of the brake pads, but this does not indicate any abnormality.

If the brake fluid level falls markedly in a short length of time, it indicates leaks from the brake system.

If this occurs, have the vehicle checked by an authorized Mitsubishi dealer.

Recommended fluid

Use the recommended brake fluid conforming to DGM-5 or DGM-4. The reservoir cap must be tightly sealed to keep dirt and water out.

CAUTION

- Do not let any petroleum-based fluid touch, mix with, or get into the brake fluid. This will damage the seals.
- Be careful when handling brake fluid. It can damage painted surfaces.
- Use only the listed brake fluid. Different brands of brake fluid have different additives, and these can cause a chemical reaction. Do not mix brands of brake fluid.
- Keep the reservoir tank cap closed to keep the brake fluid from evaporating.

Power steering fluid

5-2-1-1

To check the fluid level

Check the fluid level in the reservoir while the engine is idling. Check to make certain that the power steering fluid level is always between the "MAX" and "MIN" level markings on the fluid reservoir and refill the fluid, if necessary.

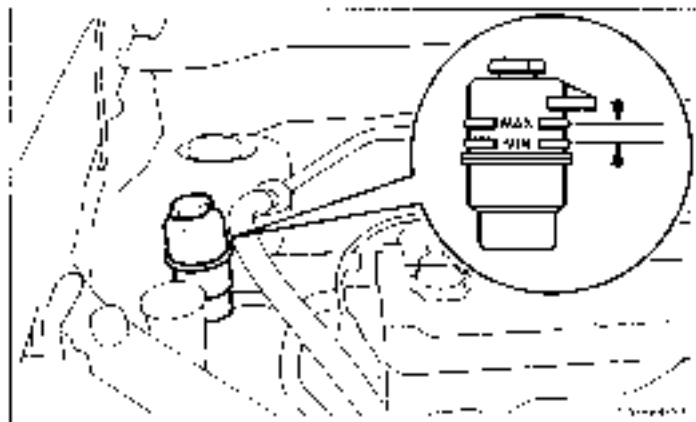

Recommended fluid

Lubricant	Genuine Mitsubishi Power Steering Fluid
-----------	---

Battery

5-2-1-2

The condition of the battery is very important for quick starting and to keep the vehicle's electrical system working properly. Check the battery regularly.

To see the charge of only one cell, check the indicator (A) on top of the battery. If the indicator is blue when looking from above, that cell is okay suggesting the battery is okay. This is not conclusive and if battery performance is suspect, have the battery and charging system tested by an authorized Mitsubishi dealer. If it is white, that cell is low on charge and the battery may only need charging.

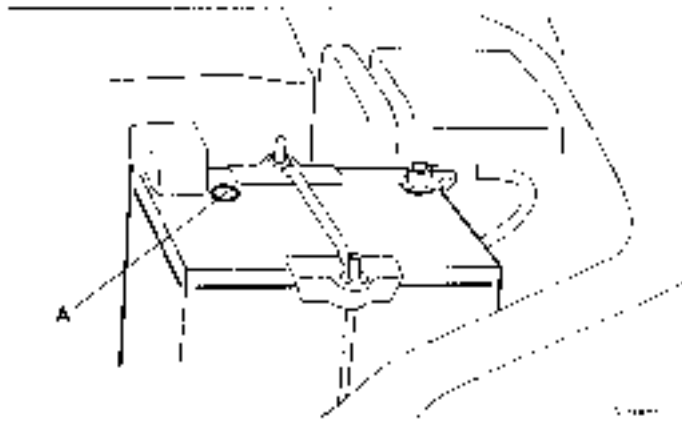

NOTE

- After replacing the battery, the electronic control system data for the engine, automatic transmission, etc., will be erased.

As a result, the engine speed may become unstable and shift shock may occur.

If the engine speed becomes unstable, initial engine adjustments will need to be performed.

(Refer to "What to do if the engine speed becomes unstable after the battery is replaced" on page 6-25.)

Shift shocks will become smoother after several changes in speed.

- Memory data for settings made by the user may be erased when the battery is replaced. If this happens, establish the settings again using the relevant procedures.

Checking battery electrolyte level

The electrolyte level must be between the limits shown on the outside of the battery. Fill it with distilled water as needed. The inside of the battery is divided into several compartments. Take the cap off of each compartment and fill to the mark.

Do not fill above the top line because a spill during driving could cause damage.

During cold weather

The battery is weaker in cold temperatures. This has to do with its chemical and physical properties and is why a very cold battery, especially one with a low charge, will have a hard time starting your vehicle.

It is recommended that you have your battery and charging system checked by an authorized Mitsubishi dealer before the start of cold weather, if necessary, have it charged. This will guarantee more reliable starting, and longer battery life.

Disconnection and connection

To disconnect the battery cable, stop the engine. Disconnect the negative (-) terminal first, then the positive (+) terminal. To reconnect the battery, first connect the positive (+) terminal and then the negative (-) terminal, before starting the vehicle.

⚠ WARNING

- Never disconnect the battery while the engine is running or you could damage the vehicle's electrical parts.
- Never short-circuit the battery. This could cause it to overheat and be damaged.
- Keep sparks, cigarettes, and flames away from the battery because the battery could explode.
- Electrolyte (battery acid) is made of corrosive diluted sulfuric acid.
If electrolyte touches your hands, clothes, or the coated surface of your vehicle, rinse thoroughly with water. If electrolyte gets in your eyes, flush them with water immediately and get immediate medical attention.
- Open doors and windows in any closed space where you may be charging or working with the battery.
- Always wear protective clothing and goggles when working with the battery, or have a skilled automobile technician do it.
- If you are quick-charging your battery, first disconnect the battery cables.
- In order to prevent a short circuit, be sure to disconnect the negative (-) terminal first, and reconnect it last.

⚠ WARNING

- If the electrolyte level is very low, have the battery checked at an authorized Mitsubishi dealer.
- Battery posts, terminals and related accessories contain lead and lead compounds. Wash hands after handling.

NOTE

- Check each battery terminal for corrosion. You can stop more corrosion by washing with a solution of baking soda and water. Loosen the posts and clamps after cleaning or regreasing them.
- Check to see that the battery is securely installed and cannot be moved. Also check each terminal for tightness.
- If you will not be driving your vehicle for a long period of time, remove the battery and store it in a place where the battery fluid will not freeze. The battery only should be stored with a full charge.
- Before cleaning the battery, tighten all the filler post caps to keep dirt and moisture out.

Tires

⚠ WARNING

- Driving with tires that are worn or improperly inflated can result in a collision and serious or fatal injury.

Tire inflation pressures

Proper tire inflation pressure is essential for the safe and satisfactory operation of your vehicle. The wrong tire pressure will cause problems in three major areas:

- **Safety**
Too little pressure increases bending in the tire and can cause tire failure. Too much pressure can cause a tire to lose its ability to cushion shock. Objects on the road and potholes could then cause tire damage that may result in tire failure.
- **Economy**
The wrong tire pressure can cause uneven wear patterns in the tire tread. These abnormal wear patterns will reduce the tread life, and the tire will have to be replaced sooner. Too little pressure also makes it harder for the tire to roll, and this uses up more fuel.

- Rule comfort and vehicle stability

The superior riding experience built into your vehicle partly depends on the correct tire pressure. Too much pressure gives an uncomfortable and jarring ride. Too little pressure feels as if your vehicle is slow to respond.

Unequal tire pressures can cause steering, your vehicle uneven and unpredictable.

The correct tire pressure for your vehicle is listed on the label attached to the sill of the driver's door.

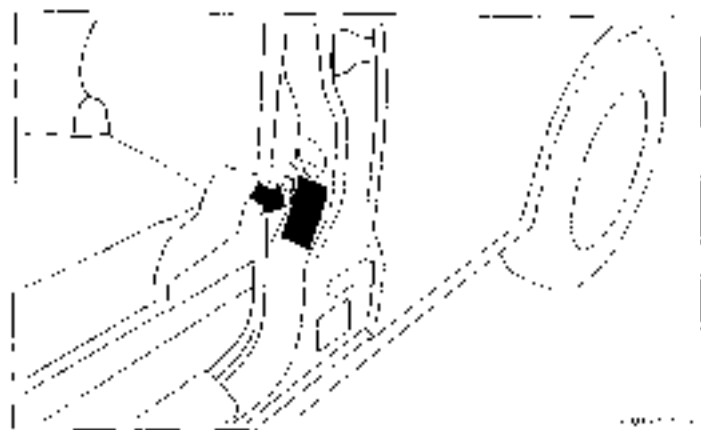

The recommended inflation pressures should be used for the tires listed below.

Item	Tire size	Front	Rear
Normal tire	P215 60R16 91 H	29 psi (200 kPa)	29 psi (200 kPa)
Compact spare tire	T 135 90D 6	60 psi (413 kPa)	

Tire pressures should be checked and adjusted if necessary, at least once a month.

Pressures should be checked more often whenever weather temperatures change severely, because tire pressures change with outside temperatures. The pressures listed on the label are always "cold inflation pressure."

Vehicle care and maintenance

Cold inflation pressure is measured after the vehicle has been parked for at least three hours or is driven less than 1 mile (1.6 km) after having been parked for three hours.

Cold inflation pressure must not go above the maximum values molded into the tire sidewall. After driving several miles, your tire inflation pressure may increase 2 to 6 psi (14 to 41 kPa) from the cold inflation pressure. Do not let air out of the tires to get back to the specified cold pressure, or your tires will be too low.

Check your tires each time you refuel. If one tire looks lower than the others, check the pressure for all of them.

You should also take the following safety precautions:

- Keep your tires inflated to the recommended pressures. (See the tire inflation pressure label attached to the sill of the driver's door.)
- Stay within the recommended load limits.
- Make sure that the weight of any load in your vehicle is evenly distributed.
- Drive at safe speeds.
- After filling your tires to the correct pressure, check them for damage and air leaks. Be sure to replace the rubber caps on the valve stems.

Tire pressure for sustained high-speed driving

7 For sustained high-speed driving, increase inflation pressure 4 psi (28 kPa) above the recommended pressure, but do not exceed the maximum inflation pressure molded into the tire sidewall.

Radial ply tires

Radial ply tires have longer-lasting treads, more road hazard resistance and give a smoother high-speed ride.

The radial ply tires installed at the factory on your vehicle are made of belts. They were chosen to give you the best riding and handling of your vehicle.

Radial ply tires can carry the same loads as bias or bias-belted tires with the same letter size. They use the same recommended inflation pressures.

Using both radial ply tires and bias or bias-belted tires on the same vehicle is not recommended. This combination can cause poor handling of your vehicle. Radial ply tires should always be used as a set of four.

Because longer-wearing tires have more chances of uneven tread wear, it is very important to rotate your tires at the times shown in the section "Tire rotation" on page 7-21. This helps the tire treads to last as long as possible.

Cuts and punctures in radial ply tires can only be repaired if they occur in the tread area, because of sidewall flexing. Consult your tire dealer for radial ply tire repairs.

Oversize tires

Using different size tires from the ones listed may cause interference with other vehicle parts that help control suspension and steering. This could damage both your vehicle and your tires.

Tire maintenance

The following maintenance steps are recommended:

- Check tire pressures regularly
- Have regular maintenance done on the wheel balance and front suspension alignment
- Rotate your tires regularly, as described in the "Tire rotation" section on page 7-21

Tread wear indicators

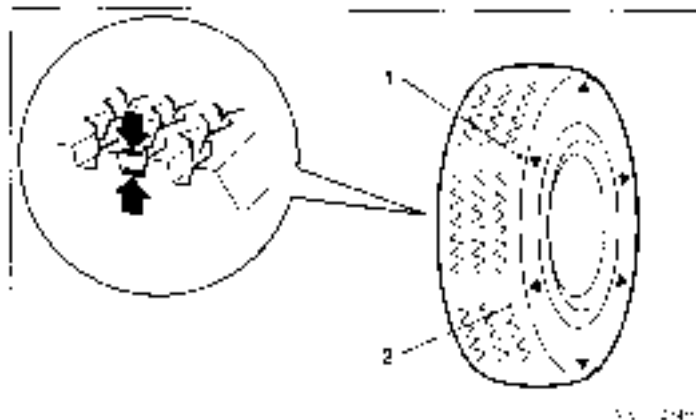

- 1 Location of the tread wear indicator
- 2 Tread wear indicator

Tread wear indicators are built into the original equipment tires on your vehicle to help you know when your tires should be replaced. Many states have laws requiring that you replace your tires at this point.

These indicators are milled into the bottom of the tread grooves and will appear as 1/2 inch (13 mm) wide bands when the tire tread is worn down to 1/16 inch (1.6 mm).

When the bands appear next to one another in two or more places, replace your tires.

NOTE

- Tire wear indicators can have different marks and locations depending on the tire manufacturer.

Tire rotation

To even out the wear on your tires and make them last longer, Mitsubishi Motors Corporation recommends that you rotate your tires approximately every 7,500 miles (12,000 km) if you drive under normal conditions, and every 6,000 miles (9,600 km) if you drive under more severe conditions.

However, the timing for tire rotation may vary according to your vehicle condition, road surface conditions, and your own personal driving habits. Any time you notice unusual wear, rotate your tires as soon as possible.

When rotating tires, check for uneven wear, damage, and wheel alignment. Abnormal wear is usually caused by a wrong tire pressure, wheels that are not aligned properly, wheels that are out-of-balance, or severe braking.

Check with an authorized Mitsubishi dealer to find out the rotation for uneven tread wear.

The first tire rotation is the most important one. It will allow all your tires to wear evenly.

Type 1

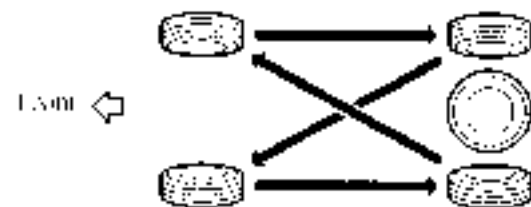

Type 2

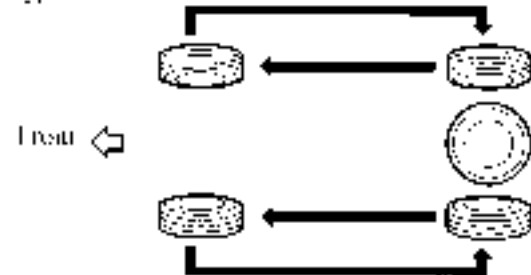

CAUTION

- A compact spare tire can be fitted temporarily in place of a tire that has been removed during the tire rotation. However, it must not be included in the regular tire rotation sequence.

CAUTION

- If the tires have arrows (A) indicating the correct direction of rotation, swap the front and rear tires on the left-hand side of the vehicle and the front and rear tires on the right-hand side of the vehicle separately. Keep each tire on its original side of the vehicle (Type 2). When fitting the tires, make sure the arrows point in the direction in which the wheels will turn when the vehicle moves forward. Any tire whose arrow points in the wrong direction will not perform to its full potential.

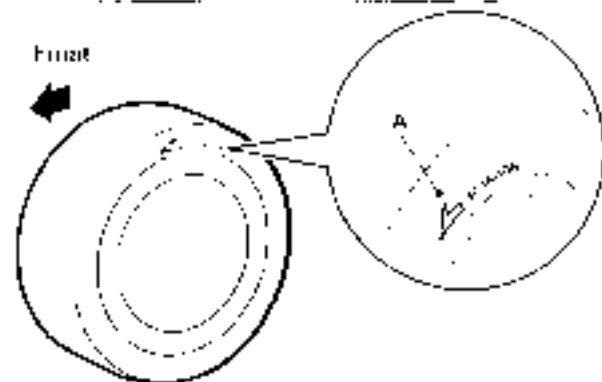

Snow tires

Some areas of the country require the use of snow tires during winter. If you require snow tires in your area, you must choose

the same size and type of tires as the original ones on your vehicle. Otherwise your safety and vehicle handling can be reduced.

Any special high performance tires you may have purchased with your model may also need to be matched with the right size mud and snow (M+S) tires. Mitsubishi Motors Corporation requires the makers of such performance tires to make matching snow tires for this reason. Ask your tire dealer for suitable snow tires.

Snow tires should be inflated 4 psi (28 kPa) higher than the cold inflation pressure listed on the label on the sill of the driver's door, but not more than the maximum pressure shown on the tire sidewall.

Even where laws may permit it, snow tires should not be operated at sustained speeds over 75 mph (120 km/h).

▲ CAUTION

- If flange nuts are used on your vehicle, change to tapered nuts when using snow tires with steel wheels.

Tire chains

▲ CAUTION

- Tire chains cannot be used on your vehicle. The clearance between the chains and the body is not sufficient to allow proper clearance, and the vehicle body might be damaged.

Brake pedal free play

7-13

To check the brake pedal free play: (A) Turn off the engine, and press the brake pedal several times with your foot. Then press the pedal down with your fingers until you first feel resistance.

Brake pedal free play:

1.1 to 1.3 inch (3 to 8 mm)

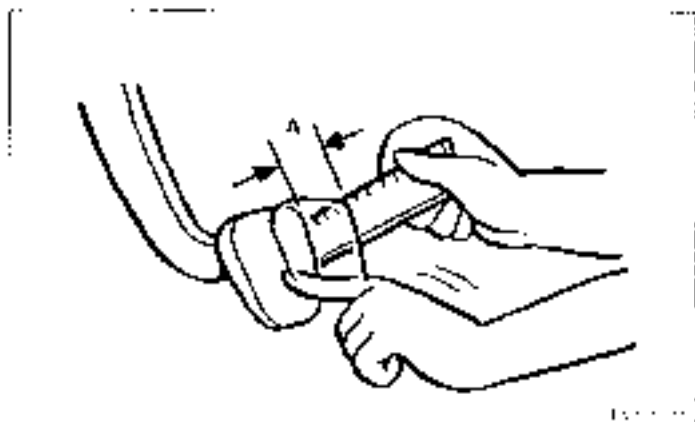

7-14

Vehicle care and maintenance

With the engine running and the selector lever in "P" (PARK), press the brake pedal all the way down (with the force of 115 pound (500N)). This distance (B) should be at least 3.9 inches (100 mm).

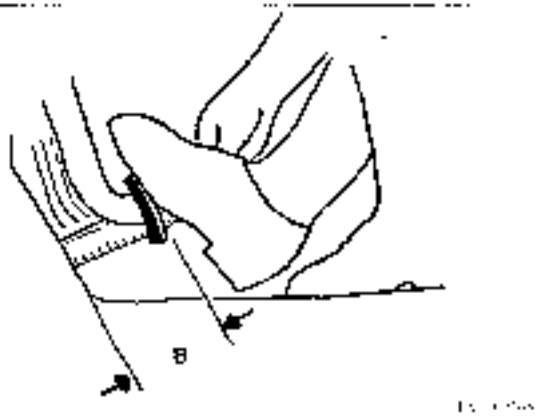

If the free play and/or the distance is not within these limits, take your vehicle to an authorized Mitsubishi dealer for adjustment.

Parking brake lever stroke

Check the parking brake lever travel occasionally. To check this, pull the lever up slowly and count the number of clicks of the ratchet. You should feel the parking brake grab between 5 to 7 notches (clicks). Also check to see if the lever stays gripped by the ratchet after pulling.

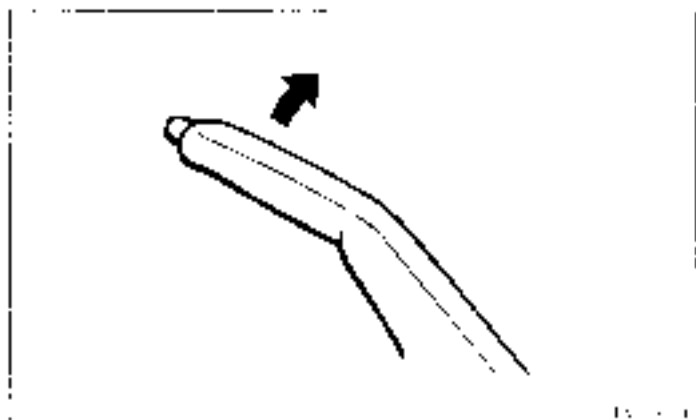

Wiper blades

Check the wiper blades occasionally. Clean them regularly to remove deposits of salt and road film. Use a sponge or cloth and a mild detergent or non-abrasive cleaner to clean the blades and glass areas.

Replace the blades if they continue to streak or smear.

NOTE:

- Do not run the wipers on dry glass for a long time. This wears out the rubber and can scratch the glass.

During cold weather

If the blades are frozen to the windshield or rear window, do not operate the wipers until the ice has melted and the blades are freed, otherwise the wiper motor may be damaged.

Emission-control system maintenance

Your vehicle is equipped with an emission-control system that meets all the requirements of the U.S. Environmental Protection Agency and Environment Canada. The emission-control system is made of:

- a positive crankcase ventilation system
- an evaporative emission-control system
- an exhaust emission-control system

The maintenance services listed in the "WARRANTY AND MAINTENANCE MANUAL" must be performed at the times or mileages listed to keep the emission-control system working properly. These, and all the other "general" maintenance services listed in this manual, need to be performed to keep your vehicle running properly and reliably.

You may need more frequent maintenance if you drive your vehicle in harsh conditions such as dusty areas or do a lot of start-and-stop driving.

To be sure the emission-control system works properly, have your vehicle inspected and maintained by an authorized Mitsubishi dealer following the schedule in the "WARRANTY AND MAINTENANCE MANUAL."

You should also have an inspection and service any time you suspect a malfunction.

NOTE

- To meet government regulations and promote cleaner air, your vehicle is equipped with an onboard diagnostic system (OBD). The engine electronic control module that controls OBD functions stores various data (especially about the exhaust emissions). This data will be erased if the battery cable is disconnected, which could make a rapid diagnosis difficult. Do not disconnect the battery cable when the malfunction indicator light ("SERVICE ENGINE SOON" or "Check engine light") is on.

Spark plugs

Spark plugs must fire properly for good engine performance and emission control.

Do not reuse them by cleaning or regapping. Change them at the mileage listed in the "WARRANTY AND MAINTENANCE MANUAL."

NOTE

- Use the spark plugs listed under "Engine specifications" on page 9-6 or plugs that are exactly the same. Other plugs could cause engine damage, performance problems or radio noise.

Fuel hoses

Check the hose surfaces for any heat and mechanical damage, hard and brittle rubber, cracking, tears, cuts and abrasions. Pay special attention to the hoses closest to high heat sources such as the exhaust manifold. Check all the hose connections, such as clamps and couplings, to make sure they are secure and that

there are no leaks. If you see any wear or damage, replace the hoses immediately.

Ignition cables

The ignition cables should be kept clean, properly connected and fully seated. Terminals should be fully seated and the metal assemblies should not be removed from the distributor or coil towers unless the cables are damaged or cable testing indicates high resistance or broken insulation. Cracked, damaged, or faulty cables must be replaced.

Fuel system (tank, pipe line and connection, and fuel tank filler tube cap)

Check these regularly for damage or leaks in the fuel lines and connections. Check the fuel tank filler tube cap for damage or looseness. Pay special attention to the fuel lines closest to high heat sources such as the exhaust manifold.

⚠ WARNING

- If you see a fuel leak or if you smell fuel, do not run the engine. Any spark (including from the ignition), flame or smoking material could cause an explosion or fire. Call an authorized Mitsubishi dealer for assistance.

Evaporative emission control system (except evaporative emission canister)

If the fuel-vapor vent line is clogged or damaged, the fuel-vapor mixture will escape, polluting the air.

Have the system checked at an authorized Mitsubishi dealer at the mileage specified on the "WARRANTY AND MAINTENANCE MANUAL".

General maintenance

The next pages list the maintenance service recommended by Mitsubishi Motors Corporation. In addition to the general maintenance that needs to be performed at the times listed, there are other parts which do not usually need regular maintenance.

But, if any of these parts stops working properly, your vehicle performance could suffer. Have these items checked if you notice a problem with them.

See your authorized Mitsubishi dealer for assistance, if you have any questions.

Disc brake pads, rear drum brake linings and rear wheel cylinders

Good brakes are essential for safe driving. Check the front brake pads and rear brake linings for wear, and check the rear wheel cylinders for leaks.

For good braking performance, replace the brake pads with the same type pads as the originals.

Brake hoses

Brake hoses and tubing should be checked for:

- Severe surface cracking, scuffing or worn spots. If the fabric casing of the hose is showing through any cracks or worn spots on the rubber hose cover, the hose should be replaced. The brakes can fail if the hose wears through.
- Early installation may cause twisting, or wheel, tire or chassis interference.

Ball joint, steering linkage seals and drive shaft boots

Check the following parts for damage and grease leaks:

- Ball joint boots of the front suspension and steering linkage
- Bellows on both ends of the drive shaft

Drive belt (for generator, power steering pump, air conditioning compressor)

Check the tension of the drive belt. Make certain that the indicator (A) is between the specified lines as shown in the illustration.

Check the drive belt for cuts and cracks, and replace it if it is damaged. When replacing the belt, make sure that there is no interference between the belt and other engine components. After replacing, recheck the tension to make sure the indicator (A) is between the specified lines.

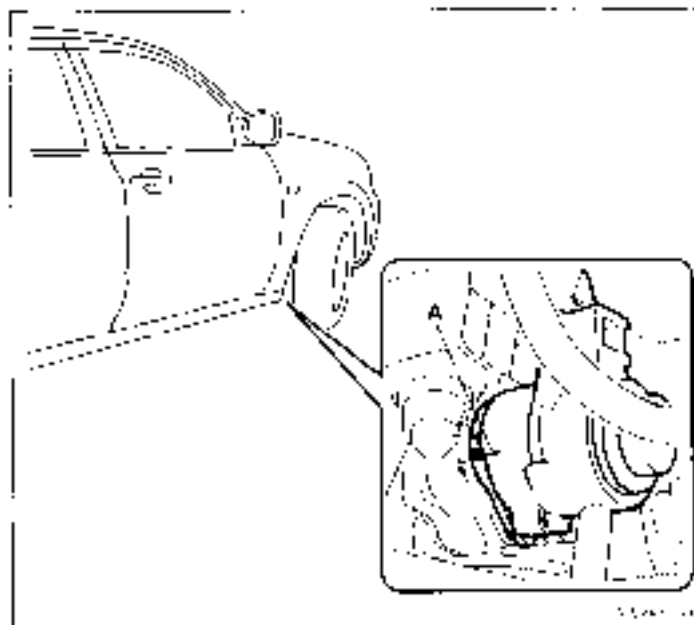

⚠ WARNING

- Do not check or touch the drive belt with the engine running, or serious injury may result.

Exhaust system

⚠ WARNING

- Carbon monoxide gas from your vehicle's exhaust is poisonous. Breathing these fumes can cause unconsciousness or death.

The best way to keep carbon monoxide gas from entering inside your vehicle is to have the engine exhaust system properly serviced.

Have a competent mechanic inspect the complete exhaust system and nearby body areas for broken, damaged, deteriorated, or mispositioned parts if you notice any of the following:

- A change in the sound of the exhaust system
- The smell of exhaust fumes inside the vehicle
- The underside or rear of the vehicle is damaged

Also check the exhaust system each time the vehicle is raised for lubrication, oil changes, or routine service. Any open seams or loose connections could let dangerous exhaust fumes seep into the luggage compartment and passenger compartments.

Check for any of the following conditions:

- Check for holes or exhaust gas leaks caused by corrosion or damage.
- Check the joints and connections for looseness or exhaust gas leaks.
- Check the rubber hangers and brackets for damage.

Timing belt

The timing belt should be replaced with a new one at the mileage listed in the "WARRANTY AND MAINTENANCE SCHEDULE".

Supplemental Restraint System (SRS)

The entire SRS must be inspected by an authorized Mitsubishi dealer 10 years after the vehicle manufacture date shown on the certification label. Refer to "SRS servicing" on page 2-521.

Door and lifegate hinges, hood lock release mechanism and safety catch

The door and lifegate hinges, hood lock release mechanism and hood safety catch should be checked, cleaned, and oiled when needed for easy movement and to stop rust and wear. Use engine oil for the hinges of the doors, hood, and lifegate. Use Multipurpose Grease (M/G) Grade 2 sparingly for all sliding parts of the hood latch and release lever. Work the grease into the hood lock mechanism until all the movable surfaces are covered.

Also, put a light coat of the same grease on the safety catch whenever moving parts meet.

For cold and snow weather

Ventilation slots

The ventilation slots in front of the windshield should be brushed clean after a heavy snowfall so that the operation of the heating and ventilation systems will not be impaired.

Weatherstripping

To prevent freezing of the weatherstripping on the doors, engine hood, etc., they should be treated with silicone grease.

Additional equipment (For regions where snow is encountered)

It is a good idea to carry a shovel or a short-handled scythe in the vehicle during the winter so that you can clear away snow if you get stranded. A small hand brush for sweeping snow off the vehicle and a plastic scraper for the windshield, side and rear windows are also useful.

Fuse links

The fuse links will melt to prevent a fire if a large current attempts to flow through certain electrical systems.

In case of a melted fuse link, see your authorized Mitsubishi dealer for inspection and replacement.

Fuses

Fuse block location

To prevent damage to the electrical system from short-circuiting or overloading, each individual circuit is equipped with a fuse. The fuse blocks are located in the passenger compartment and in the engine compartment.

Passenger compartment

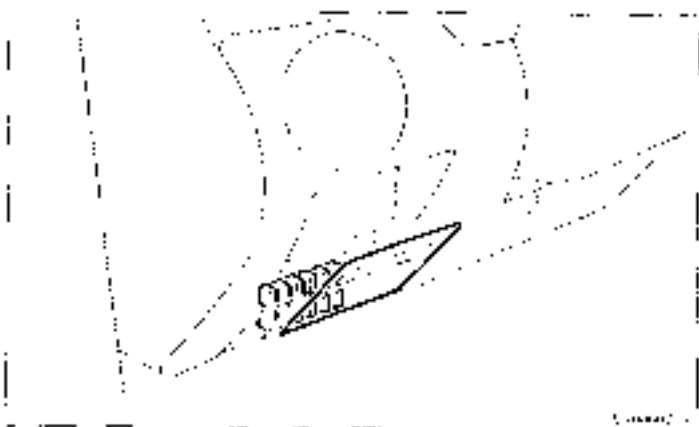

The fuse block in the passenger compartment is located behind the personal box.

Engine compartment

In the engine compartment, the fuse block is located as shown in the illustration.

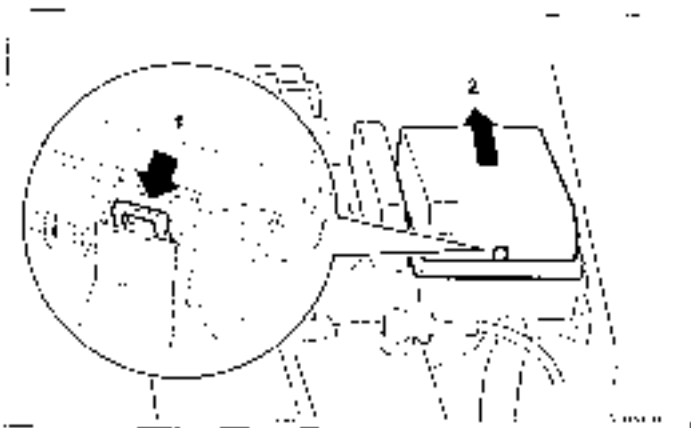

1. Push the lock lever.
2. Remove the fuse block cover.

Fuse load capacities

This Fuse List shows the names of the electrical systems and their fuse capacities.

There are spare fuses in the personal box lid. Always replace a blown fuse with one of the same capacity as the original.

Passenger compartment fuse location label

Passenger compartment fuse location

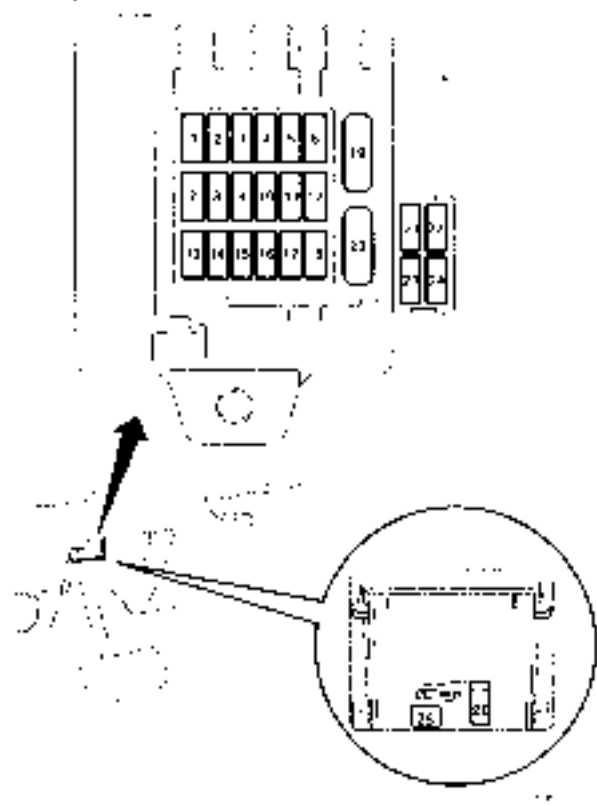

No.	Symbol	Electrical system	Capacity
1	⊖	Ignition coil	10A
2	⊖	Gauge	7.5A
3	⊖	Back-up lights	7.5A
4	⊖	Cruise control	7.5A
5	⊖	Relay	7.5A
6	⊖	Door mirror heater	7.5A
7	⊖	Wiper motor (wiper)	20A
8	⊖	Engine control	7.5A
9	⊖	Cigarette lighter	15A
10	⊖	—	—
11	⊖	Outside rear view mirrors	7.5A
12	⊖	Engine control	7.5A
13	⊖	Radio	10A
14	⊖	Rear window wiper	15A
15	⊖	Power door locks	15A
16	⊖	Rear fog light	10A
17	⊖	—	—
18	⊖	Door lock	10A
19	⊖	Heater	20A
20	⊖	Rear window defogger	30A

No.	Symbol	Electrical system	Capacity
21	—	Subtotal	20A
22	—	Heated seat	10A
23	—	Water cooler/water spray	10A
24	—	—	—
25	—	Spare fuse	20A
26	—	Spare fuse	10A

- Some fuses may not be installed on your vehicle, depending on the vehicle model or specifications.
- The table above shows the main equipment corresponding to each fuse.

The fuse box does not contain spare 7.5 A, 10 A and 15 A fuses. If a fuse of one of these capacities blows, replace it temporarily by borrowing the one that matches from:

7.5 A: Door mirror heater or Cruise control

10 A: Radio (in engine compartment)

15 A: Cigarette lighter

Replace the borrowed fuse as soon as possible.

Engine compartment fuse location table

Engine compartment fuse location

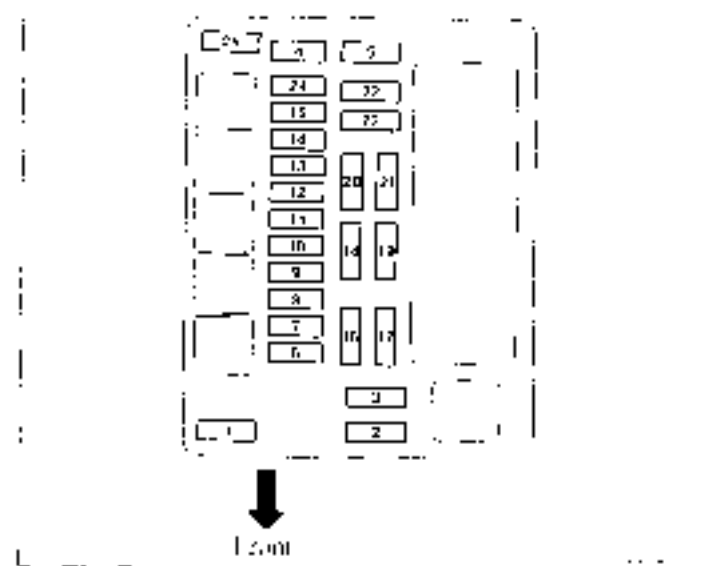

Vehicle care and maintenance

No.	Symbol	Electrical system	Capacity
1		Fuse (F)	60A
2		Radiator fan motor	30A
3		Anti-lock braking system	60A
4		Ignition switch	10A
5		Power window control	30A
6		Front fog lights	15A
7		Daytime running lamps	15A
8		Heated seat	20A
9		Heater	6A
10		Engine control	70A
11		Air conditioning	10A
12		Stop lights	5A
13		Audio amplifier	70A
14		Alternator	7.5A
15		Hazard warning flasher	10A
16		Automatic transaxle	20A
17		Headlight high beam (right)	10A
18		Headlight high beam (left)	10A
19		Headlight low beam (right)	10A
20		Headlight low beam (left)	10A

No.	Symbol	Electrical system	Capacity
20		Tail light (right)	7.5A
21		Tail light (left)	7.5A
22		Dome light	10A
23		Radio	10A
24		Fuel pump	5A
25		Accessory socket	15A

- Some fuses may not be installed on your vehicle, depending on the vehicle model or specifications.
- The table above shows the main equipment corresponding to each fuse.

Identification of fuse

7.5A	Brown
10A	Red
15A	Blue
20A	Yellow
30A	Orange (slide type) / Purple (slide type)
40A	Green
50A	Red
60A	Yellow

Fuse replacement

1. Before replacing a fuse, always turn off the electrical item connected to the fuse and turn the ignition key to the "LOCK" position.
2. Open the personal box (A).

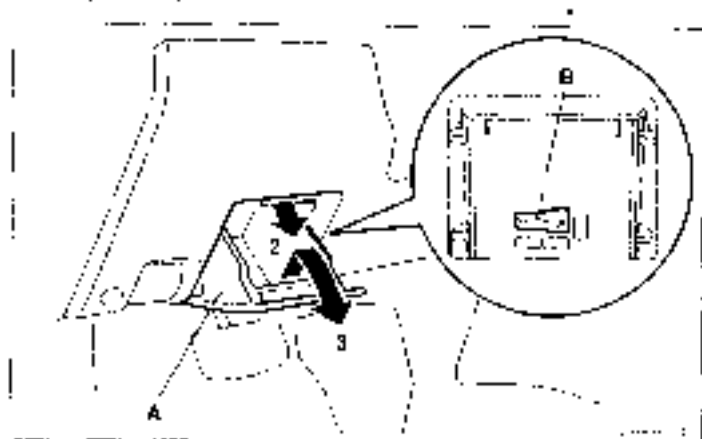

3. Pull the personal box toward you while lifting it up to remove it.
4. Remove the fuse holder (B) from the box lid.

5. Clamp it on the fuse you wish to remove, and pull the fuse straight out from the fuse block.

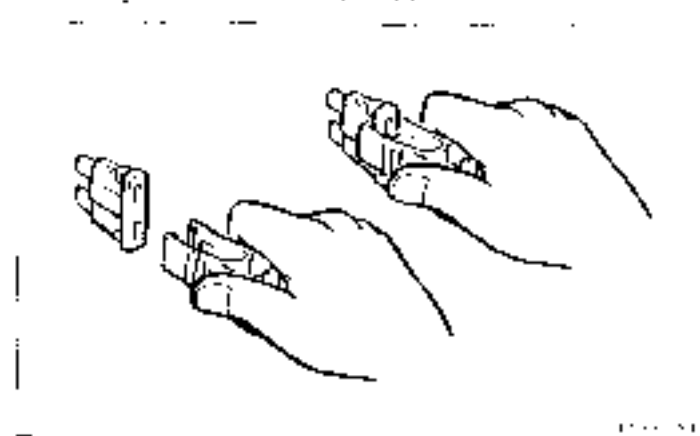

Vehicle care and maintenance

- Use the fuse location diagrams and the matching tables to check the fuse that is related to the problem. If the fuse is not blown, something else must be causing the problem. Contact an authorized Mitsubishi dealer to have the problem checked.

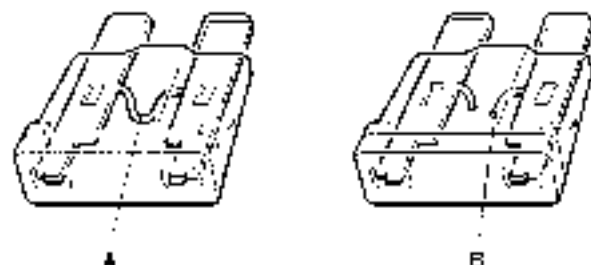

- A: Fuse is OK
B: Blown fuse

- Insert a new fuse of the same capacity securely into the appropriate slot.

⚠ CAUTION

- Never use a fuse with a capacity greater than the one listed or any substitute, such as wire, foil etc. This would cause the circuit wiring to heat up and could cause a fire.
- If the replacement fuse blows again after a short time, have the electrical system checked by an authorized Mitsubishi dealer to find and correct the cause.

Replacement of light bulbs

Before replacing a bulb, be sure the light is off. Do not touch the glass part of the new bulb with your bare fingers, the oil from your skin will stay on the glass and dim or destroy the bulb when it gets hot.

Bulb capacity

The bulb should only be replaced with a new bulb with the same rating and type. The type and rating are listed on the base of the bulb.

Outside

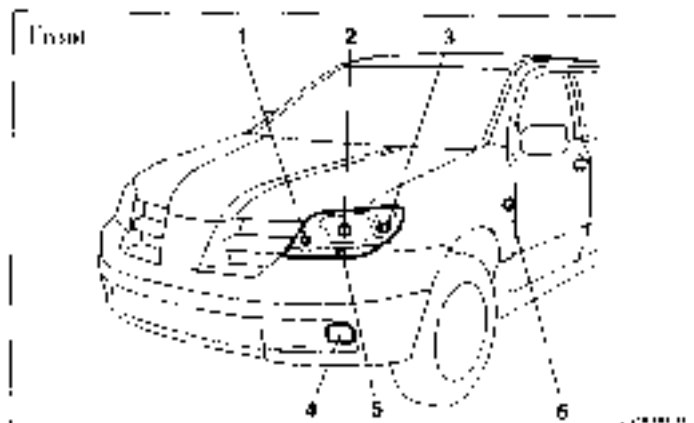

Description	Wattage or Candle power	ANSI Trade No or Bulb type
1 - Front turn-signal light	21W	WV21W
2 - Headlight		H11S 9007
3 - Front side-marker light	5W	W5W
4 - Front fog light (if so equipped)		H11 9005
5 - Parking light	5W	W5W
6 - Side turn-signal light	5W	WY5W

Vehicle care and maintenance

Rear

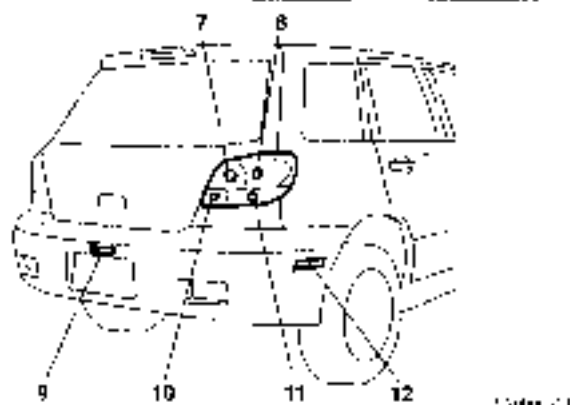

Description	Voltage or Candle power	ANSI Trade No. or Bulb type
7 - Stop light	21W	7440
8 - Tail light	21-35W	7440
9 - License plate light	5W	W-5W
10 - Back-up light	21W	7410
11 - Rear turn signal light	21W Amber 21W White	WY-21W 7410
12 - Rear side marker light	3cp	168

Inside

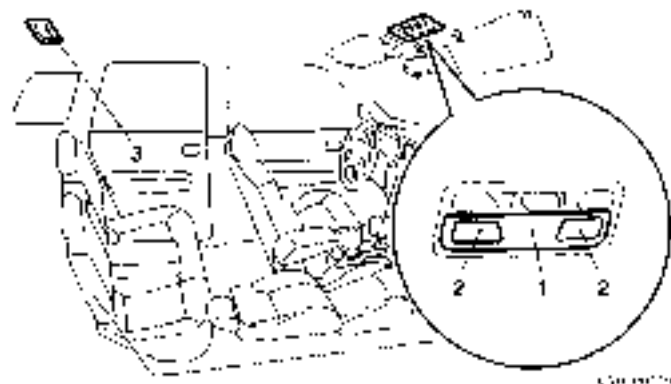

Description	Voltage
1 - Dome light (Front)	7.5W
2 - Reading light	7.5W
3 - Dome light (Rear)	8W

Headlights

Depress the tab (A) on the harness connector and pull the harness connector toward you to remove it.

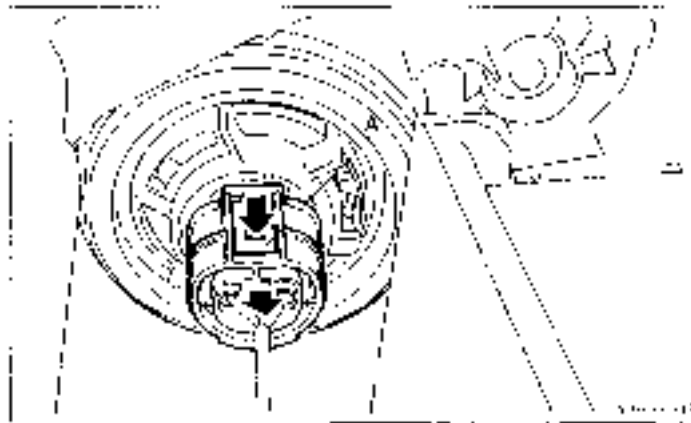

Remove the locking cap (B) by turning it counterclockwise.

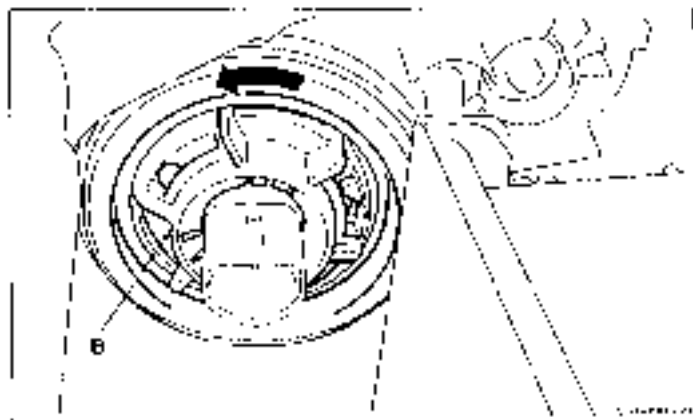

Remove the headlight bulb (1) with holder.

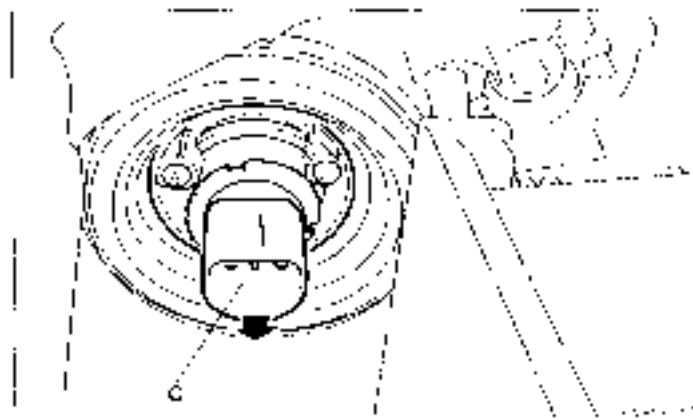

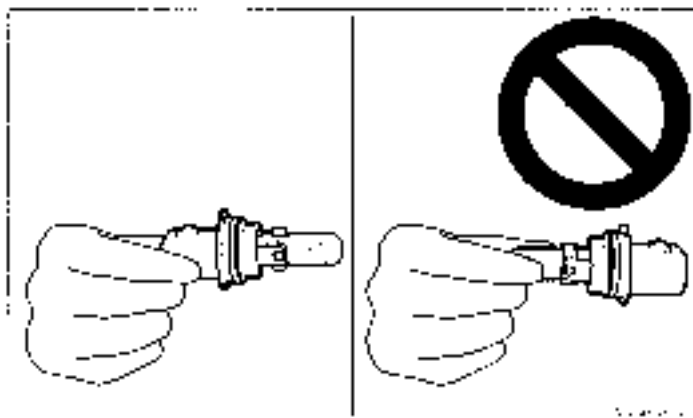

⚠ CAUTION

- Never hold the halogen light bulb with a bare hand, dirty glove, etc. The oil from your hand could cause the bulb to break the next time the headlights are used.

If the glass surface is dirty, clean it with alcohol and let it dry completely before installing the bulb.

Front side-marker lights

Turn the bulb socket counterclockwise to remove it. And remove the bulb from the socket by pulling out.



7 Adjustment of headlight aim

The alignment of the headlights should be checked by an authorized Mitsubishi dealer.

Parking lights

Turn the bulb socket counterclockwise to remove it. And remove the bulb from the socket by pulling out.

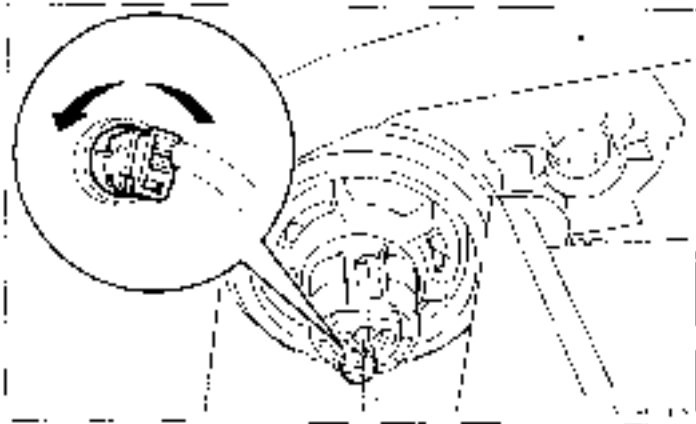

Front turn-signal lights

Turn the bulb socket counterclockwise to remove it. And remove the bulbs from the socket by pulling out.

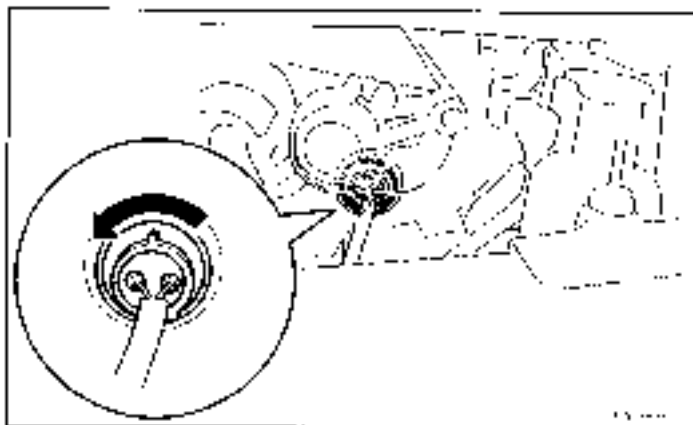

Side turn-signal lights

Insert a screwdriver into the notch of the lens and pry gently to remove the lens.

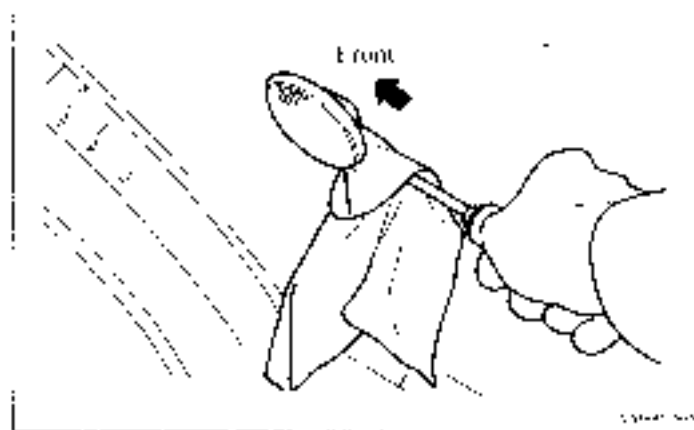

NOTE:

- Wrap a piece of cloth around the tip of the screwdriver to keep from scratching the lens or damaging the paint.

Remove the socket and bulb assembly together by turning it counterclockwise, and then remove the bulb by pulling it out.

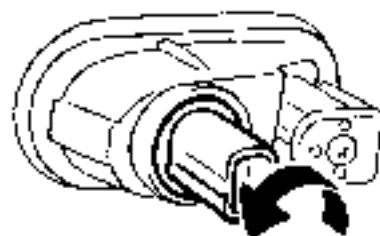

Fog lights (if so equipped)

Remove the light mounting screws (A) and pull the entire light bracket out.

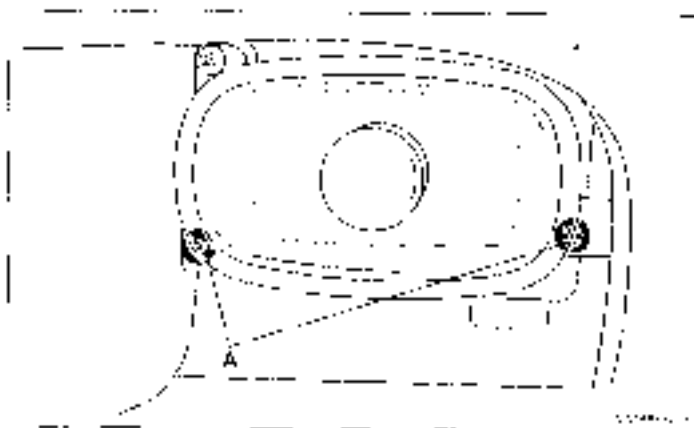

Push the connector (B) to disengage and remove the fog light.

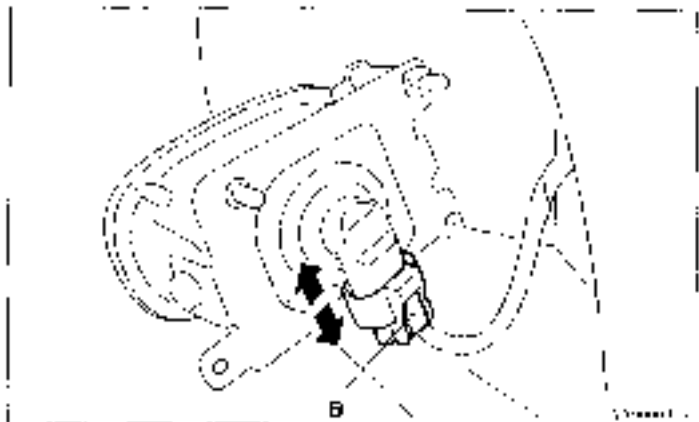

Vehicle care and maintenance

Remove the entire socket and bulb assembly (C) by turning it counterclockwise.

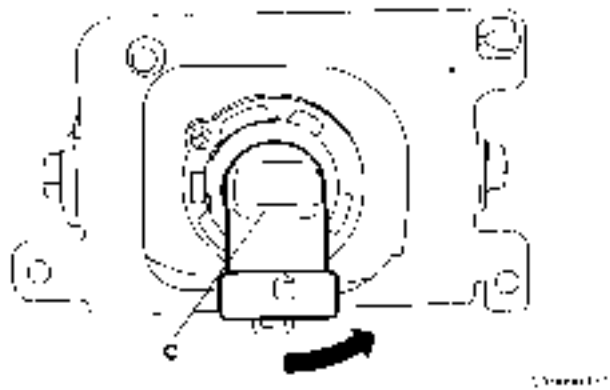

NOTE:

- When mounting the light unit, align the pin (D) on the light unit with the hole in the body.

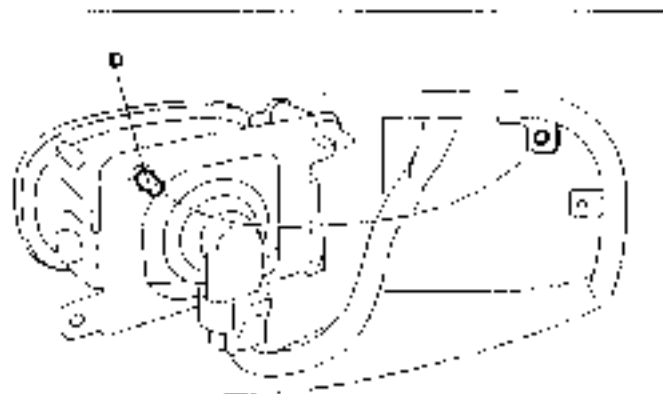

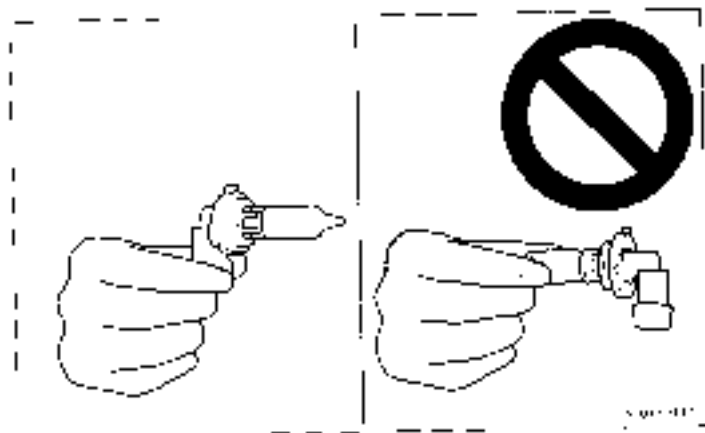

Fig. 10.11

⚠ CAUTION

- Never hold the halogen light bulb with a bare hand, dirty glove, etc. The oil from your hand could cause the bulb to break the next time the fog lights are used.

If the glass surface is dirty, clean it with alcohol and let it dry completely before installing the bulb.

Rear combination lights

Remove the screws (A) that hold the light unit

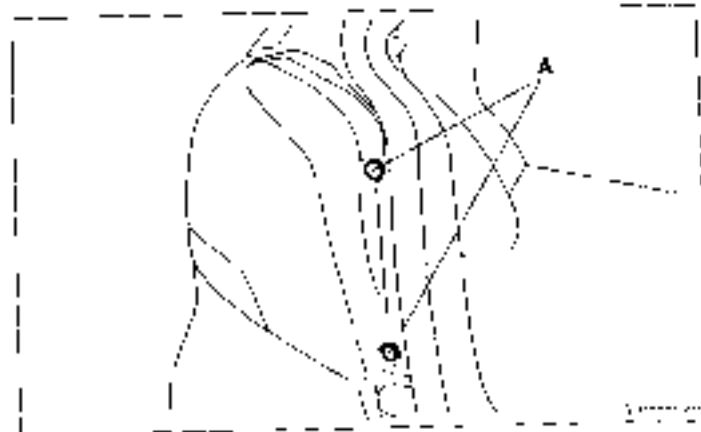

Vehicle care and maintenance

1. Move the light unit toward the outer side of the vehicle and loosen the clips (B).
2. Move the light unit toward the rear of the vehicle and remove the clips (H).

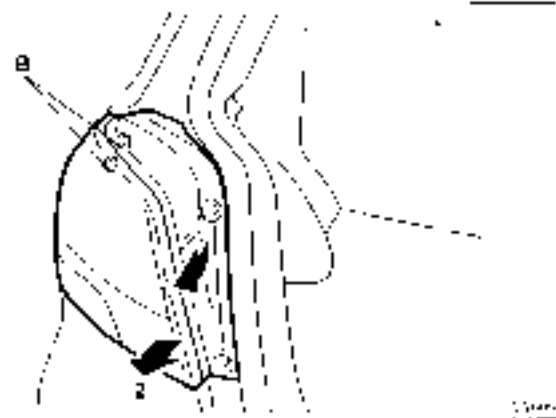

After remove the socket and bulb assemblies by turning them counter clockwise, remove the bulb by pulling it out.

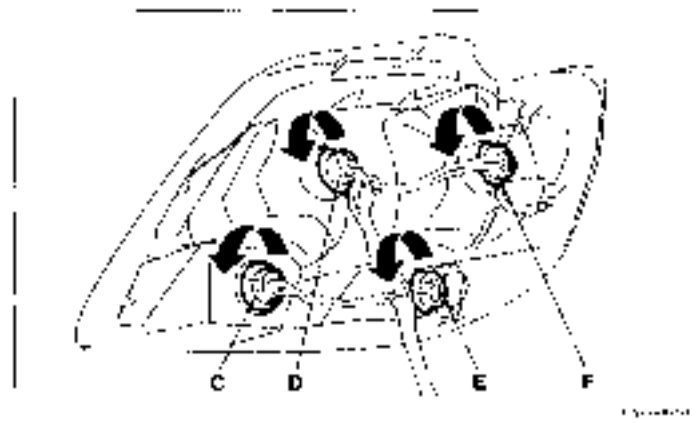

- C - Back-up light
- D - Stop light
- E - Rear turn-signal light
- F - Tail light

NOTE:

- When mounting the light unit, align the clips (G) on the light unit with the hole in the body.

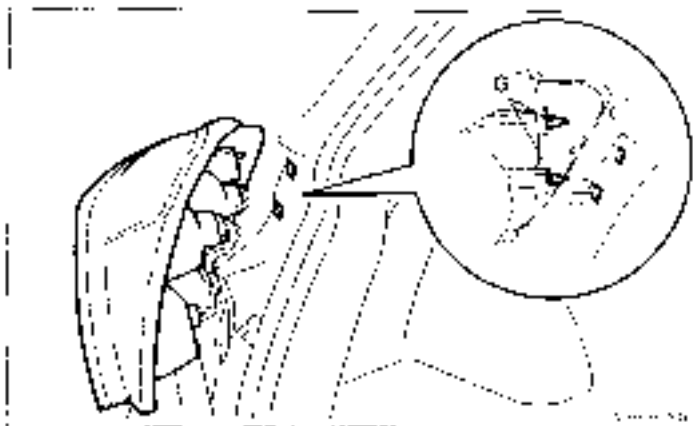
**Rear side marker lights**

Remove the light mounting screws (A) and remove the light unit.

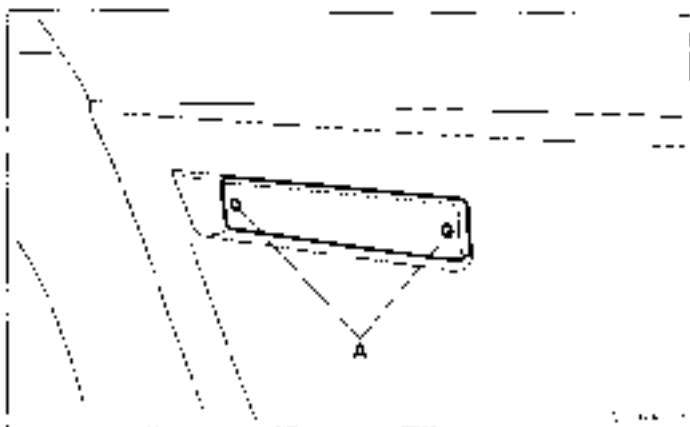

Vehicle care and maintenance

Remove the socket and bulb assembly (B) together by turning it counterclockwise, and then remove the bulb by pulling it out.

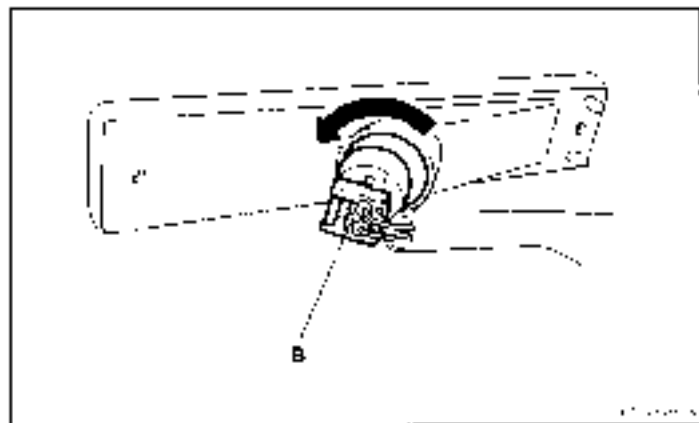

NOTE:

- When mounting the light unit, align the pins (A) on the light unit with the hole in the body.

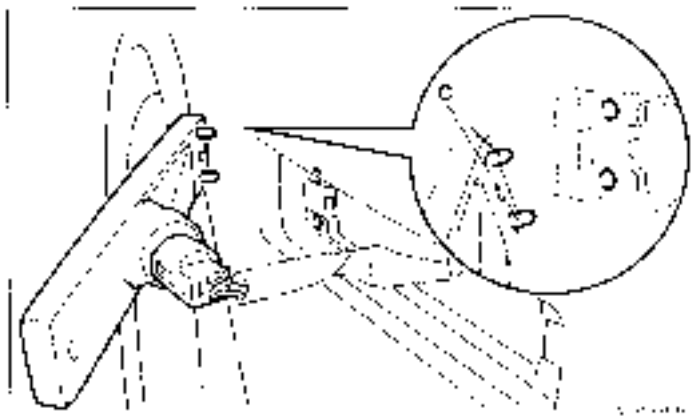

License plate light

Remove the screw (A) from the license plate light lens (B). Then, remove the lens and gasket (C) and withdraw the bulb.

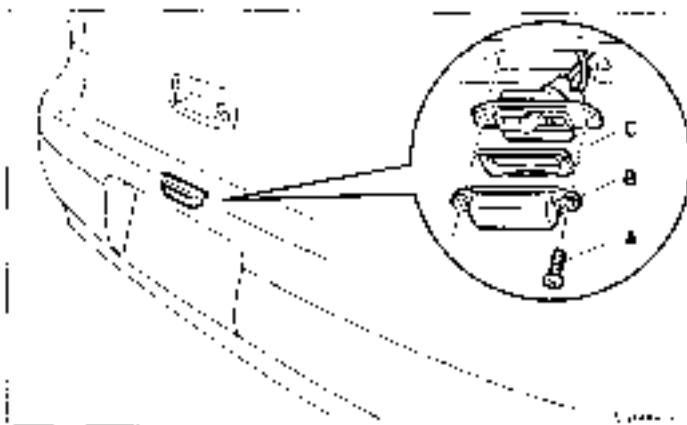

Remove the socket and bulb assembly together by turning it counterclockwise, and then to move the bulb by pulling out.

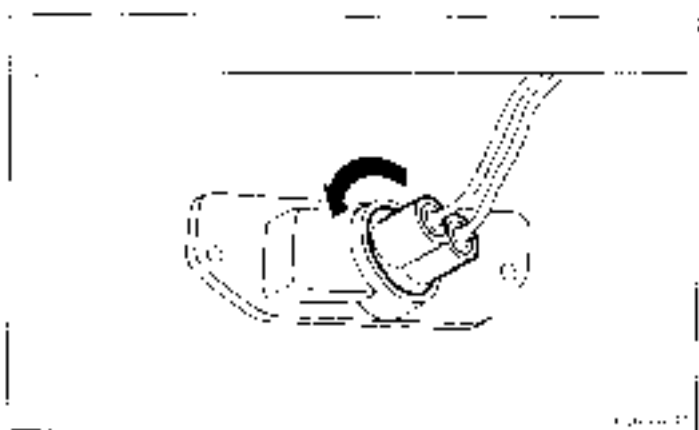

Dome light



Insert a screwdriver into the notch of the light assembly and try gently to remove the lens. Pull the light bulb out from the light holder.

NOTE

- Wrap a cloth around the tip of the screwdriver to keep from scratching the lens.

Dome light and reading lights

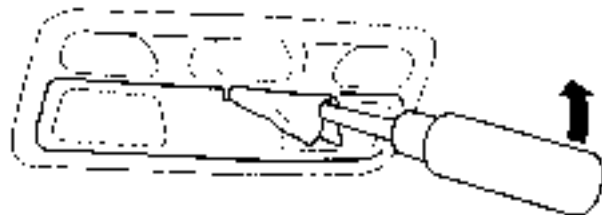

Insert a screwdriver into the notch of the light assembly. Pry gently to remove the lens, then remove the bulb from the light holder.

NOTE

- Wrap a cloth around the tip of the screwdriver to keep from scratching the lens.

Vehicle care precautions

In order to maintain the value of your vehicle, perform regular maintenance using the proper materials and procedures. Be sure to use only those materials and procedures that meet your local environmental pollution control regulations. Choose the materials you will use carefully, to be sure that they do not contain corrosives. If you are not sure, contact an authorized Mitsubishi dealer for help in choosing these materials.

CAUTION

● Cleaning products can be dangerous. Some are poisonous. Others are highly flammable. Some are dangerous if you breathe their fumes in a closed space. When you use anything in a container to clean your vehicle, be sure to follow the instructions. Always open your vehicle doors or windows when you're cleaning the inside. Never use the following chemicals to clean your vehicle:

- Gasoline
- Carbon Tetrachloride
- Benzine
- Naphtha
- Acetone
- Turpentine
- Paint Thinner
- Lacquer Thinner
- Nail Polish Remover

These can all be dangerous, and they all can damage your vehicle.

Cleaning the inside of your vehicle

After washing the inside of your vehicle with any cleaner, wipe it dry in a shady, well-ventilated area.

NOTE

- Always read the instructions on the cleaner label.

Plastic, vinyl leather, fabric, and flocced parts

- 1 Lightly wipe these off with a soft cloth soaked in a 3% solution of gentle soap and water.
- 2 Dip cloth in fresh water and wring out well. Using this cloth, wipe off the detergent thoroughly.

Upholstery

- 1 To maintain the value of your new vehicle, maintain the upholstery carefully and keep the interior clean. Use a vacuum cleaner and brush to clean the seats. If stained, vinyl and synthetic leather should be cleaned with an appropriate cleaner. Cloth fabrics can be cleaned with either upholstery cleaner or a 3% solution of gentle soap in lukewarm water.
- 2 Clean the carpeting with a vacuum cleaner and remove any stains with carpet cleaner. Clean the carpeting with a vacuum cleaner and remove any stains with carpet cleaner. Oil and grease can be removed by lightly dabbing with a clean white cloth and spot remover.

NOTE

- If fuzzing is difficult to remove from the seat upholstery, draw a suitable defuzzing brush over the surface in one direction.

Genuine leather (if so equipped)

1. To clean, lightly wipe the leather with a soft cloth soaked in a 3% solution of gentle soap and water.
2. To rinse, dip the cloth in fresh water, wring it out well, and wipe off all the soap.
3. To preserve and protect, use a leather protecting agent on the genuine leather surface.

NOTE

- If genuine leather is wet with water, wipe it with a dry, soft cloth.
- Light stains on genuine leather may be removed with a leather cleaner.
- The genuine leather surface can be damaged if brushed with a nylon or synthetic fiber brush.
- Organic solvents such as benzene, alcohol, paraffine, acid or alkaline solvents can discolor the genuine leather surface and should not be used.
- Genuine leather seats can mildew if not kept clean. Clean up any oil stains immediately.
- The genuine leather surface may harden and shrink if it is exposed to the direct sunlight for long hours. When your vehicle is parked, place it in the shade as much as possible.
- When the temperature of the vehicle interior rises in summer, vinyl products left on the genuine leather seat may deteriorate and stick to the seat.

Cleaning the outside of your vehicle

To protect your vehicle's finish, wash it often and thoroughly. If desired, you may wax your vehicle using a nonabrasive auto-mobile wax.

Foreign material

Industrial pollution, road tar, bird droppings, tree sap, insect remains, sea water and other foreign matters can damage the finish on your vehicle.

Generally, the longer any foreign material stays on the finish, the worse the damage. Wash your vehicle as soon as possible whenever the finish gets soiled.

Washing

Elements contained in the dirt and dust picked up from air, rain, snow, or road surfaces can damage the paint and body of your vehicle if left on.

Frequent washing and waxing is the best way to protect your vehicle from this damage.

Do not wash the vehicle in direct sunlight. Park the vehicle in the shade and spray it with water to remove dust. Next, using plenty of clean water and a car washing mitt or sponge, wash the vehicle from top to bottom.

Use a mild car washing soap if necessary. Rinse thoroughly and wipe dry with a chamois or soft cloth. After washing the vehicle, carefully clean the joints and flanges of the doors, fuses, etc., where dirt is likely to remain.

⚠ CAUTION

- When washing the underside of your vehicle or the wheels, wear a pair of rubber gloves to protect your hands.
- Never spray or splash water on the electrical parts in the engine compartment. This may damage them. Be careful also when washing the underbody. Do not spray water into the engine compartment.
- Avoid automatic car washes that use rotating brushes. These brushes may scratch the paint surface and make it dull. Scratches are more noticeable on darker colored vehicles.
- Some hot water washing equipment uses high pressure and heat to clean your vehicle. This heated water may damage your vehicle's resin parts. It can flood the interior of the vehicle. Therefore, be sure of the following:
 - Keep the washing nozzle at least 20 inches (50 cm) away from the vehicle body.
 - When washing around the door glass, hold the nozzle at a distance of more than 20 inches (50 cm) and at right angles to the glass surface.

⚠ CAUTION

- Make sure to do the following when using an automatic car wash, with help from either this manual or the car wash operator, to avoid damaging your vehicle:
 - Fold the outside mirrors.
 - Remove the antenna.
 - Tape or remove the rear wiper arm assembly.
 - If your vehicle is equipped with a rear spoiler or roof rails, check with the car wash operator before using the car wash.

During cold weather

Salt and other chemicals spread on winter roads in some geographical areas can have a detrimental effect on the vehicle underbody. You should flush the underbody with a high pressure hose every time you wash the outside of your vehicle.

Take special care to remove mud or other debris which could trap and hold salt and moisture.

After washing your vehicle, wipe off all water drops on the rubber parts around the doors to prevent the doors from freezing.

NOTE

- When the door is frozen, opening it by force may tear off or crack the rubber gasket installed around the door. Pour warm water to melt the ice. Be sure to thoroughly wipe off the water after opening the door. To prevent freezing of the weatherstripping on the doors, rest, etc. them with silicone lubricant.

Waxing

Wax your vehicle once or twice a year, or when water does not bead up on the paint.

Use a soft cloth to put a small amount of wax on the painted surfaces. After the wax has dried, polish with a dry soft cloth.

Do not wax your vehicle in direct sunlight.

You should wax when the painted surfaces are cool.

⚠ CAUTION

- Waxes containing high abrasive compounds should not be used. These waxes remove rust and stain effectively from the paintwork, but are harmful to the finish of the paint, because they also remove paint/clearcoat. They are also harmful to other glossy surfaces such as the grille, trim, moldings, etc.
- Do not use gasoline, kerosene, benzene or paint thinners to remove road tar or other dirt from the painted surface.
- Do not put wax on the areas having black matte coating because it can cause uneven discoloration, patches, blurs, etc. If these get wax on them, wipe the wax off right away with a soft cloth and warm water.
- On vehicles with sunroof, be careful not to apply any wax on the weatherstrip (black rubber) when waxing the area around the sunroof opening. If stained with wax, the weatherstrip cannot maintain a weatherproof seal with the sunroof.

Polishing

If painted surfaces have been severely damaged and lost their original luster and color tone, polish the surface lightly with a fine polishing compound. Avoid limiting your polishing to the damaged surface only; polish a somewhat wider area, moving the polishing cloth in one direction. After polishing, flush the compound from the surface and apply a coat of wax to regain a beautiful luster.

Damaged paint

Small cracks and scratches in the paint coat should be touched up as soon as possible with touch-up paint to prevent corrosion. Check body areas facing the road or the trees carefully for damage to the paint caused by flying stones, etc. The paint code number for your vehicle can be found on the vehicle information code plate in the engine compartment.

Cleaning plastic parts

Use a sponge or chambray to clean these parts. If a vehicle wax sticks to a gray or black rough surface at the bumper, molding or lights, the surface may appear white in color. In this case, wipe it off using lukewarm water and a soft cloth or chambray.

⚠ CAUTION

- Do not use a scrubbing brush or other rough scrubber as these may damage the plastic surface.
- Do not use wax containing compounds (polishing powder) which may damage the plastic surface.

⚠ CAUTION

- Do not let plastic parts get soiled with brake fluids, engine oils, greases, paint thinner, and sulfuric acid (battery electrolyte). These fluids, etc. may stain, crack or discolor the plastic parts.
- If any of these get on a plastic part, wipe them up with a soft cloth or chamois and a watery solution of gentle soap. Then rinse them immediately with water.

Chrome parts

To prevent spots and corrosion of chrome parts, wash with water, dry thoroughly, and apply a nonabrasive automotive wax. If the chrome is severely damaged or pitted, use a commercially available chrome polish.

Aluminum wheels (if so equipped)

The aluminum wheels have a protective coating. Clean the aluminum wheels with a cleaner made for use on aluminum and then use an appropriate protection agent.

⚠ CAUTION

- Do not use abrasive cleaners.
- Brushes may damage the aluminum wheel surface. Be sure to use a sponge, chamois, etc.
- Do not use hot water straight out of a steam cleaner on the wheel surface.
- Wheels soiled from sea water or road chemicals should be cleaned as soon as possible.

Window glass

The window glass can usually be cleaned using only a sponge and water. Glass cleaner can be used to remove wax, oil, grease, dead insects, etc. After washing the glass, wipe it dry with a clean, dry, soft cloth.

Wiper blades

Use a soft cloth and glass cleaner to remove grease, mud, insects, etc. from the wiper blades. Replace the wiper blades when they no longer clean the windshield and rear window properly.

Cleaning the sunroof (if so equipped)

Clean the inside of the sunroof with a soft cloth. Hard glass surfaces should be wiped away with a cloth dipped in warm, neutral detergent solution. Wipe away the solution with a sponge dipped in fresh water.

NOTE

- The surface treatment on the inside of the glass may be removed if a hard cloth or organic solvent is used.

Engine compartment

Never spray or splash water on the electrical components in the engine compartment, as this may cause damage.

Customer assistance/Reporting safety defects

Customer information

For vehicles sold in U.S.A. 8- 2

Reporting safety defects 8- 3

Important facts to know in case of an accident 8- 4

⋮

⋮

⋮

⋮

Consumer information (For vehicles sold in U.S.A.)

This information is provided in compliance with the requirements of the National Highway Traffic Safety Administration, Department of Transportation. It provides the purchasers and/or prospective purchasers with information on reporting safety defects.

Uniform tire quality grading

DOT quality grades - All passenger vehicle tires must conform to Federal Safety Requirements in addition to these grades. The specific grade rating in each grade category is shown on the sidewall of the tires on your vehicle.

Treadwear

The treadwear grade is a comparative rating based on the wear rate of the tire when tested under controlled conditions on a specified government test course. For example, a tire graded 150 would wear one and one-half (1 1/2) times as well on the government course as a tire graded 100. The relative performance of tires depends upon the actual conditions of their use, however, and may depart significantly from the norm due to variations in driving habits, service practices and differences in road characteristics and climate.

Traction AA, A, B, C

The traction grades, from highest to lowest, are AA, A, B and C. Those grades represent the tire's ability to stop on wet pavement as measured under controlled conditions on specified government test surfaces of asphalt and concrete. A tire marked C may have poor traction performance.

⚠ WARNING

- The traction grade assigned to this tire is based on straight-ahead braking traction tests, and does not include acceleration, cornering, hydroplaning, or peak traction characteristics.

Temperature A, B, C

The temperature grades, A (the highest), B and C, represent the tire's resistance to the generation of heat and its ability to dissipate heat when tested under controlled conditions on a specified rubber laboratory test wheel. Sustained high temperature can cause the material of the tire to degenerate and reduce tire life, and excessive temperature can lead to sudden tire failure. The grade C corresponds to a level of performance which all passenger car tires must meet under the Federal Motor Vehicle Safety Standard No. 109. Grades B and A represent higher levels of performance on the laboratory test wheel than the minimum required by law.

⚠ WARNING

- The temperature grade for this tire is established for a tire that is properly inflated and not overloaded. Excessive speed, underinflation, or excessive loading, either separately or in combination, can cause heat buildup and possible tire failure.

Reporting safety defects

For vehicles sold in U.S.A.

If you believe that your vehicle has a defect which could cause a crash or could cause injury or death, you should immediately inform the National Highway Traffic Safety Administration (NHTSA) in addition to notifying Mitsubishi Motor Sales of America, Inc.

If NHTSA receives similar complaints, it may open an investigation and, if it finds that a safety defect exists in a group of vehicles, it may order a recall and remedy campaign. However, NHTSA cannot become involved in individual problems between you, your dealer, or Mitsubishi Motor Sales of America, Inc.

To contact NHTSA, you may either call the Auto Safety Hotline toll free at 1-800-424-9393 or 366-0123 in the Washington D.C. area or write to:

**NHTSA, U.S. Department of Transportation
Washington D.C. 20590**

You can also obtain other information about motor vehicle safety from the Hotline:

To contact Mitsubishi Motor Sales of America, Inc. call 1-888-4MITSU (1-888-448-7876) or write to:

**Mitsubishi Motor Sales of America, Inc.
Customer Relations Department
P.O. Box 6014
Cypress, CA 90630-0064**

For vehicles sold in Canada

If you live in Canada, and you believe that your vehicle has a safety defect, you should immediately notify Transport Canada, in addition to notifying Mitsubishi Motor Sales of Canada, Inc. You may write to:

**Transport Canada
330 Sparks Street
Tower C
Ottawa, Ontario K1A 0N5**

To contact Mitsubishi Motor Sales of Canada, Inc. call 1-888-57-MITSU (1-888-576-4878) or write to:

**Mitsubishi Motor Sales of Canada, Inc.
Customer Relations Department
P.O. Box 41009
4141 Dixie Road
Mississauga, ON L4W 5C9**

Important facts to know in case of an accident

We hope you will never be involved in an accident, but there is always that potential danger. So, please be sure to buckle up and drive safely.

In the event of an accident

- Remain calm.
- Check for injuries. Report all injuries to the police, and, if necessary, call for an ambulance.
- Record all the details of the accident. This will provide you with accurate records of the collision for discussions with your insurance company and other persons who may be acting on your behalf.

Key information to discuss with your insurance company

- Understand your repair estimate before approving repairs.
- Choosing the repair shop and the brand of parts that they use on your vehicle is your decision.
- Ask for genuine Mitsubishi parts. Many times, to save money, your insurance company will recommend imitation parts that do not meet the original specifications of fit, finish, corrosion resistance or workmanship.

Mitsubishi built-in protection

The strength and integrity built into your Mitsubishi vehicle is the result of a special design referred to as "Energy Management". Individual body parts are designed to let energy in or the exact opposite. Shock waves are absorbed by protective panels or are channeled around the passenger compart-

ment. This important feature is possible because high tensile steel is used in Mitsubishi panels and structural parts, something that cannot be guaranteed by the manufacturers of imitation parts. All Genuine Mitsubishi body panels and support brackets are designed and constructed as important protective features in the event of an accident. By replacing body parts with imitations, your vehicle may no longer meet original equipment specifications.

Consumer rights (For vehicles sold in U.S.A.)

As a consumer requesting repair on your vehicle, you have consumer rights. Across the country, State Insurance Commissioners have begun considering rules on the use of non-OEM parts. This could mean that repair shops will have to disclose to the consumer when they intend to use non-OEM parts. Since regulations are not consistent on this point, remember you have a choice. So, if you want genuine Mitsubishi parts, you may have to specifically request them. Make certain your insurance company understands imitations are not to be used in the repair of your vehicle. You deserve the best genuine Mitsubishi parts.

Genuine Mitsubishi parts

Genuine Mitsubishi parts are built with the high quality and durability standards you expect. Genuine Mitsubishi replacements parts are your guarantee that your vehicle will have all the technological advantages and maintain the style and protection of a brand new Mitsubishi. Remember to ask for genuine Mitsubishi parts.

Specifications

Vehicle labelling	9- 2
Vehicle dimensions	9- 4
Vehicle weights	9- 5
Engine specifications	9- 6
Battery	9-
Tires and wheels	9- 7
Capacities	9- 8

Vehicle labeling

Keep a record of the classes number and vehicle identification number as such information will assist the police in your vehicle's safety.



1 - Vehicle emission control information label

The vehicle emission control information label is affixed on the underside of the engine hood.

2 - Vehicle identification number plate

This is stamped on the number plate riveted to the left front corner of the dashboard. It is visible from outside of the vehicle through the windshield.

3 - Vehicle information code plate

The vehicle information code plate is located on the bulkhead inside the engine compartment.

4 - Air conditioning label

The air conditioning label is affixed on the inside panel of the engine hood.

5 - Chassis number

The chassis number is stamped on the bulkhead as shown in the illustration.

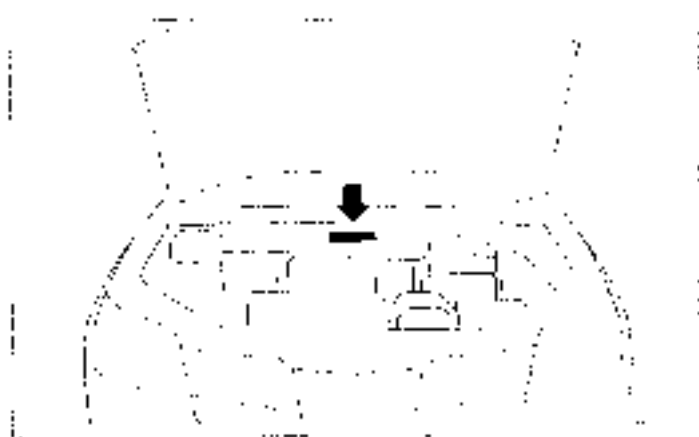

6 - Engine serial number

The engine serial number is stamped on the cylinder block as shown in the illustration.



Fig. 1 of the serial no.

7- Tire inflation pressure label

The tire inflation pressure label is located on the inside sill of the driver's door.

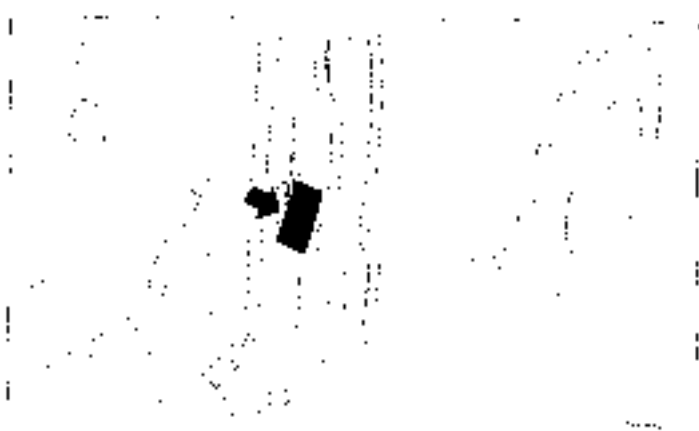

Specifications

8 - Certification label

The certification label is located on the driver's door sill.

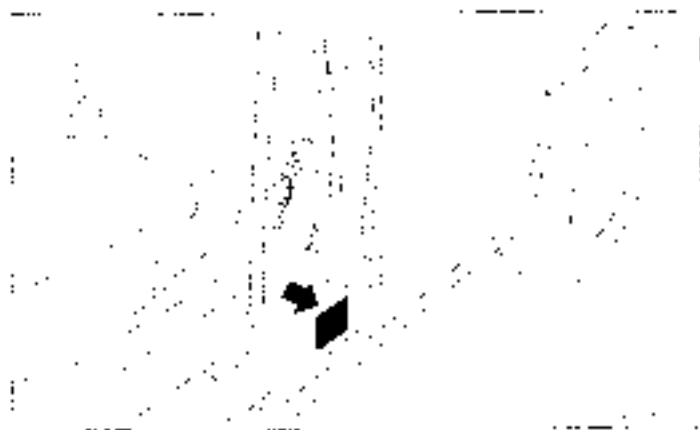

Vehicle dimensions

Overall length	1781 mm (17550 mm)
Overall width	683 mm (1750 mm)
Overall height	743 mm (1605 mm) 693 mm (1582 mm)*
Wheel base	1033 mm (2125 mm)

* Vehicle with roof rails

Vehicle weights

Item	Front-wheel drive	All-wheel drive
Gross vehicle weight rating	4,450 lb (2,020 kg)	4,505 lb (2,045 kg)
Gross axle weight rating	Front: 2,515 lb (1,140 kg) Rear: 2,428 lb (1,100 kg)	
Maximum load	110 lbs (50 kg)	
Seating capacity	2 persons	

NOTE:

- For cargo only. Refer to the section "Cargo loads must not" on page 47.

Engine specifications

Engine model		4004
Engine displacement		1434 cc (110 x 75.1 mm)
No. of cylinders and cylinder arrangement		4 in line
Bore		74.1 mm (2.916 in)
Stroke		75.1 mm (2.957 in)
Compression ratio		9.0
Thermostat valve opening temperature		190 ± 1 (358 ± 0.2 °C)
Spark plugs	NGK	0KR7L-11
	0Z-NX0	K16PR-11
	CHAMPION	BC-105C4
Spark plug gap		0.90 mm (0.0354 in) standard
Firing order		1-3-4-2
Ignition timing (idle speed, at start)		Refer to the "Vehicle emission control information" label on the driver's side door.

Battery

75D23L

Battery is 12 volt type

Tires and wheels

Tire	Type	Radial, tubeless	
	Size	P235/60R16-97H	
Wheel	Spare tire	1135-901016	
	Type	Aluminum	Steel
	Size	6 x 6.5	
	PCD	150 mm (14.3 mm)	
	Offset	151 mm (4.6 in)	

PCD: Pitch Circle Diameter (result from holes)

Capacities

Item	Capacity	Recommended Lubricants
Fuel (approximate)	15.7 gal (59.7 L)	
Engine oil	Oil pan 4.2 qt (4.0 L) Oil filter 3.2 qt (3.1 L)	Engine oils displaying JFSM certification symbol or containing the API classification SAE 10W/30 or SAE 15W/40
Power steering	1.1 qt (1.0 L)	Use only Mitsubishi Power Steering Fluid
Automatic transaxle	Front-wheel drive 8.1 qt (7.7 L) All-wheel drive 8.6 qt (8.1 L)	DIAMOND MILE SFI II
Transfer oil	0.5 qt (0.5 L)	Hypoid gear oil API classification of SAE 90
Dr. Covering	Rear axle 0.5 qt (0.5 L)	Hypoid gear oil API classification of SAE 90 Adeco 410, 1-25, C, SAE 80S5W, 90, 90W, 90 Fronco 30, 1-34, C, 10, 15, 15, C, SAE 80W, 90W, 90 Honey 30, 1-34, C, SAE 75W
Brake	As required	Consult to Brake fluid DB13 or DB14
Hood, lock and catch, door and luggage lock strikers, seat and center parking brake cable, rear transaxle linkage	As required	Multipurpose type grease NCF Grease 2
Door hinges, luggage hinges	As required	Lubricate
Engine coolant	2.3 qt (2.1 L) Inoperative qt (liters) for reserve tank	Long Life Antifreeze Coolant or its equivalent
Windshield washer fluid	2.3 qt (2.1 L)	
Refrigerant (air conditioning)	Refer to the air conditioning LBS on page 9-2	1013-14

A

- Accessory boxes 3-26
- Accessory socket 3-72
- Accessory installation 1-6
- Air bag 2-35
- Air cleaner filter 3-11
- Air conditioning:
 - Important operating tips for the air conditioning 3-14
 - Manual air conditioning 3-3
- All-wheel drive operation 3-40
- Aluminum wheels 7-55
- Antenna Whip antenna 3-20
- Anti-lock braking system 3-43
 - Warning light 3-43
- Armrest 2-19
- Audio:
 - XM electronically-tuned radio with CD player 3-15
 - Handling of compact discs 3-27
- Automatic transaxle 3-35
 - Fluid 7-15, 9-8
 - Select lever operation 3-33
 - Select lever positions 3-36
 - Sports mode 3-36

B

- Backup lights 7-37, 7-45
- Ball joint, steering linkage shaft, drive shaft boots 7-25
- Batteries 7-16

- Charging system warning light 3-59
- Checking battery electrolyte level 7-17
- Disconnecting and reconnecting 7-17
- During cold weather 7-17
- Specifications 9-7

Brake

- Anti-lock braking system 3-43
- Braking 2-6
- Fluid 7-15, 9-8
- Issue 7-27
- Pad wear alarm 3-42
- Parking brake 3-18
- Parking brake lever (stick) 7-24
- Pedal 3-43
- Pedal feedback 7-23
- Power brakes 3-42
- Service brake 3-42
- Warning light 3-38

Break-in recommendations 3-2

- Bulk capacity 7-27

C

- Capacitors 9-5
- Card holder 3-11
- Carpet light 4-7
- Catalytic converter 7-3
- CD tray accessory box 3-26
- Certification label 9-4
- Charging system warning light 3-59

Alphabetical index

Child restraints 2-25

Child proof on rear door locks 3-9

Cleaning

Inside of your vehicle 7-51

Outside of your vehicle 7-53

Clock 3-73

Compass 3-73

Consumer information

Reporting safety defects 8-3

Constant temperature 7-9, 9-8

Course control 3-46

Indicator light 3-47

Cup holder 3-80

D

Daytime running lights 3-61

Defogger (rear window) 3-69

Defrosting or defogging windshield, door windows 3-61

Dimensions 9-1

Dimmer (right low beam change) 3-62

Disc brake pads 7-27

Domestic light 3-74, 7-38, 7-50

Door and hinge hinges, hood lock release mechanism
and safety catch 7-29

Door ajar warning light 3-69

Doors

Lock 3-6

Power door locks 3-7

Drive belt 7-28

Driving during cold weather 1-5

Driving alcohol readings 2-7

E

Electric rear window defogger switch 3-69

Electronic inside rearview mirror 3-21

Emissions control system maintenance 7-25

Engine

Component 7-6

Coolant 7-9, 9-8

Coolant temperature gauge 3-20

Hood 7-1

Oil and oil filter 7-6, 9-8

Overheating 3-5

Serial number 3-3

Specifications 9-9

Use of engine only safety instructions 1-5

Euro cycles 3-25

Exhaust system 7-29

F

Floor console box 3-77

Flood

Automatic transmission 7-15, 9-8

brake fluid 7-15, 9-8

engine coolant 7-9, 9-8

power steering fluid 7-16, 9-8

washer fluid 7-14, 9-8

Fluid capacities and adjustments 9-8

fog light

- Bulb capacity 7-37

- Indicator 3-58

- Replacement 7-38

- Switch 3-65

- Front seat adjustment 7-1

- Front side-marker lights 7-37, 7-40

- Front turn signal lights 7-37, 7-41

Fuel

- Filling the fuel tank 4-2

- Fuel economy 4-2

- Fuel gauge 3-55

- Fuel hoses 7-26

- Fuel selection 4-2

- Low-fuel warning light 3-56

- Modification of elements to the electrical or fuel systems 4-7

- Tank capacity 3-68

- Fuse links 7-30

- Fuses 7-31

G

- Gauges 3-53, 3-57

- General maintenance

- Maintenance schedule 3-27

- General vehicle data 9-4

- Getting parts 4-5

- Glaze compound 3-17

H

- Handling of compact discs 3-2

- Hazard warning (Parker) switch 3-64

- Hazard warning lights 3-58

- Head restraint 7-10

- Headlights 7-37

- Dimmer 3-62

- Headlight (Parker) 3-63

- Replacement 7-39

- Switch 3-60

- High beam indicator 3-58

- Homework 3-20

I

- If the vehicle breaks down 9-2

- Ignition switch 3-27

- Indicator and warning light package 3-57

- Indicator lights 3-55

- Inside rear-view mirror 3-20

- Instrument cluster 3-55

- Insurance (panel light/dimmer control) 3-48

J

Jack

- Storage 6-6

- Jack-up the vehicle 6-5

- Jump-starting the engine 6-2

Alphabetical index

K

Key reminder buzzer 3-1, 3-28

Keyless-entry system 3-3

Keys 3-2

L

Landing 9-3

License plate lights 3-33, 3-49

Luggage 3-10

Low-fuel warning light 3-50

Lubricants 3-8

Luggage, floor boxes 3-81

 luggage bins 3-86

M

Malfunction indicator light 3-59

Manual air conditioning 3-3

Master

 electrochromic inside rearview mirror 3-21

 inside rearview mirror 3-20

 outside rearview mirrors 3-25

O

Octane rating 3-2

Odometer 3-54

Oil

 Engine oil 7-6

 Rear axle oil 7-14, 9-3

 Transfer oil 7-13, 9-3

Oil pressure warning light 3-60

Oil pressure warning 4-4

Operation under adverse driving conditions 6-15

Outside rearview mirrors 3-25

Overhauling 6-5

Oversize tires 3-10

P

Parking 4-6

 Parking brake 3-18

 Parking brake lever stroke 3-21

Parking lights 7-37, 7-41

Personal box 3-79

Polishing 7-51

Power brakes 3-21

Power door locks 3-7

Power steering

 Fluid 7-16, 9-3

 System 3-45

Power windows 3-12

Prepaid maintenance 2-23

Puncture tire changing 6-14

R

Radiator plenums 7-29

Radiator cap 7-6, 7-10

Radio

 XM/FM electronically tuned radio with CD player 3-15

 General information about your radio 3-30

Reaching lights 3-75, 7-38, 7-50

Rear axle oil 7-14, 9-8

Rear combination lights 7-37, 7-45

Rear shock absorbers 2-8

Rear side marker lights 7-37, 7-27

Rear turn signal lights 7-37, 7-45

Rear window defogger switch 3-69

Rearview mirror

 Inside 3-29

 Outside 3-28

Replacement of light bulbs 7-37

S

Safe driving for Engines 1-1

Seat 2-5

 Adjusters 3-10

 Front seats 2-3

 High restraints 2-19

 Heated seats 2-7

 Marking a car seat 2-12

 Rear seats 7-8

 Seat and restraint systems 2-7

Seat belt 3-16

 Adjustable seat belt shoulder anchor 3-21

 Child restraints 2-25

 Maintenance and inspection 7-34

 Pregnant women restraint 2-23

 Pre-tensioner 2-24

 Seat belt extender 2-23

 Seat belt reminder/warning light 3-60

 Three-point restraint system 7-17

Service brake 3-23

Service precautions 7-2

Side turn signal lights 7-37, 7-42

Snow tires 7-22

Spark plug 6-11

Spark plugs 7-20

Speedometer 3-54

Start button of automatic transmission vehicle with ambient temperature of 31°F (1.5°C) or more 3-31

Starting

 At extremely cold ambient temperature 3-31

 Floated engine 3-37

 Normal conditions 3-31

Steering

 Power steering fluid 7-16, 9-8

 Tie-rod ends 3-19

 Wheel Lcs 3-29

Stop lights 7-37, 7-45

Struts 3-71

Suicidal 3-15

Alphabetical index

Supplemental Restraint System 2-38

How the Supplemental Restraint System works 2-39

Maintenance 2-29

Servicing 2-52

Warning light 2-52

T

tachometer 3-51

Tail lights 2-31, 2-49

Tank capacity 3-68

Temperature display 3-22

Tire 2-11, 2-21

Tires 2-18

How to change a tire 2-14

Inflation pressure 2-8, 2-63

Maintenance 2-20

Overuse tires 2-20

Quality grades 2-2

Radial ply tires 2-20

Rotation 2-21

Sizing and wheel 2-2

Stove tires 2-22

Spare tire 2-11

Tire chains 2-23

Tread wear indicators 2-21

Tire wear cover 2-83

Tolls 2-7

Towing 2-12

Traction control 2-19

Transmission 2-13, 2-5

Trip odometer 2-54

Turn signal light

Indicators 2-58

Level 2-63

V

Vanity mirror 2-72

Vehicle care precautions 2-51

Vehicle dimensions 2-4

Vehicle latching 2-7

Vehicle preparation before towing 2-13

Vehicle weights 2-5

Vents 2-7

W

Warning lights 2-58

Washer

Fluid 2-14

Rear window washer 2-65

Switch 2-67

Washer fluid 2-8

Washing 2-37

Waxing 2-54

Weights 2-5

Wheel

Locks 2-18

Specification 2-2

Wheel antenna 2-29

Window

- Power windows 3-12

Wiper

- Rear window wiper 3-65

- See also 3-66

- Wiper blades 7-25

