



# 2017 QUEST

OWNER'S MANUAL  
and MAINTENANCE INFORMATION

For your safety, read carefully and keep in this vehicle.

# Foreword

Welcome to the growing family of new NISSAN owners. This vehicle is delivered to you with confidence. It was produced using the latest techniques and strict quality control.

This manual was prepared to help you understand the operation and maintenance of your vehicle so that you may enjoy many miles of driving pleasure. Please read through this manual before operating your vehicle.

**A separate Warranty Information Booklet explains details about the warranties covering your vehicle. Additionally, a separate Customer Care/Lemon Law Booklet (U.S. only) will explain how to resolve any concerns you may have with your vehicle, as well as clarify your rights under your state's lemon law.**

In addition to factory installed options, your vehicle may also be equipped with additional accessories installed by NISSAN or by your NISSAN dealer prior to delivery. It is important that you familiarize yourself with all disclosures, warnings, cautions and instructions concerning proper use of such accessories prior to operating the vehicle and/or accessory. It is recommended that you see a NISSAN dealer for details concerning the particular accessories with which your vehicle is equipped.

Your NISSAN dealer knows your vehicle best.

When you require any service or have any questions, we will be glad to assist you with the extensive resources available to us.

## READ FIRST — THEN DRIVE SAFELY

Before driving your vehicle, read your Owner's Manual carefully. This will ensure familiarity with controls and maintenance requirements, assisting you in the safe operation of your vehicle.



## WARNING

### IMPORTANT SAFETY INFORMATION REMINDERS!

Follow these important driving rules to help ensure a safe and comfortable trip for you and your passengers!

- **NEVER** drive under the influence of alcohol or drugs.
- **ALWAYS** observe posted speed limits and never drive too fast for conditions.
- **ALWAYS** give your full attention to driving and avoid using vehicle features or taking other actions that could distract you.
- **ALWAYS** use your seat belts and appropriate child restraint systems.

**Pre-teen children should be seated in the rear seat.**

- **ALWAYS** provide information about the proper use of vehicle safety features to all occupants of the vehicle.
- **ALWAYS** review this Owner's Manual for important safety information.

## MODIFICATION OF YOUR VEHICLE

This vehicle should not be modified. Modification could affect its performance, safety or durability, and may even violate governmental regulations. In addition, damage or performance problems resulting from modification may not be covered under NISSAN warranties.





## WARNING

**Installing an aftermarket On-Board Diagnostic (OBD) plug-in device that uses the port during normal driving, for example remote insurance company monitoring, remote vehicle diagnostics, telematics or engine reprogramming, may cause interference or damage to vehicle systems. We do not recommend or endorse the use of any aftermarket OBD plug-in devices, unless specifically approved by NISSAN. The vehicle warranty may not cover damage caused by any aftermarket plug-in device.**

### WHEN READING THE MANUAL

**This manual includes information for all features and equipment available on this model. Features and equipment in your vehicle may vary depending on model, trim level, options selected, order, date of production, region or availability. Therefore, you may find information about features or equipment that are not included or installed on your vehicle.**

All information, specifications and illustrations in this manual are those in effect at the time of

printing. NISSAN reserves the right to change specifications, performance, design or component suppliers without notice and without obligation. From time to time, NISSAN may update or revise this manual to provide owners with the most accurate information currently available. Please carefully read and retain with this manual all revision updates sent to you by NISSAN to ensure you have access to accurate and up-to-date information regarding your vehicle. Current versions of vehicle Owner's Manuals and any updates can also be found in the Owner section of the NISSAN website at <https://owners.nissanusa.com/nowners/navigation/manualsGuide>. If you have questions concerning any information in your Owner's Manual, contact NISSAN Consumer Affairs. See the NISSAN CUSTOMER CARE PROGRAM page in this Owner's Manual for contact information.

### IMPORTANT INFORMATION ABOUT THIS MANUAL

You will see various symbols in this manual. They are used in the following ways:



## WARNING

**This is used to indicate the presence of a hazard that could cause death or serious personal injury. To avoid or reduce the risk, the procedures must be followed precisely.**



## CAUTION

**This is used to indicate the presence of a hazard that could cause minor or moderate personal injury or damage to your vehicle. To avoid or reduce the risk, the procedures must be followed carefully.**

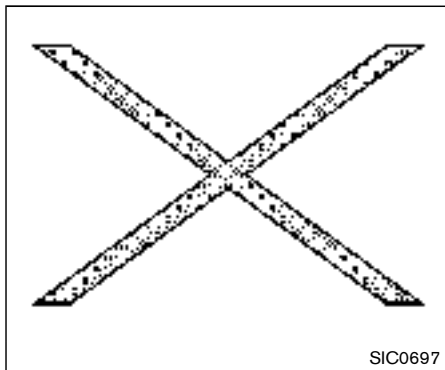

If you see the symbol above, it means **“Do not do this”** or **“Do not let this happen”**.

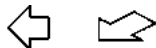

If you see a symbol similar to those above in an illustration, it means the arrow points to the front of the vehicle.



Arrows in an illustration that are similar to those above indicate movement or action.



Arrows in an illustration that are similar to those

above call attention to an item in the illustration.  
**CALIFORNIA PROPOSITION 65  
 WARNING**

**WARNING**

**Engine exhaust, some of its constituents, and certain vehicle components contain or emit chemicals known to the State of California to cause cancer and birth defects or other reproductive harm. In addition, certain fluids contained in vehicles and certain products of component wear contain or emit chemicals known to the State of California to cause cancer and birth defects or other reproductive harm.**

**CALIFORNIA PERCHLORATE ADVISORY**

**Some vehicle parts, such as lithium batteries, may contain perchlorate material. The following advisory is provided: “Perchlorate Material - special handling may apply, see [www.dtsc.ca.gov/hazardouswaste/perchlorate](http://www.dtsc.ca.gov/hazardouswaste/perchlorate).”**



Bluetooth® is a trademark owned by Bluetooth SIG, Inc. and licensed to Visteon Corporation and Clarion Co., Ltd.



SiriusXM Satellite Radio requires subscription, sold separately. Not available in Alaska, Hawaii or Guam. For more information, visit [www.siriusxm.com](http://www.siriusxm.com).

© 2016 NISSAN MOTOR CO., LTD.

All rights reserved. No part of this Owner’s Manual may be reproduced or stored in a retrieval system, or transmitted in any form, or by any means, electronic, mechanical, photocopying, recording or otherwise, without the prior written permission of Nissan Motor Co., Ltd.

## **NISSAN CUSTOMER CARE PROGRAM**

### **NISSAN CARES ...**

Both NISSAN and your NISSAN dealer are dedicated to serving all your automotive needs. Your satisfaction with your vehicle and your NISSAN dealer are our primary concerns. Your NISSAN dealer is always available to assist you with all your automobile sales and service needs.

We appreciate your interest in NISSAN and thank you for buying a quality NISSAN vehicle.

However, if there is something that your NISSAN dealer cannot assist you with or you would like to provide NISSAN directly with comments or questions, please contact the NISSAN Consumer Affairs Department using our toll-free number:

**For U.S. customers**

**1-800-NISSAN-1**

**(1-800-647-7261)**

**For Canadian customers**

**1-800-387-0122**

The Consumer Affairs Department will ask for the following information:

- Your name, address, and telephone number
- Vehicle identification number (attached to the top of the instrument panel on the driver's side)
- Date of purchase
- Current odometer reading
- Your NISSAN dealer's name
- Your comments or questions

OR

You can write to NISSAN with the information at:

**For U.S. customers**

**Nissan North America, Inc.**

**Consumer Affairs Department**

**P.O. Box 685003**

**Franklin, TN 37068-5003**

**or via e-mail at:**

**[nnaconsumeraffairs@nissan-usa.com](mailto:nnaconsumeraffairs@nissan-usa.com)**

**For Canadian customers**

**Nissan Canada Inc.**

**5290 Orbitor Drive**

**Mississauga, Ontario L4W 4Z5**

**or via e-mail at:**

**[information.centre@nissancanada.com](mailto:information.centre@nissancanada.com)**

If you prefer, visit us at:

**[www.nissanusa.com](http://www.nissanusa.com)**(for U.S. customers) or

**[www.nissan.ca](http://www.nissan.ca)**(for Canadian customers)

We appreciate your interest in NISSAN and thank you for buying a quality NISSAN vehicle.



# Table of Contents

<b>Illustrated table of contents</b>	<b>0</b>
<b>Safety — Seats, seat belts and supplemental restraint system</b>	<b>1</b>
<b>Instruments and controls</b>	<b>2</b>
<b>Pre-driving checks and adjustments</b>	<b>3</b>
<b>Monitor, heater, air conditioner, audio, phone and voice recognition systems</b>	<b>4</b>
<b>Starting and driving</b>	<b>5</b>
<b>In case of emergency</b>	<b>6</b>
<b>Appearance and care</b>	<b>7</b>
<b>Do-it-yourself</b>	<b>8</b>
<b>Maintenance and schedules</b>	<b>9</b>
<b>Technical and consumer information</b>	<b>10</b>
<b>Index</b>	<b>11</b>





# 0 Illustrated table of contents

Seats, seat belts and supplemental restraint system (SRS) .....	0-2	Instrument panel .....	0-7
Exterior front .....	0-3	Meters and gauges .....	0-8
Exterior rear .....	0-4	Engine compartment .....	0-9
Passenger compartment .....	0-5	VQ35DE engine .....	0-9
Cockpit .....	0-6	Warning and indicator lights .....	0-10

## SEATS, SEAT BELTS AND SUPPLEMENTAL RESTRAINT SYSTEM (SRS)

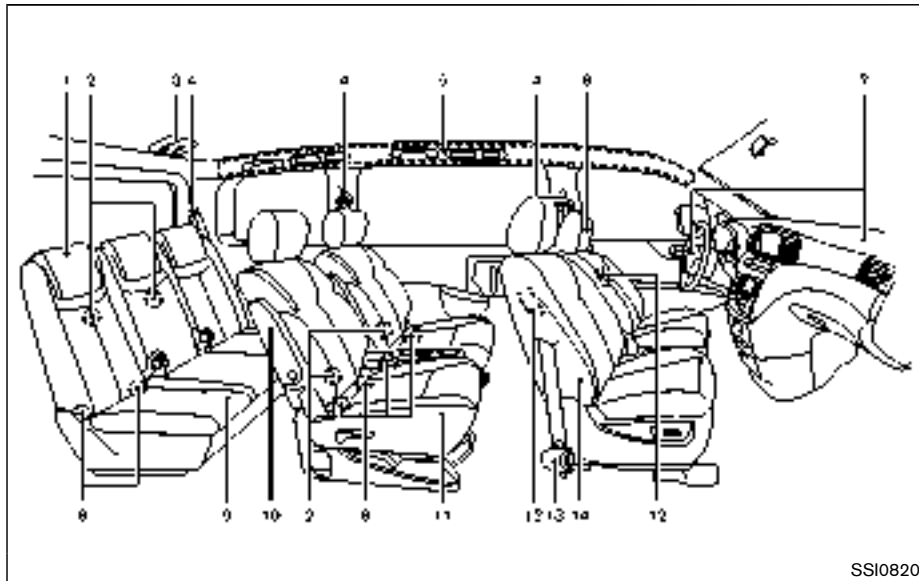

9. 3rd row seats (P.1-7)
  - Child restraints (P.1-27)
10. Armrest (2nd row seat) (P.1-7)
11. 2nd row seats (P.1-6)
  - Child restraints (P.1-27)
12. Front seat-mounted side-impact supplemental air bags (P.1-48)
13. Seat belt pretensioner (P.1-62)
14. Front seats (P.1-3)
  - Occupant classification sensors (weight sensors) (P.1-54)

- |  |   |
|--|---|
| <ol style="list-style-type: none"> <li>1. Non-adjustable head restraints/headrests (Page 1-10)</li> <li>2. Child restraint anchor points (for top tether strap child restraint) (P.1-32)</li> <li>3. Seat belt for 3rd row center seat (P.1-20)</li> <li>4. Seat belts (P.1-15)</li> </ol> | <ol style="list-style-type: none"> <li>5. Roof-mounted curtain side-impact supplemental air bags (P.1-48)</li> <li>6. Adjustable head restraints (P.1-10)           <ul style="list-style-type: none"> <li>— Front-seat Active Head Restraints (P.1-14)</li> </ul> </li> <li>7. Supplemental front-impact air bags (P.1-48)</li> <li>8. LATCH (Lower Anchors and Tethers for Children) system (P.1-29)</li> </ol> |
|--|---|

## EXTERIOR FRONT

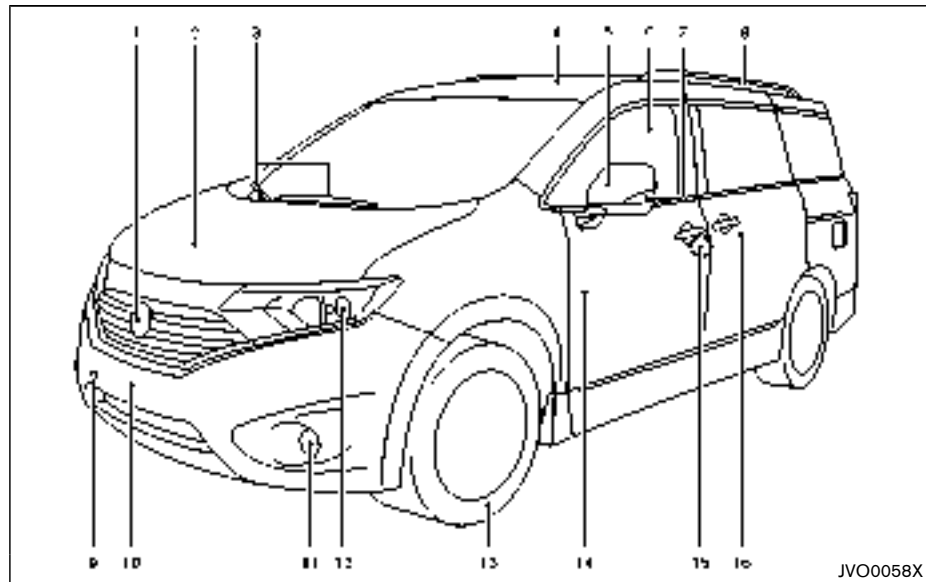

1. Front view camera\* (P.4-32)
2. Hood (P.3-25)
3. Windshield wiper and washer
  - Switch operation (P.2-31)
  - Blade replacement (P.8-14)
  - Window washer fluid (P.8-10)
4. Moonroof\* (P.2-54)
5. Outside mirrors (P.3-35)
  - Side view camera\* (P.4-32)
6. Power windows (P.2-52)
7. Side turn signal light\*
  - Switch operation (P.2-38)
  - Bulb replacement (P.8-24)
8. Roof rack (rail)\* (P.2-50)

9. Recovery hook (P.6-15)
  10. License plate installation (P.10-11)
  11. Fog lights\*
    - Switch operation (P.2-39)
    - Bulb replacement (P.8-24)
  12. Headlight and turn signal lights
    - Switch operation (P.2-34)
    - Bulb replacement (P.8-24)
  13. Tires
    - Wheel and tires (P.8-27, P.10-7)
    - Flat tire (P.6-3)
    - Tire Pressure Monitoring System (TPMS) (P.2-14, P.5-3)
  14. Doors
    - Keys (P.3-3)
    - Door locks (P.3-5)
    - Intelligent Key system (P.3-13)
    - Security system (P.2-28)
  15. Child safety rear door lock (P.3-9)
  16. Sliding doors (P.3-7)
- \*: if so equipped

## EXTERIOR REAR

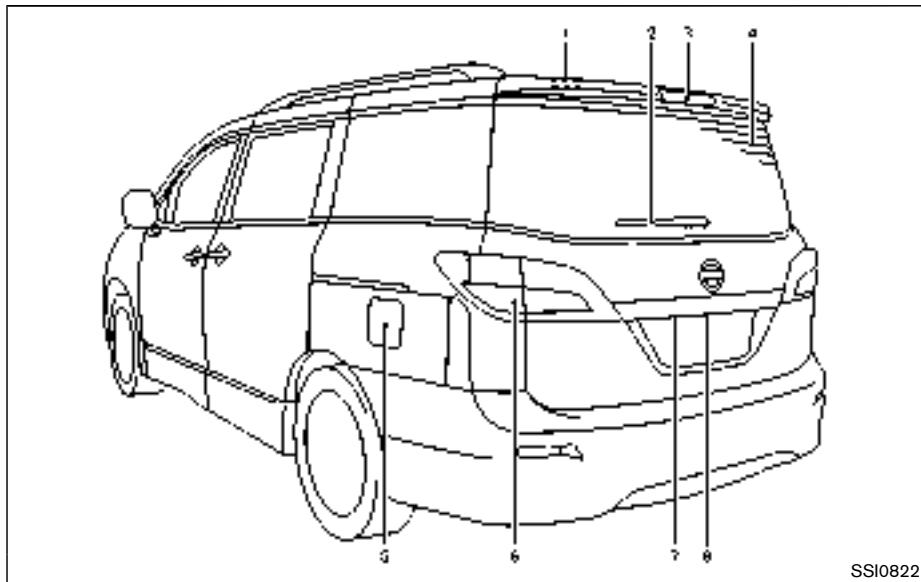

1. Antenna (P.4-109)
  - Satellite radio antenna\* (P.4-110)
2. Rear window wiper and washer
  - Switch operation (P.2-32)
  - Window washer fluid (P.8-10)
3. High-mounted stop light
  - Bulb replacement (P.8-24)
4. Rear window defroster (P.2-33)
5. Fuel-filler door
  - Operation (P.3-30)
  - Fuel information (P.10-3)
6. Rear combination light
  - Bulb replacement (P.8-24)

7. Rear view camera\*
  - RearView Monitor (P.4-25)
  - Around View<sup>®</sup> Monitor (P.4-32)
8. Liftgate (P.3-26)
  - Remote keyless entry system (P.3-21)
  - Intelligent Key system (P.3-13)

\*: if so equipped

## PASSENGER COMPARTMENT

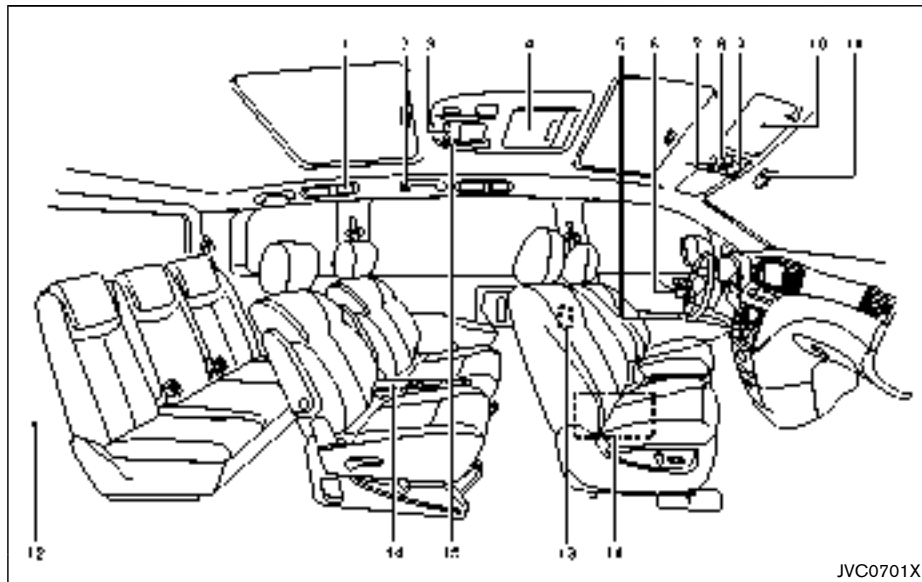

- |   |   |
|---|---|
| 1. Rear personal light (P.2-57)                     | — Outside mirror remote control switch (P.3-35) |
| 2. Coat hooks (P.2-51)                              |   |
| 3. Heater/Air conditioner rear controller* (P.4-47) | 6. Automatic drive positioner switch* (P.3-36)  |
| 4. Mobile Entertainment System (MES)* (P.4-110)     | 7. Moonroof switch* (P.2-54)                    |
| 5. Door armrest                                     | 8. Front map lights (P.2-57)                    |
| — Power window switch (P.2-52)                      | — Mood light (P.2-59)                           |
| — Power door lock switch (P.3-6)                    | 9. Sunglasses holder (P.2-46)                   |

- |   |
|---|
| 10. Sun visors (P.3-33)                     |
| 11. Inside rearview mirror (P.3-33)         |
| — HomeLink® universal transceiver* (P.2-60) |
| — Compass* (P.2-8)                          |
| 12. Cargo area                              |
| — Cargo floor box (P.2-48)                  |
| — Luggage hooks (P.2-49)                    |
| — Cargo light (P.2-60)                      |
| — Spare tire (P.6-6)                        |
| — Power outlet (P.2-42)                     |
| 13. Hooks (P.2-49)                          |
| 14. Console box (P.2-47)                    |
| — Power outlet* (P.2-42)                    |
| — Auxiliary input jacks* (P.4-106)          |
| — iPod® connector* (P.4-99)                 |
| — USB connector* (P.4-94)                   |
| — Cup holders (P.2-44)                      |
| 15. Rear moonroof switch* (P.2-56)          |
| *: if so equipped                           |

## COCKPIT

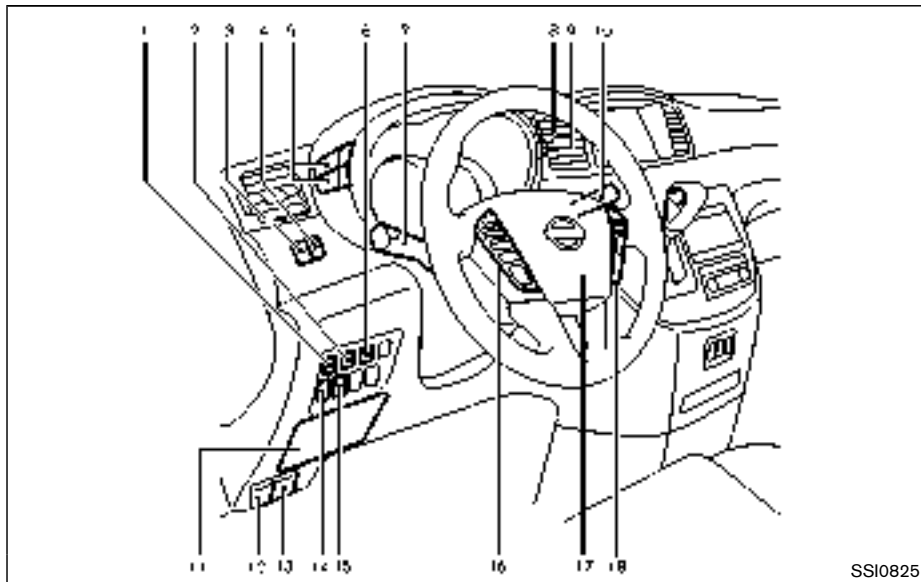

- |  |   |
|--|---|
| 1. Vehicle Dynamic Control (VDC) OFF switch (P.2-41)                                 | 6. Power liftgate switch* (P.3-26)  |
| 2. Blind Spot Warning (BSW) switch* (P.2-41)<br>— Blind Spot Warning (BSW)* (P.5-17) | 7. Headlight, fog light and turn signal switch<br>— Headlight (P.2-34)<br>— Turn signal (P.2-38)<br>— Fog light* (P.2-39) |
| 3. Sliding door switch* (driver's side) (P.3-10)                                     | 8. Trip computer switch (P.2-24)  |
| 4. Sliding door switch* (passenger's side) (P.3-10)                                  |   |
| 5. Instrument brightness control switch (P.2-38)                                     |   |

9. TRIP/RESET switch for twin trip odometer (P.2-6)
10. Wiper and washer switch (P.2-31)
11. Fuse box cover (P.8-18)
12. Fuel-filler door opener handle (P.3-30)
13. Hood release handle (P.3-25)
14. Headlight aiming control\* (P.2-37)
15. Power door main switch\* (P.3-10, P.3-27)
16. Steering-wheel-mounted controls (left side)  
— Audio control steering switch\* (P.4-108)  
— Hands-Free Phone System switch\* (P.4-122, P.4-133)
17. Horn (P.2-39)
18. Steering-wheel-mounted controls (right side)  
— Cruise control system (P.5-25)

\*: if so equipped

## INSTRUMENT PANEL

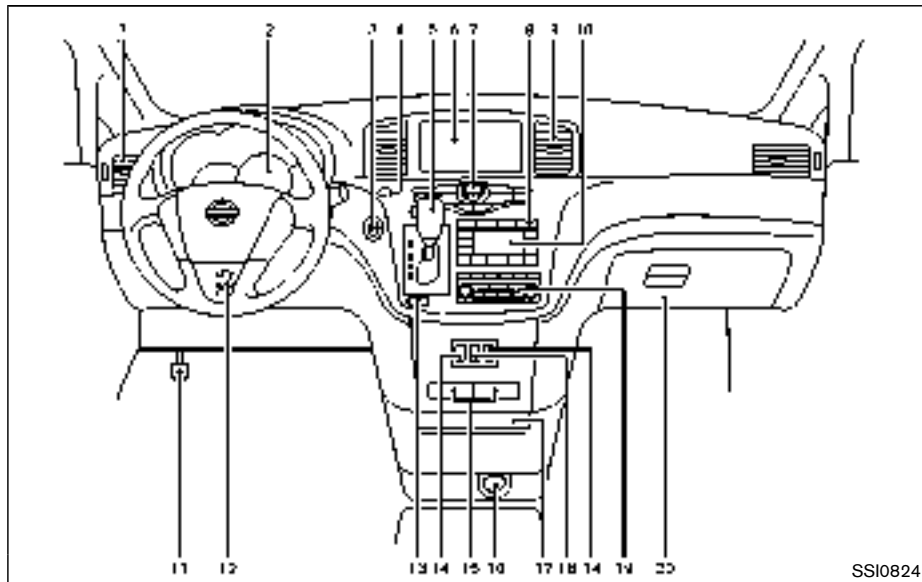

1. Side ventilator (P.4-46)
2. Meters and gauges (P.2-5)
3. Push-button ignition switch (P.5-8)
4. Hazard warning flasher switch (P.6-2)
5. Shift lever (P.5-13)
6. Center display
  - Center color display\* (P.4-5)
7. Center multi-function control panel\* (P.4-5)
  - Navigation system\*\*
  - Navigation system\*\*
  - Vehicle information and setting buttons\* (P.4-10)
  - RearView Monitor\* (P.4-25)
  - Around View<sup>®</sup> Monitor\* (P.4-32)

8. Rear window and outside mirror\* defroster switch (P.2-33)
  9. Center ventilator (P.4-46)
  10. Heater/air conditioner control (P.4-47) or audio system (P.4-61)
  11. Parking brake (P.5-16)
  12. Tilting telescopic steering wheel lever (P.3-32)
  13. Front passenger air bag status light (P.1-55)
  14. Heated seat switch\* (P.2-39)
  15. Cup holders (P.2-44)
  16. Power outlet (P.2-42)
  17. Instrument lower box (P.2-47) or CD/DVD slot (P.4-111)
  18. Power outlet main switch\* (P.2-42)
  19. Audio system (P.4-61)
  20. Glove box (P.2-47)
- \*: if so equipped
- \*\* : Refer to the separate Navigation System Owner's Manual (if so equipped).



## METERS AND GAUGES

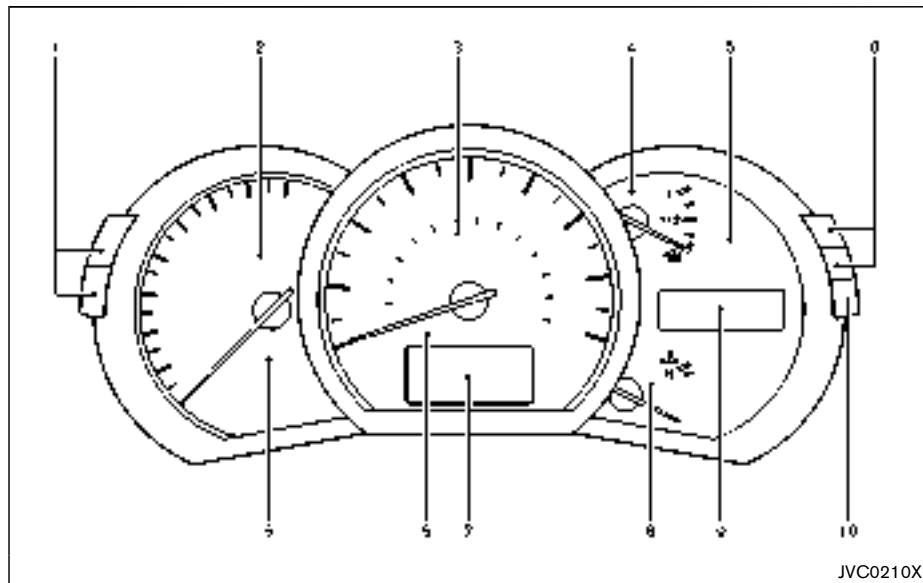

1. Instrument brightness control switch (P.2-38)
2. Tachometer (P.2-7)
3. Speedometer (P.2-6)
4. Fuel gauge (P.2-8)
5. Warning/indicator lights (P.2-11)
6. Trip computer switch (P.2-24)
7. Vehicle information display (P.2-19)
8. Engine coolant temperature gauge (P.2-7)
9. Odometer/twin trip odometer (P.2-6)/Continuously Variable Transmission (CVT) position indicator (P.2-16)
10. TRIP/RESET switch for twin trip odometer (P.2-6)



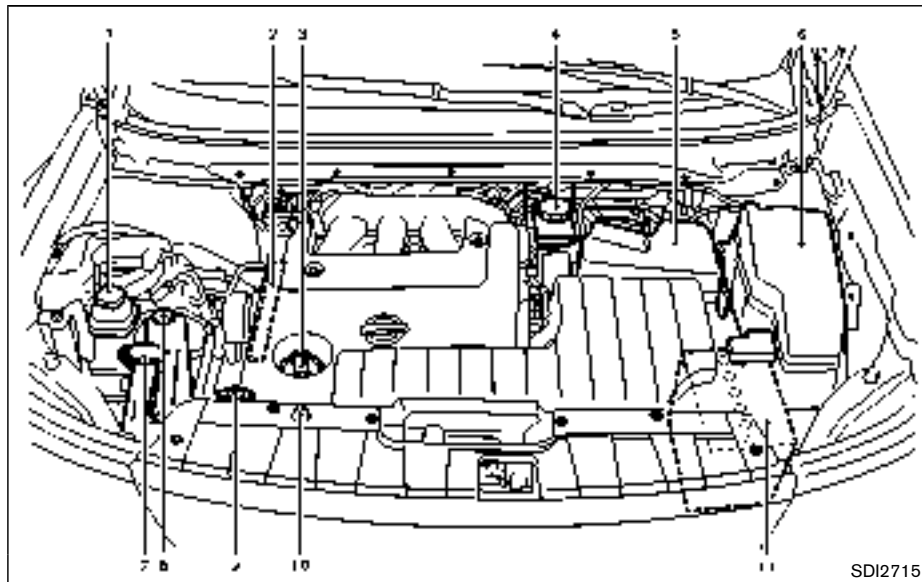









## ENGINE COMPARTMENT













### VQ35DE ENGINE

1. Power steering fluid reservoir (P.8-8)
2. Drive belt location (P.8-12)
3. Engine oil filler cap (P.8-5)
4. Brake fluid reservoir (P.8-9)
5. Air cleaner (P.8-14)
6. Fuse/fusible link holder (P.8-18)
7. Window washer fluid reservoir (P.8-10)
8. Engine coolant reservoir (P.8-4)
9. Radiator filler cap (P.8-4)
10. Engine oil dipstick (P.8-5)
11. Battery (P.8-10)

## WARNING AND INDICATOR LIGHTS

Warning light	Name	Page
	Anti-lock Braking System (ABS) warning light	2-12
	Blind Spot Warning (BSW) system warning light (if so equipped)	2-12
	Brake warning light	2-12
	Charge warning light	2-13
	Engine oil pressure warning light	2-13
	Hydraulic pump electric power steering warning light	2-13
	Intelligent Key system warning light	2-14
	Low tire pressure warning light	2-14
	Master warning light	2-15
	Seat belt warning light	2-15
	Supplemental air bag warning light	2-15
	Vehicle Dynamic Control (VDC) warning light	2-16

Indicator light	Name	Page
	Continuously Variable Transmission (CVT) position indicator light	2-16
	Cruise indicator light	2-16
	Exterior light indicator	2-17
	Front passenger air bag status light	2-17
	High beam indicator light	2-17
	Malfunction Indicator Light (MIL)	2-17
	Overdrive off indicator light	2-18
	Security indicator light	2-18
	Turn signal/hazard indicator lights	2-18
	Vehicle Dynamic Control (VDC) off indicator light	2-18

# 1 Safety — Seats, seat belts and supplemental restraint system

Seats .....	1-2	Child restraints .....	1-27
Front seats .....	1-3	Precautions on child restraints .....	1-27
2nd row seats .....	1-6	Lower Anchors and Tethers for Children System (LATCH) .....	1-29
3rd row seats .....	1-7	Top tether strap child restraint .....	1-32
Armrests .....	1-7	Rear-facing child restraint installation using LATCH .....	1-32
Flexible seating .....	1-8	Rear-facing child restraint installation using the seat belts .....	1-34
Head restraints/headrests .....	1-10	Forward-facing child restraint installation using LATCH .....	1-37
Adjustable head restraint/headrest components .....	1-11	Forward-facing child restraint installation using the seat belt .....	1-40
Non-adjustable head restraint/headrest components .....	1-12	Booster seats .....	1-45
Remove .....	1-12	Supplemental restraint system .....	1-48
Install .....	1-12	Precautions on supplemental restraint system .....	1-48
Adjust .....	1-13	NISSAN advanced air bag system (front seats) .....	1-54
Front-seat Active Head Restraint .....	1-14	Front seat-mounted side-impact supplemental air bag and roof-mounted curtain side-impact supplemental air bag systems .....	1-61
Seat belts .....	1-15	Seat belts with pretensioners (front seats) .....	1-62
Precautions on seat belt usage .....	1-15	Supplemental air bag warning labels .....	1-63
Pregnant women .....	1-17	Supplemental air bag warning light .....	1-64
Injured persons .....	1-17	Repair and replacement procedure .....	1-64
Three-point type seat belt .....	1-17		
Seat belt extenders .....	1-23		
Seat belt maintenance .....	1-24		
Child safety .....	1-24		
Infants .....	1-25		
Small children .....	1-25		
Larger children .....	1-26		

## SEATS

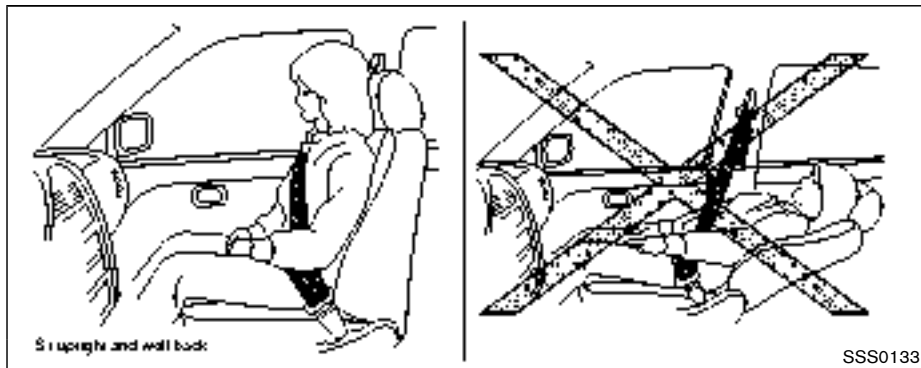

### WARNING

- Do not ride in a moving vehicle when the seatback is reclined. This can be dangerous. The shoulder belt will not be against your body. In an accident, you could be thrown into it and receive neck or other serious injuries. You could also slide under the lap belt and receive serious internal injuries.
- For the most effective protection when the vehicle is in motion, the seat should be upright. Always sit

well back and upright in the seat with both feet on the floor and adjust the seat belt properly. See "Precautions on seat belt usage" (P.1-15).

- After adjustment, gently rock in the seat to make sure it is securely locked.
- Do not leave children unattended inside the vehicle. They could unknowingly activate switches or controls. Unattended children could become involved in serious accidents.

- To help avoid risk of injury or death through unintended operation of the vehicle and/or its systems, do not leave children, people who require the assistance of others or pets unattended in your vehicle. Additionally, the temperature inside a closed vehicle on a warm day can quickly become high enough to cause a significant risk of injury or death to people and pets.
- Do not adjust the driver's seat while driving so full attention may be given to vehicle operation. The seat may move suddenly and could cause loss of control of the vehicle.
- The seatback should not be reclined any more than needed for comfort. Seat belts are most effective when the passenger sits well back and straight up in the seat. If the seatback is reclined, the risk of sliding under the lap belt and being injured is increased.

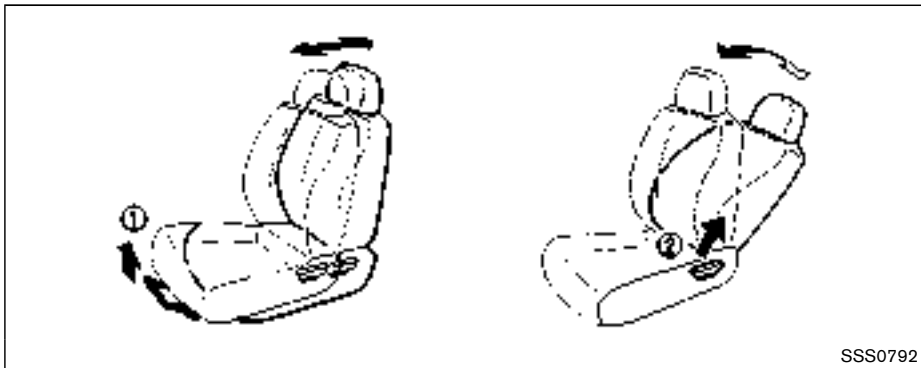

## FRONT SEATS

### Front manual seat adjustment

#### **Forward and backward:**

Pull the lever ① up and hold it while you slide the seat forward or backward to the desired position. Release the lever to lock the seat in position.

#### **Reclining:**

To recline the seatback, pull the lever ② up and lean back. To bring the seatback forward, pull the lever up and lean your body forward. Release the lever to lock the seatback in position.

The reclining feature allows adjustment of the

seatback for occupants of different sizes for added comfort and to help obtain proper seat belt fit. (See "Precautions on seat belt usage" (P.1-15).) Also, the seatback can be reclined to allow occupants to rest when the vehicle is stopped and the transmission in the P (Park) position.

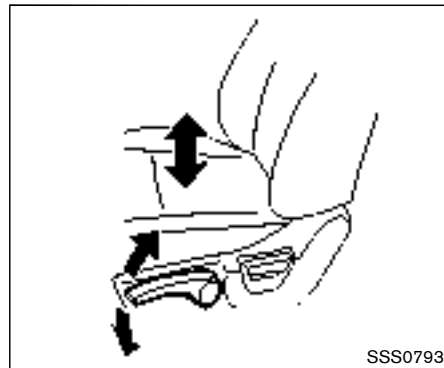

#### **Seat lifter (if so equipped):**

Pull up or push down the adjusting lever to adjust the seat height until the desired position is achieved.

## Front power seat adjustment

### Operating tips:

- The power seat motor has an auto-reset overload protection circuit. If the motor stops during operation, wait 30 seconds, then reactivate the switch.
- Do not operate the power seat switch for a long period of time when the engine is off. This will discharge the battery.

See “Automatic drive positioner” (P.3-36) for the seat position memory function (if so equipped).



### CAUTION

**When adjusting the seat positions, be sure not to contact any moving parts to avoid possible injuries and/or damages.**

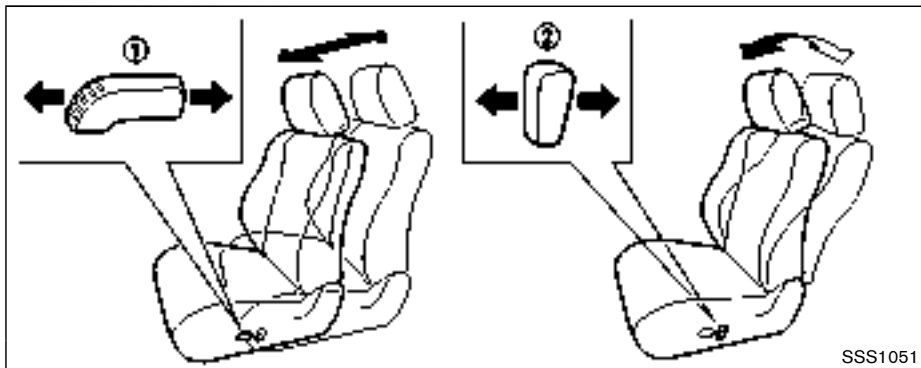

### Forward and backward:

Moving the switch ① forward or backward will slide the seat forward or backward to the desired position.

### Reclining:

Move the recline switch ② backward until the desired angle is obtained. To bring the seatback forward again, move the switch ② forward.

The reclining feature allows adjustment of the seatback for occupants of different sizes for added comfort and to help obtain proper seat belt fit. (See “Precautions on seat belt usage” (P.1-15).) Also, the seatback can be reclined to allow occupants to rest when the vehicle is

stopped and the transmission is in the P (Park) position.

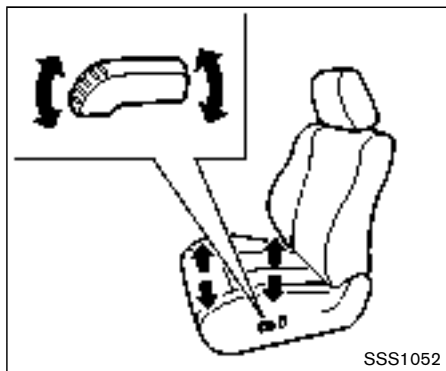

**Seat lifter (if so equipped):**

1. Pull up or push down the adjusting switch to adjust the seat height until the desired position is achieved.
2. Tilt up or down the adjusting switch to adjust the front angle of the seat until the desired position is achieved (for driver's seat).

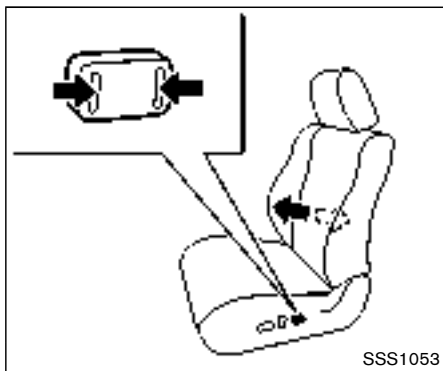

**Lumbar support (if so equipped):**

- The lumbar support feature provides lower back support to the occupants.
- Push the front or back end of the switch to adjust the seatback lumbar area.



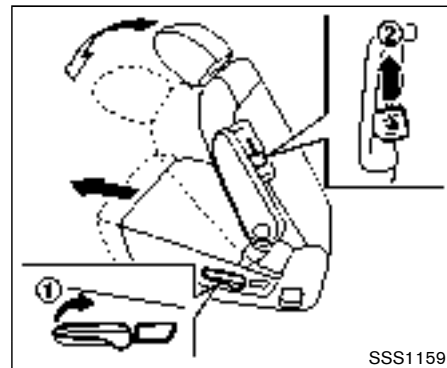
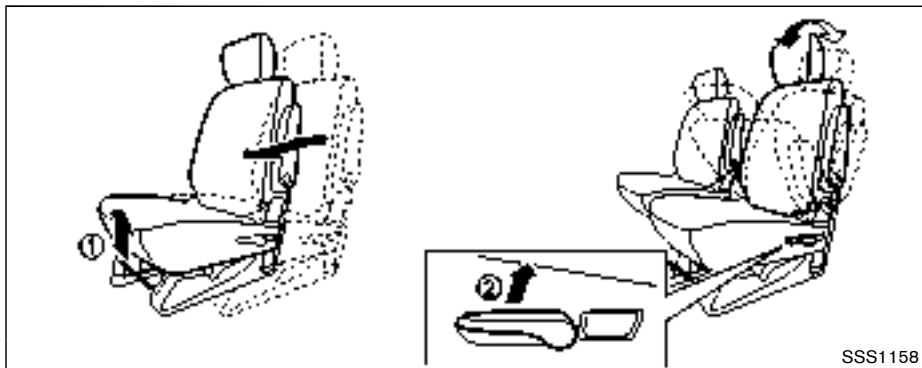

## 2ND ROW SEATS

### Seat adjustment

#### **WARNING**

- **The 2nd row seats are heavy. Be careful when folding and unfolding.**
- **To avoid injury to yourself and others, keep hands and body clear when folding.**

#### **Forward and backward:**

Pull the lever ① up and hold it while you slide the seat forward or backward to the desired

position. Release the lever to lock the seat in position.

#### **Reclining:**

To recline the seatback, pull the lever ② up and lean back. To bring the seatback forward, pull the lever up and lean your body forward. Release the lever to lock the seatback in position.

The reclining feature allows adjustment of the seatback for occupants of different sizes for added comfort and to help obtain proper seat belt fit. (See “Precautions on seat belt usage” (P.1-15).) Also, the seatback can be reclined to allow occupants to rest when the vehicle is stopped and the transmission in the P (Park) position.

### Entry to the 3rd row seat

The 2nd row seats can tilt and slide forward for easy entry/exit to/from the 3rd row seats.

To enter or exit the 3rd row seat, pull up the lever ① or ② to tilt down the seatback and slide the seat forward.

Return and lock the 2nd row seats by sliding the seats to the rearmost position and tilting up the seatback after use.

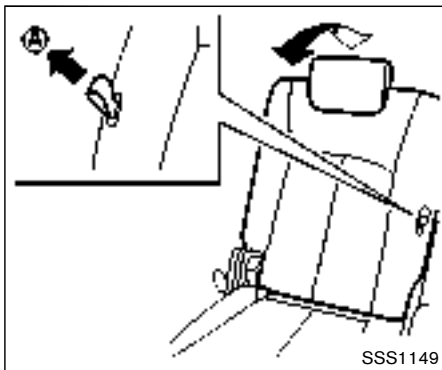

### 3RD ROW SEATS

#### Reclining

Pull the strap on the seatback (A) and lean back. Release the strap at the desired angle.

The reclining feature allows adjustment of the seatback for occupants of different sizes to help obtain proper seat belt fit. (See "Precautions on seat belt usage" (P.1-15).) The seatback may also be reclined to allow occupants to rest when the vehicle is parked.

### WARNING

- After adjustment, check to be sure the seat is securely locked.
- Do not ride in a moving vehicle when the seatback is reclined. This can be dangerous. The shoulder belt will not be against your body. In an accident, you could be thrown into it and receive neck or other serious injuries. You could also slide under the lap belt and receive serious internal injuries.
- For the most effective protection when the vehicle is in motion, the seat should be upright. Always sit well back and upright in the seat with both feet on the floor and adjust the seat belt properly. See "Precautions on seat belt usage" (P.1-15).



Front and 2nd row seats

### ARMRESTS

#### Front and 2nd row seats

To use the armrests on any seat, pull them down to the resting position.

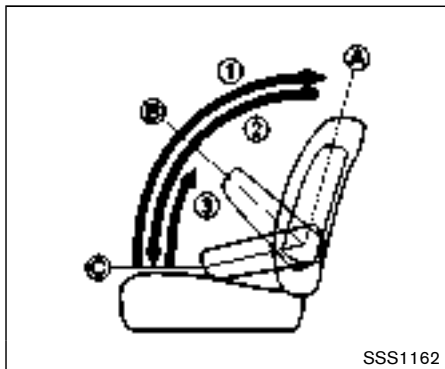

SSS1162

The armrest angle can be adjusted freely.

- ① Pull the armrest between **(A)** and **(B)** .
- ② Pull it down to **(C)** .
- ③ Pull up the armrest slowly, it can be secured between **(B)** and **(C)** .

## FLEXIBLE SEATING

### **WARNING**

- Never allow anyone to ride in the cargo area or on the rear seats when they are in the fold-down position. In a collision, people riding in these areas without proper restraints are more likely to be seriously injured or killed.
- Do not allow people to ride in any area of your vehicle that is not equipped with seats and seat belts. Be sure everyone in your vehicle is in a seat and using a seat belt properly.
- Do not fold down the rear seats when occupants are in the rear seat area or any cargo is on the rear seats.
- Head restraints and headrests should be adjusted properly as they may provide significant protection against injury in an accident. Always replace and adjust them properly if they have been removed for any reason.

- If the head restraints/headrests are removed for any reason, they should be securely stored to prevent them from causing injury to passengers or damage to the vehicle in case of sudden braking or an accident.
- When returning the seatbacks to the upright position, be certain they are completely secured in the latched position. If they are not completely secured, passengers may be injured in an accident or sudden stop.
- Properly secure all cargo to help prevent it from sliding or shifting. Do not place cargo higher than the seatbacks. In a sudden stop or collision, unsecured cargo could cause personal injury.

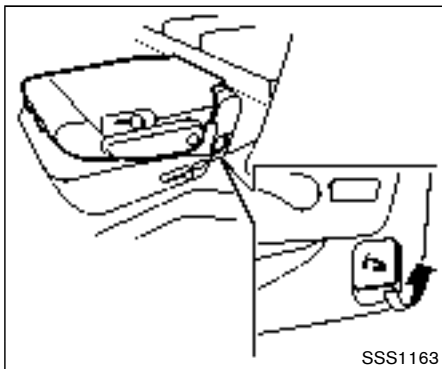

### Folding the 2nd row seats

#### **Before folding the rear seats:**

Secure the seat belts on the seat belt hooks on the side wall. (See "Seat belt hooks" (P.1-23).)

#### **To fold down the seatbacks:**

Pull the lever on the 2nd row seat.

#### **To return the seatbacks:**

Lift up each seatback and push it to the upright position until it is latched.

## CAUTION

When folding the 2nd row seat for maximum cargo hauling, be sure that cargo does not contact the center console of the 2nd row seat to avoid possible damage to the console.

### Folding the 3rd row seats

#### **Before folding the 3rd row seats:**

- Secure the seat belts on the seat belt hooks on the side wall. (See "Seat belt hooks" (P.1-23).)
- Disconnect and stow the center seat belt and tongue into the retractor base. (See "3rd row center seat belt" (P.1-20).)
- Always reconnect the center seat belt when the seat is returned to the upright position.
- Remove drink containers from the rear cup holder.

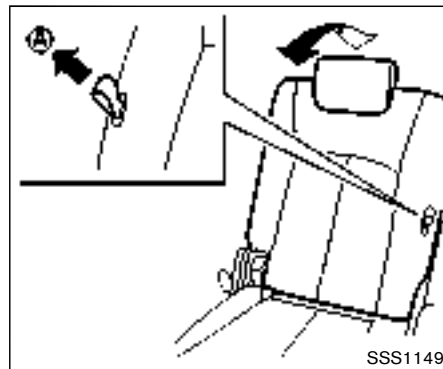

Third row seatback

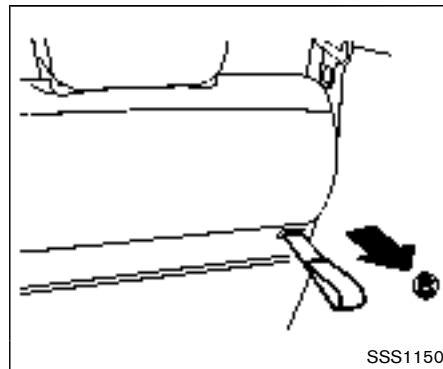

Back side of the third row seatback

## HEAD RESTRAINTS/HEADRESTS

### Manual folding:

Pull the strap on the seatback (A) or on the back side of the seatback (B) and fold the seatback.

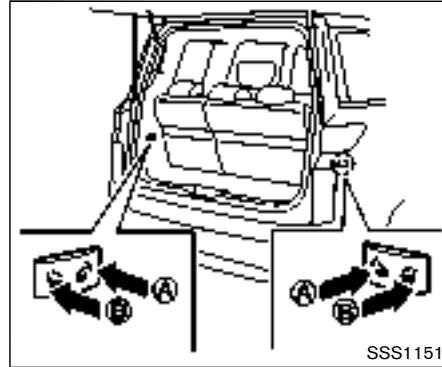

### Power folding (if so equipped):

Push the front side of the switch (A) located on the right side or left side of the cargo area. The corresponding 3rd row seatback will be folded down automatically.

Push and hold the rear side of the switch (B). The 3rd row seatback will be returned automatically. A beep sounds and the rear seatback will rise up while holding the switch. A beep sounds when the seatback is fully returned in position.

## WARNING

Head restraints/headrests supplement the other vehicle safety systems. They may provide additional protection against injury in certain rear end collisions. Adjustable head restraints/headrests must be adjusted properly, as specified in this section. Check the adjustment after someone else uses the seat. Do not attach anything to the head restraint/headrest stalks or remove the head restraint/headrest. Do not use the seat if the head restraint/headrest has been removed. If the head restraint/headrest was removed, reinstall and properly adjust the head restraint/headrest before an occupant uses the seating position. Failure to follow these instructions can reduce the effectiveness of the head restraint/headrest. This may increase the risk of serious injury or death in a collision.

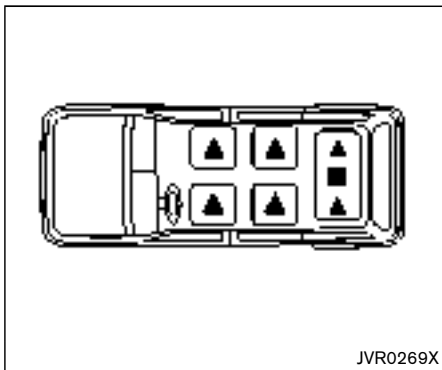

The illustration shows the seating positions equipped with head restraint/headrest.

▲ Indicates the seating position is equipped with a head restraint.

■ Indicates the seating position is equipped with a headrest.

+ Indicates the seating position is not equipped with a head restraint or headrest. (if applicable)

- Your vehicle is equipped with a head restraint/headrest that may be integrated, adjustable or non-adjustable.
- Adjustable head restraints/headrests have multiple notches along the stalk to lock them in a desired adjustment position.

- The non-adjustable head restraints/headrests have a single locking notch to secure them to the seat frame.
- Proper Adjustment:
  - For the adjustable type, align the head restraint/headrest so the center of your ear is approximately level with the center of the head restraint/headrest.
  - If your ear position is still higher than the recommended alignment, place the head restraint/headrest at the highest position.
- If the head restraint/headrest has been removed, ensure that it is reinstalled and locked in place before riding in that designated seating position.

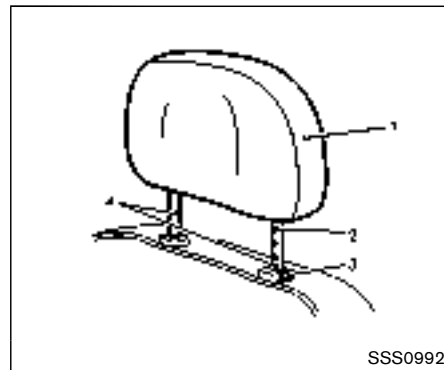

#### ADJUSTABLE HEAD RESTRAINT/ HEADREST COMPONENTS

1. Removable head restraint/headrest
2. Multiple notches
3. Lock knob
4. Stalks

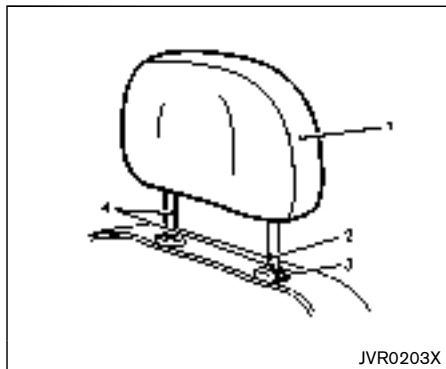

JVR0203X

### NON-ADJUSTABLE HEAD RESTRAINT/HEADREST COMPONENTS

1. Removable head restraint/headrest
2. Single notch
3. Lock knob
4. Stalks

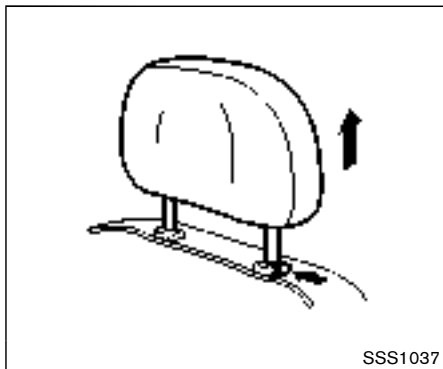

SSS1037

### REMOVE

Use the following procedure to remove the head restraint/headrest.

1. Pull the head restraint/headrest up to the highest position.
2. Push and hold the lock knob.
3. Remove the head restraint/headrest from the seat.
4. Store the head restraint/headrest properly in a secure place so it is not loose in the vehicle.
5. Reinstall and properly adjust the head restraint/headrest before an occupant uses the seating position.

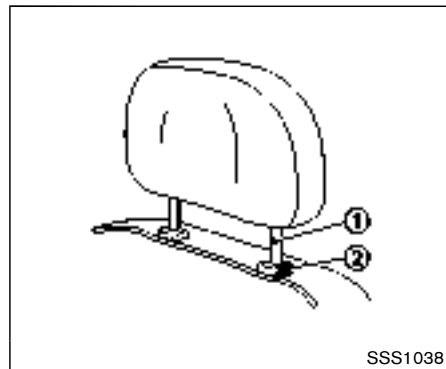

SSS1038

### INSTALL

1. Align the head restraint/headrest stalks with the holes in the seat. Make sure that the head restraint/headrest is facing the correct direction. The stalk with the adjustment notch ① must be installed in the hole with the lock knob ②.
2. Push and hold the lock knob and push the head restraint/headrest down.
3. Properly adjust the head restraint/headrest before an occupant uses the seating position.

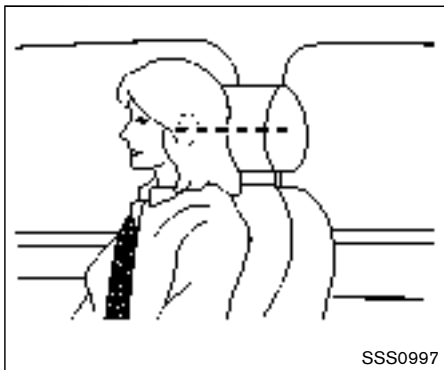

## ADJUST

### For adjustable head restraint/headrest

Adjust the head restraint/headrest so the center is level with the center of your ears. If your ear position is still higher than the recommended alignment, place the head restraint/headrest at the highest position.

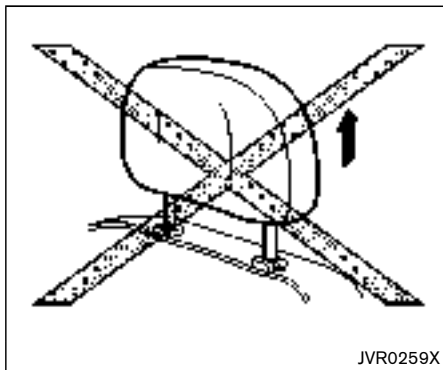

### For non-adjustable head restraint/headrest

Make sure the head restraint/headrest is positioned so the lock knob is engaged in the notch before riding in that designated seating position.

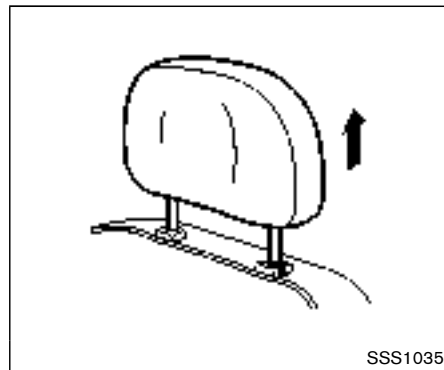

## Raise

To raise the head restraint/headrest, pull it up. Make sure the head restraint/headrest is positioned so the lock knob is engaged in the notch before riding in that designated seating position.



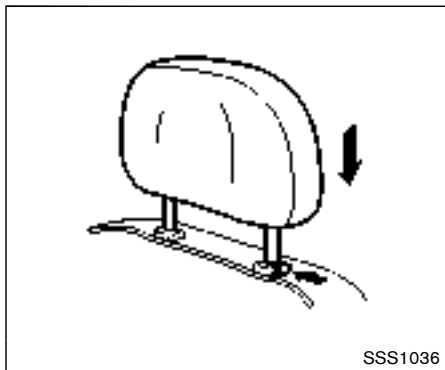

#### Lower

To lower, push and hold the lock knob and push the head restraint/headrest down.

Make sure the head restraint/headrest is positioned so the lock knob is engaged in the notch before riding in that designated seating position.

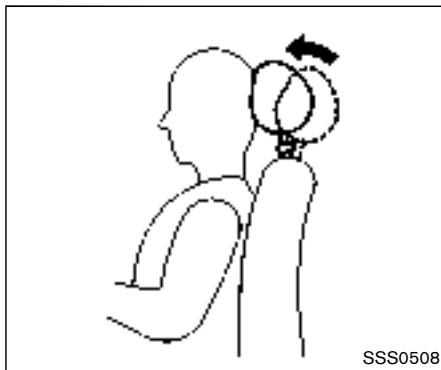

#### FRONT-SEAT ACTIVE HEAD RESTRAINT

The Active Head Restraint moves forward utilizing the force that the seatback receives from the occupant in a rear-end collision. The movement of the head restraint helps support the occupant's head by reducing its backward movement and helping absorb some of the forces that may lead to whiplash-type injuries.

Active Head Restraints are effective for collisions at low to medium speeds in which it is said that whiplash injury occurs most.

Active Head Restraints operate only in certain rear-end collisions. After the collision, the head restraints return to their original position.

Adjust the Active Head Restraints properly as described earlier in this section.

## SEAT BELTS

### PRECAUTIONS ON SEAT BELT USAGE

If you are wearing your seat belt properly adjusted, and you are sitting upright and well back in your seat with both feet on the floor, your chances of being injured or killed in an accident and/or the severity of injury may be greatly reduced. NISSAN strongly encourages you and all of your passengers to buckle up every time you drive, even if your seating position includes a supplemental air bag.

**Most U.S. states and Canadian provinces or territories specify that seat belts be worn at all times when a vehicle is being driven.**

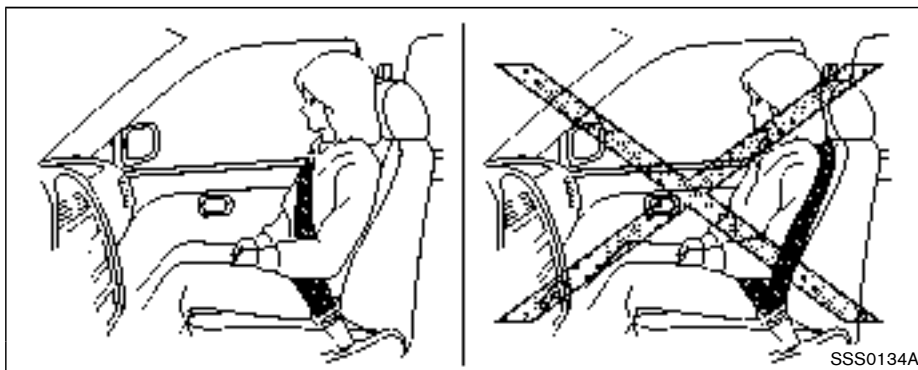
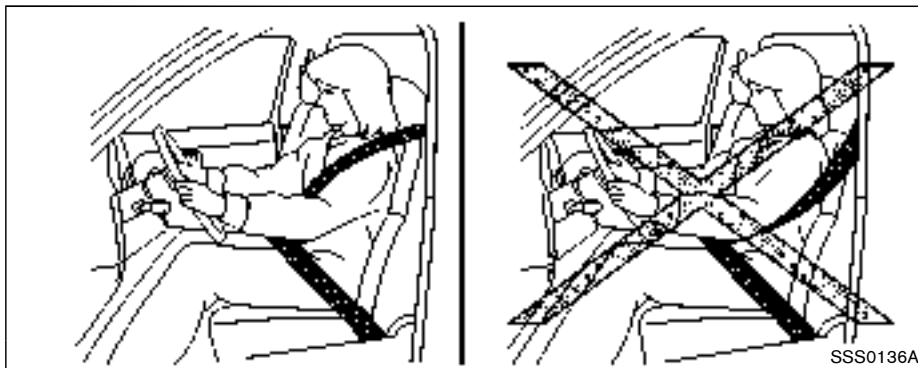



## WARNING

- Every person who drives or rides in this vehicle should use a seat belt at all times. Children should be properly restrained in the rear seat and, if appropriate, in a child restraint.
- The seat belt should be properly adjusted to a snug fit. Failure to do so may reduce the effectiveness of the entire restraint system and increase the chance or severity of injury in an accident. Serious injury or death can occur if the seat belt is not worn properly.
- Always route the shoulder belt over your shoulder and across your chest. Never put the belt behind your back, under your arm or across your neck. The belt should be away from your face and neck, but not falling off your shoulder.
- Position the lap belt as low and snug as possible **AROUND THE HIPS, NOT THE WAIST**. A lap belt worn too high could increase the risk of internal injuries in an accident.

- Be sure the seat belt tongue is securely fastened to the proper buckle.
- Do not wear the seat belt inside out or twisted. Doing so may reduce its effectiveness.
- Do not allow more than one person to use the same seat belt.
- Never carry more people in the vehicle than there are seat belts.
- If the seat belt warning light glows continuously while the ignition is turned ON with all doors closed and all seat belts fastened, it may indicate a malfunction in the system. Have the system checked. It is recommended you visit a NISSAN dealer for this service.
- No changes should be made to the seat belt system. For example, do not modify the seat belt, add material or install devices that may change the seat belt routing or tension. Doing so may affect the operation of the seat belt system. Modifying or tampering with the seat belt system may result in serious personal injury.

- Once a seat belt pretensioner has activated, it cannot be reused and must be replaced together with the retractor. It is recommended you visit a NISSAN dealer for this service.
- All seat belt assemblies, including retractors and attaching hardware, should be inspected after any collision. It is recommended you visit a NISSAN dealer for this service. NISSAN recommends that all seat belt assemblies in use during a collision be replaced unless the collision was minor and the belts show no damage and continue to operate properly.  
  
Seat belt assemblies not in use during a collision should also be inspected and replaced if either damage or improper operation is noted.
- All child restraints and attaching hardware should be inspected after any collision. Always follow the restraint manufacturer's inspection instructions and replacement recommendations. The child restraints should be replaced if they are

damaged.

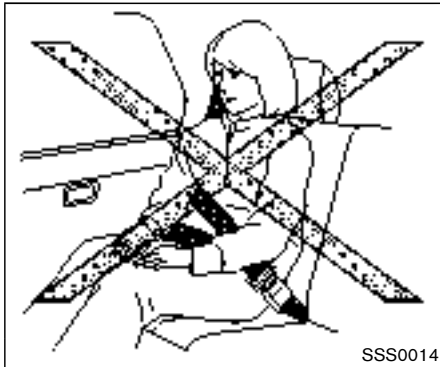
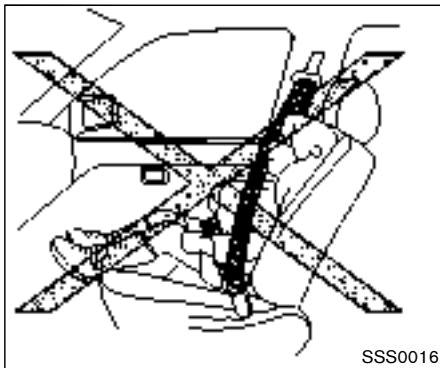

## PREGNANT WOMEN

NISSAN recommends that pregnant women use seat belts. The seat belt should be worn snug, and always position the lap belt as low as possible around the hips, not the waist, and place the shoulder belt over your shoulder and across your chest. Never run the lap/shoulder belt over your abdominal area. Contact your doctor for specific recommendations.

## INJURED PERSONS

NISSAN recommends that injured persons use seat belts, depending on the injury. Check with your doctor for specific recommendations.

## THREE-POINT TYPE SEAT BELT



## WARNING

- **Every person who drives or rides in this vehicle should use a seat belt at all times.**
- **Do not ride in a moving vehicle when the seatback is reclined. This can be dangerous. The shoulder belt will not be against your body. In an accident, you could be thrown into it and receive neck or other serious injuries. You could also slide under the lap belt and receive serious**

internal injuries.

- For the most effective protection when the vehicle is in motion, the seat should be upright. Always sit well back and upright in the seat with both feet on the floor and adjust the seat belt properly.

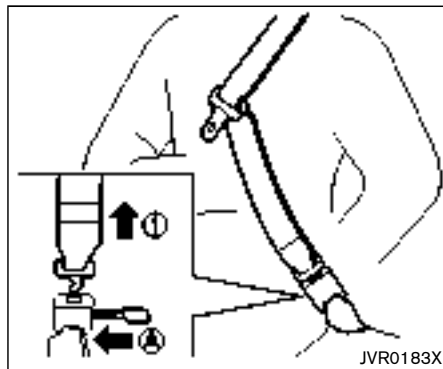

tongue ① may also be released. Release the connector tongue by inserting a suitable tool (such as a key) into the connector buckle ②. If the seat belt cannot be unbuckled or is already unbuckled, release the child by cutting the seat belt with a suitable tool (such as a knife or scissors) to release the seat belt.

### WARNING

Do not allow children to play with the seat belts. Most seating positions are equipped with Automatic Locking Retractor (ALR) mode seat belts. If the seat belt becomes wrapped around a child's neck with the ALR mode activated, the child can be seriously injured or killed if the seat belt retracts and becomes tight. This can occur even if the vehicle is parked. Unbuckle the seat belt to release the child. For the center of the 3rd row seat, the connector



### Fastening the seat belts

1. Adjust the seat. (See "Seats" (P.1-2).)
2. Slowly pull the seat belt out of the retractor and insert the tongue into the buckle until you hear and feel the latch engage.
  - **The retractor is designed to lock during a sudden stop or on impact. A slow pulling motion permits the belt to move, and allows you some freedom of movement in the seat.**
  - **If the seat belt cannot be pulled from its fully retracted position, firmly pull the belt and release it. Then smoothly pull the belt out of the retractor.**



3. Position the lap belt portion **low and snug on the hips** as shown.
4. Pull the shoulder belt portion toward the retractor to take up extra slack. Be sure the shoulder belt is routed over your shoulder and across your chest.

The three-point type seat belts have two modes of operation:

- Emergency Locking Retractor (ELR)
- Automatic Locking Retractor (ALR)

The Emergency Locking Retractor (ELR) mode allows the seat belt to extend and retract to allow the driver and passengers some freedom of movement in the seat. The ELR locks the seat

belt when the vehicle slows down rapidly or during impacts.

The Automatic Locking Retractor (ALR) mode (child restraint mode) locks the seat belt for child restraint installation.

When the ALR mode is activated the seat belt cannot be extended again until the seat belt tongue is detached from the buckle and fully retracted. The seat belt returns to the ELR mode after the seat belt fully retracts. For additional information, see "Child restraints" (P.1-27).

**The ALR mode should be used only for child restraint installation. During normal seat belt use by an occupant, the ALR mode should not be activated. If it is activated, it may cause uncomfortable seat belt tension.**



### WARNING

**When fastening the seat belts, be certain that seatbacks are completely secured in the latched position. If they are not completely secured, passengers may be injured in an accident or sudden stop.**

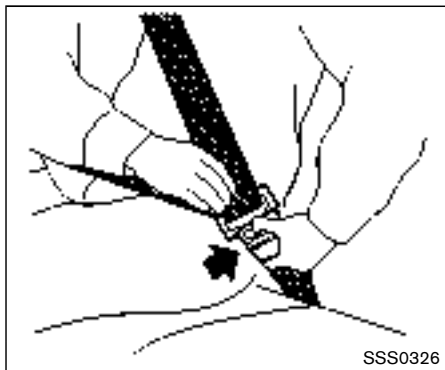

restrict further belt movement. If the retractor does not lock during this check, get the system checked. It is recommended you visit a NISSAN dealer for this service, or to learn more about seat belt operation.

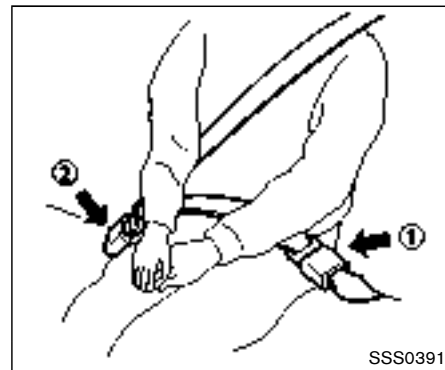

### Unfastening the seat belts

To unfasten the seat belt, push the button on the buckle. The seat belt automatically retracts.

### Checking seat belt operation

Seat belt retractors are designed to lock seat belt movement by two separate methods:

- When the belt is pulled quickly from the retractor.
- When the vehicle slows down rapidly.

To increase your confidence in the seat belts, check the operation as follows:

- Grasp the shoulder belt and pull forward quickly. The retractor should lock and

### 3rd row center seat belt

The 3rd row center seat belt has a connector tongue ① and a seat belt tongue ②. Both the connector tongue and the seat belt tongue must be securely latched for proper seat belt operation.

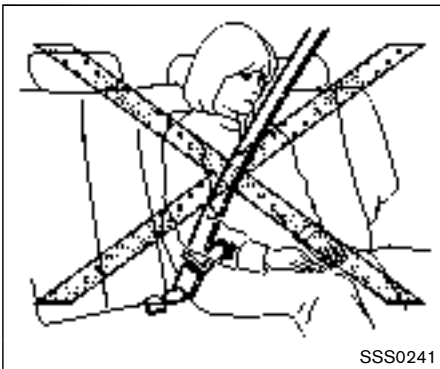

## WARNING

- Always fasten the connector tongue and the seat belt in the order shown.
- Always make sure both the connector tongue and the seat belt tongue are secured when using the seat belt or installing a child restraint. Do not use the seat belt or child restraint with only the seat belt tongue attached. This could result in serious personal injury in case of an accident or a sudden stop.

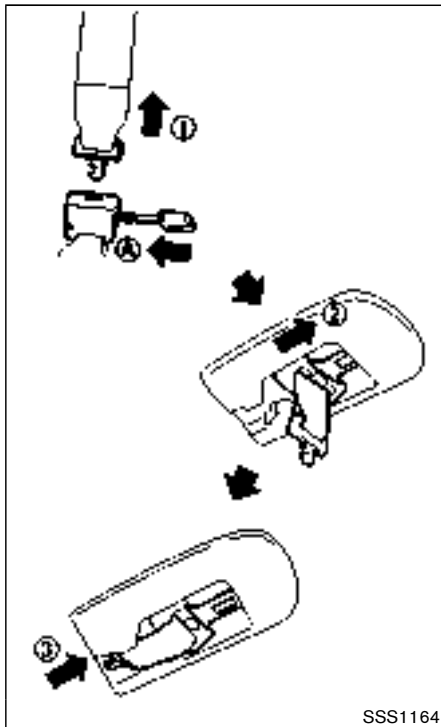

### Stowing 3rd row center seat belt:

When folding down the 3rd row seat, the 3rd row center seat belt can be retracted into a stowed position as follows:

1. Hold the connector tongue ① so that the seat belt does not retract suddenly when the tongue is released from the connector buckle. Release the connector tongue by inserting a suitable tool such as key ② into the connector buckle.
2. Insert the seat belt tongue into the retractor base first ②.
3. Then secure the connector tongue into the retractor base ③.



## WARNING

**Do not unfasten the 3rd row center seat belt connector except when folding down the rear seat.**



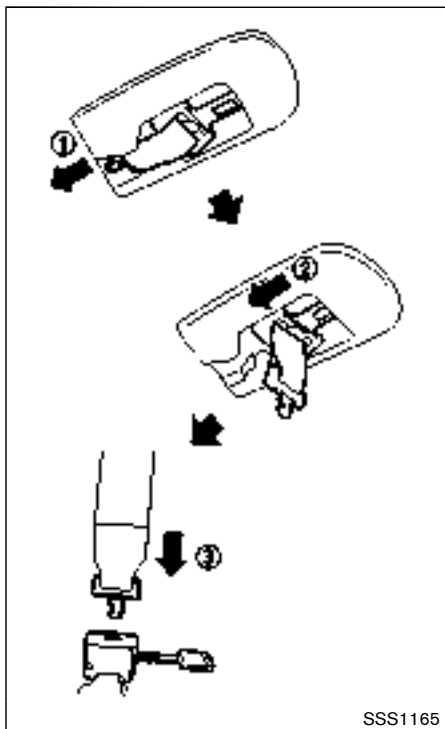

### Attaching 3rd row center seat belt:

Always be sure the 3rd row center seat belt connector tongue and connector buckle are attached. Disconnect only when folding down the 3rd row seat.

To connect the buckle:

1. Pull out the connector tongue from the retractor base (1).
2. Pull out the seat belt tongue from the retractor base (2).
3. Pull the seat belt and secure the connector buckle until it clicks (3).

The center seat belt connector tongue and buckle are indicated by the ▼ and ▲ mark.

The center seat belt connector tongue can be attached only into the 3rd row center seat belt connector buckle.

To fasten the seat belt, see "Fastening the seat belts" (P.1-19).

connector is completely secured.

- If the 3rd row center seat belt connector and the seatbacks are not secured in the correct position, serious personal injury may result in an accident or sudden stop.

### WARNING

- When attaching the 3rd row center seat belt connector, be certain that the seatbacks are completely secured in the latched position and the 3rd row center seat belt con-

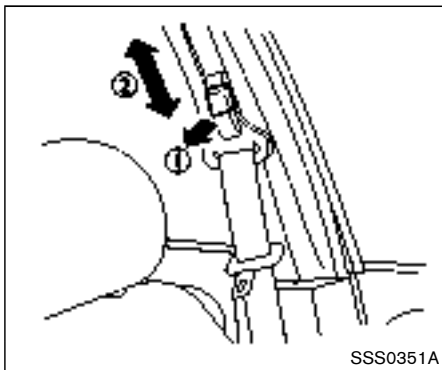

### Shoulder belt height adjustment (if so equipped)

The shoulder belt anchor height should be adjusted to the position best for you. (See "Precautions on seat belt usage" (P.1-15).)

To adjust, pull the adjustment button (1), and then move the shoulder belt anchor to the desired position (2), so that the belt passes over the center of the shoulder. The belt should be away from your face and neck, but not falling off of your shoulder. Release the adjustment button to lock the shoulder belt anchor into position.

## WARNING

- After adjustment, release the adjustment button and try to move the shoulder belt anchor up and down to make sure it is securely fixed in position.
- The shoulder belt anchor height should be adjusted to the position best for you. Failure to do so may reduce the effectiveness of the entire restraint system and increase the chance or severity of injury in an accident.

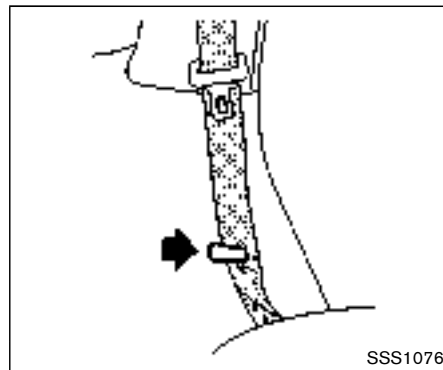

### Seat belt hooks

When the 2nd or 3rd row seat belts are not in use and when folding down the 2nd or 3rd row seats, hook the 2nd and 3rd outer seat belts on the seat belt hooks.

### SEAT BELT EXTENDERS

If, because of body size or driving position, it is not possible to properly fit the lap-shoulder belt and fasten it, an extender that is compatible with the installed seat belts is available that can be purchased. The extender adds approximately 8 in (200 mm) of length and may be used for either the driver or front passenger seating position. It is recommended you visit a NISSAN dealer for

assistance with purchasing an extender if an extender is required.

## WARNING

- It is recommended that only **NISSAN seat belt extenders, made by the same company which made the original equipment seat belts, be used with the NISSAN seat belts.**
- **Adults and children who can use the standard seat belt should not use an extender. Such unnecessary use could result in serious personal injury in the event of an accident.**
- **Never use seat belt extenders to install child restraints. If the child restraint is not secured properly, the child could be seriously injured or killed in a collision or a sudden stop.**

## SEAT BELT MAINTENANCE

- **To clean the seat belt webbing,** apply a mild soap solution or any solution recommended for cleaning upholstery or carpets. Then, wipe with a cloth and allow the seat belts to dry in the shade. Do not allow the seat belts to retract until they are completely dry.

- **If dirt builds up in the shoulder belt guide** of the seat belt anchors, the seat belts may retract slowly. Wipe the shoulder belt guide with a clean, dry cloth.
- **Periodically check to see that the seat belt and the metal components** such as buckles, tongues, retractors, flexible wires and anchors work properly. If loose parts, deterioration, cuts or other damage on the webbing is found, the entire seat belt assembly should be replaced.

## CHILD SAFETY

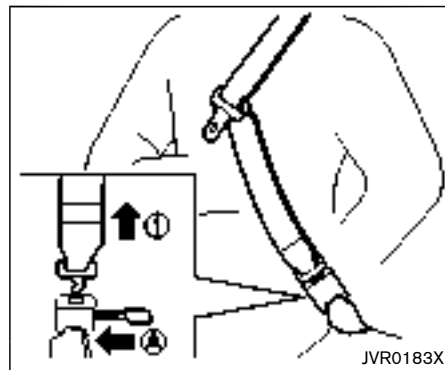

## WARNING

**Do not allow children to play with the seat belts. Most seating positions are equipped with Automatic Locking Retractor (ALR) mode seat belts. If the seat belt becomes wrapped around a child's neck with the ALR mode activated, the child can be seriously injured or killed if the seat belt retracts and becomes tight. This can occur even if the vehicle is parked. Unbuckle the seat belt to release the child. For the center of the 3rd row seat, the connector**

tongue may also be released. Release the connector tongue ① by inserting a suitable tool (such as a key) into the connector buckle ②. If the seat belt cannot be unbuckled or is already unbuckled, release the child by cutting the seat belt with a suitable tool (such as a knife or scissors) to release the seat belt.

### Children need adults to help protect them.

#### They need to be properly restrained.

In addition to the general information in this manual, child safety information is available from many other sources, including doctors, teachers, government traffic safety offices, and community organizations. Every child is different, so be sure to learn the best way to transport your child.

There are three basic types of child restraint systems:

- Rear-facing child restraint
- Forward-facing child restraint
- Booster seat

The proper restraint depends on the child's size. Generally, infants up to about 1 year and less than 20 lbs (9 kg) should be placed in rear-facing child restraints. Forward-facing child restraints are available for children who outgrow

rear-facing child restraints and are at least 1 year old. Booster seats are used to help position a vehicle lap/shoulder belt on a child who can no longer use a forward-facing child restraint.



### WARNING

**Infants and children need special protection. The vehicle's seat belts may not fit them properly. The shoulder belt may come too close to the face or neck. The lap belt may not fit over their small hip bones. In an accident, an improperly fitting seat belt could cause serious or fatal injury. Always use appropriate child restraints.**

All U.S. states and Canadian provinces or territories require the use of approved child restraints for infants and small children. See "Child restraints" (P.1-27).

A child restraint may be secured in the vehicle by using either the LATCH (Lower Anchors and Tethers for CHildren) system or with the vehicle seat belt. See "Child restraints" (P.1-27) for more information.

**NISSAN recommends that all pre-teens and children be restrained in the rear seat. Studies show that children are safer when**

**properly restrained in the rear seat than in the front seat.**

**This is especially important because your vehicle has a supplemental restraint system (Air bag system) for the front passenger. See "Supplemental restraint system" (P.1-48).**

### INFANTS

Infants up to at least 1 year old should be placed in a rear-facing child restraint. NISSAN recommends that infants be placed in child restraints that comply with Federal Motor Vehicle Safety Standards or Canadian Motor Vehicle Safety Standards. You should choose a child restraint that fits your vehicle and always follow the manufacturer's instructions for installation and use.

### SMALL CHILDREN

Children that are over 1 year old and weigh at least 20 lbs (9 kg) should remain in a rear-facing child restraint as long as possible up to the height or weight limit of the child restraint. Children who outgrow the height or weight limit of the rear-facing child restraint and are at least 1 year old should be secured in a forward-facing child restraint with a harness. Refer to the manufacturer's instructions for minimum and maximum weight and height recommendations. NISSAN recommends that small children be

placed in child restraints that comply with Federal Motor Vehicle Safety Standards or Canadian Motor Vehicle Safety Standards. You should choose a child restraint that fits your vehicle and always follow the manufacturer's instructions for installation and use.

### LARGER CHILDREN

Children should remain in a forward-facing child restraint with a harness until they reach the maximum height or weight limit allowed by the child restraint manufacturer.

Once a child outgrows the height or weight limit of the harness-equipped forward-facing child restraint, NISSAN recommends that the child be placed in a commercially available booster seat to obtain proper seat belt fit. For a seat belt to fit properly, the booster seat should raise the child so that the shoulder belt is properly positioned across the chest and the top, middle portion of the shoulder. The shoulder belt should not cross the neck or face and should not fall off the shoulder. The lap belt should lie snugly across the lower hips or upper thighs, not the abdomen. A booster seat can only be used in seating positions that have a three-point type seat belt. The booster seat should fit the vehicle seat and have a label certifying that it complies with Federal Motor Vehicle Safety Standards or Canadian Motor Vehicle Safety Standards.

A booster seat should be used until the child can pass the seat belt fit test below:

- Are the child's back and hips against the vehicle seatback?
- Is the child able to sit without slouching?
- Do the child's knees bend easily over the front edge of the seat with feet flat on the floor?
- Can the child safely wear the seat belt (lap belt low and snug across the hips and shoulder belt across mid-chest and shoulder)?
- Is the child able to use the properly adjusted head restraint/headrest?
- Will the child be able to stay in position for the entire ride?



If you answered no to any of these questions, the child should remain in a booster seat using a three-point type seat belt.

#### NOTE:

**Laws in some communities may follow different guidelines. Check local and state regulations to confirm your child is using the correct restraint system before traveling.**



#### WARNING

**Never let a child stand or kneel on any seat and do not allow a child in the cargo area. The child could be seriously**

**injured or killed in a sudden stop or collision.**

## CHILD RESTRAINTS

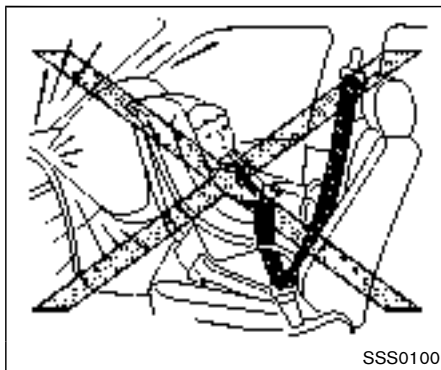
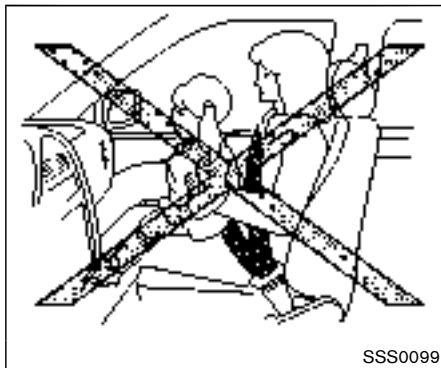

## PRECAUTIONS ON CHILD RESTRAINTS

### **WARNING**

- Failure to follow the warnings and instructions for proper use and installation of child restraints could result in serious injury or death of a child or other passengers in a sudden stop or collision:
  - The child restraint must be used and installed properly. Always follow all of the child restraint manufacturer's instructions for installation and use.
  - Infants and children should never be held on anyone's lap. Even the strongest adult cannot resist the forces of a collision.
  - Do not put a seat belt around both a child and another passenger.
  - NISSAN recommends that all child restraints be installed in the rear seat. Studies show that children are safer when properly restrained in the rear seat than

in the front seat. If you must install a forward-facing child restraint in the front seat, see “Forward-facing child restraint installation using LATCH” (P.1-37).

- Even with the NISSAN Advanced Air Bag System, never install a rear-facing child restraint in the front seat. An inflating air bag could seriously injure or kill a child. A rear-facing child restraint must only be used in the rear seat.
- Be sure to purchase a child restraint that will fit the child and vehicle. Some child restraints may not fit properly in your vehicle.
- Child restraint anchor points are designed to withstand loads from child restraints that are properly fitted.
- Never use the anchor points for adult seat belts or harnesses.

- A child restraint with a top tether strap should not be used in the front passenger seat.
- Keep seatbacks as upright as possible after fitting the child restraint.
- Infants and children should always be placed in an appropriate child restraint while in the vehicle.
- When the child restraint is not in use, keep it secured with the LATCH system or a seat belt. In a sudden stop or collision, loose objects can injure occupants or damage the vehicle.



## CAUTION

**A child restraint in a closed vehicle can become very hot. Check the seating surface and buckles before placing a child in the child restraint.**

This vehicle is equipped with a universal child restraint anchor system, referred to as the LATCH (Lower Anchors and Tethers for CHil-

dren) system. Some child restraints include rigid or webbing-mounted attachments that can be connected to these anchors.

For details, see “Lower Anchors and Tethers for CHildren System (LATCH)” (P.1-29).

If you do not have a LATCH compatible child restraint, the vehicle seat belts can be used.

Several manufacturers offer child restraints for infants and small children of various sizes. When selecting any child restraint, keep the following points in mind:

- Choose only a restraint with a label certifying that it complies with Federal Motor Vehicle Safety Standard 213 or Canadian Motor Vehicle Safety Standard 213.
- Check the child restraint in your vehicle to be sure it is compatible with the vehicle's seat and seat belt system.
- If the child restraint is compatible with your vehicle, place your child in the child restraint and check the various adjustments to be sure the child restraint is compatible with your child. Choose a child restraint that is designed for your child's height and weight. Always follow all recommended procedures.
- If the combined weight of the child and child restraint is less than 65 lbs (29.5 kg), you may use either the LATCH anchors or the seat belt to install the child restraint (not

both at the same time).

- If the combined weight of the child and child restraint is greater than 65 lbs (29.5 kg), use the vehicle's seat belt (not the lower anchors) to install the child restraint.
- Be sure to follow the child restraint manufacturer's instructions for installation.

**All U.S. states and Canadian provinces or territories require that infants and small children be restrained in an approved child restraint at all times while the vehicle is being operated. Canadian law requires the top tether strap on forward-facing child restraints be secured to the designated anchor point on the vehicle.**

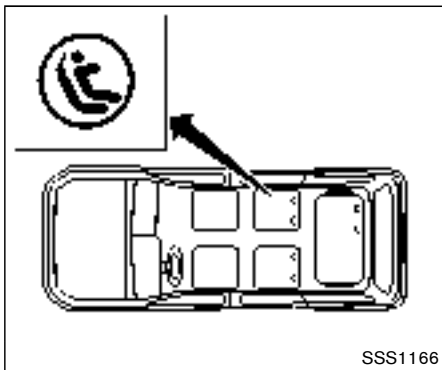

### Lower Anchors and Tethers for Children System (LATCH)

Your vehicle is equipped with special anchor points that are used with LATCH (Lower Anchors and Tethers for Children) system compatible child restraints. This system may also be referred to as the ISOFIX or ISOFIX compatible system. With this system, you do not have to use a vehicle seat belt to secure the child restraint unless the combined weight of the child and child restraint exceeds 65 lbs (29.5 kg). If the combined weight of the child and child restraint is greater than 65 lbs (29.5 kg), use the vehicle's seat belt (not the lower anchors) to install the child restraint. Be sure to follow the

child restraint manufacturer's instructions for installation.

The LATCH anchor points are provided to install child restraints in the following positions only:

- 2nd row seats
- 3rd row seat (for the right outboard seat only)

LATCH lower anchor



## WARNING

**Failure to follow the warnings and instructions for proper use and installation of child restraints could result in serious injury or death of a child or other passengers in a sudden stop or collision:**

- **Attach LATCH system compatible child restraints only at the locations shown in the illustration.**
- **Do not secure a child restraint in the center rear seating position using the LATCH lower anchors. The child restraint will not be secured properly.**
- **Inspect the lower anchors by inserting your fingers into the lower**



anchor area. Feel to make sure there are no obstructions over the anchors such as seat belt webbing or seat cushion material. The child restraint will not be secured properly if the lower anchors are obstructed.

Child restraint anchorages are designed to withstand only those loads imposed by correctly fitted child restraints. Under no circumstances are they to be used to attach adult seat belts, or other items or equipment to the vehicle. Doing so could damage the child restraint anchorages. The child restraint will not be properly installed using the damaged anchorage, and a child could be seriously injured or killed in a collision.

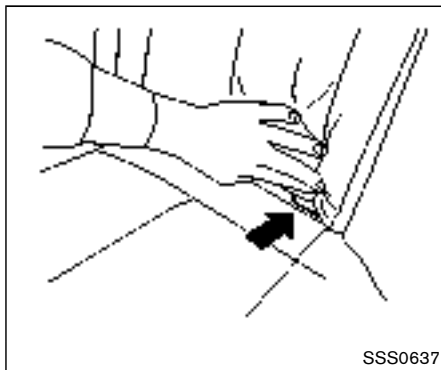

LATCH lower anchor location

SSS0637

### LATCH lower anchor location

The LATCH lower anchors are located at the rear of the seat cushion near the seatback. A label is attached to the seatback to help you locate the LATCH lower anchors.

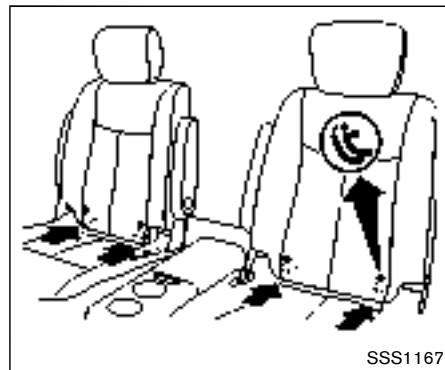

2nd row seats

SSS1167

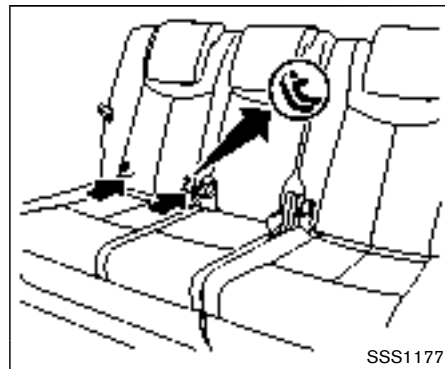

3rd row seat

SSS1177

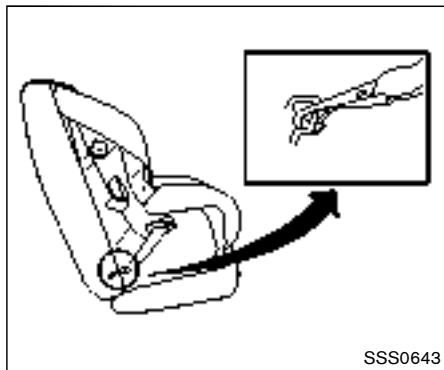

LATCH webbing-mounted attachment

SSS0643

### Installing child restraint LATCH lower anchor attachments

LATCH compatible child restraints include two rigid or webbing-mounted attachments that can be connected to two anchors located at certain seating positions in your vehicle. With this system, you do not have to use a vehicle seat belt to secure the child restraint. Check your child restraint for a label stating that it is compatible with LATCH. This information may also be in the instructions provided by the child restraint manufacturer.

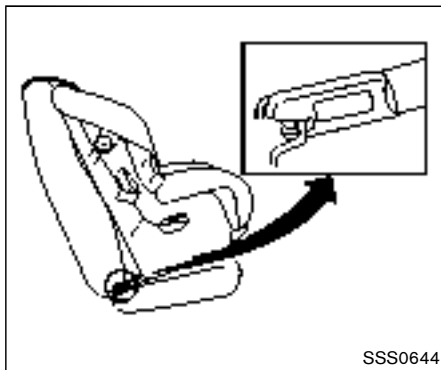

LATCH rigid-mounted

SSS0644

When installing a child restraint, carefully read and follow the instructions in this manual and those supplied with the child restraint.

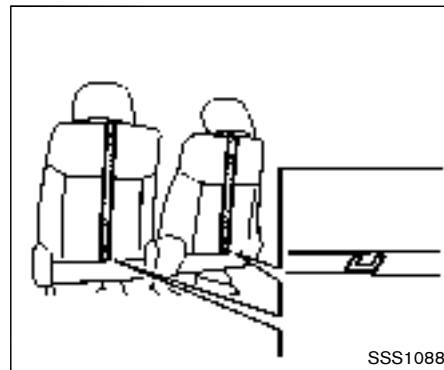

2nd row seat

SSS1088

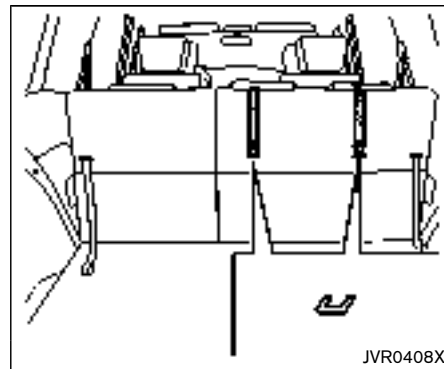

3rd row seat

JVR0408X

## TOP TETHER STRAP CHILD RESTRAINT

If the manufacturer of your child restraint requires the use of a top tether strap, it must be secured to an anchor point.



### WARNING

- In the 3rd row seat, a child restraint with a top tether strap can only be used in the center and right outboard seating position. Do not place a child restraint with a tether strap in the center and left outboard seating position and attempt to angle the tether strap to the right outboard position.
- Child restraint anchorages are designed to withstand only those loads imposed by correctly fitted child restraints. Under no circumstances are they to be used to attach adult seat belts, or other items or equipment to the vehicle. Doing so could damage the child restraint anchorages. The child restraint will not be properly installed using the damaged anchorage, and a child could be seriously injured or

killed in a collision.

- Do not allow cargo to contact the top tether strap when it is attached to the top tether anchor. Properly secure the cargo so it does not contact the top tether strap. Cargo that is not properly secured or cargo that contacts the top tether strap may damage the top tether strap during a collision. Your child could be seriously injured or killed in a collision if the child restraint top tether strap is damaged.

### Top tether anchor point locations

Anchor points are located in the following locations:

- 2nd row seats on the back side of the seatback as shown.
- 3rd row seat on the back side of the seatback as shown.

**If you have any questions when installing a top tether strap child restraint on the rear seat, it is recommended you visit a NISSAN dealer for this service.**

## REAR-FACING CHILD RESTRAINT INSTALLATION USING LATCH

Refer to all Warnings and Cautions in the “Child safety” and “Child restraints” sections before installing a child restraint.

Do not use the lower anchors if the combined weight of the child and the child restraint exceeds 65 lbs (29.5 kg). If the combined weight of the child and the child restraint is greater than 65 lbs (29.5 kg), use the vehicle's seat belt (not the lower anchors) to install the child restraint. Be sure to follow the child restraint manufacturer's instructions for installation.

Follow these steps to install a rear-facing child restraint in the 2nd row seats and 3rd row seat using the LATCH system:

1. Position the child restraint on the seat. Always follow the child restraint manufacturer's instructions.

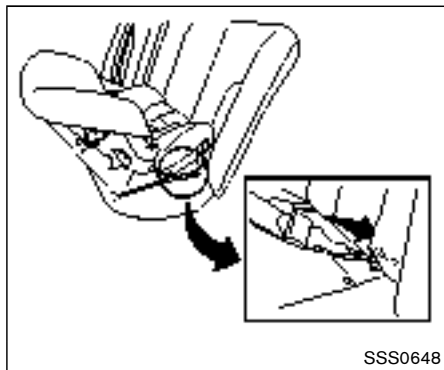

Rear-facing web-mounted — step 2

- Secure the child restraint anchor attachments to the LATCH lower anchors. Check to make sure the LATCH attachment is properly attached to the lower anchors.

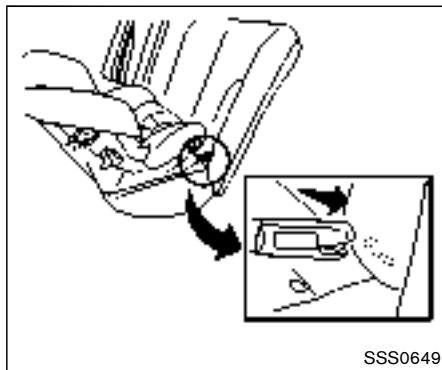

Rear-facing rigid-mounted — step 2

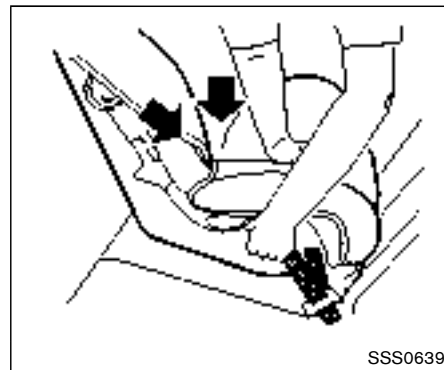

Rear-facing — step 3

- For child restraints that are equipped with webbing-mounted attachments, remove any additional slack from the anchor attachments. Press downward and rearward firmly in the center of the child restraint with your hand to compress the vehicle seat cushion and seatback while tightening the webbing of the anchor attachments.



SSS0650

Rear-facing — step 4

4. After attaching the child restraint, test it before you place the child in it. Push it from side to side while holding the child restraint near the LATCH attachment path. The child restraint should not move more than 1 inch (25 mm), from side to side. Try to tug it forward and check to see if the LATCH attachment holds the restraint in place. If the restraint is not secure, tighten the LATCH attachment as necessary, or put the restraint in another seat and test it again. You may need to try a different child restraint or try installing by using the vehicle seat belt (if applicable). Not all child restraints fit in all types of vehicles.

5. Check to make sure the child restraint is properly secured prior to each use. If the child restraint is loose, repeat steps 1 through 4.

### REAR-FACING CHILD RESTRAINT INSTALLATION USING THE SEAT BELTS

#### **WARNING**

- **The three-point seat belt with Automatic Locking Retractor (ALR) must be used when installing a child restraint. Failure to use the ALR mode will result in the child restraint not being properly secured. The restraint could tip over or be loose and cause injury to a child in a sudden stop or collision. Also, it can change the operation of the front passenger air bag. See “Front passenger air bag and status light” (P.1-55).**
- **When installing a child restraint system in the 3rd row center position, both the center seat belt connector tongue and buckle tongue must be secured. See “3rd row center seat belt” (P.1-20).**

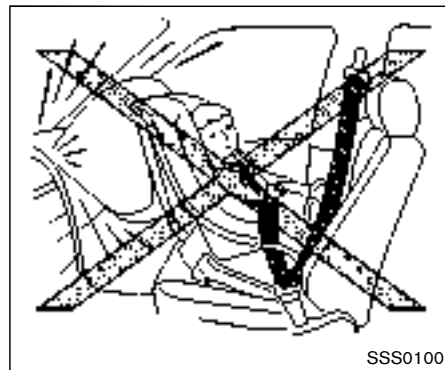

SSS0100

Rear-facing — step 1

Refer to all Warnings and Cautions in the “Child safety” (P.1-24) and “Child restraints” (P.1-27) before installing a child restraint.

Do not use the lower anchors if the combined weight of the child and the child restraint exceeds 65 lbs (29.5 kg). If the combined weight of the child and the child restraint is greater than 65 lbs (29.5 kg), use the vehicle’s seat belt (not the lower anchors) to install the child restraint. Be sure to follow the child restraint manufacturer’s instructions for installation.

Follow these steps to install a rear-facing child restraint using the vehicle seat belts in the rear seats:

1. **Child restraints for infants must be used in the rear-facing direction and therefore must not be used in the front seat.** Position the child restraint on the seat. Always follow the restraint manufacturer's instructions.

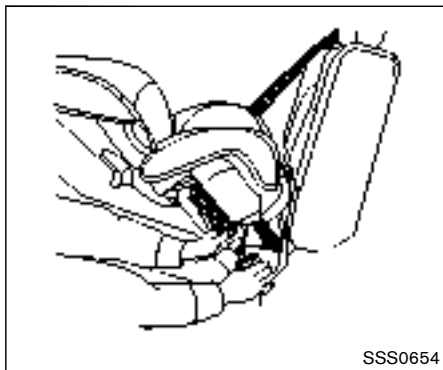

Rear-facing — step 2

2. Route the seat belt tongue through the child restraint and insert it into the buckle until you hear and feel the latch engage. Be sure to follow the child restraint manufacturer's instructions for belt routing.

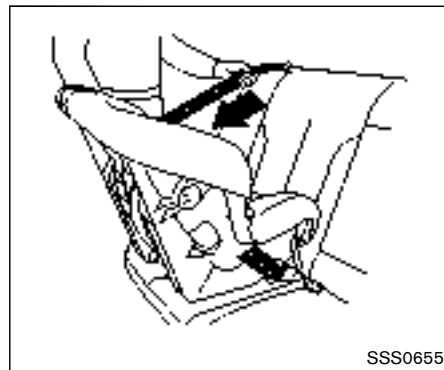

Rear-facing — step 3

3. Pull the shoulder belt until the belt is fully extended. At this time, the seat belt retractor is in the Automatic Locking Retractor (ALR) mode (child restraint mode). It reverts to the Emergency Locking Retractor (ELR) mode when the seat belt is fully retracted.

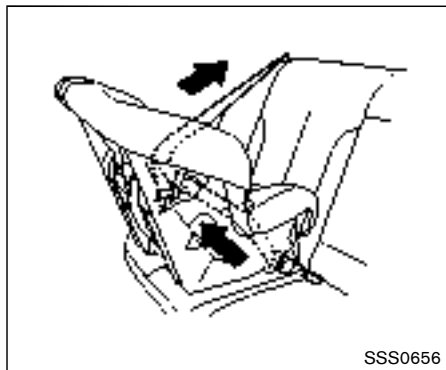

Rear-facing — step 4

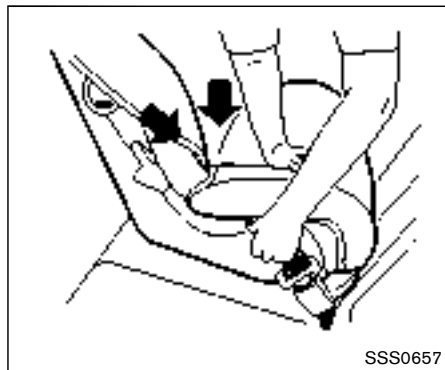

Rear-facing — step 5



Rear-facing — step 6

4. Allow the seat belt to retract. Pull up on the shoulder belt to remove any slack in the belt.
5. Remove any additional slack from the seat belt; press downward and rearward firmly in the center of the child restraint to compress the vehicle seat cushion and seatback while pulling up on the seat belt.
6. After attaching the child restraint, test it before you place the child in it. Push it from side to side while holding the child restraint near the seat belt path. The child restraint should not move more than 1 inch (25 mm), from side to side. Try to tug it forward and check to see if the belt holds the restraint in place. If the restraint is not secure, tighten the seat belt as necessary, or put the restraint in another seat and test it again. You may need to try a different child restraint. Not all child restraints fit in all types of vehicles.
7. Check to make sure that the child restraint is properly secured prior to each use. If the

seat belt is not locked, repeat steps 1 through 6.

After the child restraint is removed and the seat belt fully retracted, the ALR mode (child restraint mode) is canceled.

## FORWARD-FACING CHILD RESTRAINT INSTALLATION USING LATCH

Refer to all Warnings and Cautions in the “Child safety” and “Child restraints” sections before installing a child restraint.

Do not use the lower anchors if the combined weight of the child and the child restraint exceeds 65 lbs (29.5 kg). If the combined weight of the child and the child restraint is greater than 65 lbs (29.5 kg), use the vehicle’s seat belt (not the lower anchors) to install the child restraint. Be sure to follow the child restraint manufacturer’s instructions for installation.

Follow these steps to install a forward-facing child restraint using the LATCH system:

1. Position the child restraint on the seat. Always follow the child restraint manufacturer’s instructions.

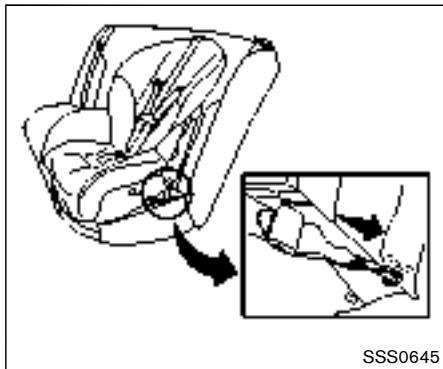

Forward-facing web-mounted — step 2

2. Secure the child restraint anchor attachments to the LATCH lower anchors. Check to make sure the LATCH attachment is properly attached to the lower anchors.

If the child restraint is equipped with a top tether strap, route the top tether strap and secure the tether strap to the tether anchor point. See “Installing top tether strap (2nd row seats)” (P.1-39). Do not install child restraints that require the use of a top tether strap in seating positions that do not have a top tether anchor.

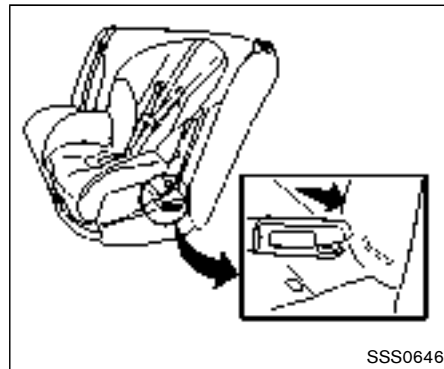

Forward-facing rigid-mounted — step 3

3. The back of the child restraint should be secured against the vehicle seatback.

If necessary, adjust or remove the head restraint to obtain the correct child restraint fit. If the head restraint is removed, store it in a secure place. **Be sure to reinstall the head restraint when the child restraint is removed.** See “Head restraints/headrests” (P.1-10) for head restraint adjustment information.

If the seating position does not have an adjustable head restraint and it is interfering with the proper child restraint fit, try another seating position or a different child restraint.



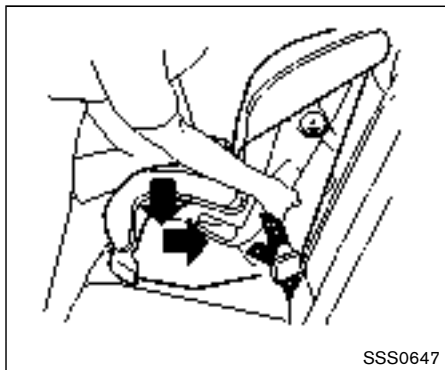

SSS0647

**Forward-facing — step 4**

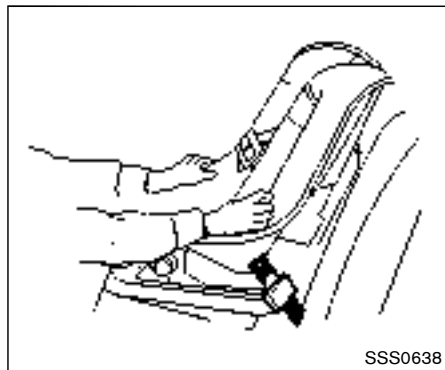

SSS0638

**Forward-facing — step 6**

4. For child restraints that are equipped with webbing-mounted attachments, remove any additional slack from the anchor attachments. Press downward and rearward firmly in the center of the child restraint with your knee to compress the vehicle seat cushion and seatback while tightening the webbing of the anchor attachments.
5. Tighten the tether strap according to the manufacturer's instructions to remove any slack.
6. After attaching the child restraint, test it before you place the child in it. Push it from side to side while holding the child restraint near the LATCH attachment path. The child restraint should not move more than 1 inch (25 mm), from side to side. Try to tug it forward and check to see if the LATCH attachment holds the restraint in place. If the restraint is not secure, tighten the LATCH attachment as necessary, or put the restraint in another seat and test it again. You may need to try a different child restraint. Not all child restraints fit in all types of vehicles.
7. Check to make sure the child restraint is properly secured prior to each use. If the

child restraint is loose, repeat steps 1 through 6.

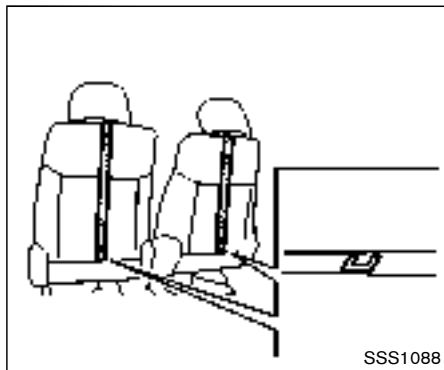

2nd row seat

Installing top tether strap (2nd row seats)



## WARNING

Child restraint anchorages are designed to withstand only those loads imposed by correctly fitted child restraints. Under no circumstances are they to be used to attach adult seat belts, or other items or equipment to the vehicle. Doing so could damage the child restraint anchorages. The child restraint will not be properly installed using the damaged anchorage, and a

**child could be seriously injured or killed in a collision.**

First, secure the child restraint with the LATCH lower anchors.

1. If necessary, raise or remove the head restraint to position the top tether strap over the top of the seatback. If the head restraint is removed, store it in a secure place. Be sure to reinstall the head restraint when the child restraint is removed. See “Head restraints/headrests” (P.1-10) for head restraint adjustment, removal and installation information.
2. Secure the tether strap to the tether anchor point on the back of each seatback behind the child restraint.
3. Tighten the tether strap according to the manufacturer’s instructions to remove any slack. Make sure the head restraint does not contact the top tether strap.

**If you have any questions when installing a top tether strap on the rear seat, it is recommended you visit a NISSAN dealer for this service.**

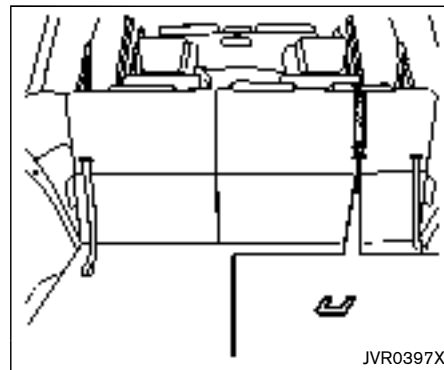

3rd row seat

Installing top tether strap (3rd row seat)



## WARNING

- In the 3rd row seat, a child restraint with a top tether strap can only be used in the right outboard seating position. Do not place in the center and left outboard seating positions and attempt to angle the tether strap to the right outboard position.
- Child restraint anchorages are designed to withstand only those loads imposed by correctly fitted

**child restraints. Under no circumstances are they to be used to attach adult seat belts, or other items or equipment to the vehicle. Doing so could damage the child restraint anchorages. The child restraint will not be properly installed using the damaged anchorage, and a child could be seriously injured or killed in a collision.**

The right side position of the 3rd row seat is the seating position that can use a top tether strap.

First, secure the child restraint with the LATCH lower anchors.

1. Position the top tether strap over the top of the right outboard seating position seatback.
2. Secure the tether strap to the tether anchor point on the seatback behind the child restraint.
3. Refer to the appropriate child restraint installation procedure steps in this section before tightening the tether strap.

**If you have any questions when installing a top tether strap child restraint on the rear seat. It is recommended you visit a NISSAN dealer for this service.**

## FORWARD-FACING CHILD RESTRAINT INSTALLATION USING THE SEAT BELT

### **WARNING**

- **The three-point seat belt with Automatic Locking Retractor (ALR) must be used when installing a child restraint. Failure to use the ALR mode will result in the child restraint not being properly secured. The restraint could tip over or be loose and cause injury to a child in a sudden stop or collision. Also, it can change the operation of the front passenger air bag. See “Front passenger air bag and status light” (P.1-55).**
- **When installing a child restraint system in the 3rd row center position, both the center seat belt connector tongue and buckle tongue must be secured. See “3rd row center seat belt” (P.1-20).**



SSS0640

### Forward-facing (front passenger seat) — step 1

Refer to all Warnings and Cautions in the “Child safety” and “Child restraints” sections before installing a child restraint.

Do not use the lower anchors if the combined weight of the child and the child restraint exceeds 65 lbs (29.5 kg). If the combined weight of the child and the child restraint is greater than 65 lbs, (29.5 kg) use the vehicle's seat belt (not the lower anchors) to install the child restraint. Be sure to follow the child restraint manufacturer's instructions for installation.

Follow these steps to install a forward-facing child restraint using the vehicle seat belt in the rear seats or in the front passenger seat:

1. **If you must install a child restraint in the front seat, it should be placed in a forward-facing direction only. Move the seat to the rearmost position. Child restraints for infants must be used in the rear-facing direction and, therefore, must not be used in the front seat.**
2. Position the child restraint on the seat. Always follow the child restraint manufacturer's instructions.

The back of the child restraint should be secured against the vehicle seatback.

If necessary, adjust or remove the head restraint or headrest to obtain the correct child restraint fit. If the head restraint or headrest is removed, store it in a secure place. **Be sure to reinstall the head restraint or headrest when the child restraint is removed.** See "Head restraints/headrests" (P.1-10) for head restraint or headrest adjustment, removal and installation information.

If the seating position does not have an adjustable head restraint or headrest and it is interfering with the proper child restraint fit, try another seating position or a different

child restraint.

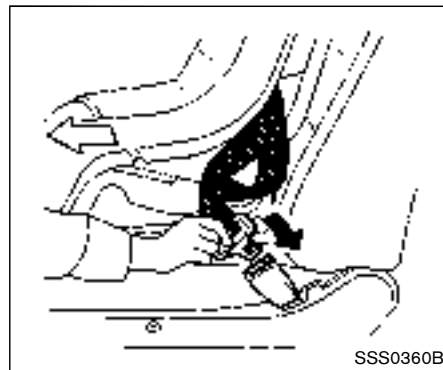

**Forward-facing — step 3**

3. Route the seat belt tongue through the child restraint and insert it into the buckle until you hear and feel the latch engage. Be sure to follow the child restraint manufacturer's instructions for belt routing.

If the child restraint is equipped with a top tether strap, route the top tether strap and secure the tether strap to the tether anchor point (rear seat installation only). See "Installing top tether strap (2nd row seats)" (P.1-44) and "Installing top tether strap (3rd row seat)" (P.1-44). Do not install child restraints that require the use of a top tether strap in seating positions that do not have a top tether anchor.

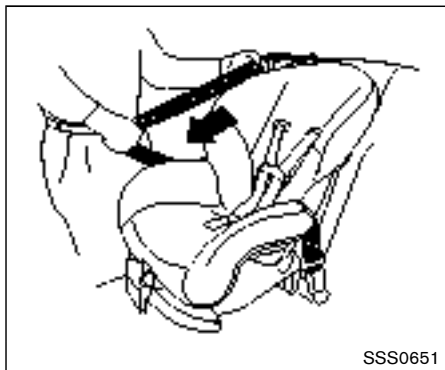

**Forward-facing — step 4**

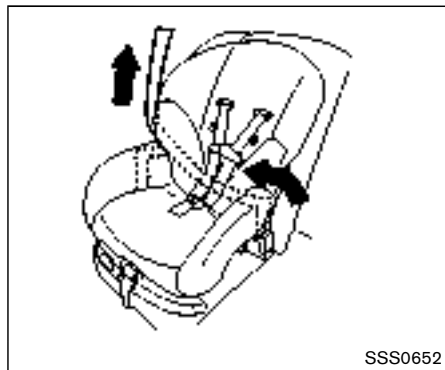

**Forward-facing — step 5**

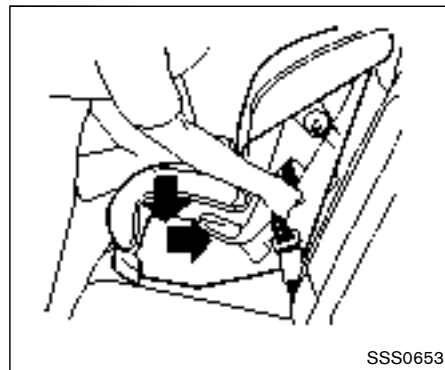

**Forward-facing — step 6**

4. Pull the shoulder belt until the belt is fully extended. At this time, the seat belt retractor is in the Automatic Locking Retractor (ALR) mode (child restraint mode). It reverts to Emergency Locking Retractor (ELR) mode when the seat belt is fully retracted.
5. Allow the seat belt to retract. Pull up on the shoulder belt to remove any slack in the belt.
6. Remove any additional slack from the seat belt; press downward and rearward firmly in the center of the child restraint with your knee to compress the vehicle seat cushion and seatback while pulling up on the seat belt.
7. Tighten the tether strap according to the manufacturer's instructions to remove any slack.



Forward-facing — step 8

8. After attaching the child restraint, test it before you place the child in it. Push it from side to side while holding the child restraint near the seat belt path. The child restraint should not move more than 1 inch (25 mm), from side to side. Try to tug it forward and check to see if the belt holds the restraint in place. If the restraint is not secure, tighten the seat belt as necessary, or put the restraint in another seat and test it again. You may need to try a different child restraint. Not all child restraints fit in all types of vehicles.
9. Check to make sure the child restraint is properly secured prior to each use. If the

seat belt is not locked, repeat steps 2 through 8.



Forward-facing — step 10

10. If the child restraint is installed in the front passenger seat, place the ignition switch in the ON position. The front passenger air bag status light  should illuminate. If this light is not illuminated, see "Front passenger air bag and status light" in this section. **Move the child restraint to another seating position.** Have the system checked. It is recommended you visit a NISSAN dealer for this service.

After the child restraint is removed and the seat belt is fully retracted, the ALR mode (child restraint mode) is canceled.

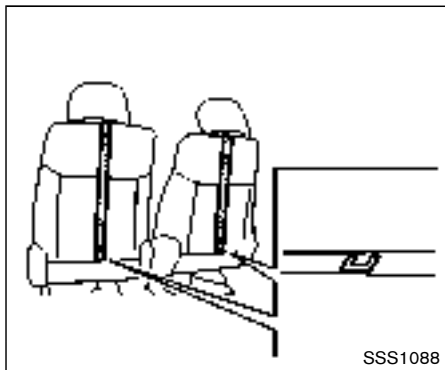

2nd row seat

Installing top tether strap (2nd row seats)



## WARNING

Child restraint anchorages are designed to withstand only those loads imposed by correctly fitted child restraints. Under no circumstances are they to be used to attach adult seat belts, or other items or equipment to the vehicle. Doing so could damage the child restraint anchorages. The child restraint will not be properly installed using the damaged anchorage, and a

**child could be seriously injured or killed in a collision.**

First, secure the child restraint with the seat belt.

1. If necessary, raise or remove the head restraint to position the top tether strap over the top of the seatback. If the head restraint is removed, store it in a secure place. Be sure to reinstall the head restraint when the child restraint is removed. See "Head restraints/headrests" (P.1-10) for head restraint adjustment, removal and installation information.
2. Secure the tether strap to the tether anchor point on the back of each seatback behind the child restraint.
3. Tighten the tether strap according to the manufacturer's instructions to remove any slack. Make sure the head restraint does not contact the top tether strap.

**If you have any questions when installing a top tether strap on the rear seat, it is recommended you visit a NISSAN dealer for this service.**

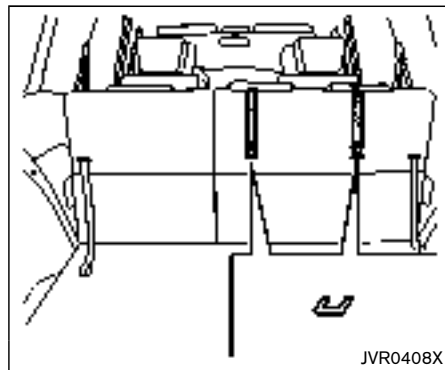

3rd row seat

Installing top tether strap (3rd row seat)



## WARNING

- In the 3rd row seat, a child restraint with a top tether strap can only be used in the center and right outboard seating position. Do not place in the left outboard seating position and attempt to angle the tether strap to the center or right outboard position.
- Child restraint anchorages are designed to withstand only those

loads imposed by correctly fitted child restraints. Under no circumstances are they to be used to attach adult seat belts, or other items or equipment to the vehicle. Doing so could damage the child restraint anchorages. The child restraint will not be properly installed using the damaged anchorage, and a child could be seriously injured or killed in a collision.

The center and right side positions of the 3rd row seat are the seating positions that can use a top tether strap.

First, secure the child restraint with the seat belt.

1. Position the top tether strap over the top of the center or right outboard seating position seatback.
2. Secure the tether strap to the tether anchor point on the seatback behind the child restraint.
3. Refer to the appropriate child restraint installation procedure steps in this section before tightening the tether strap.

**If you have any questions when installing a top tether strap child restraint on the rear seat, it is recommended you visit a NISSAN**

dealer for this service.

## BOOSTER SEATS

Precautions on booster seats



### WARNING

If a booster seat and seat belt are not used properly, the risk of a child being injured in a sudden stop or collision greatly increases:

- **Make sure the shoulder portion of the belt is away from the child's face and neck and the lap portion of the belt does not cross the stomach.**
- **Make sure the shoulder belt is not behind the child or under the child's arm.**
- **A booster seat must only be installed in a seating position that has a lap/shoulder belt.**

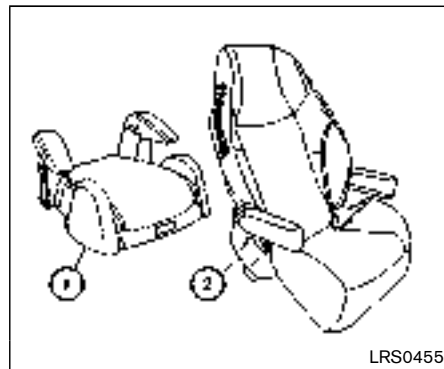

Booster seats of various sizes are offered by several manufacturers. When selecting any booster seat, keep the following points in mind:

- Choose only a booster seat with a label certifying that it complies with Federal Motor Vehicle Safety Standard 213 or Canadian Motor Vehicle Safety Standard 213.
- Check the booster seat in your vehicle to be sure it is compatible with the vehicle's seat and seat belt system.



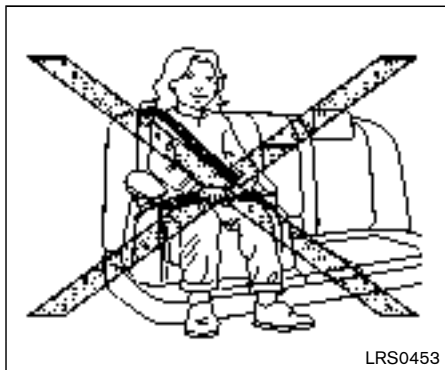

- Make sure the child's head will be properly supported by the booster seat or vehicle seat. The seatback must be at or above the center of the child's ears. For example, if a low back booster seat ① is chosen, the vehicle seatback must be at or above the center of the child's ears. If the seatback is lower than the center of the child's ears, a high back booster seat ② should be used.
- If the booster seat is compatible with your vehicle, place your child in the booster seat and check the various adjustments to be sure the booster seat is compatible with your child. Always follow all recommended procedures.



**All U.S. states and Canadian provinces or territories require that infants and small children be restrained in an approved child restraint at all times while the vehicle is being operated.**

The instructions in this section apply to booster seat installation in the rear seats or the front passenger seat.

## Booster seat installation



### WARNING

**To avoid injury to child, do not use the lap/shoulder belt Automatic Locking Retractor (ALR) mode when using a booster seat with the seat belts.**

Refer to all Warnings and Cautions in the "Child safety", "Child restraints" and "Booster seats" sections earlier in this section before installing a child restraint.

Follow these steps to install a booster seat in the rear seat or in the front passenger seat:



1. **If you must install a booster seat in the front seat, move the seat to the rear-most position.**
2. Position the booster seat on the seat. Only place it in a forward-facing direction. Always follow the booster seat manufacturer's instructions.



Front passenger position

3. The booster seat should be positioned on the vehicle seat so that it is stable.

If necessary, adjust or remove the head restraint or headrest to obtain the correct booster seat fit. If the head restraint or headrest is removed, store it in a secure place. **Be sure to reinstall the head restraint or headrest when the booster seat is removed.** See "Head restraints/headrests" (P.1-10) or "Adjust" (P.1-13) for head restraint or headrest adjustment, removal and installation information.

If the seating position does not have an adjustable head restraint or headrest and it

is interfering with the proper booster seat fit, try another seating position or a different booster seat.

4. Position the lap portion of the seat belt low and snug on the child's hips. Be sure to follow the booster seat manufacturer's instructions for adjusting the seat belt routing.
5. Pull the shoulder belt portion of the seat belt toward the retractor to take up extra slack. Be sure the shoulder belt is positioned across the top, middle portion of the child's shoulder. Be sure to follow the booster seat manufacturer's instructions for adjusting the seat belt routing.
6. Follow the warnings, cautions and instructions for properly fastening a seat belt shown in "Seat belts" (P.1-15).



7. If the booster seat is installed in the front passenger seat, push the ignition switch to the ON position. The front passenger air bag status light  may or may not illuminate depending on the size of the child and the type of booster seat used. See "Front passenger air bag and status light" (P.1-55).

## SUPPLEMENTAL RESTRAINT SYSTEM

### PRECAUTIONS ON SUPPLEMENTAL RESTRAINT SYSTEM

This Supplemental Restraint System (SRS) section contains important information concerning the following systems.

- Driver and passenger supplemental front-impact air bag (NISSAN Advanced Air Bag System)
- Front seat-mounted side-impact supplemental air bag
- Roof-mounted curtain side-impact supplemental air bag
- Seat belt with pretensioner

**Supplemental front-impact air bag system:** The NISSAN Advanced Air Bag System can help cushion the impact force to the head and chest of the driver and front passenger in certain frontal collisions.

**Front seat-mounted side-impact supplemental air bag system:** This system can help cushion the impact force to the chest and pelvis area of the driver and front passenger in certain side impact collisions. The supplemental side air bag is designed to inflate on the side where the vehicle is impacted.

**Roof-mounted curtain side-impact supplemental air bag system:** This system can help cushion the impact force to the head of

occupants in front and rear (2nd and 3rd) outboard seating positions in certain side impact collisions. The curtain air bags are designed to inflate on the side where the vehicle is impacted.

These supplemental restraint systems are designed to **supplement** the crash protection provided by the driver and passenger seat belts and are **not a substitute** for them. Seat belts should always be correctly worn and the occupant seated a suitable distance away from the steering wheel, instrument panel and door finishers. (See "Seat belts" (P.1-15) for instructions and precautions on seat belt usage.)

**The supplemental air bags operate only when the ignition switch is in the ON position.**

**After pushing the ignition switch to the ON position, the supplemental air bag warning light illuminates. The supplemental air bag warning light will turn off after about 7 seconds if the systems are operational.**

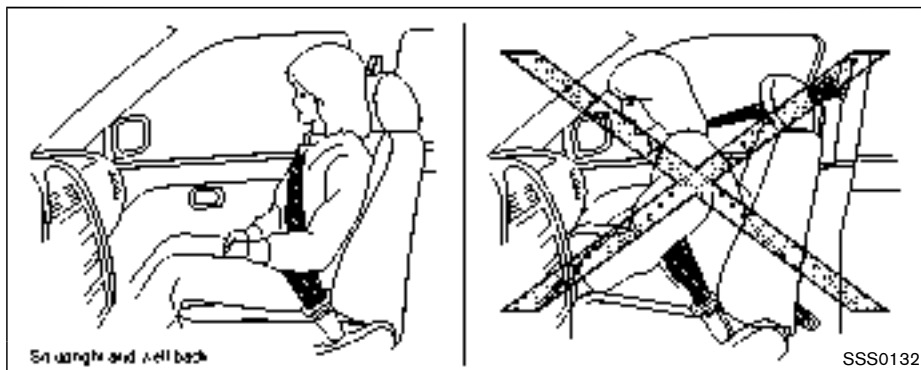
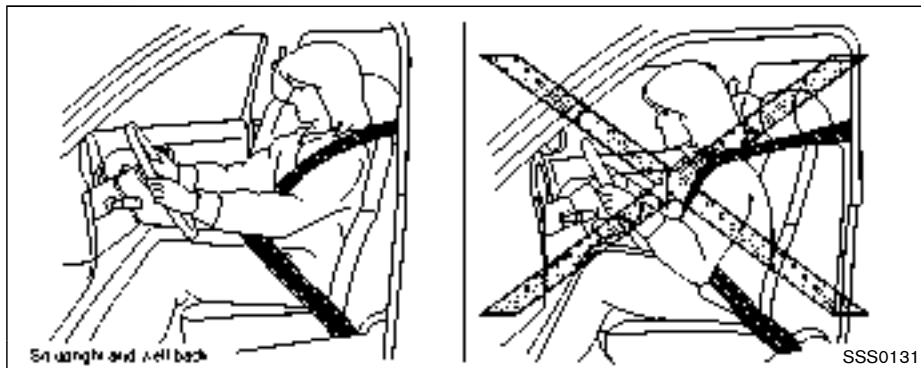

## WARNING

- The supplemental front air bags ordinarily will not inflate in the event of a side impact, rear impact, rollover, or lower severity frontal collision. Always wear your seat belts to help reduce the risk or severity of injury in various kinds of accidents.
- The front passenger air bag will not inflate if the passenger air bag status light is lit or if the front passenger seat is unoccupied. See "Front passenger air bag and status light" (P.1-55).
- The seat belts and the front air bags are most effective when you are sitting well back and upright in the seat. The front air bags inflate with great force. Even with the NISSAN Advanced Air Bag System, if you are unrestrained, leaning forward, sitting sideways or out of position in any way, you are at greater risk of injury or death in a crash. You may also receive serious or fatal injuries from the front air bag if you are up against it when it inflates. Always sit

back against the seatback and as far-away as practical from the steering wheel or instrument panel. Always use the seat belts.

- The driver and front passenger seat belt buckles are equipped with sensors that detect if the seat belts are fastened. The Advanced Air Bag System monitors the severity of a collision and seat belt usage then inflates the air bags. Failure to properly wear seat belts can increase the risk or severity of injury in an accident.
- The front passenger seat is equipped with occupant classification sensors (weight sensors) that turn the front passenger air bag OFF under some conditions. This sensor is only used in this seat. Failure to be properly seated and wearing the seat belt can increase the risk or severity of injury in an accident. See "Front passenger air bag and status light" (P.1-55).
- Keep hands on the outside of the steering wheel. Placing them inside the steering wheel rim could increase the risk of injury if the front

air bag inflates.

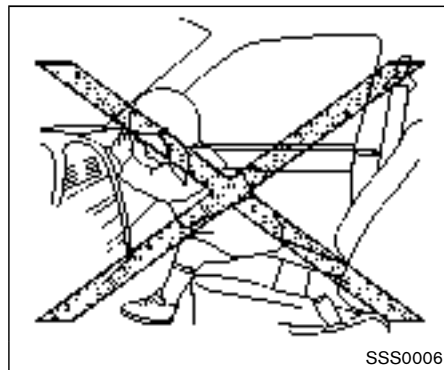
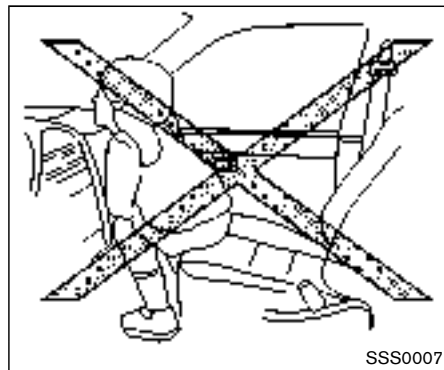

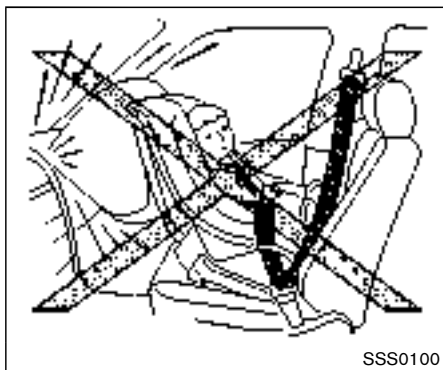
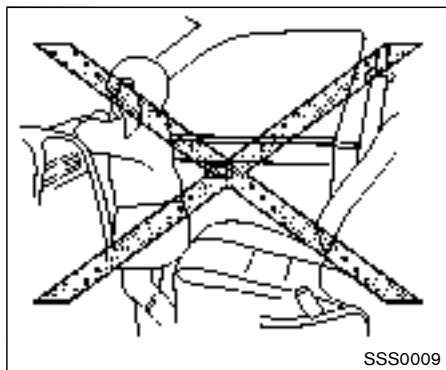
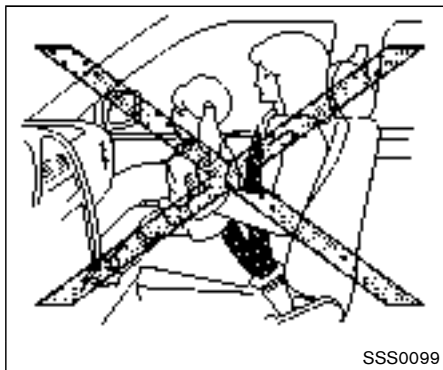
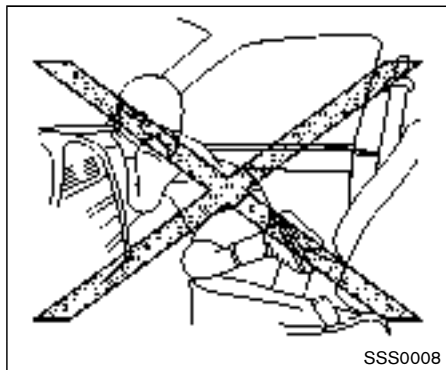

## **WARNING**

- Never let children ride unrestrained or extend their hands or face out of the window. Do not attempt to hold them in your lap or arms. Some examples of dangerous riding positions are shown in the illustrations.
- Children may be severely injured or killed when the front air bags, side air bags or curtain air bags inflate if they are not properly restrained. Pre-teens and children should be properly restrained in the rear seat, if possible.
- Even with the NISSAN Advanced Air Bag System, never install a rear-facing child restraint in the front seat. An inflating front air bag could seriously injure or kill your child. See "Child restraints" (P.1-27) for details.

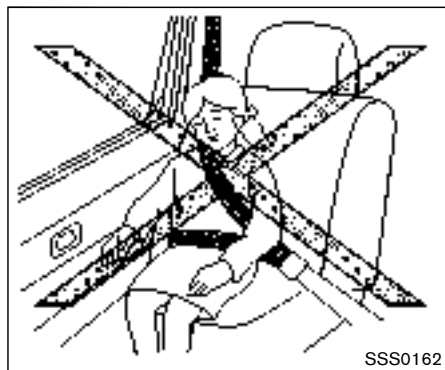
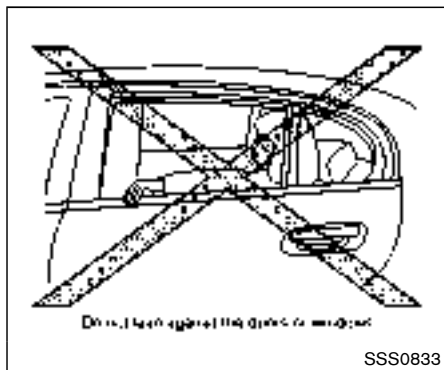
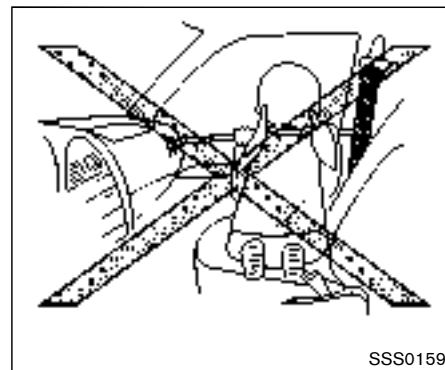
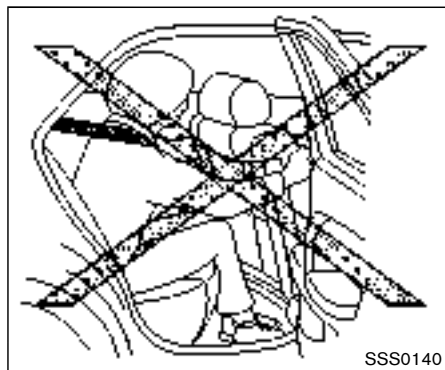
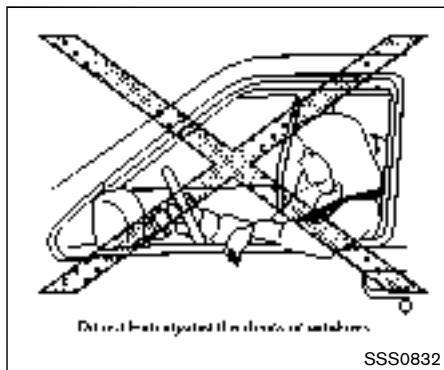

 **WARNING**

Front seat-mounted side-impact supplemental air bags and roof-mounted curtain side-impact supplemental air bags:

- The side-impact and curtain supplemental air bags ordinarily will not inflate in the event of a front impact, rear impact, rollover, or lower severity side collision. Always wear your seat belts to help reduce the risk or severity of injury in various kinds of accidents.

- The seat belts, the side air bags and curtain air bags are most effective when you are sitting well back and upright in the seat. The side air bags and curtain air bags inflate with great force. Do not allow anyone to place their hand, leg or face near the side air bags on the side of the seatback of the front seat or near the side roof rails. Do not allow anyone sitting in the front seats or rear outboard seats to extend their hand out of the window or lean against the door. Some examples of dangerous riding positions are shown in the previous illustrations.
- When sitting in the rear seat, do not hold onto the seatback of the front seat. If the side air bag inflates, you may be seriously injured. Be especially careful with children, who should always be properly restrained. Some examples of dangerous riding positions are shown in the illustrations.
- Do not use seat covers on the front seatbacks. They may interfere with side air bag inflation.

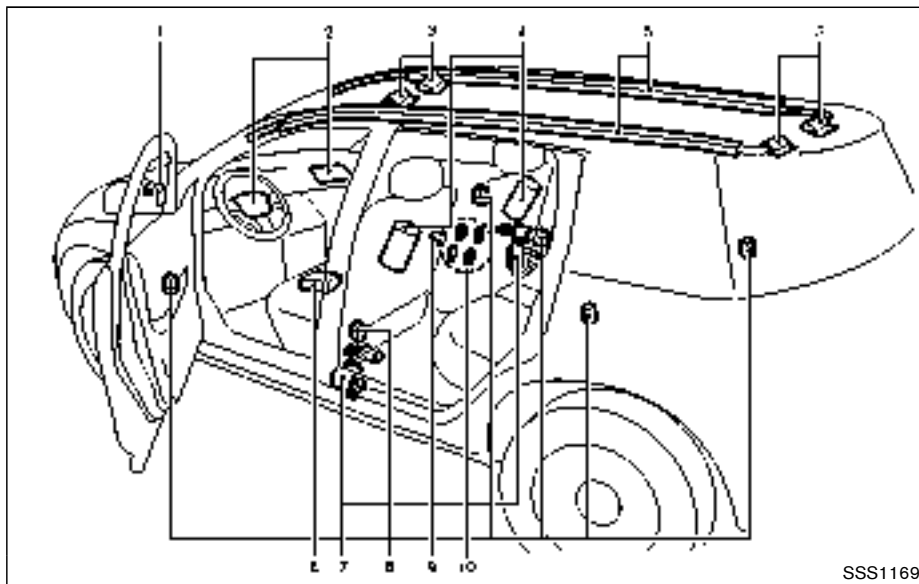

SSS1169

- |   |   |
|---|---|
| 1. Crash zone sensor  | 5. Roof-mounted curtain side-impact supplemental air bags |
| 2. Supplemental front-impact air bag modules (NISSAN Advanced Air Bags) | 6. Air bag Control Unit (ACU)                             |
| 3. Roof-mounted curtain side-impact supplemental air bag inflators      | 7. Seat belt pre-tensioners                               |
| 4. Front seat-mounted side-impact supplemental air bag modules          | 8. Satellite sensors                                      |
|   | 9. Occupant classification system control unit            |
|   | 10. Occupant classification sensors (weight sensors)      |



## NISSAN ADVANCED AIR BAG SYSTEM (front seats)



### WARNING

To ensure proper operation of the passenger's advanced air bag system, please observe the following items.

- Do not allow a passenger in the rear seat to push or pull on the seatback pocket.
- Do not place heavy loads heavier than 9.1 lbs. (4 kg) on the seatback or in the seatback pocket. Do not hang anything from the head restraint.
- Do not store cargo behind the seat that can press into the seatback.
- Do not position the front passenger seat so it contacts the rear seat. If the front seat does contact the rear seat, the air bag system may determine a sensor malfunction has occurred and the front passenger air bag status light may illuminate and the supplemental air bag warning light may flash.

- If a forward facing child restraint is installed in the front passenger seat, do not position the front passenger seat so the child restraint contacts the instrument panel. If the child restraint does contact the instrument panel, the system may determine the seat is occupied and the passenger air bag may deploy in a collision. Also the front passenger air bag status light may not illuminate. See "Child restraints" (P.1-27) for information about installing and using child restraints.
- Confirm the operating condition with the front passenger air bag status light.
- If you notice that the front passenger air bag status light is not operating, it is recommended you visit a NISSAN dealer to check the occupant classification system.
- Until you have confirmed with your dealer that your passenger seat occupant classification system is working properly, position the occupants in the rear seating positions.

This vehicle is equipped with the NISSAN Advanced Air Bag System for the driver and front passenger seats. This system is designed to meet certification requirements under U.S. regulations. It is also permitted in Canada. **All of the information, cautions and warnings in this manual apply and must be followed.**

The driver supplemental front-impact air bag is located in the center of the steering wheel. The passenger supplemental front-impact air bag is mounted in the instrument panel above the glove box. The front air bags are designed to inflate in higher severity frontal collisions, although they may inflate if the forces in another type of collision are similar to those of a higher severity frontal impact. They may not inflate in certain frontal collisions. Vehicle damage (or lack of it) is not always an indication of proper front air bag operation.

The NISSAN Advanced Air Bag System has dual stage air bag inflators. The system monitors information from the Air bag Control Unit (ACU), seat belt buckle sensors and the occupant classification sensors (weight sensors). Inflator operation is based on the severity of a collision and seat belt usage for the driver. For the front passenger, the occupant classification sensors are also monitored. Based on information from the sensors, only one front air bag may inflate in a crash, depending on the crash severity and

whether the front occupants are belted or unbelted. Additionally, the front passenger air bag may be automatically turned OFF under some conditions, depending on the information provided by the occupant classification sensors. If the front passenger air bag is OFF, the front passenger air bag status light will be illuminated (if the seat is unoccupied, the light will not be illuminated, but the air bag will be off). (See “Front passenger air bag and status light” (P.1-55) for further details.) One front air bag inflating does not indicate improper performance of the system.

If you have any questions about your air bag system, it is recommended you visit a NISSAN dealer to obtain information about the system. If you are considering modification of your vehicle due to a disability, you may also contact NISSAN. Contact information is contained in the front of this Owner’s Manual.

When a front air bag inflates, a fairly loud noise may be heard, followed by release of smoke. This smoke is not harmful and does not indicate a fire. Care should be taken not to inhale it, as it may cause irritation and choking. Those with a history of a breathing condition should get fresh air promptly.

Front air bags, along with the use of seat belts, help to cushion the impact force on the head

and chest of the front occupants. They can help save lives and reduce serious injuries. However, an inflating front air bag may cause facial abrasions or other injuries. Front air bags do not provide restraint to the lower body.

Even with NISSAN advanced air bags, seat belts should be correctly worn and the driver and passenger seated upright as far as practical away from the steering wheel or instrument panel. The front air bags inflate quickly in order to help protect the front occupants. Because of this, the force of the front air bag inflating can increase the risk of injury if the occupant is too close to, or is against, the air bag module during inflation.

The front air bags deflate quickly after a collision.

**The front air bags operate only when the ignition switch is in the ON position.**

**After pushing the ignition switch to the ON position, the supplemental air bag warning light illuminates. The supplemental air bag warning light will turn off after about 7 seconds if the system is operational.**



Front passenger air bag status light

Front passenger air bag and status light

 **WARNING**

**The front passenger air bag is designed to automatically turn OFF under some conditions. Read this section carefully to learn how it operates. Proper use of the seat, seat belt and child restraints is necessary for most effective protection. Failure to follow all instructions in this manual concerning the use of seats, seat belts and child restraints can increase the risk or severity of injury in**

an accident.



### Status light:

The front passenger seat is equipped with occupant classification sensors (weight sensors) that turn the front passenger air bag on or off depending on the weight applied to the front passenger seat.

The status of the front passenger air bag (ON or OFF) is indicated by the front passenger air bag status light  which is located on the instrument panel.

After the ignition switch is placed in the ON position, the front passenger air bag status light illuminates for about 7 seconds and then turns off or illuminates depending on the front passenger seat occupied status. The light operates as follows:

The light operates as follows:

- Unoccupied passenger seat: The  light is OFF and the front passenger air bag is OFF and will not inflate in a crash.
- Front passenger seat occupied by a small adult, child or child restraint as outlined in this section: The  light illuminates to indicate that the front passenger air bag is OFF and will not inflate in a crash.

- Occupied passenger seat and the passenger meets the conditions outlined in this section: The  light is OFF to indicate that the front passenger air bag is operational.

In addition to the above, certain objects placed on the front passenger seat may also cause the light to operate as described above depending on their weight.

For additional information related to the normal operation and troubleshooting of this occupant classification sensor system, please refer to “Normal operation” (P.1-57) and “Troubleshooting” (P.1-58) in this section.

### Front passenger air bag:

The front passenger air bag is designed to automatically turn OFF when the vehicle is operated under some conditions as described below as permitted by U.S. regulations. If the front passenger air bag is OFF, it will not inflate in a crash. The driver air bag and other air bags in your vehicle are not part of this system.

The purpose of the regulation is to help reduce the risk of injury or death from an inflating air bag to certain front passenger seat occupants, such as children, by requiring the air bag to be automatically turned OFF.

The occupant classification sensors (weight sensors) are on the seat cushion frame under the front passenger seat and are designed to

detect an occupant and objects on the seat. For example, if a child is in the front passenger seat, the Advanced Air Bag System is designed to turn the passenger air bag OFF in accordance with the regulations. Also, if a child restraint of the type specified in the regulations is on the seat, the occupant classification sensors can detect it and cause the air bag to turn OFF.

Front passenger seat adult occupants who are properly seated and using the seat belt as outlined in this manual should not cause the passenger air bag to be automatically turned OFF. For small adults it may be turned OFF, however, if the occupant does not sit in the seat properly (for example, by not sitting upright, by sitting on an edge of the seat, or by otherwise being out of position), this could cause the sensor to turn the air bag OFF. Always be sure to be seated and wearing the seat belt properly for the most effective protection by the seat belt and supplemental air bag.

NISSAN recommends that pre-teens and children be properly restrained in a rear seat. NISSAN also recommends that appropriate child restraints and booster seats be properly installed in a rear seat. If this is not possible, the occupant classification sensors are designed to operate as described above to turn the front passenger air bag OFF for specified child restraints. Failing to properly secure child

restrains and to use the ALR mode may allow the restraint to tip or move in an accident or sudden stop. This can also result in the passenger air bag inflating in a crash instead of being OFF. (See "Child restraints" (P.1-27) for proper use and installation.)

If the front passenger seat is not occupied, the passenger air bag is designed not to inflate in a crash. However, heavy objects placed on the seat could result in air bag inflation, because of the object being detected by the occupant classification sensors. Other conditions could also result in air bag inflation, such as if a child is standing on the seat, or if two children are on the seat, contrary to the instructions in this manual. Always be sure that you and all vehicle occupants are seated and restrained properly.

Using the front passenger air bag status light, you can monitor when the front passenger air bag is automatically turned OFF with the seat occupied. The light will not illuminate when the front passenger seat is unoccupied.

If an adult occupant is in the seat but the front passenger air bag status light is illuminated (indicating that the air bag is OFF), it could be that the person is a small adult, or is not sitting on the seat properly.

If a child restraint must be used in the front seat, the front passenger air bag status light may or

may not be illuminated, depending on the size of the child and the type of child restraint being used. If the front passenger air bag status light is not illuminated (indicating that the air bag might inflate in a crash), it could be that the child restraint or seat belt is not being used properly. Make sure that the child restraint is installed properly, the seat belt is used properly and the occupant is positioned properly. If the front passenger air bag status light is still not illuminated, reposition the occupant or child restraint in a rear seat.

If the front passenger air bag status light will not illuminate even though you believe that the child restraint, the seat belts and the occupant are properly positioned, the system may be sensing an unoccupied seat (in which case the air bag is OFF). Your NISSAN dealer can check that the system is OFF by using a special tool. However, until you have confirmed with your dealer that your air bag is working properly, reposition the occupant or child restraint in a rear seat.

The NISSAN Advanced Air Bag System and the front passenger air bag status light will take a few seconds to register a change in the passenger seat status. However, if the seat becomes unoccupied, the front passenger air bag status light will remain off.

If a malfunction occurs in the front passenger air

bag system, the supplemental air bag warning light , located in the meter and gauges area will blink. Have the system checked. It is recommended you visit a NISSAN dealer for this service.

#### **Normal operation:**

In order for the occupant classification sensor system to classify the front passenger based on weight, please follow the precautions and steps outlined below:

#### **Precautions:**

- Make sure that there are no objects weighing over 9.1 lbs. (4 kg) hanging on the seat or placed in the seatback pocket.
- Make sure that a child restraint or other object is not pressing against the rear of the seatback.
- Make sure that a rear passenger is not pushing or pulling on the back of the front passenger seat.
- Make sure that the front passenger seat or seatback is not forced back against an object on the seat or floor behind it.
- Make sure that there is no object placed under the front passenger seat.

### Steps:

1. Adjust the seat as outlined. (See “Seats” (P.1-2).) Sit upright, leaning against the seatback, and centered on the seat cushion with your feet comfortably extended to the floor.
2. Make sure there are no objects on your lap.
3. Fasten the seat belt as outlined. (See “Seat belts” (P.1-15).)
4. Remain in this position for 30 seconds allowing the system to classify the front passenger before the vehicle is put into motion.
5. Ensure proper classification by checking the front passenger air bag status light.

### NOTE:

**This vehicle's occupant classification sensor system locks the classification during driving so it is important that you confirm that the front passenger is properly classified prior to driving. Also, the occupant classification sensor system may recalculate the weight of the occupant when the vehicle comes to a stop (i.e. stop light, stop sign, etc.), so the front passenger seat occupant should continue to remain seated as outlined above.**

### Troubleshooting:

If you think the front passenger air bag status light is incorrect:

1. If the light is ON with no front passenger and no objects on the front passenger seat:

This may be due to the following conditions that may be interfering with the weight sensors:

- An object weighing over 9.1 lbs. (4 kg) hanging on the seat or placed in the seatback pocket.
- A child restraint or other object pressing against the rear of the seatback.
- A rear passenger pushing or pulling on the back of the front passenger seat.
- Forcing the front seat or seatback against an object on the seat or floor behind it.
- An object placed under the front passenger seat.
- An object placed between the seat cushion and center console or between the seat cushion and the door.

If the vehicle is moving, please come to a stop when it is safe to do so. Check and correct any of the above conditions. Restart the vehicle and wait 1 minute.

### NOTE:

**A system check will be performed during which the front passenger air bag status**

**light will remain lit for about 7 seconds initially.**

If the light is still ON after this, the vehicle should be checked as soon as possible. It is recommended you visit a NISSAN dealer for this service.

2. If the light is ON with an adult occupying the front passenger seat:
  - Occupant is a small adult — the front passenger air bag status light is functioning as intended. The front passenger air bag is suppressed.

However, if the occupant is not a small adult, then this may be due to the following conditions that may be interfering with the weight sensors:

- Occupant is not sitting upright, leaning against the seatback, and centered on the seat cushion with his/her feet comfortably extended to the floor.
- A child restraint or other object pressing against the rear of the seatback.
- A rear passenger pushing or pulling on the back of the front passenger seat.
- Forcing the front seat or seatback against an object on the seat or floor behind it.
- An object placed under the front passenger seat.

- An object placed between the seat cushion and center console or between the seat cushion and the door.

If the vehicle is moving, please come to a stop when it is safe to do so. Check and correct any of the above conditions. Restart the vehicle and wait 1 minute.

**NOTE:**

**A system check will be performed during which the front passenger air bag status light will remain lit for about 7 seconds initially.**

If the light is still ON after this, the person should be advised not to ride in the front passenger seat and the vehicle should be checked as soon as possible. It is recommended you visit a NISSAN dealer for this service.

3. If the light is OFF with a small adult, child or child restraint occupying the front passenger seat.  
This may be due to the following conditions that may be interfering with the weight sensors:
  - Small adult or child is not sitting upright, leaning against the seatback, and centered on the seat cushion with his/her feet comfortably extended to the floor.
  - The child restraint is not properly installed as outlined. (See “Child restraints” (P.1-27).)

- An object weighing over 9.1 lbs. (4 kg) hanging on the seat or placed in the seatback pocket.
- A child restraint or other object pressing against the rear of the seatback.
- A rear passenger pushing or pulling on the back of the front passenger seat.
- Forcing the front seat or seatback against an object on the seat or floor behind it.
- An object placed under the front passenger seat.
- An object placed between the seat cushion and center console.

If the vehicle is moving, please come to a stop when it is safe to do so. Check and correct any of the above conditions. Restart the vehicle and wait 1 minute.

**NOTE:**

**A system check will be performed during which the front passenger air bag status light will remain lit for about 7 seconds initially.**

If the light is still OFF after this, the small adult, child or child restraint should be repositioned in the rear seat and the vehicle should be checked as soon as possible. It is recommended you visit a NISSAN dealer for this service.

Other supplemental front-impact air bag precautions



**WARNING**

- **Do not place any objects on the steering wheel pad or on the instrument panel. Also, do not place any objects between any occupant and the steering wheel or instrument panel. Such objects may become dangerous projectiles and cause injury if the front air bags inflate.**
- **Do not place objects with sharp edges on the seat. Also, do not place heavy objects on the seat that will leave permanent impressions in the seat. Such objects can damage the seat or occupant classification sensors (weight sensors). This can affect the operation of the air bag system and result in serious personal injury.**
- **Do not use water or acidic cleaners (hot steam cleaners) on the seat. This can damage the seat or occupant classification sensors. This can also affect the operation of the air bag system and result in serious**

personal injury.

- Immediately after inflation, several front air bag system components will be hot. Do not touch them; you may severely burn yourself.
- No unauthorized changes should be made to any components or wiring of the supplemental air bag system. This is to prevent accidental inflation of the supplemental air bag or damage to the supplemental air bag system.
- Do not make unauthorized changes to your vehicle's electrical system, suspension system or front end structure. This could affect proper operation of the front air bag system.
- Tampering with the air bag system may result in serious personal injury. Tampering includes changes to the steering wheel and the instrument panel assembly by placing material over the steering wheel pad and above the instrument panel or by installing additional trim material around the air bag system.

- Removing or modifying the front passenger seat may affect the function of the air bag system and result in serious personal injury.
- Modifying or tampering with the front passenger seat may result in serious personal injury. For example, do not change the front seats by placing material on the seat cushion or by installing additional trim material, such as seat covers, on the seat that is not specifically designed to assure proper air bag operation. Additionally, do not stow any objects under the front passenger seat or the seat cushion and seatback. Such objects may interfere with the proper operation of the occupant classification sensors.
- No unauthorized changes should be made to any components or wiring of the seat belt system. This may affect the front air bag system. Tampering with the seat belt system may result in serious personal injury.
- It is recommended you visit a NISSAN dealer for work on and around the front air bag. It is also

recommended you visit a NISSAN dealer for installation of electrical equipment. The Supplemental Restraint System (SRS) wiring harnesses\* should not be modified or disconnected. Unauthorized electrical test equipment and probing devices should not be used on the air bag system.

- A cracked windshield should be replaced immediately by a qualified repair facility. A cracked windshield could affect the function of the supplemental air bag system.

\* The SRS wiring harness connectors are yellow and orange for easy identification.

When selling your vehicle, we request that you inform the buyer about the front air bag system and guide the buyer to the appropriate sections in this Owner's Manual.

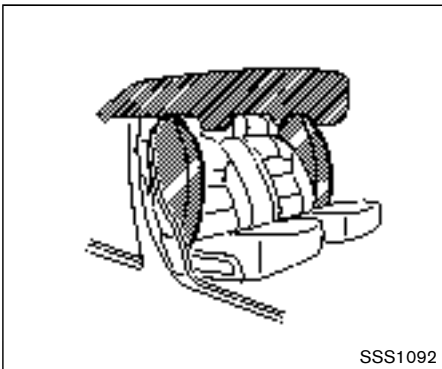

### FRONT SEAT-MOUNTED SIDE-IMPACT SUPPLEMENTAL AIR BAG AND ROOF-MOUNTED CURTAIN SIDE-IMPACT SUPPLEMENTAL AIR BAG SYSTEMS

The side air bags are located in the outside of the seatback of the front seats. The curtain air bags are located in the side roof rails. **All of the information, cautions and warnings in this manual apply and must be followed.** The side air bags and curtain air bags are designed to inflate in higher severity side collisions, although they may inflate if the forces in another type of collision are similar to those of a higher severity side impact. They are designed to inflate

on the side where the vehicle is impacted. They may not inflate in certain side collisions on the side where the vehicle is impacted.

Vehicle damage (or lack of it) is not always an indication of proper side air bag and curtain air bag operation.

When side air bags and curtain air bags inflate, a fairly loud noise may be heard, followed by release of smoke. This smoke is not harmful and does not indicate a fire. Care should be taken not to inhale it, as it may cause irritation and choking. Those with a history of a breathing condition should get fresh air promptly.

Side air bags, along with the use of seat belts, help to cushion the impact force on the chest and pelvis of the front occupants. Curtain air bags help to cushion the impact force to the head of occupants in the front and rear (2nd and 3rd) outboard seating positions. They can help save lives and reduce serious injuries. However, an inflating side air bag or curtain air bag may cause abrasions or other injuries. Side air bags and curtain air bags do not provide restraint to the lower body.

The seat belts should be correctly worn and the driver and passenger seated upright as far as practical away from the side air bag. Rear seat passengers should be seated as far away as practical from the door finishers and side roof

rails. The side air bags and curtain air bags inflate quickly in order to help protect the occupants. Because of this, the force of the side air bags and curtain air bags inflating can increase the risk of injury if the occupant is too close to, or is against, these air bag modules during inflation. The side air bags and curtain air bags will deflate quickly after the collision is over.

**The side air bags and curtain air bags operate only when the ignition switch is in the ON position.**

**After pushing the ignition switch to the ON position, the supplemental air bag warning light illuminates. The air bag warning light will turn off after about 7 seconds if the systems are operational.**



### WARNING

- **Do not place any objects near the seatback of the front seats. Also, do not place any objects (an umbrella, bag, etc.) between the front door finisher and the front seat. Such objects may become dangerous projectiles and cause injury if side air bag inflates.**



- Right after inflation, several side air bags and curtain air bag system components will be hot. Do not touch them; you may severely burn yourself.
- No unauthorized changes should be made to any components or wiring of side air bag and curtain air bags. This is to prevent damage to or accidental inflation of the side air bag and curtain air bag systems.
- Do not make unauthorized changes to your vehicle's electrical system, suspension system or side panel. This could affect proper operation of the side air bag and curtain air bag systems.
- Tampering with the air bag system may result in serious personal injury. For example, do not change the front seats by placing material near the seatback or by installing additional trim material, such as seat covers, around the side air bags.
- It is recommended you visit a NISSAN dealer for work on and around the side air bag and curtain air bag systems. It is also recommended you visit a NISSAN dealer

for installation of electrical equipment. The Supplemental Restraint System (SRS) wiring harness\* should not be modified or disconnected. Unauthorized electrical test equipment and probing devices should not be used on the side-impact air bag system.

- \* The SRS wiring harness connectors are yellow and orange for easy identification.

When selling your vehicle, we request that you inform the buyer about the side air bag and curtain air bag systems and guide the buyer to the appropriate sections in this Owner's Manual.

#### SEAT BELTS WITH PRETENSIONERS (front seats)



#### WARNING

- The pretensioners cannot be reused after activation. They must be replaced together with the retractor and buckle as a unit.
- If the vehicle becomes involved in a collision but a pretensioner is not activated, be sure to have the pretensioner system checked and, if necessary replaced. It is recom-

mended you visit a NISSAN dealer for this service.

- No unauthorized changes should be made to any components or wiring of the pretensioner system. This is to prevent damage to or accidental activation of the pretensioners. Tampering with the pretensioner system may result in serious personal injury.
- It is recommended you visit a NISSAN dealer for work on and around the pretensioner system. It is also recommended you visit a NISSAN dealer for installation of electrical equipment. Unauthorized electrical test equipment and probing devices should not be used on the pretensioner system.
- If you need to dispose of a pretensioner or scrap the vehicle, it is recommended you visit a NISSAN dealer for this service. Correct pretensioner disposal procedures are set forth in the appropriate NISSAN Service Manual. Incorrect disposal procedures could cause personal injury.

The pretensioner system may activate with the supplemental air bag system in certain types of collisions. Working with the seat belt retractor, it helps tighten the seat belt when the vehicle becomes involved in certain types of collisions, helping to restrain front seat occupants.

The pretensioner is encased with the seat belt retractor. These seat belts are used the same way as conventional seat belts.

When a pretensioner activates, smoke is released and a loud noise may be heard. The smoke is not harmful, and it does not indicate a fire. Care should be taken not to inhale it as it may cause irritation and choking. Those with a history of a breathing condition should get fresh air promptly.

After pretensioner activation, load limiters allow the seat belt to release webbing (if necessary) to reduce forces against the chest.

The supplemental air bag warning light  is used to indicate malfunctions in the pretensioner system. (See “Supplemental air bag warning light” (P.1-64) for more details.) If the operation of the supplemental air bag warning light indicates there is a malfunction, have the system checked. It is recommended you visit a NISSAN dealer for this service.

When selling your vehicle, we request that you inform the buyer about the pretensioner system

and guide the buyer to the appropriate sections in this Owner's Manual.

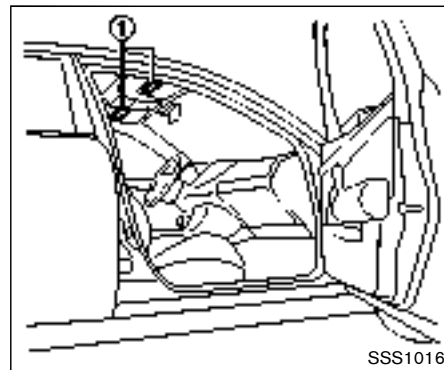

## SUPPLEMENTAL AIR BAG WARNING LABELS

Warning labels about the supplemental front-impact air bag system are placed in the vehicle as shown in the illustration.

### SRS air bag

The warning labels ① are located on the surface of the sun visors.



## SUPPLEMENTAL AIR BAG WARNING LIGHT

The supplemental air bag warning light, displaying  in the instrument panel, monitors the circuits for the air bag systems, pretensioners and all related wiring.

When the ignition switch is in the ON position, the supplemental air bag warning light illuminates for about 7 seconds and then turns off. This means the SRS air bag systems are operational.

If any of the following conditions occur, the air bag and/or pretensioner systems need servicing:

- The supplemental air bag warning light remains on approximately 7 seconds after the ignition switch is pushed to the ON position.
- The supplemental air bag warning light flashes intermittently.
- The supplemental air bag warning light does not come on at all.

Under these conditions, the air bag and/or pretensioner systems may not operate properly. They must be checked and repaired. It is recommended you visit a NISSAN dealer for this service.



### WARNING

**If the supplemental air bag warning light is on, it could mean that the front air bag, side air bag and curtain air bag and/or pretensioner systems will not operate in an accident. To help avoid injury to yourself or others, have your vehicle checked as soon as possible. It is recommended you visit a NISSAN dealer for this service.**

## REPAIR AND REPLACEMENT PROCEDURE

The front air bags, side air bags and curtain air bags and pretensioners are designed to activate on a one-time-only basis. As a reminder, unless it is damaged, the supplemental air bag warning light will remain illuminated after inflation has occurred. These systems should be repaired and/or replaced as soon as possible. It is recommended you visit a NISSAN dealer for this service.

When maintenance work is required on the vehicle, the front air bags, side air bags and curtain air bags, pretensioners and related parts should be pointed out to the person conducting the maintenance. The ignition switch should always be in the LOCK position when working under the hood or inside the vehicle.



### WARNING

- **Once a front air bag, side air bag or curtain air bag has inflated, the air bag module will not function again and must be replaced. Additionally, the activated pretensioner must also be replaced. The air bag module and pretensioner should be replaced. It is recommended you**

visit a NISSAN dealer for this service. However, the air bag module and pretensioner system cannot be repaired.

- The front air bag, side air bag, curtain air bag and the pretensioner should be inspected if there is any damage to the front end or side portion of the vehicle. It is recommended you visit a NISSAN dealer for this service.
- If you need to dispose of a supplemental air bag or pretensioner or scrap the vehicle, it is recommended you visit a NISSAN dealer. Correct supplemental air bag and pretensioner system disposal procedures are set forth in the appropriate NISSAN Service Manual. Incorrect disposal procedures could cause personal injury.
- If there is an impact to your vehicle from any direction, your Occupant Classification Sensor (OCS) should be checked to verify it is still functioning correctly. It is recommended you visit a NISSAN dealer for this service. The OCS should be checked even if no air bags deploy

as a result of the impact. Failure to verify proper OCS function may result in an improper air bag deployment resulting in injury or death.

**MEMO**

**MEMO**

**MEMO**

## 2 Instruments and controls

Cockpit .....	2-3	Rear window and outside mirror defroster switch .....	2-33
Instrument panel .....	2-4	Headlight and turn signal switch .....	2-33
Meters and gauges .....	2-5	Xenon headlights (if so equipped) .....	2-33
Meter/ring illumination and needle sweep .....	2-5	Headlight switch .....	2-34
Speedometer and odometer .....	2-6	Turn signal switch .....	2-38
Tachometer .....	2-7	Fog light switch (if so equipped) .....	2-39
Engine coolant temperature gauge .....	2-7	Horn .....	2-39
Fuel gauge .....	2-8	Heated seats (if so equipped) .....	2-39
Compass (if so equipped) .....	2-8	Blind Spot Warning (BSW) switch (if so equipped) .....	2-41
Zone variation change procedure .....	2-10	Vehicle Dynamic Control (VDC) OFF switch .....	2-41
Warning lights, indicator lights and audible reminders .....	2-11	Power outlet .....	2-42
Checking lights .....	2-12	Storage .....	2-44
Warning lights .....	2-12	Cup holders .....	2-44
Indicator lights .....	2-16	Sunglasses holder .....	2-46
Audible reminders .....	2-18	Glove box .....	2-47
Vehicle information display .....	2-19	Instrument lower box (if so equipped) .....	2-47
Operational indicators .....	2-21	Console box .....	2-47
Maintenance indicators .....	2-23	Cargo floor box .....	2-48
Trip computer .....	2-24	Hooks .....	2-49
Security systems .....	2-28	Roof rack (if so equipped) .....	2-50
Vehicle security system .....	2-28	Coat hooks .....	2-51
NISSAN vehicle immobilizer system .....	2-30	Sunshade (if so equipped) .....	2-51
Wiper and washer switch .....	2-31	Windows .....	2-52
Rear window wiper and washer switch .....	2-32	Power windows .....	2-52



Moonroof (if so equipped) .....	2-54	Cargo lights .....	2-60
Power moonroof .....	2-54	HomeLink® Universal Transceiver (if so equipped) .....	2-60
Front moonroof .....	2-55	Programming HomeLink® .....	2-61
Rear moonroof .....	2-56	Programming HomeLink® for Canadian Customers	
If the front or rear moonroof does not operate .....	2-56	and gate openers .....	2-62
Interior lights .....	2-57	Operating the HomeLink®	
Map lights .....	2-57	Universal Transceiver .....	2-62
Rear personal lights .....	2-57	Programming troubleshooting .....	2-63
Interior light control switch .....	2-58	Clearing the programmed information .....	2-63
Mood lights .....	2-59	Reprogramming a single HomeLink® button .....	2-63
Vanity mirror lights .....	2-59	If your vehicle is stolen .....	2-63

## COCKPIT

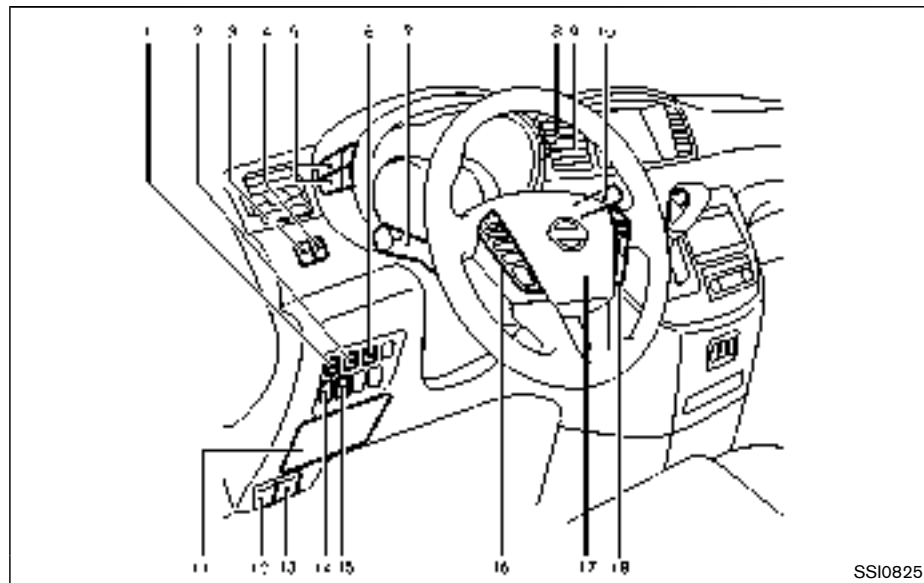

1. Vehicle Dynamic Control (VDC) OFF switch
2. Blind Spot Warning (BSW) switch\*
  - Blind Spot Warning (BSW)\*
3. Sliding door switch\* (driver's side)
4. Sliding door switch\* (passenger's side)
5. Instrument brightness control switch
6. Power liftgate switch\*

7. Headlight, fog light and turn signal switch
  - Headlight
  - Turn signal
  - Fog light\*
8. Trip computer switch
9. TRIP/RESET switch for twin trip odometer
10. Wiper and washer switch

11. Fuse box cover
  12. Fuel-filler door opener handle
  13. Hood release handle
  14. Headlight aiming control\*
  15. Power door main switch\*
  16. Steering-wheel-mounted controls (left side)
    - Audio control steering switch\*
    - Hands-Free Phone System switch\*
  17. Horn
  18. Steering-wheel-mounted controls (right side)
    - Cruise control system
- \*: if so equipped

SSI0825

## INSTRUMENT PANEL

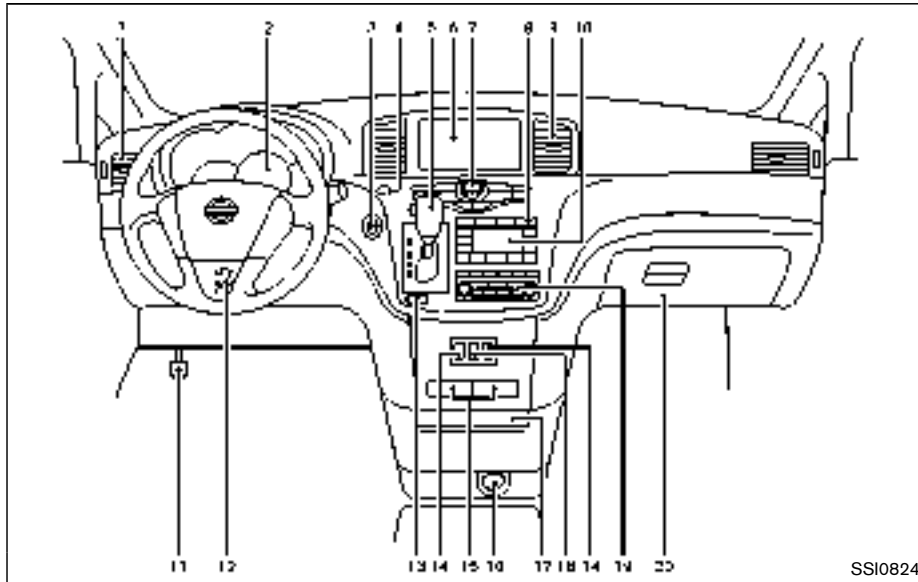

- |  |  |
|--|--|
| <ol style="list-style-type: none"> <li>1. Side ventilator</li> <li>2. Meters and gauges</li> <li>3. Push-button ignition switch</li> <li>4. Hazard warning flasher switch</li> <li>5. Shift lever</li> <li>6. Center display             <ul style="list-style-type: none"> <li>— Center color display*</li> </ul> </li> </ol> | <ol style="list-style-type: none"> <li>7. Center multi-function control panel*             <ul style="list-style-type: none"> <li>— Navigation system**</li> <li>— Navigation system**</li> <li>— Vehicle information and setting buttons*</li> <li>— RearView Monitor*</li> <li>— Around View<sup>®</sup> Monitor*</li> </ul> </li> </ol> |
|--|--|

8. Rear window and outside mirror\* defroster switch
  9. Center ventilator
  10. Heater/air conditioner control or audio system
  11. Parking brake
  12. Tilting telescopic steering wheel lever
  13. Front passenger air bag status light
  14. Heated seat switch\*
  15. Cup holders
  16. Power outlet
  17. Instrument lower box or CD/DVD slot
  18. Power outlet main switch\*
  19. Audio system
  20. Glove box
- \*: if so equipped  
 \*\*: Refer to the separate Navigation System Owner's Manual (if so equipped).

## METERS AND GAUGES

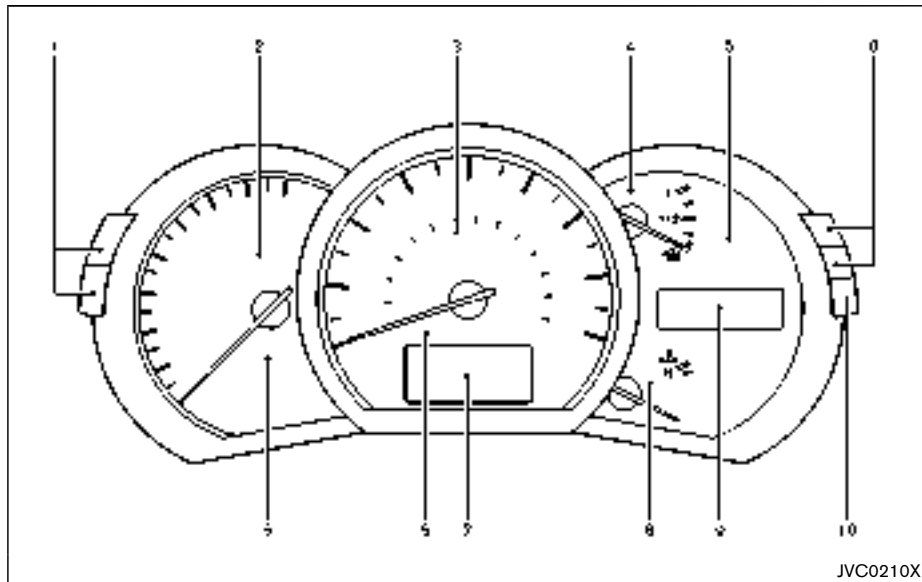

1. Instrument brightness control switch
2. Tachometer
3. Speedometer
4. Fuel gauge
5. Warning/indicator lights
6. Trip computer switch
7. Vehicle information display  
— Trip computer
8. Engine coolant temperature gauge
9. Odometer/twin trip odometer/Continuously Variable Transmission (CVT) position indicator
10. TRIP/RESET switch for twin trip odometer

The needle indicators may move slightly after the ignition switch is pushed to the OFF position. This is not a malfunction.

### CAUTION

- For cleaning, use a soft cloth, dampened with water. Never use a rough cloth, alcohol, benzene, thinner or any kind of solvent or paper towel with a chemical cleaning agent. They will scratch or cause discoloration to the lens.
- Do not spray any liquid such as water on the meter lens. Spraying liquid may cause the system to malfunction.

### METER/RING ILLUMINATION AND NEEDLE SWEEP

The ring illumination surrounding meters and gauges illuminates when the driver's door is closed after getting into the vehicle with the Intelligent Key carried in.

When the engine is started, the indicator needles will sweep in the speedometer and tachometer and the ring illumination will be brightened gradually. This function can be turned off. (See "Trip computer" (P.2-24).)

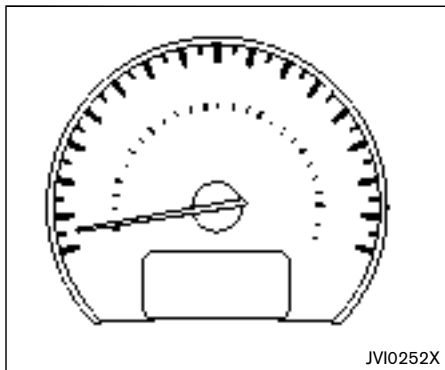

Speedometer

## SPEEDOMETER AND ODOMETER

### Speedometer

The speedometer indicates vehicle speed in miles per hour (MPH) and kilometers per hour (km/h).

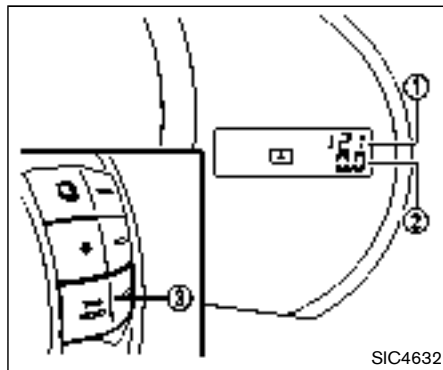

Odometer/twin trip odometer

### Odometer/twin trip odometer

The odometer ① and twin trip odometer ② are displayed when the ignition switch is in the ON position.

The odometer records the total distance the vehicle has been driven.

The twin trip odometer records the distance of individual trips.

### Changing the display:

Pushing the TRIP RESET switch ③ on the right side of the combination meter panel changes the display as follows:

TRIP A → TRIP B → TRIP A

### Resetting the trip odometer:

Pushing the TRIP RESET switch ③ for more than 1 second resets the trip odometer to zero.

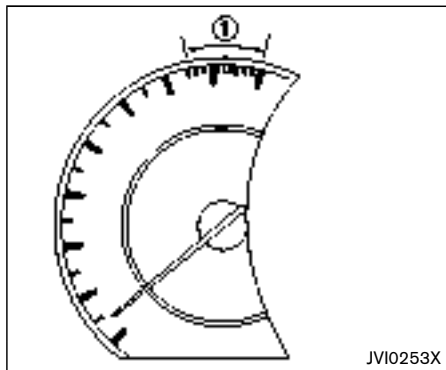

## TACHOMETER

The tachometer indicates engine speed in revolutions per minute (RPM). **Do not rev the engine into the red zone ①.**

### CAUTION

**When engine speed approaches the red zone, shift to a higher gear or reduce engine speed. Operating the engine in the red zone may cause serious engine damage.**

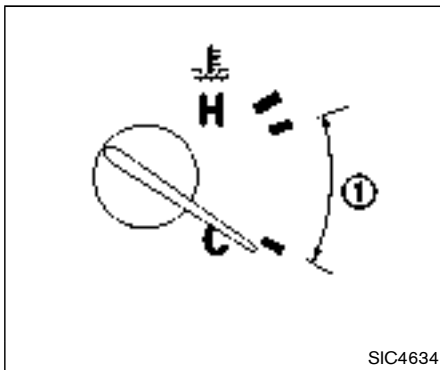

## ENGINE COOLANT TEMPERATURE GAUGE

The gauge indicates the engine coolant temperature.

The engine coolant temperature is within the normal range when the gauge needle points within the zone ① shown in the illustration.

The engine coolant temperature varies with the outside air temperature and driving conditions.

### CAUTION

**If the gauge indicates engine coolant temperature near the hot (H) end of the**

**normal range, reduce vehicle speed to decrease temperature. If gauge is over the normal range, stop the vehicle as soon as safely possible and let the engine idle. If the engine is overheated, continued operation of the vehicle may seriously damage the engine. See "If your vehicle overheats" (P.6-12) for immediate action required.**

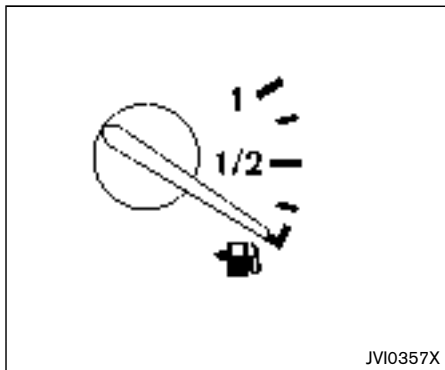

## FUEL GAUGE

The gauge indicates the **approximate** fuel level in the tank.

The gauge may move slightly during braking, turning, acceleration, or going up or down hills.

The gauge needle returns to "0" (empty) after the ignition switch is pushed to the OFF position.



**Refill the fuel tank before the gauge registers "0" (empty).**

The low fuel warning  appears on the vehicle information display when the fuel level in the tank is getting low. Refuel as soon as it is convenient, preferably before the gauge reaches "0". There

will be a small reserve of fuel in the tank when the fuel gauge needle reaches "0".

The  indicates that the fuel-filler door is located on the driver's side of the vehicle.

## CAUTION

- If the vehicle runs out of fuel, the  malfunction indicator light (MIL) may come on. Refuel as soon as possible. After a few driving trips, the  light should turn off. If the light remains on after a few driving trips, have the vehicle inspected. It is recommended you visit a **NISSAN dealer for this service.**
- For additional information, see "Malfunction Indicator Light (MIL)" (P.2-17).

## COMPASS (if so equipped)

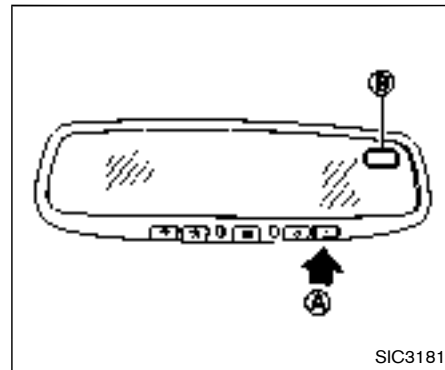

When the ignition switch is pushed to the ON position, the compass display (B) will indicate the direction of the vehicle's heading.

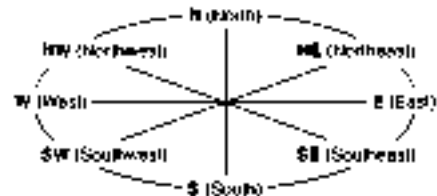

If the display reads "C", calibrate the compass by driving the vehicle in 3 complete circles at less than 5 MPH (8 km/h). You can also calibrate the compass by driving your vehicle

on your everyday route. The compass will be calibrated once it has tracked 3 complete circles.

To turn on and off the compass manually, push the  switch (A) while the ignition switch is in the ON position.

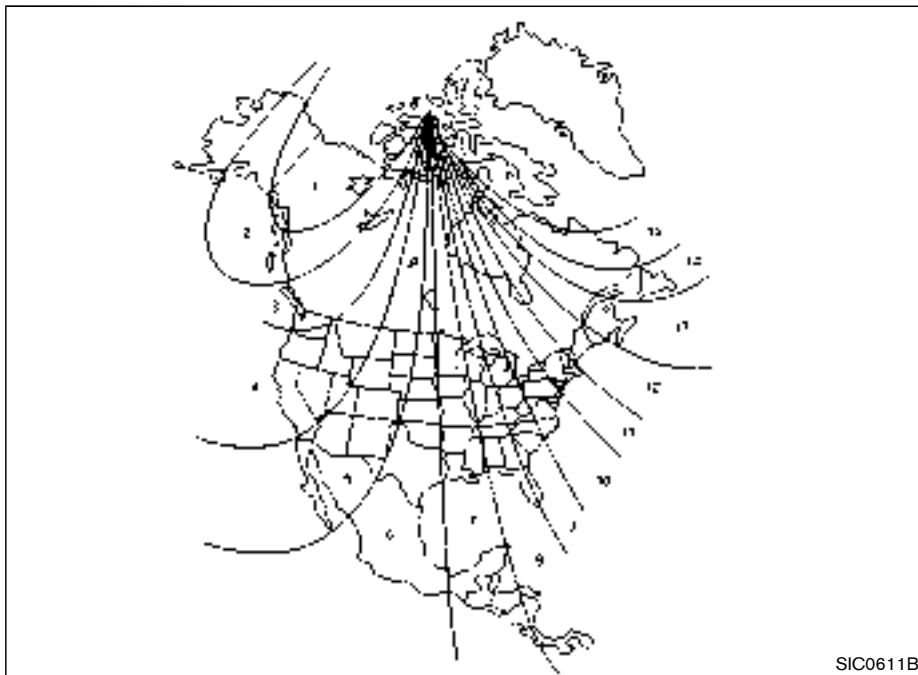

SIC0611B

Zone map



## ZONE VARIATION CHANGE PROCEDURE

The difference between magnetic north and geographical north is known as variance. In some areas, this difference can sometimes be great enough to cause false compass readings. Follow these instructions to set the variance for your particular location if this happens:

1. Push the  switch for more than 3 seconds. The current zone number will appear in the display.
2. Find your current location and variance number on the zone map.

### NOTE:

**Use zone number 5 for Hawaii.**

3. Push the  switch repeatedly until the new zone number appears in the display, then release the switch. After you release the switch, the display will show a compass direction within a few seconds.
  - If the compass deviates from the correct indication soon after repeated adjustment, have the compass checked. It is recommended you visit a NISSAN dealer for this service.
  - The compass may not indicate the correct compass point in tunnels or while driving up or down a steep hill.

























(The compass returns to the correct compass point when the vehicle moves to an area where the geomagnetism is stabilized.)



## CAUTION

- **Do not install a ski rack, antenna, etc., which are attached to the vehicle by means of a magnet. They affect the operation of the compass.**
- **When cleaning the mirror, use a paper towel or similar material dampened with glass cleaner. Do not spray glass cleaner directly on the mirror as it may cause the liquid cleaner to enter the mirror housing.**

## WARNING LIGHTS, INDICATOR LIGHTS AND AUDIBLE REMINDERS

	Anti-lock Braking System (ABS) warning light		Intelligent Key system warning light		Exterior light indicator
			Low tire pressure warning light		Front passenger air bag status light
	Blind Spot Warning (BSW) system warning light (if so equipped)		Master warning light		High beam indicator light
	Brake warning light		Seat belt warning light and chime		Malfunction Indicator Light (MIL)
			Supplemental air bag warning light		Overdrive off indicator light
	Charge warning light		Vehicle Dynamic Control (VDC) warning light		Security indicator light
	Engine oil pressure warning light		Continuously Variable Transmission (CVT) position indicator light		Turn signal/hazard indicator lights
	Hydraulic pump electric power steering warning light		Cruise indicator light		Vehicle Dynamic Control (VDC) off indicator light

## CHECKING LIGHTS

With all doors closed, apply the parking brake, fasten the seat belts and place the ignition switch in the ON position without starting the engine. The following lights (if so equipped) will come on:



The following lights (if so equipped) come on briefly and then go off:



If any light does not come on or operates in a way other than described, it may indicate a burned-out bulb and/or a system malfunction. It is recommended you have the system checked by a NISSAN dealer.

Some indicators and warnings are also displayed on the vehicle information display on the speedometer. (See "Vehicle information display" (P.2-19).)

## WARNING LIGHTS

### or Anti-lock Braking System (ABS) warning light

When the ignition switch is in the ON position, the Anti-lock Braking System (ABS) warning light illuminates and then turns off. This indicates the ABS is operational.

If the ABS warning light illuminates while the engine is running, or while driving, it may indicate the ABS is not functioning properly. Have the system checked. It is recommended you visit a NISSAN dealer for this service.

If an ABS malfunction occurs, the anti-lock function is turned off. The brake system then operates normally, but without anti-lock assistance. (See "Brake system" (P.5-30).)

### Blind Spot Warning (BSW) system warning light (if so equipped)

If the light comes on and remains on, it may indicate that the BSW system is not functioning properly. Although the vehicle is still driveable, have the system checked. It is recommended you visit a NISSAN dealer for this service. See "Blind Spot Warning (BSW)" (P.5-17).

### or Brake warning light

This light functions for both the parking brake and the foot brake systems.

#### **Parking brake indicator:**

When the ignition switch is in the ON position, the light comes on when the parking brake is applied.

#### **Low brake fluid warning light:**

When the ignition switch is in the ON position, the light warns of a low brake fluid level. If the light comes on while the engine is running with the parking brake not applied, stop the vehicle and perform the following:

1. Check the brake fluid level. Add brake fluid as necessary. (See "Brake fluid" (P.8-9).)
2. If the brake fluid level is correct, have the warning system checked. It is recommended you visit a NISSAN dealer for this service.

#### **Anti-lock Braking System (ABS) warning indicator:**

When the parking brake is released and the brake fluid level is sufficient, if both the brake warning light and the Anti-lock Braking System (ABS) warning light illuminate, it may indicate the ABS is not functioning properly. Have the brake system checked. It is recommended you visit a NISSAN dealer for this service. (See

“Anti-lock Braking System (ABS) warning light” (P.2-12).)



## WARNING

- **Your brake system may not be working properly if the warning light is on. Driving could be dangerous. If you judge it to be safe, drive carefully to the nearest service station for repairs. Otherwise, have your vehicle towed because driving it could be dangerous.**
- **Pressing the brake pedal with the engine stopped and/or low brake fluid level may increase your stopping distance and braking will require greater pedal effort as well as pedal travel.**
- **If the brake fluid level is below the minimum or MIN mark on the brake fluid reservoir, do not drive until the brake system has been checked. It is recommended you visit a NISSAN dealer for this service.**



## Charge warning light

If the light comes on while the engine is running, it may indicate the charging system is not functioning properly. Turn the engine off and check the alternator belt. If the belt is loose, broken, missing or if the light remains on, have your vehicle serviced immediately. It is recommended you visit a NISSAN dealer for this service.



## CAUTION

**Do not continue driving if the alternator belt is loose, broken or missing.**



## Engine oil pressure warning light

This light warns of low engine oil pressure. If the light flickers or comes on during normal driving, pull off the road in a safe area, stop the engine **immediately** and call a NISSAN dealer or other authorized repair shop.

**The engine oil pressure warning light is not designed to indicate a low oil level. Use the dipstick to check the oil level.** (See “Engine oil” (P.8-5).)



## CAUTION

**Running the engine with the engine oil pressure warning light on could cause serious damage to the engine almost immediately. Such damage is not covered by warranty. Turn off the engine as soon as it is safe to do so.**



## Hydraulic pump electric power steering warning light

When the ignition switch is in the ON position, the hydraulic pump electric power steering warning light illuminates. After starting the engine, the hydraulic pump electric power steering warning light turns off. This indicates that the electric power steering is operational.

If the hydraulic pump electric power steering warning light illuminates while the engine is running, it may indicate the hydraulic pump electric power steering is not functioning properly and may need servicing. It is recommended you have the hydraulic pump electric power steering checked by a NISSAN dealer. (See “Hydraulic pump electric power steering” (P.5-30).)



### Intelligent Key system warning light

After the ignition switch is pushed to the ON position, this light comes on for about 2 seconds and then turns off.

This light warns of a malfunction with the Intelligent Key system.

If the light comes on while the engine is stopped, it may be impossible to start the engine. If the light comes on while the engine is running, you can drive the vehicle. However in these cases, it is recommended you visit a NISSAN dealer for repair as soon as possible.



### Low tire pressure warning light

Your vehicle is equipped with a Tire Pressure Monitoring System (TPMS) that monitors the tire pressure of all tires except the spare.

The low tire pressure warning light warns of low tire pressure or indicates that the TPMS is not functioning properly.

After the ignition switch is pushed ON, this light illuminates for about 1 second and turns off.

#### Low tire pressure warning:

If the vehicle is being driven with low tire pressure, the warning light will illuminate. A CHECK TIRE PRESSURE warning also appears on the vehicle information display.

When the low tire pressure warning light illuminates, you should stop and adjust the tire pressure to the recommended COLD tire pressure shown on the Tire and Loading Information label. The low tire pressure warning light does not automatically turn off when the tire pressure is adjusted. After the tire is inflated to the recommended pressure, the vehicle must be driven at speeds above 16 MPH (25 km/h) to activate the TPMS and turn off the low tire pressure warning light. Use a tire pressure gauge to check the tire pressure.

The CHECK TIRE PRESSURE warning appears each time the ignition switch is placed in the ON position as long as the low tire pressure warning light remains illuminated.

For additional information, see "Vehicle information display" (P.2-19), "Tire Pressure Monitoring System (TPMS)" (P.5-3) and "Tire Pressure Monitoring System (TPMS)" (P.6-3).

#### TPMS malfunction:

If the TPMS is not functioning properly, the low tire pressure warning light will flash for approximately 1 minute when the ignition switch is pushed ON. The light will remain on after 1 minute. Have the system checked. It is recommended you visit a NISSAN dealer for this service. The CHECK TIRE PRESSURE warning does not appear if the low tire pressure warning

light illuminates to indicate a TPMS malfunction.

For additional information, see "Tire Pressure Monitoring System (TPMS)" (P.5-3). For the CHECK TIRE PRESSURE warning, see "Vehicle information display" (P.2-19).



## WARNING

- **If the light does not illuminate with the ignition switch pushed ON, have the vehicle checked as soon as possible. It is recommended you visit a NISSAN dealer for this service.**
- **If the light illuminates while driving, avoid sudden steering maneuvers or abrupt braking, reduce vehicle speed, pull off the road to a safe location and stop the vehicle as soon as possible. Driving with under-inflated tires may permanently damage the tires and increase the likelihood of tire failure. Serious vehicle damage could occur and may lead to an accident and could result in serious personal injury. Check the tire pressure for all four tires. Adjust the tire pressure to the recommended COLD tire pressure**

shown on the Tire and Loading Information label to turn the low tire pressure warning light OFF. If the light still illuminates while driving after adjusting the tire pressure, a tire may be flat or the TPMS may be malfunctioning. If you have a flat tire, replace it with a spare tire as soon as possible. If no tire is flat and all tires are properly inflated, it is recommended you consult a NISSAN dealer.

- Since the spare tire is not equipped with the TPMS, when a spare tire is mounted or a wheel is replaced, the TPMS will not function and the low tire pressure warning light will flash for approximately 1 minute. The light will remain on after 1 minute. Have your tires replaced and/or TPMS system reset as soon as possible. It is recommended you visit a NISSAN dealer for these services.
- Replacing tires with those not originally specified by NISSAN could affect the proper operation of the TPMS.



## CAUTION

- The TPMS is not a substitute for the regular tire pressure check. Be sure to check the tire pressure regularly.
- If the vehicle is being driven at speeds of less than 16 MPH (25 km/h), the TPMS may not operate correctly.
- Be sure to correctly install the specified size of tires to the four wheels.



### Master warning light

When the ignition switch is in the ON position, the master warning light illuminates if any of the following are displayed on the vehicle information display:

- No key warning
- Low fuel warning
- Low washer fluid warning
- Parking brake release warning
- Door/liftgate open warning
- Loose fuel cap warning
- Check tire pressure warning

- Extended storage fuse warning  
See "Vehicle information display" (P.2-19).



### Seat belt warning light and chime

The light and chime remind you to fasten seat belts. The light illuminates whenever the ignition switch is pushed to the ON position, and will remain illuminated until the driver's seat belt is fastened. At the same time, the chime will sound for approximately 6 seconds unless the driver's seat belt is securely fastened.

The seat belt warning light for the front passenger will illuminate if the seat belt is not fastened when the front passenger's seat is occupied. For approximately 5 seconds after the ignition switch is in the ON position, the system does not activate the warning light for the front passenger.

See "Seat belts" (P.1-15) for precautions on seat belt usage.



### Supplemental air bag warning light

After pushing the ignition switch to the ON position, the supplemental air bag warning light will illuminate. The supplemental air bag warning light will turn off after about 7 seconds if the supplemental front air bag and supplemental side air bag, curtain air bag systems and/or pretensioner seat belt are operational.

If any of the following conditions occur, the front air bag, side air bag, curtain air bag and pretensioner systems needs servicing.

- The supplemental air bag warning light remains on after approximately 7 seconds.
- The supplemental air bag warning light flashes intermittently.
- The supplemental air bag warning light does not come on at all.

It is recommended you visit a NISSAN dealer for these services.

Unless checked and repaired, the Supplemental Restraint Systems (air bag systems) and/or the pretensioners may not function properly.

For additional information, see “Supplemental restraint system” (P.1-48).



## WARNING

**If the supplemental air bag warning light is on, it could mean that the front air bag, side air bag, curtain air bag and/or pretensioner systems will not operate in an accident. To help avoid injury to yourself or others, have your vehicle checked. It is recommended you visit a NISSAN dealer for this service.**



## Vehicle Dynamic Control (VDC) warning light

When the ignition switch is in the ON position, the Vehicle Dynamic Control (VDC) warning light illuminates and then turn off.

The light will blink when the VDC system or the traction control system is operating, thus alerting the driver that the vehicle is nearing its traction limits. The road surface may be slippery.

If the VDC warning light comes on and stays on while the VDC system is on, this light alerts the driver to the fact that the VDC system's fail-safe mode is operating, for example the VDC system may not be functioning properly. Have the system checked. It is recommended you visit a NISSAN dealer for this service. If a malfunction occurs in the system, the VDC system function will be canceled but the vehicle is still driveable. For additional information, see “Vehicle Dynamic Control (VDC) system” (P.5-32).

## INDICATOR LIGHTS



### Continuously Variable Transmission (CVT) position indicator light

When the ignition switch is pushed to the ON position, the indicator shows the automatic shift position. (See “Continuously Variable Transmission (CVT)” (P.5-13).)



### Cruise indicator light



#### **Cruise main switch indicator:**

This light illuminates when the cruise control main switch is pushed. The light turns off when the main switch is pushed again. When the cruise main switch indicator light illuminates, the cruise control system is operational. (See “Cruise control” (P.5-25).)

#### **Cruise malfunction:**

If the cruise indicator light blinks while the engine is running, it may indicate the cruise control system is not functioning properly. Have the system checked. It is recommended you visit a NISSAN dealer for this service. (See “Cruise control” (P.5-25).)

### Exterior light indicator

This indicator illuminates when the headlight switch is turned to the AUTO (if so equipped),  or  position and the front side marker lights, the front parking lights, instrument panel lights, tail lights, rear side marker lights, license plate lights or headlights are on. The indicator turns off when these lights are turned off.

### Front passenger air bag status light

The front passenger air bag status light () will be lit and the passenger front air bag will be OFF depending on how the front passenger seat is being used.

For front passenger air bag status light operation, see “NISSAN advanced air bag system (front seats)” (P.1-54) of this manual.

### High beam indicator light

This light comes on when the headlight high beam is on and goes out when the low beam is selected.

### Malfunction Indicator Light (MIL)

If the malfunction indicator light comes on steady or blinks while the engine is running, it may indicate a potential emission control and/or Continuously Variable Transmission (CVT) malfunction.

The malfunction indicator light may also come on steady if the fuel-filler cap is loose or missing, or if the vehicle runs out of fuel. Check to make sure the fuel-filler cap is installed and closed tightly, and that the vehicle has at least 3 US gallons (11.4 liters) of fuel in the fuel tank.



After a few driving trips, the  light should turn off if no other potential emission control system malfunction exists.

If this indicator light remains on for 20 seconds and then blinks for 10 seconds when the engine is not running, it indicates that the vehicle is not ready for an emission control system inspection/maintenance test. (See “Readiness for inspection/maintenance (I/M) test” (P.10-26).)

#### Operation:

The malfunction indicator light will come on in one of two ways:

- Malfunction indicator light on steady — An emission control system and/or CVT malfunction has been detected. Check the fuel-filler cap if the LOOSE FUEL CAP warning

appears on the vehicle information display. If the fuel-filler cap is loose or missing, tighten or install the cap and continue to drive the vehicle. The  light should turn off after a few driving trips. If the  light does not turn off after a few driving trips, have the vehicle inspected. It is recommended you visit a NISSAN dealer for this service. You do not need to have your vehicle towed to the dealer.

- Malfunction indicator light blinking — An engine misfire has been detected which may damage the emission control system.

To reduce or avoid emission control system damage:

- 1) Do not drive at speeds above 45 MPH (72 km/h).
- 2) Avoid hard acceleration or deceleration.
- 3) Avoid steep uphill grades.
- 4) If possible, reduce the amount of cargo being hauled or towed.

The malfunction indicator light may stop blinking and remain on.

Have the vehicle inspected. It is recommended you visit a NISSAN dealer for this service. You do not need to have your vehicle towed to the dealer.





## CAUTION

**Continued vehicle operation without having the emission control system and/or CVT system checked and repaired as necessary could lead to poor driveability, reduced fuel economy, and possible damage to the emission control system.**



### Overdrive off indicator light

The overdrive off indicator light illuminates when the overdrive off mode is selected.

For additional information, see “Continuously Variable Transmission (CVT)” (P.5-13) of this manual.



### Security indicator light

The light blinks when the ignition switch is in the ACC, OFF or LOCK position. This function indicates the security system equipped on the vehicle is operational.

If the security system is malfunctioning, this light will remain on while the ignition switch is in the ON position. For additional information, see “Security systems” (P.2-28).



### Turn signal/hazard indicator lights

The light flashes when the turn signal switch lever or hazard switch is turned on.



### Vehicle Dynamic Control (VDC) off indicator light

When the ignition switch is in the ON position, the Vehicle Dynamic Control (VDC) off indicator light illuminates and then turn off.



The light comes on when the VDC off switch is pushed to OFF. This indicates that the VDC system and traction control system are not operating.

## AUDIBLE REMINDERS

### Key reminder chime

A chime will sound if the driver side door is opened while the ignition switch is pushed to the ACC position. Make sure the ignition switch is pushed to the OFF position, and take the Intelligent Key with you when leaving the vehicle.

### Light reminder chime

A chime will sound when the driver side door is opened with the light switch in the  or  position and the ignition switch in the ACC or OFF position.

Turn the light switch off when you leave the

vehicle.

### Parking brake reminder chime

The chime will sound if the vehicle is driven at more than 4 MPH (7 km/h) with the parking brake applied. Stop the vehicle and release the parking brake.

### Brake pad wear warning

The disc brake pads have audible wear warnings. When a brake pad requires replacement, it will make a high pitched scraping sound when the vehicle is in motion. This scraping sound will first occur only when the brake pedal is depressed. After more wear of the brake pad, the sound will always be heard even if the brake pedal is not depressed. Have the brakes checked as soon as possible if the warning sound is heard.

## VEHICLE INFORMATION DISPLAY

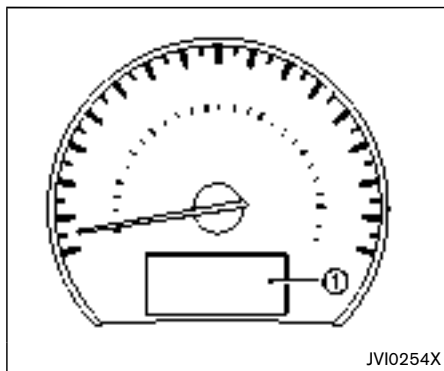

The vehicle information display ① is located in the speedometer, and it displays, the key operation information and other warnings and information.

For the detail about the Intelligent Key system, see "Intelligent Key system" (P.3-13).



1



2



3



4



5



6



7



8

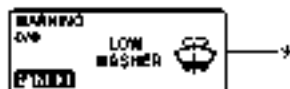

9



10



11



12

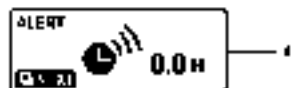

13



14



15

JVI0539X

## OPERATIONAL INDICATORS

### 1. Engine start operation indicator

This indicator appears when the shift lever is in the P (Park) position.

This indicator means that the engine will start by pushing the ignition switch with the brake pedal depressed.

You can start the engine directly in any position.

### 2. NO KEY warning

This warning appears in either of the following conditions.

#### **No key inside the vehicle:**

The warning appears when the door is closed with the Intelligent Key left outside the vehicle and the ignition switch in the ACC or ON position. Make sure that the Intelligent Key is inside the vehicle.

#### **Unregistered key:**

The warning appears when the ignition switch is pushed from the LOCK position and the key cannot be recognized by the system. You cannot start the engine with an unregistered key. Use the registered key.

See "Intelligent Key system" (P.3-13) for more details.

### 3. SHIFT "P" warning

This warning appears when the ignition switch is pushed to stop the engine with the shift lever in any position except the P (Park) position.

If this warning appears, move the shift lever to the P (Park) position or push the ignition switch to the ON position.

An inside warning chime will also sound. (See "Intelligent Key system" (P.3-13).)

### 4. "PUSH" warning

This warning appears when the shift lever is moved to the P (Park) position with the ignition switch in the ACC position after the SHIFT "P" warning appears.

To push the ignition switch to the OFF position, perform the following procedure:

**SHIFT "P" warning** → (Move the shift lever to "P") → **PUSH warning** → (Push the ignition switch → ignition switch position is turned to ON) → **PUSH warning** → (Push the ignition switch → ignition switch position is turned to OFF)

### 5. Key battery discharge indicator

This indicator appears when the key battery is running out of power.

If this indicator appears, replace the battery with a new one. (See "Intelligent Key battery replacement" (P.8-20).)

### 6. Engine start operation for Intelligent Key system indicator

This indicator appears when the Intelligent Key battery is running out of power and when the Intelligent Key System and vehicle are not communicating normally.

If this indicator appears, touch the ignition switch with the Intelligent Key while depressing the brake pedal. (See "Intelligent Key battery discharge" (P.5-11).)

### 7. Parking brake release warning

This warning appears when the vehicle speed is above 4 MPH (7 km/h) and the parking brake is applied. Stop the vehicle and release the parking brake.

## 8. Low fuel warning

This warning appears when the fuel level in the tank is getting low. Refuel as soon as it is convenient, preferably before the fuel gauge reaches the empty (0) position.

**There is a small reserve of fuel remaining in the tank when the fuel gauge reaches the empty (0) position.**

## 9. Low washer fluid warning

This warning appears when the washer tank fluid is at a low level. Add washer fluid as necessary. (See "Window washer fluid" (P.8-10).)

## 10. Door/liftgate open warning (ignition switch is in the ON position)

This warning appears if any of the doors and/or the liftgate are open or not closed securely. The vehicle icon indicates which door is open on the display.

## 11. Loose fuel cap warning

This warning appears when the fuel-filler cap is not tightened correctly after the vehicle has been refueled. (See "Fuel-filler cap" (P.3-30).)

## 12. Check tire pressure warning

This warning appears when the low tire pressure warning light in the meter illuminates and low tire pressure is detected. The warning appears each time the ignition switch is placed in the ON position as long as the low tire pressure warning light remains illuminated. If this warning appears, stop the vehicle and adjust the tire pressure to the recommended COLD tire pressure shown on the Tire and Loading Information label. (See "Low tire pressure warning light" (P.2-14) and "Tire Pressure Monitoring System (TPMS)" (P.5-3).)

## 13. "TIMER" indicator

This indicator appears when the set "timer" indicator activates. You can set the time for up to 6 hours. (See "Trip computer" (P.2-24).)

## 14. Low outside temperature warning

This warning appears if the outside temperature is below 37°F (3°C). The warning can be set not to be displayed. (See "Trip computer" (P.2-24).)

## 15. Extended storage fuse warning

This warning may appear if the extended storage fuse switch is not pushed in (switched on). When this warning appears, push in (switch on) the extended storage fuse switch to turn off the warning. For more information, see "Extended

storage fuse switch" (P.8-19).

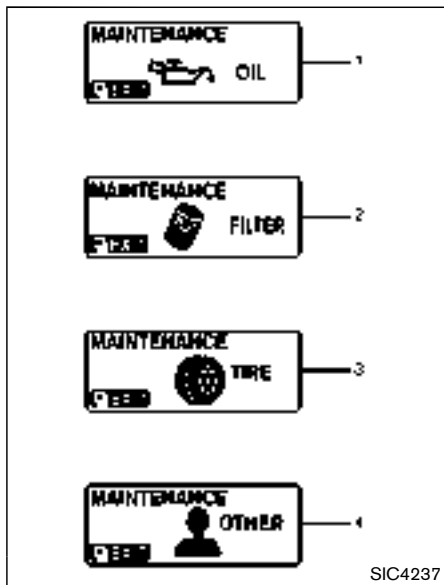

## MAINTENANCE INDICATORS

### 1. Engine oil replacement indicator

This indicator appears when the customer set time comes for changing the engine oil. You can set or reset the distance for changing the engine oil. (See “Trip computer” (P.2-24).)

### 2. Oil filter replacement indicator

This indicator appears when the customer set time comes for replacing the oil filter. You can set or reset the distance for replacing the oil filter. (See “Trip computer” (P.2-24).)

### 3. Tire replacement indicator

This indicator appears when the customer set distance comes for replacing tires. You can set or reset the distance for replacing tires. (See “Trip computer” (P.2-24).)

**replacement indicator for a certain driving distance does not mean your tires will last that long. Use the tire replacement indicator as a guide only and always perform regular tire checks. Failure to perform regular tire checks, including tire pressure checks could result in tire failure. Serious vehicle damage could occur and may lead to a collision, which could result in serious personal injury or death.**

### 4. “OTHER” indicator

This indicator appears when the set time comes for replacing items other than the engine oil, oil filter and tires. You can set or reset the distance for replacing the items. (See “Trip computer” (P.2-24).)



## WARNING

**The tire replacement indicator is not a substitute for regular tire checks, including tire pressure checks. See “Changing wheels and tires” (P.8-35). Many factors including tire inflation, alignment, driving habits and road conditions affect tire wear and when tires should be replaced. Setting the tire**

Models with center multi-function control panel: More maintenance reminders are also available on the center display. (models with center multi-function control panel) (See “How to use INFO button” (P.4-11).)

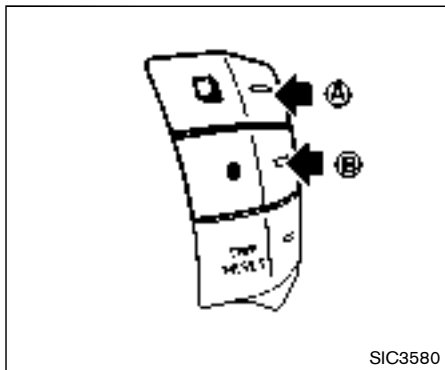

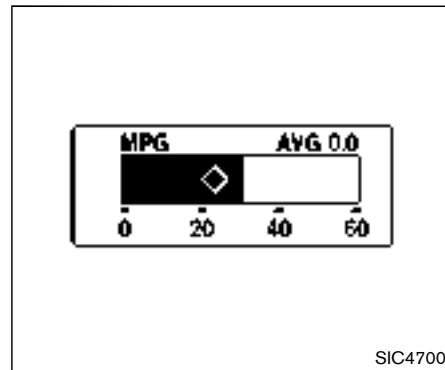

Each time the  switch (A) is pushed, the display will change as follows:

Current and average fuel consumption →  
 Average fuel consumption and speed →  
 Elapsed time and trip odometer → Distance to empty (dte) → Outside air temperature (ICY) →  
 Setting → Warning check



## TRIP COMPUTER

Switches for the trip computer are located on the right side of the combination meter panel. To operate the trip computer, push the side of the switches as shown above.

- (A)  switch
- (B)  switch

When the ignition switch is pushed to the ON position, modes of the trip computer can be selected by pushing the  switch (A).

Current and average fuel consumption (MPG, l (liter)/100 km or km/l)

The current and average fuel consumption mode shows the current and average fuel consumption.

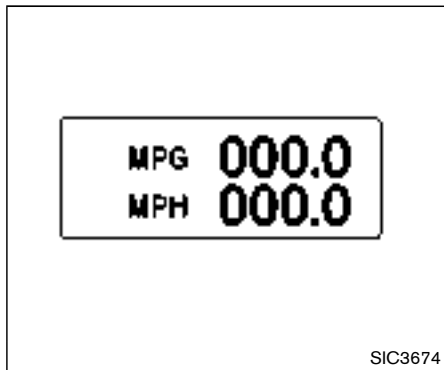

Average fuel consumption (MPG, l/100 km or km/l) and speed (MPH or km/h)

**Fuel consumption:**

The average fuel consumption mode shows the average fuel consumption since the last reset. Resetting is done by pushing the ● switch (B) for longer than 1 second. (The average speed is also reset at the same time.)

The display is updated every 30 seconds. At about the first 1/3 mile (500 m) after a reset, the display shows "—".

**Speed:**

The average speed mode shows the average vehicle speed since the last reset. Resetting is

done by pushing the ● switch (B) for longer than 1 second. (The average fuel consumption is also reset at the same time.)

The display is updated every 30 seconds. The first 30 seconds after a reset, the display shows "—".

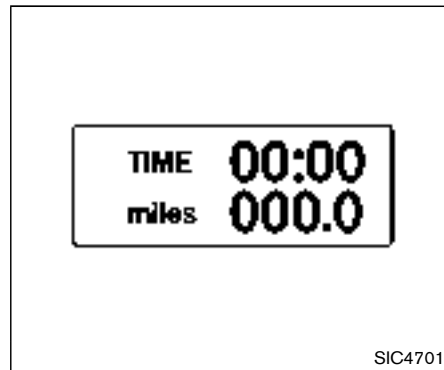

Elapsed time and trip odometer (miles or km)

**Elapsed time:**

The elapsed time mode shows the time since the last reset. The displayed time can be reset by pushing the ● switch (B) for longer than 1 second. (The trip odometer is also reset at the same time.)

**Trip odometer:**

The trip odometer mode shows the total distance the vehicle has been driven since the last reset. Resetting is done by pushing the ● switch (B) for longer than 1 second. (The elapsed time is also reset at the same time.)



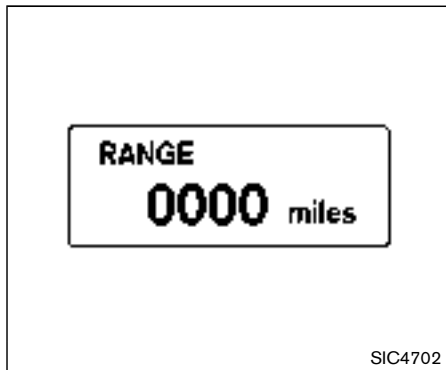

pushed to the OFF position may continue to be displayed.

- When driving uphill or rounding curves, the fuel in the tank shifts, which may momentarily change the display.

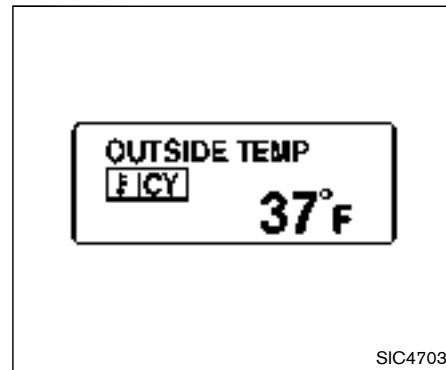

### Distance to empty (dte — miles or km)

The distance to empty (dte) mode provides you with an estimation of the distance that can be driven before refueling. The dte is constantly being calculated, based on the amount of fuel in the fuel tank and the actual fuel consumption.

The display is updated every 30 seconds.

The dte mode includes a low range warning feature. If the fuel level is low, the warning is displayed on the screen.

When the fuel level drops even lower, the dte display will change to "—".

- If the amount of fuel added is small, the display just before the ignition switch is

### Outside air temperature (ICY — °F or °C)

The outside air temperature is displayed in °F or °C in the range of -22 to 140°F (-30 to 60°C).

The outside air temperature mode includes a low temperature warning feature. If the outside air temperature is below 37°F (3°C), the warning is displayed on the screen.

The outside temperature sensor is located in front of the radiator. The sensor may be affected by road or engine heat, wind directions and other driving conditions. The display may differ from the actual outside temperature or the temperature displayed on various signs or billboards.



## Setting

**Setting cannot be made while driving. A message “Setting can only be operated when stopped” is also displayed on the vehicle information display.**

The switch (A) and switch (B) are used in the setting mode to select and decide a menu.

### SKIP:

Push the switch (A) to move to the warning check mode.

Push the switch (B) to select other menus.

### ALERT:

Alert menu can be set to notify the following items.

- TIMER  
Select this submenu to specify when the “TIMER” indicator activates.
- ICY  
Select this submenu to display the low outside temperature warning.

To return to the top page of the setting mode, select “BACK”.

### MAINTENANCE:

The maintenance intervals of the following items can be set or reset for the reminders.

- OIL  
Select this submenu to set or reset the distance for changing the engine oil.
- FILTER  
Select this submenu to set or reset the distance for replacing the oil filter.
- TIRE  
Select this submenu to set or reset the distance for replacing tires.
- OTHER  
Select this submenu and set or reset the distance for replacing items other than the engine oil, oil filter and tires.

To return to the top page of the setting mode, select “BACK”.

### OPTIONS:

The following option menus can be set to your preference.

- LANGUAGE  
Select this submenu to choose English, French or Spanish for display.
- UNIT  
Select this submenu to choose the unit.
- EFFECTS  
Select this menu to set the effects described below to on or off.

- The indicator needles sweep in the meters and the ring illumination will be brightened gradually when the engine is started.

To return to the top page of the setting mode, select “BACK”.



Push the ● switch (B) to select other menus.

**DETAIL:**

This item is available only when a warning is displayed.

Select this menu to see the details of warnings.

## SECURITY SYSTEMS

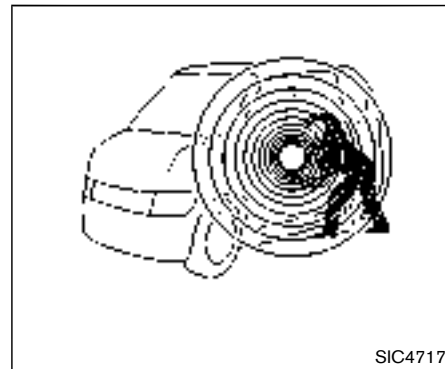

### Warning check

To see if there are any of the following warnings and corresponding details, select this menu.

- No key warning
- Low fuel warning
- Low washer fluid warning
- Parking brake release warning
- Door/liftgate open warning
- Loose fuel cap warning
- Check tire pressure warning

**SKIP:**

Push the □ switch (A) to move to the warning check mode.

Your vehicle has two types of security systems, as follows:

- Vehicle security system
- NISSAN Vehicle Immobilizer System

The security condition will be shown by the security indicator light.

### VEHICLE SECURITY SYSTEM

The vehicle security system provides visual and audio alarm signals if someone opens the doors or liftgate when the system is armed. It is not, however, a motion detection type system that activates when a vehicle is moved or when a vibration occurs.

The system helps deter vehicle theft but cannot

prevent it, nor can it prevent the theft of interior or exterior vehicle components in all situations. Always secure your vehicle even if parking for a brief period. Never leave your Intelligent Key(s) in the vehicle, and always lock it when unattended. Be aware of your surroundings, and park in secure, well-lit areas whenever possible. Many devices offering additional protection, such as component locks, identification markers, and tracking systems, are available at auto supply stores and specialty shops. Your NISSAN dealer may also offer such equipment. Check with your insurance company to see if you may be eligible for discounts for various theft protection features.

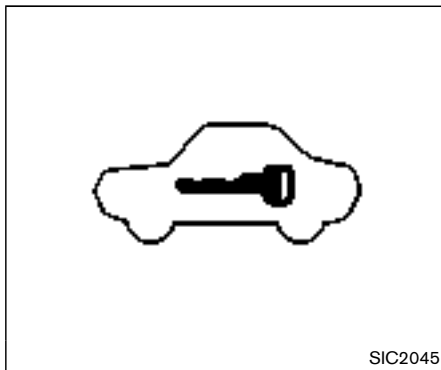

#### How to arm the vehicle security system

1. Close all windows.  
**The system can be armed even if the windows are open.**
2. Push the ignition switch to the OFF position.
3. Remove the Intelligent Key from the vehicle.
4. Close all doors and liftgate. Lock all doors. The doors can be locked with the Intelligent Key, door handle request switch, power door lock switch or mechanical key.
5. Confirm that the security indicator light comes on. The security indicator light stays on for about 30 seconds. The vehicle security system is now pre-armed. After

about 30 seconds the vehicle security system automatically shifts into the armed phase. The security light begins to flash once every approximately 3 seconds. If, during this 30-second pre-arm time period, the door is unlocked, or the ignition switch is pushed to ACC or ON, the system will not arm.

**Even when the driver and/or passengers are in the vehicle, the system will activate with all doors and liftgate locked with the ignition switch in the LOCK position. When pushing the ignition switch to the ACC or ON position, the system will be released.**

#### Vehicle security system activation

The vehicle security system will give the following alarm:

- The headlights blink and the horn sounds intermittently.
- The alarm automatically turns off after approximately 1 minute. However, the alarm reactivates if the vehicle is tampered with again.

The alarm is activated by:

- Unlocking the door or opening the liftgate without using the button on the Intelligent Key, the door handle request switch or the mechanical key. (Even if the door is opened

by releasing the door inside lock knob, the alarm will activate.)

### How to stop an activated alarm

The alarm will stop by unlocking a door by pushing the unlock button on the Intelligent Key, the door handle request switch or using the mechanical key. The alarm will not stop if the ignition switch is pushed to the ACC or ON position.

**If the system does not operate as described above, it is recommended you have it checked by a NISSAN dealer.**

### NISSAN VEHICLE IMMOBILIZER SYSTEM

The NISSAN Vehicle Immobilizer System will not allow the engine to start without the use of the registered Intelligent Key. **Never leave these keys in the vehicle.**

#### FCC Notice:

#### For USA:

**This device complies with Part 15 of the FCC Rules. Operation is subject to the following two conditions:**

**(1) This device may not cause harmful interference, and (2) this device must accept any interference received, including interference that may cause undesired**

#### operation.

**Note: Changes or modifications not expressly approved by the party responsible for compliance could void the user's authority to operate the equipment.**

#### For Canada:

**This device complies with Industry Canada licence-exempt RSS standard(s). Operation is subject to the following two conditions:**

**(1) this device may not cause interference, and (2) this device must accept any interference, including interference that may cause undesired operation of the device.**

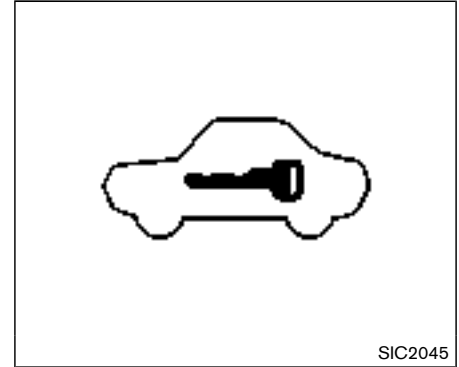

### Security indicator light

The security indicator light is located on the meter panel. It indicates the status of the NISSAN Vehicle Immobilizer System.

The light blinks after the ignition switch is in the LOCK, ACC or OFF position. This function indicates the security systems equipped on the vehicle are operational.

If the NISSAN Vehicle Immobilizer System is malfunctioning, this light will remain on while the ignition switch is in the ON position.

**If the light still remains on and/or the engine will not start, seek service for the NISSAN Vehicle Immobilizer System as**

## WIPER AND WASHER SWITCH

soon as possible. Please bring all registered keys that you have. It is recommended you visit a NISSAN dealer for this service.



### WARNING

In freezing temperatures the washer solution may freeze on the windshield and obscure your vision which may lead to an accident. Warm windshield with the defroster before you wash the windshield.



### CAUTION

- Do not operate the washer continuously for more than 30 seconds.
- Do not operate the washer if the reservoir tank is empty.
- Do not fill the window washer reservoir tank with washer fluid concentrates at full strength. Some methyl alcohol based washer fluid concentrates may permanently stain the grille if spilled while filling the window washer reservoir tank.
- Pre-mix washer fluid concentrates with water to the manufacturer's recommended levels before pouring the fluid into the window washer

reservoir tank. Do not use the window washer reservoir tank to mix the washer fluid concentrate and water.

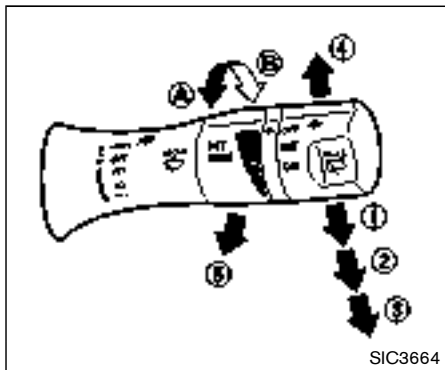

The windshield wiper and washer operates when the ignition switch is in the ON position.

Push the lever down to operate the wiper at the following speed:

- ① INT — intermittent operation can be adjusted by turning the knob toward **A** (Slower) or **B** (Faster).

Models with center multi-function control panel: When the speed sensing wiper interval function is turned on, the intermittent operation speed varies in accordance with the vehicle speed. (For example, when the vehicle speed is high, the intermittent operation speed will be faster.)

Note that the function is set to disabled as the factory default setting. To turn this function on and off, see "How to use SETTING button" (P.4-

15).

- ② LO — continuous low speed operation
- ③ HI — continuous high speed operation

Push the lever up **④** (MIST) to have one sweep operation of the wiper.

Pull the lever toward you **⑤** to operate the washer. Then the wiper will also operate several times.

### REAR WINDOW WIPER AND WASHER SWITCH



#### WARNING

**In freezing temperatures the washer solution may freeze on the rear window glass and obscure your vision. Warm the rear window with the defroster before you wash the rear window.**



#### CAUTION

- **Do not operate the washer continuously for more than 30 seconds.**
- **Do not operate the washer if the reservoir tank is empty.**

- **Do not fill the window washer reservoir tank with washer fluid concentrates at full strength. Some methyl alcohol based washer fluid concentrates may permanently stain the grille if spilled while filling the window washer reservoir tank.**
- **Pre-mix washer fluid concentrates with water to the manufacturer's recommended levels before pouring the fluid into the window washer reservoir tank. Do not use the window washer reservoir tank to mix the washer fluid concentrate and water.**

**If the rear window wiper operation is interrupted by snow or ice, the wiper may stop moving to protect its motor. If this occurs, turn the wiper switch to the OFF position and remove the snow or ice that is on and around the wiper arms. In approximately 1 minute, turn the switch on again to operate the wiper.**

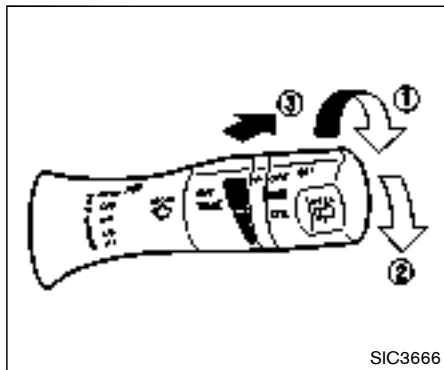

The rear window wiper and washer operate when the ignition switch is in the ON position. Turn the switch clockwise from the OFF position to operate the wiper.

- ① Intermittent (INT) — intermittent operation (not adjustable)
- ② Low (ON) — continuous low speed operation

Push the switch forward ③ to operate the washer. Then the wiper will also operate several times.

## REAR WINDOW AND OUTSIDE MIRROR DEFROSTER SWITCH

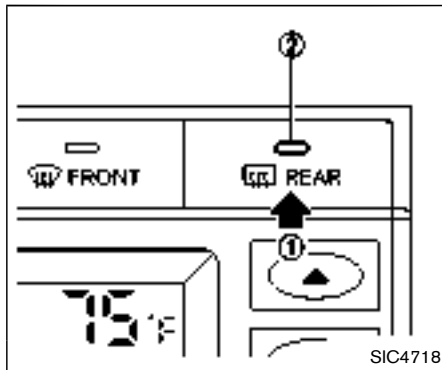

To defog/defrost the rear window glass and outside mirrors (if so equipped), start the engine and push the switch ① on. The indicator light ② will come on. Push the switch again to turn the defroster off.

It will automatically turn off in approximately 15 minutes.

### CAUTION

**When cleaning the inner side of the rear window, be careful not to scratch or damage the rear window defroster.**

## HEADLIGHT AND TURN SIGNAL SWITCH

XENON HEADLIGHTS (if so equipped)

### WARNING

#### HIGH VOLTAGE

- When xenon headlights are on, they produce a high voltage. To prevent an electric shock, never attempt to modify or disassemble. It is recommended to have your xenon headlights replaced at a NISSAN dealer.
- Xenon headlights provide considerably more light than conventional headlights. If they are not correctly aimed, they might temporarily blind an oncoming driver or the driver ahead of you and cause a serious accident. If headlights are not aimed correctly, it is recommended to take your vehicle to a NISSAN dealer and have the headlights adjusted correctly.

When the xenon headlight is initially turned on, its brightness or color varies slightly. However, the color and brightness will soon stabilize.

- The life of xenon headlights will be shortened by frequent on-off opera-



tion. It is generally desirable not to turn off the headlights for short intervals (for example, when the vehicle stops at a traffic signal). This way the life of the xenon headlights is not reduced.

- If the xenon headlight bulb is close to burning out, the brightness will drastically decrease, the light will start blinking, or the color of the light will become reddish. If one or more of the above signs appear, it is recommended you visit a NISSAN dealer.

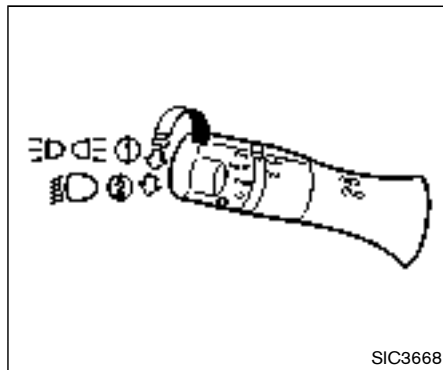

SIC3668

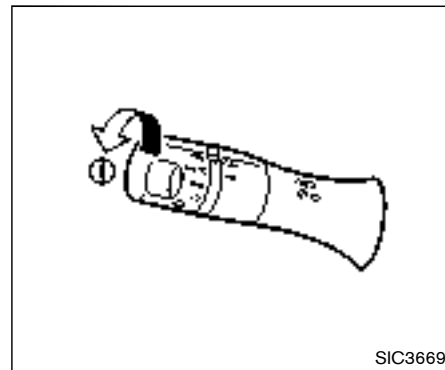

SIC3669

## HEADLIGHT SWITCH

### Lighting

- ① Turn the switch to the OFF position:  
The front parking, side marker, tail, license plate and instrument lights will come on.
- ② Turn the switch to the AUTO position:  
Headlights will come on and all the other lights remain on.

### Autolight system (if so equipped)

The autolight system allows the headlights to be set so they turn on and off automatically.

To set the autolight system:

1. Make sure the headlight switch is in the AUTO position ①.
2. Push the ignition switch to the ON position.
3. The autolight system automatically turns the headlights on and off.

To turn the autolight system off, turn the switch to the OFF, OFF, or OFF position.

The autolight system can turn on the headlights automatically when it is dark and turn off the

headlights when it is light.

The headlights will also be turned on automatically at twilight or in rainy weather (when the windshield wiper is operated continuously) (if so equipped).

If the ignition switch is pushed to the OFF position and one of the doors is opened and this condition is continued, the headlights remain on for a specified period of time.

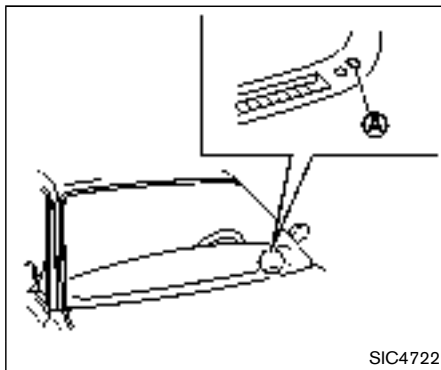

SIC4722

**Be sure not to put anything on top of the photo sensor (A) located on the top of the instrument panel. The photo sensor controls the autolight; if it is covered, the photo sensor reacts as if it is dark and the headlights will illuminate.**

#### **Automatic headlights off delay:**

You can keep the headlights on for 45 seconds after you push the ignition switch to OFF and open any door then close all the doors.

Models with center multi-function control panel:

You can adjust the period of the automatic headlights off delay from 0 seconds (OFF) to 180 seconds. The factory default setting is 45

seconds.

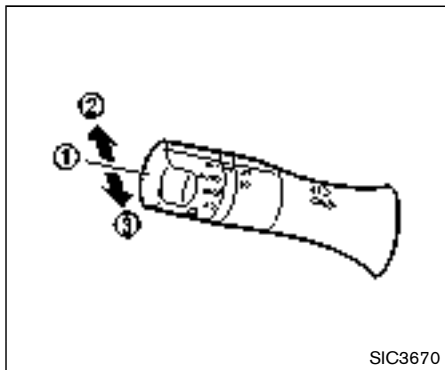

For automatic headlights off delay setting, see "Vehicle information and settings (models with center multi-function control panel)" (P.4-10).







### Headlight beam select

- ① To select the low beam, put the lever in the neutral position as shown.
- ② To select the high beam, push the lever forward while the switch is in the  position. Pull it back to select the low beam.
- ③ Pulling the lever toward you will flash the headlight high beam even when the headlight switch is in the OFF position.

### Battery saver system

A chime will sound when the driver side door is opened with the light switch in the  or  position and the ignition switch in the ACC, OFF or LOCK position.

When the headlight switch is in the  or  position while the ignition switch is in the ON position, the lights will automatically turn off after a period of time when the ignition switch has been pushed to the OFF position.

When the headlight switch remains in the  or  position after the lights automatically turn off, the lights will turn on when the ignition switch is pushed to the ON position.

**headlights turn off automatically.**

### CAUTION

- **When you turn on the headlight switch again after the lights automatically turn off, the lights will not turn off automatically. Be sure to turn the light switch to the OFF position when you leave the vehicle for extended periods of time, otherwise the battery will be discharged.**
- **Never leave the light switch on when the engine is not running for extended periods of time even if the**

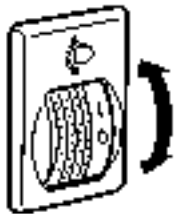

SIC2275

### Headlight aiming control (if so equipped)

Depending on the number of occupants in the vehicle and the load it is carrying, the headlight axis may be higher than desired. If the vehicle is traveling on a hilly road, the headlights may directly hit the rearview mirror of the vehicle ahead or the windshield of the oncoming vehicle. The light axis can be lowered with the operation of the switch.

The larger the number designated on the switch, the lower the axis.



When traveling with no heavy load or on a flat road, select position 0.



### WARNING

**Xenon headlights (if so equipped) are extremely bright compared to conventional headlights. If the xenon headlights hit the rearview mirror of the vehicle ahead or the windshield of oncoming vehicle, the driver of these vehicles may have difficulty driving because of the brightness. Use the headlight aiming control switch to lower the light axis. See “Xenon headlights” (P.2-33) for additional information.**

### Daytime running light system (Canada only)

The daytime running lights automatically illuminate when the engine is started with the parking brake released. The daytime running lights operate with the headlight switch in the OFF position or in the  position. Turn the headlight switch to the  position for full illumination when driving at night.

If the parking brake is applied before the engine is started, the daytime running lights do not illuminate. The daytime running lights illuminate once the parking brake is released. The daytime

running lights will remain on until the ignition switch is pushed to the OFF position.



### WARNING

**When the daytime running light system is active, tail lights on your vehicle are not on. It is necessary at dusk to turn on your headlights. Failure to do so could cause an accident injuring yourself and others.**

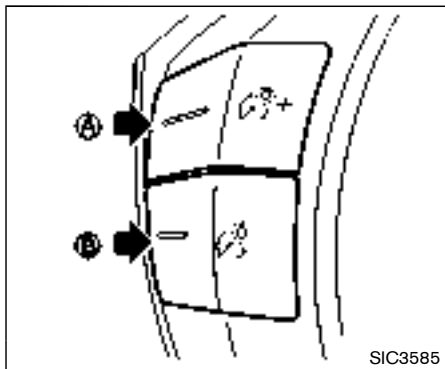

### Instrument brightness control

The instrument brightness control operates when the ignition switch is in the ON position.

To adjust the brightness of instrument panel lights, push the control switches. Pushing the upper switch **A** will brighten the lights. When the brightness reaches the maximum level, a beep will sound. The lower switch **B** dims the lights. Repeatedly pushing the lower switch will turn the lights off and a beep will sound.

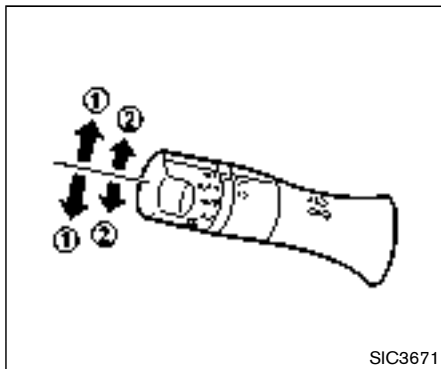

### TURN SIGNAL SWITCH

#### ① Turn signal

Move the lever up or down to signal the turning direction. When the turn is completed, the turn signals cancel automatically.



#### ② Lane change signal

- Move the lever up or down until the turn signal begins to flash, but the lever does not latch, to signal a lane change. Hold the lever until the lane change is completed.
- Move the lever up or down until the turn signal begins to flash, but the lever does not latch, and release the lever. The turn signal will automatically flash three times.

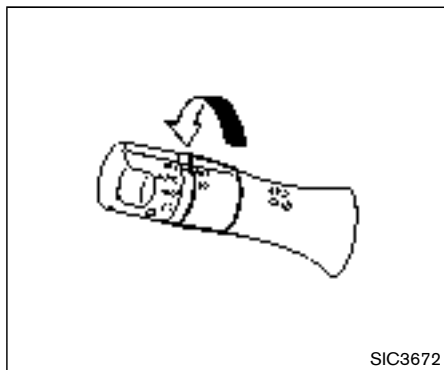
Choose the appropriate method to signal a lane change based on road and traffic conditions.



### FOG LIGHT SWITCH (if so equipped)

To turn the fog lights on, turn the headlight switch to the  position, then turn the switch to the  position. To turn them off, turn the switch to the OFF position.

The headlights must be on and the low beams selected for the fog lights to operate. The fog lights automatically turn off when the high beam headlights are selected.

### HORN

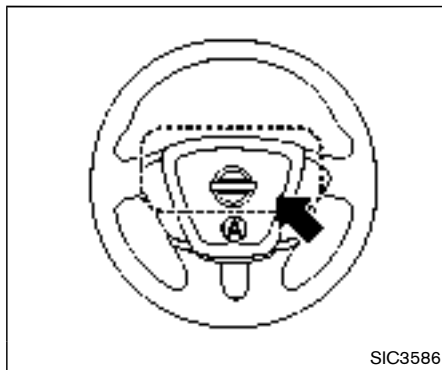

To sound the horn, push the pad area **A** of the steering wheel.

### WARNING

**Do not disassemble the horn. Doing so could affect proper operation of the supplemental front air bag system. Tampering with the supplemental front air bag system may result in serious personal injury.**

### HEATED SEATS (if so equipped)

#### WARNING

**Do not use or allow occupants to use the seat heater if you or the occupants cannot monitor elevated seat temperatures or have an inability to feel pain in those body parts in contact with the seat. Use of the seat heater by such people could result in serious injury.**

#### CAUTION

- **The battery could run down if the seat heater is operated while the engine is not running.**
- **Do not use the seat heater for extended periods or when no one is using the seat.**
- **Do not put anything on the seat which insulates heat, such as a blanket, cushion, seat cover, etc. Otherwise, the seat may become overheated.**
- **Do not place anything hard or heavy on the seat or pierce it with a pin or similar object. This may result in**

**damage to the heater.**

- **Any liquid spilled on the heated seat should be removed immediately with a dry cloth.**
- **When cleaning the seat, never use gasoline, thinner, or any similar materials.**
- **If any malfunctions are found or the heated seat does not operate, turn the switch off and have the system checked. It is recommended you visit a NISSAN dealer for this service.**

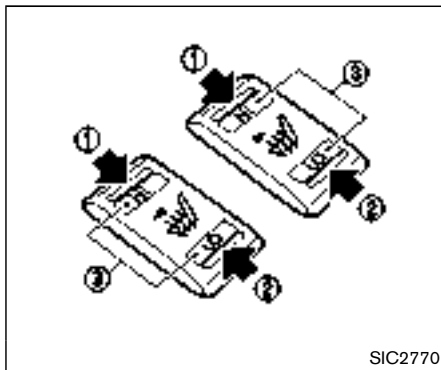

SIC2770

The heater is controlled by a thermostat, automatically turning the heater on and off. The indicator light will remain on as long as the switch is on.

When the vehicle's interior is warmed, or before you leave the vehicle, be sure to turn off the switch.

The seats are warmed by built-in heaters. The switches located on the instrument panel can be operated independently of each other.

1. Start the engine.
2. Select heat range.
  - ① For high heat, push the HI (High) side of the switch.
  - ② For low heat, push the LO (Low) side of the switch.

The indicator light in the switch ③ will illuminate when the heater is on.

3. To turn off the heater, return the switch to the level position. Make sure the indicator light goes off.

## BLIND SPOT WARNING (BSW) SWITCH (if so equipped)

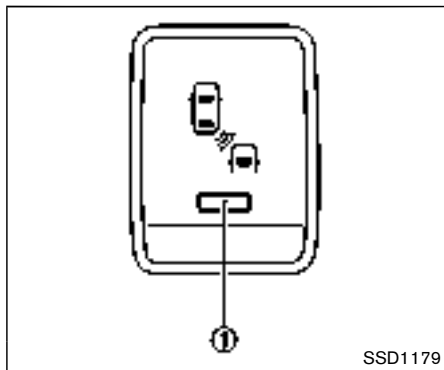

indicator light ① will turn off.

The Blind Spot Warning (BSW) switch will turn on and off the BSW system.

The BSW system will illuminate the side indicator lights, in the outside mirrors, when the radar sensors detect a vehicle in the detection zone. If the turn signal is activated in the direction of the detected vehicle, a chime sounds twice and the side indicator light will flash. (See “Blind Spot Warning (BSW)” (P.5-17).)

The BSW system will remain in the last ON or OFF state it was left in until it is manually changed by pushing the BSW switch.

To cancel the BSW system, push the BSW switch to turn off the system. The BSW ON

## VEHICLE DYNAMIC CONTROL (VDC) OFF SWITCH

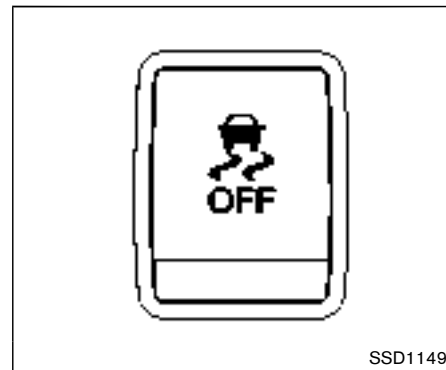

The vehicle should be driven with the Vehicle Dynamic Control (VDC) system on for most driving conditions.

If the vehicle is stuck in mud or snow, the VDC system reduces the engine output to reduce wheel spin. The engine speed will be reduced even if the accelerator is depressed to the floor. If maximum engine power is needed to free a stuck vehicle, turn the VDC system off.

To turn off the VDC system, push the VDC OFF switch. The  indicator light will illuminate.

Push the VDC OFF switch again or restart the engine to turn on the system. (See “Vehicle Dynamic Control (VDC) system” (P.5-32).)



## POWER OUTLET

### CAUTION

- Use power outlet with the engine running to avoid discharging the vehicle battery.
- Avoid using power outlet when the air conditioner, headlights or rear window defroster is on.
- Before inserting or disconnecting a plug, be sure the electrical accessory being used is turned OFF.
- When not in use, be sure to close the cap. Do not allow water or any liquid to contact the outlet.



Instrument panel



Cargo area

### Type A

To use the power outlet, pull the cover as illustrated.

### CAUTION

- The outlet and plug may be hot during or immediately after use.
- Do not use with accessories that exceed a 12 volt, 120W (10A) power draw. Do not use double adapters or more than one electrical accessory.
- This power outlet is not designed for use with a cigarette lighter unit.
- Push the plug in as far as it will go. If good contact is not made, the plug may overheat or the internal temperature fuse may open.

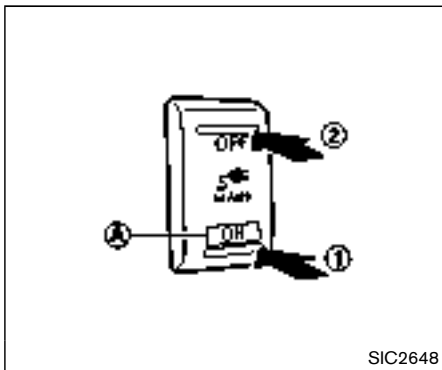

Main switch

### Type B (if so equipped)

The power outlet (plug type) is located on the front console. It can operate when the ignition switch in the ON position and the main switch (located on the instrument panel) is ON.

**The specification of this power outlet is for use of a 120 volt, 150W (1.25A) power draw.**

To turn on or off the power supply to the outlet, push the ON ① or OFF ② side of the main switch. When the switch is turned to the ON position, the indicator light A will illuminate.

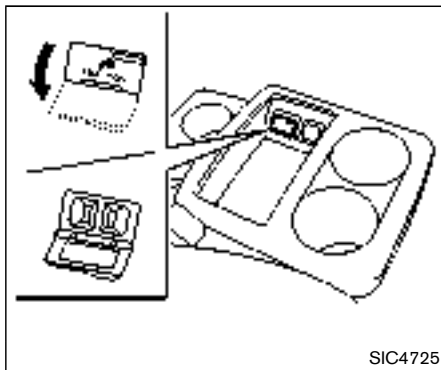

Power outlet

Pull up the cover and plug in.

After using the power outlet, be sure to turn off the main switch.

### CAUTION

- **Make sure that there is no fluid or other foreign substance in the power outlet. Also, be sure not to connect or disconnect the outlet with wet hands or insert any metal objects into it. Doing so could result in an electric shock or malfunction.**

- **Do not use with accessories that exceed a 120 volt, 150W (1.25A) power draw or the power outlet may switch off automatically. If this occurs, turn the main switch on the power outlet off and wait a short period of time before turning it back on again. If an electrical appliance with a wattage of less than 150W is used, the power outlet will be usable again.**
- **Use this power outlet with the engine running. (If the engine is stopped, this could result in a discharged battery.)**
- **When using the outlet for a long period of time such as when idling etc., the battery may discharge depending on the vehicle conditions, even if the engine is running.**
- **Some electrical appliances with wattages below 150W, may not operate normally. For example:**
  - **Electrical appliances which consume a large amount of wattage when turned on (CRT TVs, electric tools etc.)**

## STORAGE

- Electrical appliances which have a switching power frequency (clocks etc.)
- Electrical appliances that measure precise data (measuring equipment etc.)
- Certain other electrical appliances (electric blankets etc.)
- Depending on the electrical appliance that is in use, some distorted noise may be audible when using the TV or radio.
- Be sure to turn the power switch of the electrical appliance used off before removing the plug from the power outlet.
- Do not use an extension cord with multiple outlets.

## CUP HOLDERS



### CAUTION

- Avoid abrupt starting and braking when the cup holder is being used to prevent spilling the drink. If the liquid is hot, it can scald you or your passenger.
- Use only soft cups in the cup holder. Hard objects can injure you in an accident.

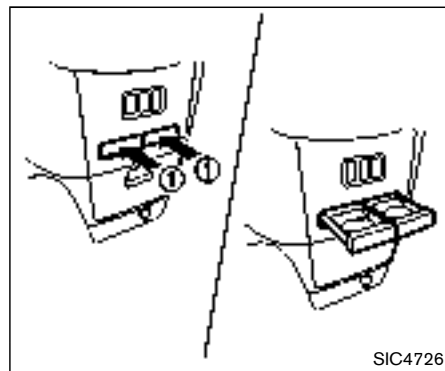

Instrument panel

Front

### Instrument panel:

To open the cup holder, push the instrument panel ①.

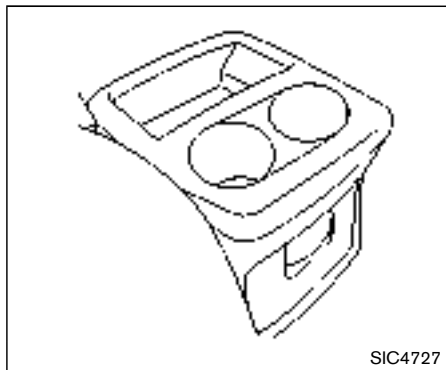

SIC4727

**Front side of the front center console**

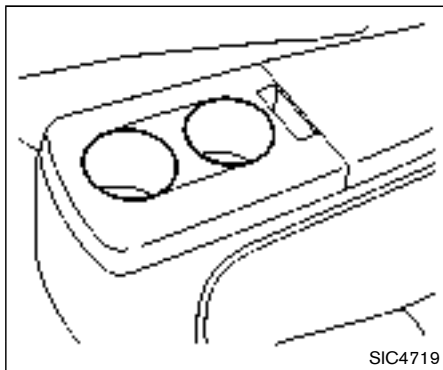

SIC4719

**2nd row seat**

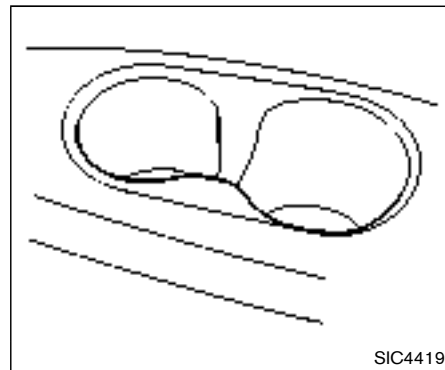

SIC4419

**3rd row seat**

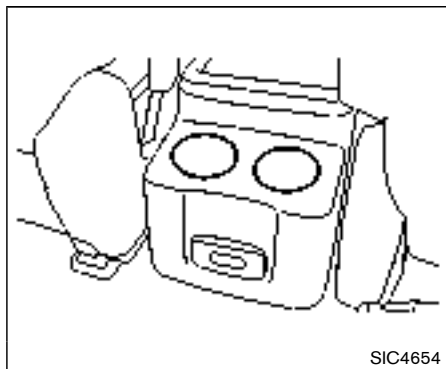

SIC4654

**Back side of the front center console**

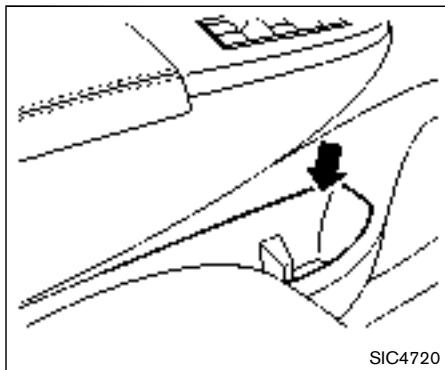

### Soft bottle holder

Soft bottle holders are located on the front doors and sliding doors.

#### CAUTION

- Do not use bottle holder for any other objects that could be thrown about in the vehicle and possibly injure people during sudden braking or an accident.
- Do not use bottle holder for open liquid containers.

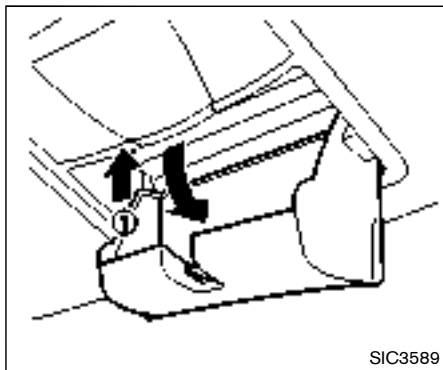

### SUNGLASSES HOLDER

#### WARNING

Keep the sunglasses holder closed while driving to avoid obstructing the driver's view and to help prevent an accident.

To open the sunglasses holder, push ①.

#### CAUTION

- Do not use for anything other than glasses.
- Do not leave glasses in the sunglasses holder while parking in direct sunlight. The heat may damage the glasses.

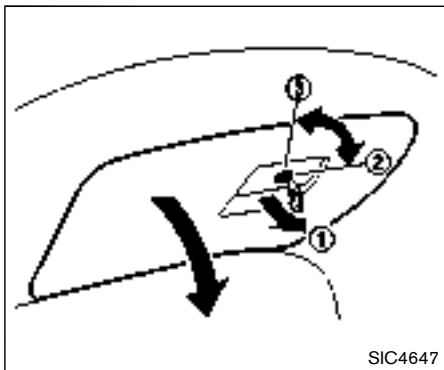

## GLOVE BOX

### **WARNING**

**Keep glove box lid closed while driving to help prevent injury in an accident or a sudden stop.**

To open the glove box, pull the handle ①.

To close, push the lid in until the lock latches.

To lock ② /unlock ③ the glove box, use the mechanical key. For the mechanical key usage, see "Keys" (P.3-3).

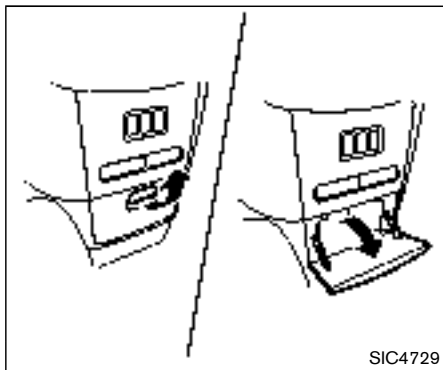

## INSTRUMENT LOWER BOX (if so equipped)

To open the box, pull the knob.

To close, push the lid in until the lock latches.

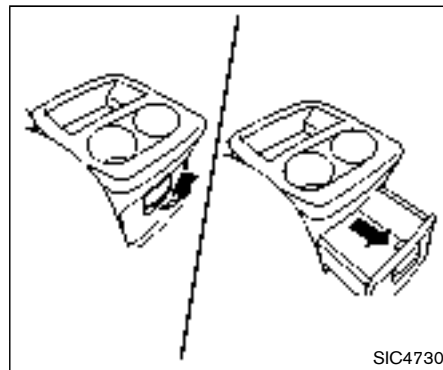

Front

## CONSOLE BOX

Front

To open the box, pull the knob. To close, push the lid in until the lock latches.

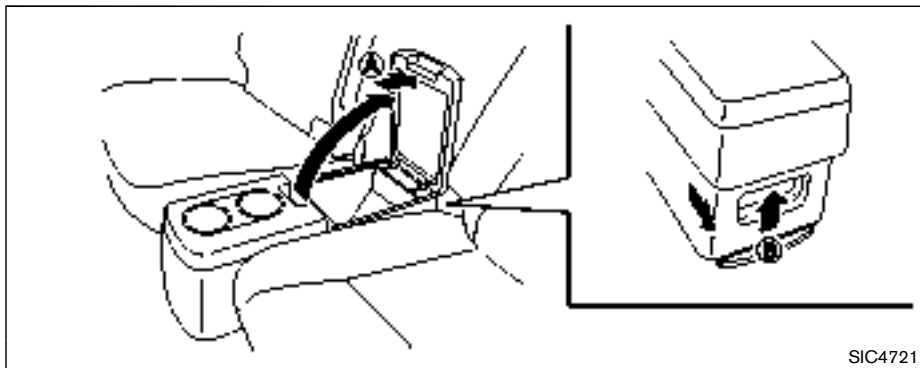

SIC4721

2nd row center console

### 2nd row center console

Pull up on lever (A) to open the console box lid.

#### To remove the 2nd row center console box:

1. Pull up on handle (B) on rear of console and tilt the console up.
2. Move the console box toward the rear of the vehicle and lift out.

#### To reinstall the 2nd row center console box:

1. Tilt the console box forward and install the front of the console box so that the hook engages the slot in the base.

2. Push down the rear of the console box to lock the console in place.

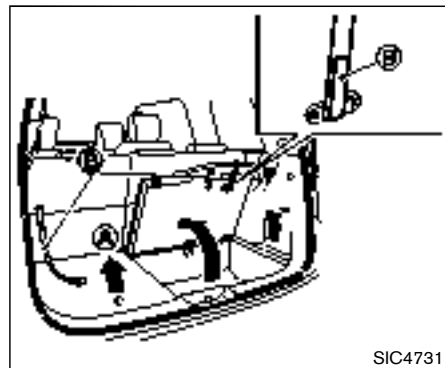

SIC4731

### CARGO FLOOR BOX

To open the cargo floor box lid, pull the strap (A).

To hold lid open, secure the strap (B) to the hook on the under side of cargo floor box lid.



### WARNING

To prevent injury in an accident or sudden stop, do not drive with the cargo floor box lids open. Always remove the strap (B) from hook and close the cargo floor box lids before driving.

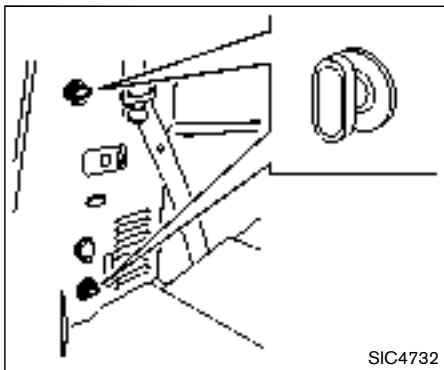

Cargo area

## HOOKS

### Cargo area

The 4 hooks are located on the right and left side of the cargo area.

### WARNING

- Always make sure that the cargo is properly secured. Use the suitable ropes and hooks.
- Unsecured cargo can become dangerous in an accident or sudden stop.

### CAUTION

Do not apply a total load of more than 7 lb (3 kg) to the hook.

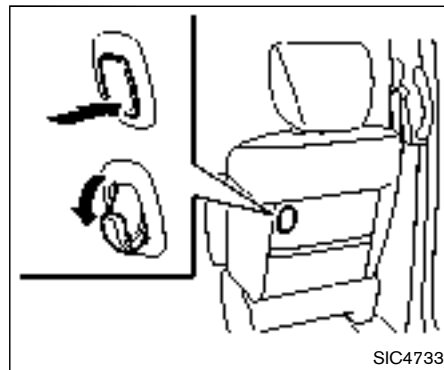

Seatbacks

## Seatbacks

The hooks are located on the front seatbacks.

To use the hook on the seatbacks, push the lower side of the hook and pull it out.

### CAUTION

Do not apply a total load of more than 9 lb (4 kg) to the hook.





### ROOF RACK (if so equipped)

Always distribute the luggage evenly on the roof rack. Do not load more than 99 lb (45 kg) on the roof rails. Observe the maximum load limit shown on the crossbars or roof carriers when you attach them on the roof rails. It is recommended that you contact a NISSAN dealer for crossbar or other equipment information. Be careful that your vehicle does not exceed the Gross Vehicle Weight Rating (GVWR) or its Gross Axle Weight Rating (GAWR front and rear). The GVWR and GAWR are located on the F.M.V.S.S. or C.V.M.S.S. certification label (located on the driver's door pillar). For more information regarding GVWR

and GAWR, see "Vehicle loading information" (P.10-12).

### **WARNING**

- **Drive extra carefully when the vehicle is loaded at or near the cargo carrying capacity, especially if the significant portion of that load is carried on the roof rack.**
- **Heavy loading of the roof rack has the potential to affect the vehicle stability and handling during sudden or unusual handling maneuvers.**
- **Roof rack load should be evenly distributed.**
- **Do not exceed maximum roof rack load weight capacity.**
- **Properly secure all cargo with ropes or straps to help prevent it from sliding or shifting. In a sudden stop or collision, unsecured cargo could cause personal injury.**

### **CAUTION**

**Use care when placing or removing items from the roof rack. If you cannot comfortably lift the items onto the roof rack from the ground, use a ladder or stool.**

## SUNSHADE (if so equipped)

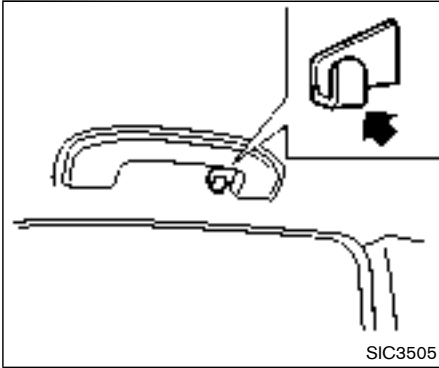

### COAT HOOKS

The coat hooks are equipped beside the rear personal lights.

#### CAUTION

Do not place items which are more than 2 lb (1 kg) on the hook.

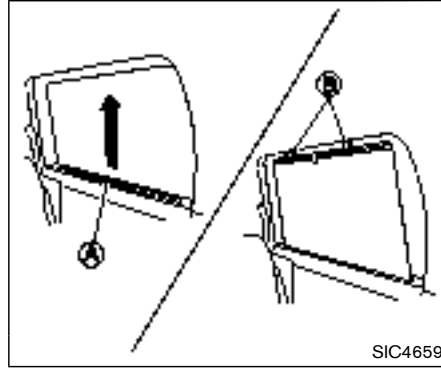

#### CAUTION

- Do not pull the sunshade in any direction other than up. This may damage the sunshade.
- Do not operate the sunshade when the sliding door is opening or closing. This may damage the sunshade.

Sunshades are equipped on the 2nd and 3rd row seat windows.

To raise the sunshade, pull the knob (A) up and hang the sunshade on the hooks (B).

To store the sunshade, remove the sunshade from the hooks and lower it.

The sliding door may be opened or closed with the sunshades in either the raised or lowered position.

## WINDOWS

### POWER WINDOWS



#### WARNING

- **Make sure that all passengers have their hands, etc. inside the vehicle while it is in motion and before closing the windows. Use the window lock switch to prevent unexpected use of the power windows.**
- **To help avoid risk of injury or death through unintended operation of the vehicle and or its systems, including entrapment in windows or inadvertent door lock activation, do not leave children, people who require the assistance of others or pets unattended in your vehicle. Additionally, the temperature inside a closed vehicle on a warm day can quickly become high enough to cause a significant risk of injury or death to people and pets.**

The power windows operate when the ignition switch is in the ON position or for about 45 seconds after the ignition switch is pushed to the OFF position. If the driver's or front passenger's door is opened during this period

of about 45 seconds, power to the windows is canceled.

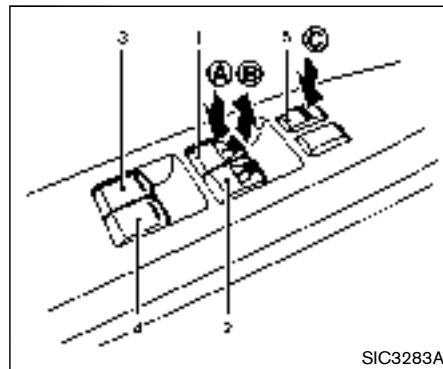

1. Driver side window
2. Front passenger side window
3. Rear left passenger side window
4. Rear right passenger side window
5. Window lock button

#### Main power window switch (driver's side)

To open or close the window, push down (A) or pull up (B) the switch and hold it. The main switch (driver side switches) will open or close all the windows.

## Locking passengers' windows

When the lock button  is pushed in, only the driver side window can be opened or closed. Push it in again to cancel.

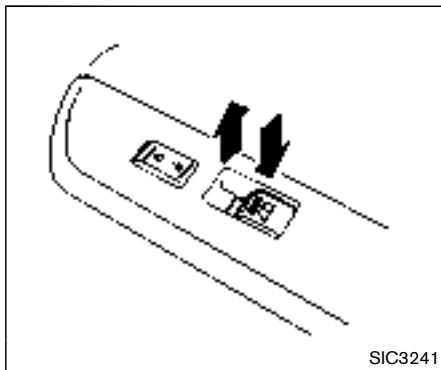

## Passenger side power window switch

The passenger side switch will open or close only the corresponding window. To open or close the window, push down or pull up the switch and hold it.

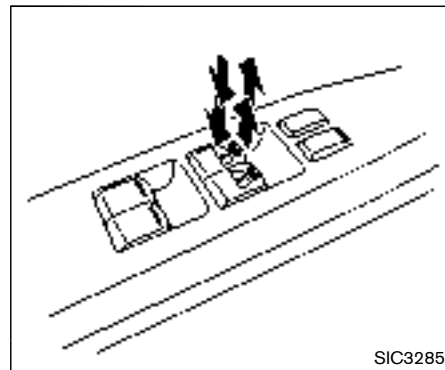

## Automatic operation

The automatic function is available for the switch that has an  mark on its surface.

To fully open or close the window, completely push down or pull up the switch and release it; it need not be held. The window will automatically open or close all the way. To stop the window, just push or lift the switch in the opposite direction.

A light push or pull on the switch will cause the window to open or close until the switch is released.

## Auto reverse function



### WARNING

**There are some small distances immediately before the closed position which cannot be detected. Make sure that all passengers have their hands, etc., inside the vehicle before closing the window.**

If the control unit detects something caught in the window as it is closing, the window will be immediately lowered.

The auto reverse function can be activated when the window is closed by automatic operation when the ignition switch is in the ON position or for 45 seconds after the ignition switch is pushed to the OFF position.

**Depending on the environment or driving conditions, the auto reverse function may be activated if an impact or load similar to something being caught in the window occurs.**

If the windows do not close automatically. If the power window automatic function (closing only) does not operate properly, perform the following procedure to initialize the power window system.

1. Push the ignition switch to the ON position.
2. Close the door.
3. Open the window completely by operating the power window switch.
4. Pull the power window switch and hold it to close the window, and then hold the switch more than 3 seconds after the window is closed completely.
5. Release the power window switch. Operate the window by the automatic function to confirm the initialization is complete.
6. Perform steps 2 through 5 above for other windows.

If the power window automatic function does not operate properly after performing the procedure above, have your vehicle checked. It is recommended you visit a NISSAN dealer for this service.

## MOONROOF (if so equipped)



### WARNING

- **In an accident you could be thrown from the vehicle through an open moonroof. Always use seat belts and child restraints.**
- **Do not allow anyone to stand up or extend any portion of their body out of the moonroof opening while the vehicle is in motion or while the moonroof is closing.**



### CAUTION

- **Remove water drops, snow, ice or sand from the moonroof before opening.**
- **Do not place any heavy object on the moonroof or surrounding area.**

## POWER MOONROOF

The moonroof only operates when the ignition switch is in the ON position.

The moonroof is operational for about 45 seconds, even if the ignition switch is pushed to the OFF position. If the driver's door or the

passenger's door is opened during this period of about 45 seconds, power to the moonroof is canceled.

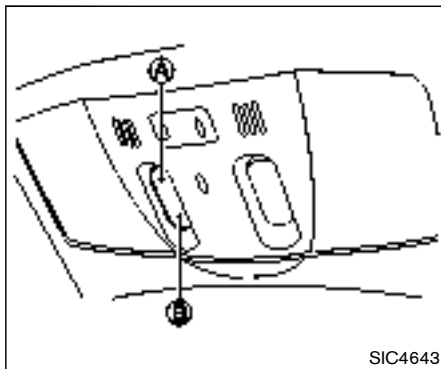

### Tilting

To tilt up, first close the moonroof.

Push the **(B)** side of the switch. The moonroof will automatically tilt up all the way.

To tilt down, push the **(A)** side of the switch. The roof will stop when the switch is released.

### FRONT MOONROOF

#### Opening and closing sunshade

The sunshade will open automatically when the front moonroof is opened. However, it must be closed manually.

#### Sliding

When the **(A)** side of the switch is pushed, the front moonroof will fully open.

When the **(B)** side of the switch is pushed and held, the front moonroof will close. To stop the moonroof while closing, release the switch.

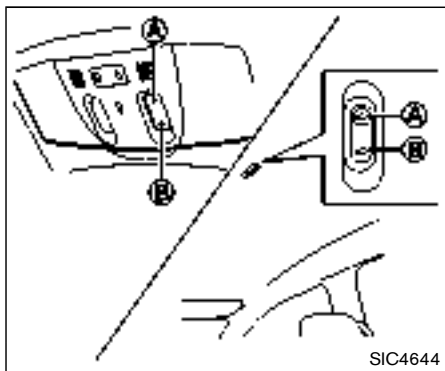

SIC4644

## REAR MOONROOF

Rear moonroof operation switches are located on the front map light and rear ceiling.

### Sunshade

The sunshade will open automatically when the rear moonroof is opened. However, it must be closed manually.

### Sliding

To fully open or close the moonroof, push the switch to the open (A) or close (B) position and release. It does not need to be held. The roof will automatically open or close all the way. To stop the roof, push the switch once more while it is opening or closing.

### Tilting

To tilt up, first close the moonroof, then push the switch to the tilt up position (B) and release it; it does not need to be held. To tilt down the moonroof, push the switch to the tilt down position (A).

### Locking

When the window lock button is pushed in, the rear moonroof cannot be operated. When the window lock position is pushed off, the rear moonroof can be operated. (See "Power windows" (P.2-52).)

### Auto-reverse function



## WARNING

**There are some small distances immediately before the closed position which cannot be detected. Make sure that all passengers have their hands, etc., inside the vehicle before closing the moonroof.**

If the control unit detects something caught in the moonroof when it is closing, the moonroof will be immediately opened.

The auto reverse function can be activated when

the moonroof is closed by automatic operation when the ignition switch is in the ON position or for about 45 seconds after the ignition switch is pushed to the OFF position.

If the moonroof cannot be closed automatically when the auto reverse function activates due to a malfunction, push and hold the moonroof switch to the close position (B).

**Depending on the environment or driving conditions, the auto reverse function may be activated if an impact or load similar to something being caught in the moonroof occurs.**

### IF THE FRONT OR REAR MOONROOF DOES NOT OPERATE

If the front or rear moonroof does not operate properly, perform the following procedure to initialize the moonroof operation system. Initialization can be performed for both the front moonroof and rear moonroof.

1. If the moonroof is open, close it fully by pushing and holding the moonroof switch to the close position (B) until the moonroof tilts up.
2. Release the moonroof switch, then push and hold the (B) side again for more than 10 seconds.

## INTERIOR LIGHTS

3. Release the moonroof switch, then continue to push on the (B) side again. The moonroof will operate in the close direction. (The moonroof operates inch by inch.)
4. After the moonroof stops moving, release the moonroof switch and within 4 seconds, push side (B) again. The moonroof will automatically open once.
5. Within 0.5 seconds after the moonroof stops moving, release the moonroof switch.
6. Check that the moonroof now operates normally.

If the moonroof does not operate properly after performing the procedure above, have your moonroof checked and repaired. It is recommended you visit a NISSAN dealer for this service.

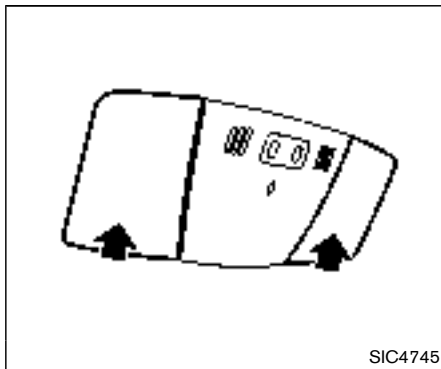

SIC4745

## MAP LIGHTS

Push the button as illustrated to turn the light on or off.

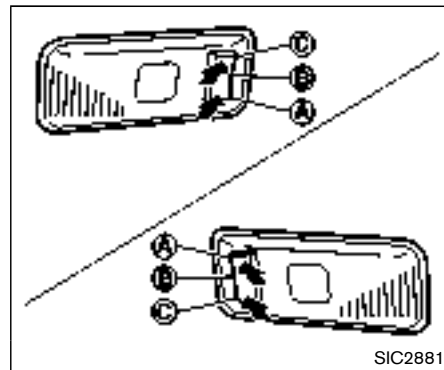

SIC2881

## REAR PERSONAL LIGHTS

The rear personal light has a three-position switch.

- (A) : OFF
- (B) : DOOR
- (C) : ON

When the switch is in the DOOR position (B), the light illuminates when a door is opened.

The interior light timer is equipped so that the interior light stays on for approximately 15 seconds when:

- The ignition switch is pushed to the OFF or LOCK position.



- The driver's door is unlocked.
- The last open door excluding the liftgate is closed.

The interior light timer will be cancelled when:

- The driver's door is locked.
- The ignition switch is pushed to the ON position.

When the rear personal light switch is in the ON position **(C)**, the rear personal lights illuminate, regardless of any condition.

When the switch is in the OFF position **(A)**, the rear personal lights do not illuminate, regardless of any condition.

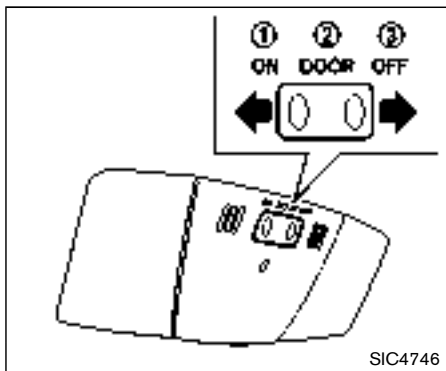

### INTERIOR LIGHT CONTROL SWITCH

The interior light control switch has three positions: ON, DOOR and OFF.

#### ON position

When the switch is in the ON position **(1)** the map lights and rear personal lights will illuminate.

#### DOOR position

When the switch is in the DOOR position **(2)**, the map lights and rear personal lights will illuminate under the following conditions:

- ignition switch is switched to the LOCK position

- remain on for about 15 seconds.
- doors are unlocked by pushing the UN-LOCK button on the Intelligent Key or door handle request switch with the ignition switch in the LOCK position
  - remain on for about 15 seconds.
- any door is opened and then closed with the ignition switch in the LOCK position
  - remain on for about 15 seconds.
- any door is opened with the ignition switch in the ACC or ON position
  - remain on while the door is opened. When the door is closed, the lights go off.

**The lights will also turn off after a period of time when the lights remain illuminated after the ignition switch has been pushed to the OFF or LOCK position to prevent the battery from becoming discharged.**

Models with center multi-function control panel:

When the auto interior illumination is set to the OFF position (see "Vehicle information and settings (models with center multi-function control panel)" (P.4-10)), the lights will illuminate under the following condition:

- any door is opened with the ignition switch in any position

- remain on while the door is opened.  
When the door is closed, the lights go off.

#### OFF position

When the switch is in the OFF position ③, the lights will not illuminate, regardless of the condition.



### CAUTION

**Do not use for extended periods of time with the engine stopped. This could result in a discharged battery.**

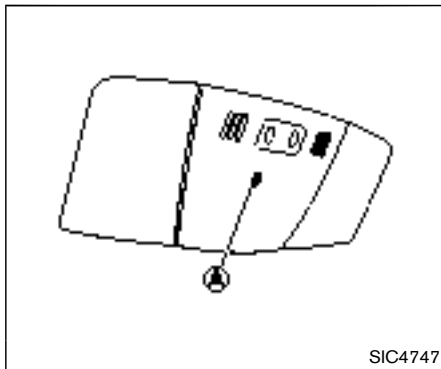
## MOOD LIGHTS



SIC4747

The mood lights (A) located in the following positions will illuminate whenever the headlight switch is in the  or  position.

- next to the map lights
- under the instrument panel
- under the driver's power window switch

## VANITY MIRROR LIGHTS

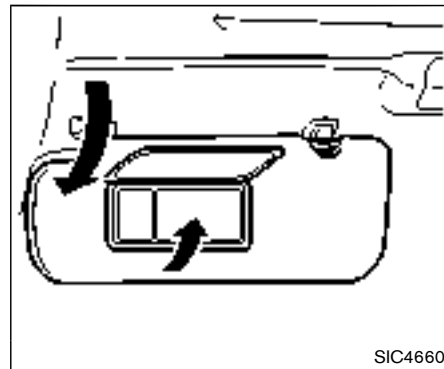

SIC4660

The light on the vanity mirror will turn on when the cover on the vanity mirror is opened.

When the cover is closed, the light will turn off.

**The lights will turn off after a period of time when the lights remain illuminated to prevent the battery from becoming discharged.**

## CARGO LIGHTS

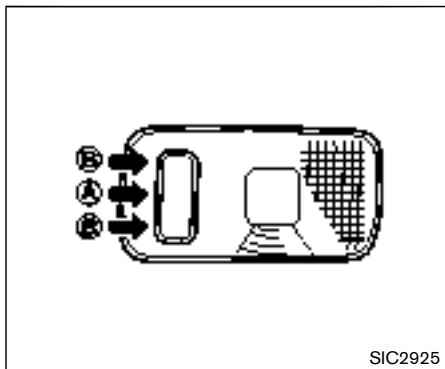

When the switch is in the DOOR position (A), the light illuminates while the liftgate is opened. When the liftgate is closed, the light will turn off.

When the switch is in the OFF position (B), the light will turn off.

**The lights will turn off after a period of time when the lights remain illuminated to prevent the battery from becoming discharged.**

## HomeLink® UNIVERSAL TRANSCEIVER (if so equipped)

The HomeLink® Universal Transceiver provides a convenient way to consolidate the functions of up to three individual hand-held transmitters into one built-in device.

HomeLink® Universal Transceiver:

- Will operate most Radio Frequency (RF) devices such as garage doors, gates, home and office lighting, entry door locks and security systems.
- Is powered by your vehicle's battery. No separate batteries are required. If the vehicle's battery is discharged or is disconnected, HomeLink® will retain all programming.

**When the HomeLink® Universal Transceiver is programmed, retain the original transmitter for future programming procedures (Example: new vehicle purchases). Upon sale of the vehicle, the programmed HomeLink® Universal Transceiver buttons should be erased for security purposes. For additional information, refer to "Programming HomeLink®" (P.2-61).**



### WARNING

- **Do not use the HomeLink® Universal Transceiver with any garage door opener that lacks safety stop and**

**reverse features as required by federal safety standards. (These standards became effective for opener models manufactured after April 1, 1982). A garage door opener which cannot detect an object in the path of a closing garage door and then automatically stop and reverse, does not meet current federal safety standards. Using a garage door opener without these features increases the risk of serious injury or death.**

- **During the programming procedure your garage door or security gate will open and close (if the transmitter is within range). Make sure that people or objects are clear of the garage door, gate, etc. that you are programming.**
- **Your vehicle's engine should be turned off while programming the HomeLink® Universal Transceiver. Do not breathe exhaust gases; they contain colorless and odorless carbon monoxide. Carbon monoxide is dangerous. It can cause unconsciousness or death.**

## PROGRAMMING HomeLink®

If you have any questions or are having difficulty programming your HomeLink® buttons, refer to the HomeLink® web site at: [www.homelink.com](http://www.homelink.com) or call 1-800-355-3515.

### NOTE:

**It is also recommended that a new battery be placed in the hand-held transmitter of the device being programmed to HomeLink® for quicker programming and accurate transmission of the radio-frequency.**

1. Position the end of your hand-held transmitter 1-3 in (26-76 mm) away from the HomeLink® surface, keeping the HomeLink® indicator light ① in view.

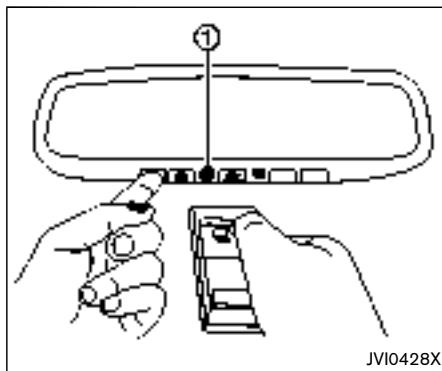

2. Using both hands, simultaneously press and hold the desired HomeLink® button and handheld transmitter button. DO NOT release until the HomeLink® indicator light ① flashes slowly and then rapidly. When the indicator light flashes rapidly, both buttons may be released. (The rapid flashing indicates successful programming.)

### NOTE:

**Some devices to be programmed may require you to replace Step 2 with the cycling procedure noted in the "Programming HomeLink® for Canadian Customers and gate openers" (P.2-62).**

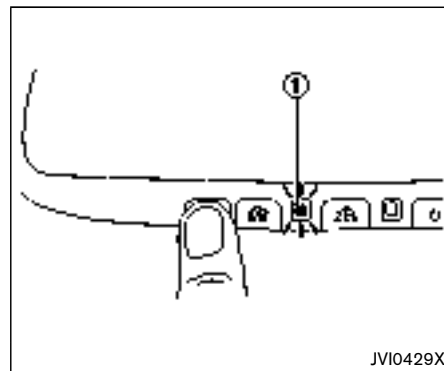

3. Press and hold the programmed HomeLink® button and observe the indicator light.
  - If the indicator light ① is solid/continuous, programming is complete and your device should activate when the HomeLink® button is pressed and released.
  - If the indicator light ① blinks rapidly for two seconds and then turns to a solid/continuous light, continue with Steps 4-6 for a rolling code device. A second person may make the following steps easier. Use a ladder or other device. Do not stand on your vehicle to perform the next steps.

4. At the receiver located on the garage door opener motor in the garage, locate the “learn” or “smart” button (the name and color of the button may vary by manufacturer but it is usually located near where the hanging antenna wire is attached to the unit). If there is difficulty locating the button, reference the garage door opener’s manual.

5. Press and release the “learn” or “smart” button.

**NOTE:**

**Once the button is pressed, you have approximately 30 seconds to initiate the next step.**

6. Return to the vehicle and firmly press and hold the programmed HomeLink® button for two seconds and release. Repeat the “press/hold/release” sequence up to 3 times to complete the programming process. HomeLink® should now activate your rolling code equipped device.
7. If you have any questions or are having difficulty programming your HomeLink® buttons, refer to the HomeLink® web site at: [www.homelink.com](http://www.homelink.com) or call 1-800-355-3515.

## PROGRAMMING HomeLink® FOR CANADIAN CUSTOMERS AND GATE OPENERS

Canadian radio-frequency laws require transmitter signals to “time-out” (or quit) after several seconds of transmission – which may not be long enough for HomeLink® to pick up the signal during programming. Similar to this Canadian law, some U.S. gate operators are designed to “time-out” in the same manner.

If you live in Canada or you are having difficulties programming a gate operator or garage door opener by using the “Programming HomeLink®” procedures, replace “Programming HomeLink®” Step 2 with the following:

**NOTE:**

**When programming a garage door opener, etc., unplug the device during the “cycling” process to prevent possible damage to the garage door opener components.**

Step 2: Using both hands, simultaneously press and hold the desired HomeLink® button and the hand-held transmitter button. During programming, your hand-held transmitter may automatically stop transmitting. Continue to press and hold the desired HomeLink® button while you press and re-press (“cycle”) your hand-held transmitter every two seconds until the frequency signal has been learned. The HomeLink®

indicator light will flash slowly and then rapidly after several seconds upon successful programming. **DO NOT** release until the HomeLink® indicator light flashes slowly and then rapidly. When the indicator light flashes rapidly, both buttons may be released. The rapid flashing indicates successful programming.

Proceed with “Programming HomeLink®” step 3 to complete.

Remember to plug the device back in when programming is completed.

## OPERATING THE HomeLink® UNIVERSAL TRANSCEIVER

The HomeLink® Universal Transceiver, after it is programmed, can be used to activate the programmed device. To operate, simply press and release the appropriate programmed HomeLink® Universal Transceiver button. The amber indicator light will illuminate while the signal is being transmitted.

For convenience, the hand-held transmitter of the device may also be used at any time.

## PROGRAMMING TROUBLESHOOTING

If the HomeLink® does not quickly learn the hand-held transmitter information:

- replace the hand-held transmitter batteries with new batteries.
- position the hand-held transmitter with its battery area facing away from the HomeLink® surface.
- press and hold both the HomeLink® and hand-held transmitter buttons without interruption.
- position the hand-held transmitter 1-3 in (26-76 mm) away from the HomeLink® surface. Hold the transmitter in that position for up to 15 seconds. If HomeLink® is not programmed within that time, try holding the transmitter in another position - keeping the indicator light in view at all times.

If you have any questions or are having difficulty programming your HomeLink® buttons, refer to the HomeLink® web site at: [www.homelink.com](http://www.homelink.com) or 1-800-355-3515.

## CLEARING THE PROGRAMMED INFORMATION

The following procedure clears the programmed information from both buttons. Individual buttons cannot be cleared. However, individual buttons can be reprogrammed, see "Reprogramming a single HomeLink® button" (P.2-63).

### To clear all programming

1. Press and hold the two outer HomeLink® buttons until the indicator light begins to flash in approximately 10 seconds. Do not hold for longer than 20 seconds.
2. Release both buttons.

HomeLink® is now in the programming mode and can be programmed at any time beginning with "Programming HomeLink®" - Step 1.

## REPROGRAMMING A SINGLE HOME LINK® BUTTON

To reprogram a HomeLink® Universal Transceiver button, complete the following.

1. Press and hold the desired HomeLink® button. **DO NOT** release the button.
2. The indicator light will begin to flash after 20 seconds. Without releasing the HomeLink® button, proceed with "Programming HomeLink®" - Step 1.

For questions or comments, contact HomeLink® at: [www.homelink.com](http://www.homelink.com) or 1-800-355-3515.

The HomeLink® Universal Transceiver button has now been reprogrammed. The new device can be activated by pushing the HomeLink® button that was just programmed. This procedure will not affect any other programmed HomeLink® buttons.

## IF YOUR VEHICLE IS STOLEN

If your vehicle is stolen, you should change the codes of any non-rolling code device that has been programmed into HomeLink®. Consult the Owner's Manual of each device or call the manufacturer or dealer of those devices for additional information.

**When your vehicle is recovered, you will need to reprogram the HomeLink® Universal Transceiver with your new transmitter information.**

### FCC Notice:

#### For USA:

**This device complies with Part 15 of the FCC Rules. Operation is subject to the following two conditions: (1) This device may not cause harmful interference, and (2) this device must accept any interference received, including interference that may cause undesired operation.**

**NOTE:**

Changes or modifications not expressly approved by the party responsible for compliance could void the user's authority to operate the equipment.

**For Canada:**

This device complies with Industry Canada licence-exempt RSS standard(s). Operation is subject to the following two conditions: (1) this device may not cause interference, and (2) this device must accept any interference, including interference that may cause undesired operation of the device.

# 3 Pre-driving checks and adjustments

Keys .....	3-3	Intelligent Key system .....	3-13
Intelligent Key system .....	3-3	Intelligent Key operating range .....	3-15
Mechanical key .....	3-4	Door locks/unlocks precaution .....	3-15
Valet hand-off .....	3-5	Intelligent Key operation .....	3-16
Doors .....	3-5	Battery saver system .....	3-19
Locking with mechanical key .....	3-5	Warning signals .....	3-19
Opening and closing windows with the mechanical key (if so equipped) .....	3-6	Troubleshooting guide .....	3-20
Locking with inside lock knob .....	3-6	Remote keyless entry system .....	3-21
Locking with power door lock switch .....	3-6	How to use remote keyless entry system .....	3-22
Automatic door locks .....	3-7	Hood .....	3-25
Sliding doors .....	3-7	Liftgate .....	3-26
Sliding door auto closure function (if so equipped) .....	3-9	Operating manual liftgate .....	3-26
Child safety sliding door lock .....	3-9	Operating power liftgate (if so equipped) .....	3-26
Power sliding door (if so equipped) .....	3-10	Auto closure .....	3-29
Precautions on power sliding door operation .....	3-10	Liftgate release .....	3-30
Switching sliding door operation .....	3-11	Fuel-filler door .....	3-30
Operating sliding door switch .....	3-12	Opening fuel-filler door .....	3-30
Operating the power sliding door with the Intelligent Key (if so equipped) .....	3-12	Fuel-filler cap .....	3-30
Operating sliding door by power assist .....	3-13	Tilt/telescopic steering .....	3-32
Sliding door auto reverse function .....	3-13	Tilt or telescopic operation .....	3-32
		Sun visors .....	3-33



Mirrors .....	3-33	Automatic drive positioner (if so equipped) .....	3-36
Inside mirror .....	3-33	Entry/exit function .....	3-36
Outside mirrors .....	3-35	Memory storage .....	3-37
Vanity mirror .....	3-36	System operation .....	3-38

## KEYS

A key number plate is supplied with your keys. Record the key number and keep it in a safe place (such as your wallet), not in the vehicle. If you lose your keys, it is recommended you visit a NISSAN dealer for duplicates by using the key number. NISSAN does not record any key numbers so it is very important to keep track of your key number plate.

A key number is only necessary when you have lost all keys and do not have one to duplicate from. If you still have a key, it can be duplicated without knowing the key number.

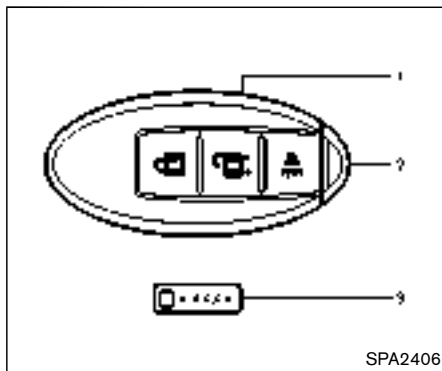

Type A (if so equipped)

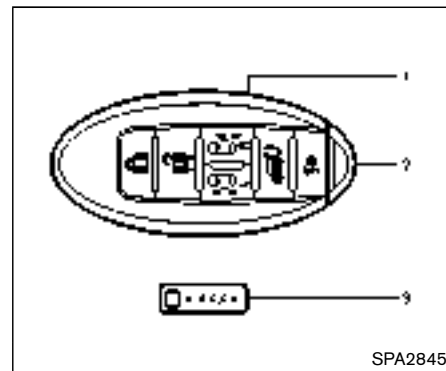

Type C (if so equipped)

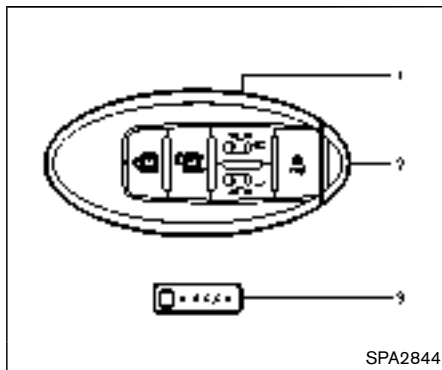

Type B (if so equipped)

1. Master key (2)
2. Mechanical key (inside the key) (2)
3. Key number plate (1)

## INTELLIGENT KEY SYSTEM

Your vehicle can only be driven with the Intelligent Keys which are registered to your vehicle's Intelligent Key system components and NISSAN Vehicle Immobilizer System components. As many as 4 Intelligent Keys can be registered and used with one vehicle. The new keys must be registered by a NISSAN dealer prior to use with the Intelligent Key system and NISSAN Vehicle Immobilizer System of your vehicle. Since the registration process requires erasing all memory in the Intelligent Key compo-

nents when registering new keys, be sure to take all Intelligent Keys that you have to the NISSAN dealer.

## CAUTION

- **Be sure to carry the Intelligent Key with you when driving. The Intelligent Key is a precision device with a built-in transmitter. To avoid damaging it, please note the following.**
  - The Intelligent Key is water resistant; however, wetting may damage the Intelligent Key. If the Intelligent Key gets wet, immediately wipe until it is completely dry.
  - Do not bend, drop or strike it against another object.
  - If the outside temperature is below 14°F (-10°C) degrees, the battery of the Intelligent Key may not function properly.
  - Do not place the Intelligent Key for an extended period in a place where temperatures exceed 140°F (60°C).

- **Do not change or modify the Intelligent Key.**
- **Do not use a magnet key holder.**
- **Do not place the Intelligent Key near an electric appliance such as a television set, personal computer or cellular phone.**
- **Do not allow the Intelligent Key to come into contact with water or salt water, and do not wash it in a washing machine. This could affect the system function.**
- **If an Intelligent Key is lost or stolen, NISSAN recommends erasing the ID code of that Intelligent Key. This will prevent the Intelligent Key from unauthorized use to unlock the vehicle. For information regarding the erasing procedure, it is recommended you visit a NISSAN dealer.**

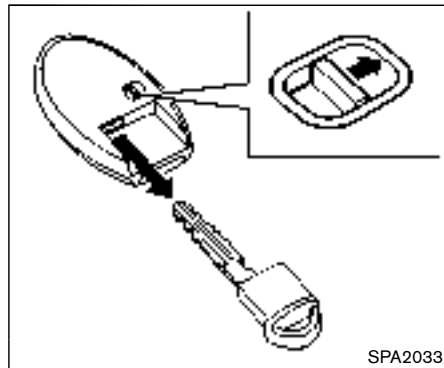

## MECHANICAL KEY

To remove the mechanical key, release the lock knob at the back of the key.

To install the mechanical key, firmly insert it into the key until the lock knob returns to the lock position.

Use the mechanical key to lock or unlock the doors and glove box, if they are equipped with a key cylinder.

See "Doors" (P.3-5) and "Storage" (P.2-44).

## DOORS



### CAUTION

**Always carry the mechanical key installed in the key.**

### VALET HAND-OFF

When you have to leave a key with a valet, give them the Intelligent Key itself after removing the mechanical key to protect your belongings.

To prevent the glove box from being opened during valet hand-off, follow the procedures below.

1. Remove the mechanical key from the Intelligent Key.
2. Lock the glove box with the mechanical key.
3. Hand the Intelligent Key to the valet, keeping the mechanical key in your pocket or bag. Insert the mechanical key into the Intelligent Key when you retrieve your vehicle.

For glove box lock, see "Storage" (P.2-44).



### WARNING

- **Always have the doors locked while driving. Along with the use of seat belts, this provides greater safety in the event of an accident by helping to prevent persons from being thrown from the vehicle. This also helps keep children and others from unintentionally opening the doors, and will help keep out intruders.**
- **Before opening any door, always look for and avoid oncoming traffic.**
- **To help avoid risk of injury or death through unintended operation of the vehicle and or its systems, including entrapment in windows or inadvertent door lock activation, do not leave children, people who require the assistance of others or pets unattended in your vehicle. Additionally, the temperature inside a closed vehicle on a warm day can quickly become high enough to cause a significant risk of injury or death to people and pets.**

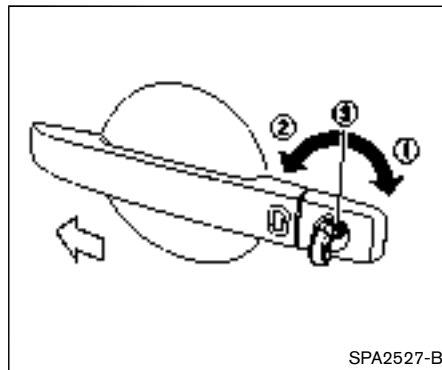

### LOCKING WITH MECHANICAL KEY

The power door lock system allows you to lock or unlock all doors simultaneously using the mechanical key.

- Turning the driver's door key cylinder to the rear of the vehicle ① will lock all doors.
- Turning the driver's door key cylinder once to the front of the vehicle ② will unlock the driver's door. After returning the key to the neutral position ③, turning it to the front again within 5 seconds will unlock all doors.
- Models with center multi-function control panel:

You can switch the lock system to the mode that allows you to open all the doors when

**Pre-driving checks and adjustments 3-5**

the key is turned once. (See “How to use SETTING button” (P.4-15).)

### OPENING AND CLOSING WINDOWS WITH THE MECHANICAL KEY (if so equipped)

The driver’s door key operation also allows you to open and close the window that is equipped with the automatic open/close function. (See “Power windows” (P.2-52).)

To open the windows, turn the driver’s door key cylinder to the front of the vehicle for **longer than 1 second**. The door is unlocked and the window keeps opening while turning the key.

This function can also be performed by pushing and holding the door UNLOCK button of the key. (See “Remote keyless entry system” (P.3-21).)

To close the windows, turn the driver’s door key cylinder to the rear of the vehicle for **longer than 1 second**. The door is locked and the window keeps closing while turning the key.

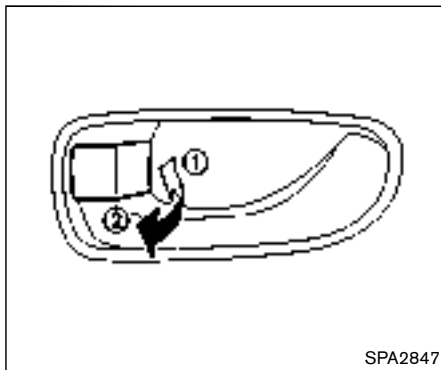

### LOCKING WITH INSIDE LOCK KNOB

To lock the door individually, move the inside lock knob to the lock position ① then close the door.

To unlock, move the inside lock knob to the unlock position ②.

**When locking the door without Intelligent Key, be sure not to leave the Intelligent Key inside the vehicle.**

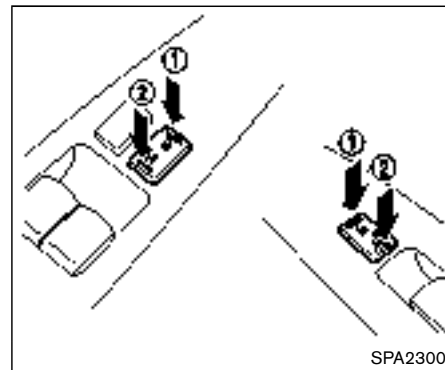

### LOCKING WITH POWER DOOR LOCK SWITCH

Operating the power door lock switch will lock or unlock all the doors. The switches are located on the driver’s and front passenger’s door armrests.

To lock the doors, push the power door lock switch to the lock position ① with the driver’s or front passenger’s door open, then close the door.

**When locking the door this way, be certain not to leave the Intelligent Key inside the vehicle.**

To unlock the doors, push the power door lock switch to the unlock position ②.

### Lockout protection

When the power door lock switch (driver or front passenger) is moved to the lock position with any door open, all doors will lock and unlock automatically. With the Intelligent Key left in the vehicle and any door open, all doors will unlock automatically and a chime will sound after the door is closed.

These functions help to prevent the Intelligent Key from being accidentally locked inside the vehicle.

### AUTOMATIC DOOR LOCKS

- All doors will be locked automatically when the vehicle speed reaches 15 MPH (24 km/h).
- All doors will be unlocked automatically when the ignition switch is placed in the OFF position.

**The automatic unlock function can be deactivated or activated.** To deactivate or activate the automatic door unlock system, perform the following procedure:

1. Close all doors.
2. Place the ignition switch in the ON position.

3. Within 20 seconds of performing Step 2, push and hold the power door lock switch to the  position (UNLOCK) for more than 5 seconds.
4. When activated, the hazard indicator will flash twice. When deactivated, the hazard indicator will flash once.
5. The ignition switch must be placed in the OFF and ON position again between each setting change.

When the automatic door unlock system is deactivated, the doors do not unlock when the ignition switch is placed in the OFF position. To unlock the door manually, use the inside lock knob or the power door lock switch (driver's or front passenger's side).

### SLIDING DOORS



### CAUTION

- **Always use the door handle to open or close the sliding door. Do not attempt to open or close the door by merely placing your hand on the door edge or door slide roller as this may cause injury.**
- **When opening the door on a slope, be sure to fully open the door until it**

### locks.

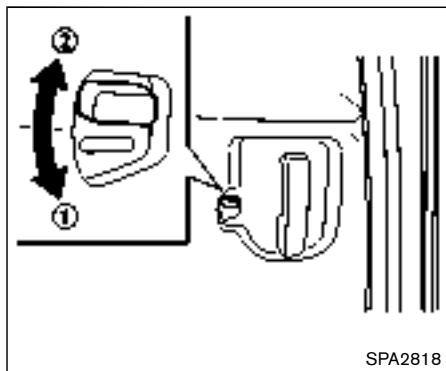

#### Locking with inside lock knob

To lock without an Intelligent Key, push the lock knob to the lock position ①, and then close the door.

To unlock, pull the inside lock knob to the unlock position ②.

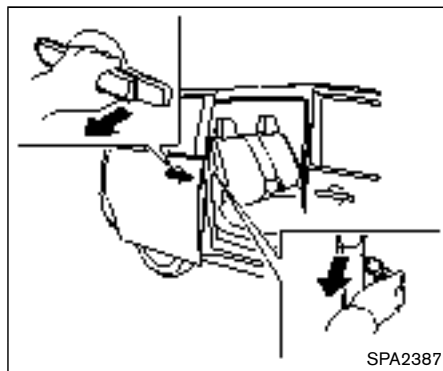

#### Opening/Closing the sliding door

The sliding door will be latched at the fully opened/closed position.

To open/close the sliding door manually, pull the door handle or the inside door handle.

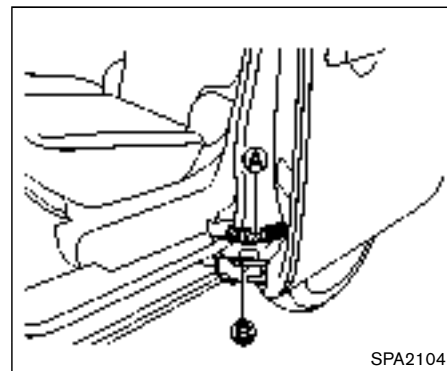

#### CAUTION

Do not put your hands or feet on the harness ① or the bracket ②. This may cause damage to the vehicle or personal injury.

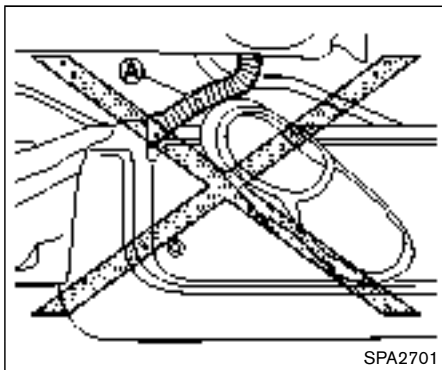

### CAUTION

Before closing the sliding door, make sure that no objects are placed on the door step. Otherwise, the harness (A) could be damaged.

### SLIDING DOOR AUTO CLOSURE FUNCTION (if so equipped)

The auto closure function will operate when the sliding door is not fully closed.

### WARNING

When the auto closure function is operating, keep hands and feet away from the sliding door to prevent injuries.

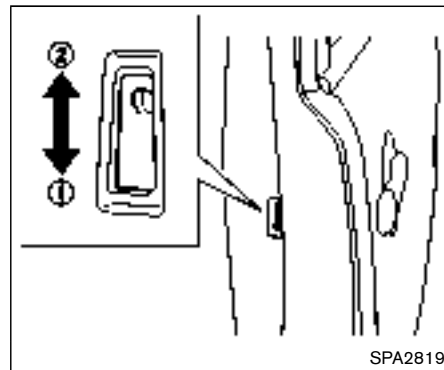

### CHILD SAFETY SLIDING DOOR LOCK

The child safety sliding door locks help prevent sliding doors from being opened accidentally, especially when small children are in the vehicle.

When the levers are in the lock position (1), the child safety sliding door locks engage and the sliding doors can only be opened by the outside door handles.

To disengage, move the levers to the unlock position (2).



## POWER SLIDING DOOR (if so equipped)

The power sliding door system will allow you to open or close the sliding doors automatically using the door handles, the sliding door switch, the Intelligent Key or sliding door one-touch switch.

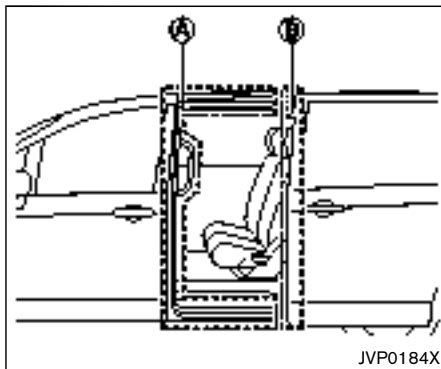

JVP0184X



### WARNING

- There are some small distances immediately before the closed position which cannot be detected. Make sure that all passengers have their hands, feet etc., inside the vehicle before closing the door.
- Do not put your hands or feet on the vehicle body (A) or the sliding door (B) while operating the sliding door.
- Operate the sliding door only when the vehicle is completely stopped.

- Before operating the power sliding door, be sure there is nothing interfering with the door opening or closing.
- Do not operate the power sliding door when the vehicle is on a steep incline.
- Do not touch the sliding door rail or cable. If you touch the power sliding door cable the door could automatically operate.

### PRECAUTIONS ON POWER SLIDING DOOR OPERATION

- Do not perform the power sliding door operation frequently when the engine is stopped. This could cause a discharged battery.
- Do not start the engine while the sliding door is in a power operation. The door may not operate properly.
- Make sure that the sliding doors are closed before starting the vehicle.
- Under the following cases, turn the power door main switch off:
  - When the sliding door is malfunctioning.
  - When operating the sliding door manually.

- When you need to keep the sliding door open for a period of time.
- When washing the vehicle or performing any maintenance work.

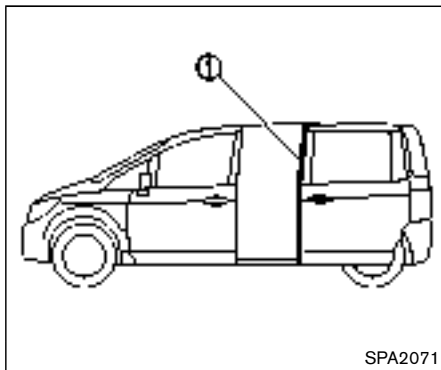

- Be careful not to damage the sensor ① of the sliding door.

When reconnecting the battery cable with the sliding door open (in case of a discharged battery, etc.), be sure to fully close the sliding door manually once before performing the power operation. Otherwise, the power open or close function may not operate properly.

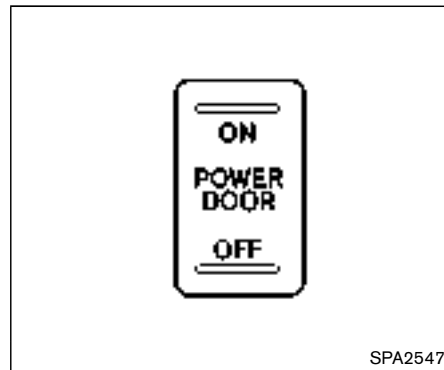

Power door main switch

### SWITCHING SLIDING DOOR OPERATION

Using the power door main switch located on the instrument panel, you can switch the sliding door between power and manual operation. To turn on the power operating mode, push the switch to the ON position. To turn off the power operation, push the switch to the OFF position, and then the sliding door can be manually operated.

When the power door main switch is pushed to the "OFF" position, the power operation is not available by the sliding door one-touch switch and power assist.

The power sliding door system can be operated when all of following conditions are satisfied.

- The vehicle is stopped.
- Battery voltage is normal.
- The sliding door is unlocked.
- The fuel-filler door is closed (for driver's side only).

When the ignition switch is in the "ON" position, the system can be operated in the above and following conditions.

- Shift lever is set in the "P" (Park) position.

If the conditions are interrupted when the power sliding door is being operated, the operation could be stopped. In this case, meet the conditions above and the power sliding door operation will return to normal.

You can also switch the power liftgate between power and manual operation using the power door main switch. (See "Liftgate" (P.3-26).)

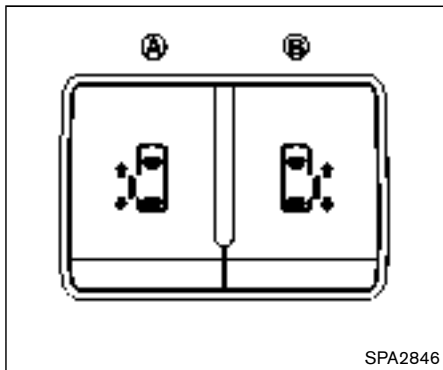

Instrument panel

- (A) Driver's side sliding door switch
- (B) Passenger's side sliding door switch

### OPERATING SLIDING DOOR SWITCH

To operate the sliding doors with the sliding door switches, turn on the power door main switch.

- When the sliding door is fully closed, push and hold the sliding door switch on the instrument panel for about 1 second. The sliding door will automatically open to the fully opened position.
- When the sliding door is fully opened, push and hold the sliding door switch on the instrument panel for about 1 second. The

sliding door will automatically close to the fully closed position.

- If the sliding door switch is pushed while the sliding door is being operated automatically, the door will start moving in the reverse direction and stop at the fully opened or closed position.
- The sliding doors can be opened by the instrument panel switch (A) or (B) even if the sliding door is locked or the power door main switch is in the OFF position.

### OPERATING THE POWER SLIDING DOOR WITH THE INTELLIGENT KEY (if so equipped)

The sliding doors can also be opened and closed by pushing the button on the Intelligent Key. (See "Intelligent Key system" (P.3-13).)

### Sliding door one-touch unlock/open function (if so equipped)

The sliding doors can be unlocked and opened with a one-touch unlock/open operation. When closed, the sliding door will not lock automatically. To lock the sliding doors, manually lock the inside knob before closing the sliding door or push the LOCK button on the Intelligent Key after the door is closed. See "Remote keyless entry system" (P.3-21).

## INTELLIGENT KEY SYSTEM

### OPERATING SLIDING DOOR BY POWER ASSIST

To operate, pull the inside or outside door handle until you hear the buzzer, the door will automatically open or close.

If the door handle is operated while the sliding door is moving, the door will reverse directions and stop at either the full open or closed position.

### SLIDING DOOR AUTO REVERSE FUNCTION

If an obstacle is detected while the power sliding door is being operated, the door will reverse directions and return to the full open or full closed position.

If you touch the sensor of the sliding door while the sliding door is closing automatically, the door will start moving in the reverse direction and stop at the fully opened position.



### WARNING

- **Radio waves could adversely affect electric medical equipment. Those who use a pacemaker should contact the electric medical equipment manufacturer for the possible influences before use.**
- **The Intelligent Key transmits radio waves when the buttons are pushed. The FAA advises that radio waves may affect aircraft navigation and communication systems. Do not operate the Intelligent Key while on an airplane. Make sure the buttons are not operated unintentionally when the unit is stored for a flight.**

The Intelligent Key system can operate all the door locks (including the liftgate) using the remote keyless function or pushing the request switch on the vehicle without taking the key out from a pocket or purse. The operating environment and/or conditions may affect the Intelligent Key system operation.

Be sure to read the following before using the Intelligent Key system.



### CAUTION

- **Be sure to carry the Intelligent Key with you when operating the vehicle.**
- **Never leave the Intelligent Key in the vehicle when you leave the vehicle.**

The Intelligent Key is always communicating with the vehicle as it receives radio waves. The Intelligent Key system transmits weak radio signals. Environmental conditions may interfere with the operation of the Intelligent Key system under the following operating conditions.

- When operating near a location where strong radio signals are transmitted, such as a TV tower, power station and broadcasting station.
- When in possession of wireless equipment, such as a cellular telephone, transceiver, and CB radio.
- When the Intelligent Key is in contact with or covered by metallic materials.
- When any type of radio wave remote control is used nearby.
- When the Intelligent Key is placed near an electric appliance such as a personal

computer.

- When the vehicle is parked near a parking meter.

In such cases, correct the operating conditions before using the Intelligent Key function or use the mechanical key.

Although the life of the battery varies depending on the operating conditions, the battery's life is approximately 2 years. If the battery is discharged, replace it with a new one.

Since the Intelligent Key is continuously receiving radio signals, if the key is left near equipment which transmits strong radio signals such as from a TV and personal computer, the battery life may become shorter.

For information regarding replacement of a battery, see "Intelligent Key battery replacement" (P.8-20).

As many as 4 Intelligent Keys can be registered and used with one vehicle. For information about the purchase and use of additional Intelligent Keys, contact a NISSAN dealer.



## CAUTION

- Do not allow the Intelligent Key, which contains electrical components, to come into contact with

**water or salt water. This could affect the system function.**

- Do not drop the Intelligent Key.
- Do not strike the Intelligent Key sharply against another object.
- Do not change or modify the Intelligent Key.
- Wetting may damage the Intelligent Key. If the Intelligent Key gets wet, immediately wipe until it is completely dry.
- If the outside temperature is below 14°F (-10°C), the battery of the Intelligent Key may not function properly.
- Do not place the Intelligent Key for an extended period in an area where temperatures exceed 140°F (60°C).
- Do not attach the Intelligent Key with a key holder that contains a magnet.
- Do not place the Intelligent Key near equipment that produces a magnetic field, such as a TV, audio equipment, personal computer or cellular phone.

If an Intelligent Key is lost or stolen, NISSAN recommends erasing the ID code of that Intelligent Key from the vehicle. This may prevent the unauthorized use of the Intelligent Key to operate the vehicle. For information regarding the erasing procedure, it is recommended that you contact a NISSAN dealer.

The Intelligent Key function can be disabled. For information about disabling the Intelligent Key function, it is recommended that you contact a NISSAN dealer.

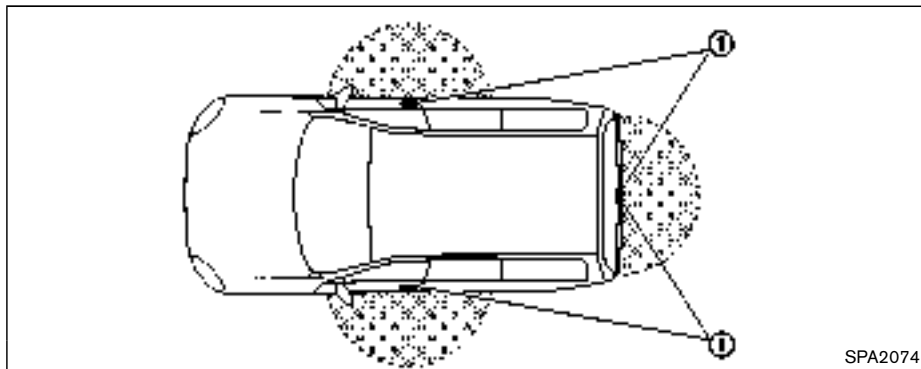

SPA2074

## INTELLIGENT KEY OPERATING RANGE

The Intelligent Key functions can only be used when the Intelligent Key is within the specified operating range from the request switch ①.

When the Intelligent Key battery is discharged or strong radio signals are present near the operating location, the Intelligent Key system's operating range becomes narrower, and the Intelligent Key may not function properly.

The operating range is within 31.50 in (80 cm) from each request switch ①.

If the Intelligent Key is too close to the door glass, handle or rear bumper the request

switches may not function.

When the Intelligent Key is within the operating range, it is possible for anyone who does not carry the Intelligent Key to push the request switch to lock/unlock the doors including the liftgate.

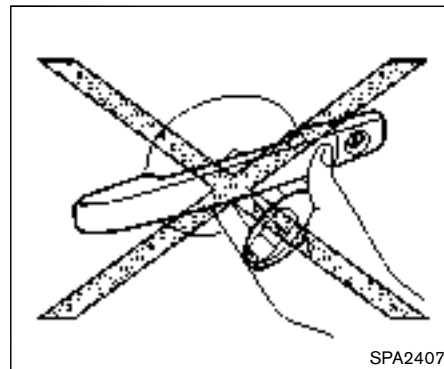

SPA2407

## DOOR LOCKS/UNLOCKS PRECAUTION

- Do not push the door handle request switch with the Intelligent Key held in your hand as illustrated. The close distance to the door handle will cause the Intelligent Key system to have difficulty recognizing that the Intelligent Key is outside the vehicle.
- After locking with the door handle request switch, verify the doors are securely locked by testing them.
- To prevent the Intelligent Key from being left inside the vehicle, make sure you carry the key with you and then lock the doors.

- Do not pull the door handle before pushing the door handle request switch. The door will be unlocked but will not open. Release the door handle once and pull it again to open the door.
- Models with center multi-function control panel:  
The Intelligent Key system (opening/closing doors with the door handle request switch) can be set to remain inactive. (See “Vehicle information and settings (models with center multi-function control panel)” (P.4-10).)

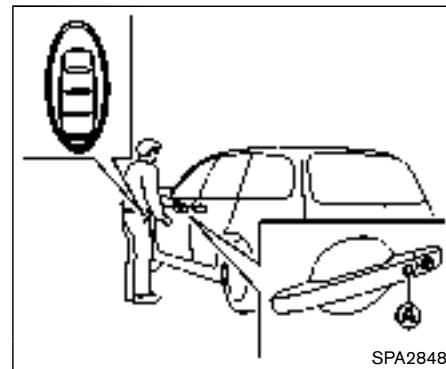
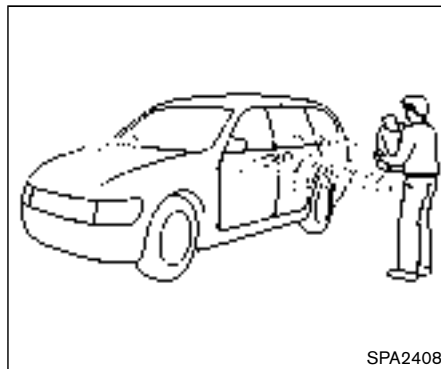

### INTELLIGENT KEY OPERATION

You can lock or unlock the doors without taking the key out from your pocket or bag.

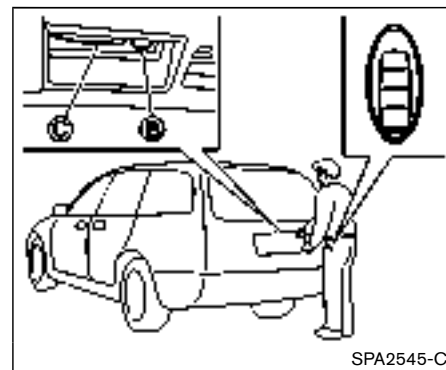

When you carry the Intelligent Key with you, you can lock or unlock all doors by pushing the door handle request switch (A) or the liftgate request switch (B) within the range of operation.

When you lock or unlock the doors or the liftgate, the hazard indicator will flash and the horn (or the outside chime) will sound as a confirmation. For details, see "Setting hazard indicator and horn mode" (P.3-23).

### Locking doors

1. Move the shift lever to the P (Park) position, push the ignition switch to the OFF position and make sure you carry the Intelligent Key with you.\*1
2. Close all the doors and the liftgate.\*2
3. Push the door handle request switch (A) or liftgate request switch (B) while carrying the Intelligent Key with you.\*3
4. All the doors and the liftgate will lock.
5. The hazard indicator flashes twice and the outside chime sounds twice.

\*1: Doors will lock with the Intelligent Key while the ignition switch is in the ACC or ON position.

\*2: Doors will not lock with the Intelligent Key while any door (including the liftgate) is open.

\*3: Doors will not lock by pushing the door handle request switch with the Intelligent Key inside the vehicle.

However, when an Intelligent Key is inside the vehicle, doors can be locked with another registered Intelligent Key.



### CAUTION

- After locking the doors using the request switch, make sure that the doors have been securely locked by operating the door handles.
- When locking the doors using the request switch, make sure to have the Intelligent Key in your possession before operating the request switch to prevent the Intelligent Key from being left in the vehicle.
- The request switch is operational only when the Intelligent Key has been detected by the Intelligent Key system.

### Lockout protection:

To prevent the Intelligent Key from being accidentally locked in the vehicle, lockout protection is equipped with the Intelligent Key system.

When the driver's side door is open, the doors are locked, and then the Intelligent Key is put inside the vehicle and all the doors are closed;

the lock will automatically unlock and the door buzzer sounds.

### NOTE:

**The doors may not lock when the Intelligent Key is in the same hand that is operating the request switch to lock the door. Put the Intelligent Key in a purse, pocket or your other hand.**



### CAUTION

The lockout protection may not function under the following conditions:

- When the Intelligent Key is placed on top of the instrument panel.
- When the Intelligent Key is placed inside the glove box or a storage bin.
- When the Intelligent Key is placed inside the door pockets.
- When the Intelligent Key is placed inside or near metallic materials.



## Unlocking doors

1. Push the door handle request switch **(A)** or the liftgate request switch **(B)** once while carrying the Intelligent Key with you.
2. The hazard indicator flashes once and the outside chime sounds once. The corresponding door or the liftgate will unlock.
3. Push the request switch again within 1 minute.
4. The hazard indicator flashes once and the outside chime sounds once again. All the doors and the liftgate will unlock.

### Automatic relock:

All doors will be locked automatically unless one of the following operations is performed within 1 minute after pushing the request switch while the doors are locked. If during this 1-minute time period, the request switch is pushed, all doors will be locked automatically after another 1 minute.

- Opening any door (including the liftgate)
- Pushing the ignition switch

## Power liftgate open (if so equipped)

1. Carry the Intelligent Key.
2. Push the power liftgate opener switch **(C)**.
3. The liftgate will unlock and automatically open.
4. The hazard indicator flashes 4 times and the outside chime sounds.

To close the liftgate, push the power liftgate button on the key, or power liftgate switch on the instrument panel or lower part of the liftgate. (See "Liftgate" (P.3-26).)

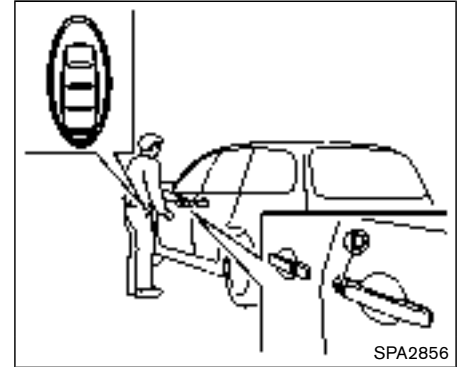

## Sliding door one-touch unlock/open function (if so equipped)

When the sliding door one-touch switch **(D)** is pushed once while the Intelligent Key is carried, the sliding door will be unlocked and will fully open automatically. All other doors, if already locked, will remain locked. If the sliding door is already unlocked, the sliding door will open automatically. To close the sliding door, push the sliding door one-touch switch **(D)** once. When the sliding door is closed, it will remain unlock so be sure to lock the vehicle. When closed, the sliding door will not lock automatically. To lock the sliding door, manually lock the inside knob before closing the sliding door or push the

LOCK button on the Intelligent Key after the door is closed. (See “Remote keyless entry system” (P.3-21).)

## BATTERY SAVER SYSTEM

When all the following conditions are met for a period of time, the battery saver system will cut off the power supply to prevent battery discharge.

- The ignition switch is in the ACC position, and
- All doors are closed, and
- The shift lever is in the P (Park) position.

## WARNING SIGNALS

To help prevent the vehicle from moving unexpectedly by erroneous operation of the Intelligent Key listed on the following chart or to help prevent the vehicle from being stolen, chime or beep sounds inside and outside the vehicle and a warning displays in the vehicle information display.

When a chime or beep sounds or the warning displays, be sure to check the vehicle and Intelligent Key.

See “Troubleshooting guide” (P.3-20) and “Vehicle information display” (P.2-19).

## TROUBLESHOOTING GUIDE

	Symptom	Possible cause	Action to take
When pushing the ignition switch to stop the engine	The SHIFT P warning appears on the display and the inside warning chime sounds continuously.	The shift lever is not in the P (Park) position.	Shift the shift lever to the P (Park) position.
When shifting the shift lever to the P (Park) position.	The inside warning chime sounds continuously.	The ignition switch is in the ACC or ON position.	Push the ignition switch to the OFF position.
When opening the driver's door to get out of the vehicle	The inside warning chime sounds continuously.	The ignition switch is in the ACC position.	Push the ignition switch to the OFF position.
When closing the door after getting out of the vehicle	The NO KEY warning appears on the display, the outside chime sounds 3 times and the inside warning chime sounds for a few seconds.	The ignition switch is in the ACC or ON position.	Push the ignition switch to the OFF position.
	The SHIFT P warning appears on the display and the outside chime sounds continuously.	The ignition switch is in the ACC or OFF position and the shift lever is not in the P (Park) position.	Move the shift lever to the P (Park) position and push the ignition switch to the OFF position.
When closing the door with the inside lock knob turned to LOCK	The outside chime sounds for a few seconds and all the doors unlock.	The Intelligent Key is inside the vehicle or cargo area.	Carry the Intelligent Key with you.
When pushing the request switch or the LOCK  button on the Intelligent Key to lock the door	The outside chime sounds for a few seconds.	The Intelligent Key is inside the vehicle or cargo area.	Carry the Intelligent Key with you.
		A door is not closed securely.	Close the door securely.
When pushing the ignition switch to start the engine	The Intelligent Key battery indicator appears on the display.	The battery charge is low.	Replace the battery with a new one. (See "Intelligent Key battery replacement" (P.8-20).)
	The NO KEY warning appears on the display and the inside warning chime sounds for a few seconds.	The Intelligent Key is not in the vehicle.	Carry the Intelligent Key with you.
When pushing the ignition switch	The Intelligent Key system warning light in the meter illuminates in yellow.	It warns of a malfunction with the Intelligent Key system.	It is recommended that you contact a NISSAN dealer.

## REMOTE KEYLESS ENTRY SYSTEM



### WARNING

The Intelligent Key transmits radio waves when the buttons are pushed. The FAA advises that radio waves may affect aircraft navigation and communication systems. Do not operate the Intelligent Key while on an airplane. Make sure the buttons are not operated unintentionally when the unit is stored for a flight.

It is possible to lock/unlock all doors and the liftgate, activate the panic alarm and operate the sliding doors/liftgate (if so equipped) by pushing the buttons on the Intelligent Key from outside the vehicle.

**Before locking the doors, make sure the Intelligent Key is not left in the vehicle.**

The LOCK/UNLOCK button on the Intelligent Key can operate at a distance of approximately 33 ft (10 m) from the vehicle. (The effective distance depends upon the conditions around the vehicle.) As many as 4 Intelligent Keys can be used with one vehicle. For information concerning the purchase and use of additional Intelligent Keys, contact a NISSAN dealer.

The lock and unlock buttons will not operate when:

- the distance between the Intelligent Key and the vehicle is over 33 ft (10 m).
- the Intelligent Key battery is discharged.

After locking with the remote keyless entry function, pull the door handle to make sure the doors are securely locked.

The LOCK/UNLOCK operating range varies depending on the environment. To securely operate the lock and unlock buttons, approach the vehicle to about 3 ft (1 m) from the door.

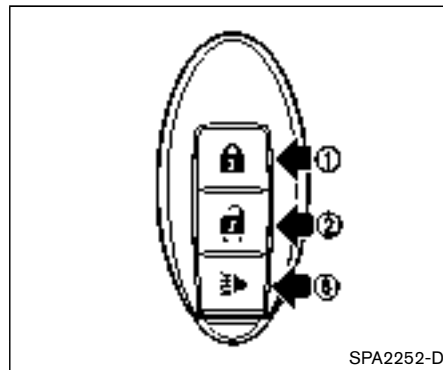

SPA2252-D

Type A (if so equipped)

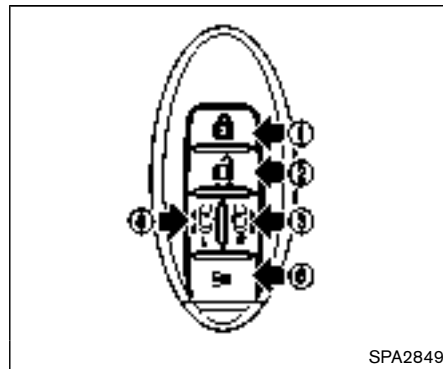

SPA2849

Type B (if so equipped)

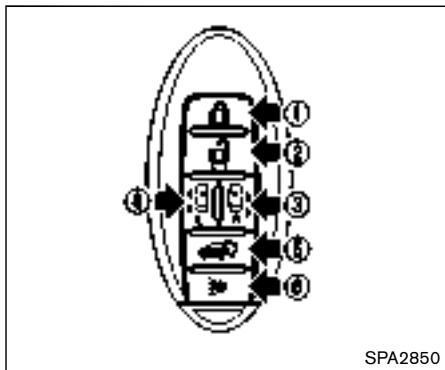

SPA2850

Type C (if so equipped)

- ① LOCK button
- ② UNLOCK button
- ③ Power sliding door button (passenger's side) \*
- ④ Power sliding door button (driver's side) \*
- ⑤ Power liftgate button \*
- ⑥ PANIC button

\*: if so equipped

## HOW TO USE REMOTE KEYLESS ENTRY SYSTEM

When you lock or unlock the doors or the liftgate, the hazard indicator will flash and the horn (or the outside chime) will sound as a confirmation. For details, see "Setting hazard indicator and horn mode" (P.3-23).

### 3-22 Pre-driving checks and adjustments

#### Locking doors

1. Move the shift lever to the P (Park) position and push the ignition switch to the OFF position. Make sure you carry the Intelligent Key with you.\*
  2. Close all the doors and liftgate.
  3. Push the LOCK button ①.
  4. All the doors and the liftgate will lock.
  5. The hazard indicator flashes twice and the horn chirps once.
- \*: Doors will lock while the ignition switch is in the ACC or ON position.

#### Unlocking doors

1. Push the UNLOCK button ② once.
2. The hazard indicator flashes once. The driver's door will unlock.
3. Push the UNLOCK button ② again within 1 minute.
4. The hazard indicator flashes once again. All the doors and the liftgate will unlock.

All doors will be locked automatically unless one of the following operations is performed within 1 minute after pushing the UNLOCK button ② while the doors are locked. If during this 1-minute time period, the UNLOCK button ② is pushed, all doors will be locked automatically after another 1 minute.

- Opening any door (including the liftgate)
- Pushing the ignition switch

#### Opening windows (if so equipped)

The UNLOCK button ② operation also allows you to open the window that is equipped with the automatic open/close function. (See "Power windows" (P.2-52).)

To open the windows, push the door UNLOCK button ② for **about 3 seconds** after the door is unlocked.



To stop opening, release the UNLOCK button ②.



Windows cannot be closed using the button on the Intelligent Key.

If the window open operation is stopped in mid-operation while pushing the UNLOCK button ②, release and push the UNLOCK button ② again until the window opens completely.



The door windows can be opened or closed by turning the mechanical key in a door lock. (See "Doors" (P.3-5).)

### Opening/closing power sliding door (if so equipped)

To open/close the sliding door, push the power sliding door button  or  on the Intelligent Key for about 1 second. The power sliding door will automatically open/close.



If the power sliding door button  or  is pushed while the sliding door is being opened or closed, the sliding door will reverse.

### Opening/closing liftgate (if so equipped)

To open/close the liftgate, push the power liftgate  button  on the Intelligent Key for more than 1 second.

The liftgate will automatically open/close.



The hazard indicator flashes 4 times and the outside chime sounds for approximately 3 seconds.

If the power liftgate  button  is pushed while the liftgate is being opened or closed, the liftgate will reverse.

### Using panic alarm





If you are near your vehicle and feel threatened, you can activate the alarm according to the following procedure to call attention.

1. Push the PANIC  button  for **more than 1 second.**





2. The theft warning alarm will sound and the headlights will flash for 25 seconds.
3. The panic alarm stops under either of the following conditions.
  - It has run for 25 seconds, or
  - Any of the buttons is pushed. (Note: the PANIC  button  should be pushed for more than 1 second.)

### Setting hazard indicator and horn mode



This vehicle is set in hazard indicator and horn mode when you first receive the vehicle.

In hazard indicator and horn mode, when the LOCK  button  is pushed, the hazard indicator flashes twice and the horn chirps once. When the UNLOCK  button  is pushed, the hazard indicator flashes once.



If horns are not necessary, the system can be switched to the hazard indicator mode.

In hazard indicator mode, when the LOCK  button  is pushed, the hazard indicator flashes twice. When the UNLOCK  button  is pushed, neither the hazard indicator nor the horn operates.



### Hazard indicator and horn mode:

	DOOR LOCK	DOOR UNLOCK
<b>Intelligent Key system</b> (Using door handle or liftgate request switch)	HAZARD - <b>twice</b> OUTSIDE CHIME - <b>twice</b>	HAZARD - <b>once</b> OUTSIDE CHIME - <b>once</b>
<b>Remote keyless entry system</b> (Using  or  button)	HAZARD - <b>twice</b> HORN - <b>once</b>	HAZARD - <b>once</b> HORN - none

### Hazard indicator mode:

	DOOR LOCK	DOOR UNLOCK
<b>Intelligent Key system</b> (Using door handle or liftgate request switch)	HAZARD - <b>twice</b> OUTSIDE CHIME - none	HAZARD - none OUTSIDE CHIME - none
<b>Remote keyless entry system</b> (Using  or  button)	HAZARD - <b>twice</b> HORN - none	HAZARD - none HORN - none

### Switching procedure:

Push the LOCK  ① and UNLOCK  ② buttons simultaneously for more than 2 seconds to switch the mode from one to the other.

When pushing the buttons to set the hazard indicator mode, the hazard indicator flashes 3 times.

When pushing the buttons to set the hazard indicator and horn mode, the hazard indicator flashes once and the horn chirps once.



## HOOD

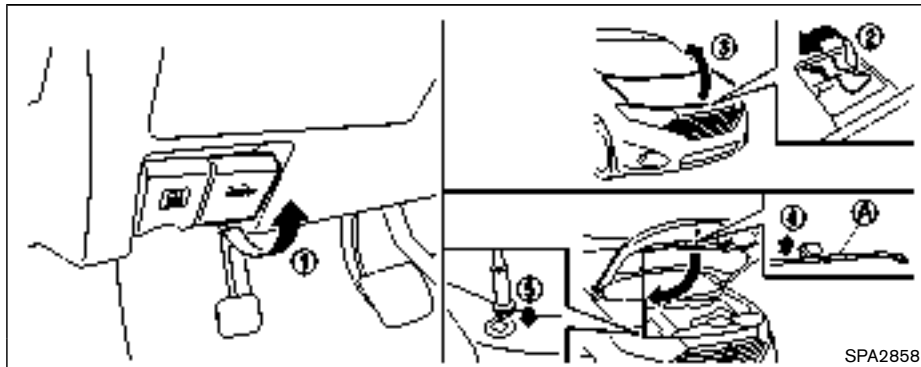

When opening the hood:

1. Pull the hood lock release handle ① located below the instrument panel; the hood will then spring up slightly.
2. Locate the lever ② in between the hood and grille and push the lever sideways with your fingertips.
3. Raise the hood ③.
4. Remove the support rod ④ and insert it into the slot ⑤.

**Hold the coated part ① when removing or resetting the support rod. Avoid direct contact with the metal parts, as they may be hot immediately after the engine has**

**been stopped.**

When closing the hood:

1. While supporting the hood, return the support rod to its original position.
2. Slowly lower the hood to about 8 to 12 in (20 to 30 cm) above the hood lock, then let it drop.
3. Make sure it is securely latched.



### WARNING

- Make sure the hood is completely closed and latched before driving. Failure to do so could cause the

hood to fly open and result in an accident.

- If you see steam or smoke coming from the engine compartment, to avoid injury do not open the hood.



## LIFTGATE

### WARNING

- Always be sure the liftgate has been closed securely to prevent it from opening while driving.
- Do not drive with the liftgate open. This could allow dangerous exhaust gases to be drawn into the vehicle. See “Exhaust gas (carbon monoxide)” (P.5-2) of this manual.
- Do not leave children unattended inside the vehicle. They could unknowingly activate switches or controls. Unattended children could become involved in serious accidents.
- Always be sure that hands and feet are clear of the gate frame to avoid injury while closing the liftgate.

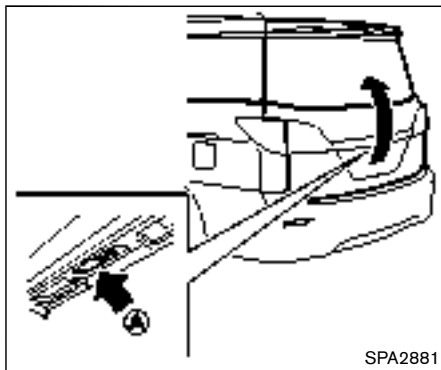

### OPERATING MANUAL LIFTGATE

To open the liftgate, unlock it and push the liftgate opener switch (A). Pull up the liftgate to open.

The liftgate can be unlocked by:

- pushing the unlock button  on the Intelligent Key twice.
- pushing the liftgate request switch while carrying the Intelligent Key.
- pushing the door handle request switch twice while carrying the Intelligent Key.
- pushing the power door lock switch to the unlock position.

- inserting the mechanical key into the driver's door key cylinder and turning it to the rear of the vehicle twice.

To close the liftgate, pull down until it securely locks.

### OPERATING POWER LIFTGATE (if so equipped)

The power liftgate system can be operated when all of following conditions are satisfied.

- The vehicle is stopped.
- Battery voltage is normal.
- The liftgate is unlocked.
- The shift lever is in the P (Park) position.

If the conditions are interrupted when the power liftgate is being operated, the operation may stop. In this case, if the conditions above are met the power liftgate operation will return to normal.

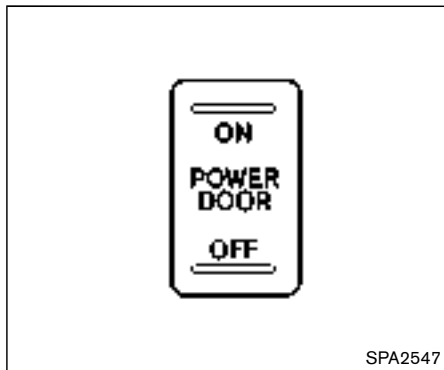

### Power door main switch

The power liftgate operation can be turned on or off by the power door main switch on the instrument panel.

When the power door main switch is pushed to the OFF position, the power operation is not available by the power liftgate switch on the liftgate and liftgate opener switch.

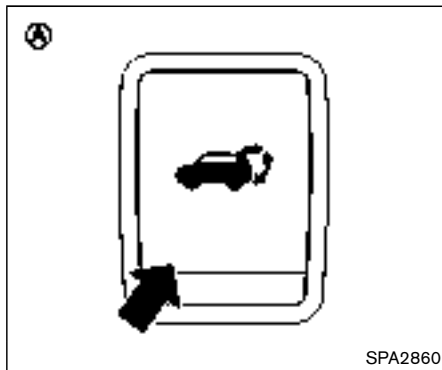

Power liftgate switch — Instrument panel

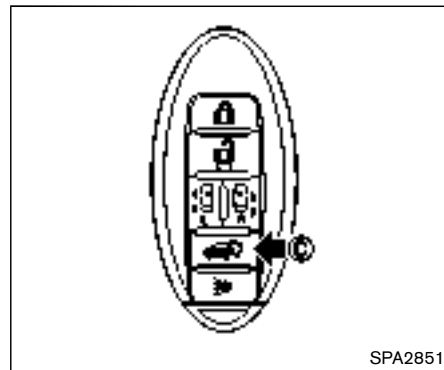

Intelligent Key

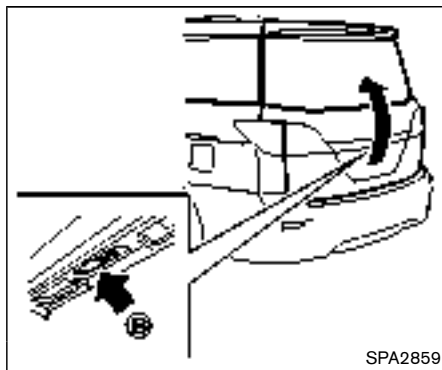

Liftgate opener switch

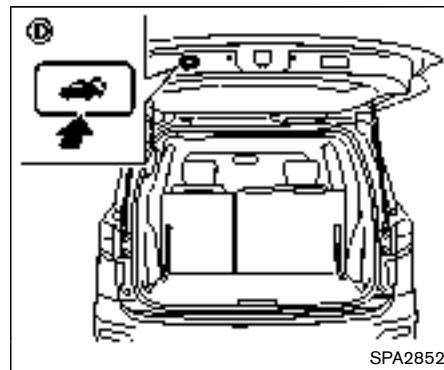

Power liftgate switch — Liftgate

## Power open

When the liftgate is fully closed, the liftgate will fully open automatically by:

- pushing the power liftgate switch **(A)** on the instrument panel for more than 1 second
- pushing the liftgate opener switch **(B)**
- pushing the power liftgate button **(C)** on the Intelligent Key for more than 1 second

The hazard flashes 4 times and the outside chime sounds when the liftgate starts opening.

### NOTE:

**The liftgate can be opened by the power liftgate switch **(A)** or the liftgate button  **(C)** even if the liftgate is locked or the power door main switch is in the OFF position. The liftgate will unlock and open.**

## Power close

When the liftgate is fully opened, the liftgate will fully close automatically by:

- pushing the power liftgate switch **(A)** on the instrument panel for more than 1 second
- pushing the power liftgate switch **(D)** on the lower part of the liftgate
- pushing the liftgate button **(C)** on the Intelligent Key for more than 1 second

The hazard flashes 4 times and the outside chime sounds when the liftgate starts closing.

## 3-28 Pre-driving checks and adjustments

## Reverse function

The power liftgate will reverse immediately if one of the following actions is performed during power open or power close.

- pushing the power liftgate switch **(A)** on the instrument panel
- pushing the liftgate switch **(D)** on the lower part of the liftgate
- pushing the liftgate button  **(C)** on the Intelligent Key.

The outside chime sounds when the liftgate starts to reverse.

## Auto reverse function

The auto-reverse function enables the liftgate to automatically reverse when something is caught in the liftgate as it is opening or closing. When the control unit detects an obstacle, the liftgate will reverse and return to the full open or full close position.

If a second obstacle is detected, the liftgate motion will stop and the drive motor will disengage. The liftgate will enter the manual mode.

A pinch sensor is mounted on each side of the liftgate. If an object is detected by the pinch sensor during power close, the liftgate will reverse and return to the full open position immediately.

### NOTE:

**If the pinch sensor is damaged or removed, the power close function will not operate.**



## WARNING

**There is a small distance immediately before the closed position that cannot be detected. Make sure that all passengers keep their hands, etc., clear from the liftgate opening before closing the liftgate.**

## Manual mode

If power operation is not available, the liftgate can be operated manually. Power operation may not be available if multiple obstacles have been detected in a single power cycle or if the battery voltage is low. When the power door main switch is in the OFF position, the liftgate can be opened manually by pushing the liftgate opener switch. If the power liftgate opener switch is pushed during power open or close, the power operation will be canceled and the liftgate can be operated manually.

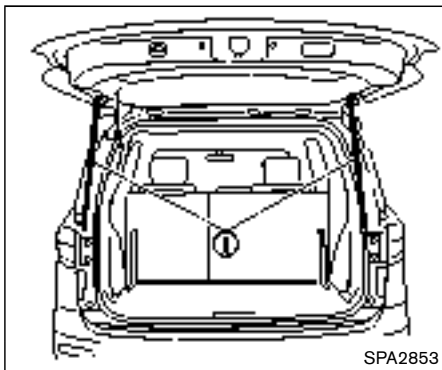

### Safe Mode

If the gas stays of the liftgate ① lose pressure, the power liftgate safe mode is activated. When the safe mode is activated, the liftgate intermittently closes. Then the liftgate will be pulled to the closed and latched position by a motor.

The power liftgate cannot be opened using the switches at any time in the safe mode.

Do not operate the liftgate again until it is checked. It is recommended you visit a NISSAN dealer.

### CAUTION

- If the power liftgate does not stay open or if the liftgate unexpectedly closes at any time, do not operate the liftgate. There may be a pressure loss in one or both of the liftgate gas stays. Have the liftgate inspected. It is recommended you visit a NISSAN dealer.
- Do not activate the power liftgate if one or both of the liftgate gas stays are removed. Damage to the liftgate or power liftgate mechanisms may occur.

### AUTO CLOSURE

If the liftgate is pulled down to a partly open position, the liftgate will pull itself to the closed position.

**Do not apply excessive force when the auto closure is operating. Excessive force applied may cause the mechanism to malfunction.**

### CAUTION

- The liftgate will automatically close from a partly open position. To avoid pinching, keep hands and fingers away from liftgate opening.
- Do not let children operate the liftgate.

## FUEL-FILLER DOOR

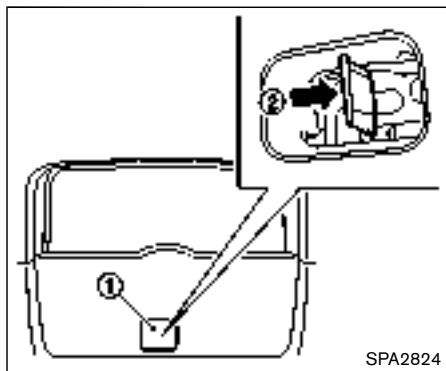

### LIFTGATE RELEASE

If the liftgate cannot be opened due to a discharged battery, follow these steps.

1. Remove the cover ① inside of the liftgate with a suitable tool.
2. Move the lever ② as illustrated to open the liftgate.

It is recommended you contact a NISSAN dealer as soon as possible for repair.

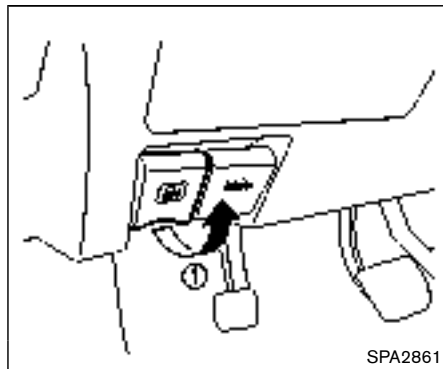

### OPENING FUEL-FILLER DOOR

To open the fuel-filler door, pull the fuel-filler door opener handle ①.

### FUEL-FILLER CAP







- Gasoline is extremely flammable and highly explosive under certain conditions. You could be burned or seriously injured if it is misused or mishandled. Always stop engine and do not smoke or allow open flames or sparks near the vehicle

when refueling.

- Do not attempt to top off the fuel tank after the fuel pump nozzle shuts off automatically. Continued refueling may cause fuel overflow, resulting in fuel spray and possibly a fire.
- Use only an original equipment type fuel-filler cap as a replacement. It has a built-in safety valve needed for proper operation of the fuel system and emission control system. An incorrect cap can result in a serious malfunction and possible injury. It could also cause the malfunction indicator light to come on.
- Never pour fuel into the throttle body to attempt to start your vehicle.
- Close the sliding door before opening the fuel-filler door.
- Do not fill a portable fuel container in the vehicle or trailer. Static electricity can cause an explosion of flammable liquid, vapor or gas in any vehicle or trailer. To reduce the risk of serious injury or death when filling portable fuel containers:

- Always place the container on the ground when filling.
- Do not use electronic devices when filling.
- Keep the pump nozzle in contact with the container while you are filling it.
- Use only approved portable fuel containers for flammable liquid.

## CAUTION

- If fuel is spilled on the vehicle body, flush it away with water to avoid paint damage.
- Insert the cap straight into the fuel-filler tube, then tighten until the fuel-filler cap clicks. Failure to tighten the fuel-filler cap properly may cause the  malfunction indicator light (MIL) to illuminate. If the  light illuminates because the fuel-filler cap is loose or missing, tighten or install the cap and continue to drive the vehicle. The  light should turn off after a few driving trips. If the  light does not turn



off after a few driving trips, have the vehicle inspected. It is recommended you visit a NISSAN dealer for this service.

For additional information, see “Malfunction Indicator Light (MIL)” (P.2-17).

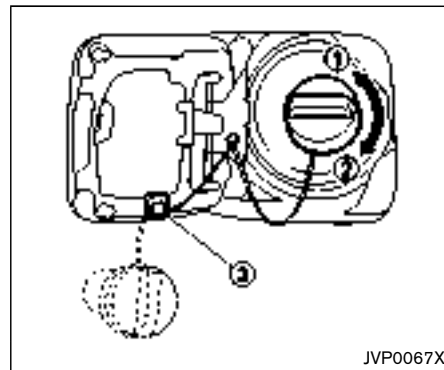
- The LOOSE FUEL CAP warning will appear if the fuel-filler cap is not properly tightened. It may take a few driving trips for the message to be displayed. Failure to tighten the fuel-filler cap properly after the LOOSE FUEL CAP warning appears may cause the  Malfunction Indicator Light (MIL) to illuminate.



To remove the fuel-filler cap:

1. Turn the fuel-filler cap counterclockwise  to remove.
2. Hang the tether of the cap on the hook  while refueling.

To install the fuel-filler cap:

1. Insert the fuel-filler cap straight into the fuel-filler tube.
2. Turn the fuel-filler cap clockwise  until a single click is heard.

## TILT/TELESCOPIC STEERING

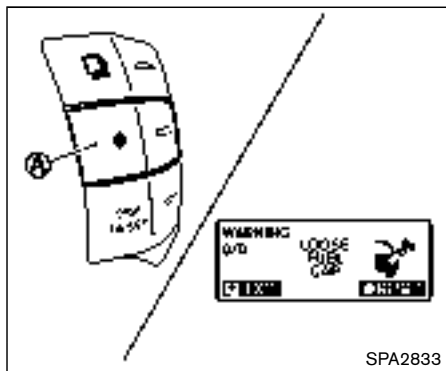

### LOOSE FUEL CAP warning

The LOOSE FUEL CAP warning appears on the vehicle information display when the fuel-filler cap is not tightened correctly after the vehicle has been refueled. It may take a few driving trips for the message to be displayed. To turn off the warning, perform the following steps:

1. Remove and install the fuel-filler cap as soon as possible. (See "Fuel-filler cap" (P.3-30).)
2. Tighten the fuel-filler cap until it clicks.
3. Push the reset switch (A) on the right side of the combination meter for about 1 second to turn off the LOOSE FUEL CAP warning after tightening the fuel cap.

### 3-32 Pre-driving checks and adjustments

## WARNING

- Do not adjust the steering wheel while driving. You could lose control of your vehicle and cause an accident.
- Do not adjust the steering wheel any closer to you than is necessary for proper steering operation and comfort. The driver's air bag inflates with great force. If you are unrestrained, leaning forward, sitting sideways or out of position in any way, you are at greater risk of injury or death in a crash. You may also receive serious or fatal injuries from the air bag if you are up against it when it inflates. Always sit back against the seatback and as far away as practical from the steering wheel. Always use the seat belts.

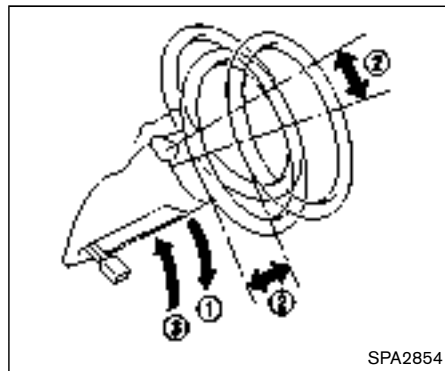

### TILT OR TELESCOPIC OPERATION

While pulling the lock lever down (1), adjust the steering wheel up, down, forward or rearward (2) until the desired position is achieved.

Push the lock lever up (3) firmly to lock the steering wheel in place.

## SUN VISORS

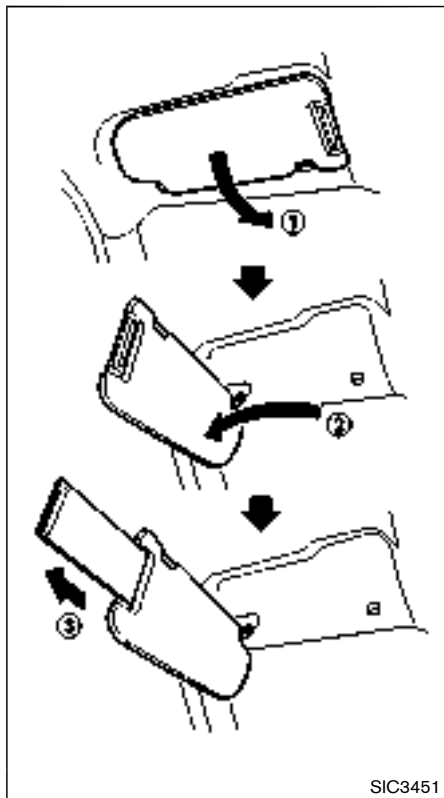

### CAUTION

- Do not store the main sun visor before storing the extension sun visor.
- Do not pull the extension sun visor forcedly downward.

1. To block out glare from the front, swing down the main sun visor ① .
2. To block glare from the side, remove the main sun visor from the center mount and swing it to the side ② .
3. Draw out the extension sun visor ③ from the main sun visor to block from further glare.

## MIRRORS

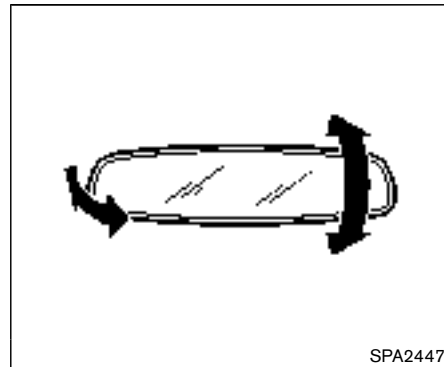

### INSIDE MIRROR

Adjust the height and the angle of the inside mirror to the desired position.



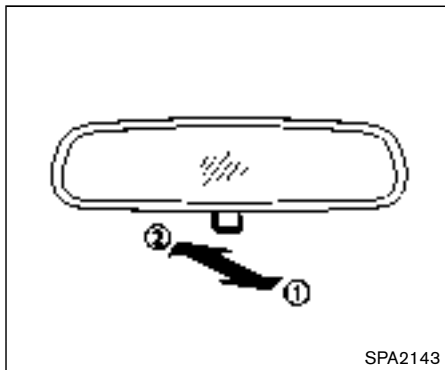

### Manual anti-glare type

The night position ① will reduce glare from the headlights of vehicles behind you at night.

Use the day position ② when driving in daylight hours.



### WARNING

Use the night position only when necessary, because it reduces rear view clarity.

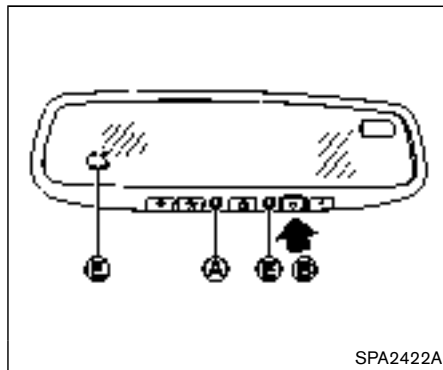

Type A (if so equipped)

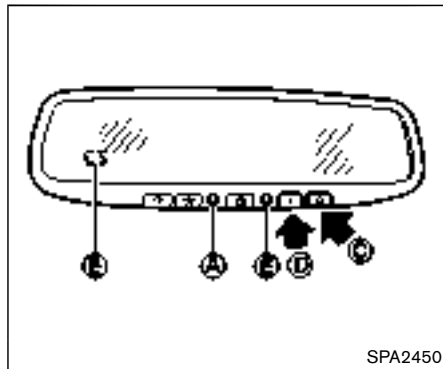

Type B (if so equipped)

### Automatic anti-glare type

The inside mirror is designed so that it automatically changes reflection according to the intensity of the headlights of the following vehicle.

The anti-glare system will be automatically turned on when the ignition switch is pushed to the ON position.

When the anti-glare system is turned on, the indicator light ② will illuminate and excessive glare from the headlights of the vehicle behind you will be reduced.

Type A (if so equipped): Push the ⏻ switch ② to make the inside rearview mirror operate normally and the indicator light will turn off. Push the ⏻ switch again to turn the system on.

Type B (if so equipped): Push the “○” switch ③ to make the inside rearview mirror operate normally. The indicator light will turn off. Push the “I” switch ④ to turn the system on.

**Do not allow any object to cover the sensors ⑤ or apply glass cleaner on them. Doing so will reduce the sensitivity of the sensor, resulting in improper operation.**

For the compass (if so equipped) operation, see “Compass” (P.2-8).

For the HomeLink® Universal Transceiver opera-

tion, see "HomeLink® Universal Transceiver" (P.2-60).

## OUTSIDE MIRRORS

### WARNING

**Objects viewed in the outside mirror on the passenger side are closer than they appear. Be careful when moving to the right. Using only this mirror could cause an accident. Use the inside mirror or glance over your shoulder to properly judge distances to other objects.**

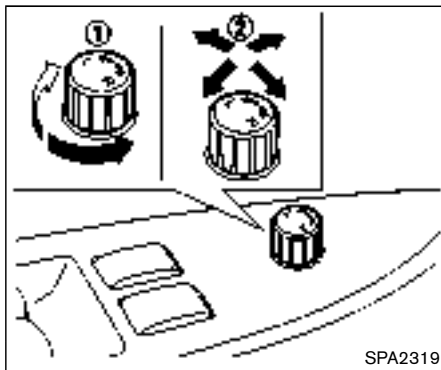

### Adjusting outside mirrors

The outside mirror control switch is located on the armrest.

The outside mirror will operate only when the ignition switch is in the ACC or ON position.

Turn the switch right or left to select the right or left side mirror ①, then adjust using the control switch ②.

### Defrosting outside mirrors (if so equipped)

The outside mirrors will be heated when the rear window defroster switch is operated.

### Reverse tilt-down feature (if so equipped)

When backing up the vehicle, the right and left outside mirrors will turn downward automatically to provide better rear visibility.

1. Push the ignition switch to the ON position.
2. Move the shift lever to the R (Reverse) position.
3. Choose the right or left outside mirror by operating the outside mirror control switch.
4. The outside mirror surfaces move downward.

When one of the following conditions has occurred, the outside mirror surfaces will return to their original positions.

- The shift lever is moved to any position other than R (Reverse).
- The outside mirror control switch is set to the center position.
- The ignition switch is pushed to the OFF position.

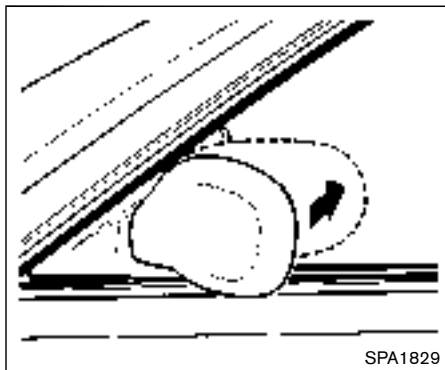

### Foldable outside mirrors

Fold the outside mirror by pushing it toward the rear of the vehicle.

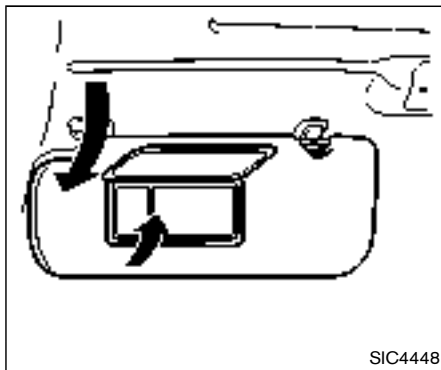

### VANITY MIRROR

To use the front vanity mirror, pull down the sun visor and pull up the cover.

## AUTOMATIC DRIVE POSITIONER (if so equipped)

The automatic drive positioner system has two features:

- Entry/exit function
- Memory storage

### ENTRY/EXIT FUNCTION

This system is designed so that the driver's seat will automatically move when the shift lever is in the P (Park) position. This allows the driver to get into and out of the driver's seat more easily.

The driver's seat will slide backward when the driver's door is opened with the ignition switch in the LOCK position.

The driver's seat will return to the previous positions when the ignition switch is pushed to the ACC position.

The driver's seat will not return to the previous positions if the seat adjusting switch is operated when the seat is at the exit position.

### Cancel or activate entry/exit function

The shift lever must be in the P (Park) position with the ignition switch in the OFF position.

The entry/exit function can be activated or canceled by pressing and holding the SET switch for more than 10 seconds.

The entry/exit function can also be activated or canceled if the "Slide Driver Seat Back on Exit" key is turned to ON or OFF in the "Comfort"

settings. (See “Vehicle information and settings (models with center multi-function control panel)” (P.4-10).)

### Initialize entry/exit function

If the battery cable is disconnected, or if the fuse opens, the entry/exit function will not work though this function was set on before. In such a case, after connecting the battery or replacing with a new fuse, open and close the driver's door more than two times after the ignition switch is placed in the LOCK position from the ON position. The entry/exit function will be activated.

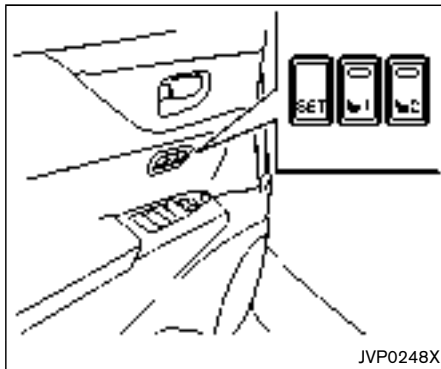

### MEMORY STORAGE

Two positions for the driver's seat and outside mirrors can be stored in the automatic drive positioner memory. Follow this procedure to use the memory system.

1. Move the shift lever to the P (Park) position.
2. Adjust the driver's seat and outside mirrors to the desired positions by manually operating each adjusting switch. For additional information, see “Seats” (P.1-2) and “Outside mirrors” (P.3-35).
3. Push the SET switch and, within 5 seconds, push the memory switch (1 or 2).

The indicator light for the pushed memory



switch will stay on for approximately 5 seconds after pushing the switch.

When the memory is stored in the memory switch (1 or 2), a buzzer will sound.

If memory is stored in the same memory switch, the previous memory will be deleted.

### Linking Intelligent Key to a stored memory position

The Intelligent Key can be linked to a stored memory position with the following procedure.

1. Follow one of the steps for storing a memory position.
  - While the indicator light for the memory switch being set is illuminated for 5 seconds, push the  button on the Intelligent Key.
  - Push the ignition switch to the OFF position, and then push the SET switch. Push the  button while pushing the memory button while the indicator light stays on for approximately 5 seconds.

If the indicator light blinks, the Intelligent Key is linked to that memory setting.

Push the ignition switch to the OFF position, and then push the  button on the Intelligent Key. The driver's seat and outside mirrors will move to the memorized position.

### Confirming memory storage

- Push the ignition switch to the ON position and push the SET switch. If the main memory has not been stored, the indicator light will come on for approximately 0.5 second. When the memory has stored in position, the indicator light will stay on for approximately 5 seconds.
- If the battery cable is disconnected, or if the fuse opens, the memory will be canceled. In this case, reset the desired position using the previous procedure.
- If optional keys are added to your vehicle, the memory storage procedure to switch 1 or 2 and linking Intelligent Key procedure to a stored memory position should be performed again for each Intelligent Key. For additional Intelligent Key information, see "Keys" (P.3-3).

### Selecting the memorized position

1. Move the shift lever to the P (Park) position.
2. Use one of the following methods to move the driver's seat and outside mirrors.
  - Push the memory switch (1 or 2).
  - Within 45 seconds of opening the driver's door, push the memory switch (1 or 2).

The driver's seat and outside mirrors will

move to the memorized position with the indicator light flashing, and then the light will stay on for approximately 5 seconds.

### SYSTEM OPERATION

The automatic drive positioner system will not work or will stop operating under the following conditions:

- When the vehicle speed is above 4 MPH (7 km/h) (entry/exit function).
- When the vehicle is driven (memory storage).
- When the adjusting switch for the driver's seat is turned on while the automatic drive positioner is operating.
- When the driver's seat and outside mirrors have already been moved to the memorized position.
- When no position is stored in the memory switch.
- When the engine is started while moving the automatic drive positioner.
- When the shift lever is moved from the P (Park) position to any other position. (However, it will not be canceled while the driver's seat is returning to the previous positions (entry/exit function).)
- When the driver's door remains open for more than 45 seconds and the ignition

switch is not in the ON position.

# 4 Monitor, heater, air conditioner, audio, phone and voice recognition systems

Safety note .....	4-4	Predictive course line settings (if so equipped) .....	4-29
Center multi-function control panel (if so equipped) .....	4-5	RearView Monitor system limitations .....	4-30
How to use multi-function controller .....	4-7	System maintenance .....	4-31
How to use touch screen (models with navigation system) .....	4-7	Around View <sup>®</sup> Monitor (if so equipped) .....	4-32
Menu options (models with navigation system) .....	4-9	Around View <sup>®</sup> Monitor system operation .....	4-33
How to select menus on the screen .....	4-10	How to adjust the screen view .....	4-39
Vehicle information and settings (models with center multi-function control panel) .....	4-10	Around View <sup>®</sup> Monitor system limitations .....	4-39
How to use STATUS button .....	4-10	System maintenance .....	4-41
How to use brightness control and display ON/OFF button .....	4-10	Moving Object Detection (MOD) (if so equipped) .....	4-42
How to use DISP button (models without navigation system) .....	4-10	MOD system operation .....	4-43
How to use ECON button (models without navigation system) .....	4-11	Turning on and off the MOD system .....	4-44
How to use INFO button .....	4-11	MOD system limitations .....	4-44
How to use SETTING button .....	4-15	System maintenance .....	4-45
RearView Monitor (if so equipped) .....	4-25	Ventilators .....	4-46
RearView Monitor system operation .....	4-25	Center ventilators .....	4-46
How to read the displayed lines .....	4-26	Side ventilators .....	4-46
Difference between predictive and actual distances (if so equipped) .....	4-26	Rear ventilators .....	4-47
How to park with predictive course lines (models with center multi-function control panel) .....	4-28	Heater and air conditioner .....	4-47
Adjusting the screen .....	4-29	Operating tips (for automatic air conditioner) .....	4-48
		Manual air conditioner .....	4-49
		Automatic air conditioner .....	4-54
		Servicing air conditioner .....	4-60
		In-cabin microfilter .....	4-60
		Audio system .....	4-61
		Audio operation precautions .....	4-61

FM-AM radio with Compact Disc (CD) player .....	4-74	Voice commands .....	4-124
FM-AM-SAT radio with Compact Disc (CD) player (Type A) .....	4-77	Control buttons .....	4-124
FM-AM-SAT radio with Compact Disc (CD) player (Type B) .....	4-87	Connecting procedure .....	4-124
DVD (Digital Versatile Disc) player operation (if so equipped) .....	4-91	Phone selection .....	4-125
USB (Universal Serial Bus) connection port (models with center multi-function control panel) ....	4-94	Quick Dial .....	4-125
iPod® player operation (models with center multi-function control panel) .....	4-99	Making a call .....	4-128
Bluetooth® streaming audio (models with navigation system) .....	4-101	Receiving a call .....	4-129
Auxiliary input jacks (if so equipped) .....	4-106	During a call .....	4-129
CD/DVD/USB memory care and cleaning .....	4-107	Phone setting .....	4-130
Steering-wheel-mounted controls for audio (if so equipped) .....	4-108	Troubleshooting guide .....	4-132
Antenna .....	4-109	Bluetooth® hands-free phone system (Type B) (if so equipped) .....	4-133
NISSAN Mobile Entertainment System (MES) (if so equipped) .....	4-110	Regulatory information .....	4-134
Digital Versatile Disc (DVD) system components .....	4-111	Using the system .....	4-135
Before operating the DVD Mobile Entertainment System .....	4-116	Control buttons .....	4-137
Playing a DVD .....	4-117	Getting started .....	4-137
Care and maintenance .....	4-121	List of voice commands .....	4-139
Car phone or CB radio .....	4-121	Speaker adaptation (SA) mode .....	4-142
Bluetooth® hands-free phone system (Type A) (if so equipped) .....	4-122	Troubleshooting guide .....	4-145
Regulatory information .....	4-123	Bluetooth® hands-free phone system (Type C) (if so equipped) .....	4-146
		Regulatory information .....	4-147
		Using the system .....	4-147
		NISSAN Voice Recognition system (models with navigation system) .....	4-154
		NISSAN Voice Recognition standard mode .....	4-155
		Using the system .....	4-157
		NISSAN Voice Recognition alternate command mode .....	4-166

Using the system .....	4-174
Troubleshooting guide .....	4-179



## SAFETY NOTE



### WARNING

- Do not disassemble or modify this system. If you do, it may result in accidents, fire, or electric shock.
- Do not use this system if you notice any abnormality, such as a frozen screen or lack of sound. Continued use of the system may result in accident, fire or electric shock.
- In case you notice any foreign object in the system hardware, spill liquid on it, or notice smoke or smell coming from it, stop using the system immediately. It is recommended you visit a NISSAN dealer for servicing. Ignoring such conditions may lead to accidents, fire, or electric shock.
- Park the vehicle in a safe location and apply the parking brake to view the images on the front center display screen.

Do not attempt to operate the system in extreme temperature conditions [below  $-4^{\circ}\text{F}$  ( $-20^{\circ}\text{C}$ ) and above  $158^{\circ}\text{F}$  ( $70^{\circ}\text{C}$ )]. Operating this system under these condi-

tions may result in system malfunctions.

## CENTER MULTI-FUNCTION CONTROL PANEL (if so equipped)

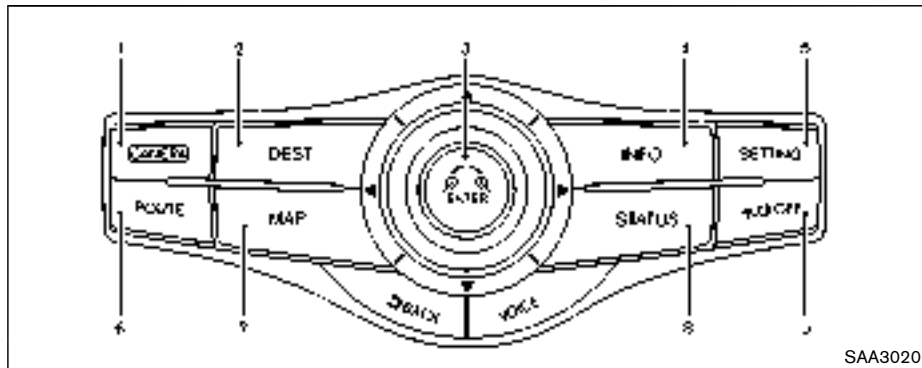

Models with navigation system

1. "CAMERA" button (P.4-32)
- 2, 6, 7. For navigation system control buttons (Refer to the separate Navigation System Owner's Manual.)
3. Multi-function controller (P.4-7)
4. "INFO" button (P.4-11)
5. "SETTING" button (P.4-15)
8. "STATUS" status display button (P.4-10)
9. "OFF" brightness control and display ON/OFF button (P.4-10)

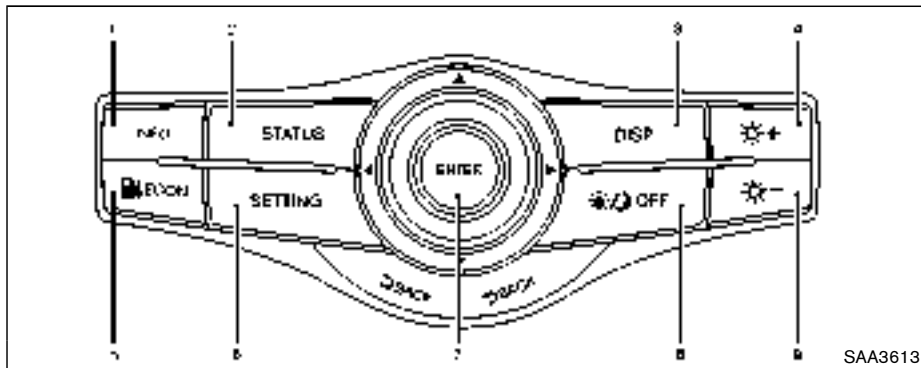

SAA3613

Models without navigation system

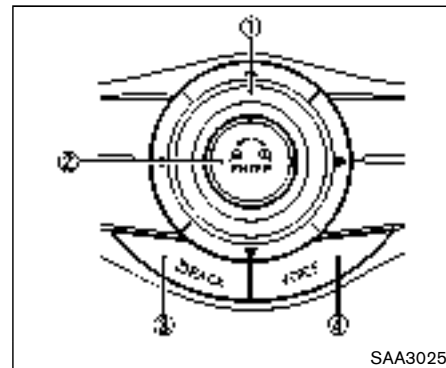

SAA3025

Models with navigation system

1. "INFO" button (P.4-11)
2. "STATUS" status display button (P.4-10)
3. "DISP" display setting button (P.4-10)
4. "☀+" brightness UP button (P.4-10)
5. "ECON" button (P.4-11)
6. "SETTING" button (P.4-15)
7. Multi-function controller (P.4-7)
8. "☀/☾ OFF" brightness control and display ON/OFF button (P.4-10)
9. "☀-" brightness DOWN button (P.4-10)

engine may not start.

When you use this system, make sure the engine is running.

**If you use the system with the engine not running (ignition ON or ACC) for a long time, it will discharge the battery and the**

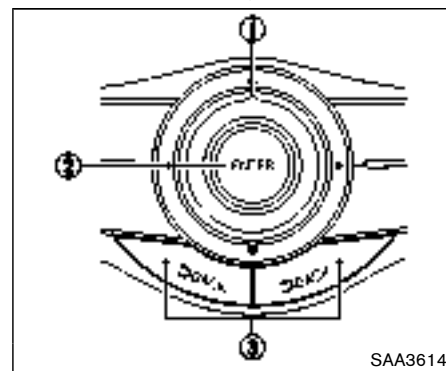

SAA3614

Models without navigation system

## HOW TO USE MULTI-FUNCTION CONTROLLER

Choose an item on the display by rotating or pushing the center dial ① upward/ downward, and push the ENTER button ② for operation.

If you push the BACK button ③ before the setup is completed, the setup will be canceled and/or the display will return to the previous screen. This button can also be used to delete characters that have been input.

After the setup is completed, push the BACK button ③ and return to the previous screen.

For the VOICE button ④ functions, refer to the separate Navigation System Owner's Manual.

## HOW TO USE TOUCH SCREEN (models with navigation system)

### WARNING

- **ALWAYS** give your full attention to driving.
- **Avoid using vehicle features that could distract you. If distracted, you could lose control of your vehicle and cause an accident.**

### CAUTION

- **The glass screen on the liquid crystal display may break if it is hit with a hard or sharp object. If the glass screen breaks, do not touch it. Doing so could result in an injury.**
- **To clean the display, use a soft, dry cloth. If additional cleaning is necessary, use a small amount of neutral detergent with a soft cloth. Never use a rough cloth, alcohol, benzine, thinner or any kind of solvent or paper towel with a chemical cleaning agent. They will scratch or deteriorate the panel.**
- **Do not splash any liquid such as water or car fragrance on the display. Contact with liquid will cause the system to malfunction.**

To ensure safe driving, some functions cannot be operated while driving.

The on-screen functions that are not available while driving will be "grayed out" or muted.

Park the vehicle in a safe location and then operate the navigation system.

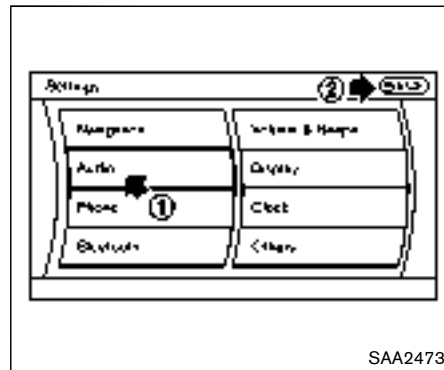

### Touch screen operation

With this system, the same operations as those for the multi-function controller are possible using the touch screen operation.

#### Selecting the item:

Touch an item to select it. To select the "Audio" settings, touch the "Audio" area ① on the screen.

Touch the "BACK" ② button to return to the previous screen.

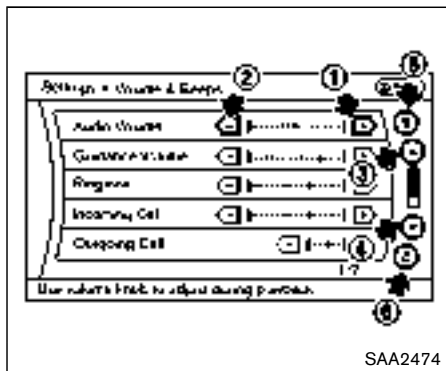

SAA2474

#### Adjusting an item:

Touch the + ① or - ② button to adjust the settings.

Touch the ← ③ or → ④ button to move to the previous or next item.

Touch the ⏪ ⑤ or ⏩ ⑥ button to move to the previous or next page.

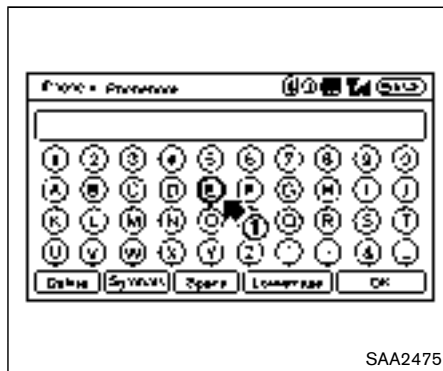

SAA2475

#### Inputting characters:

Touch the letter or number ①.

There are some options available when inputting characters.

- **Uppercase:**  
Shows uppercase characters.
- **Lowercase:**  
Shows lowercase characters.
- **Symbols:**  
Shows symbols such as the question mark (?).
- **Space:**  
Inserts a space.

- **Delete:**

Deletes the last character that has been input with one touch. Push and hold the button to delete all of the characters.

- **OK:**

Completes character inputs.

#### Touch screen maintenance

If you clean the display screen, use a dry, soft cloth. If additional cleaning is necessary, use a small amount of neutral detergent with a soft cloth. Never spray the screen with water or detergent. Dampen the cloth first, and then wipe the screen.

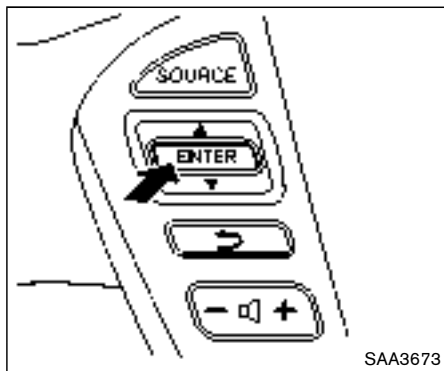

## MENU OPTIONS (models with navigation system)

The start menu can be displayed using the menu control switch on the steering-wheel-mounted controls.

1. While the MAP or STATUS screen is displayed, push and hold the menu control switch until the "Menu Options" screen appears.
2. Highlight the preferred item by tilting the menu control switch up or down, and then push the menu control switch to select it.

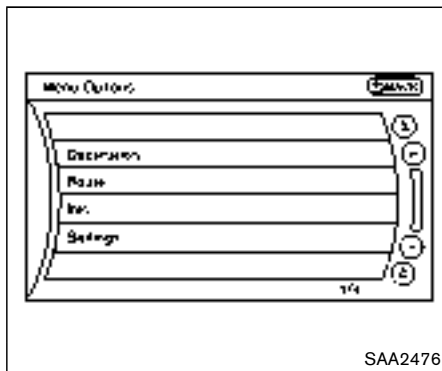

## Available items

### Destination/Route:

These items are for the navigation system. See the separate Navigation System Owner's Manual for details.

### Info:

Displays the information screen. It is the same screen that appears when you push the INFO button.

### Settings:

Displays the settings screen. It is the same screen that appears when you push the SETTING button.

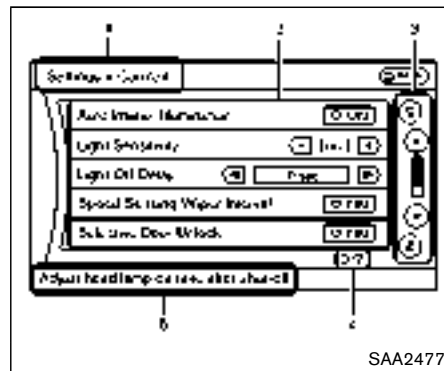

Models with navigation system

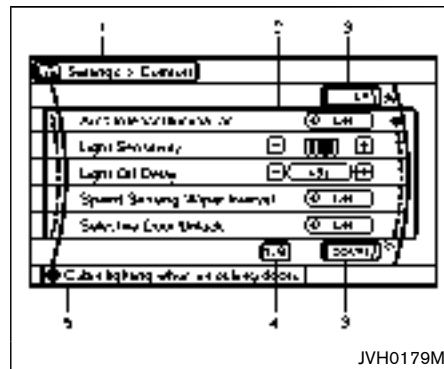

Models without navigation system

## HOW TO SELECT MENUS ON THE SCREEN

Vehicle functions are viewed on the display screen in menus. To select each key item, highlight the preferred item using the multi-function controller and push the ENTER button.

Whenever a menu selection is made or menu item is highlighted, different areas on the screen provide you with important information. See the following for details.

### 1. Header:

Shows the path used to get to the current screen. (for example, push SETTING button > choose "Comfort" menu item.)

### 2. Menu Selections:

Shows the options to choose within that menu screen.

### 3. UP/DOWN Movement indicator:

Shows that the multi-function controller may be used to move UP/DOWN on the screen and select more options.

### 4. Menu Items Counter:

Shows the total number of items listed across all pages for the current menu (for example, 3/7).

### 5. Footer/Information Line:

Provides more information (if available)

about the menu selection currently highlighted. (for example, Adjust head lamp on time after shut-off.)

## VEHICLE INFORMATION AND SETTINGS (models with center multi-function control panel)

### HOW TO USE STATUS BUTTON

You can check information related to the audio, climate control system, fuel consumption and navigation system (if so equipped) by pressing the STATUS button repeatedly.

### HOW TO USE BRIGHTNESS CONTROL AND DISPLAY ON/OFF BUTTON

Push the "☀️ OFF" button to switch the display brightness to the daytime mode or the nighttime mode, and to adjust the display brightness using the multi-function controller while the indicator is displayed at the bottom of the screen.

Push and hold the "☀️ OFF" button for more than 2 seconds to turn the display off. Push the button again to turn the display on.

Models without navigation system:

- The display brightness can also be adjusted using the brightness UP button ( + ) or brightness DOWN button ( - ).

### HOW TO USE DISP BUTTON (models without navigation system)

Push the DISP button to show the display setting screen. (See "Display settings (models without navigation system)" (P.4-18).)

## HOW TO USE ECON BUTTON (models without navigation system)

Push the “ ECON” button to show fuel economy information. (See “How to use INFO button” (P.4-11).)

## HOW TO USE INFO BUTTON

The display screen shows vehicle and navigation information for your convenience.

The information shown on the screen should be a guide to determine the condition of the vehicle. See the following for details.

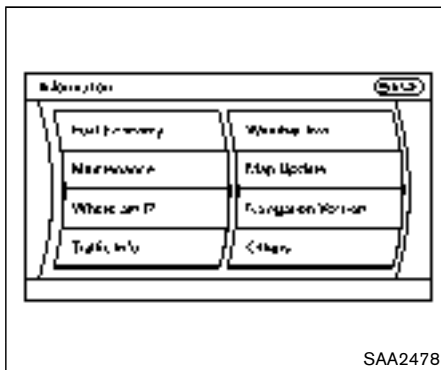

Models with navigation system

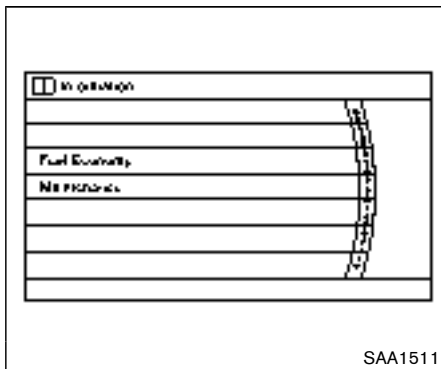

Models without navigation system

1. Push the INFO button on the control panel.
2. Select an item from the INFO menu.
3. After viewing or adjusting the information on the following screens, push the BACK button to return to the INFO menu.

See the separate Navigation System Owner's Manual for the following items:

- Where am I?
- Traffic Info
- Weather Info
- Map Update
- Navigation Version

\*When the ignition switch is in the ON position, the “Navigation Version” key is displayed after selecting the “Others” key.



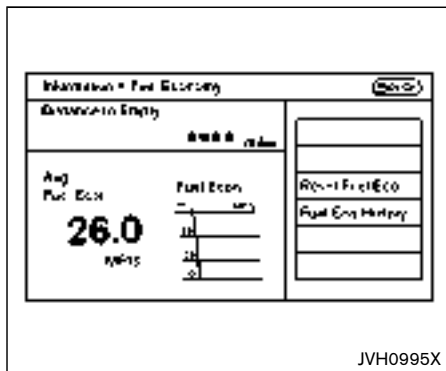

JVH0995X

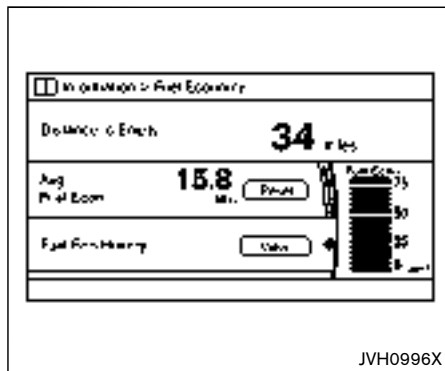

JVH0996X

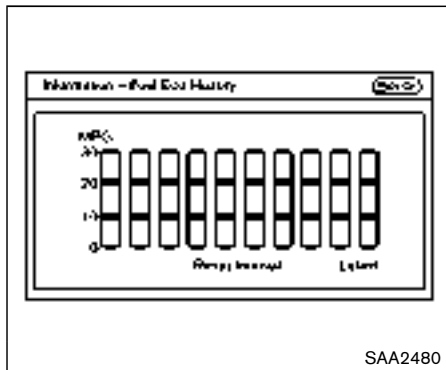

SAA2480

Models with navigation system

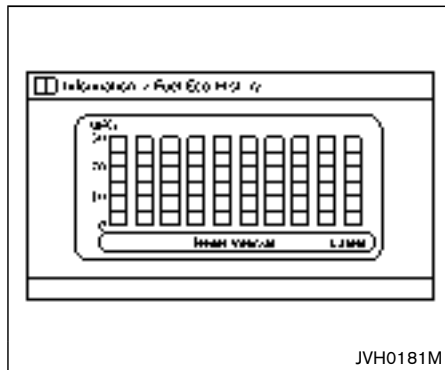

JVH0181M

Models without navigation system

## Fuel Economy information

The approximate distance to empty, average fuel economy and current fuel economy will be displayed for reference.

To reset the average fuel economy (Avg Fuel Econ or Average Fuel Economy), select the "Reset Fuel Eco" or "Reset" key.

If the "Fuel Eco History" or "View" key is selected, the average fuel consumption history will be displayed in graph form along with the average for the previous Reset-to-Reset period.

The unit can be converted between "US" and "Metric". (See "How to use SETTING button" (P.4-15).)

The fuel economy information may differ from the information displayed on the vehicle information display. This is due to the timing difference in updating the information and does not indicate a malfunction.

For models without the navigation system, the information can also be displayed by pushing the  ECON button on the control panel.

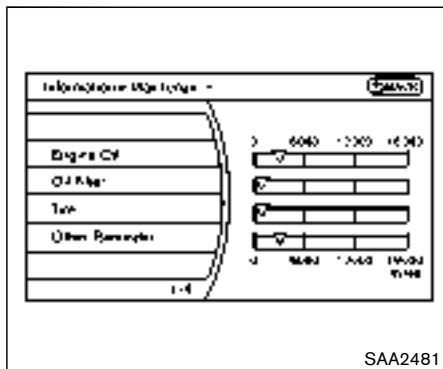

SAA2481

Models with navigation system

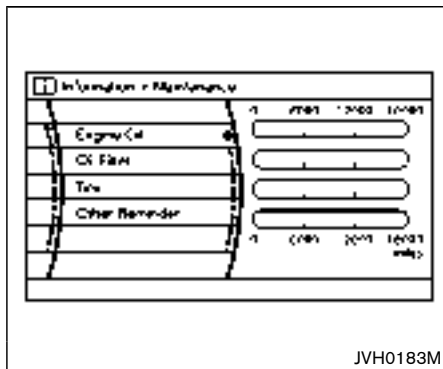

JVH0183M

Models without navigation system

## Maintenance information

The maintenance intervals can be displayed for the engine oil, oil filter, tire and other reminders. To set a maintenance interval, select a preferred item from the list.

You can also set to display a message to remind you that the maintenance needs to be performed.

The following example shows how to set the engine oil maintenance information. Use the same steps to set the other maintenance information.

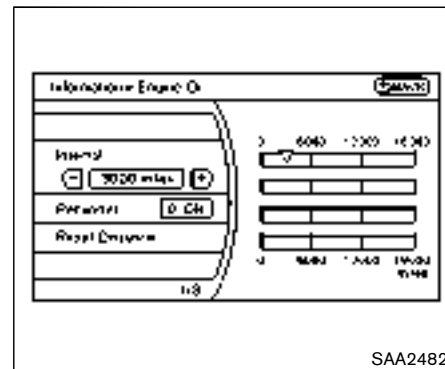

SAA2482

Models with navigation system

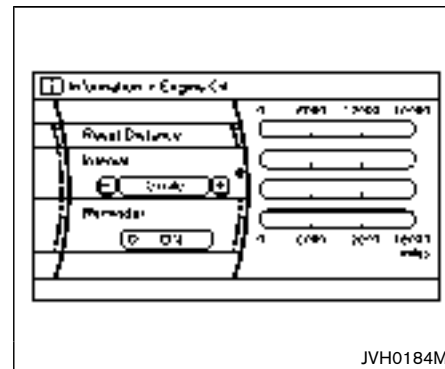

JVH0184M

Models without navigation system

1. Set the interval (mileage) of the maintenance schedule. To determine the recommended maintenance interval, refer to the “9. Maintenance and schedules” section.
2. To display the reminder automatically when the desired distance is reached, select the “Reminder” key.
3. Reset the driving distance to the new maintenance schedule.
4. To return to the previous screen, push the BACK button.

The unit can be converted between “US” and “Metric”. (See “How to use SETTING button” (P.4-15).)

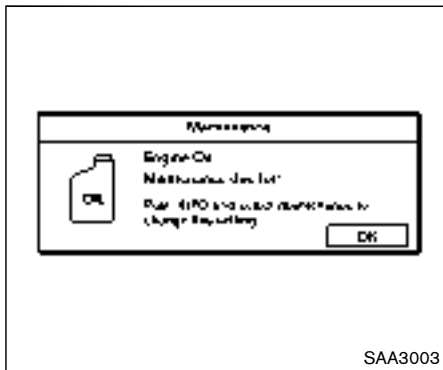

Example

The Reminder will be automatically displayed when the specified distance has been driven and every time the ignition switch is placed in the ACC or ON position. The reminder will not appear while driving.

Select the “OK” key to hide the reminder for the rest of the current drive.

To stop the reminder from appearing, perform one of the following actions:

- Select the “Reset Distance”.
- Deactivate the “Reminder”.
- Increase the “Interval” distance to be more than the current distance being tracked.

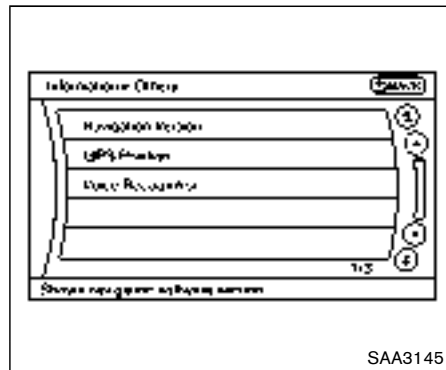

SAA3145

Others information (models with navigation system)

The Others information display will appear when pushing the INFO button and selecting the “Others” key.

#### Navigation Version:

For the details of this item, see the separate Navigation System Owner’s Manual.

When the ignition switch is in the ignition position, the “Navigation Version” key is displayed after pushing the INFO button.

#### GPS Position:

For the details of this item, see the separate

Navigation System Owner's Manual.

**Voice Recognition:**

For the details of this item, see "NISSAN Voice Recognition system (models with navigation system)" (P.4-154).

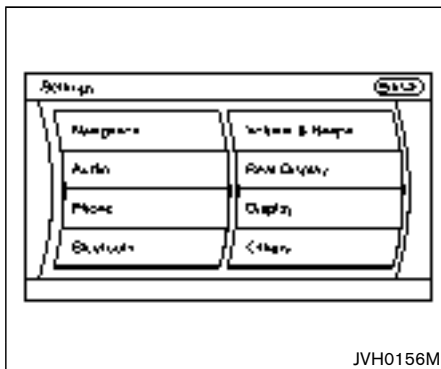

JVH0156M

Models with navigation system

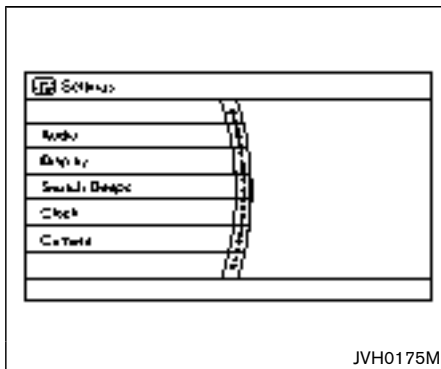

JVH0175M

Models without navigation system

**HOW TO USE SETTING BUTTON**

The display as illustrated will appear when the SETTING button is pushed.

For navigation settings, refer to the separate Navigation System Owner's Manual.

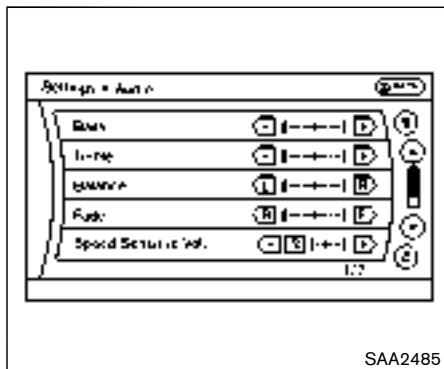

SAA2485

Models with navigation system

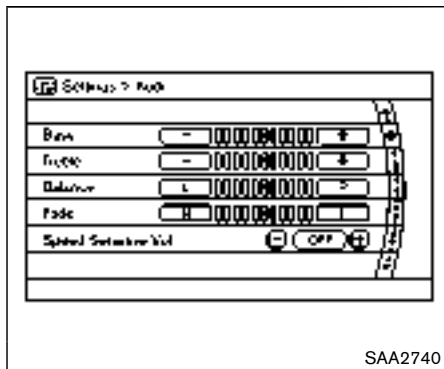

SAA2740

Models without navigation system

## Audio settings

The display as illustrated will appear when pushing the SETTING button and selecting the "Audio" key.

### Bass/Treble/Balance/Fade:

To adjust the speaker tone quality and sound balance, select the "Bass", "Treble", "Balance" or "Fade" key and adjust it with the multi-function controller.

These items can also be adjusted by pushing and turning the AUDIO knob.

### Speed Sensitive Vol.:

The audio system's volume is increased with the vehicle speed. Select the "Speed Sensitive Vol." and adjust the effect level with the multi-function controller. The Speed Sensitive Volume function is turned off when the level is set to "OFF". Increasing the value will cause the volume to increase faster with vehicle speed.

### DivX Registration Code (models with navigation system):

The registration code for a device that is used to download DivX® files will be displayed on the screen. If a disc is loaded or a USB memory is connected to the audio system, this function will not be activated.

### Display Album Cover Art (models with navigation system):

When this item is turned on, the album cover image is displayed when playing iPod® or MP3 music files through a CD, DVD or USB memory. When the image is not properly embedded in the file or device, the image will not be displayed.

### Phone settings (models with navigation system)

For details of the "Phone" settings, see "Bluetooth® hands-free phone system (Type A)" (P.4-122).

### Bluetooth® settings (models with navigation system)

For details of the "Bluetooth" settings, see "Bluetooth® hands-free phone system (Type A)" (P.4-122) or "Bluetooth® streaming audio (models with navigation system)" (P.4-101).

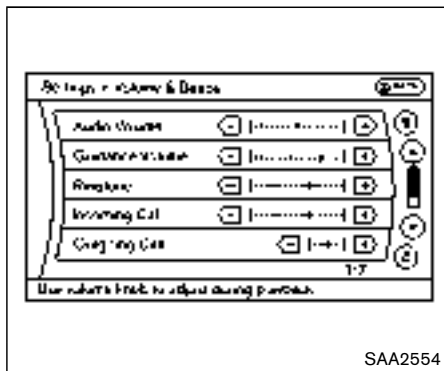

Example

### Volume & Beeps settings (models with navigation system)

The display as illustrated will appear when pushing the SETTING button, selecting the "Volume & Beeps" key.

#### Audio Volume:

To increase or decrease the audio volume, select the "Audio Volume" and adjust it with the multi-function controller. You can also adjust the audio volume by turning the VOLUME control knob.

#### Guidance Volume:

To adjust the guidance voice volume, select the

"Guidance Volume" and adjust it with the multi-function controller.

#### Ringtone/Incoming Call/Outgoing Call:

For the details of these items, see "Bluetooth® hands-free phone system (Type A)" (P.4-122).

#### Switch Beeps:

When this item is turned on, you will hear a beep sound when you use a button.

#### Guidance Voice:

When this item is turned on, you will hear voice guidance in the navigation operation or in other operations.

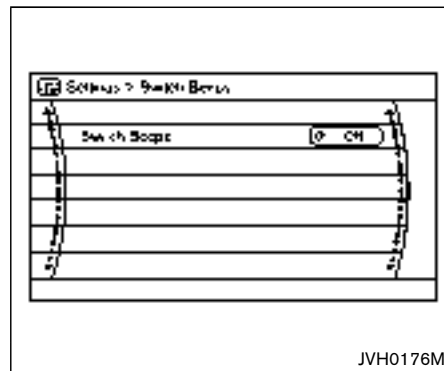

### Switch Beeps settings (models without navigation system)

The "Switch Beeps" screen will appear when pushing the SETTING button, selecting the "Switch Beeps" key with the multi-function controller and pushing the ENTER button.

#### Switch Beeps:

When this item is turned to ON, you will hear a beep sound when you use a button.

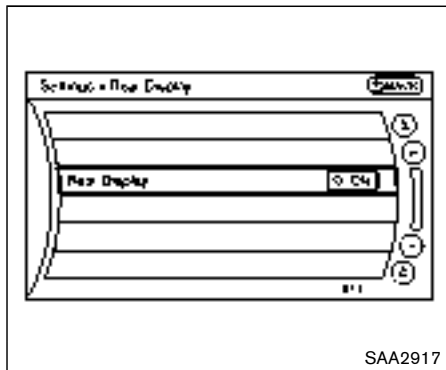

Models with navigation system

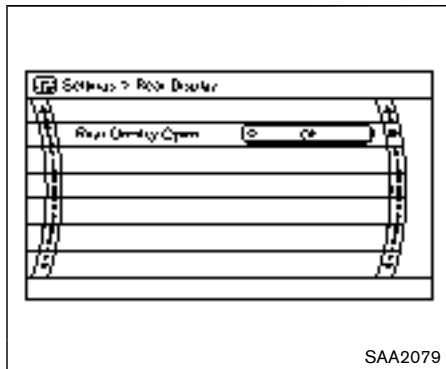

Models without navigation system

### REAR DISPLAY settings (if so equipped)

The "Rear Display" screen will appear when pushing the SETTING button, selecting the "Rear Display" key.

#### Rear Display (models with navigation system)/Rear Display Open (models without navigation system):

When this item is turned to ON, the rear display opens. When the ignition switch is pushed to the ACC or ON position, the rear display is flipped down automatically.

When the ignition switch is pushed to the OFF position, the rear display is closed automatically if ON is selected.

The rear display can also be opened or closed using the remote controller. (See "NISSAN Mobile Entertainment System (MES)" (P.4-110).)

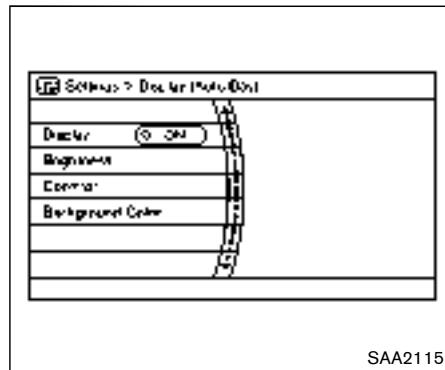

### Display settings (models without navigation system)

The "Display" screen will appear when pushing the SETTING button on the control panel.

#### Display:

To turn off the screen, push the ENTER button and turn the "ON" indicator off.

When any mode button is pushed with the screen off, the screen turns on for further operation. The screen will turn off automatically 5 seconds after the operation is finished.

To turn on the screen, set this item to the "ON" position or push the "\*/OFF" button.

### Brightness/Contrast/Background Color:

To adjust the brightness, contrast and background color of the screen, select the appropriate “Brightness”, “Contrast” or “Background Color” key and push the ENTER button.

You can then adjust the brightness and contrast using the multi-function controller. Switch the background color to the daytime mode or the nighttime mode by pushing the ENTER button.

### Driver Assistance settings (if so equipped)

For the details of the “Driver Assistance” settings, see “Turning on and off the MOD system” (P.4-44).

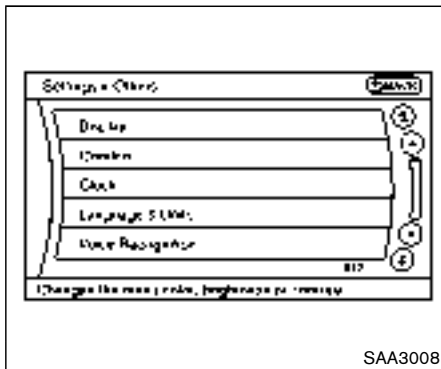

### Others settings (models with navigation system)

The Others settings display will appear when pushing the SETTING button and selecting the “Others” key.

The following items are available:

- Display
- Comfort
- Clock
- Language & Units
- Voice Recognition
- Image Viewer

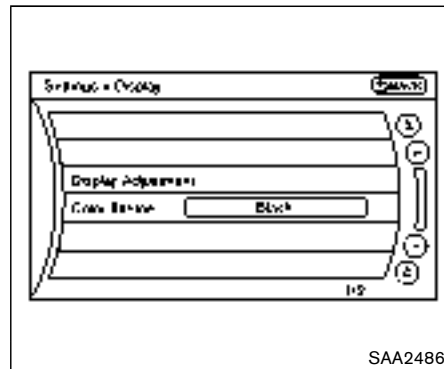

### Display settings (models with navigation system)

The display as illustrated will appear when pushing the SETTING button and selecting the “Display” key.

### Display Adjustment:

To adjust the display settings, select the “Display Adjustment” key. The following settings are available.

- Display

To turn off the screen, push the ENTER button and turn the “Display” indicator off. The other method is to push and hold the “OFF” button for more than 2 seconds.



When any mode button is pushed with the screen off, the screen turns on for further operation. The screen will turn off automatically 5 seconds after the operation is finished.

To turn on the screen, set this item to the ON position, or push and hold the "OFF" button.

- **Brightness/Contrast/Background Color**

To adjust the brightness and contrast of the screen, select the "Brightness" or "Contrast" key.

Then, you can adjust the brightness and the contrast using the multi-function controller.

For information on the "Background Color" key, refer to the separate Navigation System Owner's Manual.

**Color Theme:**

Choose the theme color of the menu screen.

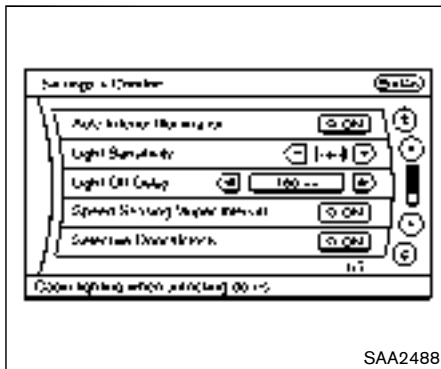

Models with navigation system

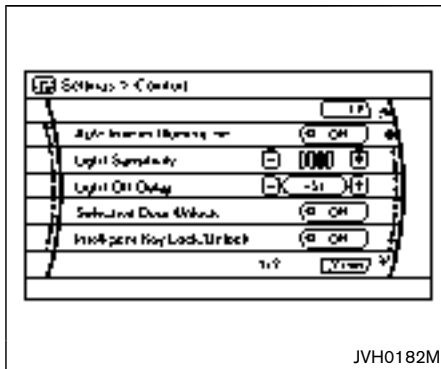

Models without navigation system

## Comfort settings

Models with navigation system:

The display as illustrated will appear when pushing the SETTING button, selecting the "Others" key and then selecting the "Comfort" key. This key does not appear on the display until the ignition switch is pushed to the ON position.

Models without navigation system:

The display as illustrated will appear when pushing the SETTING button and selecting the "Comfort" key. This key does not appear on the display until the ignition switch is pushed to the ON position.

**Auto Interior Illumination:**

When this item is turned on, the interior lights will illuminate if any door is unlocked.

**Light Sensitivity:**

Adjust the sensitivity of the automatic headlights higher (right) or lower (left).

**Light Off Delay:**

Choose the duration of the automatic headlight off timer from 0, 30, 45, 60, 90, 120, 150 and 180 second periods.

**Speed Sensing Wiper Interval:**

When this item is turned on, the wiper interval is adjusted automatically according to the vehicle speed.

### Slide Driver Seat Back on Exit (if so equipped):

When this item is turned on, the driver's seat moves backward for easy exit if the ignition switch is in the OFF position and the driver's door is opened. After getting into the vehicle and pushing the ignition switch to the ACC position, the driver's seat moves to the previous position.

### Selective Door Unlock:

When this item is turned on, only the driver's door is unlocked first after the door unlock operation. When the door handle request switch on the driver's or front passenger's side door is pushed to be unlocked, only the corresponding door is unlocked first. All the doors can be unlocked if the door unlock operation is performed again within 60 seconds.

When this item is turned off, all the doors will be unlocked after the door unlock operation is performed once.

### Intelligent Key Lock/Unlock:

When this item is turned on, door lock/unlock function by pushing the door handle request switch will be activated.

### Return All Settings to Default:

Select this item and then select "YES" to return all settings to the default.

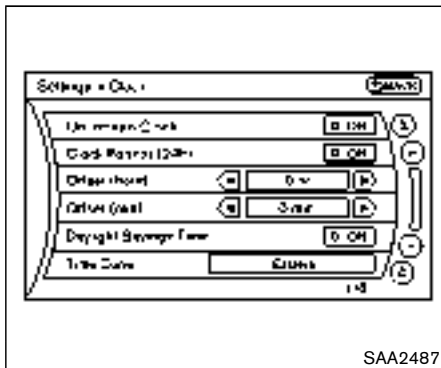

SAA2487

Models with navigation system

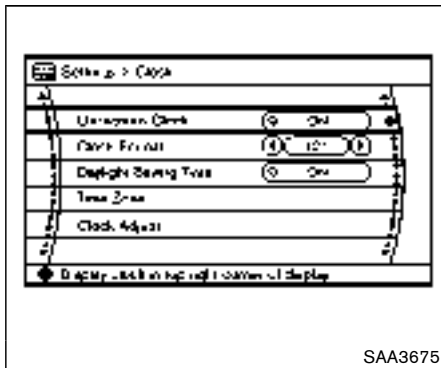

SAA3675

Models without navigation system

### Clock settings

Models with navigation system:

The display as illustrated will appear when pushing the SETTING button and selecting the "Others" key, and then selecting the "Clock" key.

Models without navigation system:

The display as illustrated will appear when pushing the SETTING button and selecting the "Clock" key.

The clock settings display cannot be operated while driving. Stop the vehicle in a safe place and apply the parking brake before setting the clock.

### On-screen Clock:

When this item is turned on, a clock is always displayed in the upper right corner of the screen.

This clock will indicate the time almost exactly because it is always adjusted by the GPS system (models with navigation system).

### Clock Format (24h):

When this item is turned on, the 24-hour clock is displayed. When this item is not turned on, the 12-hour clock is displayed.

**Offset (hour)/(min) (models with navigation system)/Clock Adjust (models without navigation system):**

Adjust the time by increasing or decreasing per

hour or per minute.

### Daylight Saving Time:

Turn this item to ON for daylight saving time application.

### Time Zone:

Choose the time zone from the following

Models with navigation system

- Pacific
- Mountain
- Central
- Eastern
- Atlantic
- Newfoundland
- Hawaii
- Alaska

Models without navigation system

- Eniwetok, Kwajalein
- Midway Island, Samoa
- Hawaii
- Alaska
- Pacific

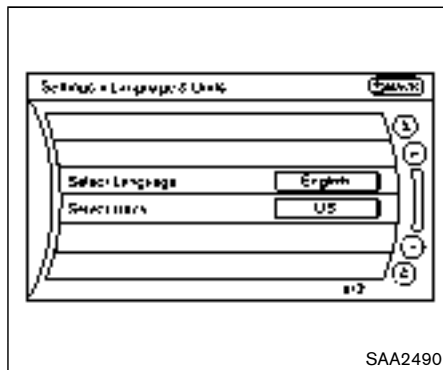

Models with navigation system

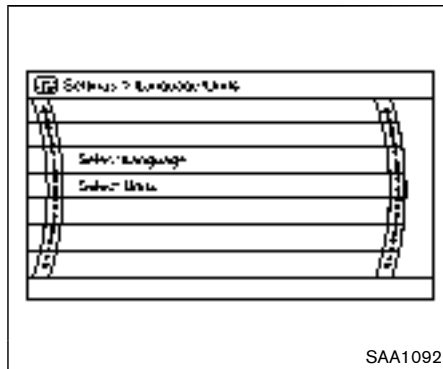

Models without navigation system

## Language & Units settings

Models with navigation system:

The Language & Units settings display will appear when pushing the SETTING button, selecting the "Others" key, and then selecting the "Language & Units" key.

Models without navigation system:

The display illustrated will appear when pushing the SETTING button and selecting the "Language & Units" key.

### Select Language:

Select the "Select Language" key. Choose "English", "Français" or "Español" for your favorite display appearance.

If you select the "Français" key, the French language will be displayed, so please use the French Owner's Manual. To obtain a French Owner's Manual, see "Owner's manual/service manual order information" (P.10-27).

### Select Units:

Select the "Select Units" key. Choose "US" (Mile, °F, MPG) or "Metric" (km, °C, L/100 km) for your favorite display appearance.

### Voice Recognition settings (models with navigation system)

For details about the "Voice Recognition" settings, see "NISSAN Voice Recognition system (models with navigation system)" (P.4-154).

### Camera settings (models without navigation system)

For the details about the "Camera" settings, see "RearView Monitor" (P.4-25).

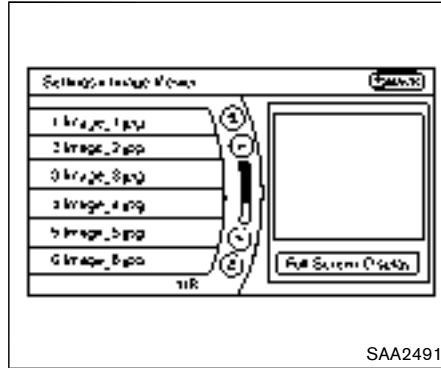

vehicle in a safe location and apply the parking brake.

### Image Viewer (models with navigation system)

The image files in the USB memory will be displayed. To display the Image Viewer, push the SETTING button, select the "Other" key and then select the "Image Viewer" key. The image of the selected file is displayed on the right side of the screen.

When a number of folders are included in the USB memory, select a folder from the list to display the file list.

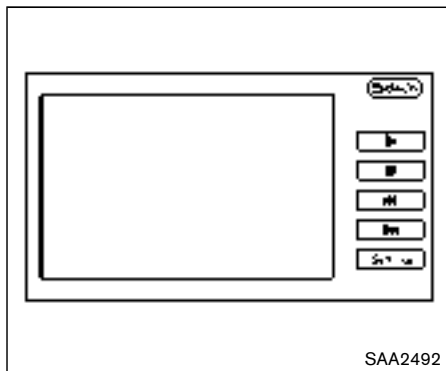

Images will not be shown on the display while the vehicle is in any drive position to reduce driver distraction. To view images, stop the



### Full Screen Display:

The full screen display will appear when selecting the “Full Screen Display” key.

To operate the Image Viewer or to change the settings, select the desired key using the multi-function controller.

-  (Start)  
Select the “▶” key to start playing the slideshow.
-  (Stop)  
Select the “■” key to stop the slideshow.
-  (Next)  
Select the “▶▶” key to display the next file.

-  (Previous)  
Select the “◀◀” key to display the previous file.

### Setting the Image Viewer:

The Image Viewer setting display will appear when selecting the “Settings” key on the full screen display. The following settings are available for the full screen display.

- Slideshow Speed  
Select the “Slideshow Speed” key. From the following display, select the changing time from 5, 10, 30, 60 seconds or “No Auto Change”.
- Slideshow Order  
Select the “Slideshow Order” key. From the following display, select “Random” or “Order List”. For “Order List”, the image order is the order of the files as stored on the USB memory.

### Operating tips:

- Only files that meet the following conditions will be displayed.
  - Image type: JPEG
  - File Extensions: \*.jpg, \*jpeg
  - Maximum Resolution: 2048 × 1536 pixels

- Maximum Size: 2-MB
- Colors: 32768 (15-bit)
- Maximum File Name lengths: 253-Bytes
- Maximum Folders: 500
- Maximum Images per Folder: 1024

- If an electronic device (such as a digital camera) is directly connected to the vehicle using a USB cable, no image will be displayed on the screen.
- If the file name is too long, some file names may not be entirely displayed.
- When the total number of characters in the file name exceeds 100 or if 1 file name in a directory exceeds 100 characters, all files will show a shortened 8-character version. The image will still be displayed when selected.

## REARVIEW MONITOR (if so equipped)

### WARNING

Failure to follow the warnings and instructions for proper use of the RearView Monitor system could result in serious injury or death.

- **The RearView Monitor is a convenience but it is not a substitute for proper backing. Always turn and look out the windows, and check mirrors to be sure that it is safe to move before operating the vehicle. Always back up slowly.**
- **The system is designed as an aid to the driver in showing large stationary objects directly behind the vehicle, to help avoid damaging the vehicle.**
- **The distance guide line and the vehicle width line should be used as a reference only when the vehicle is on a level paved surface. The distance viewed on the monitor is for reference only and may be different than the actual distance between the vehicle and displayed objects.**

### CAUTION

**Do not scratch the camera lens when cleaning dirt or snow from the front of the camera.**

The RearView Monitor system automatically shows a rear view of the vehicle when the shift lever is placed in the R (Reverse) position.

The radio can still be heard while the RearView Monitor is active.

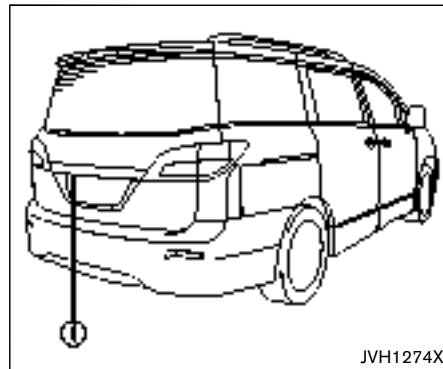

To display the rear view, the RearView Monitor system uses a camera located just above the vehicle's license plate ①.

### REARVIEW MONITOR SYSTEM OPERATION

With the ignition switch in the "ON" position, move the shift lever to the R (Reverse) position to operate the RearView Monitor.

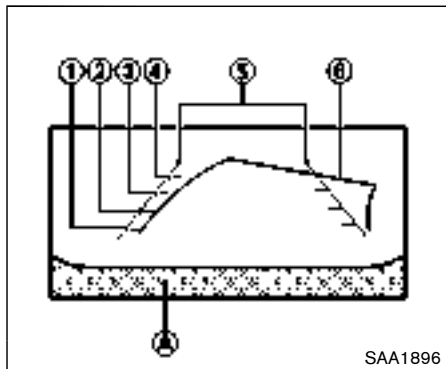

SAA1896

## HOW TO READ THE DISPLAYED LINES

Guiding lines which indicate the vehicle width and distances to objects with reference to the bumper line **A** are displayed on the monitor.

### Distance guide lines:

Indicate distances from the bumper.

- Red line **①** : approx. 1.5 ft (0.5 m)
- Yellow line **②** : approx. 3 ft (1 m)
- Green line **③** : approx. 7 ft (2 m)
- Green line **④** : approx. 10 ft (3 m)

### Vehicle width guide lines **⑤** :

Indicate the vehicle width when backing up.

### Predictive course lines **⑥** (models with center multi-function control panel):

Indicate the predictive course when backing up. The predictive course lines will be displayed on the monitor when the shift lever is in the R (Reverse) position and the steering wheel is turned. The predictive course lines will move depending on how much the steering wheel is turned and will not be displayed while the steering wheel is in the neutral position.

The vehicle width guide lines and the width of the predictive course lines are wider than the actual width and course.

### DIFFERENCE BETWEEN PREDICTIVE AND ACTUAL DISTANCES (if so equipped)

The displayed guide lines and their locations on the ground are for approximate reference only. Objects on uphill or downhill surfaces or projecting objects will be actually located at distances different from those displayed in the monitor relative to the guide lines (refer to illustrations). When in doubt, turn around and view the objects as you are backing up, or park and exit the vehicle to view the positioning of objects behind the vehicle.

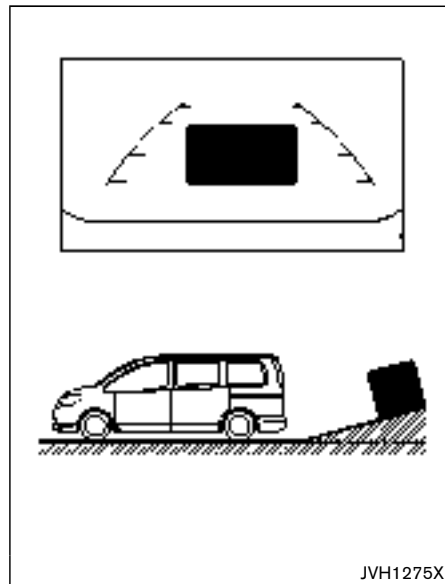

JVH1275X

### Backing up on a steep uphill

When backing up the vehicle up a hill, the distance guide lines and the vehicle width guide lines are shown closer than the actual distance. Note that any object on the hill is further than it appears on the monitor.

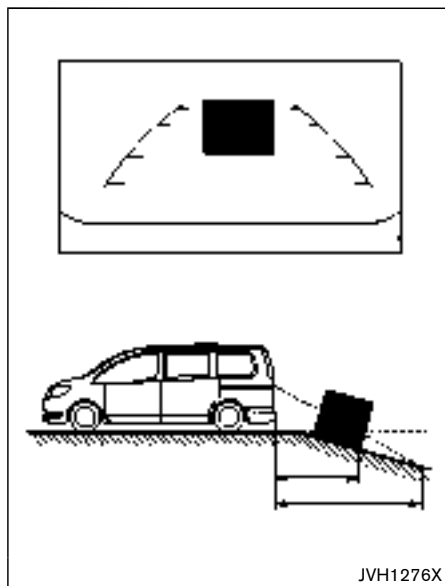

### Backing up on a steep downhill

When backing up the vehicle down a hill, the distance guide lines and the vehicle width guide lines are shown further than the actual distance. Note that any object on the hill is closer than it appears on the monitor.

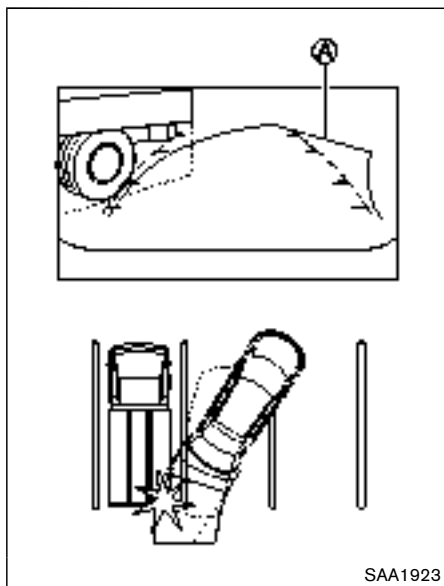

### Backing up near a projecting object

The predictive course lines (A) do not touch the object in the display. However, the vehicle may hit the object if it projects over the actual backing up course.

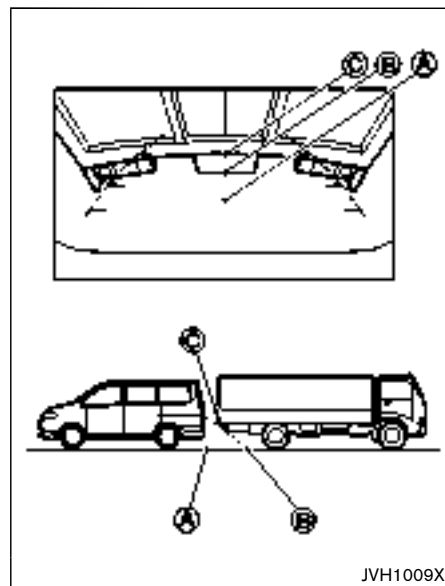

### Backing up behind a projecting object

The position (C) is shown further than the position (B) in the display. However, the position (C) is actually at the same distance as the position (A). The vehicle may hit the object when backing up to the position (A) if the object projects over the actual backing up



course.

## HOW TO PARK WITH PREDICTIVE COURSE LINES (models with center multi-function control panel)

### WARNING

- If the tires are replaced with different sized tires, the predictive course line may not be displayed correctly.
- On a snow-covered or slippery road, there may be a difference between the predictive course line and the actual course line.
- The displayed lines will appear slightly off to the right because the rearview camera is not installed in the rear center of the vehicle.

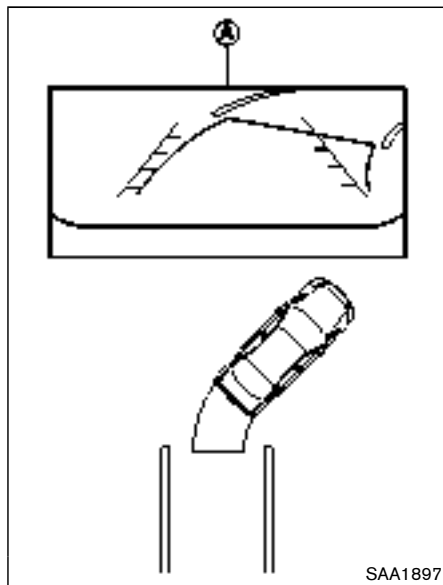

1. Visually check that the parking space is safe before parking your vehicle.
2. The rearview of the vehicle is displayed on the screen (A) when the shift lever is moved to the R (Reverse) position.

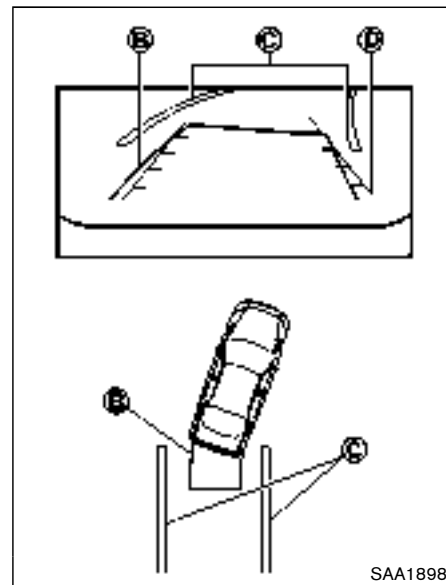

3. Slowly back up the vehicle adjusting the steering wheel so that the predictive course lines (B) enter the parking space (C).
4. Maneuver the steering wheel to make the vehicle width guide lines (D) parallel to the parking space (C) while referring to the predictive course lines.

5. When the vehicle is parked in the space completely, move the shift lever to the P (Park) position and apply the parking brake.

## ADJUSTING THE SCREEN

Models with Center Multi-function Control Panel:

- To adjust the Display ON/OFF, Brightness, Tint, Color, Contrast and Black Level of the RearView Monitor, push the SETTING button with the RearView Monitor on, select the item key and adjust the level using the multifunction controller.

Do not adjust the Brightness, Tint, Color, Contrast and Black Level of the RearView Monitor while the vehicle is moving. Make sure the parking brake is firmly applied.

The display of the predictive course lines can be set to ON or OFF. For details, see "Predictive course line settings" (P.4-29).

Models without Center Multi-function Control Panel:

- To set up the RearView Monitor to your preferred settings, push the ENTER/SETTING button while the RearView Monitor screen is displayed. Each time the ENTER/SETTING button is pushed, the next setting item is selected. Turn the TUNE SCROLL control knob to adjust each item.

Available setting items:

- Brightness
- Contrast

The setting items will disappear and the display will return to the original screen if ENTER/SETTING button is pushed when the last setting item is selected or if the screen is left without operation for some time. For details, see "FM-AM-SAT radio with Compact Disc (CD) player (Type A)" (P.4-77).

### NOTE:

**Do not adjust any of the display settings of the RearView Monitor while the vehicle is moving. Make sure the parking brake is firmly applied.**

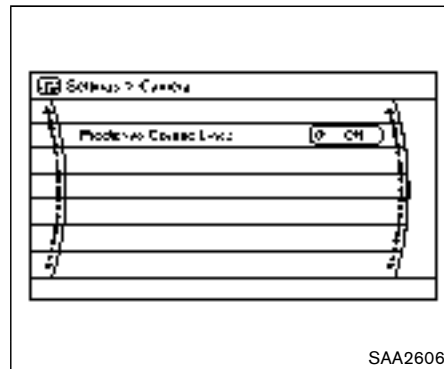

SAA2606

## PREDICTIVE COURSE LINE SETTINGS (if so equipped)

To toggle on and off the predictive course lines:

- Push the **SETTING** button.
- Select "Camera" key and push the **ENTER** button.

### Predictive Course Lines:

When this item is turned on, the predictive course lines will be displayed on the monitor when the shift lever is in the R (Reverse) position.

## REARVIEW MONITOR SYSTEM LIMITATIONS



### WARNING

Listed below are the system limitations for RearView Monitor. Failure to operate the vehicle in accordance with these system limitations could result in serious injury or death.

- The system cannot completely eliminate blind spots and may not show every object.
- Underneath the bumper and the corner areas of the bumper cannot be viewed on the RearView Monitor because of its monitoring range limitation. The system will not show small objects below the bumper, and may not show objects close to the bumper or on the ground.
- Objects viewed in the RearView Monitor differ from actual distance because a wide-angle lens is used.
- Objects in the RearView Monitor will appear visually opposite compared to when viewed in the rear view and outside mirrors.

- **Use the displayed lines as a reference. The lines are highly affected by the number of occupants, fuel level, vehicle position, road conditions and road grade.**
- **Make sure that the liftgate is securely closed when backing up.**
- **Do not put anything on the rearview camera. The rearview camera is installed above the license plate.**
- **When washing the vehicle with high-pressure water, be sure not to spray it around the camera. Otherwise, water may enter the camera unit causing water condensation on the lens, a malfunction, fire or an electric shock.**
- **Do not strike the camera. It is a precision instrument. Otherwise, it may malfunction or cause damage resulting in a fire or an electric shock.**

The following are operating limitations and do not represent a system malfunction:

- When the temperature is extremely high or low, the screen may not clearly display objects.

- When strong light is directly coming on the camera, objects may not be displayed clearly.
- Vertical lines may be seen in objects on the screen. This is due to strong reflected light from the bumper.
- The screen may flicker under fluorescent light.
- The colors of objects on the RearView Monitor may differ somewhat from the actual color of objects.
- Objects on the monitor may not be clear in a dark environment.
- If dirt, rain or snow accumulates on the camera, the RearView Monitor may not display objects clearly. Clean the camera.
- Do not use wax on the camera window. Wipe off any wax with a clean cloth dampened with mild detergent diluted with water.

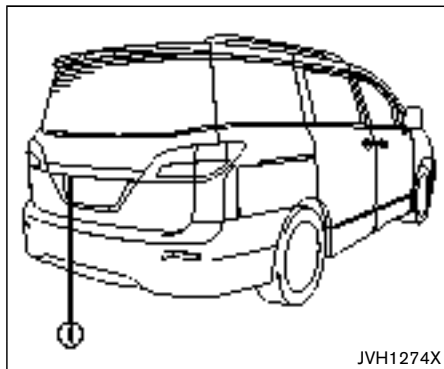

JVH1274X

If dirt, rain or snow accumulates on the camera ①, RearView Monitor may not display objects clearly. Clean the camera by wiping it with a cloth dampened with a diluted mild cleaning agent and then wiping it with a dry cloth.

## SYSTEM MAINTENANCE



### CAUTION

- Do not use alcohol, benzine or thinner to clean the camera. This will cause discoloration. To clean the camera, wipe with a cloth dampened with diluted mild cleaning agent and then wipe with a dry cloth.
- Do not damage the camera as the monitor screen may be adversely affected.

## AROUND VIEW<sup>®</sup> MONITOR (if so equipped)

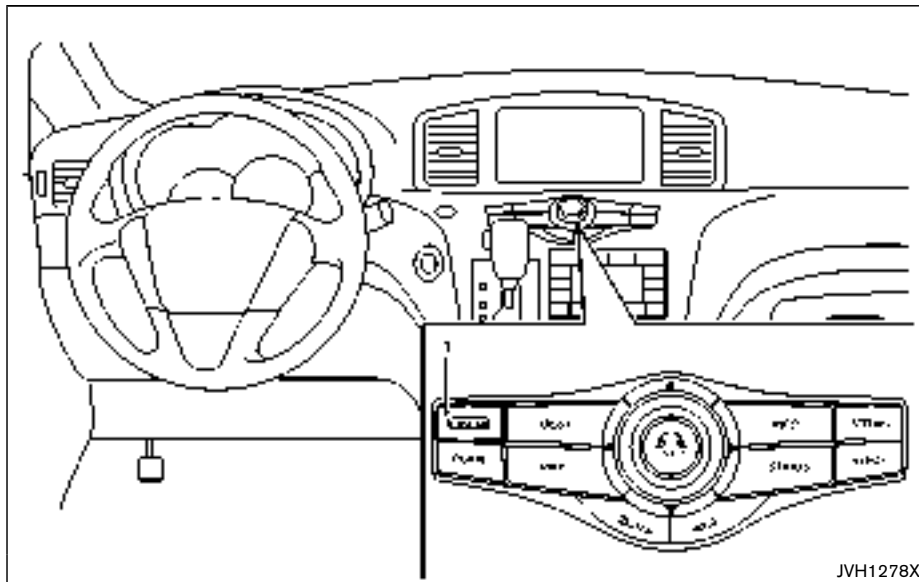

### 1. **CAMERA** button



## **WARNING**

Failure to follow the warnings and instructions for the proper use of the

**Around View<sup>®</sup> Monitor system could result in serious injury or death.**

- **The Around View<sup>®</sup> Monitor is a convenience feature and is not a substitute for proper vehicle operation because it has areas where**

objects cannot be viewed. The four corners of the vehicle in particular, are areas where objects do not always appear in the bird's-eye, front, or rear views. Always check your surroundings to be sure that it is safe to move before operating the vehicle. Always operate the vehicle slowly.

- **The driver is always responsible for safety during parking and other maneuvers.**



## **CAUTION**

**Do not scratch the lens when cleaning dirt or snow from the front of the camera.**

The Around View<sup>®</sup> Monitor system is designed as an aid to the driver in situations such as slot parking or parallel parking.

The monitor displays various views of the position of the vehicle in a split screen format. All views are not available at all times.

#### Available views:

- Front View  
The view to the front of the vehicle.
- Rear View  
The view to the rear of the vehicle.
- Bird's-Eye View  
The surrounding view of the vehicle.
- Front-side View  
The view around and ahead of the front passenger's side wheel.

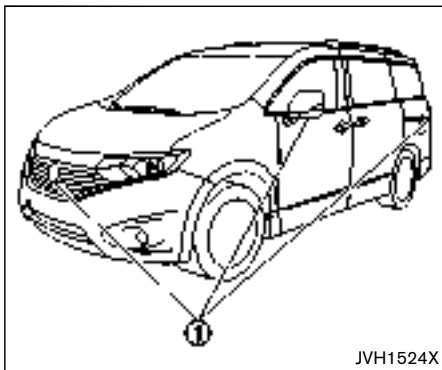

To display the multiple views, the Around View<sup>®</sup> Monitor system uses cameras ① located in the front grill, on the vehicle's outside mirrors and one just above the vehicle's license plate.

#### AROUND VIEW<sup>®</sup> MONITOR SYSTEM OPERATION

With the ignition switch in the ON position, move the shift lever to the R (Reverse) position or press the **CAMERA** button to operate the Around View<sup>®</sup> Monitor.

The screen displayed on the Around View<sup>®</sup> Monitor will automatically return to the previous screen 3 minutes after the **CAMERA** button has been pushed while the shift lever is in a position other than the R (Reverse) position.

#### Available views

### **WARNING**

- The distance guide lines and the vehicle width lines should be used as a reference only when the vehicle is on a paved, level surface. The apparent distance viewed on the monitor may be different than the actual distance between the vehicle and displayed objects.
- Use the displayed lines and the bird's-eye view as a reference. The lines and the bird's-eye view are greatly affected by the number of occupants, fuel level, vehicle position, road condition and road grade.
- If the tires are replaced with different sized tires, the predictive course lines and the bird's-eye view may be displayed incorrectly.
- When driving the vehicle up a hill, objects viewed in the monitor are further than they appear. When driving the vehicle down a hill, objects viewed in the monitor are closer than they appear.

- Objects in the monitor will appear visually opposite compared to when viewed in the rear view and outside mirrors.
- Use the mirrors or actually look to properly judge distances to other objects.
- The distance between objects viewed in the rear view differs from actual distance because a wide-angle lens is used.
- On a snow-covered or slippery road, there may be a difference between the predictive course line and the actual course line.
- The vehicle width and predictive course lines are wider than the actual width and course.
- The displayed lines on the rear view will appear slightly off to the right because the rear view camera is not installed in the rear center of the vehicle.

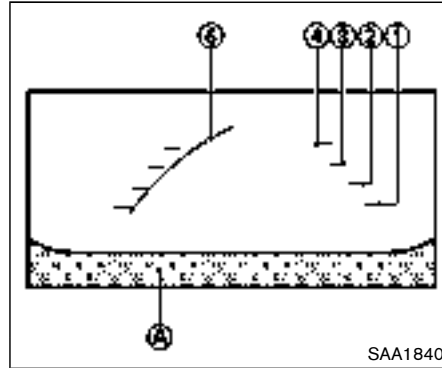

Front view

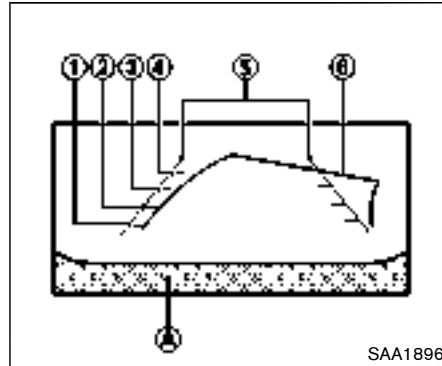

Rear view

### Front and rear view:

Guiding lines that indicate the approximate vehicle width and distances to objects with reference to the vehicle bumper line (A) are displayed on the monitor.

### Distance guide lines

Indicate distances from the bumper.

- Red line ① : approx. 1.5 ft (0.5 m)
- Yellow line ② : approx. 3 ft (1 m)
- Green line ③ : approx. 7 ft (2 m)
- Green line ④ : approx. 10 ft (3 m)

### Vehicle width guide lines ⑤

Indicate the vehicle width when backing up.

### Predictive course lines ⑥

Indicate the predictive course when operating the vehicle. The predictive course lines will be displayed on the monitor when the steering wheel is turned. The predictive course lines will move depending on how much the steering wheel is turned and will not be displayed while the steering wheel is in the straight-ahead position.

The front view will not be displayed when the vehicle speed is above 6 MPH (10 km/h).

### NOTE:

**When the monitor displays the front view and the steering wheel turns about 90**

degrees or less from the straight ahead position, both the right and left predictive course lines ⑥ are displayed. When the steering wheel turns about 90 degrees or more, a line is displayed only on the opposite side of the turn.

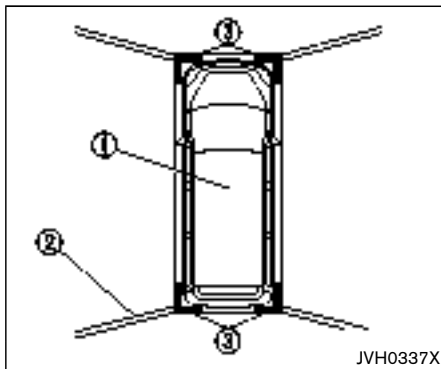

#### Bird's-eye view:

The bird's-eye view shows the overhead view of the vehicle which helps confirm the vehicle position and the predicted course to a parking space.

The vehicle icon ① shows the position of the vehicle. Note that the distance between objects viewed in the bird's-eye view differs from the actual distance.

The areas that the cameras cannot cover ② are indicated in black.

After the ignition switch is placed in the ON position, the non-viewable area ② is highlighted in yellow for 3 seconds after the bird's-

eye view is displayed.

In addition, the non-viewable corners are displayed in red (blink for the first 3 seconds) ③ to remind the drivers to be cautious.



## WARNING

- Objects in the bird's-eye view will appear further than the actual distance because the bird's-eye view is a pseudo view that is processed by combining the views from the cameras on the outside mirrors, the front and the rear of the vehicle.
- Tall objects, such as a curb or vehicle, may be misaligned or not displayed at the seam of the views.
- Objects that are above the camera cannot be displayed.
- The view for the bird's-eye view may be misaligned when the camera position alters.
- A line on the ground may be misaligned and is not seen as being straight at the seam of the views. The misalignment will increase as the line proceeds away from the vehicle.



- Tire angle display does not indicate the actual tire angle.

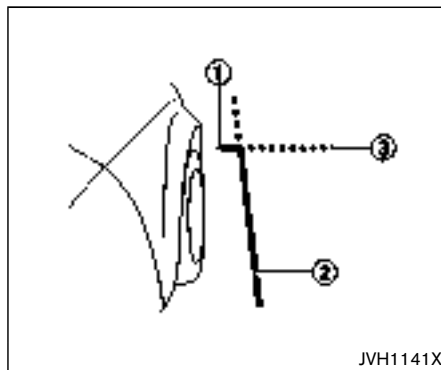

#### Front-side view:

#### Guiding lines:

Guiding lines that indicate the width and the front end of the vehicle are displayed on the monitor.

The front-of-vehicle line ① shows the front part of the vehicle.

The side-of-vehicle line ② shows the vehicle width including the outside mirrors.

The extensions ③ of both the front ① and side ② lines are shown with a green dotted line.



## CAUTION

The turn signal light may look like the side-of-vehicle line. This is not a malfunction.

### Difference between predictive and actual distances

The displayed guide lines and their locations on the ground are for approximate reference only. Objects on uphill or downhill surfaces or projecting objects will be actually located at distances different from those displayed in the monitor relative to the guide lines (refer to illustrations). When in doubt, turn around and view the objects as you are backing up, or park and exit the vehicle to view the positioning of objects behind the vehicle.

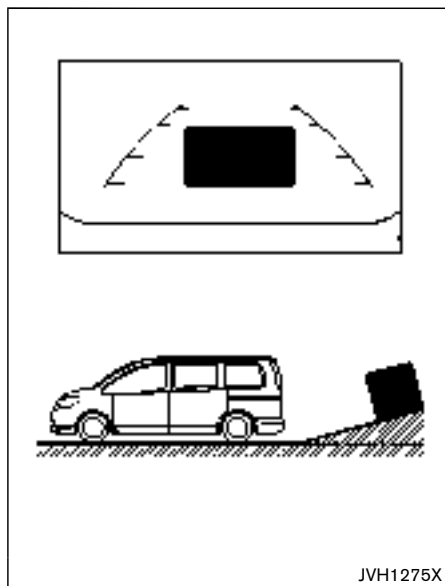

#### Backing up on a steep uphill:

When backing up the vehicle up a hill, the distance guide lines and the vehicle width guide lines are shown closer than the actual distance. Note that any object on the hill is further than it appears on the monitor.

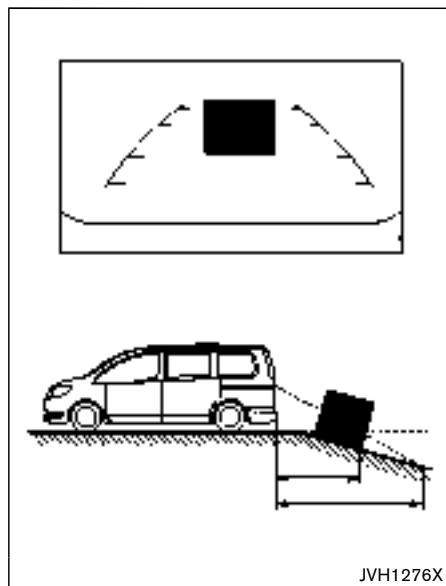

#### Backing up on a steep downhill:

When backing up the vehicle down a hill, the distance guide lines and the vehicle width guide lines are shown further than the actual distance. Note that any object on the hill is closer than it appears on the monitor.

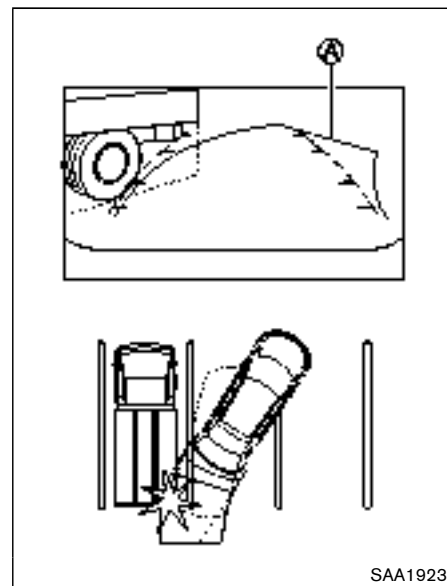

#### Backing up near a projecting object:

The predictive course lines (A) do not touch the object in the display. However, the vehicle may hit the object if it projects over the actual backing up course.

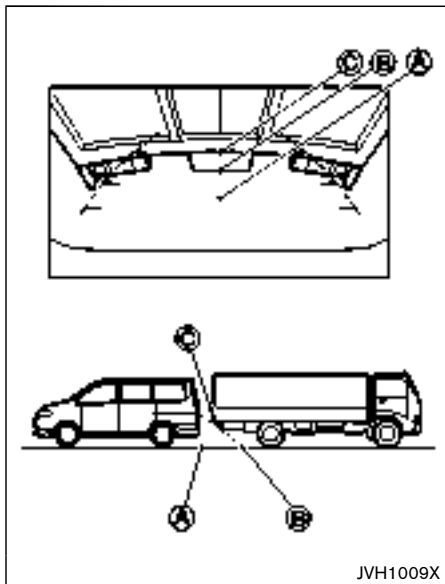

#### Backing up behind a projecting object:

The position ③ is shown further than the position ② in the display. However, the position ③ is actually at the same distance as the position ①. The vehicle may hit the object when backing up to the position ① if the object projects over the actual backing up

course.

How to park with predictive course lines

#### WARNING

- If the tires are replaced with different sized tires, the predictive course lines may be displayed incorrectly.
- On a snow-covered or slippery road, there may be a difference between the predictive course line and the actual course line.

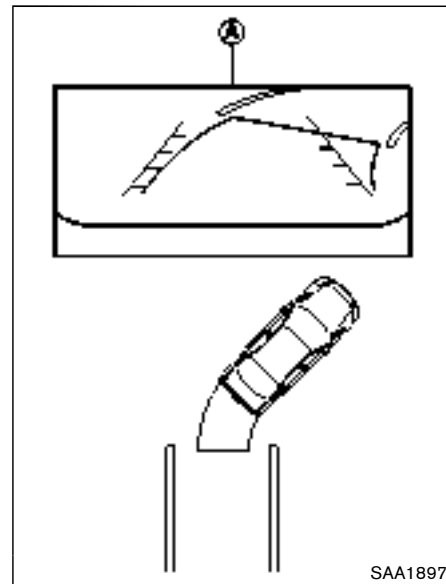

1. Visually check that the parking space is safe before parking your vehicle.
2. The rear view of the vehicle is displayed on the screen ① when the shift lever is moved to the R (Reverse) position.

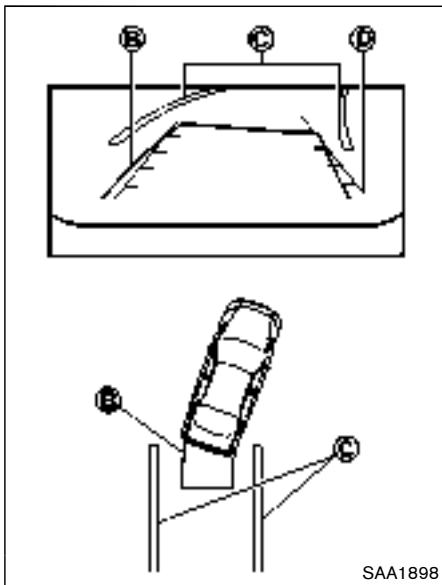

3. Slowly back up the vehicle adjusting the steering wheel so that the predictive course lines **(B)** enter the parking space **(C)**.
4. Maneuver the steering wheel to make the vehicle width guide lines **(D)** parallel to the parking space **(C)** while referring to the predictive course lines.

5. When the vehicle is parked in the space completely, move the shift lever to the P (Park) position and apply the parking brake.

#### How to switch the display

The Around View<sup>®</sup> Monitor can display two split views. Push the CAMERA button or change the shift lever position, to switch between the available views.

#### HOW TO ADJUST THE SCREEN VIEW

The display settings such as Display ON/OFF, Brightness, Tint, Color, Contrast and Black Level of the Around View<sup>®</sup> Monitor can be adjusted.

1. Push the **SETTING** button with the Around View<sup>®</sup> Monitor turned on.
2. Select an item you wish to adjust.
3. Adjust the level of the setting item using the multi-function controller.

#### NOTE:

**Do not adjust any of the display settings of the Around View<sup>®</sup> Monitor while the vehicle is moving. Make sure the parking brake is firmly applied.**

## AROUND VIEW<sup>®</sup> MONITOR SYSTEM LIMITATIONS



Listed below are the system limitations for Around View<sup>®</sup> Monitor. Failure to operate the vehicle in accordance with these system limitations could result in serious injury or death.

- Do not use the Around View<sup>®</sup> Monitor with the outside mirrors in the stored position, and make sure that the liftgate is securely closed when operating the vehicle using the Around View<sup>®</sup> Monitor.
- The apparent distance between objects viewed on the Around View<sup>®</sup> Monitor differs from the actual distance.
- The cameras are installed on the front grille, the outside mirrors and above the rear license plate. Do not put anything on the vehicle that covers the cameras.
- When washing the vehicle with high pressure water, be sure not to spray it around the cameras. Otherwise,

water may enter the camera unit causing water condensation on the lens, a malfunction, fire or an electric shock.

- Do not strike the cameras. They are precision instruments. Doing so could cause a malfunction or cause damage resulting in a fire or an electric shock.

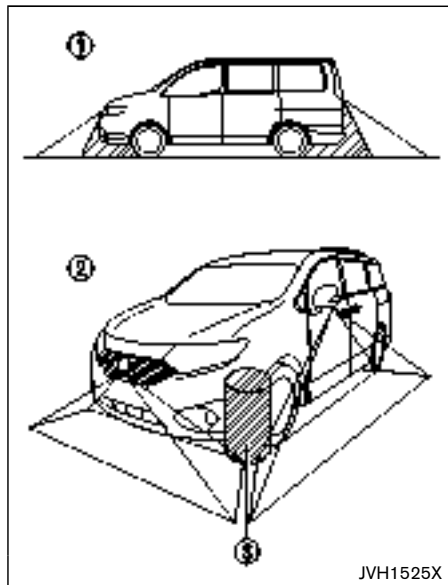

There are some areas where the system will not show objects and the system does not warn of moving objects. When in the front or the rear view display, an object below the bumper or on the ground may not be viewed ①. When in the bird's-eye view, a tall object near the seam ③ of the camera viewing areas will not appear in

the monitor ②.

The following are operating limitations and do not represent a system malfunction:

- There may be a delay when switching between views.
- When the temperature is extremely high or low, the screen may not display objects clearly.
- When strong light directly shines on the camera, objects may not be displayed clearly.
- The screen may flicker under fluorescent light.
- The colors of objects on the Around View<sup>®</sup> Monitor may differ somewhat from the actual color of objects.
- Objects on the monitor may not be clear and the color of the object may differ in a dark environment.
- There may be differences in sharpness between each camera view of the bird's-eye view.
- If dirt, rain or snow accumulates on the camera, the Around View<sup>®</sup> Monitor may not display objects clearly. Clean the camera.
- Do not use wax on the camera lens. Wipe off any wax with a clean cloth that has been dampened with a diluted mild cleaning agent, then wipe with a dry cloth.

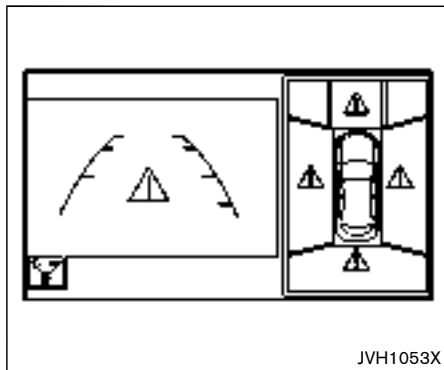

### System temporarily unavailable

When the “” icon is displayed on the screen, there are abnormal conditions in the Around View<sup>®</sup> Monitor. This will not hinder normal driving operation but the system should be inspected. It is recommended you visit a NISSAN dealer.

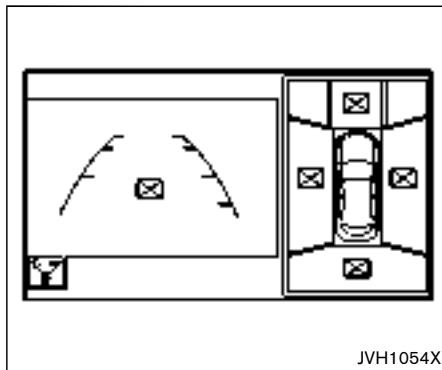

When the “” icon is displayed on the screen, the camera image may be receiving temporary electronic disturbances from surrounding devices. This will not hinder normal driving operation. If it occurs frequently, the system should be inspected. It is recommended you visit a NISSAN dealer.

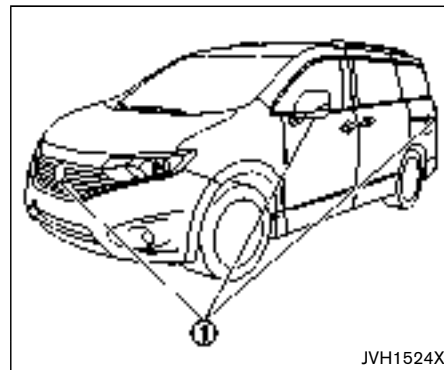

### SYSTEM MAINTENANCE

#### CAUTION

- Do not use alcohol, benzine or thinner to clean the camera. This will cause discoloration. To clean the camera, wipe with a cloth dampened with diluted mild cleaning agent and then wipe with a dry cloth.
- Do not damage the camera as the monitor screen may be adversely affected.

## MOVING OBJECT DETECTION (MOD) (if so equipped)

If dirt, rain or snow accumulates on any of the cameras ①, the Around View® Monitor may not display objects clearly. Clean the camera by wiping with a cloth dampened with a diluted mild cleaning agent and then wiping with a dry cloth.

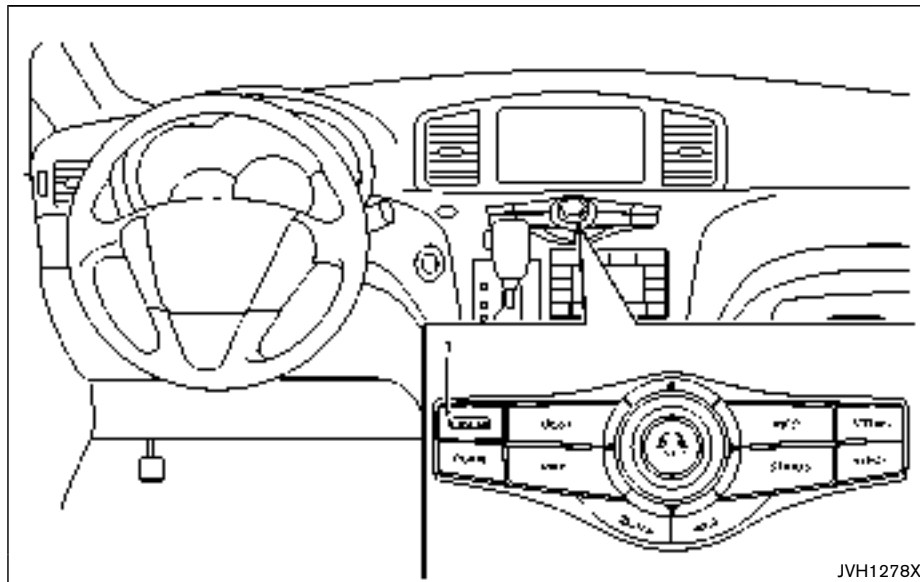

JVH1278X

1. **CAMERA** button



### WARNING

Failure to follow the warnings and instructions for proper use of the Mov-

ing Object Detection system could result in serious injury or death.

- The MOD system is not a substitute for proper vehicle operation and is not designed to prevent contact with the objects surrounding the

**vehicle. When maneuvering, always use the outside mirror and rearview mirror and turn and check the surrounding to ensure it is safe to maneuver.**

- **The system is deactivated at speeds above 5 MPH (8 km/h). It is reactivated at lower speeds.**
- **The MOD system is not designed to detect the surrounding stationary objects.**

The Moving Object Detection (MOD) system can inform the driver of the moving objects surrounding the vehicle when driving out of garages, maneuvering into parking lots and in other such instances.

The MOD system detects moving objects by using image processing technology on the image shown on the display.

## MOD SYSTEM OPERATION

The MOD system will turn on automatically under the following conditions:

- When the shift lever is in the R (Reverse) position.
- When the CAMERA button is pushed, the camera view is activated on the display.
- When vehicle speed decreases below approximately 5 MPH (8 km/h).

The MOD system operates in the following conditions when the camera view is displayed:

- When the shift lever is in the P (Park) or N (Neutral) position and the vehicle is stopped, the MOD system detects the moving objects in the bird's-eye view. The MOD system will not operate if the outside mirrors are moving in or out or if either door is opened.
- When the shift lever is in the D (Drive) position, and the vehicle speed is below approximately 5 MPH (8 km/h), the MOD system detects moving objects in the front view.
- When the shift lever is in the R (Reverse) position and the vehicle speed is below approximately 5 MPH (8 km/h), the MOD system detects moving objects in the rear view. The MOD system will not operate if the liftgate is open.

- When the ignition switch is placed in the "OFF" position and then back to the "ON" position.

The MOD system does not detect moving objects in the front-side view. The MOD icon is not displayed on the screen when in this view.

When the MOD system detects a moving object near the vehicle, the yellow frame will be displayed on the view where the objects are detected and a chime will sound once. While the MOD system continues to detect moving objects, the yellow frame continues to be displayed.



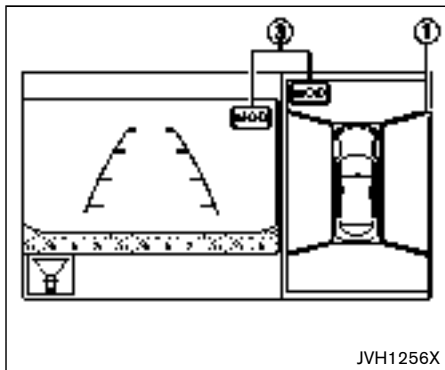

Front and bird's-eye views

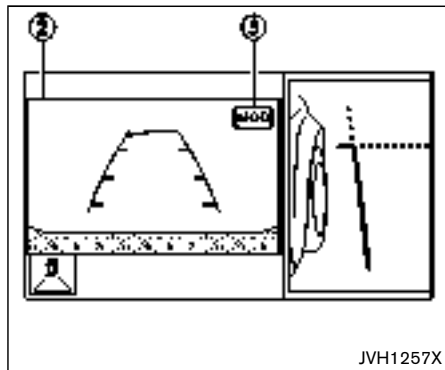

Rear and front-side views

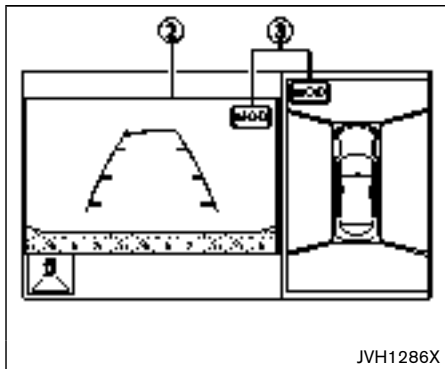

Rear and bird's-eye views

In the bird's-eye view, the yellow frame ① is displayed on each camera image (front, rear, right, left) depending on where moving objects are detected.

The yellow frame ② is displayed on each view in the front view and rear view modes.

A blue MOD icon ③ is displayed in the view where the MOD system is operative. A gray MOD icon ③ is displayed in the view where the MOD system is not operative.

If the MOD system is turned off, the MOD icon ③ is not displayed.

## TURNING ON AND OFF THE MOD SYSTEM

To set Moving Object Detection (MOD) on/off, push the SETTING button, select the "Driver Assistance" key.

### Moving Object Detection (MOD):

When this item is set to ON, the MOD is activated. When this item is turned to OFF (indicator turns off), the MOD system is deactivated.

## MOD SYSTEM LIMITATIONS



## WARNING

Listed below are the system limitations for MOD. Failure to operate the vehicle in accordance with these system limitations could result in serious injury or death.

- Do not use the MOD system when towing a trailer. The system may not function properly.
- Excessive noise (for example, audio system volume or open vehicle window) will interfere with the chime sound, and it may not be heard.

- The MOD system performance will be limited according to environmental conditions and surrounding objects such as:
  - When there is low contrast between background and the moving objects.
  - When there is blinking source of light.
  - When strong light such as another vehicle's headlight or sunlight is present.
  - When camera orientation is not in its usual position, such as when mirror is folded.
  - When there is dirt, water drops or snow on the camera lens.
  - When the position of the moving objects in the display is not changed.
- The MOD system might detect flowing water droplets on the camera lens, white smoke from the muffler, moving shadows, etc.
- The MOD system may not function properly depending on the speed, direction, distance or shape of the

moving objects.

- If your vehicle sustains damage to the parts where the camera is installed, leaving it misaligned or bent, the sensing zone may be altered and the MOD system may not detect objects properly.
- When the temperature is extremely high or low, the screen may not display objects clearly. This is not a malfunction.

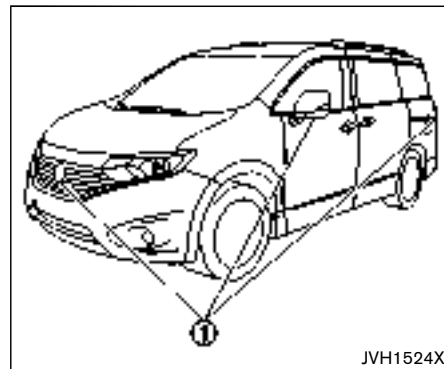

JVH1524X

## SYSTEM MAINTENANCE

### CAUTION

- Do not use alcohol, benzine or thinner to clean the camera. This will cause discoloration. To clean the camera, wipe with a cloth dampened with diluted mild cleaning agent and then wipe with a dry cloth.
- Do not damage the camera as the monitor screen may be adversely affected.

## VENTILATORS

If dirt, rain or snow accumulates on any of the cameras ①, the MOD system may not operate properly. Clean the camera by wiping with a cloth dampened with a diluted mild cleaning agent and then wiping with a dry cloth.

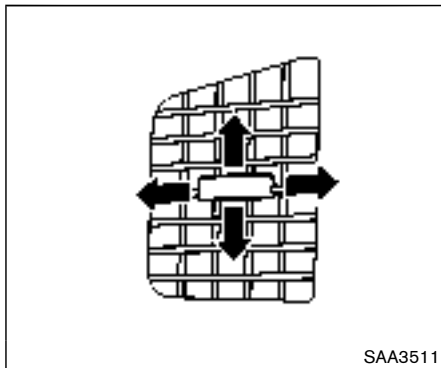

Center

### CENTER VENTILATORS

Adjust the air flow direction of the ventilators by moving the center knob (up/down, left/right) until the desired position is achieved.

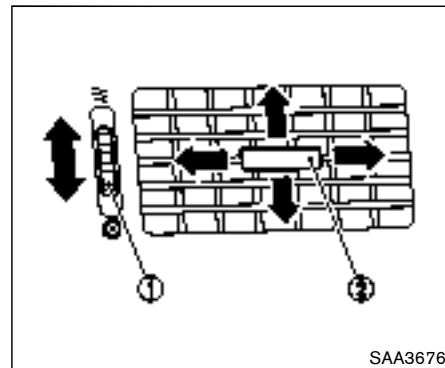

Side

### SIDE VENTILATORS

Open/close the ventilators by moving the control dial ① to either direction.

- ☒ : This symbol indicates that the ventilators are closed. Moving the side control to this direction will close the ventilators.
- ≡ : This symbol indicates that the ventilators are open. Moving the side control to this direction will open the ventilators.

Adjust the air flow direction of the ventilators by moving the center knob ② (up/down, left/right) until the desired position is achieved.

## HEATER AND AIR CONDITIONER



### WARNING

- The heater and air conditioner operate only when the engine is running.
- Never leave children or adults who would normally require the support of others alone in the vehicle. Pets should not be left alone either. They could unknowingly activate switches or controls and inadvertently become involved in a serious accident and injure themselves. On hot, sunny days, temperatures in a closed vehicle could quickly become high enough to cause severe or possibly fatal injuries to people or animals.
- Do not use the recirculation mode for long periods as it may cause the interior air to become stale and the windows to fog up.
- Do not adjust the heating and air conditioning controls while driving so that full attention may be given to vehicle operation.

even if the engine is turned off and the ignition switch is in the ON position.

### NOTE:

- Odors from inside and outside the vehicle can build up in the air conditioner unit. Odor can enter the passenger compartment through the vents.
- When parking, set the heater and air conditioner controls to turn off air recirculation to allow fresh air into the passenger compartment. This should help reduce odors inside the vehicle.

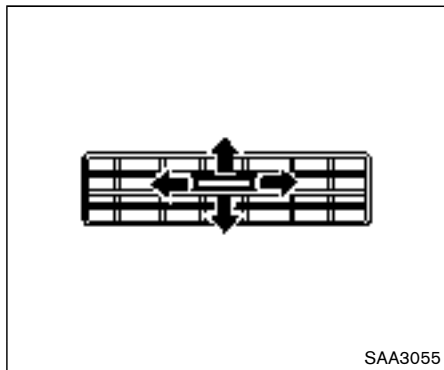

Rear

### REAR VENTILATORS

If the center knob is moved fully to the left or right, the ventilators will be closed.

Adjust the air flow direction of the ventilators by moving the center knob (up/down, left/right) until the desired position is achieved.

The heater and air conditioner operate when the engine is running. The air blower will operate

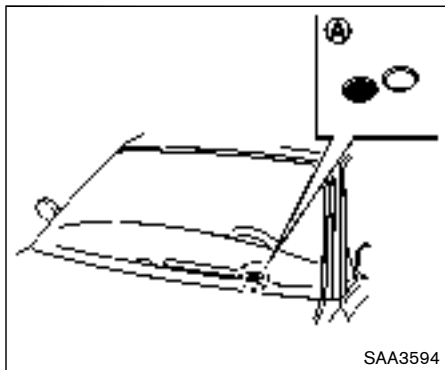

#### OPERATING TIPS (for automatic air conditioner)

When the engine coolant temperature and outside air temperature are low, the air flow from the foot outlets may not operate. However, this is not a malfunction. After the coolant temperature warms up, the air flow from the foot outlets will operate normally.

The sensors (A) and (B) located on the instrument panel help maintain a constant temperature. Do not put anything on or around the sensors.

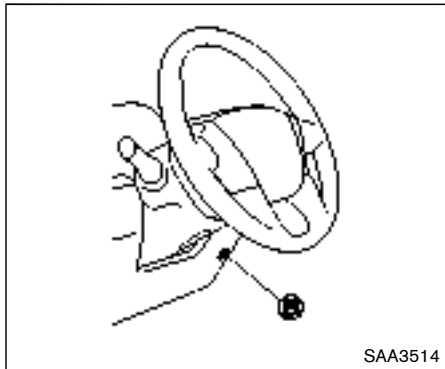

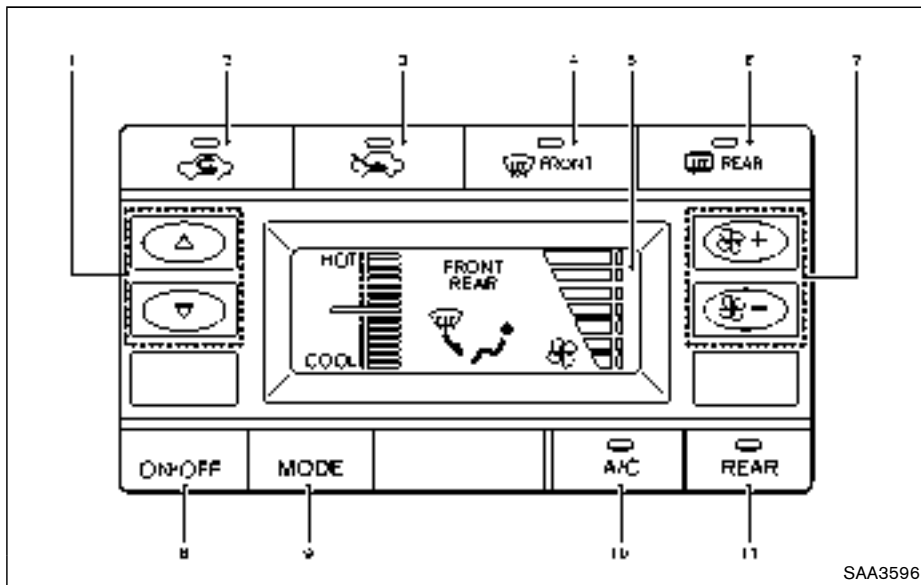

1. Temperature control buttons
2. "Air recirculation" button
3. "Outside air circulation" button
4. "FRONT" front defroster button
5. Display
6. "REAR" rear window defroster button (See "Rear window and outside mirror defroster switch" (P.2-33).)
7. " - " and " + " fan speed control buttons
8. "ON-OFF" button for air conditioning system
9. "MODE" air flow control button
10. "A/C" air conditioner ON/OFF button
11. "REAR" control button

## MANUAL AIR CONDITIONER

### Controls

To turn off the heater and air conditioner, push the "ON-OFF" button.

### Fan speed control:

Push the fan speed control button " + " to increase the fan speed.

Push the fan speed control button " - " to decrease the fan speed.

### A/C (Air Conditioner) operation:

Push the A/C button to turn on or off the air conditioner. When the air conditioner is on, the A/C indicator light on the button illuminates.

### Air flow control:



Push the "MODE" button to change the air flow mode.

- : Air flows from the center and side ventilators.
- : Air flows from the center and side ventilators, and foot outlets.
- : Air flows mainly from the foot outlets.
- : Air flows from the defroster and foot outlets.

### Temperature control:



Push the temperature control buttons (" ▲ " and " ▼ ") to set the desired temperature.

### **Air recirculation:**

Push the air recirculation “” button to recirculate interior air inside the vehicle. The indicator light on the air recirculation “” button will illuminate.

The air recirculation mode cannot be activated when the air conditioner is in the front defrosting mode.



### **Outside air circulation:**

Push the outside air circulation “” button to draw outside air into the passenger compartment. The indicator light on the outside air circulation “” button will turn on.

### **Heater operation**



#### **Heating:**

This mode is used to direct heated air to the foot outlets.

1. Push the outside air circulation “” button to switch to the outside air circulation mode. (The indicator light turns on.)
2. Push the air flow control button to change to the  mode.
3. Push the fan speed control buttons to set the desired fan speed.
4. Push the temperature control buttons to set the desired temperature between the middle and the hot position.



### **Ventilation:**

This mode directs outside air to the side and center ventilators.

1. Push the outside air circulation “” button to switch to the outside air circulation mode. (The indicator light turns on.)
2. Push the air flow control button to change to the  mode.
3. Push the fan speed control  buttons to set the desired position.



### **Bi-level heating:**

This mode directs cool air from the side and center vents and warm air from the foot outlets. When the temperature is set to the maximum hot or cool position, the air between the ventilators and the foot outlets is the same temperature.

1. Push the outside air circulation “” button to switch to the outside air circulation mode. (The indicator light turns on.)
2. Push the air flow control button to change to the  mode.
3. Push the fan speed control buttons to set the desired fan speed.
4. Push the temperature control buttons to set the desired temperature.

### **Heating and defogging:**

This mode heats the interior and defogs the windows.

1. Push the air flow control button to change to the  mode.
2. Push the fan speed control  buttons to set the desired fan speed.
3. Push the temperature control buttons to set the desired temperature.



When the  mode is selected, the air conditioner will automatically turn on. This will dehumidify the air and help to defog the windows.

### **Air conditioner operation**

The air conditioner system should be operated for approximately 10 minutes at least once a month. This helps prevent damage to the air conditioner system due to the lack of lubrication.

### **Cooling:**



This mode is used to cool and dehumidify the air.

1. Push the outside air circulation “” button to switch to the outside air circulation mode. (The indicator light turns on.)
2. Push the air flow control button to change to the  mode.

3. Push the fan speed control buttons to set the desired fan speed.
4. Push the A/C button on. (The A/C indicator light will illuminate.)
5. Push the temperature control buttons to set the desired temperature between the middle and the cool position.
  - For quick cooling when the outside temperature is high, push the air recirculation  button to switch to the air recirculation mode. (The indicator light turns on.) Be sure to turn off the air recirculation mode for normal cooling.
  - A visible mist may be seen coming from the ventilators in hot, humid conditions as the air is cooled rapidly. This does not indicate a malfunction.

#### Dehumidified heating:

This mode is used to heat and dehumidify the air.

1. Push the outside air circulation "" button to switch to the outside air circulation mode. (The indicator light turns on.)
2. Push the air flow control button to change to the  position.
3. Push the fan speed control buttons to the desired fan speed.

4. Push the A/C button on. (The A/C indicator light will illuminate.)
5. Push the temperature control buttons to set the desired temperature between the middle and the hot position.

#### Dehumidified or defrosting/defogging:

This mode is used to defog the windows and dehumidify the air.

1. Push the front defroster button  on. (The indicator light turns on.)
2. Push the fan speed control buttons to set the desired fan speed.
3. Push the temperature control buttons to set the desired temperature.

When the  mode is selected, the air conditioner will automatically turn on. This will dehumidify the air and help to defog the windows.

To remove frost from the outside surface of the windshield quickly, set the temperature to the maximum hot position and the fan speed to maximum position.

#### Rear air conditioning system

##### Operating from front control buttons:

To control the rear air conditioning system independently with the front air conditioner control panel, push the "REAR" button. When the rear air conditioning system control is on, the indicator light on the "REAR" button will illuminate and "REAR" will appear on the display.



In this state, the rear air conditioning system can be adjusted with the front air conditioner control panel. However, if no operation is conducted for approximately 10 seconds after the "REAR" button is pushed, the front air conditioner control panel will automatically switch to the front air conditioning mode.

To cancel the rear air conditioning mode and switch back to the front air conditioning mode, push "REAR" button one more time.

##### ● Temperature control

Push the temperature control buttons ("▲" and "▼") to set the desired temperature.

##### ● Fan speed control



Push the fan speed control " -" button or " +" button to control the fan speed.

##### ● Air flow control

Push the "MODE" button to change the air



flow mode.

-  : The air outlet is fixed at foot level.
-  : The air outlet is fixed at both the head and foot level.
-  : The air outlet is fixed at the head level.

#### NOTE:

**Pushing the "A/C" button when the rear air conditioning system is turned on and "REAR" does not appear on the display will turn off the rear air conditioning system (except when the air flow is set to the  position).**

#### ● Rear Heating (A/C off)

1. Push the "REAR" button to display "REAR" on the front display when the rear air conditioning system is on.
  2. Switch the air flow mode to  by pressing the "MODE" button.
  3. If the A/C indicator light illuminates, push the "A/C" button. (The A/C indicator light will turn off.)
  4. Push the temperature control buttons ("▲" and "▼") to set the desired temperature between the middle and the hot position.
- To dehumidify the air, push the "A/C" button before turning on the heater.

- Air does not blow out from the vents on the ceiling when the system is used for heating.

#### Turning the system off:

To turn off the rear air conditioner, push the "ON-OFF" button when "REAR" is on the display.

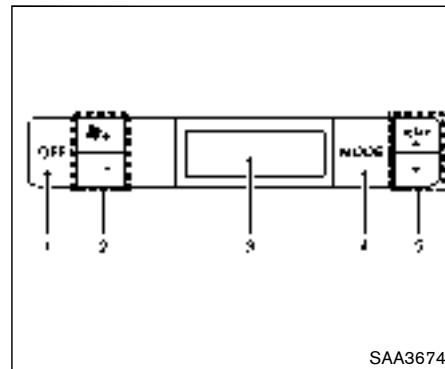

1. "OFF" button
2. "  " Fan speed control buttons
3. Display
4. "MODE" button
5. "TEMP" buttons

#### Rear control buttons:

The rear seat passengers can adjust the rear air conditioning system using the control switches located on the ceiling above the rear seats.

The rear control buttons do not function when "REAR" is shown on the front display. To activate the rear control buttons, push the "REAR" button on the front air conditioner control panel and cancel the rear air conditioner control mode ("REAR" will disappear from the

front display).

“OFF” button: Turns off the rear air conditioning system.

“  ” Fan speed control buttons: Adjust rear fan speed

“MODE” button: Changes the rear air flow

“TEMP” buttons: Adjust the rear temperature

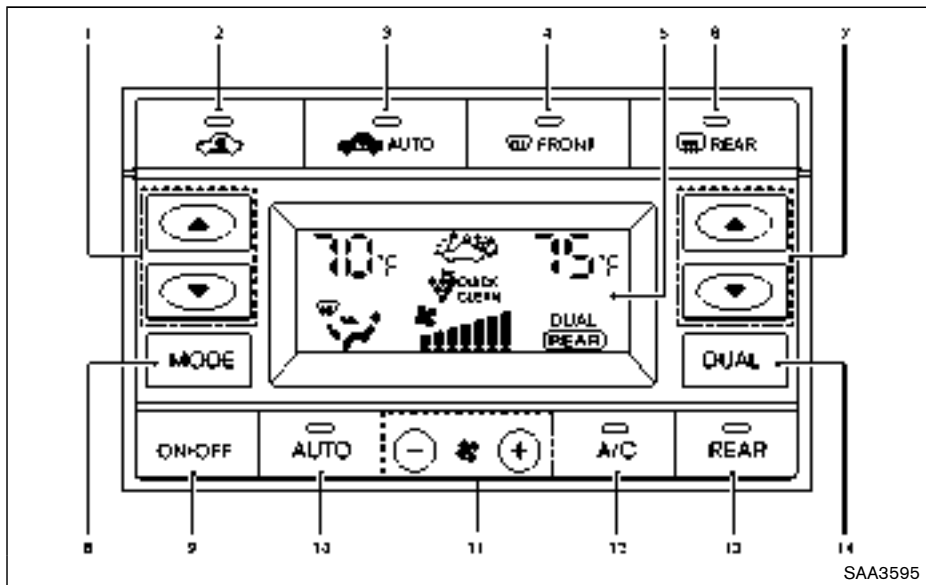

- |   |   |
|---|---|
| 1. Temperature control buttons (driver side)  | 5. Display  |
| 2. “” air recirculation button  | 6. “ REAR” rear window defroster button (See “Rear window and outside mirror defroster switch” (P.2-33).) |
| 3. “ AUTO” auto-recirculation button (models with Advanced Climate Control System)/“” Outside air circulation button (models without Advanced Climate Control System) | 7. Temperature control buttons (passenger side)   |
| 4. “ FRONT” front defroster button  | 8. “MODE” manual air flow control button  |
|   | 9. “ON-OFF” button for air conditioning system  |

10. “AUTO” button
11. “ - + ” fan speed control buttons
12. “A/C” air conditioner ON/OFF button
13. “REAR” control button
14. “DUAL” zone control ON/OFF button

## AUTOMATIC AIR CONDITIONER

### Automatic operation (AUTO)

The AUTO mode may be used year-round as the system automatically controls constant temperature, air flow distribution and fan speed after the desired temperature is set manually.

To turn the heater and air conditioner on or off, push the “ON-OFF” button.



### Cooling and dehumidified heating:

1. Push the “AUTO” button.  
(The AUTO indicator light will illuminate.)
2. If the A/C indicator light does not illuminate, push the “A/C” button.  
(The A/C indicator light will illuminate.)
3. Push the temperature control buttons (“▲” and “▼”) (driver’s side) to set the desired temperature.
  - When “DUAL” does not appear on the display:  
Pushing the “AUTO” button changes both the driver’s and front passenger’s side temperature.



- Pushing the “DUAL” button allows the user to independently change the front passenger’s side temperature with the passenger side temperature control buttons (“▲” and “▼”). (“DUAL” will appear on the display.)



To cancel the separate temperature setting, push the “DUAL” button (“DUAL” will disappear from the display) and the driver’s side temperature setting will be applied to both the driver’s and front passenger’s sides.

#### 4. Models with Advanced Climate Control System:

- Push the “ AUTO” auto-recirculation button. The indicator light on the “ AUTO” auto-recirculation button will illuminate. In this mode, the sensor detects odors and gas to automatically switch between the air recirculation mode and the outside air circulation mode. (See “Advanced climate control system” (P.4-57) for details.)

#### Models without Advanced Climate Control System:

- Push and hold the air recirculation “” button or outside air circulation “” button (the one with the indicator light on) for more than 2 seconds to set the automatic control between the air recir-

ulation and outside air circulation modes. (The “” and “” indicator lights will blink twice.)

The following conditions need to be met for the automatic air intake control mode to function properly.

- The air flow control is not in the front defroster mode (the indicator light on the front defroster “ FRONT” button is turned off).
- The outside temperature is approximately 32°F (0°C) or above.

A visible mist may be seen coming from the ventilators in hot, humid conditions as the air is cooled rapidly. This does not indicate a malfunction.

#### Heating (A/C off):



1. Push the “AUTO” button.  
(The AUTO indicator light will illuminate.)
2. If the A/C indicator light illuminates, push the “A/C” button.  
(The A/C indicator light will turn off.)
3. Push the temperature control buttons (“▲” and “▼”) (driver’s side) to set the desired temperature.

When the DUAL mode is turned off (“DUAL” does not appear on the display):



- Pushing the “AUTO” button changes both the driver’s and front passenger’s side temperature.
- Pushing the “DUAL” button allows the user to independently change the front passenger’s side temperature with the passenger side temperature control buttons (“▲” or “▼”). (“DUAL” will appear on the display.)



To cancel the separate temperature setting, push the “DUAL” button (“DUAL” will disappear from the display) and the driver’s side temperature setting will be applied to both the driver’s and front passenger’s sides.

#### 4. Models with Advanced Climate Control System:

- Push the “ AUTO” auto-recirculation button. The indicator light on the “ AUTO” auto-recirculation button will illuminate. In this mode, the sensor detects odors and gas to automatically switch between the air recirculation mode and the outside air circulation mode. (See “Advanced climate control system” (P.4-57) for details.)

#### Models without Advanced Climate Control System:

- Push and hold the air recirculation “” button or outside air circulation “”

button (the one with the indicator light on) for more than 2 seconds to set the automatic control between the air recirculation and outside air circulation modes. (The “” or “” indicator light will blink twice.)



The following conditions need to be met for the automatic air intake control mode to function properly.

- The air flow control is not in the front defroster mode (the indicator light on the front defroster “ FRONT” button is turned off).
- The outside temperature is approximately 32°F (0°C) or above.

#### NOTE:

- **Do not set the temperature lower than the outside air temperature. Doing so may prevent the temperature from being controlled properly.**
- **To dehumidify the air, push the “A/C” button before turning on the heater.**

#### Dehumidified defrosting/defogging:

1. Push the front defroster “ FRONT” button. (The indicator light will illuminate.)
2. Push the temperature control buttons (“” and “”) to set the desired temperature.

- To remove frost from the outside surface of the windshield quickly, set the temperature control and fan speed control to their maximum position.
- After the windshield is cleared, push the “AUTO” button to set to the automatic mode.
- When the front defroster “ FRONT” button is pushed, the air conditioner will automatically turn on sensing the outside air temperature to defog the windshield. Do not select the air recirculation mode for the best defogging performance.

#### NOTE:

**Do not set the temperature too low when the front defroster mode is on (the indicator on the front defroster “ FRONT” button is illuminated). Doing so may fog up the windshield.**

#### Manual operation

The manual mode can be used to control the heater and air conditioner to your desired settings.

#### Fan speed control:





Push the fan speed control button “ +” to increase the fan speed.

Push the fan speed control button “ -” to decrease the fan speed.



Push the “AUTO” button to change the fan speed to the automatic mode.

#### Air flow control:



Push the “MODE” button to change the air flow mode.

-  : Air flows from the center and side ventilators.
-  : Air flows from the center and side ventilators, and foot outlets.
-  : Air flows mainly from the foot outlets.
-  : Air flows from the defroster and foot outlets.

#### Temperature control:

Push the temperature control buttons (“” and “”) to set the desired temperature.

#### Air recirculation:



Push the air recirculation “” button to recirculate interior air inside the vehicle. The indicator light on the air recirculation “”

button will illuminate.



The air recirculation mode cannot be activated when the air conditioner is in the front defrosting mode.

#### Outside air circulation:

- Models with Advanced Climate Control System:



Push the air recirculation “” button twice to draw outside air into the passenger compartment. The indicator light on the air recirculation “” button will turn off.

- Models without Advanced Climate Control System:

Push the outside air circulation “” button to draw outside air into the passenger compartment. The indicator light on the outside air circulation “” button will turn on.





#### Automatic air intake control:

- Models with Advanced Climate Control System:

Push the “ AUTO” auto-recirculation” button to switch to the automatic air intake control mode. The indicator light on the “ AUTO” auto-recirculation button will illuminate. In this mode, the sensor detects odors and gas to automatically switch between the air recirculation mode and the

outside air circulation mode. (See “Advanced climate control system” (P.4-57) for details.)

- Models without Advanced Climate Control System:

To switch to the automatic control mode, push the air recirculation “” button to recirculate interior air inside the vehicle. The indicator light on the air recirculation “” button for about 2 seconds. The indicator lights (both air recirculation “” and outside air circulation “” buttons) will flash twice, and then the intake air will be controlled automatically.

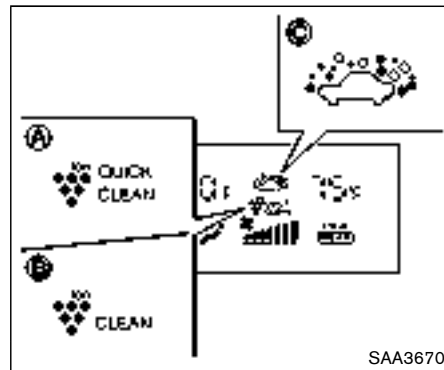

The following conditions need to be met for the automatic air intake control mode to function properly.

- The air flow control is not in the front defroster mode (the indicator light on the front defroster “ FRONT” button is turned off).
- The outside temperature is approximately 32°F (0°C) or above.



#### Advanced climate control system (if so equipped)

The advanced climate control system keeps the air inside of the vehicle clean, using the ion control and the automatic air intake control with exhaust gas detecting sensor.

Push the “ AUTO” auto-recirculation button (the indicator light on the “ AUTO” auto-recirculation button will illuminate) to activate the ion control and the automatic air intake control.

#### Ion control:

This unit generates highly concentrated Plasmacluster® ions into the air blown from the ventilators and reduces odor absorbed into the

interior trim.

When the air conditioner is turned on, the system generates Plasmacluster® ions automatically.

“The high-density Plasmacluster® ions generated in the air conditioner’s air stream not only suppress airborne bacteria and reduce the adherence of odors to the interior trim, but also have a proven skin moisture preserving effect.”



The amount of Plasmacluster® ions increases according to the amount of air flow. When the air flow is high, “ψ...” (A) is displayed on the screen and when the air flow is low, the indication in the screen changes to “ψ...” (B).

Plasmacluster® and Plasmacluster® ions are registered trademark of Sharp corporation.

#### **Automatic air intake control with exhaust gas/outside odor detection sensor:**

This vehicle is equipped with an exhaust gas detection sensor. When the automatic air intake control is activated, the sensor detects industry odors such as pulp or chemicals, and exhaust gas such as gasoline or diesel. When such odors or gas are detected, “” (C) will appear on the display and the system automatically changes from the outside air circulation mode to the recirculation mode.

The automatic air intake control can be activated

when the “ AUTO” auto-recirculation button is pushed (the indicator light on the “ AUTO” auto-recirculation button will illuminate) under the following conditions.

- The air flow control is not in the front defroster mode (the indicator light on the front defroster “ FRONT” button is turned off).
- The outside temperature is about 32°F (0°C) or above.

When the automatic air intake control is ON, for the first 5 minutes, the recirculation mode is selected to prevent dust, dirt and pollen from entering the vehicle and cleans the air inside of the vehicle with positive and negative ions that are emitted from the ventilator.

After 5 minutes, the sensor detects exhaust gas and automatically alternates between the recirculation mode and outside air circulation mode.

#### **Turning the system off**

Push the “ON-OFF” button.



#### **Rear air conditioning system**

To control the rear air conditioning system independently with the front air conditioner control panel, push the “REAR” button. When the rear air conditioning system control is on, the indicator light on the “REAR” button will illuminate and “ REAR” will appear on the display.

In this state, the rear air conditioning system can be adjusted with the front air conditioner control panel. However, if no operation is conducted for approximately 10 seconds after the “REAR” button is pushed, the front air conditioner control panel will automatically switch to the front air conditioning mode.

To cancel the rear air conditioning mode and switch back to the front air conditioning mode, push “REAR” button one more time.

#### **Automatic operation:**

1. Push the “REAR” button to display “ REAR” on the front display when the rear air conditioning system is on.
2. Push the “AUTO” button. (The AUTO indicator light will illuminate.)
3. Push the temperature control buttons (“ ” and “ ”) (driver’s side) to set the desired temperature.

### Manual operation:

To operate the rear air conditioning system using the front air conditioner control panel, push "REAR" button (the indicator light on the "REAR" button will illuminate and "REAR" will appear on the display).

#### ● Temperature control

Push the temperature control buttons ("▲" and "▼") (driver's side) to set the desired temperature.

#### ● Fan speed control

Push the fan speed control "🌀 -" button or "🌀 +" button to manually control the fan speed.

#### ● Air flow control

Push the "MODE" button to change the air flow mode.

🌀: The air outlet is fixed at foot level.

🌀: The air outlet is fixed at both the head and foot level.

🌀: The air outlet is fixed at the head level.

### NOTE:

**Pushing the "A/C" button when the rear air conditioning system is turned on and "REAR" does not appear on the display will turn off the rear air conditioning system (except when the air flow is set to the 🌀 position).**

### Rear Heating (A/C off):

1. Push the "REAR" button to display "REAR" on the front display when the rear air conditioning system is on.
  2. Switch the air flow mode to 🌀 by pressing the "MODE" button.
  3. Push the "AUTO" button. (The AUTO indicator light will illuminate.)
  4. If the A/C indicator light illuminates, push the "A/C" button. (The A/C indicator light will turn off.)
  5. Push the temperature control buttons ("▲" and "▼") (driver's side) to set the desired temperature.
- Do not set the temperature lower than the outside air temperature. Doing so may cause the temperature to not be controlled properly.
  - To dehumidify the air, push the "A/C" button before turning on the heater.
  - Air does not blow out from the vents on the ceiling when the system is used for heating.

### Turning the system off:

To turn off the rear air conditioner, push the "ON-OFF" button when "REAR" is on the display.

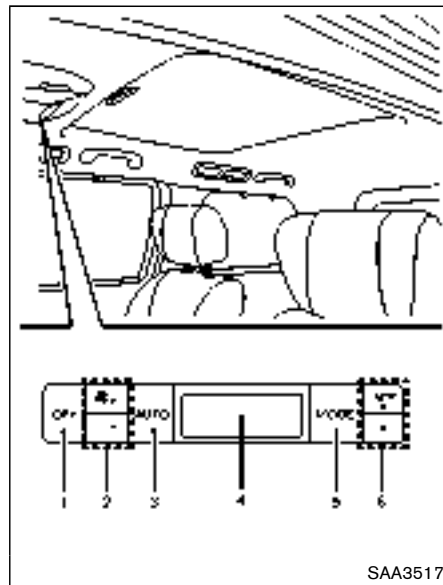

1. "OFF" button
2. "🌀" Fan speed control buttons
3. "AUTO" button
4. Display
5. "MODE" button
6. "TEMP" buttons



### Rear control buttons:

The rear seat passengers can adjust the rear automatic air conditioning system using the control switches located on the ceiling above the rear seats (models with NISSAN Mobile Entertainment System) or on the upper left side of the second row seat (models without NISSAN Mobile Entertainment System).

The rear control buttons do not function when "REAR" is shown on the front display. To activate the rear control buttons, push the "REAR" button on the front air conditioner control panel and cancel the rear air conditioner control mode ("REAR" will disappear from the front display).

"OFF" button: Turns off the rear air conditioning system.

" " Fan speed control buttons: Adjust rear fan speed

"AUTO" button: Turns on/off the automatic operation mode when rear air conditioning system is on

"MODE" button: Changes the rear air flow

"TEMP" buttons: Adjust the rear temperature

### SERVICING AIR CONDITIONER



#### WARNING

**The air conditioner contains refrigerant under high pressure. To avoid personal injury, any air conditioner service should be done only by an experienced technician with the proper equipment.**

The air conditioner system in your vehicle is charged with a refrigerant designed with the environment in mind.

**This refrigerant will not harm the earth's ozone layer.** However, it may contribute in a small part to global warming.

Special charging equipment and lubricant are required when servicing your vehicle's air conditioner. Using improper refrigerants or lubricants will cause severe damage to the air conditioner system. (See "Air conditioning system refrigerant and lubricant recommendations" (P.10-6).)

A NISSAN dealer will be able to service your environmentally friendly air conditioner system.

### IN-CABIN MICROFILTER

The climate control system is equipped with an in-cabin microfilter which collects dirt, pollen, dust, etc. To make sure the air conditioner heats, defogs, and ventilates efficiently, replace the filter in accordance with the specified maintenance intervals listed in the "9. Maintenance and schedules" section. It is recommended to visit a NISSAN dealer to replace the filter. A natural grape seed polyphenol filter (if so equipped) collects and neutralizes dirt, pollen, dust, etc.

**The filter should be replaced if air flow is extremely decreased or when windows fog up easily when operating heater or air conditioning system.**

## AUDIO SYSTEM

### AUDIO OPERATION PRECAUTIONS

#### Radio

Push the ignition switch to the ACC or ON position and push the radio band select button to turn on the radio. If you listen to the radio with the engine not running, the ignition switch should be pushed to the ACC position.

Radio reception is affected by station signal strength, distance from radio transmitter, buildings, bridges, mountains and other external influences. Intermittent changes in reception quality normally are caused by these external influences.

**Using a cellular phone in or near the vehicle may influence radio reception quality.**

#### Radio reception:

Your vehicle radio system is equipped with state-of-the-art electronic circuits to enhance radio reception. These circuits are designed to extend reception range, and to enhance the quality of that reception.

However there are some general characteristics of both FM and AM radio signals that can affect radio reception quality in a moving vehicle, even when the finest equipment is used. These characteristics are completely normal in a given reception area, and do not indicate any mal-

function in your vehicle radio system.

Reception conditions will constantly change because of vehicle movement. Buildings, terrain, signal distance and interference from other vehicles can work against ideal reception. Described below are some of the factors that can affect your radio reception.

Some cellular phones or other devices may cause interference or a buzzing noise to come from the audio system speakers. Storing the device in a different location may reduce or eliminate the noise.

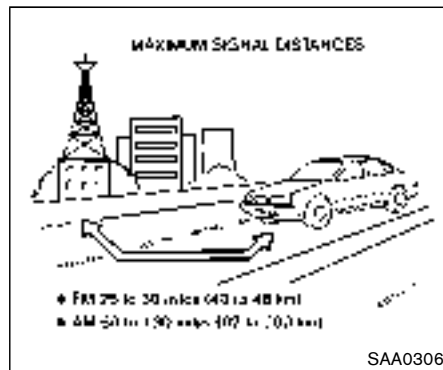

#### FM radio reception:

Range: FM range is normally limited to 25 to 30 miles (40 to 48 km), with monaural (single channel) FM having slightly more range than stereo FM. External influences may sometimes interfere with FM station reception even if the FM station is within 25 miles (40 km). The strength of the FM signal is directly related to the distance between the transmitter and receiver. FM signals follow a line-of-sight path, exhibiting many of the same characteristics as light. For example they will reflect off objects.

Fade and drift: As your vehicle moves away from a station transmitter, the signals will tend to fade and/or drift.

**Static and flutter:** During signal interference from buildings, large hills or due to antenna position, usually in conjunction with increased distance from the station transmitter, static or flutter can be heard. This can be reduced by lowering the treble setting to reduce the treble response.

**Multipath reception:** Because of the reflective characteristics of FM signals, direct and reflected signals reach the receiver at the same time. The signals may cancel each other, resulting in momentary flutter or loss of sound.

#### **AM radio reception:**

AM signals, because of their low frequency, can bend around objects and skip along the ground. In addition, the signals can be bounced off the ionosphere and bent back to earth. Because of these characteristics. AM signals are also subject to interference as they travel from transmitter to receiver.

**Fading:** Occurs while the vehicle is passing through freeway underpasses or in areas with many tall buildings. It can also occur for several seconds during ionospheric turbulence even in areas where no obstacles exist.

**Static:** Caused by thunderstorms, electrical power lines, electric signs and even traffic lights.

#### **Satellite radio reception (if so equipped):**

When the satellite radio is used for the first time or the battery has been replaced, the satellite radio may not work properly. This is not a malfunction. Wait more than 10 minutes with the satellite radio ON and the vehicle outside of any metal or large building for the satellite radio to receive all of the necessary data.

The satellite radio mode requires an active SiriusXM Satellite Radio subscription. The satellite radio is not available in Alaska, Hawaii and Guam.

The satellite radio performance may be affected if cargo carried on the roof blocks the satellite radio signal.

If possible, do not put cargo near the satellite antenna.

A build up of ice on the satellite radio antenna can affect satellite radio performance. Remove the ice to restore satellite radio reception.

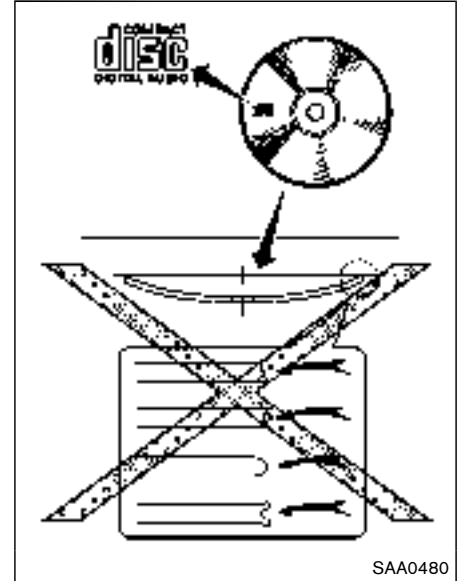

#### **Compact Disc (CD) player**

- Do not force a compact disc into the CD insert slot. This could damage the CD and/or CD changer/player.
- Trying to load a CD with the CD door closed could damage the CD and/or CD changer.

- During cold weather or rainy days, the player may malfunction due to the humidity. If this occurs, remove the CD and dehumidify or ventilate the player completely.
- The player may skip while driving on rough roads.
- The CD player sometimes cannot function when the passenger compartment temperature is extremely high. Decrease the temperature before use.
- Only use high quality 4.7 in (12 cm) round discs that have the "COMPACT disc DIGITAL AUDIO" logo on the disc or packaging.
- Do not expose the CD to direct sunlight.
- CDs that are of poor quality, dirty, scratched, covered with fingerprints, or that have pin holes may not work properly.
- The following CDs may not work properly:
  - Copy control compact discs (CCCD)
  - Recordable compact discs (CD-R)
  - Rewritable compact discs (CD-RW)
- Do not use the following CDs as they may cause the CD player to malfunction.
  - 3.1 in (8 cm) discs
  - CDs that are not round
  - CDs with a paper label
  - CDs that are warped, scratched, or have abnormal edges

- This audio system can only play prerecorded CDs. It has no capabilities to record or burn CDs.
- If the CD cannot be played, one of the following messages will be displayed.
 

CHECK DISC:

  - Confirm that the CD is inserted correctly (the label side is facing up, etc.).
  - Confirm that the CD is not bent or warped and it is free of scratches.

PUSH EJECT:

This is an error due to the temperature inside the player is too high. Remove the CD by pushing the EJECT button, and after a short time reinsert the CD. The CD can be played when the temperature of the player returns to normal.

UNPLAYABLE:

The file is unplayable in this audio system (only MP3 or WMA CD).

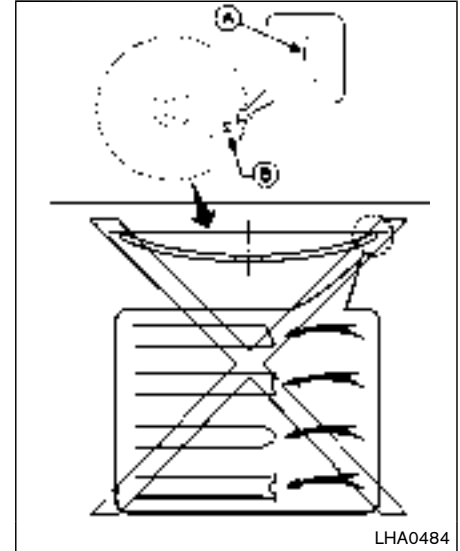

### DVD (Digital Versatile Disc) player (if so equipped)

- Do not force a compact disc into the CD/DVD insert slot. This could damage the CD/DVD player.
- During cold weather or rainy days, the player may malfunction due to humidity. If this occurs, remove the CD/DVD and dehumidify

or ventilate the player completely.

- The player may skip while driving on rough roads.
- The CD/DVD player sometimes cannot function when the passenger compartment temperature is extremely high. Decrease the temperature before use.
- Only use high quality 4.7 in (12 cm) round discs that have the "COMPACT disc DIGITAL AUDIO" or "DVD Video" logo on the disc or packaging.
- Do not expose the CD/DVD to direct sunlight.
- CD/DVDs that are of poor quality, dirty, scratched, covered with fingerprints, or that have pinholes may not work properly.
- The following CD/DVDs are not guaranteed to play:
  - Copy control compact discs (CCCD)
  - Recordable compact discs (CD-R)
  - Rewritable compact discs (CD-RW)
  - Recordable DVDs (DVD±R, DVD±R DL)
  - Rewritable DVDs (DVD±RW, DVD±RW DL)
- Do not use the following CD/DVDs as they may cause the CD/DVD player to malfunction.

- 3.1 in (8 cm) discs
- CD/DVDs that are not round
- CD/DVDs with a paper label
- CD/DVDs that are warped, scratched or have abnormal edges
- This audio system can only play pre-recorded CD/DVDs. It has no capabilities to record or burn CD/DVDs.

- If the CD/DVD cannot be played, one of the following messages will be displayed.

Disc Read Error:

- Confirm that the CD/DVD is inserted correctly (the label side is facing up, etc.).
- Confirm that the CD/DVD is not bent or warped and it is free of scratches.

Please Eject Disc:

- This may be an error due to the temperature inside the player being too high. Remove the CD/DVD by pushing the EJECT button, and after a short time reinsert the CD/DVD. The CD/DVD can be played when the temperature of the player returns to normal. If the error persists, consult your local dealer.

Unplayable File:

- The file may be copy protected.

- The file is not MP3, WMA, AAC, M4A or DivX<sup>®</sup> type.

Region Invalid:

- The DVD is not for region 1 or all regions. Use DVDs with a region code "1", "ALL" or "1 included" for your DVD entertainment system. (The region code **A** is displayed as a small symbol printed on the top of the DVD **B**.) This vehicle-installed DVD player cannot play DVDs with a region code other than "1" or "ALL".

#### Copyright and trademark:

- The technology protected by the U.S. patent and other intellectual property rights owned by Macrovision Corporation and other right holders is adopted for this system.
- This copyright protected technology cannot be used without a permit from Macrovision Corporation. It is limited to be personal use, etc., as long as the permit from Macrovision Corporation is not issued.
- Modifying or disassembling is prohibited.
- Dolby digital is manufactured under license from Dolby Laboratories, Inc.
- Dolby and the double D mark "Dolby" are trademarks of Dolby Laboratories, Inc.

- DTS and DTS 2.0 “” are registered trademarks of DTS, Inc.

### Parental level (parental control):

DVDs with the parental control setting can be played with this system. Please use your own judgement to set the parental control with the system.

### Disc selection:

The following disc formats can be played with the DVD drive.

- DVD-VIDEO
- VIDEO-CD
- CD-DA (Conventional Compact Disc)
- DTS-CD (models with navigation system)

USB (Universal Serial Bus) Connection Port (if so equipped)



## WARNING

**Do not connect, disconnect or operate the USB device while driving. Doing so can be a distraction. If distracted you could lose control of your vehicle and cause an accident or serious injury.**



## CAUTION

- **Do not force the USB device into the USB port. Inserting the USB device tilted or up-side-down into the port may damage the port. Make sure that the USB device is connected correctly into the USB port.**
- **Do not grab the USB port cover (if so equipped) when pulling the USB device out of the port. This could damage the port and the cover.**
- **Do not leave the USB cable in a place where it can be pulled unintentionally. Pulling the cable may damage the port.**

The vehicle is not equipped with a USB device. USB devices should be purchased separately as necessary.

This system cannot be used to format USB devices. To format a USB device, use a personal computer.

In some states/area, the USB device for the front seats plays only sound without images for regulatory reasons, even when the vehicle is parked.

This system supports various USB memory

devices, USB hard drives and iPod® players. Some USB devices may not be supported by this system.

- Partitioned USB devices may not be played correctly.
- Some characters used in other languages (Chinese, Japanese, etc.) are not displayed properly on display. Using English language characters with a USB device is recommended.

### General notes for USB use:

Refer to your device manufacturer's owner information regarding the proper use and care of the device.

### Notes for iPod® use:

“Made for iPod®”, “Made for iPhone®”, and “Made for iPad®” mean that an electronic accessory has been designed to connect specifically to iPod®, iPhone®, or iPad®, respectively, and has been certified by the developer to meet Apple performance standards.

Apple is not responsible for the operation of this device or its compliance with safety and regulatory standards.

Please note that the use of this accessory with iPod®, iPhone®, or iPad® may affect wireless performance.

iPad®, iPhone®, iPod®, iPod classic®, iPod

nano®, iPod shuffle®, and iPod touch® are trademarks of Apple Inc., registered in the U.S. and other countries. Lightning is a trademark of Apple Inc.

- Improperly plugging in the iPod® may cause a checkmark to be displayed on and off (flickering). Always make sure that the iPod® is connected properly.
- An iPod nano® (1st Generation) may remain in fast forward or rewind mode if it is connected during a seek operation. In this case, please manually reset the iPod®.
- An iPod nano® (2nd Generation) will continue to fast-forward or rewind if it is disconnected during a seek operation.
- An incorrect song title may appear when the Play Mode is changed while using an iPod nano® (2nd Generation)
- Audiobooks may not play in the same order as they appear on an iPod®.
- Large video files cause slow responses in an iPod®. The vehicle center display may momentarily black out, but will soon recover.
- If an iPod® automatically selects large video files while in the shuffle mode, the vehicle center display may momentarily black out, but will soon recover.

## Compressed Audio Files (MP3/WMA/AAC)

### Explanation of terms:

- MP3 — MP3 is short for Moving Pictures Experts Group Audio Layer 3. MP3 is the most well known compressed digital audio file format. This format allows for near “CD quality” sound, but at a fraction of the size of normal audio files. MP3 conversion of an audio track can reduce the file size by approximately a 10:1 ratio (Sampling: 44.1 kHz, Bit rate: 128 kbps) with virtually no perceptible loss in quality. The compression reduces certain parts of sound that seem inaudible to most people.
- WMA — Windows Media Audio (WMA) is a compressed audio format created by Microsoft as an alternative to MP3. The WMA codec offers greater file compression than the MP3 codec, enabling storage of more digital audio tracks in the same amount of space when compared to MP3s at the same level of quality.
- AAC/M4A (if so equipped) — Advanced Audio Coding (AAC) is a lossy audio compression format. Audio files that have been encoded with AAC are generally smaller in size and deliver a higher quality of sound than MP3.

- Bit rate — Bit rate denotes the number of bits per second used by a digital music file. The size and quality of a compressed digital audio file is determined by the bit rate used when encoding the file.
  - Sampling frequency — Sampling frequency is the rate at which the samples of a signal are converted from analog to digital (A/D conversion) per second.
  - Multisession — Multisession is one of the methods for writing data to media. Writing data once to the media is called a single session, and writing more than once is called a multisession.
  - ID3/WMA Tag — The ID3/WMA tag is the part of the encoded MP3 or WMA file that contains information about the digital music file such as song title, artist, album title, encoding bit rate, track time duration, etc. ID3 tag information is displayed on the Album/Artist/Track title line on the display.
- \* Windows® and Windows Media® are registered trademarks or trademarks of Microsoft Corporation in the United States of America and/or other countries.

This product is protected by certain intellectual property rights of Microsoft Corporation and third parties. Use or distribution of such technology outside of this product is prohibited

without a license from Microsoft or an authorized Microsoft subsidiary and third parties.

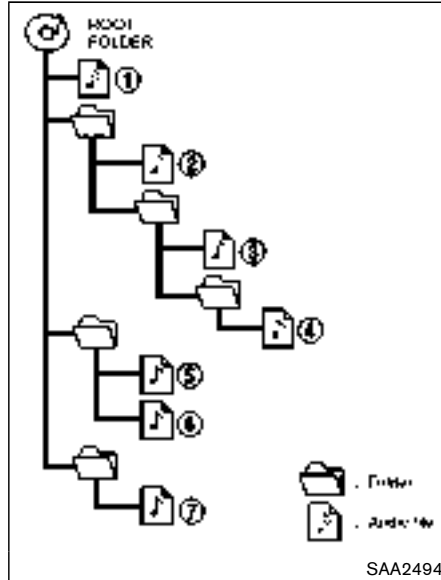

- The playback order is the order in which the files were written by the writing software, so the files might not play in the desired order.
- Music playback order of compressed audio files is as illustrated.

**Playback order:**

- The folder names of folders not containing compressed audio files are not shown in the display.
- If there is a file in the top level of a disc/USB, "Root Folder" is displayed.



**Specification chart (for FM-AM Radio with Compact Disc (CD) Player):**

Supported media		CD, CD-R, CD-RW	
Supported file systems		ISO9660 LEVEL1, ISO9660 LEVEL2, Romeo, Joliet * ISO9660 Level 3 (packet writing) is not supported. * Files saved using the Live File System Component (on a Windows Vista-based computer) are not supported.	
Supported versions*1	MP3	Version	MPEG1, MPEG2, MPEG2.5
		Sampling frequency	8 kHz - 48 kHz
		Bit rate	8 kbps - 320 kbps, VBR*4
	WMA*3	Version	WMA7, WMA8, WMA9 (except WMA9 Pro, WMA9 Lossless, WMA9 Voice)
		Sampling frequency	32 kHz - 48 kHz
		Bit rate	32 kbps - 192 kbps, VBR*4
Tag information (Song title and Artist name)		ID3 tag VER1.0, VER1.1, VER2.2, VER2.3, VER2.4 (MP3 only) WMA tag (WMA only)	
Folder levels		Folder levels: 8, Folders:255 (including root folder), files: 512	
Displayable character codes*2		01: ASCII, 02: ISO-8859-1, 03: UNICODE (UTF-16 BOM Big Endian), 04: UNICODE (UTF-16 Non-BOM Big Endian), 05: UNICODE (UTF-8), 06: UNICODE (Non-UTF-16 BOM Little Endian)	

\*1 Files created with a combination of 48 kHz sampling frequency and 64 kbps bit rate cannot be played.

\*2 Available codes depend on what kind of media, versions and information are going to be displayed.

\*3 Protected WMA files (DRM) cannot be played.

\*4 When VBR files are played, the playback time may not be displayed correctly. WMA7 and WMA8 are not applied to VBR.

**Specification chart (for FM-AM-SAT radio with Compact Disc (CD) player (Type A)):**

Supported media		CD, CD-R, CD-RW	
Supported file systems		ISO9660 LEVEL1, ISO9660 LEVEL2, Apple ISO, Romeo, Joliet * ISO9660 Level 3 (packet writing) is not supported.	
Supported versions*1	MP3	Version	MPEG1, MPEG2, MPEG2.5
		Bit rate	8 kHz - 48 kHz
		Sampling frequency	8 kbps - 320 kbps, VBR
	WMA	Version	WMA7, WMA8, WMA9
		Sampling frequency	32 kHz - 48 kHz
		Bit rate	48 kbps - 192 kbps, VBR
Tag information		ID3 tag VER1.0, VER1.1, VER2.2, VER2.3 (MP3 only)	
Folder levels		Folder levels: 8, Max folders: 255 (including root folder), Files: 512 (Max. 255 files for one folder)	
Text character number limitation		128 characters	
Displayable character codes*2		01: ASCII, 02: ISO-8859-1, 03: UNICODE (UTF-16 BOM Big Endian), 04: UNICODE (UTF-16 Non-BOM Big Endian), 05: UNICODE (UTF-8), 06: UNICODE (Non-UTF-16 BOM Little Endian)	

\*1 Files created with a combination of 48 kHz sampling frequency and 64 kbps bit rate cannot be played.

\*2 Available codes depend on what kind of media, versions and information are going to be displayed.

**Specification chart (for FM-AM-SAT Radio with Compact Disc (CD) Player (Type B)):**

Supported media		CD, CD-R, CD-RW, USB2.0	
Supported file systems		CD, CD-R, CD-RW: ISO9660 LEVEL1, ISO9660 LEVEL2, Romeo, Joliet * ISO9660 Level 3 (packet writing) is not supported. * Files saved using the Live File System component (on a Windows Vista-based computer) are not supported. USB memory: FAT16, FAT32	
Supported versions*1	MP3	Version	MPEG1 Audio Layer 3
		Sampling frequency	8 kHz - 48 kHz
		Bit rate	8 kbps - 320 kbps, VBR*4
	WMA*2	Version	WMA7, WMA8, WMA9
		Sampling frequency	32 kHz - 48 kHz
		Bit rate	32 kbps - 192 kbps, VBR*4
Tag information (Song title and Artist name)		ID3 tag VER1.0, VER1.1, VER2.2, VER2.3, VER2.4 (MP3 only) WMA tag (WMA only)	
Folder levels	CD, CD-R, CD-RW	Folder levels: 8, Folders and files: 999 (Max. 255 files for one folder)	
	USB	Folder levels: 8, Folders 255, Files: 2500 (Max. 255 files for one folder) Memory size: 4GB	
Displayable character codes*3		01: ASCII, 02: ISO-8859-1, 03: UNICODE (UTF-16 BOM Big Endian), 04: UNICODE (UTF-16 Non-BOM Big Endian), 05: UNICODE (UTF-8), 06: UNICODE (Non-UTF-16 BOM Little Endian), 07: SHIFT-JIS	

- \*1 Files created with a combination of 48 kHz sampling frequency and 64 kbps bit rate cannot be played.
- \*2 Protected WMA files (DRM) cannot be played.
- \*3 Available codes depend on what kind of media, versions and information are going to be displayed.
- \*4 When VBR files are played, the playback time may not be displayed correctly.

## Troubleshooting guide:

Symptom	Cause and Countermeasure
Cannot play	Check if the disc or USB device was inserted correctly.
	Check if the disc is scratched or dirty.
	Check if there is condensation inside the player, and if there is, wait until the condensation is gone (about 1 hour) before using the player.
	If there is a temperature increase error, the player will play correctly after it returns to the normal temperature.
	If there is a mixture of music CD files (CD-DA data) and compressed audio files on a CD, only the music CD files (CD-DA data) will be played.
	Files with extensions other than ".MP3 (.mp3)", ".WMA (.wma)", ".AAC (.aac)", ".M4A (.m4a)", or ".AA3 (.aa3)" cannot be played. In addition, the character codes and number of characters for folder names and file names should be in compliance with the specifications.
	Check if the disc or the file is generated in an irregular format. This may occur depending on the variation or the setting of compressed audio writing applications or other text editing applications.
	Check if the finalization processes, such as session close and disc close, has been performed for the disc.
Poor sound quality	Check if the disc or USB device is copyright protected.
It takes a relatively long time before the music starts playing.	Check if the disc is scratched or dirty.
Music cuts off or skips	If there are many folder or file levels on the disc or USB device, some time may be required before the music starts playing.
Skipping with high bit rate files	The writing software and hardware combination might not match, or the writing speed, writing depth, writing width, etc., might not match the specifications. Try using the slowest writing speed.
Move immediately to the next song when playing.	Skipping may occur with large quantities of data, such as for high bit rate data.
The songs do not play back in the desired order.	If an unsupported compressed audio file has been given a supported extension like .MP3, or when play is prohibited by copyright protection, the player will skip to the next song.
	The playback order is the order in which the files were written by the writing software, so the files might not play in the desired order. Random/Shuffle may be active on the audio system or on a USB device.

## Compressed Video Files (if so equipped)

### Explanation of terms:

- DivX<sup>®</sup> - DivX<sup>®</sup> refers to the DivX<sup>®</sup> codec owned by DivX, Inc. used for a lossy compression of video based on MPEG-4.
- AVI - AVI stands for Audio Video Interleave. It is a standard file format originated by Microsoft Corporation. A ".divx" encoded file can be saved into the ".avi" file format for playback on this system if it meets the requirements stated in the table in this section. However, not all the ".avi" files are playable on this system since different encodings can be used than the DivX<sup>®</sup> codec.
- ASF - ASF stands for Advanced Systems Format. It is a file format owned by Microsoft Corporation. Note: Only ".asf" files that meet the requirements stated in the table in this section can be played.
- Bit rate — Bit rate denotes the number of bits per second used by a digital video file. The size and quality of a compressed digital audio file is determined by the bit rate used when encoding the file.

### Requirement for Supporting Video Playback:

Media	CD, CD-R, CD-RW, DVD, DVD±R, DVD±RW, DVD±RW DL, USB 2.0 Memory		
File Systems	CD, CD-R, CD-RW, DVD, DVD±R, DVD±RW, DVD±RW DL	ISO9660 LEVEL1, ISO9660 LEVEL2, Romeo, Joliet, UDF Bridge (UDF1.02+ISO9660), UDF1.5, UDF2.0 - ISO9660 Level 3 (packet writing) is not supported. - Files saved using the Live File System component (on a Windows Vista-based computer) are not supported. - VDF1.5/VDF2.0 (packet writing) is not supported.	
	USB Memory	FAT16, FAT32	
File Types	.divx, .avi	Video Codecs	DivX3, DivX4, DivX5, DivX6
		Audio Codecs	MP3, MPEG2.5 Audio Layer3, AC3, LPCM
	.asf	Video Codec	ISO-MPEG4
		Audio Codec	G.726
Bit Rates	.divx, .avi	Maximum Average	4Mbps
		Maximum Peak	8Mbps
Resolution	.divx, .avi	Minimum	32 × 32
		Maximum	720 × 480
	.asf	Minimum	32 × 32
		Maximum	720 × 576

## Bluetooth® Audio player (if so equipped)



Bluetooth® is a trademark owned by Bluetooth SIG, Inc. and licensed to Visteon Corporation and Clarion Co., Ltd.

- Some Bluetooth® audio devices may not be recognized by the in-vehicle audio system.
- It is necessary to set up the wireless connection between a compatible Bluetooth® audio device and the in-vehicle Bluetooth® module before using the Bluetooth® audio player.
- Operating procedure of the Bluetooth® audio player will vary depending on the device. Make sure you understand how to operate an audio device before using it with this system.
- The Bluetooth® audio player may be stopped under the following conditions:
  - Receiving a hands-free call.
  - Checking the connection to the hands-free phone.
- Do not place a Bluetooth® audio device in an area surrounded by metal or far away from the in-vehicle Bluetooth® module to prevent tone quality degradation and wireless connection disruption.
- While an audio device is connected through a Bluetooth® wireless connection, the bat-

tery power of the device may discharge quicker than usual.

- This system supports the Bluetooth® Audio Distribution Profile (A2DP, AVRCP).
- Wireless LAN (Wi-Fi) and the Bluetooth® functions share the same frequency band (2.4 GHz). Using the Bluetooth® and the wireless LAN functions at the same time may slow down or disconnect the communication and cause undesired noise. It is recommended that you turn off the wireless LAN (Wi-Fi) when using the Bluetooth® functions.

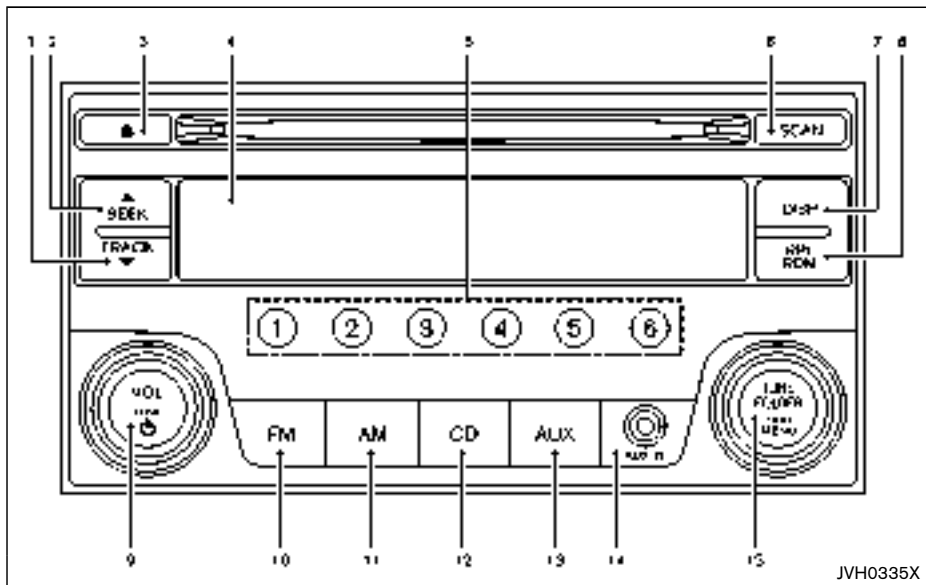

- |                          |   |
|--------------------------|---|
| 1. TRACK button          | 8. RPT (Repeat)-RDM (Random) button       |
| 2. SEEK button           | 9. VOL (volume) control knob/Power button |
| 3. CD EJECT button       | 10. FM button                             |
| 4. Display               | 11. AM button                             |
| 5. Radio memory buttons  | 12. CD button                             |
| 6. SCAN button           | 13. AUX (Auxiliary) button                |
| 7. DISP (Display) button | 14. AUX (Auxiliary) IN jack               |

15. TUNE-FOLDER knob/MENU button

## FM-AM RADIO WITH COMPACT DISC (CD) PLAYER

### Audio main operation

The audio system operates when the ignition switch is in the ACC or ON position.

### ON-OFF/Volume control:

To turn on the audio system, push the Power button.

- The system will turn on in the mode (radio or CD) which was used immediately before the system was turned off.
- If no CD is loaded, the radio will be turned on.

To turn on and off the audio system, push the Power button.

To control the volume, turn the VOL control knob.

### Adjusting sound preference:

1. To adjust the sound settings, push the MENU button until the item (Bass, Treble, Balance, Fade or AUX IN Volume) to be adjusted is displayed.
2. Turn the TUNE knob to adjust the settings.

When no action is taken for 5 seconds, the display will automatically return to the original mode.

### Clock setting:

#### Turning the clock ON/OFF:

1. Push the MENU button until "Clock: ON" or "Clock: OFF" is displayed.
2. Turn the TUNE-FOLDER knob to toggle between "Clock: ON" and "Clock: OFF".

#### Adjusting the clock:

1. Turn on the clock.
2. Push the MENU button until "Adjust Clock" is displayed, and then select the "Yes".
3. Push the MENU button. Turn the TUNE knob to adjust the hour.
4. Push the MENU button. Turn the TUNE knob to adjust the minutes.
5. Push the MENU button to exit the clock mode.

When no action is taken for 5 seconds, the display will automatically return to the original mode.

#### **AUX** AUX button:

The AUX IN jack is located on the audio unit. The AUX IN audio input jack accepts any standard analog audio input such as from a portable cassette tape player, CD player, digital audio player or laptop computer.

Push the AUX button to play a compatible

device when it is plugged into the AUX IN jack. NISSAN strongly recommends using a stereo mini plug cable when connecting your music device to the audio system. Music may not play properly when a monaural cable is used.

#### FM-AM radio operation

##### **FM** / **AM** radio (FM/AM) band select:

When the FM/AM button is pushed while the audio system is off, the audio system will turn on and the radio will turn on.

When the FM/AM button is pushed while another audio source is playing, the other audio source will turn off and the radio will turn on.

To change the radio bands (FM1, FM2, or AM), push the FM/AM buttons.

#### TUNE (Tuning):

When adjusting the broadcasting station frequency manually, turn the TUNE-FOLDER knob until the preferred frequency is achieved.

##### **SEEK** / **TRACK** SEEK tuning:

To adjust the broadcasting station frequency automatically, push and release the SEEK or TRACK button. When the system detects a broadcasting station, it will stop at the station.

Detected stations are skipped while SEEK or

TRACK button is pushed and held.

##### **SCAN** SCAN tuning:

When the SCAN button is pushed, the system will seek and stop at the detected broadcasting station for 5 seconds, and then it will start to seek for the next broadcasting station.

Push the SCAN button in this 5-second period to stop seeking.

#### ① to ⑥ Radio memory operations:

The audio system can store up to 12 FM station frequencies (for FM1 and FM2) and 6 AM station frequencies.

During radio reception, pushing the radio memory button for less than 1.5 seconds will play the stored radio station.

To store the station frequency manually:

1. Tune to the desired broadcasting station frequency using the SEEK /TRACK buttons.
2. Push and hold one of the radio memory buttons ① - ⑥ until a beep sounds.
3. The frequency of the selected channel will appear on the display when the memory is stored properly.
4. Perform steps 1 - 3 for all other memory buttons.



## Compact Disc (CD) player operation

Place the ignition switch in the ACC or ON position, and insert the CD into the slot with the label side facing up. The CD will be guided automatically into the slot and start playing. After loading the disc, the number of tracks on the disc will appear on the display.

If the radio is already operating, it will automatically turn off and the CD will play.

If the system has been turned off while the CD was playing, pushing the Power button will start the CD.

### **CD** CD PLAY:

When the CD button is pushed while a CD is loaded, the CD will start playing.

### **DISP** CD DISPLAY information:

When the DISP is pushed while a CD with title information is playing, the information text on the display will change as follows:

CD:

Track time → Album Title → Artist Name →  
Song Title → Track time

CD with MP3/WMA:

Track time → Folder Title → Album Title → Artist  
Name → Song Title → Track time

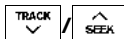

### **Next/Previous Track and Fast Forward/Rewind:**

#### **Fast forward/Rewind:**

Push and hold the FF or REW button for more than 1.5 seconds to fast forward or rewind through the track. Release the button to play the CD at normal speed.

#### **Track up/down:**

To play the next track, push the FF button for less than 1.5 seconds while a CD is playing.

To play the previous track, push the REW button for less than 1.5 seconds within 2 seconds after the current track started playing. To return to the beginning of the current track, push the REW button for less than 1.5 seconds after 2 seconds from when the current track started playing.

### **Folder Selector Knob (CD with MP3/WMA):**

To skip to the next folder, turn the TUNE-FOLDER knob.

To skip to the next or previous track within the folder, push SEEK/TRACK button



### **REPEAT (RPT), RANDOM (RDM):**

When the RPT/RDM button is pushed while a CD is playing, the play mode will change as follows:

CD:

DISC REPEAT → TRACK REPEAT → DISC  
RANDOM → DISC REPEAT

CD with MP3/WMA:

DISC REPEAT → FOLDER REPEAT → TRACK  
REPEAT → DISC RANDOM → FOLDER  
RANDOM → DISC REPEAT

### **SCAN** SCAN tuning:

When the SCAN button is pushed while a CD is being played, the first 10 seconds of all the tracks will be played.

When the SCAN button is pushed again, the CD will return to the regular play mode.

### **EJECT** CD EJECT button:

When the CD EJECT button is pushed with the CD loaded, the CD will be ejected.

When this button is pushed while the CD is being played, the CD will come out and the system will turn off.

**If the CD comes out and is not removed, it will be pulled back into the slot to protect it.**

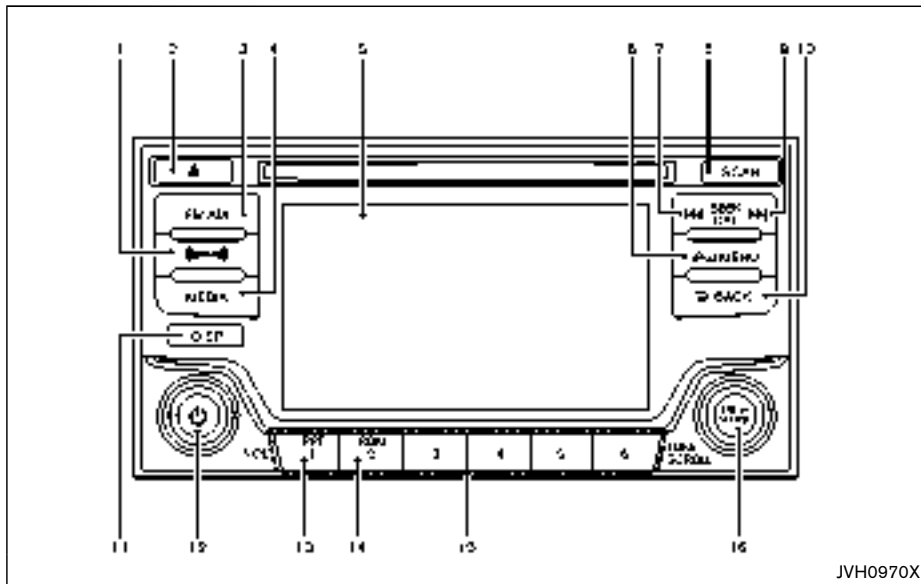

JVH0970X

- |  |   |
|--|---|
| 1. XM band select button                                   | 8. Radio SCAN tuning button                                     |
| 2. CD EJECT button   | 9. Radio CAT (category)/FF (fast forward) button for SEEK/TRACK |
| 3. FM-AM band select button                                | 10. BACK button   |
| 4. MEDIA button  | 11. DISP (display) button                                       |
| 5. Color display   | 12. Power button/VOL (volume) control knob                      |
| 6. iPod MENU button  | 13. RPT (repeat) play button                                    |
| 7. Radio CAT (category)/REW (rewind) button for SEEK/TRACK |   |

- 14. RDM (random) play button
- 15. Radio station preset select buttons
- 16. ENTER/SETTING button/TUNE-SCROLL control knob

### FM-AM-SAT RADIO WITH COMPACT DISC (CD) PLAYER (Type A)

For all operation precautions, see "Audio operation precautions" (P.4-61).

- No satellite radio reception is available when the SAT band option is selected unless the optional satellite receiver and antenna are installed, and there is an active SiriusXM Satellite Radio subscription.
- The satellite radio mode requires an active SiriusXM Satellite Radio subscription. The satellite radio is not available in Alaska, Hawaii and Guam.
- It may take some time to receive the activation signal after subscribing the SiriusXM Satellite Radio. After receiving the activation signal, an available channel list will be automatically updated in the radio. Push the ignition switch from LOCK to ACC to update the channel list.

## Audio main operation

The audio system operates when the ignition switch is placed in the ON or ACC position.

### Head unit:

The auto loudness circuit enhances the low and high frequency ranges automatically in both radio reception and CD playback.

### Power button / VOL (volume) control knob:

Push the Power button/VOL (volume) control knob to turn on and off the audio system.

Turn the Power button/VOL (volume) control knob to adjust the volume.

### Audio settings:

The settings screen will appear when pushing the ENTER/SETTING button.

The following items are available in the settings screen.

- Bluetooth  
It is possible to set the Bluetooth® settings. For details of the Bluetooth® settings, see “Bluetooth® audio player operation” (P.4-84).
- Bass, Treble, Balance and Fade  
Controls the sound of the audio system. Balance adjusts the sound between the left and right speakers. Fade adjusts the sound

between the front and rear speakers.

Select the “Bass”, “Treble”, “Balance” or “Fade” using the TUNE-SCROLL control knob and then push the ENTER/SETTING button. Turn the TUNE-SCROLL control knob to adjust the Bass, Treble, balance and Fade of the screen to the preferred level.

- Brightness and Contrast  
Adjust the brightness and contrast of the screen.  
Select the “Brightness” or “Contrast” using the TUNE-SCROLL control knob and then push the ENTER/SETTING button. Turn the TUNE-SCROLL control knob to adjust the brightness and contrast of the screen to the preferred level.
- Clock Adjust  
Adjust the clock according to the following procedure.
  - 1) Select “Clock Adjust” using the TUNE-SCROLL control knob and then push the ENTER/SETTING button.
  - 2) Adjust the hour with the TUNE-SCROLL control knob and then push the ENTER/SETTING button.
  - 3) Adjust the minute with the TUNE-SCROLL control knob and then push the ENTER/SETTING button.

24 hour clock is not available.

- On-Screen Clock  
When this item is turned on, a clock is always displayed in the upper right corner of the screen.  
Select the “On-Screen Clock” using the TUNE-SCROLL control knob and then push the ENTER/SETTING button. You can toggle between ON and OFF using the TUNE-SCROLL control knob.
- RDS Display (if so equipped)  
RDS (radio data system) information can be shown on the display. Select “RDS Display” using the TUNE-SCROLL control knob and then push the ENTER/SETTING button. You can toggle between ON and OFF using the TUNE-SCROLL control knob.
- Speed Sensitive Vol.  
To change the Speed Sensitive Volume (Speed Sensitive Vol.) level from off (0) to 5, turn the TUNE-SCROLL control knob.
- AUX Vol.  
Controls the volume level of incoming sound when an auxiliary device is connected to the system. Choose a setting between +1 and +3 or choose 0 to disable the feature entirely.

- Language Select

The language settings can be changed.

Select "Language Select" using the TUNE-SCROLL control knob and then push the ENTER/SETTING button. Use the TUNE-SCROLL control knob knob to select the preferred language.

#### **DISP** DISP button:

Display of the screen can be canceled by pushing the DISP button. You can still listen to music that is being played back even while the screen display is turned off. If you want to display the screen again, either push the DISP button once more or push the FM-AM, CD, MEDIA or iPod MENU button.

#### **MEDIA** MEDIA button:

Pushing the MEDIA button will switch the audio source as follows:

CD → USB/iPod® → Bluetooth → AUX → CD

### FM-AM-SAT radio operation

#### **FM-AM** radio (FM-AM) band select:

Pushing the FM-AM button will change the band as follows:

AM → FM1 → FM2 → AM

#### **XM** radio (SAT) band select:

Pushing the XM band select button will change the band as follows:

XM1 → XM2 → XM3 → XM1

When the XM band select button is pushed while the ignition switch is in the ACC or ON position, the radio will come on at the channel last played.

The last channel played will also come on when the power button is pushed to ON.

The satellite radio is not available in Alaska, Hawaii and Guam.

If another audio source is playing when the radio band select button is turned to ON, the audio source will automatically be turned off and the last radio channel played will come on.

When the stereo broadcast signal is weak, the radio will automatically change from stereo to monaural reception.

### TUNE (Tuning):

- For AM and FM radio  
Turn the radio TUNE-SCROLL control knob for manual tuning.
- For SiriusXM Satellite Radio  
Turn the radio TUNE-SCROLL control knob to seek channels from all of the categories when any category is not selected.

#### **◀◀ ▶▶** SEEK tuning/CAT (category):

- For AM and FM radio  
Push the SEEK button ◀◀ or ▶▶ to tune from low to high or high to low frequencies and to stop at the next broadcasting station.
- For SiriusXM Satellite Radio  
Push the SEEK button ◀◀ or ▶▶ to tune to the first channel of the next or previous category.

#### **SCAN** SCAN tuning:

Push the SCAN tuning button to tune from low to high frequencies and stop at each broadcasting station for 5 seconds. Pushing the button again during this 5 seconds period will stop SCAN tuning and the radio will remain tuned to that station.

If the SCAN tuning button is not pushed within 5 seconds, SCAN tuning moves to the next

station.

**1** to **6** **Station memory operations:**

12 stations can be set for the FM band (6 each for FM1 and FM2) and 6 stations can be set for the AM band.

1. Choose the radio band using the FM·AM button.
2. Tune to the desired station using the SEEK·TRACK, SCAN button or the TUNE·SCROLL control knob.
3. Push and hold the desired station preset button **1** to **6** until beep sounds.
4. The station indicator will then come on and the sound will resume. Memorizing is now complete.
5. Other buttons can be set in the same manner.

If the battery cable is disconnected, or if the fuse opens, the station memory will be erased. In that case, reset the desired stations.

### CD player operation

Place the ignition switch in the ON or ACC position. Insert the Compact Disc (CD) into the slot with the label side facing up. The CD will be guided automatically into the slot and start playing.

After loading the CD, the number of tracks on the CD and the play time will appear on the display.

If the radio is already operating, it will automatically turn off and the CD will play.

If the system has been turned off while the CD was playing, pushing the Power/VOL dial will start the CD.

**MEDIA** **PLAY:**

With a CD loaded, press the Media button until the CD mode is displayed on the screen.

**⏮** **⏭** **SEEK/CAT:**

When the **⏮** or **⏭** button is pushed for more than 1.5 seconds while the CD is being played, the CD will play while fast forwarding or rewinding. When the button is released, the CD will return to normal play speed.

When the **⏮** or **⏭** button is pushed for less than 1.5 seconds while the CD is being played, the next track or the beginning of the current

track on the CD will be played.

**RPT** **REPEAT (RPT):**

When the RPT button is pushed while the CD is played, the play pattern can be changed as follows:

(CD)

(Normal) ⇔ 1 Track Repeat

(CD with compressed audio files)

(Normal) → 1 Folder Repeat → 1 Track Repeat → (Normal)

**RDM** **RANDOM (RDM):**

When the RDM button is pushed while a CD is being played, the play pattern can be changed as follows:

(CD)

(Normal) ⇔ 1 Disc Random

(CD with compressed audio files)

(Normal) → 1 Disc Random → 1 Folder Random → (Normal)

**▲** **CD eject:**

When the CD eject button is pushed with the CD loaded, the CD will be ejected.

When this button is pushed while the CD is being played, the CD will be ejected.

If the CD comes out and is not removed, it will be pulled back into the slot to protect it.

USB (Universal Serial Bus) connection port

### **WARNING**

Do not connect, disconnect or operate the USB device while driving. Doing so can be a distraction. If distracted you could lose control of your vehicle and cause an accident or serious injury.

### **CAUTION**

- Do not force the USB device into the USB port. Inserting the USB device tilted or up-side-down into the port may damage the port. Make sure that the USB device is connected correctly into the USB port.
- Do not grab the USB port cover (if so equipped) when pulling the USB device out of the port. This could damage the port and the cover.

- Do not leave the USB cable in a place where it can be pulled unintentionally. Pulling the cable may damage the port.

Refer to your device manufacturer's owner information regarding the proper use and care of the device.

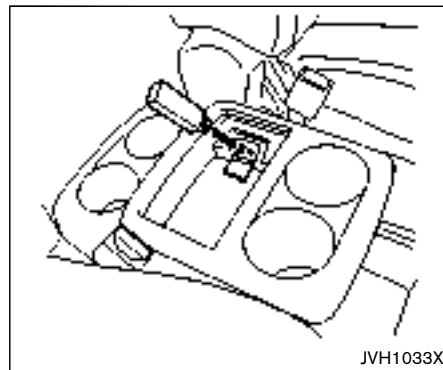

#### **Audio main operation:**

The USB connection port is located in the center console. Open the lid and connect a USB memory as illustrated. Then, switch to the USB memory mode automatically.

If the system has been turned off while the USB memory was playing, pushing the Power button will start the USB memory.

#### **MEDIA PLAY:**

When the MEDIA button is pushed with the system off and the USB memory inserted, the system will turn on.

If another audio source is playing with a USB

device inserted, push the MEDIA button repeatedly until the center display changes to the USB memory mode.

 **Next/Previous Track and Fast Forward/Rewind:**

When the FF or REW button is pushed for more than 1.5 seconds while a USB memory is being played, the USB memory will play while forwarding or rewinding. When the button is released, the USB memory will return to normal play speed.

When the FF or REW button is pushed for less than 1.5 seconds while the USB memory is being played, the next track or the beginning of the current track on the USB memory will be played.

**Folder selection:**

To change to another folder in the USB memory, choose a folder displayed on the screen using the TUNE:SCROLL knob.

 **REPEAT (RPT):**

When the RPT button is pushed while the USB memory is played, the play pattern can be change as follows.

To change the play mode, push the RPT button repeatedly and the mode will change as follows.

(Normal) → 1 Folder Repeat → 1 Track Repeat → (Normal)

 **RANDOM (RDM):**

When the RDM button is pushed while a USB memory is being played, the play pattern can be changed as follows.

To change the play mode, push the RDM button repeatedly, and the mode will change as follows.

(Normal) → All Random → 1 Folder Random → (Normal)

 **BACK button:**

When the BACK button is pushed, it returns to the previous display.

iPod® player operation

 **WARNING**

**Do not connect, disconnect or operate the USB device while driving. Doing so can be a distraction. If distracted you could lose control of your vehicle and cause an accident or serious injury.**

 **CAUTION**

- **Do not force the USB device into the USB port. Inserting the USB device tilted or up-side-down into the port may damage the port. Make sure that the USB device is connected correctly into the USB port.**
- **Do not grab the USB port cover (if so equipped) when pulling the USB device out of the port. This could damage the port and the cover.**
- **Do not leave the USB cable in a place where it can be pulled unintentionally. Pulling the cable may damage the port.**

Refer to your device manufacturer's owner information regarding the proper use and care of the device.

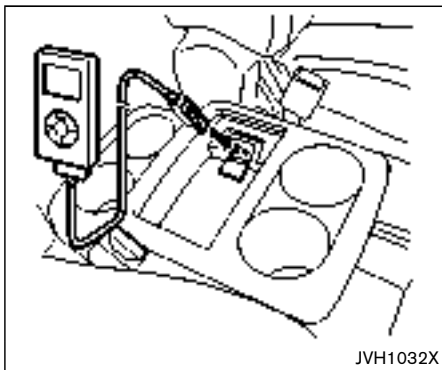

### Connecting iPod®:

The USB connection port is located in the center console. Open the lid and connect the iPod® cable to the USB connector. The battery of the iPod® is charged while the connection to the vehicle.

Depending on the version of the iPod®, the display on the iPod® shows a NISSAN or Accessory Attached screen when the connection is completed. When the iPod® is connected to the vehicle, the iPod® music library can only be operated by the vehicle audio controls.

### Compatibility:

The following models are available:

- Third generation iPhone® (Firmware version IOS4/4.0)
- Fourth generation iPhone® (Firmware version IOS4/4.0)
- Fifth generation iPod® (Firmware version 1.3)
- First generation iPod Classic® (Firmware version 1.1.1 or 1.1.2PC)
- Second generation iPod Classic® (Firmware version 2.0.1)
- First generation iPod touch® (Firmware version 1.1.5 or 2.2.1)
- Second and third generation iPod touch® (Firmware version 2.2.1 or IOS4/4.0.0)
- First generation iPod nano® (Firmware version 1.3.1)
- Second generation iPod nano® (Firmware version 1.1.3)
- Third generation iPod nano® (Firmware version 1.1.2PC or 1.1.3PC)
- Fourth generation iPod nano® (Firmware version 1.0.2 or 1.0.4)
- Fifth generation iPod nano® (Firmware version 1.0.1 or 1.0.2)

The iPod touch® may not response quickly with the system in some cases.

Make sure that the iPod® firmware is updated.

### Audio main operation:

Place the ignition switch in the ACC or ON position. Then, push the iPod MENU button to switch to the iPod® mode.

You can also switch to the iPod® mode by pushing the MEDIA button repeatedly.

If the system has been turned off while the iPod® was playing, pushing the Power button will start the iPod®.

### iPod MENU button:

Place the ignition switch in the ACC or ON position. Then, push the iPod MENU button to switch to the iPod® mode.

If another audio source is playing with an iPod® connected, pushing the iPod MENU button changes to the iPod® mode.

You can also switch to the iPod® mode by pushing the MEDIA button repeatedly.

If the system has been turned off while the iPod® was playing, pushing the Power button will start the iPod®.

When the iPod MENU button is pushed while the iPod® is connected, the interface for iPod® operation is shown on the audio display. The items on the menu list can be scrolled by pushing the ◀◀ or ▶▶ while the iPod® is



operational. To select an item, push ENTER. Items in the iPod® menu appear on the display in the following order.

- Now Playing
- Playlists
- Artists
- Albums
- Songs
- Podcasts
- Genres
- Composers
- Audiobooks
- Shuffle Songs

For more information about each item, see the iPod® Owner's Manual.

  **Next/Previous Track and Fast Forward/Rewind:**

When the FF or REW button is pushed for more than 1.5 seconds while the iPod® is playing, the iPod® will play while fast forwarding or rewinding. When the button is released, the iPod® will return to the normal play speed.

When the FF or REW button is pushed for less than 1.5 seconds while the iPod® is playing, the next track or the beginning of the current track on the iPod® will be played. Push the buttons several times to skip through the tracks.

The multi-function controller can also be used to select tracks when the iPod® is playing.

 **REPEAT (RPT):**

When the RPT play button is pushed while a track is being played, the play pattern can be changed as follows:

(Repeat Off) → 1 Track Repeat → All Repeat → (Repeat Off)

 **Random (RDM):**

When the RDM play button is pushed while a track is being played, the play pattern can be changed as follows:

(Shuffle Off) → Track Shuffle → (Shuffle Off)

 **BACK button:**

When the BACK button is pushed, it returns to the previous display.

## Bluetooth® audio player operation

If you have a compatible Bluetooth® audio device that is capable of playing audio files, the device can be connected to the vehicle's audio system so that the audio files on the device play through the vehicle's speakers.

### Regulatory information:

#### Bluetooth® trademark:



Bluetooth® is a trademark owned by Bluetooth SIG, Inc. and licensed to Visteon Corporation.

### Connecting Bluetooth® device:

To connect your Bluetooth® device to the vehicle, follow the procedure below:

1. Push the ENTER/SETTING button.

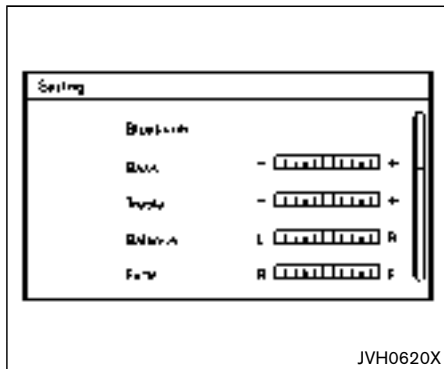

JVH0620X

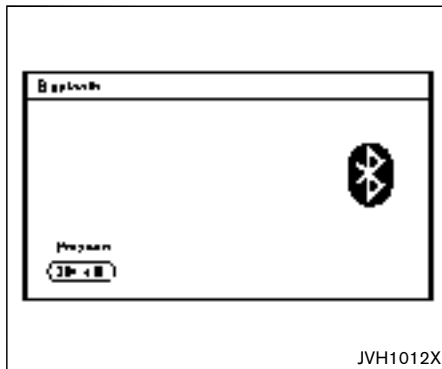

JVH1012X

2. Select the "Bluetooth" key.
3. Select the "Add Phone" key. This same screen can be accessed to remove, replace or select a different Bluetooth® device.
4. The system acknowledges the command and asks you to initiate connecting from the Bluetooth® device. The connecting procedure of the Bluetooth® device varies according to each cellular phone model. See the Owner's manual of the Bluetooth® device for details.

#### Bluetooth® audio main operation:

To switch to the Bluetooth® audio mode, push the MEDIA button repeatedly until the Bluetooth® audio mode is displayed on the screen.

The controls for the Bluetooth® audio are displayed on the screen. Use the Preset 3 button to play and use the Preset 4 button to pause.

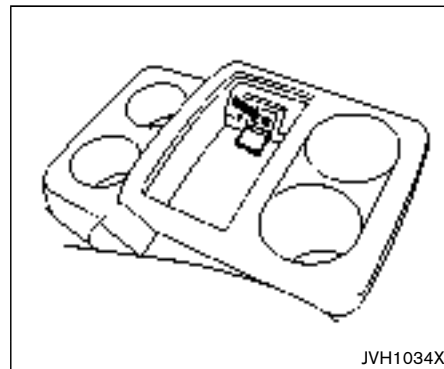

JVH1034X

#### AUX (Auxiliary) input

##### AUX IN jack:

The AUX IN jack is located in the center console. The AUX IN audio input jack accepts any standard analog audio input such as from a portable cassette tape/CD player, MP3 player or laptop computer.

##### **MEDIA** MEDIA button:

Push the MEDIA button repeatedly to play a compatible device when it is plugged into the AUX IN jack.

NISSAN strongly recommends using a stereo mini plug cable when connecting your music

device to the audio system. Music may not play properly when a monaural cable is used.

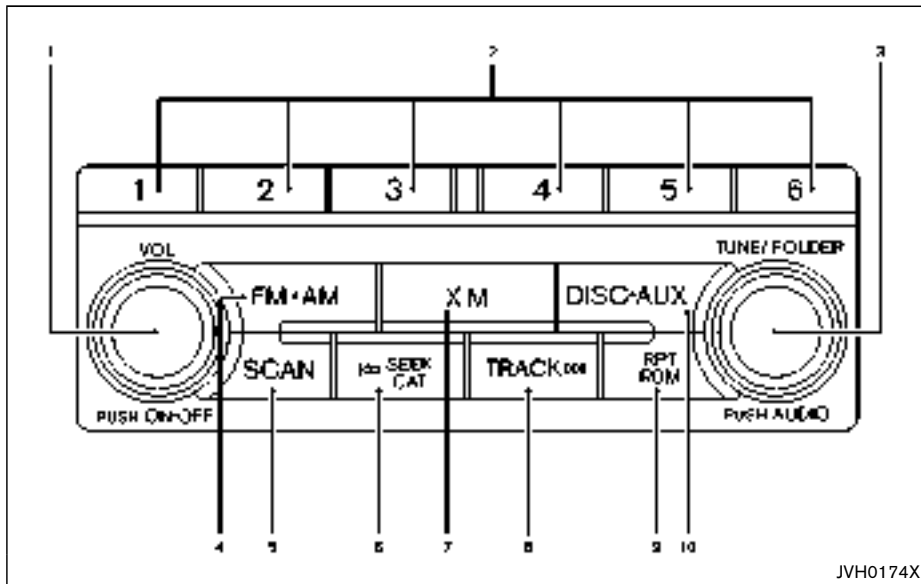

- |  |  |
|--|--|
| 1. ON-OFF button/VOL (volume) control knob                 | 7. XM button                               |
| 2. Radio station preset buttons                            | 8. FF (fast forward) button for SEEK/TRACK |
| 3. AUDIO control button/Radio tuning/FOLDER selector knob  | 9. RPT (repeat)/RDM (random) play button   |
| 4. FM-AM band select button                                | 10. DISC-AUX button                        |
| 5. Radio SCAN (tuning) button                              |  |
| 6. Radio CAT (category)/REW (rewind) button for SEEK/TRACK |  |

## FM-AM-SAT RADIO WITH COMPACT DISC (CD) PLAYER (Type B)

For all operation precautions, see "Audio operation precautions" (P.4-61).

The satellite radio mode requires an active SiriusXM Satellite Radio subscription. The satellite radio is not available in Alaska, Hawaii and Guam.

It may take some time to receive the activation signal after subscribing the SiriusXM Satellite Radio. After receiving the activation signal, an available channel list will be automatically updated in the radio. Push the ignition switch from LOCK to ACC to update the channel list.

### Audio main operation

#### Head unit:

The auto loudness circuit enhances the low and high frequency ranges automatically in both radio reception and CD playback.

#### ON-OFF/Volume control:

Push the ignition switch to the ACC or ON position, and then push the ON-OFF button while the system is off to turn on the last audio source, which was playing immediately before the system was turned off. While the system is on, pushing the ON-OFF button turns the system off.

Turn the VOL control knob to adjust the volume.

### Adjusting tone quality and speaker balance:

To adjust Bass, Treble, Balance and Fade, push the Audio control knob. When the display shows the setting you want to change (Bass, Treble, Balance and Fade), rotate the Audio control knob to set the desired setting. For the other setting methods, see "How to use SETTING button" (P.4-15).

This vehicle has some sound effect functions as follows:

- Speed Sensitive Vol.

For more details, see "Vehicle information and settings (models with center multi-function control panel)" (P.4-10).

### Switching the display:

Pushing the DISC-AUX button will switch the displays as follows:

iPod®/USB → CD/DVD → Bluetooth® Audio (if so equipped) → AUX → iPod®/USB

### FM-AM-SAT radio operation

When the radio band select button is pushed while the ignition switch is in the ACC or ON position, the radio will come on at the channel last played.

The last channel played will also come on when the ON-OFF button is pushed to ON.

If another audio source is playing when the radio band select button is turned on, the audio source will automatically be turned off and the last radio channel played will come on.

When the stereo broadcast signal is weak, the radio will automatically change from stereo to monaural reception.

#### **radio (FM/AM) band select:**

Pushing the radio band select button will change the band as follows:

AM → FM1 → FM2 → AM

#### **radio (SAT) band select:**

Pushing the radio band select button will change the band as follows:



XM1 → XM2 → XM3 → XM1

The satellite radio is not available in Alaska, Hawaii and Guam.

### TUNE (Tuning):

- For AM and FM radio  
Turn the radio TUNE knob for manual tuning.
- For SiriusXM Satellite Radio  
Turn the radio TUNE knob to seek channels from all of the categories when any category is not selected.

#### **SEEK tuning/CATEGORY (CAT):**

- For AM and FM radio  
Push the SEEK button  or  to tune from low to high or high to low frequencies and to stop at the next broadcasting station.
- For SiriusXM Satellite Radio  
Push the SEEK button  or  to tune to the first channel of the next or previous category.

During satellite radio reception, the following notices will be displayed under certain conditions.

- NO SIGNAL (No signal is received while the SAT tuner is connected.)
- OFF AIR (Broadcasting signed off)
- CHECK ANTENNA (Antenna connection error)
- LOADING (When the initial setting is performed)

- UPDATING (When the satellite radio subscription is not active)

#### **SCAN SCAN tuning:**

Push the SCAN tuning button to tune from low to high frequencies and stop at each broadcasting station/channel for 5 seconds. Pushing the button again during this 5 seconds period will stop SCAN tuning and the radio will remain tuned to that station/channel.

If the SCAN tuning button is not pushed within 5 seconds, SCAN tuning moves to the next station/channel.

#### **① to ⑥ Station memory operations:**

12 stations/channels can be set for the FM band (6 each for FM1 and FM2), 18 for SiriusXM Satellite Radio (6 each for XM1, XM2 and XM3) and 6 stations can be set for the AM band.

1. Choose the radio band using the radio band select button.
2. Tune to the desired station/channel using the SEEK/TRACK, SCAN button or the radio TUNE knob.
3. Push and hold the desired station preset button ① to ⑥ until the radio mutes.
4. The station indicator will then come on and the sound will resume. Memorizing is now complete.

5. Other buttons can be set in the same manner.

If the battery cable is disconnected, or if the fuse opens, the radio memory will be erased. In that case, reset the desired stations/channels.

#### **List (AM and FM radio) (models with navigation system):**

When the "List" key on the display is selected while the FM or AM radio is being played, the preset station list will be displayed.

If 1 of the 6 preset stations listed is touched and held, the current station will be stored as the new preset.

#### **Menu (SiriusXM Satellite Radio):**

When the "Menu" key on the display is selected while the SiriusXM Satellite Radio is being played, the menu list will be displayed.

The following items are available.

- Preset List  
Displays the preset channel list. If 1 of the 6 preset stations listed is touched and held, the current station will be stored as the new preset.
- Customize Channel List  
Selects specific channels to skip while using the TUNE, SEEK/CATEGORY or Menu-Categories feature.

- Favorite Artists & Songs

Stores the current artist or song that is being played. Touch the "Alert" key to be reminded when the stored artist or song is playing on a station while listening to SiriusXM Satellite Radio.

- Categories

Selecting a category will go to the first channel in that category as defined by SiriusXM Satellite Radio.

- Direct Tune

Inputs the channel number by using a keypad.

#### **Text (models without navigation system):**

When the "Text" key is selected with the multi-function controller on the display and then the ENTER button is pushed while the satellite radio is being played, the text information listed below will be displayed on the screen.

- CH Name
- Category
- Name
- Title
- Other

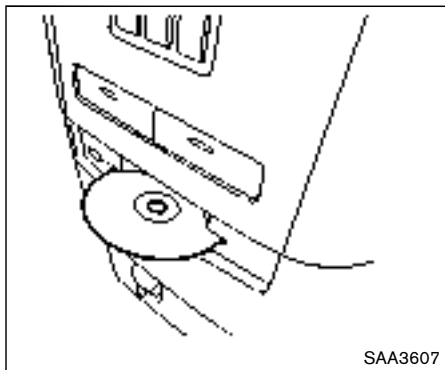

### Compact Disc (CD) player operation

The CD slot is located on the instrument lower panel.

Push the ignition switch to the ACC or ON position and insert the Compact Disc (CD) into the slot with the label side facing up. The CD will be guided automatically into the slot and start playing.

After loading the CD, the number of tracks on the CD and the play time will appear on the display.

If the radio is already operating, it will automatically turn off and the CD will play.

If the system has been turned off while the CD

was playing, pushing the ON-OFF button will start the CD.

Do not use 3.1 in (8 cm) discs.

#### **DISC-AUX PLAY:**

When the DISC-AUX button is pushed with the system off and the CD loaded, the system will turn on and the CD will start to play.

When the DISC-AUX button is pushed with the CD loaded and the radio playing, the radio will automatically be turned off and the CD will start to play.

#### **Menu (models with navigation system):**

When the "Menu" key on the display is selected while the CD is being played, the menu screen will be displayed. The following menu options are available.

- Folder List (CD with compressed audio files)  
Displays the folder list.
- Track List  
Displays the track list.
- Play Mode  
Select a play mode from the following items.
  - Normal
  - 1 Folder Repeat (CD with compressed audio files)

- 1 Track Repeat
- 1 Disc Random
- 1 Folder Random (CD with compressed audio files)



#### **Text (models without navigation system):**



When the "Text" key is selected in the screen using the multi-function controller and then the ENTER button is pushed while the CD is being played, the music information below will be displayed on the screen.

CD:

- Disc title
  - Track title
- CD with compressed audio files:
- Folder title
  - File title
  - Song title
  - Album title
  - Artist

#### **Next/Previous Track and Fast Forward/Rewind:**

When the  or  button is pushed for more than 1.5 seconds while the CD is being played, the CD will play while fast forwarding or rewinding. When the button is released, the CD will return to normal play speed.

When the  or  button is pushed for less than 1.5 seconds while the CD is being played, the next track or the beginning of the current track on the CD will be played.

 **REPEAT (RPT), RANDOM (RDM):**

When the RPT button is pushed while the CD is played, the play pattern can be changed as follows:

(CD)

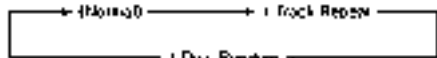

(CD with compressed audio files)

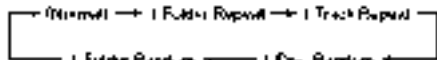

 **CD EJECT:**

When the CD EJECT button is pushed with the CD loaded, the CD will be ejected.

When this button is pushed while the CD is being played, the CD will be ejected.

**If the CD comes out and is not removed, it will be pulled back into the slot to protect it.**

## DVD (Digital Versatile Disc) PLAYER OPERATION (if so equipped)

### Precautions

Start the engine when using the DVD entertainment system.

Movies will not be shown on the front display while the vehicle is in any drive position to reduce driver distraction. Audio is available when a movie is played. To view movies in the front display, stop the vehicle in a safe location, move the shift lever to the P (Park) position and apply the parking brake.

### WARNING

- **The driver must not attempt to operate the DVD system or wear the headphones while the vehicle is in motion so that full attention may be given to vehicle operation.**
- **Do not attempt to modify the system to display a movie on the front screen while the vehicle is being driven. Doing so may distract the driver and may cause a collision and serious personal injury or death.**

### CAUTION

- **Only operate the DVD while the vehicle engine is running. Operating the DVD for extended periods of time with the engine OFF can discharge the vehicle battery.**
- **Do not allow the system to get wet. Excessive moisture such as spilled liquids may cause the system to malfunction.**
- **While playing VIDEO-CD media, this DVD player does not guarantee complete functionality of all VIDEO-CD formats.**

### Display settings

To adjust the front display mode, push the SETTING button while the DVD is being played.

To adjust the display ON/OFF, brightness, tint, color and contrast, select the "Display Adjustment" key and then select each key.

Then you can adjust each item using the multi-function controller. After changes have been made push the BACK button to save the setting.





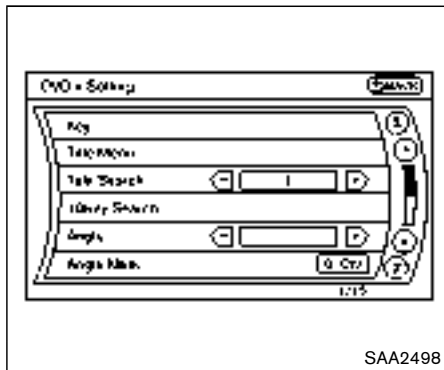

Type A (example)

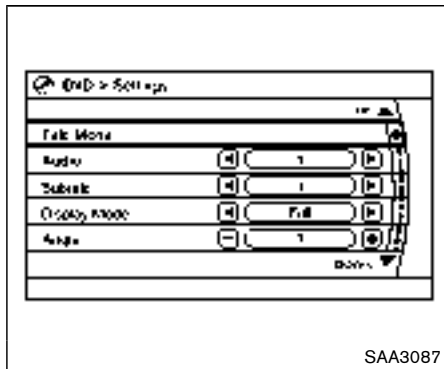

Type B (example)

## DVD settings

Select the "Settings" key to adjust the following settings.

### Key (DVD-VIDEO) (Type A):

Keys for the DVD menu operation are displayed.



: Move the cursor to select a DVD menu.

Enter: Enter the selected menu.

Move: Change the display location by moving the operation key.

Back: Return to the previous screen.



Hide: Hide the operation key.

### Title Menu (DVD-VIDEO):

Some menus specific to each disc will be shown. For details, see the instructions on the disc.

### Title Search (DVD-VIDEO, DVD-VR):

The scene with the specified title will be displayed each time the "+" side or "-" side is selected.

### Group Search (VIDEO CD):

A scene in the specified group will be displayed each time the "+" side or "-" side is selected.

## 10 Key Search (DVD-VIDEO, VIDEO-CD, CD-DA, DVD-VR):

Select the "10 Key Search" key to open the number entry screen. Input the number to be searched and select the "OK" key. The specified Title/Chapter or Group/Track will be played.

### Select No. (VIDEO-CD):

Select the "Select No." key to open the number entry screen. Input the number to be searched and select the "OK" key. The specified scene will be played.

### Angle (DVD-VIDEO):

If the DVD contains different angles (such as moving images), the current image angle can be switched to another one. Select the "Angle" key. The angle will change each time the "+" side or "-" side is selected.

### Angle Mark (DVD-VIDEO):

When this item is turned on, an angle mark will be shown on the bottom of the screen if the scene can be seen from a different angle.

### Menu Skip (DVD-VIDEO):

DVD menus are automatically configured and the contents will be played directly when the "Menu Skip" key is turned on. Note that some discs may not be played directly even if this item is turned on.

**CM Skip (DVD-VIDEO) (Type A):**

Select the "CM Skip" key. Choose the setting time from 15, 30 or 60 seconds by selecting the "+" side or "-" side.

**DRC (DVD-VIDEO, DVD-VR):**

DRC (Dynamic Range Compression) automatically adjusts the soundtrack volume level to maintain a more even sound to the speakers.

**DVD Language (DVD-VIDEO, VIDEO-CD):**

Select the "DVD Language" key to open the number entry screen. Input the number corresponding to the preferred language and select the "OK" key. The DVD top menu language will be changed to the one specified.

**Display:**

To adjust the image quality of the screen, select the preferred adjustment items.

**Audio:**

Select the preferred language for audio.

**Subtitle (DVD-VIDEO, DVD-VR):**

Select the preferred language for subtitles.

**Display Mode (DVD-VIDEO, VIDEO-CD, DVD-VR):**

Select from the "Full", "Wide", "Normal" or "Cinema" modes.

**Title List (DVD-VR):**

Select the preferred title from the list.

**Play Mode:**

Select the preferred play mode.

**PG/PL Mode (DVD-VR):**

Select the "PG" or "PL" mode.

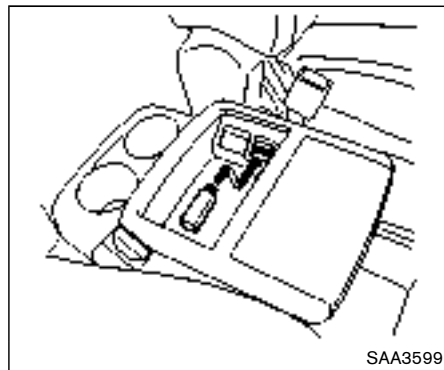

USB (Universal Serial Bus) CONNECTION PORT (models with center multi-function control panel)

**Audio main operation**

The USB connection port is located in the center console.

Open the USB connection port cover and connect a USB memory as illustrated. Then, push the DISC-AUX button repeatedly to switch to the USB memory mode.

If the system has been turned off while the USB memory was playing, pushing the ON-OFF/VOL control knob will start the USB memory.



## WARNING

Do not connect, disconnect or operate the USB device while driving. Doing so can be a distraction. If distracted you could lose control of your vehicle and cause an accident or serious injury.



## CAUTION

- Do not force the USB device into the USB port. Inserting the USB device tilted or up-side-down into the port may damage the port. Make sure that the USB device is connected correctly into the USB port.
- Do not grab the USB port cover (if so equipped) when pulling the USB device out of the port. This could damage the port and the cover.
- Do not leave the USB cable in a place where it can be pulled unintentionally. Pulling the cable may damage the port.

Refer to your device manufacturer's owner information regarding the proper use and care of the device.



File selection (models with navigation system)

When there are both audio and movie files in the USB memory, the mode select screen is displayed. Select the preferred content to play.

When there is only one type of file, the audio or movie operation screen is displayed and starts to play.

If a video file restricts the number of playbacks, a pop-up screen will appear to confirm it is ok to play. Answer yes or no as requested by the display.

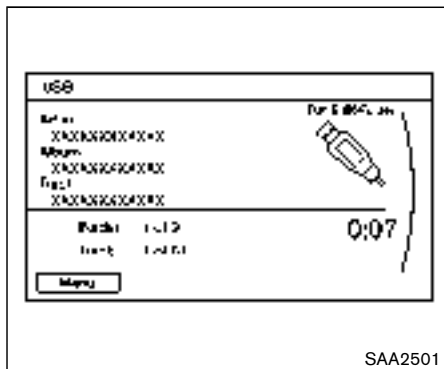

SAA2501

Models with navigation system

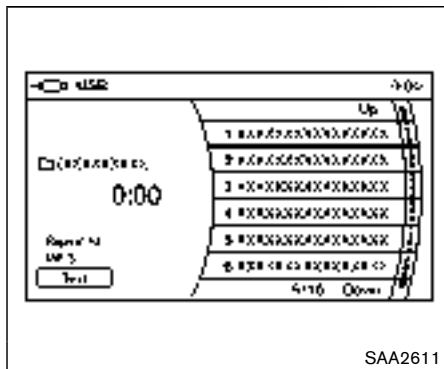

SAA2611

Models without navigation system

## Audio file operation

### **DISC/AUX** **PLAY:**

When the DISC/AUX button is pushed with the system off and the USB memory inserted, the system will turn on.

If another audio source is playing and a USB memory is inserted, push the DISC/AUX button repeatedly until the center display changes to the USB memory mode.

### **Next/Previous Track and Fast Forward/Rewind:**

When the **Next/Previous Track** or **Fast Forward/Rewind** button is pushed for more than 1.5 seconds while a USB memory is being played, the USB memory will play while forwarding or rewinding. When the button is released, the USB memory will return to normal play speed.

When the **Next/Previous Track** or **Fast Forward/Rewind** button is pushed for less than 1.5 seconds while the USB memory is being played, the next track or the beginning of the current track on the USB memory will be played.

The multi-function controller can also be used to select tracks when the USB memory is being played.

## Folder selection:

To change to another folder on the USB memory, turn the FOLDER selector or choose a folder displayed on the screen using the multi-function controller.

### **RPT/RDM** **REPEAT (RPT), RANDOM (RDM):**

When the RPT/RDM button is pushed while the USB memory is played, the play pattern can be change as follows.

To change the play mode, push the RPT button repeatedly and the mode will change as follows.

Normal → 1 Folder Repeat → 1 Track Repeat → All Random → 1 Folder Random → Normal

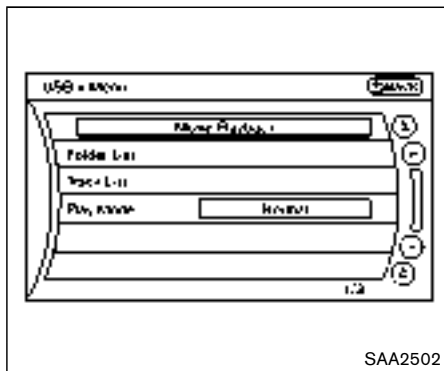

SAA2502

### Menu (models with navigation system):

There are some options available during playback. Select one of the following options that are displayed on the screen if necessary. Refer to the following information for each item.

- **Movie Playback**

Switch to the movie playback mode. This item is displayed only when a USB memory contains movie files.

- **Folder List/Track List**

Displays the folder or track list. The "Movie Playback" key is also displayed in this list screen, and enables switching to the movie playback mode.

- **Play Mode**

Select the preferred play mode.

### Text (models without navigation system):

When the "Text" key is selected on the screen using the multi-function controller and then the ENTER button is pushed while a USB memory is being played, the music information listed below will be displayed on the screen.

- Folder title
- File title
- Song title
- Album Title
- Artist

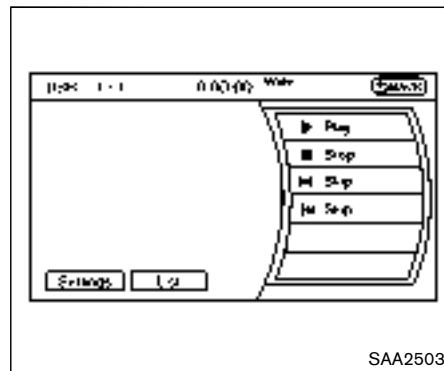

SAA2503

Movie file operation (models with navigation system)

**Park the vehicle in a safe location for the front seat occupants to operate the USB memory while watching the images.**

### DISC AUX PLAY:



When the DISC-AUX button is pushed with the system off and the USB memory inserted, the system will turn on.

If another audio source is playing and a USB memory is inserted, push the DISC-AUX button repeatedly until the center display changes to the USB memory mode.

### Operation keys:

To operate the USB memory, select the desired key displayed on the operation screen using the multi-function controller.

#### **Pause**

Select the "" key to pause the movie file. To resume playing the movie file, select the "" key.

#### **Play**

Select the "" key to start playing a movie file, for example, after pausing a movie file.



#### **STOP**

Select the "" key to stop playing a movie file.

#### **Skip (Next chapter)**

Select the "" key to skip the chapter(s) of the file forward. The chapters will advance the number of times the ENTER button is pushed.

#### **Skip (Previous chapter)**

Select the "" key to skip the chapter(s) of the file backward. The chapters will go back the number of times the "" key is selected.

### List:

Select the "List" key on the movie file operation screen to display the file list.

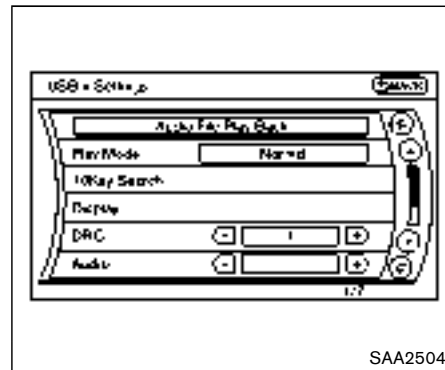

Example

### Settings:

Select the "Settings" key to adjust the following settings.

- **Audio File Playback**

Switch to the audio playback mode. This item is displayed only when the USB memory contains audio files.

- **Play Mode**

Select the "Normal" or "1 Track Repeat" play mode.

- **10 Key Search**

Select the "10 Key Search" key to open the number entry screen. Input the number to be searched and select

the "OK" key.

The specified folder/file will be played.

- **Display**

To adjust the image quality of the screen, select the preferred adjustment items.

- **DRC**

DRC (Dynamic Range Compression) automatically adjusts the soundtrack volume level to maintain a more even sound to the speakers.

- **Audio**

Select the preferred language for audio.

- **Subtitle**

Select the preferred language for subtitle.

- **Display Mode**

Select the "Normal", "Wide", "Cinema" or "Full" mode.

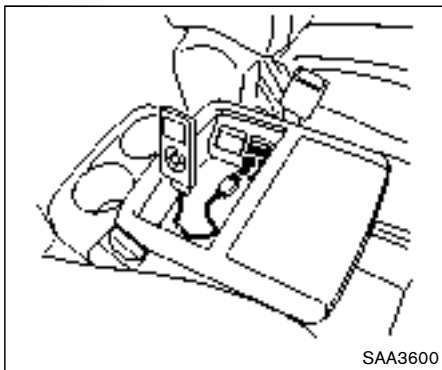

iPod® PLAYER OPERATION (models with center multi-function control panel)

### Connecting iPod®

The USB connection port is located in the center console.

Open the USB connection port cover and connect the iPod® cable to the USB connector. If compatible, the battery of the iPod® is charged while the connection to the vehicle.

Depending on the version of the iPod®, the display on the iPod® shows a NISSAN or Accessory Attached screen when the connection is completed. When the iPod® is connected to the vehicle, the iPod® music library can only

be operated by the vehicle audio controls.



### WARNING

**Do not connect, disconnect or operate the USB device while driving. Doing so can be a distraction. If distracted you could lose control of your vehicle and cause an accident or serious injury.**



### CAUTION

- **Do not force the USB device into the USB port. Inserting the USB device tilted or up-side-down into the port may damage the port. Make sure that the USB device is connected correctly into the USB port.**
- **Do not grab the USB port cover (if so equipped) when pulling the USB device out of the port. This could damage the port and the cover.**
- **Do not leave the USB cable in a place where it can be pulled unintentionally. Pulling the cable may damage the port.**



Refer to your device manufacturer's owner information regarding the proper use and care of the device.

## Compatibility

The following models are available:

### Models with navigation system:

- Fifth generation iPod® (firmware version 1.2.3 or later)
- iPod Classic® (firmware version 1.1.1 or later)
- First generation iPod touch® (firmware version 2.0.0 or later)
- Second generation iPod touch® (firmware version 1.2.3 or later)
- First generation iPod nano® (firmware version 1.3.1 or later)
- Second generation iPod nano® (firmware version 1.1.3 or later)
- Third generation iPod nano® (firmware version 1.1 or later)
- Fourth generation iPod nano® (firmware version 1.0.2 or later)

### Models without navigation system:

- Fifth generation iPod® (firmware version 1.3)
- First generation iPod Classic® (firmware version 1.1.2 PC)

- Second generation iPod Classic® (firmware version 2.0 PC)
- First generation iPod touch® (firmware version 2.1)
- Second generation iPod touch® (firmware version 2.1.1)
- First generation iPod nano® (firmware version 1.3.1)
- Second generation iPod nano® (firmware version 1.1.3)
- Third generation iPod nano® (firmware version 1.1 PC)
- Third generation iPhone® (firmware version 2.1)

Make sure that the iPod® version is updated.

## Audio main operation

Push the ignition switch to the ACC or ON position. Then, push the DISC-AUX button repeatedly to switch to the iPod® mode.

If the system has been turned off while the iPod® was playing, pushing the ON-OFF button will start the iPod®.

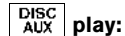

**play:**

When the DISC-AUX button is pushed with the system off and the iPod® connected, the system will turn on. If another audio source is playing and the iPod® is connected, push the DISC-AUX

button repeatedly until the center display changes to the iPod® mode.

## Interface:

The interface for iPod® operation shown on the vehicle center display is similar to the iPod® interface. Use the multi-function controller and the ENTER or BACK button to play the iPod® with your favorite settings.

The following items can be chosen from the menu list screen. For further information about each item, see the iPod® Owner's Manual.

- Now Playing
- Playlists
- Artists
- Albums
- Songs
- Podcasts
- Genres
- Composers
- Audiobooks
- Shuffle Songs
- Play mode

The following touch-panel buttons shown on the screen are also available:

- **MENU** : returns to the previous screen.
- **▶||** : plays/pauses the music selected.



### Next/Previous Track and Fast Forward/Rewind:

When the or button is pushed for more than 1.5 seconds while the iPod® is playing, the iPod® will play while fast forwarding or rewinding. When the button is released, the iPod® will return to the normal play speed.

When the or button is pushed for less than 1.5 seconds while the iPod® is playing, the next track or the beginning of the current track on the iPod® will be played.

The multi-function controller can also be used to select tracks when the iPod® is playing.



### REPEAT (RPT), RANDOM (RDM):

When the RPT button is pushed while a track is being played, the play pattern can be changed as follows:

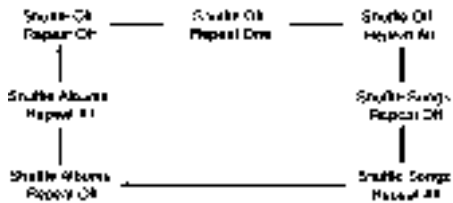

### Bluetooth® STREAMING AUDIO (models with navigation system)

Your vehicle is equipped with Bluetooth® Streaming Audio. If you have a compatible Bluetooth® device with streaming audio (A2DP profile), you can set up the wireless connection between your Bluetooth® device and the in-vehicle audio system. This connection allows you to listen to the audio from the Bluetooth® device using your vehicle speakers. It also may allow basic control of the device for playing and skipping audio files using the AVRCP Bluetooth® profile. All Bluetooth® Devices do not have the same level of controls for AVRCP. Please consult the manual for your Bluetooth® Device for more details.

Once your Bluetooth® device is connected to the in-vehicle audio system, it will automatically reconnect whenever the device is present in the vehicle and you select Bluetooth® Audio from your audio system. You do not need to manually reconnect for each usage.

Wireless LAN (Wi-Fi) and the Bluetooth® functions share the same frequency band (2.4 GHz). Using the Bluetooth® and the wireless LAN functions at the same time may slow down or disconnect the communication and cause undesired noise. It is recommended that you turn off the wireless LAN (Wi-Fi) when using the

Bluetooth® functions.

### Regulatory information

#### FCC Regulatory information:

- CAUTION: To maintain compliance with FCC's RF exposure guidelines, use only the supplied antenna. Unauthorized antenna, modification, or attachments could damage the transmitter and may violate FCC regulations.
- Operation is subject to the following two conditions:
  - 1) This device may not cause interference and
  - 2) This device must accept any interference, including interference that may cause undesired operation of the device

#### IC Regulatory information:

- Operation is subject to the following two conditions:
  - 1) This device may not cause interference, and
  - 2) This device must accept any interference, including interference that may cause undesired operation of the device.
- This Class B digital apparatus meets all requirements of the Canadian Interference-Causing Equipment Regulations.

Bluetooth trademark:



Bluetooth® is a trademark owned by Bluetooth SIG, Inc. and licensed to Clarion Co., Ltd.

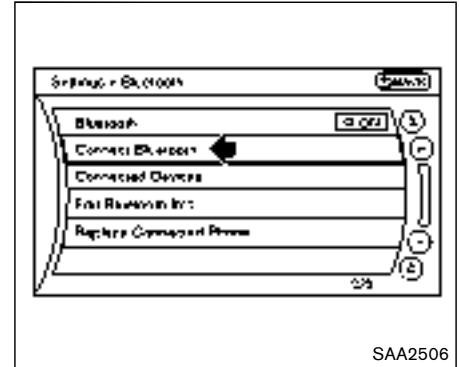
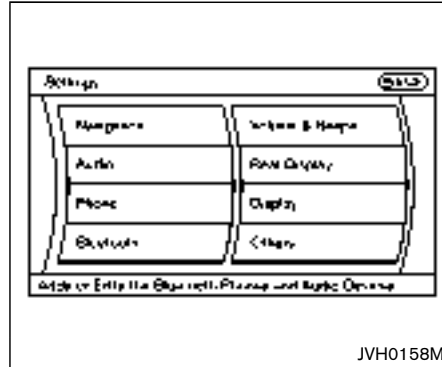

### Connecting procedure

1. Push the SETTING button and select the "Bluetooth" key.

2. Select the "Connect Bluetooth" key.

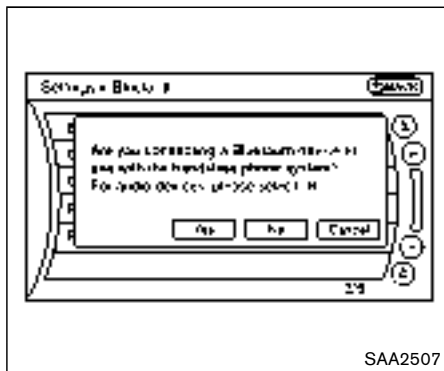

3. A confirmation screen will be displayed. Select "No".

Note: Selecting "Yes" will only connect the hands free phone portion of a Bluetooth® device.

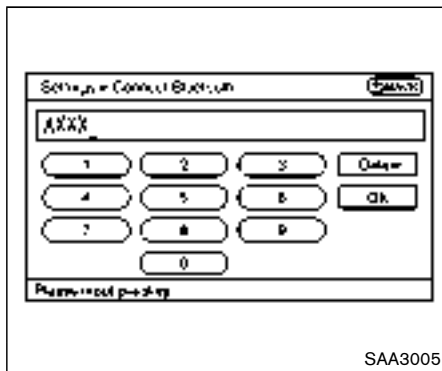

4. Choose a PIN code to use with the compatible Bluetooth® audio device using the number input screen. The PIN code will need to be entered into the Bluetooth® audio device after step 5. Select the "OK" key.

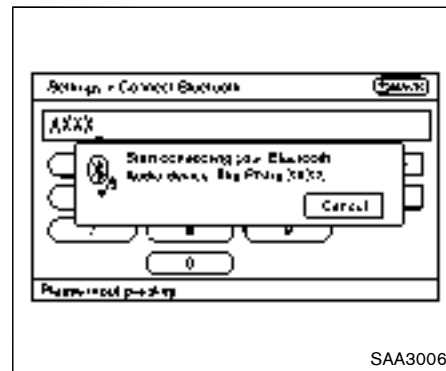

5. The standby message screen will appear. Operate the compatible Bluetooth® audio device. For the connecting procedure of the audio device, see the Bluetooth® audio instructions.

When the connecting is completed, the screen will return to the Bluetooth® setup display.

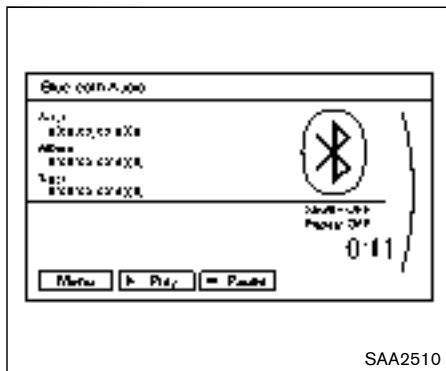

### Audio main operation



Push the ignition switch to the ACC or ON position. Then, push the DISC-AUX button repeatedly to switch to the Bluetooth® audio mode. If the system has been turned off while the Bluetooth® audio device was playing, pushing the ON-OFF/VOL control knob will start the Bluetooth® audio device.



The ability to pause, change tracks, fast forward, rewind, randomize and repeat music may be different between devices. Some or all of these functions may not be supported on each device.

### **DISC-AUX button:**

When the DISC-AUX button is pushed with the system off and the Bluetooth® audio device connected, the system will turn on. If another audio source is playing and the Bluetooth® audio device is connected, push the DISC-AUX button repeatedly until the display changes to the Bluetooth® audio mode.

### **Next/Previous Track and Fast Forward/Rewind:**

When the  or  button is pushed for more than 1.5 seconds while a Bluetooth® audio file is being played, the Bluetooth® audio device will play while forwarding or rewinding. When the button is released, the Bluetooth® audio device will return to normal play speed.

When the  or  button is pushed for less than 1.5 seconds while a Bluetooth® audio file is being played, the next track or the beginning of the current track on the Bluetooth® audio device will be played. The multi-function controller can also be used to select tracks when the Bluetooth® audio play mode screen is shown on the display. ("Bluetooth audio") will be indicated on the header of the screen.)

### **REPEAT (RPT), RANDOM (RDM):**

To change the play mode, push the  button repeatedly and the mode changes as follows.

Normal → Shuffle All Tracks → Shuffle Group → Repeat 1 Track → Repeat All Tracks → Repeat Group → Normal

### **Operation keys:**

To operate a Bluetooth® audio device, select a key displayed on the operation screen using the multi-function controller.

### **Play**

Select the  key to start playing when pausing. Select this key again to pause the audio play.

### **Pause**

Select the  key to pause the Bluetooth® audio device. Select this key again to resume playing.

### **Play Mode:**

The play mode setting display will appear when the "Menu" key is selected.

Choose the preferred play mode from the following items.

- **Shuffle**

Choose "Shuffle OFF", "Shuffle All Tracks" and "Shuffle Group".

- **Repeat**

Choose from "Repeat OFF", "Repeat 1 Track", "Repeat All Tracks" and "Repeat Group".

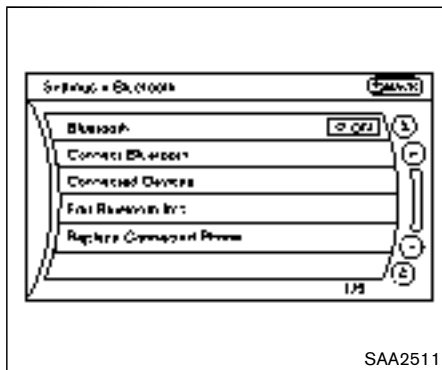

### Bluetooth® settings

To set up the Bluetooth® device system to the preferred settings, push the SETTING button and select the "Bluetooth" key.

#### **Bluetooth:**

If this setting is turned off, the connection between the Bluetooth® devices and the in-vehicle Bluetooth® module will be canceled.

#### **Connect Bluetooth:**

Connects to the Bluetooth® device. See "Connecting procedure" (P.4-102). Up to 5 devices can be registered.

### **Connected Devices:**

Registered devices are shown on the list. Select a Bluetooth® device from the list, the following options will be available.

- **Select**

Select "Select" to connect the selected device to the vehicle. If there is a different device currently connected, the selected device will replace the current device.

- **Edit**

Rename the selected Bluetooth® device using the keypad displayed on the screen. (See "How to use touch screen (models with navigation system)" (P.4-7).)

- **Delete**

Delete the selected Bluetooth® device.

#### **Edit Bluetooth Info:**

Change the name broadcasted by this system over Bluetooth®. Change the PIN code that is entered when connecting a hands free device to this system.

#### **Replace Connected Phone:**

Replace the Bluetooth® connection with a connected Bluetooth® cellular phone. For details about Hands-Free Phone System, see "Bluetooth® hands-free phone system (Type A)" (P.4-122).



### AUXILIARY INPUT JACKS (if so equipped)

The auxiliary input jacks are located on the center console. NTSC/PAL compatible devices such as video games, camcorders and portable video players can be connected to the auxiliary jacks. Compatible audio devices, such as some MP3 players, can also be connected to the system through the auxiliary jacks.

The auxiliary jacks are color coded for identification purposes.

- Yellow - video input
- White - left channel audio input

- Red - right channel audio input
- Before connecting a device to a jack, turn off the power of the portable device.

With a compatible device connected to the jacks, push the DISC-AUX button repeatedly until the display switches to the AUX mode.

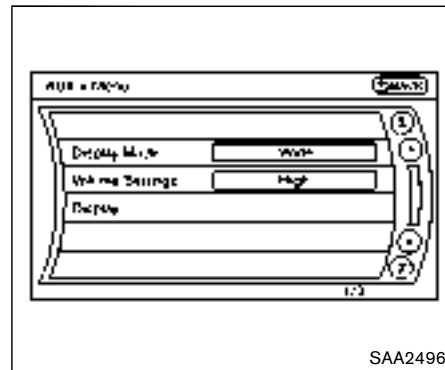

Models with navigation system

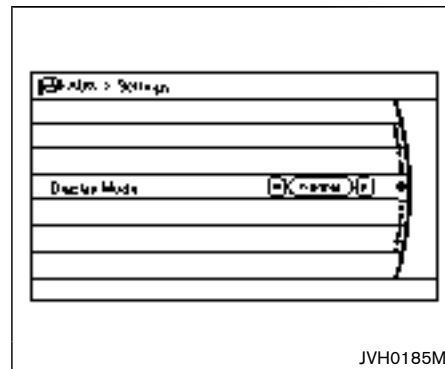

Models without navigation system

## AUX Menu

When the “Menu” key on the display is selected while in the AUX mode, the menu screen will be displayed.

### Display Mode:

Choose the display mode from the following items.

- Normal
- Wide
- Cinema

### Volume Settings (models with navigation system):

Choose the volume setting from the following items.

- Low
- Medium
- High

### Display (models with navigation system):

Adjust the image quality of the screen, select the preferred adjustment items.

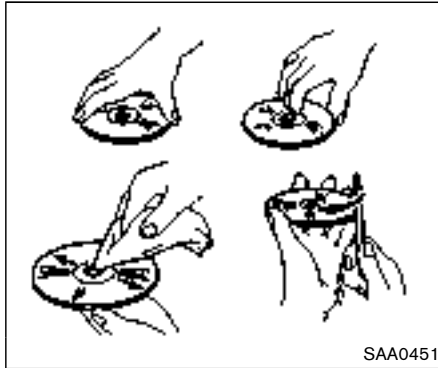

## CD/DVD/USB MEMORY CARE AND CLEANING

### CD/DVD

- Handle a CD/DVD by its edges. Never touch the surface of the disc. Do not bend the disc.
- Always place the discs in the storage case when they are not being used.
- To clean a disc, wipe the surface from the center to the outer edge using a clean, soft cloth. Do not wipe the disc using a circular motion.

Do not use a conventional record cleaner or alcohol intended for industrial use.

- A new disc may be rough on the inner and outer edges. Remove the rough edges by rubbing the inner and outer edges with the side of a pen or pencil as illustrated.

### USB memory

- Do not touch the terminal portion of the USB memory.
- Do not place heavy objects on the USB memory.
- Do not store the USB memory in highly humid locations.
- Do not expose the USB memory to direct sunlight.
- Do not spill any liquids on the USB memory. Refer to the USB memory Owner's Manual for the details.



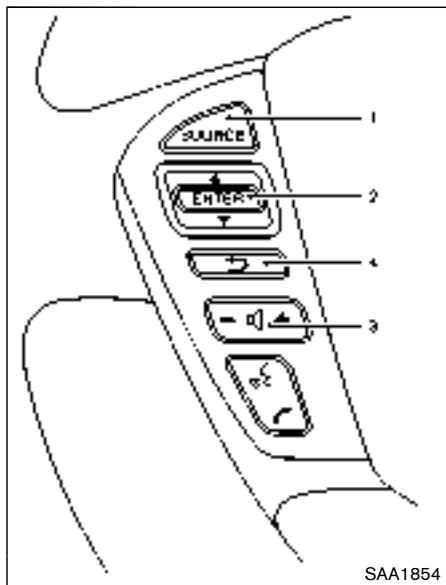

Models with navigation system

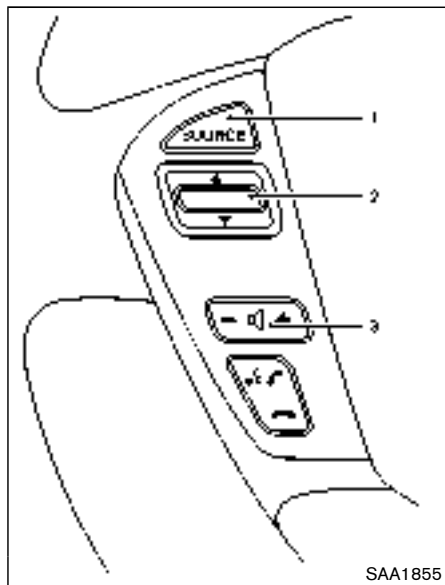

Models without navigation system

1. SOURCE select switch
2. Menu control (models with navigation system) or audio tuning switch (models without navigation system) switch
3. Volume control switch
4. BACK switch

## STEERING-WHEEL-MOUNTED CONTROLS FOR AUDIO (if so equipped)

Menu control switch (models with navigation system) or audio tuning switch (models without navigation system)

While the display is showing a MAP (navigation systems only), STATUS or Audio screen, tilt the switch upward/downward to select a station, track, CD or folder. For most audio sources, tilting the switch up/down for more than 1.5 seconds provides a different function than tilting up/down for less than 1.5 seconds.

### AM and FM radio:

- Tilting up/down for less than 1.5 seconds will skip up/down to the next or previous preset station.
- Tilting up/down for more than 1.5 seconds will seek up or down to the next station.
- Pushing the menu control switch will show the list of preset stations.

### SiriusXM Satellite Radio (if so equipped):

- Tilting up/down for less than 1.5 seconds will skip up/down to the next or previous preset channel.
- Tilting up/down for more than 1.5 seconds will go to the next or previous category.

- Pushing the menu control switch will show the XM Menu.

#### **iPod® (if so equipped):**

- Tilting up/down for less than 1.5 seconds will skip up/down to the next or previous track.
- Tilting up/down for more than 1.5 seconds will skip to the next or previous playlist.

#### **CD:**

- Tilting up/down for less than 1.5 seconds will skip up/down to the next or previous track.
- Tilting up/down for more than 1.5 seconds will skip up/down to the next or previous folder number (if playing compressed audio files).
- Pushing the menu control switch will show the CD Menu.

#### **DVD (if so equipped):**

- Tilting up/down for less than 1.5 seconds will skip up/down to the next or previous track.
- Tilting up/down for more than 1.5 seconds will skip up/down to the next or previous title.
- Pushing the menu control switch will select an item from the DVD display.

- When the transparent operation menu appears, the switch will control the menu.

#### **USB (if so equipped):**

- Tilting up/down for less than 1.5 seconds will skip up/down to the next or previous track.
- Tilting up/down for more than 1.5 seconds will skip up/down to the next or previous folder number
- Pushing the menu control switch will show the USB Menu.

#### **Bluetooth® Audio (if so equipped):**

- Tilting up/down for less than 1.5 seconds will skip up/down to the next or previous track.

 **BACK switch** (models with navigation system)

Push this switch to go back to the previous screen or cancel the selection if it is not completed.

#### **Volume control switches**

Push the upper (+) or lower (-) side switch to increase or decrease the volume.

#### **SOURCE select switch**

Push the source select switch to change the mode to available audio source.

#### **ANTENNA**

##### **Window antenna**

The antenna pattern is printed inside the rear side window.



### **CAUTION**

- **Do not place metalized film near the rear side window glass or attach any metal parts to it. This may cause poor reception or noise.**
- **When cleaning the inside of the rear side window, be careful not to scratch or damage the rear side window antenna. Lightly wipe along the antenna with a dampened soft cloth.**

## NISSAN MOBILE ENTERTAINMENT SYSTEM (MES) (if so equipped)

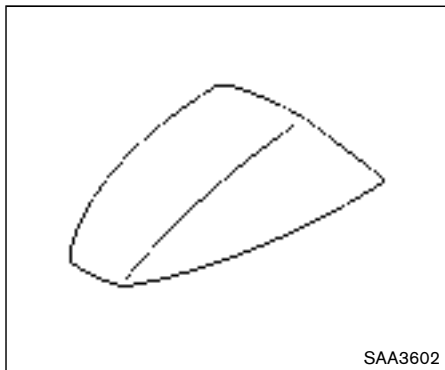

### Satellite antenna (if so equipped)

There is a satellite antenna on the rear part of the vehicle roof.

This vehicle is equipped with the Mobile Entertainment System, which enables you to play a Digital Versatile Disc (DVD) or USB, providing the images and sounds both in the front and rear display screens.



### WARNING

- **The driver must not attempt to operate or view the Mobile Entertainment System (MES) while the vehicle is in motion so that full attention may be given to vehicle operation.**
- **Do not attempt to modify the system to display a movie on the front screen while the vehicle is being driven. Doing so may distract the driver and may cause a collision and serious personal injury or death.**



### CAUTION

- **The glass screen on the liquid crystal display may break if hit with a hard or sharp object. If the glass breaks, do not touch the liquid crystalline material.**

- **Use a damp, soft cloth when cleaning the Mobile Entertainment System components. Do not use solvents or cleaning solutions.**

- Do not attempt to use the system in extreme temperature conditions [below  $-4^{\circ}\text{F}$  ( $-20^{\circ}\text{C}$ ) or above  $158^{\circ}\text{F}$  ( $70^{\circ}\text{C}$ )].
- To avoid discharging the vehicle battery, do not operate the system more than 15 minutes without starting the engine.

Movies will not be shown on the front display while the vehicle is in any drive position to reduce driver distraction. Audio is available when a movie is played. To view movies in the front display, stop the vehicle in a safe location, move the shift lever to the P (Park) position and apply the parking brake.

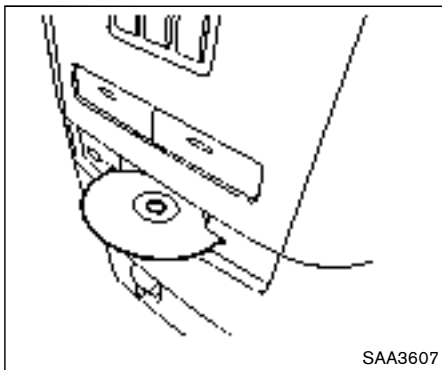

## DIGITAL VERSATILE DISC (DVD) SYSTEM COMPONENTS

### DVD drive

The DVD slot is located on the instrument lower panel.

Insert a DVD into the slot with the label side facing up. The DVD will be guided automatically into the slot.

When ejecting the DVD, push the EJECT button



### CAUTION

- Do not force a DVD into the slot. This could cause damage the player.
- Do not use 3.1 in (8 cm) discs.

### Displays

### WARNING

**Park the vehicle in a safe location and apply the parking brake to view the images on the front center display screen using the DVD drive or other devices connected to the auxiliary input jacks.**

### CAUTION

- **The glass screen on the liquid crystal display may break if hit with a hard or sharp object. If the glass breaks, do not touch the liquid crystalline material.**
- **Use soft, damp cloth when cleaning the Mobile Entertainment System**

**components. Do not use solvents or cleaning solutions.**

- **Be sure to stow the rear display when it is not used.**

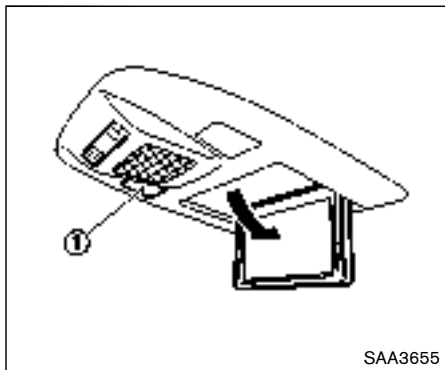

SAA3655

#### Flip-down screen

Use the remote controller to operate the motorized flip-down rear display screen.

1. Push the REAR DISPLAY OPEN/CLOSE button on the remote controller to open or close the display.
2. Adjust the display angle by pushing the DISPLAY TILT button  $\wedge$  or  $\vee$ .

The screen can also be opened using the multi-function controller. (See "How to use SETTING button" (P.4-15).)

Do not block the range of the wireless remote controller receiver and wireless headphones transmitter ①.



#### CAUTION

**Do not touch the display when it is opening or closing.**

Headphones



#### CAUTION

**Do not leave headphones on the seats. Sitting on headphones left on a seat could damage the headphones and may result in personal injury due to shards from the headphones.**

Headphones are a wireless type and no cables are necessary. You can use them in almost all the ranges in the rear seat for listening to the sound from DVD, AUX or USB. (It is not possible to use the headphones in the front seat.)



SAA3608

#### Power ON/OFF:

Push the POWER button to turn the headphones on or off.

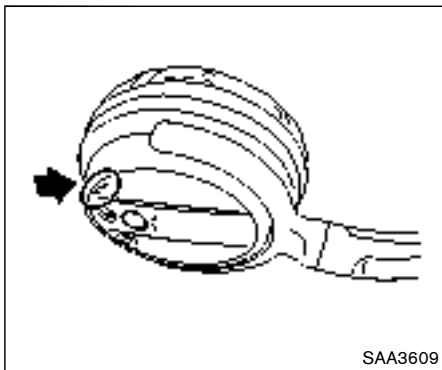

#### Volume control:

Turn the volume control knob to adjust the volume.

The headphones will automatically be turned off within approximately 5 minutes if there is no infrared signal input during that period. To prevent the battery from being discharged, keep the power turned off when not in use.

If the sound from the headphones is not clear it may be because:

- of an infrared communication device or cellular phone, turn down the headphone volume or stop using the headphones, or

- the headphones maybe out of the range of the transmitter installed in the rear flip-down display screen. This is not a malfunction, or
- the sound may be interrupted temporarily when there is an obstacle between the headphones and the transmitter. Remove the obstacle, such as opaque materials, hands, hair, etc.

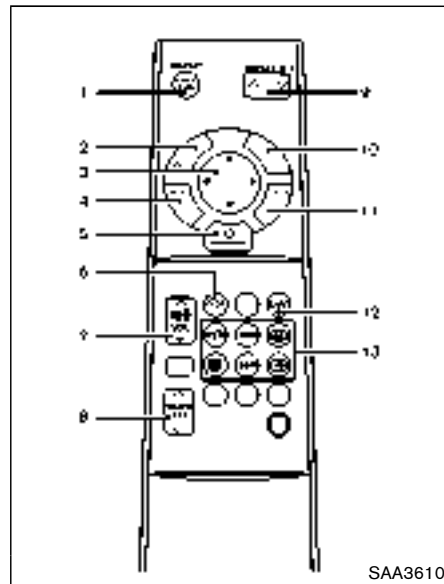

Models with navigation system

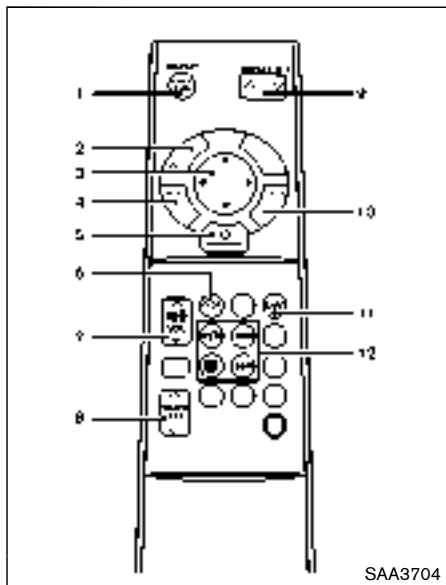

Models without navigation system

#### Remote controller

The remote controller has the following controls:

- **Models with navigation system**

- 1) REAR DISPLAY OPEN/CLOSE button

- 2) DVD button
- 3) Joystick
- 4) AUX button
- 5) ENTER button
- 6) DISP button
- 7) SPEAKER VOLUME CONTROL button ( ^ or v )
- 8) TRACK/CHANNEL button ( ^ or v )
- 9) DISPLAY TILT button ( ^ or v )
- 10) USB button (if so equipped)
- 11) BACK button
- 12) SOUND button
- 13) Keypad (Some models do not have a Commercial Skip button.)

- **Models without navigation system**

- 1) REAR DISPLAY OPEN/CLOSE button
- 2) DVD button
- 3) Joystick
- 4) AUX button
- 5) ENTER button
- 6) DISP button
- 7) SPEAKER VOLUME CONTROL button ( ^ or v )

- 8) TRACK/CHANNEL button ( ^ or v )
- 9) DISPLAY TILT button ( ^ or v )
- 10) BACK button
- 11) SOUND button
- 12) Keypad

See "Remote controller operation" (P.4-120) for the function of each buttons.

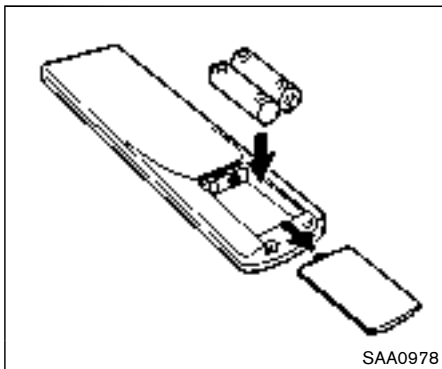

Remote controller



Headphones

## Remote controller and headphones battery replacement

Replace the battery as follows:

1. Open the lid.  
The lid is easy to open if a flat head screwdriver etc., is used.
2. Replace both batteries with new ones.
  - Size AA (remote control)
  - Size AAA (headphones)

**Make sure that the ⊕ and ⊖ ends on the batteries match the markings inside the compartment.**

3. Close the lid securely.

**If the battery is removed for any reason other than replacement, close the lid securely.**

- If you will not be using the remote control for long periods of time, remove the batteries.
- Replacement of the batteries is needed when the remote control only functions at extremely close distances to the MES or not at all.
- Be careful not to touch the battery terminal.
- An improperly disposed battery can harm the environment. Always confirm local regulations for battery disposal.

- When changing batteries, do not let dust or oil get on the remote control and headphones.

### FCC Notice:

#### For USA:

**This device complies with Part 15 of the FCC Rules. Operation is subject to the following two conditions: (1) This device may not cause harmful interference, and (2) this device must accept any interference received, including interference that may cause undesired operation.**

**Note: Changes or modifications not expressly approved by the party responsible for compliance could void the user's authority to operate the equipment.**

#### For Canada:

**This device complies with RSS-210 of Industry Canada. Operation is subject to the following two conditions: (1) this device may not cause interference, and (2) this device must accept any interference, including interference that may cause undesired operation of the device.**



## BEFORE OPERATING THE DVD MOBILE ENTERTAINMENT SYSTEM

### Precautions

Start the engine when using the DVD entertainment system.



### WARNING

The driver must not attempt to operate the DVD system or wear the headphones while the vehicle is in motion so that full attention may be given to vehicle operation.



### CAUTION

- Only operate the DVD while the vehicle engine is running. Operating the DVD for extended periods of time with the engine OFF can discharge the vehicle battery.
- Do not allow the system to get wet. Excessive moisture such as spilled liquids may cause the system to malfunction.

- While playing VIDEO-CD media, this DVD player does not guarantee complete functionality of all VIDEO-CD formats.

### Parental level (parental control)

DVDs with the parental control setting can be played with this system. Please use your own judgement to set the parental control with the system.

### Disc selection

The following disc formats can be played with the DVD drive.

- DVD-VIDEO
- VIDEO-CD
- DTS-CD (models with navigation system)

Use DVDs with the region code "ALL" or the code applicable to your country. (The region code is displayed as a small symbol printed on the top of the DVD.) This vehicle-installed DVD player can only play DVDs with an applicable region code.

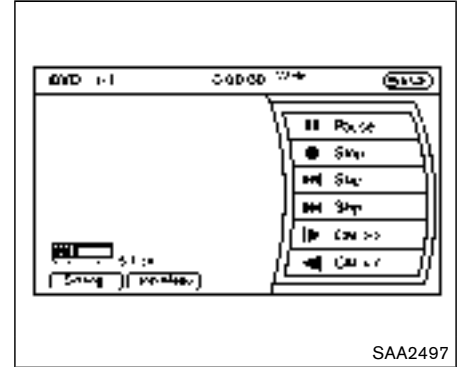

SAA2497

Front screen (models with navigation system)

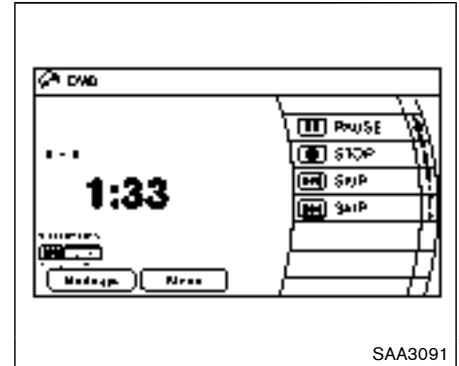

SAA3091

Front screen (models without navigation system)

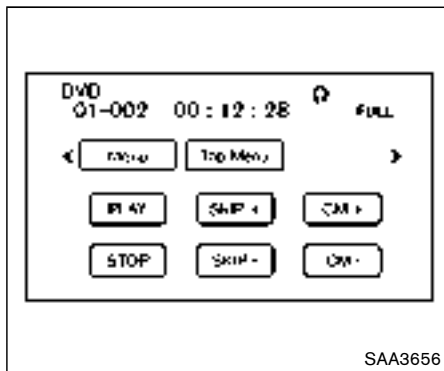

Rear display

## PLAYING A DVD

### DISC-AUX button

**Park the vehicle in a safe location for the front seat occupants to operate the DVD drive while watching the images.**

Insert a DVD into the CD/DVD slot with the labeled side up. The DVD will be guided automatically into the slot. When ejecting the DVD, push the EJECT button.

Push the DISC-AUX button on the instrument panel, turn the display to the DVD mode, and begin playing DVD automatically.

When a DVD is loaded, it will be replayed

automatically.

The front screen will be turned on when the DISC-AUX button is pushed while a DVD is being played, and it will turn off automatically after a period of time. To turn it on again, push the DISC-AUX button again.

### Adjust Front/Rear display

#### Front display:

To adjust the front display, push the **SETTING** button while the DVD is being played, select the "Others" key and then select the "Display" key.

To adjust the display ON/OFF, brightness, tint, color and contrast, select the "Display Adjustment" key and then select the preferred key for setting.

You can then adjust each item using the multi-function controller. After changes have been made press the BACK button to save the setting.

#### Rear display:

To adjust the rear display, push the "DISP" (Display) button on the remote controller.

To adjust aspect, color system, 3D Y/C filter and picture mode, select each key using the joystick on the remote controller and tilt the joystick to right or left.

Push the BACK button to apply the settings and

return to the previous display.

### DVD operation keys

To operate the DVD drive, select the desired key displayed on the operation screen using the multi-function controller.

#### || PAUSE:

Select the " || " key to pause the DVD. To resume playing the DVD, use the "PLAY" key.

To pause the DVD, it is also possible to push the "⏸" button on the keypad of the remote controller.

#### ▶ PLAY:

Select the " ▶ " key to start playing the DVD, for example, after pausing the DVD.

To start playing the DVD, it is also possible to push the "▶" button on the keypad of the remote controller.

#### ■ STOP:

Select the " ■ " key to stop playing the DVD.

To stop playing the DVD, it is also possible to push the "■" button on the keypad of the remote controller.

### **SKIP (FORWARD):**

Select the “” key to skip the chapter(s) of the disc forward. The chapters will advance the number of times the ENTER button is pushed.

To skip the chapter(s) forward, it is also possible to push the “” button on the keypad of the remote controller.



### **SKIP (REWIND):**



Select the “” key to skip the chapter(s) of the disc backward. The chapters will go back the number of times the ENTER button is pushed.

To skip the chapter(s) backward, it is also possible to push the “” button on the keypad of the remote controller.

### / **Commercial Skip (if so equipped):**

This function is only for DVD-VIDEO and DVD-VR.

Select the “” or “” key to skip forward or backwards by the set amount as defined in the DVD settings menu.

To skip forward or backward, it is also possible to push the “” or “” button on the keypad of the remote controller.

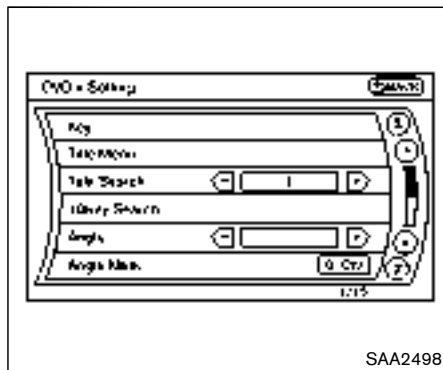

SAA2498  
Front screen (models with navigation system)

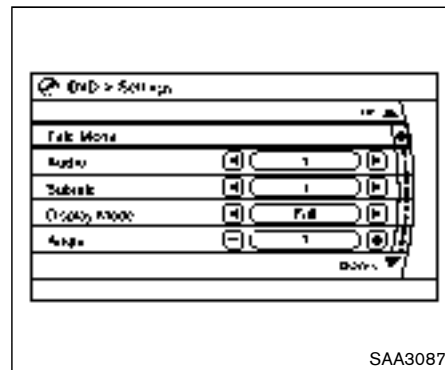

SAA3087  
Front screen (models without navigation system)

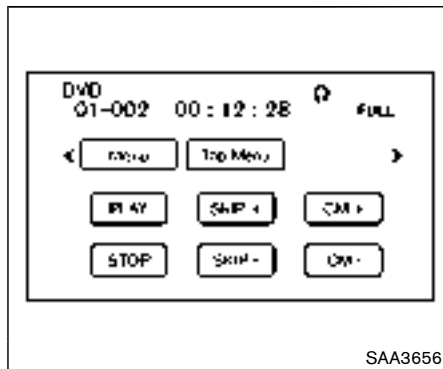

SAA3656  
Rear screen (models with navigation system)

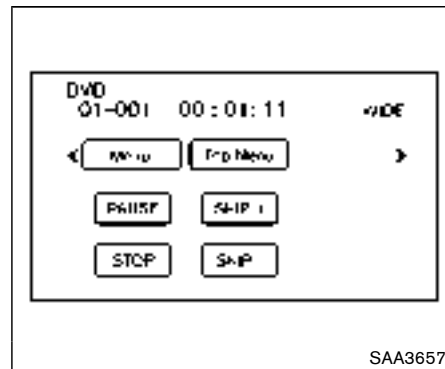

SAA3657  
Rear screen (models without navigation system)

## Setting keys

Select the "Settings" key with the multi-function controller and push the ENTER button to adjust the following settings.

The items indicated with " \* " can also be set from the rear display. Push the " DVD " button on the remote controller while a DVD is being played. Select the preferred item using the joystick " ⬇️ " on the remote controller and push the ENTER " ⏹️ " button.

### **Key (DVD-VIDEO) (models with navigation system):**

Keys for the DVD menu operation are displayed.



: Move the cursor to select a DVD menu.

Enter: Enter the selected menu.

Move: Change the display location by moving the operation key.

Back: Return to the previous screen.



Hide: Hide the operation key.

### **Title Menu (front)/Menu (rear) (DVD-VIDEO):**

Menus specific to each disc will be shown. For details, see the instructions attached to the disc.

### **Title Search (DVD-VIDEO):**

A scene that belongs to a specified title will be displayed each time the "+" side or "-" side is

selected.

### **10 Key Search (DVD-VIDEO, VIDEO-CD, CD-DA):**

Select the "10 Key Search" key and push the ENTER button to open the number entry screen.

Input the number you want to search for and select the "OK" key with the multi-function controller. Then push the ENTER button. The specified Title/Chapter or Group/Track will be played.

### **Angle (DVD-VIDEO):**

If the DVD contains different angles (such as moving images), the current image angle can be switched to another one.

Select the "Angle" key and push the ENTER button. When the "+" side or "-" side is selected, the angle will change.

### **Angle Mark (DVD-VIDEO):**

When this item is turned on, an angle mark will be shown on the bottom of the screen if the scene can be seen from a different angle.

### **Menu Skip (DVD-VIDEO):**

DVD menus are automatically configured and the contents will be played directly when the "Menu Skip" key is turned on. Note that some discs may not be played directly even if this item is turned on.

### **CM Skip (DVD-VIDEO) (models with navigation system):**

The number of seconds for CM Skip can be set to 15, 30 or 60 seconds.

### **DRC (DVD-VIDEO):**

DRC (Dynamic Range Compression) allows tuning of the dynamic range of sound recorded in the Dolby Digital format.

### **DVD Language (DVD-VIDEO, VIDEO-CD):**

Select the "DVD Language" key and push the ENTER button to open the number entry screen.

Input the number corresponding to the preferred language and select the "OK" key with the multi-function controller. Then push the ENTER button. The DVD top menu language will be changed to the one selected.

### **Display:**

Adjust the image quality of the screen, select the preferred adjustment items and push the ENTER button.

### **Audio:**

Choose the preferred language using the multi-function controller and push the ENTER button.

### **Subtitle (DVD-VIDEO):**

Choose the preferred language using the multi-function controller and push the ENTER button.

To turn off the subtitles, push and hold the ENTER button until a beep sounds.

#### **Display Mode (DVD-VIDEO, VIDEO-CD):**

Choose from the “Full”, “Wide”, “Normal” or “Cinema” mode using the multi-function controller and push the ENTER button again.

#### **Play Mode:**

Choose the preferred play mode using the multi-function controller and push the ENTER button.

#### **Remote controller operation**

Use the remote controller to adjust the following items.

#### **Rear display open/close:**

To open or close the flip-down rear display, push the  button.

#### **Joystick:**

Use the joystick  to select the items displayed on the rear screen.

#### **ENTER button:**

Push the ENTER  button to make the selected item complete on the rear screen.

#### **BACK button:**

Push to go back to the previous screen or cancel the selection.

#### **Display tilt:**

Adjust the display angle by pushing the DISPLAY TILT button .

#### **DVD mode:**

To select the DVD mode, push the DVD button.

#### **USB mode (if so equipped):**

To select the USB mode, push the USB button.

#### **AUX mode:**

To select the AUX (auxiliary input jacks), mode, push the AUX button.

#### **Volume:**

To control the speaker volume level, push the VOL button .

#### **Display:**

To adjust the rear display screen (aspect, color system, 3D Y/C filter and picture mode etc.), push the DISP button.

#### **Sound:**

To change the language, push the SOUND button. Each time the button is pushed, the language will change to each language stored in the DVD.

#### **Track/Channel:**

To skip to the previous or next DVD scene selection, push the TRACK CH button .

#### **Keypad:**

 : PLAY/PAUSE button

 : STOP button

 : FORWARD button

 : REWIND button

 : FORWARD button for commercial skip (for DVD-VIDEO and DVD-VR)

 : REWIND button for commercial skip (for DVD-VIDEO and DVD-VR)

#### **Rear display settings**

To adjust rear display setting, select the preferred key and push the ENTER  button. The following settings are available:

#### **Aspect:**

Select the display size from “CINEMA”, “WIDE”, “FULL” or “NORMAL” using the joystick on the remote controller.

#### **Picture Mode:**

To adjust the display brightness automatically, select the “Brightness” key and then select from “DARKER”, “NORMAL” or “BRIGHTER”. When adjusting manually, select “OFF” and adjust using the joystick on the remote controller and tilt the joystick to the right or left.

To adjust tint, color, contrast or black level, select a key using the joystick on the remote

controller and tilt the joystick to the right or left. Push the BACK button on the remote controller to apply the settings and return to the previous display.

To return the adjustment levels to the default value, select "Execute" next to "Initialization" using the joystick on the remote controller and push the ENTER  button. The "Execute" key is deactivated when the picture mode settings are already in the default value.

#### **Color System:**

To choose the color system, select from "NTSC", "PAL", "PAL-60", "PAL-M", "PAL-N" or "AUTO" using the joystick on the remote controller and tilt the joystick to the right or left.

#### **3D Y/C filter:**

Set to ON/OFF using the joystick on the remote controller. When turned on, small characters and an outline of the shapes will be displayed more clearly than when turned off.

### **CARE AND MAINTENANCE**

Use a lightly dampened, lint free cloth to clean the surfaces of your Mobile Entertainment System (DVD player face, screen, remote controller, etc.).



### **CAUTION**

- **Do not use any solvents or cleaning solutions when cleaning the video system.**
- **Do not use excessive force on the monitor screen.**
- **Avoid touching or scratching the monitor screen as it may become dirty or damaged.**
- **Do not attempt to operate the system in extreme temperature conditions [below  $-4^{\circ}\text{F}$  ( $-20^{\circ}\text{C}$ ) and above  $158^{\circ}\text{F}$  ( $70^{\circ}\text{C}$ )].**
- **Do not attempt to operate the system in extreme humidity conditions (less than 10% or more than 75%).**

### **CAR PHONE OR CB RADIO**

When installing a car phone or a CB radio in your vehicle, be sure to observe the following cautions, otherwise the new equipment may adversely affect the electronic control modules and electronic control system harness.



### **WARNING**

- **A cellular phone should not be used for any purpose while driving so full attention may be given to vehicle operation. Some jurisdictions prohibit the use of cellular phones while driving.**
- **If you must make a call while your vehicle is in motion, the hands-free cellular phone operational mode (if so equipped) is highly recommended. Exercise extreme caution at all times so full attention may be given to vehicle operation.**
- **If you are unable to devote full attention to vehicle operation while talking on the phone, pull off the road to a safe location and stop your vehicle.**

## Bluetooth® HANDS-FREE PHONE SYSTEM (Type A) (if so equipped)

\*Type A is models with navigation system.



### CAUTION

- Keep the antenna as far away as possible from the electronic control modules.
- Keep the antenna wire more than 8 in (20 cm) away from the electronic control system harness. Do not route the antenna wire next to any harness.
- Adjust the antenna standing-wave ratio as recommended by the manufacturer.
- Connect the ground wire from the CB radio chassis to the body.
- For details, it is recommended you visit a NISSAN dealer.



### WARNING

- Use a phone after stopping your vehicle in a safe location. If you have to use a phone while driving, exercise extreme caution at all times so full attention may be given to vehicle operation.
- If you find yourself unable to devote full attention to vehicle operation while talking on the phone, pull off the road to a safe location and stop your vehicle before doing so.



### CAUTION

**To avoid draining the vehicle battery, use a phone after starting the engine.**

Your vehicle is equipped with Bluetooth® Hands-Free Phone System. If you are an owner of a compatible Bluetooth® enabled cellular phone, you can set up the wireless connection between your cellular phone and the in-vehicle phone module. With Bluetooth® wireless technology, you can make or receive a telephone call

with your cellular phone in your pocket.

Once a cellular phone is connected to the in-vehicle phone module, no phone connecting procedure is required anymore. Your phone is automatically connected with the in-vehicle phone module when the ignition switch is pushed to the ON position with the registered cellular phone turned on and carried in the vehicle.

You can register up to 5 different Bluetooth® cellular phones in the in-vehicle phone module. However, you can talk on only one cellular phone at a time.

The NISSAN Voice Recognition system supports the phone commands, so dialing a phone number using your voice is possible. For more details, see "NISSAN Voice Recognition system (models with navigation system)" (P.4-154).

Before using the Bluetooth® Hands-Free Phone System, refer to the following notes.

- Wireless LAN (Wi-Fi) and the Bluetooth® functions share the same frequency band (2.4 GHz). Using the Bluetooth® and the wireless LAN functions at the same time may slow down or disconnect the communication and cause undesired noise. It is recommended that you turn off the wireless LAN (Wi-Fi) when using the Bluetooth® functions.

- Set up the wireless connection between a compatible cellular phone and the in-vehicle phone module before using the Bluetooth® Hands-Free Phone System.
- Some Bluetooth® enabled cellular phones may not be recognized by the in-vehicle phone module. Please visit [www.nissanusa.com/bluetooth](http://www.nissanusa.com/bluetooth) for a recommended phone list.
- You will not be able to use a hands-free phone under the following conditions:
  - Your vehicle is outside of the telephone service area.
  - Your vehicle is in an area where it is difficult to receive radio waves; such as in a tunnel, in an underground parking garage, behind a tall building or in a mountainous area.
  - Your cellular phone is locked in order not to be dialed.
- When the radio wave reception is not good or ambient sound is too loud, it may be difficult to hear the other person's voice during a call.
- Immediately after the ignition switch is pushed to the ON position, it may be impossible to receive a call for a short period of time.
- Do not place the cellular phone in an area surrounded by metal or far away from the in-vehicle phone module to prevent tone quality degradation and wireless connection disruption.
- While a cellular phone is connected through the Bluetooth® wireless connection, the battery power of the cellular phone may discharge quicker than usual.
- If the Bluetooth® Hands-Free Phone System seems to be malfunctioning, please visit [www.nissanusa.com/bluetooth](http://www.nissanusa.com/bluetooth) for troubleshooting help.
- Some cellular phones or other devices may cause interference or a buzzing noise to come from the audio system speakers. Storing the device in a different location may reduce or eliminate the noise.
- Refer to the cellular phone Owner's Manual regarding the telephone pairing procedure specific to your phone, battery charging, cellular phone antenna, etc.
- The antenna display on the monitor will not coincide with the antenna display of some cellular phones.
- Keep the interior of the vehicle as quiet as possible to hear the caller's voice clearly as well as to minimize its echoes.

- If reception between callers is unclear, adjusting the incoming or outgoing call volume may improve the clarity.

## REGULATORY INFORMATION

### FCC Regulatory information

- CAUTION: To maintain compliance with FCC's RF exposure guidelines, use only the supplied antenna. Unauthorized antenna, modification, or attachments could damage the transmitter and may violate FCC regulations.
- Operation is subject to the following two conditions:
  1. this device may not cause interference and
  2. this device must accept any interference, including interference that may cause undesired operation of the device

### IC Regulatory information

- Operation is subject to the following two conditions: (1) this device may not cause interference, and (2) this device must accept any interference, including interference that may cause undesired operation of the device.
- This Class B digital apparatus meets all requirements of the Canadian Interference-Causing Equipment Regulations.



Bluetooth trademark:



Bluetooth® is a trademark owned by Bluetooth SIG, Inc., and licensed to Clarion Co., Ltd.

## VOICE COMMANDS

You can use voice commands to operate various Bluetooth® Hands-Free Phone System features using the NISSAN Voice Recognition system.

For more details, see “NISSAN Voice Recognition system (models with navigation system)” (P.4-154).



### CONTROL BUTTONS

1. TALK /PHONE SEND button

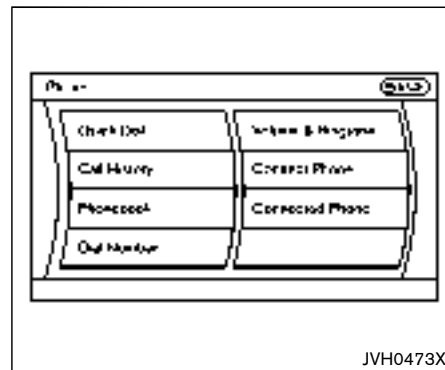

### CONNECTING PROCEDURE

1. Push the button, and select the “Connect Phone” key.

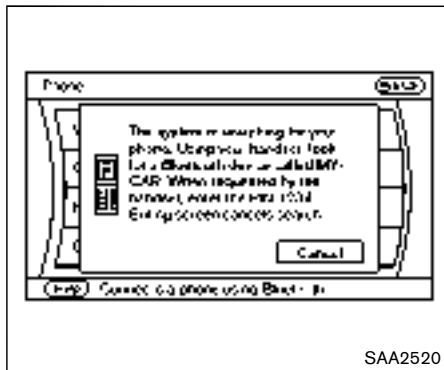

- When a PIN code appears on the screen, operate the compatible Bluetooth® cellular phone to enter the PIN code.

If you have the phone corresponding to Bluetooth® Secure Simple Pairing, select MY-CAR on the cellular phone device searching screen.

- Select "Yes" if the PIN code displayed on the cellular phone is the same as the one displayed on the screen.
- Both vehicle system and mobile side approval operation on the screens will make Bluetooth® pairing.

The connecting procedure of the cellular phone varies according to each cellular

phone. See the cellular phone Owner's Manual for the details. You can also visit

[www.nissanusa.com/bluetooth](http://www.nissanusa.com/bluetooth) or call NISSAN Consumer Affairs Department for instructions on pairing NISSAN recommended cellular phones.

When the connection process is completed, the screen will return to the Phone menu display.

## PHONE SELECTION

Up to 5 cellular phones can be registered to the system. To switch to connect another cellular phone, push  button and select the "Connected Phones" key. The registered cellular phones are shown on the list. If you select a cellular phone that is different from the one currently connected, the newly selected phone will be connected to the system.

## QUICK DIAL

This vehicle has two phonebooks available for hands-free use. Depending on the phone, the system may automatically download the entire cell phone's phonebook into the "Phonebook". For the details about downloading a phonebook, see "Phone setting" (P.4-130). If a phonebook does not automatically download, the Quick Dial may be set for up to 1,000 entries. This Quick Dial allows the recording of a name to speak

while using the Voice Recognition system.

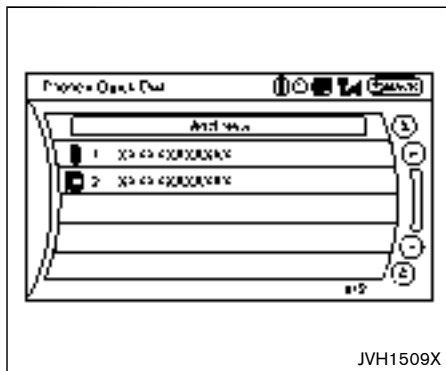

JVH1509X

1. Push the  button and select the "Quick Dial" key.
2. Select the "Add New" key at the top of the screen.

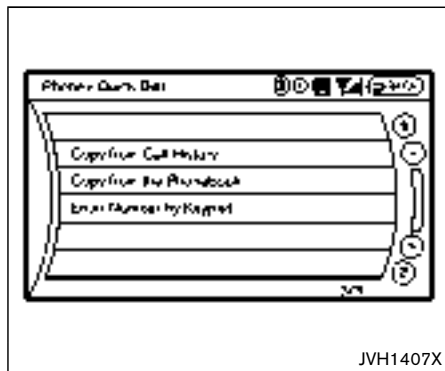

JVH1407X

3. Choose the method for entering the phonebook entry. For this example, select "Enter Number by Keypad".
4. Input the name and phone number manually using the keypad displayed on the screen. (See "How to use touch screen (models with navigation system)" (P.4-7).)

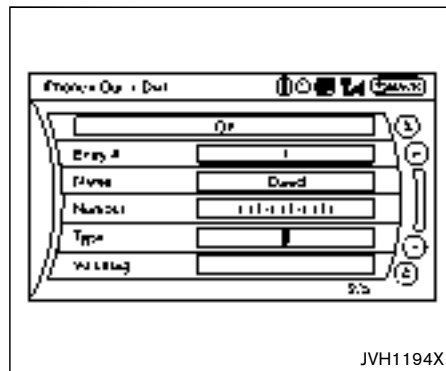

JVH1194X

5. Select the "Voicetag" key to record a name to speak when using the NISSAN Voice Recognition system.
6. Select the "Store" key and prepare to speak the name after the tone.
7. When the voicetag is successfully saved, select the "OK" key to save the Quick Dial entry.
8. After the Quick Dial entry is saved, it will show a screen that is ready to call the number. Press the BACK button to return to the Quick Dial.

There are different methods to input a phone number. Select one of the following options

instead of “Enter Number by Keypad” in step 3.

- **Copy from Call History**

The system will show a list of incoming, outgoing or missed calls that were downloaded from the connected cellular phone (depending on the phone's compatibility). Select one of these entries to save in the Quick Dial.

- **Copy from the Phonebook**

The system will show the connected cellular phone's phonebook that was downloaded (depending on the phone's compatibility). Select one of these entries to save in the Quick Dial.

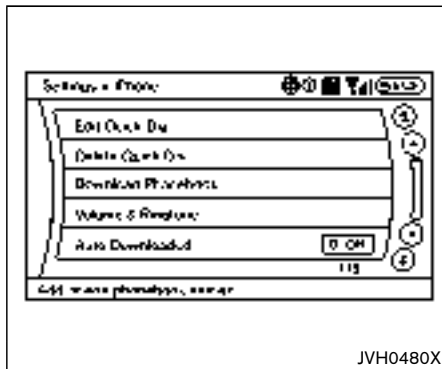

### Editing the Quick Dial

1. Push the SETTING button and select the “Phone” key.
2. Select the “Edit Quick Dial” key.
3. Select the desired entry from the displayed list.
4. Select the desired item to change.

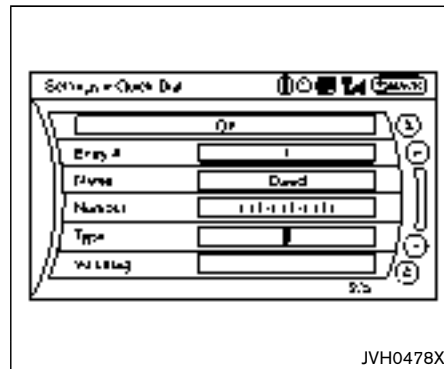

The following editing items are available:

- **Entry #**  
Changes the displayed number of the selected entry.
- **Name**  
Edit the name of the entry using the keypad displayed on the screen.
- **Number**  
Edit the phone number using the keypad displayed on the screen.
- **Type**  
Select an icon from the icon list.
- **Voicetag**  
Confirm and store the voicetag. Voicetags

allow easy dialing using the NISSAN Voice Recognition system. (See “NISSAN Voice Recognition system (models with navigation system)” (P.4-154).)

To delete an entry, select the “Delete” key at step 3.

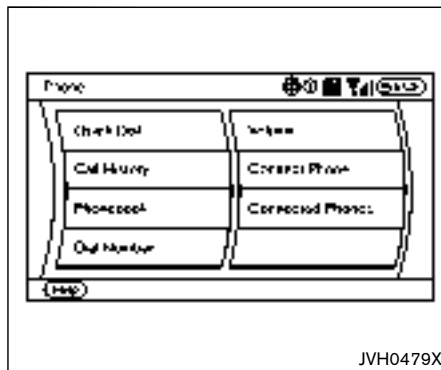

- **Quick Dial**

Select an entry stored in the Quick Dial.

- **Call History**

Select an outgoing, incoming or missed call downloaded from your cell phone (depending on your phone's compatibility).

- **Dial Number**

Input the phone number manually using the keypad displayed on the screen. (See “How to use touch screen (models with navigation system)” (P.4-7).)

## MAKING A CALL

To make a call, follow this procedure.

1. Push the  button on the steering wheel. The “PHONE” screen will appear on the display.
2. Select the “Phonebook” key on the “PHONE” menu.
3. Select the desired entry from the list.
4. Confirm the correct entry by selecting for the correct number from the list.

There are different methods to make a call. Select one of the following options instead of “Phonebook” in step 2 above.

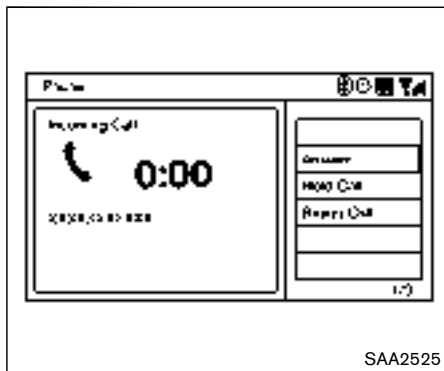

## RECEIVING A CALL

When you hear a phone ring, the display will change to the incoming call mode. To receive a call, perform one of the following procedures listed below.

- Select the "Answer" key.
- Push the  button on the steering wheel.

There are some options available when receiving a call. Select one of the following displayed on the screen.

- **Answer**  
Accept an incoming call to talk.
- **Hold Call**  
Put an incoming call on hold.

- **Reject Call**

Reject an incoming call.

To finish the call, perform one of the following procedures listed below.

- Select the "Hang up" key.
- Push the  button on the steering wheel.

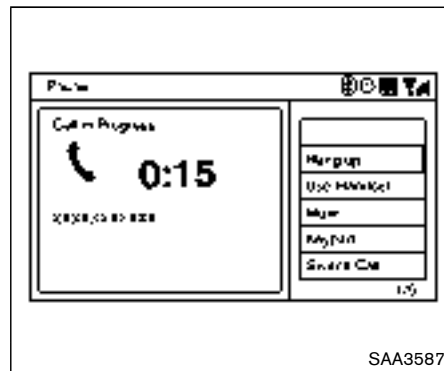

## DURING A CALL

There are some options available during a call. Select one of the following displayed on the screen if necessary.

- **Hang up**  
Finish the call.
- **Use Handset**  
Transfer the call to the cellular phone.
- **Mute**  
Mute your voice to the person.
- **Keypad**  
Using the touch tone, send digits to the connected party for using services such as voicemail.

- **Cancel Mute**

This will appear after “Mute” is selected. Mute will be canceled.

- **Switch Call\***

Select “Switch Call” to answer another incoming call. By selecting “Hang up”, you can end a call and can speak to a caller who is on hold again.

\* This function may not be usable, depending on the model of phone.

To adjust the person’s voice to be louder or quieter, push the volume control switch (+ or -) on the steering wheel or turn the volume control knob on the instrument panel while talking on the phone. This adjustment is also available in the SETTING mode.

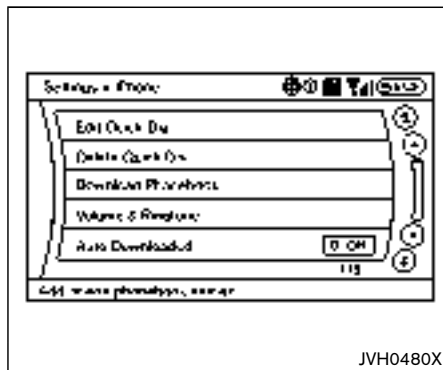

## PHONE SETTING

To set up the Bluetooth® Hands-Free Phone System to your preferred settings, push the SETTING button on the instrument panel and select the “PHONE” key.

### Edit Quick Dial

To edit the Quick Dial, use the same procedure as described in “Quick Dial” (P.4-125).

### Delete Quick Dial

The Quick Dial entries can be deleted all at the same time or one by one.

### Download Phonebook

Download the contacts registered in a Bluetooth® cellular phone. Availability of this function depends on each cellular phone. The memory downloading procedure from the cellular phone also varies according to each cellular phone. See cellular phone Owner’s Manual for details.

### Volume & Ringtone

The following kinds of phone volume can be set. Pushing the  button and selecting the “Volume & Ringtone” key can also operate the same settings.

- **Ringtone/Incoming Call/Outgoing Call**

To increase or decrease the volume, select the “Ringtone”, “Incoming Call” or “Outgoing Call” key and adjust it with the multi-function controller.

- **Automatic Hold**

When this function is activated, an incoming phone call is automatically held.

- **Vehicle Ringtone**

When this function is activated, a specific ringtone that is different from the cellular phone will sound when receiving a call.

## Auto Downloaded

When this item is activated, the phonebook of a hands-free phone is automatically downloaded at the same time that the hands-free phone is connected.



## TROUBLESHOOTING GUIDE

The system should respond correctly to all voice commands without difficulty. If problems are encountered, try the following solutions.

Where the solutions are listed by number, try each solution in turn, starting with number 1, until the problem is resolved.

Symptom	Solution
The system fails to interpret the command correctly.	1. Ensure that the command is valid. (See "NISSAN Voice Recognition system (models with navigation system)" (P.4-154).)
	2. Ensure that the command is spoken after the tone.
	3. Speak clearly without pausing between words and at a level appropriate to the ambient noise level in the vehicle.
	4. Ensure that the ambient noise level is not excessive (for example, windows open or defroster on). NOTE: If it is too noisy to use the phone, it is likely that the voice commands will not be recognized.
	5. If more than one command was said at a time, try saying the commands separately.
The system consistently selects the wrong voicetag.	1. Ensure that the voicetag requested matches what was originally stored. (See "Quick Dial" (P.4-125).)
	2. Replace one of the names being confused with a new name.

## Bluetooth® HANDS-FREE PHONE SYSTEM (Type B) (if so equipped)

\* Type B is models without navigation system/without text message function.



### WARNING

- Use a phone after stopping your vehicle in a safe location. If you have to use a phone while driving, exercise extreme caution at all times so full attention may be given to vehicle operation.
- If you find yourself unable to devote full attention to vehicle operation while talking on the phone, pull off the road to a safe location and stop your vehicle before doing so.

### CAUTION

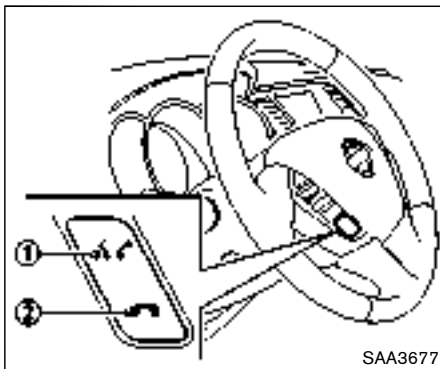
To avoid draining the vehicle battery, use a phone after starting the engine.



1. PHONE SEND  button
2. PHONE END  button

Your vehicle is equipped with the Bluetooth® Hands-Free Phone System. If you have a compatible Bluetooth® enabled cellular phone, you can set up the wireless connection between your cellular phone and the in-vehicle phone module. With Bluetooth® wireless technology, you can make or receive a hands-free telephone call in your vehicle.

Once your cellular phone is connected to the in-vehicle phone module, no other phone connecting procedure is required. Your phone is automatically connected with the in-vehicle phone module when the ignition switch is

pushed to the ON position with the connected cellular phone turned on and carried in the vehicle.

You can connect up to 5 different Bluetooth® cellular phones in the in-vehicle phone module. However, you can talk on only one cellular phone at a time.

Before using the Bluetooth® Hands-Free Phone System, refer to the following notes.

- Wireless LAN (Wi-Fi) and the Bluetooth® functions share the same frequency band (2.4 GHz). Using the Bluetooth® and the wireless LAN functions at the same time may slow down or disconnect the communication and cause undesired noise. It is recommended that you turn off the wireless LAN (Wi-Fi) when using the Bluetooth® functions.
- Set up the wireless connection between a compatible cellular phone and the in-vehicle phone module before using the Bluetooth® Hands-Free Phone System.
- Some Bluetooth® enabled cellular phones may not be recognized by the in-vehicle phone module. Please visit [www.nissanusa.com/bluetooth](http://www.nissanusa.com/bluetooth) for a recommended phone list and connecting.
- You will not be able to use a hands-free phone under the following conditions:

- Your vehicle is outside of the telephone service area.
- Your vehicle is in an area where it is difficult to receive radio waves; such as in a tunnel, in an underground parking garage, near a tall building or in a mountainous area.
- Your cellular phone is locked to prevent it from being dialed.
- When the radio wave condition is not ideal or ambient sound is too loud, it may be difficult to hear the other person's voice during a call.
- Immediately after the ignition switch is pushed to the ON position, it may be impossible to receive a call for a short period of time.
- Do not place the cellular phone in an area surrounded by metal or far away from the in-vehicle phone module to prevent tone quality degradation and wireless connection disruption.
- While a cellular phone is connected through the Bluetooth® wireless connection, the battery power of the cellular phone may discharge quicker than usual. The Bluetooth® Hands-Free Phone System cannot charge cellular phones.
- If the Bluetooth® Hands-Free Phone System seems to be malfunctioning, see "Troubleshooting guide" later in this section. You can also visit [www.nissanusa.com/bluetooth](http://www.nissanusa.com/bluetooth) for troubleshooting help.
- Some cellular phones or other devices may cause interference or a buzzing noise to come from the audio system speakers. Storing the device in a different location may reduce or eliminate the noise.
- Refer to the cellular phone Owner's Manual regarding battery charging, cellular phone antenna, etc.
- This wireless hands free car kit is based on Bluetooth® technology,
  - Frequency: 2402 MHz - 2480 MHz
  - Output Power: 4.14 dBm E.I.R.P
  - Modulation: FHSS GFSK 8DPSK,  $\pi/4$  DQPSK
  - Number of Channels: 79
  - This wireless equipment can't be used for any services related to safety because there is the possibility of radio interference.

## REGULATORY INFORMATION

### FCC Regulatory information

- CAUTION: To maintain compliance with FCC's RF exposure guidelines, use only the supplied antenna. Unauthorized antenna, modification, or attachments could damage the transmitter and may violate FCC regulations.
- Operation is subject to the following two conditions:
  - 1) this device may not cause interference and
  - 2) this device must accept any interference, including interference that may cause undesired operation of the device

### IC Regulatory information

- Operation is subject to the following two conditions: (1) this device may not cause interference, and (2) this device must accept any interference, including interference that may cause undesired operation of the device.
- This Class B digital apparatus meets all requirements of the Canadian Interference-Causing Equipment Regulations.

Bluetooth trademark:



Bluetooth® is a trademark owned by Bluetooth SIG, Inc., and licensed to Visteon Corporation.

## USING THE SYSTEM

The NISSAN Voice Recognition system allows hands-free operation of the Bluetooth® Hands-Free Phone System.

If the vehicle is in motion, some commands may not be available so full attention may be given to vehicle operation.

### Initialization

When the ignition switch is pushed to the ON position, NISSAN Voice Recognition is initialized, which may take up to one minute. If the  button is pushed before the initialization completes, the system will accept any command.

### Operating tips

To get the best performance out of the NISSAN Voice Recognition system, observe the following:

- Keep the interior of the vehicle as quiet as possible. Close the windows to eliminate surrounding noises (traffic noises, vibration sounds, etc.), which may prevent the system from recognizing voice commands correctly.

- Wait until the tone sounds before speaking a command. Otherwise, the command will not be received properly.
- Start speaking a command within 5 seconds after the tone sounds.
- Speak in a natural voice without pausing between words.

### Giving voice command

To operate NISSAN Voice Recognition, push and release the  button located on the steering wheel. After the tone sounds, speak a command.

The command given is picked up by the microphone, and voice feedback is given when the command is accepted.

- If you need to hear the available commands for the current menu again, say “Help” and the system will repeat them.
- If a command is not recognized, the system announces, “Command not recognized. Please say again.” Repeat the command in a clear voice.
- If you want to go back to the previous command, you can say “Go back” or “Correction” anytime the system is waiting for a response.
- You can cancel a command when the system is waiting for a response by saying,

“Cancel” or “Quit.” The system announces “Cancel” and ends the VR session. You can also push and hold the  button for 5 seconds on the steering wheel at any time to cancel the VR session. Whenever the VR session is cancelled, a double beep is played to indicate you have exited the system.

### Voice prompt interrupt:

In most cases you can interrupt the voice feedback to speak the next command by pressing the  button on the steering wheel.

### One Shot Call:

To use the system faster, you may speak the second level commands with the main menu command on the main menu. For example, press the  button and after the tone say, “Call Redial.” Note: The combined command of Call and (Speak Name) cannot be used.

### How to say numbers

NISSAN Voice Recognition requires a certain way to speak numbers in voice commands. Refer to the rules and examples below.

- Either “zero” or “oh” can be used for “0”.  
Example: 1-800-662-6200  
— “One eight oh oh six six two six two oh oh”, or

- “One eight zero zero six six two six two oh oh”
- Words can be used for the first 4 digits places only.  
Example: 1-800-662-6200
  - “One eight hundred six six two six two oh oh”,
  - NOT “One eight hundred six six two sixty two hundred, and
  - NOT “One eight oh oh six six two sixty two hundred.
- Numbers can be spoken in small groups. The system will prompt you to continuing entering digits, if desired.  
Example: 1-800-662-6200
  - “One eight zero zero”  
The system repeats the numbers and prompts you to enter more.
  - “six six two”  
The system repeats the numbers and prompts you to enter more.
  - “six two zero zero”
- You can say “Star” for “\*” and “Pound” for “#” at any time in any position of the phone number. (Available only when using the “Special Number” command.)  
Example: 1-555-1212 \*123

- “One five five five one two one two star one two three”
- Say “pound” for “#”. Say “star” for “\*” (available when using the “Special Number” command and the “Send” command during a call).
- Say “plus” for “+” (available only when using the “Special Number” command).
- Say “pause” for a 2 second pause (available only when storing a phone book number).  
See “Making a call by entering a phone number” (P.4-138) and “List of voice commands” (P.4-139) for more information.

**NOTE:**



**For best results, say phone numbers as single digits.**

The voice command “Help” is available at any time. Please say the “Help” command to get information about how to use the system.

**INFO**

- If you are controlling the telephone system by voice command for the first time or do not know the appropriate voice command, speak “Help”. The system announces the available commands.
- When you speak numbers, you can speak both “zero” or “oh” for “0”.

**Manual command selection**

Commands can be selected manually. While the commands are displayed on the screen, select a command by operating the Tune switch, and then push the  button. Once a command is manually selected, the voice command function is cancelled. To return to voice command mode, push the  button to cancel the current operation, and then perform the first procedure of voice command.

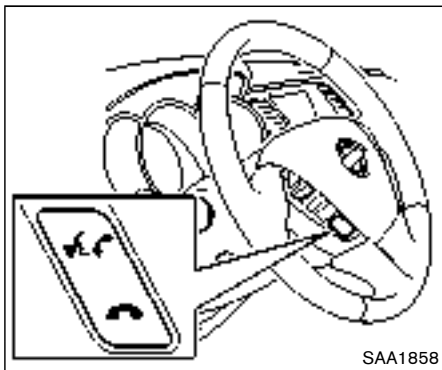

## CONTROL BUTTONS

The control buttons for the Bluetooth® Hands-Free Phone System are located on the steering wheel.

### ☎️ PHONE SEND

Push the ☎️ button to initiate a Voice Recognition (VR) session or answer an incoming call.

You can also use the ☎️ button to interrupt system feedback and give a command at once.

### ↶ PHONE END

While the Voice Recognition system is active, press the ↶ button to go back one step. Press and hold the ↶ button for 5 seconds to quit

the Voice Recognition system at any time.

## GETTING STARTED

The following procedures will help you get started using the Bluetooth® Hands-Free Phone System with NISSAN Voice Recognition. For additional command options, refer to “List of voice commands” (P.4-139).

### Choosing a language

For models with center multi-function control panel:

The available voice commands are only applicable to the relevant language set in the LANGUAGE setting screen. (See “How to use SETTING button” (P.4-15).)

For models without center multi-function control panel:

You can interact with the Bluetooth® Hands-Free Phone System using English, Spanish or French.

To change the language, perform the following.

1. Press and hold the ☎️ button for more than 5 seconds.
2. The system announces: “Press the PHONE SEND (☎️) button for the hands-free phone system to enter the speaker adaptation mode or press the PHONE END (↶) button to select a different language.”

3. Press the ↶ button.

For information on speaker adaptation, see “Speaker adaptation (SA) mode” (P.4-142).

4. The system announces the current language and gives you the option to change the language to Spanish (in Spanish) or French (in French). To select the current language, press the ☎️ button. To select a different language, tilt the tuning switch (▲ or ▼) up or down.

### NOTE:

**You must press the ☎️ button within 5 seconds to change the language.**

5. If you decide not to change the language, do not press either button. After 5 seconds, the VR session will end, and the language will not be changed.

## Connecting procedure

### NOTE:

**The connecting procedure must be performed when the vehicle is stationary. If the vehicle starts moving during the procedure, the procedure will be cancelled.**

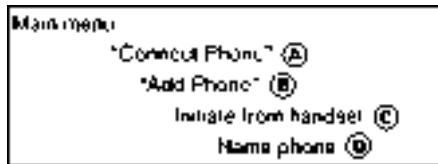

1. Push the button on the steering wheel. The system announces the available commands.
2. Say: "Connect Phone" (A). The system acknowledges the command and announces the next set of available commands.
3. Say: "Add phone" (B). The system acknowledges the command and asks you to initiate pairing from the phone handset (C).

The connecting procedure of the cellular phone varies according to each cellular phone. See the cellular phone Owner's Manual for details. You can also visit [www.nissanusa.com/bluetooth](http://www.nissanusa.com/bluetooth) for instructions on connecting NISSAN recommended cellular phones.

When prompted for a Passkey code, enter "1234" from the handset. The Passkey code "1234" has been assigned by NISSAN and cannot be changed.

4. The system asks you to say a name for the phone (D).

If the name is too long or too short, the system tells you, then prompts you for a name again.

Also, if more than one phone is connected and the name sounds too much like a name already used, the system tells you, then prompts you for a name again.

### Making a call by entering a phone number

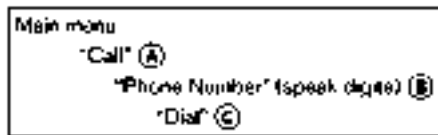

1. Push the button on steering wheel. A tone will sound.
2. Say: "Call" (A). The system acknowledges the command and announces the next set of available commands.
3. Say: "Phone Number" (B). The system acknowledges the command and announces the next set of available commands. Say: "Special Number" to dial more than 10 digits or any special characters.
4. Say the number you wish to call starting with the area code in single digit format. If the system has trouble recognizing the correct

phone number, try entering the number in the following groups: 3-digit area code, 3-digit prefix and the last 4-digits. For example, 555-121-3354 can be said as "five five five" as the 1st group, then "one two one" as the 2nd group, and "three three five four" as the 3rd group. For dialing more than 10 digits or any special characters, say "Special Number". See "How to say numbers" (P.4-135) for more information.

5. When you have finished speaking the phone number, the system repeats it back and announces the available commands.
6. Say: "Dial" (C). The system acknowledges the command and makes the call.

For additional command options, see "List of voice commands" (P.4-139).

### Receiving a call

When you hear the ring tone, press the button on the steering wheel.

Once the call has ended, press the button on the steering wheel.

### NOTE:

**If you do not wish to take the call when you hear the ring tone, press the button on the steering wheel to reject the call.**

## LIST OF VOICE COMMANDS

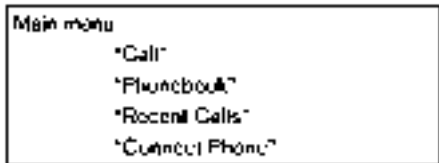

When you push and release the  button on the steering wheel, you can choose from the commands on the Main Menu. The following pages describe these commands and the commands in each sub-menu.

### **Remember to wait for the tone before speaking.**

You can say “Help” to hear the list of commands currently available anytime the system is waiting for a response.

A menu item can also be selected by scrolling the display with the SEEK switch and entering by pushing the  button.

If you want to end an action without completing it, you can say “Cancel” or “Quit” at anytime the system is waiting for a response. The system will end the VR session. Whenever the VR session is cancelled, a double beep is played to indicate you have exited the system.

If you want to go back to the previous command, you can say “Go back” or “Correction” anytime

the system is waiting for a response.

### Call

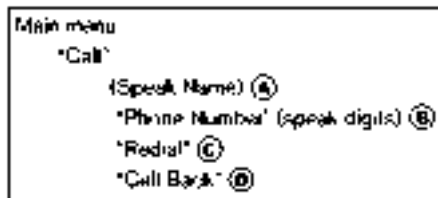

#### **(Speak Name) (A)**

If there are entries stored in the phonebook, a number associated with a name and location can be dialed.

See “Phonebook (phones without automatic phonebook download function)” (P.4-140) to learn how to store entries.

When prompted by the system, say the name of the phonebook entry to call. The system acknowledges the name.

If there are multiple locations associated with the name, the system asks the user to choose the location.

Once the name and location are confirmed, the system begins the call.

#### **“Phone Number” (speak digits) (B)**

When prompted by the system, say the number

to call. Refer to “Making a call by entering a phone number” (P.4-138) for more details.

#### **“Redial” (C)**

Use the Redial command to call the last number that was dialed.

The system acknowledges the command, repeats the number and begins dialing.

If a redial number does not exist, the system announces, “There is no number to redial” and ends the VR session.

#### **“Call back” (D)**

Use the Call Back command to dial the number of the last incoming call within the vehicle.

The system acknowledges the command, repeats the number and begins dialing.

If a call back number does not exist, the system announces, “There is no number to call back” and ends the VR session.

#### **Special Number**

To dial more than 10 digits or any special characters, please say “Special Number”. When the system acknowledges the command, the system will prompt you to speak the number.

#### **During a call**

During a call there are several command options available. Push the  button on the steering wheel to mute the receiving voice and enter



commands.

- “Help” — The system announces the available commands.
- “Go back/Correction” — The system announces “Go back,” ends the VR session and returns to the call.
- “Cancel/Quit” — The system announces “Cancel,” ends the VR session and returns to the call.
- “Send/Enter/Call/Dial” — Use the Send command to enter numbers, “\*” or “#” during a call. For example, if you were directed to dial an extension by an automated system:

Say: “Send one two three four.”

The system acknowledges the command and sends the tones associated with the numbers. The system then ends the VR session and returns to the call. Say “star” for “\*”, say “pound” for “#”.

- “Transfer call” — Use the Transfer Call command to transfer the call from the Bluetooth® Hands-Free Phone System to the cellular phone when privacy is desired. The system announces, “Transfer call. Call transferred to privacy mode.” The system then ends the VR session. To reconnect a call from the cellular phone to the Bluetooth® Hands-Free Phone sys-

tem, push the  button.

- “Mute” — Use the Mute command to mute your voice so the other party cannot hear it. Use the mute command again to unmute your voice.

#### NOTE:

**If a call is ended or the cellular phone network connection is lost while the Mute feature is on, the Mute feature will be reset to “off” for the next call so the other party can hear your voice.**

Phonebook (phones without automatic phonebook download function)

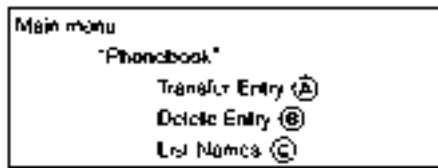

#### “Transfer Entry” (A)

Use the Transfer Entry command to store a new name in the system.

When prompted by the system, say the name you would like to give the new entry.

For example, say: “Mary.”

If the name is too long or too short, the system tells you, then prompts you for a name again.

Also, if the name sounds too much like a name already stored, the system tells you, then prompts you for a name again.

The system will ask you to transfer a phone number stored in the cellular phone’s memory.

To enter a phone number by voice command:

For example, say: “five five five one two one two.” See “How to say numbers” earlier in this section for more information.

To transfer a phone number stored in the cellular phone’s memory:

Say: “Transfer entry.” The system acknowledges the command and asks you to initiate the transfer from the phone handset. The new contact phone number will be transferred from the cellular phone via the Bluetooth® communication link.

The transfer procedure varies according to each cellular phone. See the cellular phone Owner’s Manual for details. You can also visit [www.nissanusa.com/bluetooth](http://www.nissanusa.com/bluetooth) for instructions on transferring phone numbers from NISSAN recommended cellular phones.

The system repeats the number and prompts you for the next command. When you have finished entering numbers or transferring an entry, choose “Store.”

The system confirms the name, location and

number.

### “Delete Entry” (B)

Use the Delete Entry command to delete one entry from the phonebook. After the system acknowledges a command, say the name to delete or say “List Names” to choose an entry.

### “List Names” (C)

Use the List Names command to hear all the names in the phonebook. The system recites the phonebook entries but does not include the actual phone numbers. When playback of the list is complete, the system returns to the main menu.

Playback of the list can be stopped at any time by pushing the  button on the steering wheel. The system ends the VR session.

Phonebook (phones with automatic phonebook download function)

#### NOTE:

**Phonebook commands are not available when the vehicle is moving.**



For phones that support automatic download of the phonebook (PBAP Bluetooth profile), the “Phonebook” command is used to manage entries to the vehicle phonebook. You can say the name of an entry at this menu to initiate dialing of that entry.

The phonebook stores up to 1000 names for each phone paired with the system. Each name can have up to 4 locations/phone numbers associated with it.

When a phone is connected to the system, the phonebook is automatically downloaded to the vehicle. This feature allows you to access your phonebook from the Bluetooth® system and call contacts by name. You can record a custom voice tag for contact names that the system has difficulty recognizing. For more information see “Record Name” in this section.

#### NOTE:

**Each phone has its own separate phonebook. You cannot access Phone A's phonebook if you are currently connected with**

### Phone B.

### “List names” (A)

Use the List Names command to hear all the names and locations in the phone book.

The system recites the phone book entries but does not include the actual phone numbers. When the playback of the list is complete, the system goes back to the main menu.

You can stop the playback of the list at any time by pressing the  button on the steering wheel. The system ends the VR session. See the “Record Name” command in this section for information about recording custom voice tags for list entries that the system has difficulty pronouncing.

### “Record name” (B)

The system allows you to record custom voice tags for contact names in the phonebook that the vehicle has difficulty recognizing. This feature can also be used to record voice tags to directly dial an entry with multiple numbers. Up to 40 voice tags can be recorded to the system.

### “Next Name” (C)

Use the Next Name command to move the next name of list.

### “Previous Name” (D)

Use the Previous Name command to move the previous name of list.

### Recent Calls

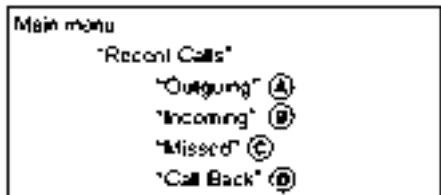

Use the Recent Calls command to access outgoing, incoming or missed calls.

#### “Outgoing” (A)

Use the Outgoing command to list the outgoing calls made from the vehicle.

#### “Incoming” (B)

Use the Incoming command to list the incoming calls made from the vehicle.

#### “Missed” (C)

Use the Missed command to list the missed calls made to the vehicle that were not answered.

#### “Call Back” (D)

Use the Call Back command to dial the number of the most recently received call.

### Connect Phone

#### NOTE:

**Add Phone command is not available when the vehicle is moving.**

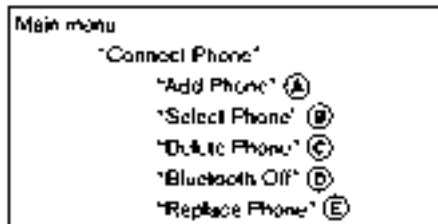

Use the Connect Phone commands to manage the phones connecting to the vehicle or to enable the Bluetooth® function on the vehicle.

#### “Add Phone” (A)

Use the Add Phone command to add a phone to the vehicle. See “Connecting procedure” (P.4-137) for more information.

#### “Select Phone” (B)

Use the Select Phone command to select from a list of phones connected to the vehicle. The system will list the names assigned to each phone and then prompt you for the phone you wish to select. Only one phone can be active at a time.

#### “Delete Phone” (C)

Use the Delete Phone command to delete a phone that is connected to the vehicle. The system will list the names assigned to each phone and then prompt you for the phone you wish to delete. Deleting a phone from the vehicle will also delete that phonebook for that phone.

#### “Bluetooth Off” (D)

Use the Bluetooth Off command to prevent a wireless connection to your phone.





#### “Replace phone” (E)

This can be used to reconnect a new phone with the vehicle you have changed your cellular phone.

### SPEAKER ADAPTATION (SA) MODE

Speaker Adaptation allows up to two out-of-dialect users to train the system to improve recognition accuracy. By repeating a number of commands, the users can create a voice model of their own voice that is stored in the system. The system is capable of storing a different speaker adaptation model for each connected phone.

## Training procedure

1. Position the vehicle in a reasonably quiet outdoor location.
2. Sit in the driver's seat with the engine running, the parking brake on, and the transmission in Park.
3. Press and hold the  button for more than 5 seconds.
4. The system announces: "Press the PHONE SEND () button for the hands-free phone system to enter the speaker adaptation mode or press the PHONE END () button to select a different language."
5. Press the  button.  
For information on selecting a different language, see "Choosing a language" (P.4-137).
6. If the connected phone is already in use, the system will prompt you to overwrite. Follow the instructions provided by the system.
7. When preparation is complete and you are ready to begin, press the  button.
8. The SA mode will be explained. Follow the instructions provided by the system.
9. When training is finished, the system will tell you an adequate number of phrases have been recorded.

10. The system will announce that speaker adaptation has been completed and the system is ready.

The SA mode will stop if:

- The  button is pressed for more than 5 seconds in SA mode.
- The vehicle is driven during SA mode.
- The ignition switch is turned to the OFF or LOCK position.

## Training phrases

During the SA mode, the system instructs you to say the following phrases.

(The system will prompt you for each phrase.)

- phonebook transfer entry
- dial 3 0 4 2 9
- delete call back number
- Incoming
- Transfer entry
- 8 pause 9 3 2 pause 7
- delete all entries
- call 7 2 4 0 9
- phonebook delete entry
- next entry
- dial star 2 1 7 0
- yes

- no
- select
- Missed
- dial 8 5 6 9 2
- Bluetooth on
- Outgoing
- call 3 1 9 0 2
- 9 7 pause pause 3 0 8
- cancel
- call back number
- call star 2 0 9 5
- delete phone
- dial 8 3 0 5 1
- Record Name
- 4 3 pause 2 9 pause 0
- delete redial number
- phonebook list names
- call 8 0 5 4 1
- correction
- connect phone
- dial 7 4 0 1 8
- previous entry
- delete
- dial 9 7 2 6 6
- call 7 6 3 0 1

- go back
- call 5 6 2 8 0
- dial 6 6 4 3 7

## TROUBLESHOOTING GUIDE

The system should respond correctly to all voice commands without difficulty. If problems are encountered, try the following solutions.

Where the solutions are listed by number, try each solution in turn, starting with number 1, until the problem is resolved.

Symptom	Solution
The system fails to interpret the command correctly.	1. Ensure that the command is valid. See "List of voice commands" (P.4-139).
	2. Ensure that the command is spoken after the tone.
	3. Speak clearly without pausing between words and at a level appropriate to the ambient noise level in the vehicle.
	4. Ensure that the ambient noise level is not excessive (for example, windows open or defroster on). NOTE: If it is too noisy to use the phone, it is likely that the voice commands will not be recognized.
	5. If more than one command was said at a time, try saying the commands separately.
	6. If the system consistently fails to recognize commands, the voice training procedure should be carried out to improve the recognition response for the speaker. See "Speaker adaptation (SA) mode" (P.4-142).
The system consistently selects the wrong entry from the phonebook.	1. Ensure that the phonebook entry name requested matches what was originally stored. This can be confirmed by using the "List Names" command. See "Phonebook (phones without automatic phonebook download function)" (P.4-140).
	2. Replace one of the names being confused with a new name.

## Bluetooth® HANDS-FREE PHONE SYSTEM (Type C) (if so equipped)

\* **Type C is models without navigation system/with text message function.**



### WARNING

- **Use a phone after stopping your vehicle in a safe location. If you have to use a phone while driving, exercise extreme caution at all times so full attention may be given to vehicle operation.**
- **If you are unable to devote full attention to vehicle operation while talking on the phone, pull off the road to a safe location and stop your vehicle.**



### CAUTION

**To avoid draining the vehicle battery, use a phone after starting the engine.**

Your vehicle is equipped with the Bluetooth® Hands-Free Phone System. If you have a compatible Bluetooth® enabled cellular phone, you can set up the wireless connection between your cellular phone and the in-vehicle phone

module. With Bluetooth® wireless technology, you can make or receive a hands-free telephone call with your cellular phone in the vehicle.

Once your cellular phone is connected to the in-vehicle phone module, no other phone connecting procedure is required. Your phone is automatically connected with the in-vehicle phone module when the ignition switch is placed in the ACC or ON position with the previously connected cellular phone turned on and carried in the vehicle.

#### NOTE:

**Some devices require the user to accept connections to other Bluetooth® devices. If your phone does not connect automatically to the system, consult the phone's Owner's Manual for details on device operation.**

You can connect up to 5 different Bluetooth® cellular phones to the in-vehicle phone module. However, you can talk on only one cellular phone at a time.

Before using the Bluetooth® Hands-Free Phone System, refer to the following notes.

- Set up the wireless connection between a compatible cellular phone and the in-vehicle phone module before using the hands-free phone system.

- Some Bluetooth® enabled cellular phones may not be recognized or work properly. For information about Bluetooth® devices that are available for use with this system, it is recommended that you contact a NISSAN dealer.
- You will not be able to use a hands-free phone under the following conditions:
  - Your vehicle is outside of the cellular service area.
  - Your vehicle is in an area where it is difficult to receive a cellular signal; such as in a tunnel, in an underground parking garage, near a tall building or in a mountainous area.
- When the radio wave condition is not ideal or ambient sound is too loud, it may be difficult to hear the other person's voice during a call.
- Do not place the cellular phone in an area surrounded by metal or far away from the in-vehicle phone module to prevent tone quality degradation and wireless connection disruption.
- While a cellular phone is connected through the Bluetooth® wireless connection, the battery power of the cellular phone may discharge quicker than usual. The Bluetooth® Hands-Free Phone System cannot

charge cellular phones.

- If the hands-free phone system seems to be malfunctioning, see “Troubleshooting guide” in this section. You can also visit [www.nissanus.com/bluetooth](http://www.nissanus.com/bluetooth) for troubleshooting help.
- Some cellular phones or other devices may cause interference or a buzzing noise to come from the audio system speakers. Storing the device in a different location may reduce or eliminate the noise.
- Refer to the cellular phone Owner’s Manual regarding the telephone charges, cellular phone antenna and body, etc.

## REGULATORY INFORMATION

### FCC Regulatory information

- **CAUTION:** To maintain compliance with FCC’s RF exposure guidelines, use only the supplied antenna. Unauthorized antenna, modification, or attachments could damage the transmitter and may violate FCC regulations.
- Operation is subject to the following two conditions:
  - 1) this device may not cause interference and
  - 2) this device must accept any interference, including interference that may cause

undesired operation of the device

### IC Regulatory information

- Operation is subject to the following two conditions: (1) this device may not cause interference, and (2) this device must accept any interference, including interference that may cause undesired operation of the device.
- This Class B digital apparatus meets all requirements of the Canadian Interference-Causing Equipment Regulations.

### Bluetooth® trademark



Bluetooth® is a trademark owned by Bluetooth SIG, Inc., and licensed to Visteon Corporation.

### USING THE SYSTEM

The Voice Recognition system allows hands-free operation of the Bluetooth® Phone System.

If the vehicle is in motion, some commands may not be available so full attention may be given to vehicle operation.



### Control buttons and microphone

The control buttons for the Bluetooth® Hands-Free Phone System are located on the steering wheel.

#### ☎️ PHONE SEND:

Push the ☎️ button to initiate a VR session or answer an incoming call.

You can also use the ☎️ button to interrupt the system feedback and give a command at once. See “List of voice commands” and “During a call” in this section for more information.

#### 📞 PHONE END:

While the Voice Recognition system is active, push and hold the 📞 button for 5 seconds to







quit the Voice Recognition system at any time.

#### **Microphone:**

Microphone is located near the map lights.

#### **Manual control:**

While using the Voice Recognition system, it is possible to select menu options by using the steering wheel controls instead of speaking voice commands. To activate manual control mode, push the  button on the steering wheel to access the phone menu and then tilt the tuning switch (  or  ) up or down.

The manual control mode does not allow dialing a phone number by digits. The user may select an entry from the Phonebook or Recent Calls lists. To reactivate Voice Recognition, exit the manual control mode by pushing and holding the  button. At that time, pushing the  button will start the Hands Free Phone System.

#### Choosing a language

You can interact with the Bluetooth® Hands-Free Phone System using several languages that are available. For operations to change the language, see “Audio main operation” (P.4-78).

#### Changing voice feedback volume

If you want to adjust the volume of the voice feedback, push the volume control switch on the steering wheel while being provided with feedback. You can also use the VOL (volume) control knob on the audio unit.

#### Initialization

When the ignition switch is placed in the ACC or ON position, the Voice Recognition system is initialized, which takes a few seconds. If the  button is pushed before the initialization completes, the system will announce “Hands-free phone system not ready” and will not react to voice commands.

#### **Connecting procedure:**

##### **NOTE:**

**The connecting procedure must be performed when the vehicle is stationary. If the vehicle starts moving during the procedure, the procedure will be cancelled.**

You can register up to 5 different Bluetooth® cellular phones in the in-vehicle phone module. However, you can talk on only one cellular phone at a time.

To connect a phone to the Bluetooth® Hands-Free Phone System;

1. Push the ENTER/SETTING button.
2. Use the TUNE-SCROLL control knob to select “Bluetooth” and then push the ENTER/SETTING button.
3. Select “Add Phone” and then push the ENTER/SETTING button.
4. When a message with a PIN appears on the screen, operate the Bluetooth® phone to enter the PIN.

The connecting procedure varies according to each phone. See the phone's Owner's Manual for details.



#### Giving voice commands

To operate voice recognition, push and release the  button located on the steering wheel. After the tone sounds, speak a command.

The command given is picked up by the microphone, and voice feedback is given when the command is accepted.

- If you need to hear the available commands for the current menu again, say “Help” and the system will repeat them.
- If a command is not recognized, the system announces, “Command not recognized. Please try again.” Make sure the command

is said exactly as prompted by the system and repeat the command in a clear voice.

- If you want to go back to the previous command, you can say “Go back” or “Correction” any time the system is waiting for a response.
- You can cancel a command when the system is waiting for a response by saying, “Cancel” or “Quit.” The system announces “Cancel” and ends the VR session. You can also push and hold the  button on the steering wheel for 5 seconds at any time to end the VR session. Whenever the VR session is cancelled, a double beep is played to indicate you have exited the system.
- If you want to adjust the volume of the voice feedback, push the (  - or  +) button on the steering wheel while being provided with feedback. You can also use the radio volume control knob.

### **Voice Prompt Interrupt:**

In most cases you can interrupt the voice feedback to speak the next command by pushing the  button on the steering wheel. After interrupting the system, wait for a beep before speaking your command.

### **One Shot Call:**

To use the system faster, you may speak the second level commands with the main menu command on the main menu. For example, push the  button and after the tone say, “Call Redial”.

### **Operating tips:**

To get the best performance out of the Voice Recognition system, observe the following:

- Keep the interior of the vehicle as quiet as possible. Close the windows to eliminate surrounding noises (traffic noises, vibration sounds, etc.), which may prevent the system from recognizing voice commands correctly.
- Wait until the tone sounds before speaking a command. Otherwise, the command will not be received properly.
- Start speaking a command within 5 seconds after the tone sounds.
- Speak in a natural voice without pausing between words.

### **Voice commands**

Voice commands can be used to operate the Bluetooth® Hands-Free Phone System. Push the  button and say “Phone” to bring up the phone command menu. The available options are:

- Call
- Phonebook
- Recent Calls
- Messaging (if so equipped)
- Select Phone

### **Call:**

For more information on the “Call” command, see “Making a call” (P.4-151).

### **Phonebook:**

The following commands are available under “Phonebook”:

- (A Name)

Say a name in the phonebook to bring up a list of options for that phonebook entry. The system will say the name it interpreted based on the voice command provided. If the name is incorrect, say “Correction” to hear another name.

Once the correct phonebook entry is identified, say “Dial” to dial the number or “Send Text” to send a text message to that

number. Say “Record Name” to record a name for the phonebook entry. Say “Delete Recording” to delete a recorded name for the phonebook entry.

- List Names

Speak this command to have the system list the names in the phonebook one by one alphabetically. Say “Dial” to dial the number of the current name or “Send Text” to send a text message to that number. Say “Next Entry” or “Previous Entry” to move through the list alphabetically. Say “Record Name” to record a name for the current phonebook entry. Say “Delete Recording” to delete a recorded name for the current phonebook entry.

- Transfer Entry

This command can be used to transfer multiple contacts at a time. To enable manual contact transfer capability, set “Phonebook Download” to “Off” in the Setting menu. The ability to transfer contacts via the OPP Bluetooth® profile depends on your mobile phone. See your phone’s Owner’s Manual for details and instructions.

- Delete Entry

Speak this command to delete an entry in the phonebook. Choose an entry to delete by speaking the desired name or say “List

Names”.

### **Recent Calls:**

The following commands are available under “Recent Calls”:

- Incoming (Calls)

Speak this command to list the last five incoming calls to the vehicle. If the call is from an entry in the phonebook, the name will be displayed. Otherwise, the phone number of the incoming call will be displayed.

Say “Dial” to call the number or “Send Text” to send a text message to that number. Say “Next Entry” or “Previous Entry” to move through the list of incoming calls.

- Missed (Calls)

Speak this command to list the last five missed calls to the vehicle. If the call is from an entry in the phonebook, the name will be displayed. Otherwise, the phone number of the missed call will be displayed.

Say “Dial” to call the number or “Send Text” to send a text message to that number. Say “Next Entry” or “Previous Entry” to move through the list of missed calls.

- Outgoing (Calls)

Speak this command to list the last five outgoing calls from the vehicle. If the call

was to an entry in the phonebook, the name will be displayed. Otherwise, the phone number of the outgoing call will be displayed.

Say “Dial” to call the number or “Send Text” to send a text message to that number. Say “Next Entry” or “Previous Entry” to move through the list of outgoing calls.

- Redial

Speak this command to call the last number dialed.

- Call Back

Speak this command to call the number of the last incoming call to the vehicle.

### **Messaging:**

Speak this command to access text messaging functions. For more information on these commands, see “Text messaging” (P.4-152).

### **Select Phone:**

Speak this command to select a phone to use from a list of those phones connected to the vehicle.

## Making a call

To make a call from a phone connected to the vehicle's Bluetooth® Hands-Free Phone System:

1. Push the  button.
2. The system will prompt you for a command. Say "Call".
3. Select one of the available voice commands to continue:
  - (A Name)

Speak the name of a phonebook entry to place a call to that entry. The system will respond with the name it interpreted from your command and will prompt you to confirm that the name is correct. Say "Yes" to initiate the call or "No" to hear another name from the phonebook.

- Phone Number

Speak this command to place a call by inputting numbers.

For 7- and 10-digit phone numbers, speak the numbers. When finished, say "Dial" to initiate the call. Say "Correction" at any time in the process to correct a misspoken or misinterpreted number.

For phone numbers with more digits or special characters, say "Special Number", then speak the digits. Up to 24 digits can be entered. Available special characters are "star", "pound", "plus" and "pause". When finished, say "Dial" to

initiate the call. Say "Correction" at any time in the process to correct a misspoken or misinterpreted number or character.

- Redial



Speak this command to dial the number of the last outgoing call. The system will display "Redialing (name/number)". The name of the phonebook entry will be displayed if it available, otherwise the number being redialed will be displayed.

- Call Back

Speak this command to dial the number of the last incoming call. The system will display "Calling back (name/number)". The name of the phonebook entry will be displayed if it available, otherwise the number being called back will be displayed.

## Receiving a call

When a call is received by the phone connected to the vehicle's Bluetooth® Hands-Free Phone System, the call information is displayed on either the vehicle information display or both the vehicle information display and the control panel display.

Push the  button to accept the call. Push the  button to reject the call.

## During a call

While a call is active, push the  button to access additional options. Speak one of the following commands:

- Send



Speak this command followed by the digits to enter digits during the phone call.

- Mute On or Mute Off

Speak the command to mute or unmute the system.



- Transfer Call

Speak this command to transfer the call to the handset. To transfer the call back from the handset to the Bluetooth® Hands-Free Phone System, push the  button and confirm when prompted.

If supported by the phone, the Bluetooth® Hands-Free Phone System allows for call waiting functionality. If a call is received while another call is already active, a message will be displayed on the screen. Push the  button to hold the active call and switch to the second call. Push the  button to reject the second call.

While the second call is active, pushing the  button will allow the same commands that are available during any call as well as two additional commands:

- **Switch Call**  
Speak this command to hold the second call and switch back to the original call.
- **End Other Call**  
Speak this command to stay with the second call and end the original call.

Push the  button to accept the call. Push the  button to reject the call.

### Ending a call

To end an active call, push the  button.

### Text messaging



## WARNING

- **Laws in some jurisdictions may restrict the use of some of the applications and features, such as social networking and texting.**
- **Laws in some jurisdictions may restrict the use of "Text-to-Speech". Check local regulations before using this feature.**

- **Use the text messaging feature after stopping your vehicle in a safe location. If you have to use the feature while driving, exercise extreme caution at all times so full attention may be given to vehicle operation.**
- **If you are unable to devote full attention to vehicle operation while using the text messaging feature, pull off the road to a safe location and stop your vehicle.**

### NOTE:

**This feature is automatically disabled if the connected device does not support the Message Access Profile (MAP). See the phone's Owner's Manual for details and instructions.**

The system allows for the sending and receiving of text messages through the vehicle interface.

### Sending a text message:

1. Push the  button.
2. Say "Messaging".
3. Say "Send Text".
4. The system will provide a list of available commands in order to determine the reci-

ipient of the text message. Choose from the following:

- (A name)
- Number
- Incoming Calls
- Outgoing Calls
- Missed Calls

If "Incoming Calls", "Outgoing Calls", or "Missed Calls" is selected, the following additional commands will be displayed:

- Send Text
- Next Entry
- Previous Entry

For more information about these options, see "Voice commands" (P.4-149).



5. Once a recipient is chosen, the system prompts for which message to send. Five predefined messages are available as well as three custom messages. To choose one of the predefined messages, speak one of the following:
  - "Driving, can't text"
  - "Call me"
  - "On my way"
  - "Running late"
  - "Okay"

To send one of the custom messages, say "Custom Message". If more than one custom message is stored, the system will

prompt for the number of the desired custom message. For more information on setting and managing custom text messages, see “Bluetooth® settings” (P.4-153).

### Reading a received text message:

1. Push the  button.
2. Say “Messaging”.
3. Say “Read Text”.

The text message, sender and delivery time are shown on the screen. Use the tuning switch on the steering wheel to scroll through all text messages if more than one are available. Push the  button to exit the text message screen. Push the  button to access the following options for replying to the text message:

- Call Back  
Speak this command to call the sender of the text message using the Bluetooth® Hands-Free Phone System.
- Send Text  
Speak this command to send a text message response to the sender of the text message.
- Read Text  
Speak this command to read the text message again.

- Previous Text  
Speak this command to move to the previous text message (if available).
- Next Text  
Speak this command to move to the next text message (if available).

### NOTE:

**Text messages are only displayed if the vehicle speed is less than 5 MPH (8 km/h).**

### Bluetooth® settings

To access and adjust the settings for the Bluetooth® Hands-Free Phone System:

1. Push the SETTING button.
2. Use the TUNE-FOLDER knob to select “Bluetooth” and then push the ENTER/SETTING button:
  - Bluetooth  
Select “On” or “Off” to turn the vehicle’s Bluetooth® system on or off.
  - Add Phone  
To connect a phone to the system, see “Initialization” (P.4-148).
  - Delete Phone  
Select to delete a phone from the displayed list. The system will ask to confirm before deleting the phone.

- Replace Phone  
Select to replace a phone from the displayed list. When a selection is made, the system will ask to confirm before proceeding. The recorded phonebook for the phone being deleted will be saved as long as the new phone’s phonebook is the same as the old phone’s phonebook.
- Select Phone  
Select to connect to a previously connected phone from the displayed list.
- Phonebook Download  
Select to turn on or off the automatic download of a connected phone’s phonebook.
- Show Incoming Calls  
Select “Driver Only” to have incoming call information displayed only in the vehicle information display. Select “Both” to have incoming call information displayed in both the vehicle information display and the center display screen
- Text Message  
Select to turn on or off the vehicle’s text messaging feature.
- New Text Sound  
Select to adjust the volume of the sound that plays when a new text is received by a phone connected to the Bluetooth® Hands-Free Phone System. The setting all the way to the left indicates that the new text sound will be muted.

- **Show Incoming Text**  
Select “Driver Only” to have incoming text messages displayed only in the vehicle information display. Select “Both” to have incoming text messages displayed in both the vehicle information display and the center display screen. Select “None” to have no display of incoming text messages.
- **Edit Custom Messages**  
Select to set a custom message that will be available with the standard options when sending a text message. To set a custom message, send a text message to your own phone number while the phone is connected to the system. Three custom messages can be set. Custom messages can only be set while the vehicle is stationary.
- **Auto Reply**  
Select to turn on or off the Auto Reply function. When enabled, the vehicle will automatically send a predefined text message to the sender when a text message is received while driving.
- **Auto Reply Message**  
Select to choose the message that is sent when the Auto Reply function is enabled. Choose from “I’m Driving” or one of the three custom messages stored in the system.
- **Vehicle Signature On/Off**  
Select to choose whether or not the

vehicle signature is added to outgoing text messages from the vehicle. This message cannot be changed or customized.

## **NISSAN VOICE RECOGNITION SYSTEM (models with navigation system)**

NISSAN Voice Recognition allows hands-free operation of the Phone, Navigation, Information and Audio systems in one of two modes, Standard Mode or Alternate Command Mode.

In Standard Mode, commands that are available are always shown on the display and announced by the system. You can complete your desired operation by simply following the prompts given by the system. (See “NISSAN Voice Recognition standard mode” (P.4-155) for details.)

For advanced operation, you can use the Alternate Command Mode. (See “NISSAN Voice Recognition alternate command mode” (P.4-166) for details.) When this mode is active, an expanded list of commands can be spoken after pushing the TALK  switch, and the voice command menu prompts are turned off. Review the expanded command list, which is available when this mode is active. Note that in this mode the recognition success rate may be affected as the number of available commands and the ways of speaking each command are increased.

To switch one mode to another, see each mode description later in this section.

To improve the recognition success rate when Alternate Command Mode is active, try using the Speaker Adaptation Function available in that mode. Otherwise, it is recommended that

Alternate Command Mode be turned off and Standard Mode be used for the best recognition performance.

For the voice commands for the navigation system, refer to the Navigation System Owner's Manual of your vehicle.

## NISSAN VOICE RECOGNITION STANDARD MODE

The following section is applicable when the Standard Mode is activated.

The Standard Mode enables you to complete the desired operation by simply following the prompts that appear on the display and also are announced by the system.

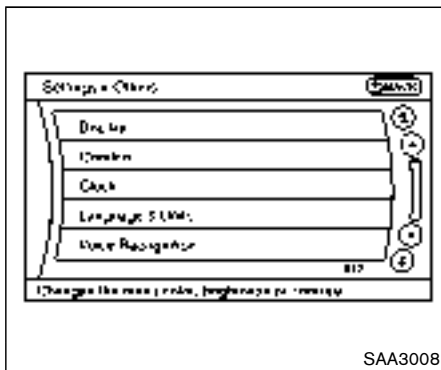

### Activating Standard Mode

When the Alternate Command Mode is active, perform the following steps to switch to the Standard Mode.

1. Push the SETTING button on the instrument panel.
2. Select the "Others" key.
3. Select the "Voice Recognition" key.

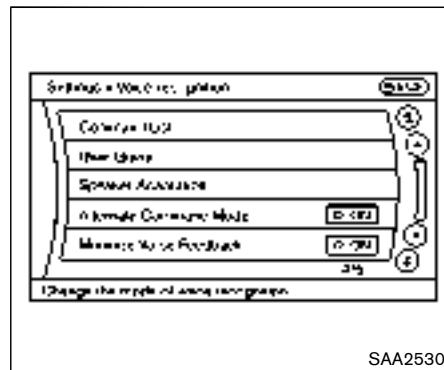

4. Select the "Alternate Command Mode" key.
5. The indicator turns off and the Standard Mode activates.

### Displaying user guide

If you use the NISSAN Voice Recognition system for the first time or you do not know how to operate it, you can display the User Guide for confirmation.

You can confirm how to use voice commands by accessing a simplified User Guide, which contains basic instructions and tutorials for several voice commands.



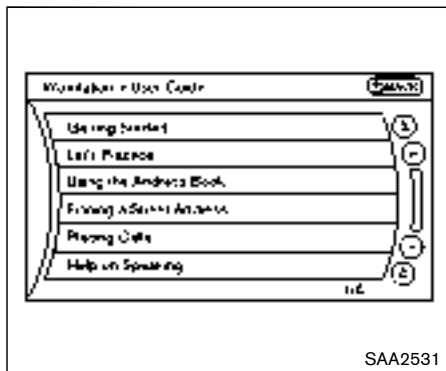

SAA2531

1. Push the INFO button on the instrument panel.
2. Select the "Others" key.
3. Select the "Voice Recognition" key.
4. Select the "User Guide" key.
5. Select a preferred item.

You can skip steps 1 and 3 above if you say "Help".

#### Available items:

- Getting Started  
Describes the basics of how to operate the NISSAN Voice Recognition system.

- Let's Practice  
Mode that allows practicing by following the instructions of the system voice.
- Using the Address Book  
Tutorial for entering a destination by using the Address Book.
- Finding a Street Address (if so equipped)  
Tutorial for entering a destination by street address.
- Placing Calls  
Tutorial for making a phone call by voice command operation.
- Help on Speaking  
Displays useful tips of speaking for correct command recognition by the system.

Note that the Command List feature is only available when Alternate Command Mode is active.

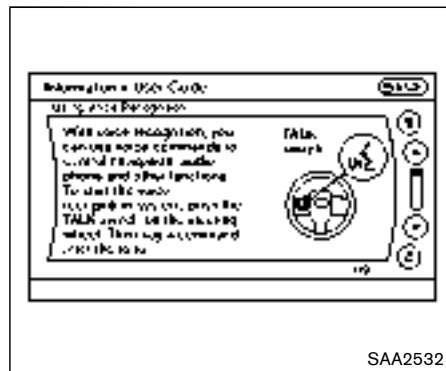

SAA2532

#### Getting Started

Before using the NISSAN Voice Recognition system for the first time, you can confirm how to use commands by viewing the Getting Started section of the User Guide.

1. Select the "Getting Started" key.
2. You can confirm the page by scrolling the screen using the multi-function controller.

#### Tutorials on the operation of the NISSAN Voice Recognition system

If you choose "Using the Address Book", "Finding a Street Address" or "Placing Calls", you can view tutorials on how to perform these operations using NISSAN Voice Recognition.

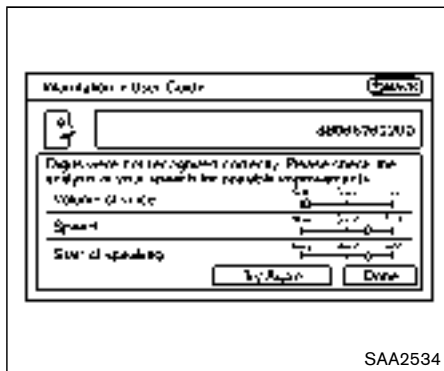

### Let's Practice

This mode helps learn how to use the NISSAN Voice Recognition system.

1. Select the "Let's Practice" key.
2. After the message screen appears, push the TALK  switch on the steering wheel.
3. Speak the displayed number after the tone. The evaluation screen will be displayed and the result can be confirmed.

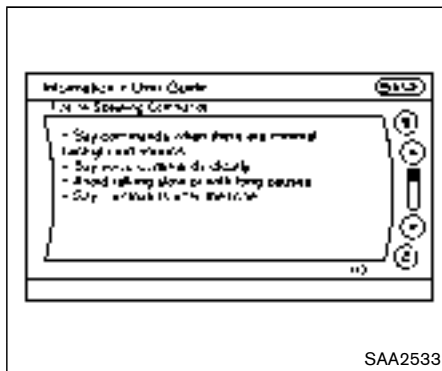

### Useful tips for correct operation

You can display useful speaking tips to help the system recognize your voice commands correctly.

Select "Help on Speaking" to start display.

## USING THE SYSTEM

### Initialization

When the ignition switch is pushed to the ON position, NISSAN Voice Recognition is initialized, which may take up to one minute. When completed, the system is ready to accept voice commands. If the TALK  switch is pushed before the initialization completes, the display will show the message: "System not ready." or a beep sounds.



### Before starting

To get the best recognition performance from NISSAN Voice Recognition, observe the following:

- The interior of the vehicle should be as quiet as possible. Close the windows to eliminate the surrounding noises (traffic noise and vibration sounds, etc.), which may prevent the system from correctly recognizing the voice commands.
- Wait until the tone sounds before speaking a command.
- Speak in a natural conversational voice without pausing between words.
- If the air conditioner is set to "Auto", the fan speed is automatically lowered so that your commands can be recognized more easily.



### Giving voice commands

1. Push the TALK  switch located on the steering wheel.
2. A list of commands appears on the screen, and you will hear a prompt.
3. After the tone sounds and the icon on the screen changes from  to , speak a command.

Selecting the "Practice" key will start the practice mode. See "Let's Practice" (P.4-157).

4. Continue to follow the voice menu prompts and speak after the tone sounds until your desired operation is completed.

Selecting the "Help" key can display the detailed information of the each command.

### Operating tips:

- Say a command after the tone.
- Commands that are available are always shown on the display and spoken through voice menu prompts. Commands other than those that are displayed are not accepted. Please follow the prompts given by the system.
- If the command is not recognized, the system announces, "Please say again". Repeat the command in a clear voice.
- Push the BACK button once to return to the previous screen.
- To exit the Voice Recognition system, push and hold the TALK  switch. The message, "Voice canceled" will be announced.

### Voice Prompt Interrupt:

To skip the voice guidance function and give the command immediately, press the TALK  switch to interrupt the system. Remember to speak after the tone.

### How to speak numbers:

NISSAN Voice Recognition requires a certain way to speak numbers when giving voice commands. Refer to the following examples.

### General rule

Only single digits 0 (zero) to 9 can be used. (For example, if you would like to say 500, "five zero zero" can be used, but "five hundred" cannot.)

### Examples

- 1-800-662-6200
  - "One eight zero zero six six two six two zero zero"

### Improving Recognition of Phone numbers

You can improve the recognition of phone numbers by saying the phone number in three groups of numbers. For example, when you try to call 800-662-6200, say "eight zero zero" first, and the system will then ask you for the next three digits. Then, say "six six two". After recognition, the system will then ask for the last four digits. Say, "six two zero zero". Using this method of phone digit entry can improve recognition performance.

When speaking a house number, speak the number "0" as "zero". If the letter "o (Oh)" is included in the house number, it will not be recognized as the number "0 (zero)" even if you speak "oh" instead of "zero". **Please speak "zero" for the number "0 (zero)", "oh" for the letter "o (oh)".**

**Send digits using dial tone:**

- Press the TALK  switch during a phone call.
- The menu will be launched and you will be provided with the following guidance: "Please say the digits to dial".
- After guidance, say the digits of the number you want to send. After this, the digits that have been recognized will be read out.
- If you press the ENTER button on the steering wheel or on the multi-function controller, the selected digits will be sent.

## Command List

### Category Command:

Command	Action
Call (Optional)	Makes a call to a contact that is stored in either phonebook. Please say "Call" followed by a stored name.
Phone	Operates the Phone function.
Navigation	Operates the Navigation function.
Information	Displays the vehicle Information function.
Audio	Operates the Audio function.
Help	Displays User Guide

### • Phone Command:

Command	Action	
Dial Number	Makes a call to a spoken phone number up to 10 digits.	
Quick Dial	Makes a call to a contact that is stored in the Quick Dial.	
Phonebook	Makes a call to a contact that is stored in the mobile phone.	
Call history	Incoming Calls	Makes a call to the incoming call number.
	Outgoing Calls	Makes a call to the dialed number.
	Missed Calls	Makes a call to the Missed calls number.
International Call	Makes an international call by allowing more than 10 digits to be spoken.	
Change Number	Corrects the recognized phone number (available during phone number entry).	

### • Navigation Command:

Command	Action
Destination Home	Sets a route to your home that is stored in the Address Book.
Address	Searches for a location by the street address specified, and sets a route to the location.
Places	Sets a route to a facility near the current vehicle location.
Address Book	Searches for stored information in the Address Book.

<b>Command</b>	<b>Action</b>
Previous Destinations	Sets a route to a previous destination.

- Information Command:

<b>Command</b>	<b>Action</b>
Fuel Economy	Displays fuel economy information.
Maintenance	Displays maintenance information.
Traffic Information	Turns the traffic information system ON and OFF.
Where am I?	Displays your current location.

- Audio Command:

<b>Command</b>	<b>Action</b>
AM	Turns to the AM band, selecting the station last played.
FM	Turns to the FM band, selecting the station last played.
XM	Turns to the SiriusXM Satellite Radio band, selecting the channel last played.
CD	Starts to play a CD.

- General Commands

<b>Command</b>	<b>Action</b>
Go back	Corrects the last recognition result to return to the previous screen.
Exit	Cancels Voice Recognition.

## Voice command examples

To use the NISSAN Voice Recognition function, speaking one command is sometimes sufficient, but at other times it is necessary to speak two or more commands. As examples, some additional basic operations by voice commands are described here.

For navigation system commands, see the separate Navigation System Owner's Manual.



### Example 1 - Placing a call to the phone number 800-662-6200:

1. Push the TALK  switch located on the steering wheel. You will hear a prompt.
2. Speak "Phone".

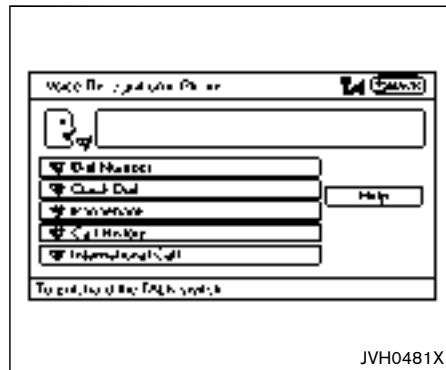

3. Speak "Dial Number".

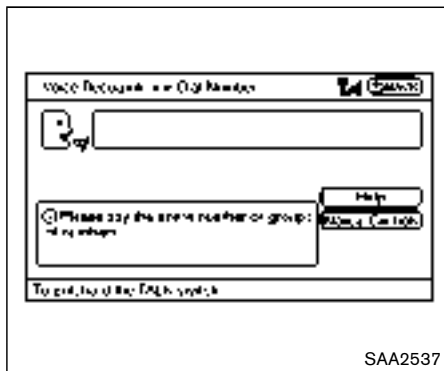

SAA2537

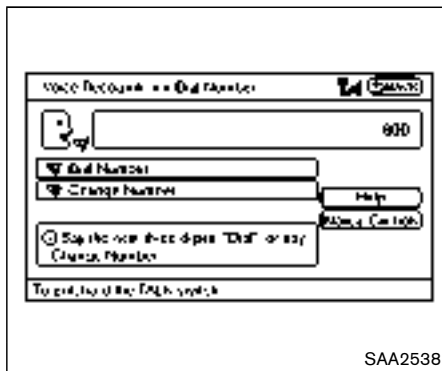

SAA2538

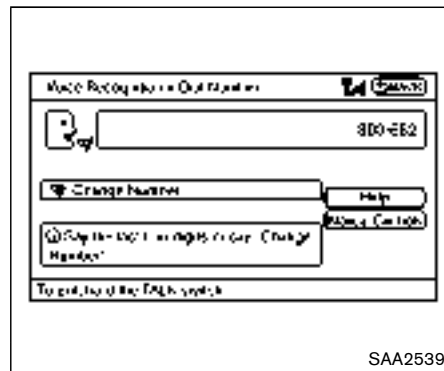

SAA2539

4. Speak "8 0 0".  
Selecting the "Manual Controls" key switches the screen to the keypad to input the phone number manually.
5. The system announces, "Please say the next three digits or dial, or say change number."
6. Speak "6 6 2".
7. The system announces, "Please say the last four digits" or say change number.
8. Speak "6 2 0 0".



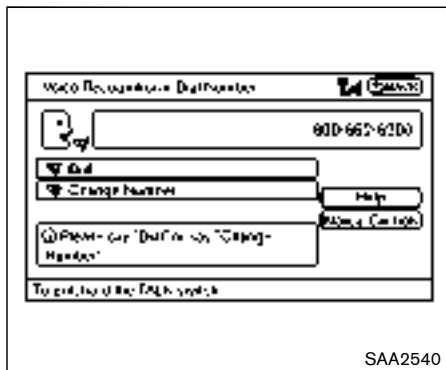

9. The system announces, “Dial or Change Number?”
10. Speak “Dial”.
11. The system makes a call to 800-662-6200.

**Note:**

- You can also speak “800-662-6200” (10 continuous digits) or “662-6200” (7 continuous digits), if the area code is not necessary. However, the 3-3-4 digit grouping is recommended for improved recognition. (See “How to speak numbers” earlier in this section.)
- You can only say a phone number using the 3-3-4 grouping, 7 digits, and 10 digits using

this command. Please use the “International Call” command for all other formats.

- If you say “Change Number” during phone number entry, the system will automatically request that you repeat the number using the 3-3-4 format. In this case please say the area code first and then follow the prompts.
- Do not add a “1” in front of the area code when speaking phone numbers.
- If the system does not recognize your command, please try repeating the command using a natural voice. Speaking too slow or too loudly may further decrease recognition performance.



**Example 2 - Placing an international call to the phone number 011-81-111-222-3333:**

1. Push the TALK  switch located on the steering wheel. You will hear a prompt.
2. Speak “Phone”.

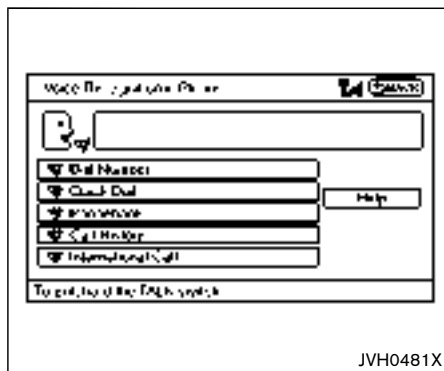

3. Speak "International Call".

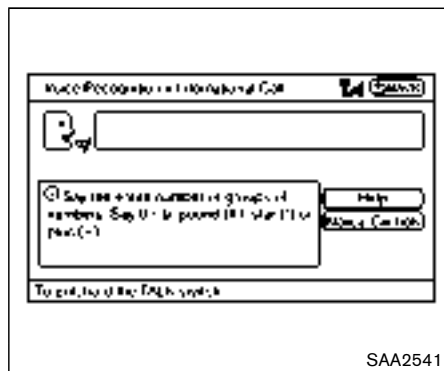

4. Speak "011811112223333".

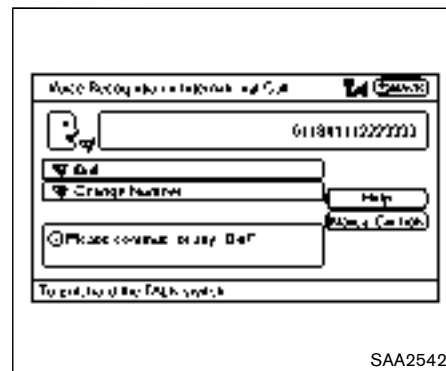

5. Speak "Dial".

6. System makes a call to 011-81-111-222-3333.

**Note:**

Any digit input format is available in the International Number input process.

## NISSAN VOICE RECOGNITION ALTERNATE COMMAND MODE

The following section is applicable when Alternate Command Mode is activated.

When Alternate Command Mode is activated, an expanded list of commands can be used after pressing the TALK  switch. In this mode, available commands are not fully shown on the display or prompted. Review the expanded command list when this mode is active. See examples of Alternate Command Mode screens.

Please note that in this mode the recognition success rate may be affected as the number of available commands and ways of speaking each command are increased. To improve the recognition success rate, try using the Speaker Adaptation Function available in that mode. (See "Speaker adaptation function (for Alternate Command Mode)" (P.4-176).) Otherwise it is recommended that Alternate Command Mode be turned OFF and Standard Mode be used for the best recognition performance.

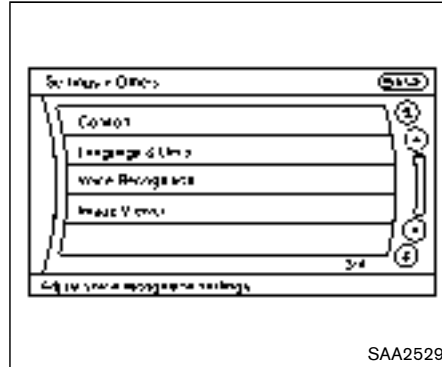

### Activating Alternate Command Mode

When the Standard Mode is active, perform the following steps to switch to the Alternate Command Mode.

1. Push the SETTING button on the instrument panel.
2. Highlight the "Others" key.
3. Highlight the "Voice Recognition" key.

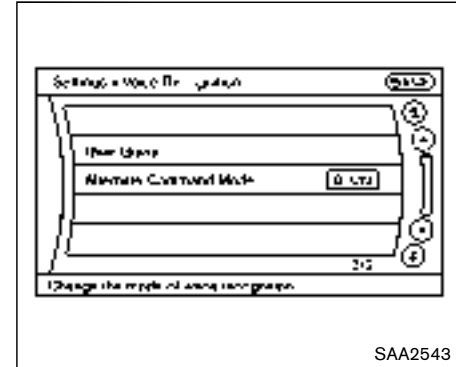

4. Highlight the "Alternate Command Mode" key.
5. The confirmation message is displayed on the screen. Push the "OK" key to activate the Alternate Command Mode.

### Displaying command list

If you are controlling the system by voice commands for the first time or do not know the appropriate voice command, perform the following procedure for displaying the voice command list (available only in Alternate Command Mode).

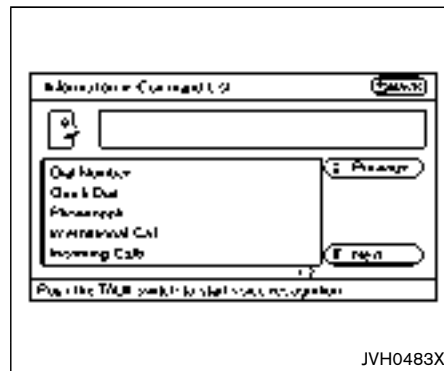
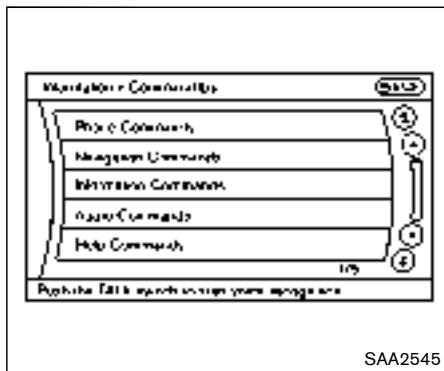
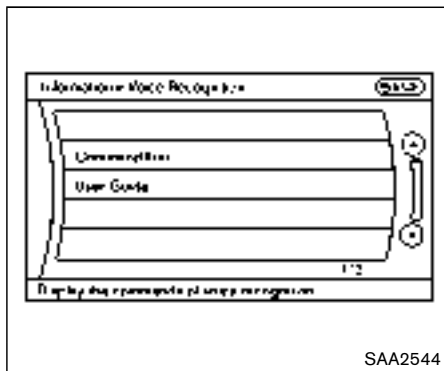

1. Push the INFO button on the instrument panel.
2. Select the "Others" key.
3. Select the "Voice Recognition" key.
4. Select the "Command List" key.
5. Select a category from the list.
6. Select an item.
7. If necessary, scroll the screen using the multi-function controller to view the entire list.
8. Press the BACK button to return to the previous screen.

## Command List

### Phone Commands:

Command		Action
Dial Number		Makes a call to a spoken phone number.
Quick Dial		Makes a call to a contact that is stored in the Quick Dial.
Phonebook		Makes a call to a contact that is stored in the mobile phone.
Call History	Incoming Calls	Makes a call to the incoming call number.
	Outgoing Calls	Makes a call to the dialed number.
	Missed Calls	Makes a call to the Missed calls number.
International Call		Makes an international call by allowing more than 10 digits to be spoken.
Call <name>		Makes a call to a contact that is stored in either Quick Dial or Phonebook. Please say "Call" followed by a stored name.
Change Number		Corrects the recognized phone number (available during phone number entry).

**Navigation Commands:**

<b>Command</b>	<b>Action</b>
Destination Home	Sets a route to your home that is stored in the Address Book.
Address	Searches for a location by the street address specified, and sets a route to the location.
Places	Sets a route to a facility near the current vehicle location.
Address Book	Searches for stored information in the Address Book.
Previous Destinations	Sets a route to a previous destination.
Previous Start Point	Sets a route to a previous starting point.
Delete Destination	Deletes a destination.

**Information Commands:**

<b>Command</b>	<b>Action</b>
Fuel Economy	Displays fuel economy information.
Maintenance	Displays maintenance information.
Where am I?	Displays your current location.
Traffic Information	Turns the traffic information system ON and OFF.
Weather Information	Displays weather information.
Weather Map	Displays a weather map.

**Audio Commands:**

Command	Action
CD	Starts to play a CD.
FM	Turns to the FM band, selecting the station last played.
AM	Turns to the AM band, selecting the station last played.
XM	Turns to the SiriusXM Satellite Radio band, selecting the channel last played.
USB	Turns on the USB memory.
Bluetooth Audio	Turns on the Bluetooth® audio player.
AUX	Turns on the AUX.



**Help Commands:**

<b>Command</b>		<b>Action</b>
Command List	Navigation Commands	Displays the navigation command list.
	Phone Commands	Displays the phone command list.
	Audio Commands	Displays the audio command list.
	Information Commands	Displays the information command list.
	Help Commands	Displays the help command list.
User Guide		Displays the User Guide.
Speaker Adaptation		The system can memorize the voices of up to three persons.

**General Commands:**

<b>Command</b>	<b>Action</b>
Go back	Corrects the last recognition result to return to the previous screen
Exit	Cancels Voice Recognition

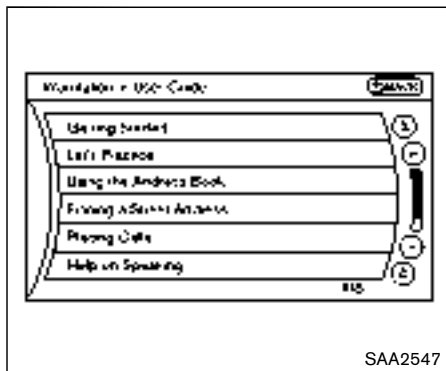

### Displaying user guide

You can confirm how to use voice commands by accessing a simplified User Guide, which contains basic instructions and tutorials for several voice commands.

1. Push the INFO button on the instrument panel.
2. Select the "Others" key using the multi-function controller and push the ENTER button.
3. Highlight the "Voice Recognition" key using the multi-function controller and push the ENTER button.

4. Highlight the "User Guide" key using the multi-function controller and push the ENTER button.
5. Highlight an item using the multi-function controller and push the ENTER button.

### Available items:

- Getting Started  
Describe the basics of how to operate the NISSAN Voice Recognition system.
- Let's Practice  
Mode that allows practicing by following the instructions of the system voice.
- Using the Address Book  
Refer to Navigation System Owner's Manual.
- Finding a Street Address (if so equipped)  
Refer to Navigation System Owner's Manual.
- Placing Calls  
Tutorial for making a phone call by voice command operation.
- Help on Speaking  
Displays useful tips for how to correctly speak commands in order for them to be properly recognized by the system.
- Voice Recognition Settings  
Describes the available voice recognition

settings.

- Adapting the System to Your Voice  
Tutorial adapting the system to your voice.

## USING THE SYSTEM

### Initialization

When the ignition switch is pushed to the ON position, NISSAN Voice Recognition is initialized, which may take up to one minute. When completed, the system is ready to accept voice commands. If the TALK  switch is pushed before the initialization completes the display will show the message: "System not ready." or a beep sounds.

### Before starting



To get the best performance from NISSAN Voice Recognition, observe the following.

- Keep the interior of the vehicle as quiet as possible. Close the windows to eliminate the surrounding noises (traffic noises, vibration sounds, etc.), which may prevent the system from recognizing the voice commands correctly.
- When the air conditioner is in the AUTO mode, the fan speed decreases automatically for easy recognition.
- Wait until a tone sounds before speaking a command.

- Speak in a natural voice without pausing between words.



### Giving voice command

1. Push and release the TALK  switch located on the steering wheel.
2. A list of commands appears on the screen, and you will hear a prompt.
3. After the tone sounds and the icon on the screen changes from  to , speak a command.

### Operating tips:

- Voice commands cannot be accepted when the icon is .
- The list displayed can be scrolled by tilting the menu control switch on the steering wheel.

- If the command is not recognized, the system announces, "Please say again". Repeat the command in a clear voice.
- Push the BACK button once to return to the previous screen.
- If you want to cancel the command, push and hold the TALK  switch for 1 second. The message "Voice canceled" will be announced.

### Voice Prompt Interrupt:

To skip the voice guidance function and give the command immediately, press the TALK  switch to interrupt the system. Remember to speak after the tone.

### How to speak numbers:

NISSAN Voice Recognition requires a certain way to speak numbers when giving voice commands. Refer to the following examples.

### General rule

Only single digits 0 (zero) to 9 can be used. (For example, if you would like to say 500, "five zero zero" can be used, but "five hundred" cannot.)

### Phone numbers

Speak phone numbers according to the following examples:

- 1-800-662-6200

- “Dial one eight zero zero six six two six two zero zero.”

Note 1: For the best voice recognition phone dialing results, say phone numbers as single digits.

Note 2: You cannot say 555-6000 as “five five five six thousands”.

Note 3: When speaking a house number, speak the number “0” as “zero”. If the letter “o (Oh)” is included in the house number, it will not be recognized as the number “0 (zero)” even if you speak “oh” instead of “ zero”. Please speak “zero” for the number “0 (zero)”, “oh” for the letter “o (oh)”.

#### Send digits using dial tone:

- Press the TALK  switch during a phone call.
- The menu will be launched and you will be provided with the following guidance: “Please say the digits to dial”.
- After guidance, say the digits of the number you want to send. After this, the digits that have been recognized will be read out.
- If you press the ENTER button on the steering wheel or on the multi-function controller, the selected digits will be sent.

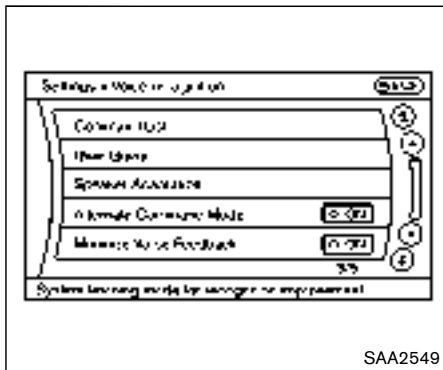

SAA2549

#### Speaker adaptation function (for Alternate Command Mode)

The Voice Recognition system has a function to learn the user's voice for better voice recognition performance. The system can memorize the voices of up to three persons.

#### Having the system learn the user's voice:

1. Push the SETTING button on the instrument panel and select the “Others” key.
2. Select the “Voice Recognition” key.
3. Select the “Speaker Adaptation” key.

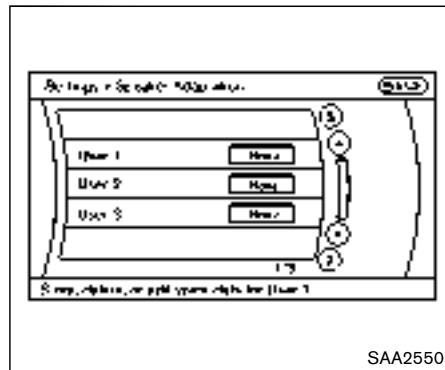

SAA2550

4. Select the user whose voice is memorized by the system.
5. Select the “Start Speaker Adaptation Learning” key.

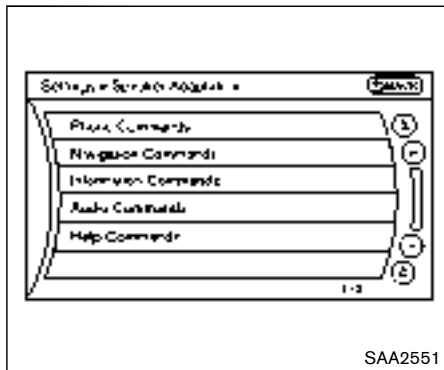



6. Select a category to be learned by the system from the following list.
  - Phone Commands
  - Navigation Commands
  - Information Commands
  - Audio Commands
  - Help Commands

The voice commands in the category are displayed.

7. Select a voice command and then push the ENTER button.  
The Voice Recognition system starts.



8. The system requests that you repeat a command after a tone.
9. After the tone sounds and the icon on the screen changes from  to , speak the command that the system requested.
10. When the system has recognized the voice command, the voice of the user is learned.  
Push the  switch or BACK button to return to the previous screen.

If the system has learned the command correctly, the voice command status on the right side of the command turns from "None" to "Stored".

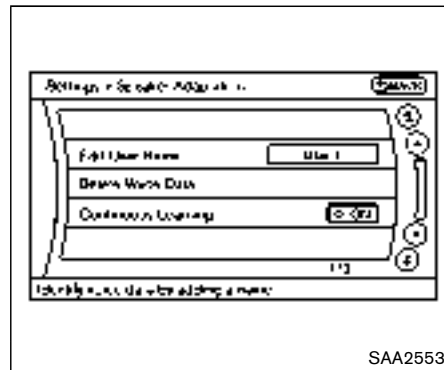

### Speaker Adaptation function settings:

#### Edit User Name

Edit the user name using the keypad displayed on the screen.

#### Delete Voice Data

Resets the user's voice that the Voice Recognition system has learned.

#### Continuous Learning

When this item is turned on, you can have the system learn the voice commands in succession, without selecting commands one by one.

## Minimize voice feedback (for Alternate Command Mode)

To minimize the voice feedback from the system, perform the following steps.

1. Push the **SETTING** button on the instrument panel.
2. Select the "Others" key.
3. Select the "Voice Recognition" key.
4. Select the "Minimize Voice Feedback" key.
5. The setting is turned on and the voice guidance will now be reduced when using the Voice Recognition system.

## TROUBLESHOOTING GUIDE

The system should respond correctly to all voice commands without difficulty. If problems are encountered, follow the solutions given in this guide for the appropriate error.

Where the solutions are listed by number, try each solution in turn, starting with number one, until the problem is resolved.

Symptom/error message	Solution
The system fails to interpret the command correctly.	1. Ensure that the command format is valid, see "Command List" (P.4-168).
	2. Speak clearly without pausing between words and at a level appropriate to the ambient noise level.
	3. Ensure that the ambient noise level is not excessive, for example, windows open or defrost on. <b>NOTE:</b> <b>If it is too noisy to use the phone, it is likely that voice commands will not be recognized.</b>
	4. If optional words of the command have been omitted, then the command should be tried with these in place.
The system consistently selects the wrong voicetag in the phonebook.	1. Ensure that the voicetag requested matches what was originally stored. (See "Bluetooth® hands-free phone system (Type A)" (P.4-122).)
	2. Replace one of the voicetags being confused with a different voicetag.



## **MEMO**

# 5 Starting and driving

Precautions when starting and driving .....	5-2	System malfunction .....	5-24
Exhaust gas (carbon monoxide) .....	5-2	System maintenance .....	5-25
Three-way catalyst .....	5-3	Cruise control .....	5-25
Tire Pressure Monitoring System (TPMS) .....	5-3	Precautions on cruise control .....	5-25
Avoiding collision and rollover .....	5-6	Cruise control operations .....	5-26
Off-road recovery .....	5-7	Break-in schedule .....	5-27
Rapid air pressure loss .....	5-7	Fuel efficient driving tips .....	5-27
Drinking alcohol/drugs and driving .....	5-8	Increasing fuel economy .....	5-28
Push-button ignition switch .....	5-8	Parking/parking on hills .....	5-29
Operating range for engine start function .....	5-9	Hydraulic pump electric power steering .....	5-30
Push-button ignition switch operation .....	5-9	Brake system .....	5-30
Push-button ignition switch positions .....	5-10	Braking precautions .....	5-30
Emergency engine shut off .....	5-10	Parking brake break-in .....	5-31
Intelligent Key battery discharge .....	5-11	Anti-lock Braking System (ABS) .....	5-31
Before starting the engine .....	5-11	Vehicle Dynamic Control (VDC) system .....	5-32
Starting the engine .....	5-12	Cold weather driving .....	5-34
Driving the vehicle .....	5-13	Freeing a frozen door lock .....	5-34
Continuously Variable Transmission (CVT) .....	5-13	Anti-freeze .....	5-34
Parking brake .....	5-16	Battery .....	5-34
Blind Spot Warning (BSW) (if so equipped) .....	5-17	Draining of coolant water .....	5-34
BSW system operation .....	5-19	Tire equipment .....	5-34
How to enable/disable the BSW system .....	5-19	Special winter equipment .....	5-34
BSW system limitations .....	5-20	Driving on snow or ice .....	5-35
BSW driving situations .....	5-21	Engine block heater (if so equipped) .....	5-35
System temporarily unavailable .....	5-24		

## PRECAUTIONS WHEN STARTING AND DRIVING



### WARNING

- Do not leave children or adults who would normally require the support of others alone in your vehicle. Pets should not be left alone either. They could accidentally injure themselves or others through inadvertent operation of the vehicle. Also, on hot, sunny days, temperatures in a closed vehicle could quickly become high enough to cause severe or possibly fatal injuries to people or animals.
- Properly secure all cargo with ropes or straps to help prevent it from sliding or shifting. Do not place cargo higher than the seatbacks. In a sudden stop or collision, unsecured cargo could cause personal injury.

## EXHAUST GAS (carbon monoxide)



### WARNING

- Do not breathe exhaust gases; they contain colorless and odorless carbon monoxide. Carbon monoxide is dangerous. It can cause unconsciousness or death.
- If you suspect that exhaust fumes are entering the vehicle, drive with all windows fully open, and have the vehicle inspected immediately.
- Do not run the engine in closed spaces such as a garage.
- Do not park the vehicle with the engine running for any extended length of time.
- Keep the liftgate closed while driving, otherwise exhaust gases could be drawn into the passenger compartment. If you must drive with the liftgate open, follow these precautions:
  1. Open all the windows.
  2. Set the  air recirculation to off and the fan control to high to

circulate the air.

- If electrical wiring or other cable connections must pass to a trailer through the seal on the liftgate or the body, follow the manufacturer's recommendation to prevent carbon monoxide entry into the vehicle.
- If a special body, camper or other equipment is added for recreational or other usage, follow the manufacturer's recommendation to prevent carbon monoxide entry into the vehicle. (Some recreational vehicle appliances such as stoves, refrigerators, heaters, etc. may also generate carbon monoxide.)
- The exhaust system and body should be inspected by a qualified mechanic whenever:
  - The vehicle is raised for service.
  - You suspect that exhaust fumes are entering into the passenger compartment.
  - You notice a change in the sound of the exhaust system.
  - You have had an accident involving damage to the exhaust

system, underbody, or rear of the vehicle.

### THREE-WAY CATALYST

The three-way catalyst is an emission control device installed in the exhaust system. Exhaust gases in the three-way catalyst are burned at high temperatures to help reduce pollutants.



#### WARNING

- **The exhaust gas and the exhaust system are very hot. Keep people, animals or flammable materials away from the exhaust system components.**
- **Do not stop or park the vehicle over flammable materials such as dry grass, waste paper or rags. They may ignite and cause a fire.**



#### CAUTION

- **Do not use leaded gasoline. Deposits from leaded gasoline will seriously reduce the three-way catalyst's ability to help reduce ex-**

haust pollutants.

- **Keep your engine tuned up. Malfunctions in the ignition, fuel injection, or electrical systems can cause overrich fuel flow into the three-way catalyst, causing it to overheat. Do not keep driving if the engine misfires, or if noticeable loss of performance or other unusual operating conditions are detected. Have the vehicle inspected promptly. It is recommended you visit a NISSAN dealer for this service.**
- **Avoid driving with an extremely low fuel level. Running out of fuel could cause the engine to misfire, damaging the three-way catalyst.**
- **Do not race the engine while warming it up.**
- **Do not push or tow your vehicle to start the engine.**

### TIRE PRESSURE MONITORING SYSTEM (TPMS)

Each tire, including the spare (if provided), should be checked monthly when cold and inflated to the inflation pressure recommended by the vehicle manufacturer on the vehicle placard or tire inflation pressure label. (If your vehicle has tires of a different size than the size indicated on the vehicle placard or tire inflation pressure label, you should determine the proper tire inflation pressure for those tires.)

As an added safety feature, your vehicle has been equipped with a Tire Pressure Monitoring System (TPMS) that illuminates a low tire pressure telltale when one or more of your tires is significantly under-inflated. Accordingly, when the low tire pressure telltale illuminates, you should stop and check your tires as soon as possible, and inflate them to the proper pressure. Driving on a significantly under-inflated tire causes the tire to overheat and can lead to tire failure. Under-inflation also reduces fuel efficiency and tire tread life, and may affect the vehicle's handling and stopping ability.

Please note that the TPMS is not a substitute for proper tire maintenance, and it is the driver's responsibility to maintain correct tire pressure, even if under-inflation has not reached the level to trigger illumination of the TPMS low tire

pressure telltale.

Your vehicle has also been equipped with a TPMS malfunction indicator to indicate when the system is not operating properly. The TPMS malfunction indicator is combined with the low tire pressure telltale. When the system detects a malfunction, the telltale will flash for approximately one minute and then remain continuously illuminated. This sequence will continue upon subsequent vehicle start-ups as long as the malfunction exists. When the malfunction indicator is illuminated, the system may not be able to detect or signal low tire pressure as intended. TPMS malfunctions may occur for a variety of reasons, including the installation of replacement or alternate tires or wheels on the vehicle that prevent the TPMS from functioning properly. Always check the TPMS malfunction telltale after replacing one or more tires or wheels on your vehicle to ensure that the replacement or alternate tires and wheels allow the TPMS to continue to function properly.

#### Additional information

- Since the spare tire is not equipped with the TPMS, the TPMS does not monitor the tire pressure of the spare tire.
- The TPMS will activate only when the vehicle is driven at speeds above 16 MPH (25 km/h). Also, this system may not detect

a sudden drop in tire pressure (for example a flat tire while driving).

- The low tire pressure warning light does not automatically turn off when the tire pressure is adjusted. After the tire is inflated to the recommended pressure, the vehicle must be driven at speeds above 16 MPH (25 km/h) to activate the TPMS and turn off the low tire pressure warning light. Use a tire pressure gauge to check the tire pressure.

- The CHECK TIRE PRESSURE warning also appears on the vehicle information display when the low tire pressure warning light is illuminated and low tire pressure is detected. The CHECK TIRE PRESSURE warning turns off when the low tire pressure warning light turns off.

The CHECK TIRE PRESSURE warning appears each time the ignition switch is placed in the ON position as long as the low tire pressure warning light remains illuminated.

The CHECK TIRE PRESSURE warning does not appear if the low tire pressure warning light illuminates to indicate a TPMS malfunction.

- Tire pressure rises and falls depending on the heat caused by the vehicle's operation and the outside temperature. Do not reduce

the tire pressure after driving because the tire pressure rises after driving. Low outside temperature can lower the temperature of the air inside the tire which can cause a lower tire inflation pressure. This may cause the low tire pressure warning light to illuminate. If the warning light illuminates in low ambient temperature, check the tire pressure for all four tires.

For additional information, see "Low tire pressure warning light" (P.2-14) and "Tire Pressure Monitoring System (TPMS)" (P.6-3).



## WARNING

- **If the low tire pressure warning light illuminates while driving, avoid sudden steering maneuvers or abrupt braking, reduce vehicle speed, pull off the road to a safe location and stop the vehicle as soon as possible. Driving with under-inflated tires may permanently damage the tires and increase the likelihood of tire failure. Serious vehicle damage could occur and may lead to an accident and could result in serious personal injury. Check the tire pressure for all four tires. Adjust the tire**

pressure to the recommended **COLD** tire pressure shown on the Tire and Loading Information label to turn the low tire pressure warning light **OFF**. If the light still illuminates while driving after adjusting the tire pressure, a tire may be flat or the TPMS may be malfunctioning. If you have a flat tire, replace it with a spare tire as soon as possible. If no tire is flat and all tires are properly inflated, it is recommended that you consult a **NISSAN** dealer.

- Since the spare tire is not equipped with the TPMS, when a spare tire is mounted or a wheel is replaced, the TPMS will not function and the low tire pressure warning light will flash for approximately 1 minute. The light will remain on after 1 minute. **Have your tires replaced and/or TPMS system reset as soon as possible. It is recommended you visit a NISSAN dealer for these services.**
- Replacing tires with those not originally specified by **NISSAN** could affect the proper operation of the TPMS.

- **Do not inject any tire liquid or aerosol tire sealant into the tires, as this may cause a malfunction of the tire pressure sensors.**



## **CAUTION**

- **The TPMS may not function properly when the wheels are equipped with tire chains or the wheels are buried in snow.**
- **Do not place metalized film or any metal parts (antenna, etc.) on the windows. This may cause poor reception of the signals from the tire pressure sensors, and the TPMS will not function properly.**

Some devices and transmitters may temporarily interfere with the operation of the TPMS and cause the low tire pressure warning light to illuminate. Some examples are:

- Facilities or electric devices using similar radio frequencies are near the vehicle.
- If a transmitter set to similar frequencies is being used in or near the vehicle.

- If a computer (or similar equipment) or a DC/AC converter is being used in or near the vehicle.

Low tire pressure warning light may illuminate in the following cases.

- If the vehicle is equipped with a wheel and tire without TPMS.
- If the TPMS has been replaced and the ID has not been registered.
- If the wheel is not originally specified by **NISSAN**.

### **FCC Notice:**

#### **For USA:**

**This device complies with Part 15 of the FCC Rules. Operation is subject to the following two conditions: (1) This device may not cause harmful interference, and (2) this device must accept any interference received, including interference that may cause undesired operation.**

**Note: Changes or modifications not expressly approved by the party responsible for compliance could void the user's authority to operate the equipment.**

#### **For Canada:**

**This device complies with Industry Canada licence-exempt RSS standard(s). Operation is subject to the following two condi-**

**tions: (1) this device may not cause interference, and (2) this device must accept any interference, including interference that may cause undesired operation of the device.**

### TPMS with Easy Fill Tire Alert

When adding air to an under-inflated tire, the TPMS with Easy Fill Tire Alert provides visual and audible signals outside the vehicle to help you inflate the tires to the recommended COLD tire pressure.

#### Vehicle set-up:

1. Park the vehicle in a safe and level place.
2. Apply the parking brake and place the shift lever in the P (Park) position.
3. Place the ignition switch in the ON position. Do not start the engine.

#### Operation:

1. Add air to the tire.
2. Within a few seconds, the hazard indicators will start flashing.
3. When the designated pressure is reached, the horn beeps once and the hazard indicators stop flashing.
4. Perform the above steps for each tire.

- If the tire is over-inflated to more than approximately 4 psi (30 kPa), the horn beeps and the hazard indicators flash 3 times. To correct the pressure, push the core of the valve stem on the tire briefly to release pressure. When the pressure reaches the designated pressure, the horn beeps once.
- If the hazard indicator does not flash within approximately 15 seconds after starting to inflate the tire, it indicates that the TPMS with Easy Fill Tire Alert is not operating.
- The TPMS will not activate the Easy Fill Tire Alert under the following conditions:
  - If there is interference from an external device or transmitter
  - The air pressure from the inflation device is not sufficient to inflate the tire
  - There is a malfunction in the TPMS system
  - There is a malfunction in the horn or hazard indicators
  - The identification code of the tire pressure sensor is not registered to the system
  - The battery of the tire pressure sensor is low

- If the TPMS with Easy Fill Tire Alert does not operate due to TPMS interference, move the vehicle about 1 m (3 ft) backward or forward and try again.

If the TPMS with Easy Fill Tire Alert is not working, use a tire pressure gauge.

### AVOIDING COLLISION AND ROLL-OVER



#### WARNING

**Failure to operate this vehicle in a safe and prudent manner may result in loss of control or an accident.**

Be alert and drive defensively at all times. Obey all traffic regulations. Avoid excessive speed, high speed cornering, or sudden steering maneuvers, because these driving practices could cause you to lose control of your vehicle.

**As with any vehicle, a loss of control could result in a collision with other vehicles or objects, or cause the vehicle to rollover, particularly if the loss of control causes the vehicle to slide sideways.** Be attentive at all times, and avoid driving when tired. Never drive when under the influence of alcohol or drugs (including prescription or over-the-counter drugs which may cause drowsiness). Always

wear your seat belt as outlined in the “Seat belts” (P.1-15) of this manual, and also instruct your passengers to do so.

Seat belts help reduce the risk of injury in collisions and rollovers. **In a rollover crash, an unbelted or improperly belted person is significantly more likely to be injured or killed than a person properly wearing a seat belt.**

## OFF-ROAD RECOVERY

If the right side or left side wheels leave the road surface, maintain control of the vehicle by following the procedure below. Please note that this procedure is only a general guide. The vehicle must be driven as appropriate based on the conditions of the vehicle, road and traffic.

1. Remain calm and do not overreact.
2. Do not apply the brakes.
3. Maintain a firm grip on the steering wheel with both hands and try to hold a straight course.
4. When appropriate, slowly release the accelerator pedal to gradually slow the vehicle.
5. If there is nothing in the way, steer the vehicle to follow the road while the vehicle speed is reduced. Do not attempt to drive the vehicle back onto the road surface until vehicle speed is reduced.

6. When it is safe to do so, gradually turn the steering wheel until both tires return to the road surface. When all tires are on the road surface, steer the vehicle to stay in the appropriate driving lane.

- If you decide that it is not safe to return the vehicle to the road surface based on vehicle, road or traffic conditions, gradually slow the vehicle to a stop in a safe place off the road.

## RAPID AIR PRESSURE LOSS

Rapid air pressure loss or a “blow-out” can occur if the tire is punctured or is damaged due to hitting a curb or pothole. Rapid air pressure loss can also be caused by driving on under-inflated tires.

Rapid air pressure loss can affect the handling and stability of the vehicle, especially at highway speeds.

Help prevent rapid air pressure loss by maintaining the correct air pressure and visually inspect the tires for wear and damage. See “Wheels and tires” (P.8-27).

If a tire rapidly loses air pressure or “blows-out” while driving maintain control of the vehicle by following the procedure below. Please note that this procedure is only a general guide. The vehicle must be driven as appropriate based on the conditions of the vehicle, road and traffic.



## WARNING

**The following actions can increase the chance of losing control of the vehicle if there is a sudden loss of tire air pressure. Losing control of the vehicle may cause a collision and result in personal injury.**

- **The vehicle generally moves or pulls in the direction of the flat tire.**
- **Do not rapidly apply the brakes.**
- **Do not rapidly release the accelerator pedal.**
- **Do not rapidly turn the steering wheel.**

1. Remain calm and do not overreact.
2. Maintain a firm grip on the steering wheel with both hands and try to hold a straight course.
3. When appropriate, slowly release the accelerator pedal to gradually slow the vehicle.
4. Gradually steer the vehicle to a safe location off the road and away from traffic if possible.
5. Lightly apply the brake pedal to gradually stop the vehicle.



6. Turn on the hazard warning flashers and either contact a roadside emergency service to change the tire or see “Changing a flat tire” (P.6-4).

## DRINKING ALCOHOL/DRUGS AND DRIVING



### WARNING

**Never drive under the influence of alcohol or drugs. Alcohol in the bloodstream reduces coordination, delays reaction time and impairs judgement. Driving after drinking alcohol increases the likelihood of being involved in an accident injuring yourself and others. Additionally, if you are injured in an accident, alcohol can increase the severity of the injury.**

NISSAN is committed to safe driving. However, you must choose not to drive under the influence of alcohol. Every year thousands of people are injured or killed in alcohol-related accidents. Although the local laws vary on what is considered to be legally intoxicated, the fact is that alcohol affects all people differently and most people underestimate the effects of alcohol.

## 5-8 Starting and driving

Remember, drinking and driving don't mix! And that is true for drugs, too (over-the-counter, prescription, and illegal drugs). Don't drive if your ability to operate your vehicle is impaired by alcohol, drugs, or some other physical condition.

## PUSH-BUTTON IGNITION SWITCH



### WARNING

**Do not operate the push-button ignition switch while driving the vehicle except in an emergency. (The engine will stop when the ignition switch is pushed 3 consecutive times or the ignition switch is pushed and held for more than 2 seconds.) If the engine stops while the vehicle is being driven, this could lead to a crash and serious injury.**

Before operating the push-button ignition switch, be sure to move the shift lever to the P (Park) position.

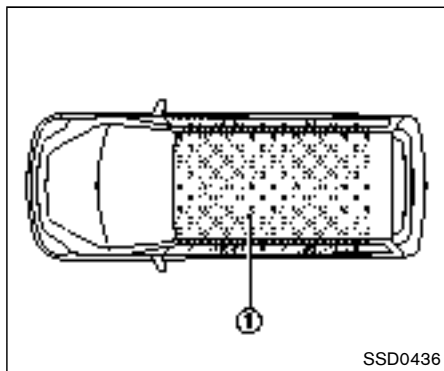

## OPERATING RANGE FOR ENGINE START FUNCTION

The Intelligent Key functions can only be used for starting the engine when the Intelligent Key is within the specified operating range ①.

When the Intelligent Key battery is almost discharged or strong radio waves are present near the operating location, the Intelligent Key system's operating range becomes narrower and may not function properly.

If the Intelligent Key is within the operating range, it is possible for anyone, even someone who does not carry the Intelligent Key, to push the ignition switch to start the engine.

- The cargo area is not included in the operating range, but the Intelligent Key may function.
- If the Intelligent Key is placed on the instrument panel, inside the glove box or door pocket, the Intelligent Key may not function.
- If the Intelligent Key is placed near the door or window outside the vehicle, the Intelligent Key may function.

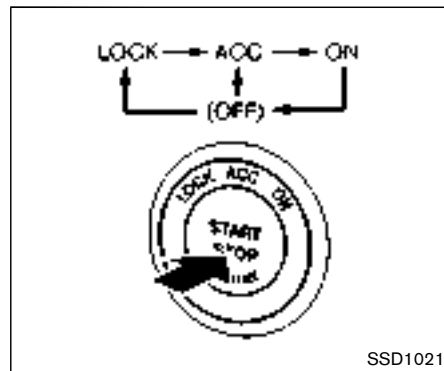

## PUSH-BUTTON IGNITION SWITCH OPERATION

When the ignition switch is pushed without depressing the brake pedal, the ignition switch position will change as follows:

- Push center once to change to ACC.
- Push center two times to change to ON.
- Push center three times to change to OFF. (No position illuminates.)
- Push center four times to return to ACC.
- Open or close any door to return to LOCK during the OFF position.

The ignition lock is designed so that the ignition switch position cannot be switched to LOCK

until the shift lever is moved to the P (Park) position.

When the ignition switch cannot be pushed toward the LOCK position, proceed as follows:

1. Move the shift lever into the P (Park) position.
2. Push the ignition switch to the OFF position. (The ignition switch position indicator will not illuminate.)
3. Open the door. The ignition switch will change to the LOCK position.

**The shift lever can be moved from the P (Park) position if the ignition switch is in the ON position and the brake pedal is depressed.**

**If the battery of the vehicle is discharged, the push-button ignition switch cannot be turned from the LOCK position.**

Some indicators and warnings for operation are displayed on the vehicle information display between the speedometer and tachometer. (See "Vehicle information display" (P.2-19).)

## PUSH-BUTTON IGNITION SWITCH POSITIONS

### LOCK (Normal parking position)

The ignition switch can only be locked in this position.

The ignition switch will be unlocked when it is pushed to the ACC position while carrying the Intelligent Key.

### ACC (Accessories)

This position activates electrical accessories such as the radio, when the engine is not running.

### ON (Normal operating position)

This position turns on the ignition system and electrical accessories.

### OFF

The engine can be turned off in this position.

The ignition lock is designed so that the ignition switch cannot be switched to the LOCK position until the shift lever is moved to the P (Park) position.



## CAUTION

**Do not leave the vehicle with the push-button ignition switch in ACC or ON positions when the engine is not running for an extended period. This can discharge the battery.**

## EMERGENCY ENGINE SHUT OFF

To shut off the engine in an emergency situation while driving perform the following procedure:

- Rapidly push the push-button ignition switch 3 consecutive times in less than 1.5 seconds, or
- Push and hold the push-button ignition switch for more than 2 seconds.

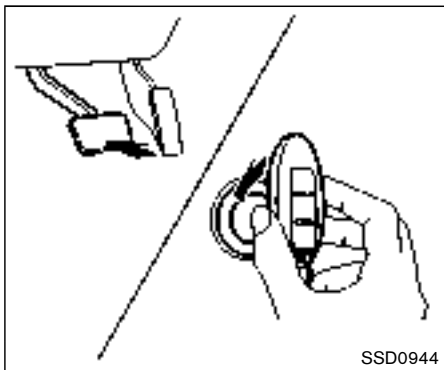

## INTELLIGENT KEY BATTERY DISCHARGE

If the battery of the Intelligent Key is discharged, or environmental conditions interfere with the Intelligent Key operation, start the engine according to the following procedure:

1. Move the shift lever to the P (Park) position.
2. Firmly apply the foot brake.
3. Touch the ignition switch with the Intelligent Key as illustrated. (A chime will sound.)
4. Push the ignition switch while depressing the brake pedal within 10 seconds after the chime sounds. The engine will start.

After step 3 is performed, when the ignition

switch is pushed without depressing the brake pedal, the ignition switch position will change to ACC.

### NOTE:

- **When the ignition switch is pushed to the ACC or ON position or the engine is started by the above procedures, the Intelligent Key battery discharge indicator appears on the vehicle information display even if the Intelligent Key is inside the vehicle. This is not a malfunction. To turn off the Intelligent Key battery discharge indicator, touch the ignition switch with the Intelligent Key again.**
- **If the Intelligent Key battery discharge indicator appears, replace the battery as soon as possible. (See "Intelligent Key battery replacement" (P.8-20).)**

## BEFORE STARTING THE ENGINE

- Make sure the area around the vehicle is clear.
- Check fluid levels such as engine oil, coolant, brake fluid and window washer fluid as frequently as possible, or at least whenever you refuel.
- Check that all windows and lights are clean.
- Visually inspect tires for their appearance and condition. Also check tires for proper inflation.
- Lock all doors.
- Position seats and adjust head restraints/headrests.
- Adjust inside and outside mirrors.
- Fasten seat belts and ask all passengers to do likewise.
- Check the operation of warning lights when the ignition switch is pushed to the ON position. (See "Warning lights, indicator lights and audible reminders" (P.2-11).)

## STARTING THE ENGINE

1. Apply the parking brake.
2. Move the shift lever to the P (Park) or N (Neutral) position. (P is recommended.)

The starter is designed not to operate unless the shift lever is in either of the above positions.

3. Push the ignition switch to the ON position. Depress the brake pedal and push the ignition switch to start the engine.

To start the engine immediately, push and release the ignition switch while depressing the brake pedal with the ignition switch in any position.

- If the engine is very hard to start in extremely cold weather or when restarting, depress the accelerator pedal a little (approximately 1/3 to the floor) and while holding, crank the engine. Release the accelerator pedal when the engine starts.
- If the engine is very hard to start because it is flooded, depress the accelerator pedal all the way to the floor and hold it. Push the ignition switch to the ON position to start cranking the engine. After 5 or 6 seconds, stop cranking by pushing the ignition switch to OFF. After cranking the engine, release the accelerator pedal. Crank the engine **with your foot off the accelerator pedal** by

depressing the brake pedal and pushing the push-button ignition switch to start the engine. If the engine starts, but fails to run, repeat the above procedure.



### CAUTION

**Do not operate the starter for more than 15 seconds at a time. If the engine does not start, push the ignition switch to OFF and wait 10 seconds before cranking again, otherwise the starter could be damaged.**

#### 4. Warm-up

Allow the engine to idle for at least 30 seconds after starting. Do not race the engine while warming it up. Drive at moderate speed for a short distance first, especially in cold weather. In cold weather, keep the engine running for a minimum of 2 - 3 minutes before shutting it off. Starting and stopping the engine over a short period of time may make the vehicle more difficult to start.

5. To stop the engine, shift the shift lever to the P (Park) position and push the ignition switch to the OFF position.

#### NOTE:

**Care should be taken to avoid situations that can lead to potential battery discharge and potential no-start conditions such as:**

1. **Installation or extended use of electronic accessories that consume battery power when the engine is not running (Phone chargers, GPS, DVD players, etc.)**
2. **Vehicle is not driven regularly and/or only driven short distances.**

**In these cases, the battery may need to be charged to maintain battery health.**

## DRIVING THE VEHICLE

### CONTINUOUSLY VARIABLE TRANSMISSION (CVT)

The Continuously Variable Transmission (CVT) in your vehicle is electronically controlled to produce maximum power and smooth operation.

The recommended operating procedures for this transmission are shown on the following pages. Follow these procedures for maximum vehicle performance and driving enjoyment.

**Engine power may be automatically reduced to protect the CVT if the engine speed increases quickly when driving on slippery roads or while being tested on some dynamometers.**

#### Starting the vehicle

1. After starting the engine, fully depress the foot brake pedal before moving the shift lever out of the P (Park) position.

**This CVT is designed so that the foot brake pedal must be depressed before shifting from P (Park) to any driving position while the ignition switch is in the ON position.**

**The shift lever cannot be moved out of the P (Park) position and into any of the other positions if the ignition switch is pushed to the LOCK, OFF or ACC position.**

2. Keep the foot brake pedal depressed and move the shift lever to a driving position.
3. Release the parking brake and foot brake pedal, and then gradually start the vehicle in motion.



### WARNING

- Do not depress the accelerator pedal while shifting from P (Park) or N (Neutral) to R (Reverse), D (Drive) or L (Low) position. Always depress the brake pedal until shifting is completed. Failure to do so could cause you to lose control and have an accident.
- Cold engine idle speed is high, so use caution when shifting into a forward or reverse gear before the engine has warmed up.
- Never shift to either the P (Park) or R (Reverse) position while the vehicle is moving forward and P (Park) or D (Drive) position while the vehicle is reversing. This could cause an accident or damage the transmission.

- Do not downshift abruptly on slippery roads. This may cause a loss of control.



### CAUTION

- Except in an emergency, do not shift to the N (Neutral) position while driving. Coasting with the transmission in the N (Neutral) position may cause serious damage to the transmission.
- To avoid possible damage to your vehicle; when stopping the vehicle on an uphill grade, do not hold the vehicle by depressing the accelerator pedal. The foot brake should be used for this purpose.

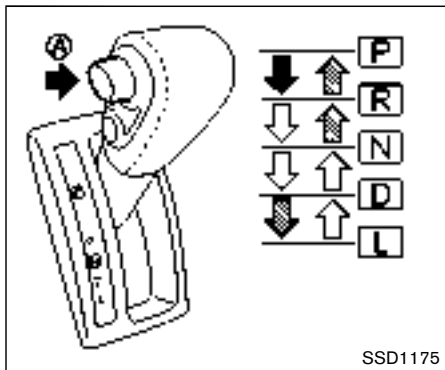

To move the shift lever,

- ➔: Push the button (A) while depressing the brake pedal.
- ▨: Push the button (A).
- ↔: Just move the shift lever.

### Shifting

After starting the engine, fully depress the brake pedal, push the shift lever button and move the shift lever from the P (Park) position to any of the desired shift positions.

## ⚠ WARNING

Apply the parking brake if the shift lever is in any position while the engine is not running. Failure to do so could cause the vehicle to move unexpectedly or roll away and result in serious personal injury or property damage.

## ⚠ CAUTION

Use the P (Park) or R (Reverse) position only when the vehicle is completely stopped.

### P (Park):

Use this position when the vehicle is parked or when starting the engine. Make sure the vehicle is completely stopped. **The brake pedal must be depressed and the shift lever button pushed in to move the shift lever from N (Neutral) or any drive position to P (Park).** Apply the parking brake. When parking on a hill, apply the parking brake first, then move the shift lever to the P (Park) position.

### R (Reverse):

Use this position to back up. Make sure the vehicle is completely stopped before selecting the R (Reverse) position. **The brake pedal must be depressed and the shift lever button pushed in to move the shift lever from P (Park), N (Neutral) or any driving position to R (Reverse).**

### N (Neutral):

Neither forward nor reverse gear is engaged. The engine can be started in this position. You may shift to N (Neutral) and restart a stalled engine while the vehicle is moving.

### D (Drive):

Use this position for all normal forward driving.

### L (Low):

Use this position for maximum engine braking on steep downhill gradients/climbing steep slopes and whenever approaching sharp bends. Do not use the L position in any other circumstances.

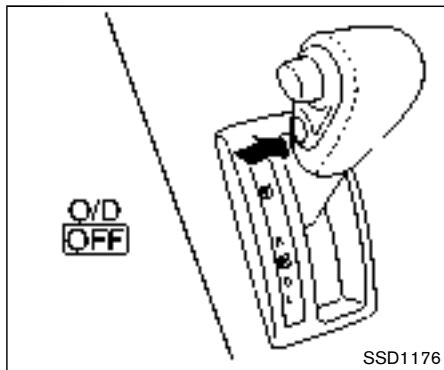

### Overdrive (O/D) OFF switch

When the O/D OFF switch is pushed with the shift lever in the D (Drive) position, the  indicator light in the instrument panel illuminates. Use the overdrive off mode when you need improved engine braking.

To turn off the overdrive off mode, push the O/D OFF switch again. The  indicator light will turn off.

Each time the engine is started, or when the shift lever is shifted to any position other than the D (Drive) position, the overdrive off mode will be automatically turned off.

### Accelerator downshift — In D position —

For passing or hill climbing, fully depress the accelerator pedal to the floor. This shifts the transmission down into a lower gear, depending on the vehicle speed.

### High fluid temperature protection mode

This transmission has a high fluid temperature protection mode. If the fluid temperature becomes too high (for example, when climbing steep grades in high temperature with heavy loads, such as when towing a trailer), engine power and, under some conditions, vehicle speed will be decreased automatically to reduce the chance of transmission damage. Vehicle speed can be controlled with the accelerator pedal, but the engine and vehicle speed may be limited.

### Fail-safe

**If the vehicle is driven under extreme conditions, such as excessive wheel spinning and subsequent hard braking, the fail-safe system may be activated. This will occur even if all electrical circuits are functioning properly. In this case, place the ignition switch in the OFF position and wait for 10 seconds. Then place the ignition switch back in the ON position. The vehicle should return to its normal operat-**

**ing condition. If it does not return to its normal operating condition, have the transmission checked and repaired, if necessary. It is recommended you visit a NISSAN dealer for this service.**



## WARNING

**When the high fluid temperature protection mode or fail-safe operation occurs, vehicle speed may be gradually reduced. The reduced speed may be lower than other traffic, which could increase the chance of a collision. Be especially careful when driving. If necessary, pull to the side of the road at a safe place and allow the transmission to return to normal operation, or have it repaired if necessary.**



## PARKING BRAKE

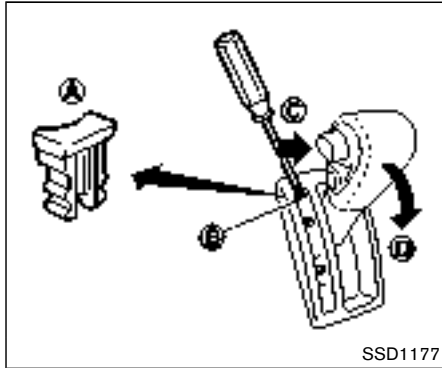

### Shift lock release

If the battery charge is low or discharged, the shift lever may not be moved from the P (Park) position even with the brake pedal depressed and the shift lever button pushed.

To move the shift lever, perform the following procedure:

1. Push the ignition switch to the OFF or LOCK position.
2. Apply the parking brake.
3. Remove the shift lock release cover (A) using a suitable tool.

4. Push down the shift lock release (B) using a suitable tool.
5. Push the shift lever button (C) and move the shift lever to the N (Neutral) position (D) while holding down the shift lock release.

The vehicle may be moved to the desired location.

Replace the removed shift lock release cover after the operation.

If the shift lever cannot be moved out of the P (Park) position, have the CVT system checked as soon as possible. It is recommended you visit a NISSAN dealer for this service.

### WARNING

- Be sure the parking brake is fully released before driving. Failure to do so can cause brake failure and lead to an accident.
- Do not release the parking brake from outside the vehicle.
- Do not use the shift lever in place of the parking brake. When parking, be sure the parking brake is fully engaged.
- To help avoid risk of injury or death through unintended operation of the vehicle and/or its systems, do not leave children, people who require the assistance of others or pets unattended in your vehicle. Additionally, the temperature inside a closed vehicle on a warm day can quickly become high enough to cause a significant risk of injury or death to people and pets.

### WARNING

**If the shift lever cannot be moved from the P (Park) position while the engine is running and the brake pedal is depressed, the stop lights may not work. Malfunctioning stop lights could cause an accident injuring yourself and others.**

## BLIND SPOT WARNING (BSW) (if so equipped)

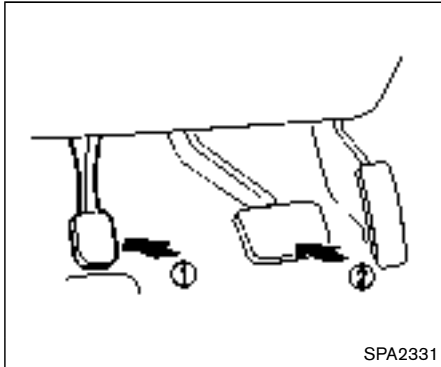

**To apply:** Fully depress the parking brake pedal ①.

### **To release:**

1. Firmly apply the foot brake ②.
2. Depress the parking brake pedal ① and the parking brake will be released.
3. Before driving, be sure the brake warning light goes out.

## **WARNING**

Failure to follow the warnings and instructions for proper use of the BSW system could result in serious injury or death.

- **The BSW system is not a replacement for proper driving procedure and is not designed to prevent contact with vehicles or objects. When changing lanes, always use the side and rear mirrors and turn and look in the direction your vehicle will move to ensure it is safe to change lanes. Never rely solely on the BSW system.**

The BSW system helps alert the driver of other vehicles in adjacent lanes when changing lanes.

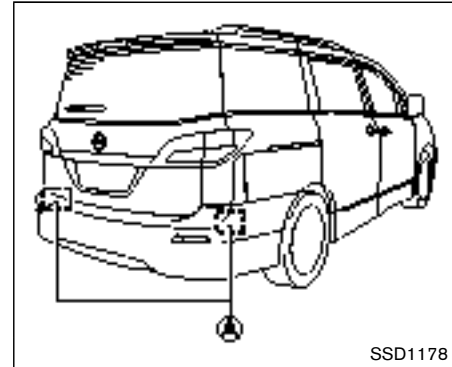

The BSW system uses radar sensors ① installed near the rear bumper to detect other vehicles in an adjacent lane.

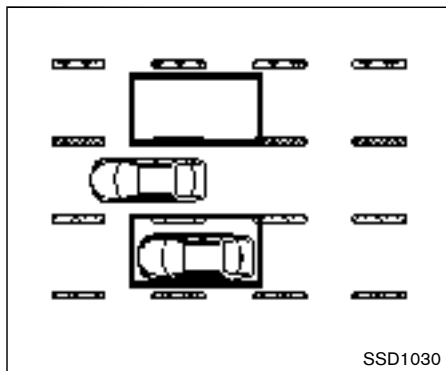

Detection zone

The radar sensors can detect vehicles on either side of your vehicle within the detection zone shown as illustrated. This detection zone starts from the outside mirror of your vehicle and extends approximately 10 ft (3.0 m) behind the rear bumper, and approximately 10 ft (3.0 m) sideways.

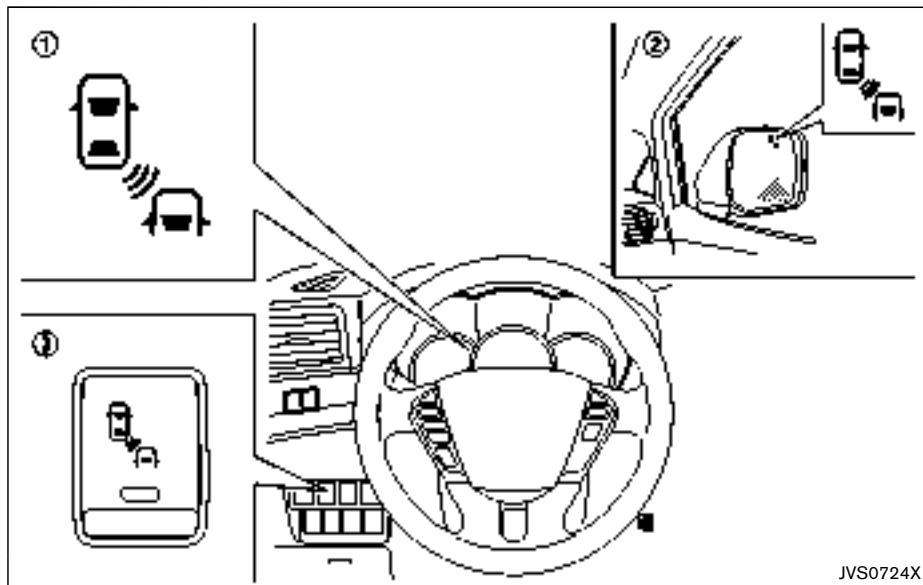

- ① BSW system warning light
- ② Side indicator light
- ③ BSW switch

## BSW SYSTEM OPERATION

The BSW system operates above approximately 20 MPH (32 km/h).

If the radar sensors detect a vehicle in the detection zone, the side indicator light illuminates.

If the turn signal is then activated, the system chimes (twice) and the side indicator light flashes. The side indicator light continues to flash until the detected vehicle leaves the detection zone.

### NOTE:

- **The side indicator light illuminates for a few seconds when the ignition switch is placed in the ON position.**
- **The brightness of the side indicator light is adjusted automatically depending on the brightness of the ambient light.**
- **If a vehicle comes into the detection zone after the driver activates the turn signal, then only the side indicator light flashes and no chime sounds. For additional information, refer to "BSW driving situations" (P.5-21).**

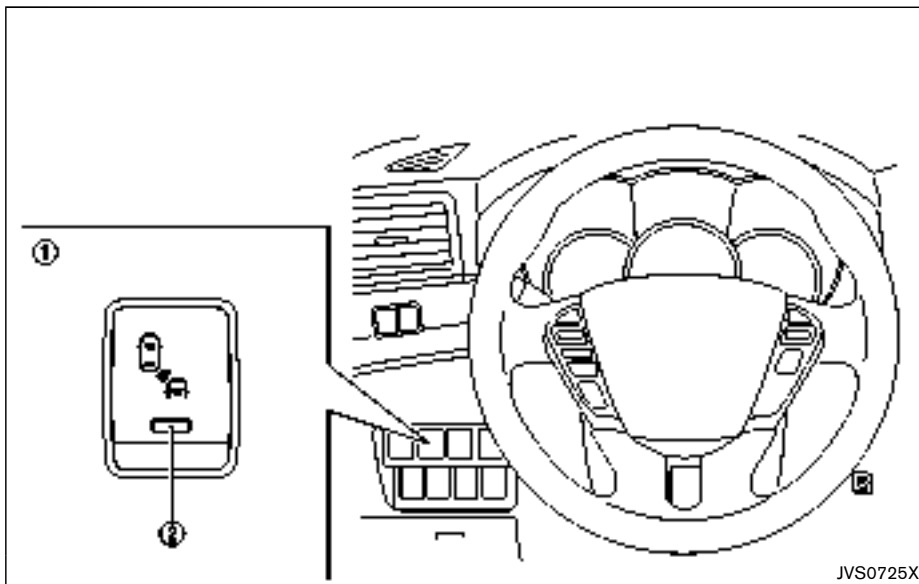

## HOW TO ENABLE/DISABLE THE BSW SYSTEM

The BSW switch ① is used to turn ON and OFF the BSW system. When the BSW switch ① is turned to off, the BSW ON indicator light ② on the switch is off.

## BSW SYSTEM LIMITATIONS



### WARNING

Listed below are the system limitations for the BSW system. Failure to operate the vehicle in accordance with these system limitations could result in serious injury or death.

- The BSW system cannot detect all vehicles under all conditions.
- The radar sensors may not be able to detect and activate BSW when certain objects are present such as:
  - Pedestrians, bicycles, animals.
  - Vehicles such as motorcycles, low height vehicles, or high ground clearance vehicles.
  - Oncoming vehicles.
  - Vehicles remaining in the detection zone when you accelerate from a stop.
  - A vehicle merging into an adjacent lane at a speed approximately the same as your vehicle.

- A vehicle approaching rapidly from behind.
- A vehicle which your vehicle overtakes rapidly.
- A vehicle that passes through the detection zone quickly.
- When overtaking several vehicles in a row, the vehicles after the first vehicle may not be detected if they are traveling close together.
- The radar sensor's detection zone is designed based on a standard lane width. When driving in a wider lane, the radar sensors may not detect vehicles in an adjacent lane. When driving in a narrow lane, the radar sensors may detect vehicles driving two lanes away.
- The radar sensors are designed to ignore most stationary objects, however objects such as guardrails, walls, foliage and parked vehicles may occasionally be detected. This is a normal operating condition.
- The following conditions may reduce the ability of the radar to detect other vehicles:

- Severe weather
- Road spray
- Ice/frost/snow build-up on the vehicle
- Dirt build-up on the vehicle
- Do not attach stickers (including transparent material), install accessories or apply additional paint near the radar sensors. These conditions may reduce the ability of the radar to detect other vehicles.
- Do not use the BSW system when towing a trailer because the system may not function properly.
- Excessive noise (for example, audio system volume, open vehicle window) will interfere with the chime sound, and it may not be heard.

## BSW DRIVING SITUATIONS

Indicator on



Indicator off



Indicator flashing

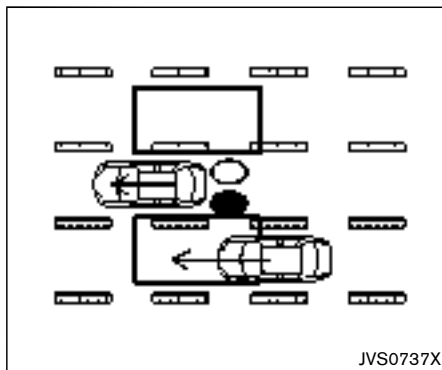

Illustration 1 – Approaching from behind

Another vehicle approaching from behind

Illustration 1: The side indicator light illuminates if a vehicle enters the detection zone from behind in an adjacent lane.

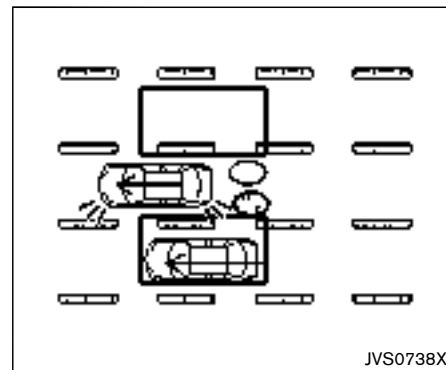

Illustration 2 – Approaching from behind

Illustration 2: If the driver activates the turn signal, then the system chimes (twice) and the side indicator light flashes.

### NOTE:

- The radar sensors may not detect vehicles which are approaching rapidly from behind.
- If the driver activates the turn signal before a vehicle enters the detection zone, the side indicator light will flash but no chime will sound when the other vehicle is detected.

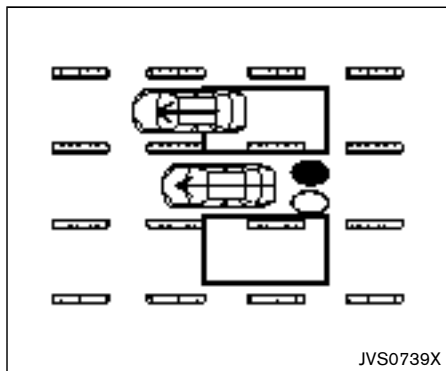

Illustration 3 – Overtaking another vehicle

### Overtaking another vehicle

Illustration 3: The side indicator light illuminates if you overtake a vehicle and that vehicle stays in the detection zone for approximately 3 seconds.

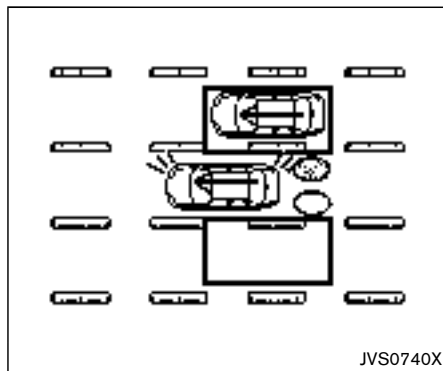

Illustration 4 – Overtaking another vehicle

Illustration 4: If the driver activates the turn signal while another vehicle is in the detection zone, then the system chimes (twice) and the side indicator light flashes.

#### NOTE:

- When overtaking several vehicles in a row, the vehicles after the first vehicle may not be detected if they are traveling close together.
- The radar sensors may not detect slower moving vehicles if they are passed quickly.
- If the driver activates the turn signal before a vehicle enters the detection

zone, the side indicator light will flash but no chime will sound when the other vehicle is detected.

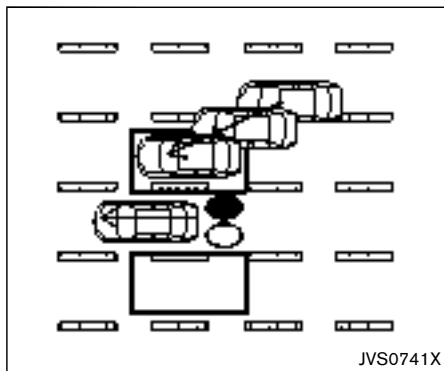

**Illustration 5 – Entering from the side**

### Entering from the side

Illustration 5: The side indicator light illuminates if a vehicle enters the detection zone from either side.

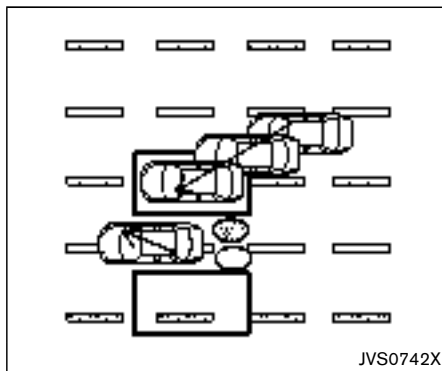

**Illustration 6 – Entering from the side**

Illustration 6: If the driver activates the turn signal, then the system chimes (twice) and the side indicator light flashes.

### **NOTE:**

- **The radar sensors may not detect a vehicle which is traveling at about the same speed as your vehicle when it enters the detection zone.**
- **If the driver activates the turn signal before a vehicle enters the detection zone, the side indicator light will flash but no chime will sound when the other vehicle is detected.**



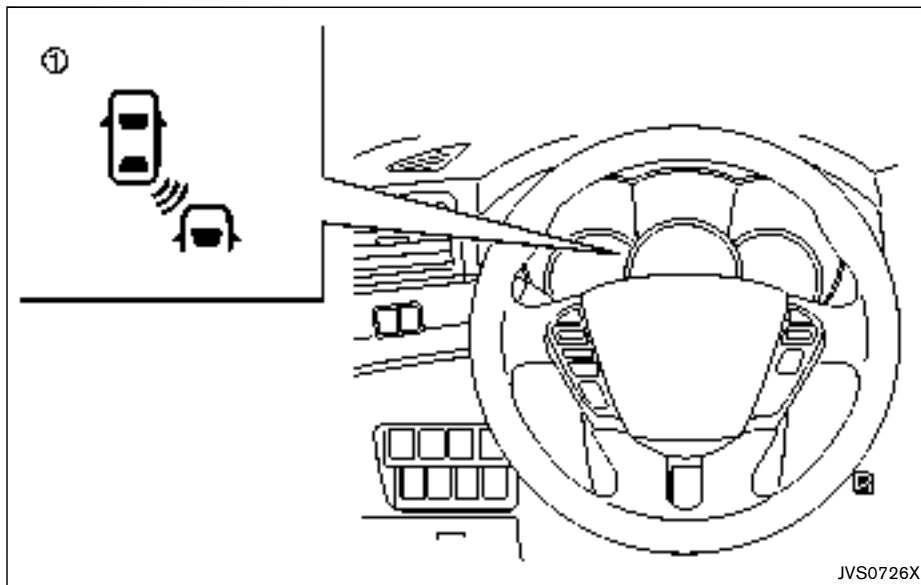

### SYSTEM TEMPORARILY UNAVAILABLE

When radar blockage is detected, the BSW system will be turned off automatically, a beep will sound and the BSW system warning light ① will blink. The system is not available until the conditions no longer exist.

The radar sensors may be blocked by temporary ambient conditions such as splashing water, mist or fog. The blocked condition may also be caused by objects such as ice, frost or dirt obstructing the radar sensors.

### Action to take:

When the above conditions no longer exist, the system will resume automatically.

If the BSW system warning light ① continues to blink, have the system checked. It is recommended you visit a NISSAN dealer for this service.

### SYSTEM MALFUNCTION

When the system malfunctions, it will be turned off automatically, a beep will sound and the BSW system warning light will illuminate.

### Action to take:

Stop the vehicle in a safe location, place the vehicle in the P (Park) position, turn the engine off and restart the engine.

If the BSW system warning light continues to illuminate, have the system checked. It is recommended you visit a NISSAN dealer for this service.

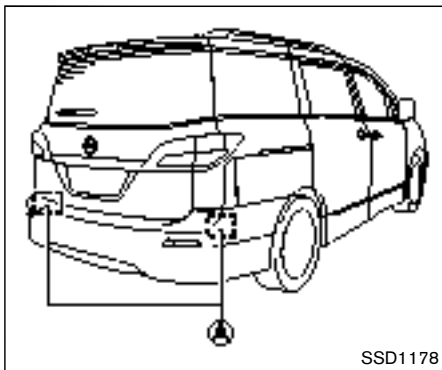

## SYSTEM MAINTENANCE

The two radar sensor units (A) for the BSW system are located near the rear bumper.

Always keep the area near the radar sensors clean.

The radar sensors may be blocked by temporary ambient conditions such as splashing water, mist or fog.

The blocked condition may also be caused by objects such as ice, frost or dirt obstructing the radar sensors.

Check for and remove objects obstructing the area around the radar sensors.

Do not attach stickers (including transparent

material), install accessories or apply additional paint near the radar sensors.

Do not strike or damage the area around the radar sensors. It is recommended you consult a NISSAN dealer if the area around the radar sensors is damaged due to a collision.

## Radio frequency statement

This device complies with part 15 of the FCC Rules and RSS-310 of Industry Canada.

Operation is subject to the following two conditions:

1. This device may not cause harmful interference.
2. This device must accept any interference received, including interference that may cause undesired operation.

Frequency of operation: 24.05GHz — 24.25GHz

Field Strength: Not greater than 2.5V/m peak (0.25V/m average) at a distance of 3 m

The manufacturer is not responsible for any radio or TV interference caused by unauthorized modifications to this equipment. Such modifications could void the user's authority to operate the equipment.

## CRUISE CONTROL

### PRECAUTIONS ON CRUISE CONTROL

- If the cruise control system malfunctions, it will cancel automatically. The CRUISE indicator light on the meter panel will then blink to warn the driver.
- If the engine coolant temperature becomes excessively high, the cruise control system will cancel automatically.
- If the CRUISE indicator light blinks, turn the cruise control main switch off and have the system checked. It is recommended you visit a NISSAN dealer for this service.
- The CRUISE indicator light may blink when the cruise control main switch is turned ON while pushing the ACCELERATE/RESUME, COAST/SET or CANCEL switch. To properly set the cruise control system, perform the following procedures.



## WARNING

**Do not use the cruise control when driving under the following conditions:**

- when it is not possible to keep the vehicle at a set speed
- in heavy traffic or in traffic that varies in speed

- on winding or hilly roads
- on slippery roads (rain, snow, ice, etc.)
- in very windy areas

Doing so could cause a loss of vehicle control and result in an accident.

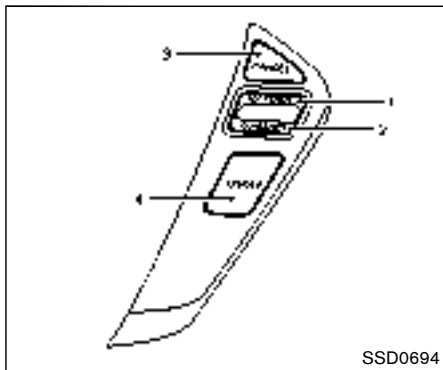

1. ACCELERATE/RESUME switch
2. COAST/SET switch
3. CANCEL switch
4. MAIN (ON-OFF) switch

### CRUISE CONTROL OPERATIONS

The cruise control allows driving at a speed between 25 to 89 MPH (40 to 144 km/h) without keeping your foot on the accelerator pedal.

**To turn on the cruise control**, push the MAIN switch on. The CRUISE indicator light will illuminate.

**To set cruising speed**, accelerate the vehicle to the desired speed, push the COAST/SET switch and release it. Take your foot off the

accelerator pedal. Your vehicle will maintain the set speed.

- **To pass another vehicle**, depress the accelerator pedal. When you release the pedal, the vehicle will return to the previously set speed.
- The vehicle may not maintain the set speed on winding or hilly roads. If this happens, drive without the cruise control.

**To cancel the preset speed**, use one of the following methods:

1. Push the CANCEL switch.
  2. Tap the brake pedal.
  3. Turn the MAIN switch off. The CRUISE light will turn off.
- If you depress the brake pedal while pushing the ACCELERATE/RESUME or COAST/SET switch and reset at the cruising speed, the cruise control will disengage. Turn the MAIN switch off once and then turn it on again.
  - The cruise control will automatically cancel if the vehicle slows more than 8 MPH (13 km/h) below the set speed.
  - If you move the shift lever to the N (Neutral) position, the cruise control will be canceled.

## BREAK-IN SCHEDULE



### CAUTION

**During the first 1,200 miles (2,000 km), follow these recommendations to obtain maximum engine performance and ensure the future reliability and economy of your new vehicle. Failure to follow these recommendations may result in shortened engine life and reduced engine performance.**

**To reset at a faster cruising speed,** use one of the following methods:

- Depress the accelerator pedal. When the vehicle attains the desired speed, push and release the COAST/SET switch.
- Push and hold the ACCELERATE/RESUME switch. When the vehicle attains the desired speed, release the switch.
- Push, then quickly release the ACCELERATE/RESUME switch. Each time you do this, the set speed will increase by about 1 MPH (1.6 km/h).

**To reset at a slower cruising speed,** use one of the following methods:

- Lightly tap the brake pedal. When the vehicle attains the desired speed, push the COAST/SET switch and release it.
- Push and hold the COAST/SET switch. Release the switch when the vehicle slows down to the desired speed.
- Push, then quickly release the COAST/SET switch. Each time you do this, the set speed will decrease by about 1 MPH (1.6 km/h).

**To resume the preset speed,** push and release the ACCELERATE/RESUME switch. The vehicle will resume the last set cruising speed when the vehicle speed is over 25 MPH (40 km/h).

- Avoid driving for long periods at constant speed, either fast or slow. Do not run the engine over 4,000 rpm.
- Do not accelerate at full throttle in any gear.
- Avoid quick starts.
- Avoid hard braking as much as possible.
- Do not tow a trailer for the first 500 miles (800 km). Your engine, axle or other parts could be damaged.

## FUEL EFFICIENT DRIVING TIPS

Follow these easy-to-use Fuel Efficient Driving Tips to help you achieve the most fuel economy from your vehicle.

1. Use smooth accelerator and brake pedal application.
  - Avoid rapid starts and stops.
  - Use smooth, gentle accelerator and brake application whenever possible.
  - Maintain constant speed while commuting and coast whenever possible.
2. Maintain constant speed.
  - Look ahead to try and anticipate and minimize stops.
  - Synchronizing your speed with traffic lights allows you to reduce your number of stops.
  - Maintaining a steady speed can minimize red light stops and improve fuel efficiency.
3. Use air conditioning (A/C) at higher vehicle speeds.
  - Below 40 MPH (64 km/h), it is more efficient to open windows to cool the vehicle due to reduced engine load.
  - Above 40 MPH (64 km/h), it is more efficient to use A/C to cool the vehicle due to increased aerodynamic drag.

## INCREASING FUEL ECONOMY

- Recirculating the cool air in the cabin when the A/C is on reduces cooling load.
4. Drive at economical speeds and distances.
    - Observing the speed limit and not exceeding 60 MPH (97 km/h) (where legally allowed) can improve fuel efficiency due to reduced aerodynamic drag.
    - Maintaining a safe following distance behind other vehicles reduces unnecessary braking.
    - Safely monitoring traffic to anticipate changes in speed permits reduced braking and smooth acceleration changes.
    - Select a gear range suitable to road conditions.
  5. Use cruise control.
    - Using cruise control during highway driving helps maintain a steady speed.
    - Cruise control is particularly effective in providing fuel savings when driving on flat terrains.
  6. Plan for the shortest route.
    - Utilize a map or navigation system to determine the best route to save time.
  7. Avoid idling.
    - Shutting off your engine when safe for stops exceeding 30-60 seconds saves fuel and reduces emissions.
  8. Buy an automated pass for toll roads.
    - Automated passes permit drivers to use special lanes to maintain cruising speed through the toll and avoid stopping and starting.
  9. Winter warm up.
    - Limit idling time to minimize impact to fuel economy.
    - Vehicles typically need no more than 30 seconds of idling at start-up to effectively circulate the engine oil before driving.
    - Your vehicle will reach its ideal operating temperature more quickly while driving versus idling.
  10. Keeping your vehicle cool.
    - Park your vehicle in a covered parking area or in the shade whenever possible.
    - When entering a hot vehicle, opening the windows will help to reduce the inside temperature faster, resulting in reduced demand on your A/C system.

- Keep your engine tuned up.
- Follow the recommended scheduled maintenance.
- Keep the tires inflated to the correct pressure. Low tire pressure increases tire wear and lowers fuel economy.
- Keep the wheels in correct alignment. Improper alignment increases tire wear and lowers fuel economy.
- Use the recommended viscosity engine oil. (See "Engine oil and oil filter recommendation" (P.10-5).)

## PARKING/PARKING ON HILLS

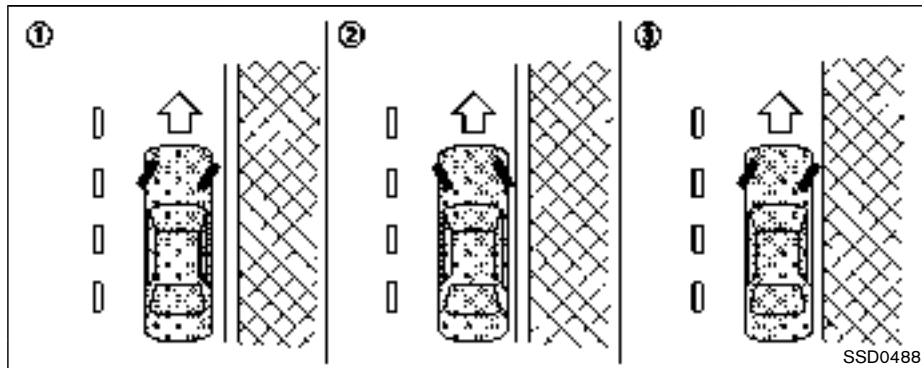

### WARNING

- Do not stop or park the vehicle over flammable materials such as dry grass, waste paper or rags. They may ignite and cause a fire.
- Safe parking procedures require that both the parking brake be set and the transmission placed into P (Park). Failure to do so could cause the vehicle to move unexpectedly or roll away and result in an accident. Make sure the shift lever has been pushed as far forward as it can go

and cannot be moved without depressing the foot brake pedal.

- Never leave the engine running while the vehicle is unattended.
- Do not leave children unattended inside the vehicle. They could unknowingly activate switches or controls. Unattended children could become involved in serious accidents.
- To help avoid risk of injury or death through unintended operation of the vehicle and/or its systems, do not leave children, people who re-

quire the assistance of others or pets unattended in your vehicle. Additionally, the temperature inside a closed vehicle on a warm day can quickly become high enough to cause a significant risk of injury or death to people and pets.

1. Firmly apply the parking brake.
2. Move the shift lever to the P (Park) position.
3. To help prevent the vehicle from rolling into traffic when parked on an incline, it is a good practice to turn the wheels as illustrated.
  - HEADED DOWNHILL WITH CURB: ①  
Turn the wheels into the curb and move the vehicle forward until the curb side wheel gently touches the curb.
  - HEADED UPHILL WITH CURB: ②  
Turn the wheels away from the curb and move the vehicle back until the curb side wheel gently touches the curb.
  - HEADED UPHILL OR DOWNHILL, NO CURB: ③  
Turn the wheels toward the side of the road so the vehicle will move away from the center of the road if it moves.
4. Push the ignition switch to the LOCK position.

## HYDRAULIC PUMP ELECTRIC POWER STEERING



### WARNING

- **If the engine is not running or is turned off while driving, the power assist for the steering will not work. Steering will be harder to operate.**
- **When the hydraulic pump electric power steering warning light illuminates with the engine running, the power assist for the steering will cease operation. You will still have control of the vehicle, but the steering will be much harder to operate.**

The hydraulic pump electric power steering is designed to provide power assistance while driving to operate the steering wheel with light force.

When the steering wheel is operated repeatedly or continuously while parking or driving at a very low speed, the power assist for the steering wheel will be reduced. This is to prevent overheating of the hydraulic pump electric power steering and protect it from getting damaged. While the power assist is reduced, steering wheel operation will become heavy. When the temperature of the power steering system goes down, the power assist level will

return to normal. Avoid repeating such steering wheel operations that could cause the hydraulic pump electric power steering to overheat.

You may hear a noise from the front of the vehicle when the steering wheel is operated. This is not a malfunction.

If the hydraulic pump electric power steering warning light illuminates while the engine is running, it may indicate the hydraulic pump electric power steering is not functioning properly and may need servicing. It is recommended you have the hydraulic pump electric power steering checked by a NISSAN dealer.

When the hydraulic pump electric power steering warning light illuminates with the engine running, the power assist for the steering will cease operation but you will still have control of the vehicle. At this time, greater steering efforts are required to operate the steering wheel, especially in sharp turns and at low speeds.

## BRAKE SYSTEM

### BRAKING PRECAUTIONS

The brake system has two separate hydraulic circuits. If one circuit malfunctions, you will still have braking at two wheels.

#### Vacuum assisted brakes

The brake booster aids braking by using engine vacuum. If the engine stops, you can stop the vehicle by depressing the brake pedal. However, greater foot pressure on the brake pedal will be required to stop the vehicle and the stopping distance will be longer.

#### Using the brakes

Avoid resting your foot on the brake pedal while driving. This will cause overheating of the brakes, wearing out the brake and pads faster and reduce gas mileage.

To help reduce brake wear and to prevent the brakes from overheating, reduce speed and downshift to a lower gear before going down a slope or long grade. Overheated brakes may reduce braking performance and could result in loss of vehicle control.



### WARNING

- **While driving on a slippery surface, be careful when braking, accelerat-**

**ing or downshifting. Abrupt braking or accelerating could cause the wheels to skid and result in an accident.**

- **If the engine is not running or is turned off while driving, the power assist for the brakes will not work. Braking will be harder.**

### Wet brakes

When the vehicle is washed or driven through water, the brakes may get wet. As a result, your braking distance will be longer and the vehicle may pull to one side during braking.

To dry brakes, drive the vehicle at a safe speed while lightly tapping the brake pedal to heat-up the brakes. Do this until the brakes return to normal. Avoid driving the vehicle at high speeds until the brakes function correctly.

### PARKING BRAKE BREAK-IN

Break in the parking brake shoes whenever the stopping effect of the parking brake is weakened or whenever the parking brake shoes and/or drums/rotors are replaced, in order to assure the best braking performance.

This procedure is described in the vehicle service manual. It is recommended you visit a NISSAN dealer for this service.

## ANTI-LOCK BRAKING SYSTEM (ABS)



### WARNING

- **The Anti-lock Braking System (ABS) is a sophisticated device, but it cannot prevent accidents resulting from careless or dangerous driving techniques. It can help maintain vehicle control during braking on slippery surfaces. Remember that stopping distances on slippery surfaces will be longer than on normal surfaces even with ABS. Stopping distances may also be longer on rough, gravel or snow covered roads, or if you are using tire chains. Always maintain a safe distance from the vehicle in front of you. Ultimately, the driver is responsible for safety.**
- **Tire type and condition may also affect braking effectiveness.**
  - **When replacing tires, install the specified size of tires on all four wheels.**
  - **When installing a spare tire, make sure that it is the proper size and type as specified on the**

**Tire and Loading Information label. See "Tire and Loading Information label" (P.10-10).**

- **For detailed information, see "Wheels and tires" (P.8-27).**

The Anti-lock Braking System (ABS) controls the brakes so the wheels do not lock during hard braking or when braking on slippery surfaces. The system detects the rotation speed at each wheel and varies the brake fluid pressure to prevent each wheel from locking and sliding. By preventing each wheel from locking, the system helps the driver maintain steering control and helps to minimize swerving and spinning on slippery surfaces.

### Using the system

Depress the brake pedal and hold it down. Depress the brake pedal with firm steady pressure, but do not pump the brakes. The ABS will operate to prevent the wheels from locking up. Steer the vehicle to avoid obstacles.



### WARNING

**Do not pump the brake pedal. Doing so may result in increased stopping distances.**



## VEHICLE DYNAMIC CONTROL (VDC) SYSTEM

### Self-test feature

The ABS includes electronic sensors, electric pumps, hydraulic solenoids and a computer. The computer has a built-in diagnostic feature that tests the system each time you start the engine and move the vehicle at a low speed in forward or reverse. When the self-test occurs, you may hear a “clunk” noise and/or feel a pulsation in the brake pedal. This is normal and does not indicate a malfunction. If the computer senses a malfunction, it switches the ABS off and illuminates the ABS warning light on the instrument panel. The brake system then operates normally, but without anti-lock assistance.

If the ABS warning light illuminates during the self-test or while driving, have the vehicle checked. It is recommended you visit a NISSAN dealer for this service.

### Normal operation

The ABS operates at speeds above 3 to 6 MPH (5 to 10 km/h). The speed varies according to road conditions.

When the ABS senses that one or more wheels are close to locking up, the actuator rapidly applies and releases hydraulic pressure. This action is similar to pumping the brakes very quickly. You may feel a pulsation in the brake pedal and hear a noise from under the hood or

feel a vibration from the actuator when it is operating. This is normal and indicates that the ABS is operating properly. However, the pulsation may indicate that road conditions are hazardous and extra care is required while driving.

The Vehicle Dynamic Control (VDC) system uses various sensors to monitor driver inputs and vehicle motion. Under certain driving conditions, the VDC system helps to perform the following functions.

- Controls brake pressure to reduce wheel slip on one slipping drive wheel so power is transferred to a non slipping drive wheel on the same axle.
- Controls brake pressure and engine output to reduce drive wheel slip based on vehicle speed (traction control function).
- Controls brake pressure at individual wheels and engine output to help the driver maintain control of the vehicle in the following conditions:
  - understeer (vehicle tends to not follow the steered path despite increased steering input)
  - oversteer (vehicle tends to spin due to certain road or driving conditions).

The VDC system can help the driver to maintain control of the vehicle, but it cannot prevent loss of vehicle control in all driving situations.

When the VDC system operates, the VDC warning light  in the instrument panel flashes so note the following:



- The road may be slippery or the system may determine some action is required to help

keep the vehicle on the steered path.

- You may feel a pulsation in the brake pedal and hear a noise or vibration from under the hood. This is normal and indicates that the VDC system is working properly.
- Adjust your speed and driving to the road conditions.

See “Vehicle Dynamic Control (VDC) warning light” (P.2-16).

If a malfunction occurs in the system, the VDC warning light  illuminates in the instrument panel. The VDC system automatically turns off.

The VDC OFF switch is used to turn off the VDC system. The VDC off indicator light  illuminates to indicate the VDC system is off. When the VDC switch is used to turn off the system, the VDC system still operates to prevent one drive wheel from slipping by transferring power to a non slipping drive wheel. The VDC warning light  flashes if this occurs. All other VDC functions are off, and the VDC warning light  will not flash. The VDC system is automatically reset to on when the ignition switch is placed in the off position then back to the on position.





See “Vehicle Dynamic Control (VDC) warning light” (P.2-16) and “Vehicle Dynamic Control (VDC) off indicator light” (P.2-18).

The computer has a built-in diagnostic feature

that tests the system each time you start the engine and move the vehicle forward or in reverse at a slow speed. When the self-test occurs, you may hear a “clunk” noise and/or feel a pulsation in the brake pedal. This is normal and is not an indication of a malfunction.



## WARNING

- **The VDC system is designed to help the driver maintain stability but does not prevent accidents due to abrupt steering operation at high speeds or by careless or dangerous driving techniques. Reduce vehicle speed and be especially careful when driving and cornering on slippery surfaces and always drive carefully.**
  - **Do not modify the vehicle's suspension. If suspension parts such as shock absorbers, struts, springs, stabilizer bars, bushings and wheels are not NISSAN recommended for your vehicle or are extremely deteriorated, the VDC system may not operate properly. This could adversely affect vehicle handling performance, and the VDC**
- warning light  may illuminate.**
- **If brake related parts such as brake pads, rotors and calipers are not NISSAN recommended or are extremely deteriorated, the VDC system may not operate properly and the VDC warning light  may illuminate.**
  - **If engine control related parts are not NISSAN recommended or are extremely deteriorated, the VDC warning light  may illuminate.**
  - **When driving on extremely inclined surfaces such as higher banked corners, the VDC system may not operate properly and the VDC warning light  may illuminate. Do not drive on these types of roads.**
  - **When driving on an unstable surface such as a turntable, ferry, elevator or ramp, the VDC warning light  may illuminate. This is not a malfunction. Restart the engine after driving onto a stable surface.**
  - **If wheels or tires other than the NISSAN recommended ones are used, the VDC system may not operate properly and the VDC warn-**

ing light  may illuminate.

- **The VDC system is not a substitute for winter tires or tire chains on a snow covered road.**

## COLD WEATHER DRIVING

### FREEING A FROZEN DOOR LOCK

To prevent a door lock from freezing, apply deicer through the key hole. If the lock becomes frozen, heat the key before inserting it into the key hole or use the remote keyless entry key fob.

### ANTI-FREEZE

In the winter when it is anticipated that the outside temperature will drop below 32°F (0°C), check the anti-freeze to assure proper winter protection. For additional information, see “Engine cooling system” (P.8-4).

### BATTERY

If the battery is not fully charged during extremely cold weather conditions, the battery fluid may freeze and damage the battery. To maintain maximum efficiency, the battery should be checked regularly. For additional information, see “Battery” (P.8-10).

### DRAINING OF COOLANT WATER

If the vehicle is to be left outside without anti-freeze, drain the cooling system, including the engine block. Refill before operating the vehicle. For details, see “Engine cooling system” (P.8-4).

### TIRE EQUIPMENT

SUMMER tires have a tread designed to provide superior performance on dry pavement. However, the performance of these tires will be substantially reduced in snowy and icy conditions. If you operate your vehicle on snowy or icy roads, NISSAN recommends the use of MUD & SNOW or ALL SEASON tires on all four wheels. It is recommended you consult a NISSAN dealer for the tire type, size, speed rating and availability information.

For additional traction on icy roads, studded tires may be used. However, some U.S. states and Canadian provinces prohibit their use. Check local, state and provincial laws before installing studded tires.

**Skid and traction capabilities of studded snow tires, on wet or dry surfaces, may be poorer than that of non-studded snow tires.**

Tire chains may be used. For details, see “Tire chains” (P.8-33).

### SPECIAL WINTER EQUIPMENT

It is recommended that the following items be carried in the vehicle during winter:

- A scraper and stiff-bristled brush to remove ice and snow from the windows and wiper blades.

- A sturdy, flat board to be placed under the jack to give it firm support.
- A shovel to dig the vehicle out of snow-drifts.
- Extra window washer fluid to refill the reservoir tank.

## DRIVING ON SNOW OR ICE



### WARNING

- **Wet ice (32°F, 0°C and freezing rain), very cold snow or ice can be slick and very hard to drive on. The vehicle will have much less traction or “grip” under these conditions. Try to avoid driving on wet ice until the road is salted or sanded.**
- **Whatever the condition, drive with caution. Accelerate and slow down with care. If accelerating or downshifting too fast, the drive wheels will lose even more traction.**
- **Allow more stopping distance under these conditions. Braking should be started sooner than on dry pavement.**
- **Allow greater following distances on slippery roads.**

- **Watch for slippery spots (glare ice). These may appear on an otherwise clear road in shaded areas. If a patch of ice is seen ahead, brake before reaching it. Try not to brake while on the ice, and avoid any sudden steering maneuvers.**
- **Do not use cruise control on slippery roads.**
- **Snow can trap dangerous exhaust gases under your vehicle. Keep snow clear of the exhaust pipe and from around your vehicle.**

## ENGINE BLOCK HEATER (if so equipped)

Engine block heaters are used to assist with cold temperature starting.

The engine block heater should be used when the outside temperature is 20°F (-7°C) or lower.

To use the engine block heater

1. Turn the engine off.
2. Open the hood and unwrap the engine block heater cord.
3. Plug the engine block heater cord into a grounded 3-wire, 3-pronged extension cord.

4. Plug the extension cord into a Ground Fault Interrupt (GFI) protected, grounded 110-volt AC (VAC) outlet.
5. The engine block heater must be plugged in for at least 2 - 4 hours, depending on outside temperatures, to properly warm the engine coolant. Use an appropriate timer to turn the engine block heater on.
6. Before starting the engine, unplug and properly store the cord to keep it away from moving parts.



### WARNING

- **Do not use your engine block heater with an ungrounded electrical system or a 2-pronged adapter. You can be seriously injured by an electrical shock if you use an ungrounded connection.**
- **Disconnect and properly store the engine block heater cord before starting the engine. Damage to the cord could result in an electrical shock and can cause serious injury.**
- **Use a heavy-duty 3-wire, 3-pronged extension cord rated for at least 10A. Plug the extension cord into a**

**Ground Fault Interrupt (GFI) protected, grounded 110-VAC outlet. Failure to use the proper extension cord or a grounded outlet can result in a fire or electrical shock and cause serious personal injury.**

# 6 In case of emergency

Hazard warning flasher switch .....	6-2	Jump starting .....	6-10
Roadside assistance program .....	6-2	Push starting .....	6-12
Emergency engine shut off .....	6-3	If your vehicle overheats .....	6-12
Flat tire .....	6-3	Towing your vehicle .....	6-14
Tire Pressure Monitoring System (TPMS) .....	6-3	Towing recommended by NISSAN .....	6-15
Changing a flat tire .....	6-4	Vehicle recovery (freeing a stuck vehicle) .....	6-15

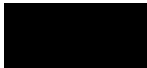

## HAZARD WARNING FLASHER SWITCH

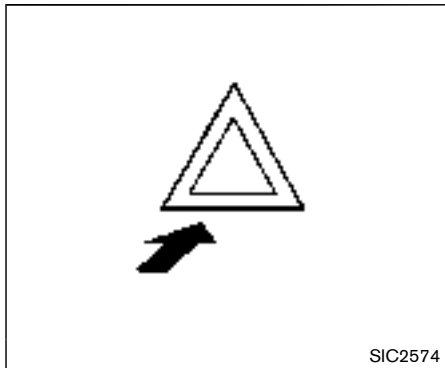

Push the switch on to warn other drivers when you must stop or park under emergency conditions. All turn signal lights will flash.

### WARNING

- If stopping for an emergency, be sure to move the vehicle well off the road.
- Do not use the hazard warning flashers while moving on the highway unless unusual circumstances force you to drive so slowly that your vehicle might become a hazard

to other traffic.

- Turn signals do not work when the hazard warning flasher lights are on.

The flasher can be actuated with the ignition switch in any position.

**Some state laws may prohibit the use of the hazard warning flasher switch while driving.**

When an impact that could activate the supplemental air bags is detected, the hazard warning flasher lights blink automatically. If the hazard warning flasher switch is pushed, the hazard warning flashers will turn off.

### WARNING

Do not turn the hazard warning flasher switch to off until you can make sure that it is safe to do so. Also, the hazard flasher warning may not blink automatically depending on the force of impact.

## ROADSIDE ASSISTANCE PROGRAM

In the event of a roadside emergency, Roadside Assistance Service is available to you. Please refer to your Warranty Information Booklet (U.S.) or Warranty & Roadside Assistance Information Booklet (Canada) for details.

## EMERGENCY ENGINE SHUT OFF

To shut off the engine in an emergency situation while driving perform the following procedure:

- Rapidly push the push-button ignition switch 3 consecutive times in less than 1.5 seconds, or
- Push and hold the push-button ignition switch for more than 2 seconds.

## FLAT TIRE

### TIRE PRESSURE MONITORING SYSTEM (TPMS)

This vehicle is equipped with the Tire Pressure Monitoring System (TPMS). It monitors tire pressure of all tires except the spare. When the low tire pressure warning light is lit and the CHECK TIRE PRESSURE warning appears on the vehicle information display, one or more of your tires is significantly under-inflated. If the vehicle is being driven with low tire pressure, the TPMS will activate and warn you of it by the low tire pressure warning light. This system will activate only when the vehicle is driven at speeds above 16 MPH (25 km/h). For more details, see "Warning lights, indicator lights and audible reminders" (P.2-11) and "Tire Pressure Monitoring System (TPMS)" (P.5-3).



### WARNING

- **If the low tire pressure warning light illuminates while driving, avoid sudden steering maneuvers or abrupt braking, reduce vehicle speed, pull off the road to a safe location and stop the vehicle as soon as possible. Driving with under-inflated tires may permanently damage the tires and increase the likelihood of tire**

**failure. Serious vehicle damage could occur and may lead to an accident and could result in serious personal injury. Check the tire pressure for all four tires. Adjust the tire pressure to the recommended COLD tire pressure shown on the Tire and Loading Information label to turn the low tire pressure warning light OFF. If the light still illuminates while driving after adjusting the tire pressure, a tire may be flat. If you have a flat tire, replace it with a spare tire as soon as possible.**

- **Since the spare tire is not equipped with the TPMS, when a spare tire is mounted or a wheel is replaced, the TPMS will not function and the low tire pressure warning light will flash for approximately 1 minute. The light will remain on after 1 minute. Have your tires replaced and/or TPMS system reset as soon as possible. It is recommended you visit a NISSAN dealer for these services.**
- **Replacing tires with those not originally specified by NISSAN could affect the proper operation of the**



### TPMS.

- **Do not inject any tire liquid or aerosol tire sealant into the tires, as this may cause a malfunction of the tire pressure sensors.**

### CHANGING A FLAT TIRE

If you have a flat tire, follow the instructions below.

#### Stopping the vehicle

1. Safely move the vehicle off the road and away from traffic.
2. Turn on the hazard warning flashers.
3. Park on a level surface and apply the parking brake. Move the shift lever to the P (Park) position.
4. Turn off the engine.
5. Raise the hood to warn other traffic, and to signal professional road assistance personnel that you need assistance.
6. Have all passengers get out of the vehicle and stand in a safe place, away from traffic and clear of the vehicle.



### WARNING

- **Make sure the parking brake is securely applied and the transmission is shifted into the P (Park) position.**
- **Never change tires when the vehicle is on a slope, ice or slippery areas. This is hazardous.**
- **Never change tires if oncoming traffic is close to your vehicle. Wait for professional road assistance.**

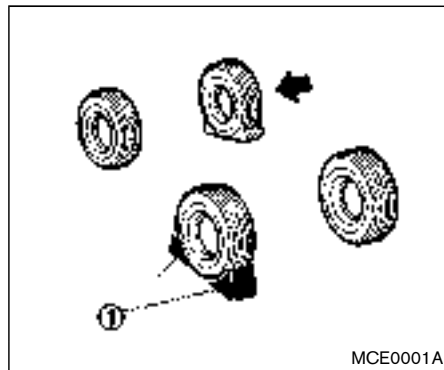

#### Blocking wheels

Place suitable blocks ① at both the front and back of the wheel diagonally opposite the flat tire to prevent the vehicle from moving when it is jacked up.



### WARNING

**Be sure to block the wheel as the vehicle may move and result in personal injury.**

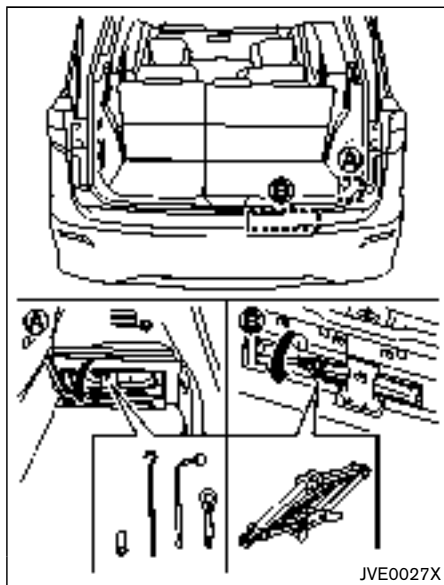

4. Remove tools (A) and jack (B) located as illustrated.

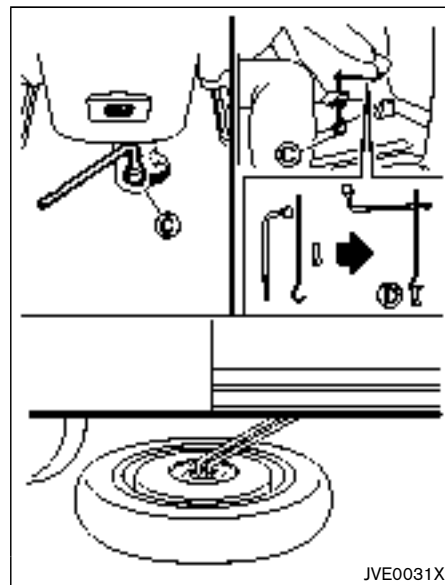

### Getting the tools and jack

1. Open the liftgate.
2. Open the cargo floor box. (See "Cargo floor box" (P.2-48).)
3. Remove the cargo floor board (if so equipped).

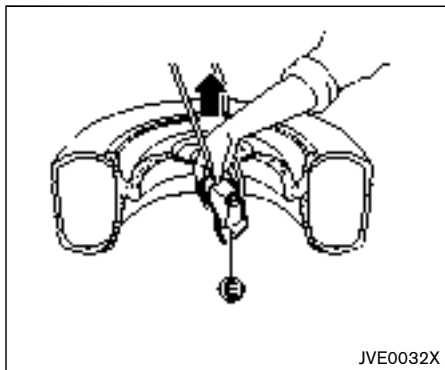

### Getting the spare tire

The spare tire is located under the center of the vehicle.

1. Lift up the floor carpeting flap behind the front center console to access the spare tire lowering mechanism (C).
2. Loosen the spare tire lowering mechanism (C) with the wheel nut wrench.
3. Using the assembled socket tool (D), turn the spare tire lowering mechanism (C) counterclockwise as illustrated to lower the spare tire.
4. When the spare tire is completely lowered, carefully slide it from under the vehicle.

### 6-6 In case of emergency

5. Remove the hanging plate (E) from the spare tire.
6. After removing the spare tire, raise the spare tire cable completely by turning the spare tire lowering mechanism clockwise using the tool (D).
7. Before moving or jacking up the vehicle, check under the vehicle to make sure the cable is stored properly.

### WARNING

- **Never jack up the vehicle before removing the spare tire from under the vehicle. This may lead to an accident could result in serious personal injury.**
- **Do not move the vehicle with the spare tire cable lowered. The cable could hit or become tangled with an object on the road. Serious vehicle damage could occur and may lead to an accident and could result in serious personal injury.**

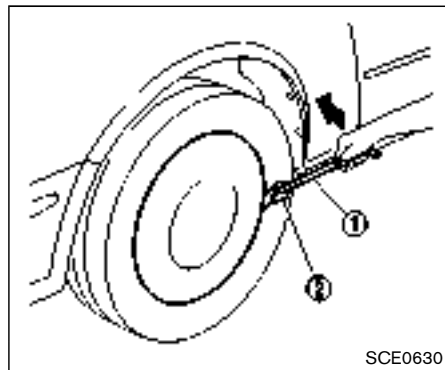

### Removing wheel cover (if so equipped)

### WARNING

**Never use your hands to remove the wheel cover. This may cause personal injury.**

To remove the wheel cover, use the jack rod (1) as illustrated.

Apply cloth (2) between the wheel and jack rod to prevent damaging the wheel and wheel cover.

Jacking up the vehicle and removing the flat tire



## WARNING

- Never get under the vehicle while it is supported only by the jack. If it is necessary to work under the vehicle, support it with safety stands.
- Use only the jack provided with your vehicle to lift the vehicle. Do not use the jack provided with your vehicle on other vehicles. The jack is designed for lifting only your vehicle during a tire change.
- Use the correct jack-up points. Never use any other part of the vehicle for jack support.
- Never jack up the vehicle more than necessary.
- Never use blocks on or under the jack.
- Do not start or run the engine while vehicle is on the jack, as it may cause the vehicle to move.
- Do not allow passengers to stay in the vehicle while it is on the jack.

Carefully read the caution label attached to the jack body and the following instructions.

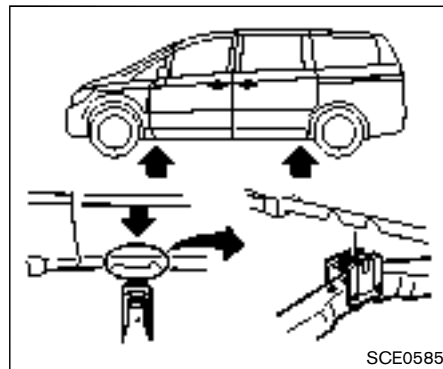

SCE0585

Jack-up point

1. Place the jack directly under the jack-up point as illustrated so the top of the jack contacts the vehicle at the jack-up point. Align the jack head between the two notches in the front or the rear as shown. Also fit the groove of the jack head between the notches as shown.

**The jack should be used on level firm ground.**

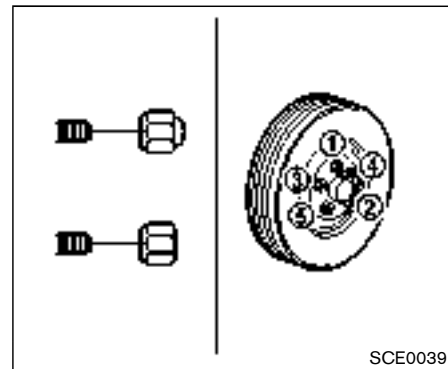
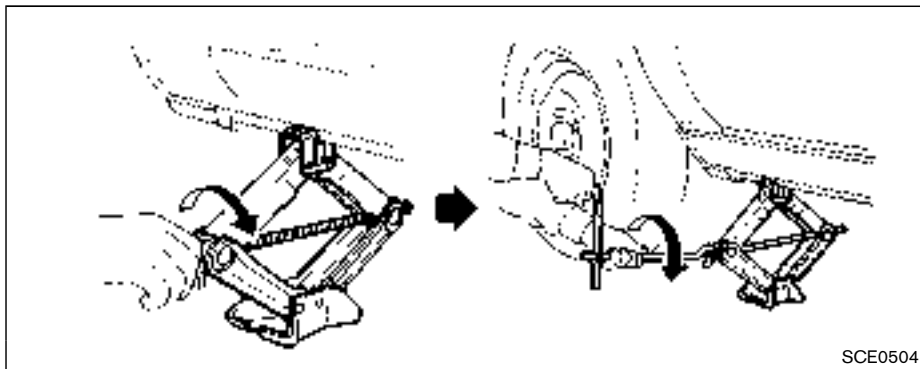

2. Loosen each wheel nut one or two turns by turning counterclockwise with the wheel nut wrench. **Do not remove the wheel nuts until the tire is off the ground.**
3. To lift the vehicle, securely hold the jack lever and rod with both hands as shown above. Carefully raise the vehicle until the tire clears the ground. Remove the wheel nuts, and then remove the tire.

### Installing the spare tire

**The spare tire is designed for emergency use. (See specific instructions under the heading “Wheels and tires” (P.8-27).)**

1. Clean any mud or dirt from the surface between the wheel and hub.
2. Carefully put the spare tire on and tighten the wheel nuts finger tight. Check that all the wheel nuts contact the wheel surface horizontally.
3. With the wheel nut wrench, tighten wheel nuts alternately and evenly in the sequence illustrated (①, ②, ③, ④, ⑤), more than 2 times, until they are tight.

- Lower the vehicle slowly until the tire touches the ground. Then, with the wheel nut wrench, tighten the wheel nuts securely in the sequence illustrated. Lower the vehicle completely.
- Securely store the flat tire, jack and tools in the vehicle.



## WARNING

- Incorrect wheel nuts or improperly tightened wheel nuts can cause the wheel to become loose or come off. This could cause an accident.**
- Do not use oil or grease on the wheel studs or nuts. This could cause the nuts to become loose.**
- Retighten the wheel nuts when the vehicle has been driven for 600 miles (1,000 km) (also in cases of a flat tire, etc.).**

- As soon as possible, tighten the wheel nuts to the specified torque with a torque wrench.**

**Wheel nut tightening torque:**

**80 ft-lb (108 N-m)**

**The wheel nuts must be kept tight-**

**ened to specification at all times. It is recommended that wheel nuts be tightened to specifications at each lubrication interval.**

- Adjust tire pressure to the COLD pressure.**

**COLD pressure:**

**After the vehicle has been parked for three hours or more or driven less than 1 mile (1.6 km).**

**COLD tire pressures are shown on the Tire and Loading Information label affixed to the driver side center pillar.**

Stowing the spare tire and the tools

Securely store the spare tire, jack and tools in their original location.



## WARNING

- Always make sure that the spare tire and jacking equipment are properly secured after use. Such items can become dangerous projectiles in an accident or sudden stop.**
- The T-type spare tire and small size spare tire are designed for emer-**

**gency use. See specific instructions under the heading "Wheels and tires" (P.8-27).**

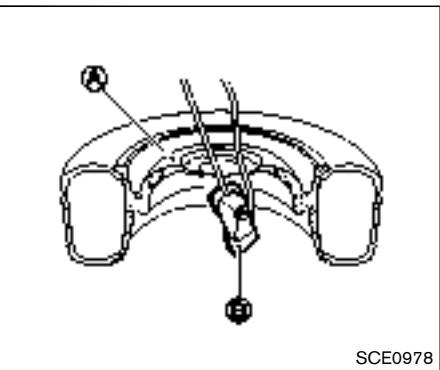

### WARNING

- When storing the spare tire, make sure that the outer side of the spare tire **A** is facing up and that the hanging plate **B** is in the center of the wheel as illustrated. Failure to store the spare tire properly could result in serious vehicle damage and may lead to an accident and could result in serious personal injury.
- Do not store any tire with the cable except the spare tire.

## JUMP STARTING

To start your engine with a booster battery, the instructions and precautions below must be followed.

### WARNING

- If done incorrectly, jump starting can lead to a battery explosion, resulting in severe injury or death. It could also damage your vehicle.
- Explosive hydrogen gas is always present in the vicinity of the battery. Keep all sparks and flames away from the battery.
- Do not allow battery fluid to come into contact with eyes, skin, clothing or painted surfaces. Battery fluid is a corrosive sulfuric acid solution which can cause severe burns. If the fluid should come into contact with anything, immediately flush the contacted area with water.
- Keep the battery out of the reach of children.
- The booster battery must be rated at 12 volts. Use of an improperly rated battery can damage your vehicle.

- Whenever working on or near a battery, always wear suitable eye protectors (for example, goggles or industrial safety spectacles) and remove rings, metal bands, or any other jewelry. Do not lean over the battery when jump starting.
- Do not attempt to jump start a frozen battery. It could explode and cause serious injury.
- Your vehicle has an automatic engine cooling fan. It could come on at any time. Keep hands and other objects away from it.

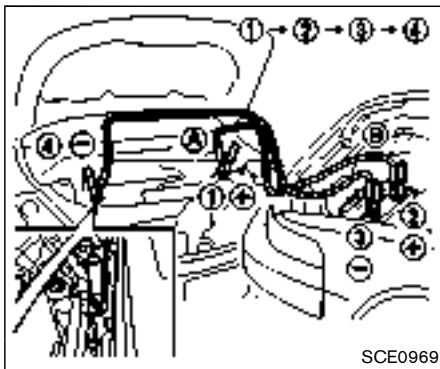

### WARNING

Always follow the instructions below. Failure to do so could result in damage to the charging system and cause personal injury.

1. If the booster battery is in another vehicle (B), position the two vehicles (A and B) to bring their batteries into close proximity to each other.

**Do not allow the two vehicles to touch.**

2. Apply the parking brake. Move the shift lever to the P (Park) position. Switch off all unnecessary electrical systems (lights, heater, air conditioner, etc.).
3. Remove vent caps on the battery (if so equipped). Cover the battery with a firmly wrung out moist cloth to reduce explosion hazard.
4. Connect jumper cables in the sequence as illustrated (1 → 2 → 3 → 4).

**If the battery is discharged, the ignition switch cannot be moved from the OFF position. Connect the jumper cables to the booster vehicle (B) before pushing the ignition switch.**

### CAUTION

- Always connect positive (+) to positive (+) and negative (-) to body ground (for example, as illustrated), not to the battery.
- Make sure the jumper cables do not touch moving parts in the engine compartment and that the cable clamps do not contact any other metal.



5. Start the engine of the booster vehicle (B) and let it run for a few minutes.
6. Keep the engine speed of the booster vehicle (B) at about 2,000 rpm, and start the engine of the vehicle (A) being jump started.



### CAUTION

**Do not keep the starter motor engaged for more than 10 seconds. If the engine does not start right away, place the ignition switch in the OFF position and wait 10 seconds before trying again.**

7. After starting your engine, carefully disconnect the negative cable and then the positive cable (4 → 3 → 2 → 1).
8. Replace the vent caps (if so equipped). Be sure to dispose of the cloth used to cover the vent holes as it may be contaminated with corrosive acid.

## PUSH STARTING

Do not attempt to start the engine by pushing.



### CAUTION

**Continuously Variable Transmission (CVT) models cannot be push-started or tow-started. Attempting to do so may cause transmission damage.**

## IF YOUR VEHICLE OVERHEATS



### CAUTION

- **Do not continue to drive if your vehicle overheats. Doing so could cause engine damage or a vehicle fire.**
- **To avoid the danger of being scalded, never remove the radiator cap while the engine is still hot. When the radiator cap is removed, pressurized hot water will spurt out, possibly causing serious injury.**
- **Do not open the hood if steam is coming out.**

If your vehicle is overheating (indicated by an extremely high temperature gauge reading), or if you feel a lack of engine power, detect abnormal noise, etc., take the following steps:

1. Move the vehicle safely off the road, apply the parking brake and move the shift lever to the P (Park) position.

**Do not stop the engine.**

2. Turn off the air conditioner. Open all the windows, move the heater or air conditioner temperature control to maximum hot and fan control to high speed.

3. Get out of the vehicle. Look and listen for steam or coolant escaping from the radiator before opening the hood. (If steam or coolant is escaping, turn off the engine.) Do not open the hood further until no steam or coolant can be seen.
4. Open the engine hood.



## **WARNING**

**If steam or water is coming from the engine, stand clear to prevent getting burned.**

5. Visually check drive belts for damage or looseness. Also check if the cooling fan is running. The radiator hoses and radiator should not leak water. If coolant is leaking, the water pump belt is missing or loose, or the cooling fan does not run, stop the engine.



## **WARNING**

**Be careful not to allow your hands, hair, jewelry or clothing to come into contact with, or get caught in, engine belts or the engine cooling fan. The engine**

### **cooling fan can start at any time.**

6. After the engine cools down, check the coolant level in the reservoir tank with the engine running. Add coolant to the reservoir tank if necessary. Have your vehicle repaired. It is recommended you visit a NISSAN dealer for this service.

## TOWING YOUR VEHICLE

When towing your vehicle, all State (Provincial in Canada) and local regulations for towing must be followed. Incorrect towing equipment could damage your vehicle. Towing instructions are available from a NISSAN dealer. Local service operators are familiar with the applicable laws and procedures for towing. To assure proper towing and to prevent accidental damage to your vehicle, NISSAN recommends that you have a service operator tow your vehicle. It is advisable to have the service operator carefully read the following precautions.



### WARNING

- **Never ride in a vehicle that is being towed.**
- **Never get under your vehicle after it has been lifted by a tow truck.**



### CAUTION

- **When towing, make sure that the transmission, axles, steering system and drivetrain are in working condition. If any unit is damaged, dollies must be used.**

- **Always attach safety chains before towing.**

For information about towing your vehicle behind a recreational vehicle (RV), see “Flat towing” (P.10-23) of this manual.

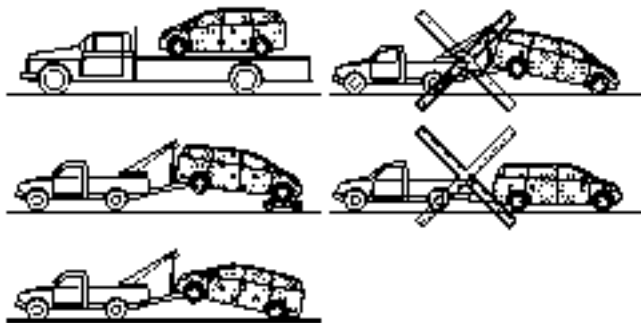

SCE0976

## TOWING RECOMMENDED BY NISSAN

NISSAN recommends that your vehicle be towed with the driving (front) wheels off the ground or place the vehicle on a flat bed truck as illustrated.



### CAUTION

- Never tow Continuously Variable Transmission (CVT) models with the front wheels on the ground or four wheels on the ground (forward or backward), as this may cause

serious and expensive damage to the drivetrain. If it is necessary to tow the vehicle with the rear wheels raised, always use towing dollies under the front wheels.

- When towing CVT models with the front wheels on towing dollies:
  - Push the ignition switch to the ACC or ON position, and secure the steering wheel in a straight-ahead position with a rope or similar device.
  - Move the shift lever to the N (Neutral) position.

- When towing a CVT model with the rear wheels on the ground (if you do not use towing dollies): Always release the parking brake.

VEHICLE RECOVERY (freeing a stuck vehicle)



### WARNING

To avoid vehicle damage, serious personal injury or death when recovering a stuck vehicle:

- Contact a professional towing service to recover the vehicle if you have any questions regarding the recovery procedure.
- Tow chains or cables must be attached only to main structural members of the vehicle.
- Do not use the vehicle tie-downs to tow or free a stuck vehicle.
- Only use devices specifically designed for vehicle recovery and follow the manufacturer's instructions.

- **Always pull the recovery device straight out from the front of the vehicle. Never pull at an angle.**
- **Route recovery devices so they do not touch any part of the vehicle except the attachment point.**

If your vehicle is stuck in sand, snow, mud, etc., use a tow strap or other device designed specifically for vehicle recovery. Always follow the manufacturer's instructions for the recovery device.

#### Rocking a stuck vehicle

If your vehicle is stuck in sand, snow, mud, etc., use the following procedure:

1. Turn off the Vehicle Dynamic Control (VDC) system.
2. Make sure the area in front and behind the vehicle is clear of obstructions.
3. Turn the steering wheel right and left to clear an area around the front tires.
4. Slowly rock the vehicle forward and backward.
  - Shift back and forth between R (Reverse) and D (Drive).
  - Apply the accelerator as little as possible to maintain the rocking motion.

- Release the accelerator pedal before shifting between R and D.
  - Do not spin the tires above 35 MPH (55 km/h).
5. If the vehicle cannot be freed after a few tries, contact a professional towing service to remove the vehicle.



### WARNING

- **Stand clear of a stuck vehicle.**
- **Do not spin your tires at high speed. This could cause them to explode and result in serious injury. Parts of your vehicle could also overheat and be damaged.**

# 7 Appearance and care

Cleaning exterior .....	7-2	Cleaning interior .....	7-4
Washing .....	7-2	Air fresheners .....	7-5
Waxing .....	7-2	Floor mats .....	7-5
Removing spots .....	7-3	Seat belts .....	7-6
Underbody .....	7-3	Corrosion protection .....	7-7
Glass .....	7-3	Most common factors contributing to	
Wheels .....	7-3	vehicle corrosion .....	7-7
Chrome parts .....	7-3	Environmental factors influence the rate	
Tire dressing .....	7-4	of corrosion .....	7-7
		To protect your vehicle from corrosion .....	7-7

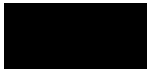

## CLEANING EXTERIOR

In order to maintain the appearance of your vehicle, it is important to take proper care of it.

To protect the paint surface, wash your vehicle as soon as you can:

- after a rainfall to prevent possible damage from acid rain
- after driving on coastal roads
- when contaminants such as soot, bird droppings, tree sap, metal particles or bugs get on the paint surface
- when dust or mud builds up on the surface

Whenever possible, store or park your vehicle inside a garage or in a covered area.

When it is necessary to park outside, park in a shady area or protect the vehicle with a body cover.

**Be careful not to scratch the paint surface when putting on or removing the body cover.**

### WASHING

Wash dirt off the vehicle with a wet sponge and plenty of water. Clean the vehicle thoroughly using a mild soap, a special vehicle soap or general purpose dishwashing liquid mixed with clean, lukewarm (never hot) water.



### CAUTION

- **Do not use car washes that use acid in the detergent. Some car washes, especially brushless ones, use some acid for cleaning. The acid may react with some plastic vehicle components, causing them to crack. This could affect their appearance, and also could cause them not to function properly. Always check with your car wash to confirm that acid is not used.**
- **Do not wash the vehicle with strong household soap, strong chemical detergents, gasoline or solvents.**
- **Do not wash the vehicle in direct sunlight or while the vehicle body is hot, as the surface may become water-spotted.**
- **Avoid using tight-napped or rough cloths, such as washing mitts. Care must be taken when removing caked-on dirt or other foreign substances so the paint surface is not scratched or damaged.**

Rinse the vehicle again with plenty of clean

water.

Inside flanges, seams and folds on the doors, hatches and hood are particularly vulnerable to the effects of road salt. Therefore, these areas must be regularly cleaned. Make sure that the drain holes in the lower edge of the door are open. Spray water under the body and in the wheel wells to loosen the dirt and wash away road salt.

Avoid leaving water spots on the paint surface by using a damp chamois to dry the vehicle.

### WAXING

Regular waxing protects the paint surface and helps retain new vehicle appearance. Polishing is recommended to remove built-up wax residue and to avoid a weathered appearance before reapplying wax.

A NISSAN dealer can assist you in choosing the proper product.

- Wax your vehicle only after a thorough washing. Follow the instructions supplied with the wax.
- Do not use a wax containing any abrasives, cutting compounds or cleaners that may damage the vehicle finish.

Machine compound or aggressive polishing on a base coat/clear coat paint finish may dull the finish or leave swirl marks.

## REMOVING SPOTS

Remove tar and oil spots, industrial dust, insects, and tree sap as quickly as possible from the paint surface to avoid lasting damage or staining. Special cleaning products are available at a NISSAN dealer or any automotive accessory stores.

## UNDERBODY

In areas where road salt is used in winter, the underbody must be cleaned regularly. This will prevent dirt and salt from building up and causing the acceleration of corrosion on the underbody and suspension. Before the winter period and again in the spring, the underseal must be checked and, if necessary, re-treated.

## GLASS

Use glass cleaner to remove smoke and dust film from the glass surfaces. It is normal for glass to become coated with a film after the vehicle is parked in the hot sun. Glass cleaner and a soft cloth will easily remove this film.



### CAUTION

**When cleaning the inside of the windows, do not use sharp-edged tools, abrasive cleaners or chlorine-based disinfectant cleaners. They could da-**

**Damage the electrical conductors, radio antenna elements or rear window defroster elements.**

## WHEELS

Wash the wheels when washing the vehicle to maintain their appearance.

- Clean the inner side of the wheels when the wheel is changed or the underside of the vehicle is washed.
- Inspect wheel rims regularly for dents or corrosion. Such damage may cause loss of pressure or poor seal at the tire bead.
- NISSAN recommends that the road wheels be waxed to protect against road salt in areas where it is used during winter.



### CAUTION

**Do not use abrasive cleaners when washing the wheels.**

## Aluminum alloy wheels

Wash regularly with a sponge dampened in a mild soap solution, especially during winter months in areas where road salt is used. Salt could discolor the wheels if not removed.



### CAUTION

**Follow the directions below to avoid staining or discoloring the wheels:**

- **Do not use a cleaner that uses strong acid or alkali contents to clean the wheels.**
- **Do not apply wheel cleaners to the wheels when they are hot. The wheel temperature should be the same as ambient temperature.**
- **Rinse the wheel to completely remove the cleaner within 15 minutes after the cleaner is applied.**

## CHROME PARTS

Clean chrome parts regularly with a non-abrasive chrome polish to maintain the finish.



## CLEANING INTERIOR

### TIRE DRESSING

NISSAN does not recommend the use of tire dressings. Tire manufacturers apply a coating to the tires to help reduce discoloration of the rubber. If a tire dressing is applied to the tires, it may react with the coating and form a compound. This compound may come off the tire while driving and stain the vehicle paint.

If you choose to use a tire dressing, take the following precautions:

- Use a water-based tire dressing. The coating on the tire dissolves more easily with an oil-based tire dressing.
- Apply a light coat of tire dressing to help prevent it from entering the tire tread/grooves (where it would be difficult to remove).
- Wipe off excess tire dressing using a dry towel. Make sure the tire dressing is completely removed from the tire tread/grooves.
- Allow the tire dressing to dry as recommended by tire dressing manufacturer.

Occasionally remove loose dust from the interior trim, plastic parts and seats using a vacuum cleaner or soft bristled brush. Wipe the vinyl and leather surfaces with a clean, soft cloth dampened in mild soap solution, then wipe clean with a dry soft cloth.

Regular care and cleaning is required in order to maintain the appearance of the leather.

Before using any fabric protector, read the manufacturer's recommendations. Some fabric protectors contain chemicals that may stain or bleach the seat material.

Use a cloth dampened only with water, to clean the meter and gauge lens.



### WARNING

**Do not use water or acidic cleaners (hot steam cleaners) on the seat. This can damage the seat or occupant classification sensor. This can also affect the operation of the air bag system and result in serious personal injury.**



### CAUTION

- **Never use benzene, thinner, or any similar material.**
- **For cleaning, use a soft cloth, dampened with water. Never use a rough cloth, alcohol, benzene, thinner or any kind of solvent or paper towel with a chemical cleaning agent. They will scratch or cause discoloration to the lens.**
- **Do not spray any liquid such as water on the meter lens. Spraying liquid may cause the system to malfunction.**
- **Small dirt particles can be abrasive and damaging to the leather surfaces and should be removed promptly. Do not use saddle soap, car waxes, polishes, oils, cleaning fluids, solvents, detergents or ammonia-based cleaners as they may damage the leather's natural finish.**
- **Never use fabric protectors unless recommended by the manufacturer.**
- **Do not use glass or plastic cleaner on meter or gauge lens covers. It**

**may damage the lens cover.**

## AIR FRESHENERS

Most air fresheners use a solvent that could affect the vehicle interior. If you use an air freshener, take the following precautions:

- Hanging-type air fresheners can cause permanent discoloration when they contact vehicle interior surfaces. Place the air freshener in a location that allows it to hang free and not contact an interior surface.
- Liquid-type air fresheners typically clip on the ventilators. These products can cause immediate damage and discoloration when spilled on interior surfaces.

Carefully read and follow the manufacturer's instructions before using air fresheners.

## FLOOR MATS



### WARNING

**To avoid potential pedal interference that may result in a collision, injury or death:**

- **NEVER place a floor mat on top of another floor mat in the driver front position or install them upside down or backwards.**

- **It is recommended that you use only genuine NISSAN floor mats specifically designed for use in your vehicle model and model year.**
- **Properly position the mats in the floorwell using the floor mat positioning hook. See "Floor mat installation" (P.7-5).**
- **Make sure the floor mat does not interfere with pedal operation.**
- **Periodically check the floor mats to make sure they are properly installed.**
- **After cleaning the vehicle interior, check the floor mats to make sure they are properly installed.**

The use of genuine NISSAN floor mats can extend the life of your vehicle carpet and make it easier to clean the interior. Mats should be maintained with regular cleaning and replaced if they become excessively worn.

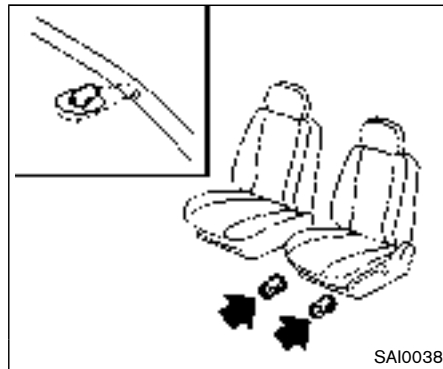

SAI0038

Front (example)

## Floor mat installation

Your vehicle is equipped with floor mat positioning hook(s). The number and shape of the floor mat positioning hooks for each seating position varies depending on the vehicle.

When installing genuine NISSAN floor mats, follow the installation instructions provided with the mat and the following:

1. Position the floor mat in the floorwell so that the floor mat grommet holes are aligned with the hook(s).
2. Secure the grommet holes into the hook(s) and ensure that the floor mat is properly positioned.

3. Make sure the floor mat does not interfere with pedal operation. With the ignition in the OFF position and the shift lever in the P (Park) position, fully apply and release all pedals. The floor mat must not interfere with pedal operation or prevent the pedal from returning to its normal position.

It is recommended you see a NISSAN dealer for details about installing the floor mats in your vehicle.

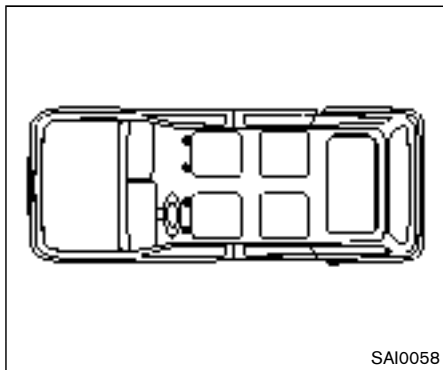

SAI0058

**Positioning hooks**

The illustration shows the location of the floor mat positioning hooks.

## SEAT BELTS

The seat belts can be cleaned by wiping them with a sponge dampened in a mild soap solution. Allow the belts to dry completely before using them.

See "Seat belts" (P.1-15).



## WARNING

**Do not allow wet seat belts to roll up in the retractor. NEVER use bleach, dye, or chemical solvents to clean the seat**

**belts, since these materials may severely weaken the seat belt webbing.**

## CORROSION PROTECTION

### MOST COMMON FACTORS CONTRIBUTING TO VEHICLE CORROSION

- The accumulation of moisture-retaining dirt and debris in body panel sections, cavities, and other areas.
- Damage to paint and other protective coatings caused by gravel and stone chips or minor traffic accidents.

### ENVIRONMENTAL FACTORS INFLUENCE THE RATE OF CORROSION

#### Moisture

Accumulation of sand, dirt and water on the vehicle body underside can accelerate corrosion. Wet floor coverings will not dry completely inside the vehicle, and should be removed for drying to avoid floor panel corrosion.

#### Relative humidity

Corrosion will be accelerated in areas of high relative humidity, especially those areas where the temperatures stay above freezing where atmospheric pollution exists, or where road salt is used.

#### Temperature

A temperature increase will accelerate the rate of corrosion to those parts which are not well ventilated.

#### Air pollution

Industrial pollution, the presence of salt in the air in coastal areas, or heavy road salt use will accelerate the corrosion process. Road salt will also accelerate the disintegration of paint surfaces.

### TO PROTECT YOUR VEHICLE FROM CORROSION

- Wash and wax your vehicle often to keep the vehicle clean.
- Always check for minor damage to the paint and repair it as soon as possible.
- Keep drain holes at the bottom of the doors open to avoid water accumulation.
- Check the underbody for accumulation of sand, dirt or salt. If present, wash with water as soon as possible.



### CAUTION

- **NEVER** remove dirt, sand or other debris from the passenger compartment by washing it out with a hose.

### Remove dirt with a vacuum cleaner.

- **Never allow water or other liquids to come in contact with electronic components inside the vehicle as this may damage them.**

Chemicals used for road surface deicing are extremely corrosive. They accelerate corrosion and deterioration of underbody components such as the exhaust system, fuel and brake lines, brake cables, floor pan and fenders.

### In winter, the underbody must be cleaned periodically.

For additional protection against rust and corrosion, which may be required in some areas, it is recommended you consult a NISSAN dealer.

## **MEMO**

# 8 Do-it-yourself

Maintenance precautions .....	8-2	Windshield wiper blades .....	8-14
Engine compartment check locations .....	8-3	Cleaning .....	8-14
VQ35DE engine .....	8-3	Replacing .....	8-15
Engine cooling system .....	8-4	Washer nozzle .....	8-16
Checking engine coolant level .....	8-5	Rear window wiper blade .....	8-17
Changing engine coolant .....	8-5	Brakes .....	8-17
Engine oil .....	8-5	Self-adjusting brakes .....	8-17
Checking engine oil level .....	8-5	Brake pad wear warning .....	8-17
Changing engine oil and filter .....	8-6	Fuses .....	8-18
Continuously Variable Transmission (CVT) fluid .....	8-8	Engine compartment .....	8-18
Power steering fluid .....	8-8	Passenger compartment .....	8-19
Brake fluid .....	8-9	Intelligent Key battery replacement .....	8-20
Window washer fluid .....	8-10	Lights .....	8-22
Battery .....	8-10	Headlights .....	8-22
Jump starting .....	8-12	Exterior and interior lights .....	8-24
Variable voltage control system .....	8-12	Wheels and tires .....	8-27
Drive belt .....	8-12	Tire pressure .....	8-27
Spark plugs .....	8-13	Tire labeling .....	8-31
Replacing spark plugs .....	8-13	Types of tires .....	8-33
Air cleaner .....	8-14	Tire chains .....	8-33
		Changing wheels and tires .....	8-35

## MAINTENANCE PRECAUTIONS

When performing any inspection or maintenance work on your vehicle, always take care to prevent serious accidental injury to yourself or damage to the vehicle. The following are general precautions which should be closely observed.



### WARNING

- **Park the vehicle on a level surface, apply the parking brake securely and block the wheels to prevent the vehicle from moving. Move the shift lever to P (Park).**
- **Be sure the ignition switch is in the OFF or LOCK position when performing any parts replacement or repairs.**
- **If you must work with the engine running, keep your hands, clothing, hair and tools away from moving fans, belts and any other moving parts.**
- **It is advisable to secure or remove any loose clothing and remove any jewelry, such as rings, watches, etc. before working on your vehicle.**
- **Always wear eye protection whenever you work on your vehicle.**

- **If you must run the engine in an enclosed space such as a garage, be sure there is proper ventilation for exhaust gases to escape.**
- **Never get under the vehicle while it is supported only by a jack. If it is necessary to work under the vehicle, support it with safety stands.**
- **Keep smoking materials, flame and sparks away from fuel tank and the battery.**
- **Because the fuel lines on gasoline engine models are under high pressure even when the engine is off, it is recommended you visit a NISSAN dealer for service of the fuel filter or fuel lines.**



### CAUTION

- **Do not work under the hood while the engine is hot. Turn the engine off and wait until it cools down.**
- **Avoid direct contact with used engine oil and coolant. Improperly disposed engine oil, and engine coolant and/or other vehicle fluids**

**can damage the environment. Always conform to local regulations for disposal of vehicle fluid.**

- **Never leave the engine or the CVT related component harnesses disconnected while the ignition switch is in the ON position.**
- **Never connect or disconnect the battery or any transistorized component while the ignition switch is in the ON position.**
- **Your vehicle is equipped with an automatic engine cooling fan. It may come on at any time without warning, even if the ignition key is in the OFF position and the engine is not running. To avoid injury, always disconnect the negative battery cable before working near the fan.**

This "8. Do-it-yourself" section gives instructions regarding only those items which are relatively easy for an owner to perform.

A genuine NISSAN Service Manual is also available. (See "Owner's manual/service manual order information" (P.10-27).)

You should be aware that incomplete or improper servicing may result in operating

## ENGINE COMPARTMENT CHECK LOCATIONS

difficulties or excessive emissions, and could affect warranty coverage. **If in doubt about any servicing, it is recommended you have it done by a NISSAN dealer.**

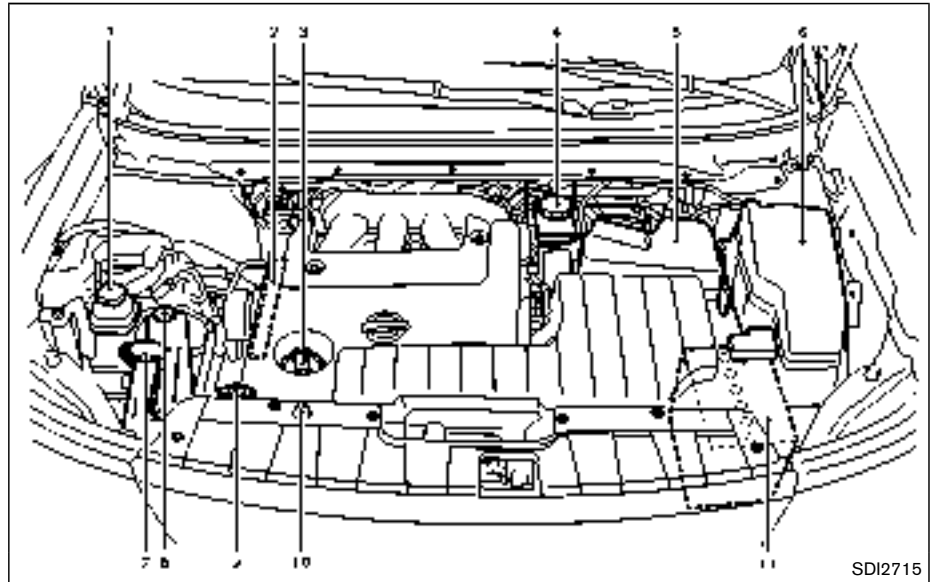

### VQ35DE ENGINE

1. Power steering fluid reservoir
2. Drive belt location
3. Engine oil filler cap
4. Brake fluid reservoir
5. Air cleaner
6. Fuse/fusible link holder
7. Window washer fluid reservoir
8. Engine coolant reservoir
9. Radiator filler cap
10. Engine oil dipstick
11. Battery



## ENGINE COOLING SYSTEM

The engine cooling system is filled at the factory with a pre-diluted mixture of 50% Genuine NISSAN Long Life Antifreeze/Coolant (blue) and 50% water to provide year-round anti-freeze and coolant protection. The anti-freeze solution contains rust and corrosion inhibitors. Additional engine cooling system additives are not necessary.



### WARNING

- **Never remove the radiator or coolant reservoir cap when the engine is hot. Wait until the engine and radiator cool down. Serious burns could be caused by high pressure fluid escaping from the radiator. See precautions in “If your vehicle overheats” (P.6-12) of this manual.**
- **The radiator is equipped with a pressure type radiator cap. To prevent engine damage, use only a genuine NISSAN radiator cap.**



### CAUTION

- **Never use any cooling system additives such as radiator sealer. Additives may clog the cooling system and cause damage to the engine, transmission and/or cooling system.**
- **When adding or replacing coolant, be sure to use only Genuine NISSAN Long Life Antifreeze/Coolant (blue) or equivalent. Genuine NISSAN Long Life Antifreeze/Coolant (blue) is pre-diluted to provide antifreeze protection to  $-34^{\circ}\text{F}$  ( $-37^{\circ}\text{C}$ ). If additional freeze protection is needed due to weather where you operate your vehicle, add Genuine NISSAN Long Life Antifreeze/Coolant (blue) concentrate following the directions on the container. If an equivalent coolant other than Genuine NISSAN Long Life Antifreeze/Coolant (blue) is used, follow the coolant manufacturer's instructions to maintain minimum antifreeze protection to  $-34^{\circ}\text{F}$  ( $-37^{\circ}\text{C}$ ). The use of other types of coolant solutions other than Genu-**

**ine NISSAN Long Life Antifreeze/Coolant (blue) or equivalent may damage the engine cooling system.**

- **The life expectancy of the factory-fill coolant is 105,000 miles (168,000 km) or 7 years. Mixing any other type of coolant other than Genuine NISSAN Long Life Antifreeze/Coolant (blue), including Genuine NISSAN Long Life Antifreeze/Coolant (green), or the use of non-distilled water will reduce the life expectancy of the factory-fill coolant. Refer to the “9. Maintenance and schedules” section of this manual for more details.**

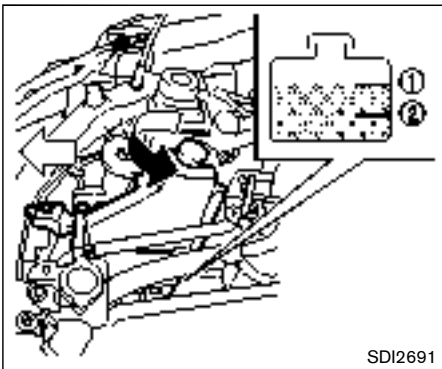

SDI2691

## CHECKING ENGINE COOLANT LEVEL

Check the coolant level **in the reservoir when the engine is cold**. If the coolant level is below the MIN level (2), open the reservoir cap and add coolant up to the MAX level (1). If the reservoir is empty, check the coolant level in the radiator **when the engine is cold**. If there is insufficient coolant in the radiator, fill the radiator with coolant up to the filler opening and also add it to the reservoir up to the MAX level (1).

**If the cooling system frequently requires coolant, have it checked. It is recommended you visit a NISSAN dealer for this service.**

## CHANGING ENGINE COOLANT

It is recommended that major cooling system repairs be performed by a NISSAN dealer. The service procedures can be found in the appropriate NISSAN Service Manual.

**Improper servicing can result in reduced heater performance and engine overheating.**



## WARNING

- **To avoid the danger of being scalded, never change the coolant when the engine is hot.**
- **Never remove the radiator cap when the engine is hot. Serious burns could be caused by high pressure fluid escaping from the radiator.**
- **Avoid direct skin contact with used coolant. If skin contact is made, wash thoroughly with soap or hand cleaner as soon as possible.**
- **Keep coolant out of reach of children and pets.**

Engine coolant must be disposed of properly. Check your local regulations.

## ENGINE OIL

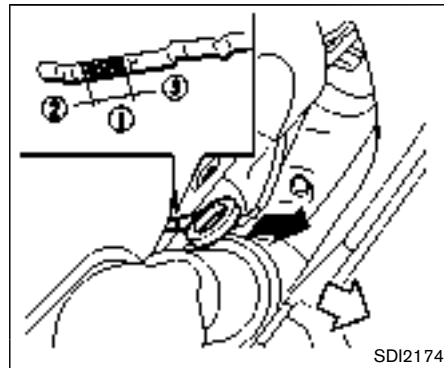

SDI2174

## CHECKING ENGINE OIL LEVEL

1. Park the vehicle on a level surface and apply the parking brake.
2. Run the engine until it reaches operating temperature.
3. Turn off the engine. **Wait more than 10 minutes for the oil to drain back into the oil pan.**
4. Remove the dipstick and wipe it clean. Reinsert it all the way.
5. Remove the dipstick again and check the oil level. It should be within the range (1). If the oil level is below (2), remove the oil filler cap and pour recommended oil through the

opening. **Do not overfill** ③.

6. Recheck oil level with the dipstick.

**It is normal to add some oil between oil maintenance intervals or during the break-in period, depending on the severity of operating conditions.**



### CAUTION

**Oil level should be checked regularly. Operating the engine with an insufficient amount of oil can damage the engine, and such damage is not covered by the warranty.**

## CHANGING ENGINE OIL AND FILTER

### Vehicle set-up

1. Park the vehicle on a level surface and apply the parking brake.
2. Start the engine and let it idle until it reaches operating temperature.
3. Turn the engine off and wait more than 10 minutes.
4. Raise and support the vehicle using a suitable floor jack and safety jack stands.
  - Place the safety jack stands under the vehicle jack-up points.

### 8-6 Do-it-yourself

- A suitable adapter should be attached to the jack stand saddle.



### CAUTION

**Make sure the correct lifting and support points are used to avoid vehicle damage.**

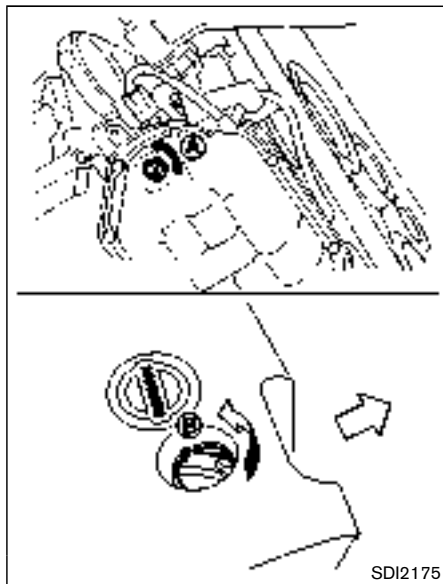

SDI2175

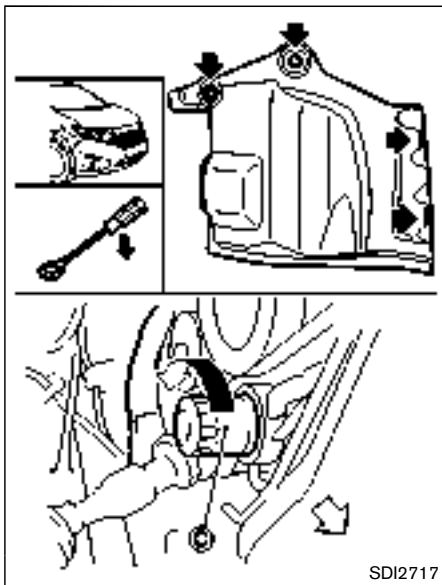

## Engine oil and filter

1. Place a large drain pan under the drain plug **(A)**.
2. Remove the oil filler cap **(B)**.
3. Remove the drain plug with a wrench and completely drain the oil.

### **CAUTION**

**Be careful not to burn yourself, as the engine oil is hot.**

- **Waste oil must be disposed of properly.**
- **Check your local regulations.**

Perform steps 4 to 9 when the engine oil filter change is needed.

4. Remove the plastic cover over the oil filter location by removing the small plastic clips as illustrated.
5. Loosen the oil filter **(C)** with an oil filter wrench. Remove the oil filter by turning it by hand.
6. Wipe the engine oil filter mounting surface with a clean rag.

### **CAUTION**

**Be sure to remove any old gasket material remaining on the mounting surface of the engine. Failure to do so could lead to engine damage.**

7. Coat the gasket on the new filter with clean engine oil.
8. Screw in the oil filter clockwise until a slight resistance is felt, then tighten additionally more than 2/3 turn.

#### **Oil filter tightening torque:**

**11 to 15 ft-lb (14.7 to 20.5 N-m)**

9. Install the plastic cover.
10. Clean and re-install the drain plug with a new washer. Securely tighten the drain plug with a wrench.

#### **Drain plug tightening torque:**

**22 to 29 ft-lb (29 to 39 N-m)**

Do not use excessive force.

11. Refill engine with recommended oil through the oil filler opening, and install the oil filler cap securely.

See "Capacities and recommended fluids/lubricants" (P.10-2) for drain and refill capacity. The drain and refill capacity depends on the oil temperature and drain time. Use these specifications for reference only. Always use the dipstick to determine the proper amount of oil in the engine.

12. Start the engine and check for leakage around the drain plug and the oil filter. Correct as required.

13. Turn the engine off and wait more than 10 minutes. Check the oil level with the dipstick. Add engine oil if necessary.

#### After the operation

1. Lower the vehicle carefully to the ground.
2. Dispose of waste oil and filter properly.

### WARNING

- Prolonged and repeated contact with used engine oil may cause skin cancer.
- Try to avoid direct skin contact with used oil. If skin contact is made, wash thoroughly with soap or hand cleaner as soon as possible.
- Keep used engine oil out of reach of children.

## CONTINUOUSLY VARIABLE TRANSMISSION (CVT) FLUID

### CAUTION

- NISSAN recommends using Genuine NISSAN CVT Fluid NS-3 (or equivalent) ONLY in NISSAN CVTs. Do not mix with other fluids.
- Do not use Automatic transmission fluid (ATF) or Manual transmission fluid in a NISSAN CVT, as it may damage the CVT. Damage caused by the use of fluids other than as recommended is not covered under NISSAN's New Vehicle Limited Warranty.
- Using fluids that are not equivalent to Genuine NISSAN CVT Fluid NS-3 may also damage the CVT. Damage caused by the use of fluids other than as recommended is not covered under NISSAN's New Vehicle Limited Warranty.

When checking or replacement is required, we recommend a NISSAN dealer for servicing.

## POWER STEERING FLUID

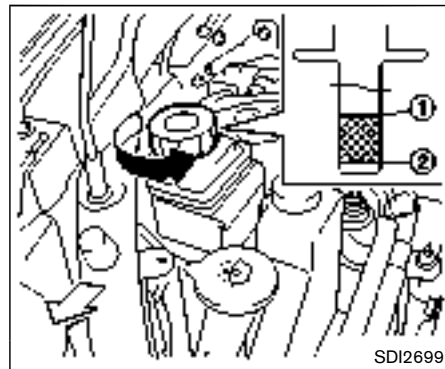

Check the fluid level in the reservoir.

The fluid level should be checked when the fluid is cold at fluid temperatures of 32 to 86°F (0 to 30°C). The fluid level can be checked with the level gauge which is attached to the cap. To check the fluid level, remove the cap. The fluid level should be between the MAX ① and MIN ② lines.

If the fluid is below the MIN ② line, add Genuine NISSAN E-PSF. Remove the cap and fill through the opening.

## CAUTION

- Do not overfill.
- Use of a power steering fluid other than Genuine NISSAN E-PSF will prevent the power steering system from operating properly.

## BRAKE FLUID

For additional brake fluid information, see "Capacities and recommended fluids/lubricants" (P.10-2) of this manual.

## WARNING

- Use only new fluid from a sealed container. Old, inferior or contaminated fluid may damage the brake system. The use of improper fluids can damage the brake system and affect the vehicle's stopping ability.
- Clean the filler cap before removing.
- Brake fluid is poisonous and should be stored carefully in marked containers out of the reach of children.

## CAUTION

Do not spill the fluid on any painted surfaces. This will damage the paint. If fluid is spilled, immediately wash the surface with water.

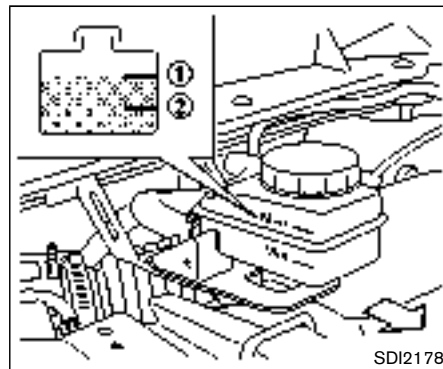

Check the fluid level in the reservoir. If the fluid is below the MIN line ② or the brake warning light comes on, add Genuine NISSAN Super Heavy Duty Brake Fluid or equivalent **DOT 3** fluid up to the MAX line ①. If fluid must be added frequently, the system should be checked. It is recommended you visit a NISSAN dealer for this service.

## WINDOW WASHER FLUID

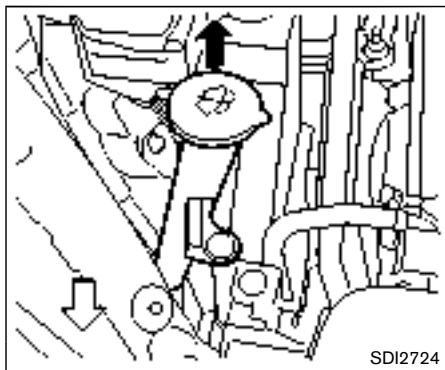

Fill the window washer fluid reservoir periodically. Add window washer fluid when the low washer fluid warning appears on the vehicle information display.

To fill the window washer fluid reservoir, lift the cap and pour the window washer fluid into the reservoir opening.

Add a washer solvent to the water for better cleaning. In the winter season, add a windshield washer antifreeze. Follow the manufacturer's instructions for the mixture ratio.

Refill the reservoir more frequently when driving conditions require an increased amount of window washer fluid.

Recommended fluid:

Genuine NISSAN Windshield Washer Concentrate Cleaner & Antifreeze or equivalent



### CAUTION

- **Do not substitute engine anti-freeze coolant for window washer solution. This may result in damage to the paint.**
- **Do not fill the window washer reservoir tank with washer fluid concentrates at full strength. Some methyl alcohol based washer fluid concentrates may permanently stain the grille if spilled while filling the window washer reservoir tank.**
- **Pre-mix washer fluid concentrates with water to the manufacturer's recommended levels before pouring the fluid into the window washer reservoir tank. Do not use the window washer reservoir tank to mix the washer fluid concentrate and water.**

## BATTERY

- Keep the battery surface clean and dry. Clean the battery with a solution of baking soda and water.
- Make certain the terminal connections are clean and securely tightened.
- If the vehicle is not to be used for 30 days or longer, disconnect the negative (-) battery terminal cable to prevent discharging it.

### NOTE:

**Care should be taken to avoid situations that can lead to potential battery discharge and potential no-start conditions such as:**

1. **Installation or extended use of electronic accessories that consume battery power when the engine is not running (Phone chargers, GPS, DVD players, etc.)**
2. **Vehicle is not driven regularly and/or only driven short distances.**

**In these cases, the battery may need to be charged to maintain battery health.**



### WARNING

- **Do not expose the battery to flames or electrical sparks. Hydrogen gas generated by the battery is explosive. Do not allow battery fluid to**

contact your skin, eyes, fabrics, or painted surfaces. After touching a battery or battery cap, do not touch or rub your eyes. Thoroughly wash your hands. If the acid contacts your eyes, skin or clothing, immediately flush with water for at least 15 minutes and seek medical attention.

- Do not operate the vehicle if the fluid in the battery is low. Low battery fluid can cause a higher load on the battery which can generate heat, reduce battery life, and in some cases lead to an explosion.
- When working on or near a battery, always wear suitable eye protection and remove all jewelry.
- Battery posts, terminals and related accessories contain lead and lead compounds. Wash hands after handling.
- Keep the battery out of the reach of children.

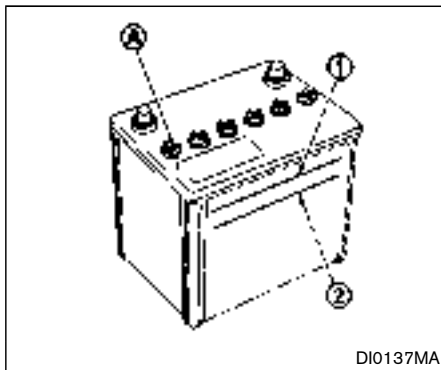

DI0137MA

Check the fluid level in each cell. (Remove the battery cover if it is necessary.) It should be between the UPPER LEVEL ① and LOWER LEVEL ② lines.

If it is necessary to add fluid, add only distilled water to bring the level to the indicator in each filler opening. **Do not overfill.**

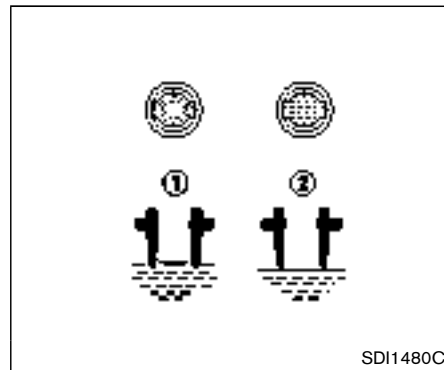

SDI1480C

1. Remove the cell plugs ① .
2. Add distilled water up to the UPPER LEVEL ① line.

If the side of the battery is not clear, check the distilled water level by looking directly above the cell; the condition ① indicates OK and the conditions ② needs more to be added.

3. Tighten cell plugs ① .

Vehicles operated in high temperatures or under severe conditions require frequent checks of the battery fluid level.



## JUMP STARTING

If jump starting is necessary, see "Jump starting" (P.6-10). If the engine does not start by jump starting, the battery may have to be replaced. It is recommended you visit a NISSAN dealer for this service.

## VARIABLE VOLTAGE CONTROL SYSTEM

### CAUTION

- **Do not ground accessories directly to the battery terminal. Doing so will bypass the variable voltage control system and the vehicle battery may not charge completely.**
- **Use electrical accessories with the engine running to avoid discharging the vehicle battery.**

The variable voltage control system measures the amount of electrical discharge from the battery and controls voltage generated by the generator.

## DRIVE BELT

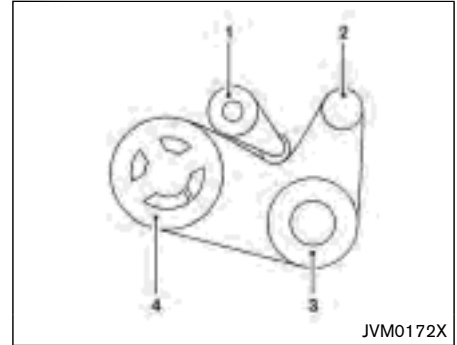

1. Drive belt auto-tensioner
2. Alternator
3. Air conditioner compressor
4. Crankshaft pulley

### WARNING

**Be sure the ignition switch is in the OFF or LOCK position before servicing drive belt. The engine could rotate unexpectedly.**

1. Visually inspect the belt for signs of unusual wear, cuts, fraying or looseness. If the belt is in poor condition or loose, have it replaced or adjusted. It is recommended you visit a

## SPARK PLUGS

NISSAN dealer for this service.

2. Have the belt condition checked regularly.



### WARNING

Be sure the engine and ignition switch are off and that the parking brake is engaged securely.



### CAUTION

Be sure to use the correct socket to remove the spark plugs. An incorrect socket can damage the spark plugs.

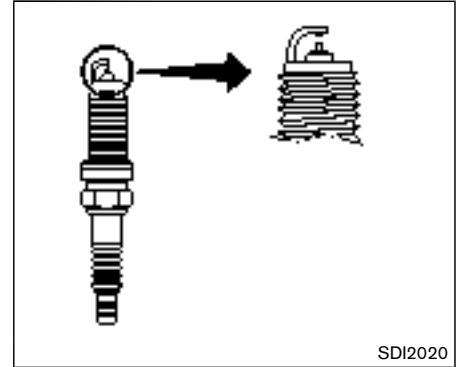

## REPLACING SPARK PLUGS

If replacement is required, it is recommended you visit a NISSAN dealer for this service.

### Iridium-tipped spark plugs

It is not necessary to replace the platinum-tipped spark plugs as frequently as the conventional type spark plugs since they will last much longer. Follow the maintenance schedule shown in the "9. Maintenance and schedules" section, but do not reuse them by cleaning or regapping.

**Always replace spark plugs with recommended or equivalent ones.**

## AIR CLEANER

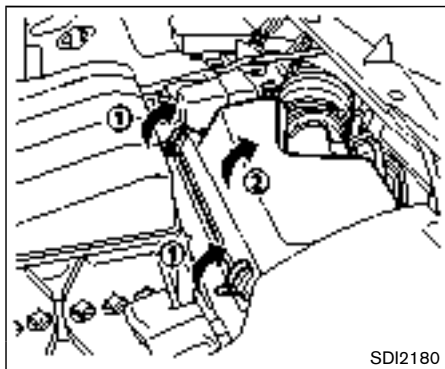

Pull the tabs ① and pull out the cover ②.

The air cleaner filter should not be cleaned and reused. Replace it according to the maintenance log shown in the "9. Maintenance and schedules" section. When replacing the filter, wipe the inside of the air cleaner housing and the cover with a damp cloth.



### WARNING

- **Operating the engine with the air cleaner removed can cause you or others to be burned. The air cleaner not only cleans the air, it stops flame if the engine backfires. If it**

**isn't there, and the engine backfires, you could be burned. Do not drive with the air cleaner removed, and be careful when working on the engine with the air cleaner removed.**

- **Never pour fuel into the throttle body or attempt to start the engine with the air cleaner removed. Doing so could result in serious injury.**

## WINDSHIELD WIPER BLADES

### CLEANING

If your windshield is not clear after using the windshield washer or if a wiper blade chatters when running, wax or other material may be on the blade or windshield.

Clean the outside of the windshield with a washer solution or a mild detergent. Your windshield is clean if beads do not form when rinsing with clear water.

Clean each blade by wiping it with a cloth soaked in a washer solution or a mild detergent. Then rinse the blade with clear water. If your windshield is still not clear after cleaning the blades and using the wiper, replace the blades.



### CAUTION

**Worn windshield wiper blades can damage the windshield and impair driver vision.**

## REPLACING

### CAUTION

- After wiper blade replacement, return the wiper arm to its original position; otherwise it may be damaged when the hood is opened.
- Make sure the wiper blades contact the glass; otherwise the arm may be damaged from wind pressure.

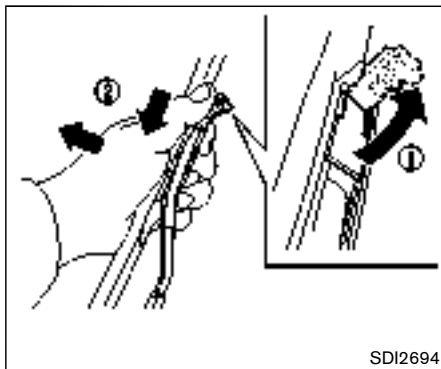

#### Type A (if so equipped)

Replace the wiper blades if they are worn.

1. Pull the wiper arm. **When lifting the wiper arm, lift the driver's side first, then the passenger's side. Otherwise, the wiper blades may be scratched and may cause damage.**
2. Release the lock tab ① and then move the wiper blade ② as illustrated.
3. Remove the wiper blade.
4. Insert the new wiper blade onto the wiper arm until it clicks into place.

It is recommended you visit a NISSAN dealer for wiper blade rubber replacement.

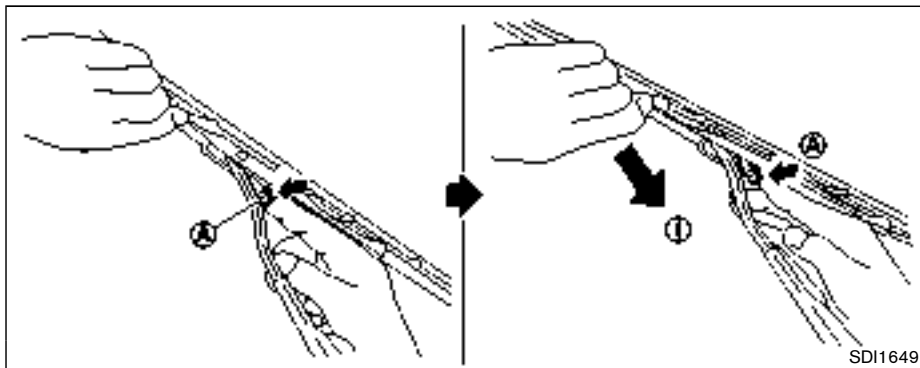

### Type B (if so equipped)

Replace the wiper blades if they are worn.

1. Lift the wiper arm away from the windshield.  
**When lifting the wiper arm, lift the driver's side first, then the passenger's side. Otherwise, the wiper blades may be scratched and may cause damage.**
2. Push and hold the release tab (A), and then move the wiper blade down the wiper arm to remove (1).
3. Remove the wiper blade.
4. Insert the new wiper blade onto the wiper arm until it clicks into place.

It is recommended you visit a NISSAN dealer for

wiper blade rubber replacement.

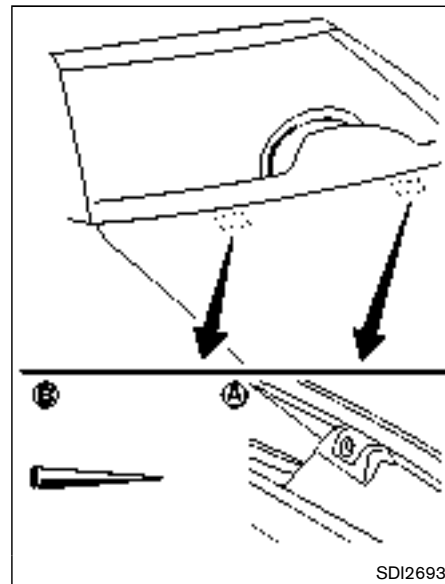

### WASHER NOZZLE

Be careful not to clog the washer nozzle (A). This may cause improper windshield washer operation. If the nozzle is clogged, remove any objects with a needle or small pin (B). Be careful not to damage the nozzle.

## REAR WINDOW WIPER BLADE

It is recommended you visit a NISSAN dealer if checking or replacement is required.

## BRAKES

If the brakes do not operate properly, it is recommended you have the brakes checked by a NISSAN dealer.

### SELF-ADJUSTING BRAKES

Your vehicle is equipped with self-adjusting brakes.

The disc-type brakes self-adjust every time the brake pedal is applied.



### WARNING

**Have your brake system checked if the brake pedal height does not return to normal. It is recommended you visit a NISSAN dealer for this service.**

### BRAKE PAD WEAR WARNING

The disc brake pads have audible wear warnings. When a brake pad requires replacement, it will make a high pitched scraping sound when the vehicle is in motion. This scraping sound will first occur only when the brake pedal is depressed. After more wear of the brake pad, the sound will always be heard even if the brake pedal is not depressed. Have the brakes checked as soon as possible if the wear warning sound is heard.

Under some driving or climate conditions,

occasional brake squeak, squeal or other noise may be heard. Occasional brake noise during light to moderate stops is normal and does not affect the function or performance of the brake system.

**Proper brake inspection intervals should be followed.** For additional information, see the maintenance schedule shown in the "9. Maintenance and schedules" section.

## FUSES

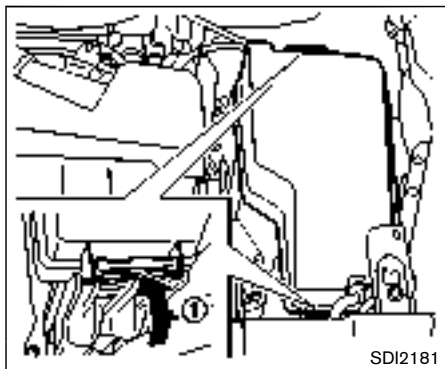

### ENGINE COMPARTMENT



#### WARNING

**Never use a fuse of a higher or lower amperage rating than that specified on the fuse box cover. This could damage the electrical system or electronic control units or cause a fire.**

If any electrical equipment does not operate, check for an open fuse.

1. Be sure the ignition switch and the headlight switch are turned off.

2. Open the engine hood.
3. Remove the fuse/fusible link holder cover by pushing the tab ①.
4. Remove the fuse with the fuse puller located in the passenger compartment fuse box.

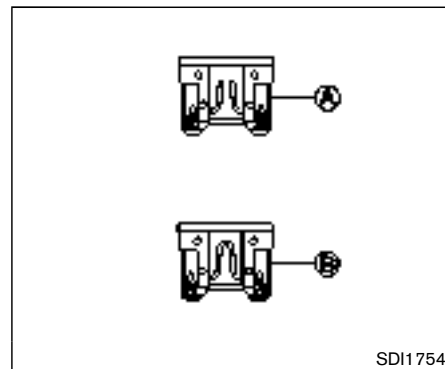

5. If the fuse is open (A), replace it with a new fuse (B). Spare fuses are stored in the passenger compartment fuse box.
6. If a new fuse also opens, have the electrical system checked and repaired. It is recommended you visit a NISSAN dealer for this service.

### Fusible links

If any electrical equipment does not operate and fuses are in good condition, check the fusible links. If any of these fusible links are melted, replace only with genuine NISSAN parts.

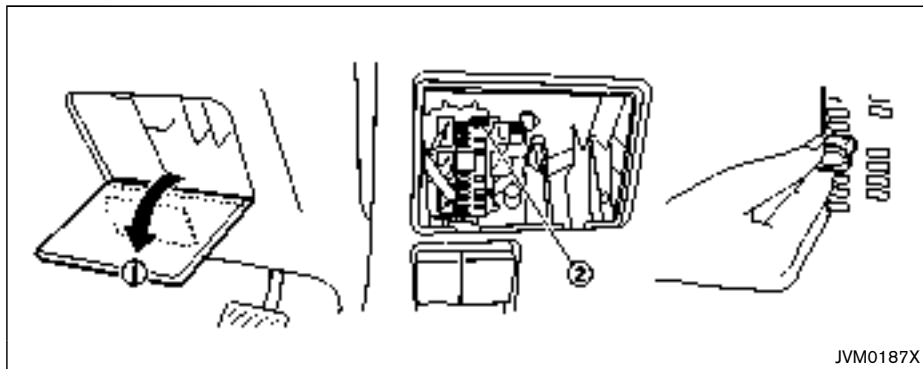

JVM0187X

## PASSENGER COMPARTMENT

### **WARNING**

**Never use a fuse of a higher or lower amperage rating than that specified on the fuse box cover. This could damage the electrical system or electronic control units or cause a fire.**

If any electrical equipment does not operate, check for an open fuse.

1. Be sure the ignition switch and the headlight switch are turned off.

2. Pull to remove the fuse box cover ①.
3. Remove the fuse with the fuse puller ②.
4. If the fuse is open, replace it with a new fuse.
5. If a new fuse also opens, have the electrical system checked and repaired. It is recommended you visit a NISSAN dealer for this service.

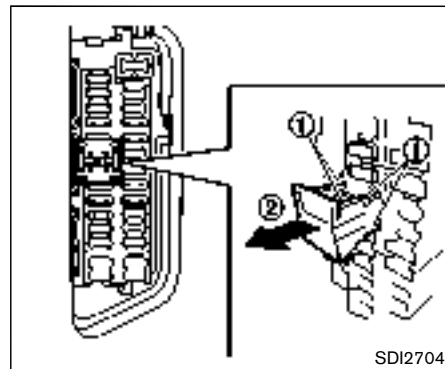

SDI2704

## Extended storage fuse switch

To reduce battery drain, the extended storage fuse switch comes from the factory switched off. Prior to delivery of your vehicle, the switch is pushed in (switched on) and should always remain on.

If the extended storage fuse switch is not pushed in (switched on), the "SHIPPING MODE ON, PUSH STORAGE FUSE" warning may appear on the vehicle information display. See "Vehicle information display" (P.2-19).

If any electrical equipment does not operate, remove the extended storage fuse switch and check for an open fuse.



## INTELLIGENT KEY BATTERY REPLACEMENT

### NOTE:

If the extended storage fuse switch malfunctions, or if the fuse is open, it is not necessary to replace the switch. In this case, remove the extended storage fuse switch and replace it with a new fuse of the same rating.

### How to remove the extended storage fuse switch:

1. To remove the extended storage fuse switch, be sure the ignition switch is in the OFF or LOCK position.
2. Be sure the headlight switch is in the OFF position.
3. Remove the fuse box cover.
4. Pinch the locking tabs ① found on each side of the storage fuse switch.
5. Pull the storage fuse switch straight out from the fuse box ②.



### CAUTION

Be careful not to allow children to swallow the battery and removed parts.

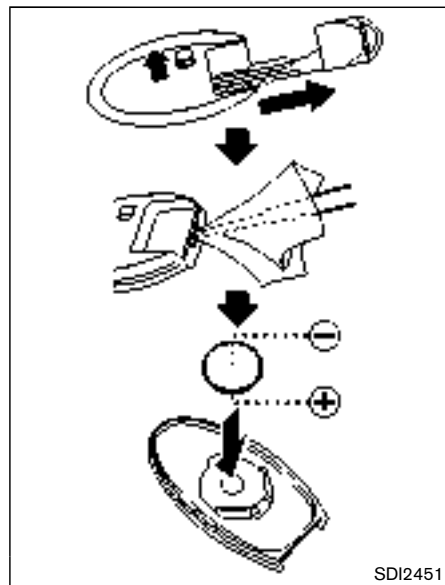

Replace the battery as follows:

1. Remove the mechanical key from the key.
2. Insert a small screwdriver into the slit of the corner and twist it to separate the upper part from the lower part. Use a cloth to protect the casing.

3. Replace the battery with a new one.

Recommended battery:

CR2025 or equivalent

- Do not touch the internal circuit and electric terminals as doing so could cause a malfunction.
- Hold the battery by the edges. Holding the battery across the contact points will seriously deplete the storage capacity.
- Make sure that the  $\oplus$  side faces the bottom case.

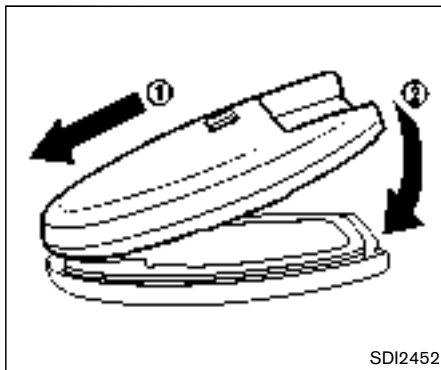

4. Align the tips of the upper and lower parts ①, and then push them together ② until it is securely closed.
5. Operate the buttons to check its operation.

If you need assistance with replacement, it is recommended you visit a NISSAN dealer for this service.

**FCC Notice:**

**For USA:**

**This device complies with Part 15 of the FCC Rules. Operation is subject to the following two conditions: (1) This device may not cause harmful interference, and (2) this device must accept any interfer-**

**ence received, including interference that may cause undesired operation.**

**Note: Changes or modifications not expressly approved by the party responsible for compliance could void the user's authority to operate the equipment.**

**For Canada:**

**This device complies with Industry Canada licence-exempt RSS standard(s). Operation subject to the following two conditions: (1) this device may not cause interference, and (2) this device must accept any interference that may cause undesired operation of the device.**

## LIGHTS

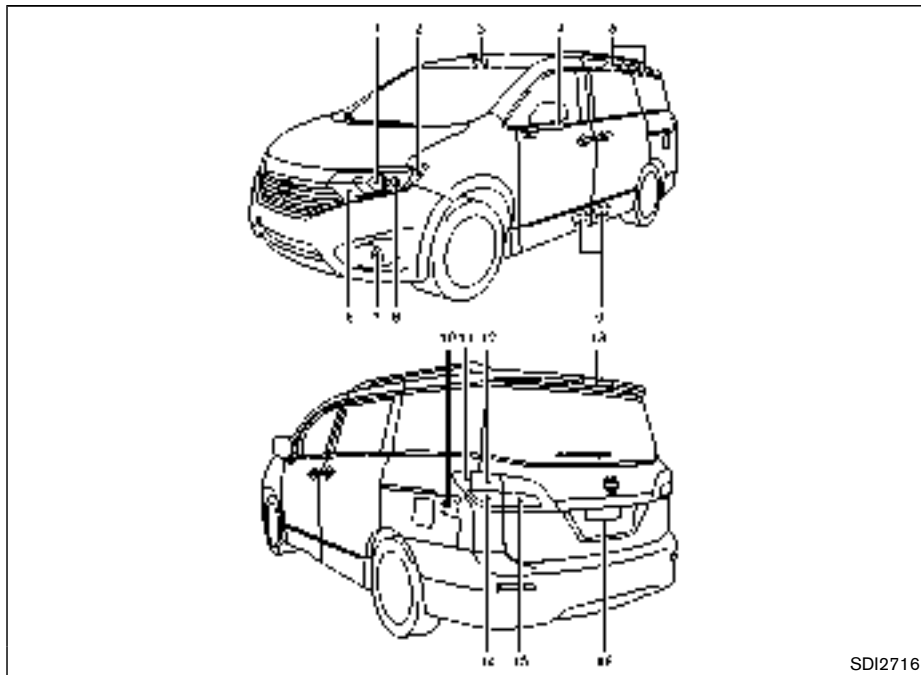

1. Headlight (high beam)
2. Front side marker light
3. Map light
4. Side turn signal light (if so equipped)
5. Rear personal light
6. Front turn signal/parking light
7. Front fog light (if so equipped)
8. Headlight (low beam)
9. Step light
10. Cargo light
11. Rear side marker light
12. Stop/tail light
13. High-mounted stop light
14. Rear turn signal light
15. Back up light
16. License plate lights

### HEADLIGHTS

Fog may temporarily form inside the lens of the exterior lights in the rain or in a car wash. A temperature difference between the inside and the outside of the lens causes the fog. This is not a malfunction. If large drops of water collect inside the lens, it is recommended you visit a NISSAN dealer for servicing.

## Replacing

If replacement is required, it is recommended you visit your NISSAN dealer for this service.

### Xenon headlight model:

#### **WARNING**

#### **HIGH VOLTAGE**

When xenon headlights are on, they produce a high voltage. To prevent an electric shock, never attempt to modify or disassemble. It is recommended to have your xenon headlights replaced at a NISSAN dealer. For additional information, see "Headlight and turn signal switch" (P.2-33).

### Halogen headlight model:

The headlight is a semi-sealed beam type which uses a replaceable headlight (halogen) bulb.

#### **CAUTION**

- Do not leave the bulb out of the headlight reflector for a long period of time. Dust, moisture, smoke, etc. entering the headlight body may

affect bulb performance.

- High pressure halogen gas is sealed inside the halogen bulb. The bulb may break if the glass envelope is scratched or the bulb is dropped.
- Only touch the plastic base when handling the bulb. Never touch the glass envelope.
- Aiming is not necessary after replacing the bulb. When aiming adjustment is necessary, it is recommended you visit a NISSAN dealer for this service.

Use the same number and wattage as originally installed as shown in the chart.

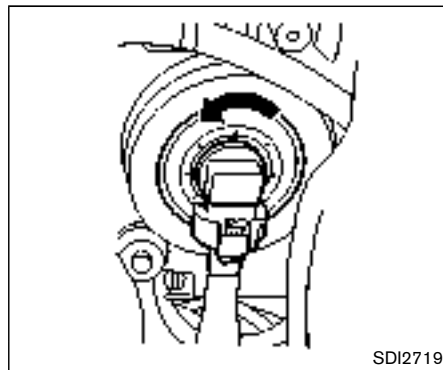

Disconnect the battery negative cable before replacing bulbs.

## EXTERIOR AND INTERIOR LIGHTS

Item	Wattage (W)	Bulb No.
Headlight		
Low beams (Xenon)*	35	D2S
High beam (Halogen)	60	HB3
Low beam (Halogen)	55	H11
Front turn signal/parking light*	27/8	S25
Side turn signal light (if so equipped)*	LED	—
Front fog light (if so equipped)	35	H8
Front side marker light	5	T10
Rear combination light*		
Turn signal	21	WY21W
Stop/tail and side marker	21/5	W21/5W
Back-up	16	W16W
License plate light*	5	T10
Front map light	8	—
Rear personal light	8	—
Vanity mirror light (if so equipped)	1.8	—
Step light*	3.4	—
High-mounted stop light*	LED	—
Cargo light	8	—
Glove box light*	1.4	—

\*: It is recommended you visit a NISSAN dealer for replacement.

NOTE: It is recommended that you check with the Parts Department at a NISSAN dealer for the latest information about parts.

## Replacement procedures

All other lights are either type A, B, C, D, E or F.  
When replacing a bulb, first remove the lens  
and/or cover.

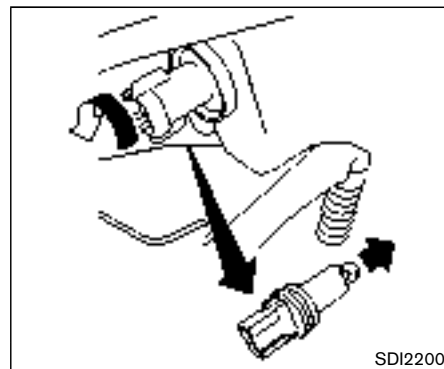
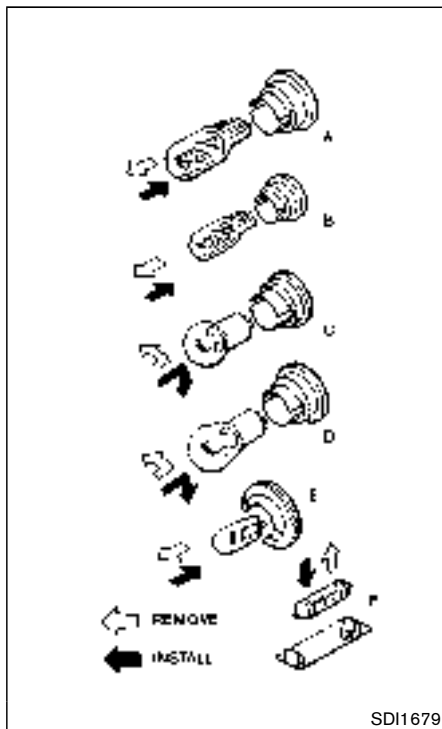

Front side marker light

1. Remove the rubber cover.
2. Remove the bulb as illustrated.

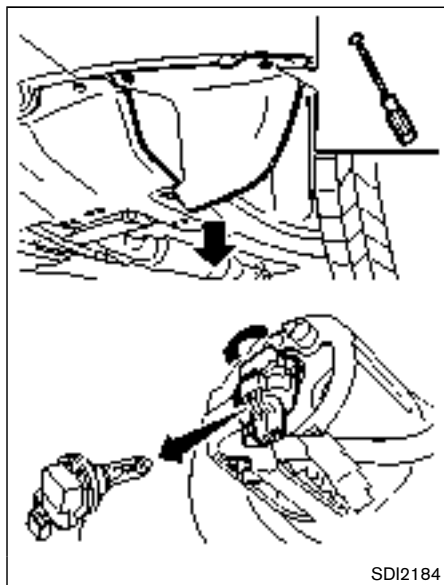

SDI2184

Front fog light (if so equipped)

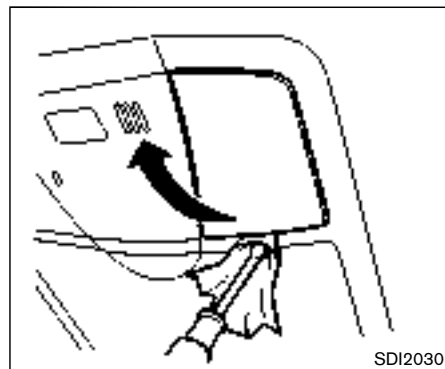

SDI2030

Front map light

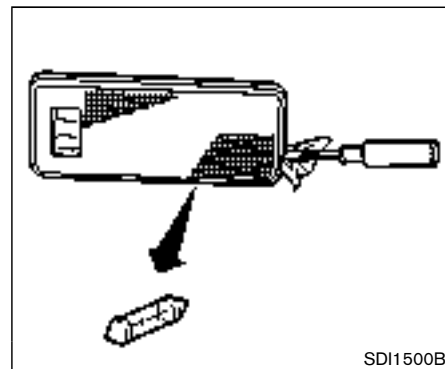

SDI1500B

Cargo light

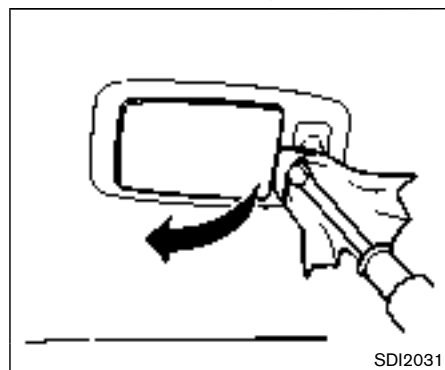

SDI2031

Rear personal light

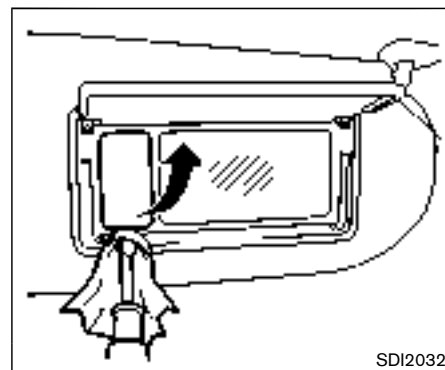

SDI2032

Vanity mirror light

## WHEELS AND TIRES

### If you have a flat tire, see “Flat tire” (P.6-3). TIRE PRESSURE

#### Tire Pressure Monitoring System (TPMS)

This vehicle is equipped with the Tire Pressure Monitoring System (TPMS). It monitors tire pressure of all tires except the spare. When the low tire pressure warning light is lit and the CHECK TIRE PRESSURE warning appears on the vehicle information display, one or more of your tires is significantly under-inflated.

The TPMS will activate only when the vehicle is driven at speeds above 16 MPH (25 km/h). Also, this system may not detect a sudden drop in tire pressure (for example a flat tire while driving).

For more details, see “Low tire pressure warning light” (P.2-14), “Tire Pressure Monitoring System (TPMS)” (P.5-3) and “Tire Pressure Monitoring System (TPMS)” (P.6-3).

#### Tire inflation pressure

Check the pressure of the tires (including the spare) often and always prior to long distance trips. The recommended tire pressure specifications are shown on the Tire and Loading Information label under the “Cold Tire Pressure” heading. The

Tire and Loading Information label is affixed to the driver side center pillar. Tire pressures should be checked regularly because:

- Most tires naturally lose air over time.
- Tires can lose air suddenly when driven over potholes or other objects or if the vehicle strikes a curb while parking.

The tire pressures should be checked when the tires are cold. The tires are considered COLD after the vehicle has been parked for 3 or more hours, or driven less than 1 mile (1.6 km) at moderate speeds.

The TPMS with Easy Fill Tire Alert provides visual and audible signals outside the vehicle for inflating the tires to the recommended COLD tire pressure. (See “TPMS with Easy Fill Tire Alert” (P.5-6).)

**Incorrect tire pressure, including under inflation, may adversely affect tire life and vehicle handling.**



## WARNING

- **Improperly inflated tires can fail suddenly and cause an accident.**
- **The Gross Vehicle Weight rating (GVWR) is located on the F. M.V.S.S./C.M.V.S.S. certification label. The vehicle weight capacity is indicated on the Tire and Loading Information label. Do not load your vehicle beyond this capacity. Overloading your vehicle may result in reduced tire life, unsafe operating conditions due to premature tire failure, or unfavorable handling characteristics and could also lead to a serious accident. Loading beyond the specified capacity may also result in failure of other vehicle components.**
- **Before taking a long trip, or whenever you heavily load**



**your vehicle, use a tire pressure gauge to ensure that the tire pressures are at the specified level.**

- **For additional information regarding tires, refer to “Important Tire Safety Information” (US) or “Tire Safety Information” (Canada) in the Warranty Information Booklet.**

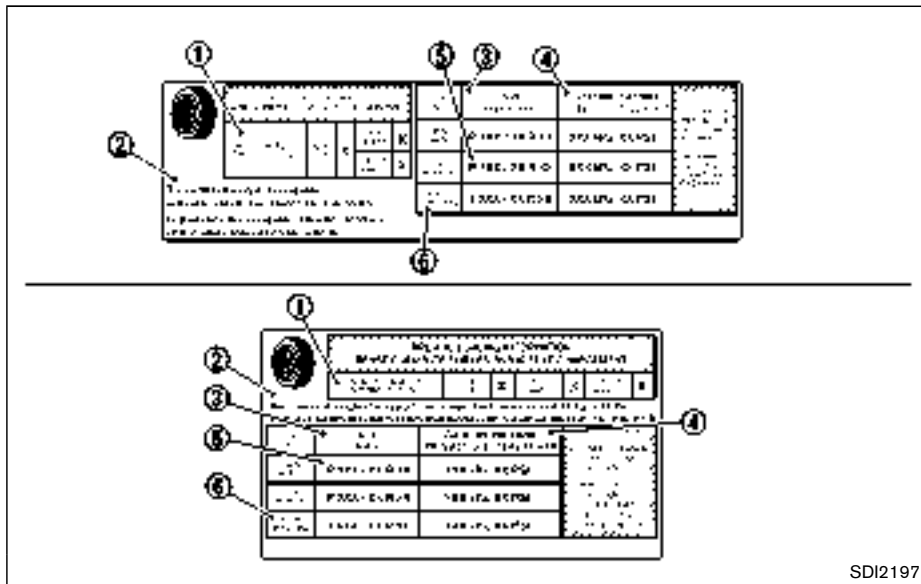

### Tire and Loading Information label

- ① Seating capacity: The maximum number of occupants that can be seated in the vehicle.
- ② Vehicle load limit: See “Vehicle loading information” (P.10-12).

- ③ Original size: The size of the tires originally installed on the vehicle at the factory.
- ④ Cold tire pressure: Inflate the tires to this pressure when the tires are cold. Tires are considered COLD

after the vehicle has been parked for 3 or more hours, or driven less than 1 mile (1.6 km) at moderate speeds. The recommended cold tire inflation is set by the manufacturer to provide the best balance of tire wear, vehicle handling, driveability, tire noise, etc., up to the vehicle’s GVWR.

- ⑤ Tire size — see “Tire labeling” (P.8-31).
- ⑥ Spare tire size or compact spare tire size (if so equipped)

SDI2197

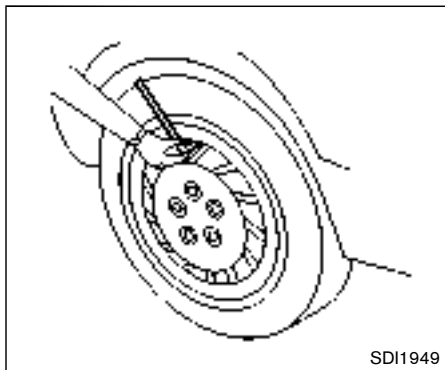

#### Checking the tire pressure

1. Remove the valve stem cap from the tire.
2. Press the pressure gauge squarely onto the valve stem. Do not press too hard or force the valve stem sideways, or air will escape. If the hissing sound of air escaping from the tire is heard while checking the pressure, reposition the gauge to eliminate this leakage.
3. Remove the gauge.

4. Read the tire pressure on the gauge stem and compare it to the specification shown on the Tire and Loading Information label.
5. Add air to the tire as needed. If too much air is added, press the core of the valve stem briefly with the tip of the gauge stem to release pressure. Recheck the pressure and add or release air as needed.
6. Install the valve stem cap.
7. Check the pressure of all other tires, including the spare.

	SIZE	COLD TIRE INFLATION PRESSURE
<b>FRONT ORIGINAL TIRE</b>	<b>P225/65R16 99T</b>	<b>240 kPa, 35 PSI</b>
	<b>P235/55R18 99T</b>	<b>240 kPa, 35 PSI</b>
<b>REAR ORIGINAL TIRE</b>	<b>P225/65R16 99T</b>	<b>240 kPa, 35 PSI</b>
	<b>P235/55R18 99T</b>	<b>240 kPa, 35 PSI</b>
<b>SPARE TIRE</b>	<b>T135/80D16 101M</b>	<b>420 kPa, 60 PSI</b>
	<b>T135/90D16 102M</b>	<b>420 kPa, 60 PSI</b>

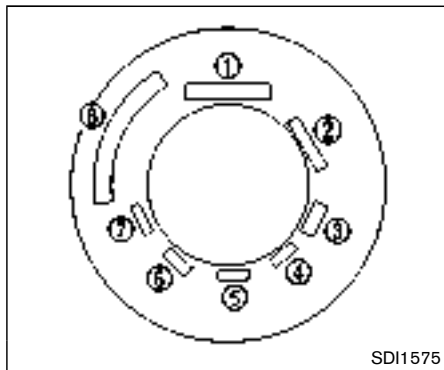

Example

SDI1575

## TIRE LABELING

Federal law requires tire manufacturers to place standardized information on the sidewall of all tires. This information identifies and describes the fundamental characteristics of the tire and also provides the tire identification number (TIN) for safety standard certification. The TIN can be used to identify the tire in case of a recall.

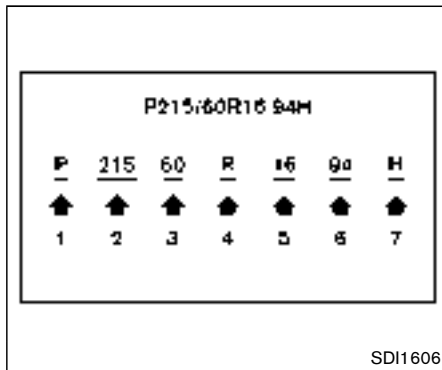

Example

SDI1606

① Tire size (example: P215/60R16 94H)

1. P: The “P” indicates the tire is designed for passenger vehicles. (Not all tires have this information.)
2. Three-digit number (215): This number gives the width in millimeters of the tire from sidewall edge to sidewall edge.
3. Two-digit number (60): This number, known as the aspect ratio, gives the tire’s ratio of height to width.

4. R: The “R” stands for radial.
5. Two-digit number (16): This number is the wheel or rim diameter in inches.
6. Two- or three-digit number (94): This number is the tire’s load index. It is a measurement of how much weight each tire can support. You may not find this information on all tires because it is not required by law.
7. H: Tire speed rating. You should not drive the vehicle faster than the tire speed rating.

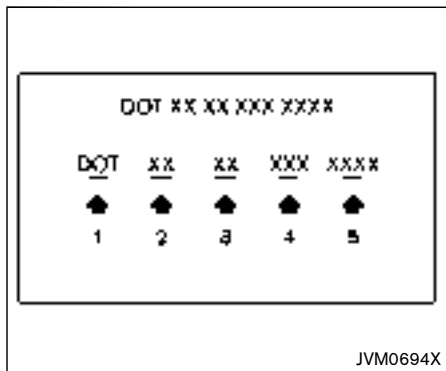

Example

② TIN (Tire Identification Number) for a new tire (example: DOT XX XX XXX XXXX)

1. DOT: Abbreviation for the “Department of Transportation”. The symbol can be placed above, below or to the left or right of the Tire Identification Number.
2. Two-digit code: Manufacturer’s identification mark
3. Two-digit code: Tire size

4. Three-digit code: Tire type code (Optional)
5. Four numbers represent the week and year the tire was built. For example, the numbers 3103 means the 31st week of 2003. If these numbers are missing, then look on the other sidewall of the tire.

③ Tire ply composition and material

The number of layers or plies of rubber-coated fabric in the tire.

Tire manufacturers also must indicate the materials in the tire, which include steel, nylon, polyester, and others.

④ Maximum permissible inflation pressure

This number is the greatest amount of air pressure that should be put in the tire. Do not exceed the maximum permissible inflation pressure.

⑤ Maximum load rating

This number indicates the maximum load in kilograms and pounds that can be

carried by the tire. When replacing the tires on the vehicle, always use a tire that has the same load rating as the factory installed tire.

⑥ Term of “tubeless” or “tube type”

Indicates whether the tire requires an inner tube (“tube type”) or not (“tubeless”).

⑦ The word “radial”

The word “radial” is shown, if the tire has radial structure.

⑧ Manufacturer or brand name

Manufacturer or brand name is shown.

**Other tire-related terminology:**

In addition to the many terms that are defined throughout this section, Intended Outboard Sidewall is (1) the sidewall that contains a whitewall, bears white lettering or bears manufacturer, brand and/or model name molding that is higher or deeper than the same molding on the other sidewall of the tire, or (2) the outward facing sidewall of an asymme-

trical tire that has a particular side that must always face outward when mounted on a vehicle.

## TYPES OF TIRES



### WARNING

- **When changing or replacing tires, be sure all four tires are of the same type (Example: Summer, All Season or Snow) and construction. A NISSAN dealer may be able to help you with information about tire type, size, speed rating and availability.**
- **Replacement tires may have a lower speed rating than the factory equipped tires, and may not match the potential maximum vehicle speed. Never exceed the maximum speed rating of the tire.**
- **Replacing tires with those not originally specified by NISSAN could affect the proper operation of the TPMS.**
- **For additional information regarding tires, refer to "Important Tire Safety Information" (US) or "Tire Safety Information" (Canada) in the**

### Warranty Information Booklet.

#### All season tires

NISSAN specifies all season tires on some models to provide good performance all year, including snowy and icy road conditions. All Season tires are identified by ALL SEASON and/or M&S (Mud and Snow) on the tire sidewall. Snow tires have better snow traction than All Season tires and may be more appropriate in some areas.

#### Summer tires

NISSAN specifies summer tires on some models to provide superior performance on dry roads. Summer tire performance is substantially reduced in snow and ice. Summer tires do not have the tire traction rating M&S on the tire sidewall.

If you plan to operate your vehicle in snowy or icy conditions, NISSAN recommends the use of SNOW tires or ALL SEASON tires on all four wheels.

#### Snow tires

If snow tires are needed, it is necessary to select tires equivalent in size and load rating to the original equipment tires. If you do not, it can adversely affect the safety and handling of your vehicle.

Generally, snow tires will have lower speed ratings than factory equipped tires and may not match the potential maximum vehicle speed. Never exceed the maximum speed rating of the tire.

If you install snow tires, they must be the same size, brand, construction and tread pattern on all four wheels.

For additional traction on icy roads, studded tires may be used. However, some U.S. states and Canadian provinces prohibit their use. Check local, state and provincial laws before installing studded tires. Skid and traction capabilities of studded snow tires, on wet or dry surfaces, may be poorer than that of non-studded snow tires.

#### TIRE CHAINS



### CAUTION

- **NISSAN recommends using the following tire cables made by Peerless**

**Chain Company on P235/55R18 size tire due to limited tire clearance. Call 800-533-8056 to order tire chains for your vehicle.**

**— P235/55R18 - Peerless Chain part number SC1040**

**Failure to use the correct traction device will cause damage to the brakes, suspension or other vehicle parts. Or, you should install P225/65R16 size tire on your vehicle.**

- **Only certain SAE class “S” tire chains can be used on this vehicle. Using the wrong Class “S” chains on this vehicle will cause damage to the vehicle. If you plan to use tire chains/cables, you should use a tire chain that meets the minimum clearances for your vehicle.**

Use of tire chains may be prohibited according to location. Check the local laws before installing tire chains. When installing tire chains, make sure they are the proper size for the tires on your vehicle and are installed according to the chain manufacturer’s suggestions.

For 18-inch size tire, the tire chain part number and Peerless Chain Company phone number

are correct at the time of printing that is shown on the back cover of this Owner’s Manual. Always confirm the correct part numbers with Peerless Chain Company before ordering. Only use other types of traction devices if the traction device manufacturer recommends it for use on your specific vehicle and the tire and wheel installed on your vehicle.

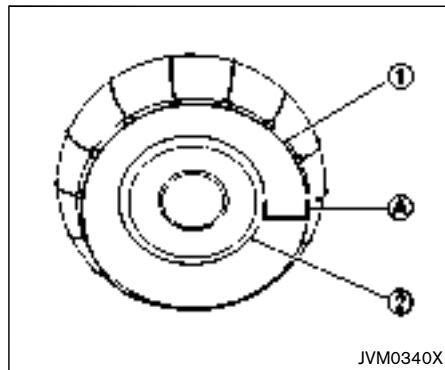

**16-inch size tire**

For 16-inch size tire, use a tire chain that is designed to provide the specified space (A) between the installed tire chain (1) and where the tire meets the rim (2) as shown on the chart.

Wheel size	Minimum space required
16 in	1.8 in (44 mm)

A tire chain that provides the specified amount of space will provide the necessary clearance between the tire and the closest vehicle suspension or body component. The minimum clearances are determined using the factory-equipped tires. Other types may damage your vehicle. Use chain tensioners when recommended by the tire chain manufacturer to ensure

a tight fit. Loose end links of the tire chain must be secured or removed to prevent the possibility of whipping action damage to the fenders or underbody. If possible, avoid fully loading your vehicle when using tire chains. In addition, drive at a reduced speed. Otherwise, your vehicle may be damaged and/or vehicle handling and performance may be adversely affected.

**Tire chains must be installed only on the front wheels and not on the rear wheels.**

Never install tire chains on a TEMPORARY USE ONLY spare tire.

Do not use tire chains on dry roads. Driving with tire chains in such conditions can cause damage to the various mechanisms of the vehicle due to some overstress.

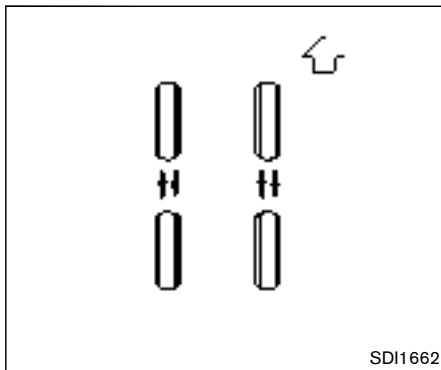

## CHANGING WHEELS AND TIRES

Tire rotation

NISSAN recommends rotating the tires every 5,000 miles (8,000 km). (See “Flat tire” (P.6-3) for tire replacing procedures.)

**As soon as possible, tighten the wheel nuts to the specified torque with a torque wrench.**

**Wheel nut tightening torque:  
80 ft-lb (108 N·m)**

**The wheel nuts must be kept tightened to the specification at all times. It is recommended that wheel nuts be tightened to the specification at each tire rotation interval.**



## WARNING

- After rotating the tires, check and adjust the tire pressure.
- Retighten the wheel nuts when the vehicle has been driven for 600 miles (1,000 km) (also in cases of a flat tire, etc.).
- Do not include the spare tire or any other small size spare tire in the tire rotation.
- For additional information regarding tires, refer to “Important Tire Safety Information” (US) or “Tire Safety Information” (Canada) in the Warranty Information Booklet.



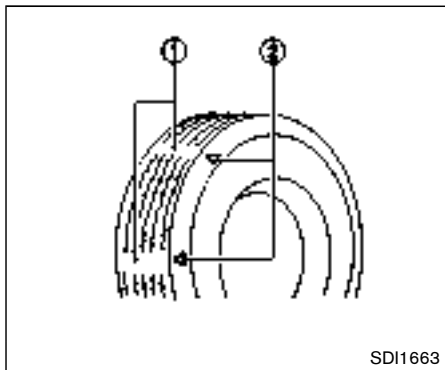

1. Wear indicator
2. Wear indicator location marks. The locations are shown by “ Δ ”, “TWI”, etc. depending on tire types.

#### Tire wear and damage



#### **WARNING**

- Tires should be periodically inspected for wear, cracking, bulging or objects caught in the tread. If excessive wear,

cracks, bulging or deep cuts are found, the tire(s) should be replaced.

- The original tires have built-in tread wear indicators. When wear indicators are visible, the tire(s) should be replaced.
- Tires degrade with age and use. Have tires, including the spare, over 6 years old checked by a qualified technician, because some tire damage may not be obvious. Replace the tires as necessary to prevent tire failure and possible personal injury.
- Improper service of the spare tire may result in serious personal injury. If it is necessary to repair the spare tire, it is recommended you visit a NISSAN dealer for this service.
- For additional information regarding tires, refer to “Impor-

**tant Tire Safety Information” (US) or “Tire Safety Information” (Canada) in the Warranty Information Booklet.**

#### Replacing wheels and tires

When replacing a tire, use the same size, tread design, speed rating and load carrying capacity as originally equipped. (See “Specifications” (P.10-7) for recommended types and sizes of tires and wheels.)



#### **WARNING**

- The use of tires other than those recommended or the mixed use of tires of different brands, construction (bias, bias-belted or radial), or tread patterns can adversely affect the ride, braking, handling, ground clearance, body-to-tire clearance, tire chain clearance, speedometer calibration, headlight aim and bumper height. Some of these effects may lead to accidents and could result in serious personal injury.

- If your vehicle was originally equipped with 4 tires that were the same size and you are only replacing 2 of the 4 tires, install the new tires on the rear axle. Placing new tires on the front axle may cause loss of vehicle control in some driving conditions and cause an accident and personal injury.
- If the wheels are changed for any reason, always replace with wheels which have the same off-set dimension. Wheels of a different off-set could cause premature tire wear, degrade vehicle handling characteristics and/or interference with the brake discs/drums. Such interference can lead to decreased braking efficiency and/or early brake pad/shoe wear. See "Wheels and tires" (P.10-7) of this manual for wheel off-set dimensions.
- Since the spare tire is not equipped with the TPMS, when a spare tire is mounted or a wheel is replaced, the TPMS will not function and the low tire pressure warning light will flash for approximately 1 minute. The light will remain on after 1 minute.

Have your tires replaced and/or TPMS system reset as soon as possible. It is recommended you visit a NISSAN dealer for this service.

- Replacing tires with those not originally specified by NISSAN could affect the proper operation of the TPMS.
- The TPMS sensor may be damaged if it is not handled correctly. Be careful when handling the TPMS sensor.
- When replacing the TPMS sensor, the ID registration may be required. It is recommended you visit a NISSAN dealer for ID registration.
- Do not use a valve stem cap that is not specified by NISSAN. The valve stem cap may become stuck.
- Be sure that the valve stem caps are correctly fitted. otherwise the valve may be clogged up with dirt and cause a malfunction or loss of pressure.
- Do not install a damaged or deformed wheel or tire even if it has been repaired. Such wheels or tires

could have structural damage and could fail without warning.

- The use of retread tire is not recommended.
- For additional information regarding tires, refer to "Important Tire Safety Information" (US) or "Tire Safety Information" (Canada) in the Warranty Information Booklet.

### Wheel balance

Unbalanced wheels may affect vehicle handling and tire life. Even with regular use, wheels can get out of balance. Therefore, they should be balanced as required.

**Wheel balance service should be performed with the wheels off the vehicle. Spin balancing the wheels on the vehicle could lead to mechanical damage.**

For additional information regarding tires, refer to "Important Tire Safety Information" (US) or "Tire Safety Information" (Canada) in the Warranty Information Booklet.

## Care of wheels

See “Cleaning exterior” (P.7-2) for details about care of the wheels.

## Spare tire

Since the spare tire is not equipped with the TPMS, when a spare tire is mounted (TEMPORARY USE ONLY or conventional), the TPMS will not function.

Observe the following precautions if the TEMPORARY USE ONLY spare tire must be used, otherwise your vehicle could be damaged or involved in an accident.



### WARNING

- The **TEMPORARY USE ONLY** spare tire should be used for emergency use. It should be replaced with the standard tire at the first opportunity to avoid possible tire or differential damage.
- Drive carefully while the **TEMPORARY USE ONLY** spare tire is installed. Avoid sharp turns and abrupt braking while driving.
- Periodically check spare tire inflation pressure. Always keep the pressure of the **TEMPORARY USE**

**ONLY** spare tire at 60 psi (420 kPa, 4.2 bar). Always keep the pressure of the full size spare tire (if so equipped) at the recommended pressure for standard tires, as indicated on the Tire and Loading Information label.

- With the **TEMPORARY USE ONLY** spare tire installed do not drive your vehicle at speeds faster than 50 MPH (80 km/h).
- When driving on roads covered with snow or ice, the **TEMPORARY USE ONLY** spare tire should be used on the rear wheels and original tire used on the front wheels (drive wheels). Use tire chains only on the front (original) tires.
- Tire tread of the **TEMPORARY USE ONLY** spare tire will wear at a faster rate than the standard tire. Replace the spare tire as soon as the tread wear indicators appear.
- Do not use the spare tire on other vehicles.
- Do not use more than one spare tire at the same time.

- Do not tow a trailer while the **TEMPORARY USE ONLY** spare tire is installed.



### CAUTION

- Do not use tire chains on a **TEMPORARY USE ONLY** spare tire. Tire chains will not fit properly and may cause damage to the vehicle.
- Because the **TEMPORARY USE ONLY** spare tire is smaller than the original tire, ground clearance is reduced. To avoid damage to the vehicle, do not drive over obstacles. Also do not drive the vehicle through an automatic car wash since it may get caught.

# 9 Maintenance and schedules

Maintenance requirement .....	9-2	Maintenance schedules .....	9-6
General maintenance .....	9-2	Additional maintenance items for severe operating conditions .....	9-6
Scheduled maintenance .....	9-2	Standard maintenance .....	9-7
Where to go for service .....	9-2	Emission control system maintenance .....	9-8
General maintenance .....	9-2	Chassis and body maintenance .....	9-11
Explanation of general maintenance items .....	9-2	Maintenance under severe driving conditions .....	9-13
Explanation of scheduled maintenance items .....	9-5	Maintenance log .....	9-14
Emission control system maintenance .....	9-5		
Chassis and body maintenance .....	9-6		

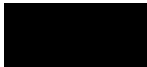

## MAINTENANCE REQUIREMENT

Some day-to-day and regular maintenance is essential to maintain your vehicle in good mechanical condition, as well as its emission and engine performance.

It is the owner's responsibility to make sure that the scheduled maintenance, as well as general maintenance, is performed.

As the vehicle owner, you are the only one who can ensure that your vehicle receives the proper maintenance care. You are a vital link in the maintenance chain.

### GENERAL MAINTENANCE

General maintenance includes those items which should be checked during normal day-to-day operation. They are essential for proper vehicle operation. It is your responsibility to perform these procedures regularly as prescribed.

Performing general maintenance checks requires minimal mechanical skill and only a few general automotive tools.

These checks or inspections can be done by yourself, a qualified technician or, if you prefer, a NISSAN dealer.

### SCHEDULED MAINTENANCE

The maintenance items listed in this section are required to be serviced at regular intervals. However, under severe driving conditions, additional or more frequent maintenance will be required.

### WHERE TO GO FOR SERVICE

If maintenance service is required or your vehicle appears to malfunction, have the systems checked and serviced. It is recommended you visit a NISSAN dealer for this service.

NISSAN technicians are well-trained specialists and are kept up-to-date with the latest service information through technical bulletins, service tips, and training programs. They are completely qualified to work on NISSAN vehicles **before** work begins.

You can be confident that a NISSAN dealer's service department performs the best job to meet the maintenance requirements on your vehicle.

## GENERAL MAINTENANCE

During the normal day-to-day operation of the vehicle, general maintenance should be performed regularly as prescribed in this section. If you detect any unusual sounds, vibrations or smell, be sure to check for the cause, or it is recommended to have a NISSAN dealer do it promptly. In addition, it is recommended you visit a NISSAN dealer if you think that repairs are required.

When performing any checks or maintenance work, see "Maintenance precautions" (P.8-2).

### EXPLANATION OF GENERAL MAINTENANCE ITEMS

**Additional information on the following items with “\*” is found in the “8. Do-it yourself” section of this manual.**

#### Outside the vehicle

The maintenance items listed here should be performed from time to time, unless otherwise specified.

**Doors and engine hood:** Check that all doors and the engine hood operate properly. Also ensure that all latches lock securely. Lubricate hinges, latches, latch pins, rollers and links if necessary. Make sure that the secondary latch keeps the hood from opening when the primary latch is released.

When driving in areas using road salt or other

corrosive materials, check lubrication frequently.

**Lights\*:** Clean the headlights on a regular basis. Make sure that the headlights, stop lights, tail lights, turn signal lights, and other lights are all operating properly and installed securely. Also check headlight aim.

**Road wheel nuts (lug nuts)\*:** When checking the tires, make sure no wheel nuts are missing, and check for any loose wheel nuts. Tighten if necessary.

**Tire rotation\*:** Tires should be rotated every 5,000 miles (8,000 km).

**Tires\*:** Check the pressure with a gauge often and always prior to long distance trips. If necessary, adjust the pressure in all tires, including the spare, to the pressure specified. Check carefully for damage, cuts or excessive wear.

**Low Tire Pressure Monitoring System (TPMS) transmitter components:** Replace the TPMS transmitter grommet seal, valve core and cap when the tires are replaced due to wear or age.

**Wheel alignment and balance:** If the vehicle should pull to either side while driving on a straight and level road, or if you detect uneven or abnormal tire wear, there may be a need for wheel alignment.

If the steering wheel or seat vibrates at normal

highway speeds, wheel balancing may be needed.

For additional information regarding tires, refer to "Important Tire Safety Information" (US) in the NISSAN Warranty Information Booklet.

**Windshield:** Clean the windshield on a regular basis. Check the windshield at least every six months for cracks or other damage. Have a damaged windshield repaired by a qualified repair facility.

**Windshield wiper blades\*:** Check for cracks or wear if they do not wipe properly.

### Inside the vehicle

The maintenance items listed here should be checked on a regular basis, such as when performing scheduled maintenance, cleaning the vehicle, etc.

**Accelerator pedal:** Check the pedal for smooth operation and make sure the pedal does not catch or require uneven effort. Keep the floor mat away from the pedal.

**Brake pedal:** Check the pedal for smooth operation. If the brake pedal suddenly goes down further than normal, the pedal feels spongy or the vehicle seems to take longer to stop, have your vehicle checked immediately. It is recommended you visit a NISSAN dealer for this service. Keep the floor mat away from the

pedal.

**Brakes:** Check that the brakes do not pull the vehicle to one side when applied.

**Continuously Variable Transmission (CVT) P (Park) position mechanism:** On a fairly steep hill, check that the vehicle is held securely with the shift lever in the P (Park) position without applying any brakes.

**Parking brake:** Check the parking brake operation regularly. The vehicle should be securely held on a fairly steep hill with only the parking brake applied. If the parking brake needs adjusted, it is recommended you visit a NISSAN dealer for this service.

**Seat belts:** Check that all parts of the seat belt system (for example, buckles, anchors, adjusters and retractors) operate properly and smoothly, and are installed securely. Check the belt webbing for cuts, fraying, wear or damage.

**Seats:** Check seat position controls such as seat adjusters, seatback recliners, etc. to ensure they operate smoothly and that all latches lock securely in every position. Check that the head restraints move up and down smoothly and that the locks (if so equipped) hold securely in all latched positions.

**Steering wheel:** Check for changes in the steering conditions, such as excessive free play, hard steering or strange noises.

**Warning lights and chimes:** Make sure that all warning lights and chimes are operating properly.

**Windshield defroster:** Check that the air comes out of the defroster outlets properly and in sufficient quantity when operating the heater or air conditioner.

**Windshield wiper and washer\*:** Check that the wipers and washers operate properly and that the wipers do not streak.

#### Under the hood and vehicle

The maintenance items listed here should be checked periodically (for example, each time you check the engine oil or refuel).

**Battery\*:** Check the fluid level in each cell.

It should be between the MAX and MIN lines. Vehicles operated in high temperatures or under severe condition require frequent checks of the battery fluid level.

#### **NOTE:**

**Care should be taken to avoid situations that can lead to potential battery discharge and potential no-start conditions such as:**

1. **Installation or extended use of electronic accessories that consume battery power when the engine is not running (Phone chargers, GPS, DVD players, etc.)**

2. **Vehicle is not driven regularly and/or only driven short distances.**

**In these cases, the battery may need to be charged to maintain battery health.**

**Brake fluid level\*:** Make sure that the brake fluid level is between the MAX and MIN lines on the reservoir.

**Engine coolant level\*:** Check the coolant level when the engine is cold.

**Engine drive belts\*:** Make sure that the drive belts are not frayed, worn, cracked or oily.

**Engine oil level\*:** Check the level after parking the vehicle on a level surface and turning off the engine. Wait more than 10 minutes for the oil to drain back into the oil pan.

**Exhaust system:** Make sure there are no loose supports, cracks or holes. If the sound of the exhaust seems unusual or there is a smell of exhaust fumes, immediately have the exhaust system inspected. It is recommended you visit a NISSAN dealer for this service. (See "Precautions when starting and driving" (P.5-2) for exhaust gas (carbon monoxide).)

**Fluid leaks:** Check under the vehicle for fuel, oil, water or other fluid leaks after the vehicle has been parked for a while. Water dripping from the air conditioner after use is normal. If you should notice any leaks or if gasoline fumes are evident,

check for the cause and have it corrected immediately.

**Power steering fluid level\* and lines:** Check the level when the fluid is cold, with the engine off. Check the lines for proper attachment, leaks, cracks, etc.

**Radiator and hoses:** Check the front of the radiator and clean off any dirt, insects, leaves, etc., that may have accumulated. Make sure the hoses have no cracks, deformation, rot or loose connections.

**Underbody:** The underbody is frequently exposed to corrosive substances such as those used on icy roads or to control dust. It is very important to remove these substances, otherwise rust will form on the floor pan, frame, fuel lines and around the exhaust system. At the end of winter, the underbody should be thoroughly flushed with plain water, being careful to clean those areas where mud and dirt may accumulate. For additional information, see "Cleaning exterior" (P.7-2).

**Windshield washer fluid\*:** Check that there is adequate fluid in the reservoir.

## EXPLANATION OF SCHEDULED MAINTENANCE ITEMS

The following descriptions are provided to give you a better understanding of the scheduled maintenance items that should be regularly checked or replaced. The maintenance schedule indicates at which mileage/time intervals each item requires service.

In addition to scheduled maintenance, your vehicle requires that some items be checked during normal day-to-day operation. Refer to "General maintenance" (P.9-2).

Items marked with "\*" are recommended by NISSAN for reliable vehicle operation. You are not required to perform maintenance on these items in order to maintain the warranties which come with your vehicle. Other maintenance items and intervals are required.

When applicable, additional information can be found in the "8. Do-it yourself" section of this manual.

### NOTE:

**NISSAN does not advocate the use of non-OEM approved aftermarket flushing systems and strongly advises against performing these services on a NISSAN product. Many of the aftermarket flushing systems use non-OEM approved chemicals or solvents, the use of which has not been validated by NISSAN.**

For recommended fuel, lubricants, fluids,

**grease, and refrigerant, refer to "Capacities and recommended fluids/lubricants" (P.10-2) of this manual.**

## EMISSION CONTROL SYSTEM MAINTENANCE

### Drive belts\*:

Check engine drive belts for wear, fraying or cracking and for proper tension. Replace any damaged drive belts.

### Engine air filter:

Replace at specified intervals. When driving for prolonged periods in dusty conditions, check/replace the filter more frequently.

### Engine coolant\*:

Replace coolant at the specified interval. When adding or replacing coolant, be sure to use only Genuine NISSAN Long Life Antifreeze/Coolant (blue) or equivalent with the proper mixture. (Refer to "Engine cooling system" (P.8-4) to determine the proper mixture for your area.)

### NOTE:

**Mixing any other type of coolant or the use of non-distilled water may reduce the recommended service interval of the coolant.**

### Engine oil and oil filter:

Replace engine oil and oil filter at the specified intervals. For recommended oil grade and viscosity refer to "Capacities and recommended fluids/lubricants" (P.10-2).

### Engine valve clearance\*:

Inspect only if valve noise increases.

Adjust valve clearance if necessary.

### Evaporative emissions control vapor lines\*:

Check vapor lines for leaks or looseness. Tighten connections or replace parts as necessary.

### Fuel filter

Periodic maintenance is not required (in-tank type filter).

### Fuel lines\*:

Check the fuel hoses, piping and connections for leaks, looseness, or deterioration. Tighten connections or replace parts as necessary.

### Spark plugs:

Replace at specified intervals. Install new plugs of the type as originally equipped.



## MAINTENANCE SCHEDULES

### CHASSIS AND BODY MAINTENANCE

#### **Brake lines and cables:**

Visually inspect for proper installation. Check for chafing, cracks, deterioration, and signs of leaking. Replace any deteriorated or damaged parts immediately.

#### **Brake pads and rotors:**

Check for wear, deterioration and fluid leaks. Replace any deteriorated or damaged parts immediately.

#### **Exhaust system:**

Visually inspect the exhaust pipes, muffler and hangers for leaks, cracks, deterioration, and damage. Tighten connections or replace parts as necessary.

#### **In-cabin microfilter:**

Replace at specified intervals. When driving for prolonged periods in dusty conditions, replace the filter more frequently.

#### **Steering gear and linkage, axle and suspension parts, drive shaft boots:**

Check for damage, looseness, and leakage of oil or grease. Under severe driving conditions, inspect more frequently.

#### **Tire rotation:**

Tires should be rotated every 5,000 miles (8,000 km) according to the instructions under "Explanation of general maintenance items" (P.9-2). When rotating tires, check for damage and uneven wear. Replace if necessary.

#### **Transmission fluid/oil:**

Visually inspect for signs of leakage at specified intervals.

If towing a trailer, using a camper or car-top carrier, or driving on rough or muddy roads:

- Replace the CVT fluid every 60,000 (96,000 km) miles or request the dealer to inspect the fluid deterioration data using a CONSULT. If the deterioration data is more than 210000, replace the CVT fluid.

To help ensure smooth, safe and economical driving, NISSAN provides two maintenance schedules that may be used, depending upon the conditions in which you usually drive. These schedules contain both distance and time intervals, up to 120,000 miles (192,000 km)/144 months. For most people, the odometer reading will indicate when service is needed. However, if you drive very little, your vehicle should be serviced at the regular time intervals shown in the schedule.

**After 120,000 miles (192,000 km)/144 months, continue maintenance at the same mileage/time intervals.**

### ADDITIONAL MAINTENANCE ITEMS FOR SEVERE OPERATING CONDITIONS

**Additional maintenance items for severe operating conditions;** should be performed on vehicles that are driven under especially demanding conditions. Additional maintenance items should be performed if you primarily operate your vehicle under the following conditions:

- Repeated short trips of less than 5 miles (8 km).
- Repeated short trips of less than 10 miles (16 km) with outside temperatures remaining below freezing.

## STANDARD MAINTENANCE

- Operating in hot weather in stop-and-go “rush hour” traffic.
- Extensive idling and/or low speed driving for long distances, such as police, taxi or door-to-door delivery use.
- Driving in dusty conditions.
- Driving on rough, muddy or salt spread roads.
- Towing a trailer, using a camper or a car-top carrier.

The following tables show the standard maintenance schedule. Depending upon weather and atmospheric conditions, varying road surfaces, individual driving habits and vehicle usage, additional or more frequent maintenance may be required. **Maintenance beyond the last period on the tables requires similar maintenance.**

## EMISSION CONTROL SYSTEM MAINTENANCE

Abbreviations: I = Inspect and correct or replace as necessary, R = Replace

MAINTENANCE OPERATION Perform at number of miles, kilometers or months, whichever comes first.	Miles × 1,000 (km × 1,000) Months	MAINTENANCE INTERVAL											
		5 (8) 6	10 (16) 12	15 (24) 18	20 (32) 24	25 (40) 30	30 (48) 36	35 (56) 42	40 (64) 48	45 (72) 54	50 (80) 60	55 (88) 66	60 (96) 72
Drive belts	See NOTE (1)								I*		I*		I*
Air cleaner filter	See NOTE (2)						R						R
EVAP vapor lines					I*				I*				I*
Fuel lines					I*				I*				I*
Fuel filter	See NOTE (3)												
Engine coolant*	See NOTE (4)(5)												
Engine oil		R	R	R	R	R	R	R	R	R	R	R	R
Engine oil filter		R	R	R	R	R	R	R	R	R	R	R	R
Spark plugs		Replace every 105,000 miles (168,000 km)											
Intake and exhaust valve clearance*	See NOTE (6)												

MAINTENANCE OPERATION Perform at number of miles, kilometers or months, whichever comes first.	Miles × 1,000 (km × 1,000) Months	MAINTENANCE INTERVAL											
		65 (104)	70 (112)	75 (120)	80 (128)	85 (136)	90 (144)	95 (152)	100 (160)	105 (168)	110 (176)	115 (184)	120 (192)
		78	84	90	96	102	108	114	120	126	132	138	144
Drive belts	See NOTE (1)		I*		I*		I*		I*		I*		I*
Air cleaner filter	See NOTE (2)						R						R
EVAP vapor lines					I*				I*				I*
Fuel lines					I*				I*				I*
Fuel filter	See NOTE (3)												
Engine coolant*	See NOTE (4)(5)												
Engine oil		R	R	R	R	R	R	R	R	R	R	R	R
Engine oil filter		R	R	R	R	R	R	R	R	R	R	R	R
Spark plugs		Replace every 105,000 miles (168,000 km)											
Intake and exhaust valve clear- ance*	See NOTE (6)												

**NOTE:**

(1) After 40,000 miles (64,000 km) or 48 months, inspect every 10,000 miles (16,000 km) or 12 months. Replace the drive belts if found damaged.

(2) If operating mainly in dusty conditions, more frequent maintenance may be required.

(3) Periodic maintenance is not required.

(4) First replacement interval is 105,000

miles (168,000 km) or 84 months. After first replacement, replace every 75,000 miles (120,000 km) or 60 months.

(5) Use only Genuine NISSAN Long Life Antifreeze/Coolant (blue) or equivalent with proper mixture ratio of 50% anti-freeze and 50% demineralized or distilled water. Mixing any other type of coolant or the use of non-distilled water may reduce the life expectancy of the factory fill cool-

ant.

(6) Periodic maintenance is not required. However, if valve noise increases, inspect valve clearance.

\*: Maintenance items and intervals with “\*” are recommended by NISSAN for reliable vehicle operation. The owner does not need to perform such maintenance in order to maintain the emission warranty or manufacturer recall liability. Other

**maintenance items and intervals are required.**

## CHASSIS AND BODY MAINTENANCE

Abbreviations: I = Inspect and correct or replace as necessary, R = Replace

MAINTENANCE OPERATION Perform at of miles, kilometers or months, whichever comes first.	Miles × 1,000 (km × 1,000) Months	MAINTENANCE INTERVAL											
		5	10	15	20	25	30	35	40	45	50	55	60
		(8)	(16)	(24)	(32)	(40)	(48)	(56)	(64)	(72)	(80)	(88)	(96)
		6	12	18	24	30	36	42	48	54	60	66	72
Brake lines and cables			I		I		I		I		I		I
Brake pads and rotors★			I		I		I		I		I		I
Brake fluid★					R				R				R
CVT fluid	See NOTE (1)		I		I		I		I		I		I
Steering gear and linkage, axle and suspension parts★					I				I				I
Tire rotation	See NOTE (2)												
Front drive shaft boots ★			I		I		I		I		I		I
Exhaust system★					I				I				I
In-cabin microfilter					R				R				R
Intelligent Key battery					R				R				R

MAINTENANCE OPERATION Perform at of miles, kilometers or months, whichever comes first.	Miles × 1,000 (km × 1,000) Months	MAINTENANCE INTERVAL											
		65 (104) 78	70 (112) 84	75 (120) 90	80 (128) 96	85 (136) 102	90 (144) 108	95 (152) 114	100 (160) 120	105 (168) 126	110 (176) 132	115 (184) 138	120 (192) 144
Brake lines and cables			I		I		I		I		I		I
Brake pads and rotors★			I		I		I		I		I		I
Brake fluid★					R				R				R
CVT fluid	See NOTE (1)		I		I		I		I		I		I
Steering gear and linkage, axle and suspension parts★					I				I				I
Tire rotation	See NOTE (2)												
Front drive shaft boots★			I		I		I		I		I		I
Exhaust system★					I				I				I
In-cabin microfilter					R				R		R		R
Intelligent Key battery					R				R		R		R

**NOTE:**

Maintenance items with “★” should be performed more frequently according to “Maintenance under severe driving conditions” (P.9-13).

(1) If towing a trailer, using a camper or car-top carrier, or driving on rough or muddy roads, inspect CVT fluid deterioration at NISSAN dealers every 60,000 miles (96,000 km), then change CVT fluid if

necessary. And if the inspection is not performed, change (not just inspect) CVT fluid every 60,000 miles (96,000 km).

(2) Refer to “Tire rotation” under “General maintenance” (P.9-2).

## MAINTENANCE UNDER SEVERE DRIVING CONDITIONS

The maintenance intervals shown on the preceding pages are for normal operating conditions. If the vehicle is mainly operated under severe driving conditions as shown below, more frequent maintenance must be performed on the following items as shown in the table.

### Severe driving conditions

- Repeated short trips of less than 5 miles (8 km).
- Repeated short trips of less than 10 miles (16 km) with outside temperatures remaining below freezing.
- Operating in hot weather in stop-and-go “rush hour” traffic.
- Extensive idling and/or low speed driving for long distances, such as police, taxi or door-to-door delivery use.
- Driving in dusty conditions.
- Driving on rough, muddy, or salt spread roads.
- Towing a trailer, using a camper or car-top carrier.

Maintenance operation: Inspect = Inspect and correct or replace as necessary.

Maintenance item	Maintenance operation	Maintenance interval
Brake fluid	Replace	Every 10,000 miles (16,000 km) or 12 months
Brake pads & rotors	Inspect	Every 5,000 miles (8,000 km) or 6 months
Steering gear & linkage, axle & suspension parts	Inspect	Every 5,000 miles (8,000 km) or 6 months
Front drive shaft boots	Inspect	Every 5,000 miles (8,000 km) or 6 months
Exhaust system	Inspect	Every 5,000 miles (8,000 km) or 6 months



## MAINTENANCE LOG

<b>5,000 Miles (8,000 km) or 6 Months</b> Dealer Name: Date: Mileage: Dealer Stamp:	<b>10,000 Miles (16,000 km) or 12 Months</b> Dealer Name: Date: Mileage: Dealer Stamp:	<b>15,000 Miles (24,000 km) or 18 Months</b> Dealer Name: Date: Mileage: Dealer Stamp:
<b>20,000 Miles (32,000 km) or 24 Months</b> Dealer Name: Date: Mileage: Dealer Stamp:	<b>25,000 Miles (40,000 km) or 30 Months</b> Dealer Name: Date: Mileage: Dealer Stamp:	<b>30,000 Miles (48,000 km) or 36 Months</b> Dealer Name: Date: Mileage: Dealer Stamp:
<b>35,000 Miles (56,000 km) or 42 Months</b> Dealer Name: Date: Mileage: Dealer Stamp:	<b>40,000 Miles (64,000 km) or 48 Months</b> Dealer Name: Date: Mileage: Dealer Stamp:	<b>45,000 Miles (72,000 km) or 54 Months</b> Dealer Name: Date: Mileage: Dealer Stamp:

<p><b>50,000 Miles (80,000 km) or 60 Months</b></p> <p>Dealer Name:</p> <p>Date:</p> <p>Mileage:</p> <p>Dealer Stamp:</p>	<p><b>55,000 Miles (88,000 km) or 66 Months</b></p> <p>Dealer Name:</p> <p>Date:</p> <p>Mileage:</p> <p>Dealer Stamp:</p>	<p><b>60,000 Miles (96,000 km) or 72 Months</b></p> <p>Dealer Name:</p> <p>Date:</p> <p>Mileage:</p> <p>Dealer Stamp:</p>
<p><b>65,000 Miles (104,000 km) or 78 Months</b></p> <p>Dealer Name:</p> <p>Date:</p> <p>Mileage:</p> <p>Dealer Stamp:</p>	<p><b>70,000 Miles (112,000 km) or 84 Months</b></p> <p>Dealer Name:</p> <p>Date:</p> <p>Mileage:</p> <p>Dealer Stamp:</p>	<p><b>75,000 Miles (120,000 km) or 90 Months</b></p> <p>Dealer Name:</p> <p>Date:</p> <p>Mileage:</p> <p>Dealer Stamp:</p>
<p><b>80,000 Miles (128,000 km) or 96 Months</b></p> <p>Dealer Name:</p> <p>Date:</p> <p>Mileage:</p> <p>Dealer Stamp:</p>	<p><b>85,000 Miles (136,000 km) or 102 Months</b></p> <p>Dealer Name:</p> <p>Date:</p> <p>Mileage:</p> <p>Dealer Stamp:</p>	<p><b>90,000 Miles (144,000 km) or 108 Months</b></p> <p>Dealer Name:</p> <p>Date:</p> <p>Mileage:</p> <p>Dealer Stamp:</p>

<p><b>95,000 Miles (152,000 km) or 114 Months</b></p> <p>Dealer Name:</p> <p>Date:</p> <p>Mileage:</p> <p>Dealer Stamp:</p>	<p><b>100,000 Miles (160,000 km) or 120 Months</b></p> <p>Dealer Name:</p> <p>Date:</p> <p>Mileage:</p> <p>Dealer Stamp:</p>	<p><b>105,000 Miles (168,000 km) or 126 Months</b></p> <p>Dealer Name:</p> <p>Date:</p> <p>Mileage:</p> <p>Dealer Stamp:</p>
<p><b>110,000 Miles (176,000 km) or 132 Months</b></p> <p>Dealer Name:</p> <p>Date:</p> <p>Mileage:</p> <p>Dealer Stamp:</p>	<p><b>115,000 Miles (184,000 km) or 138 Months</b></p> <p>Dealer Name:</p> <p>Date:</p> <p>Mileage:</p> <p>Dealer Stamp:</p>	<p><b>120,000 Miles (192,000 km) or 144 Months</b></p> <p>Dealer Name:</p> <p>Date:</p> <p>Mileage:</p> <p>Dealer Stamp:</p>

# 10 Technical and consumer information

Capacities and recommended fluids/lubricants .....	10-2	Vehicle load capacity .....	10-12
Fuel information .....	10-3	Securing the load .....	10-14
Engine oil and oil filter recommendation .....	10-5	Loading tips .....	10-14
Air conditioning system refrigerant and lubricant recommendations .....	10-6	Measurement of weights .....	10-15
Specifications .....	10-7	Towing a trailer .....	10-15
Engine .....	10-7	Maximum load limits .....	10-16
Wheels and tires .....	10-7	Maximum gross vehicle weight (GVW)/maximum gross axle weight (GAW) .....	10-17
Dimensions and weights .....	10-8	Towing load/specification .....	10-19
When traveling or registering in another country .....	10-8	Towing safety .....	10-20
Vehicle identification .....	10-8	Flat towing .....	10-23
Vehicle Identification Number (VIN) plate .....	10-8	Uniform tire quality grading .....	10-24
Vehicle identification number (chassis number) .....	10-9	Treadwear .....	10-24
Engine serial number .....	10-9	Traction AA, A, B and C .....	10-24
F.M.V.S.S./C.M.V.S.S. certification label .....	10-9	Temperature A, B and C .....	10-24
Emission control information label .....	10-10	Emission control system warranty .....	10-25
Tire and Loading Information label .....	10-10	Reporting safety defects .....	10-25
Air conditioner specification label .....	10-10	Readiness for inspection/maintenance (I/M) test .....	10-26
Installing front license plate .....	10-11	Event data recorders (EDR) .....	10-27
Vehicle loading information .....	10-12	Owner's manual/service manual order information .....	10-27
Terms .....	10-12		

## CAPACITIES AND RECOMMENDED FLUIDS/LUBRICANTS

The following are approximate capacities. The actual refill capacities may be a little different. When refilling, follow the procedure instructed in the "8. Do-it-yourself" section to determine the proper refill capacity.

Fluid type		Capacity (approximate)			Recommended Fluids/Lubricants
		Metric Measure	US Measure	Imperial Measure	
Fuel		75.6 L	20 gal	16-5/8 gal	<ul style="list-style-type: none"> <li>See "Fuel information" (P.10-3).</li> </ul>
Engine oil Drain and refill  For additional information, see "Engine oil" (P.8-5) for changing engine oil.	With oil filter change	4.6 L	4-7/8 qt	4 qt	<ul style="list-style-type: none"> <li>Genuine "NISSAN Motor Oil 0W-20 SN" is recommended.</li> <li>If the above motor oil is not available, use an equivalent motor oil that matches the above grade and viscosity. For additional information, see "Engine oil and oil filter recommendation" (P.10-5).</li> </ul>
	Without oil filter change	4.3 L	4-1/2 qt	3-3/4 qt	
Engine coolant	With reservoir	11.3 L	12 qt	10 qt	<ul style="list-style-type: none"> <li>Pre-diluted Genuine NISSAN Long Life Antifreeze/Coolant (Blue) or equivalent</li> </ul>
	Reservoir	0.75 L	3/4 qt	5/8 qt	
Continuously Variable Transmission (CVT) fluid		—	—	—	<ul style="list-style-type: none"> <li>Genuine NISSAN CVT Fluid NS-3</li> <li>NISSAN recommends using Genuine NISSAN CVT Fluid NS-3 (or equivalent) ONLY in NISSAN CVTs. Do not mix with other fluids. Using fluids that are not equivalent to Genuine NISSAN CVT Fluid NS-3 may damage the CVT. Damage caused by the use of fluids other than as recommended is not covered under NISSAN's New Vehicle Limited Warranty.</li> </ul>
Power steering fluid (PSF)		Refill to the proper oil level according to the instructions in the "8. Do-it yourself" section.			<ul style="list-style-type: none"> <li>Genuine NISSAN E-PSF or equivalent</li> <li>Use of a power steering fluid other than Genuine NISSAN E-PSF will prevent the power steering system from operating properly.</li> </ul>
Brake fluid					<ul style="list-style-type: none"> <li>Genuine NISSAN Super Heavy Duty Brake Fluid* or equivalent DOT 3</li> <li>*: Available in mainland U.S.A. through a NISSAN dealer.</li> </ul>
Multi-purpose grease		—	—	—	<ul style="list-style-type: none"> <li>NLGI No. 2 (Lithium soap base)</li> </ul>
Air conditioning system refrigerant		—	—	—	<ul style="list-style-type: none"> <li>HFC-134a (R-134a)</li> <li>For additional information, see "Vehicle identification" (P.10-8) for air conditioner specification label.</li> </ul>
Air conditioning system lubricants		—	—	—	<ul style="list-style-type: none"> <li>NISSAN A/C System Oil Type S or exact equivalent</li> </ul>
Window washer fluid		4.5 L	1-1/4 gal	1 gal	<ul style="list-style-type: none"> <li>Genuine NISSAN Windshield Washer Concentrate Cleaner &amp; Antifreeze or equivalent</li> </ul>

## FUEL INFORMATION

Use unleaded regular gasoline with an octane rating of at least 87 AKI (Anti-Knock Index) number (Research octane number 91).



### CAUTION

- Using a fuel other than that specified could adversely affect the emission control system, and may also affect warranty coverage.
- Under no circumstances should a leaded gasoline be used, because this will damage the three-way catalyst.
- Do not use E-15 or E-85 fuel in your vehicle. Your vehicle is not designed to run on E-15 or E-85 fuel. Using E-15 or E-85 fuel in a vehicle not specifically designed for E-15 or E-85 fuel can adversely affect the emission control devices and systems of the vehicle. Damage caused by such fuel is not covered by the NISSAN new vehicle limited warranty.
- Do not use fuel that contains the octane booster methylcyclopenta-

**dienyl manganese tricarbonyl (MMT). Using fuel containing MMT may adversely affect vehicle performance and vehicle emissions. Not all fuel dispensers are labeled to indicate MMT content, so you may have to consult your gasoline retailer for more details. Note that Federal and California laws prohibit the use of MMT in reformulated gasoline.**

- **U.S. government regulations require ethanol dispensing pumps to be identified by a small, square, orange and black label with the common abbreviation or the appropriate percentage for that region.**

### Gasoline specifications

NISSAN recommends using gasoline that meets the World-Wide Fuel Charter (WWFC) specifications where it is available. Many of the automobile manufacturers developed this specification to improve emission control system and vehicle performance. Ask your service station manager if the gasoline meets the WWFC specifications.

### Reformulated gasoline

Some fuel suppliers are now producing reformulated gasolines. These gasolines are specially designed to reduce vehicle emissions. NISSAN supports efforts towards cleaner air and suggests that you use reformulated gasoline when available.

### Gasoline containing oxygenates

Some fuel suppliers sell gasoline containing oxygenates such as ethanol, MTBE and methanol with or without advertising their presence. NISSAN does not recommend the use of fuels of which the oxygenate content and the fuel compatibility for your NISSAN cannot be readily determined. If in doubt, ask your service station manager.

If you use oxygenate-blend gasoline, please take the following precautions as the usage of such fuels may cause vehicle performance problems and/or fuel system damage.

- **The fuel should be unleaded and have an octane rating no lower than that recommended for unleaded gasoline.**
- **If an oxygenate-blend, other than methanol blend is used, it should contain no more than 10% oxygenate. (MTBE may, however, be added up to 15%.)**

- **E-15 fuel contains more than 10% oxygenate. E-15 fuel will adversely affect the emission control devices and systems of the vehicle and should not be used. Damage caused by such fuel is not covered by the NISSAN new vehicle limited warranty.**
- **If a methanol blend is used, it should contain no more than 5% methanol (methyl alcohol, wood alcohol). It should also contain a suitable amount of appropriate cosolvents and corrosion inhibitors. If not properly formulated with appropriate cosolvents and corrosion inhibitors, such methanol blends may cause fuel system damage and/or vehicle performance problems. At this time, sufficient data is not available to ensure that all methanol blends are suitable for use in NISSAN vehicles.**

If any driveability problems such as engine stalling and difficult hot-starting are experienced after using oxygenate-blend fuels, immediately change to a non-oxygenate fuel or a fuel with a low blend of MTBE.

**Take care not to spill gasoline during refueling. Gasoline containing oxygenates can cause paint damage.**

#### E-15 fuel

E-15 fuel is a mixture of approximately 15% fuel ethanol and 85% unleaded gasoline. E-15 can only be used in vehicles designed to run on E-15 fuel. Do not use E-15 in your vehicle. U.S. government regulations require fuel ethanol dispensing pumps to be identified with small, square, orange and black label with the common abbreviation or the appropriate percentage for that region.

#### E-85 fuel

E-85 fuel is a mixture of approximately 85% fuel ethanol and 15% unleaded gasoline. E-85 can only be used in a Flexible Fuel Vehicle (FFV). Do not use E-85 fuel in your vehicle. U.S. government regulations require fuel ethanol dispensing pumps to be identified by a small, square, orange and black label with the common abbreviation or the appropriate percentage for that region.

#### Fuel containing MMT

MMT, or methylcyclopentadienyl manganese tricarbonyl, is an octane boosting additive. NISSAN does not recommend the use of fuel containing MMT. Such fuel may adversely affect vehicle performance, including the emissions control system. Note that while some fuel pumps label MMT content, not all do, so you may have

to consult your gasoline retailer for more details.

#### Aftermarket fuel additives

NISSAN does not recommend the use of any aftermarket fuel additives (for example, fuel injector cleaner, octane booster, intake valve deposit removers, etc.) which are sold commercially. Many of these additives intended for gum, varnish or deposit removal may contain active solvent or similar ingredients that can be harmful to the fuel system and engine.

#### Octane rating tips

**Using unleaded gasoline with an octane rating lower than recommended can cause persistent, heavy “spark knock”. (Spark knock is a metallic rapping noise.) If severe, this can lead to engine damage. If you detect a persistent heavy spark knock even when using gasoline of the stated octane rating, or if you hear steady spark knock while holding a steady speed on level roads, it is recommended you have a NISSAN dealer correct the condition. Failure to correct the condition is misuse of the vehicle, for which NISSAN is not responsible.**

Incorrect ignition timing will result in spark knock, after-run and/or overheating, which may cause excessive fuel consumption or engine

damage. If any of the above symptoms are encountered, have your vehicle checked. It is recommended you visit a NISSAN dealer for servicing.

**However, now and then you may notice light spark knock for a short time while accelerating or driving up hills. This is not a cause for concern, because you get the greatest fuel benefit when there is light spark knock for a short time under heavy engine load.**

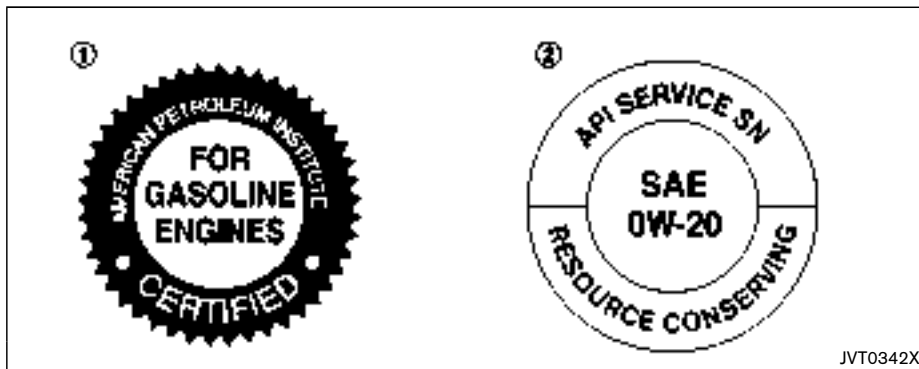

① API certification mark

② API service symbol

## ENGINE OIL AND OIL FILTER RECOMMENDATION

### Selecting the correct oil

It is essential to choose the correct grade, quality, and viscosity engine oil to ensure satisfactory engine life and performance, see "Capacities and recommended fluids/lubricants" (P.10-2). NISSAN recommends the use of an energy conserving oil in order to improve fuel economy.

Select only engine oils that meet the American Petroleum Institute (API) certification or Interna-

tional Lubricant Standardization and Approval Committee (ILSAC) certification and SAE viscosity standard. These oils have the API certification mark on the front of the container. Oils which do not have the specified quality label should not be used as they could cause engine damage.

### Oil additives

NISSAN does not recommend the use of oil additives. The use of an oil additive is not necessary when the proper oil type is used and maintenance intervals are followed.

Oil which may contain foreign matter or has been previously used should not be used.



## Oil viscosity

The engine oil viscosity or thickness changes with temperature. Because of this, it is important to select the engine oil viscosity based on the temperatures at which the vehicle will be operated before the next oil change. Choosing an oil viscosity other than that recommended could cause serious engine damage.

## Selecting the correct oil filter

Your new NISSAN vehicle is equipped with a high-quality genuine NISSAN oil filter. When replacing, use a genuine NISSAN oil filter or its equivalent for the reason described in "Change intervals".

## Change intervals

The oil and oil filter change intervals for your engine are based on the use of the specified quality oils and filters. Using an engine oil and filter other than the specified quality, or exceeding recommended oil and filter change intervals could reduce engine life. Damage to the engine caused by improper maintenance or use of incorrect oil and filter quality and/or viscosity is not covered by the NISSAN new vehicle limited warranty.

Your engine was filled with a high quality engine oil when it was built. You do not have to change the oil before the first recommended change

interval.

## AIR CONDITIONING SYSTEM REFRIGERANT AND LUBRICANT RECOMMENDATIONS

**The air conditioning system in your NISSAN vehicle must be charged with the refrigerant HFC-134a (R-134a) and the oil, NISSAN A/C system oil Type S or the exact equivalents.**



### CAUTION

**The use of any other refrigerant or oil may cause severe damage to the air conditioning system and may require the replacement of all air conditioner system components.**

The refrigerant HFC-134a (R-134a) in your NISSAN vehicle will not harm the earth's ozone layer. Although this refrigerant does not affect the earth's atmosphere, certain governmental regulations require the recovery and recycling of any refrigerant during automotive air conditioning system service. A NISSAN dealer has the trained technicians and equipment needed to recover and recycle your air conditioning system refrigerant.

It is recommended you visit a NISSAN dealer when servicing your air conditioning system.

## SPECIFICATIONS

### ENGINE

Model		VQ35DE
Type		Gasoline, 4-cycle
Cylinder arrangement		6-cylinder, V-slanted at 60°
Bore × Stroke	in (mm)	3.760 × 3.205 (95.5 × 81.4)
Displacement	cu in (cm <sup>3</sup> )	213.45 (3,498)
Firing order		1-2-3-4-5-6
Idle speed	rpm	No adjustment is necessary.
Ignition timing (B.T.D.C.)	degree/rpm	
Spark plug	Standard	FXE22HR-11
Spark plug gap (Normal)	in (mm)	0.043 (1.1)
Camshaft operation		Timing chain

**This spark ignition system complies with the Canadian standard ICES-002.**

### WHEELS AND TIRES

#### Road wheel

Type	Size	Offset in (mm)
Steel	16 × 6-1/2JJ	1.97 (50)
	16 × 7J	1.97 (50)
Aluminum	18 × 7J	2.17 (55)
T-type	16 × 4T	1.18 (30)

#### Tire

Type	Size	Pressure PSI (kPa) [Cold]
Conventional	P225/65R16 99T	35 (240)
	P235/55R18 99T	
T-type	T135/80D16 101M	60 (420)
	T135/90D16 102M	

## DIMENSIONS AND WEIGHTS

Overall length	in (mm)	200.8 (5,100)*1 201.2 (5,110)*2
Overall width	in (mm)	77.6 (1,970)
Overall height with- out roof rack rail	in (mm)	71.5 (1,815)
Overall height with roof rack rail	in (mm)	73.0 (1,855)
Front tread	in (mm)	68.1 (1,730)*3 67.7 (1,720)*4
Rear tread	in (mm)	68.1 (1,730)*3 67.7 (1,720)*4
Wheelbase	in (mm)	118.1 (3,000)
Gross vehicle weight rating	lb (kg)	See the F.M.V.S.S. or C.M.V.S.S. cer- tification label on the driver's side center pillar.
Gross axle weight rating	lb (kg)	
Front	lb (kg)	
Rear	lb (kg)	

- \*1: Without front license plate bracket
- \*2: With front license plate bracket
- \*3: 16-inch tire equipped models
- \*4: 18-inch tire equipped models

## WHEN TRAVELING OR REGISTERING IN ANOTHER COUNTRY

**When planning to travel in another country,** you should first find out if the fuel available is suitable for your vehicle's engine.

Using fuel with an octane rating that is too low may cause engine damage. All gasoline vehicles must be operated with unleaded gasoline. Therefore, avoid taking your vehicle to areas where appropriate fuel is not available.

**When transferring the registration of your vehicle to another country, state, province or district,** it may be necessary to modify the vehicle to meet local laws and regulations.

The laws and regulations for motor vehicle emission control and safety standards vary according to the country, state, province or district; therefore, vehicle specifications may differ.

**When any vehicle is to be taken into another country, state, province and registered, its modifications, transportation, and registration are the responsibility of the user. NISSAN is not responsible for any inconvenience that may result.**

## VEHICLE IDENTIFICATION

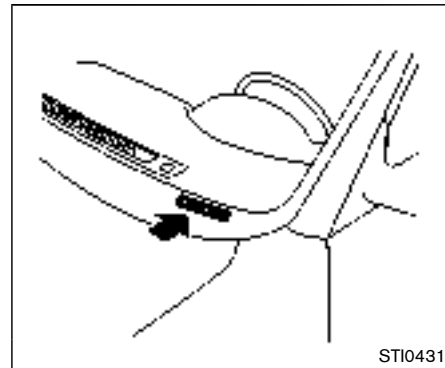

## VEHICLE IDENTIFICATION NUMBER (VIN) PLATE

The vehicle identification number plate is attached as shown. This number is the identification for your vehicle and is used in the vehicle registration.

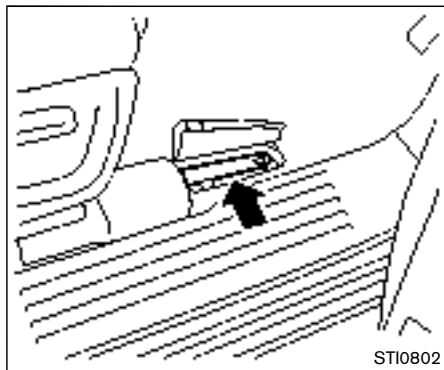

### VEHICLE IDENTIFICATION NUMBER (chassis number)

The vehicle identification number is located as shown.

Remove the cover to access the number.

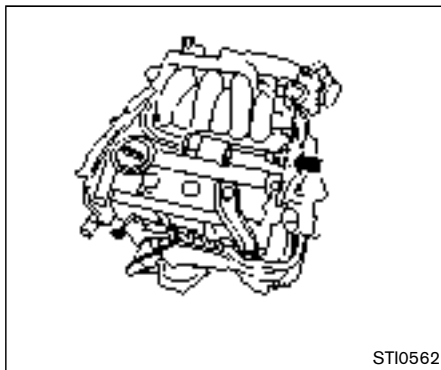

### ENGINE SERIAL NUMBER

The number is stamped on the engine as shown.

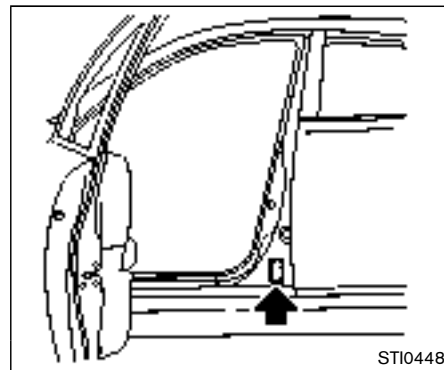

### F.M.V.S.S./C.M.V.S.S. CERTIFICATION LABEL

The Federal/Canadian Motor Vehicle Safety Standards (F.M.V.S.S./C.M.V.S.S.) certification label is affixed as shown. This label contains valuable vehicle information, such as: Gross Vehicle Weight Ratings (GVWR), Gross Axle Weight Rating (GAWR), month and year of manufacture, Vehicle Identification Number (VIN), etc. Review it carefully.

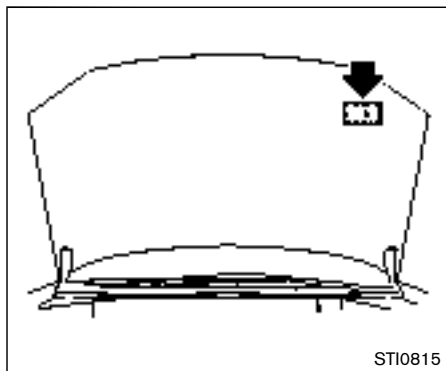

#### EMISSION CONTROL INFORMATION LABEL

The emission control information label is attached as shown.

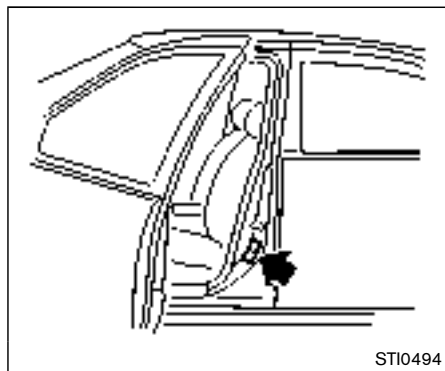

#### TIRE AND LOADING INFORMATION LABEL

The cold tire pressure is shown on the Tire and Loading Information label affixed to the pillar as illustrated.

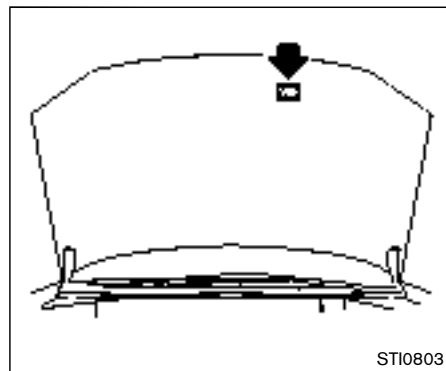

#### AIR CONDITIONER SPECIFICATION LABEL

The air conditioner specification label is attached as shown.

## INSTALLING FRONT LICENSE PLATE

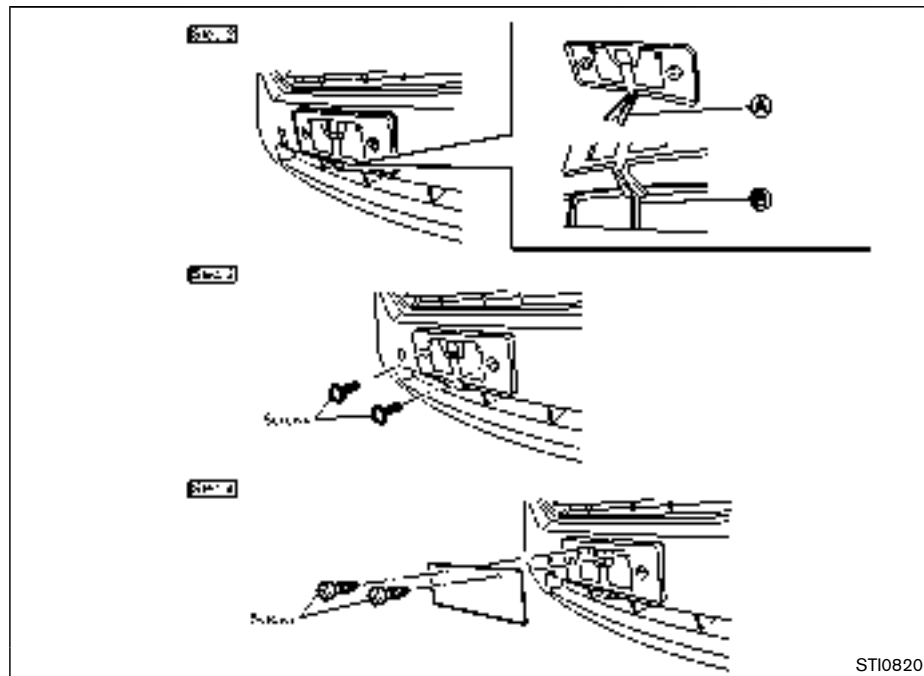

Use the following steps to mount the license plate.

Before mounting the license plate, confirm that the following parts are enclosed in the plastic bag.

- License plate bracket
  - Screw × 2 (for license plate bracket)
1. Park the vehicle on flat, level ground.
  2. Line up the tab **(A)** on the license plate bracket under the top of the front bumper **(B)**.
  3. Install the license plate bracket with screws.
  4. Install the license plate with screws (sold separately).

Use a screw of 1/4 inch (6 mm) in diameter and approximately 5/8 inch (16 mm) in length.

## VEHICLE LOADING INFORMATION



### WARNING

- It is extremely dangerous to ride in a cargo area inside the vehicle. In a collision, people riding in these areas are more likely to be seriously injured or killed.
- Do not allow people to ride in any area of your vehicle that is not equipped with seats and seat belts.
- Be sure everyone in your vehicle is in a seat and using a seat belt properly.

### TERMS

It is important to familiarize yourself with the following terms before loading your vehicle:

- Curb Weight (actual weight of your vehicle) - vehicle weight including: standard and optional equipment, fluids, emergency tools, and spare

tire assembly. This weight **does not** include passengers and cargo.

- GVW (Gross Vehicle Weight) - curb weight plus the combined weight of passengers and cargo.
- GVWR (Gross Vehicle Weight Rating) - maximum total combined weight of the unloaded vehicle, passengers, luggage, hitch, trailer tongue load and any other optional equipment. This information is located on the F.M.V.S.S./C.M.V.S.S. label.
- GAWR (Gross Axle Weight Rating) - maximum weight (load) limit specified for the front or rear axle. This information is located on the F.M.V.S.S./C.M.V.S.S. label.
- GCWR (Gross Combined Weight Rating) - The maximum total weight rating of the vehicle, passengers, cargo, and trailer.
- Vehicle Capacity Weight, Load limit, Total load capacity - maximum total weight limit specified of the load (passengers and cargo) for the vehicle. This is the maximum combined

weight of occupants and cargo that can be loaded into the vehicle. If the vehicle is used to tow a trailer, the trailer tongue weight must be included as part of the cargo load. This information is located on the Tire and Loading Information label.

- Cargo capacity - permissible weight of cargo, the subtracted weight of occupants from the load limit.

### VEHICLE LOAD CAPACITY

Do not exceed the load limit of your vehicle shown as “The combined weight of occupants and cargo” on the Tire and Loading Information label. Do not exceed the number of occupants shown as “Seating Capacity” on the Tire and Loading Information label.

To get “the combined weight of occupants and cargo”, add the weight of all occupants, then add the total luggage weight. Examples are shown in the following illustration.

Example

$$\begin{array}{l}
 \text{Load limit} \\
 1,400 \text{ lb} \\
 (640 \text{ kg})
 \end{array}
 - \left( \begin{array}{l}
 \text{Occupants} \\
 \text{Luggage} \\
 \text{Trailer Tongue} \\
 \text{Weight}
 \end{array} \right) = \begin{array}{l}
 \text{Remaining available} \\
 \text{cargo and luggage} \\
 \text{load capacity} = \\
 740 \text{ lb} \\
 (335 \text{ kg})
 \end{array}$$

$150 \text{ lb} \times 2 = 300 \text{ lb}$      $30 \text{ lb} \times 2 = 60 \text{ lb}$      $308 \text{ lb}$   
 $(70 \text{ kg})$      $(135 \text{ kg})$      $(14 \text{ kg})$      $(27 \text{ kg})$      $(135 \text{ kg})$

$$\begin{array}{l}
 \text{Load limit} \\
 1,400 \text{ lb} \\
 (640 \text{ kg})
 \end{array}
 - \left( \begin{array}{l}
 \text{Occupants} \\
 \text{Luggage}
 \end{array} \right) = \begin{array}{l}
 \text{Remaining available} \\
 \text{cargo and luggage} \\
 \text{load capacity} = \\
 1,040 \text{ lb} \\
 (472 \text{ kg})
 \end{array}$$

$150 \text{ lb} \times 2 = 300 \text{ lb}$      $30 \text{ lb} \times 2 = 60 \text{ lb}$   
 $(70 \text{ kg})$      $(135 \text{ kg})$      $(14 \text{ kg})$      $(27 \text{ kg})$

$$\begin{array}{l}
 \text{Load limit} \\
 1,400 \text{ lb} \\
 (640 \text{ kg})
 \end{array}
 - \left( \begin{array}{l}
 \text{Occupants} \\
 \text{Luggage}
 \end{array} \right) = \begin{array}{l}
 \text{Remaining available} \\
 \text{cargo and luggage} \\
 \text{load capacity} = \\
 300 \text{ lb} \\
 (227 \text{ kg})
 \end{array}$$

$150 \text{ lb} \times 5 = 750 \text{ lb}$      $30 \text{ lb} \times 5 = 150 \text{ lb}$   
 $(70 \text{ kg})$      $(340 \text{ kg})$      $(14 \text{ kg})$      $(70 \text{ kg})$

ST10445

Steps for determining correct load limit

1. Locate the statement "The combined weight of occupants and cargo should never exceed XXX kg or XXX lbs" on your vehicle's placard.
2. Determine the combined weight of the driver and passengers that will be riding in your vehicle.
3. Subtract the combined weight of the driver and passengers from XXX kg or XXX lbs.
4. The resulting figure equals the available amount of cargo and luggage load capacity. For example, if the XXX amount equals 1400 lbs. and there will be five 150 lb. passengers in your vehicle, the amount of available cargo and luggage load capacity is 650 lbs.  $(1400 - 750 (5 \times 150) = 650 \text{ lbs})$  or  $(640 - 340 (5 \times 70) = 300 \text{ kg})$ .
5. Determine the combined weight of luggage and cargo being loaded on the vehicle. That weight may not safely exceed the available cargo and luggage load capacity calculated



in Step 4.

- If your vehicle will be towing a trailer, load from your trailer will be transferred to your vehicle. Consult this manual to determine how this reduces the available cargo and luggage load capacity of your vehicle.

Before driving a loaded vehicle, confirm that you do not exceed the Gross Vehicle Weight Rating (GVWR) or the Gross Axle Weight Rating (GAWR) for your vehicle. (See “Measurement of weights” (P.10-15).)

Also check tires for proper inflation pressures. See the Tire and Loading Information label.

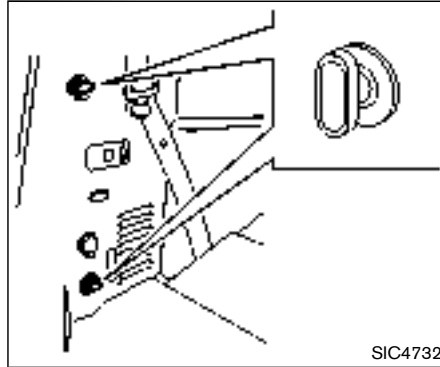

### SECURING THE LOAD

There are tie down hooks located in the cargo area as shown. The tie down hooks can be used to secure cargo with ropes or other types of straps.

**Do not apply a total load of more than 7 lb. (3 kg) to a single hook when securing cargo.**



### WARNING

- Properly secure all cargo with ropes or straps to help prevent it from sliding or shifting. Do not place

**cargo higher than the seatbacks. In a sudden stop or collision, unsecured cargo could cause personal injury.**

- The child restraint top tether strap may be damaged by contact with items in the cargo area. Secure any items in the cargo area. Your child could be seriously injured or killed in a collision if the top tether strap is damaged.
- Do not load your vehicle any heavier than the GVWR or the maximum front and rear GAWRs. If you do, parts of your vehicle can break, tire damage could occur, or it can change the way your vehicle handles. This could result in loss of control and cause personal injury.

### LOADING TIPS

- The GVW must not exceed GVWR or GAWR as specified on the F.M.V.S. S./C.M.V.S.S. certification label.
- Do not load the front and rear axle to the GAWR. Doing so will exceed the GVWR.



## WARNING

- Properly secure all cargo with ropes or straps to help prevent it from sliding or shifting. Do not place cargo higher than the seatbacks. In a sudden stop or collision, unsecured cargo could cause personal injury.
- Do not load your vehicle any heavier than the GVWR or the maximum front and rear GAWRs. If you do, parts of your vehicle can break, tire damage could occur, or it can change the way your vehicle handles. This could result in loss of control and cause personal injury.
- Overloading not only can shorten the life of your vehicle and the tire, but can cause unsafe vehicle handling and longer braking distances. This

may cause a premature tire failure, which could result in a serious accident and personal injury. Failures caused by overloading are not covered by the vehicle's warranty.

## MEASUREMENT OF WEIGHTS

Secure loose items to prevent weight shifts that could affect the balance of your vehicle. When the vehicle is loaded, drive to a scale and weigh the front and the rear wheels separately to determine axle loads. Individual axle loads should not exceed either of the Gross Axle Weight Ratings (GAWR). The total of the axle loads should not exceed the Gross Vehicle Weight Rating (GVWR). These ratings are given on the vehicle certification label. If weight ratings are exceeded, move or remove items to bring all weights below the ratings.

## TOWING A TRAILER



## WARNING

Overloading or improper loading of a trailer and its cargo can adversely affect vehicle handling, braking and performance and may lead to accidents.



## CAUTION

- Do not tow a trailer or haul a heavy load for the first 500 miles (800 km). Your engine, axle or other parts could be damaged.
- For the first 500 miles (800 km) that you tow a trailer, do not drive over 50 MPH (80 km/h) and do not make starts at full throttle. This helps the engine and other parts of your vehicle wear in at the heavier loads.

Your new vehicle was designed to be used primarily to carry passengers and cargo. Remember that towing a trailer places additional loads on your vehicle's engine, drivetrain, steering, braking and other systems.

A NISSAN Towing Guide (U.S. only) is available on the website at [www.nissanusa.com](http://www.nissanusa.com). This

guide includes information on trailer towing capability and the special equipment required for proper towing.

## MAXIMUM LOAD LIMITS

### Maximum trailer loads

Never allow the total trailer load to exceed the value specified in the "Towing Load/Specification" chart. The total trailer load equals trailer weight plus its cargo weight.

- **When towing a trailer load of 1,000 lbs (454 kg) or more, trailers with a brake system MUST be used.**

The maximum GCWR (Gross Combined Weight Rating) should not exceed the value specified in the following "Towing Load/Specification" chart.

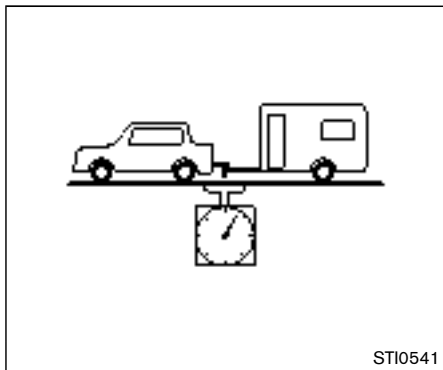

The GCWR equals the combined weight of the towing vehicle (including passengers and cargo) plus the total trailer load. Towing loads greater than these or using improper towing equipment could adversely affect vehicle handling, braking and performance.

The ability of your vehicle to tow a trailer is not only related to the maximum trailer loads, but also the places you plan to tow. Tow weights appropriate for level highway driving may have to be reduced on very steep grades or for low traction situations (for example, on slippery boat ramps).

Temperature conditions can also affect towing. For example, towing a heavy trailer in high

outside temperatures on graded roads can affect engine performance and cause overheating. The transmission high fluid temperature protection mode, which helps reduce the chance of transmission damage, could activate and automatically decrease engine power. Vehicle speed may decrease under high load. Plan your trip carefully to account for trailer and vehicle load, weather and road conditions.



## WARNING

**Overheating can result in reduced engine power and vehicle speed. The reduced speed may be lower than other traffic, which could increase the chance of a collision. Be especially careful when driving. If the vehicle cannot maintain a safe driving speed, pull to the side of the road in a safe area. Allow the engine to cool and return to normal operation. See "If your vehicle overheats" (P.6-12) of this manual.**



## CAUTION

**Vehicle damage resulting from improper towing procedures are not covered**

by NISSAN warranties.

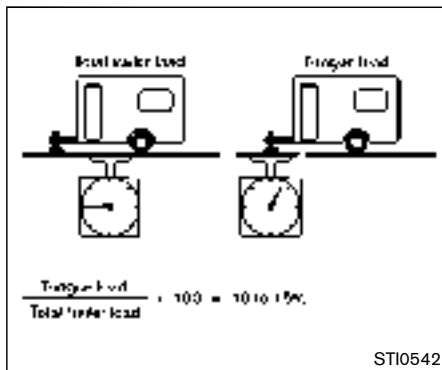

### Tongue load

When using a weight carrying or a weight distributing hitch, keep the tongue load between 10 to 15% of the total trailer load within the maximum tongue load limits shown in the following "Towing Load/Specification" chart. If the tongue load becomes excessive, rearrange cargo to allow for proper tongue load.

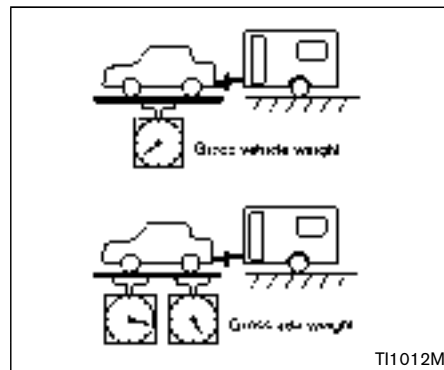

### MAXIMUM GROSS VEHICLE WEIGHT (GVW)/MAXIMUM GROSS AXLE WEIGHT (GAW)

The GVW of the towing vehicle must not exceed the Gross Vehicle Weight Rating (GVWR) shown on the F.M.V.S.S./C.M.V.S.S. certification label. The GVW equals the combined weight of the unloaded vehicle, passengers, luggage, hitch, trailer tongue load and any other optional equipment. In addition, front or rear GAW must not exceed the Gross Axle Weight Rating (GAWR) shown on the F.M.V.S.S./C.M.V.S.S. certification label.

Towing capacities are calculated assuming a base vehicle with driver and any options

required to achieve the rating. Additional passengers, cargo and/or optional equipment, such as the trailer hitch, will add weight to the vehicle and reduce your vehicle's maximum towing capacity and trailer tongue load.

The vehicle and trailer need to be weighed to confirm the vehicle is within the GVWR, Front GAWR, Rear GAWR, Gross Combined Weight Rating (GCWR) and Towing capacity.

All vehicle and trailer weights can be measured using platform type scales commonly found at truck stops, highway weigh stations, building supply centers or salvage yards.

To determine the available payload capacity for tongue load, use the following procedure.

1. Locate the GVWR on the F.M.V.S.S./C.M.V.S.S. certification label.
2. Weigh your vehicle on the scale with all of the passengers and cargo that are normally in the vehicle when towing a trailer.
3. Subtract the actual vehicle weight from the GVWR. The remaining amount is the available maximum tongue load.

To determine the available towing capacity, use the following procedure.

1. Find the GCWR for your vehicle on the "Towing Load/Specification" chart found later in this section.

2. Subtract the actual vehicle weight from the GCWR. The remaining amount is the available maximum towing capacity.

To determine the Gross Trailer Weight, weigh your trailer on a scale with all equipment and cargo, that are normally in the trailer when it is towed. Make sure the Gross trailer weight is not more than the Gross Trailer Weight Rating shown on the trailer and is not more than the calculated available maximum towing capacity.

Also weigh the front and rear axles on the scale to make sure the Front Gross Axle Weight and Rear Gross Axle Weight are not more than Front Gross Axle Weight and Rear Gross Axle Weight on the F.M.V.S.S./C.M.V.S.S. certification label. The cargo in the trailer and vehicle may need to be moved or removed to meet the specified ratings.

Example:

- Gross Vehicle Weight (GVW) as weighed on a scale - including passengers, cargo and hitch - 5,520 lb. (2,503 kg).
- Gross Vehicle Weight Rating (GVWR) from F.M.V.S.S./C.M.V.S.S. certification label - 5,818 lb. (2,639 kg).
- Gross Combined Weight Rating (GCWR) from "Towing Load/Specification" chart - 8,500 lb. (3,856 kg).

- Maximum Trailer towing capacity from "Towing Load/Specification" chart - 3,500 lb. (1,588 kg).

5,818 lb. (2,639 kg)	GVWR
- 5,520 lb. (2,503 kg)	GVW
= 298 lb. (135 kg)	Available for tongue weight
8,500 lb. (3,856 kg)	GCWR
- 5,520 lb. (2,503 kg)	GVW
= 2,980 lb. (1,351 kg)	Capacity available for towing
298 lb. (135 kg) /	Available tongue weight
2,980 lb. (1,351 kg)	Available capacity
	= 10 % tongue weight

The available towing capacity may be less than the maximum towing capacity due to the passenger and cargo load in the vehicle.

Remember to keep trailer tongue weight between 10 to 15% of the trailer weight. If the tongue load becomes excessive, rearrange the cargo to obtain the proper tongue load. Do not exceed the 10 to 15% tongue weight specification even if the calculated available tongue weight is greater than 15%. If the calculated tongue weight is less than 10%, reduce the total trailer weight to match the available tongue weight.

Always verify that available capacities are within the required ratings.

## TOWING LOAD/SPECIFICATION

TOWING LOAD/SPECIFICATION CHART		Unit: lb (kg)
WEIGHT	MODEL	VQ35DE
		CVT
MAXIMUM TRAILER WEIGHT*1		3,500 (1,588)
MAXIMUM TONGUE LOAD		350 (159)
GROSS COMBINED WEIGHT RATING		8,500 (3,856)
RECOMMENDED EQUIPMENT*2		Sway Control Device (SCD)

- 1: All towing above 1,000 lb (454 kg) requires the use of trailer brakes. NISSAN recommends the use of a tandem axle trailer whenever towing above 3,000 lb (1,361 kg).
- 2: A sway control device is recommended for all towing above 2,000 lb (907 kg). Sway control devices are not offered by NISSAN. See a professional trailer/hitch outlet for a properly designed sway control device for your trailer.

## TOWING SAFETY

### Trailer hitch

Choose a proper hitch for your vehicle and trailer. A genuine NISSAN trailer hitch is available from a NISSAN dealer. Make sure the trailer hitch is securely attached to the vehicle to help avoid personal injury or property damage due to sway caused by crosswinds, rough road surfaces or passing trucks.



### WARNING

**Trailer hitch components have specific weight ratings. Your vehicle may be capable of towing a trailer heavier than the weight rating of the hitch components. Never exceed the weight rating of the hitch components. Doing so can cause serious personal injury or property damage.**

### Hitch ball

Choose a hitch ball of the proper size and weight rating for your trailer:

- The required hitch ball size is stamped on most trailer couplers. Most hitch balls also have the size printed on top of the ball.

- Choose the proper class hitch ball based on the trailer weight.
- The diameter of the threaded shank of the hitch ball must be matched to the ball mount hole diameter. The hitch ball shank should be no more than 1/16" smaller than the hole in the ball mount.
- The threaded shank of the hitch ball must be long enough to be properly secured to the ball mount. There should be at least 2 threads showing beyond the lock washer and nut.

### Sway control device

Sudden maneuvers, wind gusts and buffeting caused by other vehicles can affect trailer handling. Sway control devices may be used to help control these affects. If you choose to use one, contact a reputable trailer hitch supplier to make sure the sway control device will work with the vehicle, hitch, trailer and the trailer's brake system. Follow the instructions provided by the manufacturer for installing and using the sway control device.

### Class I hitch

Class I trailer hitch equipment (receiver, ball mount and hitch ball) can be used to tow trailers of a maximum weight of 2,000 lb (907 kg).

### Class II hitch

Class II trailer hitch equipment (receiver, ball mount and hitch ball) can be used to tow trailers of a maximum weight of 3,500 lb (1,588 kg).



### CAUTION

- **Use hitches designed for your vehicle when towing. Check with your NISSAN dealer for availability of suitable genuine NISSAN hitches.**
- **The hitch should not be attached to or affect the operation of the impact-absorbing bumper.**
- **Do not use axle-mounted hitches.**
- **Do not modify the vehicle exhaust system, brake system, etc. to install a trailer hitch.**
- **To reduce the possibility of additional damage if your vehicle is struck from the rear, where practical, remove the hitch and/or receiver when not in use. After the hitch**

is removed, seal the bolt holes to prevent exhaust fumes, water or dust from entering the passenger compartment.

- Regularly check that all trailer hitch mounting bolts are securely mounted.

#### Tire pressures

- When towing a trailer, inflate the vehicle tires to the recommended cold tire pressure indicated on the Tire and Loading Information label.
- Trailer tire condition, size, load rating and proper inflation pressure should be in accordance with the trailer and tire manufacturers' specifications.

#### Safety chains

Always use a suitable chain between your vehicle and the trailer. The safety chains should be crossed and should be attached to the hitch, not to the vehicle bumper or axle. The safety chains can be attached to the bumper if the hitch ball is mounted to the bumper. Be sure to leave enough slack in the chains to permit turning corners.

#### Trailer lights



#### CAUTION

**When splicing into the vehicle electrical system, a commercially available power-type module/converter must be used to provide power for all trailer lighting. This unit uses the vehicle battery as a direct power source for all trailer lights while using the vehicle tail light, stoplight and turn signal circuits as a signal source. The module/converter must draw no more than 15 milliamps from the stop and tail lamp circuits. Using a module/converter that exceeds these power requirements may damage the vehicle's electrical system. See a reputable trailer dealer to obtain the proper equipment and to have it installed.**

Trailer lights should comply with federal and/or local regulations. For assistance in hooking up trailer lights, it is recommended you contact a NISSAN dealer or reputable trailer dealer.

#### Trailer brakes

If your trailer is equipped with a braking system, make sure it conforms to federal and/or local regulations and that it is properly installed.



#### WARNING

**Never connect a trailer brake system directly to the vehicle brake system.**

#### Pre-towing tips

- Be certain your vehicle maintains a level position when a loaded or unloaded trailer is hitched. Do not drive the vehicle if it has an abnormal nose-up or nose-down condition; check for improper tongue load, overload, worn suspension or other possible causes of either condition.
- Always secure items in the trailer to prevent load shift while driving.
- Keep the cargo load as low as possible in the trailer to keep the trailer center of gravity low.
- Load the trailer so approximately 60% of the trailer load is in the front half and 40% is in the back half. Also make sure the load is balanced side to side.



- Check your hitch, trailer tire pressure, vehicle tire pressure, trailer light operation, and trailer wheel lug nuts every time you attach a trailer to the vehicle.
- Be certain your rearview mirrors conform to all federal, state or local regulations. If not, install any mirrors required for towing before driving the vehicle.
- Determine the overall height of the vehicle and trailer so the required clearance is known.

### Trailer towing tips

In order to gain skill and an understanding of the vehicle's behavior, you should practice turning, stopping and backing up in an area which is free from traffic. Steering stability, and braking performance will be somewhat different than under normal driving conditions.

- Always secure items in the trailer to prevent load shift while driving.
- Lock the trailer hitch coupler with a pin or lock to prevent the coupler from inadvertently becoming unlatched.
- Avoid abrupt starts, acceleration or stops.
- Avoid sharp turns or lane changes.
- Always drive your vehicle at a moderate speed. Some states or provinces have specific speed limits for vehicles that are

towing trailers. Obey the local speed limits.

- When backing up, hold the bottom of the steering wheel with one hand. Move your hand in the direction in which you want the trailer to go. Make small corrections and back up slowly. If possible, have someone guide you when you are backing up.

Always block the wheels on both vehicle and trailer when parking. Parking on a slope is not recommended; however, if you must do so:



### CAUTION

**If you move the shift lever to the P (Park) position before blocking the wheels and applying the parking brake, transmission damage could occur.**

1. Apply and hold the brake pedal.
2. Have someone place blocks on the downhill side of the vehicle and trailer wheels.
3. After the wheel blocks are in place, slowly release the brake pedal until the blocks absorb the vehicle load.
4. Apply the parking brake.
5. Shift the transmission into P (Park).

6. Turn off the engine.

To drive away:

1. Apply and hold the brake pedal.
  2. Start the engine.
  3. Shift the transmission into gear.
  4. Release the parking brake.
  5. Drive slowly until the vehicle and trailer are clear from the blocks.
  6. Apply and hold the brake pedal.
  7. Have someone retrieve and store the blocks.
- When going down a hill, shift into a lower gear and use the engine braking effect. When going up a long grade, downshift the transmission to a lower gear and reduce speed to reduce chances of engine overloading and/or overheating.
  - If the engine coolant rises to an extremely high temperature when the air conditioning system is on, turn off the air conditioner. Coolant heat can be additionally vented by opening the windows, switching the fan control to high and setting the temperature control to the HOT position.
  - Trailer towing requires more fuel than normal circumstances.
  - Avoid towing a trailer for the first 500 miles (800 km).

- Have your vehicle serviced more often than at intervals specified in the recommended maintenance schedule shown in the “9. Maintenance and schedules” section.
- When making a turn, your trailer wheels will be closer to the inside of the turn than your vehicle wheels. To compensate for this, make a larger than normal turning radius during the turn.
- Crosswinds and rough roads will adversely affect vehicle/trailer handling, possibly causing vehicle sway. When being passed by larger vehicles, be prepared for possible changes in crosswinds that could affect vehicle handling. If swaying does occur, firmly grip the steering wheel, steer straight ahead, and immediately (but gradually) reduce vehicle speed. This combination will help stabilize the vehicle. Never increase speed.

Do the following if the trailer begins to sway:

1. Take your foot off the accelerator pedal to allow the vehicle to coast and steer as straight ahead as the road conditions allow. This combination will help stabilize the vehicle.
  - Do not correct trailer sway by steering or applying the brakes.

2. When the trailer sway stops, gently apply the brakes and pull to the side of the road in a safe area.
3. Try to rearrange the trailer load so it is balanced as described earlier in this section.
  - Be careful when passing other vehicles. Passing while towing a trailer requires considerably more distance than normal passing. Remember the length of the trailer must also pass the other vehicle before you can safely change lanes.
  - Down shift the transmission to a lower gear for engine braking when driving down steep or long hills. This will help slow the vehicle without applying the brakes.
  - Avoid holding the brake pedal down too long or too frequently. This could cause the brakes to overheat, resulting in reduced braking efficiency.
  - Increase your following distance to allow for greater stopping distances while towing a trailer. Anticipate stops and brake gradually.
  - Do not use cruise control while towing a trailer.
  - Some states or provinces have specific regulations and speed limits for vehicles that are towing trailers. Obey the local speed limits.

- Check your hitch, trailer wiring harness connections, and trailer wheel lug nuts after 50 miles (80 km) of travel and at every break.
- When stopped in traffic for long periods of time in hot weather, put the vehicle in the P (Park) position.
- When launching a boat, don't allow the water level to go over the exhaust tail pipe or rear bumper.
- Make sure you disconnect the trailer lights before backing the trailer into the water or the trailer lights may burn out.

**When towing a trailer, the transmission fluid should be changed more frequently. For additional information, see the “9. Maintenance and schedules” section.**

## FLAT TOWING

Towing your vehicle with all four wheels on the ground is sometimes called flat towing. This method is sometimes used when towing a vehicle behind a recreational vehicle, such as a motor home.



## CAUTION

- **Failure to follow these guidelines can result in severe transmission**

damage.

- **Whenever flat towing your vehicle, always tow forward, never backward.**
- **DO NOT tow any continuously variable transmission vehicle with all four wheels on the ground (flat towing). Doing so WILL DAMAGE internal transmission parts due to lack of transmission lubrication.**
- **For emergency towing procedures refer to “Towing recommended by NISSAN” (P.6-15) of this manual.**

### Continuously Variable Transmission (CVT)

To tow a vehicle equipped with a Continuously Variable Transmission (CVT), an appropriate vehicle dolly **MUST** be placed under the towed vehicle's driving wheels. **Always** follow the dolly manufacturer's recommendations when using their product.

## UNIFORM TIRE QUALITY GRADING

DOT (Department Of Transportation) Quality Grades: All passenger car tires must conform to federal safety requirements in addition to these grades.

Quality grades can be found where applicable on the tire sidewall between tread shoulder and maximum section width. For example:

### Treadwear 200 Traction AA Temperature A TREADWEAR

The treadwear grade is a comparative rating based on the wear rate of the tire when tested under controlled conditions on a specified government test course. For example, a tire graded 150 would wear one and one-half

(1 1/2) times as well on the government course as a tire graded 100. The relative performance of tires depends upon actual conditions of their use, however, and may depart significantly from the norm due to variations in driving habits, service practices and differences in road characteristics and climate.

### TRACTION AA, A, B AND C

The traction grades, from highest to lowest, are AA, A, B and C. Those grades represent the tire's ability to stop on wet pavement as measured under controlled conditions on specified government test surfaces of asphalt and concrete. A tire marked C may have poor

traction performance.



## WARNING

**The traction grade assigned to this tire is based on straight-ahead braking traction tests, and does not include acceleration, cornering, hydroplaning, or peak traction characteristics.**

### TEMPERATURE A, B AND C

The temperature grades A (the highest), B, and C, representing the tire's resistance to the generation of heat and its ability to dissipate heat when tested under controlled conditions on a specified indoor laboratory test wheel. Sustained high temperature can cause the material of the tire to degenerate and reduce tire life, and excessive temperature can lead to sudden tire failure. The grade C corresponds to a level of performance which all passenger car tires must meet under the Federal Motor Vehicle Safety Standard No. 109. Grades B and A represent higher levels of performance on the laboratory test wheel than the minimum required by law.



## WARNING

The temperature grade for this tire is established for a tire that is properly inflated and not overloaded. Excessive speed, under-inflation, or excessive loading, either separately or in combination, can cause heat build-up and possible tire failure.

## EMISSION CONTROL SYSTEM WARRANTY

Your NISSAN is covered by the following emission warranties.

### For USA:

- Emission Defects Warranty
- Emissions Performance Warranty

Details of these warranties may be found with other vehicle warranties in your Warranty Information Booklet which comes with your NISSAN. If you did not receive a Warranty Information Booklet, or it has become lost, you may obtain a replacement by writing to:

- Nissan North America, Inc.  
Consumer Affairs Department  
P.O. Box 685003  
Franklin, TN 37068-5003

### For Canada:

Emission Control System Warranty

Details of these warranties may be found with other vehicle warranties in your Warranty Information Booklet which comes with your NISSAN. If you did not receive a Warranty Information Booklet, or it has become lost, you may obtain a replacement by writing to:

- Nissan Canada Inc.  
5290 Orbitor Drive  
Mississauga, Ontario,  
L4W 4Z5

## REPORTING SAFETY DEFECTS

### For USA

If you believe that your vehicle has a defect which could cause a crash or could cause injury or death, you should immediately inform the National Highway Traffic Safety Administration (NHTSA) in addition to notifying NISSAN.

If NHTSA receives similar complaints, it may open an investigation, and if it finds that a safety defect exists in a group of vehicles, it may order a recall and remedy campaign. However, NHTSA cannot become involved in individual problems between you, your dealer, or NISSAN.

To contact NHTSA, you may call the Vehicle Safety Hotline toll-free at 1-888-327-4236 (TTY: 1-800-424-9153); go to <http://www.safercar.gov>; or write to: Administrator, NHTSA, 400 Seventh Street, SW., Washington, D.C. 20590. You can also obtain other information about motor vehicle safety from <http://www.safercar.gov>.

You may notify NISSAN by contacting our Consumer Affairs Department, toll-

**Technical and consumer information 10-25**

free, at 1-800-NISSAN-1 (1-800-647-7261).

### **For Canada**

If you believe that your vehicle has a defect which could cause a crash or could cause injury or death, you should immediately inform Transport Canada in addition to notifying NISSAN.

If Transport Canada receives complaints, it may open an investigation, and if it finds that a safety defect exists in a group of vehicles, it may request that NISSAN conduct a recall campaign. However, Transport Canada cannot become involved in individual problems between you, your dealer, or NISSAN.

You may contact Transport Canada's Defect Investigations and Recalls Division toll free at 1-800-333-0510. You may also report safety defects online at:

<https://wwwapps.tc.gc.ca/Saf-Sec-Sur/7/PCDB-BDPP/Index.aspx>.

Additional information concerning motor vehicle safety may be obtained from

Transport Canada's Road Safety Information Centre at 1-800-333-0371 or online at [www.tc.gc.ca/roadsafety](http://www.tc.gc.ca/roadsafety) (English speakers) or [www.tc.gc.ca/securiter-outiere](http://www.tc.gc.ca/securiter-outiere) (French speakers).

To notify NISSAN of any safety concerns please contact our Consumer Information Centre toll free at 1-800-387-0122.

## **READINESS FOR INSPECTION/ MAINTENANCE (I/M) TEST**

Due to legal requirements in some states/areas or provinces, your vehicle may be required to be in what is called the "ready condition" for an Inspection/Maintenance (I/M) test of the emission control system.

The vehicle is set to the "ready condition" when it is driven through certain driving patterns. Usually, the "ready condition" can be obtained by ordinary usage of the vehicle.

If a powertrain system component is repaired or the battery is disconnected, the vehicle may be reset to a "not ready condition". Before taking the I/M test, check the vehicle's inspection/maintenance test readiness condition. Place the ignition switch in the ON position without starting the engine. If the Malfunction Indicator Light (MIL) comes on steady for 20 seconds and then blinks for 10 seconds, the I/M test condition is "not ready". If the MIL does not blink after 20 seconds, the I/M test condition is "ready".

It is recommended you visit a NISSAN dealer to set "ready condition" or to prepare the vehicle for testing.

## EVENT DATA RECORDERS (EDR)

This vehicle is equipped with an Event Data Recorder (EDR). The main purpose of an EDR is to record, in certain crash or near crash-like situations, such as an air bag deployment or hitting a road obstacle, data that will assist in understanding how a vehicle's systems performed. The EDR is designed to record data related to vehicle dynamics and safety systems for a short period of time, typically 30 seconds or less. The EDR in this vehicle is designed to record such data as:

- How various systems in your vehicle were operating;
- Whether or not the driver and passenger safety belts were buckled/fastened;
- How far (if at all) the driver was depressing the accelerator and/or brake pedal; and,
- How fast the vehicle was traveling.
- Sounds are not recorded.

These data can help provide a better understanding of the circumstances in which crashes and injuries occur.

NOTE: EDR data are recorded by your vehicle only if a nontrivial crash situation occurs; no data are recorded by the EDR under normal driving conditions and no personal data (e.g. name, gender, age and crash location) are recorded. However, other parties, such as law enforcement, could combine the EDR data with the type

of personally identifying data routinely acquired during a crash investigation.

To read data recorded by an EDR, special equipment is required and access to the vehicle or the EDR is needed. In addition to the vehicle manufacturer and NISSAN dealer, other parties, such as law enforcement, that have the special equipment, can read the information if they have access to the vehicle or the EDR. EDR data will only be accessed with the consent of the vehicle owner or lessee or as otherwise required or permitted by law.

## OWNER'S MANUAL/SERVICE MANUAL ORDER INFORMATION

Genuine NISSAN Service Manuals for this model year and prior can be purchased. A genuine NISSAN Service Manual is the best source of service and repair information for your vehicle. This manual is the same one used by the factory-trained technicians working at NISSAN dealers. Genuine NISSAN Owner's Manuals can also be purchased.

### For USA:

For current pricing and availability of genuine **NISSAN Service Manuals**, contact:

[www.nissan-techinfo.com](http://www.nissan-techinfo.com)

For current pricing and availability of genuine **NISSAN Owner's Manuals**, contact:

1-800-247-5321

### For Canada:

To purchase a copy of a genuine NISSAN Service Manual or Owner's Manual for this model year and prior, contact a NISSAN dealer. For the phone number and location of a NISSAN dealer in your area, call the NISSAN Information Center at 1-800-387-0122 and a bilingual NISSAN representative will assist you.

## **MEMO**

# 11 Index

## A

A/C (Air Conditioner) operation .....	4-49
ABS (Anti-lock Braking System) .....	5-31
Advanced air bag system .....	1-54
Aiming control, Headlights .....	2-37
Air bag system	
Advanced air bag system .....	1-54
Front passenger air bag and status light .....	1-55
Front-seat mounted side-impact supplemental air bag system .....	1-61
Roof-mounted curtain side-impact supplemental air bag system .....	1-61
Air bag warning labels .....	1-63
Air bag warning light .....	1-64, 2-15
Air cleaner housing filter .....	8-14
Air conditioner	
Air conditioner operation .....	4-47
Air conditioner service .....	4-60
Air conditioner specification label .....	10-10
Air conditioning system refrigerant and lubricant recommendations .....	4-60, 10-6
In-cabin microfilter .....	4-60
Alarm, How to stop alarm (see vehicle security system) .....	2-30
Alcohol, drugs and driving .....	5-8
Antenna .....	4-109
Anti-lock Braking System (ABS) .....	5-31
Anti-lock braking system (ABS) warning light .....	2-12
Appearance care	
Exterior appearance care .....	7-2
Interior appearance care .....	7-4
Armrests .....	1-7
Around view <sup>®</sup> monitor .....	4-32
Audible reminders .....	2-18

Audio operation precautions .....	4-61
Audio system .....	4-61
Steering wheel audio controls .....	4-108
Auto closure .....	3-29
Autolight system .....	2-34
Automatic	
Air conditioner .....	4-54
Door locks .....	3-7
Drive positioner .....	3-36
Moonroof .....	2-54
Seat positioner .....	3-36
AUX (Auxiliary) input .....	4-85
Avoiding collision and rollover .....	5-6

## B

Back door (See liftgate) .....	3-26
Battery .....	8-10
Battery saver system .....	2-36
Intelligent Key .....	8-20
Variable voltage control system .....	8-12
Before starting the engine .....	5-11
Blind Spot Warning (BSW) system .....	5-17
Blind Spot Warning (BSW) system warning light .....	2-12
Bluetooth <sup>®</sup> hands-free phone system (Type A) .....	4-122
Bluetooth <sup>®</sup> hands-free phone system (Type B) .....	4-133
Bluetooth <sup>®</sup> hands-free phone system (Type C) .....	4-146
Bluetooth <sup>®</sup> streaming audio .....	4-101
Booster seats .....	1-45
Brake	
Anti-lock Braking System (ABS) .....	5-31
Brake fluid .....	8-9

Brake system .....	5-30
Parking brake operation .....	5-16
Warning light .....	2-12
Break-in schedule .....	5-27
Brightness control	
Display ON/OFF button .....	4-10
Instrument panel .....	2-38
Bulb replacement .....	8-22

## C

Cabin air filter .....	4-60
Capacities and recommended fluids/lubricants .....	10-2
Car phone or CB radio .....	4-121
Cargo floor box .....	2-48
Cargo lights .....	2-60
Catalytic converter, Three way catalyst .....	5-3
CD/DVD/USB memory care and cleaning .....	4-107
Center multi-function control panel .....	4-5
Chassis and body maintenance .....	9-11
Checking lights .....	2-12
Child restraints .....	1-27
Booster seats .....	1-45
LATCH system .....	1-29
Precautions on child restraints .....	1-27
Top tether strap .....	1-32
Child safety .....	1-24
Chimes	
Audible reminders .....	2-18
Seat belt warning light and chime .....	2-15
Circuit breaker, Fusible link .....	8-18
Cleaning exterior and interior .....	7-2, 7-4
Coat hooks .....	2-51
Cockpit .....	2-3
Cold weather driving .....	5-34



Compact Disc (CD) player (See audio system) .....	4-90
Compass .....	2-8
Console box .....	2-47
Continuously Variable Transmission (CVT) fluid ...	8-8
Controls, Control panel .....	4-5
Coolant	
Capacities and recommended fluids/lubricants .....	10-2
Changing engine coolant .....	8-5
Checking engine coolant level .....	8-5
Corrosion protection .....	7-7
Cruise control .....	5-25
Cup holders .....	2-44
CVT, Driving with CVT (Continuously Variable Transmission) .....	5-13

## D

Daytime running light system .....	2-37
Defroster switch, Rear window and outside mirror defroster switch .....	2-33
Dimensions and weights .....	10-8
DISP button .....	4-10
Drive belt .....	8-12
Drive positioner .....	3-36
Driving	
Cold weather driving .....	5-34
Driving with CVT (Continuously Variable Transmission) .....	5-13
Precautions when starting and driving .....	5-2
DVD player, NISSAN Mobile Entertainment .....	4-110

## E

ECON button .....	4-11
Economy, Fuel .....	5-28

Elapsed time .....	2-25
Emission control information label .....	10-10
Emission control system maintenance .....	9-8
Emission control system warranty .....	10-25
Engine	
Before starting the engine .....	5-11
Break-in schedule .....	5-27
Capacities and recommended fluids/lubricants .....	10-2
Changing engine coolant .....	8-5
Changing engine oil and filter .....	8-6
Checking engine coolant level .....	8-5
Checking engine oil level .....	8-5
Coolant temperature gauge .....	2-7
Emergency engine shut off .....	5-10
Engine block heater .....	5-35
Engine compartment check locations .....	8-3
Engine cooling system .....	8-4
Engine oil .....	8-5
Engine oil and oil filter recommendation .....	10-5
Engine oil replacement indicator .....	2-23
Engine oil viscosity .....	10-6
Engine serial number .....	10-9
Engine specifications .....	10-7
Engine start operation indicator .....	2-21
If your vehicle overheats .....	6-12
Starting the engine .....	5-12
Entry/exit function, Automatic drive positioner ...	3-36
Event Data Recorders (EDR) .....	10-27
Exhaust gas (carbon monoxide) .....	5-2
Explanation of scheduled maintenance items .....	9-5
Extended storage fuse warning .....	2-22

## F

F.M.V.S.S./C.M.V.S.S. certification label .....	10-9
---	------

Filter	
Air cleaner housing filter .....	8-14
Changing engine oil and filter .....	8-6
Flashers (See hazard warning flasher switch) .....	6-2
Flat tire .....	6-3
Flat towing .....	10-23
Flexible seating .....	1-8
Floor mat cleaning .....	7-5
Fluid	
Brake fluid .....	8-9
Capacities and recommended fluids/lubricants .....	10-2
Continuously Variable Transmission (CVT) fluid .....	8-8
Engine coolant .....	8-4
Engine oil .....	8-5
Power steering fluid .....	8-8
Window washer fluid .....	8-10
FM-AM radio with Compact Disc (CD) player ...	4-74
FM-AM-SAT radio with Compact Disc (CD) player .....	4-77, 4-87
Fog light switch .....	2-39
Front manual seat adjustment .....	1-3
Front passenger air bag and status light .....	1-55
Front power seat adjustment .....	1-4
Front seat, Front seat adjustment .....	1-3
Front-seat active head restraint .....	1-14
Fuel	
Capacities and recommended fluids/lubricants .....	10-2
Fuel economy .....	5-28
Fuel economy information (display) .....	4-12
Fuel octane rating .....	10-3
Fuel recommendation .....	10-3
Fuel-filler cap .....	3-30
Fuel-filler door .....	3-30
Gauge .....	2-8

LOOSE FUEL CAP warning .....	3-32
Fuel efficient driving tips .....	5-27
Fuses .....	8-18
Fusible links .....	8-18

## G

Garage door opener, HomeLink® .....	
Universal Transceiver .....	2-60
Gas cap .....	3-30
Gauge .....	2-5
Engine coolant temperature gauge .....	2-7
Fuel gauge .....	2-8
Odometer .....	2-6
Speedometer .....	2-6
Tachometer .....	2-7
Trip computer .....	2-24
General maintenance .....	9-2
Glove box .....	2-47

## H

Hands-free phone system, Bluetooth® .....	
(Type A) .....	4-122
Hands-free phone system, Bluetooth® .....	
(Type B) .....	4-133
Hands-free phone system, Bluetooth® .....	
(Type C) .....	4-146
Hazard warning flasher switch .....	6-2
Head restraints/headrests .....	1-10
Headlights .....	
Aiming control .....	2-37
Bulb replacement .....	8-22
Headlight switch .....	2-34
Xenon headlights .....	2-33
Heated seats .....	2-39

Heater .....	
Engine block heater .....	5-35
Heater and air conditioner operation .....	4-47
HomeLink® Universal Transceiver .....	2-60
Hood release .....	3-25
Hook, Coat hooks .....	2-51
Horn .....	2-39
Hydraulic pump electric power steering .....	5-30

## I

Ignition switch (Push-button) .....	5-8
Immobilizer system .....	2-30
In-cabin microfilter .....	4-60
Indicator .....	
Lights .....	2-16
Vehicle information display .....	2-19
INFO button .....	4-11
Inside mirror .....	3-33
Inspection/maintenance (I/M) test .....	10-26
Instrument brightness control .....	2-38
Instrument panel .....	2-4, 2-44
Intelligent Key system .....	3-3, 3-13
Battery replacement .....	8-20
Intelligent Key system warning light .....	2-14
Key operating range .....	3-15
Key operation .....	3-16
Warning signals .....	3-19
Interior light control switch .....	2-58
Interior light replacement .....	8-24
Interior lights .....	2-57
iPod® player operation .....	4-99
ISOFIX child restraint .....	1-29

## J

Jump starting .....	6-10
---------------------	------

## K

Keyless entry (See remote keyless entry system) .....	3-21
Keys .....	3-3
For Intelligent Key system .....	3-3, 3-13

## L

Labels .....	
Air bag warning labels .....	1-63
Air conditioner specification label .....	10-10
Emission control information label .....	10-10
Engine serial number .....	10-9
F.M.V.S.S./C.M.V.S.S. certification label .....	10-9
Tire and Loading Information label ...	8-29, 10-10
Vehicle identification number (VIN) .....	10-8
LATCH system .....	1-29
License plate, Installing front license plate .....	10-11
Liftgate .....	3-26
Light .....	
Air bag warning light .....	1-64
Bulb replacement .....	8-22
Cargo lights .....	2-60
Fog light switch .....	2-39
Headlight switch .....	2-34
Headlights bulb replacement .....	8-22
Indicator lights .....	2-16
Interior light control switch .....	2-58
Interior lights .....	2-57
Map lights .....	2-57
Mood lights .....	2-59
Replacement .....	8-22

Vanity mirror lights .....	2-59
Warning/indicator lights and audible reminders .....	2-12
Xenon headlights .....	2-33
Lights, Exterior and interior light replacement ...	8-24
Loading information (See vehicle loading information) .....	10-12
Lock	
Automatic door locks .....	3-7
Door locks .....	3-5
Liftgate lock .....	3-26
Power door lock .....	3-5
Locking with mechanical key .....	3-5
Loose fuel cap warning .....	2-22, 3-30
Low outside temperature warning .....	2-22
Low tire pressure warning light .....	2-14
Low tire pressure warning system (See tire pressure monitoring system (TPMS)) .....	5-3

## M

Maintenance	
Battery .....	8-10
General maintenance .....	9-2
Inside the vehicle .....	9-3
Maintenance indicators .....	2-23
Maintenance log .....	9-14
Maintenance precautions .....	8-2
Maintenance requirements .....	9-2
Maintenance schedules .....	9-6
Maintenance under severe driving conditions .....	9-13
Outside the vehicle .....	9-2
Seat belt maintenance .....	1-24
Standard maintenance .....	9-7
Maintenance schedules .....	9-6
Malfunction indicator light (MIL) .....	2-17

Manual air conditioner .....	4-49
Manual front seat adjustment .....	1-3
Map lights .....	2-57
Master warning light .....	2-15
Mechanical key (Intelligent Key system) .....	3-4
Memory storage, Automatic drive positioner .....	3-37
Meter	
Trip computer .....	2-24
Meters and gauges .....	2-5
Instrument brightness control .....	2-38
Mirror	
Inside mirror .....	3-33
Outside mirrors .....	3-35
Vanity mirror .....	3-36
Monitor, RearView Monitor .....	4-25
Mood lights .....	2-59
Moonroof .....	2-54
Moving Object Detection (MOD) .....	4-42
Multi-function controller .....	4-7

## N

New vehicle break-in .....	5-27
NISSAN Mobile Entertainment System (MES) .....	4-110
NISSAN Vehicle Immobilizer System .....	2-30
NISSAN Voice Recognition system .....	4-154

## O

Odometer .....	2-6
Off-road recovery .....	5-7
Oil	
Capacities and recommended fluids/lubricants .....	10-2
Changing engine oil and filter .....	8-6
Checking engine oil level .....	8-5

Engine oil .....	8-5
Engine oil viscosity .....	10-6
Oil filter replacement indicator .....	2-23
Operation, Operational indicators .....	2-21
Outside air temperature display .....	2-26
Outside mirrors .....	3-35
Overdrive OFF switch .....	5-15
Overheat, If your vehicle overheats .....	6-12
Owner's Manual/Service Manual order information .....	10-27

## P

Panic alarm .....	3-23
Parking	
Brake break-in .....	5-31
Parking brake operation .....	5-16
Parking on hills .....	5-29

## Phone

Bluetooth® hands-free phone system (Type A) .....	4-122
Bluetooth® hands-free phone system (Type B) .....	4-133
Bluetooth® hands-free phone system (Type C) .....	4-146
Car phone or CB radio .....	4-121

## Power

Front seat adjustment .....	1-4
Power door lock .....	3-5
Power outlet .....	2-42
Power sliding door .....	3-10
Power steering fluid .....	8-8
Power windows .....	2-52

## Precautions

Audio operation .....	4-61
Braking precautions .....	5-30
Child restraints .....	1-27

Cruise control.....	5-25
Maintenance.....	8-2
Seat belt usage.....	1-15
Supplemental restraint system.....	1-48
When starting and driving.....	5-2
Push starting.....	6-12
Push-button ignition switch.....	5-8, 5-9

## R

Radio.....	4-61
Car phone or CB radio.....	4-121
FM-AM-SAT radio with Compact Disc (CD) player.....	4-77, 4-87
Rapid air pressure loss.....	5-7
Readiness for inspection/maintenance (I/M) test.....	10-26
Rear personal lights.....	2-57
Rear window and outside mirror defroster switch.....	2-33
Rear window wiper and washer switch.....	2-32
RearView Monitor.....	4-25
Recorders, Event data.....	10-27
Registering in another country.....	10-8
Remote controller (DVD).....	4-120
Remote keyless entry system.....	3-21
Reporting safety defects (US only).....	10-25
Roadside assistance program.....	6-2
Rollover.....	5-6
Roof, Roof rack.....	2-50

## S

Safety	
Child seat belts.....	1-24
Reporting safety defects (US only).....	10-25
Towing safety.....	10-20

Satellite radio operation.....	4-88
Seat adjustment	
Front manual seat adjustment.....	1-3
Front power seat adjustment.....	1-4
Front seats.....	1-3
Seat belt(s)	
Child safety.....	1-24
Infants.....	1-25
Injured persons.....	1-17
Larger children.....	1-26
Precautions on seat belt usage.....	1-15
Pregnant women.....	1-17
Seat belt cleaning.....	7-6
Seat belt extenders.....	1-23
Seat belt hooks.....	1-23
Seat belt maintenance.....	1-24
Seat belt warning light and chime.....	2-15
Seat belts.....	1-15
Seat belts with pretensioners.....	1-62
Shoulder belt height adjustment.....	1-23
Small children.....	1-25
Three-point type.....	1-17
Seat(s)	
Driver-side memory.....	3-36
Heated seats.....	2-39
Seats.....	1-2
Security system (NISSAN Vehicle Immobilizer System), Engine start.....	2-30
Security system, Vehicle security system.....	2-28
Servicing air conditioner.....	4-60
SETTING button.....	4-15
Shift lever	
Shift lock release.....	5-16
Shift lock release, Transmission.....	5-16
Shifting, CVT (Continuously Variable Transmission).....	5-13
Shoulder belt height adjustment.....	1-23

Sliding doors.....	3-7
SOURCE select switch.....	4-109
Spare tire.....	8-38, 10-7
Spark plugs.....	8-13
Speedometer.....	2-6
Standard maintenance.....	9-7
Starting	
Before starting the engine.....	5-11
Jump starting.....	6-10
Precautions when starting and driving.....	5-2
Push starting.....	6-12
Starting the engine.....	5-12
STATUS button.....	4-10
Status light, Front passenger air bag.....	1-55
Steering	
Power steering fluid.....	8-8
Steering-wheel-mounted controls for audio.....	4-108
Tilt/telescopic steering.....	3-32
Storage.....	2-44
Sun visors.....	3-33
Sunglasses holder.....	2-46
Supplemental air bag warning labels.....	1-63
Supplemental air bag warning light.....	1-64, 2-15
Supplemental restraint system.....	1-48
Precautions on supplemental restraint system.....	1-48
Switch	
Autolight switch.....	2-34
Fog light switch.....	2-39
Hazard warning flasher switch.....	6-2
Headlight aiming control.....	2-37
Headlight switch.....	2-34
Overdrive OFF switch.....	5-15
Power door lock switch.....	3-6
Rear window and outside mirror defroster switch.....	2-33

Turn signal switch.....	2-38
Vehicle dynamic control (VDC) off switch ....	2-41

## T

Tachometer.....	2-7
Temperature display.....	2-26
Temperature gauge, Engine coolant temperature gauge.....	2-7
Theft (NISSAN Vehicle Immobilizer System), Engine start.....	2-30
Three-way catalyst.....	5-3
Tilt/telescopic steering.....	3-32
Tire	
Pressure, Low tire pressure warning light ....	2-14
Tire replacement indicator.....	2-23
Tires	
Flat tire.....	6-3
Low tire pressure warning system.....	5-3
Tire and Loading Information label....	8-29, 10-10
Tire chains.....	8-33
Tire dressing.....	7-4
Tire pressure.....	8-27
Tire pressure monitoring system (TPMS).....	5-3, 6-3
Tire rotation.....	8-35
Types of tires.....	8-33
Uniform tire quality grading.....	10-24
Wheel/tire size.....	10-7
Wheels and tires.....	8-27
Top tether strap child restraints.....	1-32
Touch screen system.....	4-7
Towing	
Flat towing.....	10-23
Tow truck towing.....	6-14
Towing a trailer.....	10-15
Towing safety.....	10-20

TPMS, Tire pressure monitoring system.....	5-3
TPMS with Easy Fill Tire Alert.....	5-6
TPMS, Tire pressure warning system.....	6-3
Trailer towing.....	10-15
Transceiver, HomeLink® Universal Transceiver ....	2-60
Transmission	
Continuously Variable Transmission (CVT) fluid.....	8-8
Driving with CVT (Continuously Variable Transmission).....	5-13
Transmission shift lever lock release.....	5-16
Transmitter (See remote keyless entry system).....	3-21
Traveling or registering in another country.....	10-8
Trip computer.....	2-24
Trip odometer.....	2-25
Turn signal switch.....	2-38

## U

Underbody cleaning.....	7-3
Uniform tire quality grading.....	10-24
USB (Universal Serial Bus) connection port.....	4-81, 4-94

## V

Vanity mirror.....	3-36
Vanity mirror lights.....	2-59
Variable voltage control system.....	8-12
Vehicle	
Dimensions and weights.....	10-8
Identification number (VIN).....	10-8
Loading information.....	10-12
Recovery (freeing a stuck vehicle).....	6-15
Security system.....	2-28
Vehicle dynamic control (VDC) off switch....	2-41

Vehicle dynamic control (VDC) system.....	5-32
Vehicle dynamic control (VDC) warning light.....	2-16
Vehicle information display.....	2-19
Ventilators.....	4-46
Voice command (Bluetooth® Hands-Free Phone System).....	4-139
Voice command (NISSAN Voice Recognition system).....	4-160, 4-168

## W

Warning	
Hazard warning flasher switch.....	6-2
Lights.....	2-12
Tire pressure monitoring system (TPMS).....	5-3, 6-3
Vehicle information display.....	2-19
Warning lights, indicator lights and audible reminders.....	2-11
Warning labels, Air bag warning labels.....	1-63
Warning light	
Air bag warning light.....	1-64, 2-15
Anti-lock braking system (ABS) warning light.....	2-12
Brake warning light.....	2-12
Intelligent Key system warning light.....	2-14
Low tire pressure warning light.....	2-14
Seat belt warning light and chime.....	2-15
Warranty, Emission control system warranty....	10-25
Washer switch	
Rear window wiper and washer switch.....	2-32
Wiper and washer switch.....	2-31
Washing.....	7-2
Waxing.....	7-2
Weights (See dimensions and weights).....	10-8
Wheel/tire size.....	10-7

Wheels and tires .....	8-27
Care of wheels .....	7-3
Cleaning aluminum alloy wheels.....	7-3
Window washer fluid.....	8-10
Window(s)	
Cleaning.....	7-3
Power windows.....	2-52
Wiper	
Rear window wiper and washer switch .....	2-32
Rear window wiper blade .....	8-17
Wiper and washer switch .....	2-31
Wiper blades .....	8-14
Wiper and washer switch .....	2-31

**X**

Xenon headlights .....	2-33
------------------------	------

## GAS STATION INFORMATION

### FUEL INFORMATION:

Use unleaded regular gasoline with an octane rating of at least 87 AKI (Anti-Knock Index) number (Research octane number 91).



### CAUTION

- **Using a fuel other than that specified could adversely affect the emission control system, and may also affect warranty coverage.**
- **Under no circumstances should a leaded gasoline be used, because this will damage the three-way catalyst.**
- **Do not use E-15 or E-85 fuel in your vehicle. Your vehicle is not designed to run on E-15 or E-85 fuel. Using E-15 or E-85 fuel in a vehicle not specifically designed for E-15 or E-85 fuel can adversely affect the emission control devices and systems of the vehicle. Damage caused by such fuel is not covered by the NISSAN new vehicle limited warranty.**

- **U.S. government regulations require ethanol dispensing pumps to be identified by a small, square, orange and black label with the common abbreviation or the appropriate percentage for that region.**

### ENGINE OIL RECOMMENDATION:

- **Genuine "NISSAN Motor Oil 0W-20 SN"**  
See "Capacities and recommended fluids/lubricants" (P.10-2) for engine oil and oil filter recommendation.

### COLD TIRE PRESSURES:

The label is typically located on the driver side center pillar or on the driver's door. For additional information, see "Wheels and tires" (P.8-27).

### NEW VEHICLE BREAK-IN PROCEDURES RECOMMENDATION:

During the first 1,200 miles (2,000 km) of vehicle use, follow the recommendations outlined in the "Break-in schedule" (P.5-27) of this Owner's Manual. Follow these recommendations for the future reliability and economy of your new vehicle.



Printing : September 2016 (20)  
Publication No.: OM17E0 0E52U0  
Printed in U.S.A.  
TOOUM-1JA7D

E52-D