



**1973**

**OPEL**

SERVICE MANUAL

## IMPORTANT SAFETY NOTICE

Proper service and repair is important to the safe, reliable operation of all motor vehicles. The service procedures recommended by BUICK and described in this service manual are effective methods for performing service operations. Some of these service operations require the use of tools specially designed for the purpose. The special tools should be used when and as recommended.

It is important to note that some warnings against the use of specific service methods that can damage the vehicle or render it unsafe are stated in this service manual. It is also important to understand these warnings are not exhaustive. BUICK could not possibly know, evaluate and advise the service trade of all conceivable ways in which service might be done or of the possible hazardous consequences of each way. Consequently, BUICK has not undertaken any such broad evaluation. Accordingly, anyone who uses a service procedure or tool which is not recommended by BUICK must first satisfy himself thoroughly that neither his safety nor vehicle safety will be jeopardized by the service method he selects.

BUICK MOTOR DIVISION  
**GENERAL MOTORS CORPORATION**  
**FLINT, MICHIGAN 48550**

© GENERAL MOTORS CORPORATION, 1972

Litho in U.S.A.

# 1973

# GT

# OPEL 1900

# MANTA

## CHASSIS SERVICE MANUAL

This manual contains service information for the 1973 Opel 1900, Manta and GT models. Refer to the introduction for a description of the arrangement of this manual for locating desired information easily.

**All information, illustrations and specifications contained in this manual are based on the latest product information available at the time of publication approval. Therefore, the right is reserved to make changes at any time without notice.**



TABLE OF CONTENTS	
GROUP NO	SUBJECT
0	GENERAL INFORMATION
1	ELECTRICAL
2	FRAME AND BUMPERS
3	SUSPENSION AND STEERING
4	REAR AXLE
5	BRAKES
6	ENGINE
7	TRANSMISSION
8	CHASSIS SHEET METAL
9	ACCESSORIES

The 1973 Opel Chassis Service Manual has been completely revised with respect to layout, format and information content in an attempt to provide you "The Technician" with a more logical and usable publication. An example of the new grouping layout 6 exhibited on the preceding page. Each group is sub-divided as follows:

Group	Subject	Contents
0	General Information	General Information Lifting Maintenance and Lubrication
1	Electrical	Battery Starting System Ignition System Charging System Washers and Wipers Lighting Systems Signal System Instrument Panel Gauges Wiring Diagrams
2	Body and Bumpers	General Body Information Frame & Body Mountings Windows & Window Moldings Doors Rear Compartment Lid Roof & Sun Roof Seat?, Interior Trim & Headlining Bumpers.
3	Suspension and Steering	Front Suspension Steering Linkages Front End Alignment Steering Gear Steering Column Rear Suspension Wheels and Tires
4	Propeller Shaft & Rear Axle	Propeller Shaft & Central Joint Differential
5	Brakes	Power Booster and Master Cylinder Front Disc Brake Rear Drum Brake
6	Engine	Engine Mechanical and Mounts Cooling System Fuel System Exhaust Systems Carburetor and Throttle Linkage Emission Control Systems Tune-up
7	Transmission	Clutch Manual Transmission Automatic Transmission
8	Chassis Sheet Metal	Hood, Fenders and Grille
9	Accessories	Heater Air-Conditioning Radio

## INTRODUCTION

The 1973 Opel Service Manual includes information on the Opel 1900, Manta and GT. It is organized to correspond with current servicing techniques. The various chassis components and systems have been classified into the nine (9) GROUPS.

Every GROUP contains one or more SECTIONS. Each SECTION deals with a specific version of a component or system.

The service information included in a SECTION is divided into five (5) basic DIVISIONS. The titles of each DIVISION are:

Description and Operation  
Trouble Diagnosis  
Maintenance and Adjustments  
Major Repair  
Specifications

A DIVISION contains one or more PARAGRAPHS which can be identified by their specific headings.

SUB-PARAGRAPHS are used when necessary for clarity or to provide distinction between component procedures.

## SPECIAL TOOLS

References are made throughout the Manual to special tool numbers, designated by the prefix letter "J". These tools are manufactured by the Kent-Moore Corporation, Inc. If equivalent special tools are not available locally, they may be obtained through:

Kent-Moore Corporation, Inc.  
28635 Mound Road  
Warren, Michigan 46092

## LOCATING DESIRED INFORMATION

To locate any desired information, locate the proper GROUP listed on the second page of the Manual. Bend the Manual until the black tab on the first page of the GROUP can be seen in line with the GROUP title on the second page. The first page of the GROUP lists the SECTIONS contained therein. Turn to the proper SECTION, locate the desired DIVISION and note the PARAGRAPH containing the information you are seeking.



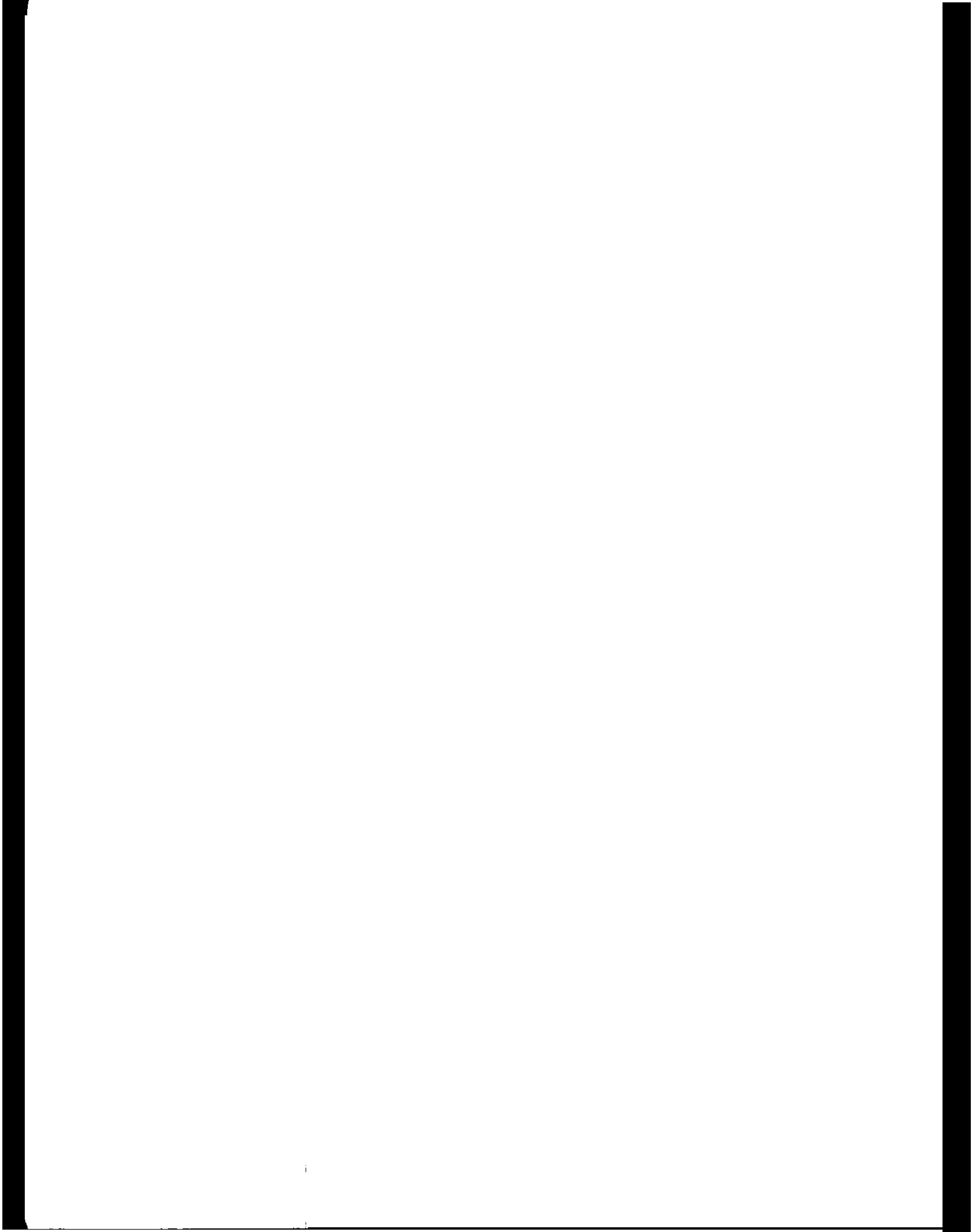
---

**GROUP 0**

**GENERAL  
INFORMATION**

<b>Section</b>	<b>Title</b>	<b>Page</b>
<b>OA</b>	<b>General Information</b>	<b>OA-1</b>
<b>OB</b>	<b>Vehicle Lifting Points</b>	<b>OB-4</b>
<b>OC</b>	<b>Maintenance and Lubrication.</b>	<b>OC-5</b>





## GENERAL INFORMATION

### KEYS AND LOCKS

Every key has a number engraved on one side which identifies the **key** blank manufacturer. On the opposite side of GT keys, is a **removable** adhesive foil on which, the profile and cutting code letters and numbers are imprinted. Attached to the protective key cover of Opel 1900 and Manta keys, is a tab on which the profile and cutting code letters and numbers are imprinted. Record the key cutting code letters and numbers before the adhesive foil or plastic tabs are discarded as this information is necessary to obtain replacement keys.

In the event of lost keys and code records, one or more locks may **be** removed to obtain the **code** numbers. The codes are stamped on the trunk and ignition lock cylinders and on the door lock plunger shaft. If a lock cylinder is damaged, it must be replaced. This then means that the owner will have an additional key.

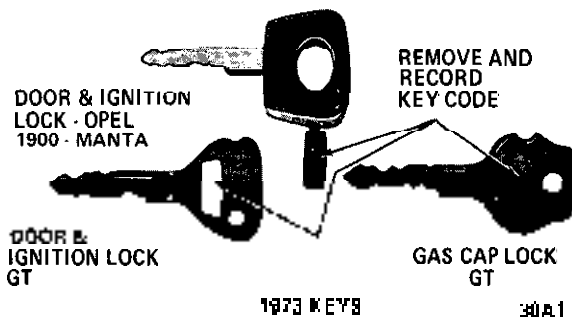


Figure OA-1 1973 Keys

### FEDERAL CERTIFICATION LABEL

In accordance with Federal Motor Vehicle Regulations, a certification label is **affixed** to all 1973 models.

The label has a certification statement, vehicle identification number, and month and year that the vehicle was built. The label is attached vertically to the left front door inner panel lock facing. See Figure OA-2.

### VEHICLE IDENTIFICATION

#### Model Identification Plate

The model identification plate as illustrated in Figure OA-3 is attached to the inside right front inner fender panel on Opel 1900 and Manta and on top of the right side of the cowl on the GT. The information embossed on this plate includes such things as; type and model of vehicle, allowable front axle load, allowable maximum vehicle weight, allowable rear axle load, paint color **code** and chassis serial number. The key to identification is that the **first** two digits

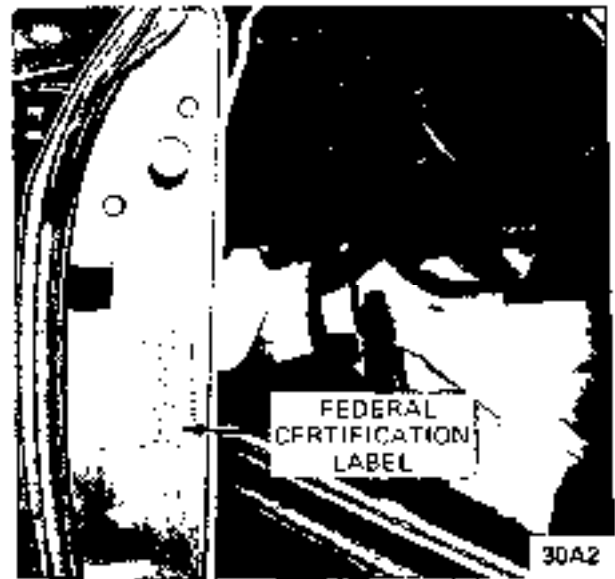


Figure OA-2 Federal Certification Label Location

of the serial number represents the vehicle model. The remaining digits are the actual serial number.

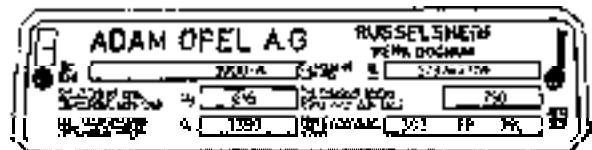


Figure OA-3 Model Identification Plate

#### Engine Number

The engine number is stamped in a machined boss on the upper left center of the engine block. The number starts with **1.9US** which denotes the displacement in Liters and also that the engine is equipped with the Opel Emission Control System.

#### Vehicle Identification Number

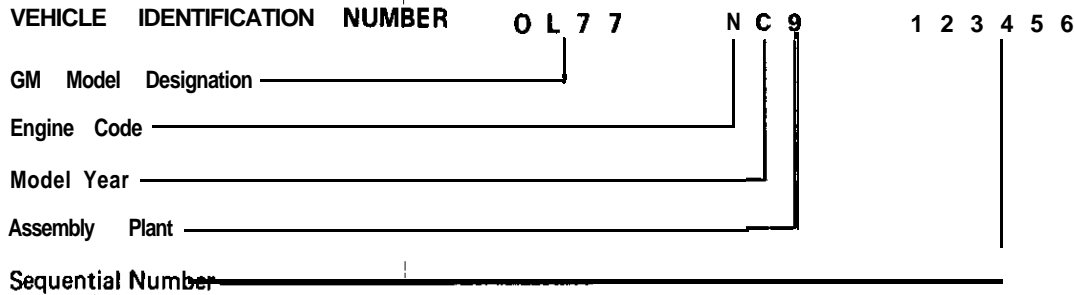
A new thirteen digit vehicle identification number is used on all Opel models imported for 1973. It is embossed on a narrow strip of metal which is attached to the left windshield post on Opel 1900 and Manta models and to the top of the left end of the instrument panel cover. In all cases the number is **visible** when looking through the windshield from outside the vehicle.

This new identification number includes; model designation, engine code, model year, assembly plant and the sequential number. See Figure OA-4.

# OA-2 1973 OPEL SERVICE MANUAL

## MODEL DESIGNATIONS

- OL11 • OPEL 1900 2DR SEDAN
- OL60 • OPEL 1900 4DR SEDAN
- OL15 OPEL 1900 3DR WAGON
- OL77 • { MANTA 2 DR SPT. CPE.  
MANTA 2DR RALLYE SPT. CPE.  
MANTA LUXUS 2DR SPT. CPE.
- OY07 GT 2DR SPT. CPE.



## GENERAL SPECIFICATIONS

SERIES	MODEL AND NAME	WHEEL BASE	FRONT TREAD	REAR TREAD	CURB WEIGHT	OVERALL		
						WIDTH	LENGT,	HEIGHT
Opel 1900	51- 2Dr Sedan	52.4	52.4	52	2138 *	64.3	164.6	52.6
	53- 4Dr Sedan				2183 *			
	54- 3Dr Wagon				2227 •			
Manta	57- 2Dr Spt. Cpe.				2183 •		171	51.3
	57R- 2Dr Rallye Spt. Cpe.				2205 •			
Manta Luxus	57L- 2Dr Luxus Spt. Cpe				2183 •			
GT	77- 2Dr Spt. Cpe.	50.6	50.6	50.6	2120 *	62.2	161.9	47.4

• Add 44 lbs. for auto. trans.

30A4

Figure OA-4 General Information

## PAINT

Two types of paint are again used for 1973, Enamel and Acrylic. The word "Acrylic" is embossed on the

Vehicle Identification Plate when that type of paint is used. Paint supplied by U.S. suppliers for repair work is applicable on either type paint except that a different match formula is required.

EXTERIOR PAINT		MODELS						
Code	Name	51	53	54	57	57L	57R	77
C	Alpine White	X	X	X	X		X	X
O	Strato Blue	X	X	X	X		X	X
F	Glacier Blue	X	X	X	X		X	
H	Jade Mist	X	X	X	X		X	X
Q	Rallye Gold	X	X	X	X		X	X
R	Flame Red	X	X	X	X		X	X
T	Antique Bronze	X	X	X	X		X	
X	Fire Glow	X	X	X	X		X	X
Y	Chrome Yellow	X	X	X	X		X	X
M	Deep Burgundy					X		
B	Regency Blue					X		
S	Grecian Silver					X		

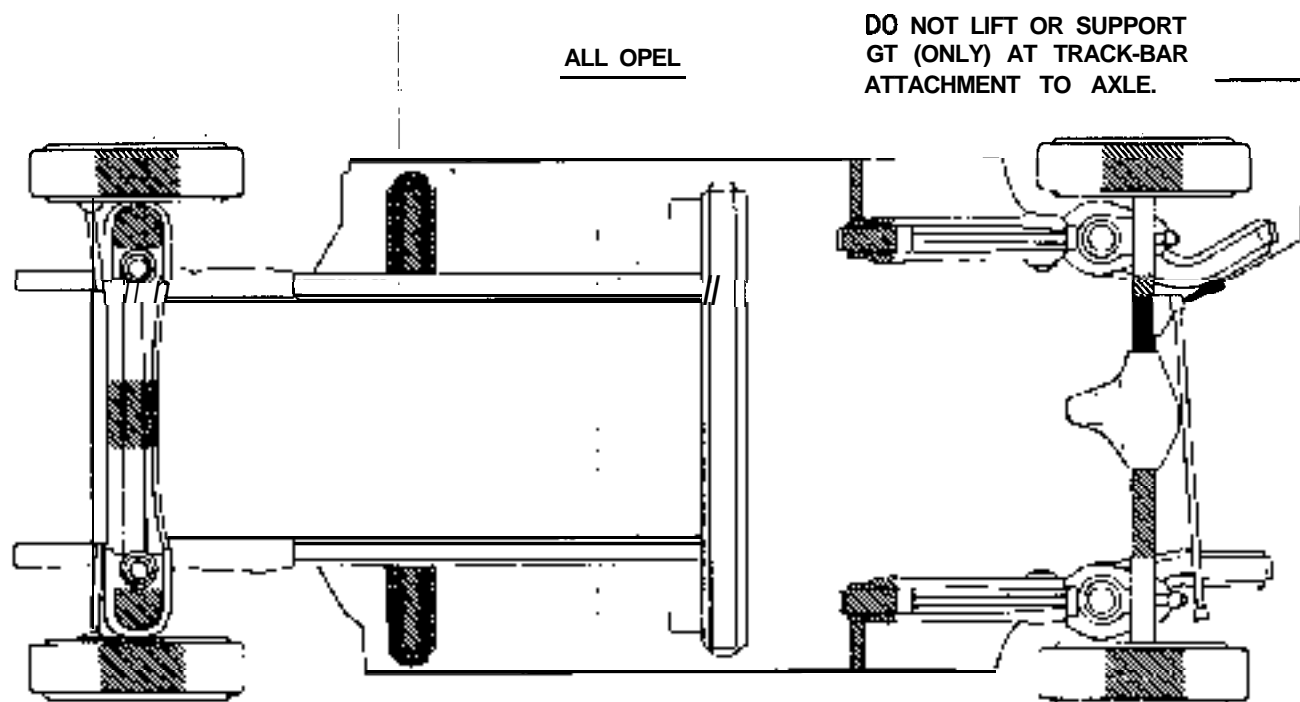
VINYL TOP COLOR		51	53	54	57	57L	57R	77
	Black				X	X <sup>a</sup>	X	
	Burgundy					X <sup>b</sup>		
	Dark Blue					X <sup>c</sup>		

<sup>a</sup>Vinyl top color coordinated with exterior color.

30A5

Figure OA-5 Paint and Vinyl Top Color Chart

# VEHICLE LIFTING ALL MODELS



NOTE: SUPPORTS MUST BE POSITIONED  
SO AS TO DISTRIBUTE LOAD AND SUPPORT  
VEHICLE IN A STABLE MANNER.

30B1

Figure 0B-1 Vehicle Lifting Points

If it is necessary to use any lifting device other than the original equipment jack, such as a hydraulic, scissors or floor jack, or a service station or dealer hoist, see Figure OB-1 for acceptable lifting points. Lifting should only be done at the positions indicated to prevent possible damage to the vehicle.

**CAUTION:** Failure to follow the procedure outlined above may result in unsatisfactory vehicle performance, or a durability failure which may result in loss of control of the vehicle.

# LUBRICATION AND MAINTENANCE

**VAPOR CANISTER (GT)** - Replace foam rubber filter in lower part of canister at 12,000 miles or 12 months, whichever occurs first.

**BRAKE MASTER CYLINDER** - Maintain level between min. and max. reservoir - MBF - 6,000

**FRONT SUSPENSION** - No lubrication required

**VAPOR CANISTER (OPEL 1900)** - Replace foam rubber filter in lower part of canister at 12,000 miles or 12 months, whichever occurs first.

**FUEL FILTER (In Line)** - Replace every 12 months or 12,000 miles, whichever occurs first.

**ENGINE OIL** - Drain and refill - EO - 4 months or 3,000 miles, whichever occurs first.

**BATTERY** - Check level periodically.

**BATTERY** - Check level periodically. (GF)

**RADIATOR** - Maintain coolant 2" below top of filler neck. Check every 4 mo. or 8,000 miles. Replace coolant: Every 2 years.

**ENGINE BELTS** - Check condition and proper tension. 6,000

**FRONT WHEEL BEARINGS** - Repack when brakes are inspected or serviced with a high melting point grease Part No. 1051344 or equivalent.

**AIR CLEANER** - Clean element (160 mesh) 15,000 inspect, replace if necessary (paper) 6,000 Replace (paper) 24,000

**TIRES** - Rotate 6,000 Maintain Pressure Periodically Refer to Group 3 for correct pressure.

**OIL FILTER** - Replace with first oil change and then at alternate oil changes.

**CRANKCASE VENTILATOR METERED ORIFICE** - Clean 6,000

**VALVE ROCKER ARM COVER - WAVE MESH** - Clean 6,000

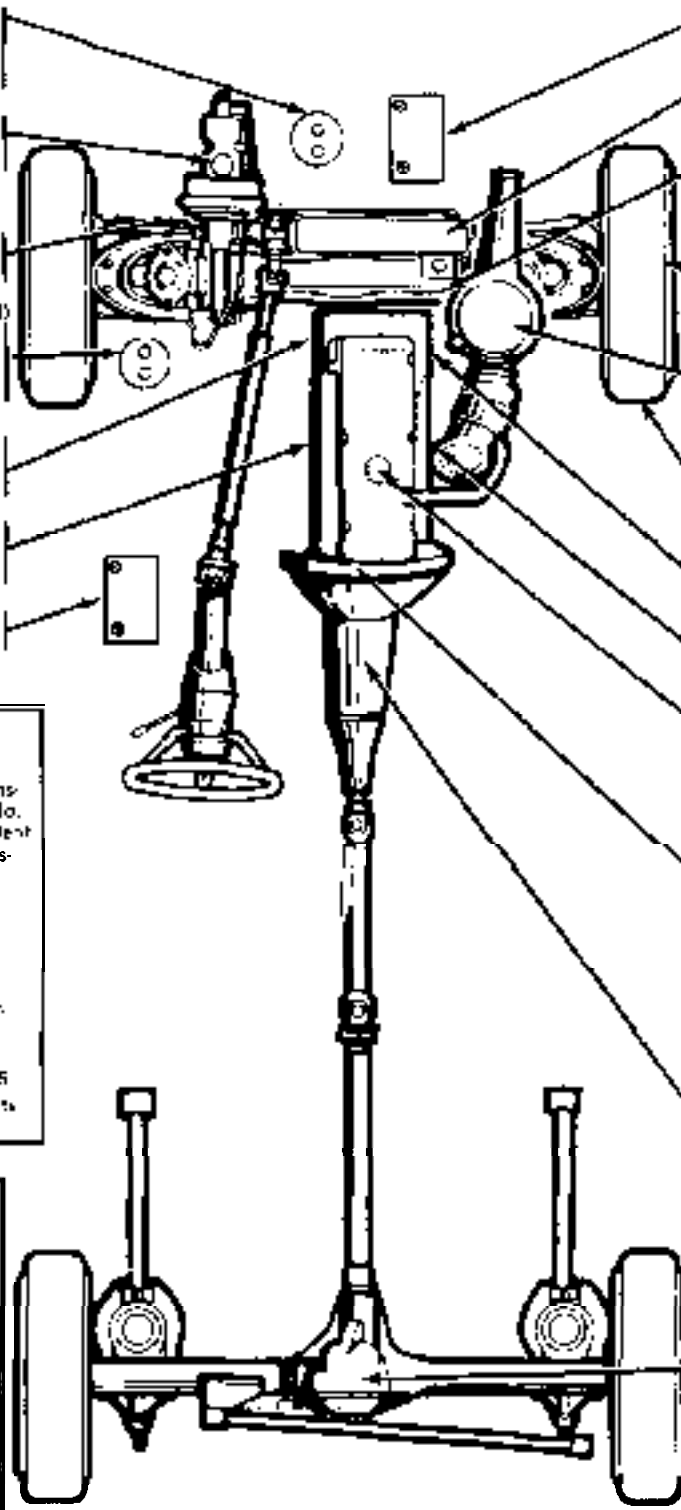
**CLUTCH LASH (GT)** - Adjust AT FIRST 3,000 (OPEL 1900) 6,000

**CLUTCH ADJUSTMENT (OPEL 1900 AND MANTA)** - Clutch adjustment is only required if the indicator light (brake warning flasher comes on).

**MANUAL TRANSMISSION** - Maintain at filler opening. Flushing and external changes NOT recommended. M.P.G. SAE 80 or 90 6,000

**AUTOMATIC TRANSMISSION** - Check fluid 6,000 Drain and replace strainer if needed Normal 24,000 Heavy Duty 12,000

**REAR AXLE** - Check lubricant level and add lubricant, if necessary, to fill to level of filler plug hole. Use SAE 80 or SAE 90 GL-5 Gear Lubricant every 4 months or 3,000 miles, whichever occurs first.



LUBRICANTS	
AT	OLYRON Automatic Transmission Fluid GM Part No. 1050860-89-79 or Equivalent
EO	Engine Oil (Current Viscosity) SE*
UB	Lubriplate*
MBF	Hydraulic Brake Fluid - Delco supreme NO. 11*
WBL	High Melting Point Wheel Bearing Lubricant Part No. 1051344 or equivalent.
MPE	Multi-Purpose Gear Lubricants SAE 80 or 90 or GL-5
*Equivalent Acceptable if it Meets Specifications.	

CAPACITIES	OPEL 1900	
	MANTA	GT
Cooling System (Qts.)	6	6
Crankcase Refill (Qts.)	5	3
With Oil Filter Change	3 1/2	3 3/4
Fuel Tank (Gals.)	11 1/2	14 1/2
Transmission (Pts.)		
Manual Trans	2 1/2	2 1/2
Auto. Trans with converter	10 1/2	10 1/2
Rear Axle (Pts.)	2 1/2	2 1/2

Figure OC-1 1973 Lubrication Chart

LUBRICATION AND GENERAL MAINTENANCE

When To Perform Service (Months or Miles, Whichever Occurs First)	Item No.	Services
Every 4 months or 3,000 miles	1	*Engine Oil
At 1st oil change—then every 2nd	2	*Engine Oil Filter
Every 4 months or 6,000 miles	3	Chassis Lubrication
	4	* Fluid Levels
Every 8,000 miles	5	Tire Rotation
	6	Clutch
Every 12,000 miles	7	Rear Axle
Every 12 months or 12,000 miles	8	*Cooling System
	9	Wheel Bearings
Every 24,000 miles	10	*Automatic Transmission

SAFETY MAINTENANCE

Every 4 months or 6,000 miles	11	Brake lines and hoses
	12	Tires and Wheels
	13	Exhaust System
	14	*Engine Drive Belts
	15	Suspension and Steering
	16	Owner Safety Checks
Every 6,000 miles	17	Disc Brakes
Every 12 months or 12,000 miles	18	Drum Brakes and Parking Brake
	19	Throttle linkage
	20	Headlights
	21	Underbody

EMISSION CONTROL MAINTENANCE

At 1st 4 months or 6,000 miles— then at 12 month/12,000 mile intervals	22	Thermostatically Controlled Air Cleaner
	23	Carburetor Choke
	24	Timing, dwell, Carburetor Idle Speed, Distributor
At 1st 4 mos. or 6,000 miles	25	Carburetor
Every 6,000 miles	26	Spark Plugs
Every 12 months or 12,000 miles	27	Carburetor Fuel Inlet Filter
	28	PCV System
	29	ECS System
	30	EGR System
Every 24 months or 24,000	31	Engine Compression
	32	Fuel Cap, Tank and Lines
Every 24,000 miles	33	Air Cleaner Element
At 1st 24/24—then every 12/12	34	Spark Plug Wires
*Also an Emission Control Service		• Also a Safety Service

30C2

Figure OC-2 1973 Maintenance Schedule

**SERVICES**

**LUBE AND GENERAL MAINTENANCE**

Vehicle operation under conditions such as heavy dust, continuous short trips, use of other than un-**leaded** or low lead fuels or pulling trailers, is not considered normal use and therefore more frequent maintenance will be required. Such additional maintenance requirements are included where applicable.

**Engine Oil**

Change each 4 months or **3,000** miles, whichever occurs first, or each 2 months or **3,000** miles when the vehicle is operated under the following conditions: (a) driving in dusty conditions, (b) trailer pulling, (c) extensive idling or (d) short-trip operation at freezing temperatures (with engine not thoroughly warmed-up).

Engine oils have a definite effect on ease of starting, oil economy, combustion chamber deposits and engine wear. It is recommended that a" oil which, according to the label on the can is; (1) intended for service SE and (2) passes car makers' tests be used. Oils conforming to these **types** contain detergent additives.

Select the proper oil viscosity from Figure OC-3.

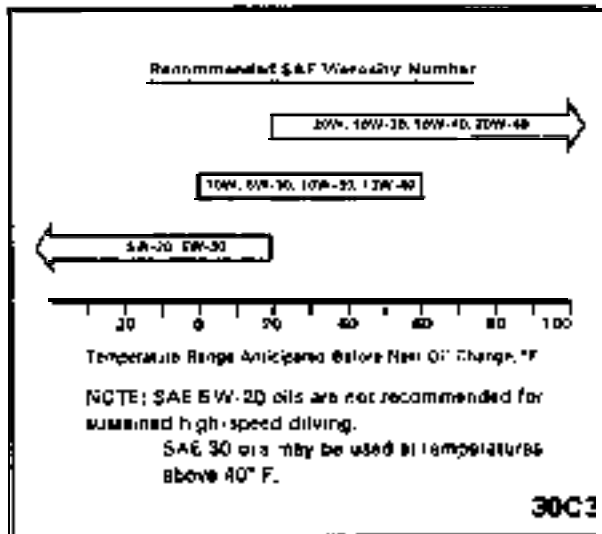


Figure OC-3 Oil Viscosity Chart

**Engine Oil Filter**

Replace at the **first** oil change and every other oil change thereafter using Part No. 7965051 or equivalent.

**Chassis**

Lubricate transmission shift linkage, hood latch and parking brake cable guides and linkage.

**Fluid Levels**

Check level of fluid in brake master cylinder, battery, engine, axle, transmission and windshield washer. Engine coolant also should be checked for proper level and for corrosion and freeze protection to at least -20°F or to the lowest temperature expected during the period of vehicle operation. Proper engine coolant also provides corrosion protection.

Any significant fluid loss in any of these systems or units could mean that a malfunction is developing and corrective action should be taken immediately. A low fluid level in the brake master cylinder front reservoir could also be a" **indicator** that the disc **brake** pads need replacing.

The engine oil should **be** maintained at proper level. The best time to check it is before operating the engine or as the last step in a fuel stop. **THIS WILL ALLOW THE NORMAL OIL ACCUMULATION IN THE ENGINE TO DRAIN BACK IN THE CRANKCASE.** To **check** the level, remove the oil gauge rod (dipstick), wipe it clean, and reinsert it for a" accurate reading. The oil level should be maintained in the safety margin, neither going **above** the "FULL" mark "or below the "ADD OIL" mark. See Figure OC-4.

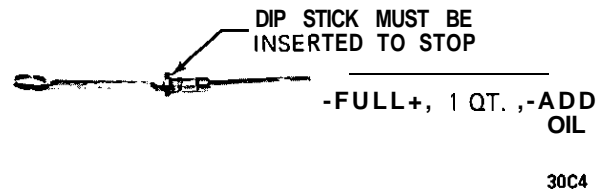


Figure OC-4 Engine Oil Dipstick

All models are equipped with tandem brake cylinders. Maintain fluid level between MIN and MAX marks on reservoir. See Figure OC-5. When adding fluid use Delco Supreme No. 11 or equivalent.

**Tires**

To equalize wear, rotate tires as illustrated in Figure OC-6.

**Clutch**

Adjust clutch when necessary as indicated by the clutch warning lamp on Opel 1900 and Manta or





Figure OC-5 Brake Master Cylinder

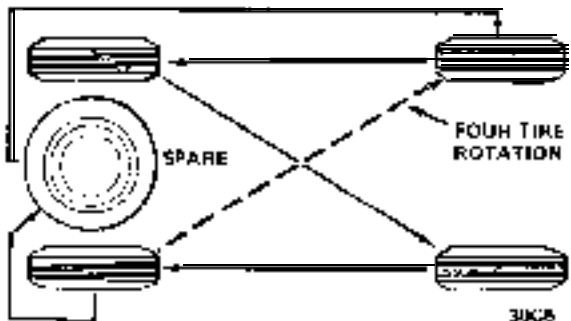


Figure OC-6 Tire Rotation Methods

when the clutch pedal has in excess of 1 1/4 inch free travel. See Figure OC-7.

**Rear Axle**

Change lubricant every 12,000 miles when vehicle is used for pulling a trailer.

**Cooling System**

Check at 12-month or 12,000-mile intervals, wash radiator cap and filler neck with clean water, pressure test system and radiator cap for proper pressure holding capacity (tighten hose clamps and inspect condition of all cooling and heater hoses). Replace hoses every 24 months or 24,000 miles or earlier if checked, swollen or otherwise deteriorated.

Also each 12 months or 12,000 miles, clean exterior of radiator core. Every 24 months or 24,000 miles,

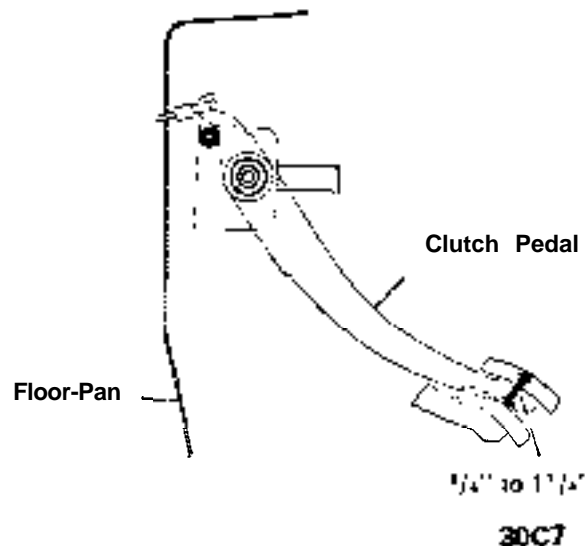


Figure OC-7 GT Clutch Lash

drain, flush, and refill the cooling system with a new coolant solution of permanent type anti-freeze and water for protection-of -20°F. DO NOT REMOVE RADIATOR CAP WHEN SOLUTION IS HOT AND UNDER PRESSURE.

**Wheel Bearings**

Clean and repack front wheel bearings with a lubricant as specified on the lubrication chart, Figure oc-1.

**Automatic Transmission Fluid**

Under normal driving conditions, change the transmission fluid every 24,000 miles. Under unusual conditions such as constant driving in heavy city traffic during hot weather, trailer pulling, etc., this service should be performed at 12,000 mile intervals.

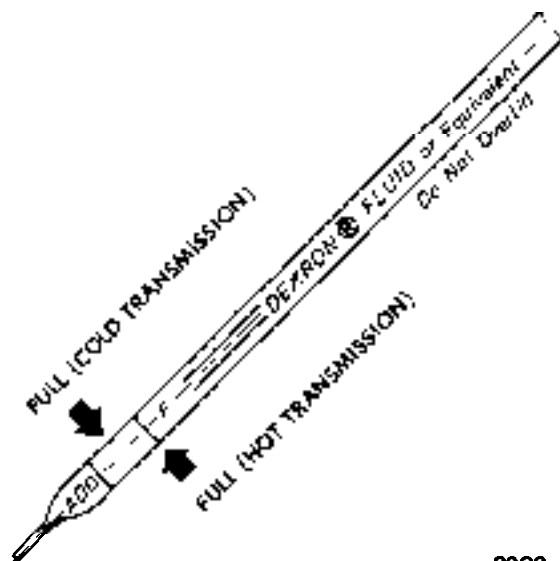
General Motors DEXRON Automatic Transmission Fluid, which has been especially formulated and tested for use in your automatic transmission, is recommended. Other automatic transmission fluids identified with the mark DEXRON are also recommended.

Check the fluid level at each engine oil change period. To make an accurate fluid level check:

1. Drive car several miles, making frequent starts and stops, to bring transmission up to normal operating temperature (approximately 180-190°F.)
2. Park car on a level surface.
3. Place selector lever in "Park" and leave engine running.

4. Remove dipstick and wipe clean.
5. Reinsert dipstick until cap seats.
6. Remove dipstick and note reading.

If fluid level is **at** or below the **ADD** mark, add sufficient fluid to raise the level to the **FULL** mark. One pint raises the level from **ADD** to **FULL**. Do not overfill.



30C8

Figure OC-8 Automatic Transmission Dipstick

## SAFETY MAINTENANCE

### Brake Lines and Hoses

Check for proper attachment, leaks, cracks, chafing, deterioration, etc. Any questionable parts noted should be replaced or repaired immediately. When abrasion or wear is evident on lines or hoses, the cause must be corrected.

### Tires and Wheels

Check tires for excessive wear, nails, glass, cuts or other damage. Make certain wheels are not bent or cracked **and** wheel nuts are tight. Uneven or abnormal tire wear may indicate the need for alignment service. Tire inflation pressure should be checked by the owner at least monthly, or more often if daily visual inspection indicates the need.

### Exhaust System

Check complete exhaust system and nearby **body** areas and trunk lid for broken, damaged, missing or **mispositioned** parts, open seams, holes loose connections or other deterioration **which** could permit ex-

haust fumes to seep into the trunk or passenger compartment. Dust or water in the trunk may be an indication of a problem in one of these areas. Any defects should **be** corrected immediately. To help insure continued integrity, exhaust system pipes and resonators rearward of the **muffler** must be replaced whenever a new **muffler** is installed. Use genuine GM parts specified for the vehicle.

### Engine Drive Belts

Adjust belts driving fan, alternator and other accessories at **first** 4 months or **6,000** miles of vehicle operation. At each subsequent 4 **month/6,000** mile interval, check belts for cracks, fraying, wear and tension. Adjust or replace as necessary. It is recommended that belts be replaced every 24 months or **24,000** miles, whichever occurs **first**.

### Suspension and Steering

Check for damaged, loose or missing parts, or parts showing visible signs of excessive wear or lack of lubrication in front and rear suspension and steering system. Questionable parts noted should be replaced without delay.

### Safety Checks to be Performed by Owner

**Listed** below are the safety checks that should be made by the owner (items a thru t). These checks should be made at least every 4 months or **6,000** miles, whichever occurs first, or more often when the need is indicated. Any deficiencies should be brought to the attention of your dealer or another service outlet, as soon as possible, so the advise of a qualified mechanic is available regarding the need for repairs or replacements.

A. Steering Column Lock • Check for proper operation by attempting to turn key to **LOCK** position and turning steering wheel with car stationary. Steering wheel should turn as long as key remains in lock. When key is **removed** steering wheel should lock. Key should be removable only in **LOCK** position.

B. Lap and Shoulder Belts • Check belts, buckles, retractors and anchors for cuts, fraying or weakened portions, loose connections, damage, and for proper operation. Check to make certain that anchor mounting bolts are tight.

C. Steering • Be alert to any changes in steering action. The need for inspection or servicing may **be** indicated by "hard" steering, excessive free play or unusual sounds when turning or parking.

D. Windshield Wipers and Washers • Check operation of wipers, as well as condition and alignment of

wiper blades. Check amount and direction of fluid sprayed by washers during use.,

E. Defrosters • Check performance by moving controls to “DEF” and noting amount of air directed against the windshield.

F. Wheel Alignment and Balance • In addition to abnormal tire wear, the need for wheel alignment service may be indicated by a pull to the right or left when driving on a straight and level road. The need for wheel balancing is usually indicated by a vibration of the steering wheel or seat while driving at normal highway speeds.

G. Brakes • Be alert to illumination of the brake warning light or changes in braking action, such as repeated pulling to one side, unusual sounds when braking or increased brake pedal travel. Any of these could indicate the need for brake system inspection and/or service.

H. Parking Brake and Transmission “PARK” Mechanism • Check parking brake holding ability by parking on a fairly steep hill and restraining the vehicle with the parking brake only. On cars with automatic transmissions, check the holding ability of the “PARK” mechanism by releasing all brakes after the transmission selector lever has been placed in the “P” position.

I. Glass • Check for broken, scratched, dirty or damaged glass on vehicle that could obscure vision or become an injury hazard.

J. Lights and Buzzers • Check all instrument panel illuminating and warning lights, seat belt reminder light and buzzer, ignition key buzzer, interior lights, license plate lights, side marker lights, headlamps, parking lamps, tail lamps, brake lights, turn signals, backup lamps, and hazard warning flashers. Have someone observe operation of each exterior light while you activate the controls: The operation of instrument panel warning lights is covered in the “Starting and Operating” section of your Owner’s Manual.

K. Transmission Shift Indicator • Check to be sure automatic transmission shift indicator accurately indicates the shift position selected.

**CAUTION:** Before making the check below, be sure to have a clear distance ahead and behind the car, set the parking brake and firmly apply the foot brake. Do not depress accelerator pedal. Be prepared to turn off ignition switch immediately if engine should start.

L. Starter Safety Switch (Automatic Transmission Cars) • Check starter safety switch by placing the transmission in each of the driving gears while at-

tempting to start the engine. The starter should operate only in the Park (“P”) or Neutral (“N”) positions.

M. Horn • Blow the horn occasionally to be sure that it works. (Ignition switch must be in the “ON” position.)

N. Seat Back Latches • Check to see that seat back latches are holding by pulling forward on the top of each folding seat back.

O. Rearview Mirrors and Sun Visors • Check that friction joints are properly adjusted so mirrors and sun visors stay in the selected position.

P. Door Latches • Check for positive closing, latching and locking.

Q. Hood Latches • Check to make sure hood closes firmly by pressing on the hood at the latching point after each closing. Check also for broken, damaged or missing parts which might prevent secure latching.

R. Fluid Leaks • Check for fuel, water, oil or other fluid leaks by observing the ground beneath the vehicle after it has been parked for a while. If gasoline fumes or fluid are noticed at any time, the cause should be determined and corrected without delay because of the possibility of fire.

S. Exhaust System • Be alert to any change in the sound of the exhaust system or a smell of fumes which may indicate a leak.

Head Restraints • Check that no head restraint components are missing, damaged or loose. (Does not apply to GT Models).

#### Disc Brakes

Check brake pads and condition of rotors while wheels are removed during tire rotation. (Note below regarding more frequent checks also applies to disc brakes.)

#### Parking and Drum Brakes

Check drum brake linings and other internal brake components at each wheel (drums, wheel cylinders, etc.). Parking brake adjustment also should be checked whenever drum brake linings are checked.

**NOTE:** More frequent checks should be made if driving conditions and habits result in frequent brake application. When brakes require relining, it is recommended that you use those genuine General Motors parts specified for your car, and Delco fluid as required.

**Throttle Linkage**

Check for damaged or missing parts, interference or binding. Any deficiencies should be corrected without delay.

**Headlights**

Check for proper aim. Correct as necessary. More frequent checks should be made if oncoming motorists signal when you are already using your low beams, or if illumination of the area ahead seems inadequate.

**Underbody**

In geographic areas using a heavy concentration of road salt or other corrosive materials for snow removal or road **dust** control, flush and inspect the complete under **side** of the car at least once each year, preferably after a winter's exposure. Particular attention should be given to cleaning out underbody members where dirt and other foreign materials may have collected.

**EMISSION CONTROL MAINTENANCE****Thermostatically Controlled Air Cleaner**

Inspect installation to make certain that all hoses and ducts are connected and correctly installed. Also, check valve for proper operation.

**Carburetor Choke**

Check **choke** mechanism for free operation. A binding condition may have developed from petroleum gum formation on the choke shaft or from **overtightening** of air cleaner clamp. Also check electric choke terminal connections and fuse.

**Timing, Dwell and Distributor**

Adjust timing **and** dwell accurately as outlined under Tune-Up in Group 6 at the first 4 months or **6,000** miles of operation, then at 12 month or **12,000** mile intervals. Adjustments must be made with test equipment known to **be accurate**.

Replace distributor points every 12 months or 12,000 miles and carefully clean and inspect the complete distributor cap to prevent misfiring and deterioration.

**Carburetor and Idle Speed**

Torque carburetor attaching bolts and/or nuts to 12 **ft.lbs.** to compensate for compression of gasket at **first** 4 months or 6,000 miles of vehicle operation.

Adjust idle speed to specifications with known accurate equipment.

Proper functioning of the carburetor is particularly essential to control of emissions. Correct mixtures for emission compliance and idle quality have been preset by Opel. Plastic idle mixture limiters have been installed on the idle mixture screw, idle air screw, and throttle stop screw to preclude unauthorized adjustment. The plastic caps on the idle mixture screw and the idle adjustment screw must be removed to perform an idle speed adjustment. The plastic cap on the throttle stop screw is not to be removed unless some major carburetor repair or replacement which affects the throttle stop screw adjustment has been necessary.

**Carburetor Fuel Inlet Filter**

Replace filter at 12 month or **12,000** mile intervals or more often if clogged.

**Spark Plugs**

Replace at **6,000** mile intervals when operating with leaded fuels or at 12,000 mile intervals when using unleaded fuels. Use of leaded fuels results in lead deposits on spark plugs and can cause misfiring at mileages less than **12,000** miles. Where misfiring occurs prior to **6,000** miles, spark plugs in good condition can often be cleaned, tested and reinstalled in an engine with acceptable results.

**Spark Plug Wires**

Inspect spark plug wires for evidence of checking or cracking of exterior insulation and tight fit in the distributor cap and at the spark plugs. Exterior of wires should **be** cleaned, any evidence of corrosion on ends removed and wire replace if deteriorated.

**Positive Crankcase Ventilation System**

The PCV metered orifice should be cleaned at 12,000 mile intervals under normal use, and at 6,000 mile intervals when the vehicle is used **under** the following conditions: driving in dusty conditions, extensive idling, trailer pulling and short trip operation at freezing temperatures (engine not thoroughly warmed-up).

**Evaporation Control System**

Check all fuel and vapor lines and hoses for proper connections and correct routing as well as condition. Remove canister and check for cracks or damage. Replace damaged or deteriorated parts as necessary. Replace filter in open end of canister at **24 month/24,000** mile intervals.

### Exhaust Gas Recirculation System

Check system operation at 12 month/12,000 mile intervals. Clean valve and EGR passages if required; A valve with a damaged diaphragm must be replaced.

### Engine Compression

Test engine cranking compression. If a problem exists, correct it. Minimum compression recorded; in any one cylinder should not be less than 70% of highest cylinder. For example, if the highest pressure in any one cylinder is 150 pounds, the lowest allowable pressure for any other cylinder would be 105 pounds ( $150 \times 70\% = 105$ ).

### Fuel Cap, Fuel Lines and Fuel Tank

Inspect the fuel tank, cap and lines for damage which could cause leakage. Inspect fuel cap for correct sealing ability and indications of physical damage. Replace any damaged or malfunctioning parts.

### Air Cleaner Element

Replace the engine air cleaner element under normal operating conditions every 24,000 miles. Operation of vehicle in dusty areas will necessitate more frequent element replacement.

**CAUTION:** *Do not operate the engine without the air cleaner unless temporary removal is necessary during repair or maintenance of the vehicle. When the air cleaner is removed, backfiring can cause fire in the engine compartment.*

---

**GROUP 1**

**ELECTRICAL**

<b>Section</b>	<b>Title</b>	<b>Page No.</b>
<b>IA</b>	<b>Battery and Cables .....</b>	<b>1A- 2</b>
<b>1B</b>	<b>Starting System .....</b>	<b>1B-10</b>
<b>1C</b>	<b>Ignition System , .</b>	<b>1C-18</b>
<b>ID</b>	<b>Charging System</b>	<b>1 D-28</b>
<b>1E</b>	<b>Washers and Wipers ..</b>	<b>1 E-37</b>
<b>IF</b>	<b>Lighting Systems</b>	<b>1 F-45</b>
<b>1G</b>	<b>Signal Systems</b>	<b>1 G-54</b>
<b>1H</b>	<b>instrument Panel .....</b>	<b>1 H-57</b>
<b>II</b>	<b>Gauges .....</b>	<b>1 I-65</b>
<b>1J</b>	<b>Wiring Circuit Diagram:</b>	<b>1 J-72</b>

# BATTERY AND CABLES

## ALL MODELS

### CONTENTS

Subject	Page No.
<b>DESCRIPTION AND OPERATION:</b>	
General Battery Information .....	1 A-2
<b>DIAGNOSIS:</b>	
Battery and Cables - Trouble Diagnosis .....	1 A-4
<b>MAINTENANCE AND ADJUSTMENTS:</b>	
Periodic Battery Inspection and Service .....	1 A-5
421 Battery Test .....	1 A-6
Hydrometer Test of Battery .....	1 A-7
Fusible Links .....	<b>1A-8</b>
Battery Recharging .....	1 A-9
<b>MAJOR REPAIR:</b>	
Battery Removal and Installation .....	1 A-9
Fusible Links Removal and Installation .....	1 A-9
<b>SPECIFICATIONS:</b>	
Battery Specifications .....	1 A-9

## DESCRIPTION AND OPERATION

### GENERAL BATTERY INFORMATION

#### Registration of Battery

United-Delco Battery dealers and distributors are prepared to carry **out** terms of the manufacturer's warranty on Delco-General batteries. In order that Opel owners shall have the protection and benefit of this warranty, it is necessary for the dealer or car owner to register his battery with the local United-Delco **Battery** dealer or distributor on all new car deliveries, and on all deliveries of new replacement Delco batteries. The Battery Owner's Certificate is located in the Owner's Protection Plan Booklet.

#### Care of Wet Batteries in Storage

Batteries in stored new cars, as well as batteries, in stock, must be given regular attention to prevent sulphation of plates that may result from inactivity and self-discharge. All automotive wet batteries will slowly discharge on standing idle, whether in stored vehicles or in stock, and will self-discharge much

faster when warm than when cold. *Batteries in stock should be rotated and the older ones used first.*

To minimize the extent of self-discharge always store batteries fully charged and in a cool place where the temperature does not go below freezing. Every 30 days check the level of electrolyte, add water as required and charge the batteries at a 5 ampere rate until fully charged.

Batteries used for display purposes or standing in cars in storage must be treated in the same manner as batteries in stock.

*When a new car, or a new replacement battery is delivered, make certain that it is fully charged and the electrolyte is at proper level.* This is extremely important because the delivery of a partially discharged battery may not only lead to its **return** for charging but may also result in shortened life of battery.

#### Importance of Maintaining Electrolyte at PROPER Level

**Water** is the only component of the battery which is

lost as the result of charging and discharging, and it must be replaced before the electrolyte level falls to the **tops** of the separators. If the water is not replaced and the plates become exposed, they may become permanently sulphated, which would impair the **performance** of the plates. Also, the plates cannot take full **part** in the battery action unless they are completely covered by the electrolyte.

### Importance of Keeping Battery Properly Charged

The battery has three major functions: (1) It provides a source of energy for cranking the engine. (2) It acts as a stabilizer to the voltage in the electrical system. (3) It **can** for a limited time furnish energy when the demand of the electrical units in operation exceed the output of the generator.

In **order** for the battery to continue to function, it is **necessary** that current withdrawal from the battery be balanced by current input from the generator so that the battery is maintained in a properly charged **condition**. If the outgo exceeds the input, the battery will **become** discharged so that it **cannot supply** sufficient energy.

The state of charge of the battery as well as the temperature of the electrolyte has an important bearing on its capacity for supplying energy. Battery **efficiency** is greatly reduced by decreased electrolyte **temperature** as it has a decided numbing effect on its **electrochemical** action. Under high discharge such as cranking, battery voltage drops to lower values in cold temperatures than in warm temperatures.

In **extremely** cold climates it is important to keep **batteries** in a nearly full charged condition to avoid the possibility of freezing, which will damage any battery!

The following table shows the temperatures at which freezing will occur in electrolytes of **different densities, with specific gravity corrected to 80 degrees F.**

### Specific Gravity Freezing Point

1.220 -35 degrees F.

1.200 -35 degrees F.

1.160 0 degrees F.

### Care of Dry Batteries in Storage

A "dry charge" battery contains fully charged positive and negative plates but no electrolyte.

Dry charged batteries should be stored in a dry place **away** from **excessive** heat. A dry charged **battery** should be kept in its original carton until ready to be

put into service. This type of battery will retain its "charged" condition indefinitely if protected from moisture. Dry batteries may be stacked in vertical columns provided they are not stacked more than four high.

### Preparing Dry Charged Batteries For Service

To prepare "dry charge" **batteries** for service use approved battery-grade acid electrolyte (1.265 sp. gr. at 80 **degrees** F). Care should be exercised in its use to prevent bodily **injury** or damage to clothing or other material resulting from actual contact with the electrolyte.

Electrolyte should be added to dry charged batteries in an area where water is readily available for flushing in case the electrolyte comes into contact with the body. Refer to instructions on side of electrolyte container for antidotes to use if electrolyte comes into contact with the body.

It is strongly recommended that a person filling batteries with electrolyte wear glasses (preferably safety glasses) to prevent possible damage to the eyes should any spattering of the electrolyte occur.

1. Remove dry charged battery from its original carton.
2. Remove the vent plugs.
3. Using a glass or acid-proof plastic funnel, **fill** each battery cell with electrolyte. **Do not use a metal funnel for filling the battery.** The cell is properly tilled when the electrolyte level rises to the split ring at the bottom of the vent well. Do not overfill or **underfill**. Overfilling will cause acid corrosion in the **battery** area; **underfilling** will cause early battery **failure**.
4. After tilling cells, wait **five** to ten minutes and add additional electrolyte, if necessary, to bring the electrolyte to the proper level.
5. Never finish tilling a dry charge battery with water. If electrolyte is spilled, more electrolyte must be obtained.

### Test After Batteries are Prepared For Service

The Delco Dry Charge Battery may be put into service immediately after activation. However, to insure good battery performance, the following activation tests are recommended:

1. After adding electrolyte, check the open circuit voltage. Less than 10 volts **indicates** a reverse cell or an open circuit and the battery should be replaced.
2. Check the specific gravity of all cells. If the specific



gravity corrected to 80 degrees F. shows more than a thirty point (.030) drop from the initial tilling with electrolyte, or if one or more **cells gas** violently after addition of electrolyte, the battery should be **fully** charged before use.

3. For best performance in cold weather (32 degrees F. or less), or if the battery and the electrolyte are not at 60 degrees F., or above at time of activation, warm the battery by boost charging.

## TROUBLE DIAGNOSIS

### BATTERY AND CABLES. TROUBLE DIAGNOSIS

#### Quick Check of Battery and Cables

Whenever electrical **trouble develops**, it is **desirable** to make a quick check of the battery and cables to make certain that this source of current is in good condition, securely connected, and is functioning properly. This check will also give a good check on the cranking system.

1. Turn on the lights. They **should burn** steadily and with normal brilliance.

2. With lights burnings, operate the cranking motor. Either have the headlights shining on a wall so their brilliance can be noted, or have someone watching the headlights.

3. When cranking motor solenoid switch is **closed**, one of the following conditions will occur; (1) Lights will stay bright or will dim slightly if temperature is cold, and engine will be cranked at normal speed; (2) Lights will **go out**; (3) Lights will **dim** considerably; (4) Lights will stay bright but no cranking action will take place. The first named condition indicates that nothing is wrong with the battery, cables, and cranking system. The other conditions indicate trouble as follows:

4. If **lights go out** as cranking motor solenoid switch is closed, it indicates a poor connection in the circuit between battery and cranking motor. Check battery cables and clean and tighten loose or corroded terminals.

5. If **lights dim considerably** as cranking motor solenoid switch is closed, it indicates that the battery is run down, or there is a condition in cranking motor or engine which causes an excessive current drain on the battery. A **low battery** will be indicated by a clattering noise in cranking motor solenoid because the battery cannot sustain the voltage required to hold solenoid plunger "in" after switch contacts close and the "pull in" winding is shorted out.

Test battery with a 421 Battery Test. If battery is found to be in good condition check cranking motor.

6. If **lights stay bright but no cranking action occurs** when cranking motor solenoid switch is closed, it indicates an open circuit in cranking motor, switch, or control circuit.

### Testing Resistance of Cables and Terminal Connections

Battery **cables** and terminal connections may be tested with equipment comprising of a voltmeter (5 volts maximum), ammeter of 300 or more amperes capacity, and carbonpile rheostat having a minimum capacity of 300 amperes connected in series with the ammeter.

1. Adjust rheostat to provide maximum resistance ("OFF" position).

2. Connect ammeter positive lead to post on starting motor. Connect ammeter negative lead to one side of rheostat and connect other side of rheostat to ground on engine, preferably at point where battery ground strap is attached. In the instrument shown in Figure 1A-1, the ammeter and rheostat are connected in series inside the case.

3. Connect voltmeter negative lead to post on starting motor. Use prod with voltmeter lead, if necessary, to insure direct contact with the terminal stud. **Do not connect to the ammeter lead clip.** Attach a prod to voltmeter positive lead and apply the prod to center of battery positive post (Figure 1A-1.) Make sure that clips of voltmeter leads have clean metal contact with prods.

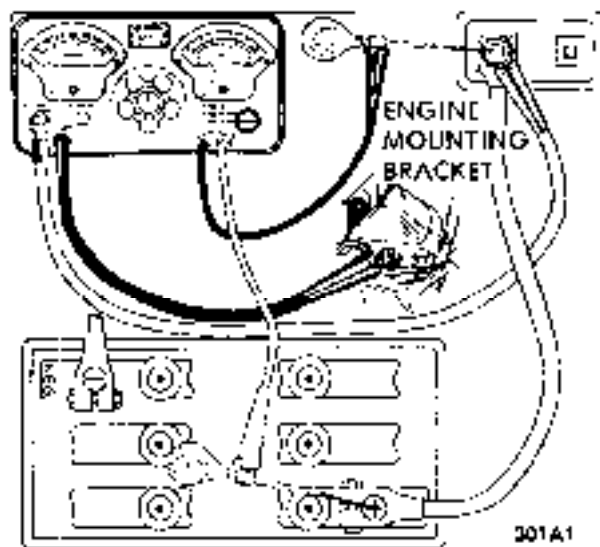


Figure 1A-1 Battery Cable Test Connections

4. Adjust rheostat until ammeter reads 200 amperes, immediately read voltmeter, then turn rheostat to starting ("OFF") position to avoid excessive drain on **battery**. Voltage drop across battery positive cable

and terminal connections should not exceed 2/10 volt.

5. **Connect** voltmeter positive lead to ground on engine. **Attach** prod to voltmeter negative lead and apply prod to **center** of battery negative post. Voltage drop across the battery ground cable and terminal **connections** should not exceed 2/10 volt at 200 am p s .

6. A reading in excess of 2/10 volt when testing either battery cable indicates excessive resistance in cable or **connections**. Clean and tighten cable or connections. Clean and tighten cable terminals (**subpara. c**, below) and recheck for voltage drop. If voltage drop **still** exceeds 2/10 volt, replace cable with a genuine **Buick-Opel** cable to insure ample capacity.

#### Undercharge Failure of Battery

The most frequent trouble experienced with storage batteries is failure to maintain a state of charge sufficient to crank the engine and also furnish current to the **ignition** system, lights and accessories. Failure to maintain a proper state of charge may be due to one or more of the following conditions:

1. **Operating Conditions**. When determining cause of premature failure of a battery, consideration must be given /to the conditions under which the car is operated.,.

In very low temperatures the capacity of a storage battery is considerably reduced and the energy required for cranking the engine is considerably increased.

Frequent starting, particularly in cold weather, **accompanied** by short runs may take more energy from the **battery** for cranking than the generator can replace in the limited running time. This condition is aggravated by night driving when lights are turned on, or by operation of an air conditioner in heavy traffic.

When **the** car is operated under these conditions, **adjusting** the voltage regulator to the high limit may allow enough increase to keep the battery at a safe state of charge. If the high limit setting does not maintain a safe state of charge, an occasional booster charge should be given to the battery.

2. **Low charging Rate**. In case of premature battery failure, the charging rate of alternator should always be checked and adjusted if below specifications.

3. **Internal Condition** The internal condition of the battery may be such that it cannot hold a charge **satisfactorily**. Check electrolyte level and test the **battery** using the 421 Battery Test.

#### Overcharge Failure of Battery

A common cause of battery failure is overcharging, that is, continued input of excessive charging current after the battery has reached a fully charged condition.

One evidence that battery is being overcharged is the need for frequent addition of water to the battery in order to maintain the electrolyte level above the tops of the battery separators, since overcharging causes rapid water loss. When this becomes evident, the charging rate of alternator should be immediately checked, as well as the voltage regulator, and adjusted to avoid internal damage to battery.

## ADJUSTMENTS AND MINOR SERVICE

### PERIODIC BATTERY INSPECTION AND SERVICE

The battery requires very little attention, but periodic inspection is essential to secure the maximum efficiency and life. The following **services** are essential to maintain the battery at maximum efficiency.

**WARNING:** *Never expose battery to open flame or electric spark • battery action generates hydrogen gas which is flammable and explosive. Do not allow battery fluid to contact skin, eyes, fabrics or painted surfaces • fluid is a sulfuric acid solution which could cause serious personal injury or property damage. Wear eye protection when working with battery.*

#### Maintain Electrolyte Level

Add distilled water as required to maintain the electrolyte level at the split ring at bottom of tiller well. See Figure 1A-2.

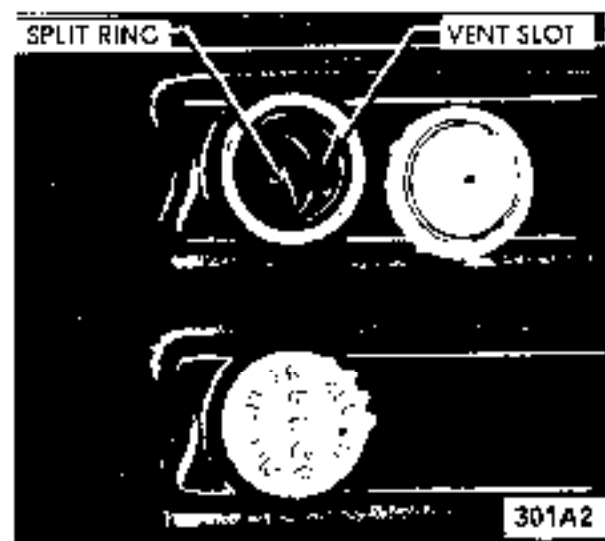


Figure 1A-2 Battery Filler Well

Do not overfill, as electrolyte may be sprayed out by gassing or may overflow due to heat expansion during charging.

If distilled water is not available, it is better to add clean, mineral-free tap water than to allow the electrolyte level to remain below the top of the plates:

In freezing weather the water should be added just before using the car or otherwise charging the battery so that the water will be mixed with the acid before it is allowed to stand in freezing temperatures.

If it is found necessary to add water to the battery more frequently than about every 1,000 miles and the quantity of water added per cell is excessive, check setting of voltage regulator and adjust, if necessary: Abnormal water loss is an indication that the battery is being overcharged.

#### Inspect Battery, Mounting and Cables

Check outside of battery for damage or signs of serious abuse such as broken case or broken covers: Check inside of battery by removing the vent caps and inspecting for signs of abuse such as electrolyte level too low to see, or bad or unusual odors. If battery shows signs of serious damage or abuse, it should be replaced.

Check the battery hold down bolts to make certain that battery is securely held in place. The nut should be drawn up to 20 lbs. in.; *excessive tightening may distort or crack the battery case.*

If the top of battery is dirty or the hold down strap is corroded, clean thoroughly with a brush dipped in ammonia or soda solution. Care must be used to prevent any solution from getting into battery cells: After the foaming of solution stops, flush off with clean water and dry thoroughly. If hold down strap is corroded it should be painted with acid-resisting paint after cleaning.

Check battery cables to make certain they are tight at bracket and junction block. If a connection is found loose it should be cleaned before being tightened as arcing and corrosion may have taken place in the loose connection. Check condition of cables and replace if badly corroded or frayed.

Special attention must be given to the battery positive cable position to eliminate the possibility of contact with the exhaust manifold on the 1.1 liter engine. The cable clamp must be rotated clockwise as necessary for the cable to run at a 45 degree angle toward the right wheelhouse panel.

#### Cleaning Cable Terminals

If loose connections are found by inspection, or high

resistance is found by voltage test, disconnect the cable for thorough cleaning of terminals. When removing a corroded cable terminal from battery post, do not pry against battery case or hammer on terminal to break it loose, since either practice will result in broken cell covers. Use a screw-type terminal puller if terminal cannot be loosened by hand.

Thoroughly clean all corrosion from disconnected battery cable terminals and terminal posts, using suitable wire brushes. If wire brushes are not available, corroded terminals may be cleaned by brushing with a strong soda solution, using care not to get solution into battery cells.

If cable strands are broken, corroded, or loose in terminals, the cable should be replaced with the correct cable to insure ample capacity.

To prevent corrosion of battery terminals and connections, apply a coating of petroleum jelly over the battery post and cable terminals after cables have been installed on terminals.

#### 421 BATTERY TEST

421 Battery Testers, manufactured and sold by a number of companies, are the only battery testers approved by Delco-Remy Division for testing one-piece cover batteries. They are also used by United Motors Service to determine whether or not a battery is defective.



Figure 1A-3 421 Battery Tester-Charger

The 421 Battery Tester shows, in a few minutes, the state-of-charge of the battery and whether it is good or bad. The tester can be used with any 12 volt battery, in or out of the car. The test can be made regardless of the state of charge of the battery; it can also be made when the electrolyte level is low • even below the top of the plates.

### 421 Test Procedure

1. Visual Inspection - The first step in testing the Energizer or 12-Volt Battery should be a visual inspection which very often will save time, labor and expense in determining the condition.

- (a) Check for broken or cracked case or cover.
- (b) Check for loose terminal posts.
- (c) Check for defective or mutilated sealing compound.
- (d) Check for other visible signs of physical damage.

Obvious damage as a result of conditions described above indicates the need for Energizer or battery replacement.

2. The "421" Test is a programmed test procedure consisting of a series of timed discharge and charge events, requiring approximately 2 to 3 minutes, that will determine the condition of the Energizer or battery with a high degree of accuracy when used in conjunction with this entire test procedure. "421" Testers are produced by a number of different manufacturers and their directions for tester operation should be carefully followed. General comments on overall "421" Tester operation follow:

- (a) Energizers or batteries **should not be charged** prior to making this test. Defects within the unit can be hidden by the charging and erroneous test results will be obtained.
- (b) Erratic, or extremely low, initial meter readings may indicate poor connections at the tester terminals. **Obtain clean and tight connections before performing the 421 Test.**
- (c) All meter readings should be made **immediately** after the meter indicator light comes on even if the meter needle is still moving.
- (d) If additional discharges are required after the initial discharge, set meter indicator following the **last** discharge cycle.
- (e) Batteries designated as "bad" by the tester should be replaced.
- (f) Batteries designated as "good" with no owner's complaint or indication of poor performance, should be left in service. Posts, cable clamps, and top should be cleaned, water should be added and recharging should be performed, if required. For dependable and reliable battery service, the battery should be in at least a 75 per cent state-of-charge.
- (g) Batteries designated as "good" that are suspected of being questionable because of owner complaint, or

age of the battery, should be further tested by the Hydrometer Test.

### HYDROMETER TEST OF BATTERY

The 421 Battery Test as described in the previous paragraph is the fastest and most accurate means of determining the serviceability of a one-piece cover battery. However, if a 421 Battery Tester is not available, a hydrometer test may be used on a battery that has failed to give proper service.

#### Hydrometer Test

1. Fully charge battery.
2. Measure specific gravity of each cell as described in sub-paragraph below.

Decide battery serviceability as follows:

- (a) If all cells read between 1.230 and 1.310, the battery is okay. All it needed was a full charge.
- (b) After fully charging battery, if any cell reads less than 1.230, the battery is defective and should be replaced.

#### Use of Hydrometer

The Hydrometer measures the percentage of sulphuric acid in the battery electrolyte in terms of specific gravity. As a battery drops from a charged to a discharged condition, the acid leaves the solution and enters the plates, causing a decrease in specific gravity of electrolyte. With a hydrometer, an indication of the concentration of the electrolyte is obtained.

The specific gravity of the electrolyte varies not only with the percentage of acid in the liquid, it also varies with temperature. As temperature increases, the electrolyte expands so that the specific gravity is reduced. As temperature drops, the electrolyte contracts so that the specific gravity increases. Unless these variations in specific gravity are taken into account, the specific gravity obtained by the hydrometer may not give a true indication of the concentration of acid in the electrolyte.

**Correction can be made for temperature** by adding .004, usually referred to as 4 "points of gravity", to the hydrometer reading for every 10 degrees F. that the electrolyte is above 80 degrees F. or subtracting .004 for every 10 degrees F. that electrolyte is below 80 degrees F. Figure IA-4 shows the exact correction figure to use for any temperature above or below 80 degrees F., the three steps used in obtaining the corrected or true specific gravity, and two examples showing how it is figured.

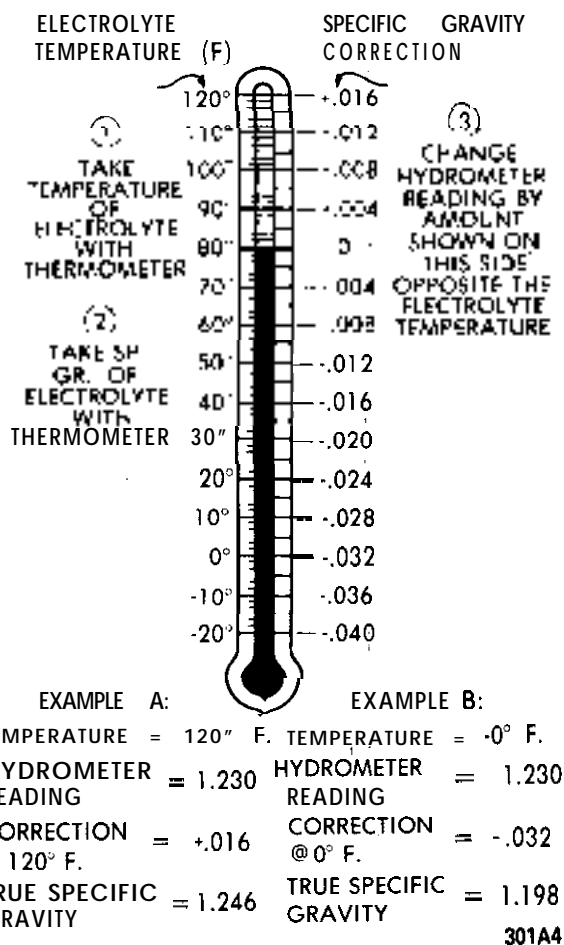


Figure 1A-4 Specific Gravity Temperature Correction Scale

When using a hydrometer, observe the following points:

1. Hydrometer must be clean, inside and out, to insure an accurate reading.
2. Hydrometer readings must never be taken immediately after water has been added. The water must be thoroughly mixed with the electrolyte by charging for at least 30 minutes before hydrometer values are reliable.
3. If hydrometer has built-in thermometer, draw liquid into it several times to insure correct temperature before taking a reading.
4. Hold hydrometer vertically and draw in just enough liquid from battery cell so that float is free floating, and with bulb fully released. Hold hydrometer at eye level so that float is vertical and free of outer tube, then take reading at surface of liquid. Disregard the curvature where the liquid rises against float stem due to surface tension.

5. Avoid dropping liquid on car or clothing as it is extremely corrosive. Any liquid that drops should be washed off immediately with soda solution.

FUSIBLE LINKS

All 1973 Opel Models have fusible links located between the starting motor post and the generator regulator. These links are the weakest point in the electrical supply system for the complete car, and, as such, will act like a fuse for every wiring harness in the car. Every electrical accessory is still protected by a fuse or circuit breaker, of course, but fusible links protect the wiring harnesses before the fuses.

A fusible link consists of soldering a smaller gauge wire to a heavier gauge wire end to end. In the event of a circuit overload where the heavier gauge becomes short circuited, the fusible link or smaller gauge wire will burn out first, thus, protecting its circuit from major damage. These fusible links are located in the engine compartment in such a manner that if overheated, the possibility of a fire is very remote.

The attachment of the fusible links and the circuits they protect are as follows: See Figure 1A-5.

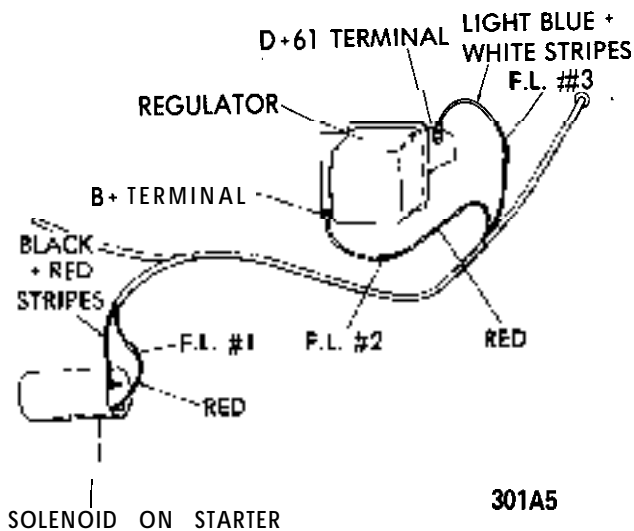


Figure 1A-5 Fusible Links

Fusible link (1) is connected to the starter solenoid at the battery cable terminal, on one end and to the red and white stripped main feed wire at the other end.

Fusible link (2) is connected between the red wire and terminal of the voltage regulator and protects against a situation where the battery will not accept a charge and the generator is charging to handle various electrical loads. Fusible link (3) is connected between the light blue with white stripes wire and D

plus 61 terminal of the voltage regulator and protects the circuit to the generator telltale light.

### BATTERY RECHARGING

There are two separate methods of recharging batteries which differ basically in the rate of charge. In the slow-charge method, the battery is supplied a relatively small amount of current for an extended period of time. In the quick-charge method, the battery is supplied with a high current for a short period of time.

#### Slow-Charging

**Slow charging** is the best and only method of completely **charging** a battery. The slow-charge method, properly applied, may be safely used under all possible conditions of the battery, provided electrolyte is at proper level in all cells. The battery may be fully charged by this method, unless the battery is not capable of taking a full charge. The normal slow charging rate for the 12-volt battery is 5 amperes.

*Full charge of battery is indicated when all cell specific gravities do not increase when checked at three intervals of one hour and all cells are gassing freely.*

Due to the low rate during slow charging, plenty of time must be allowed. Charge periods of 24 hours or more are often required.

#### Quick-Charging

Since time is often of most importance to the battery owner, quick-charging must sometimes be used to partially charge the battery so that the engine will start and the owner can be on his way.

Charge at 50 amperes for 20 minutes (50 times 20 equals 1000 ampere minutes). If charger will not give this rate, charge for an equal number of ampere minutes at the best rate available. Too high a current during quick-charging will damage battery plates.

A battery cannot be brought up to a fully charged condition by the quick-charge method. The battery can be substantially recharged or boosted, but in order to bring the battery to a fully charged condition, the charging cycle must be finished by charging at a low or normal rate. Some quick-chargers have a provision for finishing the charging cycle at a low rate so that the battery can be brought up to a fully charged condition.

Used with care, and employing all safeguards provided by the manufacturer, a quick-charger will not damage a battery which is in good condition.

### BATTERY REMOVAL AND INSTALLATION

#### Removal

1. Disconnect battery cables (remove negative cable first to prevent possible shorting).
2. Remove battery hold down bracket.
3. Remove battery.

#### Installation

1. Place battery back in hold down position.
2. Tighten hold down bracket bolts.
3. Connect battery cables (connect positive cable first to prevent possible shorting).

### FUSIBLE LINK REMOVAL AND INSTALLATION

Replace a burned out fusible link as follows:

1. Disconnect battery.
2. Disconnect connector eye on end of fusible link.
3. Cut off other end of burned out link, along with solder joint.
4. Strip insulation from end of new fusible link and from end of wiring harness so that each will slide into soldering sleeve.
5. Crimp new link in soldering sleeve and solder carefully.
6. Cover new connection tightly with electrical tape.
7. Install new link connector eye on other end of fusible link.

A burned out fusible link connected to the starter solenoid would be indicated by:

1. All electrical accessories dead.
2. Starter dead • will not even click. Even with a nearly dead battery, the starter solenoid will generally engage; therefore, no click means no solenoid action, possibly due to a burned out fusible link.

### SPECIFICATIONS

#### BATTERY SPECIFICATIONS

Delco-General 12 volt-44 amp hour storage battery is installed as original equipment. Replace with a Delco Energizer Y55.

# STARTING SYSTEM

## ALL MODELS

### CONTENTS

Subject	Page No.
<b>DESCRIPTION AND OPERATION:</b>	
Starting System Description .....	1B-10
<b>DIAGNOSIS:</b>	
Starting System Diagnosis, .....	1B-10
<b>MAINTENANCE AND ADJUSTMENTS:</b>	
Starting System Checks .....	1B-12
<b>MAJOR REPAIR:</b>	
Removal .....	1B-13
Disassembly .....	1B-13
Cleaning and Inspecting Parts .....	1B-14
Replacing Field Coils .....	1B-14
Checking and Replacing Brushes .....	1B-15
Replacing Bushings .....	1B-16
Assembly .....	1B-16
Installation .....	1B-17
<b>SPECIFICATIONS:</b>	
Starter Specifications .....	1B-17

## DESCRIPTION AND OPERATION

### STARTING SYSTEM DESCRIPTION

The new Delco Remy starter for 1973 is a brush-type series wound electric motor equipped with an overrunning clutch and operated by a solenoid. The field frame is enclosed by the commutator end frame and the drive housing and carries the pole shoes and the field coils. The armature has a spline on the drive end which carries the over-running clutch and pinion assembly. The armature shaft is supported in sintered bronze bushings in the commutator end frame and the drive end housing. These bushings are packed with lubricant during initial assembly and

require no additional lubrication between overhaul periods.

As the starter is operated by turning the ignition switch on the instrument panel, the shift lever is moved against spring tension. By means of the guide ring, the shift lever moves the pinion into mesh with the flywheel ring gear.

After the pinion meshes with the flywheel ring gear teeth, the solenoid contact disc closes the circuit and the engine is cranked. When the engine starts, the speed of the rotating flywheel causes the pinion to over-run the clutch and armature. The pinion continues to be engaged as long as the shift lever is kept in the cranking position.

## TROUBLE DIAGNOSIS

### STARTING SYSTEM DIAGNOSIS

In case of cranking motor breakdown, it should be kept in mind that the relevant cause(s) for the trouble may not only lie in the cranking motor itself

but also in the condition of related units, such as battery, switches, electrical wiring and wiring connections.

Condition	Possible Cause	Correction
When ignition switch is on, cranking motor locks up or <b>drags</b> .	1. Battery discharged.	1. Charge battery.
	2. Battery defective. Battery terminals loose, corroded or improperly grounded.	1. Test and replace as required. Retighten terminals, clean battery posts and terminals <b>and</b> coat them with acid-proof grease.
	3. Cranking motor or brush terminals grounded.	1. Eliminate grounds.
	4. Cranking motor brushes do not rest on commutator, or arc jammed in their guides, worn out, oily or clogged.	1. Check brushes • clean or replace as required. Clean guides on <b>brush</b> -holders.
	5. Ignition switch damaged (loose parts preventing switch from closing or burnt parts).	1. Replace ignition switch.
	6. Solenoid switch damaged.	1. Repair or replace as required.
	7. Excessive voltage drop in wiring switches damaged, connections loose.	1. Check wiring and connections. Repair or replace switches.
The armature revolves but the <b>drive pinion</b> does not come into mesh.	1. Drive pinion clogged.	1. Clean drive pinion.
	2. Drive pinion or ring gear teeth <b>flattened</b> or burred.	1. Replace ring gear and overrunning clutch.
	3. Poor condition of shaft <b>splines</b> .	1. Replace <b>armature</b> and overrunning clutch.
	4. Voltage drop.	1. Replace shift lever.
When <b>ignition</b> switch is on, armature revolves until drive pinion engages and then <b>stops</b> .	1. Battery discharged.	1. Charge battery.
	2. Brush spring tension too weak.	1. Check brushes • clean or replace as required.
	3. Cranking motor solenoid or switch defective.	1. Replace or repair solenoid or switch.



Condition	Possible Cause	Correction
	4. Voltage drop.	1. Check wiring and wiring connections.
	5. Overrun&g clutch slips.	1. Replace overrunning clutch.
The cranking motor keeps on rotating after ignition switch is off.	1. Ignition switch does not cut off or solenoid switch sticks.	1. Immediately disconnect cranking motor cable from battery. Inspect and/or replace or repair ignition and solenoid switches as required.
The drive pinion does not demesh after engine has been cranked.	1. Drive pinion or ring gear teeth clogged or flattened. Return spring slack or broken.	1. Clean components as specified. Replace as required.

## MAINTENANCE AND ADJUSTMENT

### STARTING SYSTEM CHECKS

#### Voltage Loss Checks

When the starter cranks too slowly, check the battery state of charge and all electrical connections between the battery and starter.

1. Turn on headlights and operate starter. If headlights dim considerably when starter is engaged, the battery may be discharged or be defective. Check the battery.

2. If the headlights stay bright but the starter does not turn over, the starter cables may be faulty or the starter defective.

(a) Test battery voltage while cranking engine (9 volts minimum).

(b) Check voltage from starter terminal of solenoid to starter frame while cranking engine.

3. The difference in readings taken in Operations 2a and 2b above represents the voltage drop through the cables and solenoid switch. Voltage drop should not exceed .5 volt.

4. Locate excessive resistance as follows:

(a) Turn voltmeter to scale above 12 volts and connect voltmeter leads across connection or switch: to be checked.

(b) With starter switch closed, turn voltmeter switch to lowest scale and take reading as quickly as possible, then turn switch back to higher scale and stop cranking engine.

(c) Voltmeter must not read more than .2 volt across any connection. If voltmeter reads more than .2 volt, the defect must be corrected.

#### Starter Current Draw - Lock Test

1. Make sure battery is fully charged and in good condition.

2. Connect a volt ampere starter tester according to manufacturer's instructions.

3. Pull parking brake on securely, shift transmission into 4th (direct) gear and actuate starter. (Starter will not turn engine because engine is locked through transmission.)

4. While starter is actuated, read voltage and current. Refer to Specification Chart.

(a) Voltage low - poor battery or a voltage loss in the starter circuit.

(b) Current high - short circuit in starter. Overhaul starter.

(c) Current low - commutator dirty, brushes worn, solenoid switch contacts defective or open circuit in starter. Overhaul starter.

#### Starter Current Draw - On Car

1. Bring engine to normal operating temperature.

2. Stop engine and disconnect coil wire from distributor.

3. Ground coil wire to prevent excessive coil voltage build up.

4. Connect test equipment and, with transmission in neutral, turn engine over until voltage stabilizes. Note readings.
5. Current draw should be between 90-130 amperes.

## MAJOR REPAIR

### STARTER OVERHAUL

#### Starter Removal

1. Disconnect starter wiring.
2. Remove starter support bracket.
3. Remove two starter bolts, one nut and lockwashers.
4. Remove starter.

#### Starter Disassembly

1. Hold starter in a vise, as shown in Figure 1B- 3. Mark end frame and field frame to ensure correct installation of parts on reassembly.

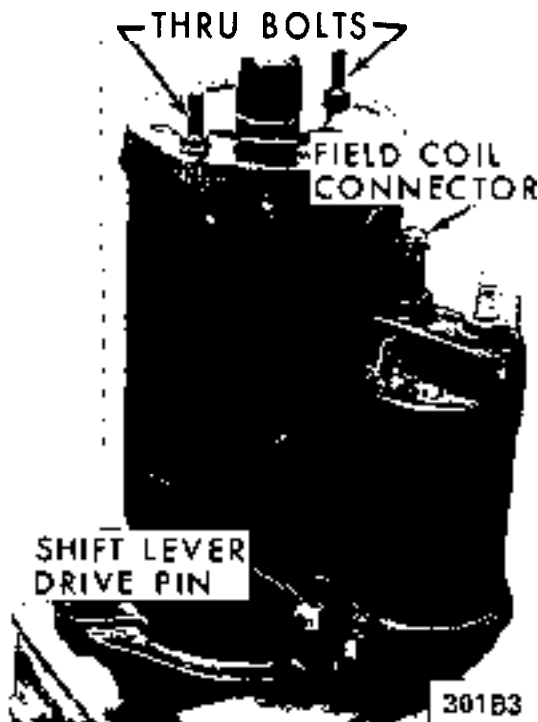


Figure 1 B-3 Cranking Motor in Vise

2. Remove both starter through bolts and field coil end from solenoid switch lower threaded bolt. See Figure 1B-3.

3. Remove end frame from field frame and pull both insulating tubes out of field frame.

4. To prevent brushes from coming out when removing the field frame, place a 29 millimeter socket over commutator while lifting up on the field frame. The brushes will be held in place by the socket. See Figure 1B-4.

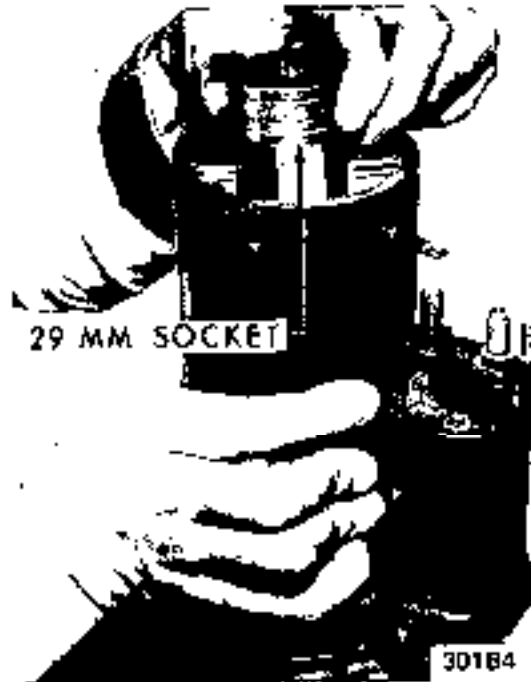


Figure 1B-4 Removing Field Frame

5. Remove the two (2) solenoid attaching screws and remove solenoid and spring.

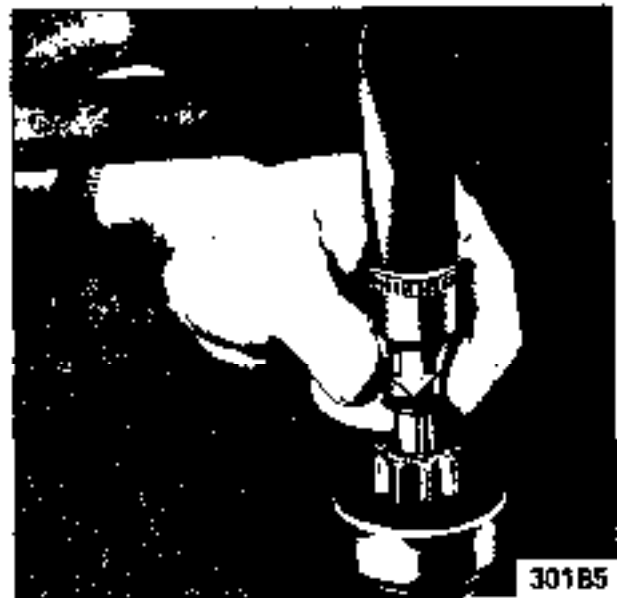


Figure 1B-5 Driving Retaining Ring Back

6. Remove shift lever shaft and lift armature and shift lever assembly.
7. Drive back retaining ring on armature shaft. See Figure 1B-5.
8. Take the lock ring, retaining ring, and overrunning clutch and pinion off armature shaft. Check groove in shaft for burrs and remove with a soft file.

**Cleaning and Inspecting Parts**

1. Clean and check all parts. Replace defective parts.
2. Turn down worn or burnt commutator on a good precision lathe. Use a spindle speed between 2,000 and 3,000 RPM. See Figure 1B-6. When turning down commutator, adjust cutting depth of tool so that no more pits exist after this operation. Do not remove any more material than necessary, however, because if commutator diameter is less than 1 15/32 inches, armature must be replaced.

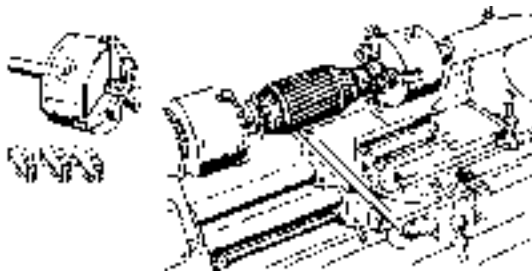


Figure 1B-6 Turning Down Commutator

3. Undercut mica approximately .020 below commutator surface. Finish and thoroughly clean commutator.
4. Check armature for short circuit on a growler.
5. With a test lamp, check armature for ground. Test lamp must not light up. See Figure 1B-7.

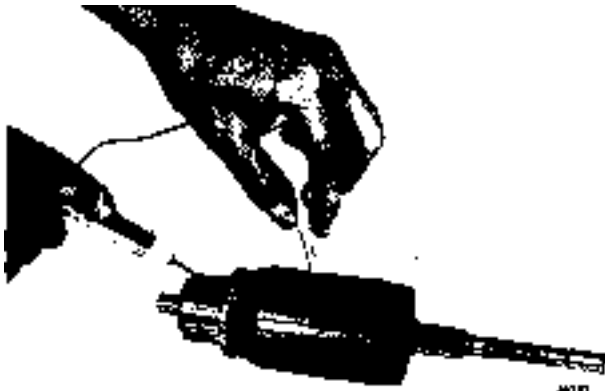


Figure 1B-7 Testing Armature for Grounds

6. Check armature for an open circuit on a growler. Considerable variation in readings between individual commutator bars would indicate an open circuit.
7. Visually check field coils. Replace burnt or scorched field coils.
8. With a test lamp, check field coils for ground. See Figure 1B-8. Test lamp must not light up. Replace grounded field coil.

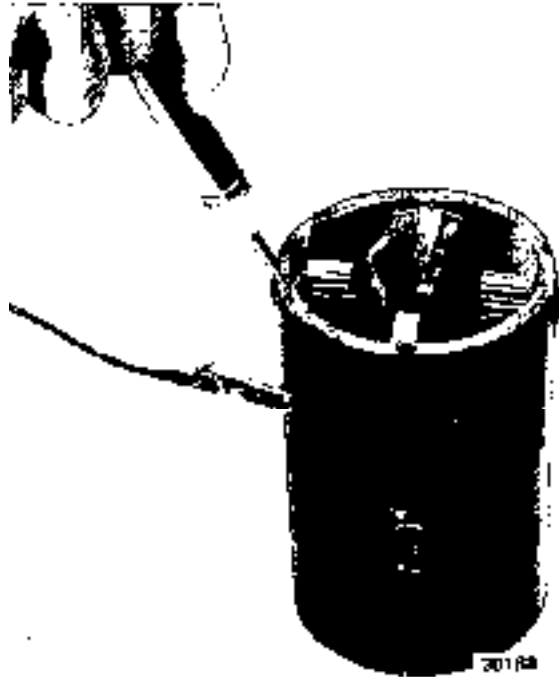


Figure 1B-8 Checking Field Coils for Ground

**Replacing Field Coils**

1. Mark locations of pole shoes to avoid incorrect installation.



Figure 1B-9 Removing Pole Shoes

2. Unscrew the four (4) pole shoe attaching bolts and take field coils out of field frame. See Figure 1B-9.
3. To ensure proper installation of the pole shoes, align shoes exactly parallel with the armature shaft prior to tightening attaching bolts.

Checking and Replacing Brushes

1. Check both positive brush holders for ground. See Figure 1B-10. Test lamp must not light up.

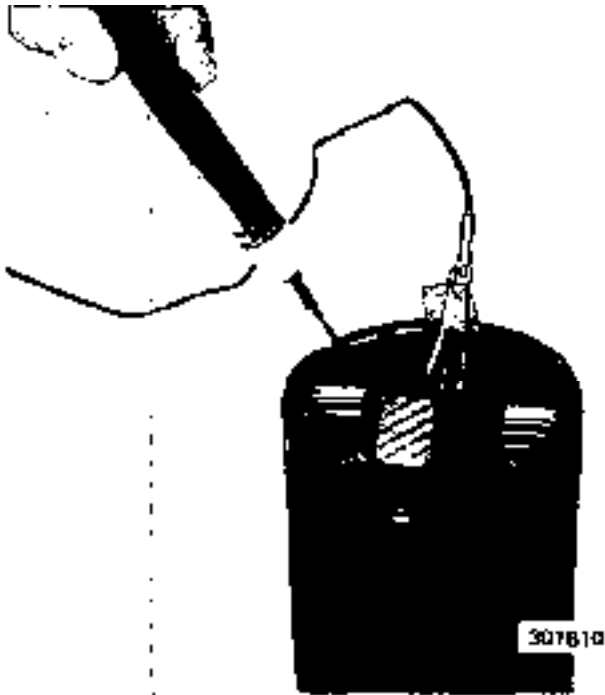


Figure 1 B-10 Checking Positive Brush Holder for Grounds



Figure 1B-11 Removing Rivet

2. Check brushes. Replace brushes, if worn down to .28 inches or less. Always replace all four (4) brushes.

3. To replace positive brushes, cut off wires at the connecting strap of the field coil. Clean soldered joint and solder stranded wire of new brushes. Hold wire with flatnose pliers so that no tin enters wire strands.

4. On replacement of the negative brushes, the complete brush holder with the welded brush has to be replaced.

5. Shear off rivet head with a chisel and drive rivet out. See Figure 1B-11.

6. A tool to replace the negative brush holder and rivet can be made up out of 1/4 inch steel. See Figure 1B-12.

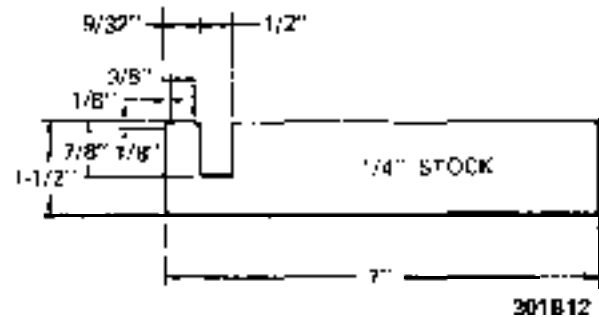


Figure 1B-12 Negative Brush Holder Installation Tool

7. Place new brush holder and new rivet on installation tool and insert rivet into bore of field frame. See Figure 1B-13.

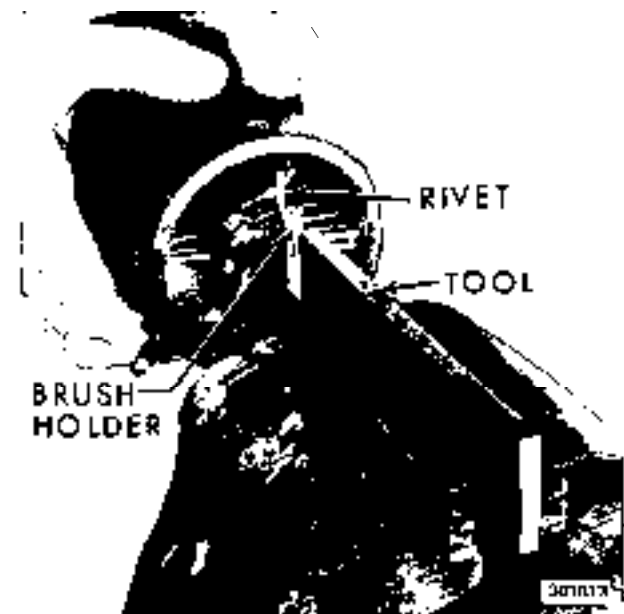


Figure 1B-13 Brush Holder and Rivet Installed on Tool

8. Making sure that brush holder is aligned at right angles to the field frame, rivet brush holder to field frame. See Figure 1B-14.

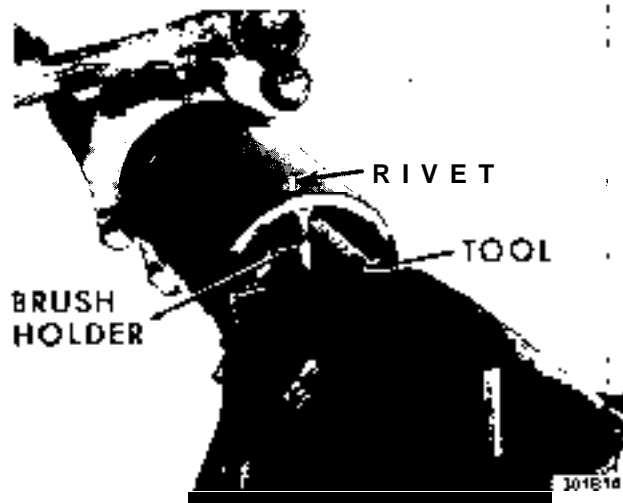


Figure 1B-14 Riveting Brush Holder to Frame

**Replacing Bushings**

If sintered bronze bushings in commutator end frame and drive housing are worn, they must be replaced. Soak new bushings in engine oil for at least half an hour prior to installation. Press out old bushings and press in new bushings. See Figure 1B-15.

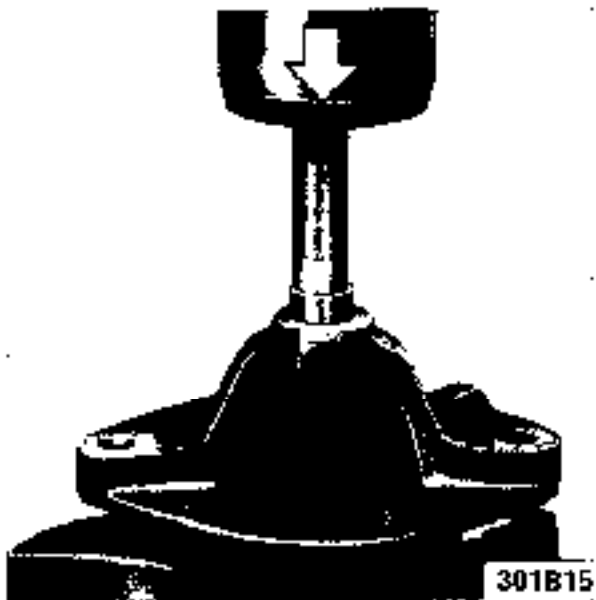


Figure 1B-15 Installing New Bushings

**Starter Assembly**

1. Lubricate armature shaft. Install drive assembly with pinion outward.

2. Slide pinion stop retainer down over shaft with recessed side outward.

3. Place a new snap ring on drive end of shaft and hold it in place with a hard wood block. Strike block with hammer to force snap ring over end of shaft, then slide the ring down into groove in shaft. See Figure 1B-16, view A.

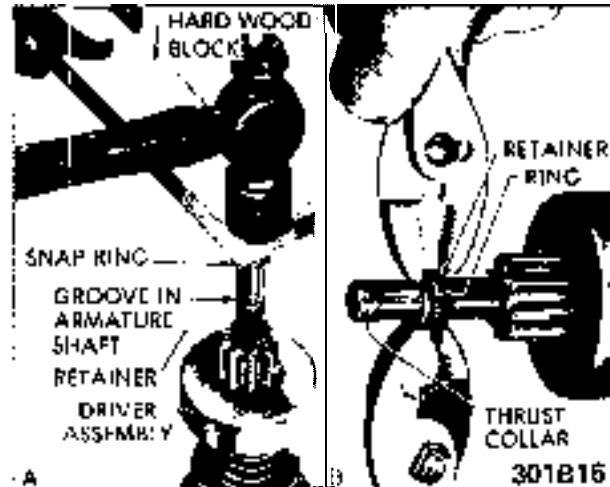


Figure 1B-16 Pinion Stop Retainer and Snap Ring Installation

4. Place thrust collar on shaft with shoulder next to snap ring and move the retainer into contact with ring. Using pliers on opposite sides of shaft, squeeze retainer and thrust collar together until snap ring is forced into the retainer. See Figure 1B-16, view B.

5. Lubricate drive housing bushing and install armature and drive assembly in housing.

6. Install solenoid thrust spring and solenoid.

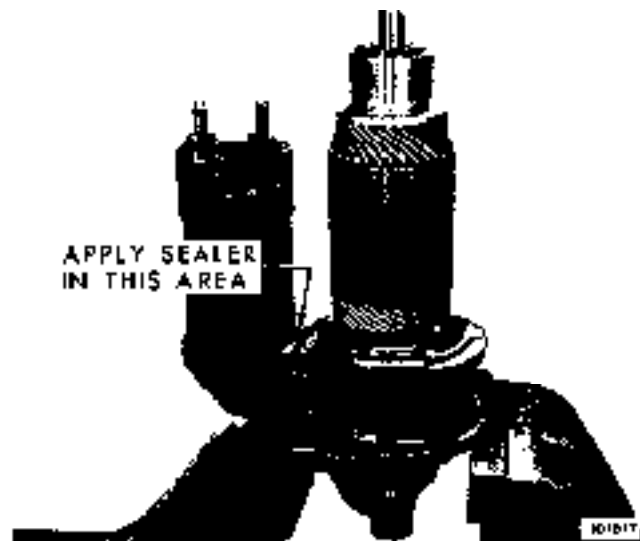


Figure 1B-17 Applying Sealer to Starter

7. Seal area between solenoid and frame. See Figure 1B-17.
8. With brushes and spring in housings held in place with a 29 millimeter socket, slide frame assembly in position.
9. Install insulating sleeves in field frame.
10. Install end frame and replace through bolts and tighten bolts.
11. Install bolt holding field frame to solenoid.

12. Check starter on bench before installing.

**Starter Installation**

1. Hold starter in position.
2. Install two bolts, one nut and lockwashers. Tighten securely.
3. Install support bracket. To ensure a stress-free installation, install bolt and two nuts only finger tight. First tighten the bolt at the engine, then tighten the two nuts at the starter end frame.

**SPECIFICATIONS**

**Starter Specifications**

Starter Number . . . . .	EF 12V0 .8 PS
Rated Voltage . . . . .	12
No Load Test:	
Volts . . . . .	10.6
Amperes . . . . .	30-50
RPM . . . . .	7300-8500
Cranking Amperes Test (In Car-Engine at Operating Temp.) . . . . .	175-205
Lock Test:	
Volts . . . . .	6 Min.
Amperes . . . . .	280-320
Voltage Required to Close Solenoid Contacts . . . . .	7.5
Minimum Diameter of Commutator in Inches . . . . .	1.46
Brush Spring Pressure in Ounces . . . . .	40-46
Minimum Length of Brushes in Inches . . . . .	.28

# IGNITION SYSTEM

## CONTENTS

Subject	Page No.
<b>DESCRIPTION AND OPERATION:</b>	
Ignition System .....	1C-18
Ignition Switch .....	1C-18
Ignition Coil.....	1C-19
Distributor .....	1C-19
<b>DIAGNOSIS: (Not Available)</b>	
<b>MAINTENANCE AND ADJUSTMENTS:</b>	
Contact Point Replacement .....	1 c-20
Dwell Angle Adjustment .....	1 c-20
Ignition Timing Adjustment .....	1 c-20
Ignition Wire Inspection .....	1C-21
Check Ignition Output .....	1C-21
Check Distributor .....	1 c-22
Check Spark Plugs .....	1 c-22
<b>MAJOR REPAIR:</b>	
Distributor Removal .....	1 r-23
Disassembly .....	1 C-23
Reassembly.....	1 c-24
Distributor Installation .....	1 C-25
<b>SPECIFICATIONS:</b>	
Ignition Coil .....	1 C-26
Distributor .....	1 C-26
Spark Plugs .....	1 C-26

### DESCRIPTION AND OPERATION

#### IGNITION SYSTEM

The ignition system basically consists of an ignition switch, ignition coil, distributor, battery and related wiring. The ignition switch is located in the steering column, the ignition coil is located left front inner fender **skirt** and the distributor is located at the left front of the engine.

#### IGNITION SWITCH

The combined ignition switch and steering lock **can be** switched to any one of the below listed positions. Insert key with notch pointing upward.

*(Fully counterclockwise)* Lock position. Ignition locked, steering locked, only with key removed. Electrical circuits disconnected except to main lighting switch and dome lamp. The **key can be** removed.

*0- (First position clockwise from lock)* Garage position. "The key and lock assembly must be pushed "in" to reach this position from lock. The steering is unlocked and the ignition is off. The electrical circuits are the same as in lock position. The key cannot be withdrawn.

*1- (On position.)* All electrical circuits controlled by ignition switch are completed through the switch. The key cannot **be** removed while switch is in drive position.

11- (*Start position.*) The ignition key must be released as soon as engine starts. The switch then returns **automatically** to the on position.

## IGNITION COIL

The ignition coil consists of a laminated non-magnetic iron **core** enclosed by two coils; the primary winding and the secondary winding.

The **primary** circuit consists of the power source (battery), the ignition switch, the ignition coil primary winding, the distributor breaker points with ignition condenser connected in parallel, and all connecting **low** tension wiring.

The secondary circuit consists of the ignition coil secondary winding, the spark plugs, all connecting **high tension** wiring, the distributor cap and the rotor.

When the ignition switch is turned on and the breaker points are closed, current flows through the ignition **coil** primary winding and produces a magnetic field wound the coil windings.

When the breaker points are separated by the revolving distributor cam, the magnetic field collapses and induces a high voltage surge in the secondary winding, **producing** a spark between the spark plug electrodes.

The ignition condenser which is connected in parallel with the breaker points, prevents arcing between the **separated** breaker contacts, and current flow **after** the **breaker** points have been separated, thus causing a **very** rapid collapse of the magnetic field around the ignition coil.

## IGNITION DISTRIBUTOR

The ignition distributor breaks the primary current, **distributes** the high voltage surges induced in the coil secondary winding to the spark plugs according to the **engine** firing order and sets ignition timing in relation to engine RPM and load.

The **housing** of the distributor contains the centrifugal advance mechanism and the movable breaker plate **with** a breaker lever and contact support. The vacuum advance mechanism is attached to the breaker **plate** and mounted on the outside of the distributor, housing. See Figure 1C-1.

The distributor shaft is driven by a helical gear on the camshaft and in turn drives the engine oil pump. The ignition condenser is mounted on the outside of the housing. The engine output is to a large extent influenced **by** the ignition timing. Maximum engine performance is obtained when the combustion process is well underway as the piston starts **down on the**

power stroke. The air-fuel charges are, however, not burned instantly, so it is necessary to advance the spark in relation to the piston top dead center as engine speed increases or as engine load decreases.

If the spark is too far advanced, the engine knocks, causing a drop in engine power output and overheating. If the spark is retarded, part of the energy developed during combustion is wasted which will result in reduced engine power output, excessive fuel consumption and overheating.

The ignition distributor has a double acting double diaphragm vacuum unit. See Figure 1C-1. The **advance** unit is supplied with "ported" vacuum. That is, vacuum is supplied from a port in the primary barrel of the carburetor located just above the closed throttle valve. This port supplies no vacuum during idling nor during closed throttle deceleration, but supplies full intake manifold vacuum at all speeds where the throttle valve is opened enough to uncover the port.



Figure 1C-1 Ignition Distributor

The retard unit is supplied with intake manifold vacuum at all times by means of a line connected directly to the intake manifold. During idling and deceleration, when there is no vacuum to the advance unit, the retard unit will cause the timing to be retarded 5 degrees. However, during part throttle operation when there is vacuum to the advance unit, the advance unit will overpower the retard unit so that the retard unit has no effect on timing.

The purpose of the retard unit is to reduce hydrocarbon and carbon monoxide emissions during idling and deceleration, where they are especially bad.

In order to avoid voltage losses for easier starting, a plastic cover has been inserted in the distributor below the rotor as a **separator** to keep the inside of the distributor cup free from condensation.



There is also a plastic hood slipped over the distributor cap with an outlet for the ignition cables as an added protection against moisture from the outside. See Figure 1C-2.



Figure 1C-2 Ignition Distributor With Hood Installed

## MAINTENANCE AND ADJUSTMENTS

### CONTACT POINT REPLACEMENT

#### Removing Contact Points

1. Remove contact support lock screw and remove contact point support. If condenser is to be replaced, it will be necessary to replace condenser and leads as an assembly.

#### Installing Contact Points

1. Lightly lubricate distributor cam with high temperature cam and ball bearing lubricant. Excessive lubricant will throw off into contact points.
2. Position support on breaker plate and install lock screw leaving slightly loose for later adjustment.
3. Plug breaker arm wire in.
4. Adjust breaker point gap to .016".

### DWELL ANGLE ADJUSTMENT

1. Connect dwell meter.
2. Remove distributor cap. Remove rotor. Loosen breaker point set screw approximately 1/8 turn.
3. Insert screwdriver in notch of stationary breaker point. Observe dwell meter while cranking engine. Twist screwdriver as required to obtain a reading of 50 degrees plus or minus 3 degrees.

4. Tighten breaker point set screw, then recheck dwell.

5. Install rotor and cap. Start engine and recheck dwell. It is important that dwell be rechecked, as installation of rotor and cap will sometimes change the dwell angle.

### IGNITION TIMING ADJUSTMENT

#### Preliminary Timing (Engine Won't Run)

To time the ignition on any engine which will run, use subparagraph b only. However, if the timing of an engine is completely off, the following procedure must first be used to get the engine to run.

1. With rocker arm cover removed, rotate crankshaft in a clockwise direction until both valves for No. 1 cylinder are closed and the timing marks line-up. (Valves are completely closed if rocker arms can be "rocked" slightly.)

2. Install distributor in engine so that vacuum advance unit is in original position and notch in distributor rotor lines-up with notch in housing. See Figure 1C-3. If distributor does not seat in engine block, turn distributor shaft so that rotor points about 20 degrees clockwise from distributor timing notch (see Figure 1C-18), then press lightly on distributor housing while cranking engine with starter. After oil pump tang snaps into slot in distributor shaft, start timing again from Step 1, leaving distributor installed.



Figure 1C-3 Rotor Position for Firing No. 1 Cylinder

3. Install distributor clamp and bolt, leaving bolt just loose enough to permit movement of distributor. Install distributor primary wire.

4. Rotate distributor counterclockwise slightly until contact points just start to open. This must be **done** very carefully or engine will not start.

5. Install distributor cap. Make sure spark plug wires are correctly installed in distributor cap, through clip and on spark plugs.

### Finish Timing

Contact point gap (.016" at widest gap) or dwell 50 degrees plus or minus 3 degrees **should** always be checked before adjusting ignition timing.

1. Connect timing light to No. 1 spark plug.
2. Disconnect and plug vacuum advance unit and retard unit hoses.
3. Connect a tachometer from distributor side of coil to ground.
4. Start engine. Set idle speed to 900 RPM.
5. Rotate distributor as necessary to align timing marks. Timing mark is a steel ball embedded in the flywheel and a pointer in a window in the right flywheel housing. See Figure 1C-4.

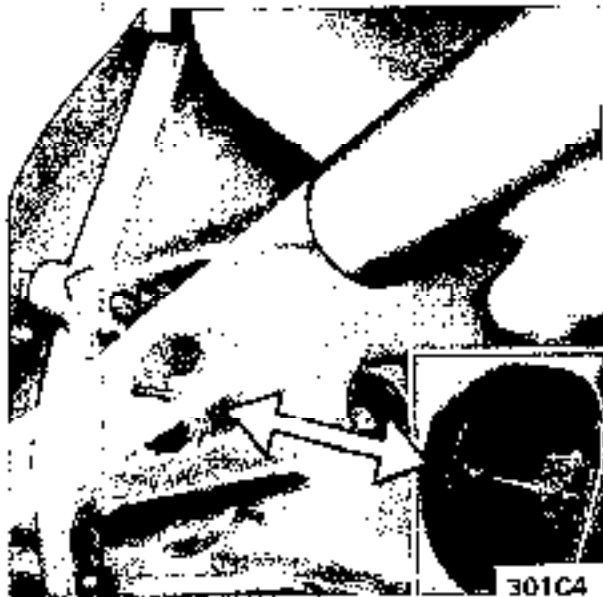


Figure 1C-4 Ignition Timing Marks

6. Tighten clamp bolt securely and recheck timing mark alignment.

7. Reconnect vacuum hoses and adjust engine idle speed and mixture.

### IGNITION WIRE INSPECTION

1. The coil and spark plug wires are of a special

resistance type. These secondary ignition wires reduce television and radio interference.

2. Wipe ignition wires with a cloth moistened with solvent and wipe dry. Bend wires to check for brittle, cracked or swollen insulation. Defective insulation will permit missing or cross-firing of spark plugs, therefore any defective wires must be replaced.

3. If wire insulation is in good condition, clean any terminals that are corroded and replace any terminals that are broken or damaged. Terminals must fit tight on spark plugs and in distributor cap.

4. Replace any hardened, cracked or loose cap nipples or spark plug boots.

5. Check resistance of each wire from contact inside distributor cap to spark plug or coil terminal. Replace any wire having over 10,000 ohms resistance reading. See Figure 1C-5.



Figure 1C-5 Checking Ignition Wire Resistance

### CHECK IGNITION OUTPUT

1. Disconnect secondary coil wire so that engine will not start. Connect a voltmeter from the battery side of the coil primary to ground and check voltage while engine is cranking. Reading should be 10 volts or more. Low reading could be caused by a defective battery, a discharged battery, high starter current draw, a **bad** connection in the starter circuit or a bad connection in the primary ignition circuit.

2. Connect an oscilloscope according to manufacturer's instructions. Disconnect coil wire. Crank engine and read coil output voltage. Reading should exceed 20 KV (20,000 volts).

3. Start engine and disconnect a wire from a spark plug. Read output voltage of disconnected spark plug circuit. Reading should exceed 20 KV (20,000 volts).

### CHECK DISTRIBUTOR

1. Clean distributor cap and inspect it for cracks or tracking. Inspect inner segments for erosion and outer sockets for corrosion.

2. Clean and inspect ignition wires. Make sure resistance of each wire is less than 10,000 ohms. Replace any defective spark plug boots or distributor cap nipples. See paragraph 1C-12.

3. Inspect breaker points and replace if necessary. Adjust breaker point gap to .016 inch with rubbing block on **peak of** cam lobe or check dwell and adjust if not 50 degrees plus or minus 3 degrees. 4. Check dwell variation by reading dwell at idle and at 3000 RPM. Dwell must not vary more than 3 degrees. Excessive variation means distributor shaft, cam or breaker plate are worn or damaged--overhaul distributor and replace defective parts.

5. Check distributor condenser for a minimum series resistance and insulation leakage. Check for a capacity between .15 and .20 microfarads.

6. Check total advance (centrifugal and vacuum) at 2500 engine RPM using a timing light having a dial for reading advance.

(a) The timing marks are aligned with both the vacuum advance and the vacuum retard hoses disconnected and plugged.

Engine idle should be 900 RPM.

(b) Reconnect vacuum hoses. Run engine at 3600 RPM and adjust knob until timing marks are aligned. Read advance on dial. Maximum centrifugal advance should be between 28-32 degrees.

7. **If** total advance is out of specifications, check centrifugal advance only, at 2500 RPM. **Disconnect** and plug all vacuum hoses. Maximum vacuum advance should be 1-5 degrees at 4.5-5.0 in. hg.

8. Replace centrifugal or vacuum advance parts as required to bring distributor total advance within specifications.

9. Check operation of vacuum retard unit (rear unit) by **first** making sure timing marks are aligned with vacuum hoses disconnected and at slow idle (700 RPM). Then connect vacuum hose to vacuum retard unit (rear unit). Timing ball should move in a **retard** direction (upward).

### CHECK SPARK PLUGS

1. Remove spark plugs. If electrodes are badly worn, discard plugs. If inner or outer porcelain is cracked or broken, discard plugs.

2. Note color and general appearance of inner end of spark plug. Brown to grayish - tan deposits and slight electrode wear indicate correct spark plug heat range. Plugs having this appearance may be cleaned, regapped, **tested** and reinstalled.

3. Clean spark plugs in a sand blast type cleaner. Clean only enough to remove deposits, not enough to wear away porcelain. If deposits are too hard to remove or if porcelain is glazed, discard plugs.

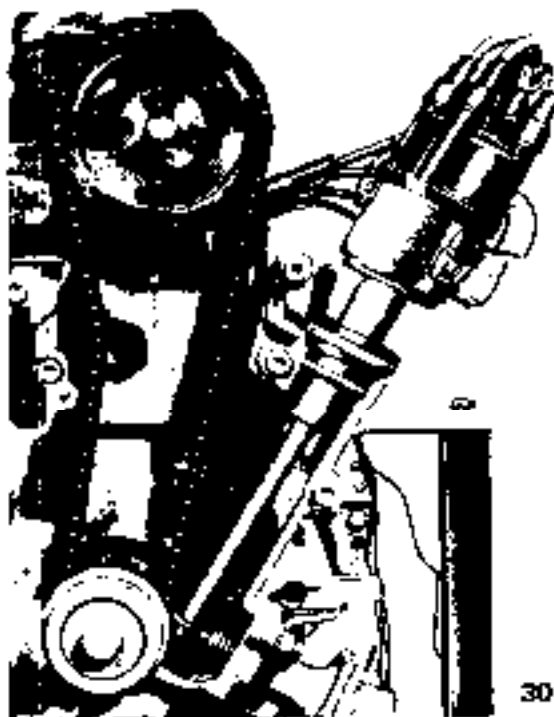
4. After cleaning spark plugs, clean firing surfaces of electrodes with a line file.

5. Test cleaned spark plugs on a pressure tester by comparing spark of the used plugs with that of a new plug. Install tested plugs, using new **gaskets**.

6. If removed spark plugs have excessive carbon fouling and if the car will be driven mostly at low speeds in city driving, it is advisable to replace plugs with a hotter plug, **AC43FS**.

7. If removed plugs show rapid electrode wear or inner porcelain breakage at low mileage. Check for a vacuum leak such as a poor manifold to head fit.

8. **Gap** spark plugs carefully (new or cleaned) using a .030 round wire feeler gage.



301C6

Figure 1C-6 Distributor Installation

9. Install spark plugs using a 13/16 deep socket, an extension and a torque wrench. Tighten to 22-29 lb.ft.

## MAJOR REPAIR

### DISTRIBUTOR OVERHAUL

#### Distributor Removal

1. Remove fuel pump. This is necessary because the fuel pump will block the distributor drive gear, thereby preventing removal of the distributor. See Figure 1C-6.

2. Set No. 1 cylinder at firing point by turning engine

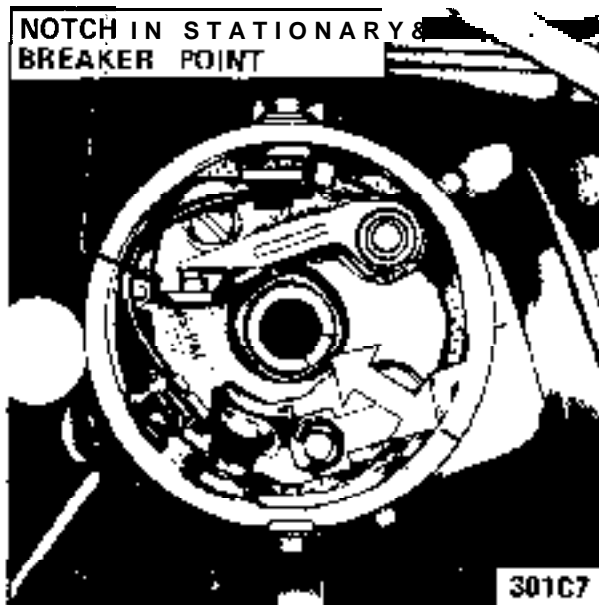


Figure 1C-7 Aligning Shaft Cutout With Notch

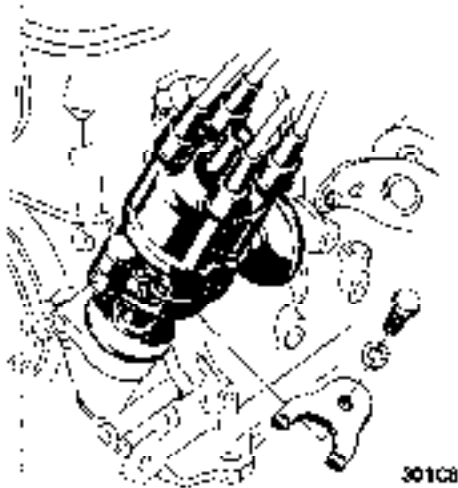


Figure 1C-8 Removing Distributor

until cutout in distributor shaft (or rotor tip) points to notch in distributor housing. See Figure 1C-7.

3. Ball imbedded in flywheel should be approximately aligned with pointer in housing. See Figure 1C-4.

4. Remove distributor hold-down clamp and remove distributor. See Figure 1C-8. Cover bore in timing case to prevent foreign material from dropping into engine. To make reinstallation of distributor easy, do not rotate crankshaft or oil pump.

#### Disassembly

1. Remove distributor cap retaining spring clips, and vacuum control units. See Figure 1C-9.

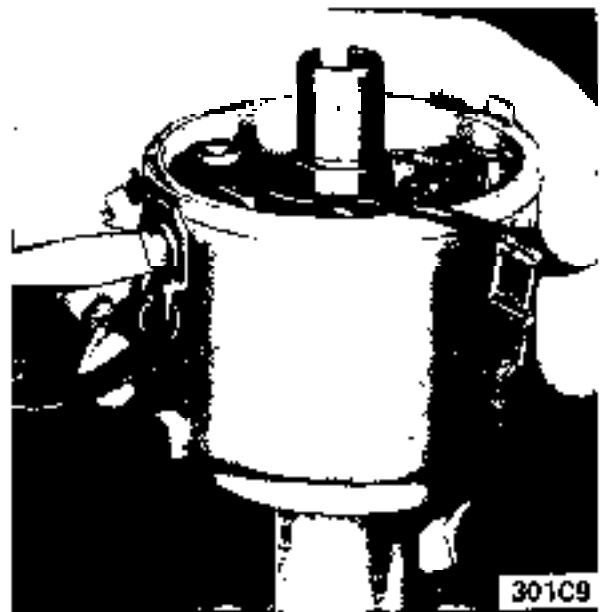


Figure 1C-9 Removing Retaining Clips

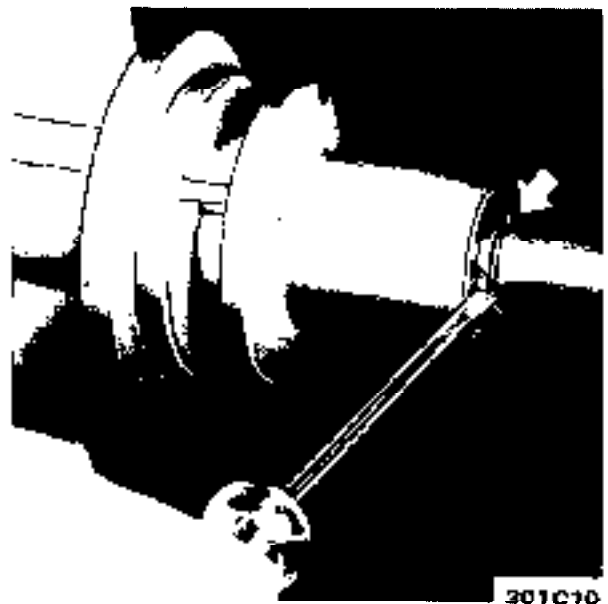
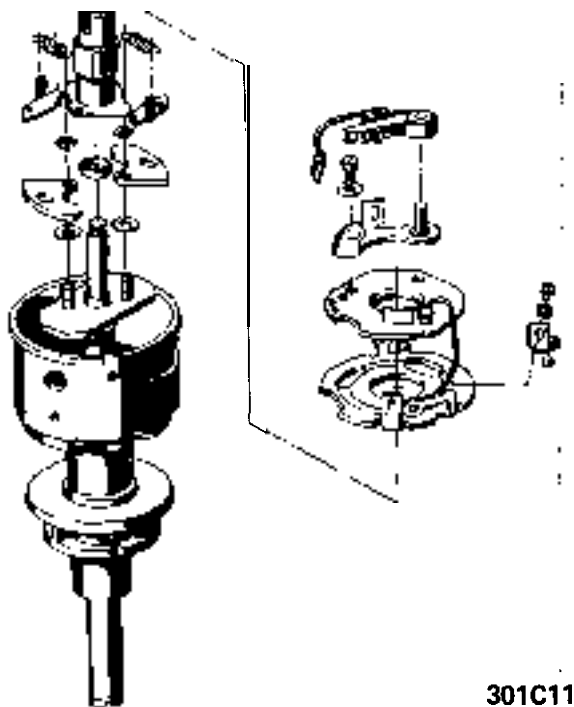


Figure 1C-10 Removing Retaining Ring

2. Push retaining ring out of groove in distributor shaft. See Figure 1C-10.

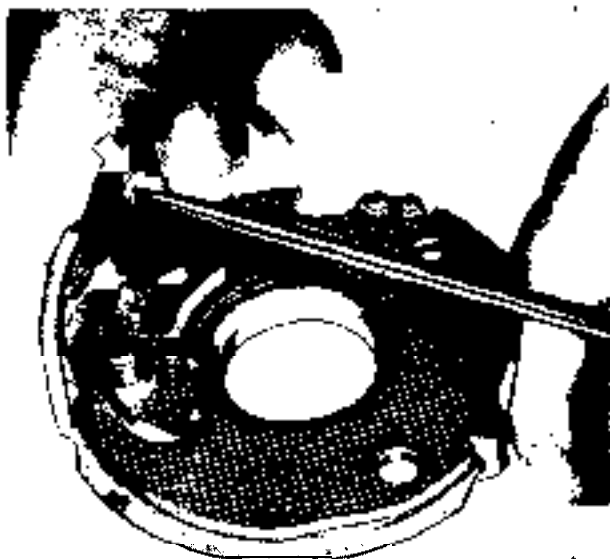
3. Push up on distributor shaft. Remove breaker plate from distributor housing. Remove breaker points from breaker plate. See Figure 1C-11.



301C11

Figure 1C-11 Removing Breaker Plate

4. Disassemble breaker plate by unscrewing ball thrust spring screw. Remove spring and ball. See Figure 1C-12.



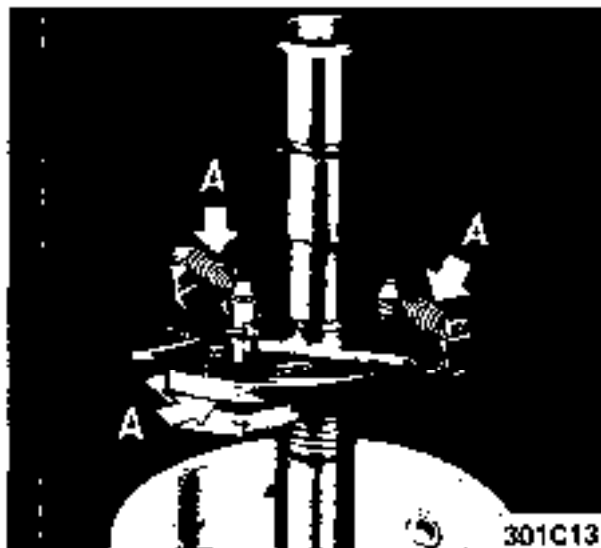
301C12

Figure 1C-12 Disassembling Breaker Plate

5. For cleaning, partly pull distributor shaft together with centrifugal advance mechanism out of distributor housing. Do not disassemble advance mechanism.

6. Clean and check all parts. Replace any defective parts.

7. Coat sliding parts of centrifugal advance mechanism and return springs with grease. See "A" in Figure 1C-13.



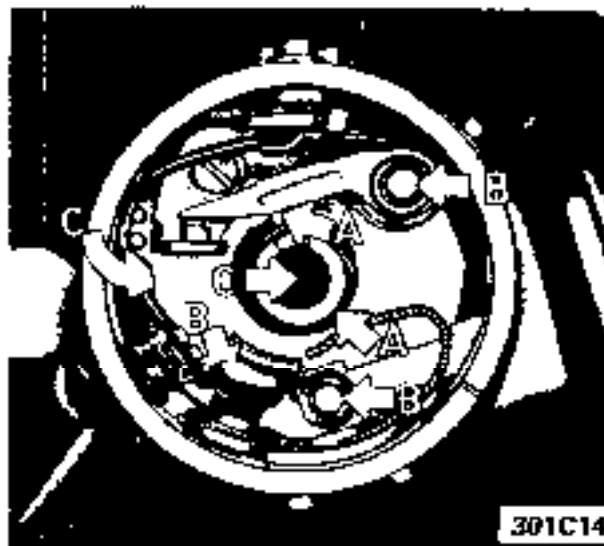
301C13

Figure 1C-13 Lubricating Centrifugal Mechanism Reassembly

1. Install new breaker points on breaker plate.

2. Install retaining ring on distributor shaft.

3. Install vacuum units, ignition condenser and cap retaining clips.



301C14

Figure 1C-14 Lubricating Upper Distributor

4. Oil sliding parts of breaker plate at "B". Oil felt in cam at "C". Apply a thin layer of high melting point grease to the cam, using a finger at "A". See Figure K-14.
5. Adjust breaker point gap to .016 inches.
6. Grease control rod eye at "A". See Figure 1C-15.

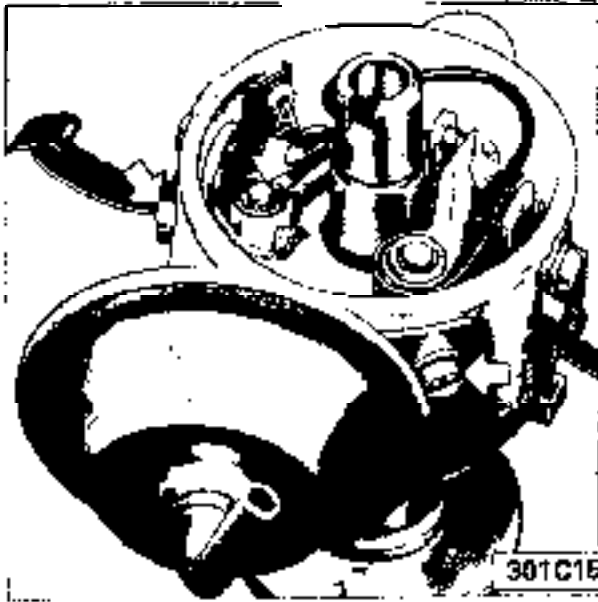


Figure 1C-15 Lubricating Control Rod Eye

7. Reinstall distributor cap nipples and spark plug boots. If hardened or cracked, use new parts. See Figure 1C-16.

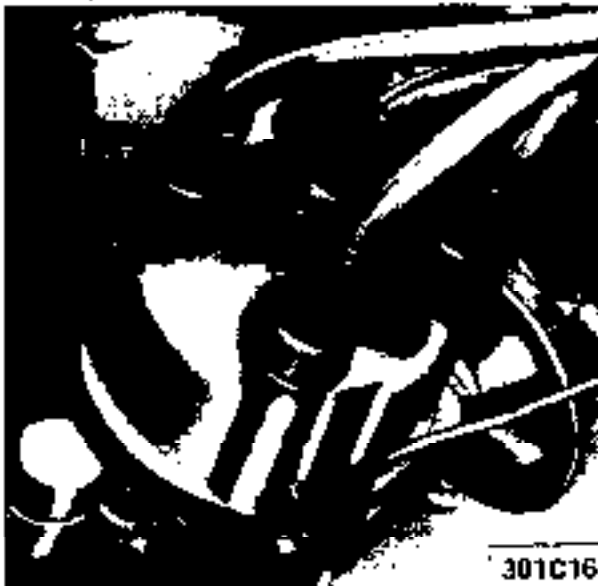


Figure 1C-16 Reinstalling Nipples

#### Distributor Installation

1. Make sure oil pump slot is in position to receive distributor shaft tang. See Figure 1C-17.

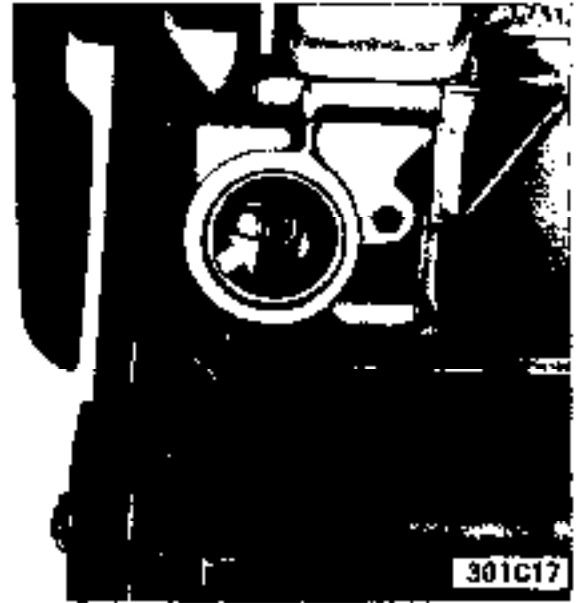


Figure 1C-17 Oil Pump Slot

2. Inspect paper gasket on distributor housing and replace if necessary.

3. Install distributor with vacuum units in original position and with shaft cutout (rotor tip) in position shown in Figure 1C-18. Distributor shaft will turn as distributor is installed, causing the rotor tip notch to align with the housing notch when distributor is seated.

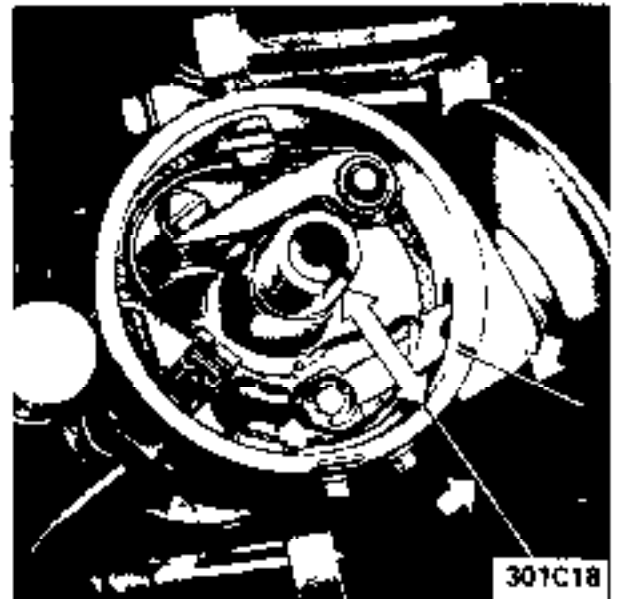


Figure 1C-18 Shaft Position for Starting Installation

4. Install distributor clamp, bolt and lockwasher tighter tight. Align marks on rotor tip and housing.

5. Install fuel pump.

6. Adjust ignition timing.

**SPECIFICATIONS**

**IGNITION COIL**

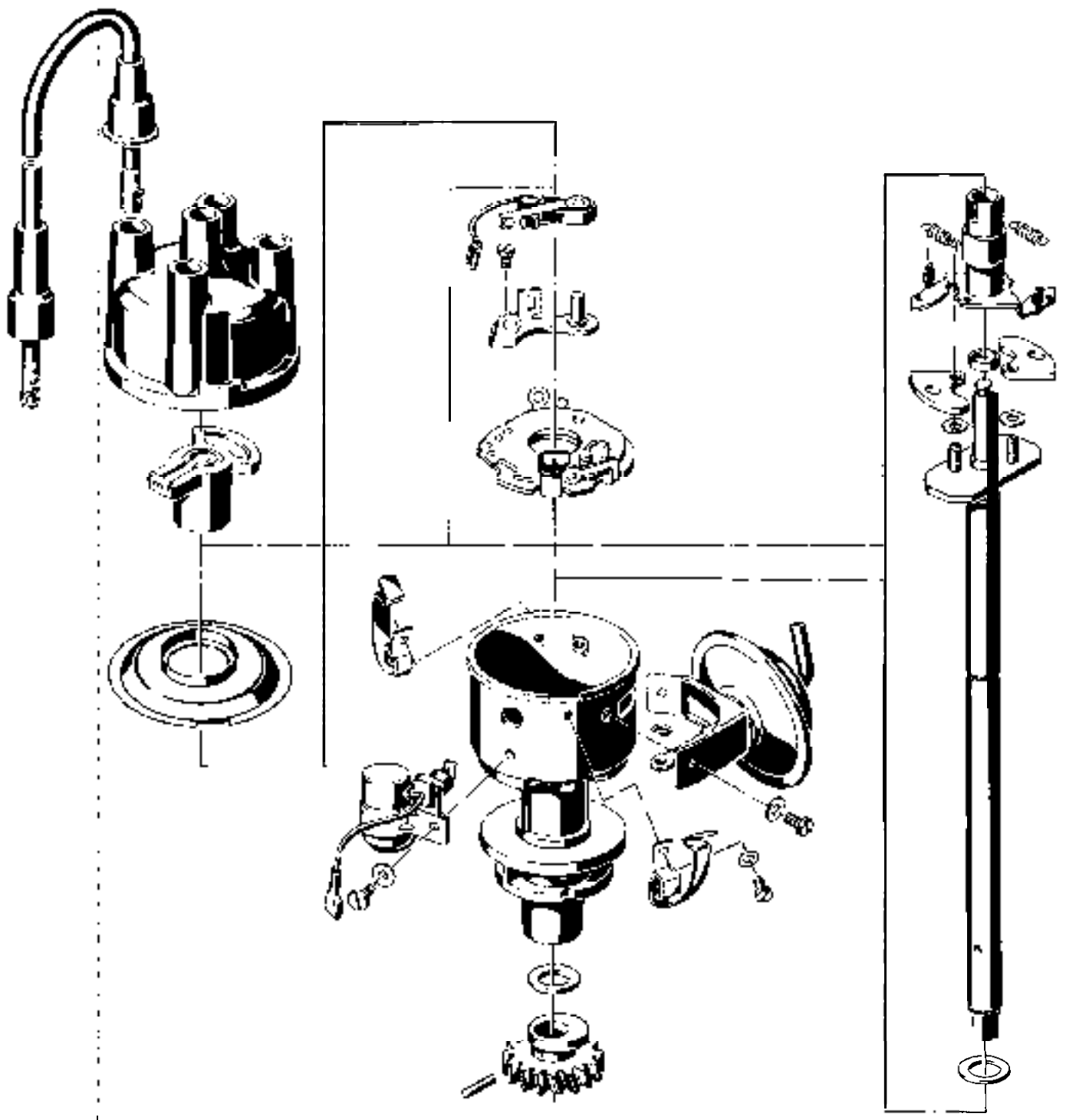
Ignition Coil Number .....	K12 V
Ignition Coil Current Draw, Amperes at 12.5 Volts	
Engine Stopped .....	3.8
Engine Idling .....	2.3

**DISTRIBUTOR**

Distributor Type Number: .....	JFU4
Total Advance (Centrifugal and Vacuum), Engine Degrees at 3600 R.P.M.	
Engine RPM .....	29-37
Centrifugal Advance, Engine Degrees and RPM	
Start Advance, at <b>RPM</b> .....	1000-1200
Medium Advance, Degrees at RPM .....	7.5-15 at 1400
Maximum Advance, <b>Degrees</b> at RPM .....	28-32 at 3600
Vacuum Advance, Engine Degrees <b>and In.</b> of Vacuum	
Start Advance, at In. of Vacuum .....	-5 at 2.9-4.1 In.
Maximum Advance, Degrees at In. of Vacuum .....	1-5 at 4.5-5.0 In.
Vacuum Retard, Engine Degrees at Closed Throttle .....	-5
Condenser Capacity in <b>MicroFarads</b> .....	15-20
Breaker Spring Tension in Ounces .....	14 to 19
Breaker Point Gap in Inches .....	,016
Dwell angle in Engine Degrees .....	50 ± 3
Firing Order .....	1-3-4-2
Spark Plug or Coil Cable, Max. <b>Resistance</b> in Ohms .....	10,000

**SPARK PLUGS**

Make and Model - Production .....	AC42FS
Make and Model - Replacement .....	AC42FS
If carbon fouling occurs, use .....	AC43FS
Spark Plug Torque in <b>Lb.Ft.</b> .....	22-29
Spark Plug Gap in Inches .....	.028-.031



301C19

Figure 1 C-1 3 Distributor Exploded



# CHARGING SYSTEM

## CONTENTS

Subject	Page No.
<b>DESCRIPTION AND OPERATION:</b>	
Alternator .....	1 D-28
Regulator.....	1 D-29
<b>DIAGNOSIS: (Not Available):</b>	
<b>MAINTENANCE AND ADJUSTMENTS:</b>	
Alternator Tests .....	1 D-29
Regulator Tests .....	1 D-29
<b>MAJOR REPAIR:</b>	
Alternator Removal .....	1 D-30
Alternator Disassembly .....	<b>1D-31</b>
Alternator Reassembly.....	1 D-34
Alternator Installation .....	1 D-35
<b>SPECIFICATIONS:</b>	
Alternator .....	1 D-35
Regulator .....	1 D-35

### DESCRIPTION AND OPERATION

#### ALTERNATOR DESCRIPTION

The K1, 35 amp alternator is standard equipment on all 1973 models.

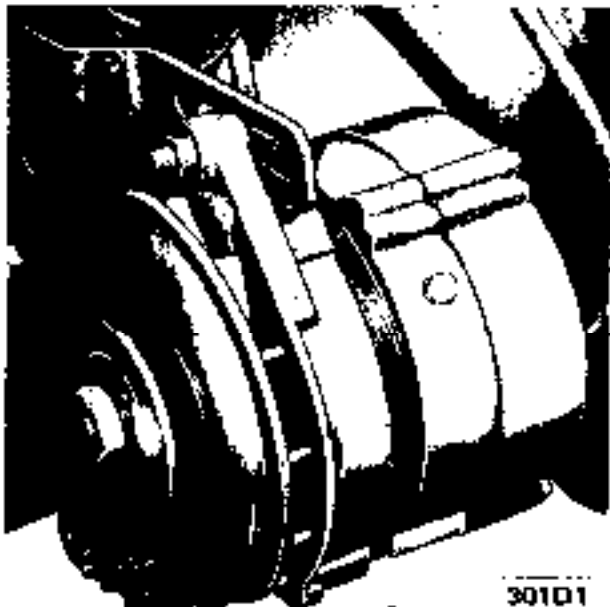


Figure 1D-1 Alternator Installed

The alternating current generator (alternator) is a continuous-output (even at idle), diode rectified generator. See Figure 1D-1.

The rotor, which carries the field winding, is mounted in ball bearings at both ends. Each bearing has a sealed-in grease supply which eliminates the need for periodic lubrication. Two brushes and two slip rings are used. One brush conducts the current provided by the voltage regulator to one end of the field coil; the other brush conducts the current from the other end of the rotating field coil to ground.

The three phase **stator** windings are assembled on the inside of a laminated core that forms the center section of the alternator frame. Nine rectifier diodes are connected to the **stator** windings (three to each phase lead). The diodes change the alternator AC voltages to DC voltage coming out of the B positive and the D positive terminals of the alternator.

If the alternator will not meet output specifications when supplied with full field current, the **assembly** must be overhauled. If the voltage regulator does not limit maximum voltage within specifications, adjust the voltage regulator. If steady voltage regulation, within specifications, cannot be achieved, the voltage regulator assembly must be replaced.

**REGULATOR DESCRIPTION**

The regulator contains only one unit • a double contact voltage regulator. See Figure 1D-2.

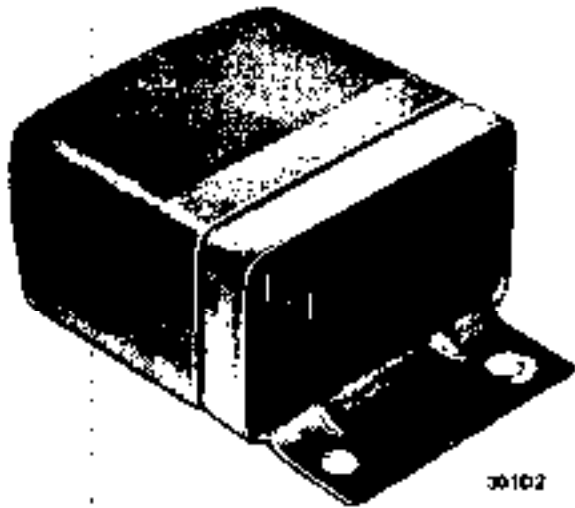
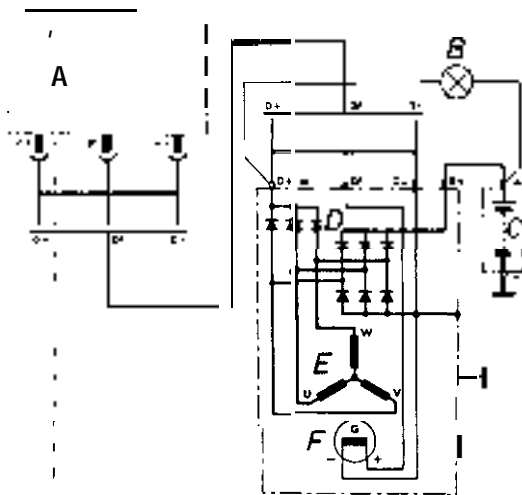


Figure 1 D-2 Voltage Regulator

Since the alternator field is grounded inside the alternator, the voltage contacts are in series with the field. Field current is supplied from the D- terminal of the alternator, goes through a small red wire to the voltage contacts in the regulator, comes out of the regulator through a brown wire, into the DF terminal of the generator, and through the field winding to ground inside the generator. See Figure 1D-3.



- A = REGULATOR
  - B = CHARGING INDICATOR LAMP
  - C = BATTERY
  - D = DIODES
  - E = STATOR
  - F = ROTOR
- 301D3

Figure 1D-3 Charging Circuit Diagram

The diodes in the alternator, since they act like one-way check valves, make a cutout relay unnecessary; battery current can flow only as far as the diodes, but cannot discharge through the alternator. However, whenever alternator voltage is higher than battery voltage, current flows freely through the diodes in the other direction to charge the battery.

A current-regulator is not necessary. Any alternator is limited by its design in regard to maximum current output. Regardless of current need, an alternator cannot put out more than its rated current output and, therefore, cannot overheat and damage itself due to excessive output.

**MAINTENANCE AND ADJUSTMENTS**

**ALTERNATOR AND REGULATOR TESTS**

**Test Current Output**

1. Check alternator belt condition and tension. Adjust to 45 lbs. using Gauge J-23600.
2. Install a battery post adapter at the positive post of the battery.
3. Connect ammeter leads to adapter with red lead toward generator and black lead toward battery positive post. Connect ground lead to battery negative post. See Figure 1D-4.

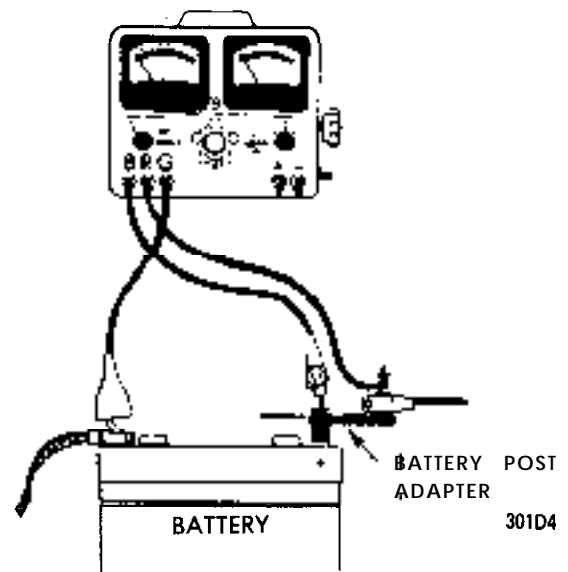


Figure 1D-4 Connecting Ammeter Leads

4. Connect voltmeter across the battery: red lead at generator side of battery post adapter and black lead to battery negative post.
5. Connect a tachometer to ignition system.

6. Make sure all electrical accessories are turned off. Start engine with battery post adapter switch closed; open switch as soon as engine is started.

7. Adjust engine speed to 2500 RPM.

8. Turn tester control knob to "LOAD" position and adjust knob to obtain highest possible ammeter reading. Output must be 30 amperes minimum. If output is okay, proceed to voltage regulator test below.

9. If output is low, defect may be in alternator or in regulator. To eliminate regulator, supply field current direct to cause full alternator output. Unplug three-way connector from regulator and plug in a jumper between the red and black leads. See Figure 1D-5. Retest as described in Steps 7 and 8. If output is still low, generator is faulty and must be removed.



301D5:

Figure 1D-5 Alternator Output Check

10. If output (using field jumper) is now okay, defect is in the regulator or wiring harness. Check all wiring connections. If all wiring is okay, try replacing regulator; if output now tests okay (without using field jumper), you have found the trouble. Always follow-up with a voltage regulator test.

#### Test and Adjust Voltage Regulator Setting

1. Always test alternator output first, as described in subparagraph a above. Leave all test instruments connected, but make sure field jumper is removed; if used.

2. With engine speed at 2500 RPM, turn tester control knob to "1/4 OHM" position. Make sure all electrical accessories are turned off. After voltage reading stabilizes, any reading between 13.5 and 14.5 volts is okay.

3. If voltage reading is out of limits, remove regulator

cover and adjust voltage regulator armature spring tension to obtain a middle reading of 14.0 volts. If reading fluctuates, voltage contacts are dirty.

4. Replace regulator cover and recheck voltage setting. A steady voltage reading between 13.5 and 14.5 volts means voltage regulator is okay.

5. Adjust engine speed to specified idle. Reseal voltage regulator cover carefully, using electrical tape.

## MAJOR REPAIR

### ALTERNATOR OVERHAUL

Always disconnect battery ground cable before making any electrical repairs.

#### Alternator Removal

1. Disconnect battery ground strap.
2. Unplug wiring connector from alternator.
3. Disconnect battery lead from alternator.
4. Remove adjusting brace bolt, lockwasher, plain washer and nut.
5. Loosen pivot bolt. Push alternator inward and remove belt from pulley.
6. Drop alternator down and remove pivot bolt, nut, lockwasher and plain washer.
7. Remove alternator.

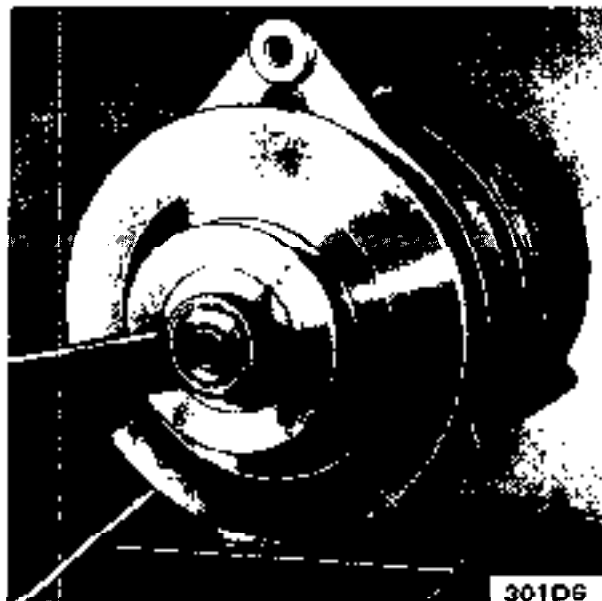


Figure 1D-6 Removing Alternator Pulley

## Alternator Disassembly

1. Remove nut and alternator pulley. See Figure 1D-6. Remove pulley and fan from rotor shaft.
2. Mark drive end frame, stator and rear end frame to ensure correct installation of parts on reassembly. Remove drive end frame. See Figure 1D-7.

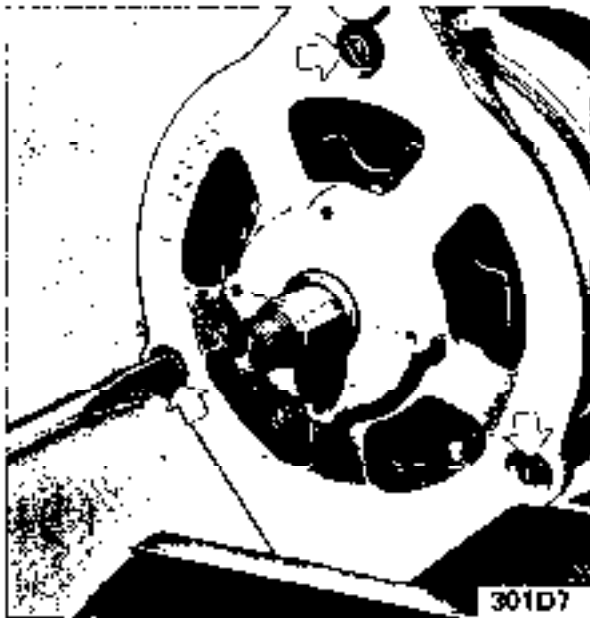


Figure 1D-7 Removing Drive End Frame and Rotor Assembly

3. Remove drive end frame and rotor assembly from generator. See Figure 1D-8.

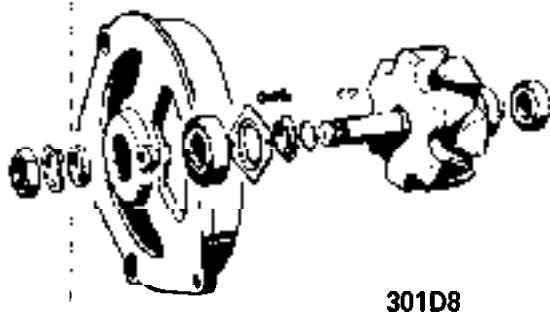


Figure 1D-8 Drive End Frame and Rotor Assembly

4. Pull drive end frame off rotor shaft. See Figure 1D-9.
5. With puller remove rear ball bearing from rotor shaft. See Figure 1D-10.
6. Remove positive diode support. See Figure 1D-11.

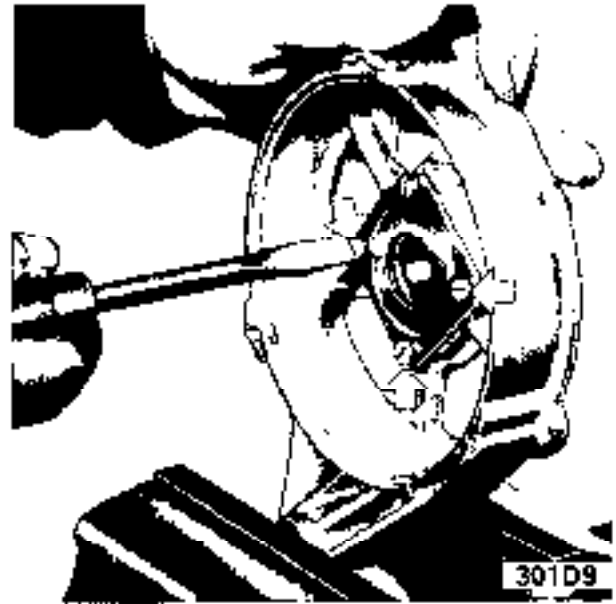


Figure 1D-9 Removing Drive End Frame Bearing



Figure 1D-10 Removing Rear Bearing

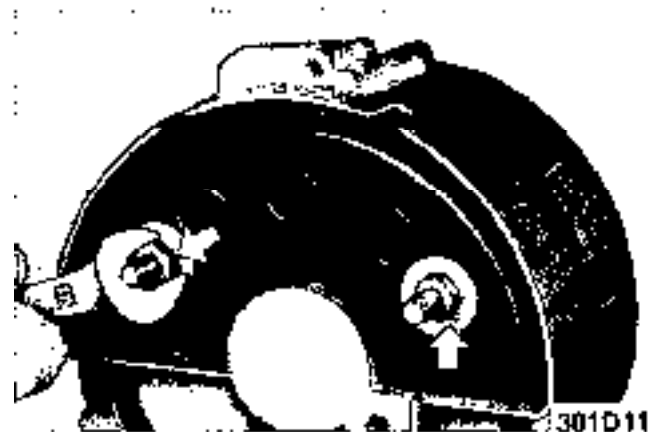


Figure 1D-11 Removing Positive Diode Support

7. Disconnect brush connector from negative diode support. See Figure 1D-12.
8. Remove brush holder. See Figure 1D-13.

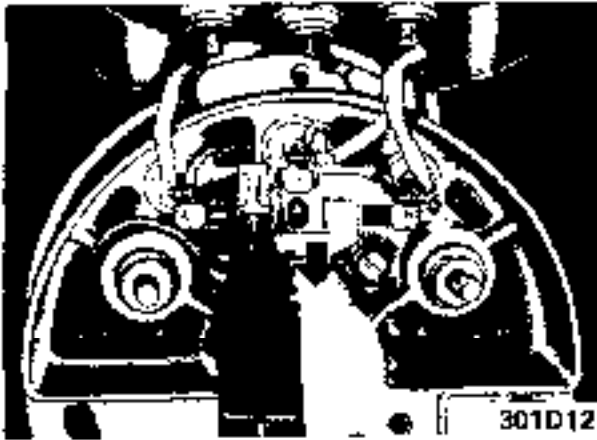


Figure 1D-12 Disconnecting Brush Connector

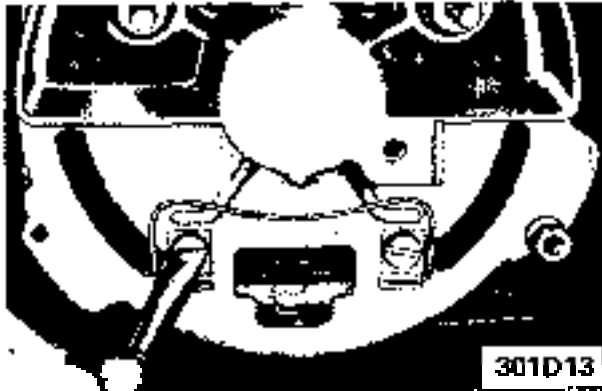


Figure 60-13 Removing Brush Holder

9. Unsolder diode connections and stator winding ends. Clamp pliers on wire to transfer heat away from diodes. Unsolder quickly using a very hot soldering iron, as the diodes are very sensitive to heat. See Figure 1D-14.

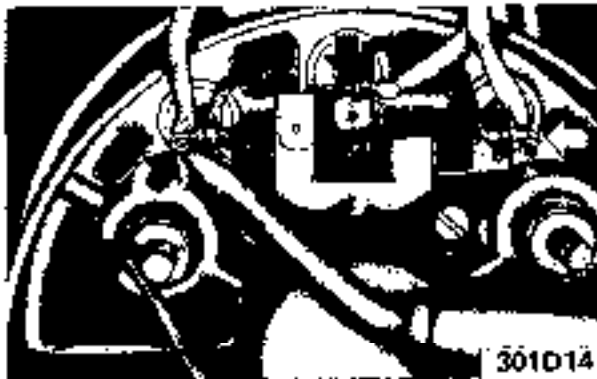


Figure 1 D-I 4 Unsoldering Connections

- 10. Remove stator assembly from housing.
- 11. Remove two screws and negative diode support.

12. Unsolder brushes, if they are worn to a length of 3/8 inch or less. Solder new brushes in place. To do this, hold connecting wire in flat-nosed pliers to prevent solder from flowing between wire strands, otherwise the wire strands will become rigid and the brushes unserviceable. See Figure 1D-15.



Figure 1 D-I 5 Soldering New Brushes

Note brush wire installation of correct assembly. See Figure 1D-16.

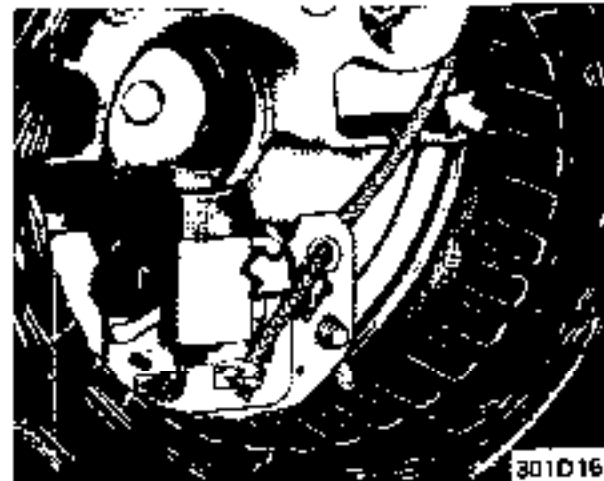


Figure 1 D-I 6 Brush Wire Installation

13. Test rotor windings and slip rings for a ground, using a test light or an ohmmeter. Test light should not light; ohmmeter should read near infinite resistance end of scale. See Figure 1D-17.

14. Test rotor windings for a short by connecting an ohmmeter between the two slip rings. Ohmmeter should read between 4.0 and 4.4 ohms. See Figure 1D-18.

15. Test stator windings for a ground, using a test light or an ohmmeter. Test light should not light; ohmmeter should read near infinite resistance end of scale. See Figure 1D-19.

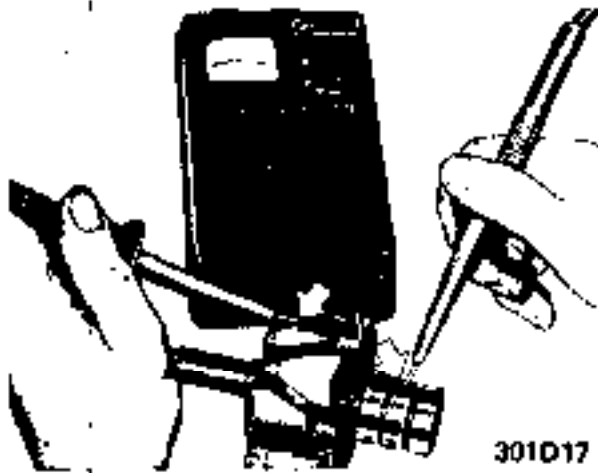


Figure 1D-17 Checking Rotor for Ground

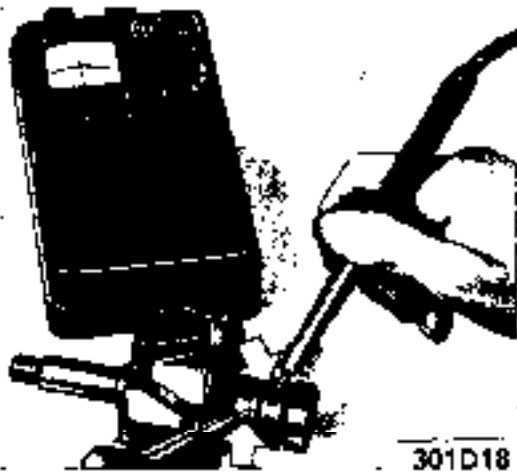


Figure 1D-18 Checking Rotor for Short

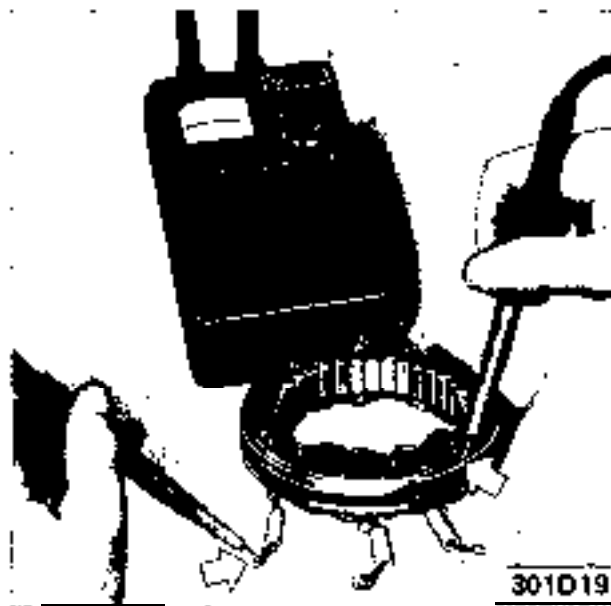


Figure 1 D-1 9 Checking Stator for Ground

16. Check **stator** windings for a short, using a low reading ohmmeter. Check two phases at a time by holding ohmmeter prods alternately on winding ends. Ohmmeter should read between .26 and .29 ohms. See Figure 1D-20.

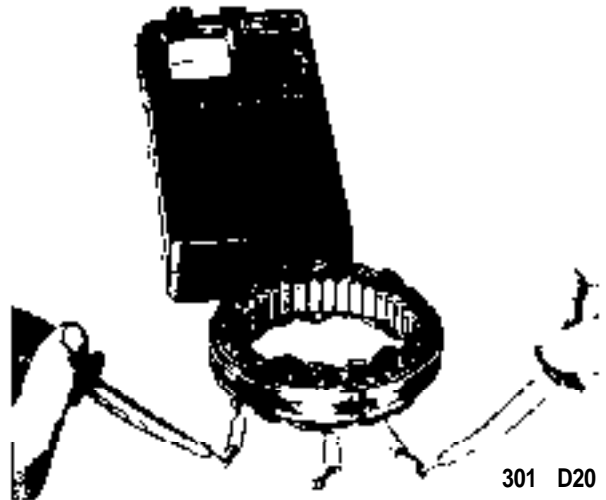


Figure 1 D-20 Checking Stator for Short

17. Clean slip rings with fine emery cloth and polish them. To avoid generating flat surfaces on slip rings, spin rotor on a lathe when cleaning and polishing. Slip rings that are not concentric can be turned **down** to a diameter of 1-1/4 inches. When doing this, remove only enough material to just clean up the worn surface, then polish slip rings and blow clean with compressed air.

18. If alternator current output is low one or more of the nine diodes may be defective. See Figure 1D-3.

19. If a defective diode is suspected, test diodes. Before testing diodes, disconnect them, otherwise it is not possible to determine which diode is defective. Use a test light supplied with a DC voltage of not more than 24 volts.

20. To test a diode, place one test light prod on diode connection and other on diode housing, then reverse test light prods. Test light should light brightly in

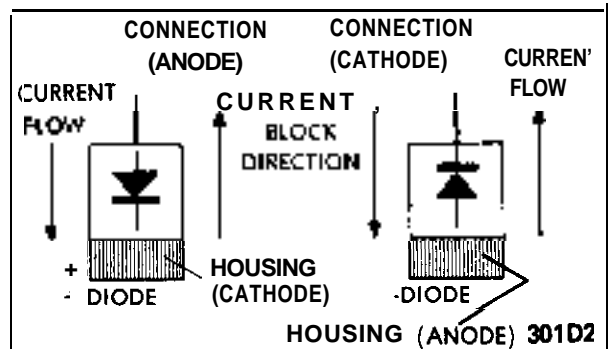


Figure 1 D-2 1 Positive and Negative Diodes

one direction, but should not light at all in the other direction. Diodes in each set of three should pass current and block current in the 'same directions' as the others in the set. See Figure 1D-21.

**Removing Diodes**

*Positive Diodes*

1. Press defective diode out of diode support, backing-up support with a sleeve slightly larger than the diode and pushing diode through with a shaft slightly smaller than diode. See Figure 1D-22.

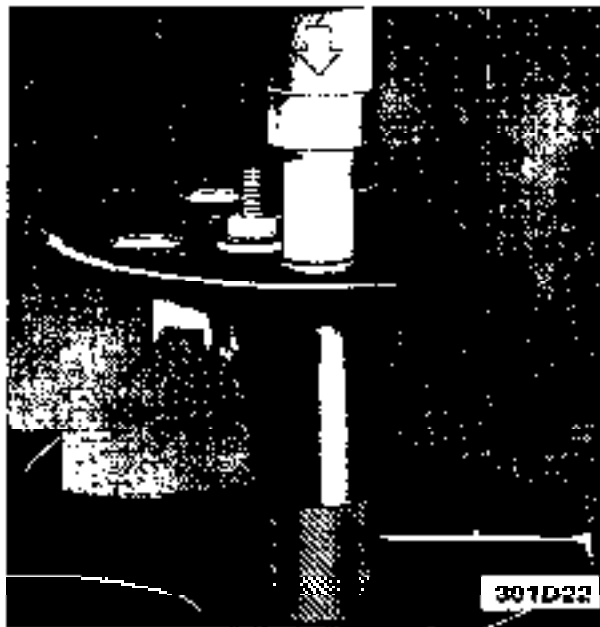


Figure 1 D-22 Removing Diode

*Negative Diodes*

1. Clip lead from defective diode. Clip lead close enough to diode so that tool will function properly.

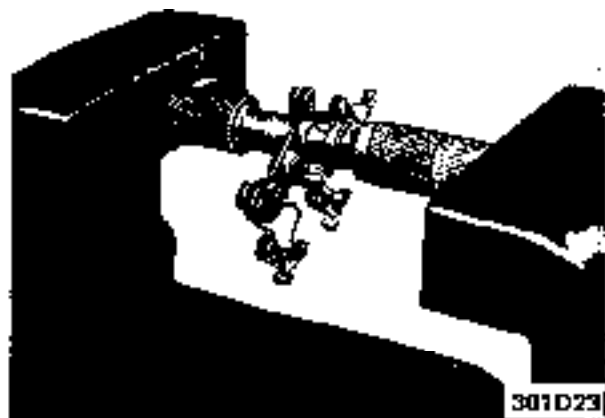


Figure 1 D-23 Removing Diode

2. Using Tool J-23526, press diode from support. See Figure 1D-23.

**Installing Diodes**

*Positive Diodes*

1. Press new diode into diode support. See Figure 1D-24.

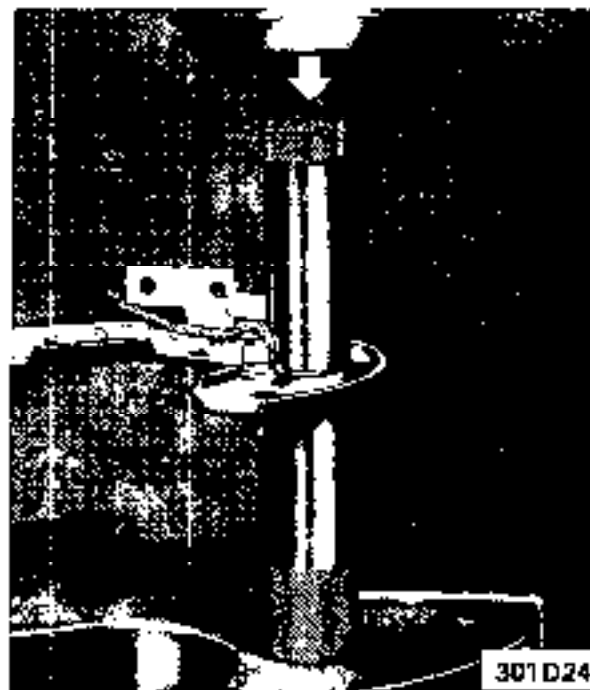


Figure 1D-24 Installing Diode

*Negative Diodes*

1. Using Tool J-23526, press diode into support. See Figure 1D-25. Insert negative diode pigtail lead through tool pilot.

**Alternator Reassembly**

1. Clean and inspect all parts. Check brushes. Replace them if they have worn **down to 3/8 inch.**
2. Lubricate both bearings with special ball bearing lubricant.
3. Press rear bearing on rotor shaft and install front bearing into drive end frame.
4. Assemble **stator** together with windings into rear end frame.
5. Install both diode supports.
6. Solder diode connections and ends of **stator** windings together. Since diodes are very sensitive to heat, solder quickly using a very hot soldering iron.

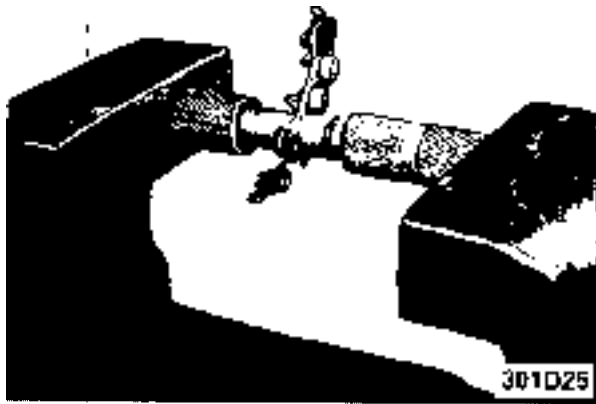


Figure 1D-25 Installing Diode

7. Install rotor together with drive end frame into stator and assemble generator in reverse order of disassembly. Make sure marks made during disassembly are aligned.

8. Install pulley and fan. Tighten nut to 30 lb.ft.

9. Test generator on test bench, if available. If not, install alternator on car and test.

**Alternator Installation**

1. Hold alternator in position and install pivot bolt, plain washer, lockwasher and nut finger tight.
2. Install alternator belt.
3. Install adjusting brace bolt, lockwasher, plain washer and nut finger tight.
4. Position a belt tension gage such as Gage J- 23600

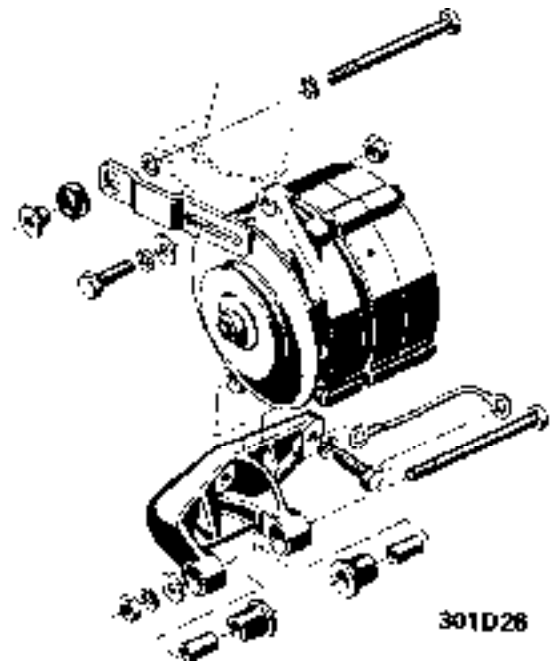


Figure 1 D-26 Alternator Installation

on belt. Pull alternator outward until gage reads 45 lbs., then tighten adjusting brace bolt.

5. Tighten alternator pivot bolt.
6. Connect battery lead to alternator.
7. Plug three-way wiring connector into alternator and engage safety catch.
8. Connect battery ground strap.

**SPECIFICATIONS**

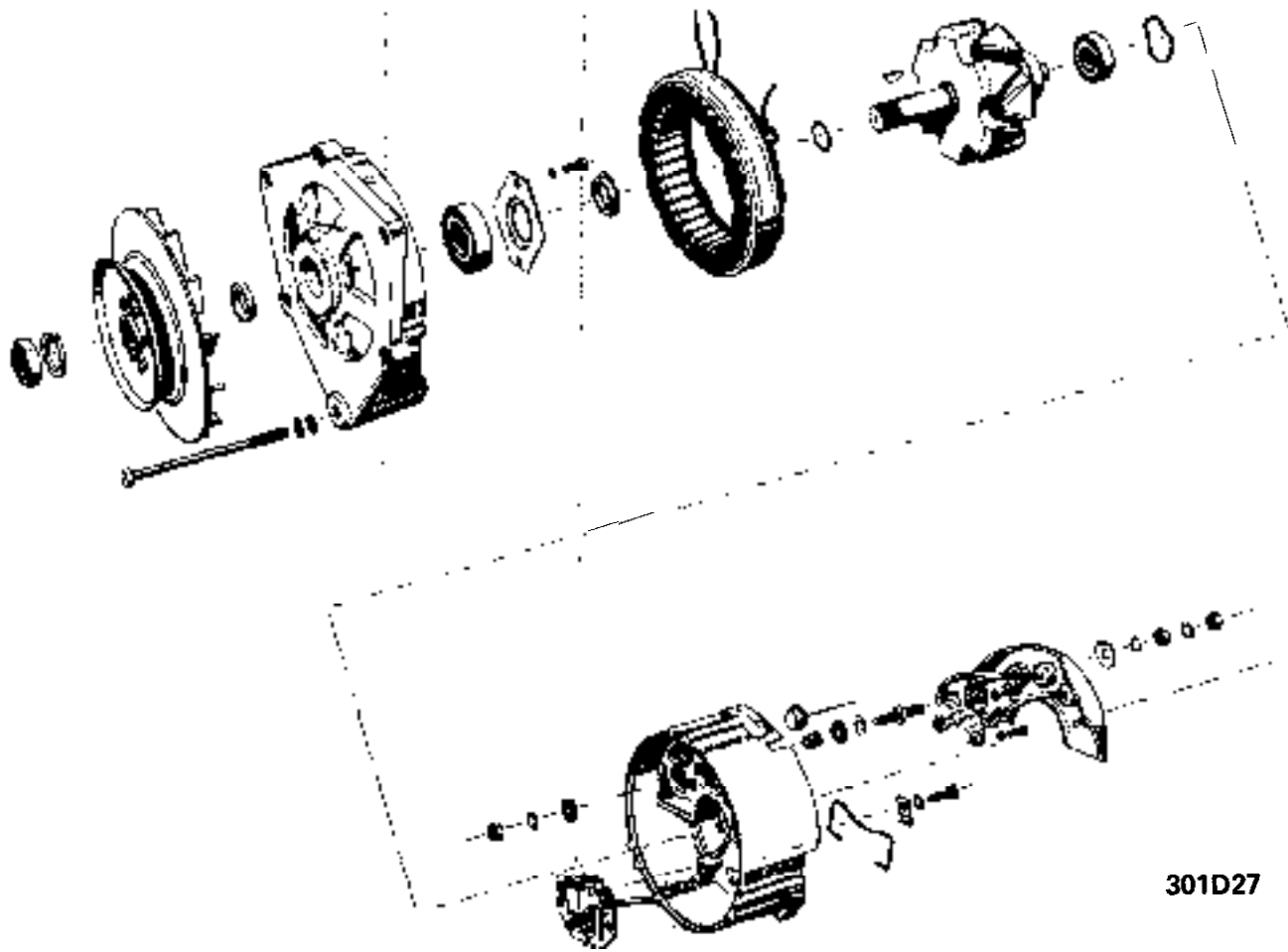
**ALTERNATOR**

35, AMP	
Alternator Number .....	KI 14V35A20
Rated Output in Volts .....	14
Continuous Rated Output in Amperes .....	35
Test Output in Amperes at 2000 Engine RPM .....	23 Min.
Resistance of Field Coil in Ohms .....	4-4.4
Resistance of Stator Windings in Ohms .....	26-29
Alternator Pulley Nut Torque in Lb.Ft. ....	30
Belt Tension in Pounds .....	45

**REGULATOR**

Regulator Number .....	AD 1/14 V
Regulator Setting in Volts at 2500 Engine R.P.M. ....	14 ± .5





301D27

Figure 1 D-27 Alternator - Exploded View

# WINDSHIELD WIPERS

## ALL MODELS

### CONTENTS

Subject	Page No.
<b>DESCRIPTION AND OPERATION:</b>	
Windshield Wiper Motor .....	1 E-37
<b>DIAGNOSIS:</b>	
Windshield Wiper .....	1 E-37
<b>MAINTENANCE AND ADJUSTMENTS: (Not Applicable)</b>	
<b>MAJOR REPAIR:</b>	
Wiper Transmission - 1900 and Manta .....	1 E-38
Wiper Transmission - GT .....	1 E-38
Disassembly of Wiper Motor .....	1 E-40
Cleaning and Inspection of Parts .....	1 E-41
Assembly of Wiper Motor .....	1 E-4 1
Installation .....	1 E-42
<b>SPECIFICATIONS:</b>	
General Specifications .....	1 E-43
Torque Specifications .....	1 E-43

## DESCRIPTION AND OPERATION

### GENERAL DESCRIPTION

The two-speed wiper consists of a round shaped permanent magnet type motor and speed reduction gear box.

### OPERATION

The wiper motor is controlled through a dash mounted switch on all cars. The Rallye and GT, in addition to the dash mounted switch, also have a switch mounted in conjunction with the windshield washer foot pump. Depressing the washer pump will allow the wipers to operate while the pump is depressed.

## DIAGNOSIS

### PRELIMINARY INSPECTION

1. Make certain of firm wire connections at wiper motor fuse block and wiper switch.

2. Check to see that the fuse is not blown.

3. Be sure wiper motor is not loose on fire wall.

4. With the yellow wire disconnected from terminal No. 53 on the wiper motor, turn the ignition switch and wiper switch to the on position and check voltage available to the wiper motor. There should be 12 volts available at the purple wire with a properly charged battery.

### Checking Wiper Operation

1. Turn ignition switch on and engage wiper switch to see if wiper motor will operate.

2. If wiper action is slow or inoperative, turn switches off and detach wiper control arm from crank arm.

3. Operate wiper manually checking for excessive bind in linkage. Correct if necessary.

4. Turn switch on to see if wiper motor will function with wiper linkage detached. If wiper motor will not run, disconnect connector at wiper motor and connect hot lead from battery to terminal No. 53 on wiper motor. If wiper motor runs, the wiper switch is faulty or there is a break in the lead wire. If wiper motor still will not run, remove and bench test.

## MAJOR REPAIR

### WIPER TRANSMISSIONS

#### Removal (1900 and Manta)

1. Remove wiper blade (2).
2. Remove the wiper transmission retaining nut, washer, and rubber seal ring. See Figure 1E-1.

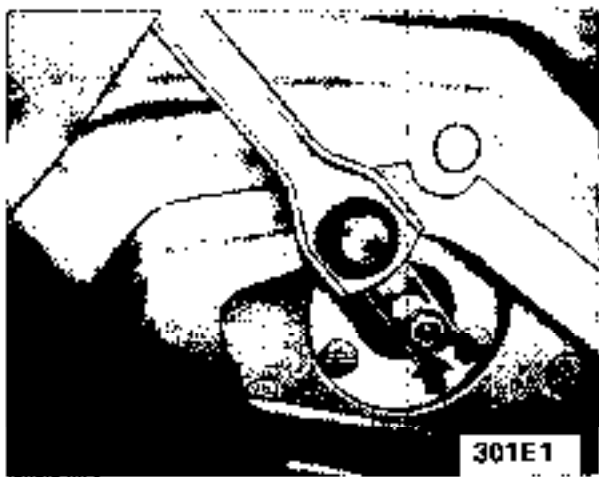


Figure 1E-1 Crank Arm Retaining Nut

3. Remove instrument cluster housing.

If only left wiper transmission is to be serviced, it can be done without removing any other instrument panel components. If the right side, or both, transmissions are to be serviced, then it will be necessary for complete instrument panel removal. On the Rallye models, the gauge carrier must also be removed. On all 1900 and Manta Models the defroster ducts are secured to the instrument panel cover, by two (2) spring clips, and should not be removed from dash cover. Remove cover and duct as a unit.

4. Remove retaining clips from transmission connecting rod pins. Pull connecting rods off pins. See Item "A", Figure 1E-2.

5. Remove the screws securing the wiper transmission to the inner side of the cowl (Items "B", Figure 13), and remove the transmission assemblies.

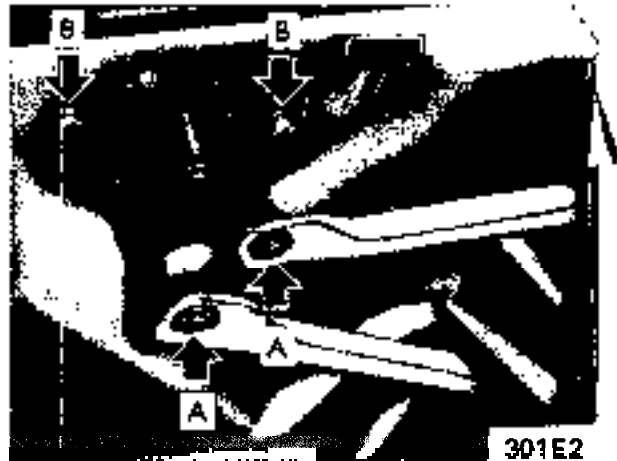


Figure 1E-2 Connecting Rod Retaining Clips

#### Installation

1. Place wiper transmissions into position at cowl and install holding screws.
2. Push connecting rods onto transmission cranking arm pins and install retaining clips. See Figure 1E-2, Item "A".
3. Reinstall dash and instrument cluster parts.
4. Install the rubber seal ring, washer, and transmission retaining nut. See Figure 1E-1.
5. Install wiper blades and check the position of the blades in the park position. See Figure 1E-3.



Figure 1E-3 Wiper Blades in Park Position

#### Removal and Installation of GT Wiper Transmission

1. Remove nuts and remove both wiper arms. See Figure 1E-4.
2. Remove three (3) bolts from each windshield

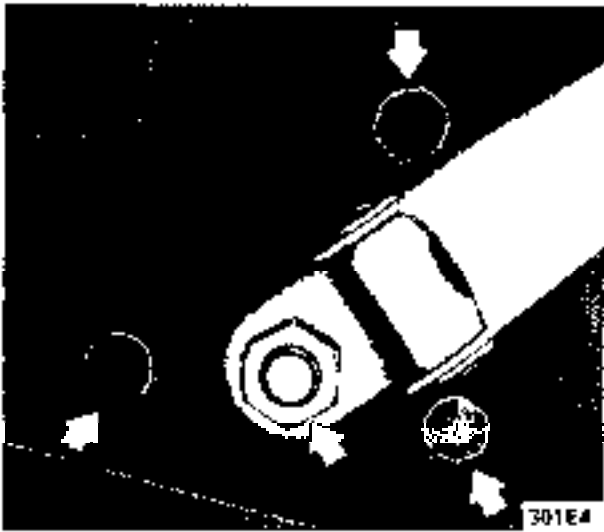


Figure 1 E-4 Removing Wiper Arms-GT

wiper transmission and drop wiper transmissions from deflector panels. See Figure 1E-4.

3. Remove screws from left and center deflector panels. See Figures 1E-5 and 6.



Figure 1 E-5 Removing Screws from Left Deflector Panel



Figure 1E-6 - Removing Screws from Center Deflector Panel

4. Remove center deflector panel. Remove left deflector panel together with wiper motor and complete wiper linkage. See Figure 1E-7.



Figure 1E-7 - Removing Left Panel, Motor and Linkage

5. Remove nut and lockwasher from wiper motor shaft and remove complete wiper linkage.

6. Install in reverse sequence, checking all parts for wear. Replace any worn parts.

## WIPER MOTOR OVERHAUL

### Removal of Wiper Motor

1. Remove the wiper motor to crank arm attaching nut, this is done from the inside of vehicle. The nut is located on inner side of cowl, just above the steering column. See Figure 1E-1.

2. Pull crank arm off motor drive shaft.

3. Remove three (3) wiper motor attaching screws. See Figure 1E-8.



Figure 1 E-8 Wiper Motor Attaching Screws

4. Remove motor from cowl.

5. Remove wiper motor electrical connector from motor.

**Disassembly**

1. Remove two (2) motor housing attaching screws (Item No. 4) and two (2) angle brackets (Item No. 3). See Figure 1E-9.

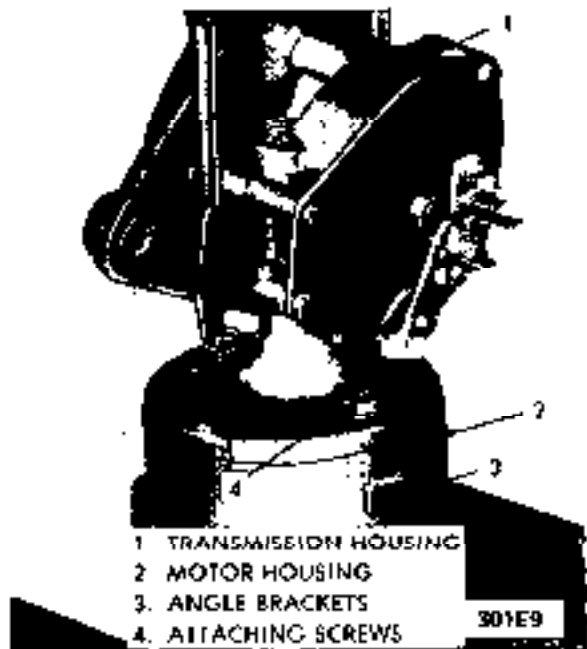


Figure 1 E-9 Removing Motor Housing Attaching Screws

2. Remove transmission housing together with armature from motor housing. See Figure 1E-10. It may be necessary to hold armature in transmission housing with a screw driver.

3. Remove armature from transmission housing.

4. Remove five (5) transmission housing cover screws. See Figure 1E-11.

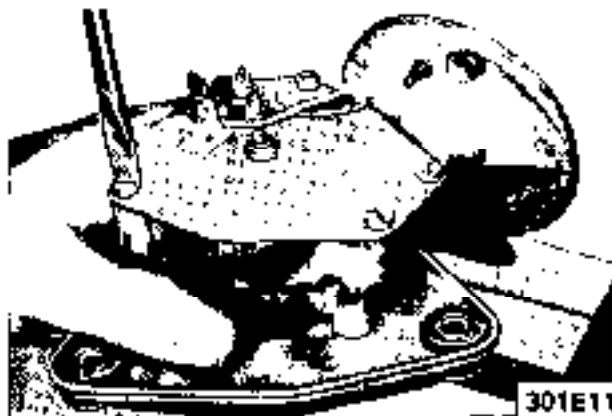


Figure 1 E-11 Remove Transmission Housing Cover Screws

5. Remove cover, gasket and driven gear from transmission housing. See Figure 1E-12. Remove pivot ball from driven gear. See Figure 1E-15.



Figure 1 E-12 Remove Driven Gear

6. If required, remove brushes.

a. To remove positive brushes, cut brush leads off at brush holder. See Figure 1E-13.

b. To remove negative brush, remove brush retaining screw from commutator end frame. See Figure 1E-14.

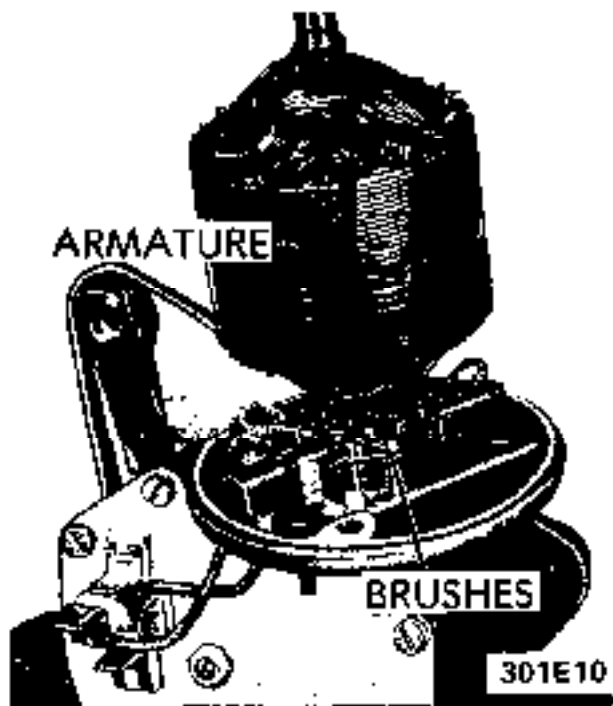


Figure 1 E-10 Transmission and Armature Removed from Motor Housing



Figure 1 E-13 Cut Off Positive Brush Leads

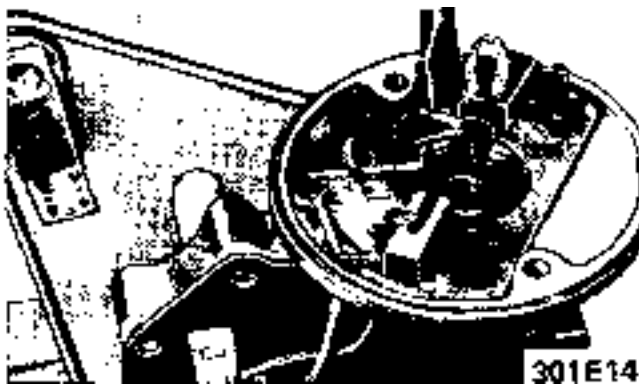


Figure 1 E-14 Remove Negative Brush Retaining Screw

#### Cleaning and Inspection of Parts

With the exception of electrical parts and bushings, clean all components in a cleaning solvent.

1. Check **armature** windings for ground, or open circuit. If a ground or open circuit is evident, the armature must be replaced. If the armature checks out, the **commutator** can be undercut.
2. Check brush springs. Spring pressure of new brushes should be 6.35 to 8.47 ounces. Spring pressure of worn brushes should be at least 3.5 ounces. In case of **lower** spring pressure, replace springs.
3. Check **brushes** for wear and replace, if necessary. Minimum brush length should be **.24 inch**.
4. Check **driven** gear for wear and replace if necessary.

#### Assembly of Wiper Motor

1. Fill transmission (driven gear) housing with **1/8 inch** layer of grease meeting GM Specification 02383.
2. Install **driven** gear into housing

3. Apply a small amount of grease to ball cavity of driven gear and insert ball. See Figure 1E-15.



Figure 1E-15 Insert Ball into Driven Gear

4. Install transmission housing cover. See Figure 1E-16.

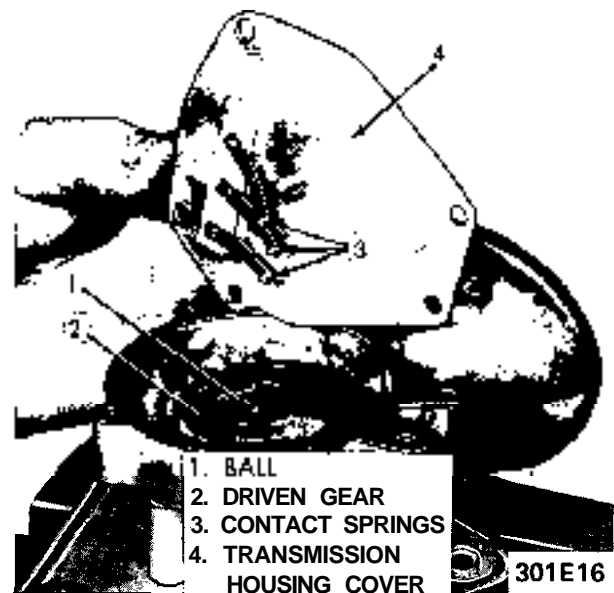


Figure 1 E-16 Install Transmission Housing Cover

5. Solder positive brush lead(s) to brush holder(s). Hold brush lead with needle nose pliers to prevent solder from running up wire strands. See Figure 1E-17.
6. Install negative brush
7. Apply a small amount of grease to end of armature shaft. Lightly oil armature shaft.
8. Insert brush springs and brushes into brush holders. Slide armature into housing, taking care not to damage brushes.

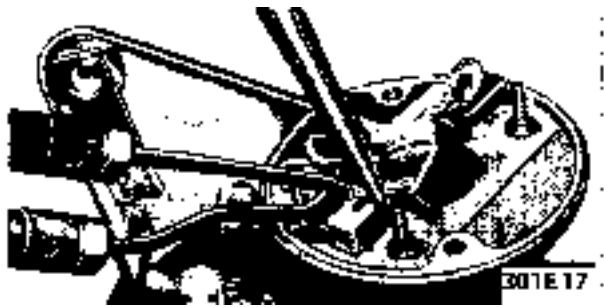


Figure 1 E-1 7 Solder Positive Brush Lead to Brush Holder

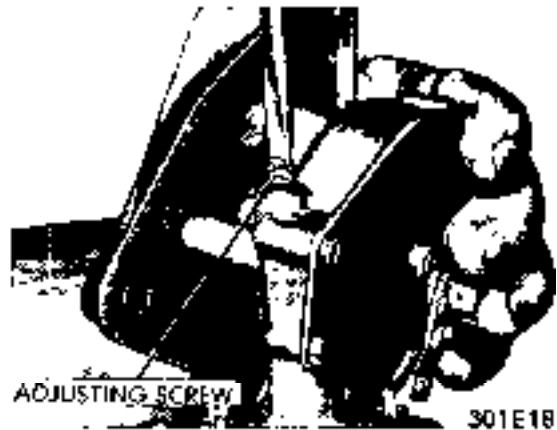


Figure 1 E-1 8 Adjusting Armature End Play

9. Install motor housing over armature so that large drain hole on housing is facing downward when motor assembly is installed in car. Insert angle brackets into motor housing and tighten attaching screws. Be sure to reseal angle brackets to motor housing after retaining screws are tightened.

10. Connect assembled motor with an ammeter and adjust end play of armature shaft and drive gear. To do so, turn in the respective adjusting screw until the current consumption increases. Then back off adjusting screw 1/2 turn. Secure driven gear adjusting screw with lock nut and armature adjusting screw with paint. See Figures 1E-18 and 1E-19.

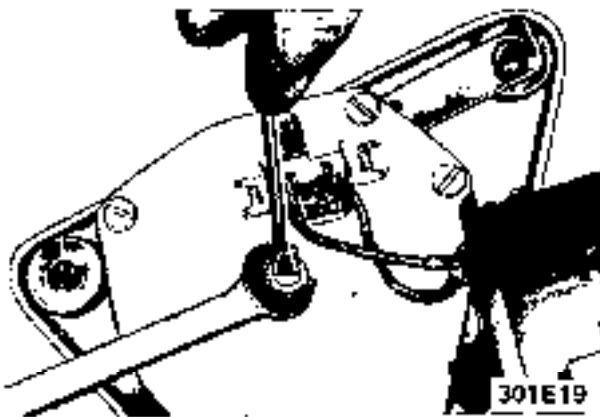


Figure 1E-19 Adjusting Driven Gear End Play

#### Installation

1. Connect wiper motor electrical connector to motor.
2. Place wiper motor in position on cowl and secure. Torque attaching nuts 14 to 17 in.lbs.
3. Place crank arm on motor drive shaft and torque nut as follows: Bosch and SWF, 70 to 87 in.lbs. and Siemens, 122 to 139 in.lbs.

4. Check the position of the windshield wiper blades for proper position after the crank arm is attached. See Figure 1E-3 for the proper distance the blades should be from the windshield molding in the park position.

## SPECIFICATIONS

### GENERAL SPECIFICATIONS

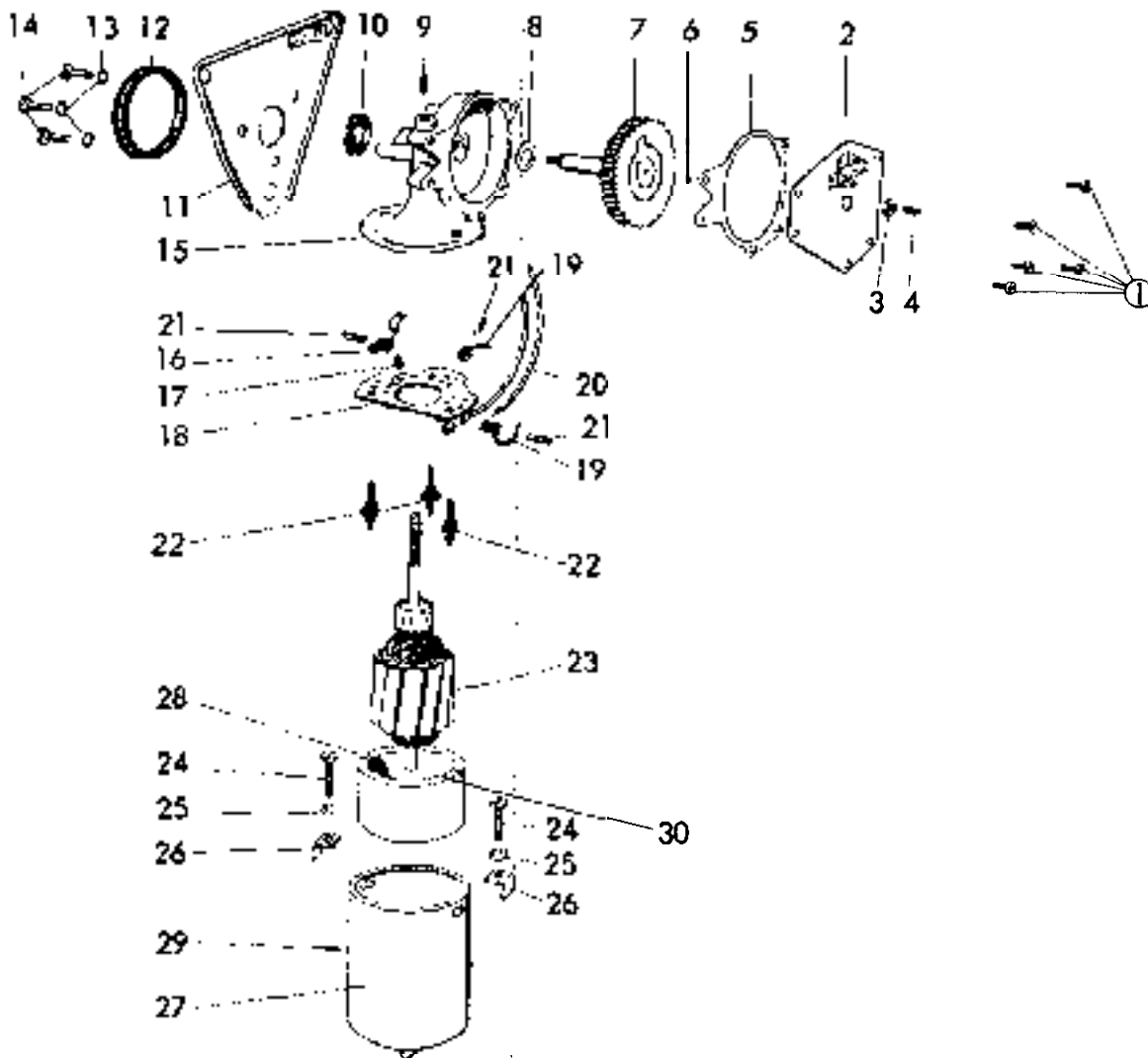
Rated Voltage .....	12 VDC
Test Voltage .....	13 VDC
Current Draw (Amps)	
No Load	
Low Speed .....	1.5
High Speed .....	2.2
Locked	
Low Speed .....	16
High Speed .....	17
Minimum Commutator Diameter .....	.86 in.
Brush Spring Pressure	
New Brush .....	6.35 to 8.47 oz.
Used Brush .....	3.5 oz. minimum
Minimum Brush Length .....	24 in.

The windshield wiper motor instead of field coils has a permanent magnet (oxide magnet). This motor design is sturdier and consumes less current.

### TORQUE SPECIFICATIONS

Crank Arm to Motor Drive Shaft .....	70 to 87 in.lbs.
per Motor to Cowl .....	14 to 17 in.lbs.





- |                                    |  |
|------------------------------------|--|
| 1. ATTACHING SCREWS                | 16. NEGATIVE BRUSH                                     |
| 2. TRANSMISSION COVER              | 17. ATTACHING SCREW                                    |
| 3. HEX. NUT                        | 18. <b>RETAINING</b> PLATE                             |
| 4. THREADED END<br><b>PLAY</b> PIN | 19. <b>POSITIVE</b> BRUSH                              |
| 5. GASKET                          | 20. WIRE   |
| 6. BALL                            | 21. THRUST SPRING                                      |
| 7. DRIVEN GEAR                     | 22. <b>RUBBER</b> MOUNTS                               |
| 8. <b>WASHER</b>                   | 23. ARMATURE   |
| 9. THREADED END<br><b>PLAY</b> PIN | 24. ATTACHING SCREWS                                   |
| 10. SLEEVE                         | 25. LOCKWASHER   |
| 11. MOUNTING PLATE                 | 26. ANGLE <b>BRACKETS</b>                              |
| 12. GASKET                         | 27. MOTOR HOUSING                                      |
| 13. TOOTHED WASHERS                | 28. MAGNET RING  |
| 14. ATTACHING SCREWS               | 29. MAGNET THREADED<br>Pi N <b>LOCATORS</b>            |
| 15. TRANSMISSION<br>HOUSING        | 30. NORTH POLE PAINT<br>MARKING ON<br><b>THIS</b> SIDE |

**NOTE:** MOTOR HOUSING WITH MAGNET RING HAS TO BE INSTALLED SO THAT THE NORTH POLE MARKING (PAINT DOT ON MAGNET RING) FACES TOWARDS **TRANSMISSION.**

Figure 1E-20 Wiper Motor - Exploded View

# LIGHTING SYSTEMS

## CONTENTS

Subject	Page No.
<b>DESCRIPTION AND OPERATION:</b>	
Lighting Systems .....	1 F-45
<b>DIAGNOSIS:</b>	
<b>MAINTENANCE AND ADJUSTMENTS:</b>	
Headlamp Aiming .....	1 F-46
<b>MAJOR REPAIR:</b>	
<b>Opel 1900 - Manta</b>	
Headlight Switch .....	1 F-46
Fog Lamp or Heated Rear Window Switch .....	1 F-47
Seal Beam .....	1 F-47
Tail Lamps .....	1 F-40
License Plate Lamp .....	1 F-49
Front Side Marker .....	1 F-49
Rear Side Marker .....	1 F-50
Courtesy Light .....	1 F-50
Door Jam Switch .....	1 F-50
<b>GT</b>	
Front Turn Signal .....	<b>1F-51</b>
Seal Beam .....	<b>1F-51</b>
Tail Lamps .....	<b>1F-51</b>
Side Marker .....	1 F-52
License Plate Lamp .....	1 F-52
Backup Lamp .....	1 F-53
Interior Light .....	1 F-53
Headlamp Switch .....	1 F-53
Door Jam Switch .....	1 F-53
<b>SPECIFICATIONS:</b>	

### DESCRIPTION AND OPERATION

#### DESCRIPTION OF LIGHTING SYSTEM

The three-position light switch on Opel 1900 and Manta controls the headlights, taillights, parking lights, side marker lights, instrument panel lights, and the license plate light.

When the light switch knob is pulled out to the first stop, the parking lights, side marker lights, the li-

ense plate light, and the instrument panel lights will light.

Pulling the knob out all the way turns the headlights on.

The instrument panel lights come on when the headlight switch is pulled out to the first stop or pulled out all the way. The instrument panel lights are turned off by turning the switch knob counterclockwise past the first detent.

### Headlight High-Low Beam Control and Passing Signal

When the headlights have **been** switched on, **high** and low beam selection is made **by** raising the directional signal lever toward steering wheel. Each **time** the lever is raised, beam position, will change.

When the headlights are not on, a flashing headlight signal may be given by raising and **lowering** the directional signal lever. With the headlights on and **in** low beam position, raising and lowering the directional signal lever will also cause the headlights to flash.

### Fog Light Switch

All Rallye models are equipped with two white fog lights mounted below the front bumper.

The fog light toggle switch is located on the **instru-**ment cluster to the left of the temperature and **fuel** gauge cluster.

The fog lights can be turned off at any time by the toggle switch, but can only be **turned** on when:

1. The ignition switch on or the **engine** running.!
2. The fog light toggle switch lower half is pushed **in**.
3. The parking lights and/or low beam headlights **are** on.

The fog lights are automatically turned off if the ignition switch is on and the headlights are **switched** to high beam position.

### Courtesy Light

The courtesy light illuminates the interior of the Car when any door is opened. The courtesy light can also be turned on with all doors closed by tilting the **lens**.

### GT Headlamp Mechanism

The concealed headlamps are moved mechanically. Pushing actuating lever on left side of console opens headlamps and pulling lever closes headlamps. Two (2) meshing gear segments convert the movement, of the lever to a rotation of 180 degrees. The pivots of the headlamps lie below the centerline so that with headlamps in closed position, the headlamp housing is flush with front sheet metal. Refer to Group 110, Section "F", for service procedures on the GT headlamp mechanism.

A white indicator lamp in the instrument panel lights if the headlamps are not completely opened **or**

closed. The switches of the headlamp electrical system are located behind the left headlamp operating mechanism.

## MAINTENANCE AND ADJUSTMENTS

### HEADLAMP AIMING

The headlamps must be properly aimed in order to obtain maximum road illumination and safety that has been built into the headlighting equipment. With the Guide T-3 type sealed beam units, proper aiming is even more important because the increased range and power of this lamp make even slight variations from recommended aiming hazardous to approaching motorists. The headlamps must be checked for proper aim whenever a sealed beam unit is replaced and after an adjustment or repairs of the front end sheet metal assembly.

Regardless of method used for checking headlamp aim, car must **be** at normal weight, that is, with gas, oil, water, and spare tire. Tires must be uniformly inflated to specified pressure. If car will regularly carry an unusual load in rear compartment, or a trailer, these loads should be on car when headlamps are checked. Some States have special requirements for headlamp aiming adjustment, and these requirements should be known and observed.

Horizontal and vertical aiming of each seal beam unit is provided by two adjusting screws which move the mounting ring in the body against the tension of the coil spring. There is no adjustment for focus, since the sealed beam unit is set for proper focus during manufacturing assembly.

## MAJOR REPAIR

### HEADLIGHT SWITCH - OPEL 1900. MANTA

#### Removal

1. Remove instrument cluster cover panel. See Section H.
2. Compress retaining springs and pull switch out. See Figure 1 F- 1.
3. Pull multiple socket off switch.

#### Installation

1. Plug multiple socket in switch and push switch in panel until clips lock in place.
2. Replace instrument cover and secure with two (2) screws.

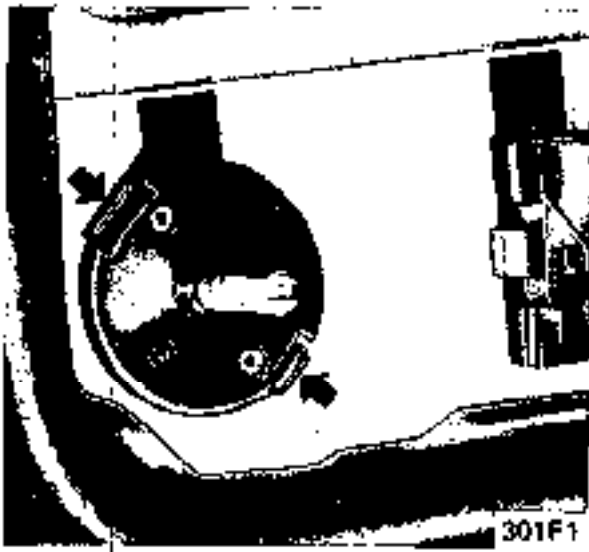


Figure 1 F-1 Removing Headlight Switch

3. Replace two (2) plugs over screws and replace heater control knobs.

**FOG LIGHT OR HEATED REAR GLASS SWITCH**

**Removal**

1. Remove instrument cluster cover. See Section H.
2. Press down retaining clip and pull switch out. See Figure 1F-2.

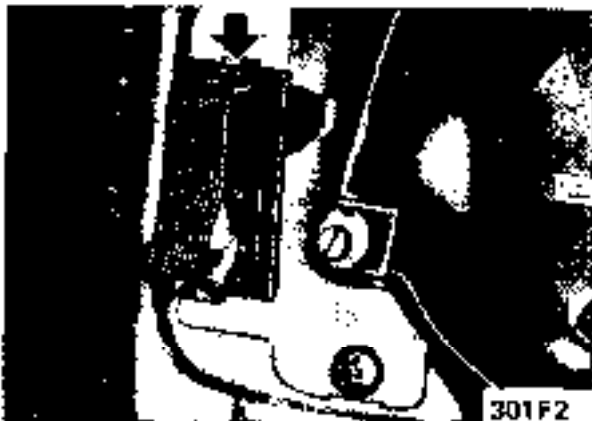


Figure 1F-2 • Removal of Fog Light or Heated Rear Glass Switch

3. Remove wires from switch.

**Installation/**

1. Connect wire to switch,

2. Install switch in panel.
3. Replace instrument cluster cover.

**EXTERIOR LIGHTS**

*Models 51-53-54*

**Headlamp Sealed Beam Unit Removal**

1. Remove two screws on headlight ring.
2. Remove four screws holding headlight retainer to body. See Figure 1F-3.



Figure 1 F-3 • Removing Headlight Retainer • Models 51-53-54

3. Disconnect wiring connectors,
4. Remove headlight from inside engine compartment.

**Installation**

1. Plug in wiring connector on sealed beam and replace four (4) headlight retaining screws.
2. Replace headlight ring.

*Models 57-57R*

**Removal**

1. Disconnect wiring connector.
2. Remove four screws holding headlight retainer from inside engine compartment.

3. Disassemble headlight assembly from retaining ring. See Figure 1F-4.

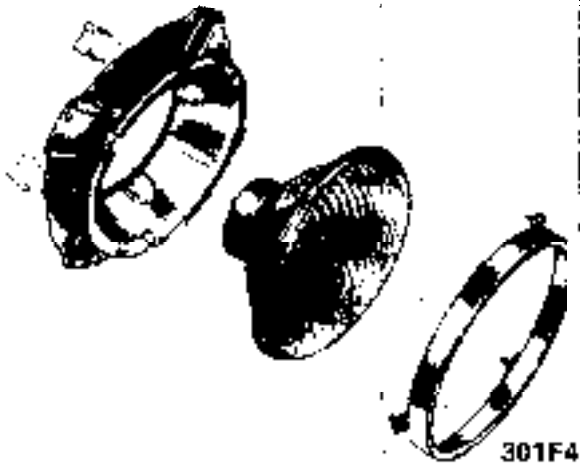


Figure 1 F-4 - Headlight Assembly - Models 57-57R

#### Installation

1. Assemble headlight to retaining rings.;
2. Install to body from inside engine compartment with four (4) screws.
3. Connect wiring harness.

#### Parking Light Housing or Lens Removal

1. Remove two screws holding lamp lens.
2. Remove two screws holding housing. See Figure 1F-5.



Figure 1F-5 Remove Parking Light Housing

3. Disconnect wiring harness.

#### Installation

1. Apply sealer to housing
2. Connect wiring harness.
3. Replace housing in body with two (2) retaining screws.
4. Replace lamp lens.

#### REAR STOP, TAIL, DIRECTIONAL SIGNAL, OR BACK-UP LAMP HOUSING

##### Models 51-53

#### Removal

1. In luggage compartment, unscrew housing attaching nuts. See Figure 1F-6.



Figure 1F-6 Tail Light Housing Attaching Nuts Models 51-53

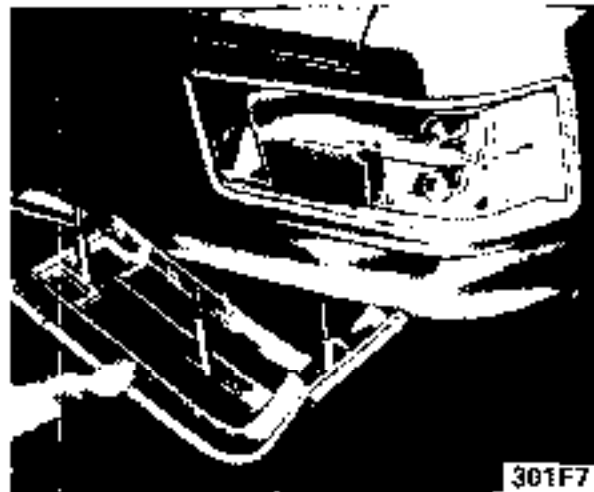


Figure 1F-7 - Removing Tail Light Lens - Models 51,53

2. Take Lens off housing. See Figure 1F-7.
3. Remove housing.

**Installation;**

1. Install lens in housing.
2. Replace housing.

**Model 54**

**Removal**

1. Remove lamp lens from outside.
2. Remove rear quarter trim pad.
3. Remove four screws from inside car. See Figure 1F- 8



Figure 1 F-8 - Removing Tail Light Housing - Model 54

4. Disconnect wiring connector.

**Installation**

1. Connect wiring to lamp
2. Install housing using four (4) screws.
3. Replace rear quarter trim pad
4. Replace lens.

**Models 57-57R**

**Removal**

1. Unscrew lens from housing.

2. In luggage compartment, unscrew three (3) housing attaching nuts. See Figure 1F-9.

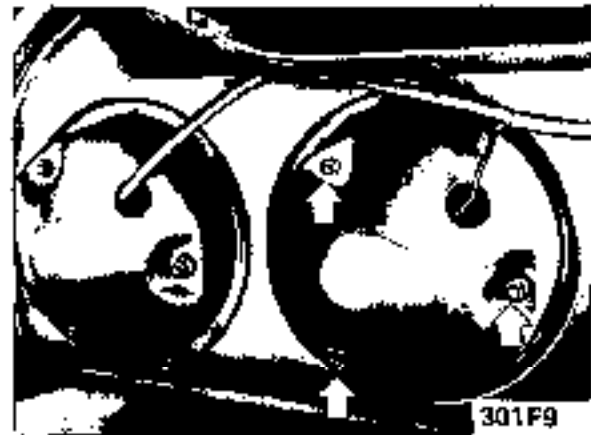


Figure 1F-9 Tail Light Housing Attaching Nuts - Models 57-57R

3. Disconnect wire connector.

**Installation**

1. Plug in wiring harness.
2. Replace housing with three (3) attaching nuts.
3. Replace lens.

**Rear License Plate Lamp Assembly Removal**

1. Remove two screws holding housing to bumper.
2. Pull lamp assembly down.
3. To replace bulb, take out two screws holding lens in place.

**Installation**

1. Replace bulb and lens to housing.
2. Replace lamp assembly to bumper with two (2) screws.

**SIDE MARKER LIGHTS**

**Front Removal**

1. Remove outer lens.
2. Remove two sheet metal screws for housing attachment.
3. Disconnect wire connectors.

**Installation**

1. Connect wiring harness.
2. Replace housing with two (2) screws.
3. Replalce lens.

**Rear Removal**

Remove two screws from support bracket and remove housing and lens. See Figure 1F-10.

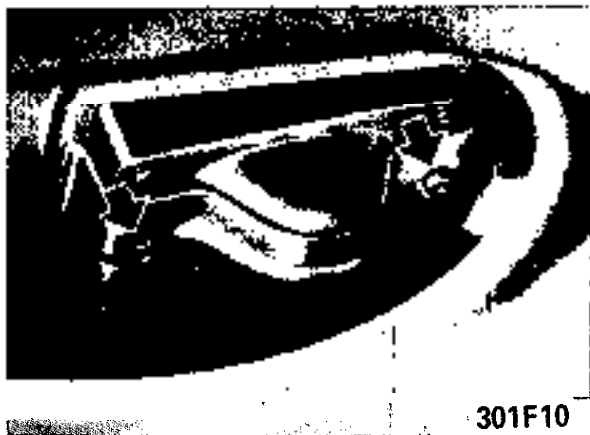


Figure 1 F-10 • Removing Rear Side Marker Lamp

**Installation**

Install housing and lens with two (2) attaching screws.

**INTERIOR LIGHTS**

**Courtesy Light Removal**

1. Pry courtesy light out of roof frame, as shown in Figure 1 F- 11.



Figure 1F-11 • Removing Courtesy Light

2. Pull wires off flat plugs. See Figure 1F-12.

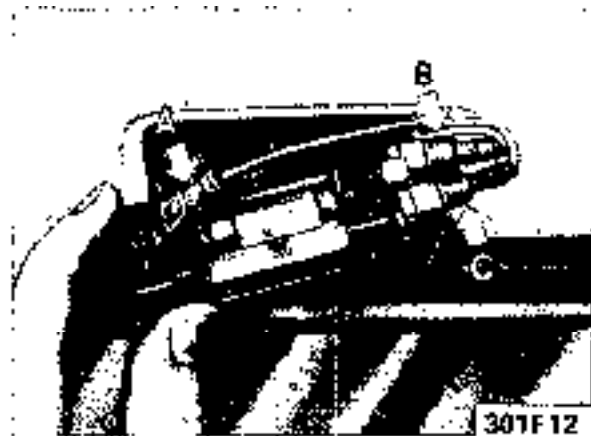


Figure 1F-12 -Courtesy Light Wire Connections

**Installation**

1. Connect wires to flat plugs, a) red wire, b) grey wire, and c) brown wire.
2. Push light back into roof frame.

**Door Jam Switch Removal**

1. Remove door jam switch attaching screws.
2. Remove switch and disconnect wire.

**Installation**

1. Connect wire to switch.

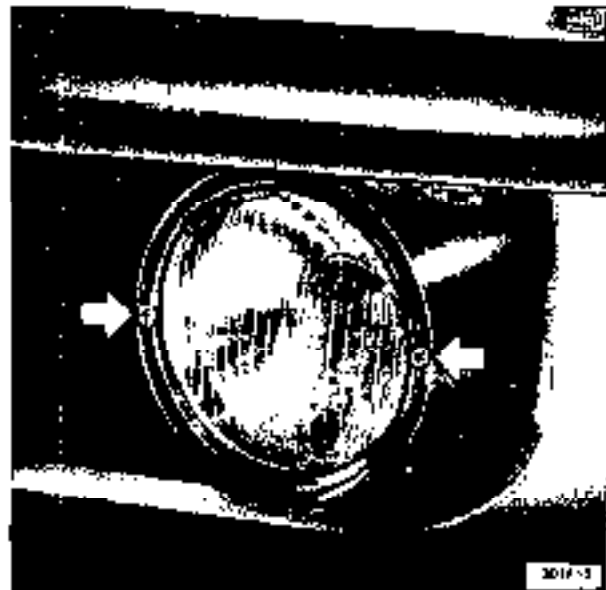


Figure 1 F-I 3 Removing Parking Light Lens

2. Install switch to door jam.

**EXTERIOR LIGHTS. GT**

**Removing Parking-Light Housing**

1. Remove lamp lens.
2. Remove lamp housing.
3. Disconnect electrical wires. See Figure 1F-13.

**Installation**

1. Connect electrical wires.
2. Install lamp housing and lens.

**Removal of Front Directional Signal Lamp**

1. Remove lamp lens.
2. Remove lamp housing.
3. Disconnect electrical wires. See Figure 1F-14.



Figure 1F-14 Removal Front Directional Lamp Lens

**Installation**

1. Connect electrical wires.
2. Install lamp housing and lens.

**Removal of Headlamp Sealed Beam**

1. Rotate headlamp to open position.
2. Remove headlamp shield. See Figure 1F-15.
3. Remove headlamp attaching screws and take off headlamp.; See Figure 1F-16.
4. Disconnect electrical wires.

**Installation**

1. Install headlamp with three (3) attaching screws.

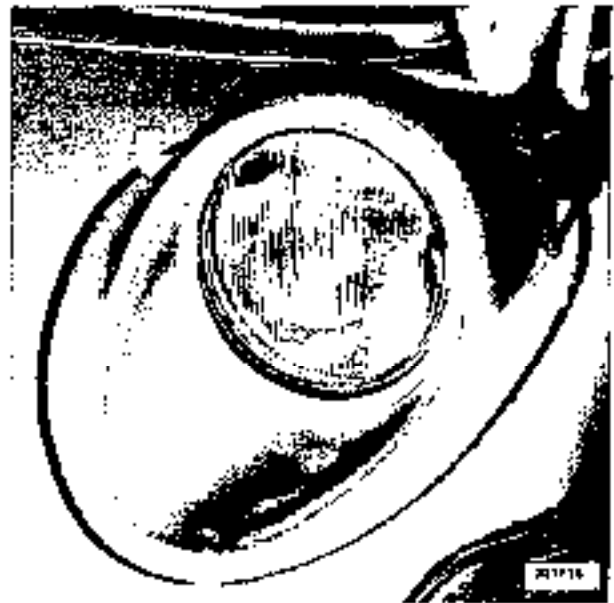


Figure 1F-15 Removing Headlamp Shield

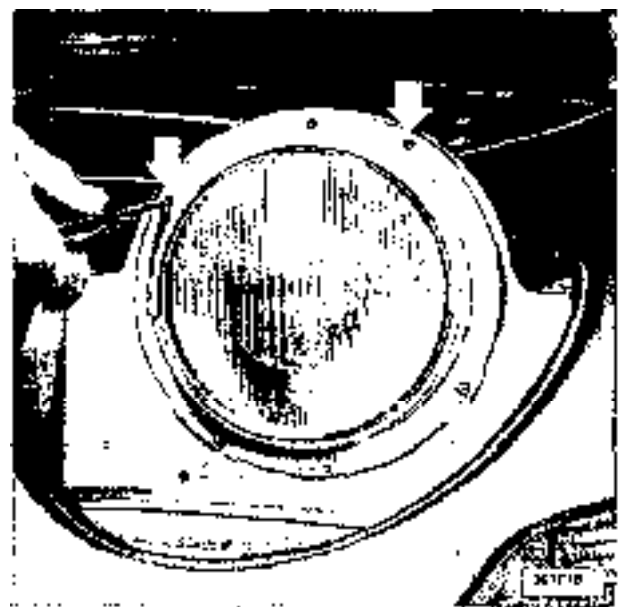


Figure 1 F-16 Removing Headlight Attaching Screws

2. Connect electrical wires.
3. Replace headlamp shield.

Before installation of headlamp shield, adjust headlamp for proper aim.

**Removal of Rear Directional Signal Lamp. Stop and Tail Lamp**

1. Remove lamp lens.



2. Remove lamp housing.
3. Disconnect electrical wires. See Figure 1F-100.

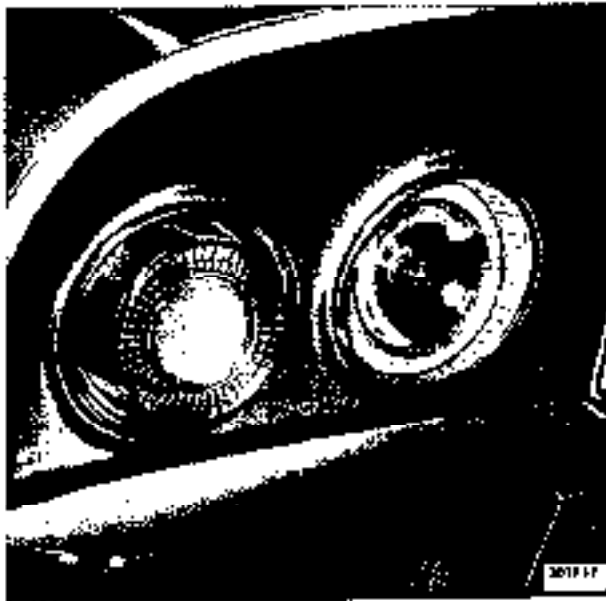


Figure 1 F-1 7 Rear Directional Signal, Stop and Tail Lamp

#### Installation

1. Connect electrical wires.
2. Install lamp housing and lens.

#### Removal of Side Marker Lights

1. Completely remove adjacent rear directional signal lamp.
2. Through directional signal lamp opening, the marker lamp assembly can be removed. See Figure 1F-18.

#### Installation

1. Install side marker.
2. Replace directional signal lamp.

#### Removal of License Plate Lamp

1. Remove adjacent tail and directional signal lamp.
2. Through opening remove bumper bolts.
3. Disconnect electrical wires.
4. Remove bumper guard from bumper.

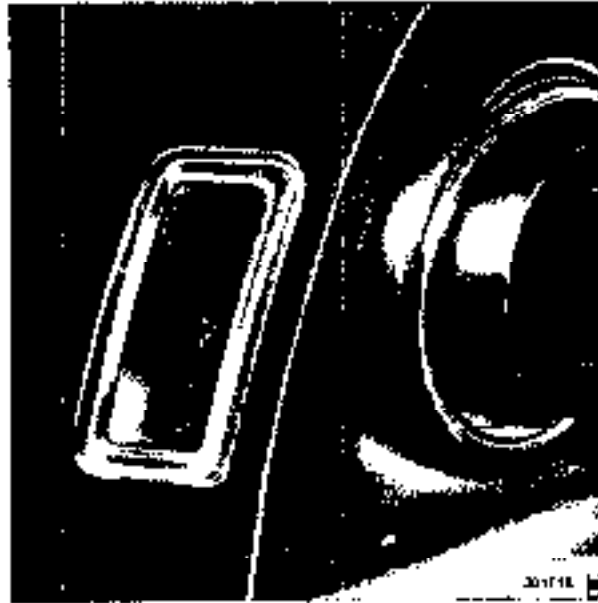


Figure 1F-18 Side Marker Light Location

5. Remove lamp housing. See Figure 1F-19.



Figure 1 F-1 9 Removing License Plate Light

#### Installation

1. Install lamp housing.
2. Install bumper guard in bumper.
3. Connect electrical wire.
4. Install bumper bolts.

**Removal of Back-Up Lamp**

1. **Remove** back-up lens.
2. **Remove** lamp housing.
3. **Disconnect** electrical wires. See Figure 1F-20



Figure 1F-20 Removal of Back-Up Light

**Interior Light Removal**

1. **Disconnect** battery.
2. **Remove** lens.
3. **Remove** base plate by removing two (2) screws.
4. **Unplug** wires.

**Installation**

1. **Connect** wires to proper plugs.
2. Install base plate.
3. Install lens.
4. Connect battery.

**Removal of Headlamp Switch**

1. Completely remove left headlamp and headlamp housing.
2. Remove switch from base plate. See Figure 1F-21.

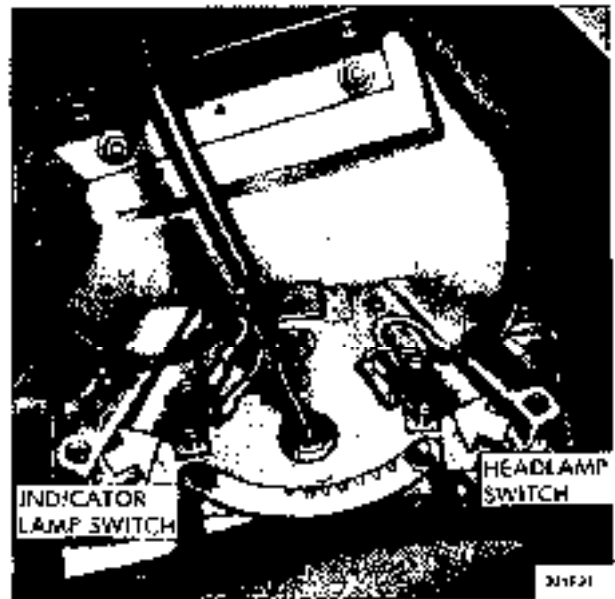


Figure 1F-21 Light Switch Positions

**Installation**

1. Install switch to base plate.
2. Install left headlamp and housing.

**Door Jam Switch Removal**

1. Remove door jam **switch** attaching screws.
2. Remove switch and disconnect wire.

**Installation**

1. Connect wire to switch.
2. Replace switch on door jam with attaching screw.

# SIGNAL SYSTEMS

## CONTENTS

Subject	Page No.
<b>DESCRIPTION AND OPERATION:</b>	
Directional Signal Lever .....	1 G-54
Horn .....	1 G-54
Hazard Warning Flasher .....	1 G-55
Brake System Warning Light .....	<b>1G-55</b>
<b>DIAGNOSIS:</b>	
Signal System .....	1 G-55
<b>MAINTENANCE AND ADJUSTMENTS:</b>	
<b>MAJOR REPAIR:</b>	
Directional Signal Switch.....	1 G-55
Horn Removal .....	<b>1G-55</b>
Removing Horn Contact .....	1 G-55
<b>SPECIFICATIONS:</b>	
Fuse Chart .....	1 G-56

### DESCRIPTION AND OPERATION

#### DIRECTIONAL SIGNAL LEVER

The direction signal switch lever is a multi-purpose lever controlling direction signals, passing signal, and high and low beams. See Figure 1G-1.

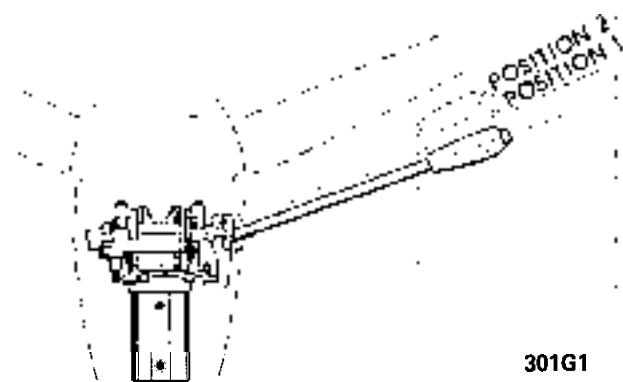


Figure 1G-1 Directional Signal Position for Headlamp Operation

The direction signal lever is provided with a two-

step mechanism for operation of headlight high and low beams, and passing signal (not in New Jersey). With headlights off, moving the lever repeatedly towards steering wheel flashes headlights as a passing signal. With headlights on, moving the lever repeatedly towards steering wheel up to first stop also flashes passing signal regardless whether or not the direction signals are switched on. When the lever is moved up to the second stop, the headlights are changed from high to low beam or vice versa. On all Rallye cars, when switching from low to high beam position, with the fog lamp instrument panel switch "ON" and ignition switch in "RUN" position, the fog lights are automatically switched off. Direction signals work in the normal manner; pushing the lever up for right turn signal and pulling the lever down for left turn signal.

#### HORN

The horn button is located in the center part of the steering wheel. The horn is actuated by pushing down on the ends of both spokes on Opel 1900 and Manta's or on the center horn button on the Rallye. The button is provided with a spring-loaded plunger. See Figure 1G-2.



Figure 1G-2 Horn Button and Contact

### HAZARD; WARNING FLASHER

The hazard warning flasher is operated by the button on the top of the steering column. When the button is pressed down and released, all four turn signal lights will flash. To turn the flasher system off, press down on the button and release. When the hazard warning system is operating, a flashing light in the instrument cluster will operate. The hazard warning flasher switch is part of the directional signal switch.

### BRAKE SYSTEM WARNING LIGHT

The brake system warning light is located in the left side of the instrument cluster assembly. The light will come on when the brake pedal is depressed and the ignition is on if there is a hydraulic leak in the brake system. The light will go out when the foot is removed from the brake pedal. The light will also glow with the parking brake applied and the ignition on. (On automatic transmission equipped vehicles, light is a reminder to release parking brake; and on manual transmission equipped vehicles, light glows when the clutch pedal needs adjustment.)

## DIAGNOSIS

### SIGNAL SYSTEM

The indicator light on the dash will show defects in the directional signal system as follows:

1. Indicator light on dash gives only one quick flash.

One of the switched-on directional signal lamp bulbs is defective. The other signal lamp will continue to flash. The most common defect is a burned out bulb.

2. Indicator light on dash stays on when directional signal lever is switched to either side. Check flasher unit.

## MAJOR REPAIR

### Removing and Installing Directional Signal Switch

Proceed as outlined in [Group 3, Section E](#).

### HORN REMOVAL

1. Remove grille (GT only).
2. Remove horn bracket attaching bolt.
3. Disconnect wires and remove horn.

### Installation

1. Install horn with bracket attaching bolt.
2. Connect horn wire.
3. Install grille (GT only).

### Removing Horn Contact

1. Disconnect battery.
2. Remove horn cap.
3. Bend lockplate tabs down and remove steering wheel nut, lockplate, and washer.
4. Mark shaft and wheel hub for reassembly alignment.
5. Remove steering wheel using Wheel Puller J-21686.
6. Remove horn contact from wheel.

### installation

1. Replace horn contact.
2. Before installing steering wheel, lubricate return pin and slide area on directional signal switch return cams and contact ring.
3. With steering wheel properly aligned to shaft, install washer, lockplate, and nut. Torque nut to 15 lb.ft.
4. Bend up lockplate tab and install horn cap.
5. Connect battery.

**FUSE POSITION      AMPS.      CIRCUITS PROTECTED**

OPEL 1900 & MANTA (51,53,54,57,57R)

1	5	LEFT PARKING LIGHT, LEFT TAIL LIGHT, LEFT SIDE MARKER LIGHTS
2	5	RIGHT PARKING LIGHT, RIGHT TAIL LIGHT, RIGHT SIDE MARKER LIGHTS, INSTRUMENT PANEL LIGHTS, SHIFT QUADRANT LIGHTS, LICENSE PLATE LIGHT, FOG LIGHTS (RALLYE ONLY)
3	8	IGNITION KEY WARNING BUZZER, TRUNK LIGHT, HAZARD WARNING FLASHER, COURTESY LIGHT, CLOCK
4	15	BACKUP LIGHTS, BLOWER MOTOR, CIGAR LIGHTER; RADIO, SAFETY BELT WARNING BUZZER AND LIGHT
5	15	WINDSHIELD WIPERS, WINDSHIELD WASHER (RALLYE ONLY), HORN
6	8	STOP LIGHTS, TURN SIGNAL AND INDICATOR LIGHT, PARKING BRAKE WARNING AND BRAKE FAILURE LIGHT, FUEL GAGE, TEMPERATURE GAGE, OIL PRESSURE INDICATOR LIGHT, CHARGING INDICATOR LIGHT, TACHOMETER AND OIL PRESSURE GAGE (RALLYE ONLY)

AIR CONDITIONING - 20 AMP INLINE FUSE

OPEL GT (77)

1	8	WINDSHIELD WIPERS, WINDSHIELD WASHER, HORN, BACKUP LIGHT, SAFETY BELT WARNING BUZZER AND LIGHT
2	5	STOP LIGHTS, TURN SIGNAL AND INDICATOR LIGHT, PARKING BRAKE WARNING LIGHT (AUTOMATIC ONLY), BRAKE FAILURE WARNING LIGHT, RADIO, TACHOMETER, OIL PRESSURE GAGE & INDICATOR LIGHT, FUEL GAGE, TEMPERATURE GAGE, CHARGING INDICATOR LIGHT
3	16	CIGAR LIGHTER, BLOWER MOTOR
4	5	IGNITION KEY WARNING BUZZER, COURTESY LIGHT, CLOCK, HAZARD WARNING FLASHER
5	5	LEFT PARKING LIGHTS, LEFT TAIL LIGHT, LEFT REAR SIDE MARKER LIGHT
6	5	RIGHT PARKING LIGHTS, RIGHT TAIL LIGHT, RIGHT REAR SIDE MARKER LIGHT
7	5	INSTRUMENT PANEL LIGHTS, LICENSE PLATE LIGHT, SHIFT QUADRANT LIGHT

AIR CONDITIONING - A/C HAS A 20 AMP INLINE FUSE AND IS CONNECTED TO THE HOT SIDE OF FUSE NO. 2

# INSTRUMENT PANEL

## CONTENTS

Subject	Page No.
<b>DESCRIPTION AND OPERATION:</b>	
Instrument Panel - Opel 1900 - Manta .....	1 H-57
Instrument Panel - GT .....	1 H-58
<b>DIAGNOSIS:</b>	
<b>MAINTENANCE AND ADJUSTMENTS:</b>	
<b>MAJOR REPAIR:</b>	
Instrument Cluster Housing - Opel 1900 - Manta . .	1 H-59
Windshield Wiper Switch .....	1 H-61
Instrument Cluster Bulbs .....	1 H-61
Instrument Cluster Housing - GT .....	1 H-61
Combined Switch Assemblies .....	1 H-63
Cigar Lighter .....	1 H-64
<b>SPECIFICATIONS: (Not Applicable)</b>	

### DESCRIPTION AND OPERATION

#### INSTRUMENT PANEL (OPEL 1900. MANTA)

##### Headlight Switch

The three position light switch controls the headlights, taillights, parking lights, side marker lights, license plate light and instrument panel lights and is located at the lower left on the instrument panel.

With the switch knob pulled outward to the first stop, the parking lights, side marker lights, license plate light and instrument panel lights will light. The instrument panel lights can be turned off by turning the lightswitch knob counterclockwise past the first detent.

By pulling the lightswitch knob out all the way, the headlights will also be turned on.

##### Fog Light Switch (Rallye)

The fog light toggle switch is located in the instrument cluster to the left of the temperature and fuel gauge cluster. The fog lights can be turned off at any time by the toggle switch, but can only be turned on when:

1. The ignition switch is on or the engine running.

2. The fog light toggle switch lower half is pushed in.

3. The parking lights and/or low beam headlights are on.

The fog lights are automatically turned off if the ignition switch is on and the headlights are on high beam.

##### Windshield Wiper Switch

The windshield wiper switch is located on the instrument panel to the right of the headlight switch.

By pushing the lower half of this switch in to the first stop, the wipers will operate at slow speed. By pushing in to the second stop, the wipers will operate at fast speed.

##### Electrically Heated Rear Window Switch (If Equipped)

The heated rear window switch is located in the instrument panel to the right of the clock opening.

To operate (only possible with the engine running), push in on the lower half of the switch. When the rear window is being heated, the switch will be lighted.

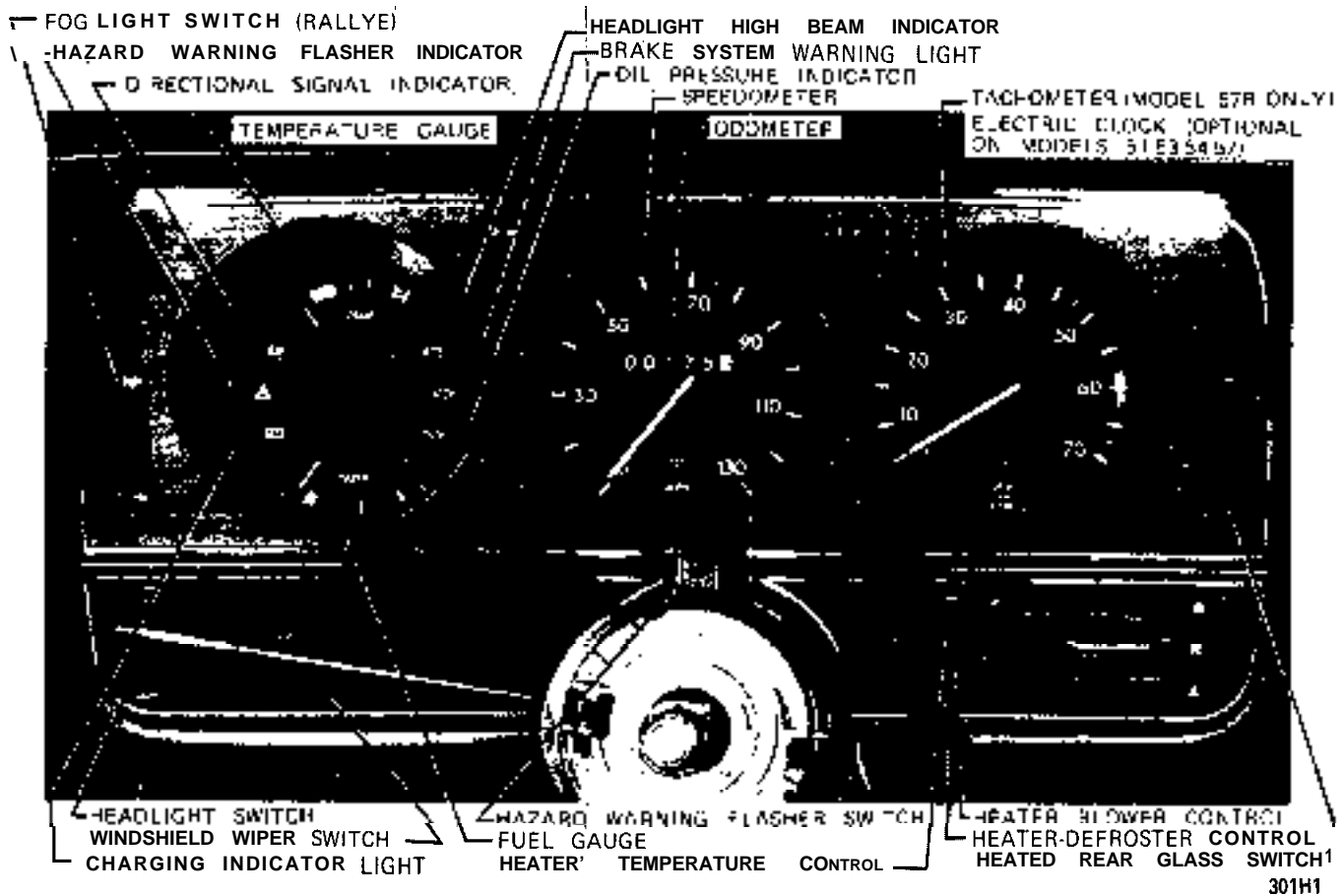


Figure 1 H-1 - 1900 Instrument Arrangement

### INSTRUMENT PANEL (GT)

#### Headlight Switches

There are two headlight switches, one for turning on the headlights and the other operates an indicator light on the instrument panel. Both switches are located behind the left headlamp assembly.

When the headlamp lever is **pushed** forward, the operating mechanism rotates the headlights to open position, **turns** the headlight **and** instrument panel indicator light switches on until the headlamps are locked in full open position at which time the **indicator** lamp switch is turned off.

Along with the headlights, the headlight **switch** also turns on the parking lights, taillights, license plate lights and rear side marker lights.

#### Parking Light and instrument Panel Light Switch Assembly

The left switch of this assembly is the Parking **Light** Switch. By pushing inward on the lower half of this

switch, the parking lights, taillights, license plate lights and rear side marker lights are **turned** on and can **be** turned off by pushing inward on the upper half of the switch providing the headlights are not turned on.

The center portion of this switch assembly is inoperative and controls nothing.

The switch on the right end of this assembly is the Instrument Panel Light switch. By pushing inward on the lower half of the switch turns on the instrument panel lights. The brightness of the instrument panel lights can be adjusted by movement of the switch. If either the Parking Light or Instrument Panel switch becomes defective, the switch assembly must be replaced.

#### Combined Windshield Wiper, Electrically Heated Rear Window and Heater Blower Switch

This switch assembly is located to the right of the cigar lighter. If any one of these switches should fail, the complete switch assembly must be replaced.

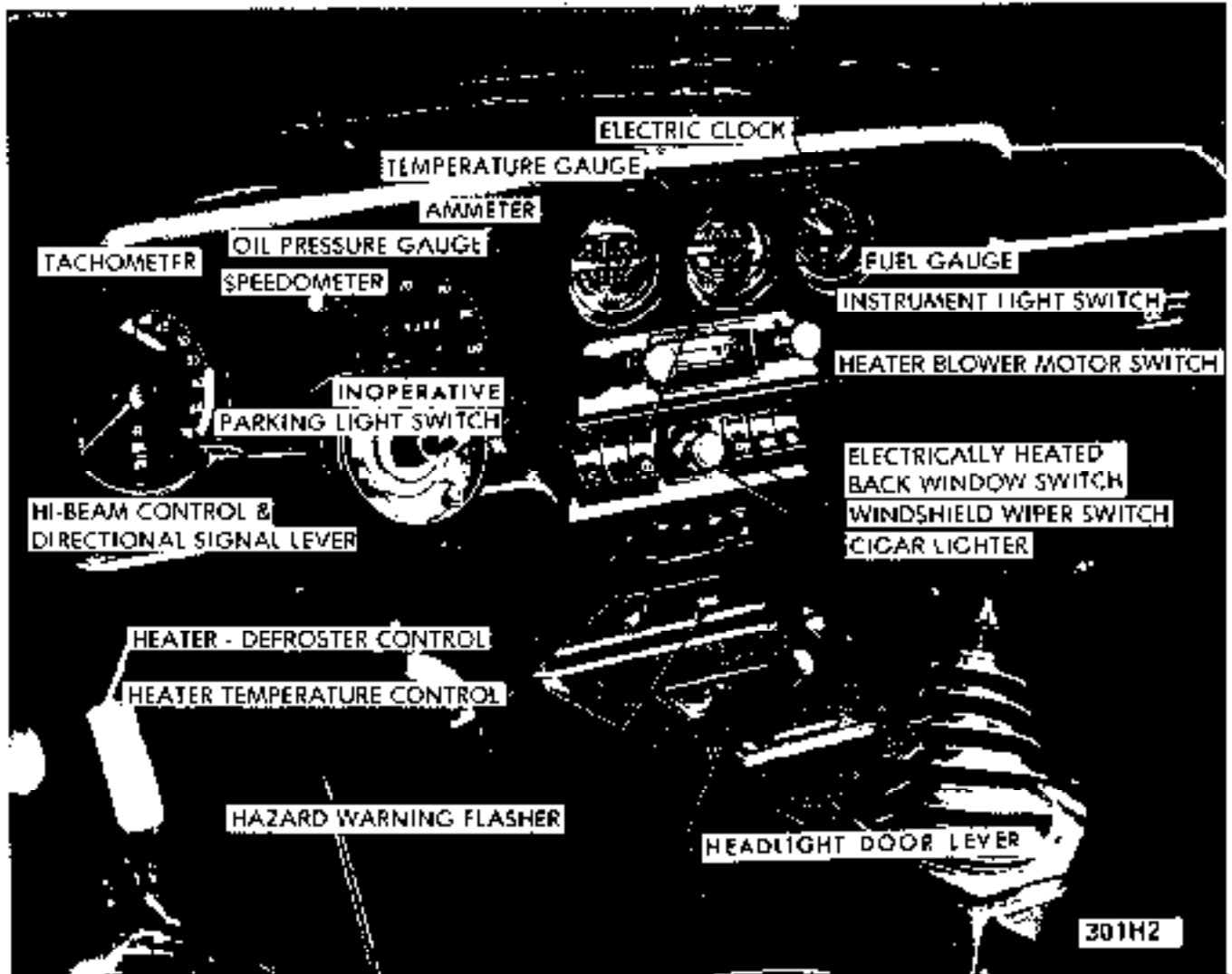


Figure 1 H-2 · GT Instrument and Switch Arrangement

The **Windshield Wipers** have two-speed operation. By **pushing** the lower half of the switch inward to the first stop, the wipers will operate at half speed and by **depressing** to the second stop will provide full speed operation. When the switch is returned to the off position, the wiper blades automatically return to their park position.

The **Electrically Heated Rear Window Switch** is standard whether or not the vehicle is equipped with this option. The engine must be running before sufficient current can be generated to energize this circuit even though the switch is depressed to the "ON" position! When the window is being heated, a warning light on the instrument panel will glow. This light is located **below** the left ventilation inlet.

The **Heater Blower Switch** is a three position switch. By depressing the lower half of the switch to the first stop, the blower will operate at low speed. When **depressed** to the second stop, the blower will operate at high speed.

#### Four Way Hazzard Warning Flasher Switch

The **hazzard** warning flasher switch is located below the heater controls in the center console. By **depressing** the lower half of the switch, all four turn-signal lamps flash at the same time. Although this system makes use of the regular turn signal system, it has a separate feed wire to the switch which allows for its operation even with the ignition switch and doors locked. No vehicle should be driven with this system in operation because of its universal meaning "This Vehicle Is Not Moving". To turn the system off, simply depress the upper half of the switch.

#### MAJOR REPAIR

##### Removal of Instrument Cluster Housing Assembly. Opel 1900 Manta

Before starting any instrument panel repair, always disconnect battery ground cable first.



1. Remove headlight switch button by depressing retaining clip on shaft and pulling back on switch knob. See Figure 1H-3.



Figure 1H-3 - Removing Headlight Switch Knob,

2. Remove two (2) plugs on cluster panel. See Figure 1H-4.

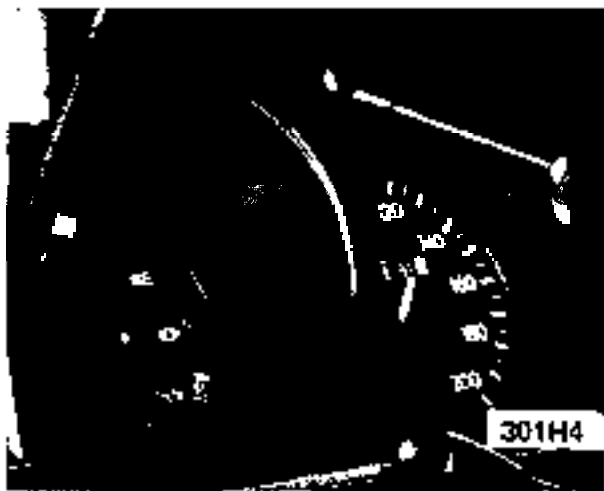


Figure 1 H-4 Removing Plugs

3. Remove two (2) sheet metal screws behind plugs on cluster. See Figure 1H-5.

4. Pull off heater control knobs toward front.

5. On top, carefully pull instrument trim plate towards steering wheel and remove plate.

6. Remove two screws for lower housing attachment. See Figure 1H-6.

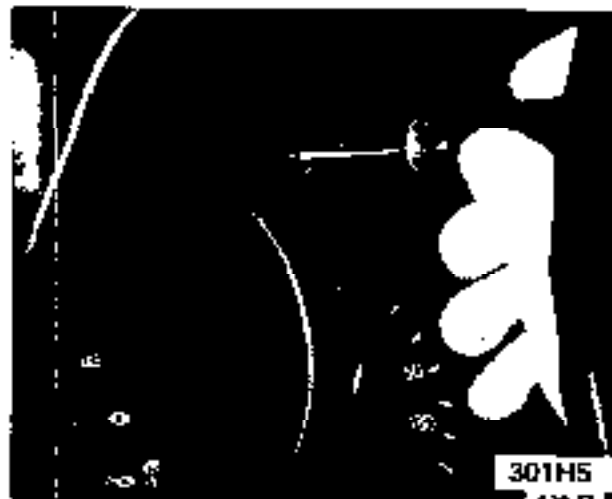


Figure 1 H-5 . Removing Cluster Screws

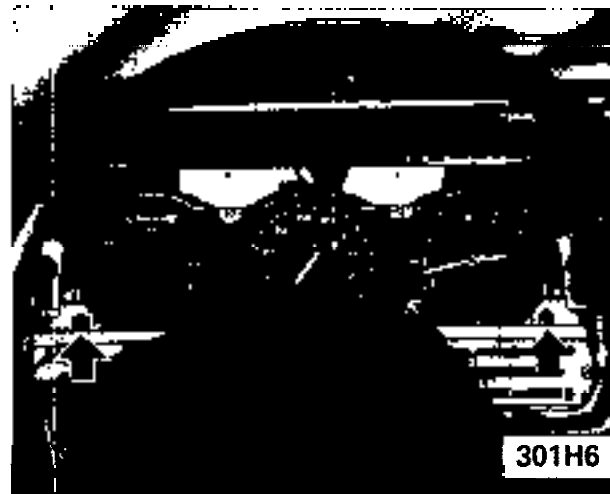


Figure 1 H-6 Lower Housing Attaching Screws

7. Disconnect **speedo** cable at cluster by turning coupling counterclockwise.

8. If equipped, pull heated rear window or fog lamp switch out of instrument housing and disconnect wires from switches.

9. Pull cluster right and left sides partially out and disconnect wires on back of cluster. See Figure 1H-7.

#### Installation

1. **Place** instrument cluster in position and connect wires on back of cluster.

2. Pull fog light or heated back glass switch wires into opening, if equipped, and connect wires and replace switch.

3. Connect two screws on lower housing attachment.



Figure 1 H-7 - Disconnecting Cluster Wires

4. **Install** instrument cluster trim plate and replace two screws and plugs.
5. **Con&t speedo** cable by turning coupling clockwise.
6. **Install light switch** button and heater control knobs.
7. **Connect** battery cable.

**Removing Windshield Wiper Switch - Opel 1900 Manta**

1. **Remove** instrument cluster trim plate.
2. **Compress** retaining clips and remove switch. See Figure 1H-8.

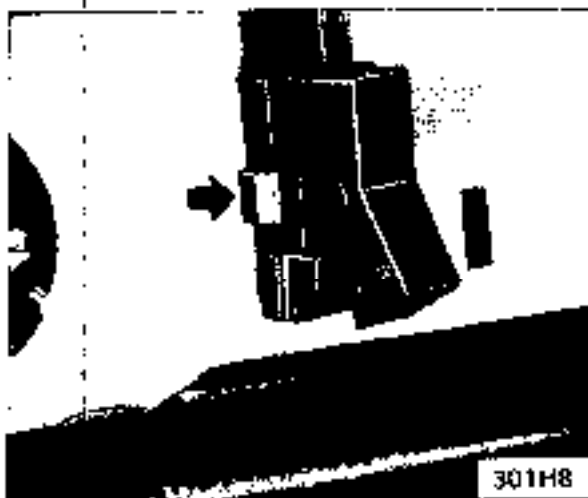


Figure 1H-8 . Removing Windshield Wiper Switch

3. **Disconnect** wiring connector.

**Installation**

1. **Connect** wiring to switch.
2. **Snap** switch back into panel.
3. **Replace** instrument cluster trim plate.

**Removing Instrument Cluster Bulbs - Opel 1900 - Manta**

1. **Remove** instrument cluster assembly.
2. **Replace** bulbs from back of cluster. See Figure 1H-9.



Figure 1H-9 Removing Instrument Cluster Bulbs

**Installation**

1. **Replace** bulbs in cluster.
2. **Replace** instrument cluster assembly.

**Removing and Installing Ignition Switch**

Refer to Group 3, Section F.

**Removal of Instrument Cluster Housing Assembly. GT**

Disconnect battery before making any electrical repairs.

1. **Disconnect** battery cable.
2. **Remove** right access cover and remove screw. See Figure 1H-10.



Figure 1 H-10 Removing Right Access Cover and Screw

3. Remove left access cover and remove screw. See Figure 1H-11.

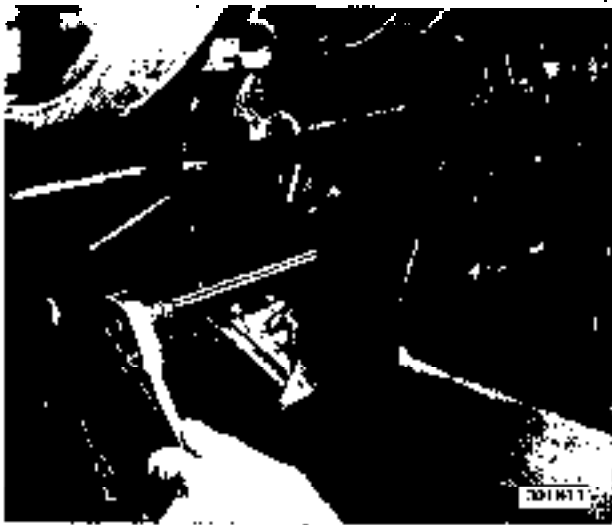


Figure 1H-11 Removing Left Access Cover and Screw

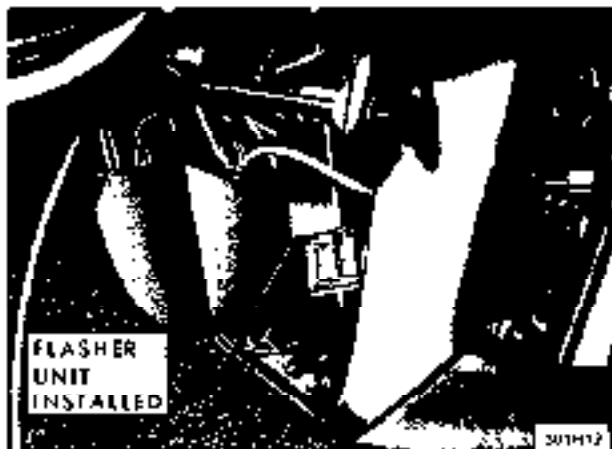


Figure 1H-12 Flasher Unit Installed

4. Remove flasher unit. See Figure 1H-12.

5. Position steering so that wheels are straight ahead.

6. Pull off heads of both tear bolts by first drilling a 3/16 inch pilot hole and then using a stud extractor to remove tear bolts. See Figure 1H-13.



Figure 1 H-13 Steering Column Attaching Bolts

7. Disconnect ignition (white) and directional signal (black) wire set plugs.

8. Support steering column assembly and remove both hex head bolts. See Figure 1H-13.

9. Drop steering column assembly to floor.

10. Disconnect speedometer cable.

11. Remove six (6) screws on instrument cluster. See Figure 1H-14.



Figure 1H-14 Instrument Cluster Screws

12. Pull back on instrument cluster from top to remove. See Figure 1H-15.

13. Disconnect wires on back of radio. See Figure 1H-16.



Figure 1H-15 Removing Instrument Cluster Assembly



Figure 1H-16 Disconnecting Radio Wires

14. Disconnect antenna lead-in at right lower corner of radio!

15. Pull cluster housing out and turn sideways to remove any instrument gauge or switches.

### Installation

**CAUTION:** Fasteners in subparagraph B are important attaching parts in that they could affect the performance of vital components and systems, and/or could result in major repair expense. They must be replaced with one of the same part number, or with an equivalent part if replacement becomes necessary. Do not use a replacement part of lesser quality or substitute design. Torque values must be used as specified during reassembly to assure proper retention of these parts.

1. Plug antenna lead-in cable and power source to radio.

2. Put instrument cluster in position and replace six (6) screws in cluster.

3. Connect speedometer cable.

4. Raise steering column into position and install hex head bolts. Be sure to install ground wire. Tighten hex head bolts to 14 lb.ft.

5. Tighten tear lock bolts until hex head of bolt is torn off.

6. Connect ignition and directional signal wire set plugs.

7. Install flasher unit.

8. Replace screws in right and left lower instrument panel and replace both access covers.

9. Connect battery cable.

### Removal of Combined Switch Assemblies. GT

1. Remove instrument cluster.

2. Turn instrument cluster to the side to remove switch assembly.

3. Remove switch by removing two retaining nuts. See Figure 1H-17.

4. Remove wiring from switch.

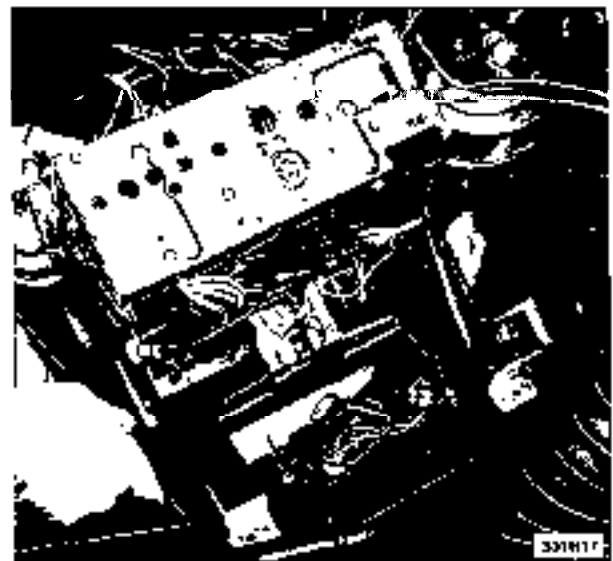


Figure 1H-17 Removing Switches

### Installation

1. Plug wiring into switch.

2. Install switch on panel.

3. Install instrument cluster.

**Removal of Cigar Lighter GT**

1. Remove **instrument** housing.
2. Disconnect electrical wire.
3. Remove hex nut on back of cigar lighter **base**.
4. Remove cigar lighter base.

**Installation**

1. Install cigar lighter base.
2. Install hex nut on back of lighter base.
3. Connect wire to lighter.
4. Replace instrument cluster.

# GAUGES

## CONTENTS

Subject	Page No.
<b>DESCRIPTION AND OPERATION:</b>	
<b>DIAGNOSIS:</b>	
Temperature and Fuel Gauge System - Opel 1900 - Manta .....	11-65
Fuel Gauge - GT .....	11-67
<b>MAINTENANCE AND ADJUSTMENTS:</b>	
<b>MAJOR REPAIR:</b>	
Opel 1900 - Manta	
Voltage Stabilizer .....	11-67
Speedometer .....	11-68
Electric Clock or Tachometer .....	11-68
Temperature Indicator or Fuel Gauge .....	11-69
Rallye Gauges .....	11-69
Temperature Sending Unit .....	11-69
Oil Pressure Sending Unit .....	11-70
GT	
Speedometer .....	11-70
Tachometer .....	11-70
Temperature Indicator and Fuel Gauge Dash, Unit .....	11-70
Electric Clock .....	11-71
Ammeter and Oil Pressure Gauge .....	11-71
<b>SPECIFICATIONS:</b>	

### DIAGNOSIS

#### TEMPERATURE & FUEL GAUGE - SYSTEM DIAGNOSIS (OPEL 1900, MANTA)

Condition	Possible Cause	Correction
Temperature and gas gauge inoperative	1. Blown fuse	1. Replace fuse. If new fuse blows, repair short.
	2. Defective voltage stabilizer	1. Install 40 ohm resistors between ground & connectors (disconnect from units) of temperature sending unit and gas gauge tank unit. If both dash units do not move to full scale (tolerance - one pointer width of either side of full scale reading) and the distance of movement on the scale is the same,, replace the voltage stabilizer.

Condition	Possible Cause	Correction
Gas gauge does not read full when tank filled	1. Tank <b>unit</b> misadjusted I	1. Install 40 ohm resistor between connector and ground (disconnect from unit). If dash unit reads full within one pointer width. Remove gas tank unit from tank, install connector, ground unit and adjust tab to <b>obtain</b> full reading on dash. Reinstall tank unit.
	2. Defective' voltage stabilizer	1. See corrective action above.
Gas gauge not operating	1. Corroded tank unit terminal	1. Check tank unit terminal, if corroded clean, pack connector with grease and reinstall connector..
	2. Loose dash gauge	1. Install 40 ohm resistor between sending unit connector. and ground (disconnect from tank terminal). If dashgauge does not read full, check dash gauge attaching nuts for secureness and tighten if required. (Requires removal of dash panel) Momentarily touch dash gauge attaching studs to 12 volt source. If indicator moves, reinstall panel; if not, replace gauge. (Caution do not keep studs connected to 12 volt source for more than a few seconds - damage to gauge can result)
	3. Open <b>wiring</b>	1. <b>Remove</b> connector from sending unit and ground (40 ohm resistor may be used if ohmmeter available. Remove multiple connector from rear of dash. Connect test light to ground and touch other end to connector socket with blue and black wire, if it does not light (40 ohm reading of ohm meter used) repair open circuit.
	4. Defective gas tank sending unit	1. Install 40 ohm resistor between temperature sending unit and ground (disconnect from unit) if dash unit reads full scale. Replace tank unit (check for terminal corrosion before replacing).

Condition	Possible Cause	Correction
Car runs out of gas with gauge indicating fuel in tank.	1. Tank unit misadjusted	1. Follow corrective action as stated above (obtain empty reading on dash)
	2. Defective voltage stabilizer.	1. See corrective action above.
Temperature gauge not	1. Loose dash gauge attaching nut.	1. See corrective action above.
	2. Defective temperature sending unit	1. Install 40 ohm resistor between temperature sending unit and ground (disconnect from unit). If dash unit reads full scale, replace temperature sending unit.
	3. Open wiring.	1. Follow corrective action as stated above (connector socket with blue wire).
Temperature gauge indicates hot when engine temperature normal.	1. Incorrect temperature sending unit	1. Check for correct sending unit (white porcelain) replace if incorrect.
	2. Defective temperature sending unit.	1. See corrective action above.
	3. Defective voltage stabilizer.	1. See Corrective action above.

### GAS GAUGE TROUBLE DIAGNOSIS - GT

An inoperative gas gauge reading can normally be found to result from a poor grounding condition within the circuit. Using the procedure as outlined below may lead to the correction of the inoperative reading without replacement of either the tank unit or the dash unit.

1. Make certain the gas tank (ground) strap is properly secured.
2. Make certain the ground wire (brown in color) for gasoline/ and temperature gauges is properly connected to the windshield wiper motor and is secured. (This ground wire is also common for the heater blower motor.)

If the above procedure does not produce a satisfactory gauge reading, an attempt to isolate the defective part, i.e. tank or dash unit should be made.

3. Remove a tank unit from parts stock.

4. Disconnect the tank unit lead wire (light blue with black tracer) from the tank unit.

5. Connect the stock tank unit; ground unit, and operate manually.

6. If the dash unit shows a correct reading, then replacement of the tank unit is required as the correction.

A correct reading will be one which resembles the movement of the manually-operated tank unit.

7. If the dash unit does not show a correct reading, then its replacement is necessary.

### MAJOR REPAIR

#### OPEL 1900. MANTA

##### Removing Voltage Stabilizer

1. Remove instrument cluster housing assembly.



2. Pull voltage stabilizer of back of printed circuit.  
See Figure 1I-1.



Figure 1I-1 -Voltage Stabilizer

**Installation**

1. Install voltage stabilizer on back of printed circuit.
2. Install instrument cluster housing assembly.

**Removing Speedometer**

1. Remove instrument cluster housing.
2. Remove six screws shown in Figure 1I-2 and remove both instrument cluster lens.



Figure 1 I-2 · Removing Instrument Cluster Lens

3. Remove three speedometer attaching screws. See Figure 1I-3.

**Installation**

1. Replace speedometer in cluster with three (3) attaching screws.

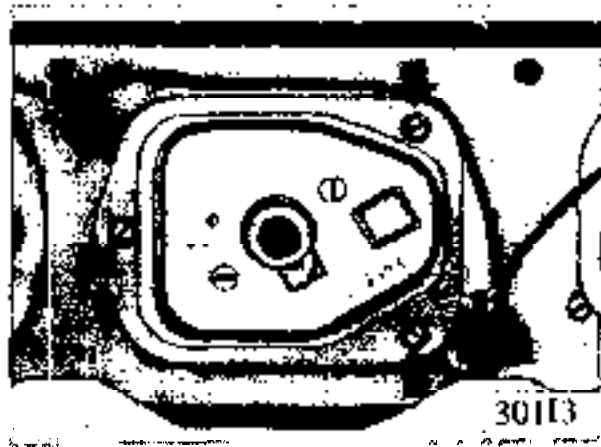


Figure 1 I-3 · Speedometer Attaching Screws

2. Install six (6) screws holding instrument cluster lens in housing.
3. Replace cluster housing.

**Removing Electric Clock or Tachometer**

1. Remove instrument housing.
2. Remove six screws and remove both instrument cluster lens, as shown in Figure 1I-2.
3. Remove three screws, as shown in Figure 1I-4, and remove clock or tachometer.

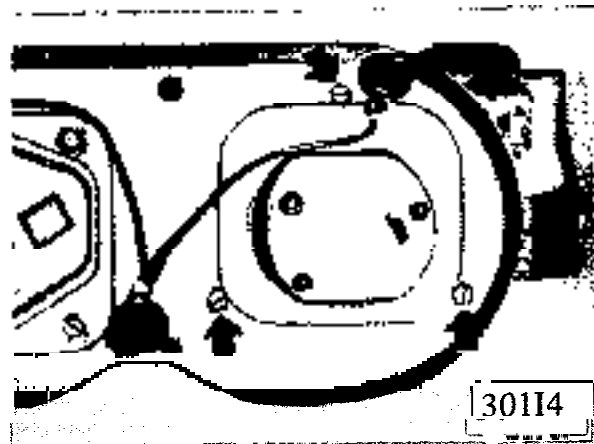


Figure 1 I-4 · Removing Electric Clock or Tachometer

**Installation**

1. Install clock or tachometer in instrument cluster with three (3) attaching screws.
2. Install six (6) screws holding instrument cluster lens.

3. Replace instrument housing.

### Removing Temperature Indicator or Fuel Gauge

1. Remove instrument cluster housing.
2. Remove six screws and remove both instrument cluster lens. See Figure 11-2.
3. Pull voltage stabilizer off printed circuit and remove four instrument attaching screws, as shown in Figure 11-5.

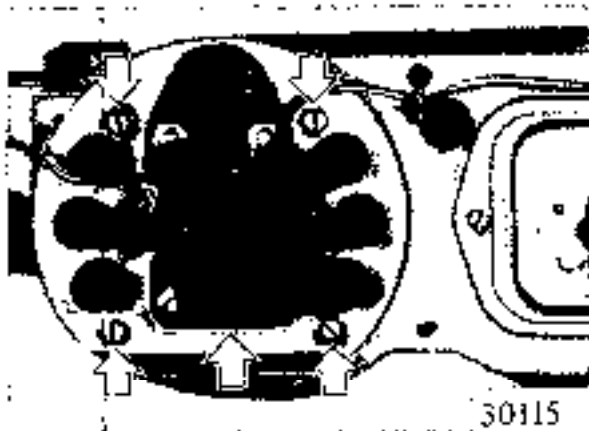


Figure 11-5 Removing Four Instrument Attaching Screws

4. Take temperature or fuel gauge out of cluster

### Installation

1. Install temperature or fuel gauge in cluster.
2. Replace voltage stabilizer on back of printed circuit.
3. Replace both instrument cluster lens.
4. Install instrument cluster housing.

### Removing Rallye Gauges

1. Remove glove compartment.
2. Remove radio, if equipped.
3. Remove screws holding instrument carrier from instrument panel.
4. Disconnect wires from instrument gauge.
5. Remove attaching nuts from gauge and remove.

### Installation

1. Replace gauge with attaching nuts on panel.
2. Hook up wires to gauges.
3. With holding screws, attach gauge cluster to instrument panel.
4. Replace radio.
5. Replace glove compartment.

### Removal of Temperature Sending Unit

1. Drain and collect coolant.

To drain radiator, remove end of lower radiator hose that is connected to radiator.

2. Remove wire from temperature sending unit.
3. Unscrew temperature sending unit from thermostat housing. See Figure 11-6.

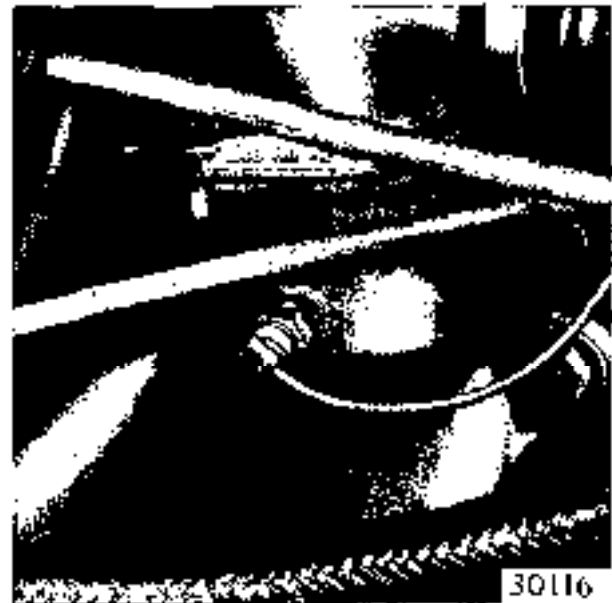


Figure 11-6 -Temperature Sending Unit

### Installation

1. Screw temperature sending unit into thermostat housing after sealing unit with non-hardening permatex.
2. Install wire on sending unit.
3. Replace coolant.

### Removing Oil Pressure Sending Unit

1. Disconnect wire from sending unit.
2. Unscrew oil pressure sending unit from block. See Figure 11-7.



Figure 11-7 Oil Pressure Sending Unit

### Installation

1. Replace oil pressure sending unit into block.
2. Connect wire to unit.

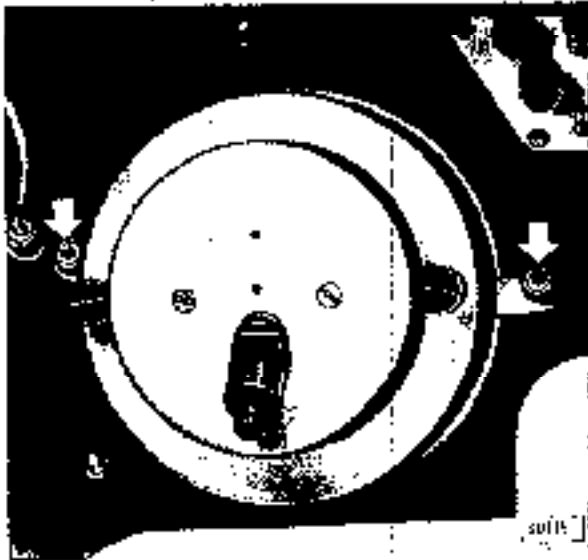


Figure 11-8 Rear View of Speedometer

### Removal of Speedometer

1. Remove instrument housing.
2. Remove speedometer. See Figure 11-9 1.

### Installation

1. Install speedometer.
2. Install instrument housing, per paragraph 11-71.

### Removal of Tachometer

1. Remove instrument housing.
2. Remove tachometer.
3. Disconnect electrical wires. See Figure 11-9.

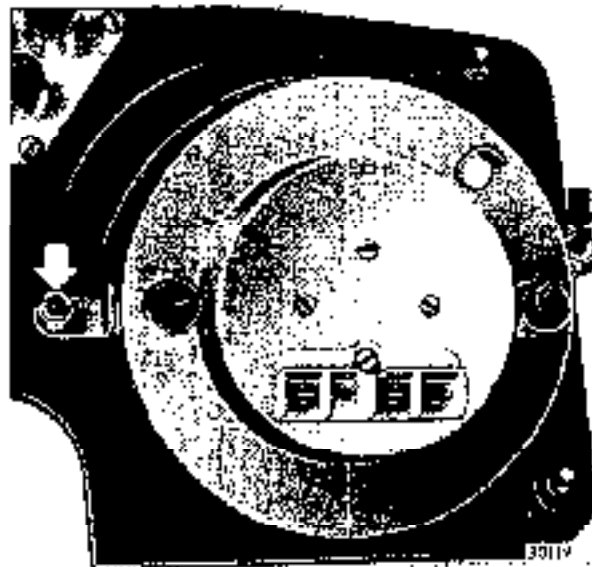


Figure 11-9 Rear View of Tachometer

### Installation

1. Connect wires.
2. Install tachometer.
3. Install instrument cluster.

### Removal of Temperature Indicator and Fuel Gauge Dash Unit

1. Remove instrument housing.
2. Remove temperature indicator and fuel gauge dash unit.
3. Disconnect electrical wires. See figure 11-10.

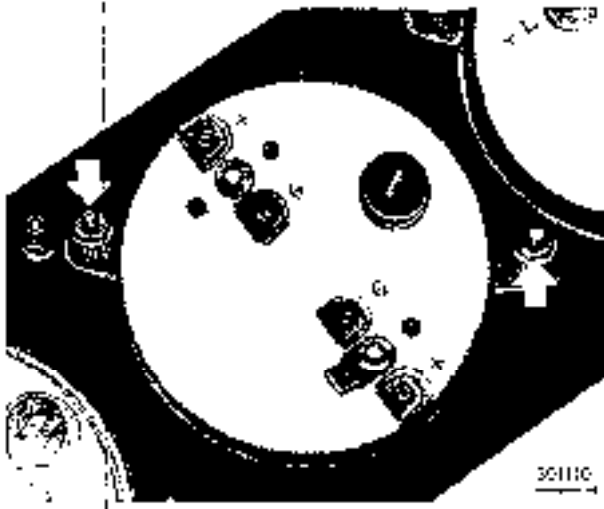


Figure 1 I-10 Rear View of Temperature Indicator and Fuel Gauge Dash Unit

#### Installation

1. Connect wires and install unit.
2. Install instrument cluster housing.

#### Removal of Electric Clock

1. Remove instrument housing.

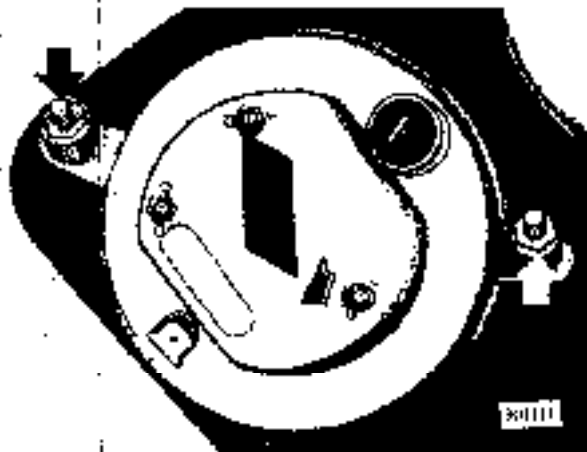


Figure 1 I-11 Rear View of Electrical Clock

2. Remove electrical clock.
3. Disconnect electrical wires. See Figure 1I-1 I.

#### Installation

1. Install clock and connect wires.
2. Install instrument cluster housing.

#### Removal of Ammeter and Oil Pressure Gauge

1. Remove instrument housing.
2. Remove ammeter and oil pressure gauge.
3. Disconnect electrical wires. See Figure 1I-12.

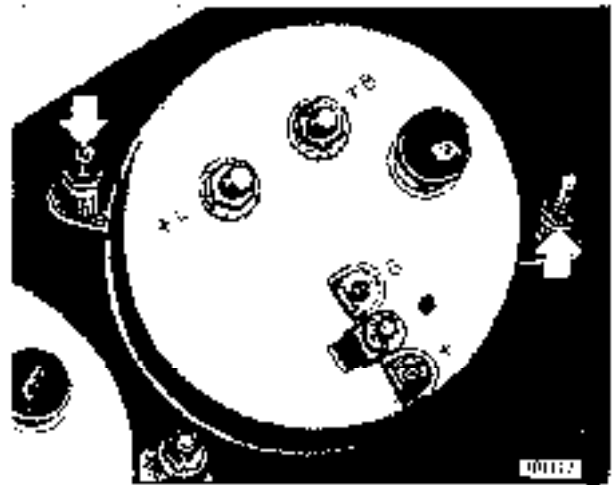


Figure 1 I-12 Rear View of Ammeter and Oil Pressure Gauge

#### Installation

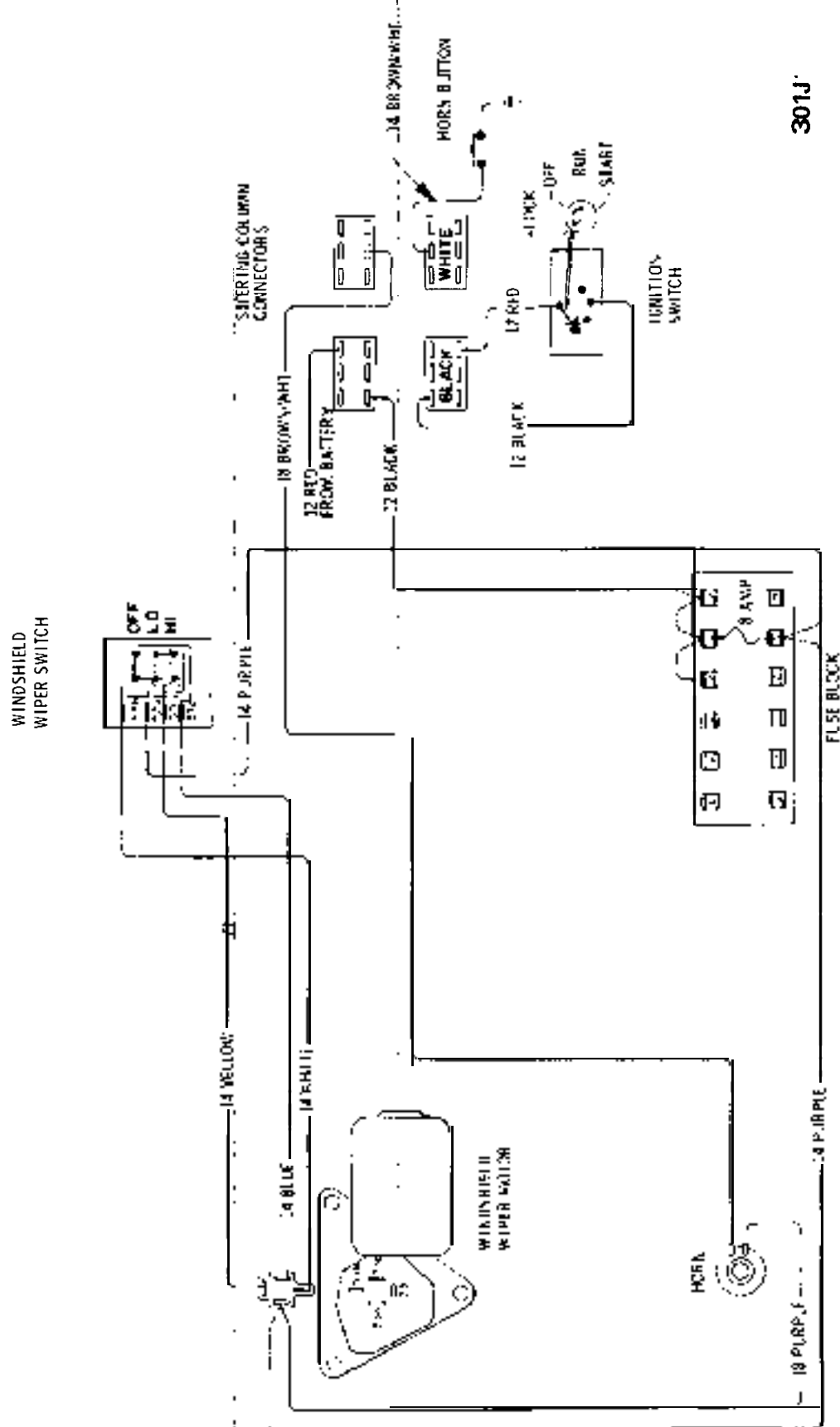
1. Connect wires to ammeter and oil pressure gauge and install.
2. Install instrument cluster housing.

# WIRING DIAGRAMS

## CONTENTS

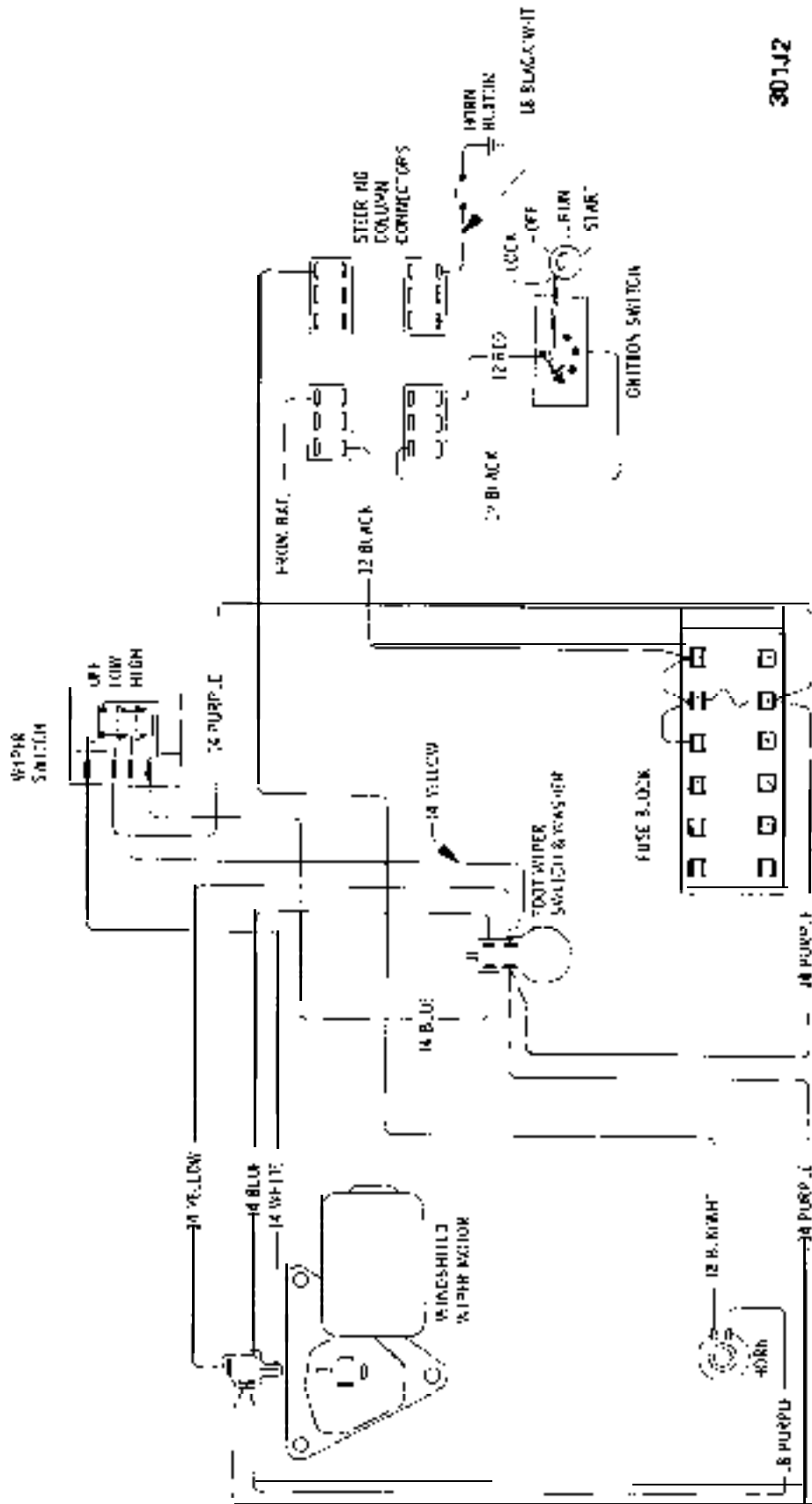
Subject	Page No.
<b>1973 WIRING DIAGRAMS:</b>	
Windshield Wiper and Horn - Opel 1900 .	
Manta .....	1 J-74
Windshield Wiper and Horn - Rallye .....	1 J-75
Windshield Wiper and Horn - GT .....	1 J-76
Turn Signal and Hazard Flasher .	
Opel 1900 - Manta .....	1 J-77
Turn Signal and Hazard Flasher - GT .....	1 J-78
Oil, Fuel, Temp, Tach, Stop and Brake	
Warning Light . GT .....	1 J-79
Blower Motor, Lighter and Backup Lights .	
Opel 1900 . Manta .....	1 J-80
Blower Motor and Lighter . GT .....	1 J-81
Indicator Lights and Gauges - Opel 1900 .	
Manta .....	1 J-82
Indicator Lights and Gauges . Rallye .....	1 J-83
Dome Light and Buzzer - Opel 1900 - Manta .....	1 J-84
Dome Light, Buzzer and Clock - GT .....	1 J-85
Headlamps - Opel 1900 .....	1 J-86
Headlamps . Manta .....	1 J-87
Headlamps and Fog Lights . Rallye .....	1 J-88
Headlamps, Parking, Tail and Instrument	
Panel Lighting . GT .....	1 J-89
Left Parking and Tail Lights - Opel 1900 .	
Manta .....	1 J-90
Right Parking and Tail Lights - Opel 1900 .	
M a n t a .....*	1 J-91
Starting, Ignition and Charging .	
Opel 1900 . Manta .....	1 J-92
Starting, Ignition and Charging - GT .....	1 J-93
Instrument Panel . GT .....	1 J-94
A/C Generator and Regulator - All Models .....	1 J-95
Seat Belt Warning System (Manual	
Transmission) - Opel 1909 - Manta .....	1 J-96
Seat Belt Warning System (Automatic	
Transmission) . Opel 1900 - Manta .....	1 J-97
Seat Belt Warning System (Manual	
Transmission) - GT .....	1 J-98

	Page No.
Seat Belt Warning System (Automatic Transmission) . GT .....	1J- 99
Heated Rear Glass . Opel 1900 . Manta .....	1J-100
Heated Rear Glass . GT .....	1J-101
Opel 1900 Color Schematic .....	1J-103
Manta Color Schematic .....	1 J-105
GT Color Schematic .....	1 J-107



301J

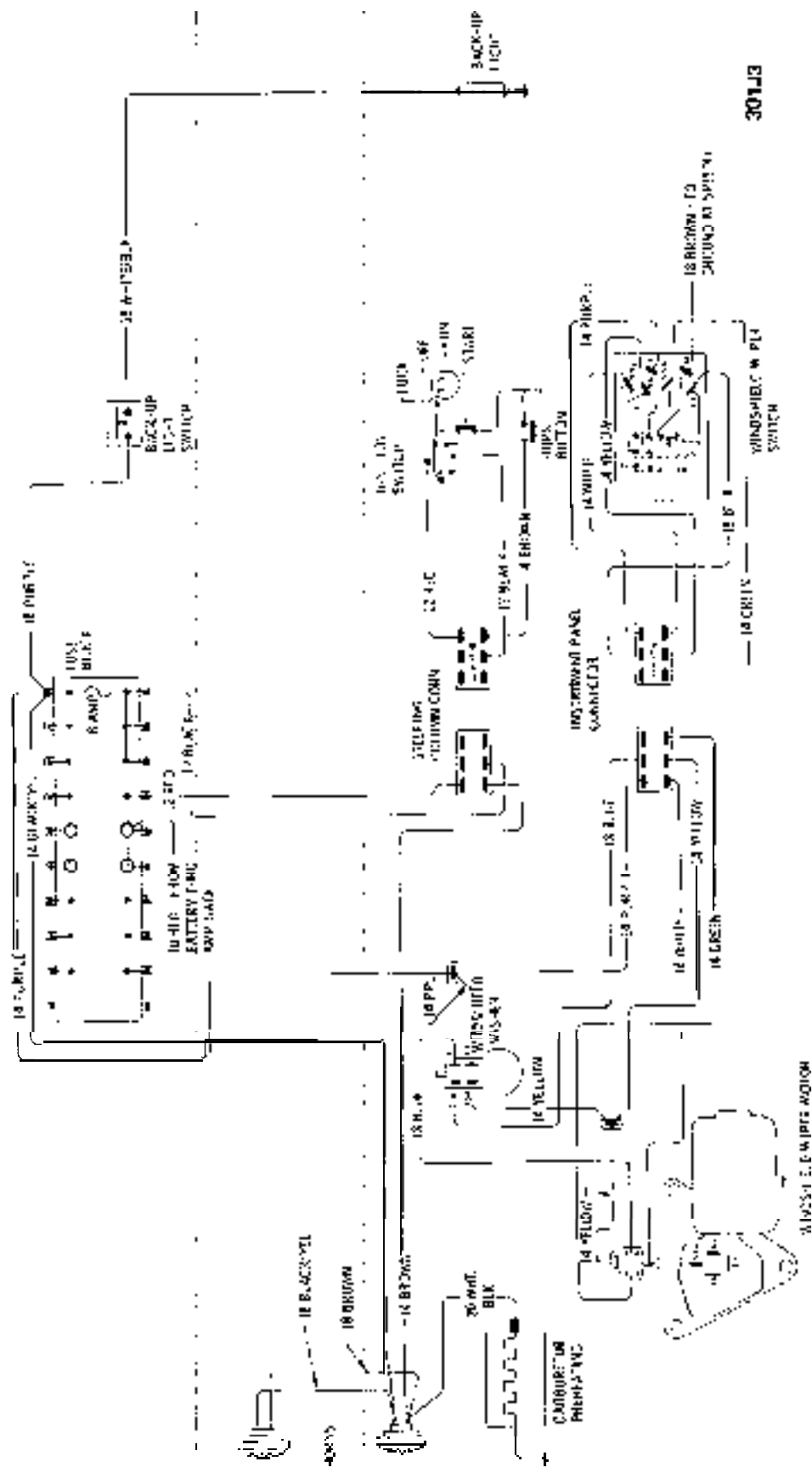
Figure 1J-1 Windshield Wiper and Horn - Opel 1900 - Manta



301J2

Figure 1J-2 Windshield Wiper and Horn - Rallye





301J3

Figure 1J-3 Windshield Wiper and Horn • GT



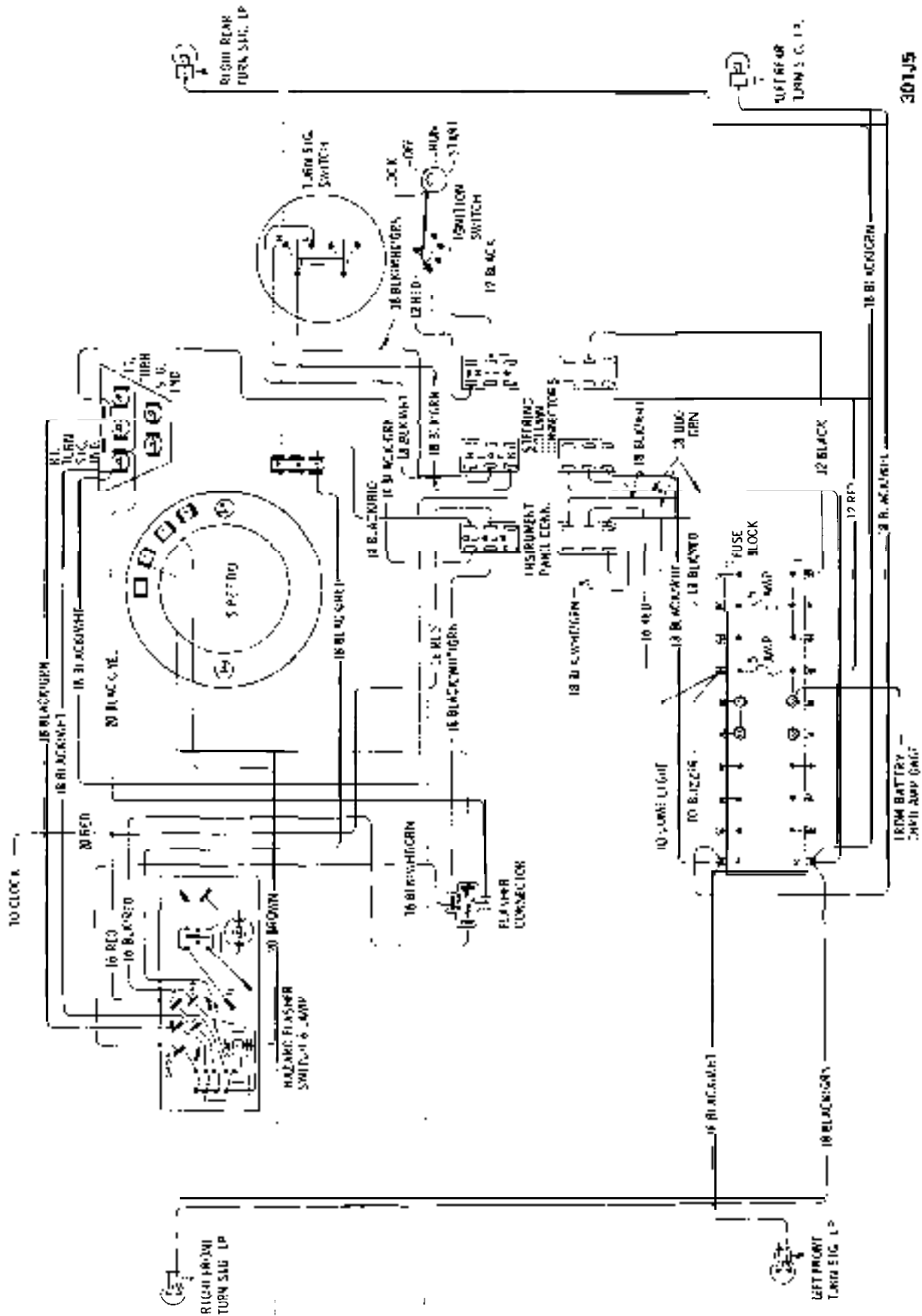


Figure 1J-5 Turn Signal and Hazard Flasher - GT

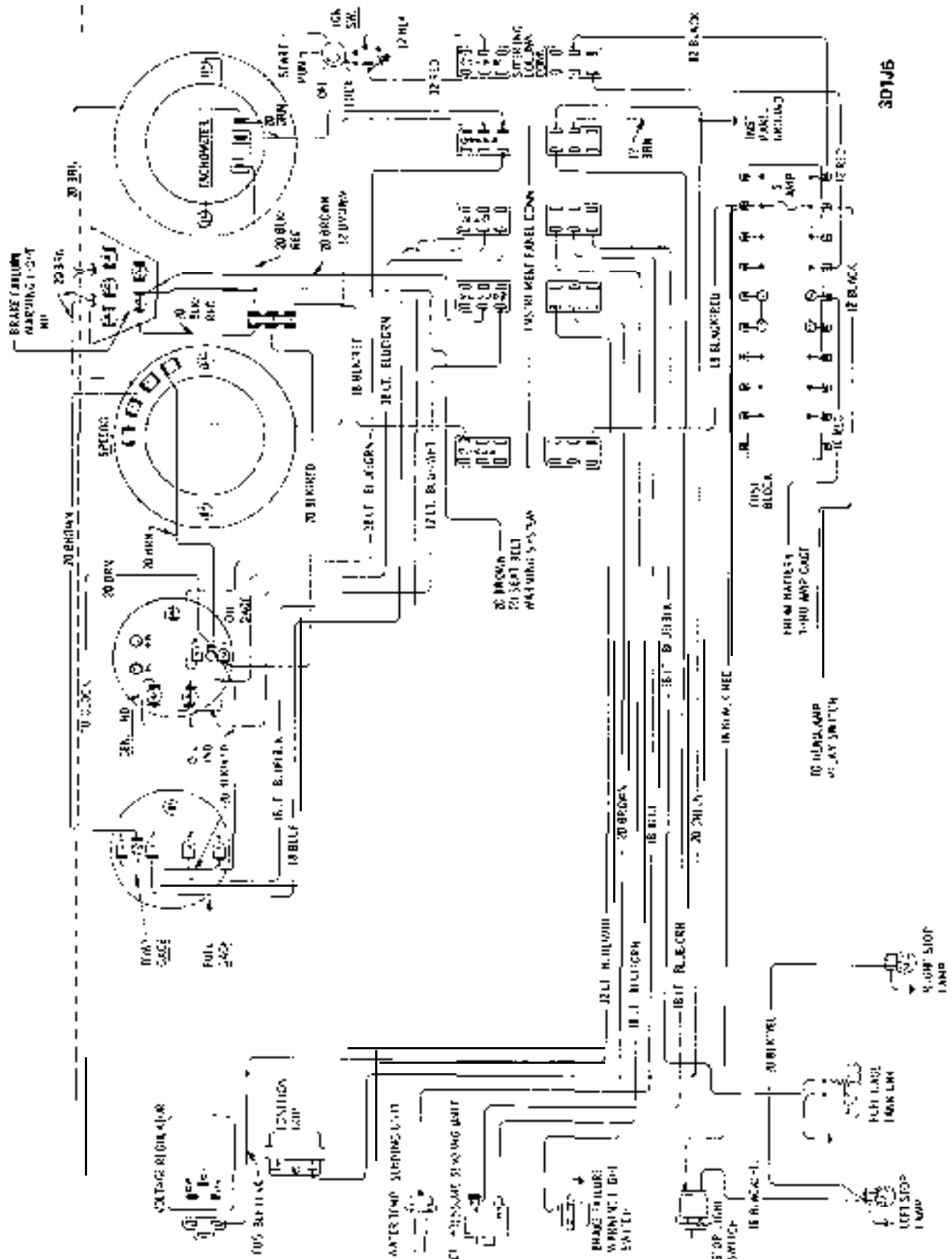


Figure 1J-6 Oil, Fuel, Temp. Tach, Stop and Brake Warning Light - GT

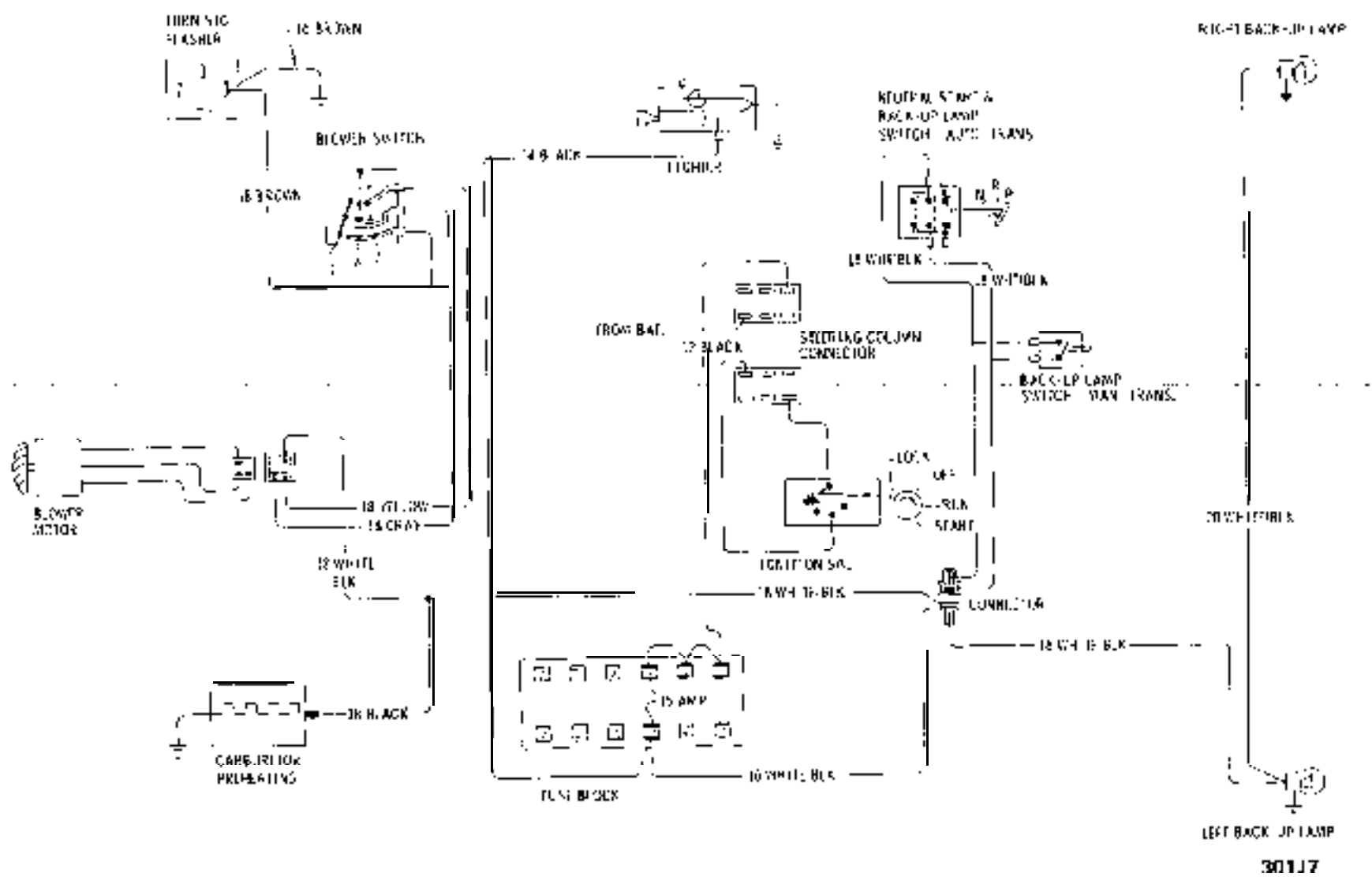


Figure 1.1.7 Blower, Lighter and Backup Lights - Opel 1900 - Mainz

30117

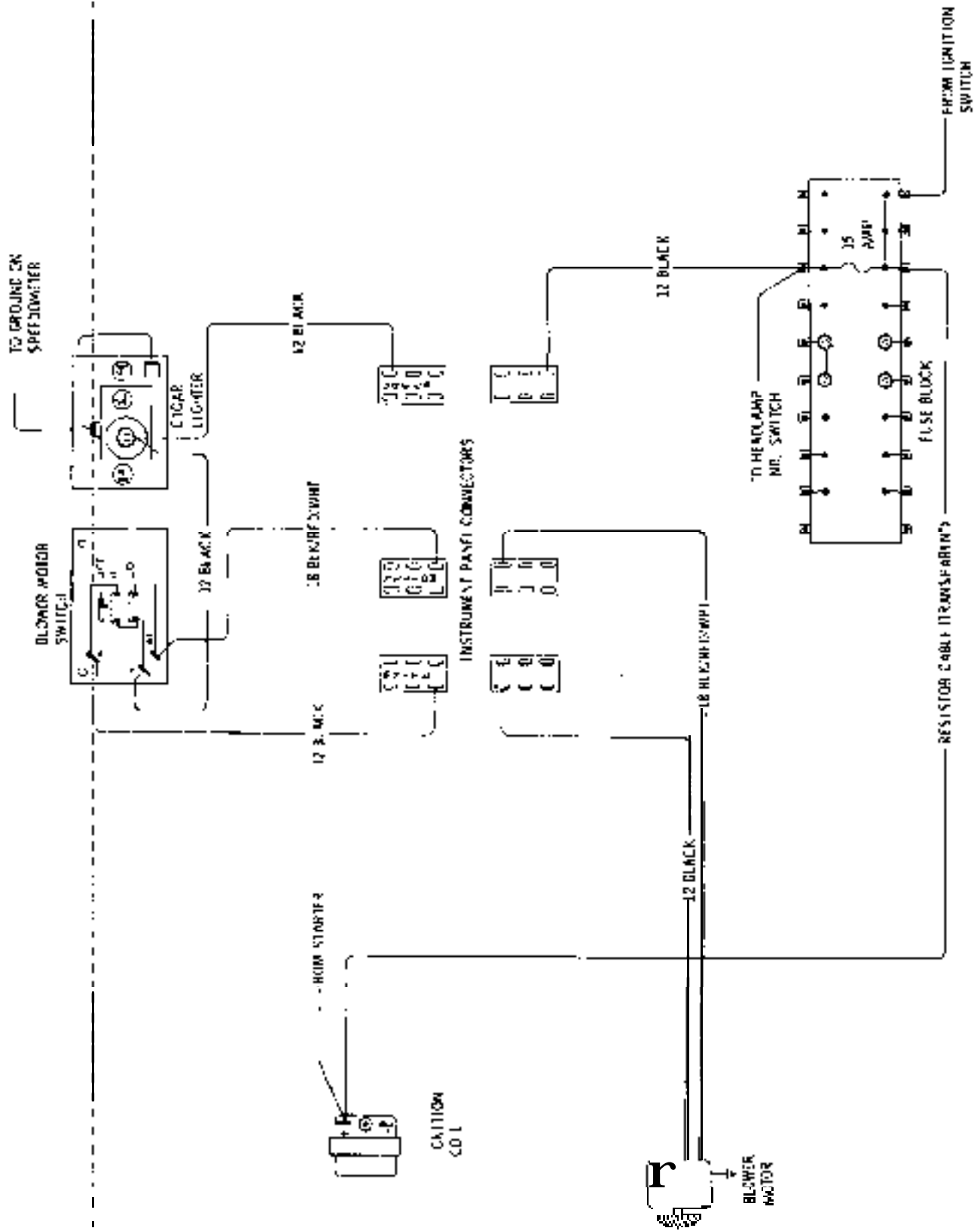


Figure 1 J-8 Blower and Lighter - GT

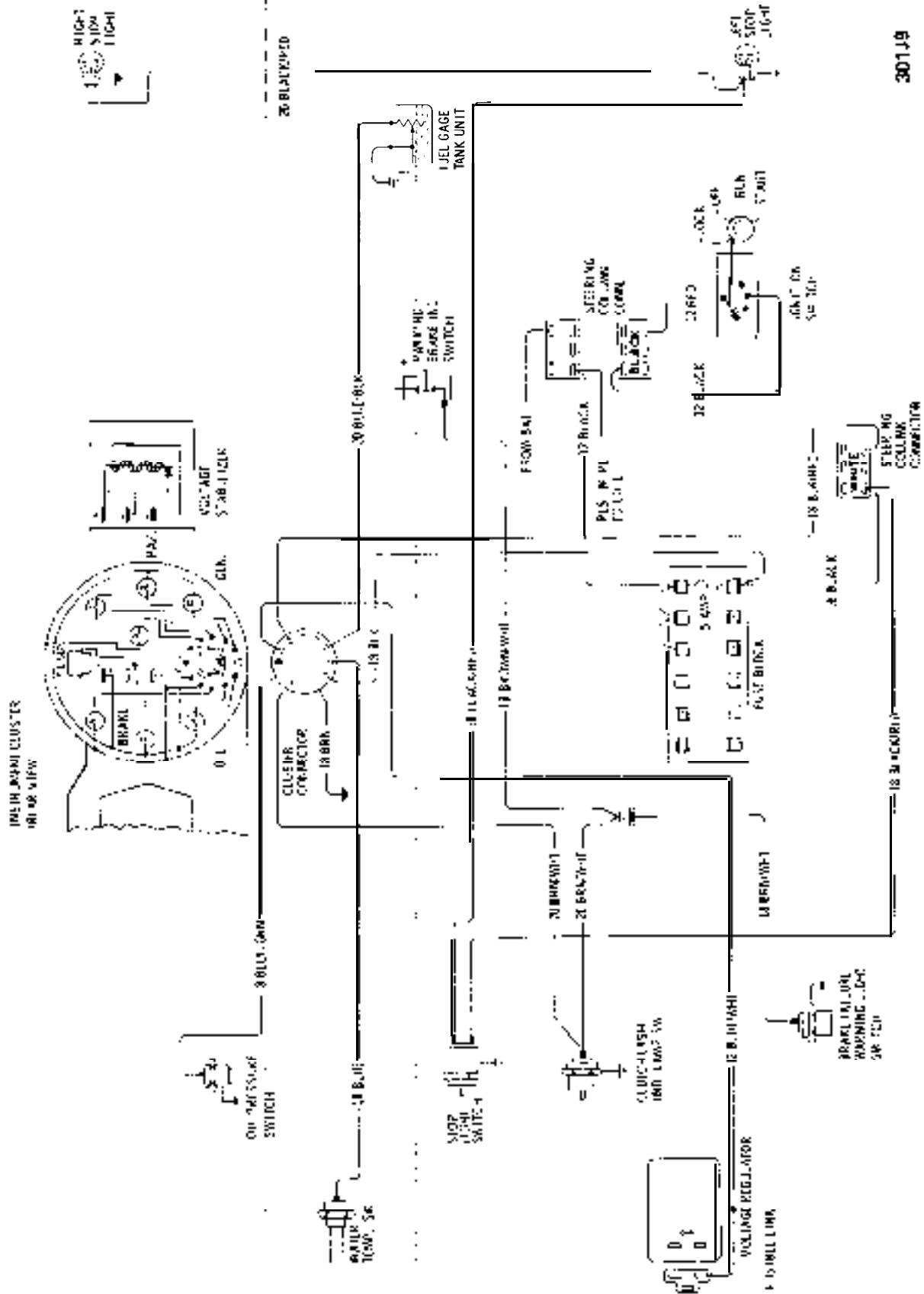
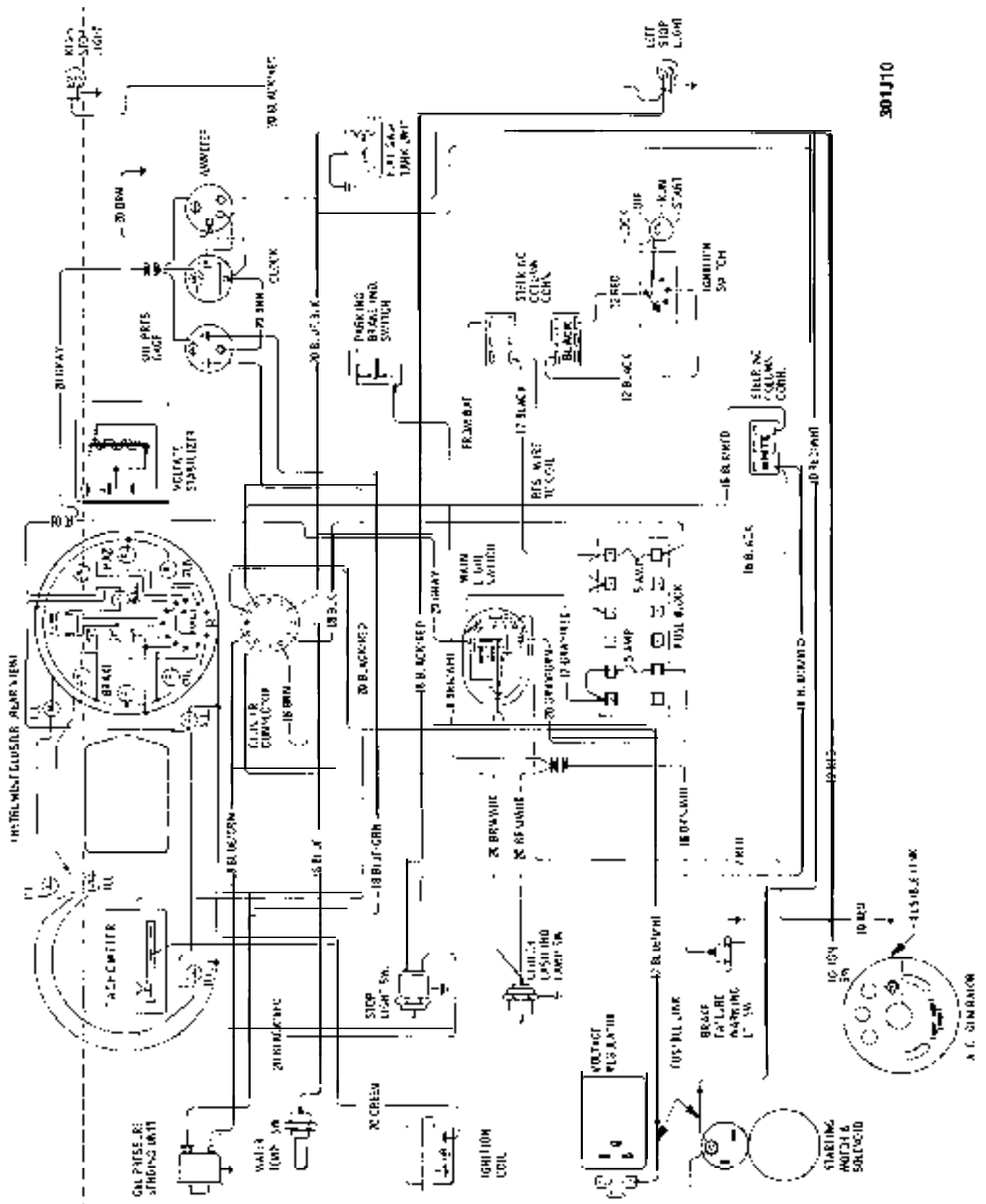


Figure 1J-9 Indicator Lights and Gauges • Opel 1900 Manta



301J10

Figure 1 J-10 Indicator Lights and Gauges - Rallye



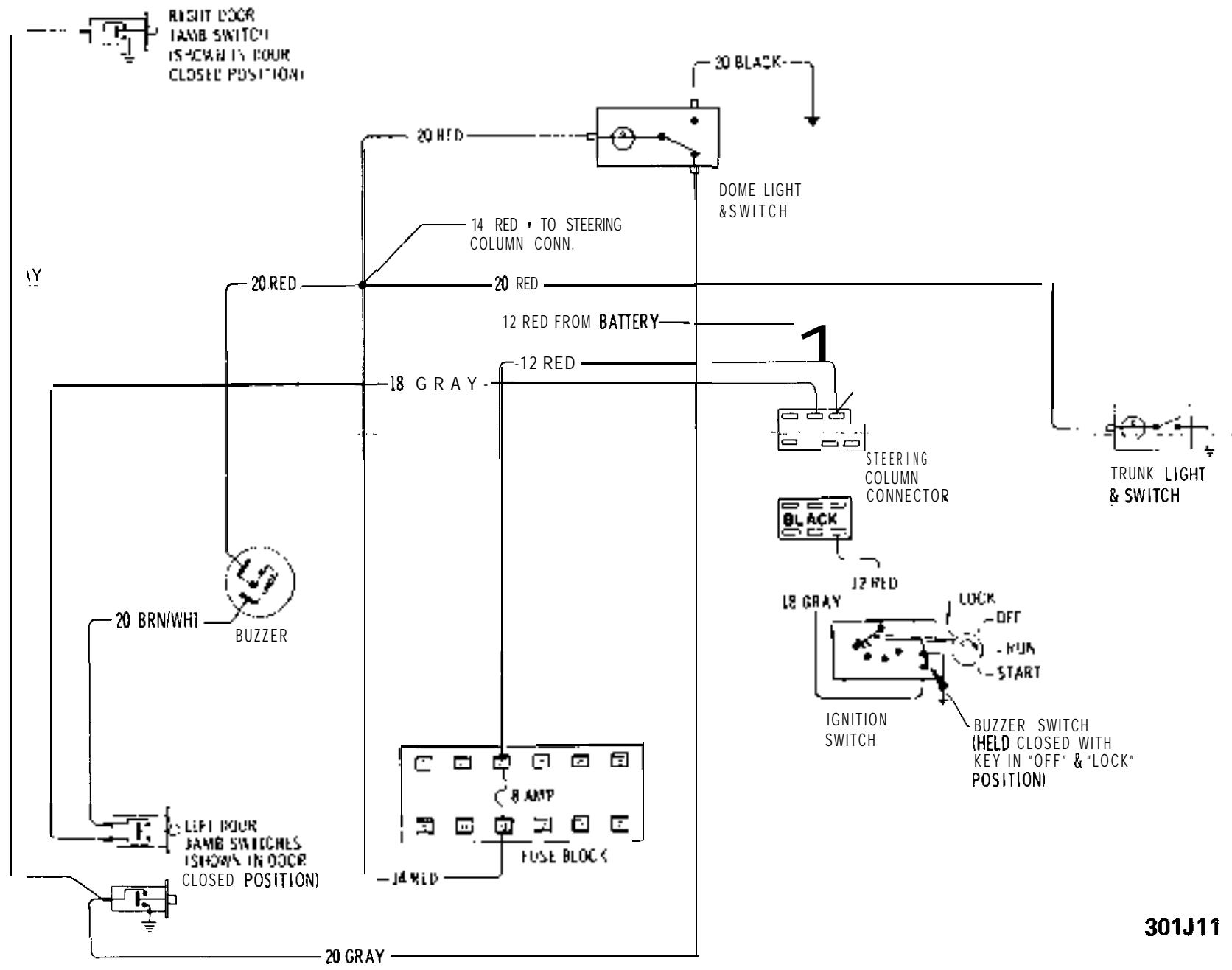
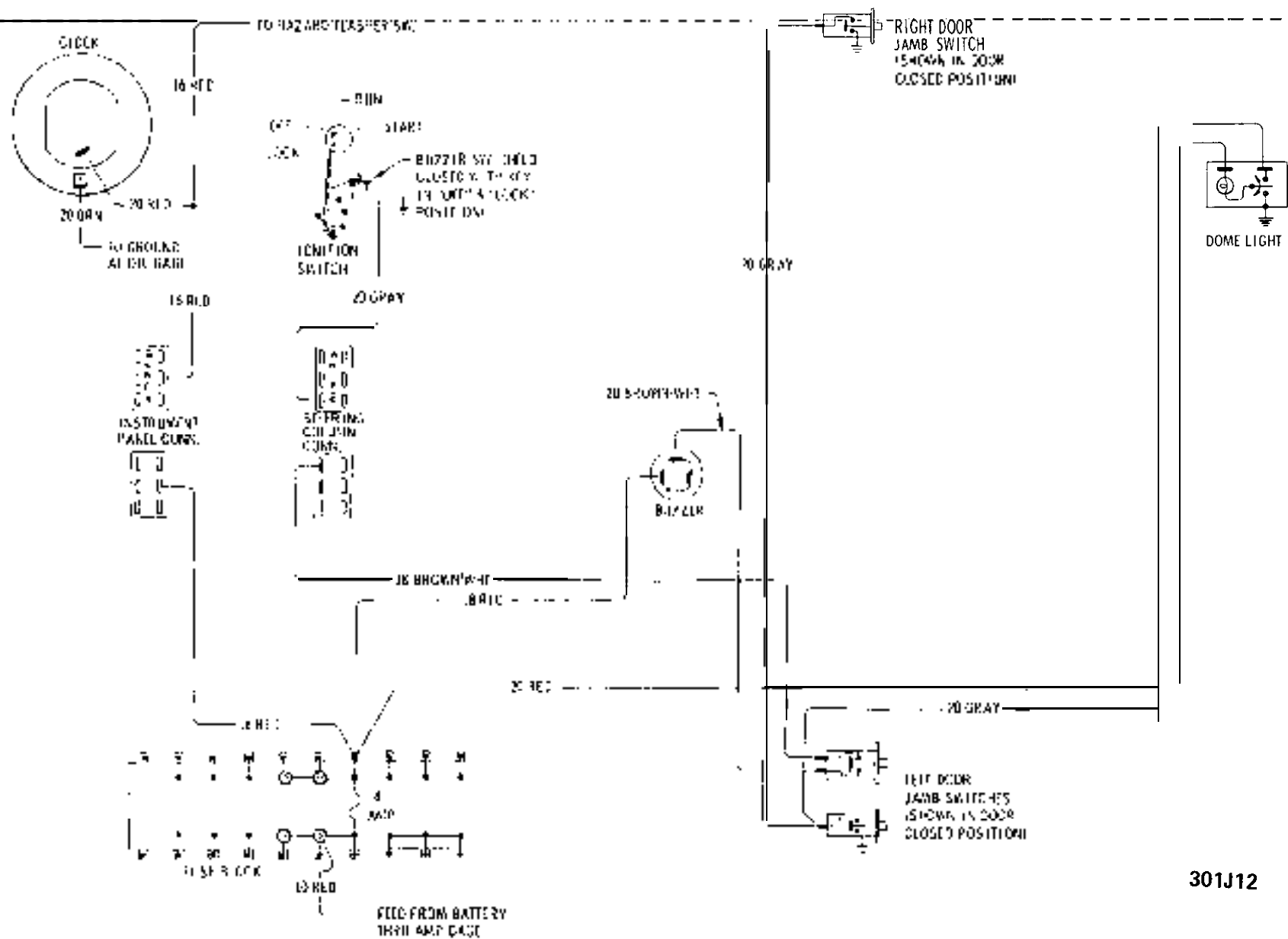


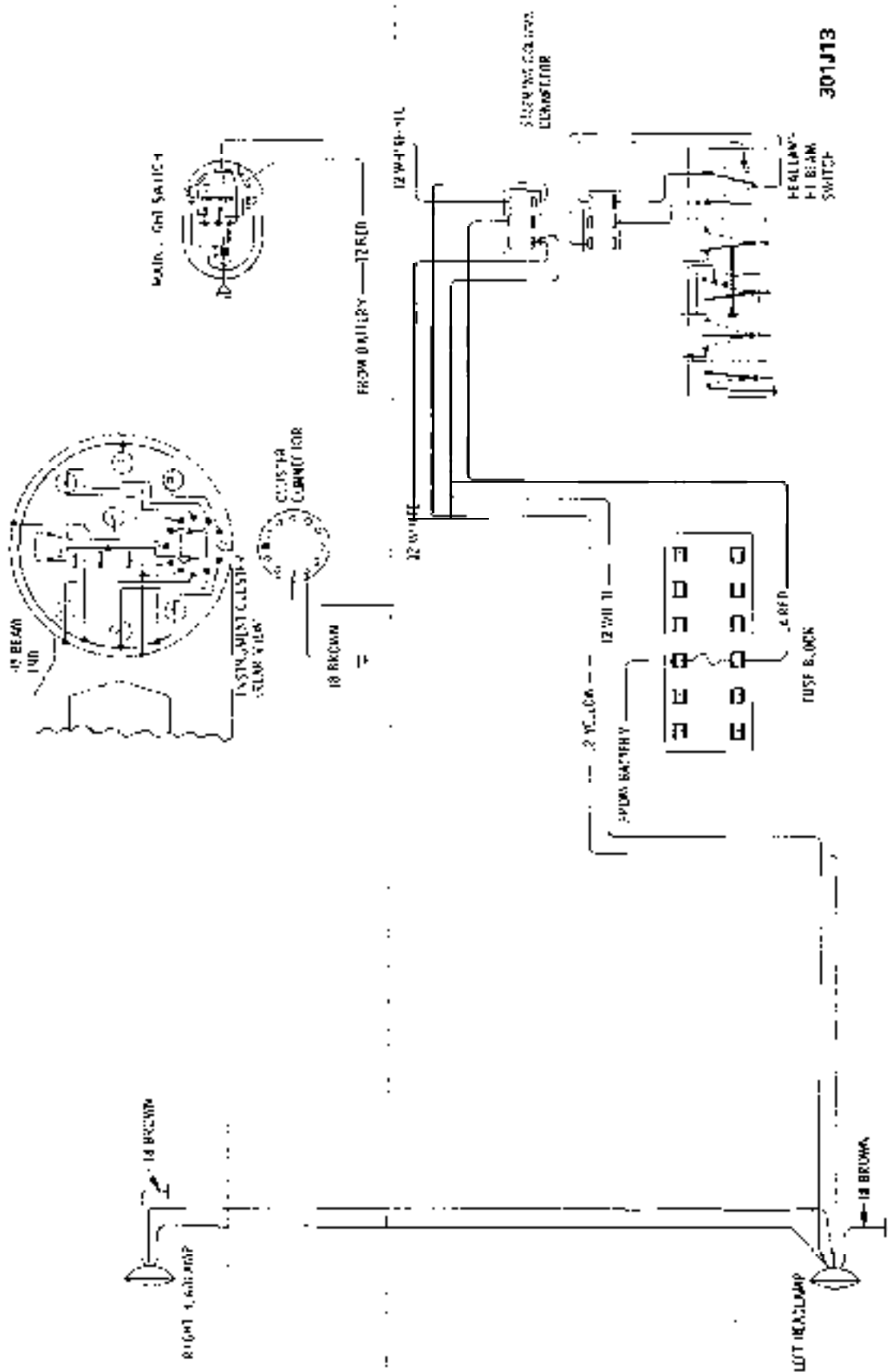
Figure 1J-11 Dome Light and Buzzer - Opel 1900 - Manta

301J11

Figure 1A-12 Dome Light, Clock and Buzzer - GT

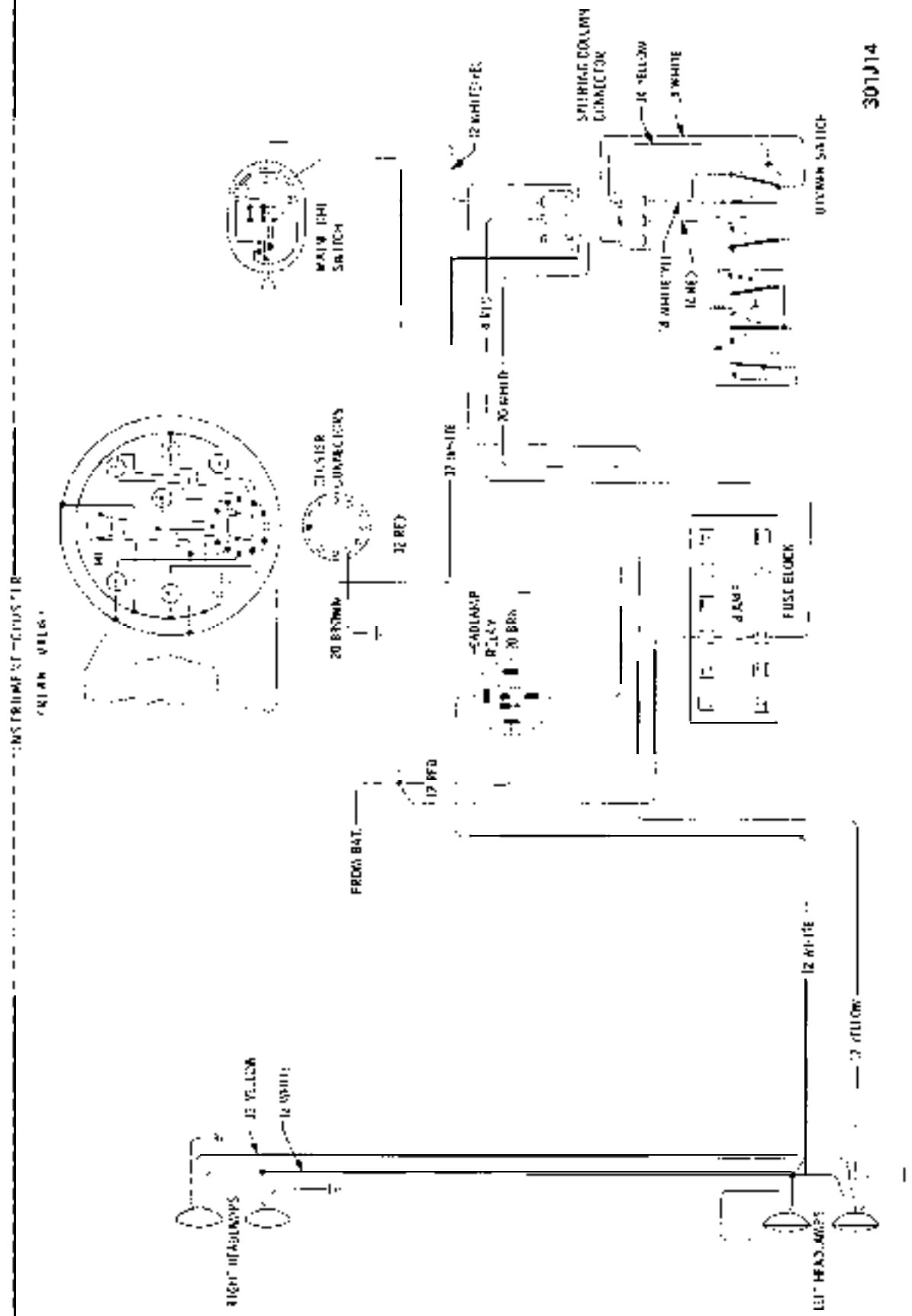


301J12



301J13

Figure 1 J-1 3; Headlamps • Opel 1900



301J14

Figure 1J-14 Headlamps Manta

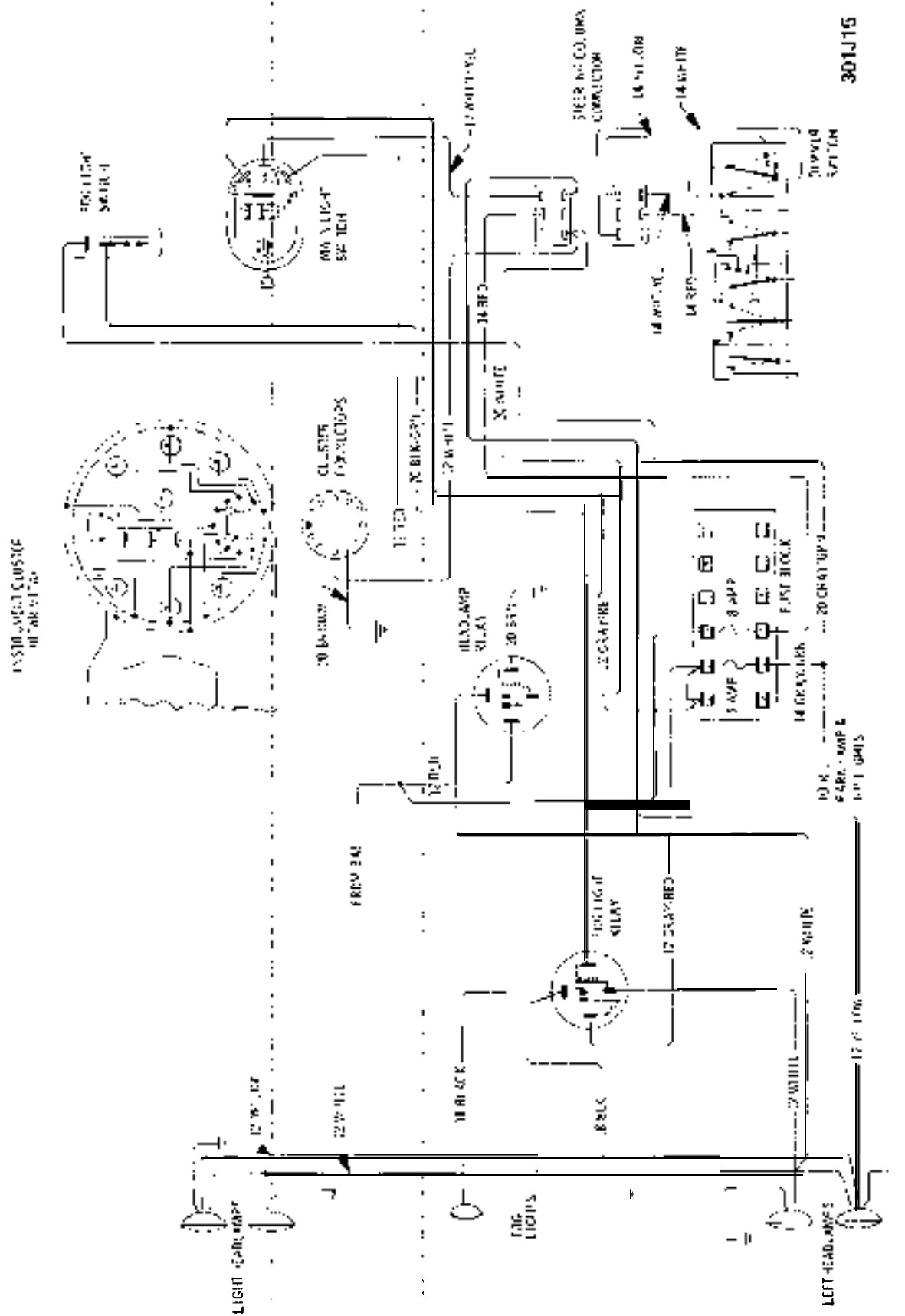


Figure 1J-15 Headlamp and Fog Lights - Rallye

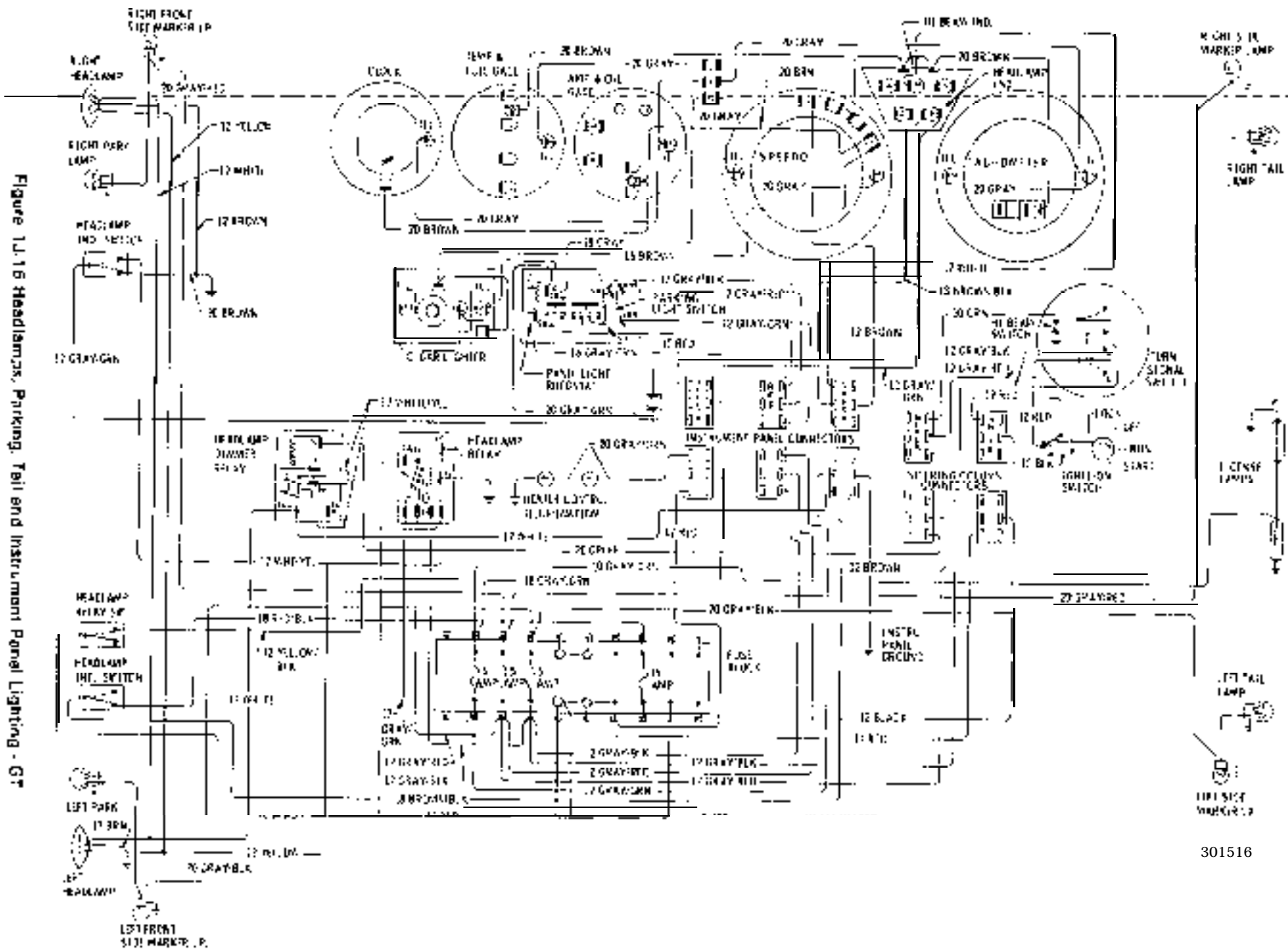


Figure 1J-16 Headlamps, Parking, Tail end and Instrument Panel Lighting - GT

301516

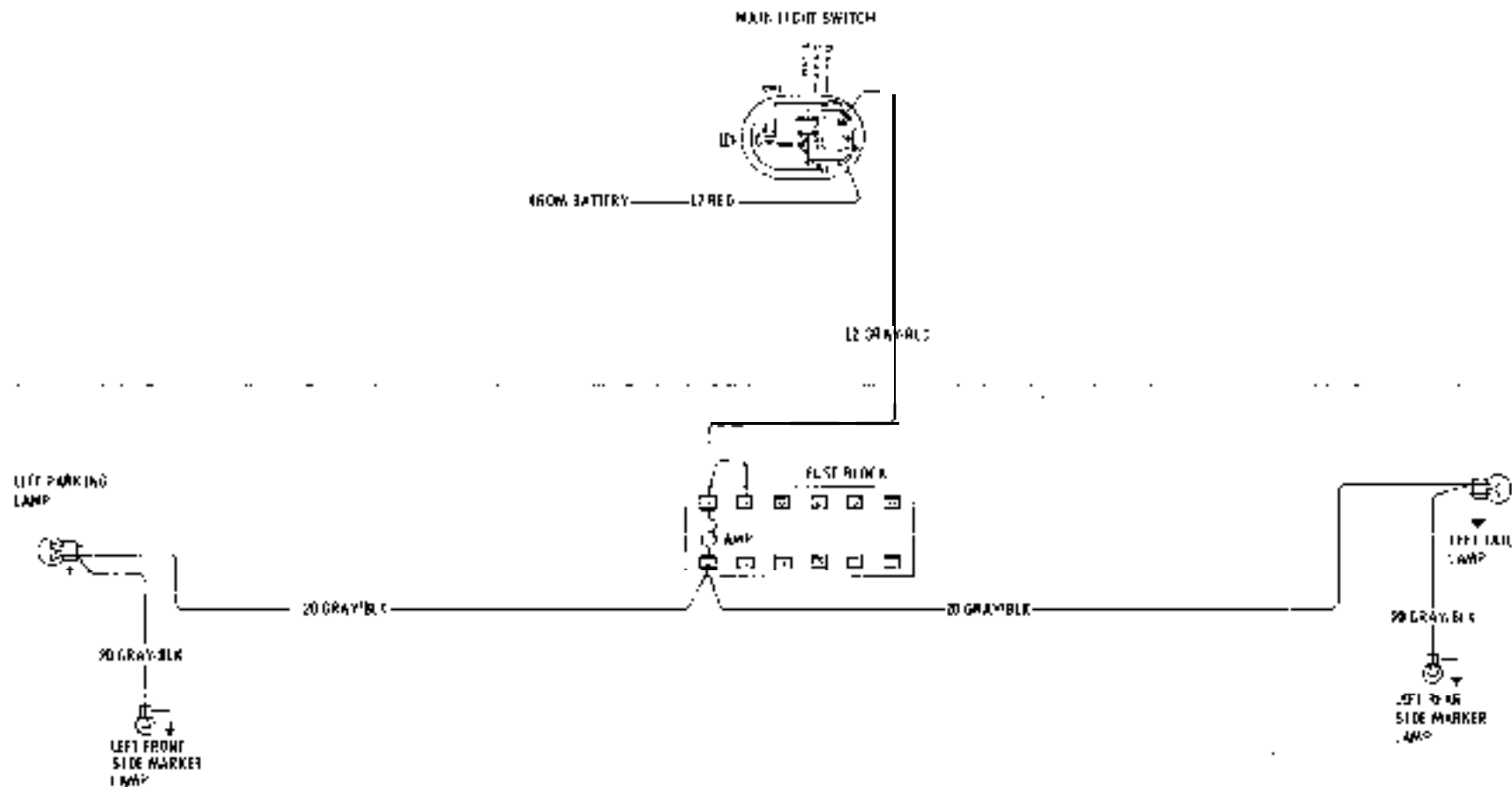


Figure 1.1-17 Left Parking and Tail Lights - Opel 1900 - Mania

301J17

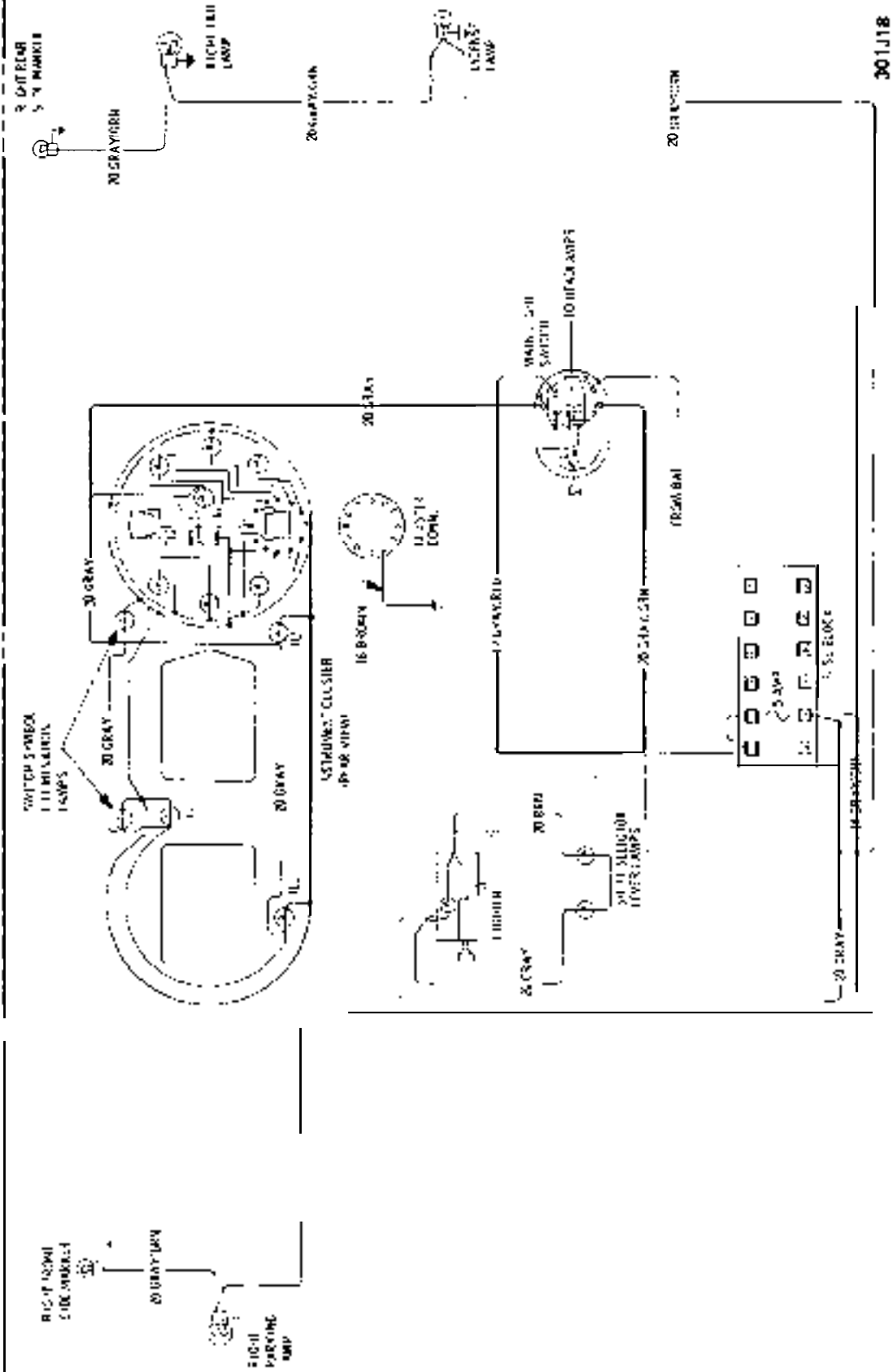


Figure 1J-18 Right Parking, Tail and Instrument Panel Lighting - Opel 1900 - Manta



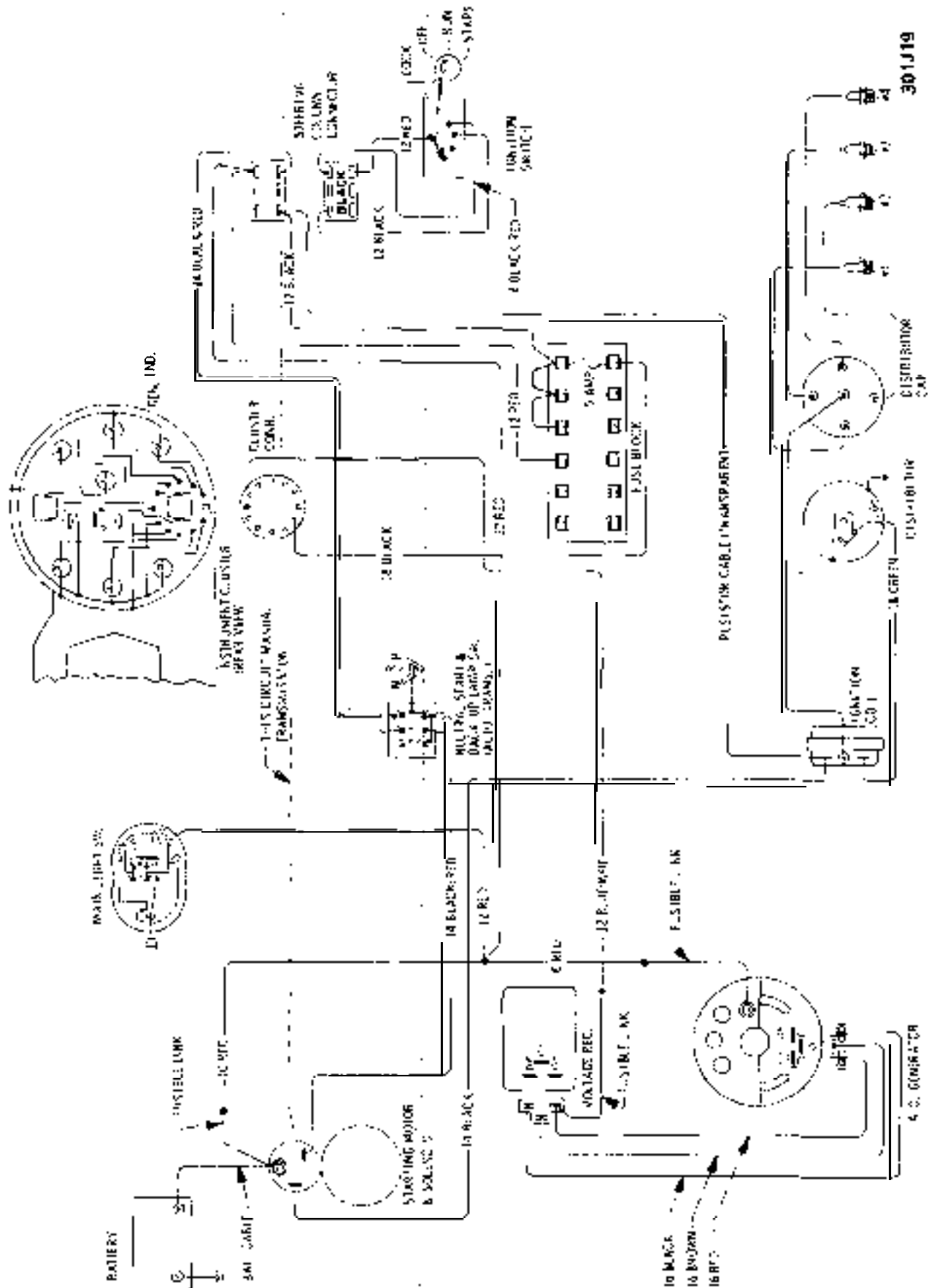


Figure 1J-19 Starting, Ignition and Charging Opel 1900 Manta



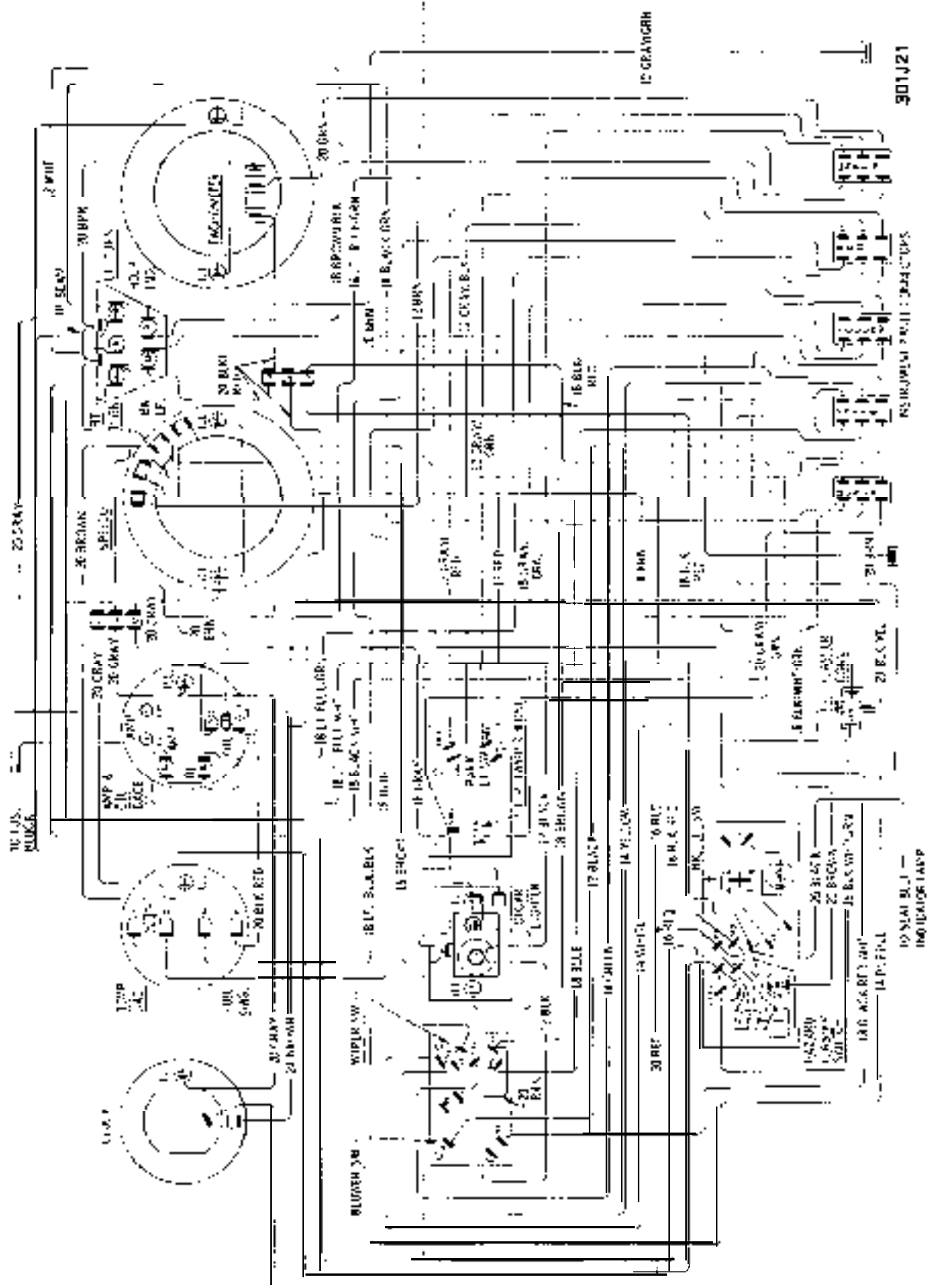


Figure 1J-21 Instrument Panel GT

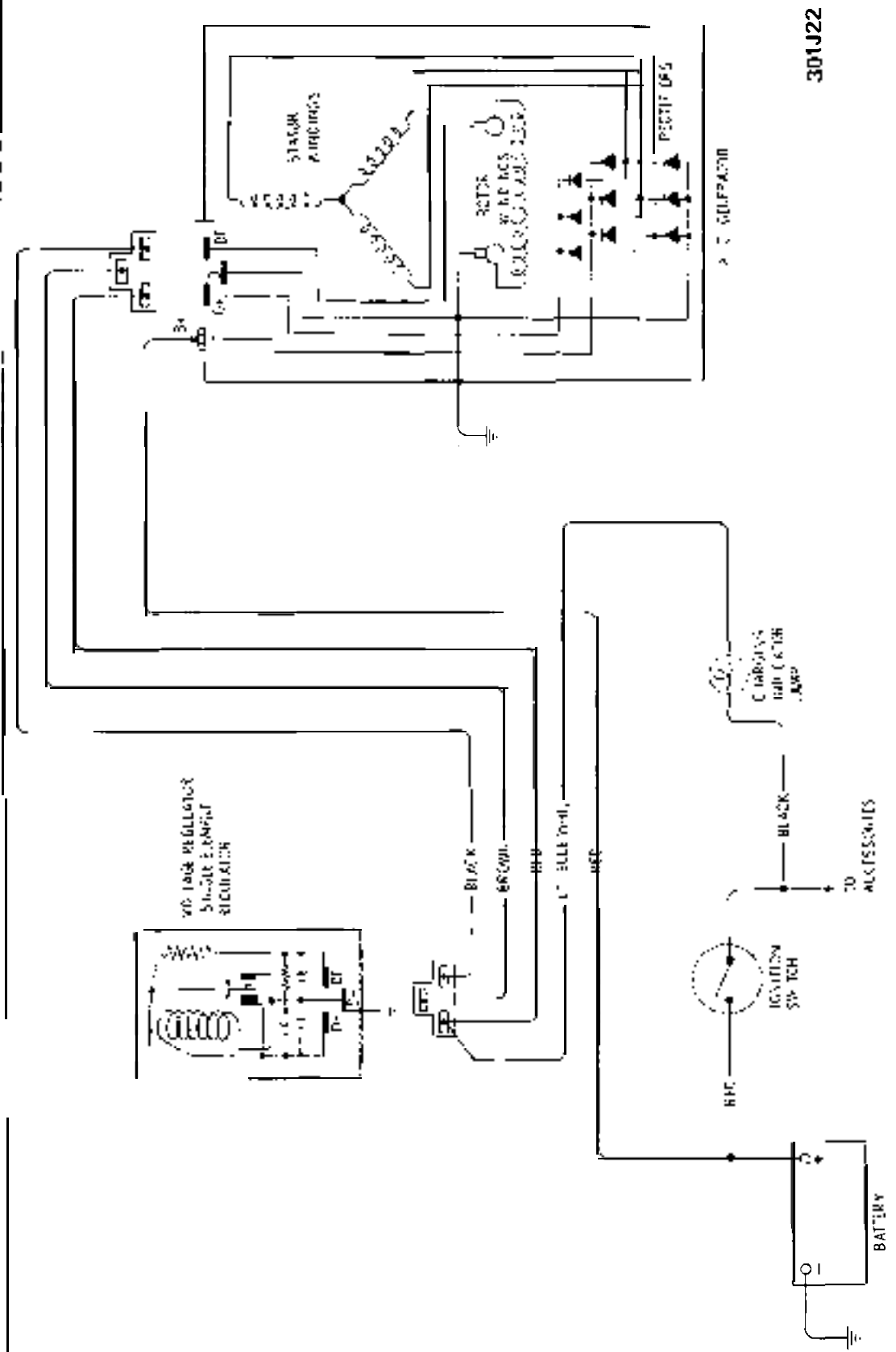
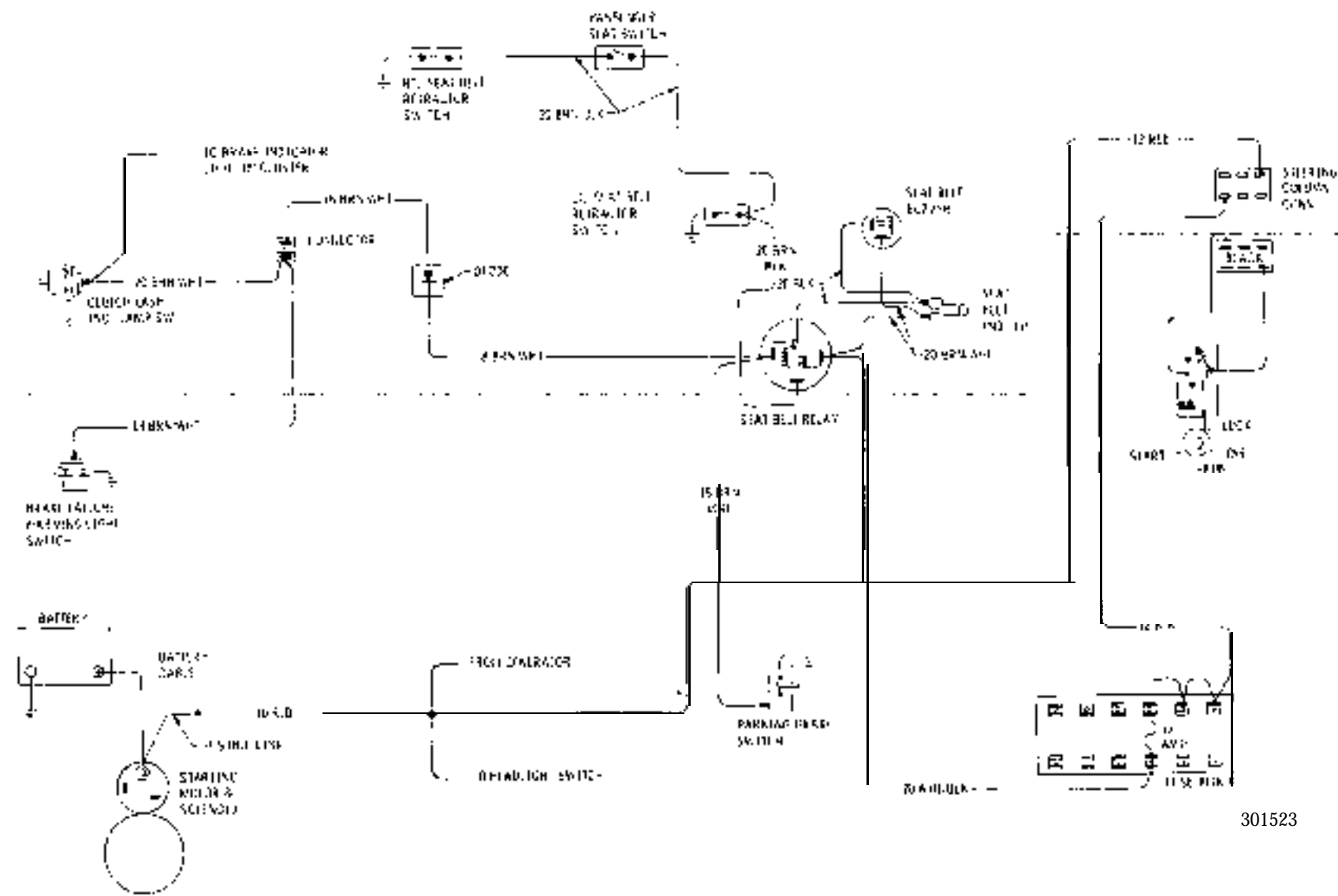
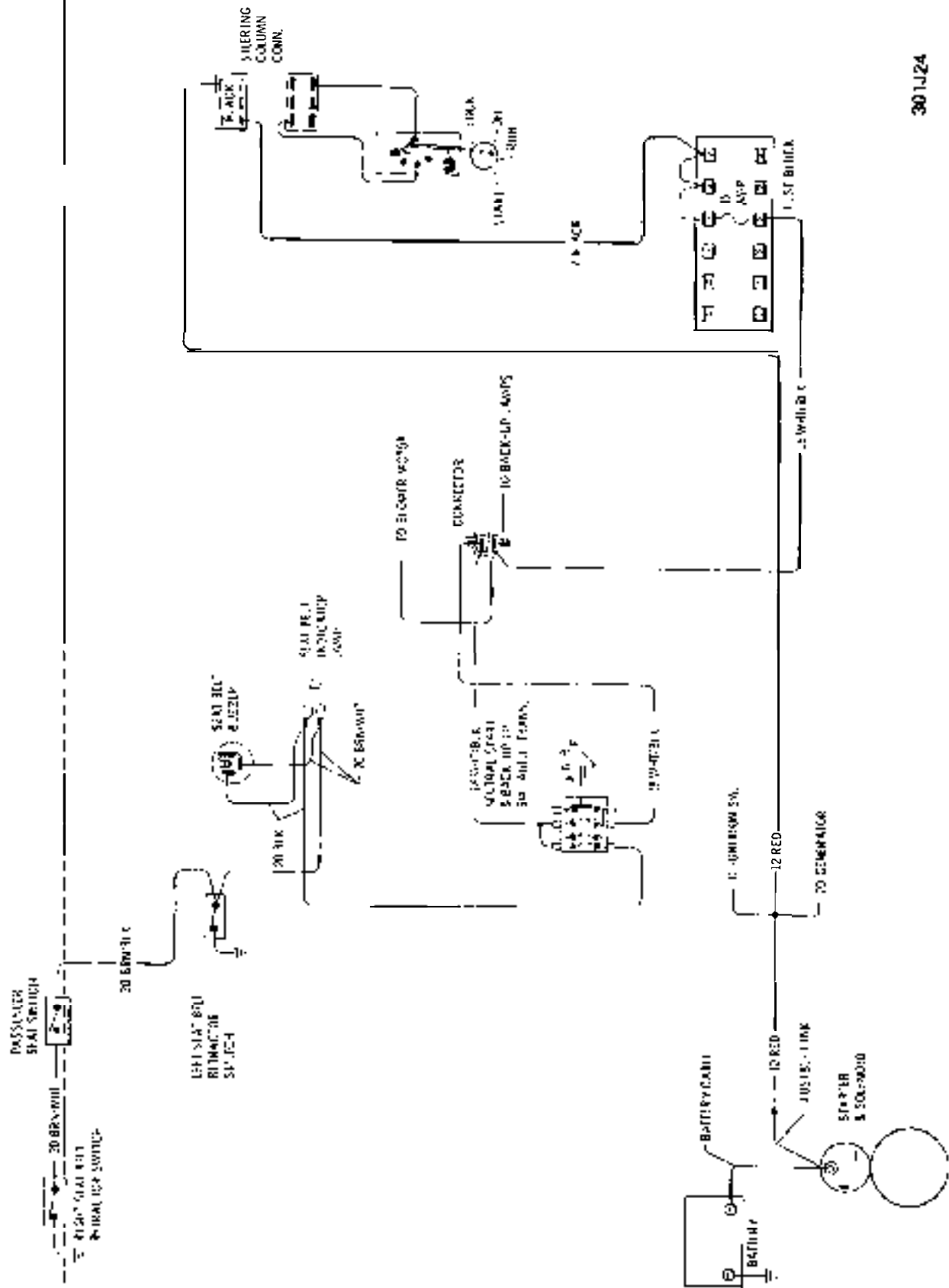


Figure 1J-22 A/C Generator and Regulator -All Models



301523

Figure 1.1.23 Seat Belt Warning System (Manual Transmission) Opel 1900 - Monza



301J24

Figure 1 J-24 Seat Belt Warning System (Automatic Transmission) Opel 1900 Manta

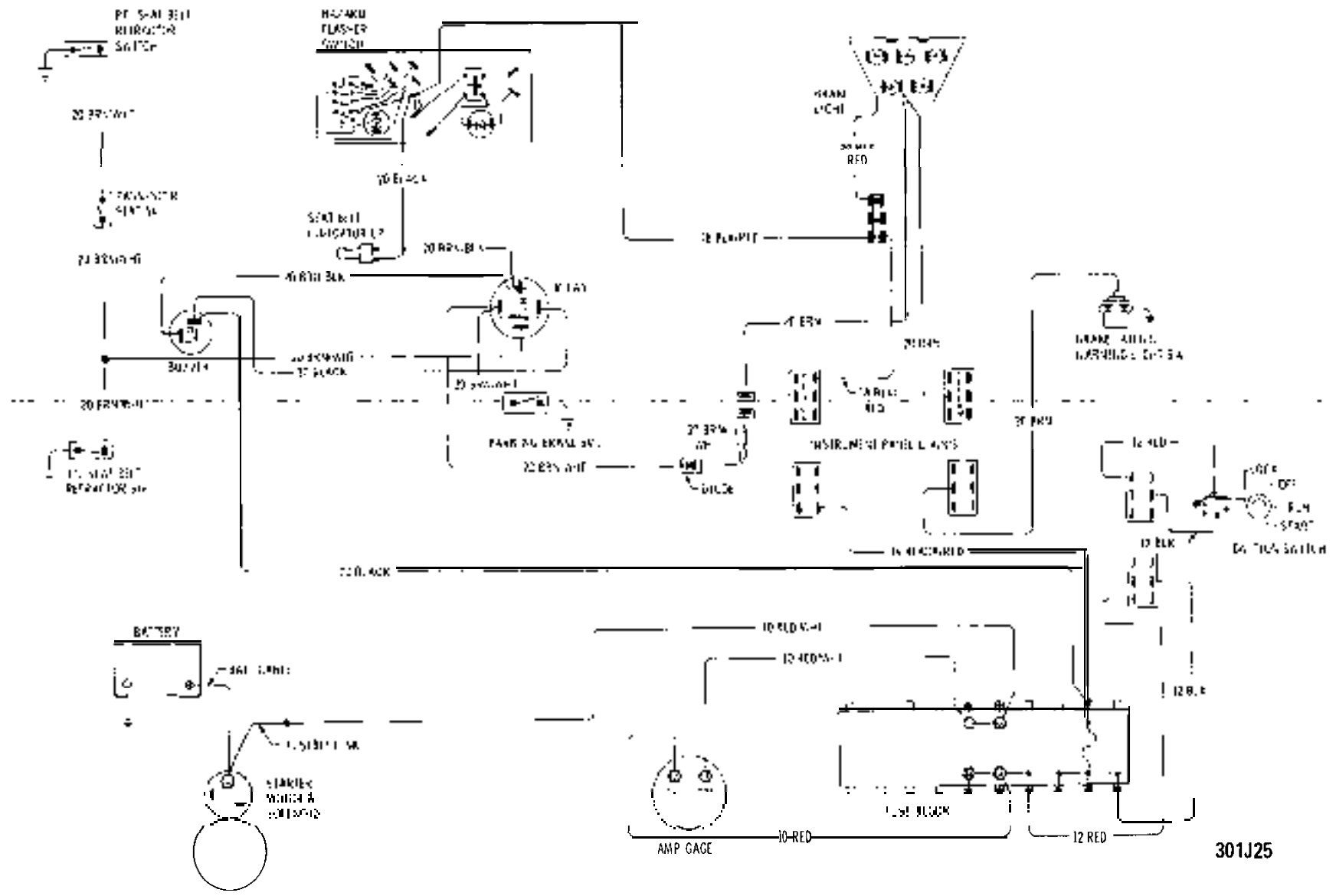
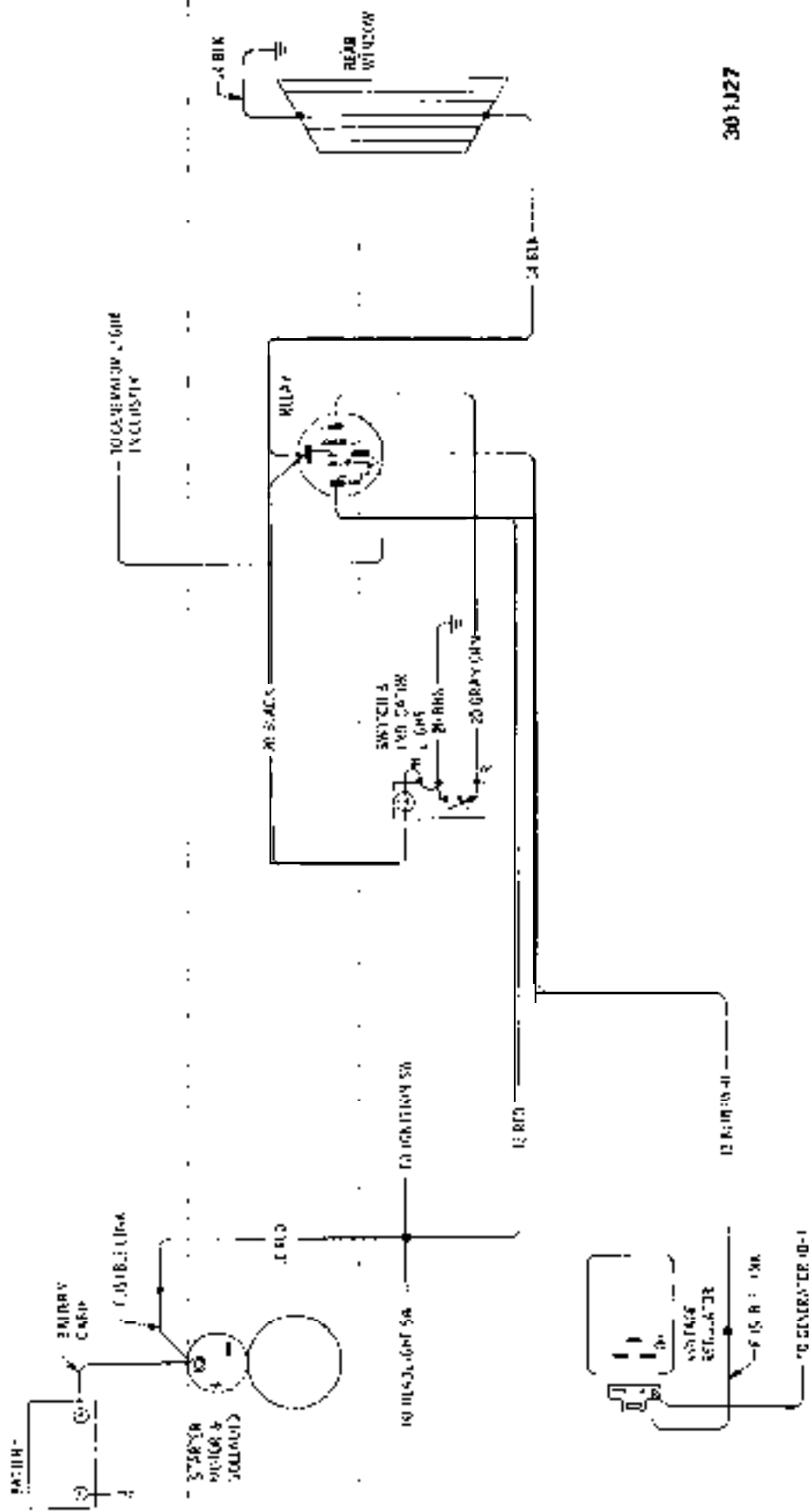


Figure 1.1.25 Sebel Belt Warning System (Manual Transmission) GT

301J25







301J27

Figure 1 J-27 Heated Rear Glass · Opel 1900 · Manta

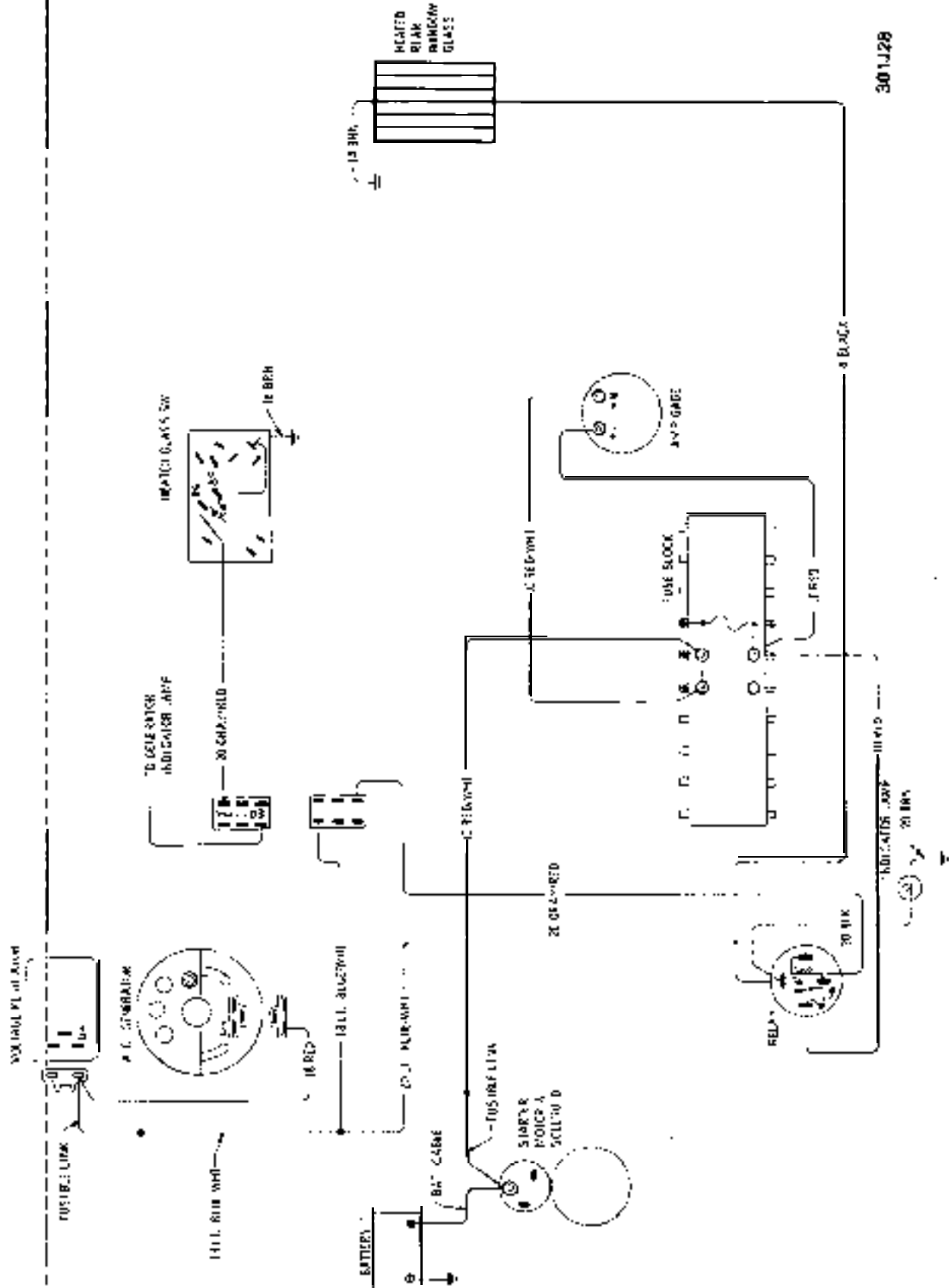


Figure 1J.2B Heated Rear Glass - GT



---

**GROUP 2**

**BODY  
AND  
BUMPERS**

<b>Section</b>	<b>Title</b>	<b>Page No.</b>
<b>2A</b>	<b>General Information</b>	<b>2A- 2</b>
<b>2B</b>	<b>Frame and Body Mountings .....</b>	<b>2B- 6</b>
<b>2 C</b>	<b>Windows and Window Moldings</b>	<b>2C- 9</b>
<b>2D</b>	<b>Doors .....</b>	<b>2D-13</b>
<b>2E</b>	<b>Rear Compartment Lid</b>	<b>2E-22</b>
<b>2F</b>	<b>Roof and Sun Roof</b>	<b>2F-24</b>
<b>2G</b>	<b>Seats, Interior Trim and Headlining</b>	<b>2G-33</b>
<b>2H</b>	<b>Bumpers .....</b>	<b>2H-38</b>

# GENERAL INFORMATION

## CONTENTS

Subject	Page No.
DESCRIPTION AND OPERATION: (Not Applicable)	
DIAGNOSIS: (Not Applicable)	
MAINTENANCE AND ADJUSTMENTS:	
Paint Maintenance .....	2A-2
Chrome Maintenance .....	2A-2
Stain Removal .....	2A-2
MAJOR REPAIR: (Not Applicable)	
SPECIFICATIONS:	
Bolt Torque Specifications .....	2A-4
Special Body Tools .....	2A-5

## MAINTENANCE AND ADJUSTMENTS

### PAINT MAINTENANCE

To remove heavy concentrations of road dirt and grime, it is recommended that the car be washed using an automotive shampoo or mild soap, and cold to lukewarm water. Use of harsh soaps or detergents is not advised. In areas where salt is used on the roads during the winter months, more frequent **washing** is recommended.

Use of cleaners and polishes are required if no high luster is obtainable by waxing. To protect the paint finish, sparingly apply several coats of wax. Each coat should be thoroughly rubbed to remove any surplus wax.

Once the car is properly waxed, road dirt may easily be removed by use of cold to lukewarm water and a sponge. Dry by use of a chamois.

### CHROME MAINTENANCE

Chrome parts should be washed with water and a mild detergent. If rust or salt corrosion should appear, they may be removed with Buick Rust Eraser or equivalent. Do not use scouring powders or stiff brushes.

## STAIN REMOVAL

Before attempting to remove spots or stains from upholstery fabrics, determine as accurately as possible: (1) Nature and age of the spot or stain. (2) The affect of stain removing agents on the color, structure and general appearance of the fabric.

For best results, stains should be removed from upholstery as soon as possible after they have been made. If they are allowed to stand for some time, they often become set, and removal becomes more **difficult** and frequently impossible.

There are three basic types of acceptable cleaners available to car owners: (1) Volatile cleaners, (2) Synthetic detergents, (3) Neutral soap (non-alkaline).

The volatile cleaners are recommended since they have great solvent powers for grease, oils and general road grime. Synthetic detergents generally loosen stains satisfactorily, however, the use of improper type detergents (containing **bleach**) involves risk of damage to the color or finish of fabrics.

### Precautions For Cleaning Fabrics

**Do** not use laundry soap or detergents containing **bleaches**. The use of these agents tends to weaken fabric and to change its color. **Do not use** too much cleaning fluid. Some interior trim assemblies are **pad-**

ded with rubber, and volatile cleaners are generally solvents for rubber. The application of too much cleaner may destroy these rubber pads. **Do not use** volatile cleaners on vinyl coated fabrics.

#### Procedure For Cleaning Vinyl Fabrics With Synthetic Detergents

1. Make a solution of the synthetic detergent in lukewarm water, working up a thick, frothy suds.
2. With a clean cloth or sponge, dampened with lukewarm water, apply suds only to the surface of the upholstery using light to medium pressure, repeating several times, applying more suds with a clean portion of the cloth or sponge.
3. With a second clean cloth, dampened with lukewarm water, rub over the area with medium pressure to remove excess detergent and loose material.
4. With a clean dry cloth, wipe off all excess moisture. A vacuum cleaner may also be used.
5. Allow the upholstery to dry partially; then repeat the above treatment if necessary to remove stain.
6. When the upholstery is satisfactorily cleaned, allow to dry completely before using.

#### Instructions for the Removal of Specific Stains From Automotive Upholstery Materials

Some types of stains and **soilage**, including blood, ink, chewing gum, etc., require special consideration for satisfactory results. For **these**, and other stains, specific instructions are outlined in succeeding paragraphs. It must be expected, particularly where water treatment is specified, that discoloration and finish disturbance may occur. In some cases fabric disturbance may be considered preferable to the stain itself. By following the procedures outlined below, reasonably satisfactory results can be expected.

1. **Battery Acids.** Apply ordinary household ammonia water with a brush or cloth to the affected **area**, saturating it thoroughly. Permit the ammonia water to remain on the spot about a minute, so that it will have ample time to neutralize the acid. Then rinse the spot by rubbing with a clean cloth saturated with cold water.

This treatment will suffice for both old and new stains. However, no type of treatment will repair **damage to fibers** resulting from the **action** of the acids on the **fibers** particularly after the spot has dried.

2. **Blood.** Do not use hot water or soap and water

on blood stains since they will set the stain, thereby making its removal practically impossible.

Rub the stain with a clean cloth saturated with cold water until no more of the stain will come out. Care must be taken so that clean portions of **cloth** are used for rubbing the stain.

This treatment should remove all of the stain. If it does not, apply a small amount of household ammonia water to the stain with a cloth or brush. After a lapse of about one minute, continue to rub the stain with a clean cloth dipped in clear cold water.

If the stain remains after the use of water and ammonia, a thick paste of corn starch and cold water may be applied to the stained area. Allow the paste to remain until it has dried and absorbed the stain. Then pick off the dry starch. Brush the surface to remove starch particles that remain. For heavy stains, several applications of starch paste may be necessary.

3. **Candy.** Candy stains, other than candy containing chocolate, can be removed by rubbing the affected area with a cloth soaked with very hot water. If the stain is not completely removed, rub area lightly (after drying) with a cloth wet with a volatile cleaner. This will usually remove the stain.

Candy stains resulting from cream and fruit-filled chocolates can be removed more easily by rubbing with a cloth soaked in lukewarm soap-suds (mild neutral soap) and scraping, while wet, with a dull knife. This treatment is followed with a rinsing by rubbing the spot with a cloth dipped in cold water.

Stains resulting from chocolate or milk chocolate can be removed by rubbing the stain with a cloth wet with lukewarm water. After the spot is dry, rub it lightly with a cloth dipped in a volatile cleaner.

4. **Chewing Gum.** Harden the gum with an ice cube, and scrape off particles with a dull knife. If gum cannot be removed completely by this method, moisten it with a volatile cleaner and work it from the fabric with a dull knife, while gum is still moist.

5. **Fruit, Fruit Stains, Liquor and Wine.** Practically all fruit stains can be removed by treatment with very hot water. Wet the stain well by applying hot water to the spot with a clean cloth. Scrape all excess pulp, if present, off the fabric with a dull knife; then rub vigorously with a cloth wet with very hot water. If the stain is very old or deep, it may be necessary to pour very hot water directly on the spot, following this treatment with the scraping and rubbing. Direct application of hot water to fabrics is not recommended for general use since discoloration usually results.

If the above treatments do not remove stain, allow

fabric to dry thoroughly; then rub lightly with a clean cloth dipped in a volatile cleaner. This is the only further treatment recommended.

Soap and water are not recommended since they will probably set the stain and cause a permanent discoloration. Drying the fabric by means of heat (such as the use of an iron) is not recommended.

6. Grease and *Oil*. If grease has been spilled on the material, as much as possible should be removed by scraping with a dull knife or spatula before further treatment is attempted.

Grease and oil stains may be removed by rubbing lightly with a clean cloth saturated with a volatile cleaner. Be sure all motions are toward the center of the stained area to decrease the possibility of spreading the stain.

7. Ice *Cream*. The same procedure is recommended for the removal of ice cream stains as that used in removing fruit stains.

If the stain is persistent, rubbing the spot with a cloth wet with soap suds (mild neutral soap) may be used to some advantage after the initial treatment with hot water. This soap treatment should be followed with a rinsing, by rubbing with a clean cloth wet with cold water. After this dries, rubbing lightly with a cloth wet with volatile cleaner will clear up the last of the stain, by removing fatty or oily matter.

8. *Vomit*. Sponge with a clean cloth, dipped in clear cold water. After most of the stain has been removed in this way wash lightly with soap (mild neutral), using a clean cloth and lukewarm water. Then rub with another clean cloth dipped in cold water. If any of the stain remains after this treatment, gently rub clean with a cloth moistened with a volatile cleaner.

9. *Shoe Polish and Dressings*. On types of shoe dressing which contain starch or dextrine or some water soluble vehicle, allow the polish to dry; then brush the spot vigorously with a brush. This will probably be all the treatment that is necessary. If further treatment is required moisten the spot with cold water and after it has dried, repeat the brushing operation.

Paste or wax type shoe polishes may require using a volatile cleaner. Rub the stain gently with a cloth wet with a volatile cleaner until the polish is removed. Use a clean portion of the cloth for each rubbing operation and rub the stained area from outside to center.

10. Tar. Moisten the spot lightly with a volatile cleaner, and then remove as much of the tar as possible with a dull knife. Follow this operation by rubbing the spot lightly with a cloth wet with the cleaner until the stain is removed.

II. *Urine*. Sponge the stain with a clean cloth saturated with soap suds (mild neutral soap) and rinse well by rubbing the stain with a clean cloth dipped in cold water. Then saturate a clean cloth with a solution of one part household ammonia water and five parts water. Apply the cloth to the stain and allow solution to remain on affected area for one minute; then rinse by rubbing with a clean wet cloth.

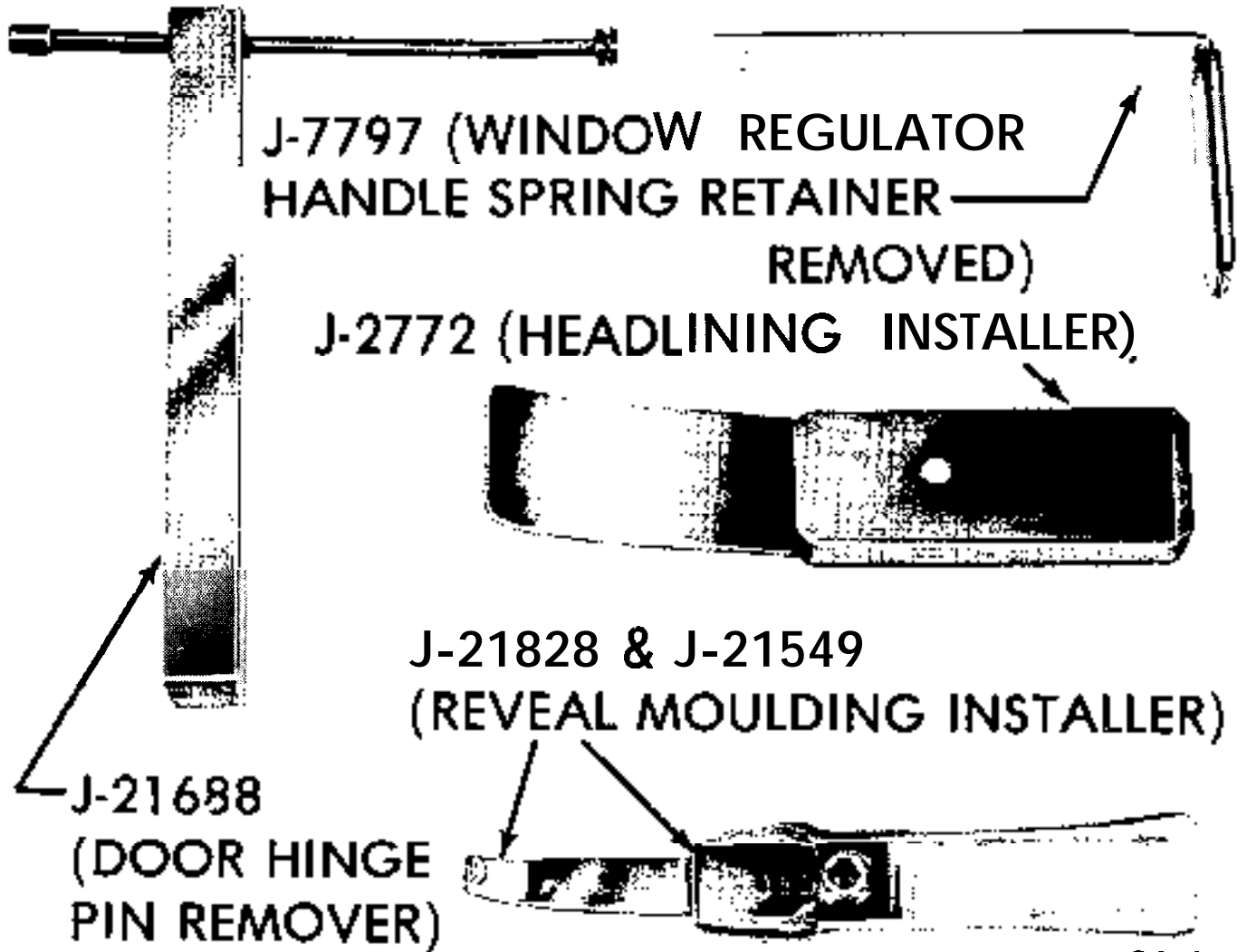
I.?. *Lipstick*. The compositions of different brands of lipsticks vary, making the stains very difficult to remove. In some instances a volatile cleaner may remove the stain. If some stain remains after repeated applications of the volatile cleaner, it is best to leave it rather than try other measures.

## SPECIFICATIONS

### BOLT TORQUE SPECIFICATIONS

Location	Torque Lb.Ft.
Door Striker to Pillar Post	14-18
<b>Front Seat Attachment to Floor</b> .....	<b>13-16</b>
Seat and Shoulder Belt Anchor Attachment .....	36-46
Stationwagon Tailgate Hinge to Body .....	<b>13-16</b>
Stationwagon Tailgate Hinge to Door .....	13-16
Stationwagon Striker Plate on <b>Body</b> .....	3-4
Stationwagon Latch Hook on <b>Body</b> .....	<b>13-16</b>
Stationwagon Latch on Door .....	3-4

SPECIAL BODY TOOLS





# OPEL 1900, MANTA AND GT FRAME AND BODY MOUNTINGS

## CONTENTS

Subject	Page No.
DESCRIPTION AND OPERATION: (Not Applicable)	
DIAGNOSIS: (Not Applicable)	
MAINTENANCE AND ADJUSTMENTS: (Not Applicable)	
MAJOR REPAIR: (Not Applicable)	
SPECIFICATIONS:	
Frame and Body Mounting Specifications .....	2B-6

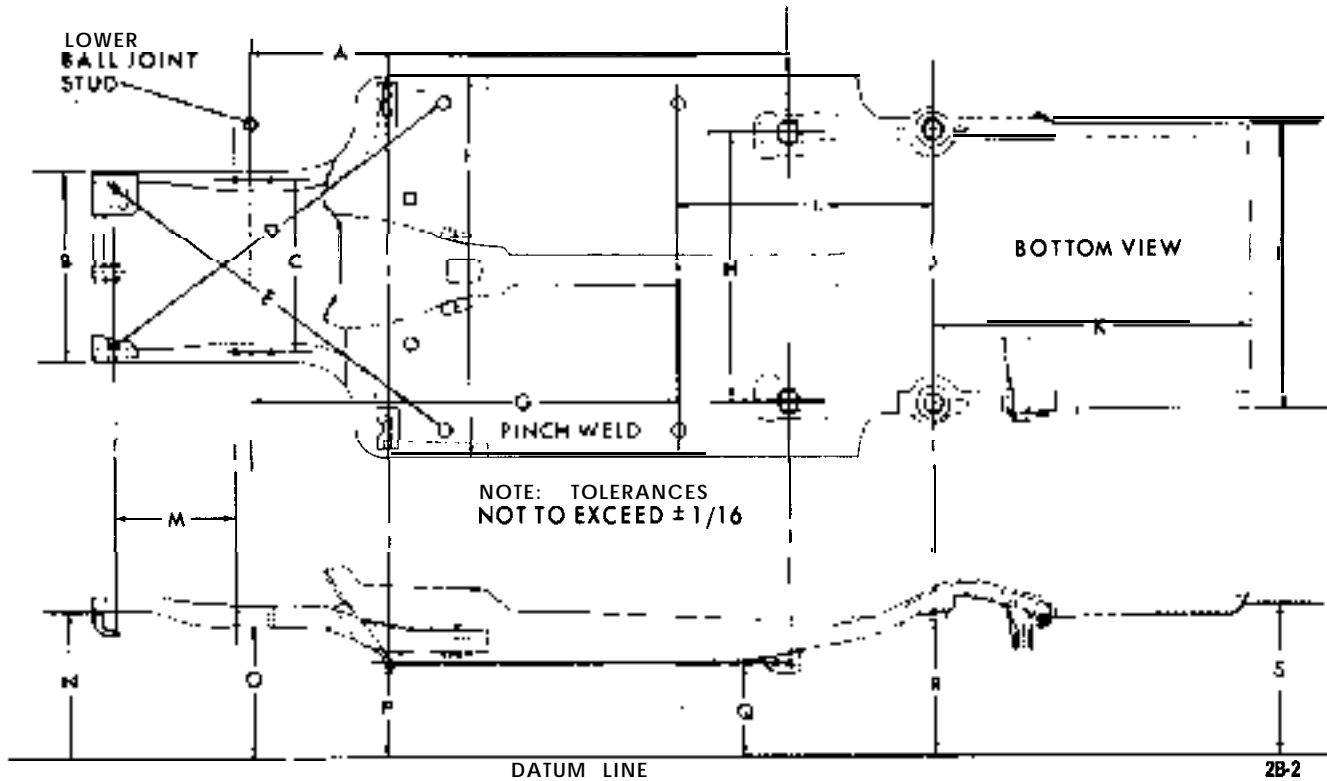


Figure 2B-2 GT Frame Details

## GT FRAME MEASUREMENTS

A	72"	From centerline of lower ball joint stud to centerline of front lower arm bushing.
B	25-1/4"	Outside of left frame horn to outside of right frame horn.
C	22-3/4"	Centerline of front crossmember right attaching bolt holes to centerline of front crossmember left attaching bolt holes.
D	50-5/16"	From centerline of hole in radiator support to right front frame horn reinforcement to centerline of left front underbody drain hole.
E	50-5/16"	From centerline of hole in radiator support to left front frame horn reinforcement to centerline of right front underbody drain hole.
F	49-7/8"	From rear outside edge of right front frame rail to rear outside edge of left front frame rail.
G	59-1/8"	From centerline of lower ball joint stud to centerline of second side drain hole.
H	35-3/4"	Centerline of right lower control arm to centerline of left lower control arm.
I	32"	Centerline of second side underbody drain hole to centerline of rear spring seat.
J	36-1/8"	Centerline of right spring seat to centerline of left spring seat.
K	28-19/32"	Centerline of spring seat to bumper bracket bolt hole on outside of lower tail panel.
L	39-1/8"	Outside edge of right rear frame rail to outside edge of left rear frame rail.
M	15-7/8"	Centerline of radiator support bolt hole to centerline of front crossmember front attaching bolt holes.
N	12-2/32"	Lower edge of front frame horn to datum line.
O	10-3/4"	Frame rail mating surface for front crossmember to datum line.
P	6"	Front portion of underbody to datum line.
Q	6"	Rear portion of underbody to datum line.
R	11-5/16"	Center of spring seal to datum line.
S	16-1/4"	Centerline of rear bumper bracket to lower tail panel bolt to datum line.

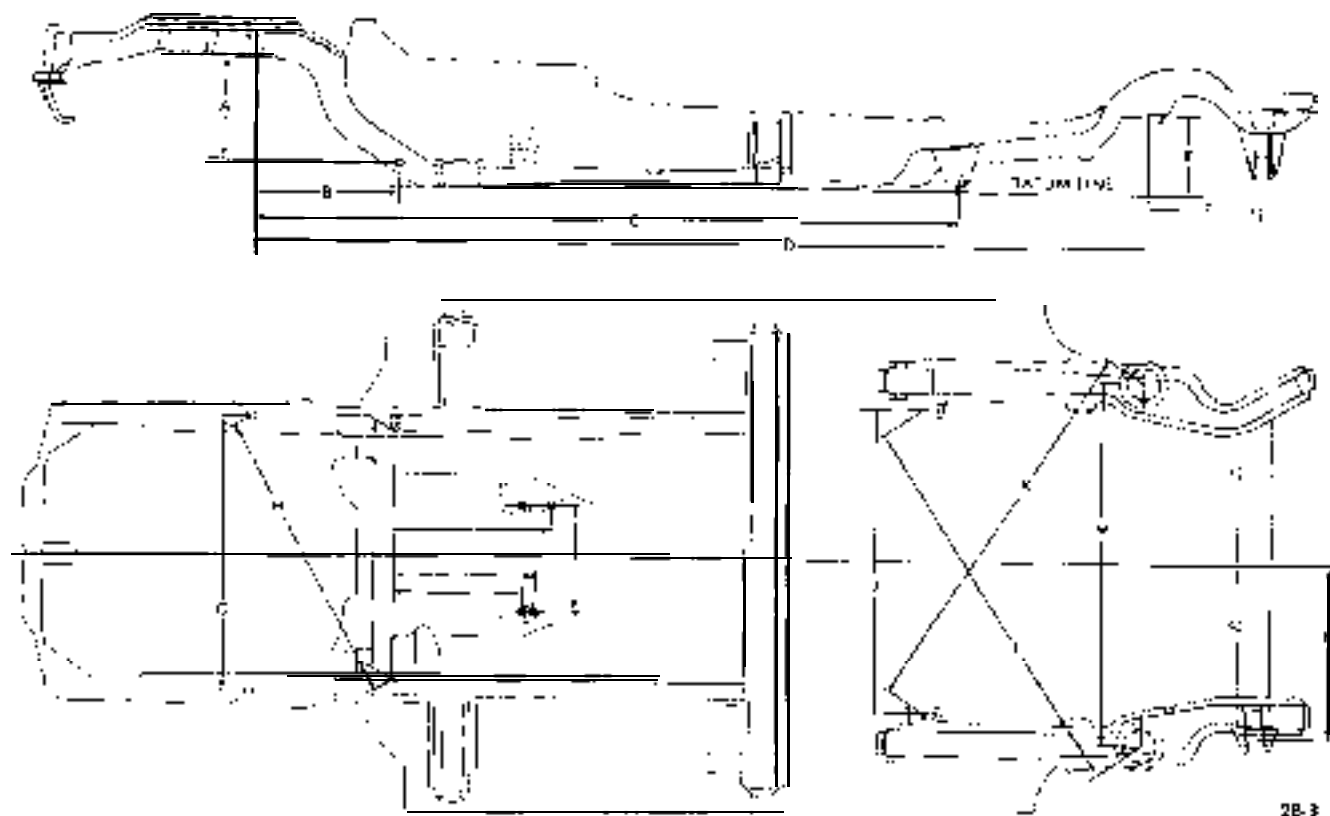


Figure 2B-3 Opel 1900 Manta Frame Details

**1900 — MANTA 1900 — MANTA FRAME MEASUREMENTS**

A	10-9/16"	Mating surface of frame rail to horizontal line from center of front crossmember to frame support bolt hole.
B	14-9/16"	Centerline of front crossmember attaching bolt hole to centerline of front crossmember to frame support bolt hole.
C	71-7/16"	Centerline of front crossmember attaching bolt hole to center of lower control arm to frame bolt hole.
D	90-1/2"	Centerline of front crossmember attaching bolt hole to center of rear spring seat.
E	8-3/16"	Rear spring seat to datum line.
F	11-5/8"	Center of spring seat to center of track rod to body attaching bolt hole.
G	27-9/16"	Centerline of front crossmember right attaching bolt hole to centerline of front crossmember left attaching bolt hole.
H	30"	Centerline of right front frame bolt hole to centerline of left front crossmember to frame support bolt hole (inboard side of frame rail).
I	24-3/4"	Distance between frame rails at front crossmember to frame support bolt holes.
J	30-9/16"	Centerline to centerline of torque tube support to frame bolt holes.
K-L	38-1/2"	Center of spring seat to center of torque tube support to frame bolt hole (inboard side of frame).
M	36-3/8"	Centerline of right spring seat to centerline of left spring seat.
N	17-5/16"	Centerline of car to centerline of track rod to body attaching bolt.

# WINDOWS AND WINDOW MOLDINGS

## CONTENTS

Subject	Page No.
DESCRIPTION AND OPERATION: (Not Applicable)	
DIAGNOSIS: (Not Applicable)	
MAINTENANCE AND ADJUSTMENTS: (Not Applicable)	
MAJOR REPAIR:	
Removal and Installation	
Windshield Reveal Molding .....	2C- 9
Windshield and Back Window .....	2C-10
Door Window .....	2C-11
Rear Quarter Window Molding .....	2C-11
Rear Quarter Window · 1900 · Manta .....	2C-12
Rear Quarter Window · GT .....	2C-12
Rear Quarter Window Lock .....	2C-12
SPECIFICATIONS: (Not Applicable)	

### MAJOR REPAIR

#### REMOVAL AND INSTALLATION OF WINDSHIELD REVEAL MOLDING

1. Remove reveal molding escutcheon. Starting at one end, pull molding out of rubber channel. See Figure 2C-2.

2. Prior to installation, place molding in water and heat up to approximately 113 • 122 degrees F.

3. With Tools J-2 1828 and J-2 1549, insert new reveal molding and install escutcheon.

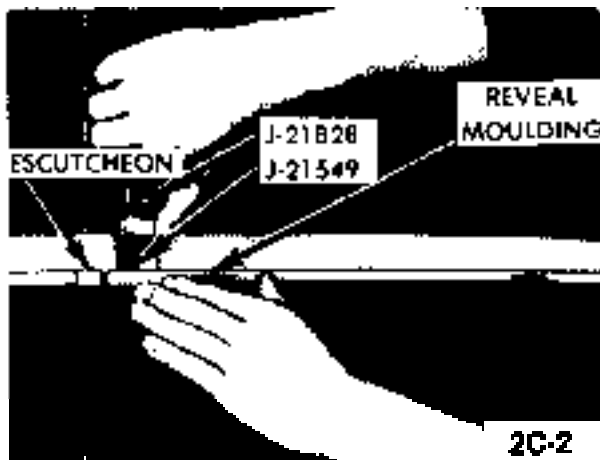


Figure 2C-2 Removing Reveal Molding

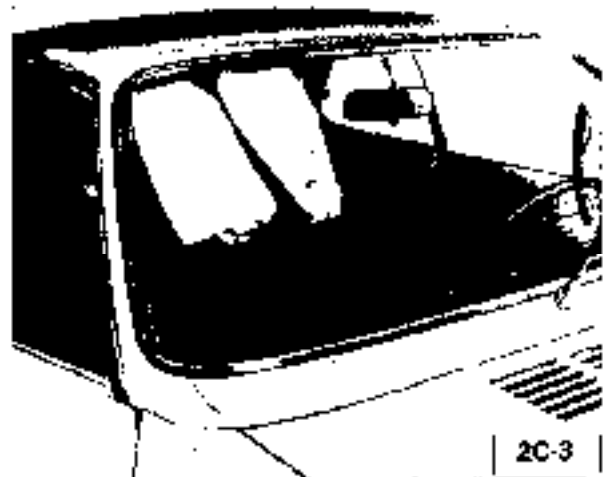


Figure 2C-3 Pushing Windshield Out

**REMOVAL AND INSTALLATION OF WINDSHIELD OR BACK WINDOW-WINDSHIELD SHOWN**

1. Flap back windshield wiper arms,
2. Beginning at one end, pull molding out of rubber channel.
3. Beginning at one corner, push out windshield together with rubber channel. See Figure 2C-3.

4. Place new windshield on glass holding fixture and fit new rubber channel. See Figure 2C-4.
5. Insert a thick string into large sealing lip of rubber channel so that both ends are crossed at bottom center of windshield. See Figure 2C-5.
6. With a sealer gun, coat outside of pinchweld flange with sealing compound. See Figure 2C-6.



Figure 2C-4 Fitting Rubber Channel on Windshield

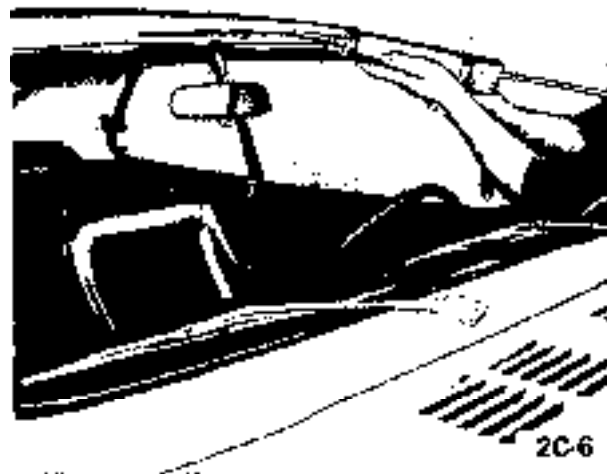


Figure 2C-6 Applying Sealer on Pinchweld Flange

7. Place windshield in body opening and, with inserted string, pull rubber channel lip over pinchweld flange, always tapping windshield from outside with a striking pad. See Figure 2C-7.

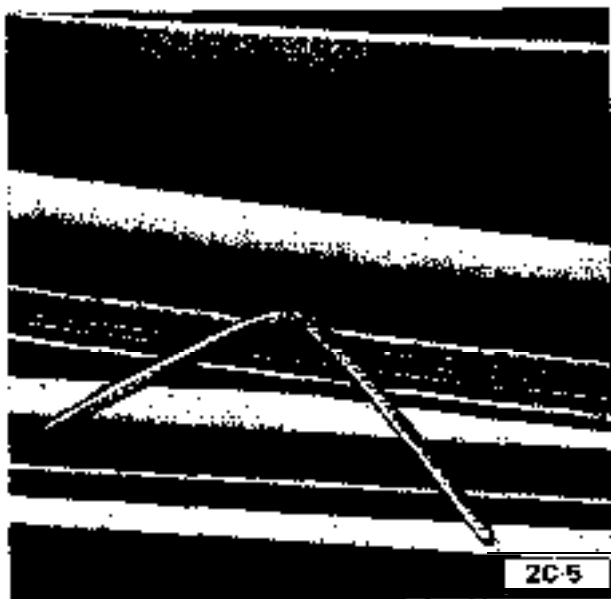


Figure 2C-5 String Inserted Into Rubber Channel

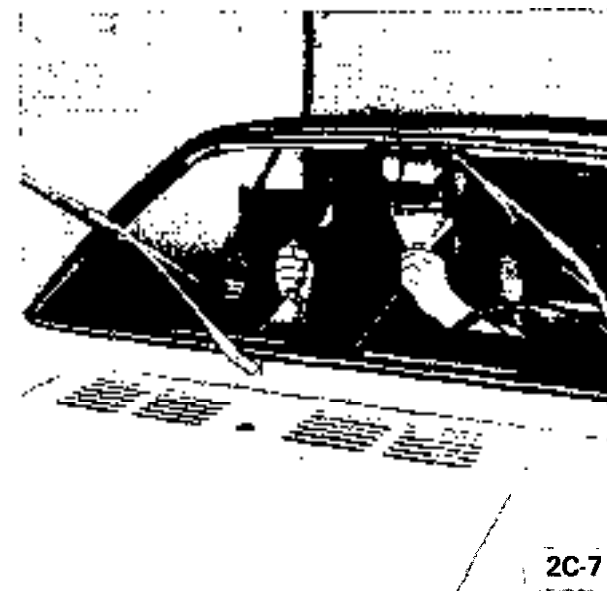


Figure 2C-7 Pulling Rubber Channel Lip Over Pinchweld Flange

8. With a sealer gun, apply window sealing compound between outside of windshield and rubber channel. See Figure 2C-8.



Figure 2C-8 Applying Sealing Compound Outside of Windshield

**REMOVAL AND INSTALLATION OF FRONT DOOR SASH WINDOW**

1. Remove and install door trim pad.
2. Remove and install lock knob.

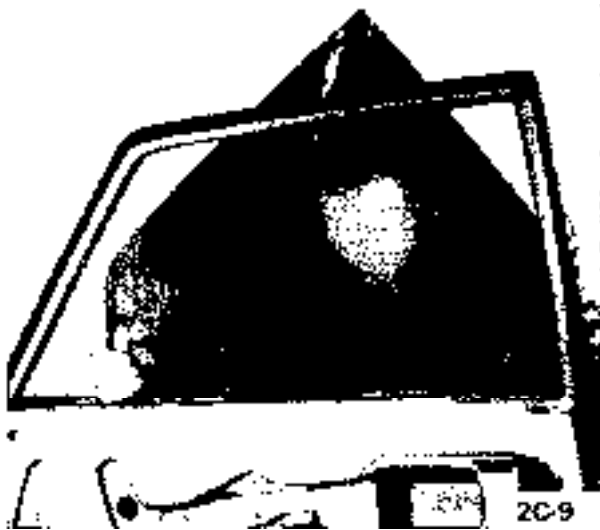


Figure 2C-9 Removing Glass

3. Remove and install door inside handle.
4. Remove and install door **belt reveal** molding.
5. Scribe position of window lifter guide rail screws.
6. For unscrewing window lifter guide rail, block sash window or support it with the hand.
7. Tilt window and take it out of door. See Figure 2C-9.

**REMOVAL AND INSTALLATION OF ORNAMENTAL BAR AT THE REAR QUARTER WINDOW**

**Removal**

1. Unscrew chromed molding and remove rear quarter window. See Figure 2C-10.

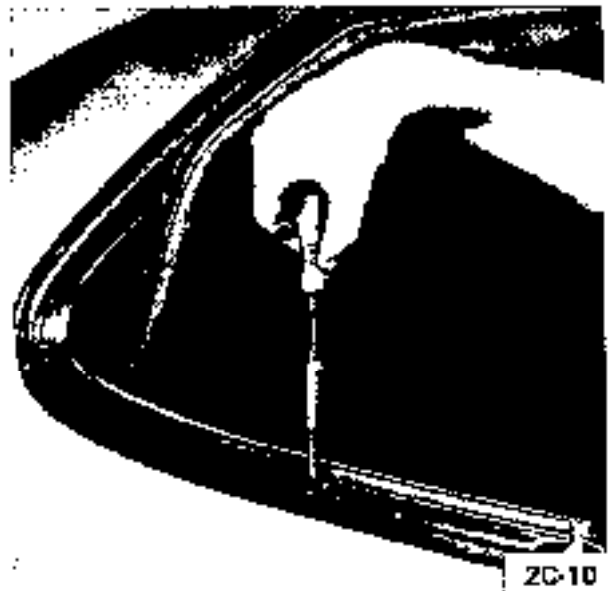


Figure 2C-10 Removing Chromed Molding

2. In the area of the rear quarter window, pull weatherstrip out of metal profile and remove sealing strip.
3. Unscrew metal profile and remove ornamental bar.

**Installation**

1. Install ornamental bar and fasten metal profile.
2. Install sealing strip and weatherstrip into metal profile.

3. Install quarter window and fasten chromed molding. See Figure 2C-10.

**REMOVAL AND INSTALLATION OF REAR QUARTER WINDOW OPEL 1900. MANTA**

1. Unscrew rear quarter window lock. See Figure 2C-11.

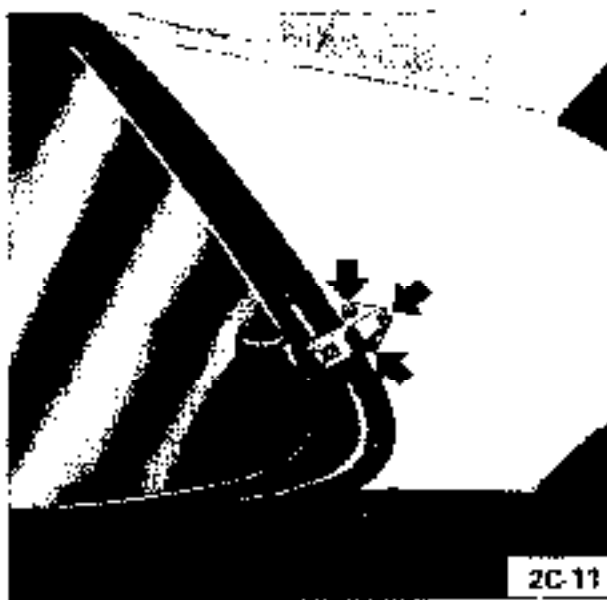


Figure 2C-11 Quarter Window Lock Attaching Screws

2. Unscrew window hinge from lock pillar while holding window. See Figure 2C-12.

3. On installation, seal hinges with a plastic compound.



Figure 2C-12 Quarter Window Hinge Attaching Screws

4. Carefully push rail off window. On rear quarter window lock, drill off pin and unscrew retainer from window. See Figure 2C-13.

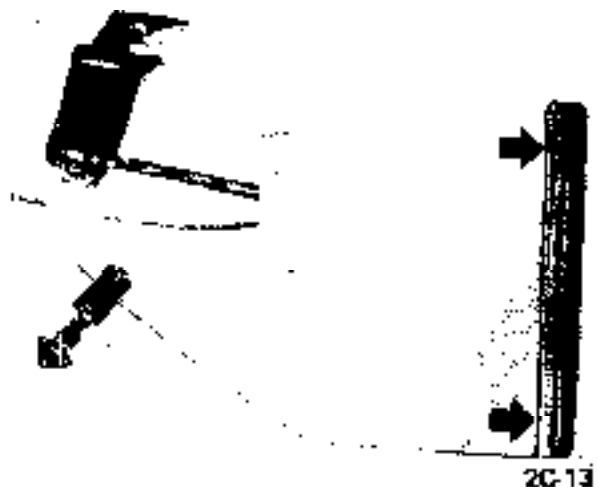


Figure 2C-13 Drilling Off Quarter Window Lock Pin

**REMOVAL AND INSTALLATION OF HINGED REAR QUARTER WINDOW - GT**

**Removal**

1. Remove three screws securing lock to rear quarter pillar. See Figure 2C-14. Swing window outward and lift off rear quarter window. Care should be taken that window does not fall off pivots when swung outward.

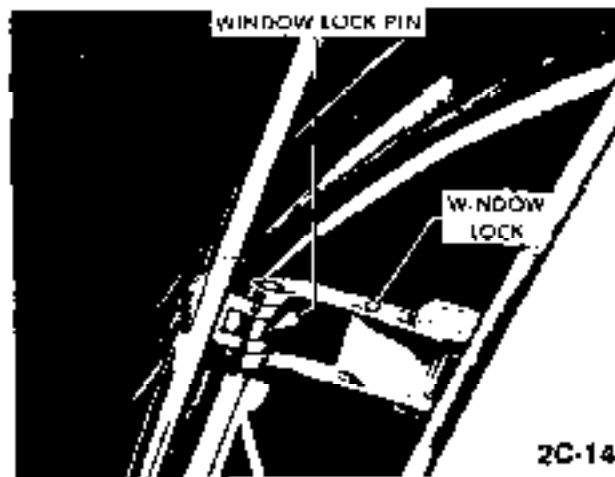


Figure 2C-14 Rear Quarter Pillar Lock - GT

2. Remove frame from glass

**Installation**

1. Install frame to glass.
2. Install lock to rear quarter pillar, **securing** with three (3) screws.

# DOORS

## CONTENTS

Subject	Page No.
<b>DESCRIPTION AND OPERATION: (Not Applicable)</b>	
<b>DIAGNOSIS: (Not Applicable)</b>	
<b>MAINTENANCE AND ADJUSTMENTS: (Not Applicable)</b>	
<b>MAJOR REPAIR:</b>	
<b>Front Door - Removal and Installation</b>	
Door Lock Striker .....	2D-13
Window Regulator Handle .....	2D-13
Trim Pad .....	2D-13
Door Handle . Inside .....	2D-15
Reveal Molding .....	2D-15
Window Lifter .....	2D-15
Door Lock Cylinder .....	2D-17
Weatherstrip .....	2D-18
Door .....	2D-18
<b>Rear Door - Removal and Installation</b>	
Sash Window .....	2D-19
Window Regulator .....	2D-20
Tail Gate .....	2D-21
Door .....	2D-21
<b>SPECIFICATIONS:</b>	

### MAJOR REPAIR

#### REMOVAL AND INSTALLATION OF DOOR LOCK STRIKER

1. Mark position of old striker on lock pillar and unscrew striker, using Tool J-23659. See Figure 2D-2.
2. Place new striker in installation position and temporarily tighten striker, observing marking on lock pillar. Close door and check whether this can be done without exerting any force. If this is not the case, adjust striker accordingly.
3. Tighten attaching screws, using Tool J-23659, and check for proper operation.

#### REMOVAL AND INSTALLATION OF WINDOW REGULATOR HANDLE

1. Insert Tool J-7797 between handle and nylon disc. See Figure 2D-3.
2. With the two fork-shaped ends of the tool, slide lock spring outwards. See Figure 2D-4.
3. Place lock spring of new handle in installation position and install it onto window regulator shaft.
4. With the window in closed position, the window regulator handle should point upwards towards the front at an angle of approximately 45 degrees.

#### REMOVAL AND INSTALLATION OF FRONT DOOR TRIM PAD

1. Remove window regulator handle.





Figure 2D-2 Door Striker



Figure 2D-4 Position of Tool on Slide Lock Spring

2. Remove door inside handle escutcheon.
3. Remove lock knob.
4. Remove arm rest. See Figure 2D-5.

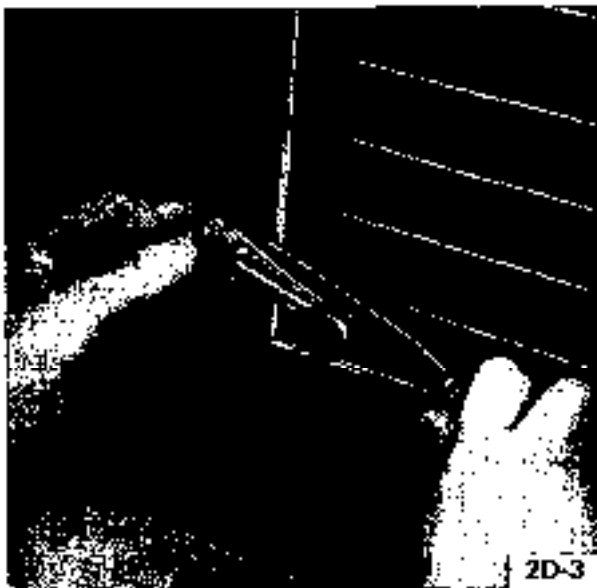


Figure 2D-3 Inserting Tool Between Handle and Nylon Disc

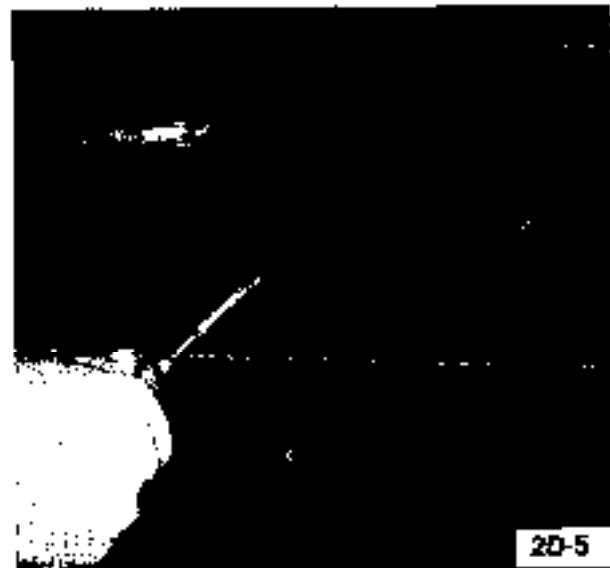


Figure 2D-5 Removing Arm Rest

5. Remove door trim pad.
6. Prior to installation of trim pad, make sure that

the water deflector foil is inserted in lower door slot. See Figure 2D-6. Reverse procedure for installation.



Figure 2D-6 Installing Water Deflector

#### REMOVAL AND INSTALLATION OF FRONT DOOR INSIDE HANDLE WITH SUPPORT

1. Remove door trim pad.
2. Unscrew support and unhook connecting rod out of door lock. See Figure 2D-7.

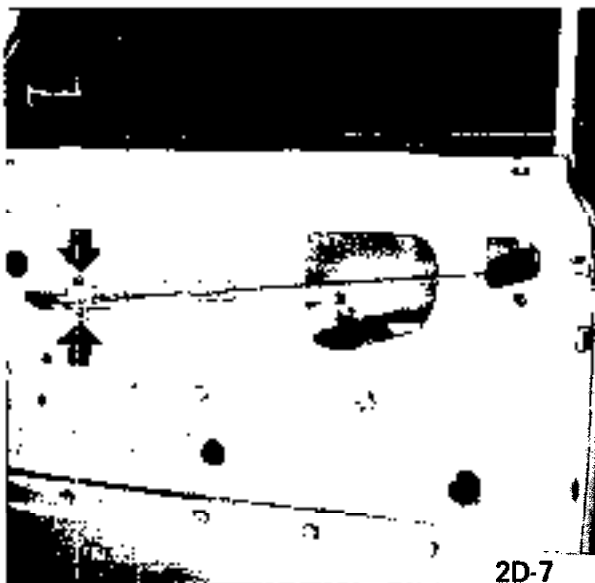


Figure 2D-7 Removing Support

3. Unhook connecting rod out of old support and hook into new support and door lock.

4. Screw support onto door inner panel so that it can be shifted in both holes. Adjust remote control so that the connecting rod has a clearance at the door lock of .02 inch (0.5 mm).

5. Tighten support to door inner panel.

6. Install door trim pad

#### REMOVAL AND INSTALLATION OF FRONT DOOR BELT REVEAL MOLDING

1. Bend up ends of molding.
2. With a wooden wedge, pry off molding towards the top. See Figure 2D-8.

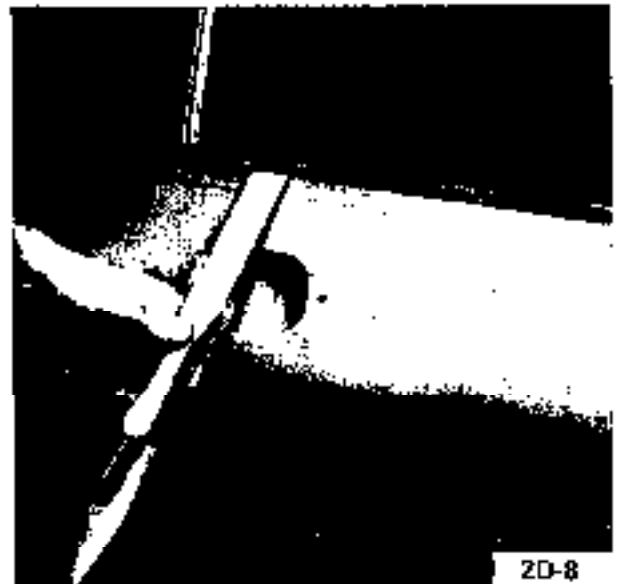


Figure 2D-8 Removing Molding

3. Check retaining clamps in outer door panel for proper position and tight seat. Push new molding onto retaining clamps and bend both ends inwards.

#### REMOVAL AND INSTALLATION OF FRONT DOOR WINDOW LIFTER

Removal

1. Remove door trim pad.

2. Remove door lock knob.
3. Remove door inside handle.
4. Adjust sash window so that the main lever with toothed segment are in alignment with the front retaining plate. See Figure 2D-9.

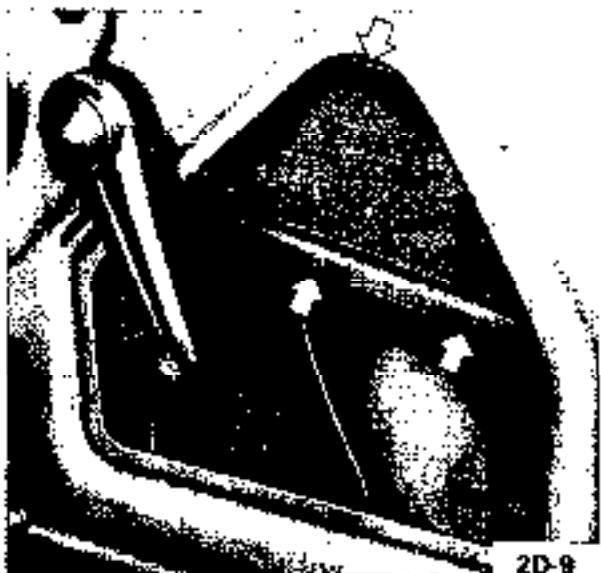


Figure 2D-9 Aligning Main Lever With Front Retaining Plate

5. On Models 57, 57L and 57R, scribe position of screw at the plastic support of window rail and unscrew.
6. Block sash window in door interior.
7. Scribe position of window lifter guide rail screws. See Figure 2D-10.



Figure 2D-10 Guide Rail Screws

8. Unscrew window lifter and let it down slowly.
9. Slide window upwards and block it.

10. Remove window lifter through opening in inner door panel upper part. See Figure 2D-11.

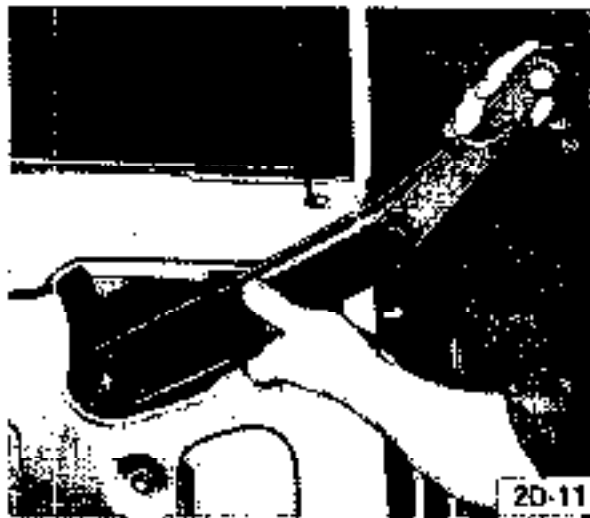


Figure 2D-11 Removing Window Lifter

#### Installation

1. Install window lifter through opening in inner door panel tipper part. See Figure 2D-11.
2. Block window upwards.
3. Secure window lifter.
4. On Models 57 and 57R, secure plastic support of window rail.
5. Install inside door handle.
6. Install door lock knob.
7. Install door trim pad.

#### REMOVAL AND INSTALLATION OF FRONT DOOR LOCK

##### Removal

1. Remove door trim pad.
2. Remove door lock knob.
3. Remove door inside handle.
4. On lock side, scribe position of guide rail bolt, unscrew bolt, push guide rail downwards, and remove it through access hole. See Figure 2D-12.
5. Remove door lock and install new one. See Figure 2D-13.



Figure 2D-12 Guide Rail Bolt



Figure 2D-14 Engaging Actuating Lever

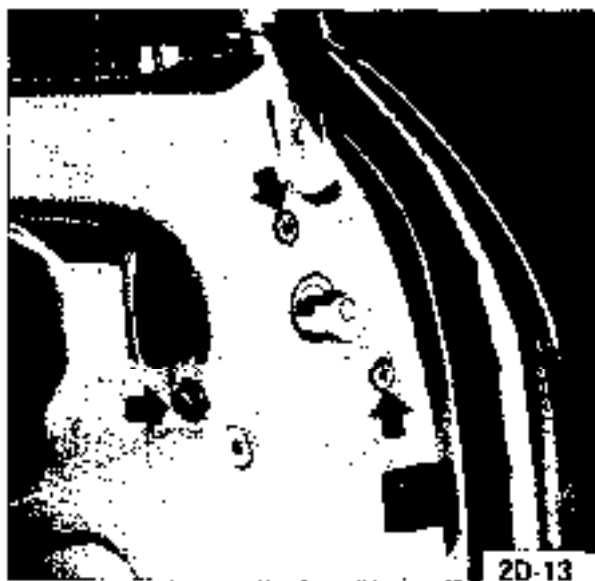


Figure 2D-13 Lock Retaining Screws

6. On Models 57, 57L and 57R, do not unscrew window guide rail. Unscrew lock and, with actuating lever engaged, remove lock from behind guide rail. See Figure 2D-14.

#### Installation

1. Install window guide rail, if removed.
2. Engage actuating lever and install lock. See Figure 2D-14.

3. Install guide rail through access hole and install bolt and rail bolt. See Figure 2D-12.
4. Install inside door handle.
5. Install door lock knob.
6. Install **door** trim pad.

#### REMOVAL AND INSTALLATION OF FRONT DOOR LOCK CYLINDER

##### Removal

1. Remove door trim pad.



Figure 2D-15 Outside Door Handle Hex. Nuts

2. With window closed, unscrew hex nut and remove door outside handle. See Figure 2D-15.
3. Clamp door outside handle in a vise provided with protective jaws.
4. With a screwdriver, lift cylinder lock ring out of handle. See Figure 2D-16.

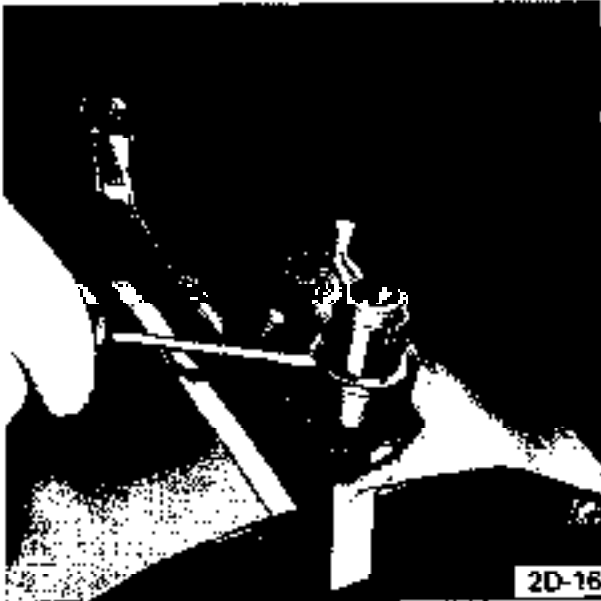


Figure 2D-16 Removing Cylinder Lock Ring Out of Handle

5. Pull lock cylinder out of door outside handle.

**Installation**

1. Clamp outside door handle in a vise and protect handle with pieces of wood.
2. Install lock cylinder into outside door handle.
3. Install lock ring into handle. See Figure 2D-16.
4. With window closed, install outside handle and hex nut. See Figure 2D-15.
5. Install door trim pad.

**REMOVAL AND INSTALLATION OF FRONT DOOR WEATHERSTRIP**

1. From below, grind the peen off door check link pin and drive out pin. See Figure 2D-18.
2. Remove weatherstrip from front door.

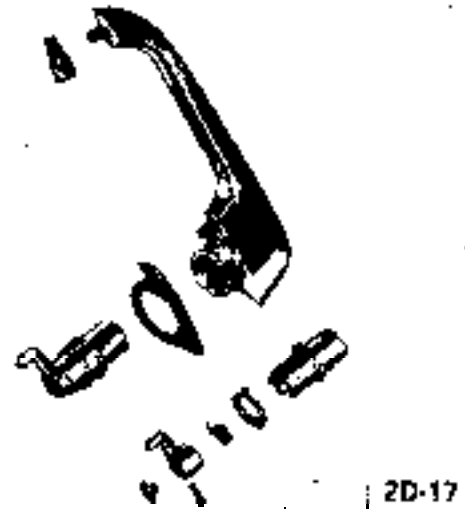


Figure 2D-17 Outside Handle - Exploded View

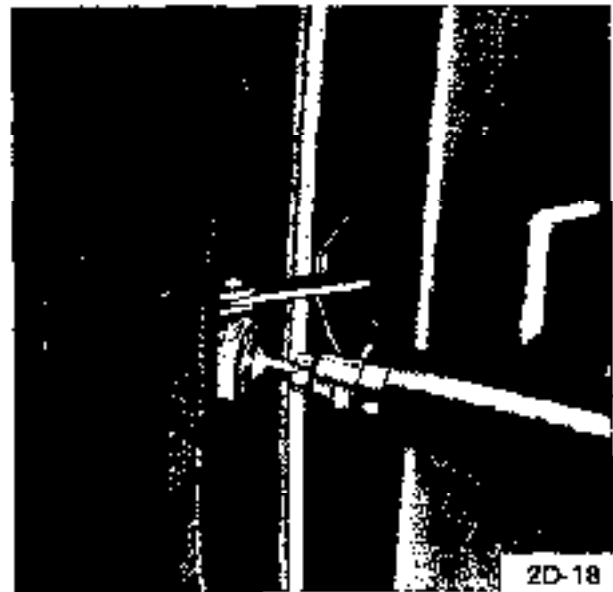


Figure 2D-18 Grinding Peen Off Of Link Pin

3. Button in new weatherstrip in the door area and push it in the metal profile in the area of the window frame. See Figure 2D-19.
4. Install door check link and rivet pin.

**REMOVAL AND INSTALLATION OF FRONT DOOR**

1. Remove door trim pad.
2. Remove lock knob.

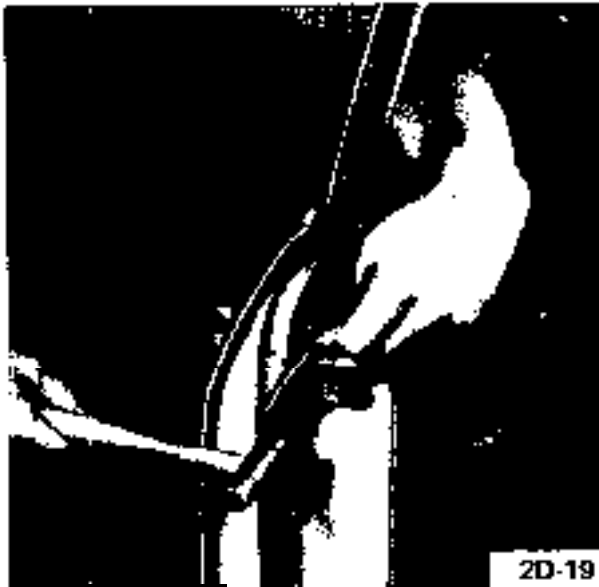


Figure 2D-19 Installing Weatherstrip

3. Remove door inside handle.
4. Remove door belt reveal molding.
5. Remove window lifter.
6. Remove sash window guide rails.
7. Remove door lock.
8. Remove door outside handle,
9. Grind off door check link pin and remove door check link.



Figure 2D-20 Removing Door Weatherstrip

10. Remove door weatherstrip, using a clip remover. See Figure 2D20.

11. Remove door rubber bumper.

12. Drive out upper and lower door hinge sleeve and remove door, using Tool J-21688. See Figure 2D-21.

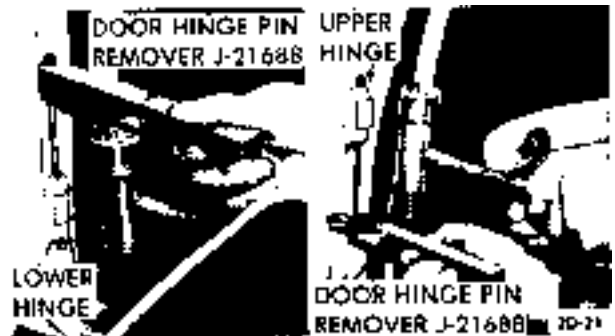


Figure 2D-21 Removing Hinge Pin

13. Install door and rivet door check link pin.

14. Reverse procedure for installation.

#### REMOVAL AND INSTALLATION OF REAR DOOR SASH WINDOW

1. Remove and install door trim pad. See Figure 2D-22.



Figure 2D-22 Trim Pad Items

2. Completely open sash window and unscrew window guide rail in the places shown in Figure 2D-23.

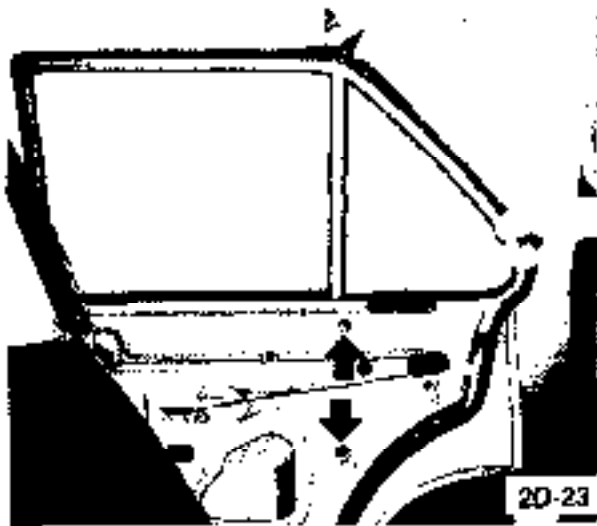


Figure 2D-23 Guide Rail Screws

3. Pull guide rail towards the top out of door.
4. Position sash window so that cable retainer can be unscrewed through access hole. Pull out sash window towards the top.
5. Push sash channel off window glass. See Figure 2D-24.



Figure 2D-24 Sash Channel

6. Place new window glass and new filler into sash channel.

**REMOVAL AND INSTALLATION OF REAR DOOR WINDOW REGULATOR**

1. Remove door trim pad.

2. Remove door sash window.

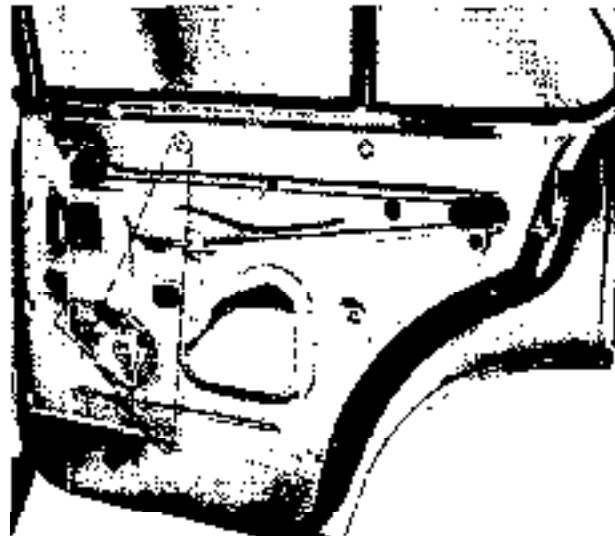


Figure 2D-25 Cable and Pully Location

3. Loosen sheave adjustable bracket. Unscrew window regulator from inner door panel and remove regulator and cable through access hole. See Figure 2D-26.

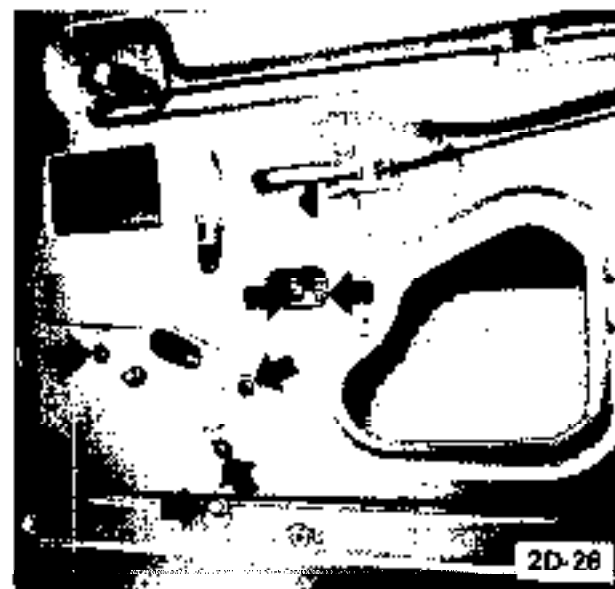


Figure 2D-26 Regulator Attaching Screws

**Installation • Left Door**

In counterclockwise direction, wind cable onto pulley up to the shoulder and clamp it behind lug. See Figure 2D-27.

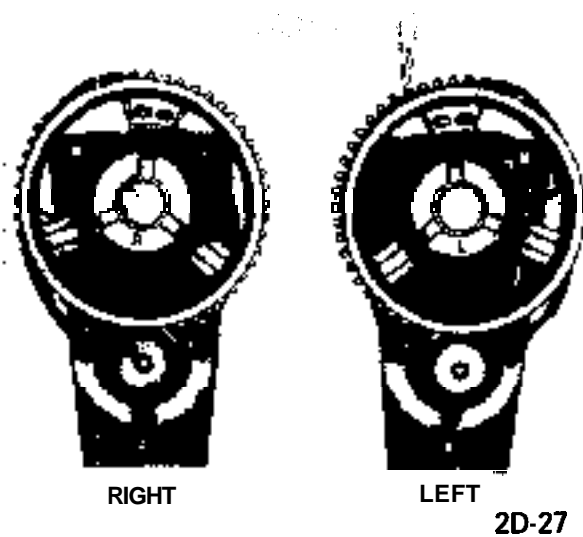


Figure 2D-27 Cables Wound On Regulators

#### Installation - Right Door

In clockwise direction, wind cable onto pulley up to the shoulder and clamp it behind lug. See Figure 2D-27.

#### REMOVING AND INSTALLING TAILGATE HINGES

##### Removal

1. Remove screws securing hinge trim panel covering tailgate hinges and lift out trim panel. See Figure 2D-28.
2. Disconnect battery, remove tailgate trim pad, and withdraw wiring from tailgate.
3. Mark position of tailgate hinges on tailgate, remove bolts securing tailgate to hinges and lift off tailgate.

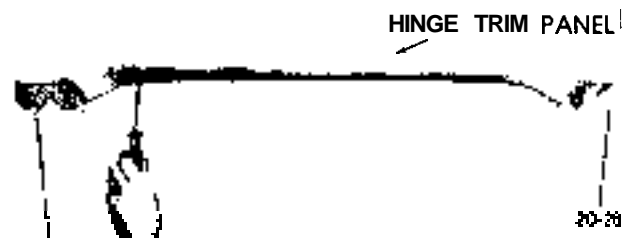


Figure 2D-28 Removing Tailgate Hinge Trim Panel

4. Release and remove torque rods. See Figure 2D-29.

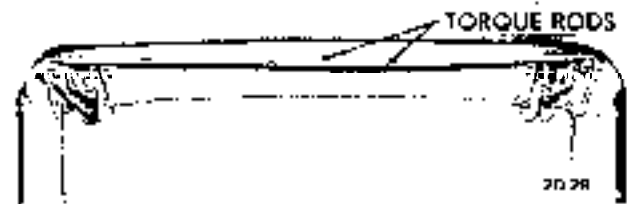


Figure 2D-29 Tailgate Torque Rods

5. Remove bolts securing tailgate hinges to roof panel and lift out tailgate hinges.

##### Installation

1. Install tailgate hinges to roof panel and secure with bolts.
2. Install torque rods. Installation of torque rods may be facilitated by using vise-grip pliers to work torque rod end over catch.
3. Install tailgate to tailgate hinges.
4. Install wiring to tailgate
5. Install tailgate trim pad and tailgate hinges panel covering.
6. Connect battery



# REAR COMPARTMENT LID

## CONTENTS

Subject	Page No.
DESCRIPTION AND OPERATION: (Not Applicable)	
DIAGNOSIS: (Not Applicable)	
MAINTENANCE AND ADJUSTMENTS: (Not Applicable)	
MAJOR REPAIR:	
Removal and Installation	
Weatherstrip .....	2E-22
Lock Cylinder .....	2E-22
Luggage Compartment Lid .....	2E-23
SPECIFICATIONS: (Not Applicable)	

### MAJOR REPAIR

#### REMOVAL AND INSTALLATION OF LUGGAGE COMPARTMENT LID WEATHERSTRIP

1. Detach old weatherstrip and clean sealing surface.
2. Coat new weatherstrip and contacting surface with rubber cement, and allow cement to dry for a few minutes.



Figure 2E-2 installing Luggage Compartment Lid Weatherstrip

3. Install new weatherstrip with rubber cement. See Figure 2E-2.

#### REMOVAL AND INSTALLATION OF LUGGAGE COMPARTMENT LID LOCK CYLINDER

##### Removal

1. Remove luggage compartment lid lock. See Figure 2E-3.

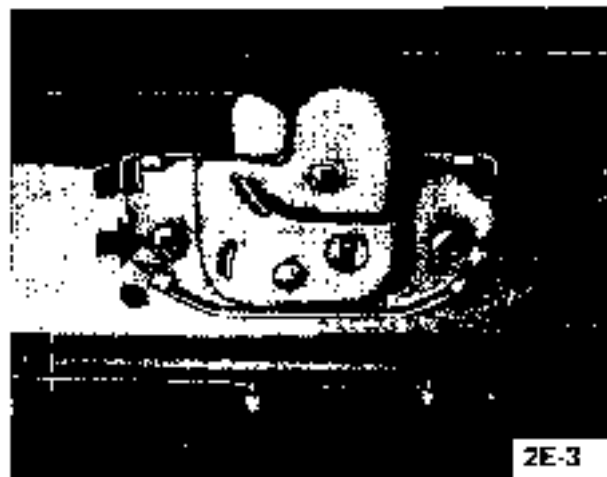


Figure 2E-3 Lid Lock Attaching Screws

2. With luggage compartment lid in almost horizontal position, unscrew lock cylinder nut, using a 13/16

inch deep socket, and remove it, together with intermediate ring. See Figure 2E-4.



Figure 2E-4 Removing Lock Cylinder Nut

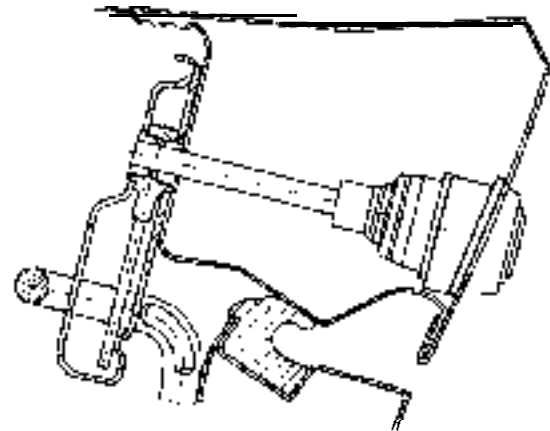
#### Installation

1. Install lock cylinder nut, together with intermediate ring, and fasten with a 13/16 inch deep socket. See Figure 2E-96.
2. Install luggage compartment lock so that the lock cylinder rod rests in opening of the lock. See Figure 2E-5.

#### REMOVAL AND INSTALLATION OF LUGGAGE COMPARTMENT LID

##### Removal

1. With a wooden wedge, remove letters and ornament.
2. From below, push ornament out of luggage compartment lid.



2E-5

Figure 2E-5 Lock Cylinder Rod Location

3. Remove rubber bumpers, lamp, lid lock, and lock cylinder. See Figure 2E-6.

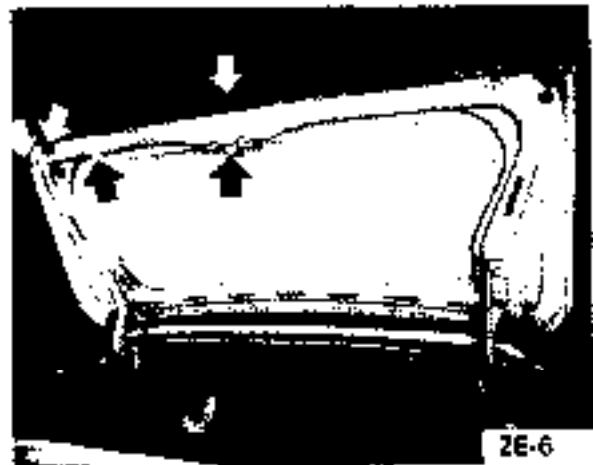


Figure 2E-6 Rubber Bumpers Lamp and Lock Location

4. Unscrew luggage compartment lid from hinges.
5. The luggage compartment lid must **be** aligned so that the gaps between lid and adjacent surfaces are almost equal.

# ROOF AND SUN ROOF

## CONTENTS

Subject	Page No.
<b>DESCRIPTION AND OPERATION: (Not Applicable)</b>	
<b>DIAGNOSIS:</b>	
Sun Roof Diagnosis .....	2F-24
<b>MAINTENANCE AND ADJUSTMENTS:</b>	
Sun Roof Height Adjustment .....	2F-26
<b>MAJOR REPAIR:</b>	
Removal and Installation	
Sun Roof Panel and Frame .....	2F-27
Velvet Strip and Weather Strip .....	2F-29
Rear Guides and Cables .....	2F-29
Drive Pinion .....	2F-30
Water Drain Hoses .....	2F-31
Luggage Rack .....	2F-32
<b>SPECIFICATIONS: (Not Applicable)</b>	

## DIAGNOSIS

### SUN ROOF DIAGNOSIS

CONDITION	CAUSE	CORRECTION
Sun roof does not operate parallel.	Transporter cable lengths equal.	Close sun roof, slide sun roof frame to rear, <b>remove crank handle and</b> cable crank. Check that sun roof bears against sun roof opening velvet strip and that lifter' portion of rear lifter guides is positioned approximately <b>90</b> degrees to guide rails. <b>Turn</b> cable crank fully clockwise and reinstall into cable box.
	Transporter cables damaged or worn.	Replace cables. Both cables must be replaced if either one is damaged or worn.

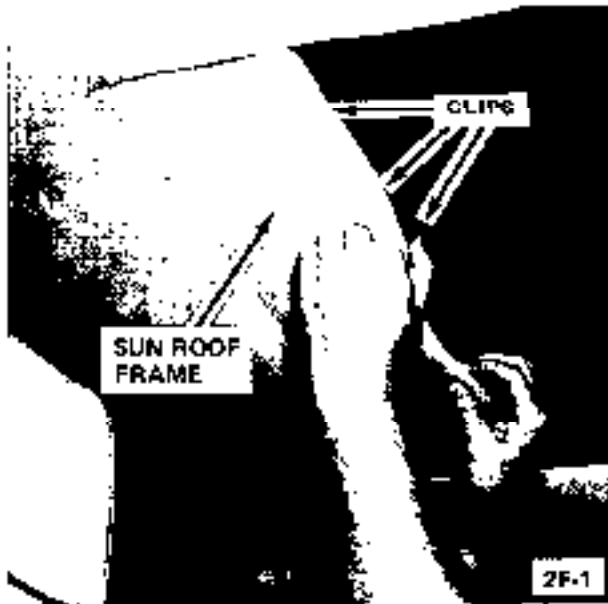
Condition	Cause	Correction
Sun roof lifts up on one side only.	Lifter wedge welded to underside of sun roof panel does not run up ramp welded in center of sun roof track.	Remove sun roof panel and bend lifter wedge so that it squarely hits ramp. The only adjustment for the ramp is the angle of the rear portion. This should be adjusted so that the wedge smoothly rides up the ramp.
	Transporter cable or drive pinion damaged.	If the transporter cable is worn or damaged, replace both cables. If drive pinion worn or damaged, replace drive pinion and also both transporter cables.
Sun roof scrapes on car roof when closing sun roof.	Lifters do not lie flat.	Close sun roof, slide sun roof frame to the rear and open and close sun roof slightly noting operation of lifters. Rework if necessary, plastic lifter cushion with tile to permit lifter to lie flat. Sparingly lubricate lifter guide.
<b>Sun</b> roof frame becomes detached.	Attaching clips have lost elasticity.	Install new clips
Water enters car interior.	Water drain hoses blocked.	Clean hoses with compressed air or a flexible steel cable.
	Bent water drain hoses	NOTE: To clear rear water drain hoses, the sun roof panel and frame must be removed. Blowing out of rear drain hoses from trunk compartment hose end is not recommended due to possibility of soiling car interior. Attempt to straighten drain hoses by working a suitable tube or cable through hose. Replace hose if above corrective action is not satisfactory.
	Rear water drain hoses have been pulled out of rubber grommets.	Apply a small amount of rubber cement to rear water drain hoses and reinsert into rubber grommet located in luggage compartment floor panel.
	Velvet strips on front and rear of sun roof do not seal properly.	Check sun roof for correct height adjustment. If height adjustment is correct, but a tight seal does not exist, relocate velvet strip upward for better seal, or replace velvet strip.

**MAINTENANCE AND ADJUSTMENTS**

**ADJUSTING HEIGHT OF SUN ROOF PANEL**

Adjust height of sun roof as follows:

1. Open sun roof to half open position and pry apart sun roof frame from sun roof panel (see Figure 2F-1).



**Figure 2F-1 Separating Sun Roof Frame From Sun Roof Panel**

2. Push detached sun roof frame rearward until it contacts car roof stop.

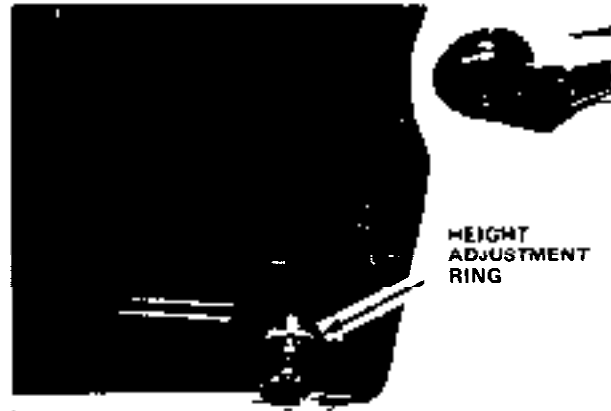
**NOTE:** If difficulty is encountered when pushing sun roof frame to rear due to the frame hooking into the sun roof panel, close sun roof until lifters come into operation. The sun roof frame should now easily slide rearward.

**ADJUSTMENT FRONT OF SUN ROOF**

To adjust height of front of sun roof proceed as follows:

1. Close sun roof.
2. Loosen screws securing front guides to front of sun roof panel (see Figure 2F-2). Rotate height adjustment ring until desired height is attained.
3. Readjust guides outward so that guides just touch sides of rails and are not wedged or cocked against rail sides and tighten screws. Recheck height adjustment.

**NOTE:** The guides should lightly contact the guide



2F-2

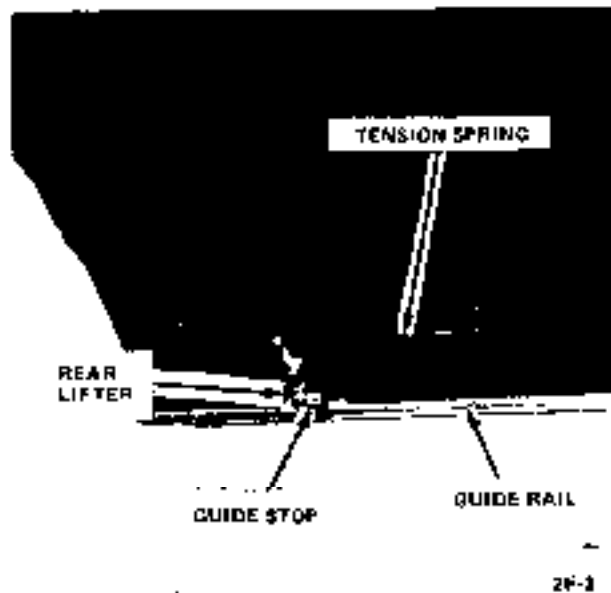
**Figure 2F-2 Sun Roof Front Guide**

rail and should have a clearance of no more than 0.02 inch.

**ADJUSTMENT. REAR OF SUN ROOF**

To adjust height of rear of sun roof proceed as follows:

1. Completely close sun roof and check that the rear sun roof lifter guides from approximately a 90 degree angle with respect to the guide rail and that the lifter contacts the guide stop (see Figure 2F-3). If this is



2F-3

**Figure 2F-3 Rear Sun Roof Lifter 90 Degrees to Guide Rail**

not the case, take off crank handle and cable crank (see Figure 2F-4) and physically reposition lifters to be approximately 90 degrees to guide rails and to contact guide stops. Rotate cable crank to its fully clockwise limit and reinstall.

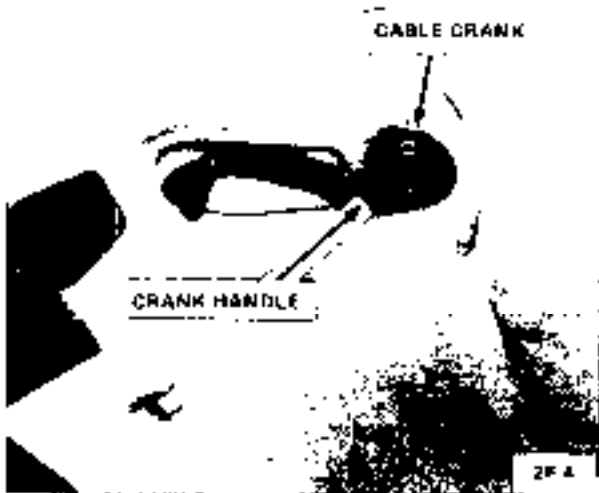


Figure 2F-4 Sun Roof Cranking Handle and Cable Crank

2. Open sun roof until rear lifters lay in a horizontal position (see Figure 2F-5), loosen lifter pin nut and turn lifter pin adjusting screw accordingly to lower or raise lifter pin in slot of lifter.

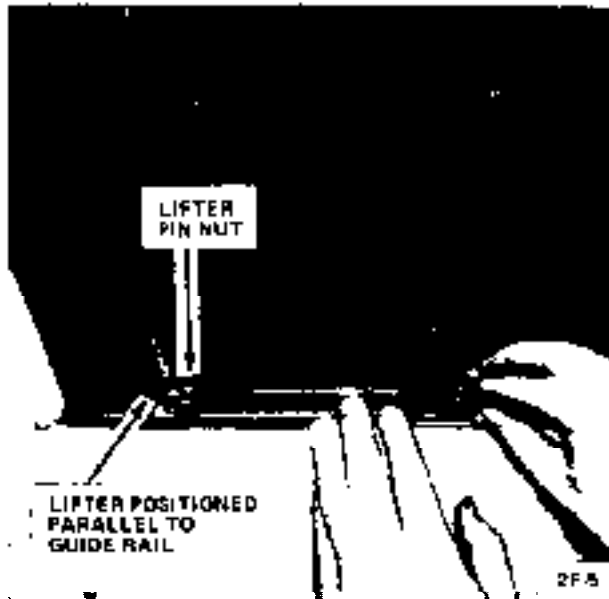


Figure 2F-5 Lifter Pin Adjusting Screw

3. Hold lifter pin adjusting screw down and tighten lifter pin nut.

4. Recheck operation of sun roof and note that lifter contacts stop when lifter is approximately 90 degrees to guide rail.

Pull sun roof frame forward and reattach to sun roof panel.

## MAJOR REPAIR

### REMOVAL AND INSTALLATION OF SUN ROOF PANEL AND SUN ROOF FRAME

#### Removal of Sun Roof Panel

1. Open sun roof to half open position and pry loose sun roof frame from sun roof panel (see Figure 2F-1).

2. Push detached sun roof frame toward the rear until it contacts car roof stop.

NOTE: If difficulty is encountered when pushing sun roof frame rearward due to the frame hooking into sun roof panel, close sun roof panel completely and then proceed to push sun roof frame toward rear of car.

3. Close sun roof panel and then open it approximately one turn of operating crank.

4. Remove one of two screws holding each of front



Figure 2F-6 Swinging Front Guide Inboard

guides to height adjustment rings, loosen second screw (see Figure 2F-6), and swing guides away from guide rail.

NOTE: When swinging front guides inboard, be careful not to change position of height adjustment rings. It is suggested that the position of the height adjustment rings be marked with a pencil prior to loosening of front guide attaching screws.

5. Retighten remaining screw holding front guide in position to prevent height adjustment rings from turning.

6. Turn lifter guide tension springs 90 degrees inboard and pull lifters out of sun roof panel brackets (see Figure 2F-7).



2F-7

Figure 2F-7 Pulling Rear Lifter Guide out of Sun Roof Panel Bracket

NOTE: Do not loosen lifter pin nut as this will change height adjustment on rear of sun roof.

7. Lift out sun roof panel.

#### Installation of Sun Roof Panel

1. Install sun roof panel onto guide rails and locate panel evenly in sun roof opening.

2. Reposition front guides in original position on guide rails. Be sure that they squarely contact guide rails and are not cocked.

NOTE: To achieve proper clearance of front guides to guide rail, the guides should lightly touch edge of

the guide rails and should have a clearance of no more than 0.02 inch.

3. Reconnect rear lifter guides onto sun roof panel brackets and reposition tension spring as shown in Figure 2F-3.

4. Crank sun roof fully closed and check that the rear lifters are at approximately 90 degrees with respect to guide rails and contact guide stops (see Figure 2F-3). If adjustment is required remove crank handle and cable crank (see Figure 2F-4) and physically reposition lifters to position described above. Rotate cable crank to its fully clockwise limit and reinstall.

5. Pull sun roof frame forward and reattach to sun roof panel.

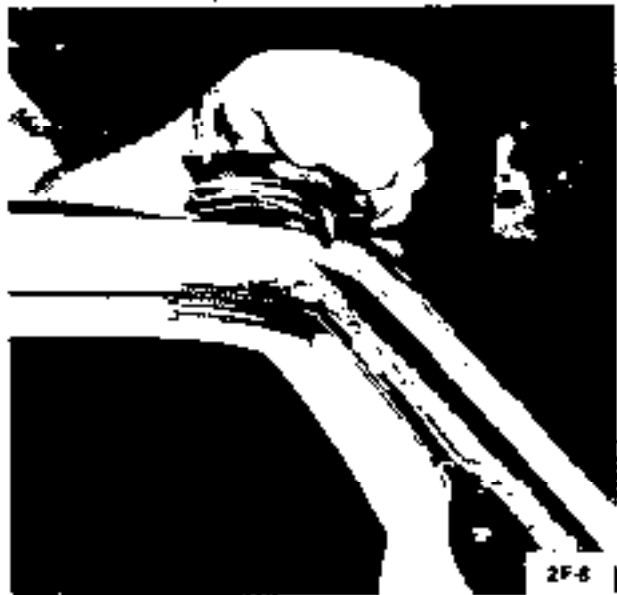
6. Open and close sun roof several times and recheck for smoothness of operation.

#### Removal of Sun Roof Frame

1. Remove sun roof panel.

2. Crank rear lifter guides to furthest rear position.

3. Remove screws securing upper corner plates in position and lift out upper corner plates (see Figure 2F-8).



2F-8

Figure 2F-8 Removing Upper Corner Plates

4. Remove screws securing left and right guide rails, lift up front ends of guide rails and insert wedge under forward guide rail ends. Slide out sun roof frame.

**Installation of Sun Roof Frame**

1. Slide sun roof frame into lower slot of guide rails, position fully rearward and reattach guide rails to roof.

NOTE: Be sure guide rail retainers at rear of guide rails are positioned with their dowels in bores of roof frame.

2. Install upper corner plates and secure in place..
3. Install sun roof panel.

**REMOVAL AND INSTALLATION OF VELVET STRIP ON SUN ROOF OPENING, AND VELVET STRIP AND WEATHERSTRIP ON REAR OF SUN ROOF PANEL**

**Removal of Velvet Strip on Sun Roof Opening**

1. Fully open sun roof.
2. Carefully pull off velvet strip using solvent to dissolve cement. Clean area thoroughly before installing new velvet strip.

**Installation of Velvet Strip On Sun Roof Opening**

1. Cut away for a distance of 1.5 inch the velvet material on velvet strip that will be on the outside when strip is cemented in position. Also cut off to this dimension the plastic cord **inside** velvet strip. **Do not** cut away velvet material on **inboard** side of velvet strip which is to be cemented to **sun roof opening**.
2. Using **nitrile** vinyl trim adhesive (3M Vinyl Trim Adhesive, Permalastic Vinyl Trim Adhesive or equivalent) apply sparingly to both sun roof opening and side of velvet strip to be cemented.
3. Immediately install new velvet strip and position so that upper edge of velvet strip is flush with car roof.
4. **Clean off excess cement** being careful not to contact velvet strip.

**Removal of Velvet Strip and Weatherstrip on Rear of Sun Roof Panel**

1. Remove sun roof panel.
2. Carefully detach weatherstrip and velvet strip from sun roof panel using solvent as required to **disdolve** cement. Thoroughly clean area before **installing** new velvet strip and weatherstrip.

**Installing Velvet Strip and Weatherstrip On Rear of Sun Roof Panel**

1. Using **nitrile** vinyl trim adhesive (3M Vinyl Trim Adhesive Permalastic Vinyl Trim Adhesive or equivalent) apply sparingly to vertical and horizontal contact areas at rear of sun roof panel (see Figure 2F-9) and also to side of velvet strip which will touch sun roof panel.

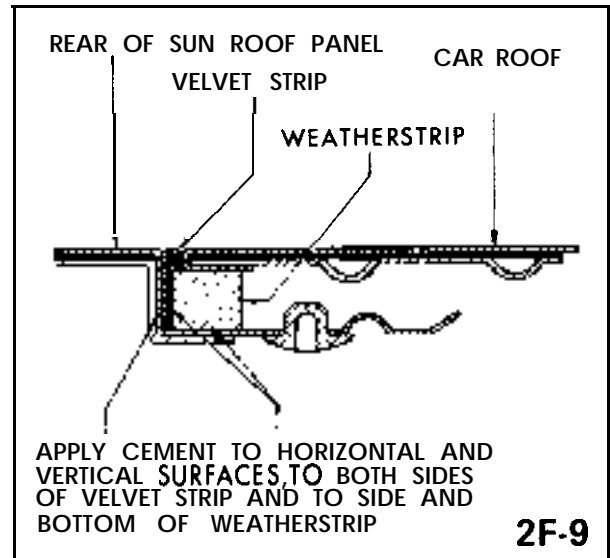


Figure 2F-9 Installing Velvet Strip and Weatherstrip on Rear of Sun Roof Panel

2. Immediately install new velvet strip and position so that top edge of velvet strip is flush with sun roof panel.
3. Apply cement to outboard edge of velvet strip and to top and bottom contact surfaces **of** weatherstrip, and install weatherstrip in position.
4. Clean off excess cement being careful not to contact velvet strip.
5. Install sun roof panel.

**REMOVAL AND INSTALLATION OF REAR GUIDES AND CABLE**

**Removal of Rear Guides and Cable**

1. Remove sun roof panel.
2. Crank rear lifter guides fully rearward and then remove crank handle and cable crank.



3. Unscrew and remove upper and lower corner plates (see Figure 2F-8).
4. Unscrew and remove left and right upper cable shields and pull cable ends out of cable box.
5. Pull cable and rear lifter guides out of left and right guide rails.

#### Installation of Rear Guides and Cable

1. Check both cables for wear or damage. If either cable is defective, replace both cables.
2. Check pinion on cable crank (see Figure 2F-10) for wear or damage. If replacement of pinion is required, also replace both cables.



2F-10

Figure 2F-10 Cable Crank

3. Install cables and rear lifter guides into guide rails and work cables inward until they hit stops.
4. Unscrew and lift off cable box cover (see Figure 2F-11).
5. Insert cable ends into cable box and locate cable ends in respective lower cable shields.
6. Install cable box cover, right and left upper cable shields and right and left upper corner plates.
7. Temporarily install cable crank and crank handle. Crank rear lifter guides to closed position. Remove cable crank and crank handle.
8. Install sun roof panel and reposition front guides to original position on guide rails. Be sure front



Figure 2F-11 Cable Box

guides squarely touch guide rails and are not cocked. Also be sure sun roof panel is not cocked and is evenly located in opening.

NOTE: To achieve proper clearance of front guides to guide rail, the guides should lightly touch the edge of guide rails and should have a clearance of no more than 0.02 inch.

9. Reconnect rear lifter guides onto sun roof panel brackets and reposition tension spring as shown in Figure 2F-3.

10. Push sun roof panel forward so that it contacts roof panel velvet strip and manually raise rear lifters to their 90 degree position. Sun roof panel will now be fully closed.

11. Rotate cable crank to its limit in a clockwise direction and reinstall.

NOTE: Be sure that drive pinion of cable crank meshes with spirals of cable.

12. Reinstall cable crank and crank handle.

13. Pull sun roof frame forward and reattach to sun roof panel.

14. Open and close sun roof several times to recheck for smoothness of operation.

#### REMOVAL AND INSTALLATION OF DRIVE PINION

##### Removal

1. Position sun roof in fully closed position and take off crank handle and cable crank.

2. Press off snap ring holding drive pinion in place and remove drive pinion (see Figure 2F-10).

**Installation**

1. Install drive pinion reverse of removal.

NOTE: If drive pinion is to be replaced, also replace both cables to insure smooth operation of sun roof.

2. Rotate cable crank to its limit in a clockwise direction and install reverse of removal procedure.

**REMOVAL AND INSTALLATION OF FRONT AND REAR WATER DRAINAGE HOSES**

**Removal of Front Water Drainage Hose**

1. Remove sun visor from side of car which will have drainage pipe taken out.

2. Partially detach pinchweld finishing strip from door opening involved.

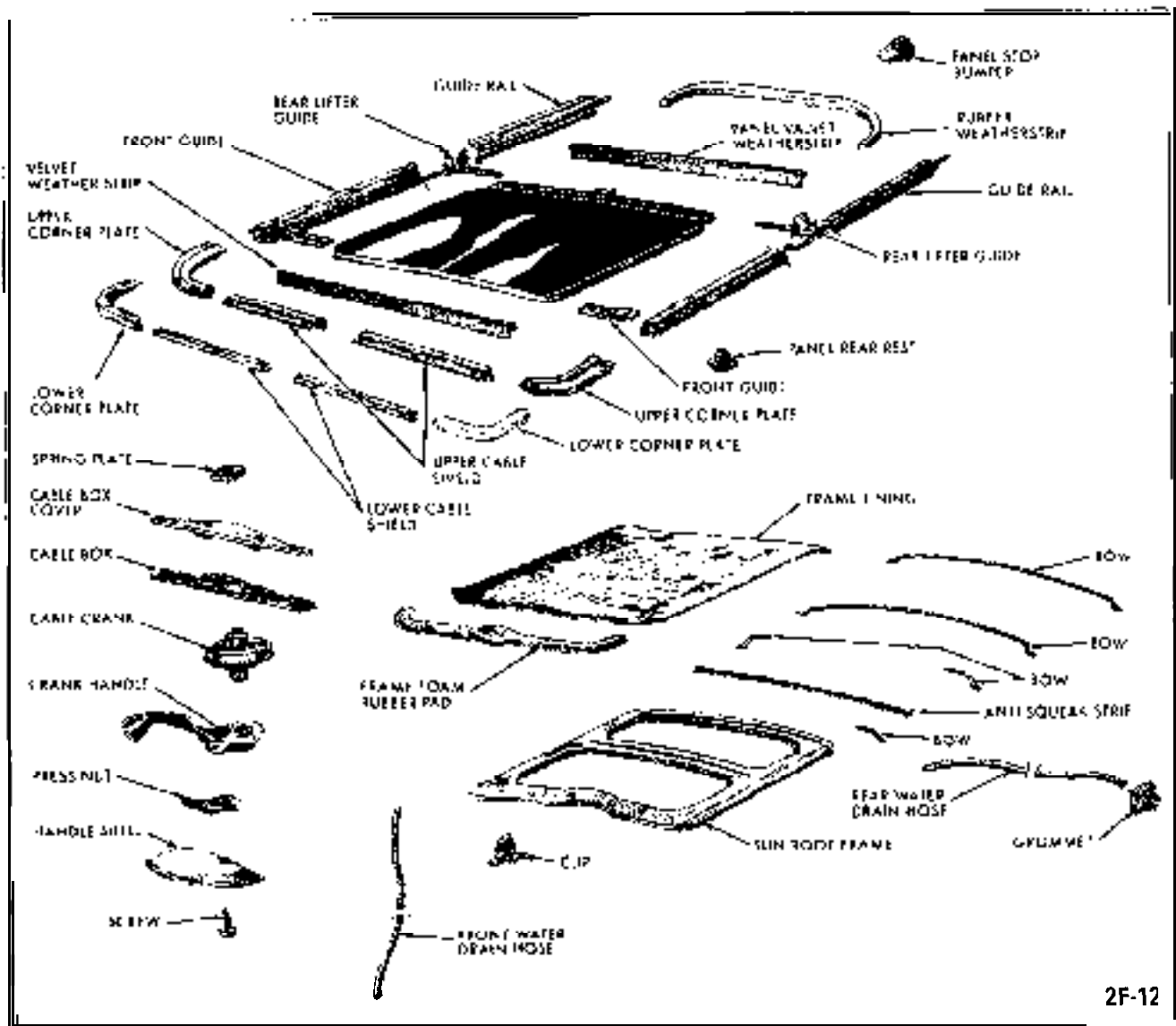


Figure 2F-12 Sun Roof (Exploded View)

3. Carefully detach a portion of headlining around window corner post involved.
4. Detach water drain hose from sun roof hose fitting.
5. Remove cowl side kickpads.
6. Pull out from upper end front water drain hose.

#### Installation of Front Water Drain Hose

1. Insert from above water drain hose (wider end upward) into door hinge pillar.

NOTE: Do not mistake front and rear water hoses. The front hose is thinner than the rear hose and is wider at the end which connects to hose fitting on sun roof. The rear hose is uniform over its entire length.

2. Work water drain hose downward through lower half of door hinge pillar and be sure hose terminates behind door sill flange at bottom of front fender.
3. Cement upper portion of water drain hose to sun roof hose fitting.
4. Cement detached portions of headlining into place by use of rubber cement or nitrile vinyl trim adhesive (3M Vinyl Trim Adhesive, Permalastic Vinyl Trim Adhesive or equivalent).
5. Complete installation reverse of removal procedures.

#### Removal of Rear Water Drain Hose

1. Remove rear seat and rear seat back.

2. Pry out plastic fasteners securing cardboard parcel shelf in position and remove shelf.
3. Remove rear quarter trim pad.
4. Detach headlining only as required from area around rear window pillar.
5. Pull out rear water drain hose.

#### Installation of Rear Water Drain Hose

1. Install rear water drain hose in original position. Insert hose from above and work downward. Cement both ends of hose in place.
2. Secure water drain hose in place along wheelhouse.
3. Complete installation reverse of removal procedures.

#### REMOVAL AND INSTALLATION OF LUGGAGE RACK

All 1973 luggage racks will be dealer installed, and are held to the roof at the 4 corners. Removal and installation is accomplished by removing the attaching screw at each corner. See Figure 2F-14.



Figure 2F-14 Luggage Rack

# SEATS, INTERIOR TRIM AND HEADLINING

## CONTENTS

Subject	Page No.
<b>DESCRIPTION AND OPERATION: (Not Applicable)</b>	
<b>DIAGNOSIS: (Not Applicable)</b>	
<b>MAINTENANCE AND ADJUSTMENTS: (Not Applicable)</b>	
<b>MAJOR REPAIR:</b>	
<b>Removal and Installation</b>	
Front Seat .....	<b>2G-33</b>
Rear Seat .....	<b>2G-33</b>
Glove Compartment Lock .....	<b>2G-34</b>
Front Side Panel Trim Pad .....	<b>2G-34</b>
Headlining .....	<b>2G-35</b>
Rear Side Panel Trim Pad .....	<b>2G-37</b>
<b>SPECIFICATIONS: (Not Applicable)</b>	

### MAJOR REPAIR

#### REMOVAL AND INSTALLATION OF FRONT SEAT

1. Pull hook out of seat lock. See Figure 2G-2.
2. Tilt seat towards the front and unscrew. See Figure 2G-3.



Figure 2G-2 Pulling Hook Out of Seat Lock

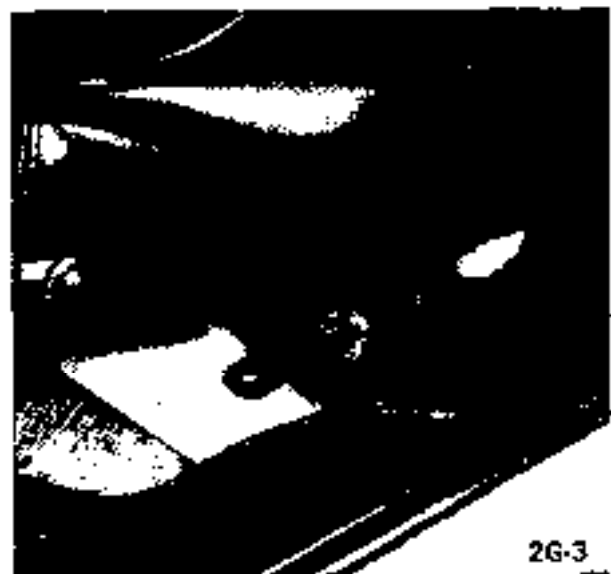


Figure 2G-3 Seat To Underbody Attachment

#### REMOVAL AND INSTALLATION OF REAR SEAT BACK

1. Push seat towards seat back and unhook it towards the top. See Figure 2G-4.
2. Unscrew safety belt on left and right side and bend up metal tabs below seat back. See Figure 2G-5.



Figure 2G-4 Seat to Underbody Hook

a 13/16 inch deep socket, and remove. See Figure 2G-6.



Figure 2G-6 Removing Glove Compartment Lock

2. Install new glove compartment lid lock.

#### REMOVAL AND INSTALLATION OF FRONT SIDE PANEL TRIM PAD

1. Lift up door sill shield and pull off sealing strip up to the instrument panel cover. See Figure 2G-7.



Figure 2G-5 Seat Back Metal Tabs

3. Remove seat back towards the top.

#### REMOVAL AND INSTALLATION OF GLOVE COMPARTMENT DOOR LOCK

1. Unscrew nut of glove compartment lid lock, using



Figure 2G-7 Pulling Off Sealing Strip

2. Push off side panel trim pad. Trim pad is held in position by a retaining button.

## REMOVAL AND INSTALLATION OF HEADLINING

### Removal

1. Disconnect battery.
2. Lift out rear seat cushion (sedans only).
3. From trunk area, loosen tabs holding cardboard against rear seat cross brace and lift out cardboard (sedans only).
4. Pry up two tabs holding lower portion of rear seat back in position, swing back of seat forward and lift out (sedans only).
5. From trunk area pry out parcel shelf plastic retainers and lift out parcel shelf (sedans only).
6. Remove rear-view mirror, sun visors, interior lamp, assist straps and coat hooks. Remove front and rear windows on all but Wagon Models. On Wagons, remove the front window and the quarter windows.
7. Work door opening pinchweld finishing strip away from pinchweld as far as necessary to expose edge of headlining.
8. Start at: left or right windshield pillar and pry headlining loose.
9. Roll back headlining to expose metal tabs securing headlining listing wire to roof and unhook headlining front listing wire from metal tabs using a blunt edge tool.
10. Pull loose the edges of headlining cemented to door openings, rear quarter window openings, rear quarter pillar and from under rear window rubber channel. On rear quarter pillars, slightly bend down cardboard of rear quarter trim pad to facilitate removal. During removal, special care should be taken not to tear headlining at seams.
11. After edges of headlining have been pulled loose, tilt remaining listing wires with headlining forward or rearward and pull listing wires free from side roof rails. Lift out headlining and listing wires.

### Installation

1. Check secureness of noise insulation pad on inside of roof panel and recement as necessary using asphalt cement. If headlining is to be replaced, insert listing wires into headlining according to their markings. Progressing from the front listing wire to the rear wire, the left ends of the wires are color coded as follows:

1st listing wire • No marking, wire is thinner than other wires

2nd listing wire • Red

3rd listing wire • Blue

4th listing wire • Green

5th listing wire • Brown

6th listing wire • White

2. Install 1st listing wire ends into retainer slots inside roof rails and hook listing wire into six metal tabs above windshield. Lightly bend tabs with a hammer as shown in Figure 2G-8.

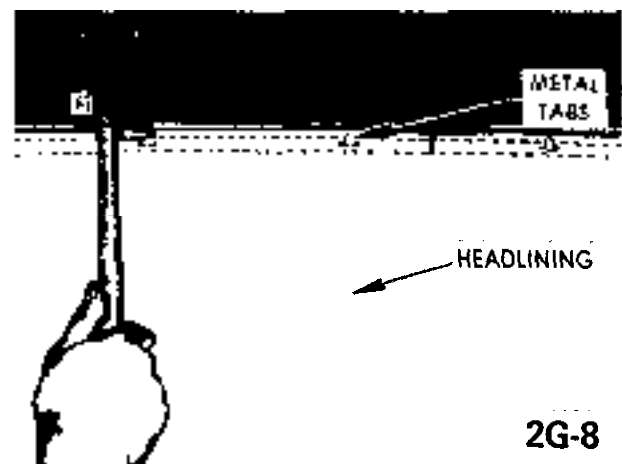


Figure 2G-8 Headlining With 1st Listing Wire Hooked Onto Metal Tabs

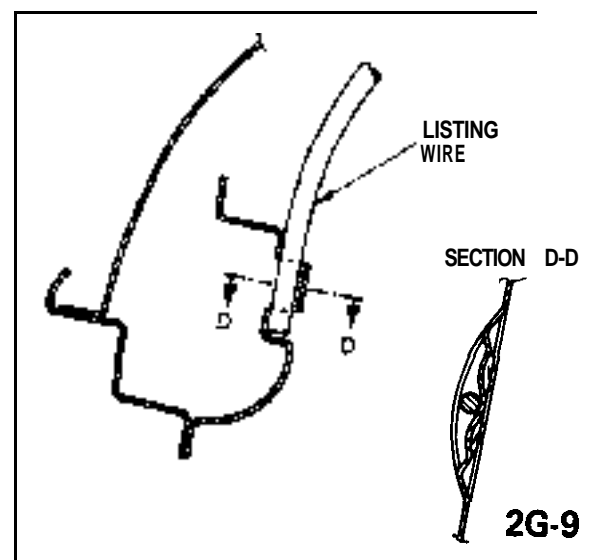


Figure 2G-9 2nd and 5th Listing Wire Attachment

3. Install and align the remaining five listing wires. If required, caulk retainers of 2nd and 5th listing wires so that wires run in a straight line transversally under the roof. See Figure 2G-9.

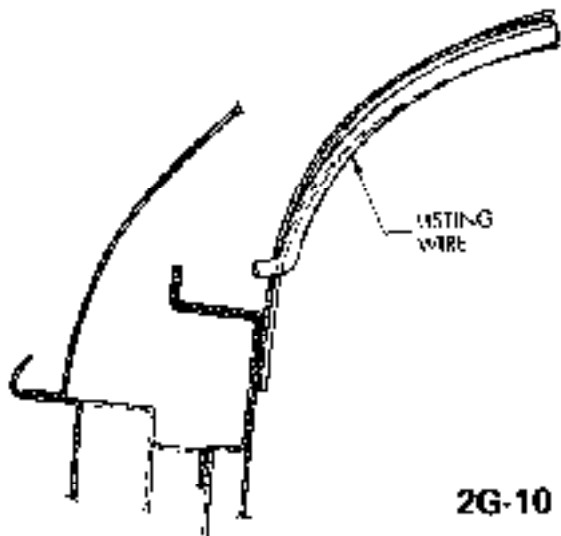


Figure 2G-10 3rd, 4th and 6th Listing Wire Attachment

4. Lightly pull headlining towards the rear and cement to the rear roof frame cross member and then to the rear quarter pillars using rubber cement. When pulling headlining toward rear be sure that the listing wires are not pulled out of line. A folded cloth

should be used to smooth down cemented portions of headlining.

5. Cut off surplus headlining along rear window, rear quarter windows, and windshield, leaving enough to fit under rubber channels.

6. Cement surplus material to pinchweld flanges.

7. Cut off excess headliner around door openings and cement trimmed edge to pinchweld flange using rubber cement.

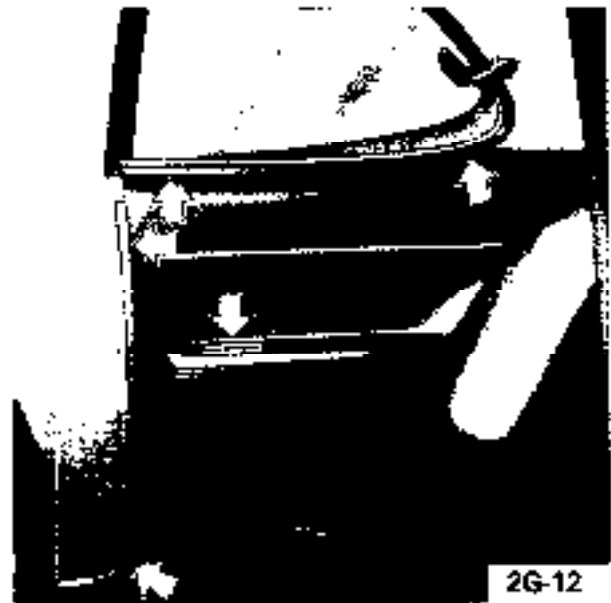


Figure 2G-12 Quarter Window and Lock Pillar Sealing Strip

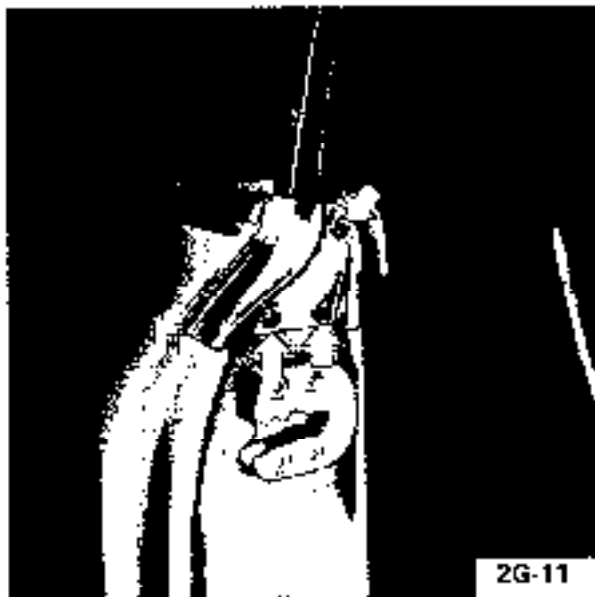


Figure 2G-11 Lock Pillar Shield Attaching Screws

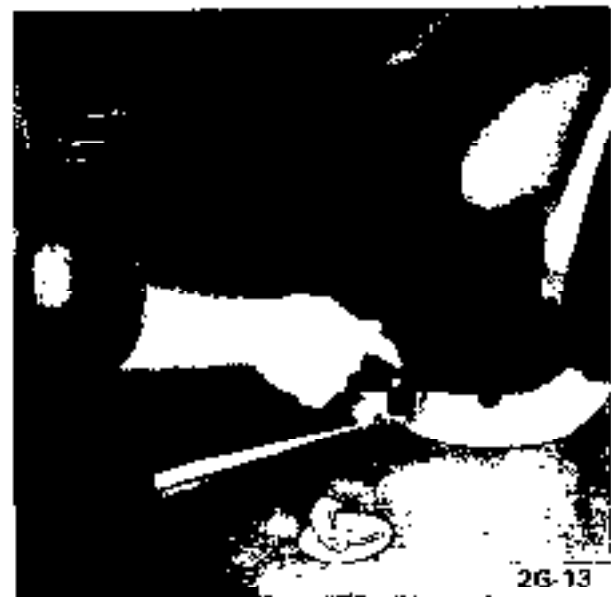


Figure 2G-13 Trim Pad and Retaining Button

8. If wagon, install front window and quarter windows. If other than wagon, install front and rear windows.

9. Install coat hooks, assist straps, interior lamp, sun visors, and rear view mirror.

10. Install parcel shelf and plastic retainers (sedans only).

11. Install rear seat back into position and bend over tabs holding lower portion of seat back (sedans only).

12. In trunk area **install** cardboard against rear seat, cross brace, and bend over tabs (sedans only).

13. Install rear seat cushion (sedans only).

14. Connect battery.

#### **REMOVAL AND INSTALLATION OF REAR SIDE PANEL TRIM PAD**

1. Unscrew shield on lock pillar. See Figure 2G- 11.

2. Pull off sealing strip on lock pillar and rear quarter window. See Figure 2G- 12.

3. Remove ash tray.

4. Remove rear seat and push retaining button out of trim pad. See Figure 2G-13.

5. Pull out trim pad towards the front.

6. Prior to installation, press together sealing strip ends to obtain a tight seat.



# BUMPERS

## CONTENTS

Subject	Page No.
<b>DESCRIPTION AND OPERATION:</b>	
Protective Moldings .....	2H-38
<b>DIAGNOSIS: (Not Applicable)</b>	
<b>MAINTENANCE AND ADJUSTMENTS: (Not Applicable)</b>	
<b>MAJOR REPAIR:</b>	
Removal and Installation	
1900 • Manta .....	2H-38
GT .....	2H-39
Trailer Hitch Installation .....	2H-41
<b>SPECIFICATIONS: (Not Applicable)</b>	

### DESCRIPTION AND OPERATION

#### PROTECTIVE MOLDINGS

All 1973 Opel bumpers are equipped with rubber protective moldings as standard equipment. The moldings are easily removed by removing the attaching nuts located on the inboard side of the bumper.

#### MAJOR REPAIR

##### REMOVAL AND INSTALLATION OF FRONT BUMPER AND BUMPER GUARDS (OPEL 1900 • MANTA)

###### Removal

1. Remove bumper attaching screws on inside • left and right • and from left and right brackets. See Figure 2H-2.
2. From the front, unscrew bumper guard attaching screws. See Figure 2H-2.

Remove bumper and bumper guards.

###### Installation

1. Attach bumper guards to bumper.



Figure 2H-2 Bumper Attaching Screws

2. From the front, secure bumper guards with attaching screws. See Figure 2H-2.
3. Install attaching bolts on left and right brackets, and on left and right inside. See Figure 2H-2.

##### REMOVAL AND INSTALLATION OF FRONT BUMPER BRACKETS (OPEL 1900 • MANTA)

The front bumper brackets are attached with three screws. Removal of the three screws will allow removal and installation of the front bumper brackets. See Figure 2H-3.

##### REMOVAL AND INSTALLATION OF REAR BUMPER AND GUARDS (OPEL 1900 • MANTA)

1. Remove license plate lamp.
2. Remove bumper attaching screws and bumper brackets. See Figure 2H-4.

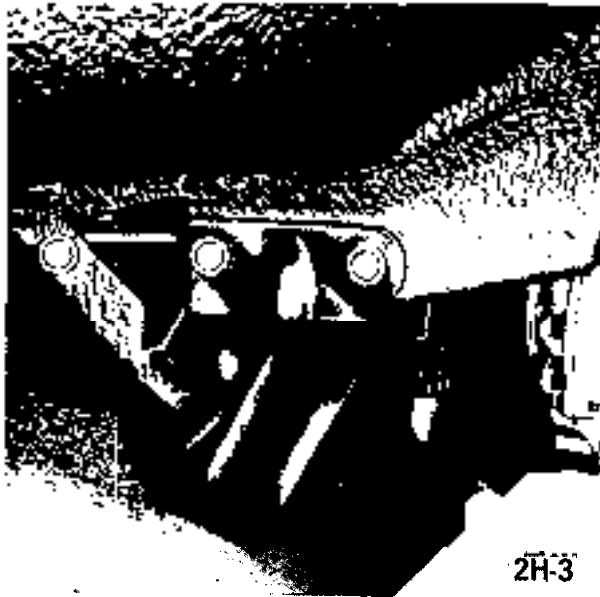


Figure 2H-3 Bumper Bracket Screws



Figure 2H-4 Bumper Attaching Screws

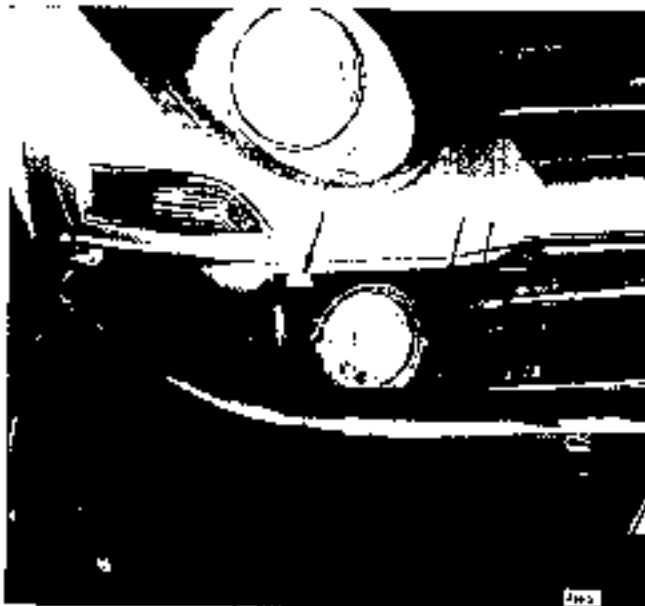


Figure 2H-5 Front Bumper Attaching Points

## REMOVAL AND INSTALLATION OF FRONT BUMPER ASSEMBLY (GT)

### Removal

1. Remove grille.
2. Disconnect bumper at points shown in Figure 2H-5 and remove bumper.

### Installation

1. Install bumper and secure at points shown in Figure 2H-5.

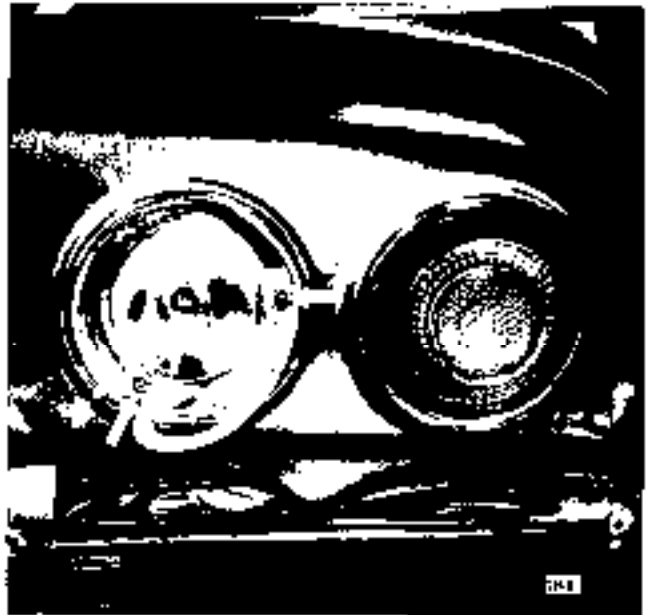


Figure 2H-6 Removing Tail Lamp Assembly

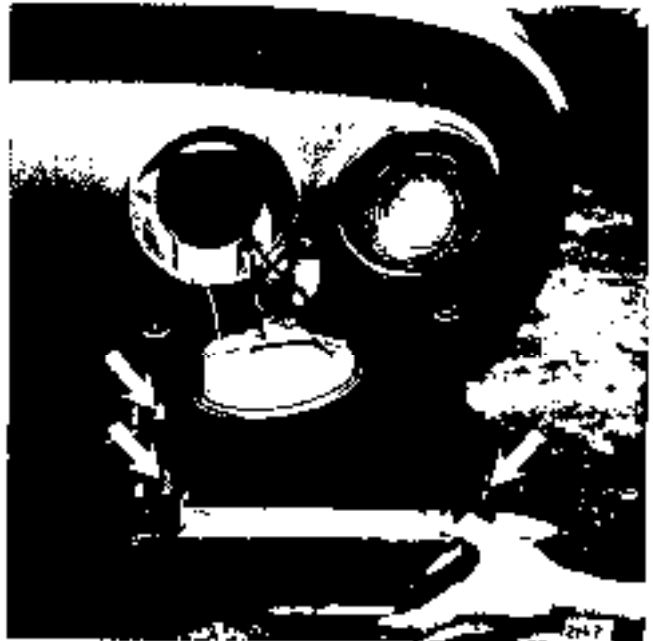


Figure 2H-7 Rear Bumper Attaching Points

2. Install grille.

**REMOVAL AND INSTALLATION OF REAR BUMPER ASSEMBLY (GT)**

**Removal**

1. Remove **tail** lamp assembly. See Figure **2H-6**.

2. Remove bumper attaching nuts accessible through lamp opening. See Figure **2H-7**.

**Installation**

1. **Install** bumper and secure with attaching nuts accessible through lamp opening. See Figure **2H-7**.

2. Install tail lamp assembly. See Figure **2H-6**.

INSTALLATION INSTRUCTIONS

1969 - 73 OPEL GT TRAILER HITCH LESS BALL

GROUP 7.068

STEP 1. REMOVE ONE RIGHT HAND AND ONE LEFT HAND TAIL LAMP ASSEMBLY,

STEP 2. PLACE TIE BAR (C) UNDER THE REAR BODY PANEL BY PULLING DOWN ON THE EXHAUST PIPES AND SLIDING THE TIE BAR OVER THE PIPES AND INTO POSITION. PLACE DRAW BAR (A) UNDER TIE BAR (C) AND FASTEN WITH A 1/2 x 2" HEX BOLT WITH LOCK WASHER AND NUT UNDER DRAW BAR (A), PLACE TIE BAR (B) UNDER DRAW BAR (A) AND SAFETY CHAIN PLATE (D) UNDER TIE BAR (B) AND FASTEN WITH A 1/2 x 2-1/4" HEX BOLT WITH FLAT WASHER, LOCK WASHER AND NUT BELOW SAFETY CHAIN PLATE (D).

STEP 3. HOLD HITCH IN POSITION WITH TIE BAR (C) UNDER THE REAR BODY PANEL AND TIE BAR (B) BETWEEN THE BUMPER GUARDS. USING THE HOLES IN THE ENDS OF TIE BAR (C) AS A GUIDE, LOCATE, MARK AND DRILL TWO 1/2" HOLES IN THE VERTICAL PORTION OF THE REAR BODY PANEL. PLACE THE 3/16" SPACERS ON THE 1/2 x 1-1/2 HEX BOLTS AND BY REACHING THROUGH THE TAIL LAMP OPENINGS, INSERT THE BOLTS THROUGH THE BODY PANEL AND TIE BAR (C) AND FASTEN WITH LOCK WASHER AND NUT.

STEP 4. ALIGN TIE BAR (B) BETWEEN THE BUMPER GUARDS AND LOCATE, MARK AND DRILL A 1/2" HOLE THROUGH BOTH SIDES OF THE BUMPER GUARD USING THE HOLES IN TIE BAR (B) AS A GUIDE. MAINTAIN 1/2 INCH MINIMUM CLEARANCE BETWEEN TOP OF DRAW BAR (A) AND BOTTOM OF BACK-UP LIGHT. FASTEN TIE BAR (B) TO THE BUMPER GUARDS WITH 1/2 x 3" BOLTS WITH TWO 1/2" SPACERS AND ONE 3/8" SPACER INSIDE EACH BUMPER GUARD. REPLACE TAIL LAMP ASSEMBLES.

TIGHTEN ALL 1/2" NUTS TO A MAXIMUM TORQUE OF 60 FOOT LBS.

INSTALL BALL USING A MAXIMUM TORQUE OF 150 FOOT LBS.

MAXIMUM GROSS WEIGHT 1000 LBS.  
MAXIMUM TONGUE WEIGHT 100 LBS.

MOST STATES PROHIBIT OBSTRUCTION OF LICENSE PLATES. BALL SHOULD BE REMOVED WHEN NOT IN USE IF IT OBSTRUCTS A CLEAR VIEW.

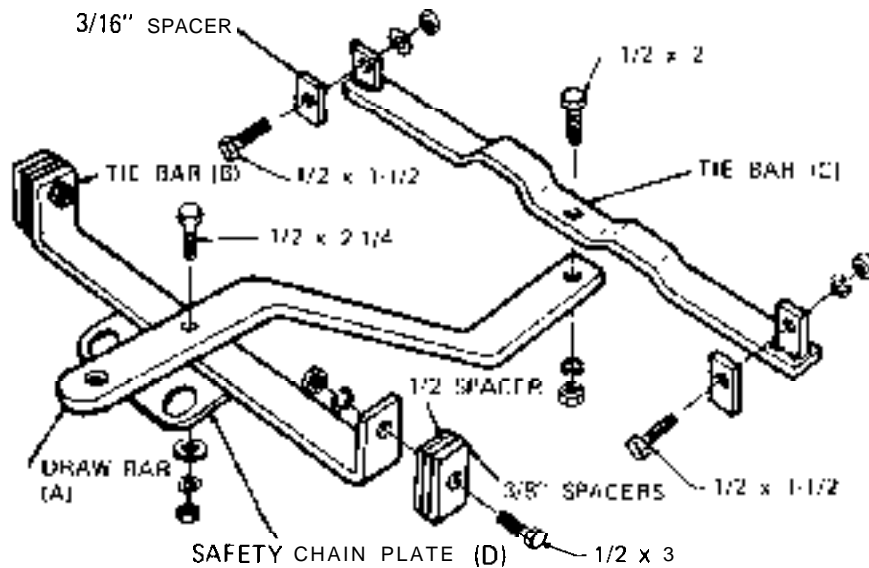


Figure 2H-8 GT Trailer Hitch Installation

2H-8

INSTALLATION INSTRUCTIONS1971 - 72 - 73 OPEL 1900 SERIES SWGROUP NO. 7.068

REMOVE LICENSE PLATE

STEP 1. ASSEMBLE HITCH AS ILLUSTRATED. HOLD HITCH IN POSITION WITH FLOOR PLATE RESTING AGAINST THE CROSS FRAME IN FRONT OF GAS TANK. CENTER DRAW BAR SUPPORT ON THE REAR BODY PANEL, RAISE UNTIL LEVEL.

STEP 2. MARK AND DRILL TWO 7/16" HOLES IN REAR BODY PANEL AND ATTACH AS SHOWN.

STEP 3. DRILL TWO 1/2" HOLES IN CROSS FRAME IN FRONT OF THE GAS TANK AND CONTINUE DRILLING UP THROUGH THE INNER FLOOR. NOTE: HOLD DRILL VERTICAL WHILE DRILLING THROUGH THE INNER FLOOR. ENLARGE BOTTOM HOLE SLIGHTLY TO ACCEPT SPACER.

STEP 4. ATTACH TRUNK PLATE AS ILLUSTRATED. PLACE THE FLOOR PLATES ON THE 2 1/2" CARRIAGE BOLTS AND INSERTS THROUGH THE OPENINGS IN THE BACK OF THE TRUNK WELL. INSERT SPACERS AS SHOWN AND COMPLETE INSTALLATION.

REPLACE LICENSE PLATE.

TIGHTEN ALL 1/2" NUTS TO A MAXIMUM TORQUE OF 60 FOOT LBS. AND 7/16" NUTS TO A MAXIMUM OF 45 FOOT LBS.

INSTALL BALL USING A MAXIMUM TORQUE OF 150 FOOT LBS.

MAXIMUM GROSS WEIGHT 100 LBS

MAXIMUM TONGUE WEIGHT 100 LBS.

MOST STATES PROHIBIT OBSTRUCTION OF LICENSE PLATES, BALL SHOULD BE REMOVED WHEN NOT IN USE IF IT OBSTRUCTS A CLEAR VIEW.

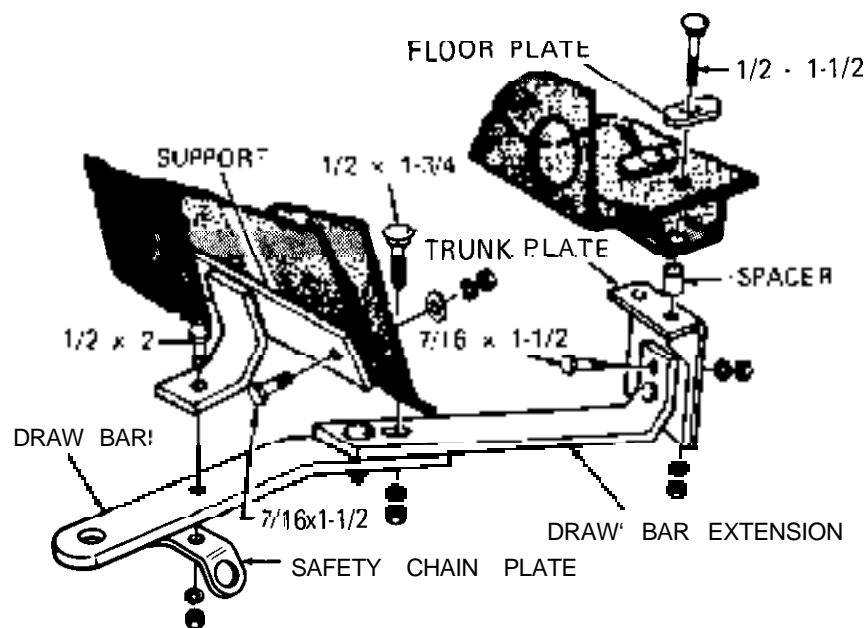
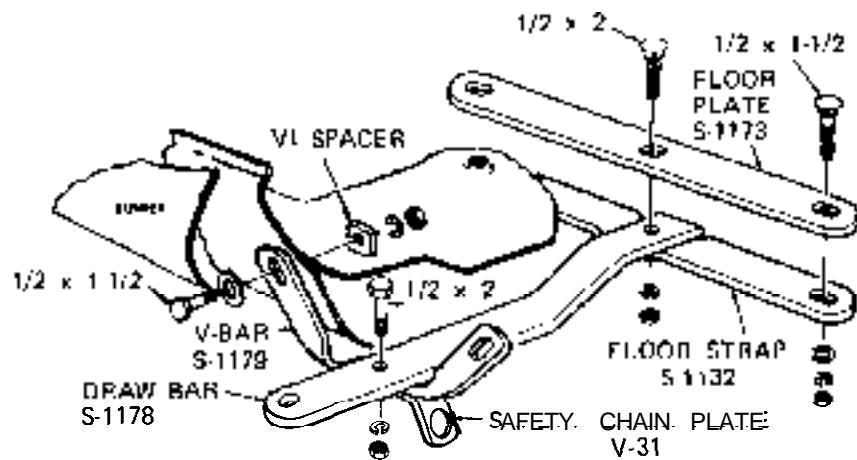


Figure 2H-9 Opel 1900 Wagon Trailer Hitch Installation



INSTALLATION INSTRUCTIONS  
 1971-72-73 OPEL 50 SER.. LESS S/WAGON CAR TRAILER HITCH  
 LESS BALL

GROUP NO. 7.068

STEP 1. REMOVE LICENSE PLATE, ASSEMBLE V-BAR AND SAFETY CHAIN PLATE TO DRAW BAR AS ILLUSTRATED. HOLD HITCH IN POSITION WITH THE DRAW EAR LEVEL AND THE V-BAR RESTING ON THE REAR BODY PANEL. MARK AND DRILL TWO 1/2" HOLES THROUGH THE BODY AND ATTACH THE V-BAR AS ILLUSTRATED.

STEP 2. ALIGN THE DRAW BAR IN THE CENTER OF THE TRUCK FLOOR AND DRILL A 1/2" HOLE THROUGH THE FLOOR USING THE HOLE IN THE DRAW BAR AS A GUIDE. ATTACH THE FLOOR PLATE AND FLOOR STRAP AS ILLUSTRATED. DRILL THE TWO REMAINING HOLES IN THE FLOOR AND COMPLETE INSTALLATION AS ILLUSTRATED. REPLACE LICENSE PLATE.

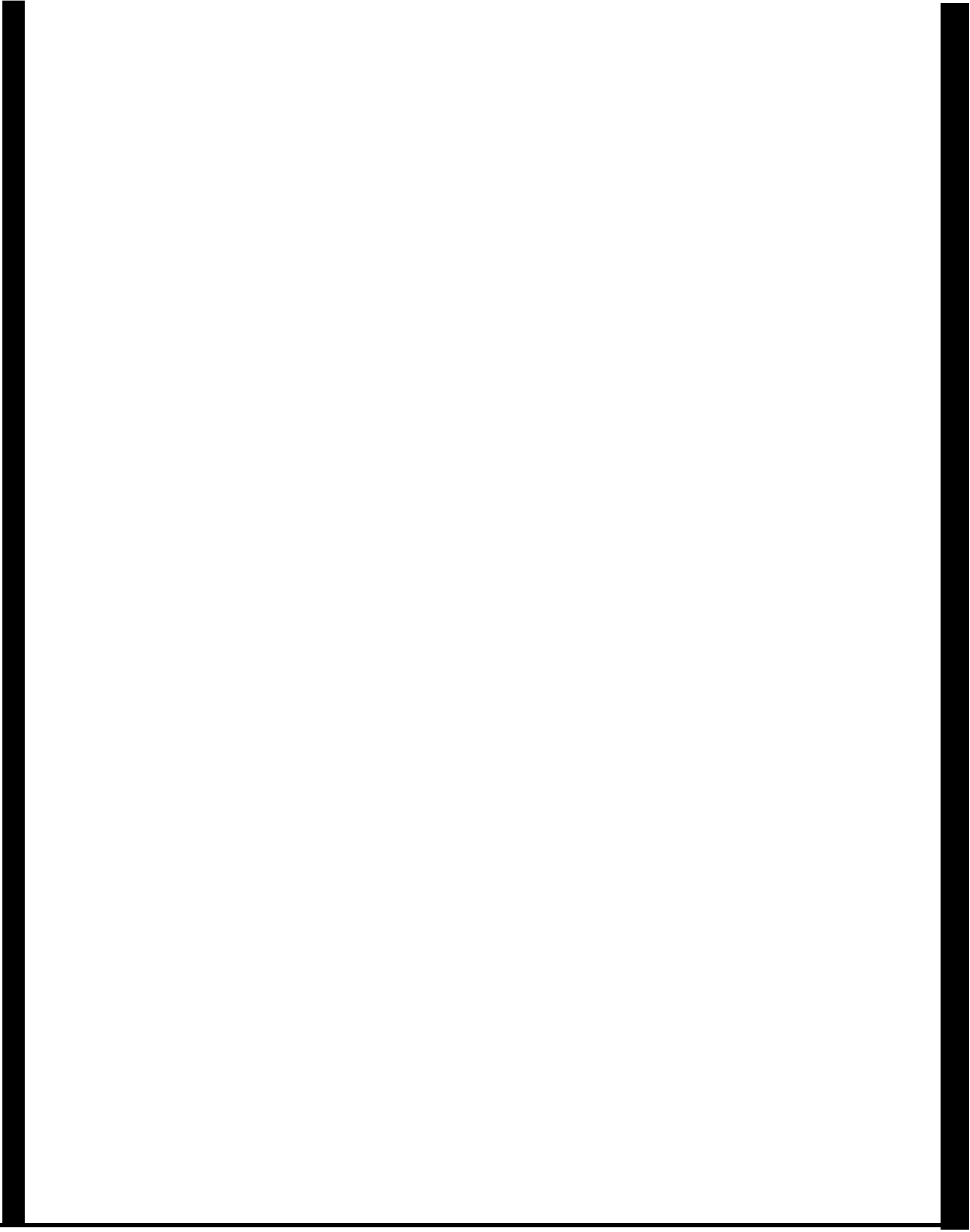
TIGHTEN ALL 1/2" NUTS TO A TORQUE OF 60 FOOT LBS. **INSTALL BALL USING A TORQUE OF 150 FOOT LBS.**

MAXIMUM GROSS WEIGHT 1000 LBS.  
 MAXIMUM TONGUE WEIGHT 100 LBS.

MOST STATES PROHIBIT OBSTRUCTION OF LICENSE PLATES. BALL SHOULD BE REMOVED WHEN NOT IN USE IF IT OBSTRUCTS A CLEAR VIEW.

2H-10

Figure 2H-10 Opel 1900 • Manta • Less Wagon -Trailer Hitch Installation



---

**GROUP 3**

**SUSPENSION  
AND  
STEERING**

<b>Section</b>	<b>Title</b>	<b>Page No</b>
<b>3A</b>	Front Suspension .....	3A- 2
<b>3B</b>	Steering Linkages	3B-19
<b>3 C</b>	Front End Alignment	3C-22
<b>3D</b>	Steering Gear .....	3D-27
<b>3E</b>	Steering Column 1900 - Manta ..... GT .....	3E-35 3E-42
<b>3F</b>	Rear Suspension .....	3F-51
<b>3G</b>	Wheels and Tires .....	3G-55



# FRONT SUSPENSION

## CONTENTS

Subject	Page No.
<b>DESCRIPTION AND OPERATION:</b>	
Suspension Description .....	3A- 2
<b>DIAGNOSIS: (Not Applicable)</b>	
<b>MAINTENANCE AND ADJUSTMENTS:</b>	
Front Wheel Bearing Adjustments .....	3A- 4
<b>MAJOR REPAIR:</b>	
Removal and Installation of Front Suspension .....	3A- 4
Upper Ball Joint Removal and Installation .....	3A- 7
Lower Ball Joint Removal and Installation .....	3A- 7
Upper Control Arm Removal and Installation .....	3A-10
Lower Control Arm Removal and Installation .....	3A-11
Steering Knuckle Removal and Installation .....	3A-13
Shock Absorber Removal and Installation .....	3A-15
Front Spring Removal and Installation .....	3A-15
<b>SPECIFICATIONS:</b>	
Bolt Torque and Front End Alignment Specifications .....	3A-18

## DESCRIPTION AND OPERATION

### SUSPENSION DESCRIPTION

#### GT

The GT uses a maintenance-free independent front wheel suspension and features unequal length control arms and a transverse three-leaf spring. The entire front suspension is attached to the front cross member and can be removed as a unit if so desired.

The engines installed in the GT are not supported by mounting brackets but rest on a separate cross member. The front suspension cross member is reinforced in the area of the attachment to the frame. A one-part damper plate is installed between cross member and frame.

Ball joints are employed in the conventional manner to provide pivoting joints between the control arms and steering knuckles. Upward movement of the control arms is limited by two large rubber bumpers attached to the cross member.

Road shock is dampened by the double direct acting shock absorbers and a transverse double or triple steel band spring. In addition, the shock absorber limits downward travel of the control arms.

All moving parts, including ball joints, have no need for lubrication as they have been pre-lubricated for the life of the vehicle.

For distinguishing the individual front suspension cross members, a red label with black letters is stuck onto the front side of the shock absorber support. See Figure 3A-3.

#### Opel 1900. Manta

The front wheel suspension has coil springs and control arms of different length.

The stabilizer is designed to act as a tie strut. The end is supported in a rubber bushing which is located in a piece of tubing welded into the longer control arm.

To minimize brake torque, the horizontal shafts of

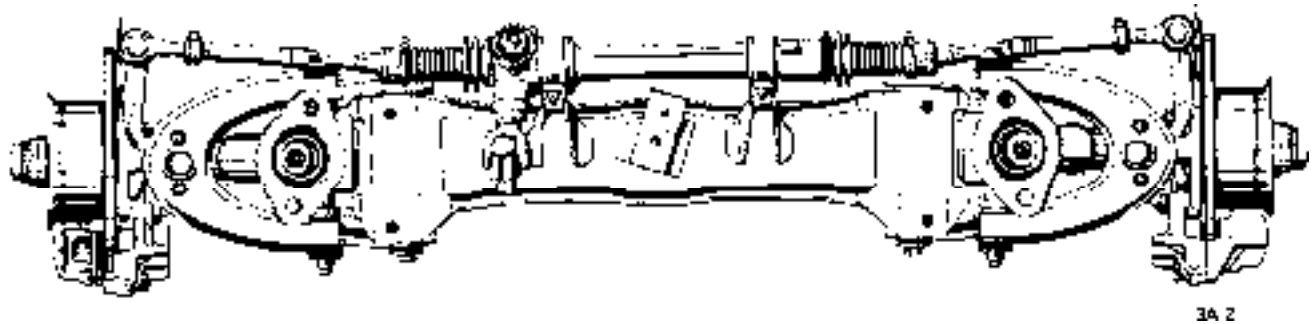
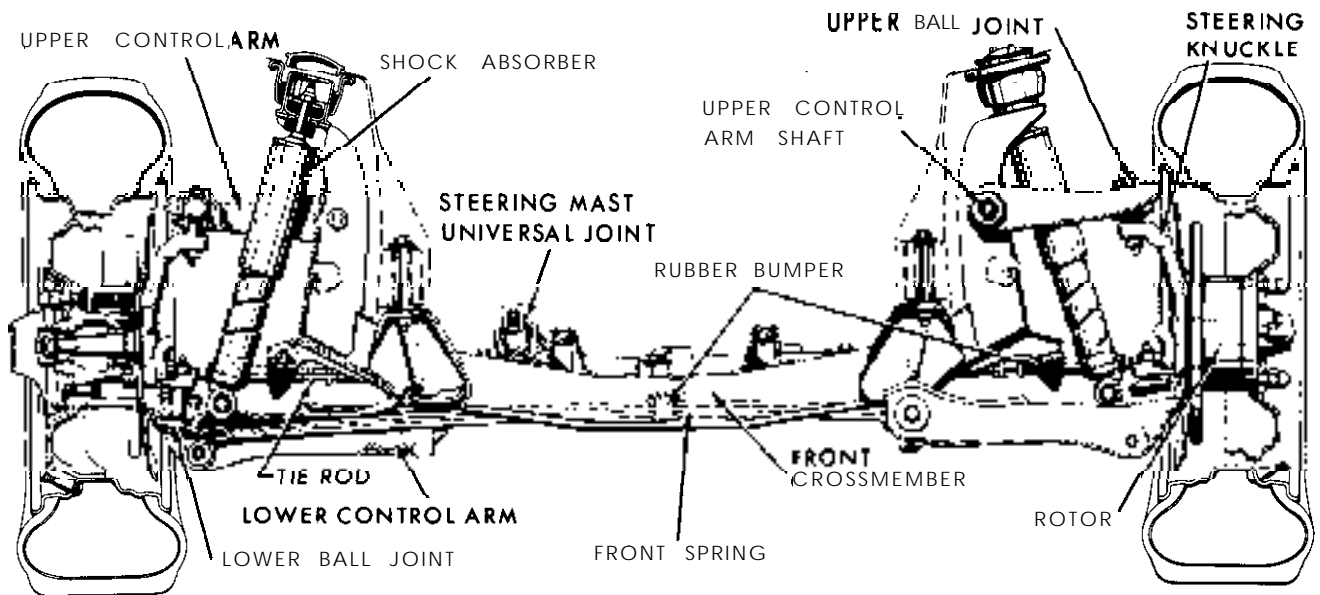


Figure 3A-2 GT Front Suspension (Disc Brakes)

the upper and lower control arm are not in parallel (anti-dive).

The lower control arm is connected to the steering knuckle with a ball joint.

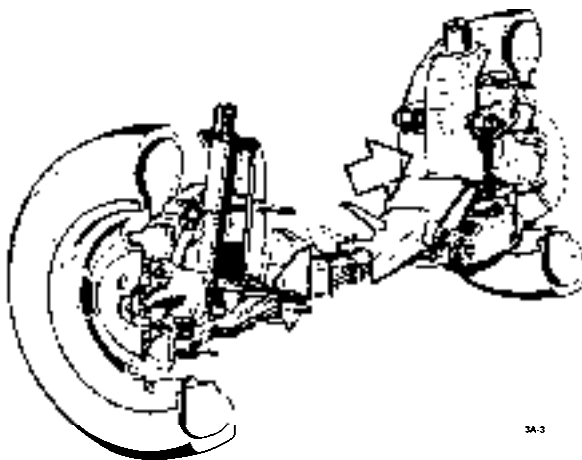


Figure 3A-3 Cross Member Marking

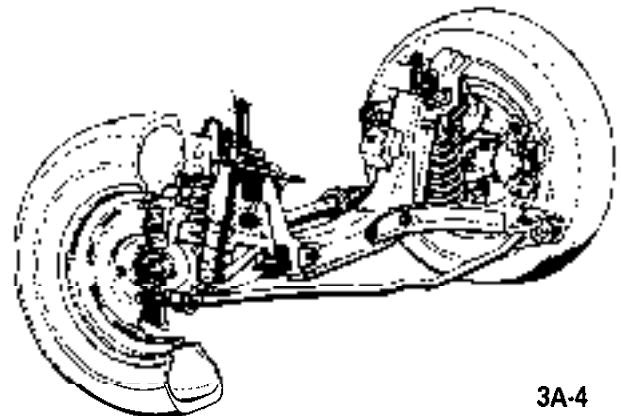


Figure 3A-4 Front Suspension • Opel 1900 Manta

The two cross-members to body supports are attached to the horizontal part of the cross-member with two bolts. The *outer bolt* serves simultaneously as support for the lower control arm. As the bolt is inserted from the front, the cross-member to body support can be removed without the lower control arm. The *inner bolt* attaches simultaneously to the steering.

The stabilizer is U-shaped and supported in rubber bushings in the two cross-members to body supports.

The complete front suspension is attached to the underbody in four places.

The engine damper blocks are bolted to the inside of the inclined parts of the cross-member.

The front wheel bearings are roller bearings.

All front suspension joints are maintenance-free.

## MAINTENANCE AND ADJUSTMENTS

### FRONT WHEEL BEARING ADJUSTMENT

1. If wheel has not previously been removed from the car, remove grease cap, cotter pin, and spindle nut. Discard cotter pin.
2. Torque spindle nut to 18 lb.ft. while rotating wheel. This will allow the bearings to settle.
3. Back off spindle nut 1/4 turn. If slot and cotter pin hole are staggered, further back off nut 1/12 turn, **but do not tighten**, until next slot in nut is in alignment with hole in spindle. Install **new** cotter pin. A properly adjusted wheel bearing has a small amount of end play and a loose nut when adjusted in the above manner.

## MAJOR REPAIR

### REMOVAL AND INSTALLATION OF FRONT SUSPENSION

(COMPLETE ASSEMBLY)

#### Removal GT

1. Prior to raising front end of car, apply parking brake and block rear wheels.
2. Raise front end of car with a jack. It is recommended that a wood block be placed between the

jack and the front cross member to prevent damage to the cross member.

3. Support front end of car by placing floor stands under jacking brackets.
4. Support engine-transmission assembly in uppermost position with jack stand at rear of engine, or an alternate method would be to use Engine Holding Fixture, Tool J-23375. See Figure 3A-5.

Install tool by removing upper engine mount nut and installing fixture. Replace nut and tighten. The engine will now be supported by the tool between the frame rails.



Figure 3A-5 Engine Holding Fixture Installed

5. Loosen steering mast at the lower universal joint and take out clamp bolt. Loosen clamp at the upper universal joint and lift steering mast upwards until it is free at the lower universal joint. See Figure 3A-6.
6. Disconnect brake lines at brake hose.
7. Disconnect shock absorber at upper mounting. It is necessary to remove air cleaner. See Figure 3A-24.
8. Disconnect engine mounts at cross member.
9. Remove front suspension cross member attaching nuts and lower the cross member.

#### Removal Opel 1900 - Manta

1. Prior to raising front end of car, apply parking brake and block rear wheels.

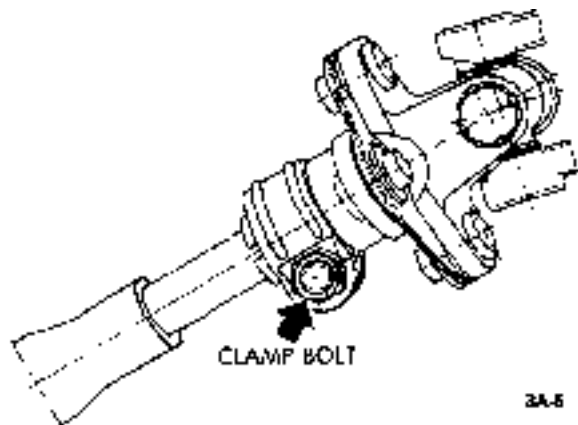


Figure 3A-6 GT Steering Mast Joint

2. Install Hooks J-23697 before jacking up car to assure proper loading of suspension bushings and mounts. See Figure 3A-7.
3. Raise front of vehicle and support with stands.
4. Remove front wheels.
5. Remove guard plate. See Figure 3A-8.
6. Remove brake line retainers on both sides. The brake system remains closed. Unscrew brake calipers and suspend them in wheel house.

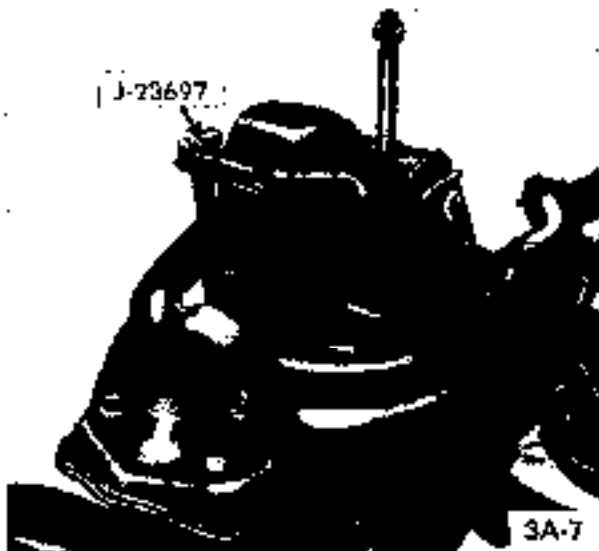


Figure 3A-7 Installing Hooks J-23697

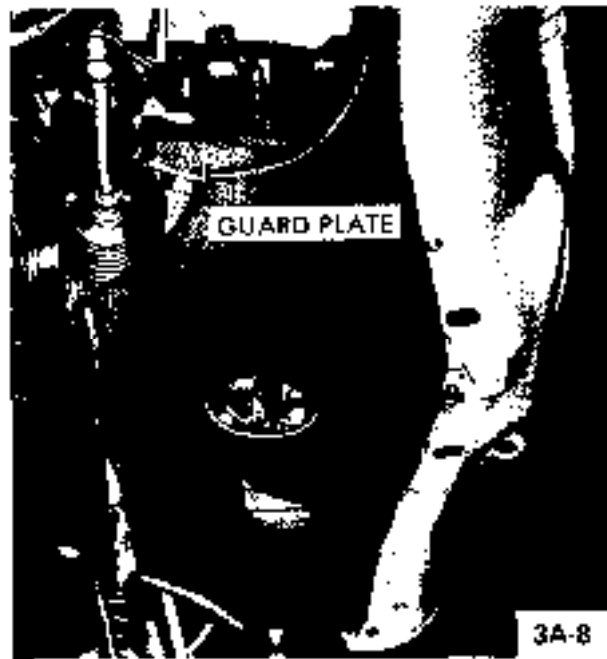


Figure 3A-8 Removing Guard Plate

7. Suspend engine with a suitable engine lifter, similar to the one shown in Figure 3A-9.
8. Unscrew lower steering mast clamp bolt out of pinion flange. See Figure 3A-10.
9. Unscrew front left and right engine mount from damper block.
10. On top and in the rear, unscrew front suspension



Figure 3A-9 Suitable Engine Lifter

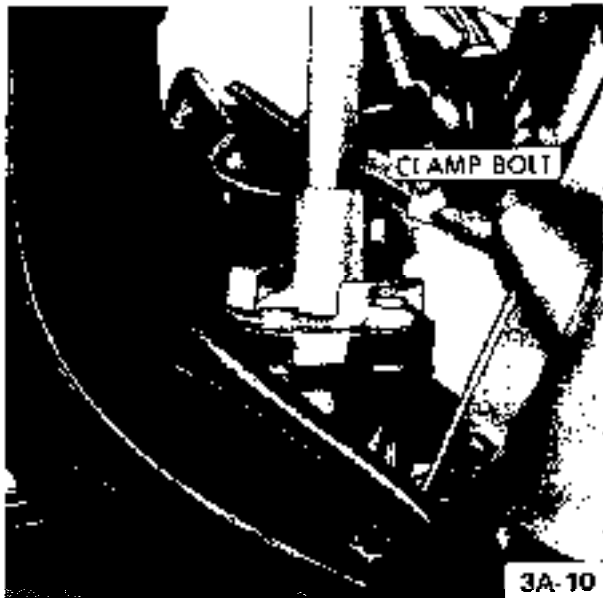


Figure 3A-10 Steering Mast Clamp Bolt

assembly at the cross member to body support from frame and let it down onto jack. See Figure 3A-11.

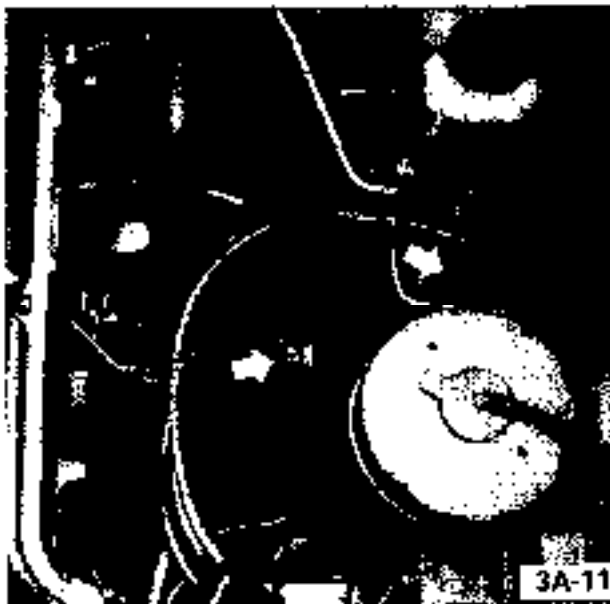


Figure 3A-11

#### Installation GT

**CAUTION:** Fasteners are important attaching parts in that they could affect the performance of vital components and systems, and/or could result in major repair expense. They must be replaced with one of the same part number or with an equivalent part if replacement becomes necessary. Do not use a replacement part or lesser quality or substitute design.

*Torque values must be used as specified during reassembly to assure proper retention of these parts.*

1. Support front suspension and cross member on jack and raise into position.
2. Attach cross member to front frame rail. Torque to 36 lb.ft.
3. Install engine mounting nuts. Remove engine support.
4. Install shock absorber mounting bolts and install air cleaner.
5. Connect brakes hoses and bleed brakes as outlined in Group 5.
6. Install radiator mounting bolt in support cross member.
7. Push steering column downwards until a 1/8" clearance is obtained between steering wheel hub and switch cover.
8. With steering wheel in centered position and front wheels straight ahead, tighten the clamp bolt at the lower universal joint to 22 lbs.ft. and the clamp at the upper universal joint to 14 lbs.ft. See Figure 3A-6.
9. Install mast guide sleeve stop bolt. Always install new lock plate. See Figure 3A-7.
10. Remove front support stands and lower vehicle.

#### Installation Opel 1900 - Manta

1. With jack, lift up front suspension assembly so that the individual attaching points coincide. At the same time, insert lower steering mast into pinion flange. See Figure 3A-12.
2. In the rear bolt cross member to body support. Torque to 58 ft.lbs. When doing this with a suitable tool, counterhold damper bushing which is installed in a certain position, to prevent it from turning. For this purpose, detach heat deflector plate on right vehicle side.
3. Torque front suspension assembly to frame attachment to 47 ft.lbs.
4. Torque lower steering mast to pinion flange attachment clamp bolt to 22 ft.lbs.
5. Reinstall both brake calipers. Torque to 72 ft.lbs. Install brake line retainer.
6. On both sides install upper control arm ball joint. Torque bolts to 29 ft.lbs.



Figure 3A-12 Front Suspension Attaching Points

Always use new self-locking nuts.

7. Reinstall guard plate.
8. Crosswise torque wheel nuts to 65 ft.lbs.

### UPPER BALL JOINT REMOVAL AND INSTALLATION

#### Removal

1. Place jack under spring eye and raise car. Remove wheel from car.
2. Remove cotter pin and castle nut from upper ball joint stud. Discard cotter pin.
3. Press ball stud from steering knuckle using puller J-21687, and remove two (2) bolts attaching ball joint to upper control arm. See Figure 3A-13.
4. If dust cap on upper ball joint is torn or missing, the ball joint should be replaced.

#### Installation

**CAUTION:** *Fasteners are important attaching parts in that they could affect the performance of vital components and systems, and/or could result in major repair expense. They must be replaced with one of the same part number or with an equivalent part if replacement becomes necessary. Do not use a replacement part of lesser quality or substitute design. Torque values must be used as specified during reassembly to assure proper retention of these parts.*

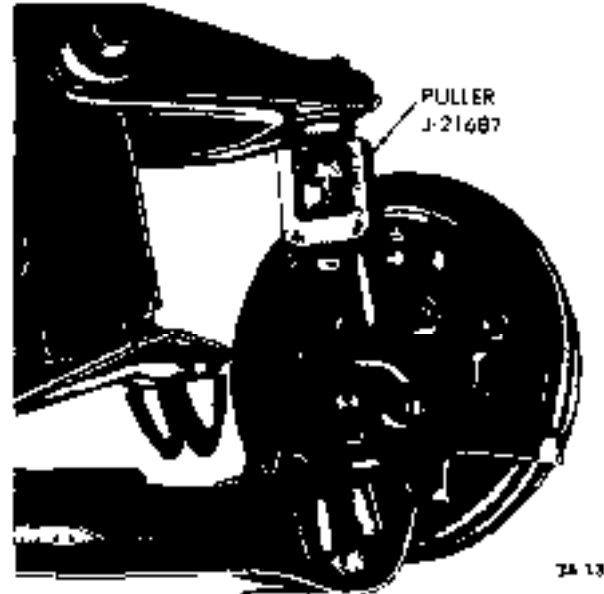


Figure 3A-13 Upper Ball Joint

1. Install upper control arm ball joint with the off center holes in flange showing towards the steering knuckle spindle.
2. Install two (2) bolts attaching ball joint to upper control arm. Torque nuts to 29 lb.ft.
3. Install upper ball joint stud in steering knuckle and torque castle nut to 29 lb.ft. on GT and 40 lb.ft. on Opel 1900 - Manta.
4. Install new cotter pin, and replace wheel.
5. Always check caster and camber after installing new ball joints.

### LOWER BALL JOINT REMOVAL AND INSTALLATION

New lower ball joints have an axial play of up to .020 inch. The maximum permissible axial play of older ball joints is .080 inch. At an axial play of more than .080 inch, the lower ball joint must be replaced. If the dust cap is torn, loose, or missing, the lower ball joint must also be replaced. See Figure 3A-14.

The lower ball joints are checked for wear by using Checking Gauge J-23402 for the GT, and using Checking Gauge J-23745 for the Opel 1900 - Manta. See Figure 3A-15.

#### Removal GT

1. Raise car and support at rear of front frame rails.
2. Remove front wheel.

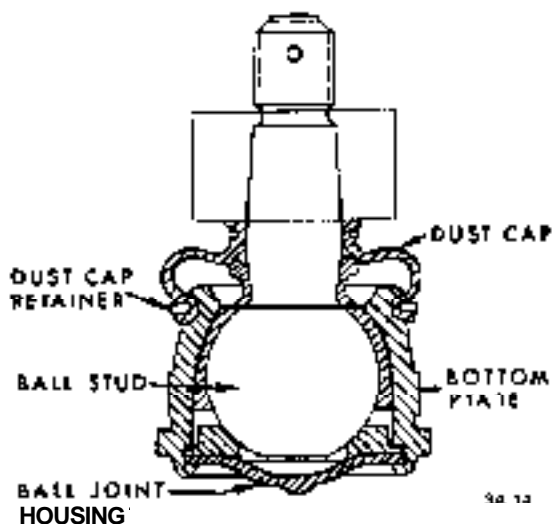


Figure 3A-14 Lower Ball Joint

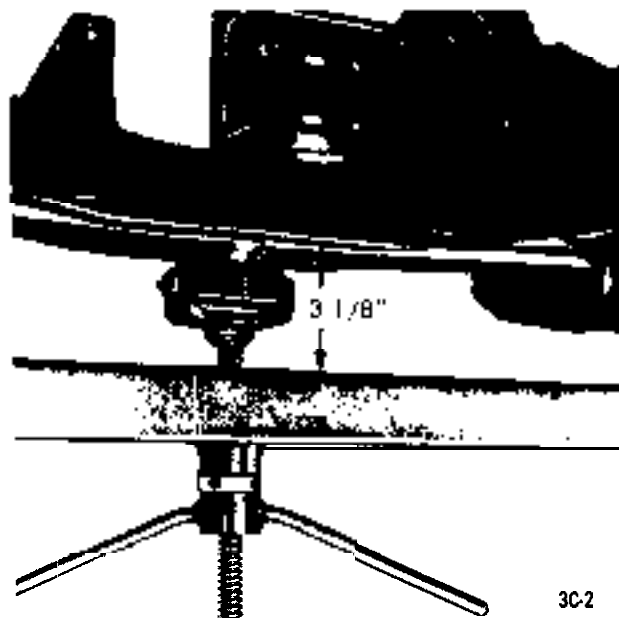


Figure 3A-16 Spring Compressor

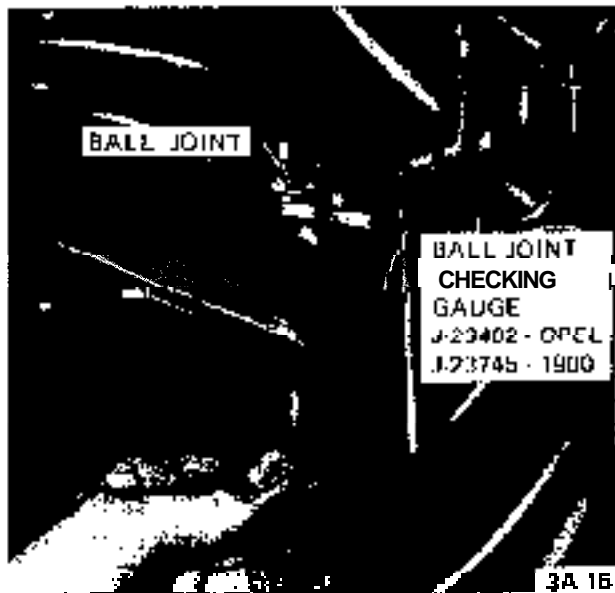


Figure 3A-15 Ball Joint Checking Gauge Installed

attachment bolt and swing shock absorber out of the way.

6. Remove castle nut from ball joint stud. Prior to the removal of the lower ball joint from the control arm, note the position of the locating notch, shown in Figure 3A-17, in the rim of the ball joint housing. Scribe or mark the control arm to facilitate alignment of the replacement ball joint during installation.

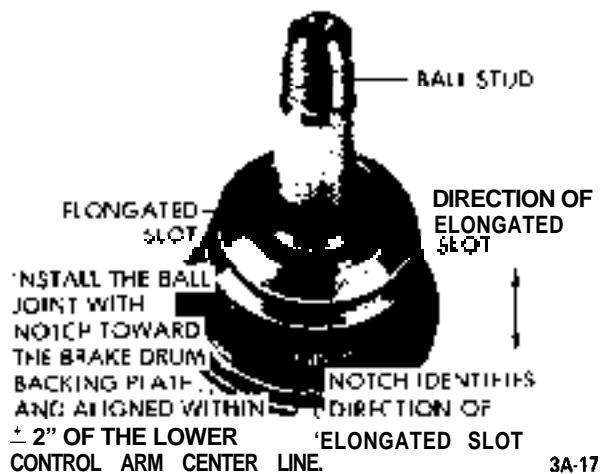


Figure 3A-17 Lower Ball Joint Notch - GT

3. Remove cotter pin from castle nut on ball joint stud and back off castle nut two (2) turns. Hit ball stud a sharp blow to break it loose. DO NOT REMOVE NUT.

4. Install spring compressor (J-21689) and compress spring until a distance of 3-1/8" is achieved between spring compressor and lower spring leaf. See Figure 3A-16.

5. Disconnect shock absorber to lower control arm

7. Pry off dust cap retainer and remove dust cap being careful not to damage it.

8. Press ball stud out of lower control arm.

### Removal Opel 1900 - Manta

Before raising vehicle, install Hooks J-23697 on respective vehicle side to cross member and upper control arm. See Figure 3A-7.

1. Raise car and support at rear of front frame rails.
2. Remove front wheel.
3. At the lower control arm ball joint, remove castle nut cotter pin and slacken back nut so that the thread can no longer be damaged.
4. With a suitable drift, detach ball joint from steering knuckle. With jack, lift up lower control arm, unscrew castle nut and remove Hooks J-23697.
5. Unscrew upper control arm ball joint and suspend front wheel hub and brake caliper in wheel house. Do not turn upper control arm ball joint flange, as this would result in a change of camber.
6. Remove defective lower control arm ball joint using Tools J-9519 and Receiver J-23754.

### Installation GT

**CAUTION:** Fasteners are important attaching parts in that they could affect the performance of vital components and systems, and/or could result in major repair expense. They must be replaced with one of the same part number or with an equivalent part if replacement becomes necessary. Do not use a replacement part of lesser quality or substitute design. Torque values must be used as specified during reassembly to assure proper retention of these parts.

1. When pressing the ball joint in place, make certain the locating notch in the lower rim of the ball joint matches the alignment reference mark placed on the lower control arm prior to removal. The notch in the ball joint bottom plate, identifying the direction of the elongated slot, must point towards the brake drum backing plate. See Figure 3A-17. Alignment must be within 2 degrees of lower control arm centerline. If proper positioning of the ball joint is not accomplished, the result is a limitation of the necessary ball stud movement. If ball stud movement is limited, an interference between the ball stud and housing is created, and binding or even fracture may occur. Replacement ball joints may or may not have marking notch as shown in Figure 3A-20. If it does not have a marking notch, the joint is completely symmetrical and may be installed in any position. When pressing in ball joint do not press on bottom plate, but on ball joint housing only.

2. Install dust cap on lower ball joint and fill with chassis lubricant. Attach dust cap retainer.
3. Press ball joint into steering knuckle. Use J-9519-3 as installer and J-21690 as a supporting sleeve.
4. Install castle nut on ball joint stud and torque to 40 lb.ft. Install new cotter pin.
5. Reconnect shock absorber to lower control arm and torque to 30 lb.ft.
6. Remove spring compressor.
7. Install front wheel, and lower the car.
8. Always check caster and camber after ball joint replacement.

### Installation Opel 1900 - Manta

**CAUTION:** Fasteners are important attaching parts in that they could affect the performance of vital components and systems, and/or could result in major repair expense. They must be replaced with one of the same part number or with equivalent parts, if replacement becomes necessary. Do not use a replacement part of lesser quality or substitute design. Torque valves must be used as specified during reassembly to assure proper retention of these parts.

1. Drive new ball joint into lower control arm using Tools J-9519 as installer and J-23755 as a supporting sleeve. Do not strike onto ball joint bottom.

The ball joint is maintenance-free. It is supplied as an assembly only and cannot be disassembled further.

2. On new lower control arm ball joint, make sure that the marking groove in the housing bottom in alignment with the axis of the lower control arm. Permissible deviation: minus 2 degrees to plus 2 degrees.

This is required, to obtain the maximum freedom of movement of the ball stud in the housing. See Figure 3A-18.

3. Attach steering knuckle together with front wheel hub and brake caliper to lower control arm ball joint. Torque castle nut to 54 ft.lbs.
4. Attach ball joint to upper control arm and torque to 29 ft.lbs. Always use new self-locking nuts.
5. Install wheel and tighten nuts to a torque of 65 ft.lbs.
6. Lower car and check caster and camber.



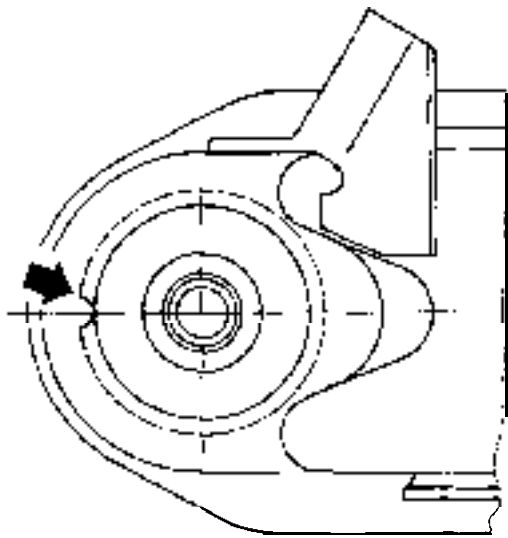


Figure 3A-18 Lower Ball Joint Notch Opel 1900 .  
Manta

## UPPER CONTROL ARM REMOVAL AND INSTALLATION

### Removal GT

1. Raise car and support at rear of front frame rails.
2. Remove front wheel.
3. Install spring compressor and compress spring until there is 3-1/8" between compressor and lower spring leaf.
4. Remove cotter pin and castle nut from upper ball joint stud. Discard cotter pin.
5. Use tie rod remover J-21687 remove ball joint from steering knuckle. 6. Support brake drum to relieve tension on brake hose.
7. Remove hex nut from upper control arm shaft. Remove shaft and washers from shock absorber support. Do not damage threads on control arm shaft.
8. Remove control arm from car. Do not lose inner toothed washers. Note size and location of toothed washers.

### Removal Opel 1900 . Manta

1. Raise car and support at rear of front frame rails.
2. Remove front wheel
3. Unscrew upper control arm to cross member self-locking attaching nut.

4. Unscrew ball joint from upper control arm. Do not turn upper control arm ball joint flange, as this would result in a change of camber.

5. Support front wheel hub so that brake hose is not stressed.

6. Pull out upper control shaft to cross member attaching bolt and remove control arm. Shims have to be reinstalled in their original location to maintain the proper caster setting.

### Installation GT

**CAUTION:** *Fasteners are important attaching parts in that they could affect the the performance of vital components and systems, and/or could result in major repair expense. They must be replaced with one of the same part number or with an equivalent part if replacement becomes necessary. Do not use a replacement part or lesser quality or substitute design. Torque values must be used as specified during reassembly to assure proper retention of these parts.*

If rubber bushings on control arms are worn, arms must be replaced.

1. Slide rubber rings over bushings. Slide rings over inner sleeves of bushings. Place control arm in position on shock absorber support, installing toothed washers in their **original** positions. See Figure 3A-19.
2. From front to rear, install control arm shaft. If necessary, align washers and control arm bushings with a small drift prior to installing control arm shaft. See Figure 3A-19.
3. Tighten hex nut on control arm shaft finger tight.
4. Increase tension on spring compressor in order to relieve tension on control arm shaft. Then torque hex nut on control arm shaft to 33 lb.ft.
5. Press ball joint stud into steering knuckle and torque castle nut to 29 lb.ft. Install new cotter pin.
6. Remove spring compressor and lower car.
7. Check front end alignment.

### Installation Opel 1900 - Manta

**CAUTION:** *Fasteners are important attaching parts in that they could affect the performance of vital components and systems, and/or could result in major repair expense. They must be replaced with one of the same part number or with equivalent parts, if replacement becomes necessary. Do not use a re-*

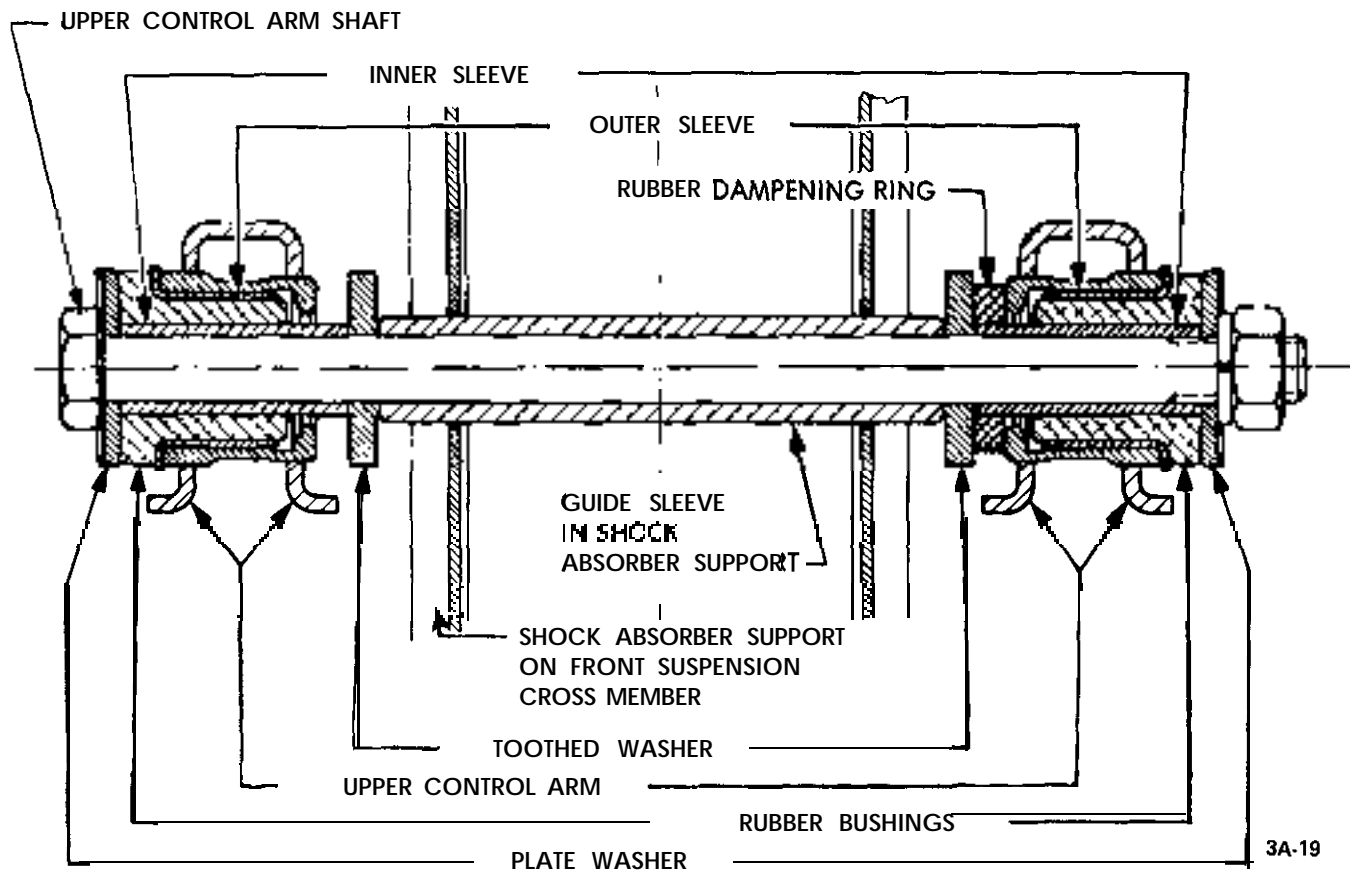


Figure 3A-19 Upper Control Arm Shaft and Bushings

*placement part of lesser quality or substitute design. Torque valves must be used as specified during reassembly to assure proper retention of these parts.*

1. On installation of the upper control arm, make sure that damper bushing with the rubber shoulder on both sides is always located in the rear.

2. Attach upper control arm to cross member and torque to **40 lb.ft.** Always use new self-locking hex nut. The upper control arm must be tightened in horizontal position only. This applies also to all other attaching joints in connection with rubber damper bushings in the control arms of the front suspension so that the rubber parts under load are in an almost twist-free condition. This position exists, if the hooks J-23697 are used.

3. Attach ball joint to upper control arm and torque to **29 lb.ft.**

4. Install wheel and torque nuts to **65 lb.ft.** Lower car.

## LOWER CONTROL ARM REMOVAL AND INSTALLATION

### Removal GT

1. Raise car and support at rear of front frame rails.

2. Remove front wheel.

3. Remove cotter pin from castle nut on ball joint stud and back off castle nut two (2) turns. Hit ball stud a sharp blow to break it loose. **DO NOT REMOVE NUT.**

4. Install spring compressor (J-21689) and compress spring until a distance of **3-1/8 inches** is achieved between spring compressor and lower spring leaf.

5. Disconnect and compress shock absorber.

6. Support rail of spring compressor with a jack. Remove lower control arm from frame cross member. Nuts may have to be removed with a punch. See Figure 3A-20. Discard the lock nuts.

7. Remove lower ball joint stud nut. Slightly lower

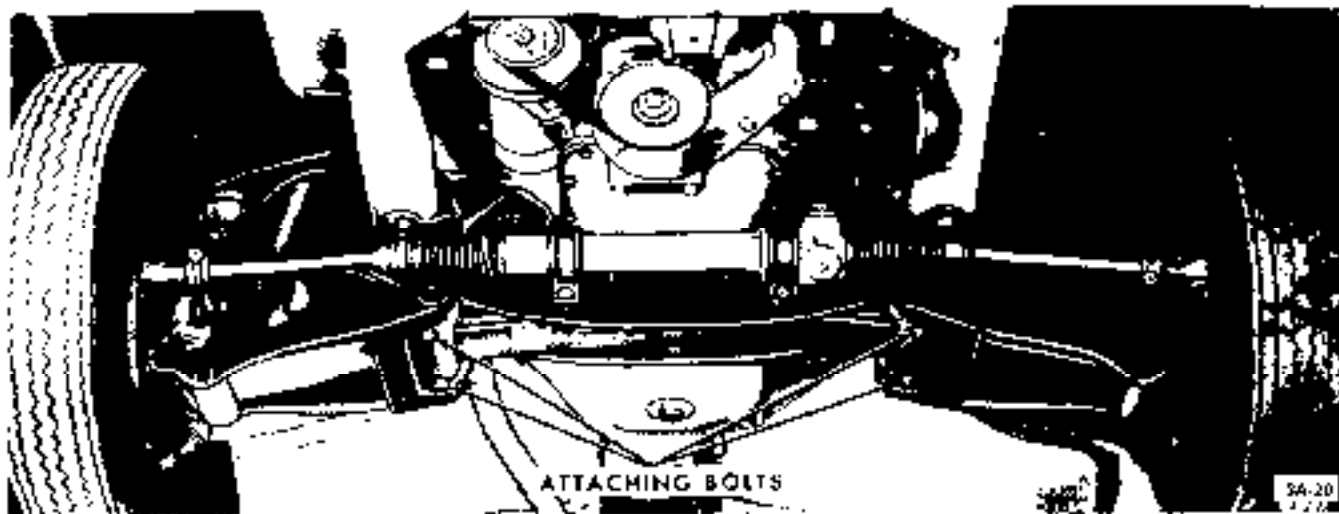


Figure 3A-20 Lower Control Arm Attachment

**jack** so that spring and lower control arm assembly is removed from the front cross member and steering knuckle.

8. Lower jack, spring compressor, and front spring with control arm assembly. Remove lower control arm to spring nuts.

9. Release spring compressor and remove control arm attaching bolts and control arm.

#### Removal Opel 1900 - Manta

1. Prior to raising car, install upper control arm hooks J-23697.

2. Raise car and support with stands. Hoist should be left in the raised position to maintain pressure on lower control arm.

3. Remove front wheel.

4. Detach both stabilizer supports from cross member to body support.

5. In lower control arm, remove self-locking hex head bolt from stabilizer support and remove washer.

6. Using a pry bar, pry stabilizer bar out of lower control arm support.

7. Remove shock absorber.

8. At lower control arm ball joint, remove castle nut cotter pin and remove nut.

9. With suitable drift, detach lower control arm ball joint from steering knuckle.

10. Loosen nut that retains lower control to front cross member.

11. Slowly lower hoist to release spring tension.

12. **Swing lower control arm downwards and remove front spring.**

13. Remove nut that retains lower control arm to front cross member and remove lower control arm.

#### Installation GT

**CAUTION:** Fasteners are important attaching parts in that they could affect the performance of vital components and systems, and/or could result in major repair expense. They must be replaced with one of the same part number or with an equivalent part if replacement becomes necessary. Do not use a replacement part of lesser quality or substitute design. Torque values must be used as specified during reassembly to assure proper retention of these parts.

1. Attach lower control arm to front spring eye. Torque bolts to 18 lb.ft.

2. Install spring compressor and with a jack raise spring compressor with spring and control arm assembly into position for pressing ball joint into steering knuckle.

3. Press ball joint into steering knuckle. Use J-9519-3 as installer and J-21690 as a supporting sleeve.

4. Install castle nut on ball joint stud and torque to 54 lb.ft. Install new cotter pin.

5. Attach lower control arm to frame cross member using new lock nuts.

6. Reconnect shock absorber to lower control arm and torque to 30 lb.ft.
7. Remove spring compressor.
8. Install front wheel, and lower the car.
9. Check front end alignment.

#### Installation Opel 1900 Manta

**CAUTION:** Fasteners are important attaching parts in that they could affect the performance of vital components and systems, and/or could result in major repair expenses. They must be replaced with one of the same part number or with an equivalent part, if replacement becomes necessary. Do not use a replacement part of lesser quality or substitute design. Torque values must be used as specified during reassembly to assure proper retention of these parts.

1. Loosely attach lower control arm to front cross member.
2. Properly seat spring between lower control arm and cross member.
3. Raise jack and place lower control into position.
4. Attach lower control ball joint to steering knuckle and torque nut to 54 lb.ft.
5. Tighten lower control arm to cross member bolt to 43 lb.ft.
6. Attach stabilizer bar to lower control arm and torque to 87 lb.ft.
7. Attach stabilizer bar to cross member to body support.
8. Install shock absorber and torque lower attaching nut and bolt to 30 lb.ft.
9. Install nuts on upper shock absorber attaching studs. Tighten nuts until a distance from top of nut to stud is approximately 1/2 inch.
10. Install front wheels and tighten nuts to 65 lb.ft.
11. Remove stands and lower car.

#### STEERING KNUCKLE REMOVAL AND INSTALLATION

##### Removal GT

1. Raise car and support with stands.
2. Remove wheel nuts. Remove wheel assembly.

3. Remove two (2) bolts holding caliper to steering knuckle. See Figure 3A-21. Hang caliper on a wire from the upper control arm as shown in Figure 3A-22.



Figure 3A-2 1 Caliper Attachment

4. Remove spindle grease cap. Remove cotter pin and spindle nut. Remove wheel hub with disc.
5. Install J-21689 spring compressor and compress spring until 3-1/8" clearance is obtained between spring compressor and lower spring leaf.
6. Remove upper ball joint using tie rod remover, J-21687.
7. Remove shock absorber at lower attachment *only*.
8. Remove lower ball joint using J-21687 remover and remove steering knuckle. Remove dust shield from steering knuckle.

##### Removal Opel 1900 - Manta

1. Raise car and support with stands.
2. Detach brake caliper and steering arm from steering knuckle.
3. Remove castle nut cotter pin, unscrew nut and pull steering knuckle off upper control arm ball joint.
4. Unscrew brake caliper and suspend it in wheel house.
5. Remove front wheel hub.
6. Unscrew steering arm and brake cover plate from

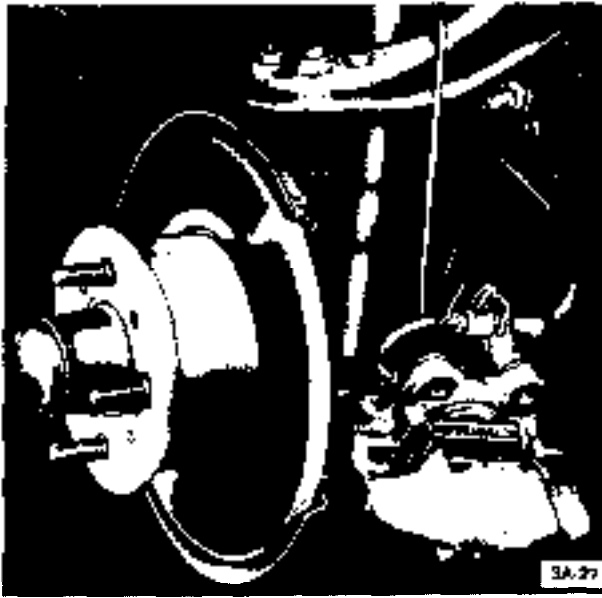


Figure 3A-22 Caliper Removed and Hung by Wire

steering knuckle. Swing steering arm and tie rod to the side.

7. Remove castle nut cotter pin, unscrew nut and pull steering knuckle off lower control arm ball joint.

Installation GT

**CAUTION:** *Fasteners are important attaching parts in that they could affect the performance of vital components and systems, and/or could result in major repair expense. They must be replaced with one of the same part number or with an equivalent part if replacement becomes necessary. Do not use a replacement part of lesser quality or substitute design. Torque values must be used as specified during reassembly to assure proper retention of these parts.*

1. Always replace paper gasket when installing dust shield on steering knuckle. Lightly *coat* both surfaces of paper gasket with chassis lubricant before installation and torque attaching bolts to 47 lb.ft.

2. Install lower ball joint in steering knuckle. Torque castle nut to 54 lb.ft. Install new cotter pin.

3. Attach shock absorber at lower end. Torque bolts to 30 lbs. ft.

4. Install upper ball joint. Torque castle nut to 29 lb.ft. Install new cotter pin.

5. Remove spring compressor.

6. Install hub and disc on spindle and tighten spindle nut as stated under MAINTENANCE AND ADJUSTMENTS in this section.

7. Install caliper on steering knuckle and torque bolts to 72 lb.ft. See Figure 3A-21.

8. Install wheel and torque wheel nuts to 65 lb.ft.

Installation Opel 1900 - Manta

**CAUTION:** *Fasteners are important attaching parts in that they could affect the performance of vital components and systems, and/or could result in major repair expense. They must be replaced with one of the same part number or with equivalent parts, if replacement becomes necessary. Do not use a replacement part of lesser quality or substitute design. Torque values must be used as specified during reassembly to assure proper retention of these parts.*

1. Attach steering knuckle to lower control arm ball joint. Torque castle nut to 54 lb.ft.

2. Attach brake cover plate and steering arm to steering knuckle. If required, install new paper gasket *between* cover plate and steering knuckle. Care for proper seat of T-head bolts. See Figure 3A-23.

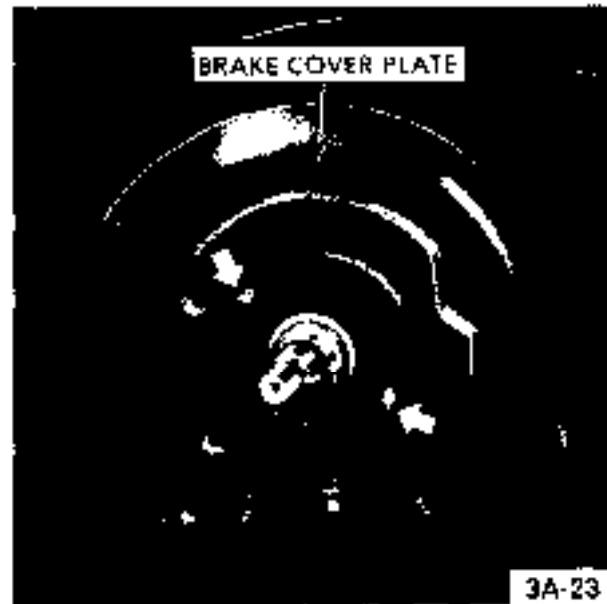


Figure 3A-23 Attaching Brake Cover Plate

3. Install front wheel hub and brake caliper.

4. Attach steering knuckle to upper control arm ball joint. Torque castle nut to 40 lb.ft.

5. Steering arm to steering knuckle - 58 lb.ft.

6. Brake caliper to *steering* knuckle - 72 lb.ft.

7. Adjust front wheel bearing clearance.

8. Remove stands and lower car

## SHOCK ABSORBER REMOVAL AND INSTALLATION

### Removal Opel 1900 - Manta

1. Raise car and support with stands.
2. Remove upper attaching nuts from shock absorber.
3. Remove lower attaching nut, lockwasher, and bolt.
4. Compress shock absorber and remove from car.

### Removal GT

1. Remove air cleaner. See Figure 3A-24.



Figure 3A-24 Removal of Air Cleaner

2. Remove plastic cover over shock absorber upper attachment.
3. Raise car and support with stands.
4. Remove upper attaching nuts from shock absorber.
5. Remove lower attaching nut, lockwasher, and bolt.
6. Compress shock absorber and remove from car.

### Installation Opel 1900 - Manta

1. Inspect shock absorber for damage and seal leaks.

Always replace the upper and lower rubber grommets when replacing a shock absorber.

2. Install the lower grommet retainer and grommets on shock absorber. Compress shock absorber and place in position.
3. Install lower attaching bolt and nut. Torque to 30 lb.ft.
4. Install nuts on upper attaching studs. Tighten nuts until distance from top of nut to stud is approximately 1/2 inch. See Figure 3A-25.
5. Install plastic cover.

### Installation GT

1. Inspect shock absorber for damage and seal leaks. Always replace the upper and lower rubber grommets when replacing a shock absorber.
2. Install the lower grommet retainer and grommets on shock absorber. Compress shock absorber and place in position.
3. Install lower attaching bolt and nut. Torque to 30 lb. ft.
4. Install nuts on upper attaching studs. Tighten nuts until distance from top of nut to stud is approximately 1/2 inch. See Figure 3A-25.
5. Install plastic cover.
6. Install air cleaner.

## FRONT SPRING REMOVAL AND INSTALLATION

### Removal (GT)

1. Raise car and support at rear of front frame rails with stands.
2. Remove front wheels.
3. Remove cotter pin from castle nut on lower ball joint studs and back off castle nut two (2) turns. Hit ball stud a sharp blow to break it loose. *Do not remove nut.*
4. Install J-21689 spring compressor and compress the spring until 3-1/8" clearance is obtained between spring and compressor.
5. Disconnect both shock absorbers at their lower attachment. Compress both shock absorbers.
6. Support the rail of J-21689 Spring Compressor with a jack. Remove lower control arm to cross member attaching nuts and bolts.

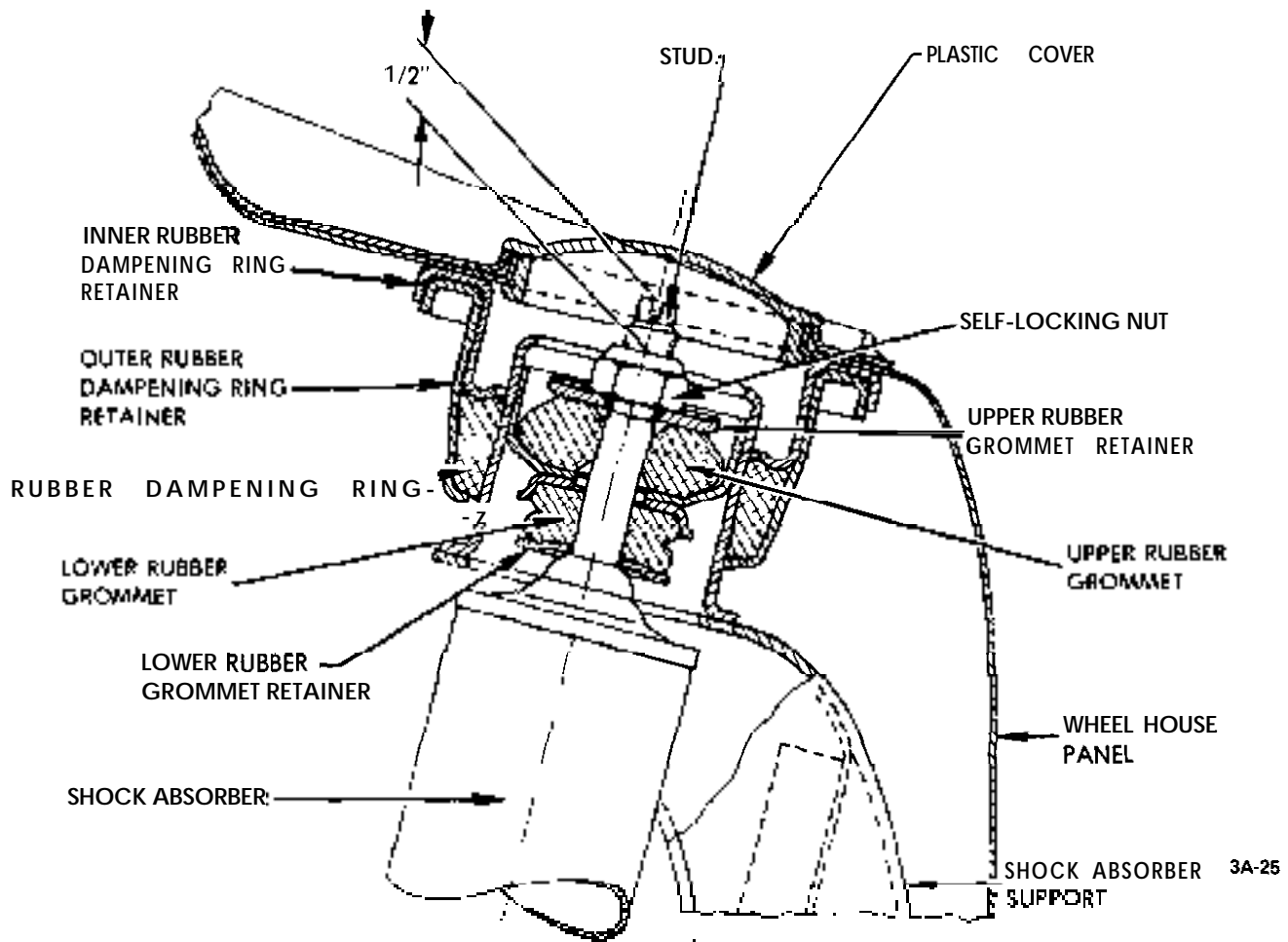


Figure 3A-25 Shock Absorber Upper Attachment

7. Remove lower ball joint stud nuts. Slightly lower jack so that the spring and lower control arm assembly is removed from the front cross member and steering knuckle.

8. Lower jack, spring compressor, and front spring and control arm assembly. Remove lower control arm to spring nuts.

9. Relieve tension on spring compressor and remove control arm attaching bolts and control arms.

**Removal (Opel 1900 - Manta)**

1. Prior to raising car, install upper control arm hooks J-23697.

2. Raise car and support with stands. Hoist should be left in the raised position to maintain pressure on lower control arm.

3. Remove front wheel.

4. Detach both stabilizer supports from cross member to body support.

5. Remove shock absorber.

6. At lower control arm ball joint, remove castle nut cotter pin and **remove nut**.

7. With suitable drift, detach lower control arm ball joint from steering knuckle.

8. Loosen nut that retains lower control to front cross member.

9. Slowly lower hoist to release spring tension.

10. Swing lower control arm downwards and remove front spring.

**Installation (GT)**

**CAUTION:** Fasteners are important attaching parts in that they could affect the performance of vital components and systems, and/or could result in major repair expense. They must be replaced with one of the same part number or with an equivalent part if replacement becomes necessary. Do not use a replacement part of lesser quality or substitute design.

*Torque values must be used as specified during reassembly to assure proper retention of these parts.*

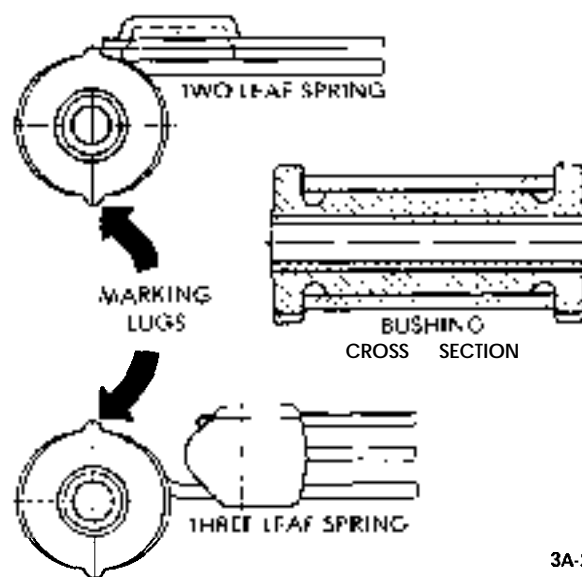
1. Attach lower control arm to front spring eye. Torque bolts to 18 lb.ft.
2. Install spring compressor on spring and compress spring to appropriate length.
3. Raise jack with spring compressor, spring and control arm assembly into position under the car.
4. Install lower ball joints and torque nuts to 54 lb.ft. Install new cotter pin.
5. Attach lower control arms to frame cross member using new lock nuts.
6. Attach both shock absorbers. Torque bolts to 30 lb.ft.
7. Remove spring compressor.
8. Install front wheels.

On replacement of the damper bushings on the front springs, only the one-part damper bushing is installed for either the two-leaf or three-leaf spring. For proper location of the marking lugs, see Figure 3A-26.

#### Installation (Opel 1900. Manta)

**CAUTION:** *Fasteners are important attaching parts in that they could affect the performance of vital components and systems, and/or could result in major repair expense. They must be replaced with one of the same part number or with an equivalent part, if replacement becomes necessary. Do not use a replacement part of lesser quality or substitute design. Torque values must be used as specified during reassembly to assure proper retention of these parts.*

1. Properly seat spring between lower control arm and cross member.
2. Raise jack and place lower control into position.



3A-26

Fig. 3A-26 Front Spring Damper Bushing.

3. Attach lower control ball joint to steering knuckle and torque nut to 54 lb.ft.
4. Tighten lower control arm to cross member bolt to 43 lb.ft.
5. Attach stabilizer bar to cross member to body support.
6. Install shock absorber and torque lower attaching nut and bolt to 30 lb.ft.
7. Install nuts on upper shock absorber attaching studs. Tighten nuts until a distance from top of nut to stud is approximately 1/2 inch.
8. Install front wheels and tighten nuts to 65 lb.ft.
9. Remove stands and lower car.

## SPECIFICATIONS

### BOLT TORQUE AND FRONT END ALIGNMENT



SPECIFICATIONS

Torque Specifications

Use a reliable torque wrench to tighten all parts listed to insure proper tightness without straining or distorting parts. These specifications are for clean and lightly-lubricated threads only; dry or dirty threads produce increased friction which prevents accurate measurement of tightness.

Location	Torque Lb.Ft.
Front Suspension Crossmember to Front Frame	36
Clamp, Steering Mast to Steering Mast Flange (GT) .....	15
Clamp, Steering Mast to Steering Mast Flange (1900 • Manta) .....	22
Clamp, Upper Universal Joint (GT) .....	14
Clamp, Lower Universal Joint (GT) .....	22
Wheel Nuts .....	65
Lower Control Arm Shaft to Lower Control Arm .....	40
Lower Control Arm Ball Joint to Steering Knuckle .....	54
Upper Control Arm Ball Joint to Steering Knuckle (GT) .....	29
Upper Control Arm Ball Joint to Steering Knuckle (1 900 Manta) .....	40
Upper Control Arm Ball Joint to Upper Control Arm	29
Shock Absorber to Lower Control Arm .....	30
Steering Arm to Steering Knuckle (1900 • Manta) .....	58
Brake Backing Plate or Brake Disc Shield and Steering Arm to Steering Knuckle (GT)	
Hex Head Bolt M 10 .....	47
Hex Head Bolt M 8 .....	18
Brake Backing Plate to Steering Knuckle (1900 Manta) .....	58
Brake Caliper to Steering Knuckle .....	72
Lower Control Arm to Front Spring Eye (GT) .....	18
Brake Disc to Front Wheel Hub .....	36
Upper Control Arm to Crossmember (1900 • Manta)	40
Lower Control Arm to Crossmember (1900 • Manta)	43
Steering Gear Housing to Front Suspension Crossmember (GT) .....	18
Steering Gear Housing to Front Suspension Crossmember (1900 • Manta) .....	30
Stabilizer Bar to Lower Control Arm (Opel 1900 • Manta) .....	87
Tie Rod Clamp Bolts (GT) .....	12
Castle Nut, Tie Rod to Steering Arm .....	29
Upper Control Arm Shaft to Shock Absorber Support and Upper Control Arm (GT) .....	33
Cross Member to Body Support Attachment .....	58
Front Suspension Assembly to Frame .....	47

Front End Alignment Specifications

Model	Caster'	Camber"	Toe-In" Min.-Max.	Outer Wheel When Inner Wheel at 20
1900	3 1/2-6 1/2	-1±1/2	1/8-3/16	19 1/4
GT	3±1	1±1/2	1/32-1/8	18 1/2

\*Permissible deviation from left to right wheel • Max. 1'.

# STEERING LINKAGE

## CONTENTS

Subject	Page No.
<b>DESCRIPTION AND OPERATION:</b>	
Description and Operation of Tie Rods .....	3B-19
<b>DIAGNOSIS: (Not Applicable)</b>	
<b>MAINTENANCE AND ADJUSTMENTS: (Not Applicable)</b>	
<b>MAJOR REPAIR:</b>	
Removal and Installation of Tie Rods .....	3B-19
Disassembly and Reassembly of Tie Rods .....	3B-21
<b>SPECIFICATIONS:</b>	
Tightening Specifications .....	3B-21

### DESCRIPTION AND OPERATION

#### DESCRIPTION AND OPERATION OF TIE RODS

Tie rods on the GT are connected to both rack ends by means of a ball joint. Two rubber bellows between ball joint and steering gear housing protect rack and ball joints against dirt, dust and mud. The ball joints of the tie rods do not require service.

Tie rods on the Opel 1900 and Manta are connected to both rack ends by means of a axial joint. Two rubber bellows between the axial joint and steering gear housing protect the rack and axial joints against dirt, dust, and mud. The ball joint of the tie rod ends on the Opel 1900 and Manta are maintenance free and must not be disassembled.

#### MAJOR REPAIR

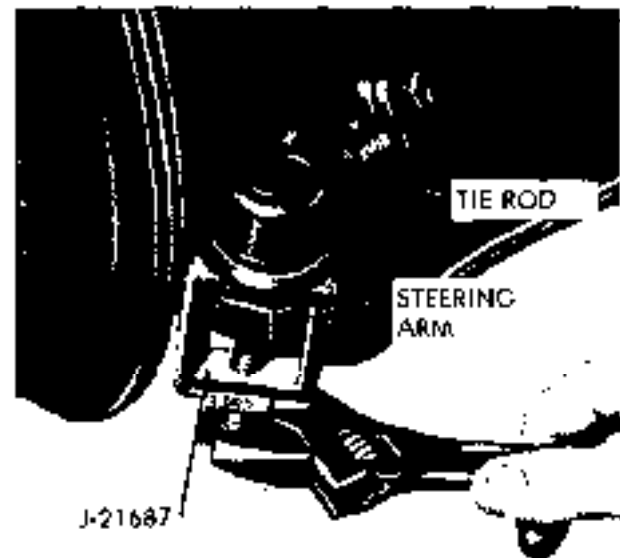
##### REMOVAL AND INSTALLATION OF TIE RODS

###### Removal

In order to avoid the possibility of dirt entering the steering gear assembly via the rack, it is recommended that rods and area immediately surrounding the gear assembly be wiped free of loose dirt prior to removal.

1. Remove cotter pins securing nuts on tie rod ends and remove nuts. Discard cotter pins.

2. Using remover J-21687, pull outer tie rod ball studs out of steering arms. See Figure 3B-2.



3B-2

Figure 3B-2 Removing Ball Stud

3. Remove clamp securing one end of rubber bellows to tie rods and slip bellows off tie rods to expose nut or lock plates. See Figure 3B-3.

4. On the GT, bend up round edges of lock plate from tie rod ball studs and unscrew ball studs From rack. See Figure 3B-4.

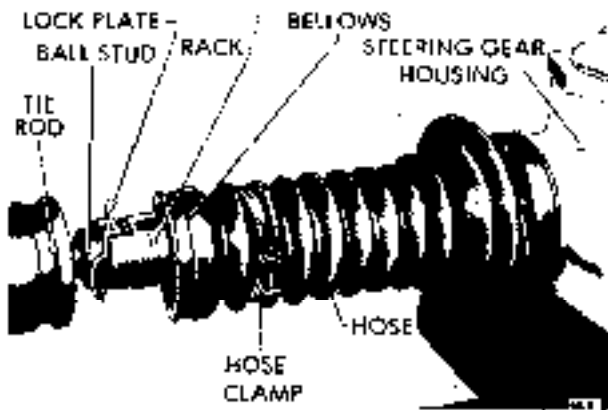


Figure 3B-3 Bellows Removed From Tie Rod GT

5. On the Opel 1900 - Manta, unscrew tie rod from axial joint. It is important that rack be held secure with open end wrench to prevent damage to rack teeth.

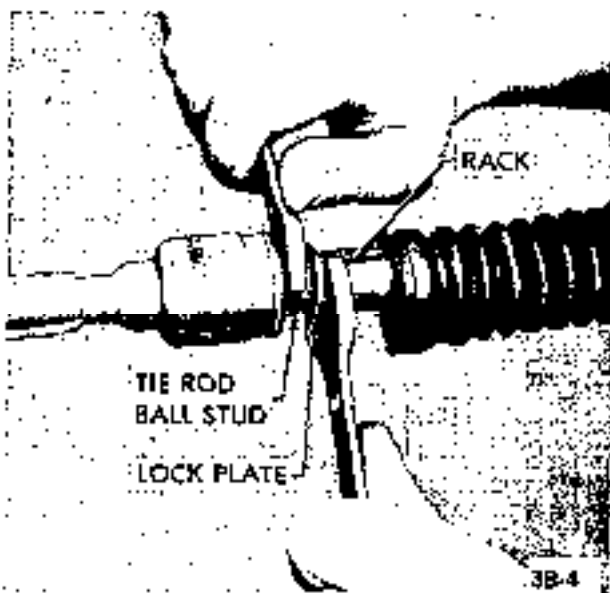


Figure 3B-4 Removing Tie Rods. GT

Installation . GT

**CAUTION:** Fasteners are important attaching parts in that they could affect the performance of vital components and systems, and/or could result in major repair expense. They must be replaced with one of the same part number or with an equivalent part if replacement becomes necessary. Do not use a replacement part or lesser quality or substitute design. Torque values must be used as specified during reassembly to assure proper retention of these parts.

1. Install new lock plates onto tie rod ball studs and screw ball studs into rack while holding bent tab of lock plates against flat on rack. Torque ball studs 43

lb.ft. See Figure 3B-5. It is important that rack be held secure with open end wrench to prevent damage to rack teeth.

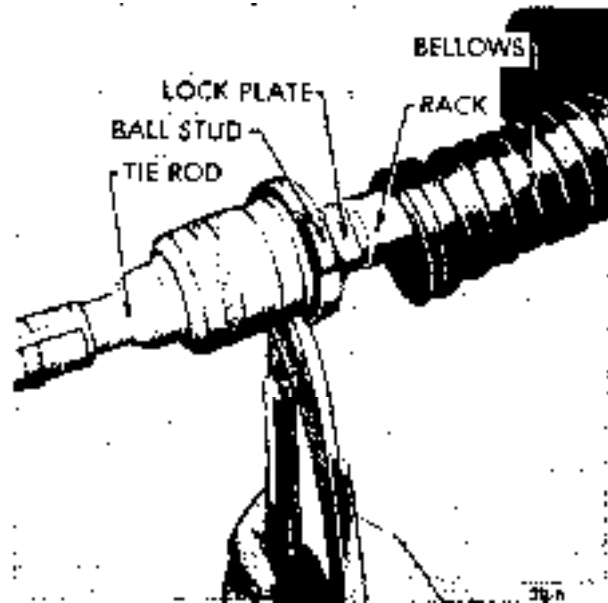


Figure 3B-5 Bending Lock Plate Over Ball Stud . GT

2. Bend round edges of lock plate over flat on ball stud to lock ball stud in position.
3. Position rubber bellows and hose clamps over tie rods and adjust clamp so that wire ends are pointing in same direction as adjusting screw. Check that bellows are not twisted and will compress and expand properly.
4. Connect outer tie rod ball stud to steering arm, torque castle nut to 29 lb.ft., and lock in position with new cotter pin.

Installation Opel 1900 . Manta

**CAUTION:** Fasteners are important attaching parts in that they could affect the performance of vital components and systems, and/or could result in major repair expense. They must be replaced with one of the same part number or with an equivalent part if replacement becomes necessary. Do not use a replacement part of lesser quality or substitute design. Torque valves must be used as specified during reassembly to assure proper retention of these parts.

1. Screw tie rod into axial joint.
2. Attach tie rod end to steering arm and torque nut to 29 lb.ft. Install new cotter pin.
3. Adjust toe-in and then torque lock nut of both tie rods to 47 lb.ft.

4. Attach rubber bellows to axial joint using hose clamp.

**DISASSEMBLY AND REASSEMBLY OF TIE RODS**

The ball joint of the tie rod end on the Opel 1900 • Manta is maintenance free and must not be disassembled.

**Disassembly • GT**

1. Loosen tie rod clamp bolt and unscrew outer tie rod ball stud from tie rod. See Figure 3B-6.
2. Remove retainer ring from outer ball stud of tie rod and take off rubber sealing cap.

**Reassembly GT**

1. Install rubber sealing cap and retainer ring onto outer ball stud.
2. Screw outer tie rod ball stud into tie rod and tighten clamp bolt.

**CAUTION:** Fasteners for tie rods are important attaching parts in that they could affect the performance of vital components and systems, and-

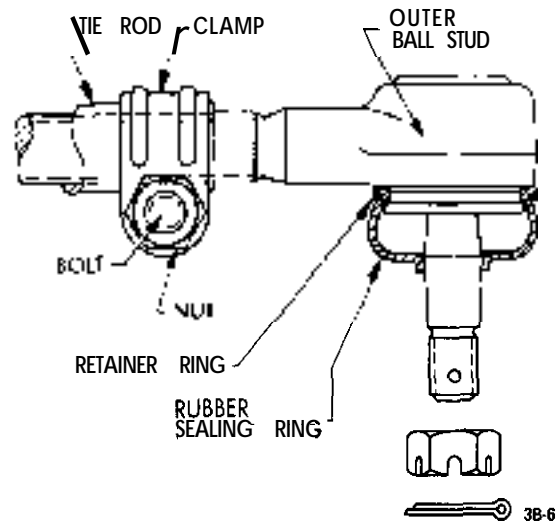


Figure 3B-6 Tie Rod and Outer Ball Stud

*or could result in major repair expense. They must be replaced with one of the same part number or with an equivalent part if replacement becomes necessary. Do not use a replacement part or lesser quality or substitute design. Torque values must be used as specified during reassembly to assure proper retention of these parts.*

**SPECIFICATIONS**

**TIGHTENING SPECIFICATIONS**

Location	Torque Lb.Ft.
Ball Stud to Rack (GT)	43
Ball Stud to Steering Arm (GT)	29
Tie Rod End to Steering Arm (1900 • Manta)	29
Tie Rod Lock Nut (1900 • Manta)	47

# FRONT END ALIGNMENT

## CONTENTS

Subject	Page No.
<b>DESCRIPTION AND OPERATION:</b>	
Front Wheel Alignment .....	3C-22
<b>DIAGNOSIS: (Not Applicable)</b>	
<b>MAINTENANCE AND ADJUSTMENTS:</b>	
Inspection Before Checking Front Wheel Alignment	3C-22
Adjusting Caster .....	3C-23
Adjusting Camber .....	3C-25
Adjusting Toe-In .....	3C-25
King Pin Inclination .....	3C-26
<b>MAJOR REPAIR: (Not Applicable)</b>	
<b>SPECIFICATIONS:</b>	
Wheel Alignment Specifications .....	3C-26

## DESCRIPTION AND OPERATION

### FRONT WHEEL ALIGNMENT

Wheel alignment is the mechanics of adjusting the position of the front wheels in order to attain the least steering effort with a minimal amount of tire wear.

Correct alignment of the chassis is essential to proper alignment of front and rear wheels. Briefly, the essentials are that the frame must be square in plain view within specified limits, that the top and bottom surfaces of the front cross member must be parallel fore and aft, and that the upper and lower control arm must be at correct location in respect to shafts and the front cross member. All bushings, ball joints and bolts must be of proper torque and in usable condition.

Wheel and tire balance has an important effect on steering and tire wear. If wheels and tires are out of balance, "shimmy" or "tramp" may develop or tires may wear unevenly and give the erroneous impression that the wheels are not in proper alignment. For this reason, the wheel and tire assemblies should be known to **be** in proper balance before assuming that wheels are out of alignment.

Close limits on caster, front wheel camber, and theoretical king pin inclination are beneficial to car

handling, but require only reasonable accuracy to provide normal tire life. With the type of front suspension used, the toe-in adjustment is much more important than caster and camber are as far as tire wear is concerned.

Caster and camber adjustments need not be considered unless visual inspection shows these settings to be out, or unless the car gives poor handling on the road. In the majority of cases, services consisting of inflating tires to specified pressure and interchanging tires at recommended intervals, balancing all wheels and tires, adjusting steering gear and setting toe-in correctly will provide more improvement in car handling and tire wear than will other front end alignment adjustments.

The correct use of accurate front end alignment equipment is essential to determine whether front suspension parts have been damaged by shock or accident, and to obtain correct alignment settings after new parts have been installed.

## MAINTENANCE AND ADJUSTMENTS

### Inspection Before Checking Front Wheel Alignment

Before making any adjustment affecting caster, camber, toe-in, theoretical king pin inclination, or **steer-**

ing geometry, the following checks and inspections must be made to insure correctness of alignment equipment readings and alignment adjustments.

1. The front tires should have approximately the same wear and all tires must be inflated to specified pressures (see Wheel and Tire Specifications - Section 3G).
2. Check front wheel bearings for looseness and adjust if necessary (see Front Suspension Adjustments - Section 3A).
3. Check for run-out of wheels and tires, (see Section 3G).
4. Check wheels and tires for balance and correct if out-of-balance (See Section 3G).
5. Check for looseness at ball joints and tie rod ends; if found excessive, it must be corrected before alignment readings will have any value.
6. Check shock absorber action and correct if necessary. Consideration must be given the optional equipment on the car, undercoating, dirt, etc.
7. It is advisable to check the condition and accuracy of any equipment being used to check front end alignment and to make certain that instructions of the manufacturer are thoroughly understood.

#### ADJUSTING CASTER (GT)

**CAUTION:** *Front suspension fasteners are important attaching parts in that they could affect the performance of vital components and systems, and/or could result in major repair expense. They must be replaced with one of the same part number or with an equivalent part if replacement becomes necessary. Do not use a replacement part of lesser quality or substitute design. Torque values must be used as specified during reassembly to assure proper retention of these parts.*

To change caster, three washers are available - one with a .12" thickness, one that is .36" thick, and one .24" thick. **To increase** caster place one of the thin washers at the front of the control arm shaft and one of the thick washers at the rear. **To decrease** caster place one thick washer at the front of the control arm shaft and one thin washer at the rear.

1. Position jack below front suspension cross member and raise front end of car.
2. Place jack stands below front frame side members and remove front wheel on side which caster is to be adjusted.
3. Install front spring compressor J-21689 and compress spring. See Figure 3C-2.

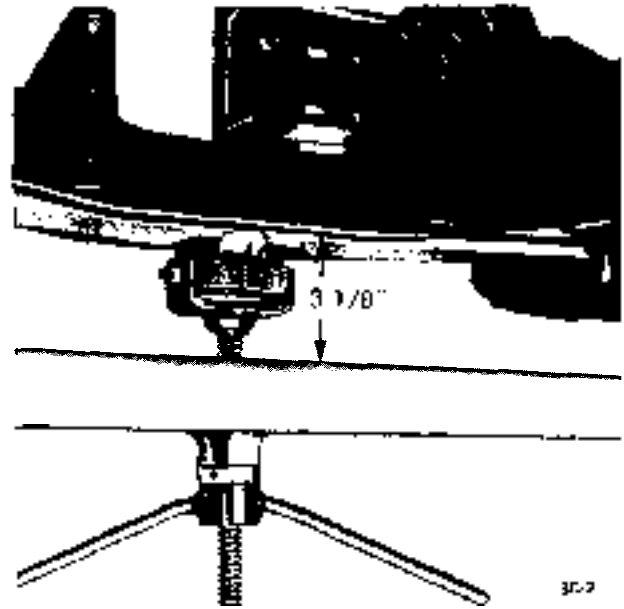
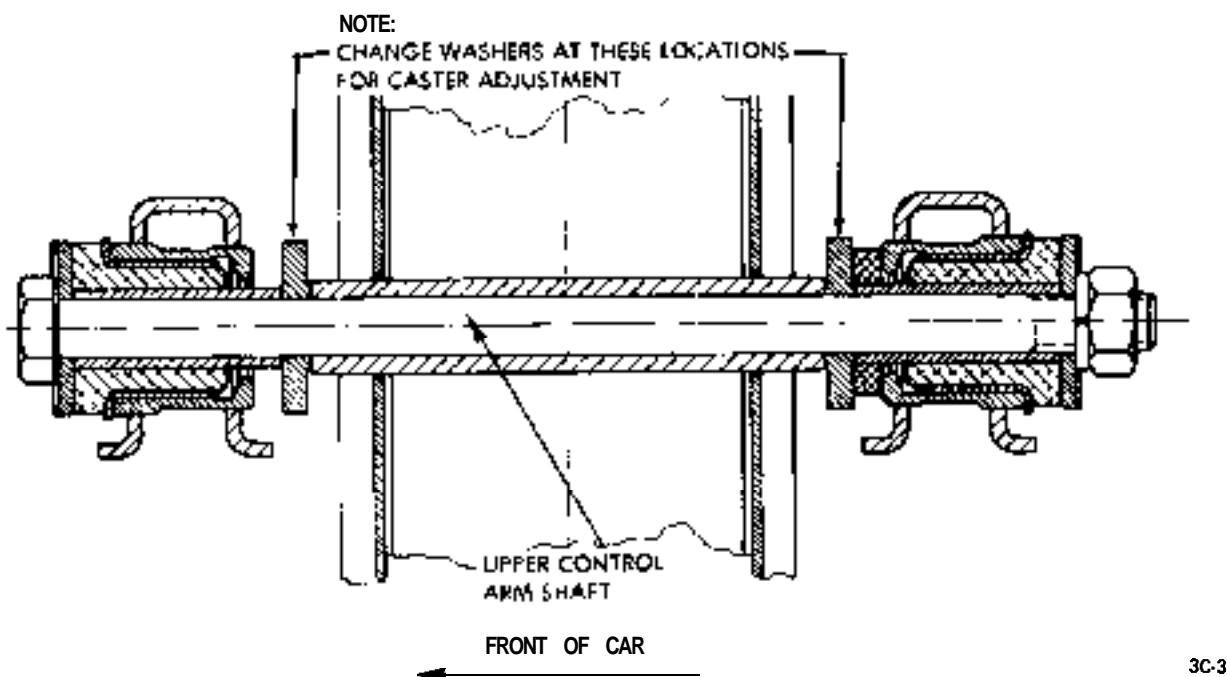


Figure 3C-2 Spring Compressor J-2 1689 Installed

4. Remove upper control arm shaft,
5. Remove upper control arm from shock absorber support, being careful not to lose toothed washers.
6. Adjust caster by installing selective toothed washers on both sides of control arm shaft, between control arm and shock absorber support. Never use more than one washer at any one location. The total thickness, front and rear washer, must equal .48". There are only two possible caster changes that can be made.
7. Using a drift to align holes, replace control arm shaft in the direction as shown in Figure 3C-3. Torque hex nut to 33 lb.ft. Make certain that crown of both plate washers shows outward.
8. Remove spring compressor, and install front wheel and torque wheel nuts to 72 ft. lbs.
9. Recheck caster.

#### ADJUSTING CASTER (OPEL 1900. MANTA)

1. Jack up vehicle and remove front wheel on the side on which caster is to be adjusted.
2. Support vehicle below both lower control arms. See Figure 3C-4.
3. Unscrew hex nut from upper control arm shaft and pull out shaft.
4. Adjust caster by replacing washers (A) (front) and



3C-3

Figure 3C-3 Upper Control Arm Shaft and Bushings

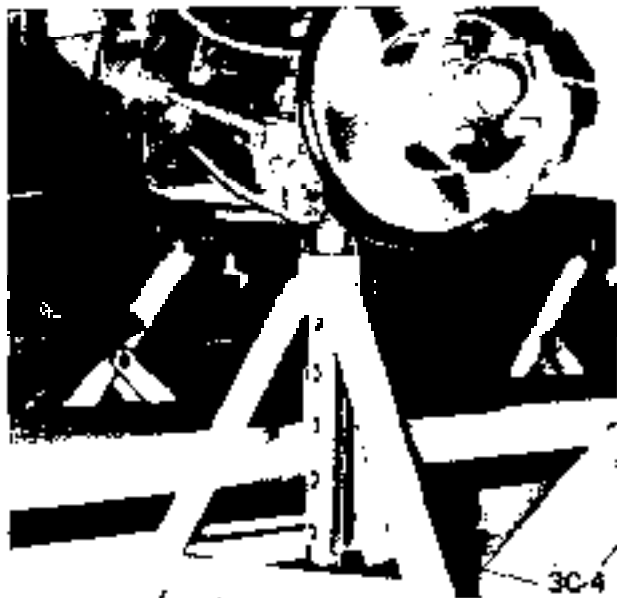


Figure 3C-4 Supporting Vehicle at Both Lower Control Arms

(B) (rear) between upper control arm and shock absorber support. See Figure 3C-5.

5. One .24" thick washer each is installed in production on each car side. Consequently, only two adjustments are possible by adding washers of different thickness.

6. One .12" in front and one .36" in the rear (caster increase of 1 degree) or one .36" in front and one .12" in the rear (caster decrease of 1 degree). Never add

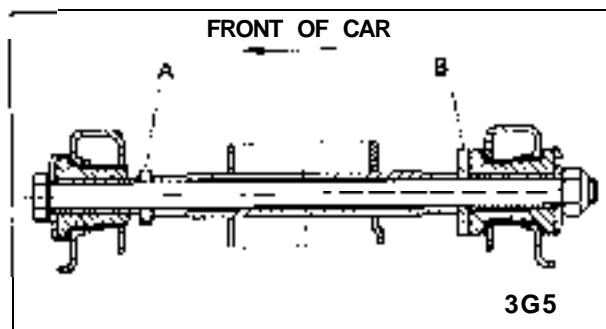


Figure 3C-5 Caster Adjustment Washer Location - Opel 1900 - Manta

several washers in one place. The washers B installed in production have a larger outer diameter than the washer A. For service, the Parts and Accessories Department supplies only larger washers with an outer diameter of 1.57".

7. Insert control arm shaft from front towards the rear into upper control arm and shock absorber support. Observe that the crown of both plate washers shows inwards. See Figure 3C-5.

8. Torque hex nut of control arm shaft to 40 ft.lbs. Always use new self-locking nut.

9. Torque wheel nuts to 75 ft.lbs.

10. Recheck caster setting.

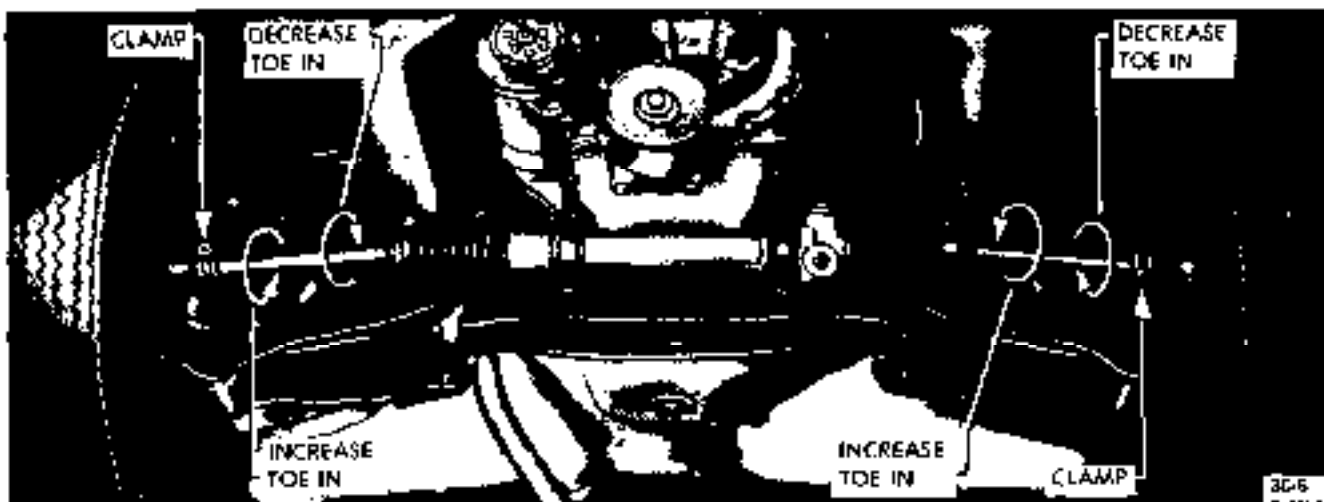


Figure 3C-6 Adjusting Toe-In (GT)

### ADJUSTING CAMBER

Camber is adjusted by turning the upper ball joint flange 180 degrees. This means that only two possible camber adjustments can be made. At the factory **camber** is set at the smallest possible positive camber setting for GT and smallest possible negative camber for Opel 1900 - Manta. Rotating the flange will make **camber** more positive on GT and more negative on Opel 1900 - Manta.

1. Raise front end of car using wood block on jack to prevent damage to front cross member.
2. Support car below lower control arm and remove front wheel on side to be adjusted.
3. Remove ball joint from upper control arm and front steering knuckle.
4. Lift upper control arm and turn the ball joint flange through 180 degrees.
5. First tighten both ball joint attaching bolts on upper control arm and then the ball stud castle nut. Torque to 29 ft. lbs. on GT and 44 ft.lbs. on Opel 1900 - Manta. Install new cotter pin.
6. Install front wheel and torque wheel nuts to 72 lb.ft. on GT and 75 lb.ft. on Opel 1900 - Manta.
7. Recheck camber.

### ADJUSTING TOE-IN (GT)

Toe-in is adjusted by rotating the tie rod sleeves. Refer to Figure 3C-6.

1. Recheck caster and camber before proceeding with toe-in adjustment. If correct, adjust toe-in.

2. Set wormshaft and ball nut to steering gear high point by turning steering wheel half way from one stop to the other, noticing the following:

(a) With the steering wheel hub button removed, the "marking" on the steering shaft end should be in a horizontal position.

(b) The steering wheel spokes should also be in a centered position.

3. Remove wire clamps on left and right tie rod and push back bellows.
4. Loosen clamp bolts and tie rods. See Figure 3C-4.
5. The toe-in should be  $1/32'' - 1/8''$ .

When adjusting toe-in, never grip tie rod on inner ball stud joint. To avoid ball stud resting against inside of hole in tie rod outer end, center outer end of each tie rod to the ball stud.

6. Pull bellows over tie rods and attach with wire clamps. The bellows must not be twisted and wire ends must show towards steering gear adjusting screw opening.
7. Torque clamp bolts to 12 lb.ft.
8. After toe-in adjustment, turn steering wheel several times completely towards the left and right to determine whether bellows are properly attached to the tie rods and steering gear housing.

### ADJUSTING TOE-IN (OPEL 1900. MANTA)

The adjustment of the toe-in has always to be carried out on both tie rods.



1. Loosen lock nut of left and right tie rod and slacken back nut.
2. Remove hose clamp for rubber bellows attachment from respective axial joint and adjust toe-in by turning axial joint. When doing this, observe that the rubber bellows, having a tight seat on the joint, is not twisted. If necessary, lubricate seat of bellows and hold back bellows when turning. See Figure 3C-7.

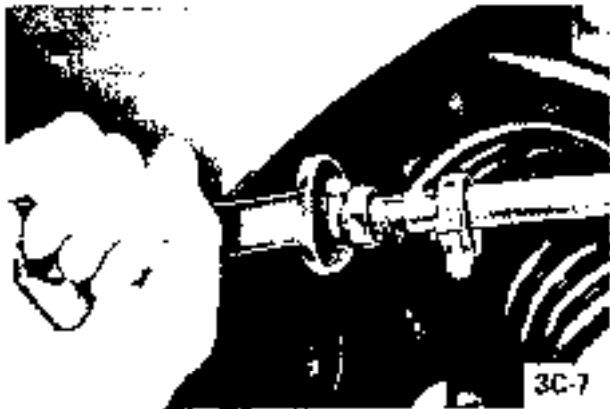


Figure 3C-7 Adjusting Toe-In Opel 1900 Manta

3. Toe-in should be  $1/8'' \pm 3/16''$ .
4. Torque lock nut of left and right tie rod to 47 ft.lbs.
5. Attach respective rubber bellows with hose clamp, making sure that clamp bolt points towards the front. The rubber bellows must not be twisted, i.e.,

the individual grooves of bellows must be in vertical position.

6. After adjustment, turn steering several times to the left and right to determine if a proper attachment of both rubber bellows to the steering gear housing is warranted.

### CHECKING THEORETICAL KING PIN INCLINATION

When checking theoretical king pin inclination, car must be on a level surface, both transversely and fore and aft, must have trim heights within limits, and must be at curb load.

With camber known to be within specified limits, theoretical king pin inclination should check to 8.5 degrees for Opel 1900 - Manta, and 6 degrees for GT.

If camber is incorrect beyond limits of adjustment and theoretical king pin inclination is correct, or nearly so, a bent steering knuckle is indicated.

There is no adjustment for theoretical king pin inclination as this factor depends on the accuracy of the front suspension parts. Distorted parts should be replaced with new parts.

The practice of heating and bending front suspension parts to correct errors must be avoided as this may produce soft spots in the metal in which fatigue and breakage may develop in service.

### Specifications

#### FRONT END ALIGNMENT

MODEL	CASTER °	CAMBER °	TOE-IN		OUTER WHEEL WHEN INNER WHEEL AT 20 °
			MIN..	MAX.	
1900	3 1/2 - 6 1/2	-1 ± 1/2	1/8 -	3/16	19 1/4
GT	3 ± 1	1 ± 1/2	1/32 -	1/8	18 1/2

\* Permissible deviation from left to right wheel - maximum 1".

# STEERING GEAR ASSEMBLY

## CONTENTS

Subject	Page No.
<b>DESCRIPTION AND OPERATION:</b>	
Description and Operation of Steering Gear .....	3D-27
<b>DIAGNOSIS: (Not Applicable)</b>	
<b>MAINTENANCE AND ADJUSTMENTS:</b>	
Adjustment of Steering Gear .....	3D-27
<b>MAJOR REPAIR:</b>	
Removal and Installation of Steering Gear	
Assembly and Tie Rods .....	3D-28
Disassembly and Reassembly of Steering Gear	
Assembly With Tie Rods .....	3D-30
<b>SPECIFICATIONS:</b>	
Tightening Specifications .....	3D-33

## DESCRIPTION AND OPERATION

### DESCRIPTION AND OPERATION OF STEERING GEAR ASSEMBLY

The Opel 1900 • Manta and GT steering gear is the rack and pinion type. The steering gear pinion shaft, connected to the lower end of the steering column, moves the rack to the left or right thereby transmitting the turning motion of the steering wheel to the tie rods and steering arms.

The steering gear housing is held to the cross member by rubber bushings and clamps. The bushings serve to prevent driving noises and vibrations from being transmitted into the passenger compartment. A pinion shaft is seated in the upper portion of the steering gear housing and is supported by a needle bearing in the upper housing, and a bushing in the lower housing. The pinion is not adjustable.

A rubber "O" ring seal is provided for sealing needle bearing, and a second "O" ring for sealing pinion bushing. The rack and pinion shaft are held in mesh by a thrust spring and shell. See Figure 3D-2.

The pressure of the thrust spring may be varied by means of an adjusting screw. The spring forces the sintered bronze shell against the rack, which in turn is held against the pinion shaft. Backlash in the steer-

ing gear is avoided, and road shocks are effectively absorbed.

The rack is seated in the long neck of the steering gear housing in a self-lubricating sintered metal bushing. It is laterally guided by the sintered bronze shell in the adjusting screw opening, and in the short gear housing neck by the rack guide bushing. See Figure 3D-3.

## MAINTENANCE AND ADJUSTMENTS

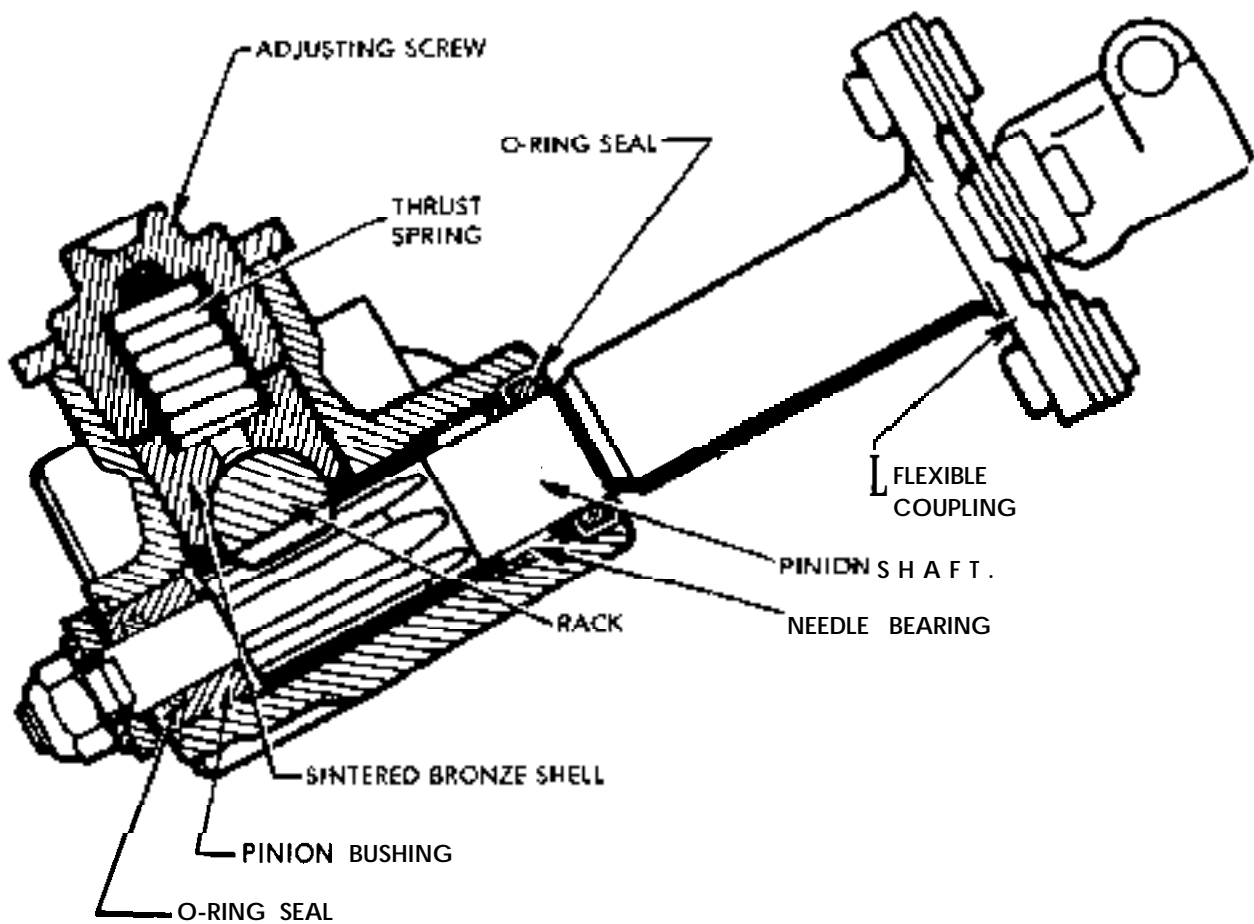
### ADJUSTMENTS OF STEERING GEAR

#### Adjustment of Steering Gear

Adjustment of the steering gear assembly is accomplished by turning the adjusting screw in or out. See Figure 3D-2.

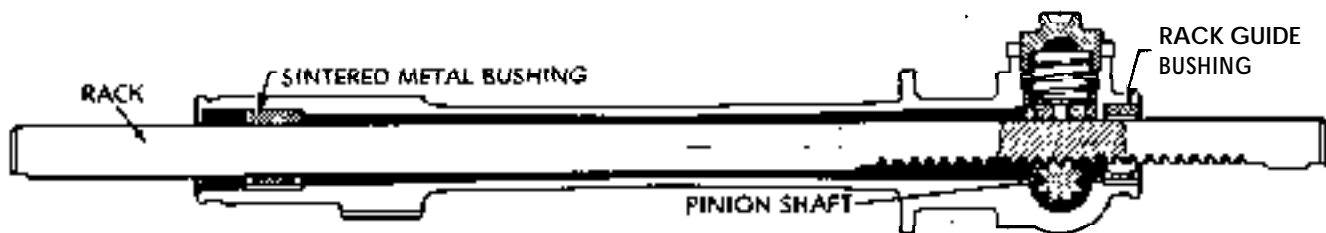
Positioning of the adjusting screw exerts a pressure on the rack, thereby varying the backlash between the pinion and rack.

1. Set steering gear to high point by positioning front wheels straight ahead with steering wheel centered. Flexible coupling bolt hole will be positioned horizontal (or parallel) to the rack.
2. Thread adjusting screw into steering gear housing



3D-2

Figure 3D-2 Steering Gear Assembly - End View



3D-3

Figure 3D-3 Steering Gear Assembly Front View

until a resistance is felt. By threading in adjusting screw when steering gear is set to highpoint, the sintered bronze shell is pushed against the rack so that the rack is blocked.

3. Back off adjusting screw 1/8 to 1/4 of a turn.
4. Tighten lock nut to a torque of 43 lbs.ft.
5. Fill area under pinion shaft rubber boot with steering gear lubricant and slide boot into position.

## MAJOR REPAIR

### REMOVAL AND INSTALLATION OF STEERING GEAR ASSEMBLY AND TIE RODS

#### Removal. GT

1. Remove rubber knee protector pad.

2. Loosen clamp securing flexible coupling to steering shaft.
4. Remove stop bolt (see Figure 3D-4) from underside of steering column (secures steering shaft bushing to mast jacket), and pull steering wheel rearward approximately three inches.

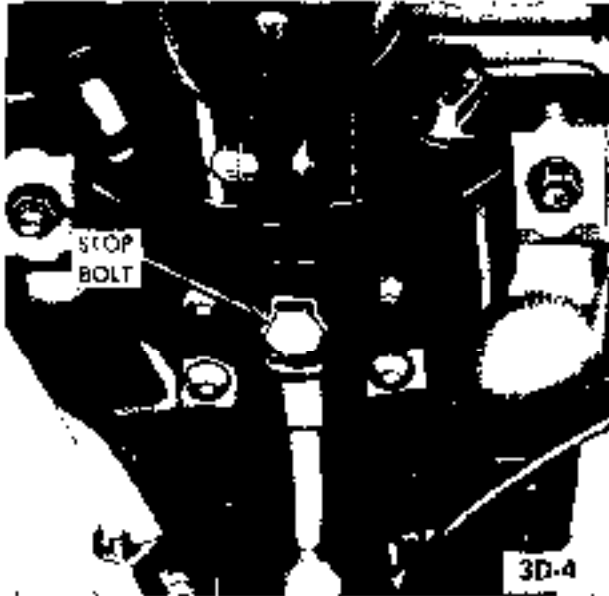


Figure 3D-4 Stop Bolt

4. Remove cotter pin located on left and right tie rod ends and unscrew nut.
5. Using remover J-21687, press ball studs out of steering arms (see Figure 3D-5).

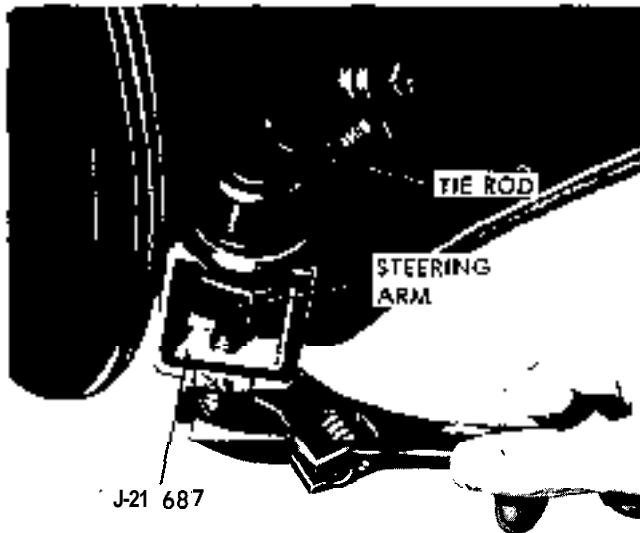


Figure 3D-5 Removing Ball Stud

6. Remove four attaching bolts securing steering gear to front suspension cross member (see Figure 3D-6) and lift off steering gear assembly and tie rods.

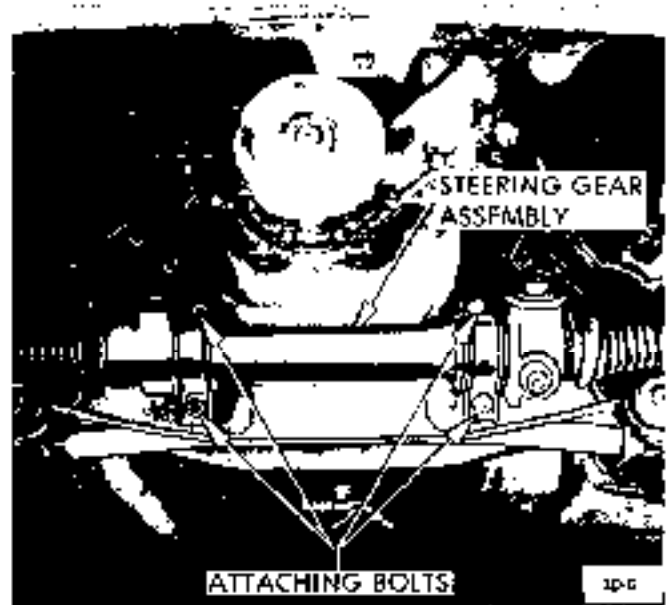


Figure 3D-6 Steering Gear Assembly Attaching Bolts

Removal (Opel 1900 - Manta)

1. Remove splash shield from lower deflector panel and both side members. See Figure 3D-7.



Figure 3D-7 Removing Splash Shield

2. Remove clamp bolt securing flexible coupling to steering shaft. See Figure 3D-8.

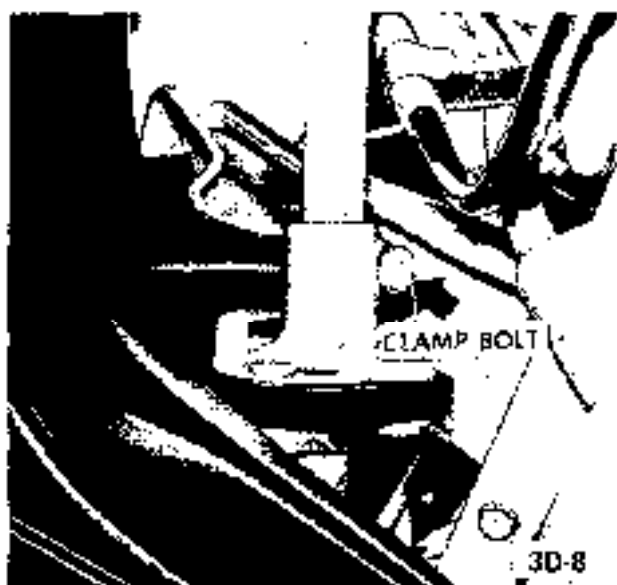


Figure 3D-8 • Removing Clamp Bolt

3. Remove cotter pin located on left and right tie rod end and unscrew nut.
4. Using Tool J-21687, press tie rod ends out of steering arms.
5. Disconnect steering gear housing from front suspension cross member and remove steering gear together with tie rods.

#### Installation . GT

**CAUTION:** *Fasteners are important attaching parts in that they could affect the performance of vital components and systems, and/or could result in major repair expense. They must be replaced with one of the same part number or with an equivalent part if replacement becomes necessary. Do not use a replacement part of lesser quality or substitute design. Torque values must be used as specified during reassembly to assure proper retention of these parts.*

1. Position steering gear on front suspension cross member and torque attaching bolts to 18 lb.ft.
2. Position tie rod ball studs in steering arms; install nuts and torque to 29 lb.ft. Lock in position with new cotter pins.
3. Fully turn steering wheel so that flat or cutout surface on lower portion of steering shaft is parallel to flexible coupling bolt hole.
4. Install the lower end of steering shaft to the flexible coupling and adjust dimension between steering wheel hub and direction signal switch housing cover to 1/8 and 3/32 inch. Maintain adjustment by tightening flexible coupling bolt and nut to 15 lb.ft. Lock the bolt and nut in position with lock-plate tabs.

5. Reinstall stop bolt into steering column.
6. Full turn steering wheel both right and left. If any resistance is noticeable, it will be necessary to remove the steering column and correct the cause.

#### D. Installation (Opel 1900 • Manta)

**CAUTION:** *Fasteners are important attaching parts in that they could affect the performance of vital components and systems, and/or could result in major repair expense. They must be replaced with one of the same part number or with an equivalent part if replacement becomes necessary. Do not use a replacement part of lesser quality or substitute design. Torque values must be used as specified during reassembly to assure proper retention of these parts.*

1. Prior to installation, set steering gear to high point. The steering wheel spokes point downwards in an oblique angle. The elongated cutout of the lower steering mast must coincide with the clamp bolt hole of the pinion flange.
2. Position steering gear on front suspension cross member and torque attaching bolts to 29 lb.ft.
3. Position tie rod studs in steering arms. Install nuts and torque to 29 lb.ft. Lock in position with new cotter pin.
4. Install the lower end of the steering shaft to flexible coupling and torque clamp bolt to 22 lb.ft.
5. Attach guard plate to both side members and lower deflector panel.

#### DISASSEMBLY AND ASSEMBLY OF STEERING GEAR ASSEMBLY WITH TIE RODS

##### Disassembly • GT

1. Carefully clamp gear assembly in soft jaw vise and slip clamps and rubber bellows off gear housing to expose area where ball joint screws into rack.
2. Bend up round edges of lockplates from tie rod ball studs and disconnect tie rod ball studs from rack. See Figure 3D-9). It is important that rack be held secure with open end wrench to prevent damage to rack teeth.
3. Loosen adjusting screw lock nut; remove adjusting screw from steering gear housing, and take out thrust spring and sintered bronze shell. See Figure 3D-11.
4. Rotate gear assembly in vise so that pinion shaft portion of assembly is held by vise, and remove pinion nut, flat washer, and special washer.

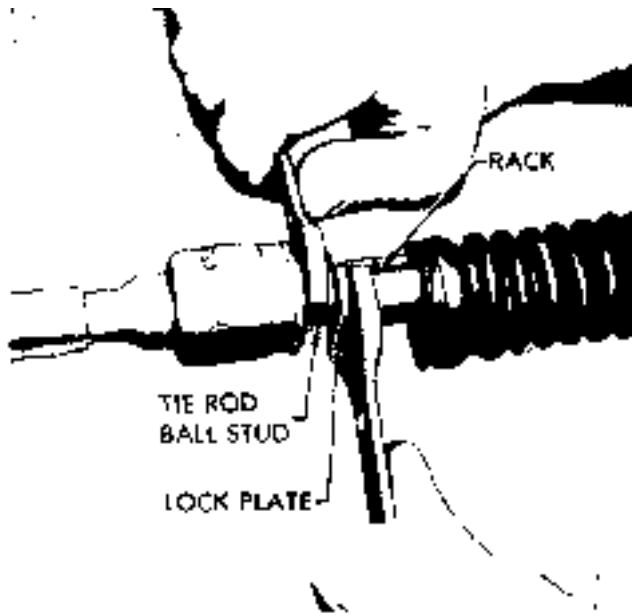


Figure 3D-9 Removing Tie Rods

5. Remove pinion shaft from gear assembly, and then withdraw rack from gear assembly.

6. From steering gear housing remove "O" rings from retainer and pinion bushing. Also take out thrust washer. See Figure 3D-17.

**Disassembly (Opel 1900 - Manta)**

1. Carefully clamp steering gear assembly in soft jaw vise.
2. Disconnect left and right tie rod end from respective axial joint (locknut). See Figure 3D-10. The ball joint of the tie rod end is maintenance-free, must not be disassembled and has to be replaced as an assembly only.

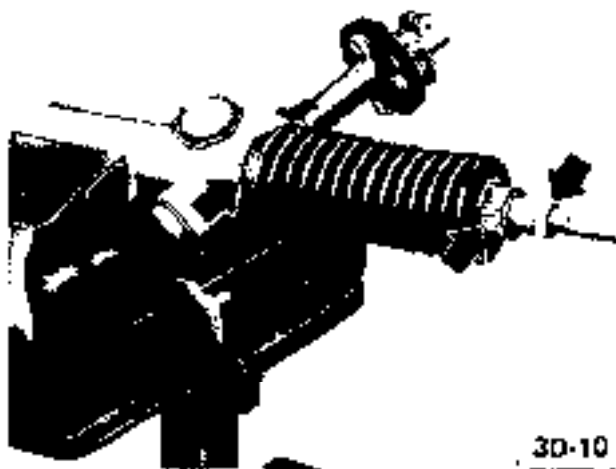


Figure 3D-10 Removing Tie Rod Ends from Axial Joint

3. Remove clamping wire and hose clamp from rubber bellows. Remove bellows from steering gear housing and axial joint. See Figure 3D-10.

4. Disconnect ball stud of axial joint from rack (lock plate, stop plate). To do this, counterhold rack with open-end wrench to avoid damage to the teeth. See Figure 3D-11. The axial joint is maintenance-free, must not be disassembled and has to be replaced as an assembly only.

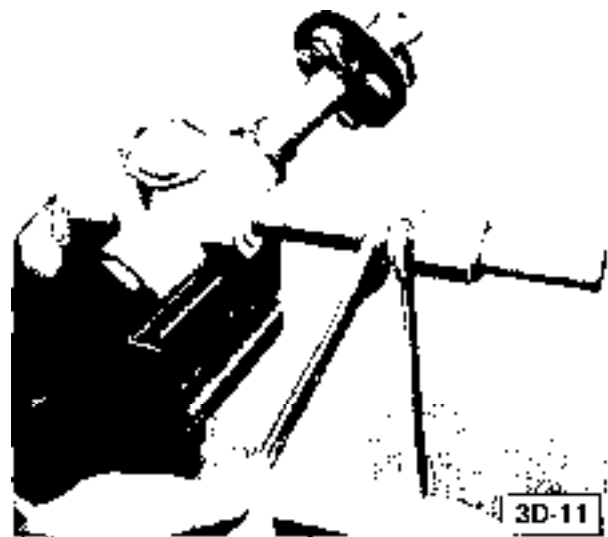


Figure 3D-11 Removing Axial Joint

5. Loosen adjusting screw locknut, screw out adjusting screw and remove thrust spring as well as bearing shell out of adjusting screw opening.

6. Remove sheet metal cap from steering gear housing and remove hex nut from pinion. Do not turn pinion in end position.

7. Pull pinion and rack out of steering gear housing.

**Reassembly. GT**

1. Clamp steering gear housing in a soft jaw vise as shown (see Figure 3D-17) and reassemble new "O" rings onto retainer and pinion shaft bushing. Also install thrust washer onto pinion bushing.

Coat all moving parts during reassembly with suitable steering gear lubricant. Fill long end of housing with approximately 1-3/4 oz. steering gear lubricant.

2. Insert long toothless end of rack into short end of housing until rack protrudes equally (approximately 2- 7/8 inch) out of both ends of housing. See Figure 3D- 13.

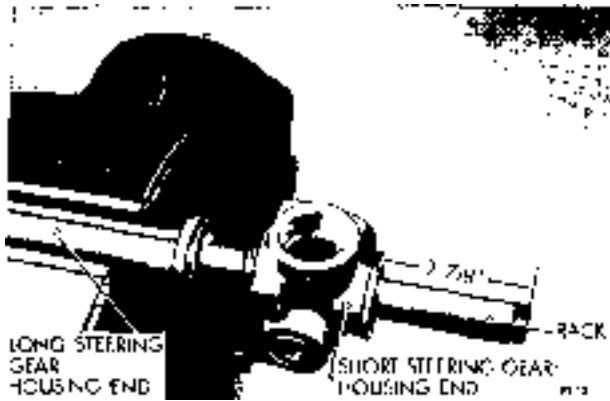


Figure 3D-13 Steering Gear Housing With Rack

Check to insure that three air channels of sintered metal bushing (See Figure 3D-17) are not obstructed by lubricant. If air channels are blocked, a vacuum condition in the bellows **may result** during operation of the gear assembly. Under such circumstances, the bellows will be drawn inward and jam into the rack teeth.

3. Reassemble pinion shaft into gear assembly so that spline in pinion shaft meshes with twelfth tooth of the rack. Use pinion mounting sleeve J-21712 during installation of pinion shaft to avoid damage to "O" ring in pinion bushing. When reassembling pinion shaft into gear housing, be sure that pinion is so positioned that bolt hole in pinion shaft flexible coupling is on top and parallel to the rack. See Figure 3D-14.

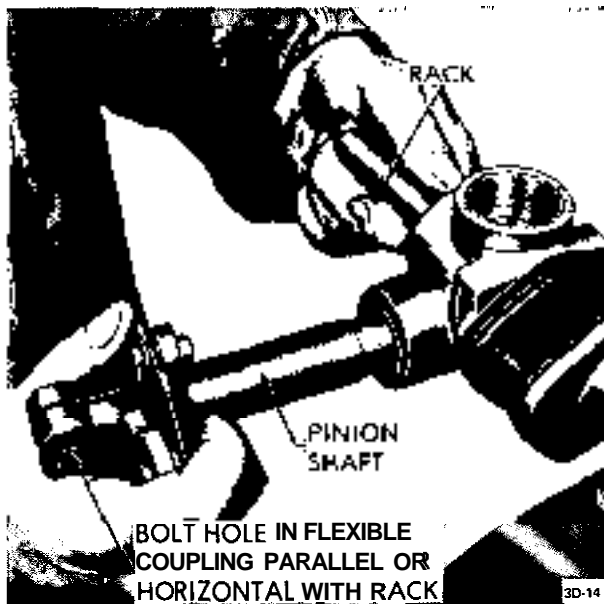


Figure 3D-14 Installing Pinion Shaft

4. Reassemble special washer, flat washer, and new pinion nut onto pinion shaft. Torque pinion nut to 11

lb.ft. Do not exceed torque due to possibility of jamming gear.

5. Place sintered bronze shell into steering gear housing **and** fill adjusting hole with Calcium Soap No. 2.

6. Reassemble thrust spring, adjuster screw and lock-nut on gear assembly.

Final adjustment of adjuster screw is performed after gear assembly and tie rods are installed in car. See Maintenance and Adjustments in this section for adjustment of steering gear.

7. Place rubber bellows, clamps, and new lock plates on ball stud portion of tie rods; and screw ball studs into rack while holding bent tab of lock plate against flat on rack. Torque ball studs 43 lb.ft. See Figure 3D-9. It is important that rack be held secure with open **end** wrench to prevent damage to rack teeth.

8. Bend **round** edges of lock plate over flat on ball stud to lock ball stud in position. See Figure 3D-15.

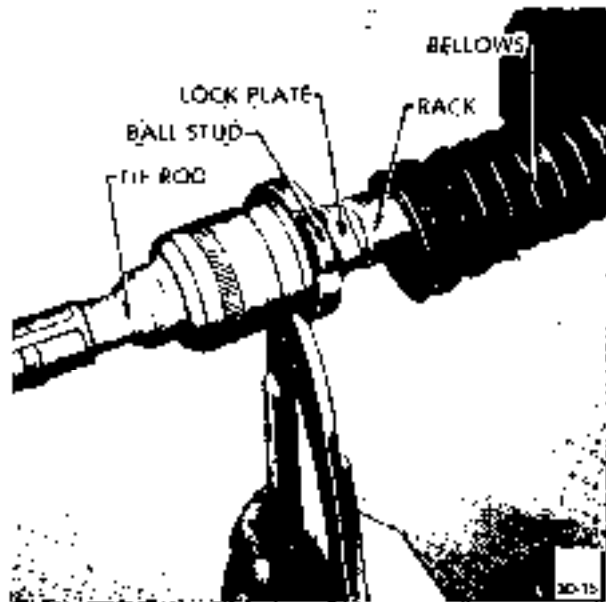


Figure 3D-15 Bending Lock Plate Over Ball Stud

9. Properly position rubber bellows and clamps over tie rod and gear housing and adjust clamps so that ends are pointing same direction as adjusting screw. Check that bellows is not twisted and will compress and expand properly.

#### Reassembly (Opel 1900 - Manta)

1. Clamp steering gear housing in a soft jaw vise and reassemble new "O" rings onto retainer and pinion shaft bushing. Also, install thrust washer onto pinion bushing.

Coat all moving parts during reassembly with **suita-**

ble steering gear lubricant. Fill long end of housing with approximately 1 3/4 oz. steering gear lubricant.

2. Insert long toothless end of rack into short end of housing until rack ends (A) protrude equally out of both ends of housing. See Figure 3D-16.

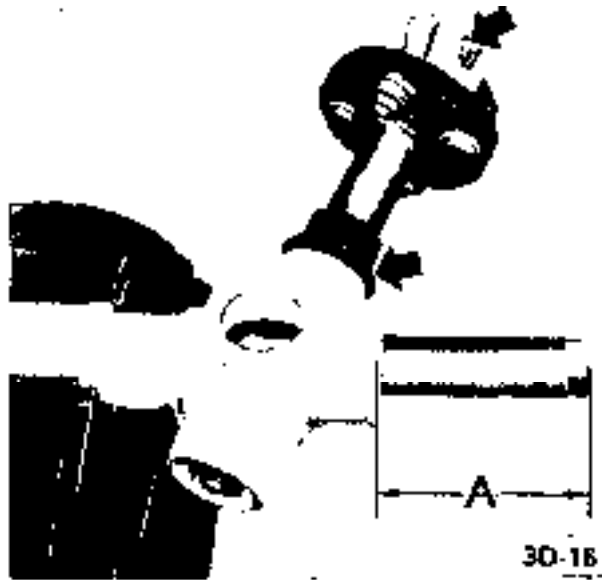


Figure 3D-16 - Steering Gear Housing With Rack

Check to insure that three air channels of sintered metal bushing are not obstructed by lubricant. If air channels are blocked, a vacuum condition in the bellows may result during operation of the gear assem-

bly. Under such circumstances, the bellows will be drawn inward and jam into the rack teeth.

3. Reassemble pinion shaft into gear assembly so that spline in pinion shaft meshes with twelfth tooth of the rack. Use pinion mounting sleeve J-21712 during installation of pinion shaft to avoid damage to "O" ring in pinion bushing. When reassembling pinion shaft into gear housing, be sure that pinion is so positioned that bolt hole in pinion shaft flexible coupling is on top and parallel to the rack. See Figure 3D-16.

4. Reassemble special washer, flat washer, and new pinion nut onto pinion shaft. Torque pinion nut to 11 lb.ft. Do not exceed torque due to possibility of jamming gear.

5. Place sintered bronze shell into steering gear housing and till adjusting hole with suitable steering gear lubricant.

6. Reassemble thrust spring, adjuster screw and locknut on gear assembly. Torque locknut to 43 lb.ft.

7. Screw ball stud of the axial joint together with stop plate onto both ends of the rack. Torque to 47 lb.ft. Counterhold rack with open-end wrench.

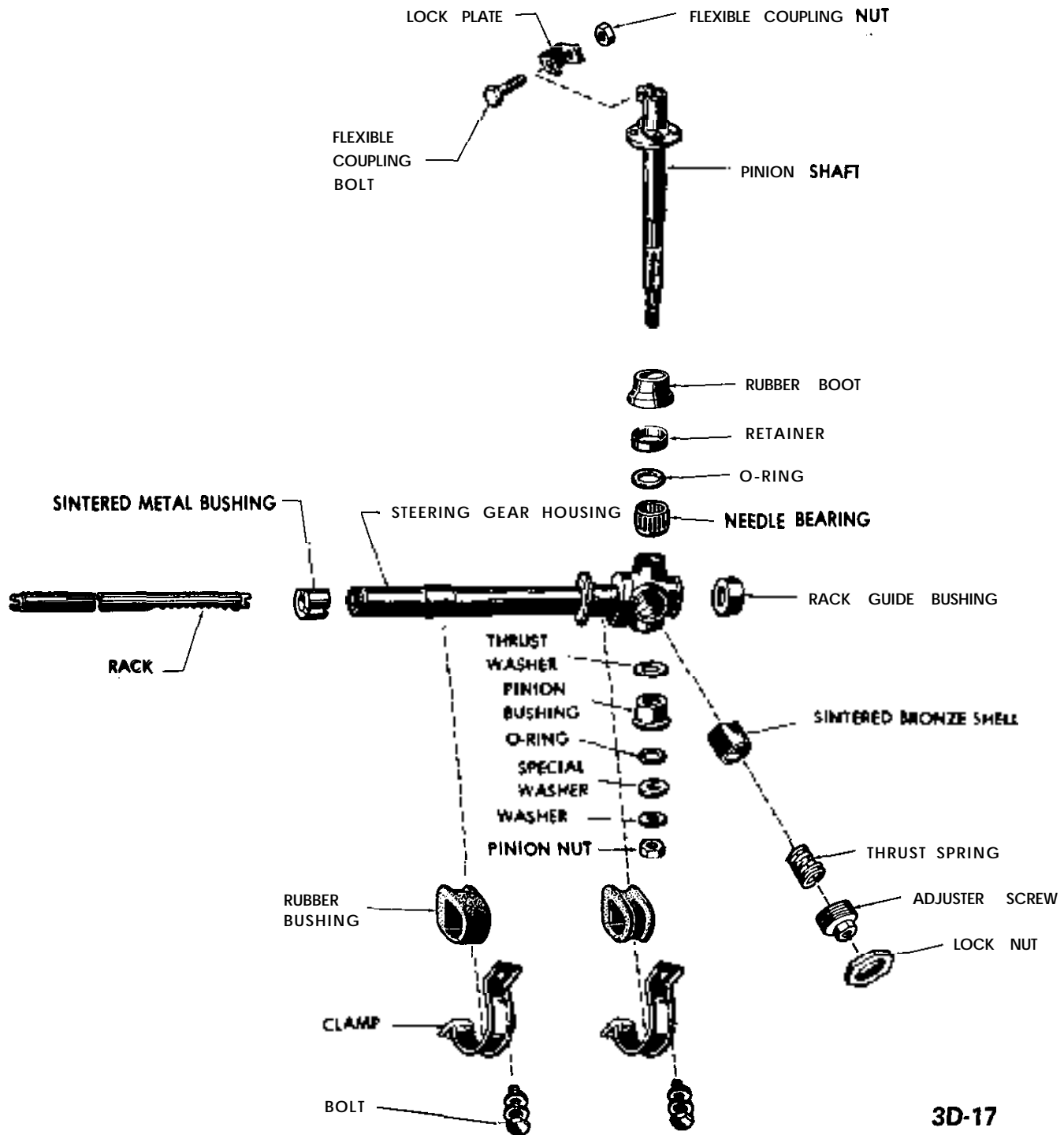
8. Slide rubber bellows onto axial joint and steering gear housing. Attach rubber bellows with loose clamp and clamping wire. Check that rubber bellows is not twisted.

## SPECIFICATIONS

### Tightening Specifications

Part	Location	Torque Lb.Ft.
Bolt	Flexible Coupling Clamp (GT)	15
Bolt	Flexible Coupling Clamp (1 900 - Manta) .....	22
Nut	Tie Rod Ball - Connects to Rack (GT) . . . . .	43
Nut	Ball Stud - Axial Joint to Rack (1900 - Manta)	47
Nut	Tie Rod Lock Nut (1900 - Manta) . . . . .	49
Bolt	Steering Gear Housing to Front Suspension Crossmember (GT) .....	18
Bolt	Steering Gear Housing to Front Suspension Crossmember (1 900 - Manta) .....	29
Nut	Adjusting Screw Lock Nut . . . . .	43
Nut	Pinion .....	11
Nut	Tie Rod to Steering Arm . . . . .	29





3D-17

Figure 3D-17 Steering Gear Assembly Exploded View

# OPEL 1900 AND MANTA STEERING COLUMN ASSEMBLY

## CONTENTS

Subject	Page No.
<b>DESCRIPTION AND OPERATION:</b>	
Description and Operation of Directional Signal Lever .....	3E-35
Description and Operation of Horn .....	3E-36
Description of Steering Column Assembly .....	3E-36
<b>DIAGNOSIS: (Not Applicable)</b>	
<b>MAINTENANCE AND ADJUSTMENTS: (Not Applicable)</b>	
<b>MAJOR REPAIR:</b>	
Removal and Installation of Steering Column Assembly .....	3E-36
Removal and Installation of Steering Wheel .....	3E-38
Disassembly and Reassembly of Direction Signal Switch .....	3E-39
Disassembly and Reassembly of Steering and Ignition Lock Cylinder, and Electrical Switch from Mast Jacket Assembly .....	3E-40
<b>SPECIFICATIONS:</b>	
Steering Column Specifications .....	3E-41

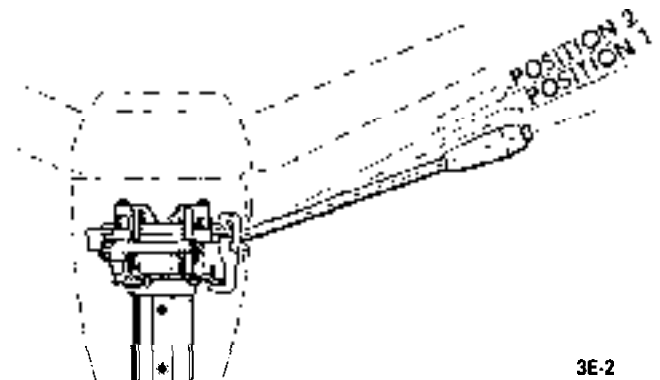
### DESCRIPTION AND OPERATION

#### DESCRIPTION AND OPERATION OF DIRECTIONAL SIGNAL LEVER

The direction signal switch lever is a multi-purpose lever controlling direction signals, passing signal and headlight high and low beams. See Figure 3E-2.

The **direction** signal lever is provided with a two-step mechanism for operation of headlight high and low beams, and passing signal (not in N.J.). With headlights off, moving the lever repeatedly towards steering wheel flashes headlights as a passing signal. With headlights on, moving the lever repeatedly towards steering wheel up to **first** stop also flashes passing signal regardless whether or not the direction signals are switched on. When the lever is moved up to the second stop, the headlights are changed from

high to low beam or vice versa. On all 1900 Rallye cars, when switching from low to high beam position, with the fog lamp instrument panel switch ON



3E-2

Figure 3E-2 Directional Signal Lever Position for Headlamp Operation

and ignition switch in RUN position, the fog lights are automatically switched off. Direction signals work in the normal manner; pushing the lever up for right turn signal and pulling the lever down for left turn signal.

### DESCRIPTION AND OPERATION OF HORN

The **horn** button is located in the center part of the steering wheel. The horn is actuated by pushing on the ends of the spokes for the Opel 1900 - Manta and by pushing on the center horn button on 57R, 57L, and GT. The button is provided with a plug connection for each springloaded plunger. See Figure 3E-3.



Figure 3E-3 Horn Button Connections (Opel 1900 Manta)

### DESCRIPTION OF STEERING COLUMN ASSEMBLY

The steering column mast jacket is provided with a tube-frame section (See B of Figure 3E-4) with bulges which compresses or folds itself, if a sufficiently large energy is exerted to one or other end of the steering mast jacket assembly. This tube-frame section absorbs most of the energy. The steering column consists of two parts, the upper and lower mast jacket assembly and the steering shaft. The **upper** steering mast is firmly connected to the tube **while** the lower steering mast is clearance-free attached to the tube by **means** of injected plastic (See Figure 3E-4). Consequently, the steering mast withstands all torsional stresses.

As soon as the primary energy becomes effective, the plastic pins (c) shear off and the steering shaft compresses. Thereafter the steering mast **jacket** is partly compressed.

A slide-off base is welded to the steering mast jacket. It is provided with two (2) slots for the respective attaching bolts. A metal piece (See Figure 3E-4) is located in each slot which is attached to the slide-off **base** with injected plastic. The open sides of the slots face the driver so that the primary energy cannot

push the steering mast jacket assembly into the passenger compartment. The secondary energy caused **by** the driver can on the other hand effect a shearing of the plastic pins and loosening of the slide-off base so that it moves downwards. Thereby the steering mast jacket assembly is compressed further and absorbs the impact energy to a large extent.

The energy absorbing steering is not more susceptible to damage than a standard steering. However, the steering mast jacket assembly, especially if removed, has in contrast with the standard steering to be given a **different** treatment.

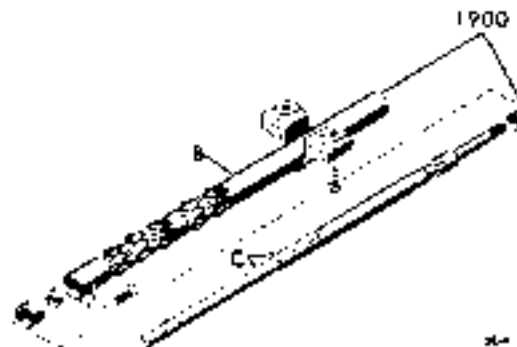


Figure 3E-4 Energy Absorbing Steering Column

The energy absorbing steering column must **by no** means be subject to impacts or blows. A sharp blow onto the exposed steering shaft ends, leaning onto steering column or dropping may loosen or even shear off the plastic attachments which bring **about** rigidity of assembly. In spite of a steering column damaged in this way the operating function of the steering is retained due to the lateral flattenings on steering shaft tube and lower steering shaft. However, after a short period of operation rattling noises will be noticeable so that the steering column has to be replaced. For pulling steering wheel off steering column use appropriate special tool. Therefore, it is of importance that the instructions for removal and installation as well as disassembly and assembly are strictly adhered to.

### MAJOR REPAIR

#### REMOVAL AND INSTALLATION OF STEERING COLUMN ASSEMBLY

The removal of this assembly is only necessary for

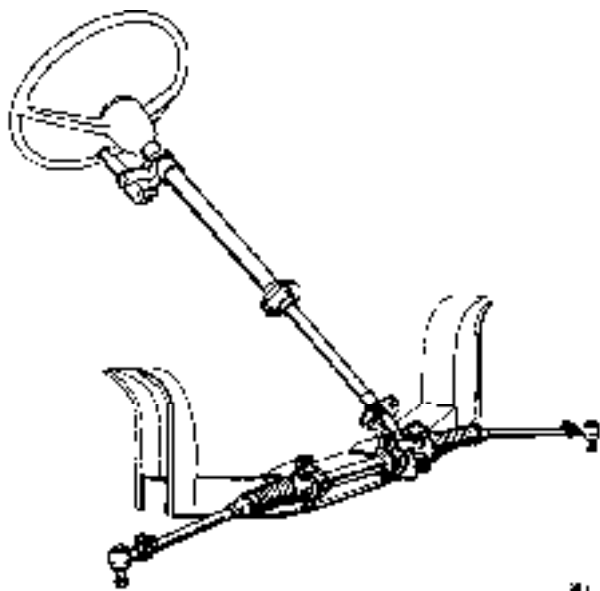


Figure 3E-5 Steering Column Assembly With Gear

replacement of steering column or steering ignition lock parts.

**Removal (Opel 1900 . Manta)**

1. Disconnect battery.
2. From underside of car, remove clamp screw of upper steering mast out of universal joint flange. See Figure 3E-6.

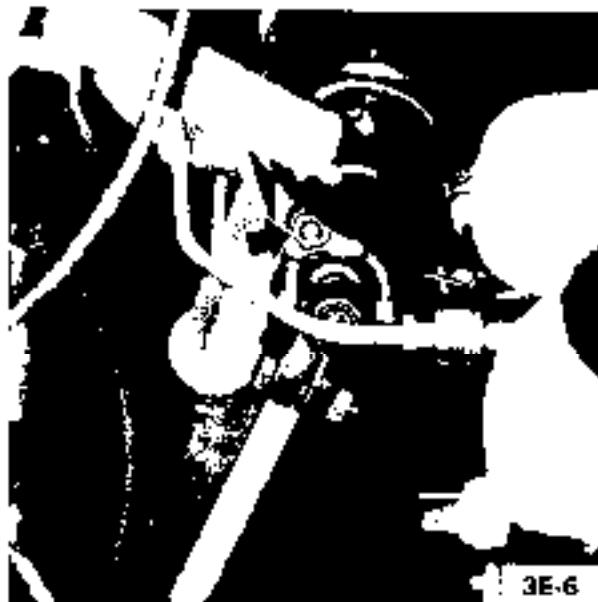


Figure 3E-6 Upper Steering Mast Clamp Screw

3. Remove hex nut from steering mast jacket attachment at front of dash panel. See Figure 3E-7.

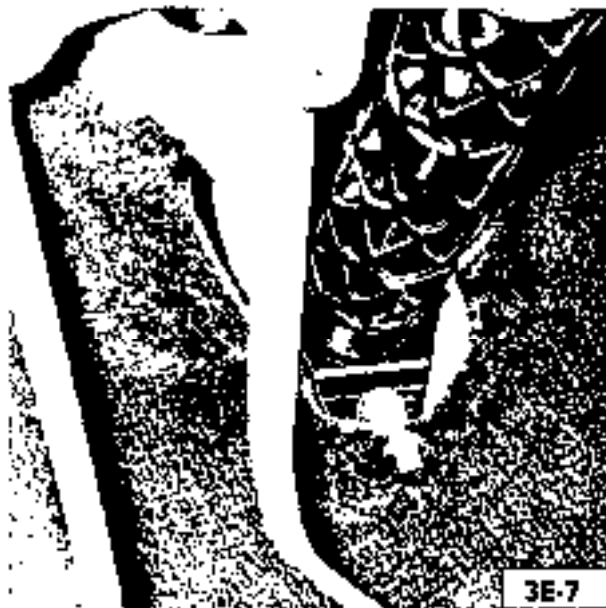


Figure 3E-7 • Steering Mast Jacket Attachment

4. Pull off signal switch, as well as steering and ignition lock wire sets.

5. Unscrew slide-off base from underside of instrument panel and remove steering column assembly from car. See Figure 3E-8. Carefully put down assembly. Avoid impacts and blows to steering column assembly.



Figure 3E-8 • Slide-Off Base Attaching Nuts

**Installation (Opel 1900. Manta)**

**CAUTION:** *Fasteners are important attaching parts in that they could affect the performance of vital com-*

ponents and systems, and/or could result in major repair expense. They must be replaced with one or the same part number or with an equivalent part if replacement becomes necessary. Do not use a replacement part of lesser quality or substitute design. Torque values must be used as specified during reassembly to assure proper retention of these parts.

On installation, make sure steering wheel spokes point downwards and steering gear is in high point.

1. Carefully insert steering mast into universal joint flange.
2. Loosely attach slide-off base attaching nuts at underside of instrument panel.
3. Attach steering mast jacket at front of dash, using a notched hex nut.
4. Torque nuts at slide-off base to 11 lb.ft.
5. Tighten screw at steering mast clamp to 22 lb.ft.
6. Reconnect wires to directional signal switch and ignition switch.
7. Reconnect battery.

### REMOVAL AND INSTALLATION OF STEERING WHEEL

This procedure may be performed with the steering column assembly either removed or installed in the car.

#### Removal

1. Disconnect battery.
2. Pry off horn cap and remove wires from cap. See Figure 3E-3.
3. Bend lockplate tabs down and take off steering shaft nut and lockplate.
4. Install steering wheel remover J-21686 as shown in Figure 3E-9 and pull off steering wheel.

#### Installation

1. Before installing steering wheel, lubricate return pin and sliding area on directional signal switch return cams and horn contact ring.
2. Make sure that clamp bolt in steering shaft flange is on top.
3. Make sure notch on steering shaft face is in horizontal position.

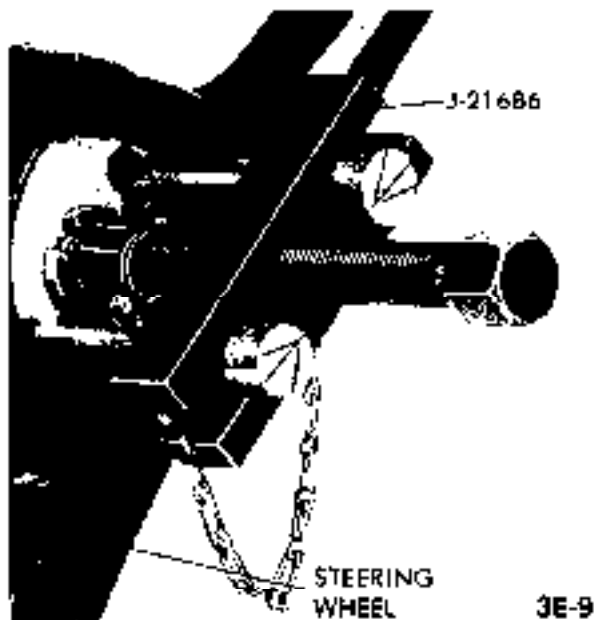


Figure 3E-9 Removing Steering Wheel

4. With the steering wheel centered, place the steering wheel onto the steering shaft.
5. Install steering wheel lockplate and nut. Torque to 11 lb.ft.

**CAUTION:** This steering wheel to steering shaft fastener is an important attaching part in that it could affect the performance of vital components and systems, and/or could result in major repair expense. It must be replaced with one of the same part number or with an equivalent part if replacement becomes necessary. Do not use a replacement part of lesser quality or substitute design. Torque values must be used as specified during reassembly to assure proper retention of this part.

6. Bend lockplate tabs up, connect horn cap wires and replace cable and cap.
7. Reconnect battery.

### REMOVAL AND REPLACEMENT OF HORN CONTACT RING

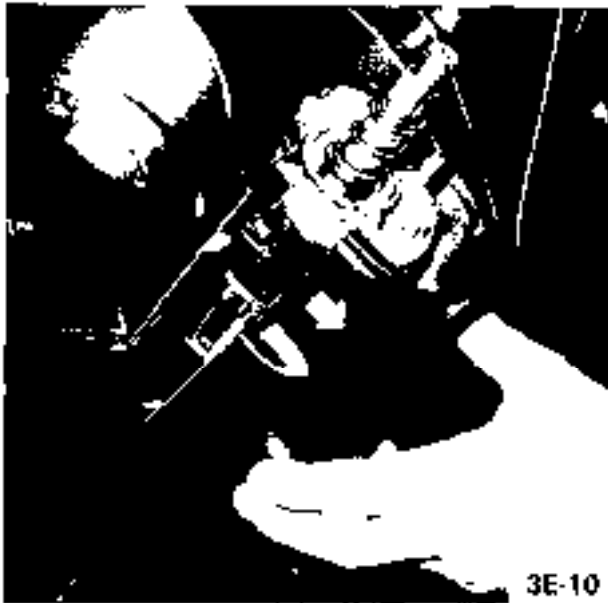
1. Remove steering wheel.
2. Cut off defective contact ring at wire.
3. Strip wire approximately 1/8".
4. Install new part and solder connection with resin core solder.
5. Lubricate contact ring with lubriplate, or equivalent.
6. Reinstall steering wheel.

**DISASSEMBLY AND REASSEMBLY OF DIRECTIONAL SIGNAL SWITCH**

This procedure may be performed with the steering column assembly removed or installed in the car.

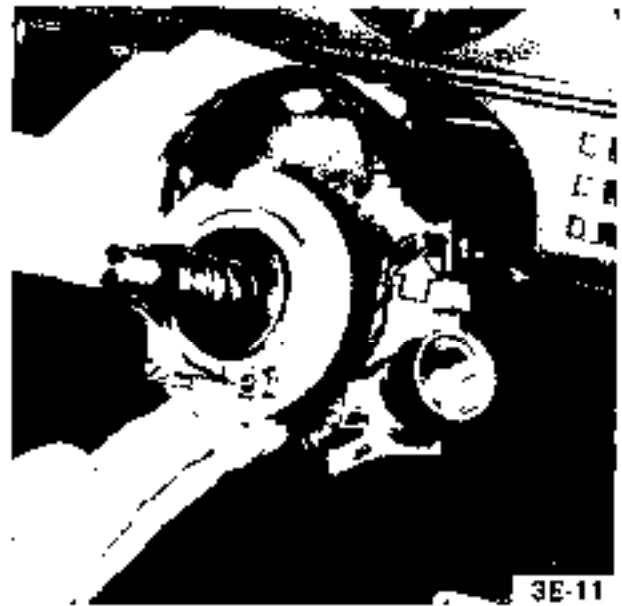
**Disassembly (Opel 1900, Manta)**

1. Remove steering wheel (see paragraph above).
2. Pull off signal switch and steering and ignition lock wire set.
3. Pull directional signal lever out of seat. Lever is held in place by a lock ball.
4. Unscrew lower half of signal switch housing cover. See Figure 3E-10.

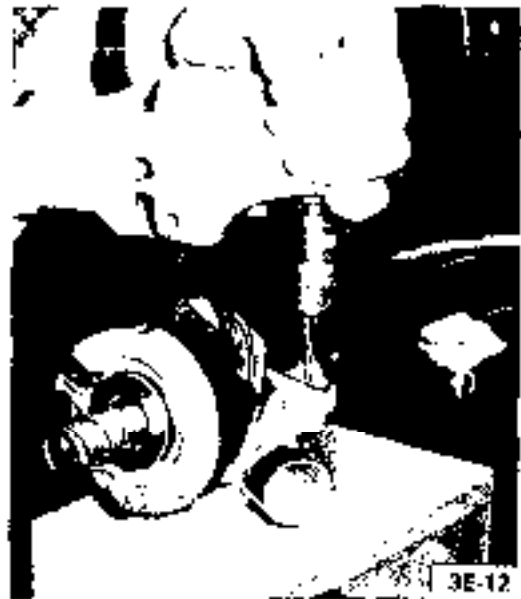


**Figure 3E-10 Lower Half of Signal Switch Housing Cover**

5. Remove hex nut from steering mast jacket attachment at front of dash panel. See Figure 3E-7.
6. Unscrew slide-off base from underside of instrument panel and remove upper part of signal switch housing cover. See Figure 3E-11.
7. Place a thick piece of wood onto front seat and let down steering mast jacket assembly. When doing this, the front seat must be in its front position.
8. Centerpunch tear-off bolt for steering and ignition lock bracket attachment. Drill a .12 in. (3mm) diameter hole, using an angular-type drill and with a bolt remover with left-hand twist screw out bolt. See Figure 3E-12.



**Figure 3E-11 Removing Upper Part of Signal Switch Housing Cover**



**Figure 3E-12 Removing Tear-Off Bolt**

9. Remove steering and ignition lock, as well as signal switch from steering mast jacket and *loosely* attach slide-off base below instrument panel.

**Reassembly (Opel 1900 • Manta)**

1. When replacing a new directional signal switch, install new bearing and snap ring in switch assembly.
2. Install signal switch, as well as steering and ignition lock, to steering mast jacket. To do this, screw

on steering and ignition lock bracket using a new tear-off bolt (hexagon head tears off).

3. Disconnect slide-off base, install upper half of signal switch housing cover, and loosely reattach slide-off base.

4. Attach steering mast jacket at front of dash panel. See Figure 3E-7.

5. Torque slide-off base attaching nuts to 11 lb.ft.

6. Install lower half of signal switch housing cover and connect signal switch, as well as steering ignition lock wire set.

7. Install steering wheel and torque nut to 11 lb.ft. Always use new lock plate.

#### DISASSEMBLY AND REASSEMBLY OF STEERING AND IGNITION LOCK CYLINDER AND ELECTRICAL SWITCH FROM MAST JACKET ASSEMBLY

##### Disassembly. GT

Disconnect the **battery** before proceeding.

1. Remove steering wheel.
2. Turn ignition switch to ON position.
3. Insert a suitable rod into stop pin hole on side of steering and ignition lock (See Figure 3E-13) and take out steering and ignition lock cylinder.

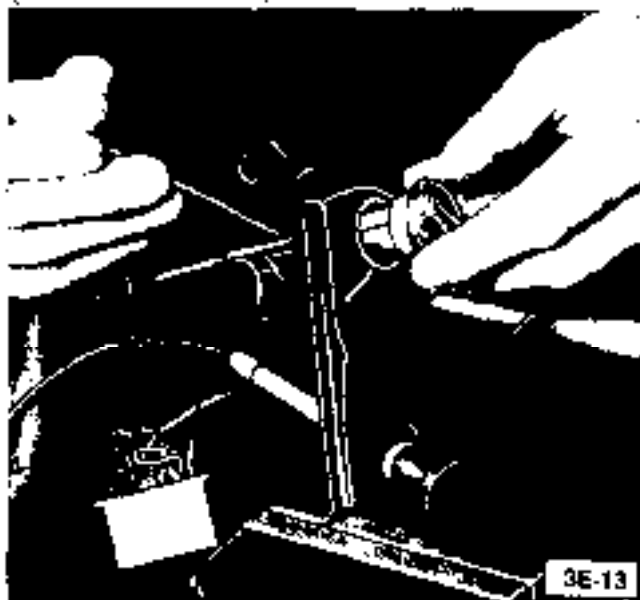


Figure 3E-13 Removing Ignition Lock Cylinder

4. Remove two screws securing electrical switch to steering and ignition lock housing and take out switch.

##### Disassembly (Opel 1900 - Manta)

1. Remove steering wheel.
2. Unscrew split signal switch housing cover and remove lower half. See Figure 3E-10.
3. Remove lock cylinder by pushing in lock spring of the cylinder using a piece of wire. Cylinder must be in the "1" position. See Figure 3E-14.

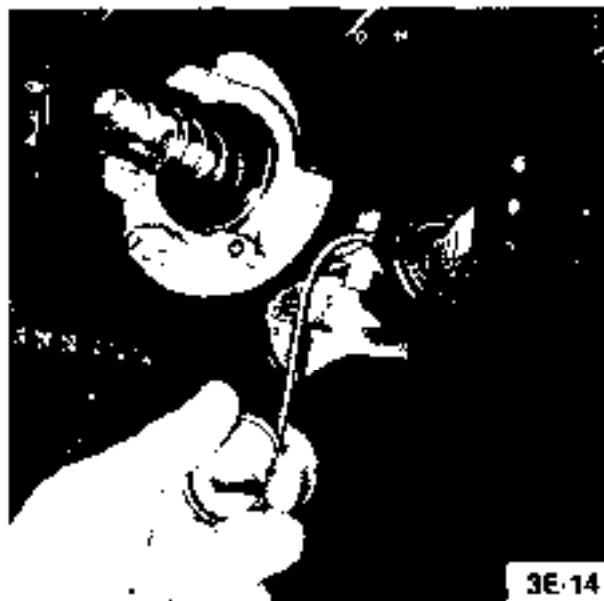


Figure 3E-14 Removing Lock Cylinder

##### Reassembly

1. On the GT reassemble electrical switch into steering and ignition **lock** housing and rotate switch until: (1) cam in lock housing recess fits into slotted hole in rear of electrical switch, and (2) projection on electrical switch fits into recess on lock housing.
2. On the Opel 1900 - Manta, insert lock cylinder in the "1" position into housing. Install lower half of signal switch housing.
3. Reinstall steering wheel.

**SPECIFICATIONS**

Steering Column Tightening Specifications

Part	Location	Torque Lb.Ft.
Nut	Steering Wheel Retaining (1900 • Manta) .....	11
Bolt	Steering Column Flexible Coupling (1900 • Manta) ...	22
Nut	Slide Off Base Attaching (1 900 • Manta) .....	10
Nut	Mass Jacket (1 900 • Manta) .....	11
screw	Steering Mast Clamp (1900 • Manta) .....	22



# GT STEERING COLUMN ASSEMBLY

## CONTENTS

Subject	Page No.
<b>DESCRIPTION AND OPERATION:</b>	
Description of Steering Column .....	<b>3E-42</b>
<b>DIAGNOSIS: (Not Applicable)</b>	
<b>MAINTENANCE AND ADJUSTMENTS: (Not Applicable)</b>	
<b>MAJOR REPAIR:</b>	
Removal and Installation of Steering Wheel .....	<b>3E-44</b>
Removal and Installation of Ignition Lock Cylinder .....	<b>3E-45</b>
Removal and Installation of Steering Column Assembly .....	<b>3E-45</b>
Removal and Installation of Center Steering Shaft	<b>3E-46</b>
Removal and Installation of Ignition Switch and/or Steering Lock .....	<b>3E-46</b>
Removal and Installation of Upper Steering Bearing and/or Directional Signal Switch .....	<b>3E-48</b>
Removal and Installation of Steering Column Lower Bearing .....	<b>3E-49</b>
<b>SPECIFICATIONS:</b>	
Steering Column Torques .....	<b>3E-50</b>

### DESCRIPTION AND OPERATION

#### DESCRIPTION OF STEERING COLUMN

The Energy Absorbing, Locking Steering Column assembly is used on the GT. This column is designed to compress under impact. When an automobile is being driven, the forward movement of the automobile and the forward movement of the driver both constitute a form of energy or force. When an automobile is involved in a frontal collision, the primary force (forward movement of the car) is suddenly halted, while the secondary force (the driver) continues its forward direction. A severe collision generally involves these two forces - the primary and the secondary forces. The secondary impact occurs when the driver is thrust forward onto the steering wheel and column.

The Energy Absorbing Column is designed to absorb these primary and secondary forces to the extent that

the severity of the secondary impact is reduced. During a collision, the steering column compresses and thereby reduces its tendency to move rearward into the driver's compartment. A split second later when the driver is thrown forward (the secondary impact) his energy is also partially absorbed by the compression characteristics of the column.

The Energy Absorbing, Locking Column assembly may be easily disassembled and reassembled. The serviceman should be aware that it is important that only the specified screws, bolts and nuts be used as designated during reassembly, and that they are tightened to their specified torque. This precaution will insure the energy absorbing action of the assembly. Particular care should be exercised to avoid using overlength bolts as they may prevent a portion of the assembly from compressing under impact. Equally as important is correct torquing of all bolts and nuts.

When the Energy Absorbing, Locking Column is

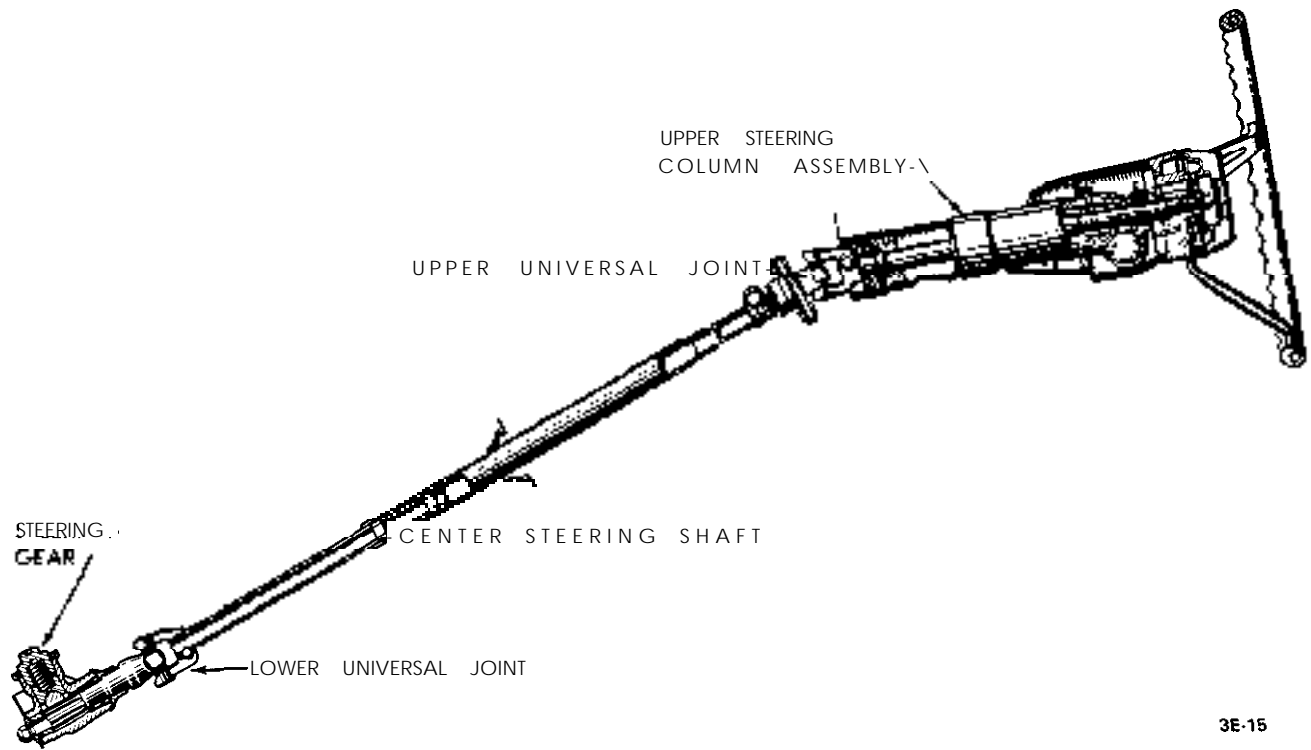


Figure 3E-15 GT Steering Column Assembly

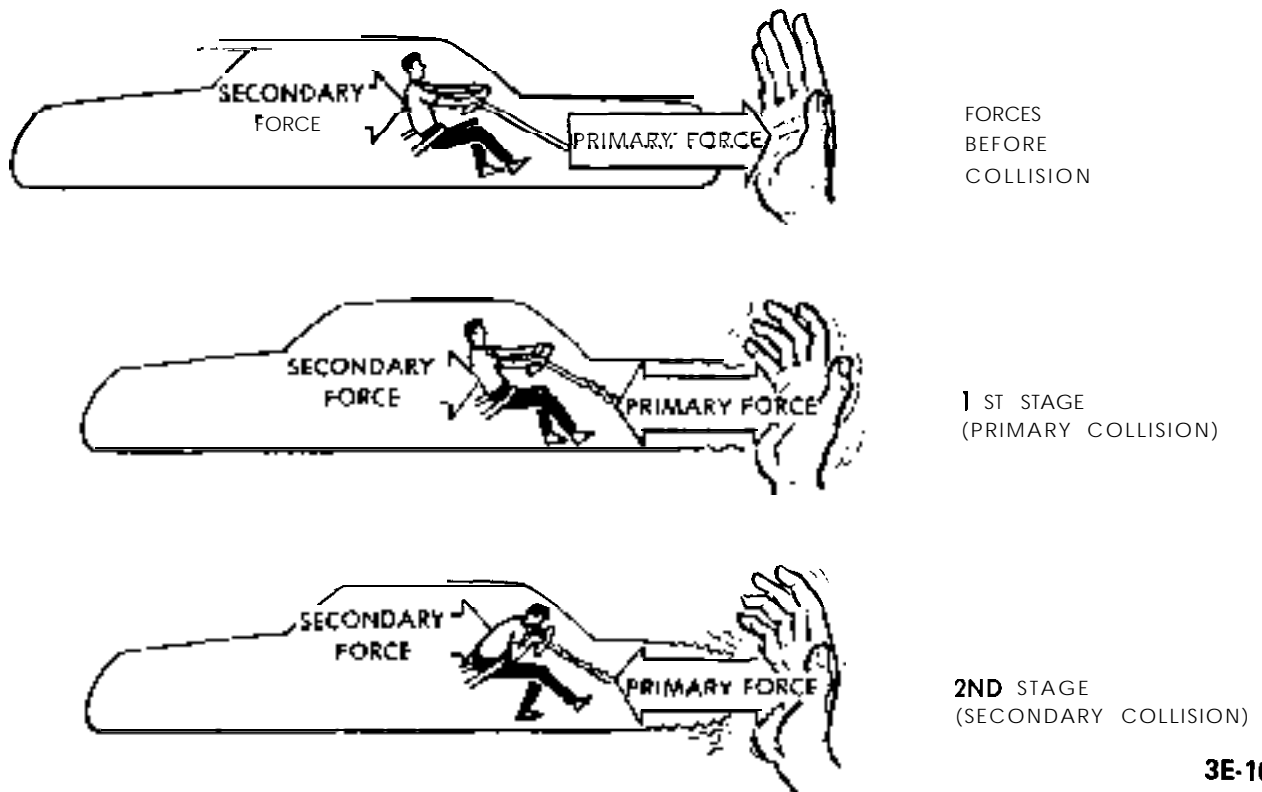


Figure 3E-16 Reaction of Forces in a Collision

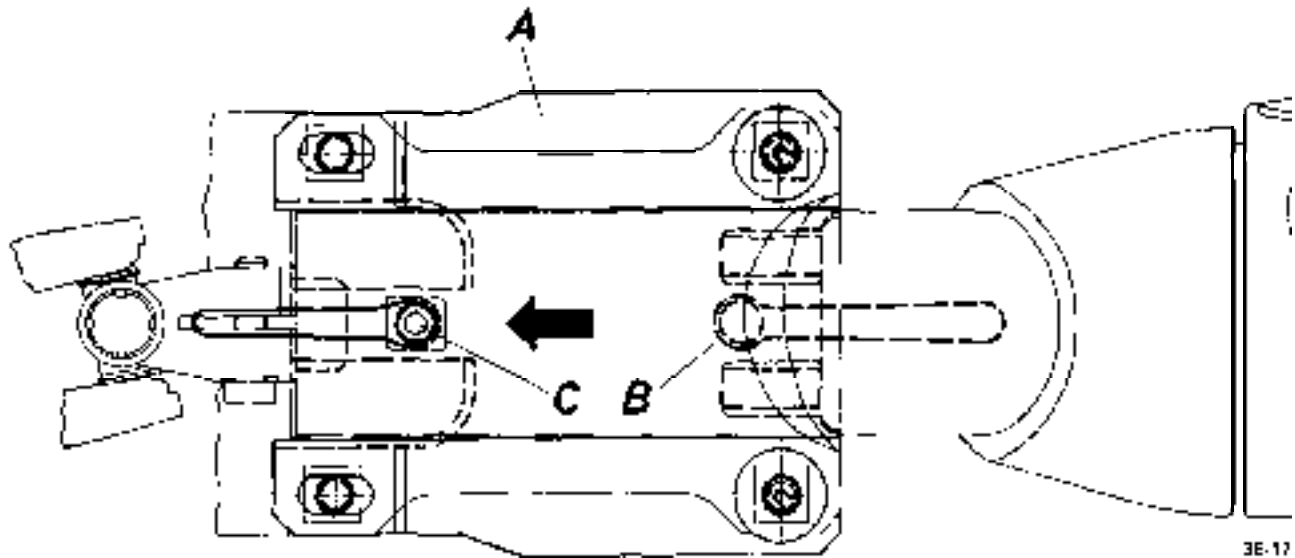


Figure 3E-17 Steering Column Bracket

installed in a car it is no more susceptible to damage through usage than an ordinary column; however, when the column is removed, special care must be taken in handling this assembly. *Only the specified wheel puller should be used.*

When the column is removed from the car, such actions as a sharp blow on the end of the steering shaft laying things across or on top of the column assembly, leaning on the column assembly, or dropping of the assembly could shear or loosen the plastic fasteners that maintain column rigidity or possibly bend the assembly causing a binding condition. *It is therefore important that the removal and installation and the disassembly and reassembly procedures be strictly followed when servicing this assembly.*

The steering column assembly is attached with a bracket (A) at four points to the connecting brace below the instrument panel. See Figure 3E-17. The two upper bolts are designed as tear-lock-bolts. A bolt (B) is welded to the bracket which engages in an narrowing elongated hole. The same applies to the upper bolt (C) of the steering column lower bearing attachment which engages in a hole of the connecting brace.

As soon as a sufficiently large secondary energy becomes effective, the steering mast jacket slides towards the front whereby the bolt (B) as well as the bolt head (C) is additionally pushed into the respective narrowing elongated holes. Both elongated holes are arranged so that the primary energy cannot push the steering mast assembly into the passenger compartment.

The GT steering column incorporates two universal

joints to allow for the offset between the steering column and the gear assembly.

The upper steering column assembly is connected to the center steering shaft with one universal joint, while the lower universal joint connects the center steering shaft to the steering gear pinion shaft.

## REMOVAL AND INSTALLATION

### REMOVAL AND INSTALLATION OF STEERING WHEEL

This procedure may be performed with the steering column assembly either removed or installed in the car.

#### Removal

1. Disconnect battery.
2. Remove horn cap.
3. Bend lockplate tabs down and remove steering wheel nut, lockplate and washer.
4. Mark shaft and wheel hub for reassembly alignment.
5. Remove steering wheel using steering wheel puller J-21686. Do not rap on end of puller in order to free wheel from shaft as this would very likely loosen plastic injections that maintain steering shaft rigidity. Striking of underside of steering wheel to jar it

loose must never be done. The only recommendation for freeing frozen steering wheels is to use a penetrating lubricant.

### Installation

1. Before installing steering wheel, lubricate return pin and slide area on direction signal switch return cams and horn ring contact.
2. With steering wheel properly aligned to shaft, install lockplate and nut. Torque nut to 15 lb.ft.

**CAUTION:** *This steering wheel to steering shaft fastener is an important attaching part in that it could affect the performance of vital components and systems, and/or could result in major repair expense. It must be replaced with one of the same part number or with an equivalent part, if replacement becomes necessary. Do not use a replacement part of lesser quality or substitute design. Torque values must be used as specified during reassembly to assure proper retention of this part.*

3. Bend up lockplate tab and install horn cap.
4. Reconnect battery.

### REMOVAL AND INSTALLATION OF IGNITION LOCK CYLINDER

#### Removal

This procedure may be performed with the steering column assembly either removed or installed in the car.

1. Remove steering wheel, as outlined previously in this Group.
2. Position lock cylinder to run position.
3. Using suitable piece of wire, push in lock cylinder retaining pin and remove lock cylinder. See Figure 3E-18.

#### Installation

1. Insert lock cylinder into lock cylinder housing.
2. Install steering wheel, as outlined previously in this section.

### REMOVAL AND INSTALLATION OF STEERING COLUMN ASSEMBLY

#### Removal

1. Position steering so that front wheels are straight ahead.

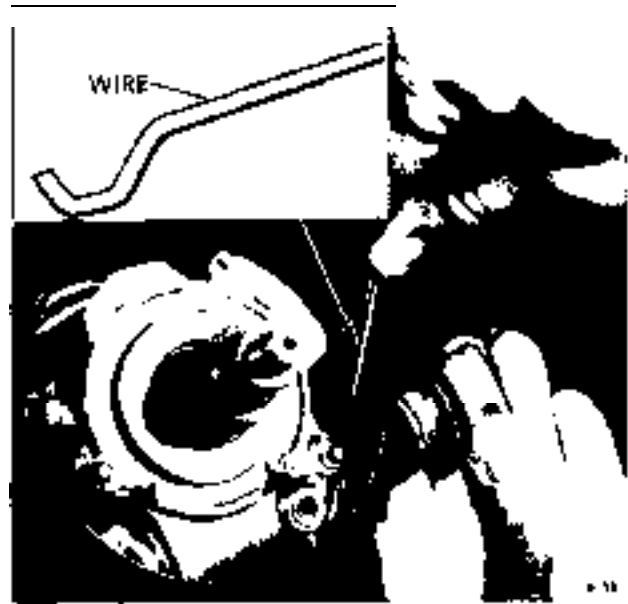


Figure 3E-18 Removing Lock Cylinder

2. Loosen steering shaft upper universal joint lower clamp bolt. See Figure 3E-19.
3. Drill off heads of both tear bolts by first drilling an  $\frac{3}{16}$  inch pilot hole and then inserting a  $\frac{1}{4}$  inch bolt extractor to remove lockbolt.
4. Disconnect ignition (white) and direction signal (black) wire set plugs.
5. Support steering column assembly and remove both hex. head bolts.
6. Pull steering column assembly off center steering shaft. Do not apply any force as plastic injections in center steering shaft may be loosened and shaft would then require replacement.

#### Installation

**CAUTION:** *Fasteners are important attaching parts in that they could affect the performance of vital components and systems, and/or could result in major repair expense. They must be replaced with one of the same part number or with an equivalent part if replacement becomes necessary. Do not use a replacement part of lesser quality or substitute design. Torque values must be used as specified during reassembly to assure proper retention of these parts.*

1. Install steering column assembly onto steering shaft and torque steering shaft upper universal joint lower clamp bolt to 14 lb.ft.
2. Install hex head bolts and torque to 14 lb.ft.

NOTE: *Be sure to install ground wire.*

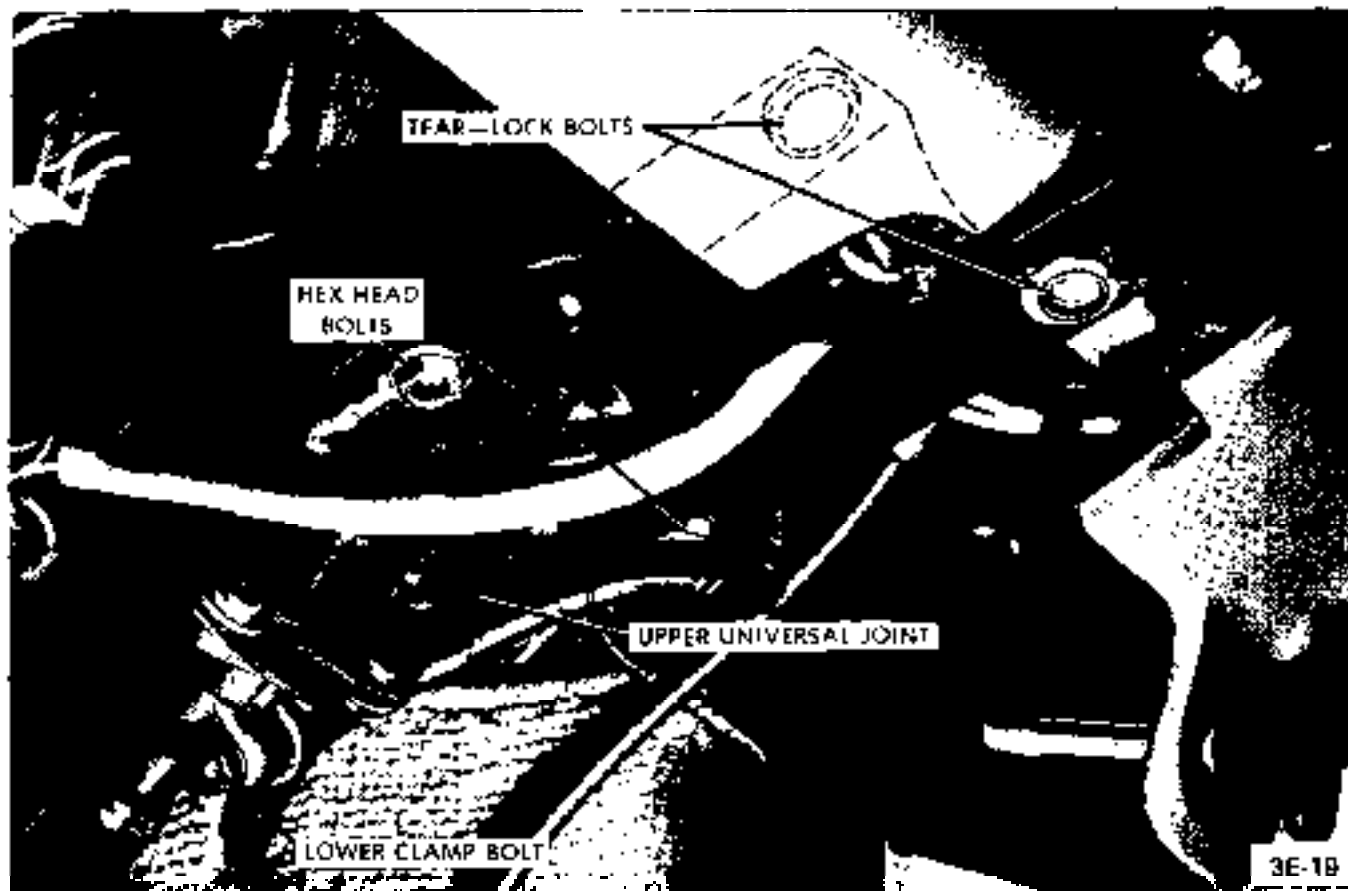


Figure 3E-19 Steering Column Attachments

3. Install new tear bolts and tighten until hex head of bolt is torn off.
4. Reconnect ignition and direction signal wire sets.

### REMOVAL AND INSTALLATION OF CENTER STEERING SHAFT

#### Removal

Steering shaft must be handled carefully so as not to loosen plastic injections as shaft would then require replacement.

1. Position steering so that front wheels are straight ahead.
2. Loosen steering shaft upper universal joint lower clamp bolt.
3. Remove steering shaft lower universal joint upper clamp screw.
4. Carefully push center steering shaft up into steel washer joint until lower end is free.
5. Remove steering shaft through bottom.

#### Installation

**CAUTION:** *Fasteners are important attaching parts in that they could affect the performance of vital components and systems, and/or could result in major repair expense. They must be replaced with one of the same part number or with an equivalent part if replacement becomes necessary. Do not use a replacement part or lesser quality or substitute design. Torque values must be used as specified during reassembly to assure proper retention of these parts.*

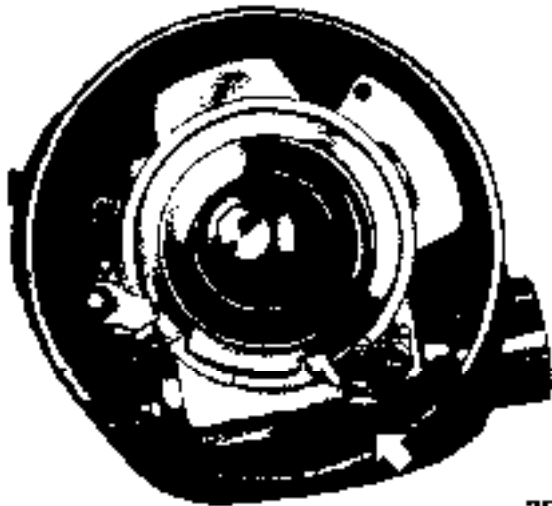
1. Install steering shaft through bottom and position into upper universal joint.
2. Insert shaft into lower universal joint and torque bolt to 22 lb.ft.
3. Torque upper universal joint bolt to 14 lb.ft.

### REMOVAL AND INSTALLATION OF IGNITION SWITCH AND/OR STEERING LOCK

#### Removal

1. Remove ignition lock cylinder, see previous paragraph in this section.

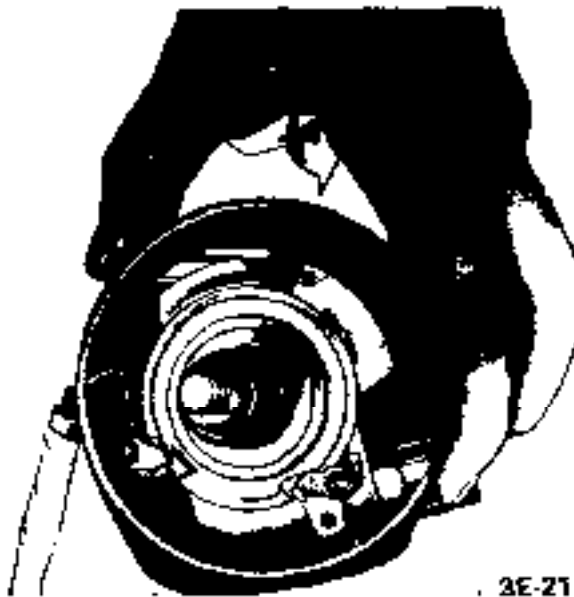
2. Disconnect ignition (white) wire set plug.
3. Remove steering lock retaining screw. See Figure 3E-20.



3E-20

Figure 3E-20 Steering Lock Retaining Screw

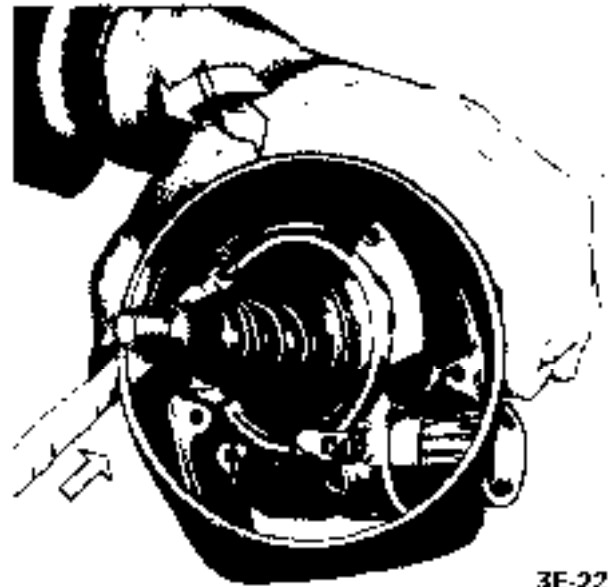
4. Remove direction signal switch lever.
5. Remove three screws securing signal switch cover to housing.
6. To remove housing cover, (a) pull cover toward direction signal switch and move it slightly to the right. See Figure 3E-21. (b) Turn cover toward the left and move it further to the right so that the left retaining screw ear is positioned under the left signal switch return cam. See Figure 3E-22. (c) Insert direc-



3E-21

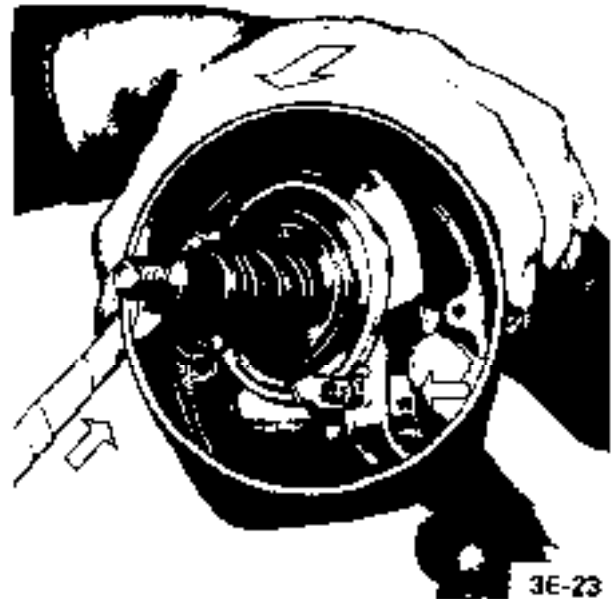
Figure 3E-21

tion signal switch lever into oblong opening in cover and push steering lock into housing and remove cover. See Figure 3E-37.



3E-22

Figure 3E-22



3E-23

Figure 3E-23

7. Remove ignition switch electrical unit. See Figure 3E-24.
8. Remove wires from connector plug making certain to note location of each.
9. Tape wire ends together and remove electrical unit and wire harness.

#### Installation

1. Position electrical unit wire harness through column and reconnect to connector plug.



3E-24

Figure 3E-24 Removing Electrical Unit

Before installing electrical unit be sure unit is in RUN position. Using a Philips screwdriver, turn inner sleeve to the tight until a springy resistance is felt. See Figure 3E-25.



3E-25

Figure 3E-25 Checking for RUN Position

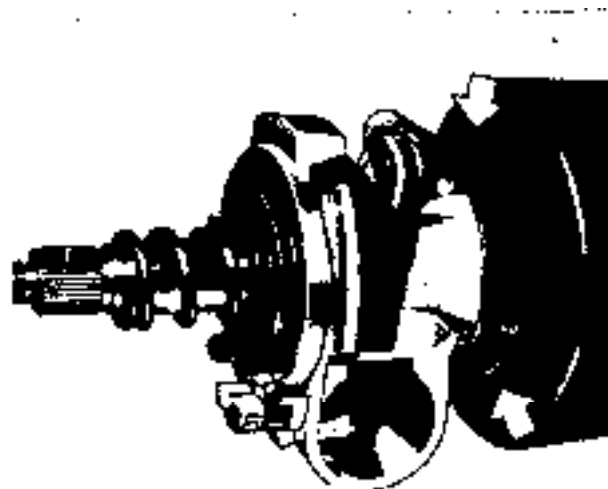
2. Install ignition switch electrical unit. See Figure 3E-24.
3. Install housing cover by attaching with three (3) screws.
4. Install steering lock retaining screw. See Figure 3E-20.
5. Reconnect ignition (white) wire set plug.

6. Install direction signal switch lever.
7. Install ignition lock cylinder. See previous paragraph in this section.

#### REMOVAL AND INSTALLATION OF UPPER STEERING BEARING AND/OR DIRECTION SIGNAL SWITCH

##### Removal

1. Remove ignition switch and steering lock, see previous paragraph in this section.
2. Disconnect direction signal (black) wire set plug.
3. Remove wires from connector plug making certain to note location of each.
4. Remove screws and direction signal housing and switch assembly. See Figure 3E-26.



3E-26

Figure 3E-26 Removing Direction Signal Switch Assembly

5. To remove upper bearing, pull horn wire out of bearing housing and pry out bearing assembly using a flat screwdriver. See Figure 3E-27.

##### Installation

1. If upper bearing has been removed, install by using the thumbs of both hands being sure to line bearing up with notched portion of housing.
2. Install direction signal housing and switch assembly. See Figure 3E-26.
3. Reposition wires into connector plug and connect direction signal wire set.

4. Install ignition switch and steering lock

### REMOVAL AND INSTALLATION OF STEERING COLUMN LOWER BEARING

#### Removal

The following is with steering column assembly removed.

1. Remove steering wheel.
2. Remove screws securing lower bearing housing to mast jacket.
3. Remove steering shaft together with universal joint and bearing and housing.
4. Remove universal joint from shaft. See Figure 3E-28.

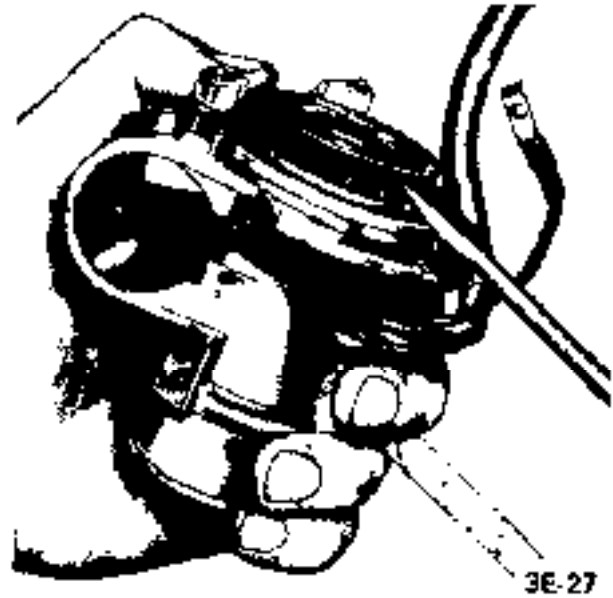
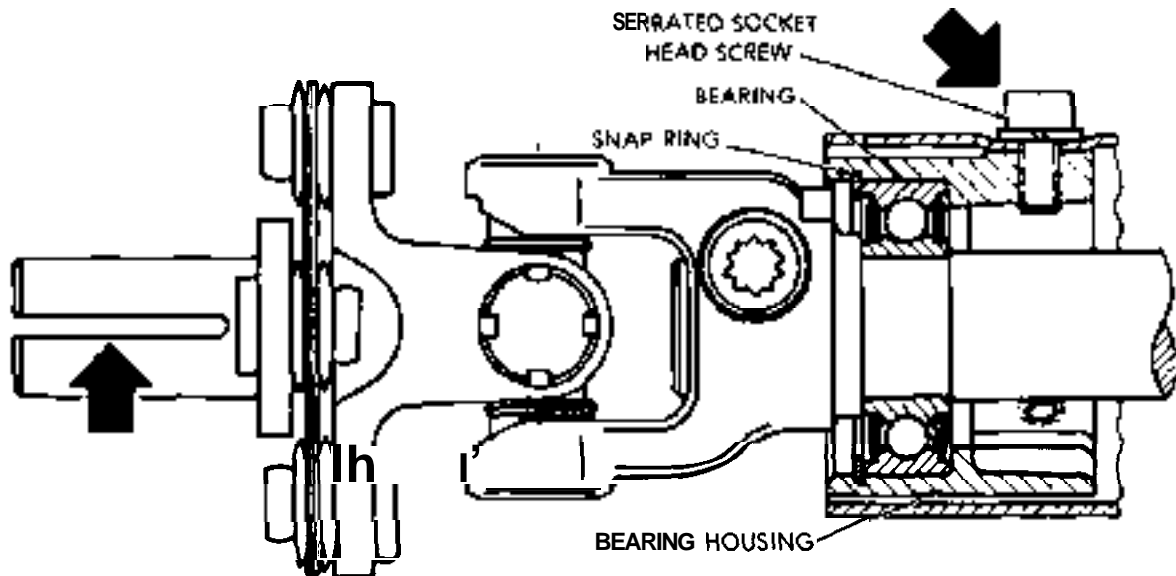


Figure 3E-27 Removing Upper Bearing



3E-28

Figure 3E-28 Removing Lower Bearing

5. Remove bearing retainer snap ring and remove bearing.

#### Installation

1. Install bearing and bearing retainer snap ring.
2. Install universal joint and torque to 22 lb.ft.

3. Install steering shaft, together with universal joint bearing and housing to mast jacket. Serrated socket head screw must be installed on top side of steering column assembly. See Figure 3E-28.

4. Install steering wheel. On installation of steering wheel, make sure that with flats of lower portion of universal joint horizontal, the center steering wheel spoke must be vertical.



PART	LOCATION	TORQUE LB.FT.
	Steering Wheel	15
	Upper Universal Joint - Lower Clamp	14
Bolt	Upper Universal Joint - Hex Head	14
Bolt	Lower Universal Joint	22

# REAR SUSPENSION

## CONTENTS

Subject	Page No.
<b>DESCRIPTION AND OPERATION:</b>	
Description and Operation of Rear Suspension .....	3F-51
<b>DIAGNOSIS: (Not Applicable)</b>	
<b>MAINTENANCE AND ADJUSTMENTS: (Not Applicable)</b>	
<b>MAJOR REPAIR:</b>	
Rear Shock Absorber Removal and Replacement . .	3F-51
Rear Spring Removal and Installation .....	3F-52
Lower Control Arm Replacement .....	3F-53
Stabilizer Rod Replacement .....	3F-53
Track Rod Replacement .....	3F-53
<b>SPECIFICATIONS:</b>	
Rear Suspension Specifications .....	3F-53

### DESCRIPTION AND OPERATION

#### DESCRIPTION AND OPERATION OF REAR SUSPENSION

All Opels utilize the three link rear suspension arrangement. This rear suspension consists of coil springs, track rod, shock absorbers and lower control arms.

The coil springs set between two seats which are situated ahead of the rear axle housing.

The track rod is utilized on all models to control the lateral stability of the rear axle assembly. It is of tubular design. A stabilizer rod is used on all Wagons as well as Fast Backs and Sedans. The GT is not equipped with a stabilizer rod.

The lower control arms are of tubular design and function as two links of the three link suspension system. They are attached to the underbody through brackets welded to the side rails and to the rear axle assembly through the front portion of the spring seat bracket. The lower control arms control the fore and aft movement of the rear axle assembly.

The third link in this suspension system is the torque tube which is connected to the differential carrier and also to the underbody through rubber bushings in the central joint support bracket.

The torque tube in conjunction with the lower control arms absorb all acceleration and braking torque.

### MAJOR REPAIR

#### REAR SHOCK ABSORBER REMOVAL AND INSTALLATION

##### Removal

NOTE: The trim panel under the spare tire must be removed on the GT to gain access to attaching nuts.

1. Remove upper attaching nut, retainer and rubber grommet.
2. Remove lower attaching nut and rubber grommet retainer, compress shock absorber and remove from lower mounting pin.

##### Installation

1. Replace upper and lower rubber grommets, if necessary, before installing shock absorber.
2. Extend shock absorber and position in car. Attach at lower end first, torque nut to 15 lb.ft. on the GT, and torque to 47 lb.ft. on the Opel 1900 - Manta.

3. Install rubber grommet, retainer and self-locking nut at top of shock absorber. Torque to 10 lb. ft. Always use new self-locking nuts.

### REAR SPRING REMOVAL AND INSTALLATION

#### Rear Spring Removal

1. Raise rear of car with floor jack under differential carrier and support with jack stands positioned under side jack brackets. See Figure 3F-2.



Figure 3F-2 Raising Rear of Car

2. Remove rear wheels.
3. Disconnect shock absorbers from rear axle.
4. Disconnect stabilizer and shackles, if equipped, from frame.
5. Lower rear axle assembly as far as possible without putting the brake hose under stress.
6. If necessary, tilt the rear axle assembly to remove springs. See Figure 3F-3. Note the upper and lower rubber damper rings.

#### Rear Spring Installation

1. Make certain the lower damper rings are properly positioned in the spring seats and position the springs in their respective position in the damper rings. See Figure 3F-4.

2. Properly install upper damper rings on springs.

**CAUTION:** Fasteners are important attaching parts in that they could affect the performance of vital components and systems, and/or could result in major repair expense. They must be replaced with one of the same part number or with an equivalent part if replacement becomes necessary. Do not use a replacement part of lesser quality or substitute design



Figure 3F-3 Removing Coil Spring

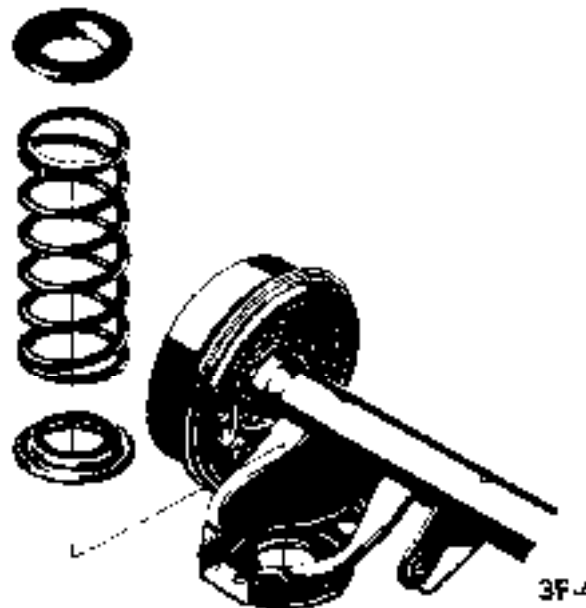


Figure 3F-4 Installing Coil Spring

*Torque values must be used as specified during reassembly to assure proper retention of these parts.*

3. Raise rear axle assembly to compress springs in their seats.
4. Attach shock absorbers and tighten retaining nuts to 15 lb.ft. For the GT and 47 lb.ft. for the Opel 1900 • Manta.
5. Attach stabilizer shackles, if equipped, to axle brackets and tighten bolts to 25 lb. ft. with vehicle at curb weight.
6. Install rear wheels torquing lug nuts to 65 lb.ft.

7. Remove jack stands.

**LOWER CONTROL ARM REPLACEMENT**

**Removal**

This operation can be performed with the vehicle standing at curb height or elevated.

1. Disconnect parking brake cable from support bracket on control arm.
2. Loosen and remove front and rear control arm attaching bolts and remove control arm.

**installation**

1. On 1900's and Manta's place a load of approximately 350 lbs. in luggage compartment or on the GT, place a load of approximately 150 lbs. on driver's seat. Torque control arm attaching nut and bolts to 18 lb.ft on GT's and 23 lb.ft. on the 1900 - Manta.
2. Connect parking brake cable to support bracket on control arm.

**STABILIZER ROD REPLACEMENT**

**Removal**

1. Raise and support rear of vehicle.
2. Disconnect stabilizer rod to shackle bolts.
3. Disconnect stabilizer rod to underbody retainers and work stabilizer rod out from under vehicle.

**SPECIFICATIONS**

**REAR SUSPENSION SPECIFICATIONS**

**Tightening Specifications**

Use a reliable torque wrench. Specifications are for clean and lightly-oiled threads.

**Installation**

1. Work stabilizer rod into position and loosely attach stabilizer to underbody retainers.
2. Connect stabilizer rod to shackles.
3. With the vehicle standing on its wheels or the rear axle assembly lifted, tighten stabilizer rod to underbody bracket bolts to 15 lb. ft.
4. Remove jack stands and lower vehicle.

**TRACK ROD REPLACEMENT**

**Removal**

1. Lift rear of car and suitably support.
2. Disconnect track rod from rear axle and frame side member.

**Installation**

1. Loosely connect track rod first to side member and then to the rear axle.
2. On the 1900 - Manta, load luggage compartment of vehicle with approximately 350 lbs. or on the GT, place a load of approximately 150 lbs. on driver's seat and tighten track rod attaching bolts to specified torque.
3. Remove supports (jack stands) and lower vehicle.

Part	Name	Torque Lb.Ft.
Nut	Wheel Nuts . . . . .	65
Nut	Control Arm Attaching (GT) . . . . .	16
Nut	Control Arm Attaching (1 900 - Manta) . . . . .	23
Bolt	Stabilizer Rod to Underbody Retainers . . . . .	15
Nut	Shock Absorber Lower Attachment (GT) . . . . .	15
Nut	Shock Absorber Lower Attachment (1900 Manta) . . . . .	47
Nut	Shock Absorber Upper Attachment . . . . .	10
Bolt	Stabilizer Shackle to Axle Bracket . . . . .	25

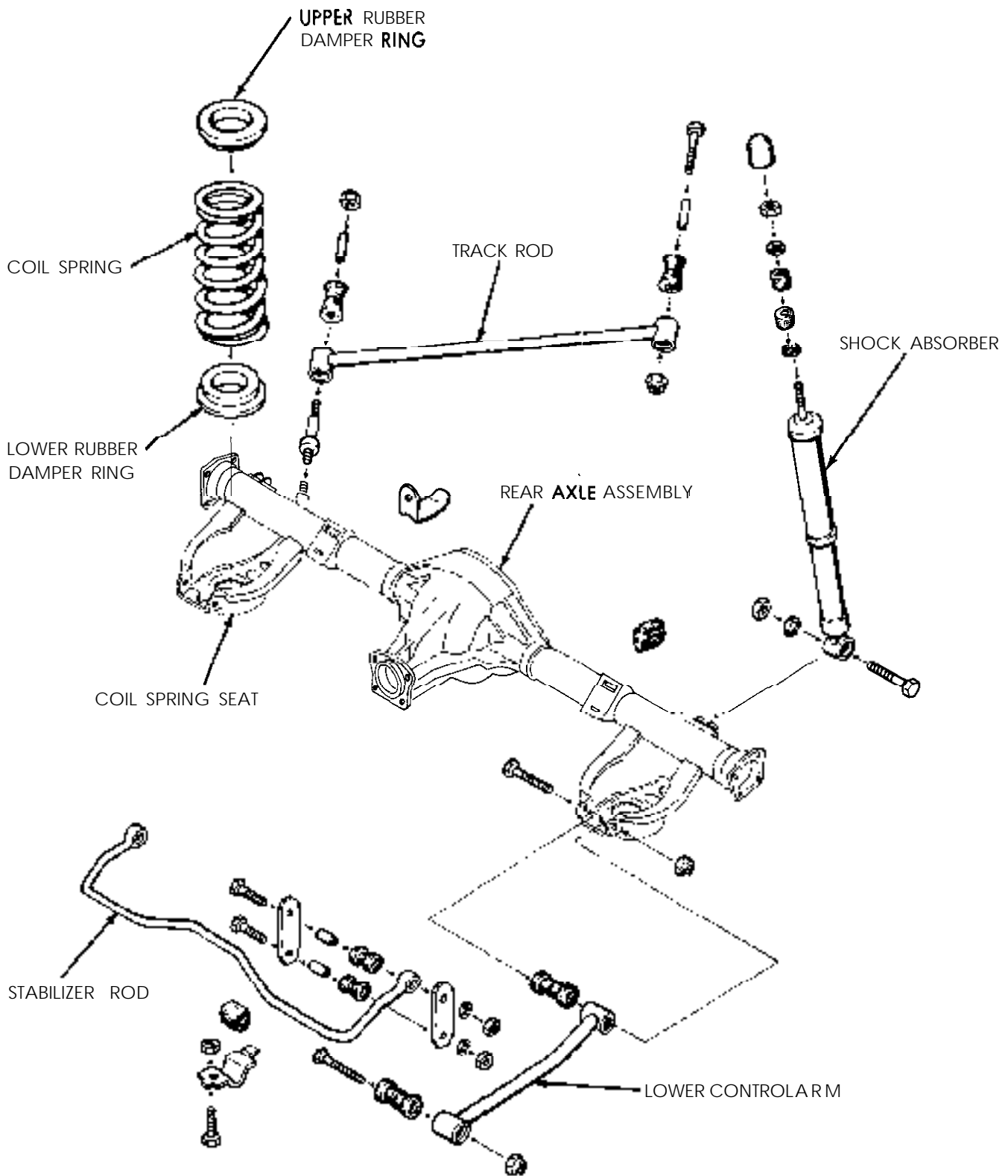


Figure 3F.5 Exploded View Rear Suspension

# WHEELS AND TIRES

## CONTENTS

Subject	Page No.
<b>DESCRIPTION AND OPERATION: (Not Applicable)</b>	
<b>DIAGNOSIS:</b>	
Car Roughness and Vibration .....	3G-55
Abnormal Tire Wear .....	3G-58
<b>MAINTENANCE AND ADJUSTMENTS:</b>	
Demounting and Mounting Tubeless Tires .....	3G-61
Wheel and Tire Balance .....	3G-62
<b>MAJOR REPAIR: (Not Applicable)</b>	
<b>SPECIFICATIONS:</b>	
Specifications .....	3G-62

### DIAGNOSIS

#### CAR ROUGHNESS AND VIBRATION

##### Possible Causes

To assist in the diagnosis and correction of some of the more stubborn cases of tire vibration and roughness conditions that may be encountered, the following information is offered:

**VIBRATION**, or a quivering motion condition, noticeable by feel through the steering column, steering wheel, floor pan, or by hood and fender shake, usually originates from the front wheels and tires. Front end vibration, when caused by unbalanced front wheels, can be generally felt as steering wheel "nibble".

A vibration felt through the seats as a side-to-side disturbance can usually be attributed to the rear wheels and tires.

Both front and rear vibration can be noticed mainly at highway speeds, usually over 60 mph.

**ROUGHNESS**, noticeable primarily at speeds between 40 and 65 mph, can be felt (and occasionally heard), and is due to certain irregularities in the tire. Roughness usually sets up a "trembling" feel or a shuddering effect.

##### Road-Test With Owner

When a ride complaint is encountered, **first** check

inflation pressures and perform tire inspection, including removal of any foreign material on tire tread or wheel large enough to upset balance.

Tire inflation pressure recommendations are very important at all times and particularly so on **all** ride complaints. Raising or lowering tire pressures to "improve" mileage or traction should not be attempted.

Next, road-test the car with the owner, if possible, and have the owner explain the specific ride disturbance.

After road-testing, raise car on hoist and proceed to isolate the offending tire/wheel assembly.

##### Reproducing the Disturbance

In an attempt to reproduce the disturbance experienced in the ride, a wheel spinner can be used on the front wheels of the car.

The rear wheels may be spun by placing car in "Drive" with engine running.

When spinning rear wheels, never exceed a speedometer speed of 35 mph with a standard rear axle assembly, or 75 **mph** on one with a positive traction rear axle. Excessive speeds may cause damage to the rear axle assembly.

Jack up both rear wheels by placing the jack under the differential housing. Spin one wheel and tire with the opposite wheel held from rotating by holding the

parking brake cable. Spin the other wheel using the same procedure.

By spinning the wheels, the offending tire will cause vibration that may be felt by touching the bumper or fender. By the process of elimination, proceed on

tires that cause vibration as follows:

**Unbalance**

Check for tire/wheel unbalance. An unbalanced wheel assembly that is causing a vibration can, in most cases, be reduced to an acceptable level by static and dynamic wheel and hub balancing. Correct by rebalancing, Figure 3G-2. It is recommended that an on-the-car balancer be used for balancing.

A tire/wheel assembly that is in balance may still be causing a vibration when the car is driven, but may not set up a vibration when the wheel is off the ground and submitted to the spinner test. In such cases, the next step is to check radial and lateral runout.

**Runout**

A runout gauge should be used to determine the amount of total radial and lateral runout at the tire that causes the vibration. See Figures 3G-3 and 3G-4.

A guide to runout maximum totals is as follows:

.035 inch Radial - Wheel

.050 inch Radial - Tire/Wheel Assembly

.045 inch Lateral - Wheel

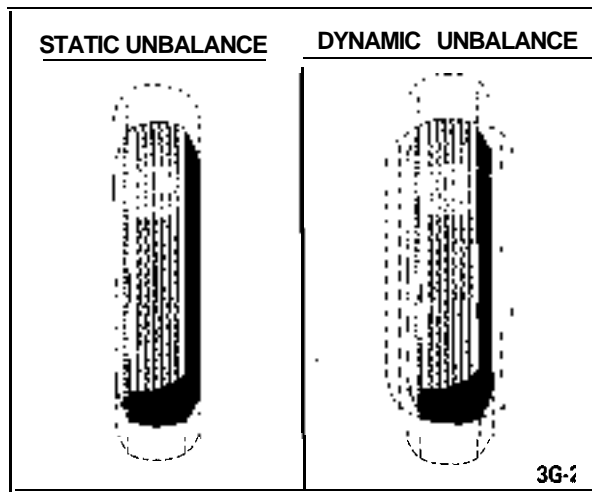


Figure 3G-2 Static and Dynamic Unbalance

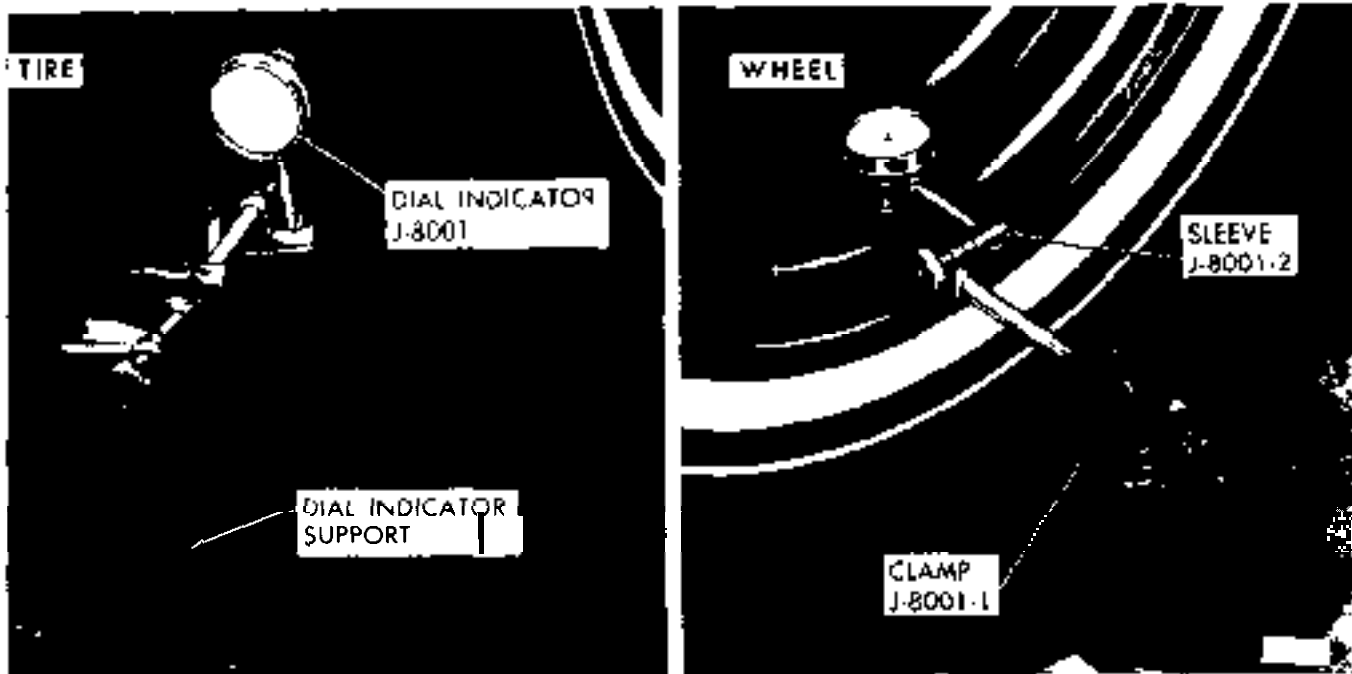


Figure 3G-3 Checking Radial Runout



Figure 3G-4 Checking Lateral Runout

**.050 inch Lateral • Tire/Wheel Assembly**

If the tire and wheel runouts are beyond any of the maximum totals above, the tire should be repositioned 180 degrees opposite its original location on the wheel. Refer to Figure 3G-5. This will, in most cases, reduce the runout and vibration to a satisfactory level.

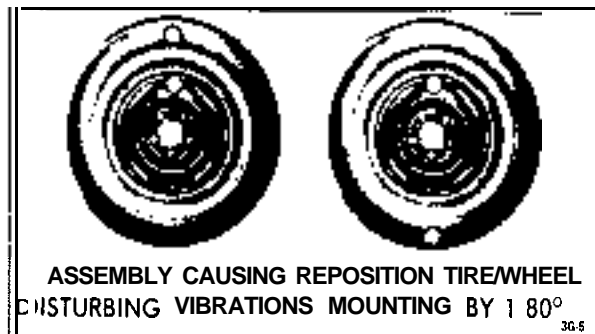


Figure 3G-5 Repositioning Tire on Wheel

There is no more work involved in repositioning a tire on a wheel than there is in putting on a new tire, and repositioning has a better chance of correcting the difficulty.

It is important that only the tire/wheel assemblies that are causing the disturbances be repositioned.

Since normally only one, and occasionally two, tire/wheel assemblies per vehicle could be causing the disturbing vibration, it is recommended that repositioning be performed only when required. Reposi-

tioning of non-disturbing assemblies could cause these assemblies to create vibration or roughness problems.

After repositioning, balancing the tire/wheel assembly is always necessary. It is very important that the tire/wheel assembly be balanced accurately.

At this point, the car should be road-tested again to assure that the disturbance has been corrected.

**Tire Grinding**

Tire grinding is very effective in eliminating tire complaints due to excessive tire runout. Grinding can be accomplished on or off the car. Grinding is approved by Opel, if done as recommended by the equipment manufacturer

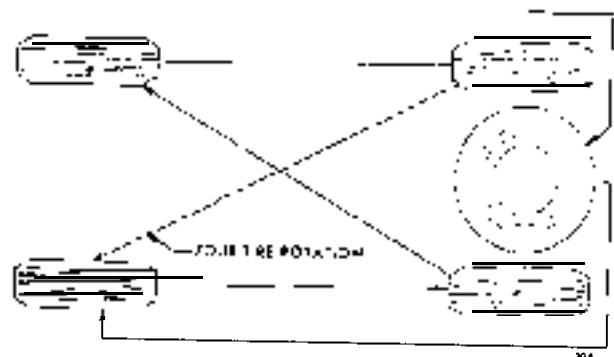


Figure 3G-6 Tire Rotation



### Tire Wear Irregularities

An additional cause of vibrations may sometimes be tire wear irregularities. These can also produce noise disturbances, and can be generally corrected by rotating the tires, Figure 3G-6. Before proceeding further, locate and correct the cause of the irregular tire wear. See Figure 3G-7.

Use the criss-cross method of rotation of tires only when all four tires are equally worn. In some instances, it may be necessary to put the truest running assemblies (those with the lowest tolerances) on the front of the car.

### Wheel Nut Torque and Tightening Specifications

During all wheel installations, it is important to use the correct **procedure** for installing wheel nuts and torquing them uniformly and in proper sequence. This is important in order to avoid possible distortion of the brake drum or disc, and to minimize damage to lug and nut threads and wheel stud holes.

To assure uniform tightening of wheel lug nuts, the following procedure is recommended:

1. Install wheel lug nuts in a criss-cross pattern and tighten just enough to seat wheel against hub. This assures proper piloting of the wheel on its hub.
2. Tighten lug nuts uniformly to proper torque of 65 lb.ft. using criss-cross pattern.

An impact wrench should not be used, as uniform torque control cannot be maintained.

### Summary of Diagnosis and Correction of Tire and Wheel Vibration

1. Inflate all tires to recommended pressure and road-test car with owner to define problem.
2. Spin front tire/wheel assemblies with wheel driving equipment. Rear wheels may be spun with tires off the ground and with one wheel held at a time. The offending tire may cause vibration that may be felt by touching the bumper or fender. By process of elimination, determine offending tire/wheel assembly.
3. Check for tire/wheel unbalance. Balance, if necessary.
4. Check each tire/wheel assembly on the car for radial **runout** on the tire tread. Wheel and tire assemblies exceeding .050 inches may be considered as offending assemblies. Offending tire/wheel assembly

should be deflated and the tire repositioned (indexed) 180 degrees from original location.

5. After repositioning, rebalance tire/wheel assembly (static and dynamic preferred).
6. Test drive and evaluate correction.

The following procedure should be used to determine cause of roughness or vibration with car in operation at various speeds:

1. Jack up all wheels having jack support rear end of car at center of rear axle housing.
2. With transmission in "Drive", run engine at various car speeds to note speeds at which vibration or roughness occurs.
3. Remove rear wheels and run engine again at the critical speeds noted in step 2. If roughness is gone, the condition is caused by unbalanced wheel and tire assemblies.
4. If roughness still exists with rear wheels removed, remove rear brake drums and repeat the running test. Elimination of the roughness indicates out of balance brake drums.
5. If roughness still exists with brake drums removed, run engine with transmission in "Neutral". Elimination of the roughness indicates that propeller shaft is out of balance. Continued roughness indicates an out-of- balance engine.

### ABNORMAL TIRE WEAR

#### General Operating Conditions

Assuming that there is no misalignment condition to cause abnormal wear, the life of tires depends largely upon car operation conditions and driving habits.

Tires wear at a much faster rate in some localities than in others because of road and operating conditions. Some types of roads are much more abrasive than others. Tire wear is also dependent upon the number of hills and mountains which the car must go up and down, the severity of grades, the number of starts and stops, driving speeds, the amount of rain and snow, and prevailing temperatures. ***Tire wear increases rapidly with speed, temperature, and load on tire.*** Tires used at low speeds, in cool climates, or with light loads will have longer life than tires used for high-speed driving in hot climates with heavy loads.

Driving habits have a very important bearing on tire life. A careful driver may obtain much greater mileage from a set of tires than **would be** obtained by a

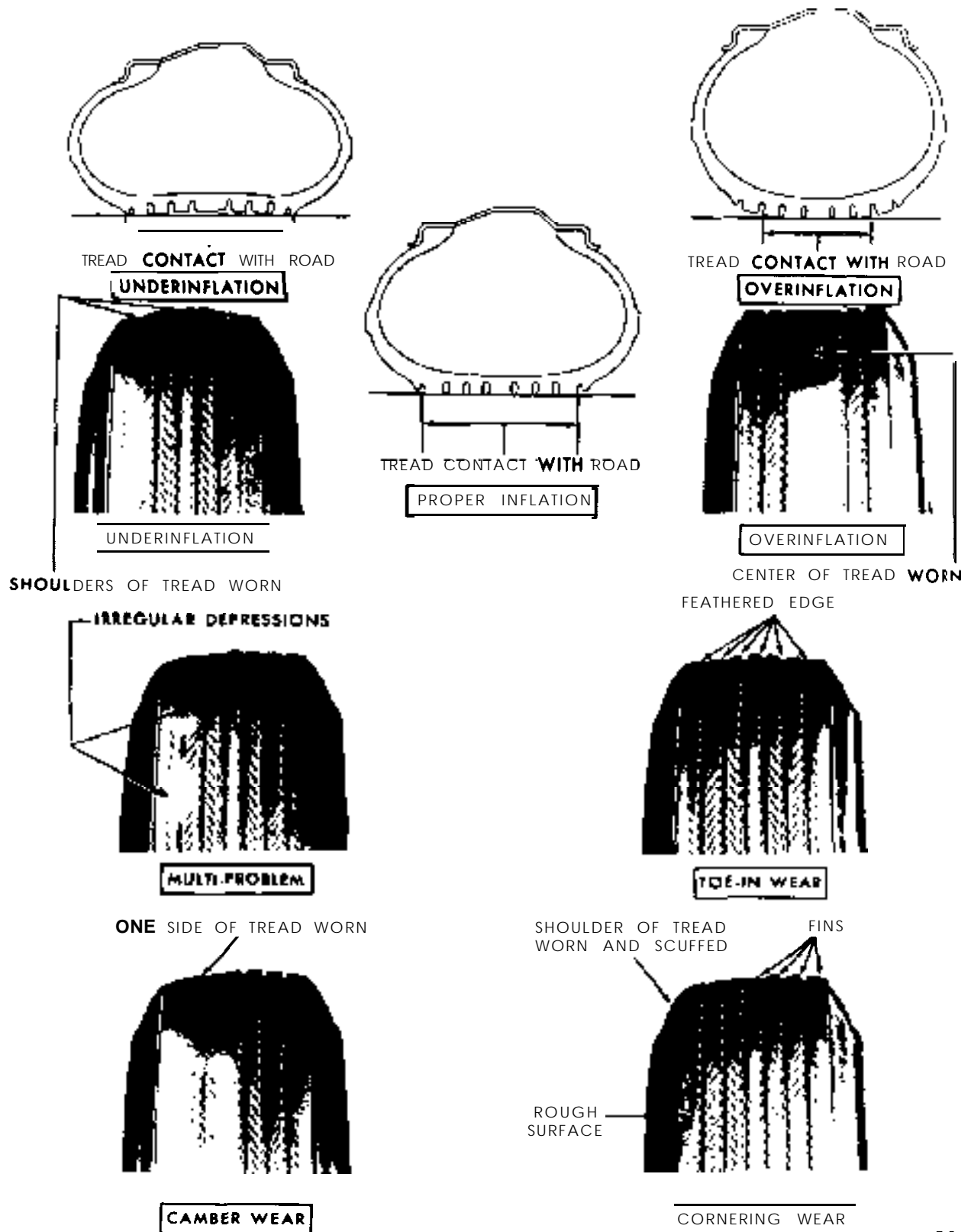


Figure 3G-7 Uneven Tire Wear

severe or careless driver. Rapid acceleration and deceleration, severe application of brakes, taking turns at excessive speed, high-speed driving, and striking curbs or other obstructions which lead to misalignment are driving habits which will shorten the life of any tire.

**Maintenance** of proper inflation pressure and periodic interchanging of tires to equalize wear are within the control of the driver. Underinflation raises the internal temperature of a tire greatly due to the continual friction caused by the flexing of the side walls. Tire squealing on turns is an indication of underinflation or excessive speed on the turns. A combination of underinflation, high road temperatures, and high-speed driving will quickly ruin the best tire made.

High speed on straight highways or expressways normally causes more rapid wear on the rear than on the front tires, although cupping of front tires can result if the tires are not periodically switched from wheel to wheel. Driving turns and curves at too high a rate of speed causes the front tires to wear much faster than the rear tires.

An inspection of the tires, together with information as to locality in which the car has **been** operated will usually indicate whether abnormal wear is due to the operating conditions described **above** or to mechanical faults which should be corrected.

The various types of **abnormal** tire wear and their causes are described in the following paragraphs.

#### Shoulder or Underinflation Tread Wear

When a tire is underinflated, the side walls and shoulders of the tread carry the load, while the center of tread folds in or compresses due to the low internal air pressure. This action causes the shoulders to **take** all of the driving and braking load, resulting in **much** faster wear of shoulders than of the center of tread. See Figure 3G-7. For maximum results in handling, riding and tire life, tire inflation pressures should never be allowed to go below the specified minimum pressure.

Continuous high-speed driving on curves, right and left, may produce **tread wear** very similar to **underinflation** wear and might very easily be mistaken for such. Side thrust when rounding **turns causes wear** on the sides of tire tread. In making a turn to the left, especially at high speeds, the outside shoulder of the right tire and the inside shoulder of the left tire take the side thrust and naturally receive the most wear. The only possible correction is to advise slower speeds on curves. Do not increase tire inflation pressures beyond specified limits, as this will cause center or over-inflation wear. See paragraph below.

#### Canter or Overinflation Tread Wear

Excessive wheel camber, either positive or negative, causes the tire to run at such an angle to the road surface that one side of the tread wears much more than the other. See Figure 3G-7.

When tire inflation pressures are maintained within the specified limits, the tire will make a full contact across the entire width of tread, thereby distributing the wear evenly over the total surface of the tread area.

#### Cross or Toe Tread Wear

When the front wheels have an excessive amount of either toe-in or toe-out, the tires are actually dragged sideways when they travel straight down the road and cross wear or scraping action takes place rapidly wearing away the tread of tires. This cross wear condition will usually produce a tapered or feathered edge on the ribs of the tire tread. See Figure 3G-7. In most cases, this can be detected by rubbing the hand across the tire **tread**.

If the tapered or feathered edges are on the inner sides of the ribs on one of both sides, it indicates that one or both tires have excessive toe-in, while the same condition in the outer sides of ribs indicates excessive toe-out. Usually, **excessive toe-in causes excessive tire wear on the outer edge of the right front tire and toe-out causes tire wear on the inner edge of the left front tire. See Section 3C for toe-in correction.**

Cornering wear caused by high-speed driving on curves (see following paragraph) sometimes has the appearance of toe wear. Care must be used to distinguish between these two types of wear so that the proper corrective **measures** will be used.

#### Side or Camber Wear

Excessive wheel camber, either positive or negative, causes the tire to run at **such an** angle to the road surface that one side of the tread wears much more than the other. See Figure 3G-7.

The amount or angle of the camber wear will be governed by the amount of positive or negative camber. Tire tread wear very similar in appearance to camber wear may be caused by driving on turns at excessive speeds. This "cornering" tread wear (see paragraph below) cannot be **corrected** by change of **camber** angle.

Adjustments for specified camber are covered in Section 3C.

### Cornering Tread Wear

The modern independently-sprung automobile allows the driver to negotiate turns at a high rate of speed with a greater feeling of safety. This fact is responsible for a comparatively new type of tread wear that can easily be mistaken for toe or camber wear.

When a car is making a turn, the tires are supposed to be rolling in a circle. When the turn is **made at** high speed, however, centrifugal force acting on the car causes the tires to be distorted sideways and to slip or skid on the road surface. This produces a diagonal cross type of wear, which in severe cases will result in a fine or sharp edge on each rib of the tire treads.

Cornering wear can be distinguished from toe or **camber** wear by the rounding of the outside shoulder of the tire and by the roughening of tread surface in this section denoting severe abrasion. See Figure 3G-7.

No alignment or tire pressure change can be made that will relieve cornering wear. Only the driver can effect a cure and that is by slowing down on curves.

### Heel and Toe Tread Wear

Heel and toe wear is a saw-tooth effect with one end of each tread block worn more than the other.

The end which wears is the one that first grips the road when the brakes are applied. High-speed driving and excessive use of the brakes will cause this type of irregular tire wear. This type of wear will occur on any type of block tread design. See Figure 3G-7.

Heel and toe wear is not so prevalent on the rear tires because of the propelling action which creates a counteracting force which wears the opposite end of the tread block. These two stresses on the rear tires wear the tread blocks in opposite directions and result in more even wear while on the front tires, the braking stress is the only one which is effective. This may be counteracted by interchanging tires.

A small amount of irregular wear, slightly saw-toothed in appearance, at the outer segments of tires is a normal condition and is due to the difference in circumference between the center and the outer edges of the tire tread. This saw-toothed appearance, however, will be exaggerated by underinflation, improper toe-in, or both.

### Cupped or Scalloped Type Tire Wear

Cupping or scalloping is associated with **wear** on a

car driven mostly at highway speeds without recommended tire rotation. Factors which promote cupping include underinflation, incorrect toe-in setting or camber setting, and steady highway speeds on smooth, paved surfaces as opposed to gravel or rough asphalt.

The following recommendations suggest action that may be taken to help prevent cupping.

1. Rotate tires as recommended in Figure 3G-6.
2. Frequently inspect front tires for irregular wear due to underinflation, improper toe-in setting, or camber setting. Regardless of the original cause of cupped tread wear on either front tire, no alignment or balance job, however perfect, can prevent future excessive wear of the spots. Once a front tire acquires flat or cupped spots, additional wear will continue at a rapid rate. At the time of correction, however, the cupped tire should be interchanged with a rear tire on which the tread runs true. The cupped tire will, to a certain degree, true itself on a rear wheel.

Although not normally the cause of cupping, the following factors can contribute to the problem.

Looseness of parts in the suspension system, such as worn steering knuckle ball joints, loose wheel bearings, inoperative shock absorbers, and any excessive looseness throughout the steering system all tend to allow the front wheels to kick around and, if any of the wheel alignment factors are incorrect, irregular spotty tire tread wear of one type or another may result.

Wobble or **runout** of a tire, either front or rear, due to bent wheel or to tire being improperly mounted will cause uneven wear.

## MAINTENANCE AND ADJUSTMENTS

### DEMOUNTING AND MOUNTING TUBELESS TIRES

Due to use of symmetrical rims, tires must be mounted over the narrow rim shoulder i.e., over outside rim flange.

When demounting a tubeless tire use care to avoid damaging the rim-seal ridges on tire beads **DO NOT USE TIRE IRONS TO FORCE BEADS AWAY FROM WHEEL RIM FLANGES.**

When tire is removed, inspect it carefully to determine whether loss of air was caused by puncture or by improper fit of beads against rim flanges. If improper fit is indicated, check wheel as follows: Do not reuse dented rims.

1. Clean rims thoroughly, using No. 3 coarse steel wool to remove all oxidized rubber, soap solution, etc. Remove rust with wire brush.
2. Inspect butt weld and other **areas** of **rim contacted by** tire beads to make certain there is no groove or high spot. Remove any groove or high spot **by** tiling smooth.
3. Inspect valve stem and replace it if damaged. Make certain that valve stem is properly installed to provide an air tight joint.
4. Before mounting a tubeless tire on a wheel, moisten a cloth with mounting compound or soap solution and wipe rim-seal **ridges** of both beads to remove all foreign substances.
5. Moisten base of both beads with mounting compound or soap solution to help beads snap into place when tire is inflated. Start tire over rim flange at point opposite valve stem.
6. Inflate tire until both beads are firmly seated against rim flanges and temporarily over inflate. Leak test wheel and tire assembly and if satisfactory, reduce to recommended pressure.

**WHEEL AND TIRE BALANCE**

Wheel and tire balance is the equal distribution of the weight of the wheel and tire assembly around the axis of rotation. Wheel unbalance is the principal cause of tramp and general car shake and roughness and contributes somewhat to steering troubles.

The original balance of the tire and wheel assembly may change as the tire wears. Severe acceleration, severe brake applications, fast cornering and side slip wear the tires out in spots and often upset the original balance condition and make it desirable to rebalance the tire and wheel as an assembly. Tire and wheel assemblies should be rebalanced after punctures are repaired.

Because of the speed at which cars are driven, it is necessary to test the wheel and tire assembly for dynamic balance. Dynamic balancing of a wheel and tire assembly must be done on a machine designed to indicate out-of-balance conditions while the wheel is rotating on the car. Since procedures differ with different machines, the instructions of the equipment manufacturer must be carefully followed.

**SPECIFICATIONS**

**General Specifications**

Wheels	
Opel 1900 • Manta and GT .....	<b>5J x 13</b>
Tires	
1900 • Manta .....	165-13
GT .....	165-13

**Tire Size and Pressures (Pounds Per Square Inch Cold)**

Model	Tire Size	Recommended Pressure		(Standard Inflation)
		Front	Rear	
<b>51.53.54.57</b>	<b>165-13</b>	<b>24 PSI</b>	<b>32 PSI</b>	
<b>57R,57L</b>	<b>165-13</b>	<b>23 PSI</b>	<b>26 PSI</b>	
<b>77</b>	<b>165-13</b>	<b>19 PSI</b>	<b>23 PSI</b>	

**NOTE:**

1. Tire inflation pressures may increase as much as 6 pounds per square inch when hot.
2. For continuous high-speed operation (over 75 MPH), increase tire inflation pressures 4 pounds per square inch over the recommended pressures up to a maximum of 30 pounds per square inch cool for 4 ply rating tires. When the 4 psi pressure adjustment for sustained high speed with maximum vehicle load

would require inflation pressures above the maximum allowable, speed must be limited to 75 miles per hour.

3. Cool tire inflation pressure: After vehicle has been inoperative for 3 hours or more, or driven less than one mile. Hot tire inflation pressure: After vehicle has been driven **10 miles or more** at 60-70 MPH.
4. Vehicles with luggage racks do not have a vehicle load limit greater than specified.
5. When towing trailers, the allowable passenger and cargo load must be reduced by an amount equal to the trailer tongue load on the trailer hitch.

**Torque Specification**

Wheel Nuts .....	65 lb.ft.
------------------	-----------

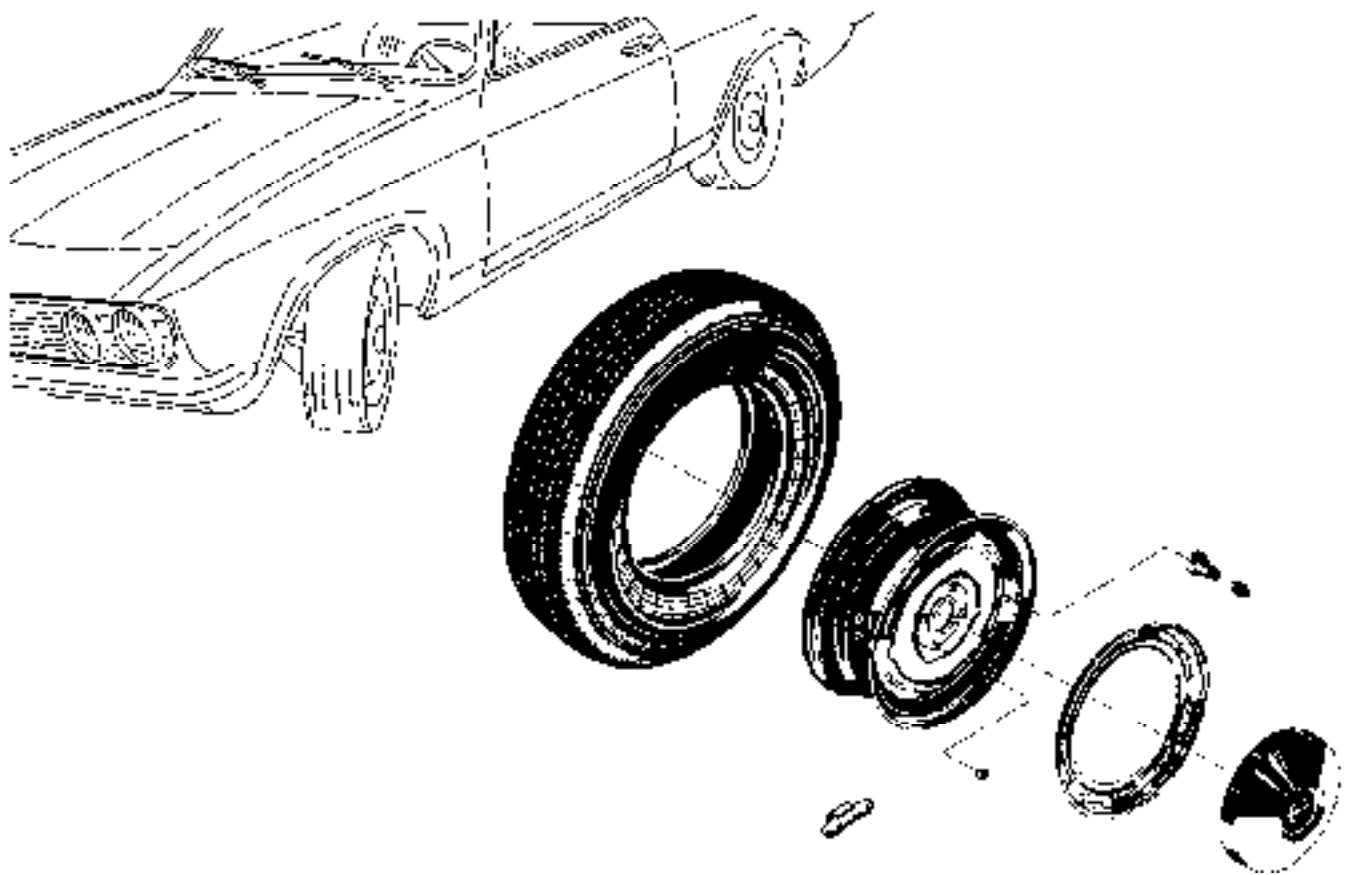
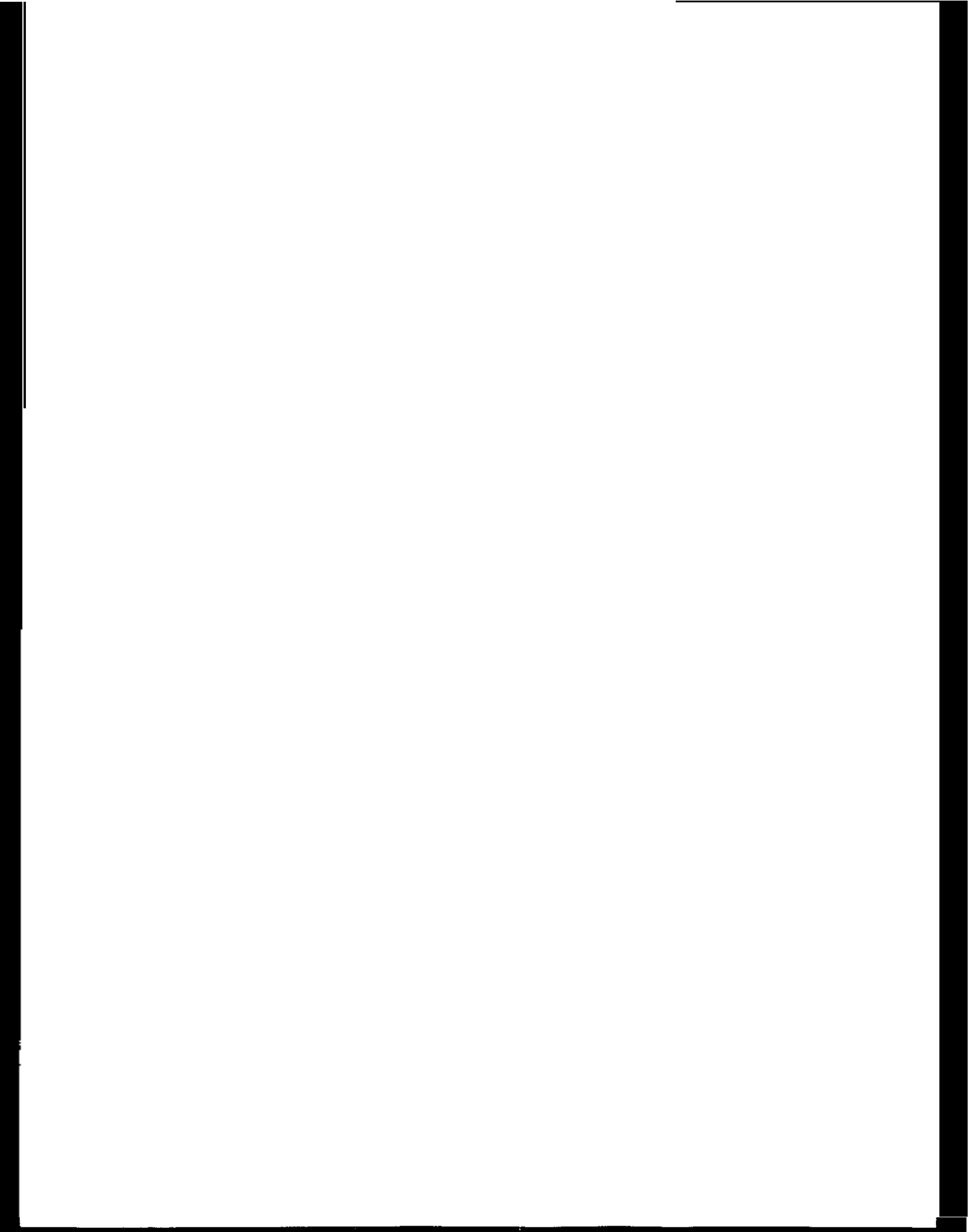


Figure 3G-8 Wheel and Tire - Exploded View



---

**GROUP 4**

**PROPELLER SHAFT  
AND DIFFERENTIAL**

<b>Section</b>	<b>Title</b>	<b>Page No.</b>
<b>4A</b>	Propeller Shaft and Central Joint .....	4A-2
<b>4B</b>	Rear Axle .....	4B-7



# PROPELLER SHAFT AND CENTRAL JOINT

## CONTENTS

Subject	Page No.
<b>DESCRIPTION AND OPERATION:</b>	
Propeller Shaft and Central Joint .....	4A-2
<b>DIAGNOSIS: (Not Applicable)</b>	
<b>MAINTENANCE AND ADJUSTMENTS: (Not Applicable)</b>	
<b>MAJOR REPAIR:</b>	
Propeller Shaft Removal and Installation .....	4A-3
Disassembly and Assembly of Central Joint .....	4A-3
<b>SPECIFICATIONS:</b>	
Propeller Shaft and Central Joint Specifications . .	4A-6

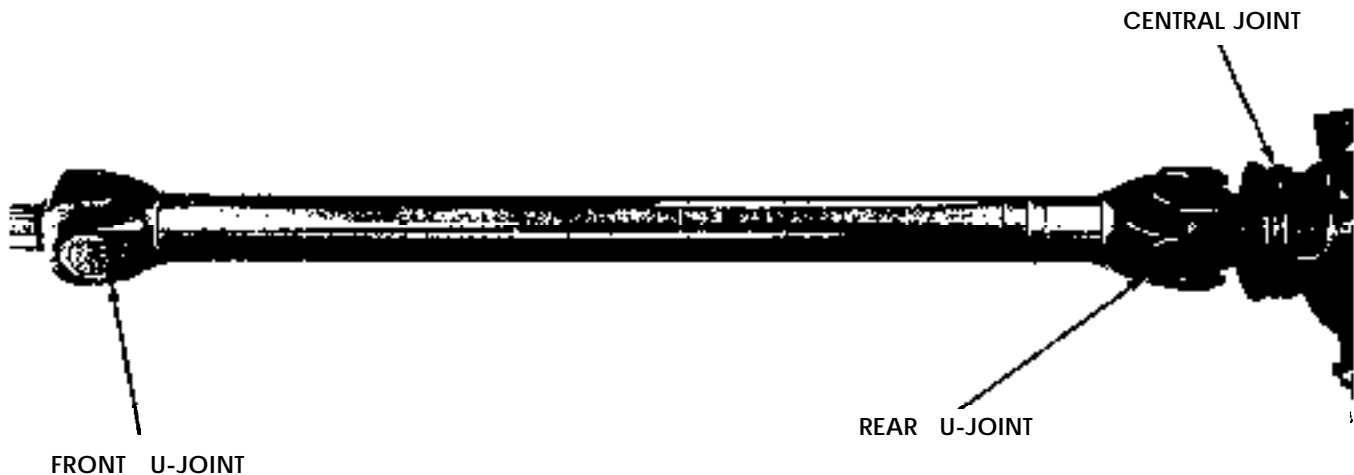
## DESCRIPTION AND OPERATION

### PROPELLER SHAFT AND CENTRAL JOINT

Due to the use of both automatic and manual transmissions, propeller shafts of various lengths are required depending upon vehicle, engine, and transmission (manual or automatic) application. The propeller shaft is of a strong design due to increased engine torque. It is also a one piece tubular shaft, but it has two universal joints. See Figure 4A-1. The front universal joint attaches to the transmission output shaft by a **splined** slip joint. The rear universal joint attaches to the pinion extension shaft flange by

two U-bolts. The splines of both propeller shafts are lubricated internally with transmission lubricant. An oil seal in the rear of the transmission extension prevents loss of lubricant and entrance of harmful foreign material.

The torque tube which houses the drive pinion extension shaft is bolted to the differential housing. The torque tube is pivoted in rubber elements of the central joint support bracket which is bolted to the floor panel. The support bracket and rubber parts of the torque tube are termed the central joint. The front end of the drive pinion extension shaft rides in a ball bearing mounted in rubber in the central joint.



4A-1

Figure 4A-1 Propeller Shaft

## MAJOR REPAIR

### PROPELLER SHAFT REMOVAL AND INSTALLATION

#### Removal

1. Raise rear of car and support on jack stands at rear jack brackets.
2. Disconnect parking brake cable equalizer from rod.
3. On the Opel 1900 and Manta, unhook parking brake cable from floor panel.
4. On the Opel 1900 and Manta, unhook exhaust system and let it down.
5. Mark the mating parts of the U-joint **and** the drive pinion extension shaft flange.
6. Loosen bolt locks and remove bolts or nuts.
7. Work propeller shaft slightly forward, lower rear end of shaft **and** slide assembly rearward. Remove thrust spring from front of propeller shaft.
8. Install plug in transmission extension housing to prevent loss of lubricant.

#### Installation

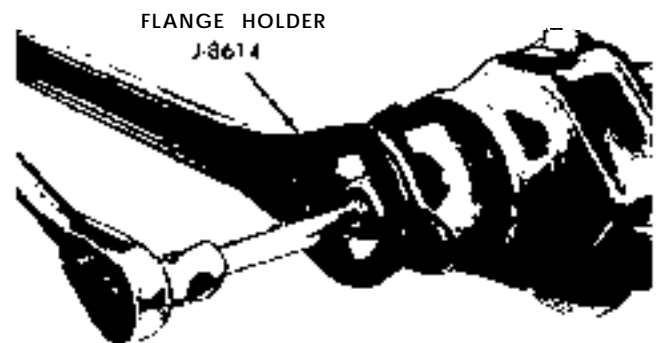
**CAUTION:** Fasteners in the following steps are important attaching parts in that they could affect the performance of vital components and systems, and/or could result in major repair expense. They must be replaced with one of the same part number or with an equivalent part if replacement becomes necessary. Do not use a replacement part of lesser quality or substitute design. Torque values must be used as specified during reassembly to assure proper retention of these parts.

1. Remove plug from rear of transmission.
2. Slide thrust spring onto transmission output shaft and slide propeller shaft through the oil seal and onto the transmission output shaft. Make certain transmission rear seal is not damaged.
3. Align rear universal joint and pinion flange locating marks and secure with respective bolts and lock plates. Torque bolts to 11 lb.ft. Bend lock plate tangs to secure bolts or nuts.
4. Connect parking brake cable equalizer to brake rod and adjust to specifications.
5. On the Opel 1900 and Manta connect parking brake cable to floor panel.

### DISASSEMBLY AND ASSEMBLY OF THE CENTRAL JOINT

#### Disassembly of Central Joint

1. Raise and support rear of car under axle tubes.
2. Release brake line bracket from rear of torque tube.
3. Disconnect parking brake cable equalizer and return spring from brake rod.
4. On the Opel 1900 and Manta, unhook exhaust system and let it down.
5. Mark universal joint and flange. Disconnect propeller shaft from flange and support it out of the way.
6. Support torque tube with floor jack using minimum pressure.
7. Remove the central joint bracket to underbody attaching bolts.
8. Allow floor jack to lower the torque tube.
9. Disconnect torque tube from differential carrier by removing the attaching bolts.
10. Install pinion flange holder J-8614 and remove self-locking flange **nut**. See Figure 4A-2.



4A-2

Figure 4A-2 Removing Pinion Flange Nut

11. Pull pinion flange using J-8614 adapter. See Figure 4A-3.
12. Remove drive pinion extension shaft from torque tube using a soft faced mallet. See Figure 4A-4.
13. Removal ball bearing from cushion.
14. With torque tube placed in vise remove support

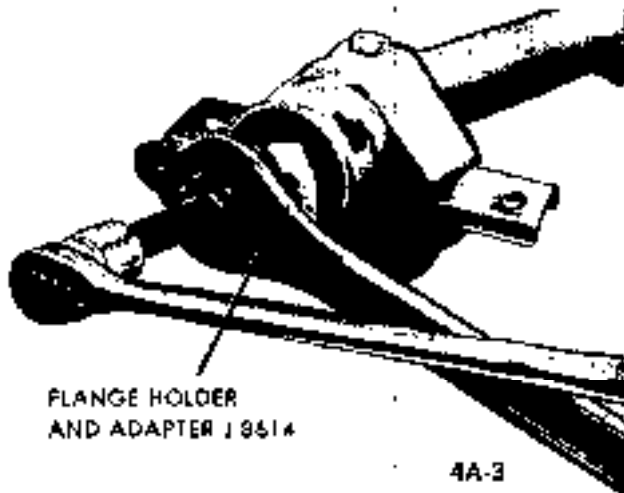


Figure 4A-3 Removing Pinion Flange

bracket to support cushion bolts and pull central joint support from torque tube. See Figure 4A-5:

**Assembly of Central Joint**

**CAUTION:** *Fasteners in the following steps are important attaching parts in that they could affect the performance of vital components and systems, and/or could result in major repair expense. They must be replaced with one of the same part number or with an equivalent part if replacement becomes necessary. Do not use a replacement part of lesser quality or substitute design. Torque values must be used as specified during reassembly to assure proper retention of these parts.*

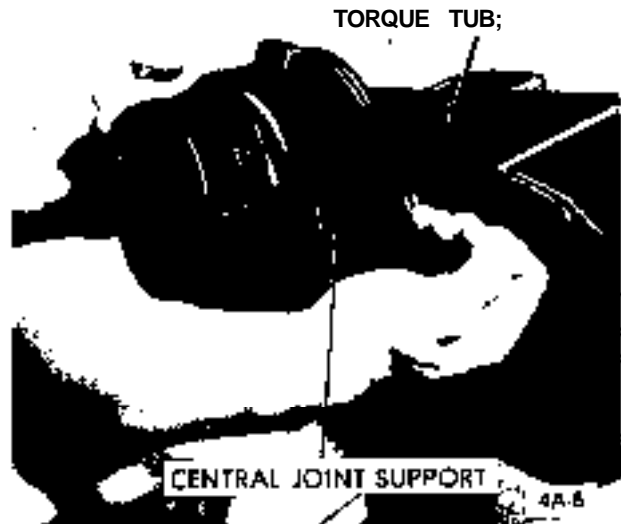


Figure 4A-5 Disassembling Central Joint

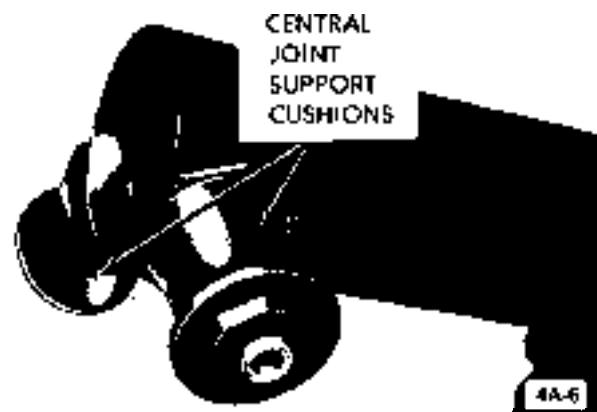


Figure 4A-6 Support Cushions Installed on Torque Tube

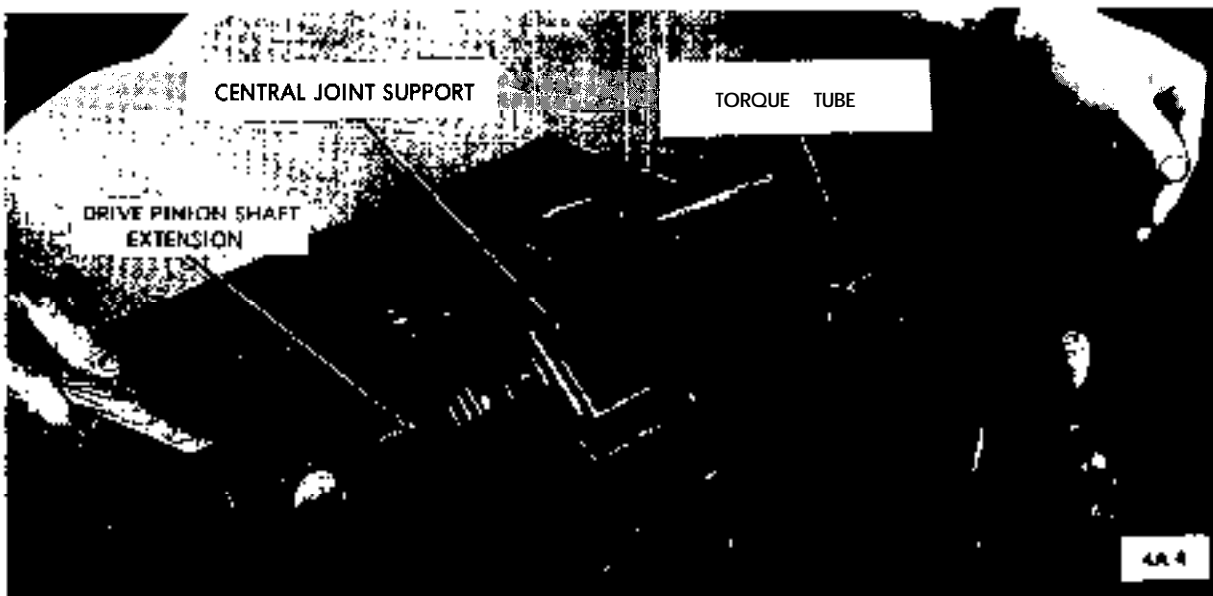


Figure 4A-4 Removing Drive Pinion Extension Shaft

1. Check condition of support cushions. If new cushions are installed, torque to 29 lb. ft. See Figure 4A-6.
2. Install ball bearing into rubber cushion with the flange facing toward front of car. Pack area in front of bearing with water resistant grease. See Figure 4A-7.

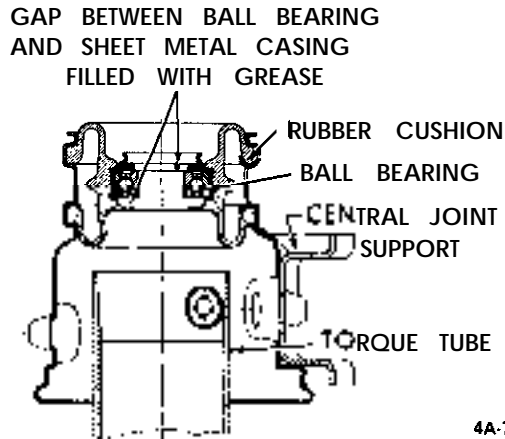


Figure 4A-7 Torque Tube Bearing Installed

3. Install support bracket onto torque tube in such a manner that one cushion is in place, then pry the other cushion into place with a screwdriver. Torque attaching bolts to 15 lb. ft.
4. Install drive pinion extension shaft into torque tube from the rear. Tap in place with soft face mallet.
5. Install flange. Tap-flange onto drive pinion extension shaft, with a soft face mallet, at least far enough to install nut.
6. Assemble flange holder J-8614 to flange, install new self-locking nut and torque to 87 lb.ft.
7. Install torque tube assembly onto differential carrier using only three of the four bolts. The fourth bolt will be used later to install the brake pipe bracket.

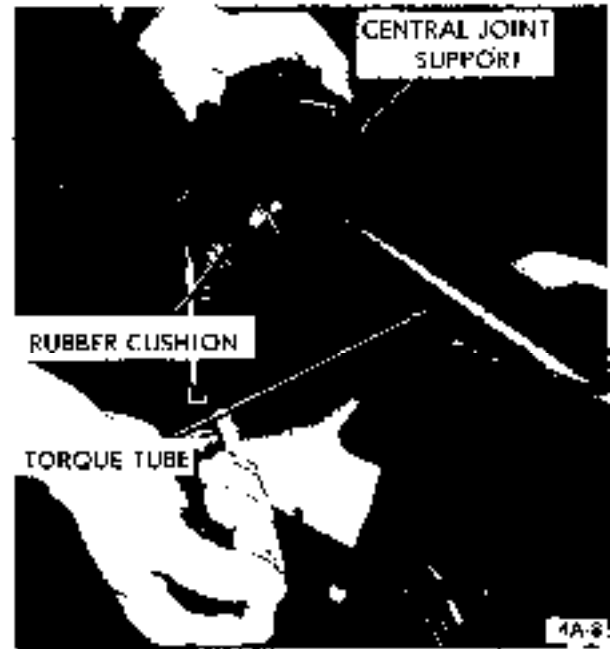


Figure 4A-8 Installing Support Bracket on Torque Tube

8. Position floor jack under torque tube and raise it far enough to install central joint support to underbody bolts finger tight. Remove jack.
9. Jounce rear of car so springs will assume normal position and torque the central joint support to underbody bolts to 36 lb. ft.
10. Align mating marks of universal joint and flange, connect universal joint to flange with respective bolts and lock plates. Torque nuts to 11 lb. ft. Bend lock plate tangs to retain bolts.
11. Assemble parking brake cable equalizer and return spring to brake rod and adjust to specifications.
12. Connect brake line bracket to torque tube.
13. Remove supports from rear of car and lower to the floor.

## SPECIFICATIONS

### PROPELLER SHAFT AND CENTRAL JOINT SPECIFICATIONS

#### Tightening Specifications

Use a reliable torque wrench. Specifications are for clean and lightly-oiled threads.

Part	Location	Torque Lb.Ft.
Bolt	Drive Pinion Extension Shaft Flange to Universal Joint .....	11
Bolt	Central Joint Support to Underbody .....	36
Bolt	Central Joint Support to Rubber Cushion	15
Torque	Tube Rubber Cushion to Torque Tube .....	15
Bolt	Support Cushion	29

# REAR AXLE

## CONTENTS

Subject	Page No.
<b>DESCRIPTION AND OPERATION:</b>	
Rear Axle Description .....	<b>4B- 7</b>
<b>DIAGNOSIS:</b>	
Rear Axle Trouble Diagnosis .....	<b>4B- 8</b>
<b>MAINTENANCE AND ADJUSTMENTS: (Not Applicable)</b>	
<b>MAJOR REPAIR:</b>	
Removal and Installation of Rear Axle Assembly	<b>4B- 9</b>
Removal and Installation of Axle Shaft Assembly	<b>4B-10</b>
Disassembly and Assembly of Differential .....	<b>4B-11</b>
<b>SPECIFICATIONS:</b>	
Differential Specifications .....	<b>4B-22</b>

## DESCRIPTION AND OPERATION

### REAR AXLE DESCRIPTION

The Opel rear axle is a semi-floating type that carries car weight through the axle shafts by way of ball bearings which are located on the outer ends of each axle shaft. The rear axle assembly is attached to the under body by way of the shock absorbers, track rod, central joint support, and lower control arms. A stabilizer rod is used on all Wagons, as well as Fast Backs and Sedans. The GT is not equipped with a stabilizer rod. The rear springs have a progressive spring rate which is attained by a gradual reduction of coil thickness. The springs are arranged between the spring seats welded onto the rear axle tubes and the under body side members. The upper and lower ends are seated in profiled rubber dampening rings. The differential housing is a malleable iron casting with tubular axle housings pressed into the sides to form a complete assembly. An oil **feed** passage to the pinion bearings and an oil return hole are provided to allow lubricant to circulate. A removable steel cover is bolted on the rear of the differential housing to permit service of the differential without removing the rear axle assembly from the vehicle. A breather fitting is located on top of the right axle tube.

Within the differential carrier, the differential case is supported **by** two tapered roller side bearings. These side bearings are **preloaded** by shims located between the bearing inner races and differential case. During installation, varying the shim thickness from side to side also determines the ring gear to pinion backlash.

The differential case houses two side gears meshed with two pinions. The pinions and side gears are backed by thrust washers. The pinion gears are held in place by a pinion shaft which is anchored in the differential case by a lock pin.

The inner end of the axle shafts engage and extend through the **splines** of the side gears with a floating fit.

The axle shafts have an enlarged diameter from **mid**-shaft to the flange end.

A ball bearing and oil seal are used on all models, and are pressed onto the outer end of the axle shaft as an **assembly**.

The drive pinion is mounted in two roller bearings in the rear axle housing. Pinion setting is established by shims located between the differential carrier and the **rear pinion** bearing outer race.

## DIAGNOSIS

## DIFFERENTIAL TROUBLE DIAGNOSIS

Condition	Possible Cause
1. Noise is the same in "Drive" or "Coast".	1. a) Road noise. b) Tire noise. c) Front wheel bearing noise. d) Front or rear U-joint angle too great.
2. Noise changes on a different type of road.	2. a) Road noise. b) Tire noise.
3. Noise lowers tone as car speed is lowered.	3. Tire noise.
4. Similar noise is produced with car standing and driving.	4. a) Engine noise. b) Transmission noise. c) Driveline angle.
5. Vibration	5. a) Rough rear wheel bearing. b) Tire unbalance. c) Worn universal joint in propeller shaft. d) Front or rear U-joint angle too great. e) Mis-indexed, propeller shaft at companion flange. f) Companion flange <b>runout</b> too
6. A knock or click approximately every two (2) revolutions of rear wheel.	6. A brinelled rear wheel bearing
7. Noise most pronounced on turns.	7. Differential side gear and pin
8. A continuous low pitch whirring or scraping noise starting at relatively low speed.	8. Pinion bearing.
9. Drive noise, coast noise or float noise.	9. Ring and pinion gear.
10. Clunk on acceleration or deceleration.	10. a) Worn differential cross shaft in case.
11. Groan in "Forward" or "Reverse".	11. Wrong lube in differential.
12. Clunk or knock on rough road operation.	12. a) Excessive end play of axle to differential cross shaft b) Excessive differential gear clearance.

## MAJOR REPAIR

### REMOVAL AND INSTALLATION OF REAR AXLE ASSEMBLY

#### Removal

1. Raise rear of car with floor jack under differential carrier and position jack stand under jack bracket on each side of car. Remove rear wheel assemblies and one brake drum.
2. Disconnect parking brake cable equalizer and return spring from brake rod.
3. Detach parking brake cable from actuator lever and backing plate at wheel with brake drum removed. Disconnect cable from lower control arm brackets and pull loose end over exhaust system.
4. Disconnect shock absorbers at lower end.
5. Disconnect track rod at left end.
6. On cars equipped with a stabilizer rod, disconnect the shackles at rear axle housing.

7. Disconnect universal joint from pinion flange and support or tie propeller shaft out of way after marking mating areas. If propeller shaft is removed, install plug in rear of transmission to prevent loss of lubricant.

8. Disconnect brake hose from brake pipe at differential and remove retaining clip.

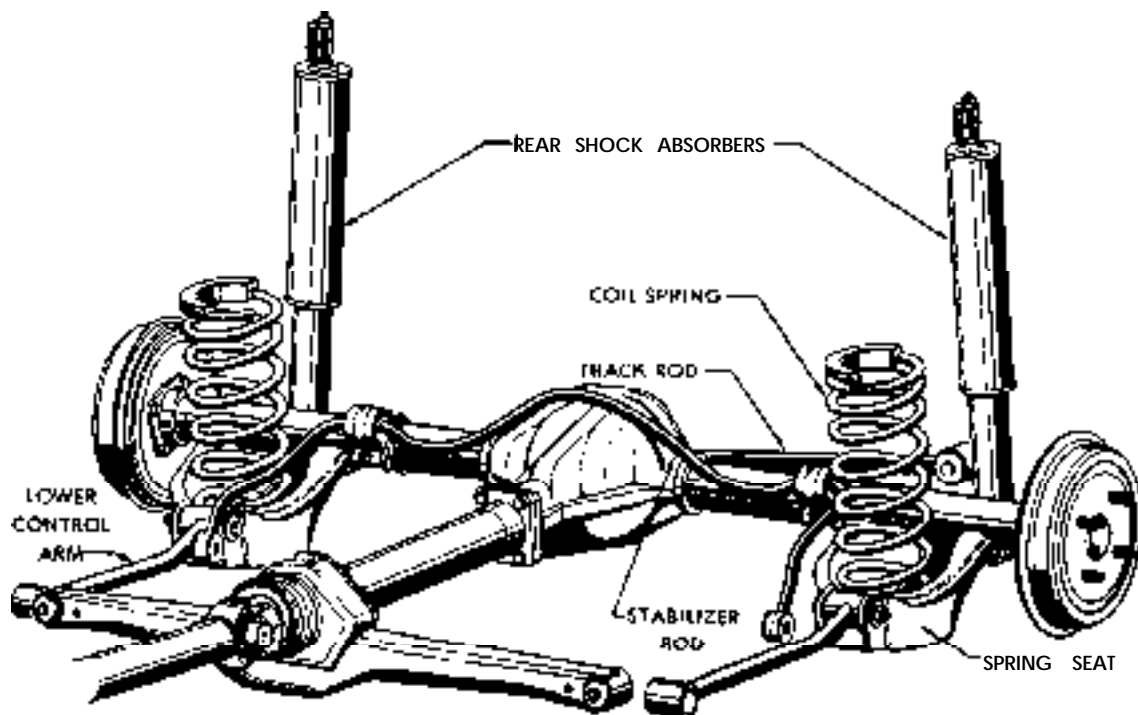
9. Lower rear axle assembly far enough to remove coil springs.

10. Remove central joint support bracket to underbody retaining bolts.

11. Disconnect lower control arms at rear axle assembly bracket and roll the assembly from under the car. See Figure 4B-2.

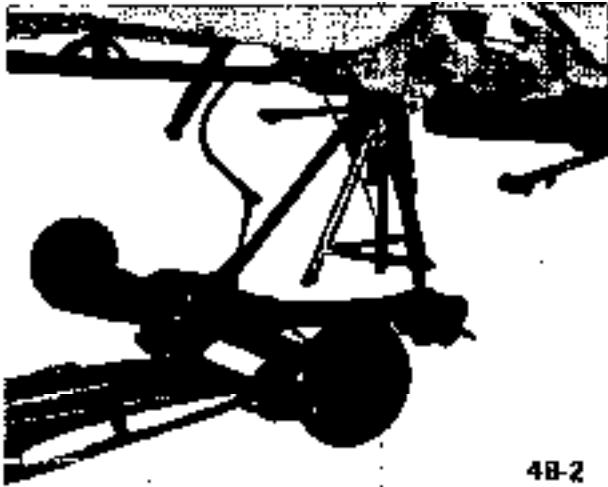
#### Installation

**CAUTION:** *Fasteners in the following steps are important attaching parts in that they could affect the performance of vital components and systems, and/or could result in major repair expense. They must be replaced with one of the same part number or with*



4B-1





4B-2

Figure 4B-2 Removing Rear Axle Assembly

*an equivalent part if replacement becomes necessary. Do not use a replacement part of lesser quality or substitute design. Torque values must be used as specified during reassembly to assure proper retention of these parts.*

1. Roll rear axle assembly under car on floor jack and loosely attach lower control arms to rear axle housing.
2. Attach central joint support, to underbody with bolts only finger tight.
3. Lower rear axle assembly, install lower damper rings in spring seats, coil springs and upper damper rings on springs. Make certain the damper rings and springs are properly positioned.
4. Install track rod on axle housing.
5. On Opel 1900 and Manta, place a load of approximately 350 lbs. in luggage compartment or on the GT, place a load of approximately 150 lbs. on drivers seat and raise rear axle far enough for underbody to clear jack stands.
6. Torque central joint support to underbody bolts to 36 lb.ft.
7. Torque lower control arm to axle housing bolts to 18 lb.ft. on the GT and 22 lb.ft. on the Opel 1900 and Manta.
8. Torque track rod to rear axle attaching nut to 40 lb.ft. on the GT and to 76 lb.ft. on the Opel 1900 and Manta and remove added weight.
9. Install shock absorbers and tighten nuts to 15 lb.ft. on the GT and to 47 lb.ft. on the Opel 1900 and Manta.

10. If car is equipped with stabilizer rod, connect shackles to axle housing. Tighten to 25 lb. ft.

11. Connect brake hose to brake pipe and install retaining clip.

12. Thread parking brake cable over exhaust system and connect to lower control arm brackets, parking brake actuating lever and brake backing plate. Install brake drum.

13. Align mating marks and connect propeller shaft to pinion flange. Tighten universal joint attaching bolts to 11 lb.ft. Bend respective lock plate tabs to secure nuts or bolts.

14. Connect parking brake cable equalizer and return spring to brake rod and adjust to specifications.

15. Bleed rear brake system and fill master cylinder.

16. Install wheel assemblies and tighten lug nuts to 65 lb.ft.

17. Remove jack stands and lower car to the floor.

## REMOVAL AND INSTALLATION OF AXLE SHAFT ASSEMBLY

### Removal

1. Raise and support rear of car at jack brackets.
2. Remove wheel and brake drum as necessary.
3. Unscrew rear axle shaft retaining plate and with axle shaft puller J-8805 coupled with slide hammer J- 2619 on axle shaft flange, remove axle shaft.
4. For replacement of the bearing parts, first remove retaining ring by cutting off with a chisel. See Figure 4B-3.
5. Press off bearing, using rear pinion bearing remover J-22912.

### Installation

**CAUTION:** *Fasteners in the following steps are important attaching parts in that they could affect the performance of vital components and systems, and/or could result in major repair expense. They must be replaced with one of the same part number or with an equivalent part if replacement becomes necessary. Do not use a replacement part of lesser quality or substitute design. Torque values must be used as specified during reassembly to assure proper retention of these parts.*

1. Check radial runout of axle shaft at ball bearing

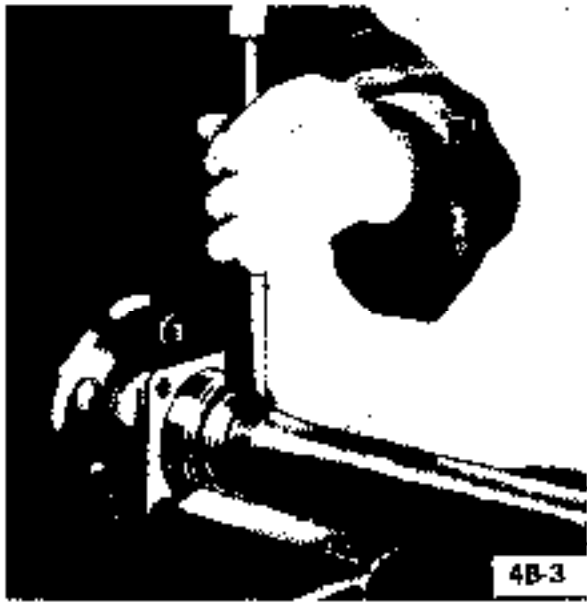


Figure 4B-3 Removing Axle Bearing Retaining Ring

seat and lateral **runout** of axle shaft flange near largest diameter.

Permissible radial **runout** is  $.002''$ , and permissible "lateral **runout** is  $.004''$ ". An axle shaft which exceeds these tolerances, or one which has been otherwise damaged during removal, must be replaced.

2. Using installer ring J-21721-2, press on bearing so that oil seal groove on bearing faces shaft splines.

3. Using installer ring J-21721-2, press on retainer ring so that shoulder faces bearing.

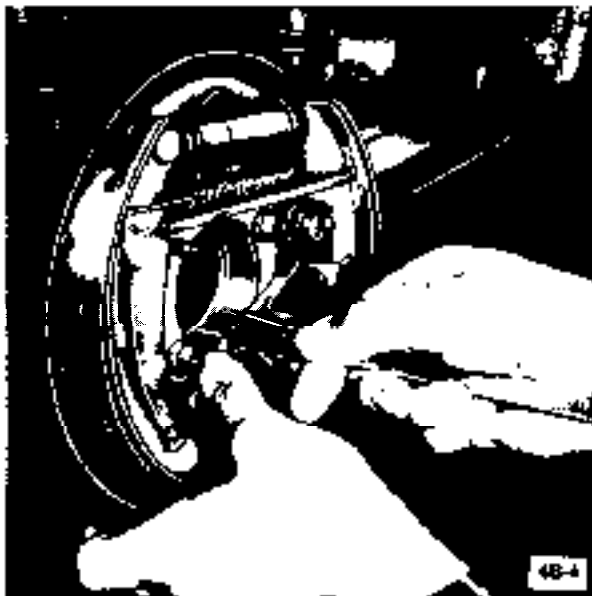


Figure 4B-4 Measuring for Axle Shaft Bearing Depth

4. Check axle shafts end play as follows:

a. Using a depth gauge, measure depth of rear axle bearing seat in axle housing (backing plate and gaskets in place). See Figure 4B-4.

b. Measure width of bearing outer race. The difference between the two measurements indicates the required thickness of the shims. The maximum permissible end play is  $.002''$ . If necessary to reduce end play, add  $.004''$  shims behind bearing as necessary. A slight crush fit (up to  $.006''$ ) is desirable.

5. Coat rear axle shaft splines with hypoid gear lubricant prior to installation.

6. Insert axle shaft into housing; using a mallet, drive axle shaft completely into housing.

7. Install lock washers and nuts. Torque to 20 lb.ft.

8. Install brake drum and wheel assembly.

9. Remove supports and lower rear of car to floor.

#### DISASSEMBLY AND ASSEMBLY OF THE DIFFERENTIAL

Removal and installation of parts for service described in the following sub-paragraph can **be** performed with the rear axle assembly in the car. The car must be raised and adequately supported to permit access to the parts to be serviced.

##### Removal and Disassembly of Differential Case

1. With car suitably supported at rear jack **bracket** on each side, remove differential cover bolts and let lubricant drain into suitable container.

2. Disconnect left end of track rod and wire to left shock absorber.

3. Remove both rear wheels and brake drums.

4. Working through access holes in axle shaft flange, remove four nuts and washers that retain the axle shaft dust shield and brake backing plate to the axle housing.

5. Unscrew rear axle shaft retaining plate.

6. Install axle shaft puller J-8805 coupled with slide hammer J-2619 on axle shaft flange to remove rear axle. In removing axle shaft, care should be exercised to avoid damage to the oil seal. See Figure 4B-5.

7. Remove differential cover and discard gasket.

8. Check and record ring gear backlash.

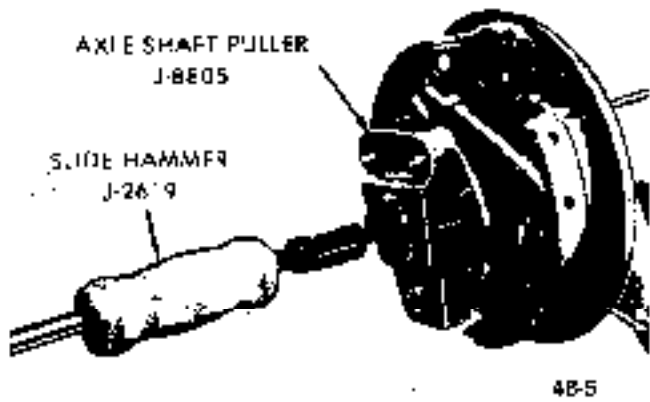


Figure 4B-5 Removing Axle Shaft

9. Mark differential side bearing caps and carrier with a prick punch, so the caps can be reinstalled in their original positions.
10. Remove differential side bearing cap bolts and caps.
11. Using two wooden hammer handles, pry differential case assembly from carrier. Do not drop or interchange differential side bearing outer races.



Figure 4B-6 Removing Differential Side Bearings

12. Insert adapter J-2241-1 1 in differential case bearing hub and remove side bearings using puller J-22588 with adapter leg J-22939. See Figure 4B-6.

13. Remove the differential case to ring gear bolts and tap ring gear off case using a soft faced hammer.

14. Remove the differential pinion shaft retaining pin using a 1/8" pin punch. See Figure 4B-7. Remove pinion shaft, pinion gears, differential side gears and thrust washers.

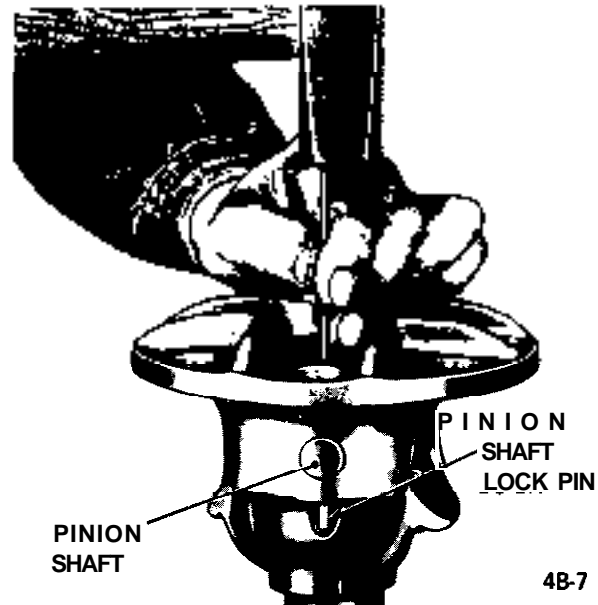


Figure 4B-7 Removing Pinion Shaft Lock Pin

Removal and Disassembly of Drive Pinion

1. Remove torque tube assembly.

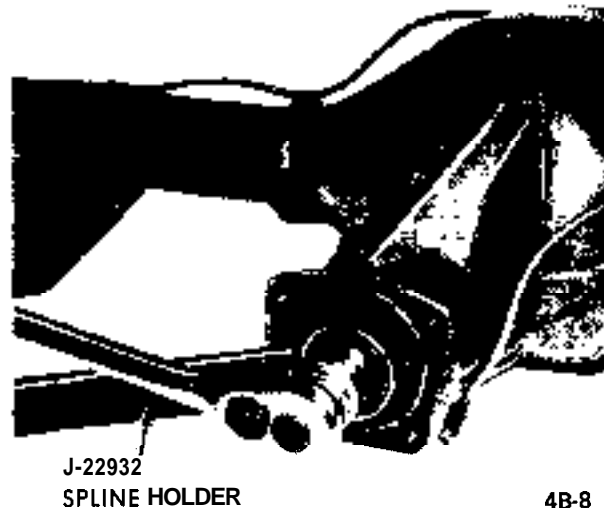


Figure 4B-8 Removing Pinion Preload Nut

2. Using Special Tool J-22932 hold barrel spline and remove pinion preload nut. See Figure 4B-8.

3. With the aid of Special Tool J-22937 remove barrel spline from drive pinion. See Figure 4B-9.

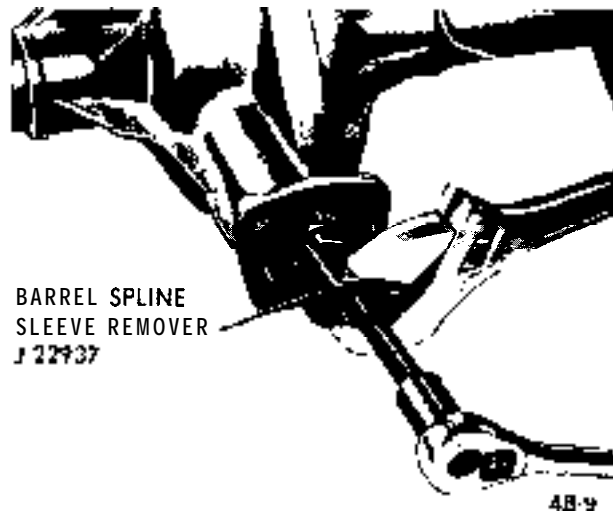


Figure 4B-9 Removing Barrel Spline Sleeve

4. Remove drive pinion by tapping rearward with a soft faced hammer.

5. Remove rear pinion bearing using Special Tool J-22912. See Figure 4B-10.

6. Remove pinion bearing outer races using a brass drift.

**Assembly and Installation of Drive Pinion**

Prior to assembly or installation, all parts should be clean and inspected for imperfections.

1. Install front pinion bearing outer race using installer J-861 1-01 and driver handle J-8092. See Figure 4B-11.

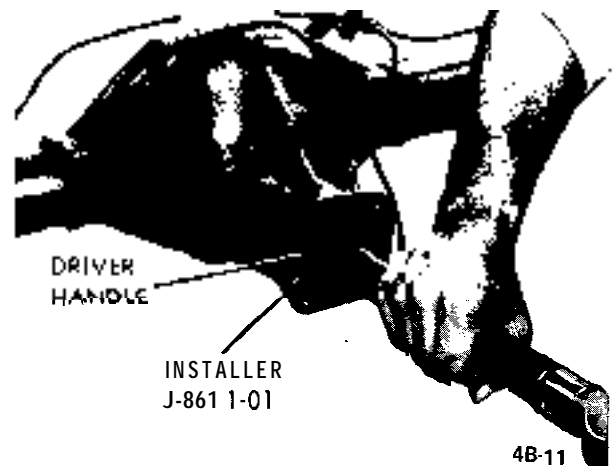


Figure 4B-11 Installing Front Pinion Bearing Outer Race

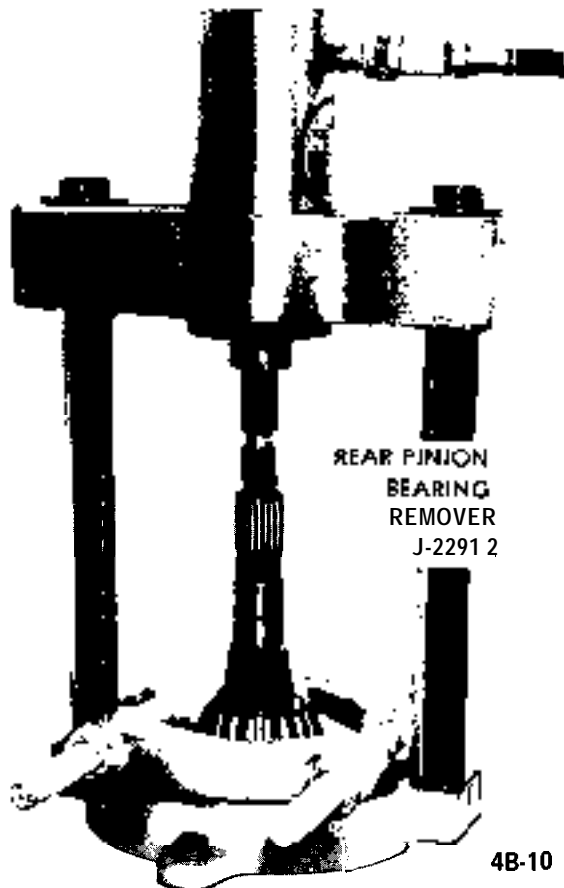


Figure 4B-10 Removing Rear Pinion Bearing

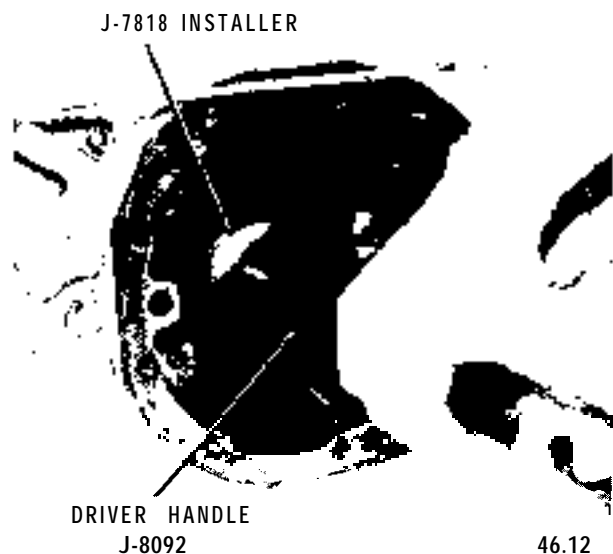
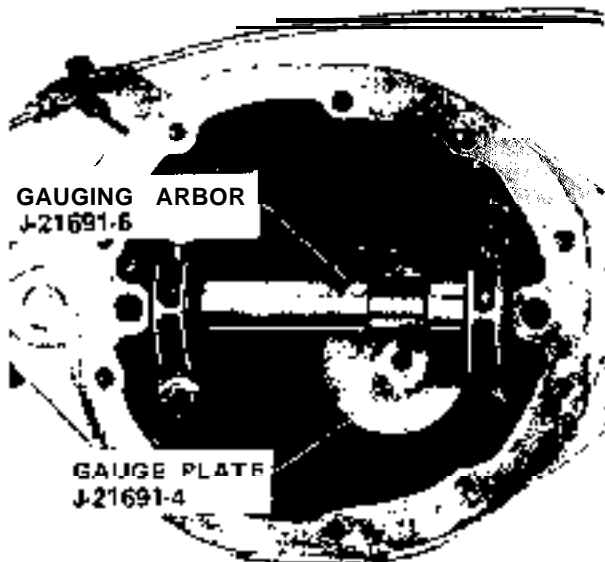


Figure 4B-12 Installing Rear Pinion Bearing Outer Race

2. Install rear pinion bearing outer race (without shims) using installer J-7818 and driver handle J-8092. See Figure 4B-12.

3. To determine the correct pinion depth setting use the following procedures:

a. Assemble gauge plate J-21691-4, rear pinion bearing (lubricated), stud J-21691-7, front pinion bearing (lubricated), pilot washer J-21691-5 and nut into differential carrier. See Figure 4B-13.



4B-13

Figure 4B-13 Pinion Depth Gauging Tools Installed

b. Alternately tighten and rotate until a torque of 7-12 lb.in. (9 lb.in. desired) new bearings or 5-7 lb.in. (6 lb.in. desired) with used bearings is required to rotate the gauge plate assembly.

c. Position gauging arbor J-21691-6 in side bearing bores of the carrier, install side bearing caps in their respective positions and torque the bearing cap bolts to 33 lb.ft. See Figure 4B-13.

d. Position adjustable height block J-21691-3 firmly against the face of gauge plate J-21691-4. Allow the movable plunger to bear against the machined surface of gauging arbor J-21691-6 and tighten the plunger set screw. See Figure 4B-14.

e. Remove the adjustable height block and use a 1" to 2" micrometer to measure the distance from the bottom of the height block to the top of the extended plunger. See Figure 4B-15.

f. Select the correct pinion depth shim thickness as follows:

(1) Record the height block dimension as determined in step (e).

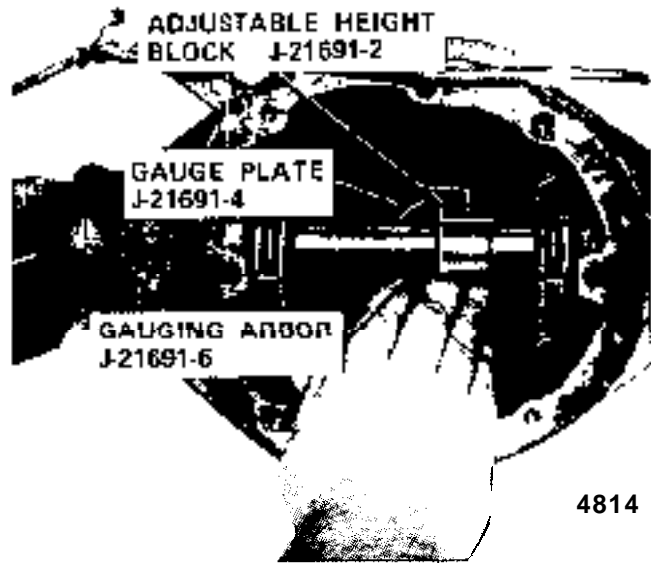


Figure 4B-14 Gauging Pinion Depth

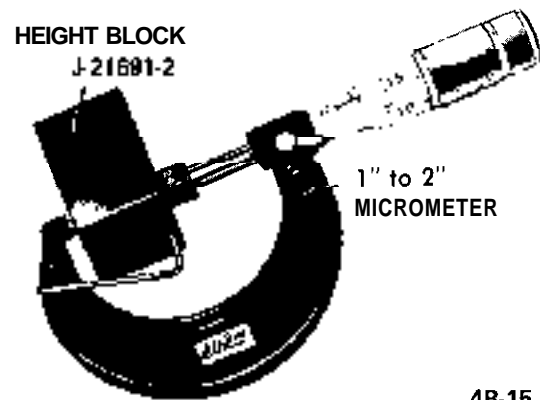


Figure 4B-15 Measuring Adjustable Height Block

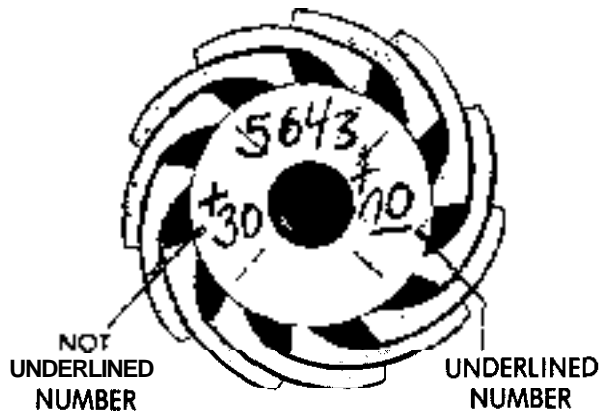
(2) The control figure (on face of pinion) is shown in Figure 4B-16.

If the CONTROL FIGURE (underlined) is plus, convert the figure from millimeters to inches and subtract from Step (1). If the CONTROL FIGURE (underlined) is minus, convert the figure from millimeters to inches and add to Step (1).

(3) Record the result from Steps (1) and (2).

(4) Subtract from Step (3) the nominal figure 1.468.

(5) The difference between Steps (3) and (4) is thickness of shims required to set the pinion,



4B-16

Figure 4B-16 - Pinion Gear Reference Number

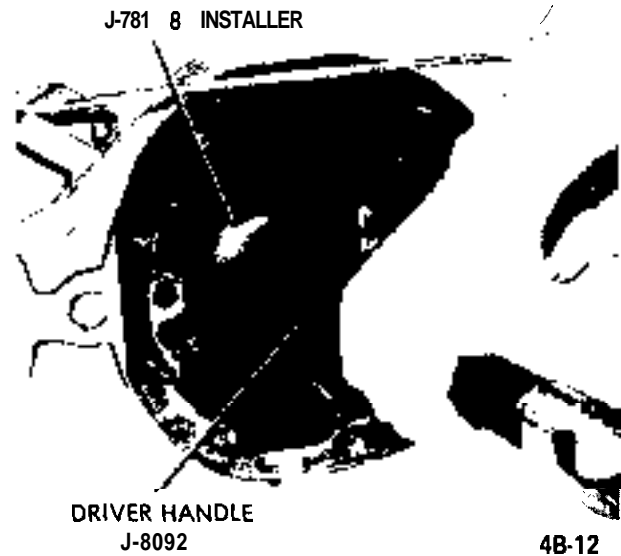


Figure 4B-18 Installing Rear Pinion Bearing Outer Race

**NOTE:** The digit "1", when written in German, resembles the digit "7". However, the digit "7: when written in German, always has a horizontal line drawn through it ("7").

4B-17

An example of how the above procedure should be applied to calculate pinion depth using markings on pinion is as follows:

1. Height block dimension  $\pm 1.4840$ .
  2. Control figure (plus 10) converted to  $\pm \cdot 0039$ .
  3. Difference between steps 1 and 2  $\pm 1.4801$ .
  4. Nominal figure  $\pm \cdot 1.4680$ .
  5. Shim thickness required  $\pm .0121$ .
  6. Shim to closest thickness  $\pm .012$ .
4. Remove differential side bearing caps, gauging arbor, gauge plate and pinion bearings.
  5. Remove the rear pinion bearing outer race using a brass drift.
  6. Install pinion depth shims selected in Step (f) in the rear pinion bearing outer race bore and install the rear pinion bearing outer race using installer J-78 18 and driver handle J-8092. See Figure 4B-18.

- I. Install rear pinion bearing onto the pinion using installer J-21022. See Figure 4B-19.

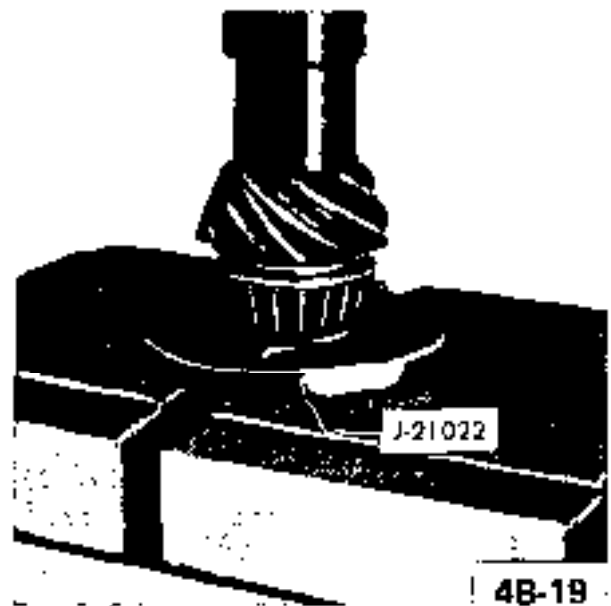
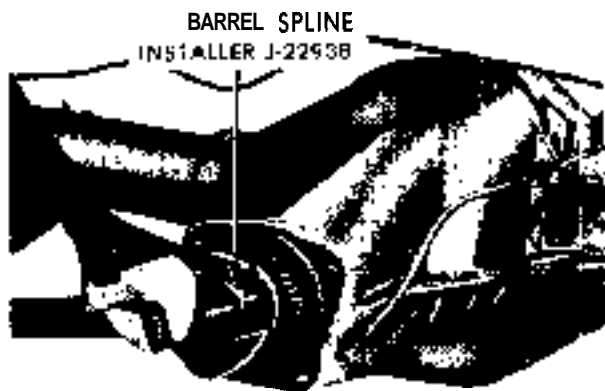


Figure 4B-19 Installing Rear Pinion Bearing

8. Lubricate pinion bearings and assemble the drive pinion, collapsible spacer, front pinion bearing, oil deflector plate and barrel spline sleeve in the differential carrier.

9. Thread barrel spline sleeve installer J-22938 onto the drive pinion and draw the spline sleeve onto the pinion until there are **sufficient** threads of the pinion

protruding to install the pinion preload nut. Do not use Installer J-22938 to adjust pinion preload. See Figure 4B-20.



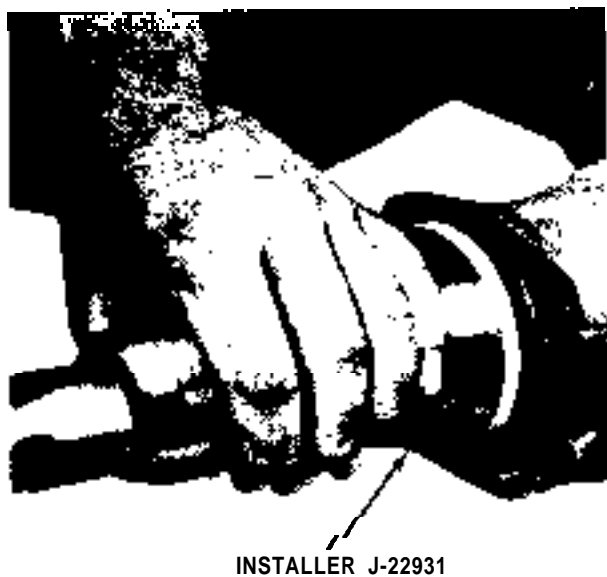
4B-20

Figure 4B-20 Installing Barrel Spline Sleeve

When the drive pinion end play is eliminated, the preload specification is being approached. If this specification is exceeded, replace the collapsible spacer.

10. Remove installer J-22938 and install washer and pinion preload nut. Using Special Tool J-22932, hold barrel spline and tighten preload nut until a preload of 6-13 lb.in. (9 lb.in. desired) with new bearings or 5-8 lb.in. (6 lb.in. desired) with used bearings is required to rotate the drive pinion.

11. Use J-2293 1 to install a new pinion oil seal that has been soaked in differential lubricant. See Figure 4B-21.

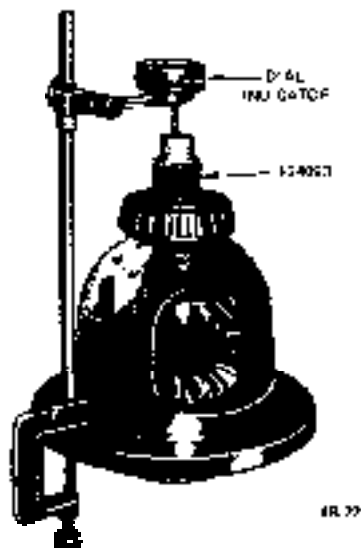


4B-21

Figure 4B-21 Installing Pinion Oil Seal

### Assembly and Installation of Differential Case. Opel 1900 and Manta

1. Install side gears without thrust washers or shims.
2. Lubricate and install pinion gears and thrust washers between the side gears 180 degrees apart and rotate the gears as an assembly until the pinion gear bores are aligned with the pinion shaft bores in the case.
3. Install pinion shaft.
4. Install Special Tool J-24093 and, with the use of a dial indicator, check end play clearance between side gear and case as follows:
  - a. Zero dial indicator on end of Tool J-24093. See Figure 4B-22.



4B-22

Figure 4B-22 Zeroing Dial Indicator

- b. Using both hands, raise side gear until it bottoms against case and record dial indicator reading. See Figure 4B-23.
- c. Measure the thickness of the concave thrust washer by using a 0" to 1" micrometer and subtract this dimension from the dial indicator reading as obtained in step b. Record dimension. See Figure 4B-24.
- d. After obtaining a dimension by subtracting concave thrust washer thickness from dial indicator reading, subtract an additional .002 to obtain the correct shim thickness to be installed.

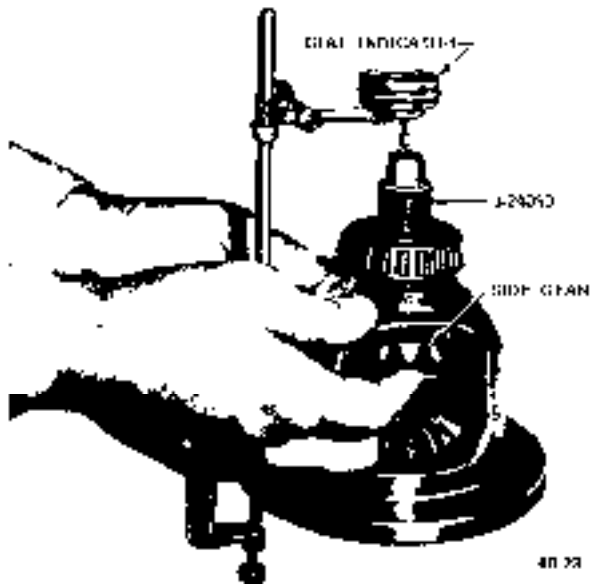


Figure 4B-23 Raising Side Gear Against Case

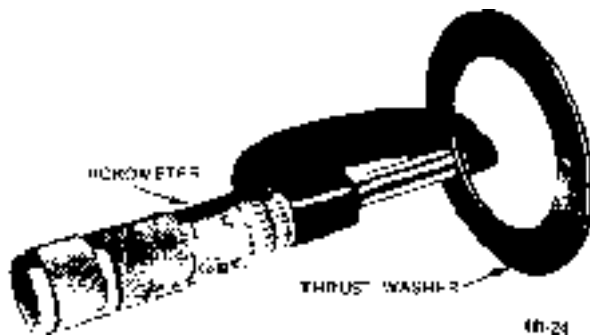


Figure 4B-24 Measuring Concave Washer Thickness

EXAMPLE:

1. Dial indicator reading  $\pm .095$ ,
  2. Subtract concave thrust washer thickness  $\pm .050$ ,
  3. Total  $\pm .045$ .
  4. Subtract an additional  $.002 \pm .002$ .
  5. Shim thickness to be used  $\pm .043$ .
5. Turn case over and repeat the above procedure to check other side gear to differential case clearance.

6. Before installing, shims must be measured to insure that the proper thickness is being used. Install shims of correct thickness to obtain desired clearance and reassemble and install pinion shaft lock pin. Install thrust washers with concave side towards differential case.

7. Using Special Tool J-24093, along with a foot-pound torque wrench, check torque to turn gears using the following procedure:

a. Install axle shaft into a vise and position differential case onto axle shaft. See Figure 4B-25.

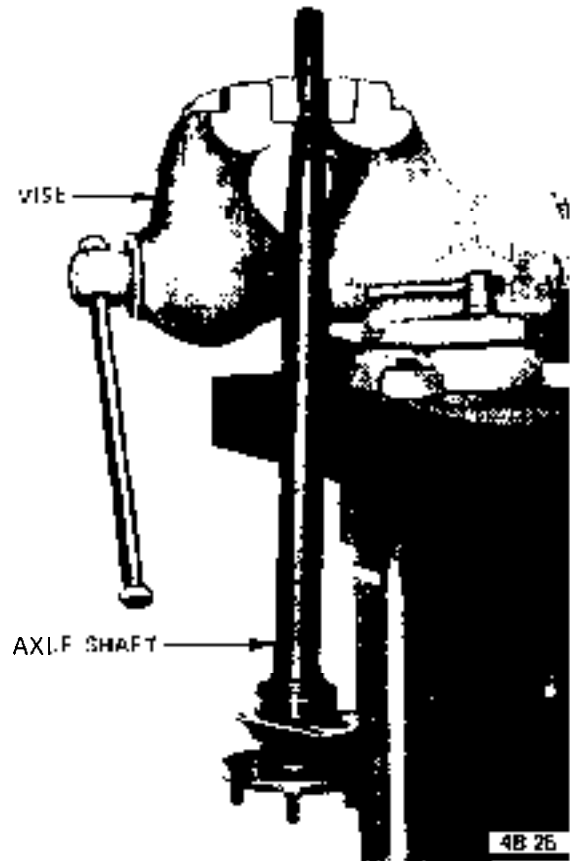


Figure 4B-25 Axle Shaft Installed in Vise

b. Insert Special Tool J-24093 into opposite side gear, attach a torque wrench, and check torque to rotate gear. See Figure 4B-26. Permissible torque to turn gears is 14 1/2 to 17 1/2 footpounds.

c. It is necessary to **check** rotating torque of both side gears.

8. If torque is not correct, it will be necessary to reshim differential gears. Add first at one side one shim of the next higher or lower thickness. If this is not enough, reshim both sides completely.

9. Install ring gear on case making certain their mat-



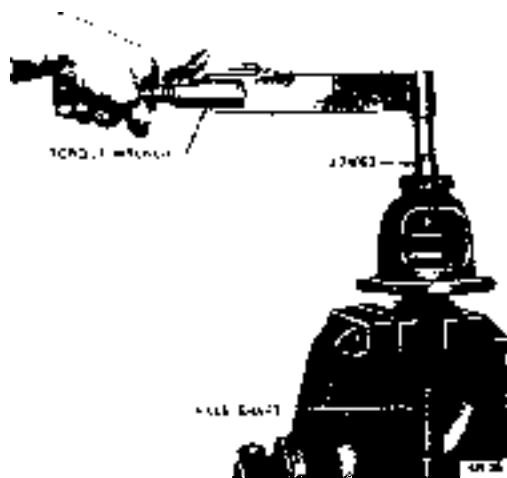


Figure 4B-26 Checking Torque to Rotate Gear

in; surfaces are free of burrs or foreign material. Tighten bolts to 47 lb.ft.

10. Check lateral runout of installed ring gear. Maximum permissible runout is .003". If runout is greater than specified, make certain that dirt or burrs are not holding the ring gear in a cocked position on the case and that the bolts are evenly torqued.

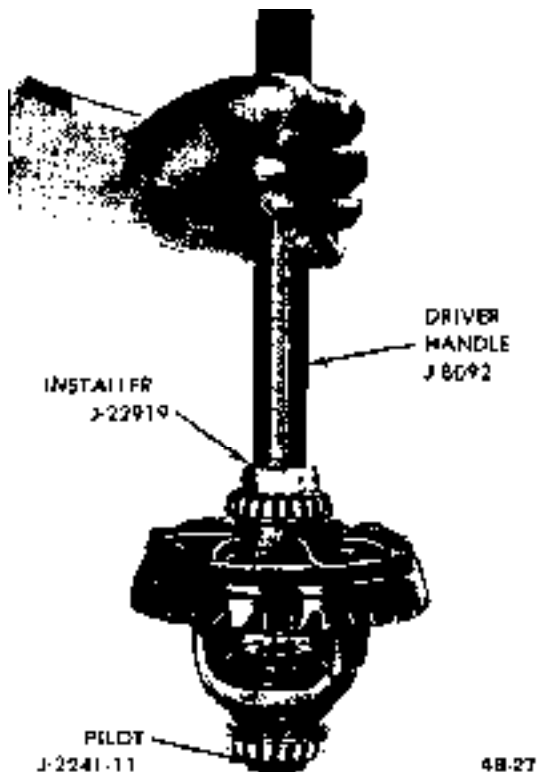


Figure 4B-27 Installing Differential Side Bearings

11. Install side bearings using installer J-22919 and drive handle J-8092. Support opposite side of case on pilot J-2241-11 to prevent bearing damage. See Figure 4B-27.

12. Determine differential side bearing preload and backlash as follows:

a. Position differential case assembly less side bearing shims into the side bearing bores of the carrier. See Figure 4B-28.



Figure 4B-28 Installing Differential Case Assembly

b. Using two sets of feeler gauges, insert feeler stock of sufficient thickness between each bearing outer race and the carrier to remove all end play. Make certain the feeler stock is pushed to the bottom of the bearing bores. See Figure 4B-29.

c. Mount dial indicator J-8001 on carrier so indicator stem is at right angles to a tooth on the ring gear. See Figure 4B-29.

d. Adjust feeler gauge thickness from side to side until ring gear backlash is .004" to .008" (.005" is desired).

e. With zero end play and correct backlash established, remove feeler gauge packs, determine thickness of shims required and add .002" to each shim pack to provide side bearing preload.

f. Remove case assembly and both side bearings using J-22588 with adapter leg J-22939 and pilot J-2241-11.

g. Install shim packs with respective side bearing

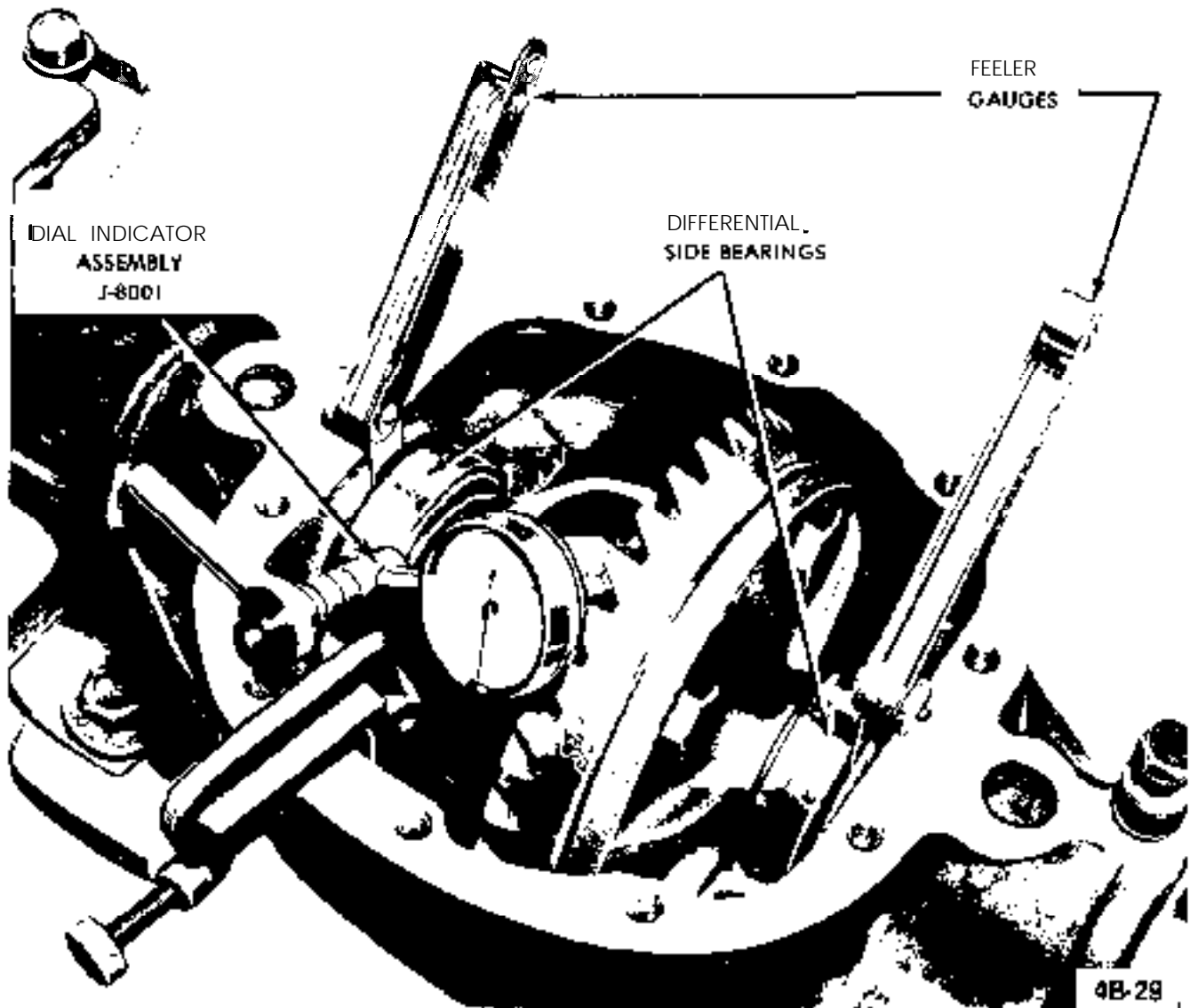


Figure 4B-29 Removing Differential Case and End Play

using installer J-22919, driver handle J-8092 and pilot J-2241-11.

13. Position case assembly and outer races in the carrier. Use a soft faced hammer to drive the case into the carrier until the side bearing outer races bottom in their bores.

14. Install side bearing caps in their original location and torque the bolts to 33 lb.ft.

15. Rotate case assembly several times to seat the bearings. Check backlash and preload using a torque wrench on a ring gear attaching bolt. See Figure 4B-68. Torque required to turn case should be 20 to 30 lb.in. for new bearings or 10 to 20 lb.in. for used bearings. If torque is not correct, it will be necessary to reshim the side bearings.

16. Install torque tube assembly.

17. Install axle shafts.

#### Assembly and Installation of Differential Case - GT

1. Lubricate the thrust washers, side and pinion gears and install the side gears with respective thrust washers in the differential case.

2. Install the pinion gears and thrust washers between the side gears 180 degrees apart and rotate the gears as an assembly until the pinion gear bores are aligned with pinion shaft bores in the case.

3. Install pinion shaft so that the lock pin hole in the shaft aligns with the lock pin hole in the case.

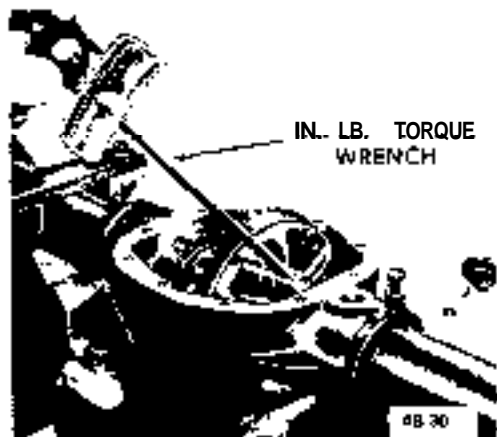


Figure 4B-30 Checking Side Bearing Preload

4. With the use of a feeler gauge, check clearance between differential side gears and case. See Figure 4B-31. Clearance should be .003" to .006". If clearance is not within these limits, remove side gears and install shims of correct thickness to obtain desired clearance, reassemble and install pinion shaft lock pin.



Figure 4B-31 Checking Side Gear to Case Clearance

5. Install ring gear on case, making certain their mating surfaces are free of burrs or foreign material. Tighten bolts to 47 lb.ft.

6. Check lateral runout of installed ring gear. Max-

imum permissible runout is .003". If runout is greater than specified, make certain that dirt or burrs are not holding the ring gear in a cocked position on the case and that the bolts are evenly torqued.

7. Install side bearings using Installer J-22919 and Drive Handle J-8092. Support opposite side of case on Pilot J-2241-1 1 to prevent bearing damage. See Figure 4B-32.

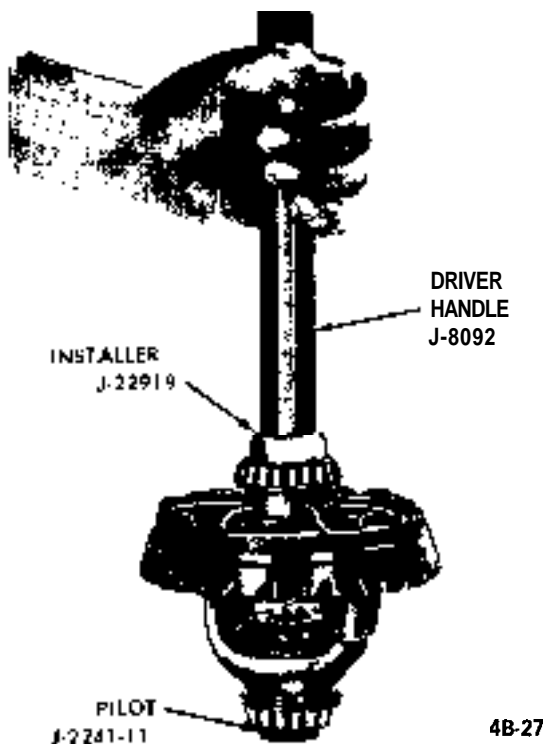


Figure 4B-32 Installing Differential Side Bearings



Figure 4B-33 Installing Differential Case Assembly

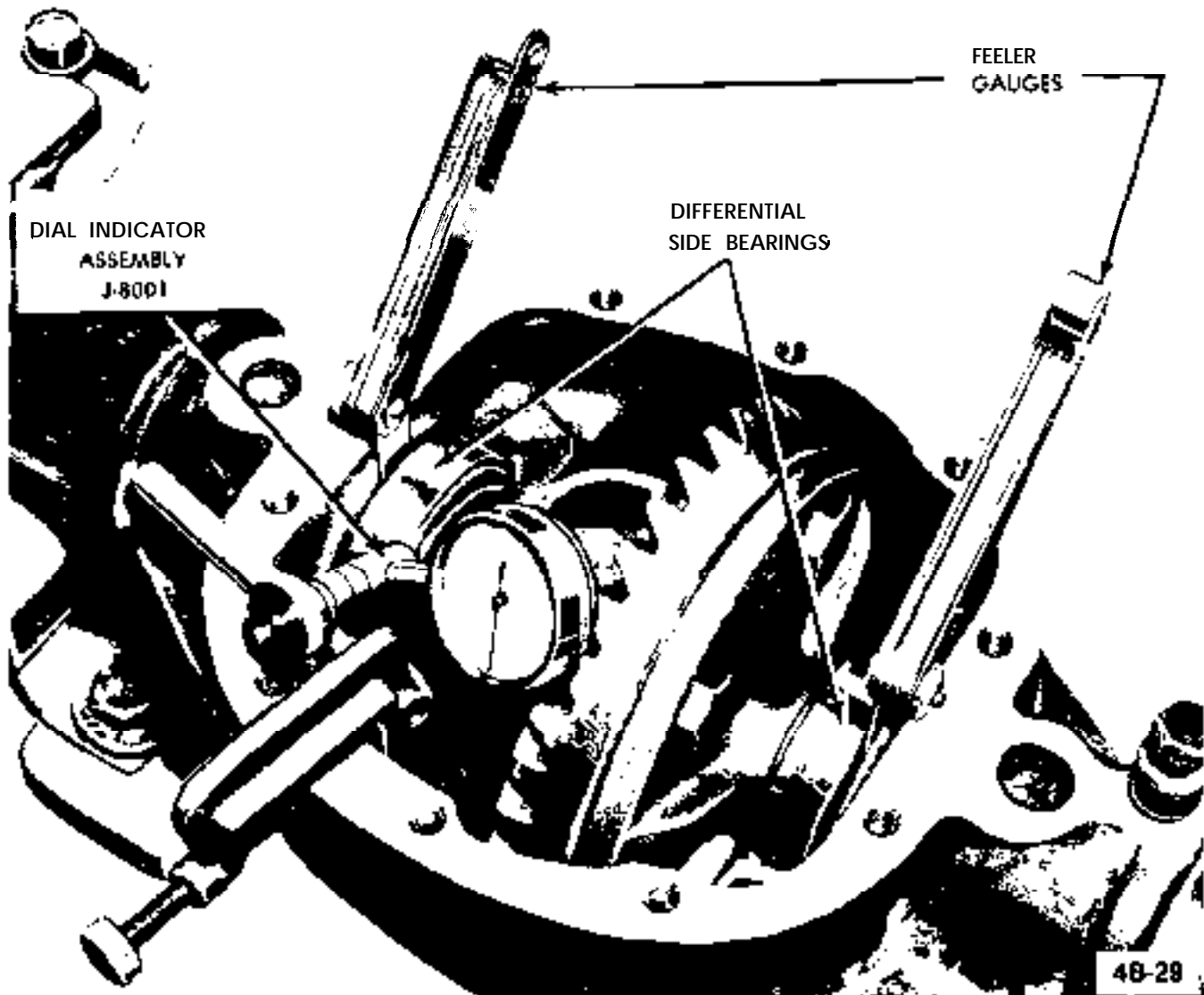


Figure 4B-34 Removing Differential Case and End Play

8. Determine differential side bearing preload and backlash as follows:

a. Position differential case assembly less side bearing shims into the side bearing bores of the carrier. See Figure 4B-33.

b. Using two (2) sets of feeler gauges, insert feeler stock of sufficient thickness between each bearing outer race and the carrier to remove all end play. Make certain the feeler stock is pushed to the bottom of the bearing bores. See Figure 4B-34.

c. Mount Dial INDICATOR J-8001 on carrier so indicator stem is at right angles to a tooth on the ring gear. See Figure 4B-34.

d. Adjust feeler gauge thickness from side to side until ring gear backlash is .004" to .008" (.005" is desired).

e. With zero end play and correct backlash established, remove feeler gauge packs, determine thickness of shims required and add .002" to each shim pack to provide side bearing preload.

f. Remove case assembly and both side bearings using J-22588 with Adapter Leg J-22939 and Pilot J-2241-11.

g. Install shim packs with respective side bearing using Installer J-22919, Driver Handle J-8092 and Pilot J-2241-1 1.

9. Position case assembly and outer races in the carrier. Use a soft-faced hammer to drive the case into the carrier until the side bearing outer races bottom in their bores.

10. Install side bearing caps in their original location and torque the bolts to 33 lb.ft.

11. Rotate case assembly several times to seat the bearings. Check backlash and preload using a torque wrench on a ring gear attaching bolt. See Figure 4B-35. Torque required to turn case should be 20 to 30 lb.in. for new bearings or 10 to 20 lb.in. for used bearings. If torque is not correct, it will be necessary to r&him the side bearings.

12. Install torque tube assembly.

13. Install axle shafts.

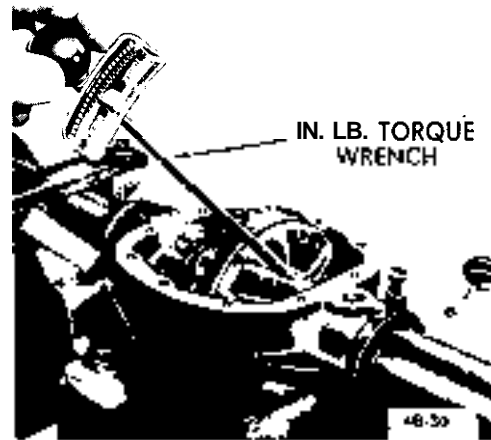


Figure 4B-35 Checking Side Bearing Preload

## SPECIFICATIONS

### DIFFERENTIAL SPECIFICATIONS

#### General Specifications

Rear Axle Type ..... Semi-Floating Hypoid  
 Rear Axle Oil Capacity ..... 2 1/2 Pt.  
 Ring and Pinion Gear Set Type ..... Hypoid

#### Axle Ratios

Model	Engine	Transmission		Axle Ratio	
		4-Speed Manual	3-Speed Automatic	4-Speed	Automatic
51	Std.	Std.	Opt.	3.44	3.44
53	Std.	Std.	Opt.	3.44	3.44
54	Std.	Std.	Opt.	3.44	3.44
57	Std.	Std.	Opt.	3.44	3.44
57L	Std.	Std.	Opt.	3.44	3.44
57R	Std.	Std.	Opt.	3.67	3.44
TJ	Std.	Std.	Opt.	3.44	3.44

**Adjusting end Fitting Specifications**

Pinion Bearing Preload With New Bearings ..... 7-13 **Lb.In.**  
 Preload With Reused Bearings ..... 5-8 **Lb.In.**  
 Pinion Depth Setting .002" to -.001" from pinion marking using following selective shims:

Thickness In.	Number of Notches in Circumference
.0097	Flattened on One Side
.0098	0
.0108	1
.0118	2
.0128	3
.0138	4
.0148	5

Clearance Between Differential Side Gears and Case Max. .000" on the Opel 1900 and Manta and .006" on the GT using the following selective shims:

Thickness In.	Number of Notches in Circumference
<b>1900</b>	
.039	0
.041	1
.043	1
.045	3
.047	2
.049	5
.051	3
.053	7
.055	8
<b>GT</b>	
.0394	0
.0433	1
.0473	2
.0512	3

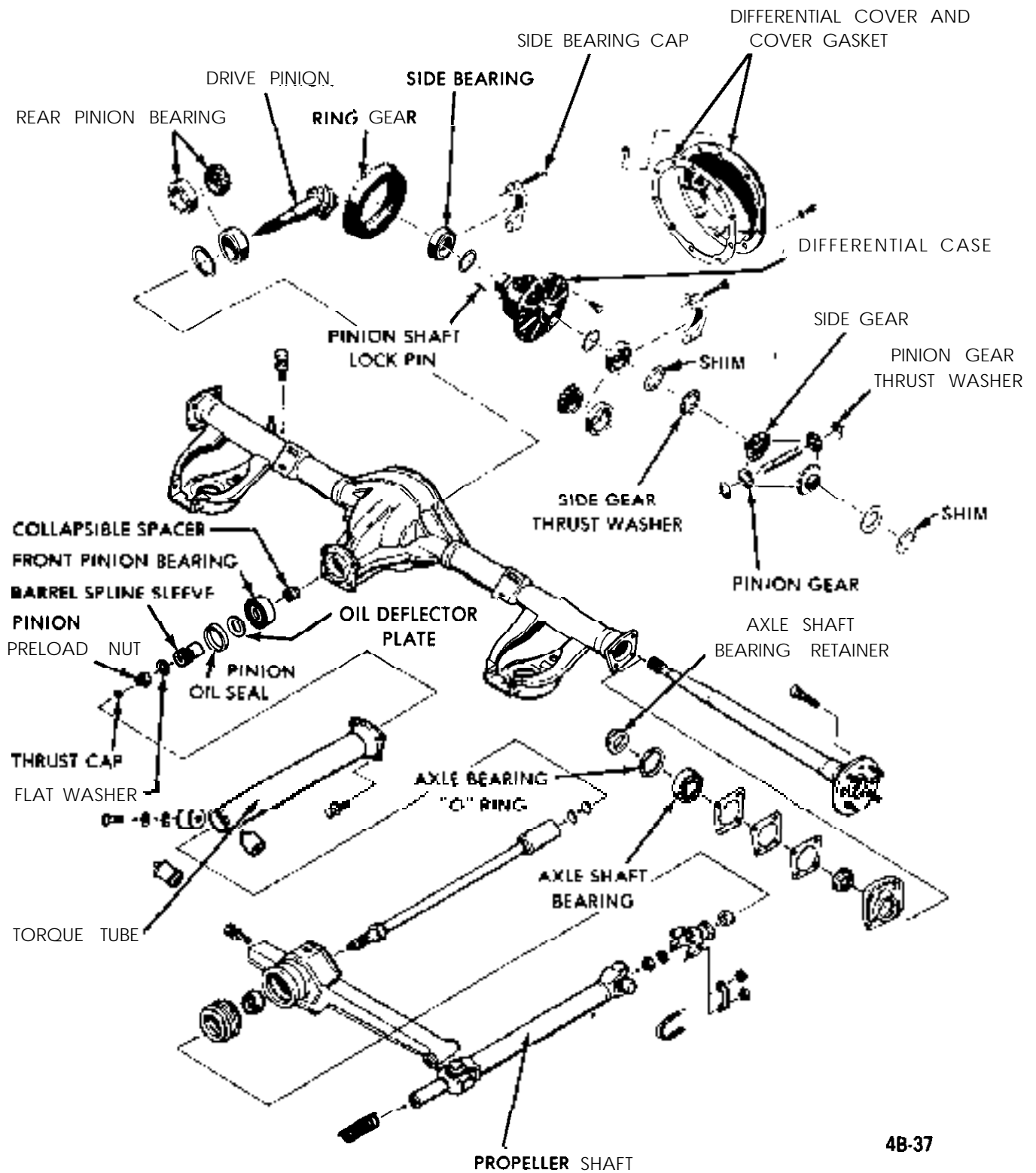
Max. Permissible Axle Shaft Bearing Seat Radial Runout ..... .002"  
 Max. Permissible Rear Axle Shaft Flange Lateral Runout . . .004" at Largest Flange Dia.  
 Max. Permissible Lateral Ring Gear R&out ..... ".003"  
 Ring Gear and Drive Pinion Backlash ..... .004"-.008"  
 Differential Side Bearing Preload New, Bearings - 20-30 **Lb.In.**; Used Bearings - 10-20 **Lb.In.**, using following selective shims:

Thickness In.	Number of Notches in Circumference
.0059	0
.0069	1
.0079	2
.0089	3
.0098	4
.0108	5
.0197	8
.0433	7

**Torque Specifications**

Use a reliable torque wrench. Specifications are for clean and lightly-oiled threads.

Part	Location	Torque Lb.Ft.	
		1.9	
Nut and Bolt	Propshaft to Drive Pinion Shaft Extension Flange .....	11	
Nut	Flange to Drive Shaft Extension .....	87	
Bolt	Ring Gear to Case .....	47	
Bolt	Side Bearing Cap to Carrier .....	33	
Bolt	Differential Housing Cover .....	22	
Nut	Track Rod Attaching (GT) .....	40	
Nut and Bolt	Stabilizer Rod to Rear Axle Shackle .....	25	
Bolt	Stabilizer Rod to Body .....	15	
Nut	Track Rod to Rear Axle (Opal 1900 & Manta) .....	76	
Nut	Track Rod to Side Member (Opel 1900 & Manta) .....	22	
	10 MM Bolt Nut .....		36
	8 MM Bolt Nut .....		15
	6 MM Bolt Nut .....		5



4B-37

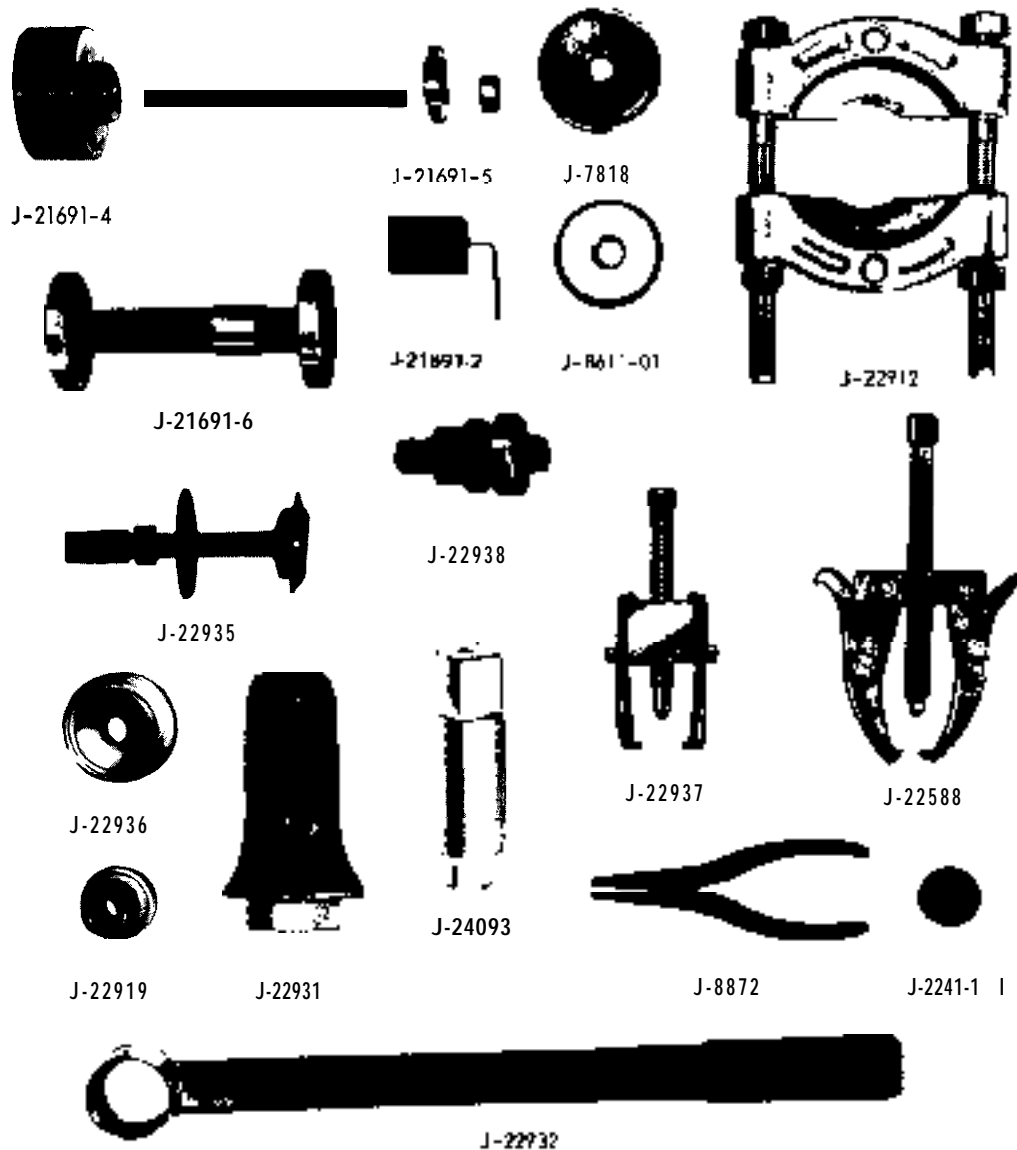
Figure 4B-37 Exploded View Rear Axle Assembly



MM Inches	MM Inches	MM Inches	MM Inches	MM Inches	MM Inches
.01 .0004	.23 .0091	.44 .0173	.65 .0256	.87 .0343	9 .3543
.02 .0008	.24 .0095	.45 .0177	.66 .0260	.88 .0347	10 .3937
.03 .0012	.25 .0098	.46 .0181	.67 .0264	.89 .0350	11 .4331
.04 .0016	.26 .0102	.47 .0185	.68 .0268	.90 .0354	
.05 .0020	.27 .0106	.48 .0186	.69 .0272	.91 .0358	12 .4724
.06 .0024	.28 .0110	.49 .0193	.70 .0276		13 .5118
.07 .0028	.29 .0114	.50 .0197	.71 .0280	.92 .0362	14 .5512
.08 .0032	.30 .0118	.51 .0201		.72 .0284	.93 .0366
.09 .0035	.31 .0122 .32 .0126		.52 .0205	.73 .0287	.94 .0370
.10 .0039		.53 .0209	.74 .0291	.95 .0374	17 .6693
.11 .0043	.33 .0130	.54 .0213	.75 .0295	.96 .0378	18 .7087
			.76 .0299	.97 .0382	19 .7480
.12 .0047	.34 .0134	.55 .0217	.77 .0303	.98 .0386	20 .7874
.13 .0051	.35 .0138	.56 .0221		.78 .0307	.99 .0390 1.00 .0394
.14 .0055	.36 .0142	.57 .0224	.79 .0311	21 .8268	
.15 .0059	.37 .0146	.58 .0228	.80 .0315	22 .8661	
.16 .0063	.38 .0150	.59 .0232		1 .0394	23 .9055
.17 .0067	.39 .0154	.60 .0236	2 .0787	24 .9449	
.18 .0071	.40 .0158	.61 .0240	.81 .0320	3 .1181	25 .9843
.19 .0075	.41 .0161		.62 .0244	.82 .0323	4 .1575
.20 .0079		.42 .0165	.63 .0246	.83 .0327	5 .1969
.21 .0083	.43 .0169	.64 .0252	.84 .0331	6 .2362	28 1.1024
		.65 .0256	.85 .0335	7 .2756	29 1.1417
.22 .0087				.86 .0339	8 .3150

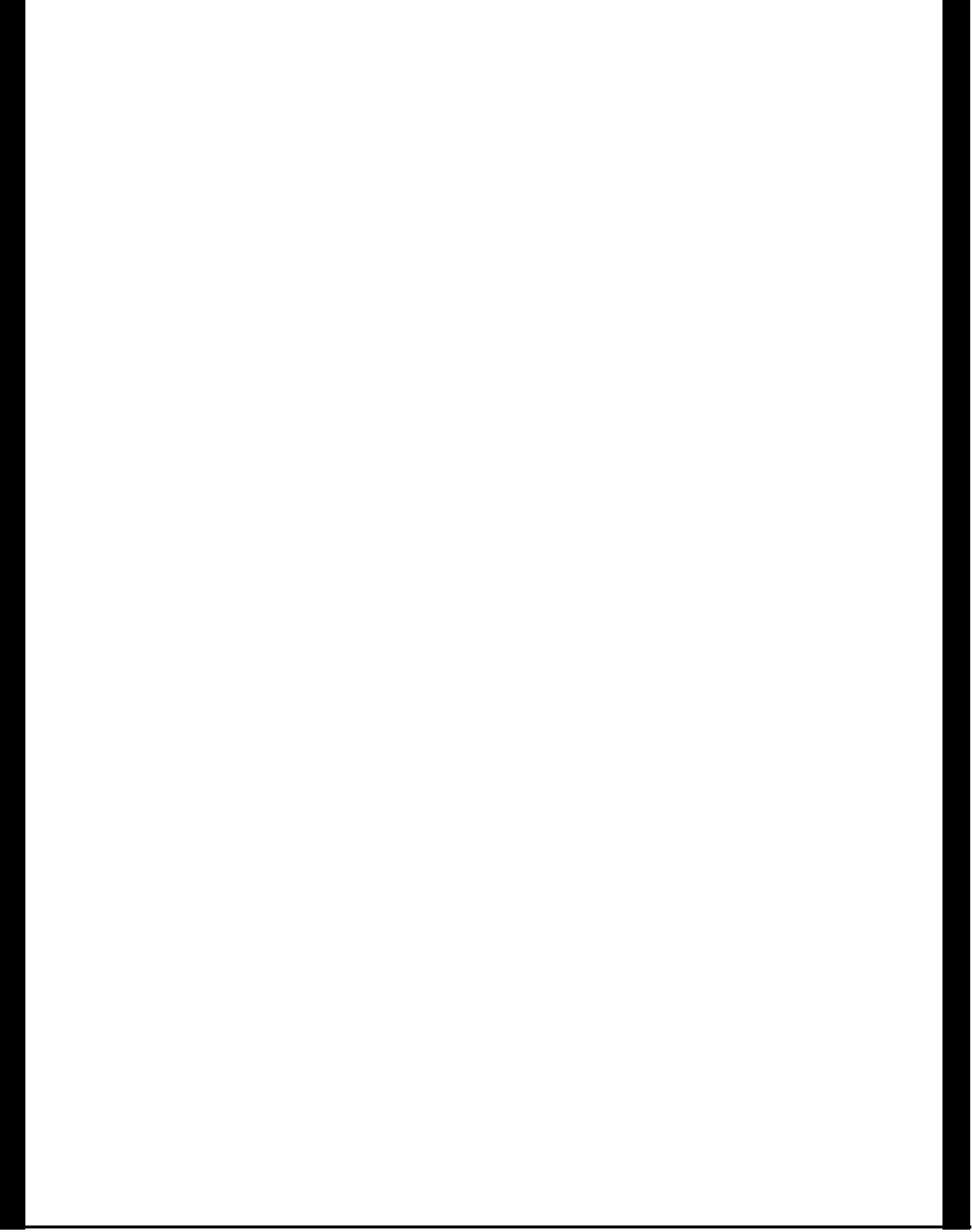
\* (one MM = .0394"; one inch = 25.4 MM)

Figure 4B-38 Conversion Table - Millimeter to Inch Equivalent



- |           |   |          |   |
|-----------|---|----------|---|
| J-21691-2 | ADJUSTABLE HEIGHT BLOCK                   | J-22937  | BARREL SPLINE SLEEVE REMOVER                    |
| J-21691-4 | GAUGE PLATE                               | J-22588  | SIDE BEARING REMOVER                            |
| J-21691-5 | PILOT WASHER                              | J-22935  | AXLE SHAFT BEARING AND SEAL INSTALLER           |
| J-21691-6 | GAUGING AREA                              | J-22919  | SIDE BEARING INSTALLER                          |
| J-7818    | REAR PINION BEARING OUTER RACE INSTALLER  | J-22931  | PINION OIL SEAL INSTALLER                       |
| J-8611-01 | FRONT PINION BEARING OUTER RACE INSTALLER | J-21022  | PINION BEARING INSTALLER (NOT ILLUSTRATED)      |
| J-22912   | PINION BEARING REMOVER                    | J-8872   | AXLE SHAFT RETAINING RING REMOVER AND INSTALLER |
| J-22939   | BARREL SPLINE SLEEVE INSTALLER            | J-2241-1 | SIDE BEARING HUB PILOT                          |
| J-22935   | AXLE SHAFT BEARING AND SEAL REMOVER       | J-24093  | BARREL SPLINE SLEEVE HOLDER                     |
| J-24093   | DIFFERENTIAL SIDE GEAR LASH ADJUSTER      |          |   |

Figure 4B-39 Differential Special Tools



---

**GROUP 5**

**BRAKES**

Section	Title	Page No.
<b>5A</b>	Brake Booster and Master Cylinder	5A- 2
<b>5B</b>	Disc Brakes .....	5B-10
<b>5C</b>	Drum Brakes .....	5C-22

# POWER BRAKE BOOSTER AND MASTER CYLINDER

## CONTENTS

Subject	Page No.
<b>DESCRIPTION AND OPERATION:</b>	
Power Brake Booster .....	5A-2
Master Cylinder .....	5A-2
<b>DIAGNOSIS:</b>	
Power Brake Unit Trouble Diagnosis .....	5A-4
<b>MAINTENANCE AND ADJUSTMENTS:</b>	
Checking Brake Booster Operation .....	5A-5
Brake Booster Filter Service .....	5A-6
Vacuum Control Valve Service .....	5A-6
<b>MAJOR REPAIR:</b>	
Brake Booster Removal and Installation .....	5A-6
Master Cylinder Overhaul .....	5A-7
<b>SPECIFICATIONS:</b>	
General Specifications .....	5A-9

## DESCRIPTION AND OPERATION

### POWER BRAKE BOOSTER

The vacuum power cylinder contains the power piston assembly which houses the control valve and reaction mechanism and the power piston return spring. The control valve is composed of the air valve and the floating control valve assembly. The reaction mechanism consists of a hydraulic piston, reaction plate, and a series of springs. An air filter element is assembled around the push rod and fills the cavity inside the hub of the power piston. This keeps dirt and dust from entering the vacuum booster. The push rod, which operates the air valve, projects out of the end of the power cylinder housing through a boot.

### MASTER CYLINDER

The master cylinder is composed of a primary piston and secondary piston; it is supplied with fluid from two separate reservoirs. A check valve is mounted on the primary circuit which supplies fluid to the rear brakes. This keeps a slight static pressure in the rear brake system. When the pedal is depressed, the push rod moves the two pistons forward simultaneously until the seals of the two pistons cover the compensating ports in the cylinder. The pressure is increased in the two chambers simultaneously, thus supplying fluid to both front and rear brake systems.

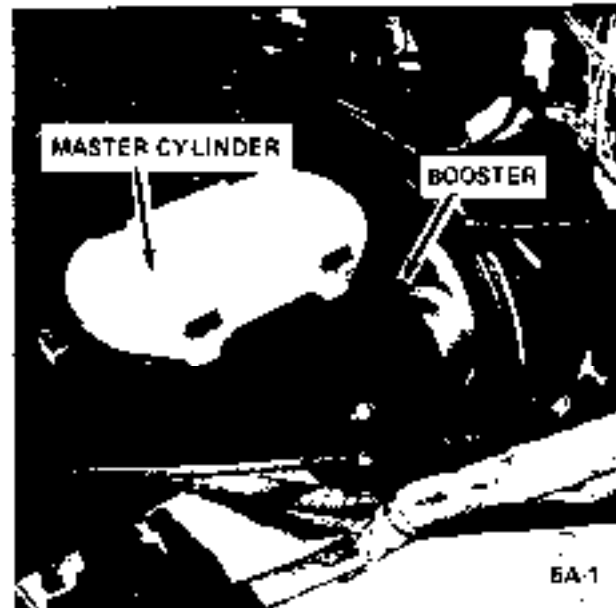


Figure 5A-1 Brake Booster Attachment (Opel 1900 and Manta)

In the GT, the brake fluid container is arranged at right angles to the tandem brake master cylinder. See Figure 5A-3. It is pushed over the feed port of the rear brake circuit onto the brake master cylinder and

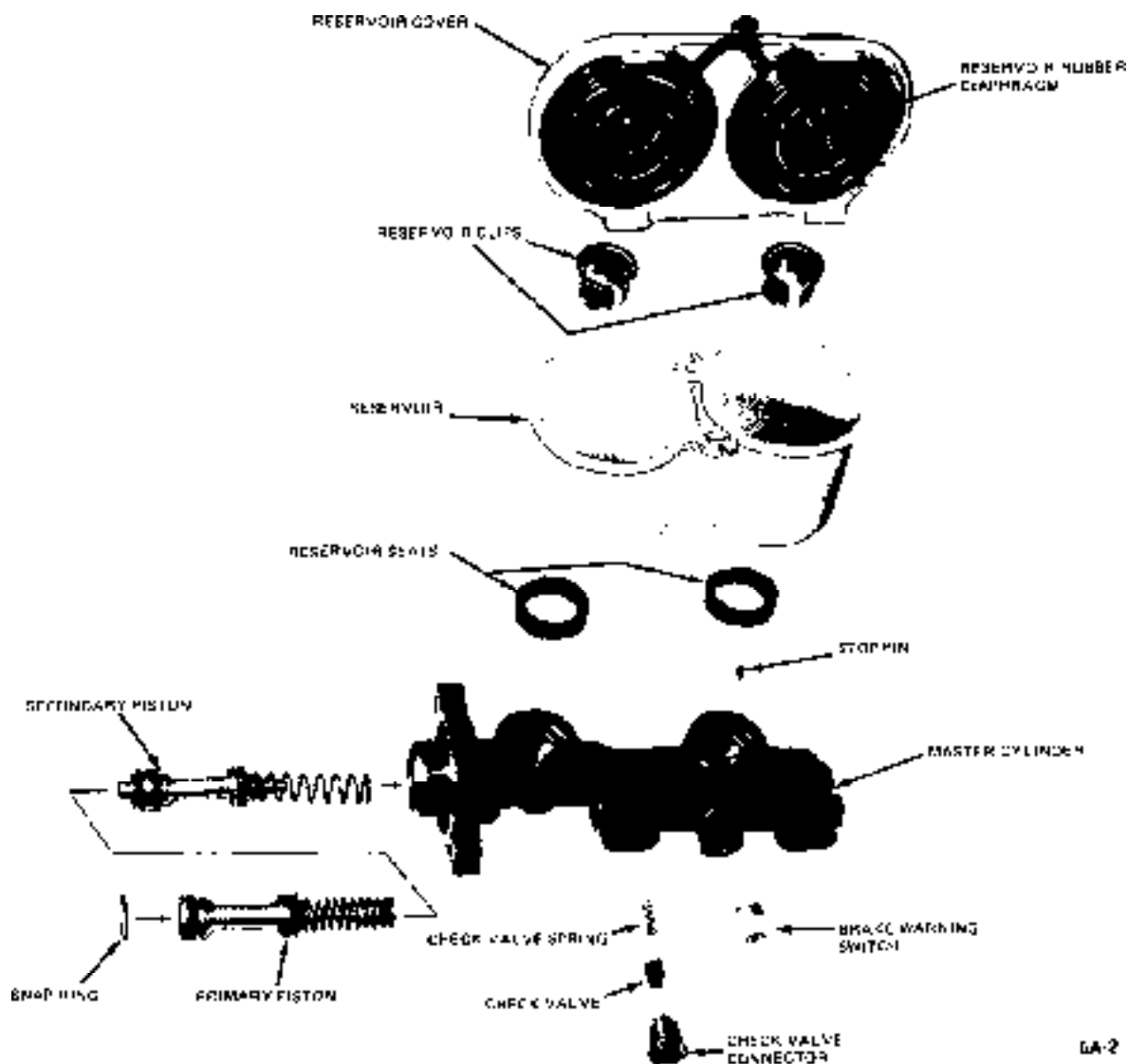


Figure 5A-2 Exploded View Master Cylinder (Opel 1900 and Manta)

held in position by a retaining plate. The front brake circuit is connected to the brake fluid container by a hose and a connector. See Figure 5A-4.

An offset brake actuating rod, consisting of pedal rod, adjuster and connecting tube, is used between the brake pedal, the tandem brake master cylinder and brake booster respectively. The connecting tube is pressed onto the pedal rod and adjuster. The specified brake pedal free travel of 1/4 inch is obtained by adjusting the brake booster piston rod and lock nut of the adjuster.

#### VACUUM CONTROL VALVE

A vacuum control valve is installed into the vacuum

hose between the intake manifold and the brake booster and serves to prevent air from flowing back (vacuum release) when the engine is shut off. See Figure 5A-5. ***This valve cannot be disassembled and must be replaced when defective.*** To do this, the short hose should be used between the intake manifold and the vacuum control valve and the long hose between the vacuum control valve and the brake booster. Arrows on the valve housing indicate its correct position in the line. Should a vacuum control valve be installed backward no air could be drawn out of brake booster, thus rendering it inoperative. Hose clamps should be installed to prevent the possibility of vacuum leaks.



Figure 5A-3 Power Brake Master Cylinder (GT)

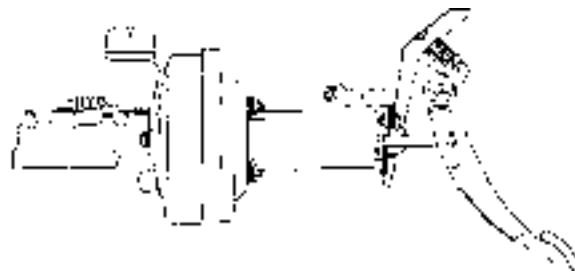


Figure 5A-4 Brake Pedal and Master Cylinder Attachment (GT)

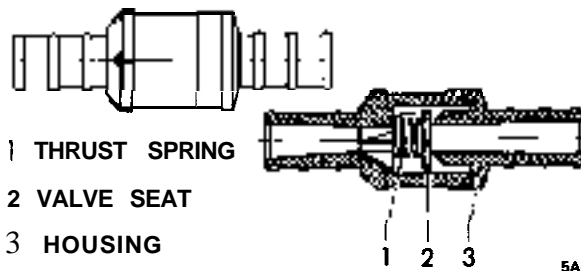


Figure 5A-5 Vacuum Control Valve

## DIAGNOSIS

### POWER BRAKE UNIT TROUBLE DIAGNOSIS

Condition	Possible Cause	Correction
Hard Pedal	1. Broken or damaged hydraulic brake lines.	1. Inspect and replace as necessary.
	2. Vacuum failure.	2. <b>Check for:</b> a) Faulty vacuum check valve or grommet • replace. b) Collapsed or damaged vacuum hose • replace. c) Plugged or loose vacuum fitting • repair. d) Faulty air valve seal or support plate seal • replace. e) Damaged floating control valve.
	3. Defective diaphragm.	3. Replace
	4. Restricted air filter element.	4. Replace
	5. Defective apply piston seals.	5. Repair and replace master cylinder.
	6. Cracked or broken power pistons or retainer.	6. Replace power unit.

Condition	Possible Cause	Correction
Grabby Brakes (Apparent Off- and On Condition)	1. Broken or damaged hydraulic brake lines.	1. Inspect and replace, as necessary.
	2. Insufficient fluid in master cylinder.	2. Fill reservoirs with approved brake fluid check for leaks.
	3. Defective master cylinder seals.	3. Repair or replace, as necessary.
	4. Cracked master cylinder casting.	4. Replace
	5. Leaks at front disc brake calipers or rear wheel cylinders in pipes or connections.	5. Inspect and repair, as necessary.
	6. Air in hydraulic system.	6. Bleed system.
Brakes Fail to Release	1. Blocked passage in power piston.	1. Inspect and repair or replace, as necessary.
	2. Air valve sticking shut.	2. Check for proper lubrication of air valve "O" ring.
	3. Broken piston return spring master cylinder.	3. Replace
	4. Tight pedal linkage.	5. Repair or replace, as necessary.

## MAINTENANCE AND ADJUSTMENTS

### CHECKING BRAKE BOOSTER OPERATION

The operation of the brake booster can be checked by simple means and without any special devices.

1. With engine off, **first** clear the booster of any vacuum by depressing brake pedal several times.
2. Then depress brake pedal and start engine. If the vacuum system is working correctly, the brake pedal, kept under even foot pressure, moves farther downwards due to the additional pressure developed by the booster. Should the brake pedal not move farther downwards, the vacuum system is deficient. In this case check the vacuum hose to booster, to vacuum control valve and to engine intake manifold connections.
3. If the vacuum system operates properly, the defect is in the brake booster itself. A dirty filter impairs or

even prevents air from entering into the booster and thereby the formation of a difference in pressure in the vacuum cylinder.

Repairs cannot be carried out on the brake booster. If no deficiency can be found in the vacuum system or filter, the brake booster has to be replaced.

Under normal operating conditions the brake booster requires no service. However, under adverse conditions such as frequent driving on sandy or dusty roads, the filter and sound **deadener** should be replaced occasionally. To do so, the brake booster must be removed but it isn't necessary to detach the master cylinder.

### BRAKE BOOSTER FILTER SERVICE

Under normal operating conditions the filter need not be exchanged for a new one.

*Under adverse operating conditions* - frequent **driv-**



ing on dusty and sandy roads - the filter and sound deadener should occasionally be replaced. To do so, brake booster has to be removed without detaching brake master cylinder.

Proceed as follows:

1. Remove protective cap (boot).
2. On the GT only, pry retainer from housing using a screwdriver. See Figure 5A-6.

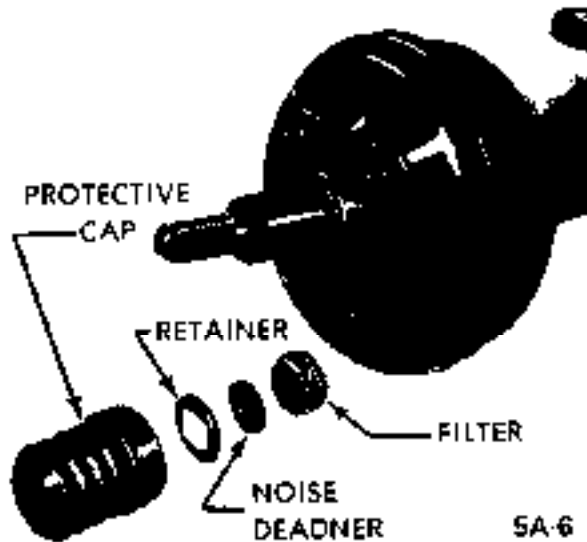


Figure 5A-6 Brake Booster Filter (GT)

3. With a pointed tool remove air silencer and filter out of control housing bore and pull it off thrust rod.

4. Install new **filter** and air silencer. On the GT, the smooth side of the filter must face towards the inside. The radial slots in filter and deadener must be staggered to each other by 180 degrees.

5. Slide retainer over control housing (GT only) and seal it with light plastic hammer strokes. Slide protective cap over control housing and slip it onto brake booster housing.

#### VACUUM CONTROL VALVE SERVICE

A vacuum control valve is installed into the vacuum hose between intake manifold and brake booster. It serves to prevent air from flowing back (vacuum release), when engine is shut off.

The vacuum control valve cannot be disassembled and has to be replaced, if defective. On replacement, note the following:

1. The vacuum control valve should be located near the intake manifold. Therefore, the short vacuum

hose has to be installed between intake manifold and vacuum control valve and the long hose between vacuum control valve and brake booster.

2. The arrows on the vacuum control valve housing must point towards the intake manifold, otherwise no air can be drawn out of the brake booster which renders the brake booster ineffective.

3. The connections of the vacuum hoses to the intake manifold, vacuum control valve and brake booster must be airtight. For this reason make sure, that the hose clamps are properly installed.

## MAJOR REPAIR

### BRAKE BOOSTER REMOVAL AND INSTALLATION

#### Removal

1. Disconnect brake pipes from master cylinder. Place a cloth under the master cylinder and brake pipes to absorb any brake fluid drippings.

2. Disconnect vacuum hose from brake booster.

3. Remove four nuts and washers attaching brake booster to brake booster support.

4. On the GT only, remove master cylinder support to fender skirt bolts.

5. On the GT, loosen thrust rod lock nut and unscrew the piston push rod while holding the master cylinder brake booster assembly. On the Opel 1900 and Manta, remove the nut and bolt attaching clevis on the pedal.

6. Remove assembly from car.

7. Disconnect master cylinder from brake booster.

#### Installation

**CAUTION:** *Fasteners in the following steps are important attaching parts in that they could affect the performance of vital components and systems, and/or could result in major repair expense. They must be replaced with one of the same part number or with an equivalent part if replacement becomes necessary. Do not use a replacement part or lesser quality or substitute design. Torque values must be used as specified during reassembly to assure proper retention of these parts.*

1. Using a new front housing seal, assemble master

cylinder to **brake** booster and torque nuts to 14 **lb.ft.** on the GT and 12 **lb.ft.** on the Opel 1900 and Manta.

2. Position assembly into brake booster bracket and, on the GT only, thread piston push rod onto the thrust rod.
3. Install brake booster to support attaching washers and nuts and tighten to 11 **lb.ft.** of torque.
4. On the GT install master cylinder support to inner fender skirt bolts.
5. Connect vacuum hose to brake booster.
6. By turning the piston push rod on the thrust rod, (GT only) adjust until the brake pedal free travel is 1/4 inch and tighten the lock nut.
7. Connect brake pipes to master cylinder and bleed brakes.

## MASTER CYLINDER OVERHAUL. GT

### Removal of Master Cylinder

1. Disconnect the two brake pipes from the master cylinder.
2. Remove the front support to skirt attaching bolts, the cylinder to booster retaining nuts and lift out master cylinder.

### Disassembly

1. Prior to brake master cylinder disassembly, pour brake fluid out of brake fluid reservoir, remove reservoir from master cylinder and take sealing plugs out of housing.
2. Screw static pressure valve(s) out of housing.
3. To facilitate disassembly, push piston somewhat into cylinder and insert a rounded off piece of welding rod approx. .12 in. thick into feed port to retain piston in this position.
4. Remove stop screw and snap ring out of housing and take out both pistons together with springs.
5. Remove stop screw from piston for rear brake circuit and remove all component parts. Remove also all component parts from intermediate piston of front brake circuit.

### Cleaning and Checking

1. Clean parts with genuine brake fluid, Delco Supreme No. 11, or equivalent. Do not use any other cleaning solvents. Dry with compressed air. Free up compensating and feed ports.

2. Polish cylinder bore of housing with crocus cloth. If lapping scores and rust spots are still noticeable, replace brake master cylinder assembly.

3. **Check** inner components for damage and replace, if required. The rubber seals and static pressure valve always have to be replaced.

### Assembly

1. Assemble front and rear brake circuit pistons. Prior to assembly coat rubber seals with brake fluid.
2. Coat cylinder bore, piston sliding surfaces and seals with brake fluid.
3. Insert preassembled intermediate piston for front brake circuit together with thrust spring and spring seat into cylinder bore. The smaller diameter of the tapered thrust spring must face piston.
4. With a drift, push piston (against spring pressure) into housing and insert a piece of welding rod **into** feed port of front brake circuit to retain piston.
5. Install stop screw with new seal ring into housing and tighten.
6. Insert preassembled piston for rear brake circuit into cylinder bore and install snap ring into groove in housing.
7. Check piston for free movement by moving it to and fro. If required, place washers under the head of the stop screw.
8. Lightly push piston into housing and remove piece of welding rod out of feed port of front brake circuit.
9. With a rounded off piece of welding rod (.020 - .024 in.) check whether compensating ports are free.
10. Screw in new static pressure valve(s).
11. Coat new sealing plugs with brake fluid and insert them into housing. Push twin brake fluid container into sealing plugs and install screen and cover with seal ring.

### Installation

1. Install master cylinder onto brake booster with washers and nuts. Torque to 14 **lb.ft.**
2. Attach the front mounting bracket.
3. Install brake lines on master cylinder, and bleed brakes.

4. If required, adjust mechanically actuated stop light switch. Pedal travel of  $5/8$ " to 1" should actuate switch. Add or subtract washers between bracket and switch to obtain proper adjustment.

5. Road test car for proper brake performance.

### MASTER CYLINDER OVERHAUL. OPEL 1900 AND MANTA

#### Removal of Master Cylinder

1. Remove master cylinder from brake booster by disconnecting brake pipes and removing two self-tightening nuts that secure master cylinder to brake booster. Be careful not to loosen the front housing seal.

#### Disassembly

1. Prior to brake master cylinder disassembly, pour brake fluid out of brake fluid reservoir.

2. Remove reservoir from master cylinder body by removing reservoir clips with snap ring pliers. See Figure 5A-7.

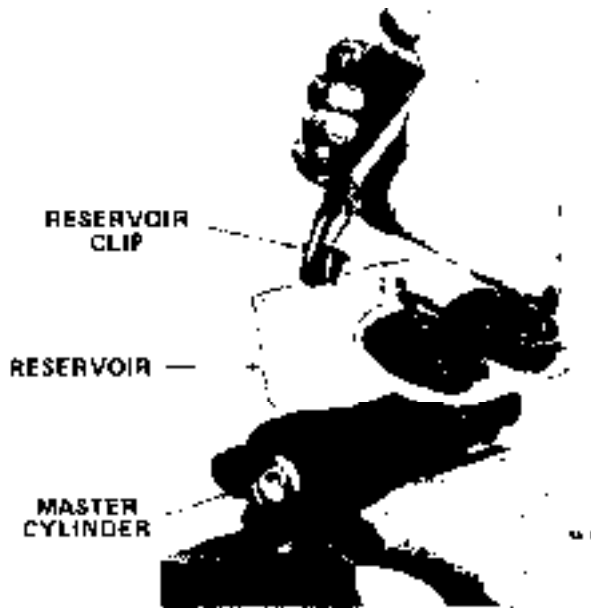


Figure 5A-7 Removing Reservoir Clips

3. Remove the piston stop screw which is fitted in master cylinder body.

4. Place master cylinder in a vise and push piston forward and insert a rod with a spherical end into the hole nearest the mounting flange. This will retain the piston in a forward position and allow for removal of snap ring. See Figures 5A-8 and 5A-9.

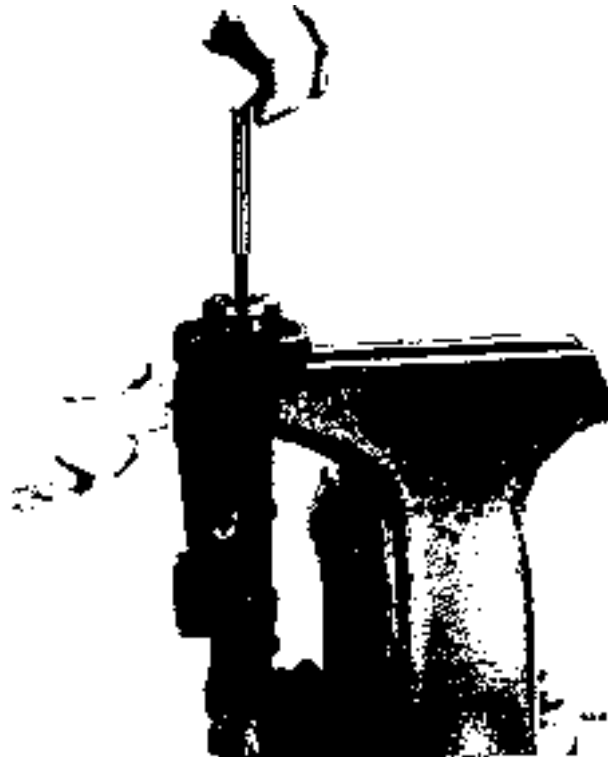


Figure 5A-8 Retaining Piston in Forward Position



Figure 5A-9 Removing Snap Ring

NOTE: Snap *ring should not be reused.*

5. Remove primary and secondary pistons from cylinder.

6. Remove check valve by unscrewing check valve connection.

**Cleaning and Checking**

1. Clean parts with genuine brake fluid, Delco Supreme No. 11, or equivalent. Do not use any other cleaning solvents. Dry with compressed air. Free up compensating and feed parts.

2. Inspect cylinder bore for pits, scoring, cracks, nicks or other defects.

NOTE: *Whenever the master cylinder is overhauled, a new repair kit must be used.*

**Assembly**

NOTE: *Before reassembly double check that there is no foreign particles in the master cylinder bore or on any parts that are to be assembled into it.*

1. Coat master cylinder bore with clean brake fluid and install secondary and primary pistons.

2. Install new snap ring while holding primary piston in a forward position.

3. Install check valve spring, check valve and check valve connector and torque to 26 lb.ft.

4. Install stop screw.

5. Lubricate reservoir seals and remount on master cylinder body.

6. Install reservoir clips into reservoir and mount reservoir onto master cylinder without distorting seals. Do not force reservoir onto master cylinder.

7. Position reservoir cover onto reservoir.

**Installation**

1. Mount master cylinder to brake booster, using a new front housing seal if old one is damaged or distorted. Torque nuts to 12 lb.ft.

2. Install brake pipes to master cylinder and bleed brakes.

**SPECIFICATIONS**

**GENERAL SPECIFICATIONS**

Brake Booster Size .....	7 in.
Brake Boost Ratio ▪ (GT) .....	2.06 to 1
Brake Boost Ratio ▪ (Opel 1900 and Manta) .....	2.64 to 1

	Name	Torque <b>Lb.Ft.</b>
Nut	Master Cylinder to Brake Booster (GT) .....	14
	Master Cylinder to Brake Booster (Opel 1900 and Manta)	12
Nut	Brake 'Booster to Support .....	11

# DISC BRAKES

## CONTENTS

Subject	Page No.
<b>DESCRIPTION AND OPERATION:</b>	
Description .....	5B-10
Operation .....	5B-11
<b>DIAGNOSIS:</b>	
Disc Brake Trouble Diagnosis .....	5B-12
<b>MAINTENANCE AND ADJUSTMENTS:</b>	
Disc Brake Maintenance .....	5B-15
Checking Disc Brake Friction Pads for Wear .....	5B-15
Replacing Friction Pads	
Checking Brake Disc for Lateral Runout .....	5B-17
<b>MAJOR REPAIR:</b>	
Removing and Installing Brake Caliper .....	5B-17
Removing and Installing Brake Disc .....	5B-17
Removing and Installing Brake Disc Shield .....	5B-19
Disassembly and Assembly of Brake Caliper .....	5 5 1 9
<b>SPECIFICATIONS:</b>	
Disc Brake Specifications .....	5B-21

## DESCRIPTION AND OPERATION

### DESCRIPTION

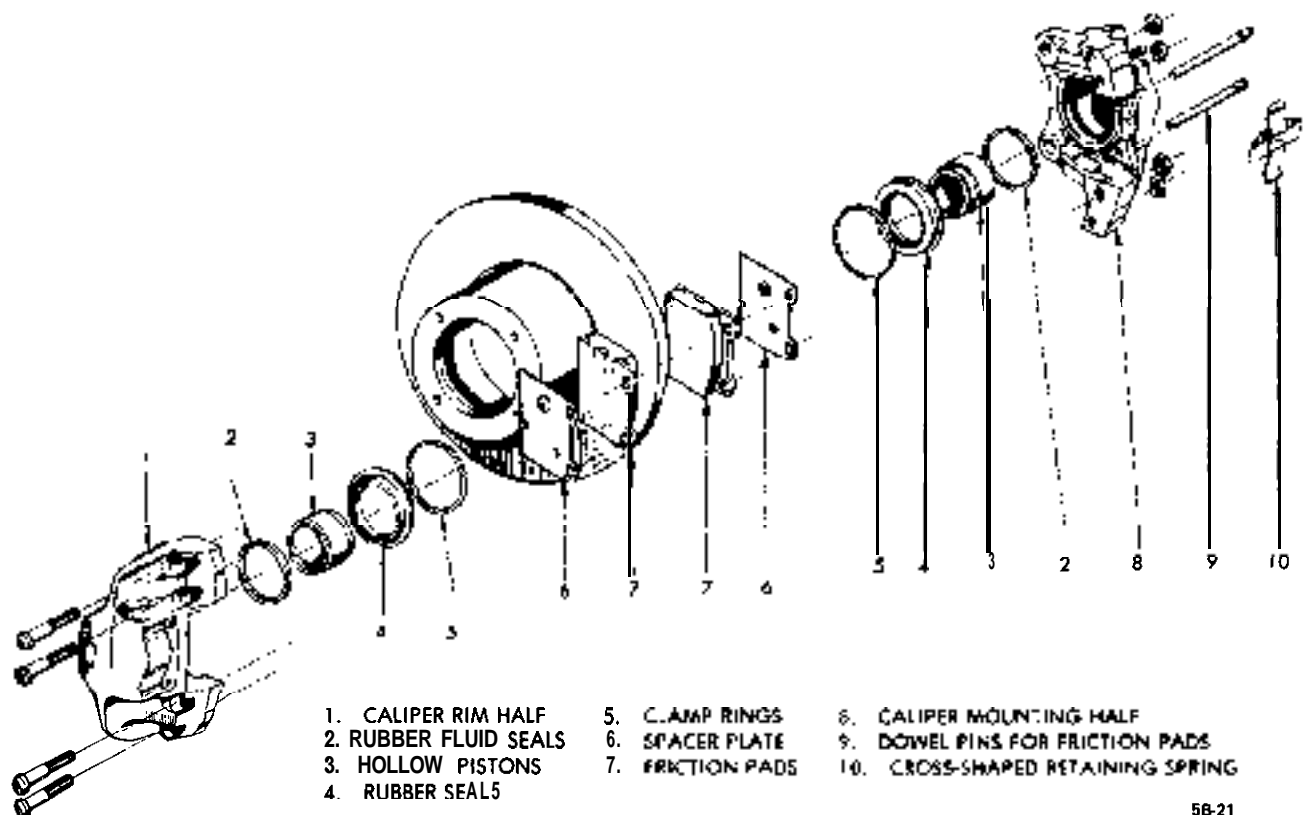
The front wheel disc brake consists of two major parts: The brake disc and the brake caliper with the two friction pads. See Figure 5B-20.

The brake disc is attached to the inside of the wheel hub flange by four bolts and centered on a shoulder of the hub. The brake caliper consists of two halves: the mounting half, arranged on the inside of the brake disc, and the rim half. The two halves are firmly attached to each other by four bolts. Two flanges on the mounting half serve as attachment of the brake caliper to the steering knuckle. The brake caliper is positioned behind the front suspension cross member at steering knuckle spindle level. It is attached to the steering knuckle by two bolts. Both caliper halves act as brake cylinders and each houses a piston and a fluid seal. The **fluid** seal, of square cross section, is positioned in an annular groove of the caliper bore, preventing fluid leakage past the piston and entry of water and dirt. The pistons and caliper half bores are protected against entry of water



Figure 5B-20 Left Front Disc Brake Assembly

and dirt in brake disc direction by a rubber seal, held on the caliper half collar by a clamp ring and against



5B-21

Figure 5B-21 Left Front Disc Brake - Exploded View

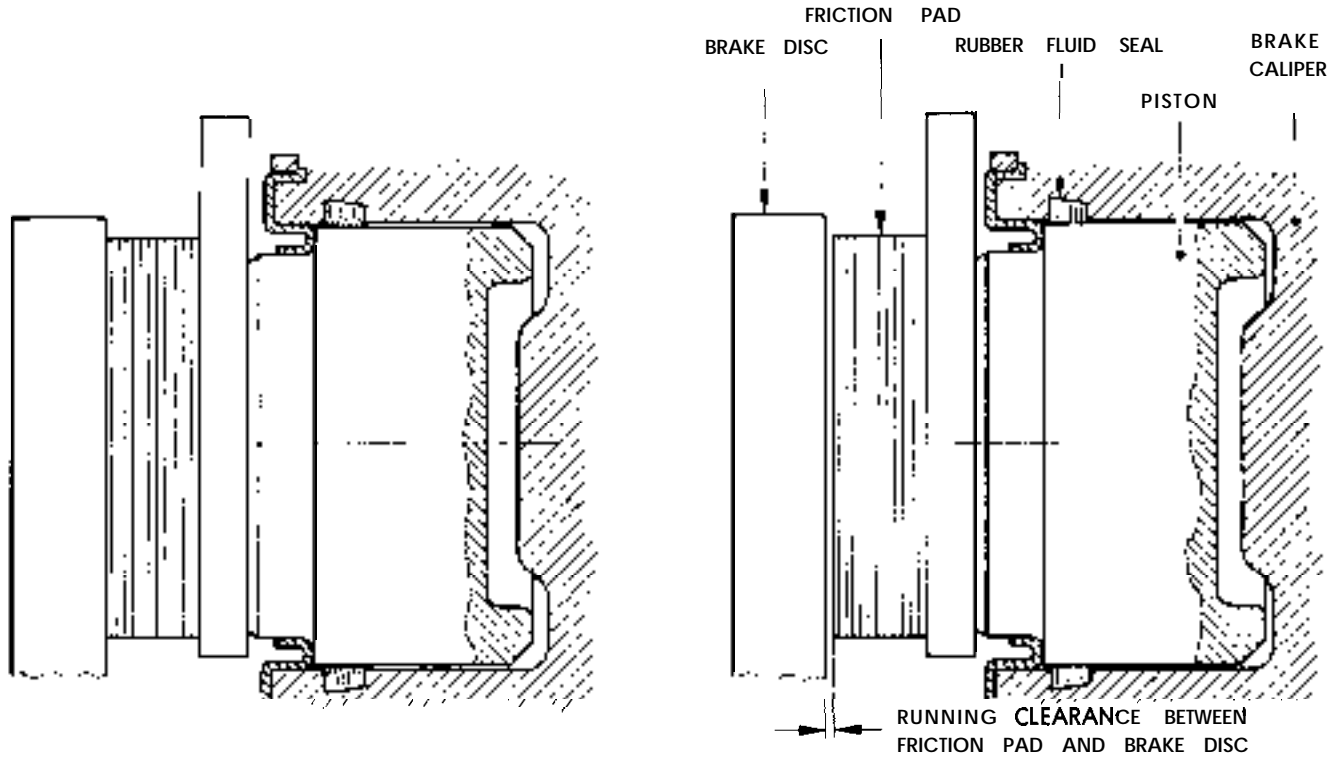
the piston circumference by its inherent tension. See Figure 5B-21. Both pistons are hollow. The open end of each piston faces the brake disc.

A sheet metal spacer plate with two impressions for preventing the piston from rotating is installed between each piston and friction pad and **secured by** the friction pad dowel pins. The two friction pads are positioned on the right and left of the brake disc recesses in the caliper halves. Each friction pad consists of a backing plate with friction material, which is abrasive-coated, bonded to it. The friction pad assemblies are held in position in the brake caliper by two dowel pins, secured by slit dowel pin retainers, and by a cross-shaped retaining spring which is **pre-loaded** and positioned under the dowel pins, thus pressing the friction pads and spacer plates firmly against the pistons. The front brake line leading from the brake master cylinder attaches to a distribution tee from which a brake line leads to each front wheel caliper. The caliper bores are interconnected by fluid ducts within the caliper halves.

#### OPERATION

The front wheel disc brakes have self-adjusting pistons. See Figure 5B-22.

The adjustment of the pads is effected by the pistons which push the friction pads ahead towards the brake disc for a distance equivalent to the amount of friction pad wear. This means that the greater the wear the closer the pistons move **towards** the brake disc. A running clearance exists between friction pads and brake disc when the brakes are in "off" position. This running clearance is provided **by** the rubber fluid seals which are positioned in the caliper half bores and which tightly grip and exert their pre-load pressure on the pistons. The rubber fluid seals also prevent the pistons from being pushed into the caliper half bores more than the distance equivalent to the running clearance. As the friction pads are adjusted by the pistons, there must be no static pressure in the front brake circuit when the brakes are in "off" position. Non-existence of a static pressure in the front brake circuit is achieved by eliminating the check valve in the brake master cylinder on the front brake circuit. During brake application the pressure from the brake master cylinder is transferred to the pistons in the brake caliper. The pistons move ahead and press the friction pads against both friction **sur-**faces of the rotating brake disc. The force exerted on the brake pedal determines the pressure of the friction pads against the brake disc. On releasing the brake pedal, the brake lines of the front brake circuit, including the caliper half bores, are relieved of hy-



A = BRAKE ON  
THE RUBBER FLUID SEAL TIGHTLY GRIPPING PISTON IS DEFLECTED IN DIRECTION OF PISTON TRAVEL

B = BRAKE OFF  
THE PISTON IS RETRACTED BY THE AMOUNT OF RUBBER FLUID SEAL DEFLECTION. THIS AMOUNT IS EQUAL TO RUNNING CLEARANCE.

5B-22

Figure 5B-22 Rubber Fluid Seal -Automatic Piston Retraction

draulic pressure, and the friction pads and pistons move away from the brake disc, leaving a small running clearance. The brake disc can now rotate freely.

The amount of brake travel is dependent upon the amount of running clearance. For this reason the runout of the brake disc should be checked, besides bleeding of the brake system and adjusting the rear brake shoes, when the pedal free travel is too great.

The running clearance between brake disc and friction pads is attained as follows: When the pistons in the caliper halves are moved towards the brake disc

during braking, the rubber seals in the annular grooves of the brake caliper bores deflect laterally in the direction of piston movement. See Figure 5B-22, View (A). The seal remains deflected for the duration of the braking operation. After braking, the caliper bores are relieved of hydraulic pressure and the rubber seals resume their normal position, thus pulling or retracting the pistons. The distance traveled by the pistons is equal to that of the running clearance between brake disc and friction pads.

The shifting of the pistons in the direction of the brake disc due to friction pad wear has no effect on the running clearance. The running clearance remains the same in all piston positions.

## DIAGNOSIS

### DISC BRAKE TROUBLE DIAGNOSIS

Condition	Possible Cause	Correction
Pulls	1. Incorrect tire pressures.	1. Inflate evenly on both sides to the recommended pressures (see Owner's Manual).

Condition	Possible Cause	Correction
	2. Front end out of line.	2. Check and align to manufacturer's specifications.
	3. Unmatched tires on same axle.	3. Tires with approximately the same amount of tread should be <b>used</b> on the same axle.
	4. Restricted brake tubes or hoses.	4. Check for soft hoses and damaged lines. Replace with new hoses and new double-walled steel brake tubing.
	5. Malfunctioning caliper assembly.	5. Frozen caliper - check for stuck or sluggish pistons, proper lubrication.
	6. Defective or damaged shoe and lining (grease or brake fluid on lining or bent shoe).	6. Install new shoe and lining in complete axle sets.
	7. Malfunctioning rear brakes.	7. Check for brake adjustment, defective lining (grease or brake fluid on lining) or defective wheel cylinders. Repair as necessary.
	8. Loose suspension parts.	8. Check all suspension mountings.
	9. Loose calipers.	9. Check and <b>torque</b> bolts to specifications.
Brake Roughness or Chatter (Pedal Pulsates)	1. Excessive lateral <b>runout</b> .	1. Check per instructions and replace or machine the rotor, if not within specifications.
	2. Parallelism not within specifications.	2. Check per instructions and replace or machine the rotor, if not within specifications.
	3. Wheel bearings not adjusted.	3. Adjust wheel bearings to correct specifications.
	4. Rear drums out of round.	4. Check <b>runout</b> and, if not within specifications, turn the drums within specifications.
	5. Shoe reversed (steel against iron).	5. Replace shoe and lining and machine rotor within specifications.
Excessive Pedal Effort	1. Malfunctioning power brake.	1. Check power brake and repair, if necessary.



Condition	Possible Cause	Correction
	2. Partial system failure.	2. Check front and rear brake system and repair, if necessary. Also, check brake warning light, if a failed system is found and light did not function.
	3. Excessively worn shoe and lining.	3. Check and replace in axle sets.
	4. Piston in caliper stuck or sluggish.	4. Remove caliper and rebuild.
	5. Fading brakes due to incorrect lining.	5. Remove and replace with original equipment lining.
	6. Vacuum leak.	6. Check for ruptured hose or loose attachment.
Excessive Pedal Travel	1. Partial brake system failure.	1. Check both front and rear system for a failure and repair. Also, check warning light • it should have indicated a failure.
	2. Insufficient fluid in master cylinder.	2. Fill reservoirs with approved brake fluid. Check for leaks.
	3. Poor rear brake adjustment.	3. Adjust rear brake per specifications.
	4. Air trapped in system.	4. Bleed system.
	5. Bent shoe and lining.	5. Replace axle set of shoe and lining.
Dragging Brakes (A very light drag is present in all disc brakes immediately after pedal is released.)	1. Master cylinder pistons not returning correctly.	1. With reservoir cover off, check for fluid spurt at bypass holes as pedal is depressed. Adjust push rod, if necessary, or rebuild master cylinder.
	2. Restricted brake tubes or hoses.	2. Check for soft hoses or damaged tubes and replace with new hoses and new double-walled steel brake tubing.
	3. Incorrect parking brake adjustment on rear brakes.	3. Check and readjust to correct specifications.
	4. Check valve installed in outlet to front disc brakes.	4. Check master cylinder outlet and remove check valve if present.
Grabbing or Uneven Braking Action (All conditions listed under "Pulls" .)	1. Malfunction of power brake unit.	1. Check operation and repair, if necessary.

Condition	Possible Cause	Correction
	2. Binding brake pedal mechanism.	2. Check and lubricate, if necessary.
	3. Corroded caliper assembly.	3. Clean and lubricate.

## MAINTENANCE AND ADJUSTMENTS

### DISC BRAKE MAINTENANCE

#### Checking Brake Fluid Level

The brake fluid level in the brake fluid container must be checked during **predelivery** inspection, then every 3,000 miles during inspection and preventive maintenance servicing.

The brake fluid level must not be higher than the inscription "MAX" and must be at least up to "MIN". Replenish brake fluid, if necessary.

Because of the relatively large brake caliper bore cross section and the self-adjustment of the disc brakes, resulting in a greater piston travel to compensate for friction pad wear, the brake fluid level drops faster than in fluid containers for drum brakes with their smaller wheel brake cylinders. For this reason pay special attention to the fluid level in the **brake** fluid container.

Drop of brake fluid level can be due to friction pad wear and may not be due to leakage in the braking system.

On loss of brake fluid due to leakage, the brake system must be checked thoroughly.

#### Friction Pad Adjustment

Friction pad adjustment is not necessary on the front wheel disc brakes as this is done automatically by the pistons in the brake calipers.

#### Lubricating Front Wheel Bearings

When removing one or both brake discs, check lubrication of front wheel bearings and the cavity of the wheel hub and replenish if necessary (see operation "Removing and Reinstalling Brake Disc"). When carrying out other work on disc brakes which does not necessitate the removal and installation of the brake disc, lubricating wheel bearings is not necessary.

### Checking Disc Brake Friction Pads for Wear

Whenever a disc brake equipped car is in for periodic service, while the car is raised, the friction pads in both brake calipers should be checked for wear by making a simple measurement. Worn or oily friction pads must be replaced.

Measure friction pad wear as follows:

1. Remove friction pads.
2. Using a one-inch micrometer, measure the thickness of the pad and friction plate. See Figure 5B-23.

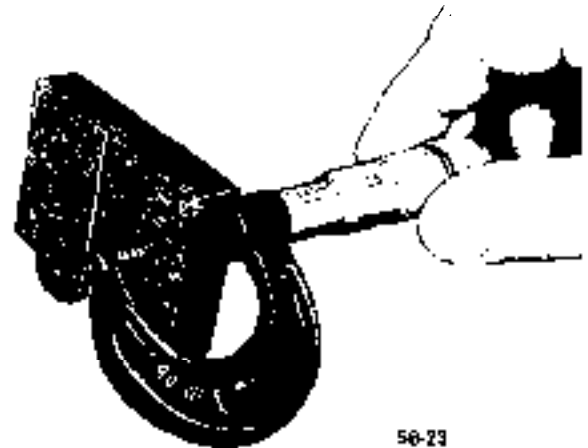


Figure 5B-23 Checking Brake Friction Pad Thickness

3. If any one of the four measurements is less than  $-.280$ , replace all four friction pads. (Partial replacement of friction pads would cause unequal braking.)

### Removal and Installation of Friction Pads

1. Raise car and remove front wheels.
2. Drive dowel pins out of brake calipers toward center of car. See Figure 5B-24. Dowel pins must be driven inward because they are secured by enlarge fluted inner ends.
3. Remove friction pads from brake calipers. See Figure 5B-25.

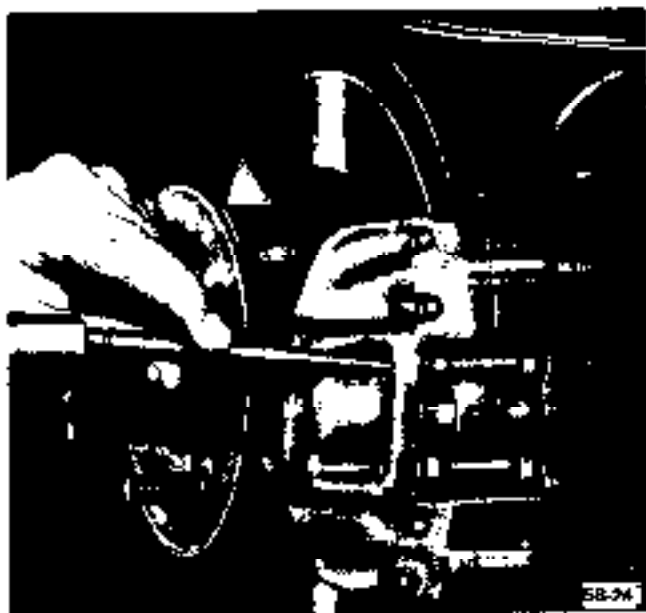


Figure 5B-24 Removing Dowel Pins

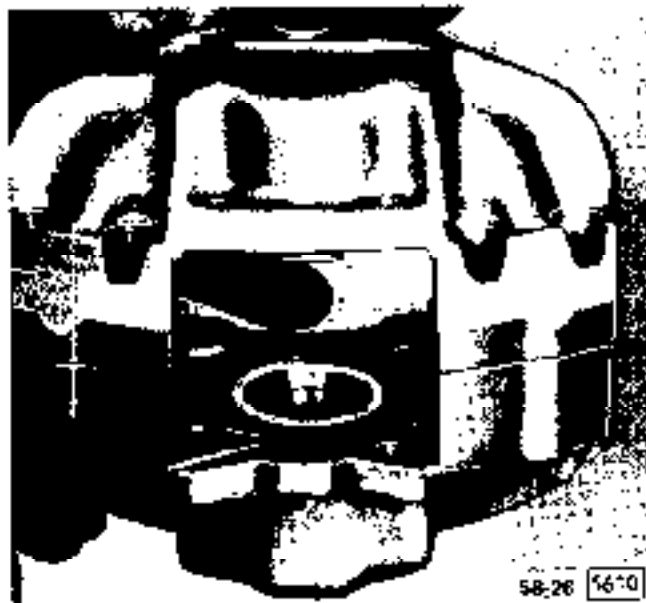


Figure 5B-26 Removing or Installing Rubber Seal Clamp Ring

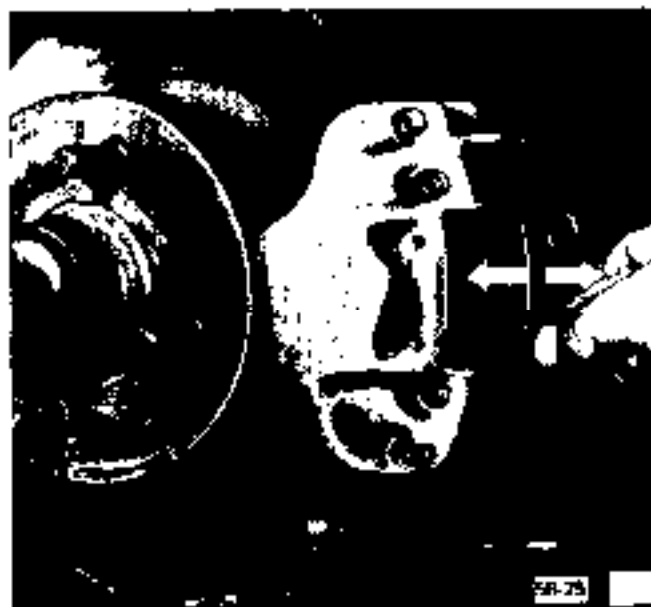


Figure 5B-25 Removing Friction Pads

4. Check rubber seals for wear. If rubber seals are hardened, brittle or cracked, they must be replaced as follows:

(a) Remove brake caliper from steering knuckle and brake disc. Leave hose attached to brake caliper.

(b) Remove seal clamp rings with screwdriver and remove seal rings from calipers. See Figure 5B-26.

(c) Install new rubber seals and clamp rings. Make sure rubber seal is properly seated. Make sure clamp ring is correctly positioned on rubber seal.

(d) Attach brake caliper to steering knuckle and torque bolts to 72 lb.ft. **Prior to installation of caliper, make sure contacting surfaces of both caliper and steering knuckle are perfectly clean and free of any burrs.**

**CAUTION:** *This disc brake caliper attachment fastener is an important attaching part in that it could affect the performance of vital components and systems, and/or could result in major repair expense. It must be replaced with one of the same part number or with an equivalent part, if replacement becomes necessary. Do not use a replacement part of lesser quality or substitute design. Torque values must be used as specified during reassembly to assure proper retention of this part.*

5. Before installing new friction pads, press both pistons of each caliper to bottom of their bores, using Return Clamp **J-22430**. **While pressing piston into bores, open caliper bleeder valve to prevent excess brake fluid from overflowing master cylinder container** As soon as pistons are bottomed, tighten bleeder valve.

6. Check brake disc for lateral runout.

7. Install new friction pads into brake caliper. **Friction pads must be free enough to be easily moved in their caliper recesses.** See Figure 5B-25.

If new friction pads are not free, it will be necessary to remove pads and clean recesses and recess corners with a wooden spatula and then with denatured alcohol and a brush. After cleaning, blow out recesses with compressed air. Remove any high spots on edges of friction pads contacting caliper recesses with

a fine cut file. **Do not use any solvent except denatured alcohol. Do not use a metallic scraper tool.**

8. With a punch, drive one dowel pin from inboard side through caliper and friction pads to stop. Install new cross-shaped retaining spring under installed dowel pin, then install second dowel pin. Loose fitting dowel pins must be replaced.

9. Before operating vehicle, depress brake pedal several times to adjust friction pads to brake discs. Check brake fluid level and add fluid as necessary to bring level up to "MAX" on reservoir.

Car owners must be informed that a break-in period exists for new friction pads, and that they must avoid unnecessary, forceful braking during the first 125 miles after installation of new friction pads.

#### Checking Brake Disc for Lateral Runout

1. Remove front wheel assembly.
2. Remove front wheel bearing hub cap and spindle nut cotter pin. Tighten spindle nut until all free play is removed from wheel bearings.
3. To check disc **runout**, use Dial Indicator Set J-8001. Attach dial support C-clamp to an upper ball joint attaching bolt as shown in Figure 5B-27. Position dial indicator button against brake disc 1/2 inch from outer circumference.

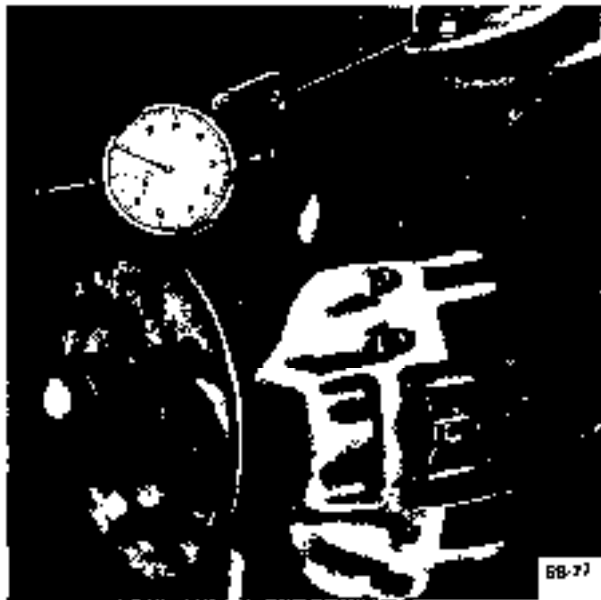


Figure 5B-27 Checking Brake Disc Lateral Runout

4. Rotate disc, reading maximum dial indicator movement. Maximum permissible **runout** is .004 inch.
5. If **runout** exceeds .004 inch, remove disc and hub

assembly and true disc in a suitable disc turning lathe, following manufacturer's instructions. The depth of cut on each side of disc should be just deep enough to get a true flat surface.

6. After truing disc on both sides, check thickness with a micrometer. A disc with a thickness of less than .394 inch is liable to warp after hard braking and, therefore, must be discarded.

7. Reinstall brake disc and hub assembly, removing all play from wheel bearings. Repeat **runout check**. If **runout** still exceeds .001 inch, replace brake disc.

8. Adjust front wheel bearings.

9. Reinstall front wheel assembly.

## MAJOR REPAIR

### REMOVING AND INSTALLING BRAKE CALIPER

1. Remove left or right front wheel and remove friction pads from brake caliper.

2. Loosen brake line to brake caliper union nut several turns. Unscrew brake caliper plus brake hose bracket from steering knuckle. Remove it from brake disc and swing it sideways. Then unscrew brake pipe from brake hose and remove brake caliper and brake pipe (bent pipe). To prevent brake fluid loss, close brake hose with a plug.

3. Prior to installation, **check contacting surfaces of the brake caliper and steering knuckle to make sure they are free of any burrs and dirt.**

4. Install brake caliper on steering knuckle and torque attaching bolts to 72 lb.ft. See Figure 5B-28.

**CAUTION:** *This disc brake caliper attachments fastener is an important attaching part in that it could affect the performance of vital components and systems, and/or could result in major repair expense. It must be replaced with one of the same part number or with an equivalent part, if replacement becomes necessary. Do not use a replacement part of lesser quality or substitute design. Torque values must be used as specified during reassembly to assure proper retention of this part.*

5. Attach brake pipe to brake hose.

6. Install friction pads and replace wheel.

### REMOVING AND INSTALLING BRAKE DISC

1. Jack-up and support front of car and remove front

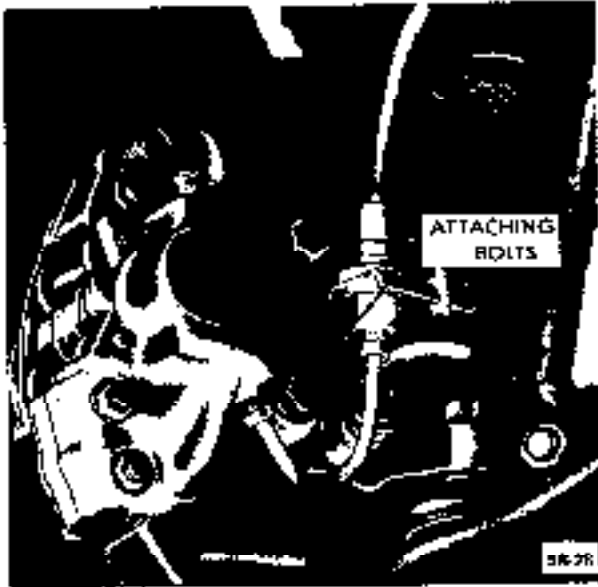


Figure 5B-28 Brake Caliper to Steering Knuckle Attaching Bolts

wheel. Disconnect brake caliper with friction pads from steering knuckle **and** support the assembly as shown in Figure 5B-29.

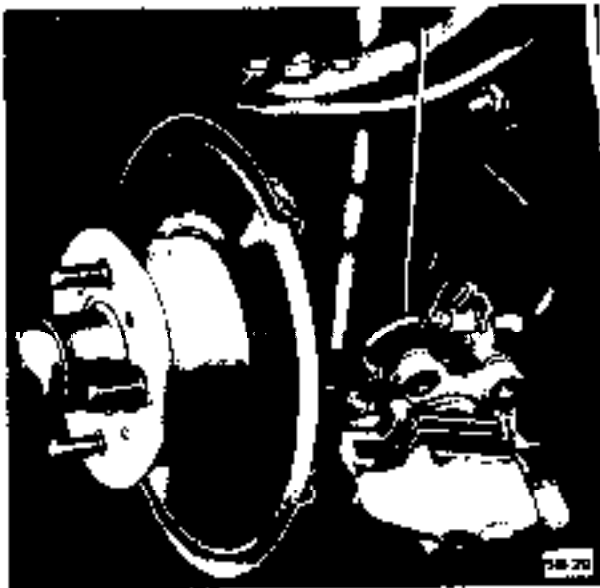


Figure 5B-29 Supporting Brake Caliper

2. Remove front wheel hub and disc assembly along with wheel bearings.

3. Mount brake disc and wheel hub between soft metal jaws in vise. **Do not hold too tightly, to avoid bending** whet-1 bolts. Remove four star head bolts with lockwashers using Star Wrench Adapter J-21737. **Prior to removal, mark position of brake disc in relation to wheel hub.** See Figure 5B-30.

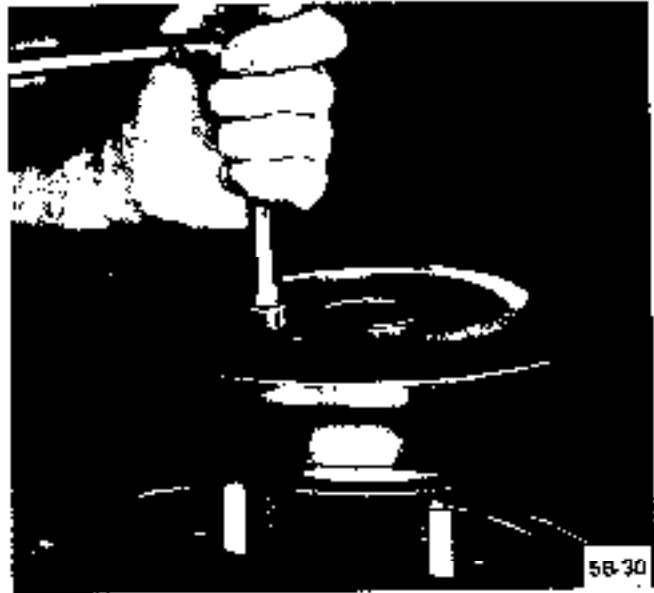


Figure 5B-30 Removing Brake Disc to Hub Bolts

4. Pull brake disc from wheel hub. Do not drive it off. Install in reverse sequence, paying attention to the following:

5. Prior to installation of the brake disc, ensure that the contacting surface of brake disc to wheel hub is free of burrs, dirt and high spots. If necessary, remove high spots and check disc for flatness on a surface plate. Carefully remove burrs with a scraper or file.

6. Also check contacting surface of wheel hub to **make** sure it is in good condition. The same applies to brake disc aligning shoulder on wheel hub. See Figure 5B-31



Figure 5B-31 Brake Disc to Hub Contact Surface

**CAUTION:** *Fasteners in Steps 7 and 9 are important attaching parts in that they could affect the performance of vital components and systems, and/or could result in major repair expense. They must be replaced with one of the same part number or with an equivalent part if replacement becomes necessary. Do not use a replacement part or lesser quality or substitute design. Torque values must be used as specified during reassembly to assure proper retention of these parts.*

7. Install brake disc on wheel hub and torque attaching bolts to 36 lb.ft. If old brake disc is reused, pay attention to locator marks on brake disc and wheel hub.

8. Prior to installing brake disc and hub assembly to steering knuckle, check lubrication of both roller bearings and quantity of grease in cavity of wheel hub. If necessary, repack front wheel bearings.

9. Adjust front wheel bearing clearance and tighten brake caliper to steering knuckle, attaching bolts to a torque of 72 lb.ft. Prior to installing brake caliper to steering knuckle, ensure that all contacting surfaces are free of dirt and burrs. Also make sure that the friction pads are not damaged when sliding the brake caliper onto brake disc.

10. Install wheel assembly, remove supports and lower front of car.

## REMOVING AND INSTALLING BRAKE DISC SHIELD

### Removal

1. Remove brake disc.
2. Remove disc shield from steering knuckle by removing one Phillips head screw on the outside and on the inside, the lower steering arm and disc shield to steering knuckle bolt. Remove paper gaskets from steering knuckle. See Figure 5B-32.

### Installation

1. Prior to placing new paper gasket between brake disc shield and steering knuckle, lightly coat both surfaces of paper gasket with chassis lubricant.
2. Install disc and tighten disc shield and steering arm to steering knuckle bolt to a torque of 47 lb.ft.

**CAUTION:** *This steering arm and steering knuckle to backing plate fastener is an important attaching part in that it could affect the performance of vital components and systems, and/or could result in major repair expense. It must be replaced with one of the*



**Figure 5B-32 Brake Disc Shield Attached to Steering Knuckle**

*same part number or with an equivalent part, if replacement becomes necessary. Do not use a replacement part of lesser quality or substitute design. Torque values must be used as specified during reassembly to assure proper retention of this part.*

3. Replace one Phillips head screw on outside of disc. See Figure 5B-32.

## DISASSEMBLY AND ASSEMBLY OF BRAKE CALIPER

1. Remove brake pipe from brake caliper. If both calipers have to be repaired, it is advisable to mark them with "L" or "R" on removal to avoid errors when installing parts, such as pistons, etc. The brake caliper halves must not be disassembled during repair work. All work, such as pressing out pistons, replacing seals in brake caliper, is carried out with the two caliper halves bolted together.

2. Pry clamp rings from rubber seals, using a screwdriver (Figure 5B-26) and remove rubber seals.

3. Remove piston first from caliper rim half (Figure 5B-33), and then out of the caliper mounting half (Figure 5B-34) of the brake caliper, using mounting clamp J-22429. To be able to force the piston out of the caliper rim half, block the piston in the caliper mounting half with mounting clamp J-22429 as shown in Figure 5B-33. To force the piston out of the caliper mounting half, place the mounting clamp on caliper rim half, as shown in Figure 5B-34, and tighten wing nut so that the rubber plate seals off the caliper rim half bore. Then connect compressed air hose to brake line connection in the caliper mounting

half, and blow out pistons, carefully regulating air flow. When removing pistons, proceed with extreme caution and always keep the fingers of the hand holding the brake caliper away from the piston.

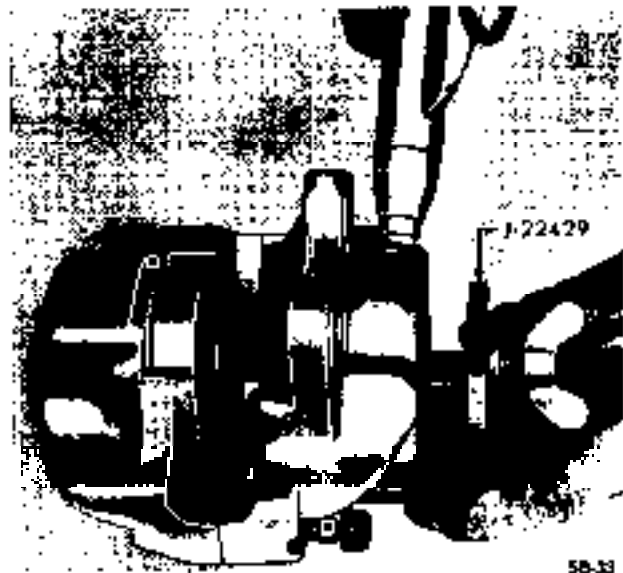


Figure 5B-33 Removing Caliper Rim Half Piston



Figure 5B-34 Removing Caliper Mounting Half Piston

4. Pry rubber fluid seals out of the annular grooves in the caliper half bores. See Figure 5B-35.

5. Check all parts of the brake caliper for wear. If the caliper half bores are scored or rusted, use a new complete brake caliper and friction pads. Small, light rust spots in the caliper half bores or on the pistons can be removed with fine emery cloth. If pistons are damaged, even though the caliper half bores are in

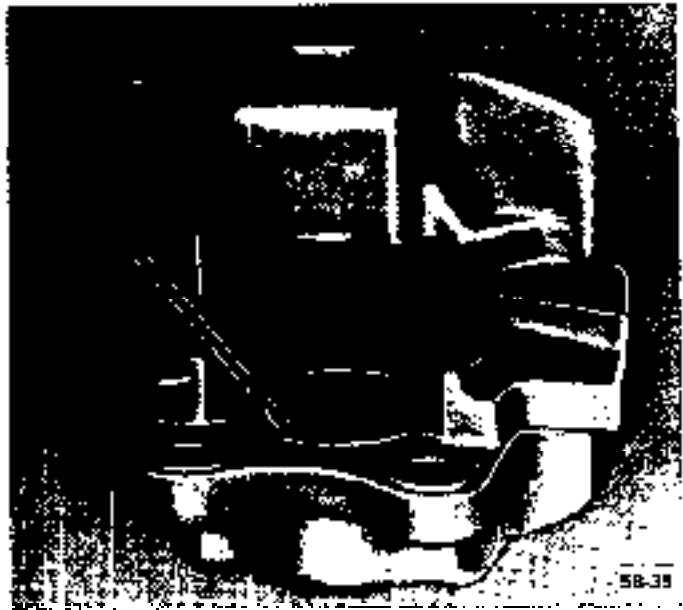


Figure 5B-35 Removing Rubber Fluid Seal From Caliper Bore

good condition, the piston must be replaced. The rubber fluid seals and rubber seals with clamp rings for the pistons are to be replaced every time repair work is carried out on the brake caliper.

6. Thoroughly clean all reusable parts - complete brake caliper and pistons - with denatured alcohol and dry with compressed air. Prior to cleaning, screw bleeder valve out of caliper.

7. Lightly coat new rubber fluid seals with brake fluid and insert fluid seals into grooves of brake caliper bores.

8. Place brake caliper into vise to install pistons. After installing one piston, change position of brake caliper in vise to install second piston. The piston to friction pad spacer plates should be used as a gauge to locate relieved edge of piston at 20 degrees to horizontal during piston installation. See Steps 9-10-11-12.

9. Place caliper mounting half in vise and coat its bore and piston lightly with brake fluid. Then push piston, with hollow end towards brake disc, into the caliper bore. Turn piston so that the relieved edge faces downwards at an angle of 20 degrees and facing in brake disc direction. The guide surface in the caliper half recess at the brake pipe connection side, will properly align the piston. Push piston into caliper bore up to the stop.

10. Change position of brake caliper and install second piston in the same manner.

11. Install new rubber seals with clamp rings. Make sure that the rubber seals are properly seated on the

caliper half collars and the clamp rings are correctly positioned on rubber seals.

12. Install brake caliper on steering knuckle, torquing bolts to 72 lb.ft.

**CAUTION:** *This disc brake caliper attachments fastener is an important attaching part in that it could affect the performance of vital components and systems, and/or could result in major repair expense. It must be replaced with one of the same part number*

*or with an equivalent part, if replacement becomes necessary. Do not use a replacement part of lesser quality or substitute design. Torque values must be used as specified during reassembly to assure proper retention of this part.*

13. Attach brake pipe to caliper and torque to 22 lb.ft.

14. Bleed brakes as necessary.

**SPECIFICATIONS**

DISC BRAKE SPECIFICATIONS

General Specifications

Disc Brake Type . . . . .	2 Piston Fixed Caliper	Disc
Location .....	Front Wheels Only	
Disc Type .....	Solid Cast Iron	
<b>Disc Diameter</b> .....		9.370
Disc Lateral Runout (Maximum) .....		.004
Disc Thickness (New) .....		.430
Disc Thickness (Minimum) .....		.394
Disc Parallelism (Thickness Tolerance) .....		.0006
Brake Shoe and Lining Type .....	Bonded	
Brake Shoe and Lining Thickness (New) .....		.550
Brake Shoe and Lining Minimum Thickness Before Replacement .....		.280
Disc Brake Master Cylinder Bore .....		.810
Disc Brake Caliper Cylinder Bore • GT .....		1.770
Disc Brake Caliper Cylinder Bore Opel 1900 and Manta .....		1.890
Disc Brake Shoe Adjustment .....	Self-Adjusting	

Torque Specifications

Use a reliable torque wrench to tighten the parts listed, to insure proper tightness without straining or distorting parts. These specifications are for clean and lightly-lubricated threads only; dry or dirty threads produce increased friction which prevents accurate measurement of tightness.

	Name	Torque Lb.Ft.
Bolt	Brake Caliper to Steering Knuckle	72
Bolt	Brake Disc to Wheel Hub	36
Bolt	Brake Disc Shield to Steering Knuckle and Steering Arm .	47
Nut	Brake Pipe to Caliper .....	22



# DRUM BRAKES

## CONTENTS

Subject	Page No.
<b>DESCRIPTION AND OPERATION:</b>	
Description of Brake Mechanism .....	5C-22
Operation of Hydraulic Service Brake .....	5C-24
<b>DIAGNOSIS:</b>	
Brake Trouble Diagnosis .....	5C-26
<b>MAINTENANCE AND ADJUSTMENTS:</b>	
Brake Adjustment .....	5C-27
Filling, Bleeding and Flushing Brake Hydraulic System .....	5C-27
<b>MAJOR REPAIR:</b>	
Replace or Reline Brake Shoes .....	5C-28
Inspecting and Reconditioning Brake Drums .....	5C-30
Brake Wheel Cylinder Overhaul .....	5C-30
Replacing Brake Pipes .....	5C-31
<b>SPECIFICATIONS:</b>	
Brake Specifications .....	5C-31

## DESCRIPTION AND OPERATION - DRUM BRAKES

### DESCRIPTION OF BRAKE MECHANISM

#### Wheel Brake Assemblies

Each rear wheel **brake** assembly uses two brake shoes which are actuated by a single wheel brake cylinder. The center of the brake shoes are held against the backing plate by a hold down pin, spring and retainer. The bottom of the shoes pivot in a support plate, and the top of the shoes rest directly on the wheel brake cylinder push rods. The brake shoes are connected by upper and lower return springs which pull the **shoes** back to resting position after application. See Figure 5C-40.

Two adjusting eccentrics at each wheel provide **individual** adjustment for each brake shoe to obtain clearance with the brake drum. An arrow on the brake **backing plate circumference** shows direction in which eccentrics must be turned to make adjustment.

A hydraulic wheel cylinder is mounted on the **back-**

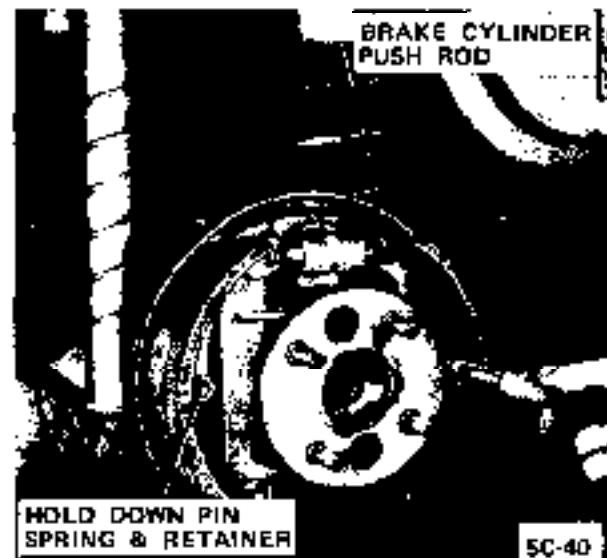


Figure 5C-40 Rear Wheel Brake

ing plate between the upper ends of the brake shoes and forces the shoes against the drum when pressure is applied on the brake pedal. A lever mounted on each rear shoe is used for applying parking brakes.

Parking Brake Control System

The hand-operated parking brake lever is mounted between the front seats on the propeller shaft tunnel. A pawl is riveted into the parking brake lever and is actuated by a control rod provided with a spring loaded push button. When the parking brake is applied, the parking brake lever is locked by the pawl which engages the teeth on a stop plate. The parking brake is disengaged by pressing the spring loaded push button. See Figure 5C-41.

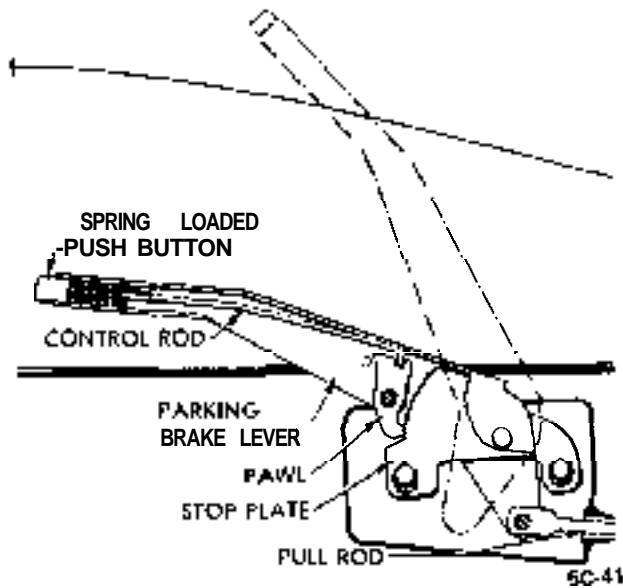


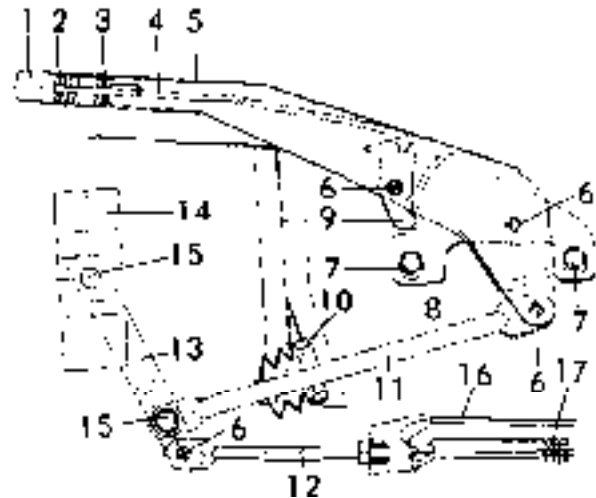
Figure 5C-4 1 Parking Brake Lever (Opel 1900 and Manta)

The GT arrangement of the parking brake is, with the exception of the additional transmittal lever at the floor panel, identical with that of the Opel models. The transmittal lever is attached to the propshaft tunnel by means of a mounting support. See Figure 5C-42.

The parking brake lever is connected with the front parking brake pull rod. By means of an equalizer, the front pull rod is connected to the forward portion of a center cable. The center cable is routed rearward through retaining guides and attaches at either end to the lower end of a parking brake lever. See Figure 5C-43. The parking brake levers and struts actuate the rear wheel brakes.

Service Brake Control System •  
Standard Brakes

The service brake control system is a pedal operated hydraulic system which applies the brakes at all four wheels with equal pedal pressure. The hydraulic system consists of a master cylinder (and attached transparent fluid reservoir) connected by pipes and



1. PUSH BUTTON
2. THRUST SPRING
3. WASHER
4. PAWL CONTROL ROD
5. PARKING BRAKE LEVER
6. RIVET
7. HEX. HEAD BOLT
8. TOOTHED SEGMENT
9. PAWL WITH TWO TEETH
10. RUBBER CAP
11. THRUST ROD
12. PULL ROD
13. TRANSMITTAL LEVER
14. MOUNTING SUPPORT
15. BOLT
16. PARKING BRAKE CABLE
17. RETURN SPRING

Figure 5C-42 Parking Brake Lever (GT)

flexible hoses to a wheel cylinder mounted between the brake shoes at each rear wheel.

A mechanically-operated stop light switch is mounted on a bracket just forward of the brake pedal on the GT and just rearward of the brake pedal on the Opel 1900 and Manta. With brake pedal released, the switch plunger is fully depressed against the switch actuating lever. See Figures 5C-45 and 5C-46. Any time the stop light switch fails, the stop lights will stay on at all times.

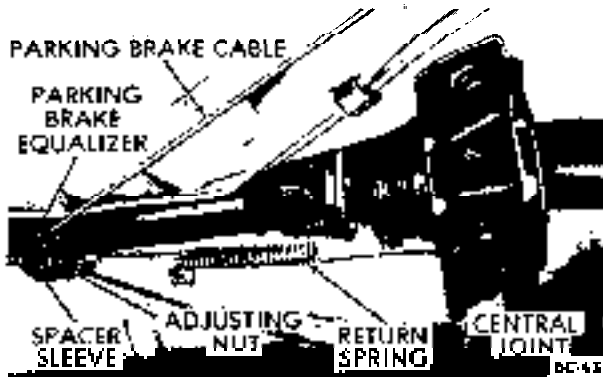


Figure 5C-43 Parking Brake Equalizer (Opel 1900 and Manta)



Figure 5C-44 Parking Brake Equalizer (GT)

The brake pedal on the GT is suspended from a pivot shaft. The pivot shaft inserts through the support bracket which is mounted on the cowl. The pedal is stopped in "off" position by the thrust rod coming in contact with the support plate on the cowl. The thrust rod (master cylinder push rod) connects directly into the brake pedal providing no pedal height adjustment. See Figure 5C-45.

**OPERATION OF HYDRAULIC SERVICE BRAKE**

A dual master cylinder, equipped with one (1) static pressure valve • for rear brake circuit • and used along with a power booster, is used on all models.

Each rear wheel cylinder contains two pistons and two rubber cups which are held in contact with the pistons by a central coil spring. The wheel cylinder



Figure 5C-45 Brake and Clutch Pedal Arrangement • GT

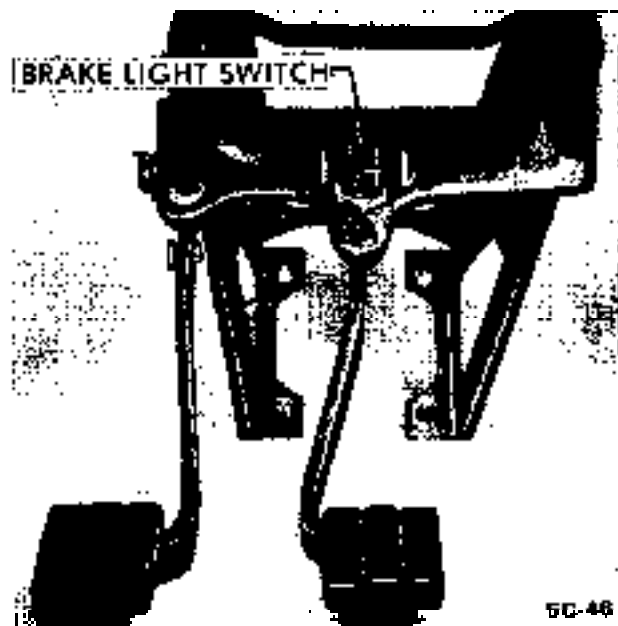


Figure 5C-46 Brake Light Switch • Opel 1900 and Manta

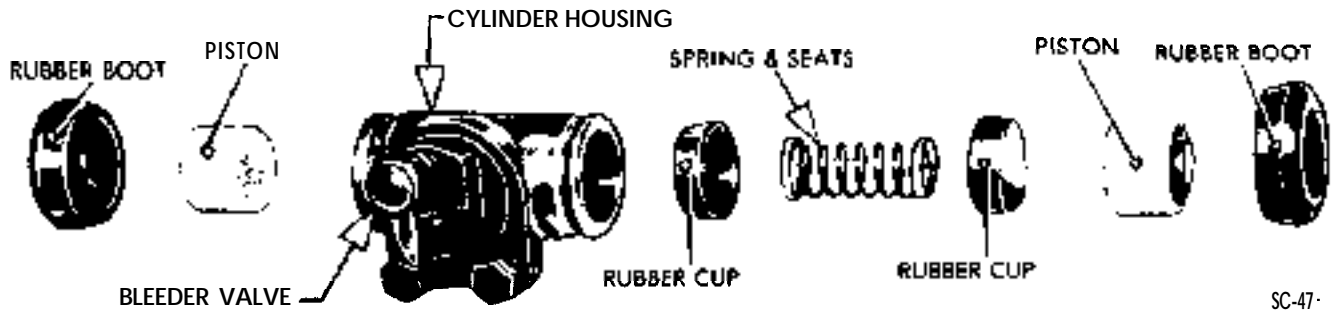


Figure 5C-47 Wheel Cylinder Exploded View

cups are of a special heat resisting rubber. The inlet port for brake fluid is located between the pistons so that when fluid pressure is applied, both pistons move outward in the wheel cylinders. The pistons impart movement to the brake shoes of the rear wheel brakes by bearing directly

against the ends of the shoes. Rubber boots enclose both ends of the cylinder to exclude foreign matter. A valve for bleeding brake pipes and wheel cylinder is located in the back of the cylinder casting and extends through the brake backing plate assembly. See Figure 5C-47.

**DIAGNOSIS**  
**BRAKE TROUBLE DIAGNOSIS CHART**

CAUSE	SYMPTOM												
	EXCESSIVE BRAKE PEDAL TRAVEL	EXCESSIVE BRAKE PEDAL EFFORT	EXCESSIVE BRAKE PEDAL TRAVEL GRADUALLY INCREASES	EXCESSIVE BRAKE PEDAL TRAVEL	EXCESSIVE BRAKE PEDAL EFFORT	EXCESSIVE BRAKE PEDAL TRAVEL GRADUALLY INCREASES	EXCESSIVE BRAKE PEDAL TRAVEL	EXCESSIVE BRAKE PEDAL EFFORT	EXCESSIVE BRAKE PEDAL TRAVEL GRADUALLY INCREASES	EXCESSIVE BRAKE PEDAL TRAVEL	EXCESSIVE BRAKE PEDAL EFFORT	EXCESSIVE BRAKE PEDAL TRAVEL GRADUALLY INCREASES	EXCESSIVE BRAKE PEDAL TRAVEL
LEAKING BRAKE LINE OR CONNECTION	x	xx											xx
LEAKING WHEEL CYLINDER OR PISTON SEAL	x	xx			x				x				x
LEAKING MASTER CYLINDER	x	xx											x
AIR IN BRAKE SYSTEM		xx								x			xx
CONTAMINATED OR IMPROVED BRAKE FLUID						x	x	x					x
LEAKING VACUUM SYSTEM					xx	x							
RESTRICTED AIR PASSAGE IN POWER HEAD					x	xx	x						
DAMAGED POWER HEAD					x	x	x	x	x				
WORN OUT BRAKE LINING - REPLACE					x	x				x	x	x	x
UNEVEN BRAKE LINING WEAR - REPLACE AND ADJUST	x				x					x	x	x	xx
GLAZED BRAKE LINING - SAND LIGHTLY					xx					x	x		y
INCORRECT LINING MATERIAL - REPLACE					x	x				x	x		x
CONTAMINATED BRAKE LINING - REPLACE						yx				xx	xx	x	x
LININGS DAMAGED BY ABUSIVE USE - REPLACE					x	xx				x	x	x	x
EXCESSIVE BRAKE LINING DUST - REMOVE WITH AIR					x	xx				xx	xx	x	yy
HEAT CRACKS OR SCORING BRAKE DRUMS OR ROTORS						x				x	x		xx
OUT-OF-ROUND OR V BRATTING BRAKE DRUMS												x	xx
OUT-OF-PARALLEL BRAKE HORNERS													xx
EXCESSIVE ROTOR RUN OUT													x
INCORRECT WHEEL CYLINDER SIZE					x	x				x	x		
WEAK OR INCORRECT BRAKE SHOE RETURN SPRINGS						x		x	xx	x	x	xx	x
BRAKE ASSEMBLY ATTACHMENTS - MISSING OR LOOSE	x									x	x	x	x
INSUFFICIENT BRAKE SHOE GUIDE LUBRICANT										x	x	x	xx
RESTRICTED BRAKE FLUID PASSAGE OR STICKING WHEEL CYLINDER PISTON			x	x		x	x			x	x		
BRAKE PEDAL LINKAGE INTERFERENCE ON RISING						y	xx	xx					
IMPROPERLY ADJUSTED PARKING BRAKE										x			
DRUMS TAPERED OR THREADED													xx
INCORRECT FRONT END ALIGNMENT													xx
INCORRECT TIRE PRESSURE										x	x		
INCORRECT WHEEL BEARING ADJUSTMENT	x											x	x
LOOSE FRONT SUSPENSION ATTACHMENTS										x	xx		x
OUT-OF-BALANCE WHEEL ASSEMBLIES													xx
OPERATOR RIDING BRAKE PEDAL	x	x	x							x	x		x
STICKING WHEEL CYLINDER OR CALIPER PISTONS										x	x	y	x

xx INDICATES MORE PROBABLE CAUSES; x INDICATED CAUSES

Figure 5C-48 Brake Trouble Diagnosis Chart

## MAINTENANCE AND ADJUSTMENTS

### BRAKE ADJUSTMENT

#### Preliminary Checks

1. Depress brake pedal firmly. If pedal travels to within two inches of toeboard and has a hard feel, brake shoes require adjustment or relining. However, if pedal has a spongy feel, brake system needs bleeding.
2. Remove one rear drum if lining is worn nearly to rivets. Reline both rear brakes (drum brakes only).
3. Check fluid level in master cylinder reservoir and add fluid if necessary.
4. Fully release parking brake lever and place transmission in neutral.
5. Pull on both ends of rear brake cable a number of times to make sure that cables operate rear brake shoes freely and do not bind in conduits. Check for free movement of cable in brake cable sheave and check brake cable spring for tension. Replace a weak or broken cable spring.

#### Pedal Height Adjustment

Brake pedal height can be adjusted by first removing the nut and lock tab from the brake pedal to clevis attaching bolt and then by turning the head of the bolt and rotating the eccentric until there is approximately 1/4 of an inch play in the brake pedal. See Figures 5C-49 and 5C-50. Replace lock tap and nut. If one of the tabs on lock tap breaks replace lock tab.

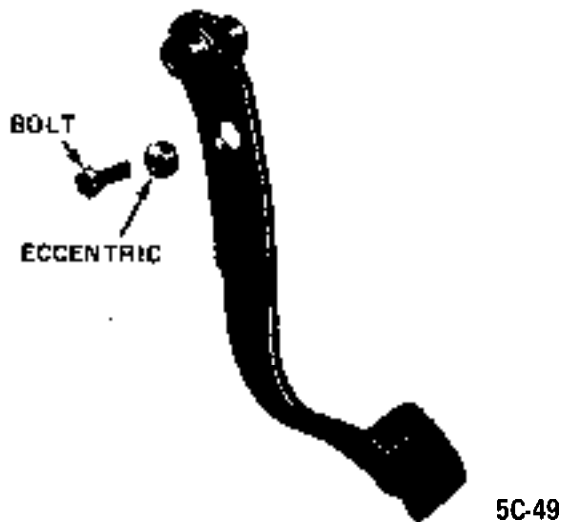


Figure 5C-49 Brake Pedal Attaching Bolt and Eccentric

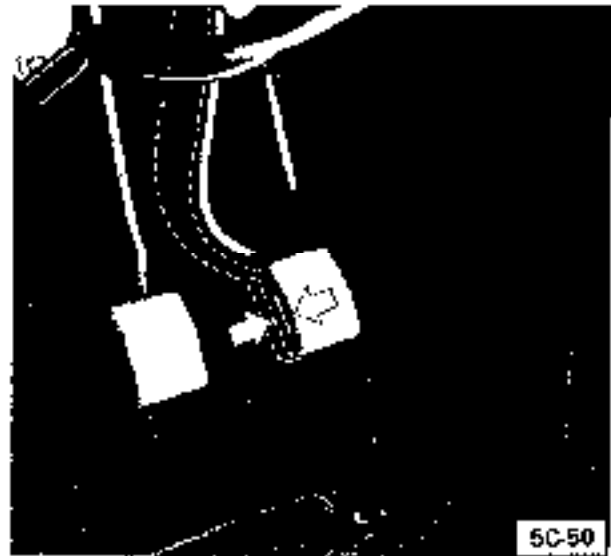


Figure 5C-50 Brake Pedal Height Adjustment

If binding does occur, take pedal assembly apart and clean. Check for broken parts. Lubricate and replace.

#### Adjustment at Wheels

At each rear wheel brake assembly there are two (2) brake shoes, and **each** brake shoe has an individual adjustment eccentric. Therefore, each shoe must be adjusted separately by turning its adjustment **eccentric** which is mounted on the brake backing plate. Arrows on backing plate circumference show direction in which eccentrics should be turned to get brake shoe-to-drum contact. See Figure X-51.

*When adjusting front brake shoe of rear brakes, turn wheel forward. When adjusting rear brake shoe of rear wheel brakes, turn wheel rearward. Adjust as follows:*

1. Raise car and support in a safe manner so that all wheels clear ground. Prior to wheel brake adjustment, check that all brake drums rotate freely.
2. Revolve drum in forward direction and turn front brake shoe eccentric in direction of arrow until brake shoe contacts brake drum. See Figure 5C-49, then turn eccentric in opposite direction until brake drum is **just free to turn**. Adjust rear brake shoe in the same way **but** revolve brake drum in backward direction.
3. Remove car jacking and support equipment, and road test car for brake performance.

Disc brakes do not require adjustment.

#### Parking Brake Adjustment

Adjustment of parking brake cable is necessary whenever the rear brake cables have been

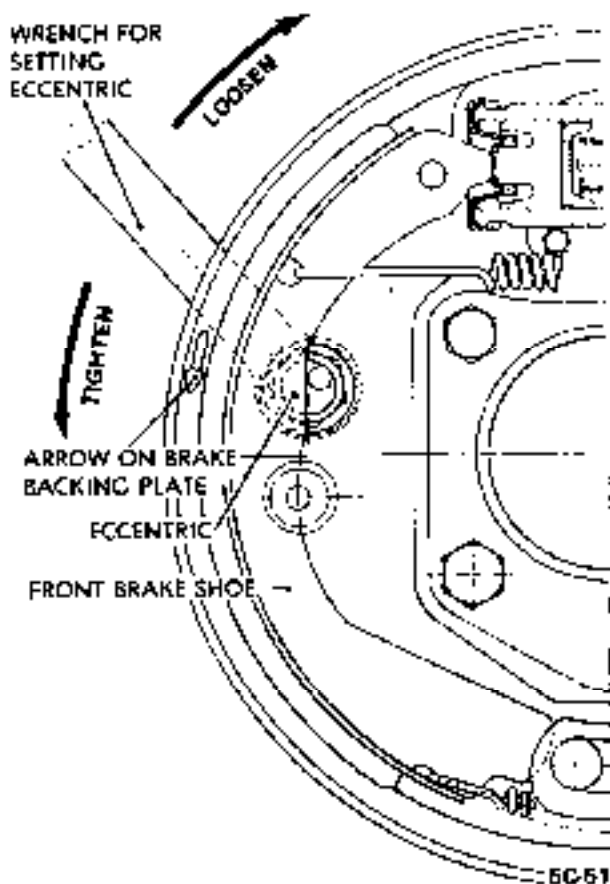


Figure 5C-51 Rear Wheel Brake Adjustment

disconnected, or when cables have been stretched through extended use. Need for parking brake adjustment is indicated if the service brake operates with good reserve, but the parking brake handle can **be** engaged, more than eight ratchet clicks under heavy pressure.

After making certain that service brakes are in good adjustment, adjust parking brake mechanism as follows:

1. Fully release parking brake lever; check parking brake cable for free movement.
2. Loosen equalizer nut or adjusting nut, depending upon whether tension is to be increased or decreased on cable.
3. Pull parking brake lever up by three (3) clicks. In this position, adjust equalizer with adjusting and lock nuts so that rear brakes just begin to bind. Take care that rear brake action is equal on both rear wheels. In case of unequal brake action, apply lubricant to equalizer and brake cable.
4. After adjustment, tighten lock nut. Be certain that equalizer is in horizontal position. Check operation of parking brake. If parking brake adjustment does

not result in proper brake action, inspect linings on both rear wheels for possible replacement.

### Filling Brake Master Cylinder

#### Reservoir

The master cylinder reservoir must be kept properly filled to insure adequate reserve and to prevent air from entering the hydraulic system. However, because of expansion due to heat absorbed from **brakes** and from engine, master cylinder must not be overfilled.

The plastic brake fluid reservoir is attached to the master cylinder which is located under the **hood** on the left side of the cowl.

Thoroughly clean reservoir cover before removal to avoid getting dirt into reservoir. Remove cover and add fluid as required to bring level up to "MAX." marked on reservoir.

Use Delco Supreme No. 11 Hydraulic Brake Fluid or equivalent.

Do not use shock **absorber** fluid or any other fluid which contains mineral oil. Do not use a container which has been used for mineral oil. Even a trace of mineral oil will cause swelling and distortion of rubber parts in the hydraulic brake system.

### Bleeding Brake Hydraulic System

A bleeding operation is necessary to remove air whenever it is introduced into the hydraulic brake **system**. Since air is compressible and hydraulic fluid is not, the presence of air in the system is indicated by a springy, spongy feeling of the brake pedal accompanied by poor braking action.

Air will be introduced into the hydraulic system if the brake pedal is operated when the fluid is too low in master cylinder reservoir. Air will also enter the system whenever any part of hydraulic system is disconnected.

It will be necessary to bleed both hydraulic systems if air has been introduced through low fluid level or by disconnecting brake pipes at master cylinder. If brake pipe is disconnected at any wheel cylinder, then that wheel cylinder only need be bled. If pipes are disconnected at any fitting located between master cylinder and wheel cylinders, then the wheel cylinder(s) served by the disconnected pipe must be bled.

### Sequence for Bleeding Wheel Cylinders or Calipers

It is advisable to bleed one wheel cylinder or caliper

at a time to avoid getting fluid level in reservoir dangerously low. The correct sequence for bleeding is bleed the wheel cylinder or caliper nearest the master cylinder first in either circuit.

Do not perform bleeding operation while any brake drum is removed.

#### Bleeding Wheel Cylinder or Caliper

1. Check fluid level, in reservoir and refill, if necessary. Level must be brought up to "MAX" mark on plastic reservoir.
2. Clean all dirt from around respective bleeder valve, and then remove cap.
3. Push bleeder hose over bleeder valve, placing other end of hose in a glass jar. Bleeder hose should always be used to avoid getting fluid on linings.
4. Hold pressure on brake pedal and crack open the bleeder valve to allow air **(and,or)** brake fluid to flow out of the system. Allow pedal to travel to the floor. Close bleeder valve. Release pedal and repeat this procedure at each wheel cylinder in the circuit until all air is removed. Frequently check reservoir fluid level. Allowing fluid to be emptied will draw air into the system.
5. Remove bleeder hose and install cap.
6. When bleeding operation is completed, make sure that fluid level is brought up to "MAX" marking on reservoir, then install cover.
7. Discard the brake fluid deposited in glass jar during bleeding operation.

#### Flushing Brake Hydraulic System

It is recommended that both brake system circuits be thoroughly flushed whenever the master cylinder is replaced or if there is any doubt as to the grade of fluid in the system.

Flushing of the brake system is performed in the same manner as the bleeding operation except that fluid is forced through the lines and wheel cylinder until it emerges clear in color. Approximately one half pint of brake fluid is required to flush the hydraulic system thoroughly.

When flushing is completed, make certain the master cylinder reservoir is filled to the proper level.

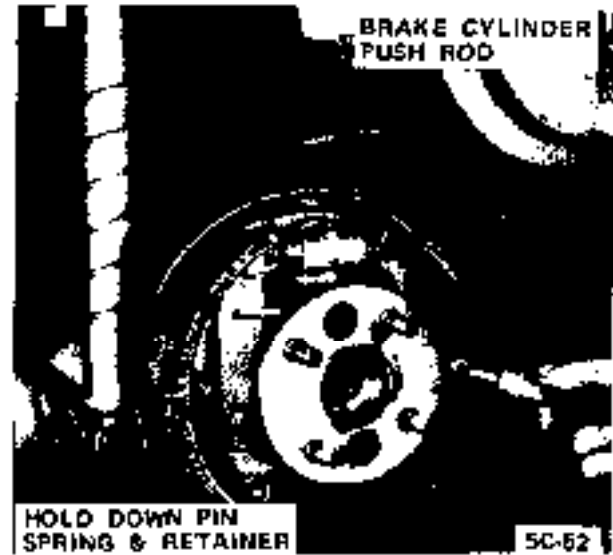


Figure 5C-52 Rear Drum Brake Assembly

## MAJOR REPAIR

### REPLACE OR RELINE BRAKE SHOES (DRUM BRAKES)

#### Removal and Inspection

1. Jack up car in safe manner and support adequately.
2. Remove wheel and drum assembly.
3. Remove upper and lower brake shoe return springs.
4. Remove retaining pins and springs, as shown in Figure 5C-52.
5. Clean all dirt out of brake drum. Inspect drums and replace or recondition if required.
6. Blow all dirt from brake assemblies and inspect for any unusual condition.
7. Carefully pull lower edges of wheel cylinder boots away from cylinders and note whether interior is wet with brake fluid. Fluid at this point indicates leakage past piston cup, requiring overhaul or replacement of wheel cylinder.
8. Inspect all brake pipe and hose connections for evidence of fluid leakage. Tighten any leaking connection, then apply heavy pressure to brake pedal and recheck connections.
9. Inspect backing plate for oil leak past rear wheel bearing oil seals. Correct any leak by installation of new seals.



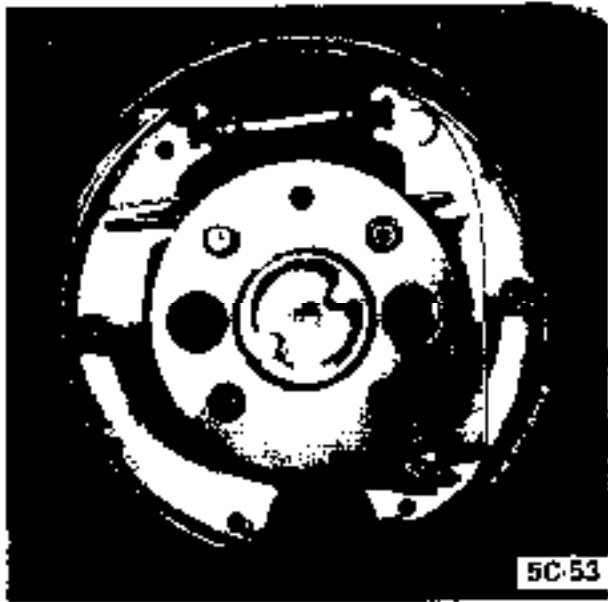


Figure 5C-53 Rear Brake Assembly

10. Check all backing plate attaching bolts to make sure they are tight. Using fine emery cloth, clean all rust and dirt from shoe contact surfaces on plate. See Figure 5C-53.

#### Relining Brake Shoes

If old brake shoes are to be relined, inspect shoes for distortion and for looseness between the rim and web; these are causes for discarding any shoe. If shoes are serviceable, be governed by the following points in installing new linings:

1. Remove old rivets by drilling them out. Punching out rivets will cause distortion of shoe rim. Care

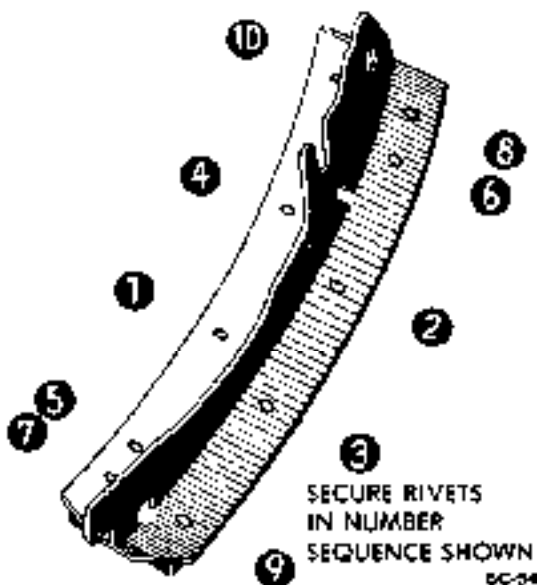


Figure 5C-54 Brake Lining Riveting Sequence

must also be taken to support shoes properly while drilling.

2. Thoroughly clean brake shoes and remove all burrs around rivet holes.

3. Use Opel brake lining or equivalent. Install in place and rivet in sequence shown in Figure 5C-54. Keep hands clean while handling brake lining. Do not permit oil or grease to come in contact with lining.

#### Installation and Adjustment

1. If any hydraulic connections were disturbed, bleed hydraulic system. If new parts were installed in brake system, flushing of hydraulic system is recommended.

2. Adjust rear wheel brakes.

3. Adjust parking brake.

4. Check fluid level in master cylinder and add fluid if necessary.

5. Check brake pedal for proper feel and for proper return.

6. Remove jacks and road test car for proper brake action. Brakes must not be severely applied immediately after installation of new brake shoes or linings. Severe application may permanently injure new linings and may score brake drums. When linings are new, they must be given moderate use for several days until burnished.

#### INSPECTING AND RECONDITIONING BRAKE DRUMS

Whenever brake drums are removed, they should be thoroughly cleaned and inspected for cracks, scores, deep grooves, and out-of-round. Any of these conditions must be corrected since they can impair the efficiency of brake operation and also can cause premature failure of other parts.

##### Cracked, Scored or Grooved Drum

A cracked drum is unsafe for further service and must be replaced. Welding a cracked drum is not recommended.

Smooth up any slight scores by polishing with fine emery cloth. Heavy or extensive scoring will cause excessive brake lining wear and it will be necessary to rebore in order to true up the braking surface.

If the brake linings are slightly worn and drum is grooved, the drum should be rebored just enough to

remove grooves, and the ridges in the lining should be lightly removed with a lining grinder.

If brake linings are more than half worn, but do not need replacement, the drum should be polished with fine emery cloth but should not be rebored. At this stage, eliminating the grooves in drum and smoothing the ridges on lining would necessitate removal of too much metal and lining, while if left alone, the grooves and ridges match and satisfactory service can be obtained.

If brake linings are to be replaced, a grooved drum should be rebored for use with oversize linings. A grooved drum, if used with new lining, will not only wear the lining but will make it **difficult**, if not impossible, to obtain **efficient** brake performance.

### Out-of-Round Drum

An out-of-round drum makes accurate brake shoe adjustment impossible and is likely to cause excessive wear of other parts of brake mechanism due to its eccentric action. An out-of-round drum can also cause brake pulsation. Maximum permissible drum runout is .004". A drum that has more run-out than **this** should be rebored. **Runout** can be accurately checked by using an inside micrometer fitted with proper extension rods.

When measuring a drum for run-out, take measurements at open and closed edges of machined surface and at right angles to each other.

### Turning Brake Drums

If a brake drum is to be turned, enough metal should be removed to obtain a true, smooth braking surface. Measure brake drum diameter; standard drum inner diameter is 9.060". Drums may be turned to an over-size of .030". If maximum inner diameter after turning exceeds 9.090", brake drum will have to be replaced. Removal of more metal will affect dissipation of heat and may cause distortion of the drum.

1. Remove rear wheels and drums.
2. Mount brake drum on brake drum lathe and turn drums as necessary, within limits.
3. After turning, check drum diameter. Inner diameter not to exceed 9.090.
4. A newly-bored drum should always have center contact with brake shoes. For this reason, arc grind linings to .010" under drum radius, or to .020" under drum diameter.
5. Clean and install drums and wheels.

### BRAKE WHEEL CYLINDER OVERHAUL

1. Remove wheel, drum, and brake shoes. Be careful not to get grease or dirt on brake lining.
2. Disconnect brake pipe or hose from wheel cylinder and cover opening with tape to prevent entrance of dirt. Remove wheel cylinder from backing plate.
3. Remove boots, pistons, cups, and spring from cylinder. Remove bleeder valve.
4. Discard rubber boots and piston cups. Thoroughly clean all other parts with hydraulic brake fluid or **Declene**. Do not use anti-freeze, alcohol, gasoline, kerosene, or any other cleaning fluid that might contain even a trace of mineral oil.
5. Inspect pistons and cylinder bore for scores, scratches, or corrosion. Light scratches may be polished with crocus cloth. Do not use emery cloth or sandpaper. **Slight corrosion** may **be cleaned with** fine steel wool. If scratches or corroded spots are too deep to be polished satisfactorily, the cylinder should be replaced since honing is not recommended.
6. Dip internal parts in brake fluid and reassembly wheel cylinder. When installing piston cups, use care to avoid damaging the edges.
7. If the rear wheel backing plate is removed: Always install new paper gaskets one on each side • on the backing plate. Prior to installation, lightly coat paper gaskets with chassis lubricant. Torque backing plate to rear axle housing bolts to 43 **lb.ft.** and wheel brake cylinder to backing plate bolts to 5 **lb.ft.** Install wheel cylinder on brake backing plate and connect brake pipe or hose.
8. Install brake shoes, drum, and wheel, then flush and bleed hydraulic system.
9. Adjust brakes, then road test car for brake performance.

**CAUTION:** *This brake backing plate to rear axle fastener is an important attaching part in that it could affect the performance of vital components and systems, and/or could result in major repair expense. It must be replaced with one of the same part number or with an equivalent part, if replacement becomes necessary. Do not use a replacement part of lesser quality or substitute design. Torque values must be used as specified during reassembly to assure proper retention of this part.*

### REPLACING BRAKE PIPES

Any brake pipe assembly which is needed must be made up from service bulk tubing and fittings. All brake pipes must be made of tin or copper coated wrapped steel tubing with the ends double lap flared.

Never use copper tubing because copper is subject to fatigue cracking which would result in brake failure.

To make up a brake pipe assembly, proceed as follows:

1. Procure the recommended tubing and fittings of the correct size. (Outside diameter of tubing is used to specify size.)

2. Cut tubing to length. The correct length may be determined by measuring the old pipe using a cord and adding 1/8" for each double lap flare.

3. Double lap flare tubing ends, using a suitable flaring tool such as J-8051. Follow the instructions included in the tool set. Make sure fittings are installed before starting second flare.

4. Bend pipe assembly to match old pipe.

## SPECIFICATIONS

### BRAKE SPECIFICATIONS

#### Torque Specifications

Use a reliable torque wrench to tighten the parts listed to insure proper tightness without straining or distorting parts. These specifications are for clean and lightly-lubricated threads only; dry or dirty threads produce increased friction which prevents accurate measurement of tightness.

Part	Name	Torque Lb.Ft.
Nut	Brake Hose to Front Wheel Brake Cylinder	22
Bolt	Brake Backing Plate to Steering Knuckle (Upper Bolts)	22
Bolt	Brake Backing Plate to Steering Knuckle and Steering Arm (Lower Bolts)	47
Bolt	Backing Plate to Rear Axle Housing	43
Nut	Master Cylinder Actuator Rod to Brake Pedal	5
Bolt	Wheel Brake Cylinder to Brake Backing Plate	5

#### General Specifications

Operating Mechanism, Service Brakes	Hydraulic
Parking Brakes	Lever and Cables
Operation of Service Brakes Independent of Parking Brakes	Yes
Wheel Brakes, Service	Front and Rear
Parking	Rear Only
Brake Pedal Height Adjustment	None
Static Pressure in Hydraulic System When Brakes are Released - Drum Brakes	4 psi Min.
Static Pressure in Hydraulic System to Rear Brakes Only - Disc Brakes	4 psi Min.
Brake Master Cylinder (for Drum Brakes) Bore	13/16
Wheel Cylinder Size - Rear - All	5/8
Approved Hydraulic Brake Fluid	GM or Delco Supreme No. 11
Fluid Level in Reservoir	Fill to "Max." Level
Brake Drum Rebore, Maximum Allowable Inside Diameter	9.090
Max. Allowable Out-of-Round	.004
Rear Brake Drum Size. New	9.060

---

**GROUP 6**

**ENGINE**

Section	Title	Page No.
<b>6A</b>	Engine Mechanical and Mounts All Models	6A- 2
<b>6B</b>	Cooling System All Models .....	6B-32
<b>6C</b>	Fuel System All Models .....	6C-36
<b>6D</b>	Exhaust Systems All Models .....	6D-42
<b>6E</b>	Carburetor And Throttle Linkage .....	6E-44
<b>6F</b>	Emission Control Systems - All Models .....	6F-60
<b>6G</b>	Tune-Up All Models .....	6G-65

# ENGINE

## CONTENTS

Subject	Page No.
<b>DESCRIPTION AND OPERATION:</b>	
Engine Construction .....	6A- 2
Lubrication System .....	6A- 4
<b>DIAGNOSIS:</b>	
Excessive Oil Consumption .....	6A- 6
Noisy Valves and Lifters .....	6A- 6
<b>MAINTENANCE AND ADJUSTMENTS:</b>	
Valve Lifter Adjustment .....	6A- 7
<b>MAJOR REPAIR:</b>	
Engine Removal and Installation .....	6A- 8
Engine Oil Pan Removal and Installation .....	6A-10
Manifold, Cylinder Head, Valve Train and Lifters .....	6A-12
Connecting Rod Bearings .....	6A-15
Crankshaft Bearings and Seals .....	6A-16
Piston, Rings and Connecting Rods .....	6A-19
Timing Chain Cover and Timing Chain .....	6A-23
Camshaft .....	6A-25
Oil Pump Cover and Gears .....	6A-26
<b>SPECIFICATIONS:</b>	
Bolt Torque Specifications .....	6A-27
General Specifications .....	6A-28
Engine Dimension and Fits .....	6A-29

### DESCRIPTION AND OPERATION

#### ENGINE CONSTRUCTION

##### Engine Usage

The 1.9 liter engine is standard equipment on all 1973 Opel 1900, Manta and GT models. This engine has a compression ratio of 7.6:1 and operates on "regular" low lead grade fuel.

##### Engine Construction

The *cylinder head* is made of high-grade chromium grey cast iron. The valve guides are cast *intergal* with the head. The overhead camshaft is supported in four bearings in the cylinder head.

Location of the valve seats in *combustion chamber* is above the center of cylinder bore. The spark plug is positioned in the center and near the highest point of combustion chamber. This arrangement provides for short flame travel, uniform combustion and **good** cold start prop&ties. **Exhaust valves have seat** inserts of highly heat and water resisting material. The head surface is aluemetized and so are the seats of the *inlet valves* Aluemetizing makes the valve heads non-scaling and promotes long life. All engines have "roto-caps".

The forged, **five** main bearing crankshaft has large-diameter main and connecting rod bearing journals with considerable overlap for vibration-free operation. **Tri-metal** bearing shells are used for main and connecting rod bearings. The crankshaft end play is controlled by the rear main bearing.

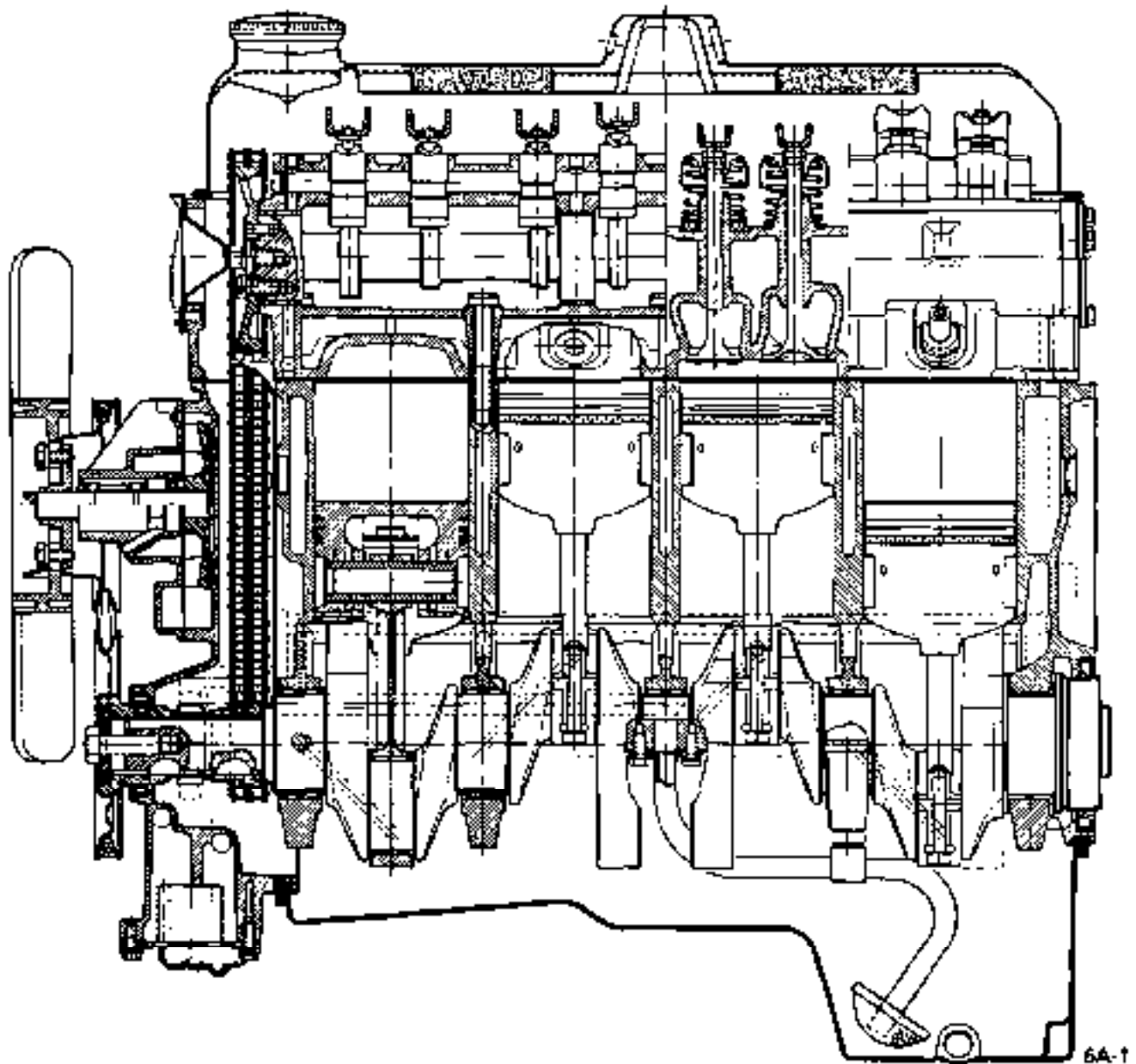


Figure 6A-1 Side Cross Section View of Engine

This engine has full skirt "Autothermic" type pistons with two horizontal slots in oil control ring groove, which partly separate head and skirt to maintain good contact with the cylinder walls throughout the entire temperature range.

The camshaft located in the cylinder head is an important design feature of the new power units. This arrangement permits an extremely rigid valve train which accounts for precise valve timing. The grey cast iron camshaft has induction hardened bearing journals and cams. Installation of camshaft is facilitated by each diameter of the four bearings and journals being slightly smaller than the preceding.

Camshaft end play is controlled at forward end by

the camshaft front bearing seat outer face in one direction, and by the front bearing cover in the other direction. A nylon bolt in camshaft forward end serves to adjust end clearance.

The camshaft is driven by an endless *Duplex roller* chain. The crankshaft double sprocket and pulley arc held by one key. The camshaft sprocket is fixed with a guide pin and attached with 3 bolts.

Inside the timing case, a long damper block is provided on the driving side of the chain and a shorter, curved spring plate tensioner on the non-driving side. Both have wear-resistant and oil-proof synthetic rubber slipper pads. The self adjusting chain tensioner located on driving side of chain at right

hand side above crankshaft sprocket, has a plunger head with oil-proof and wear-resistant synthetic rubber pad, which is pressed against chain by both spring and oil pressure.

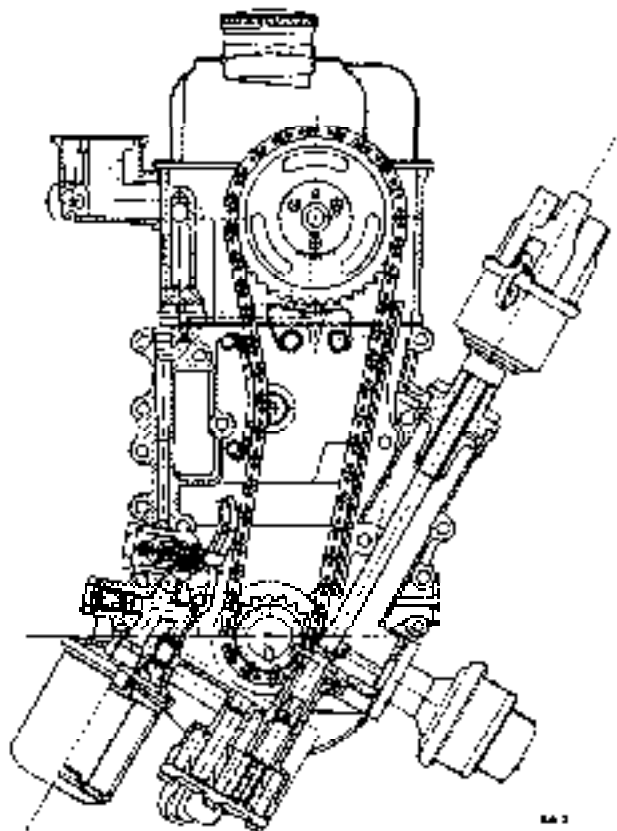


Figure 6A-2 Sectional View. Timing System

The top end of the short, light-weight *hydraulic valve lifters* is provided with a cup in which tits the ball end of a stud engaged in an elongated hole in rocker arm, thus maintaining transverse alignment of the rocker arm.

The *rocker arm* is a steel stamping and pivots on a ball secured by a self-locking nut on a stud screwed into the cylinder head. This arrangement permits easy valve clearance adjustment. All valves have oil seals installed between valve spring and cap.

The *fuel pump* is located at bottom left-hand side of timing case and operated by, a cam integral with distributor drive gear riveted to distributor drive shaft.

The aluminum alloy cast *intake manifold* with smooth walls provide better charge of cylinders, especially at high engine RPM. It is a four-port manifold, i.e. there are separating walls between all arms, one for each cylinder. An adapter for crank-case ventilation hose leading to rocker arm cover is arranged on front portion of intake manifold.

Hot exhaust gases are used for heating a vaporization plate located at bend of intake manifold below carburetor and communicating with its tinned underside with the interior of the exhaust manifold to ensure that only vaporized fuel reaches the cylinders.

#### LUBRICATION SYSTEM AND OIL PUMP

The engine is lubricated by a forced feed system

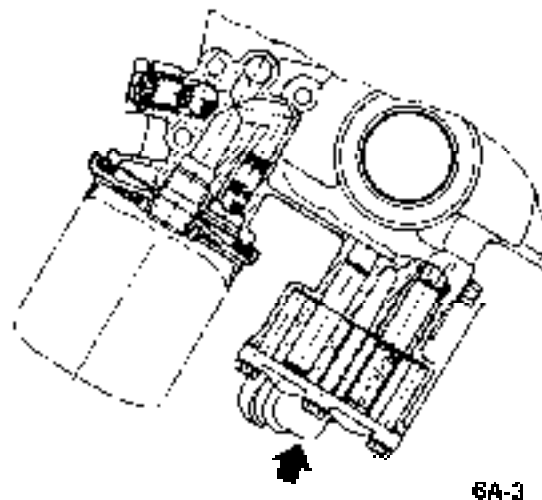


Figure 6A-3 Oil Pump Pressure Relief Valve

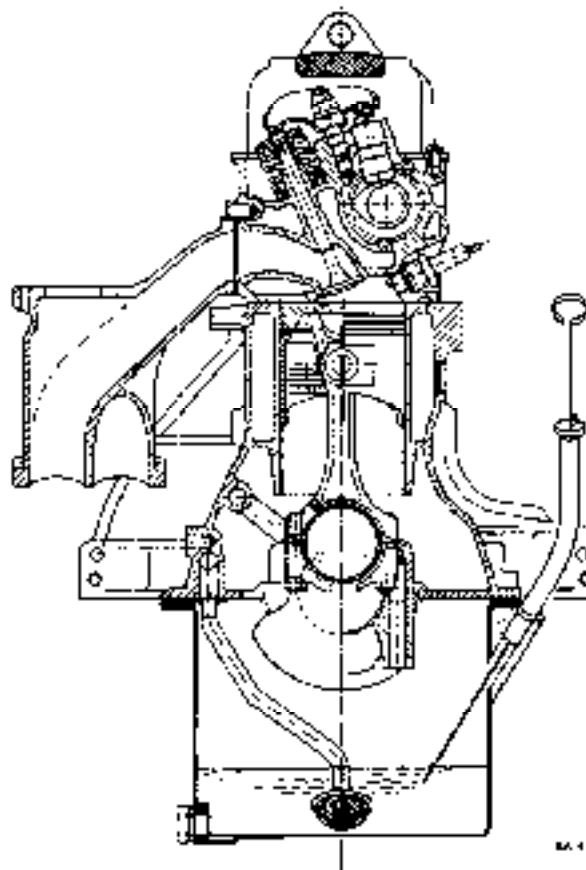


Figure 6A-4 Rear Cross Sectional View

incorporating a gear-type pump driven by the distributor shaft. The pump body forms part of the timing case. A passage cast in cylinder block and a suction pipe connect the pump to the screen cover assembly in the sump of the oil pan.

The oil pump pressure relief valve is located in the engine oil pump cover. See Figure 6A-3. The pressure relief valve serves to feed surplus oil back into the suction passage should the required oil pressure be exceeded. The old oil pressure relief valve which is located above the oil filter is inoperative. A heavier spring has been installed to keep the valve seated at all times.

The oil filter is of the full flow type. With it in parallel is a by-pass system controlled by a valve in the timing chain cover above the oil filter which ensures oil circulation directly to lubrication points if element becomes clogged by dirt or oil is too thick to pass through. Only when oil flow through element is unrestricted the by-pass valve will close and filtered oil is fed to the engine.

Oil flow through the engine is as follows: The oil pump draws oil from the sump through the screen

and pumps it through drilled passages in timing case to the full flow filter. From there it passes to the cylinder block main oil gallery with a branch in timing case to no. 1 camshaft bearing. Drilled passages lead from the oil gallery to crankshaft main bearings and in the crankshaft from main bearings to connecting rod bearings. The camshaft front journal has a crescent shaped groove which controls the oil supply to cylinder head oil gallery. The cylinder head oil gallery delivers oil under pressure to all valve lifters, to Nos. 2, 3 and 4 camshaft bearings, and to rocker arm seats. An additionally drilled passage connects the valve lifter circular groove with circular groove of rocker arm stud from where the oil is directed upwards through a drilled passage to the rocker arm seat. The cams are lubricated by oil under pressure.

Surplus oil collects at end of cylinder head and returns through a passage to the crankcase. A calibrated squirt hole in connecting rod big end bearing sprays oil against right-hand side of cylinder wall: Additional cylinder wall and piston pin lubrication is through oil splash from crankshaft. A jet in timing case projects oil against oil pump drive, and the timing chain receives lubrication from above the chain tensioner.

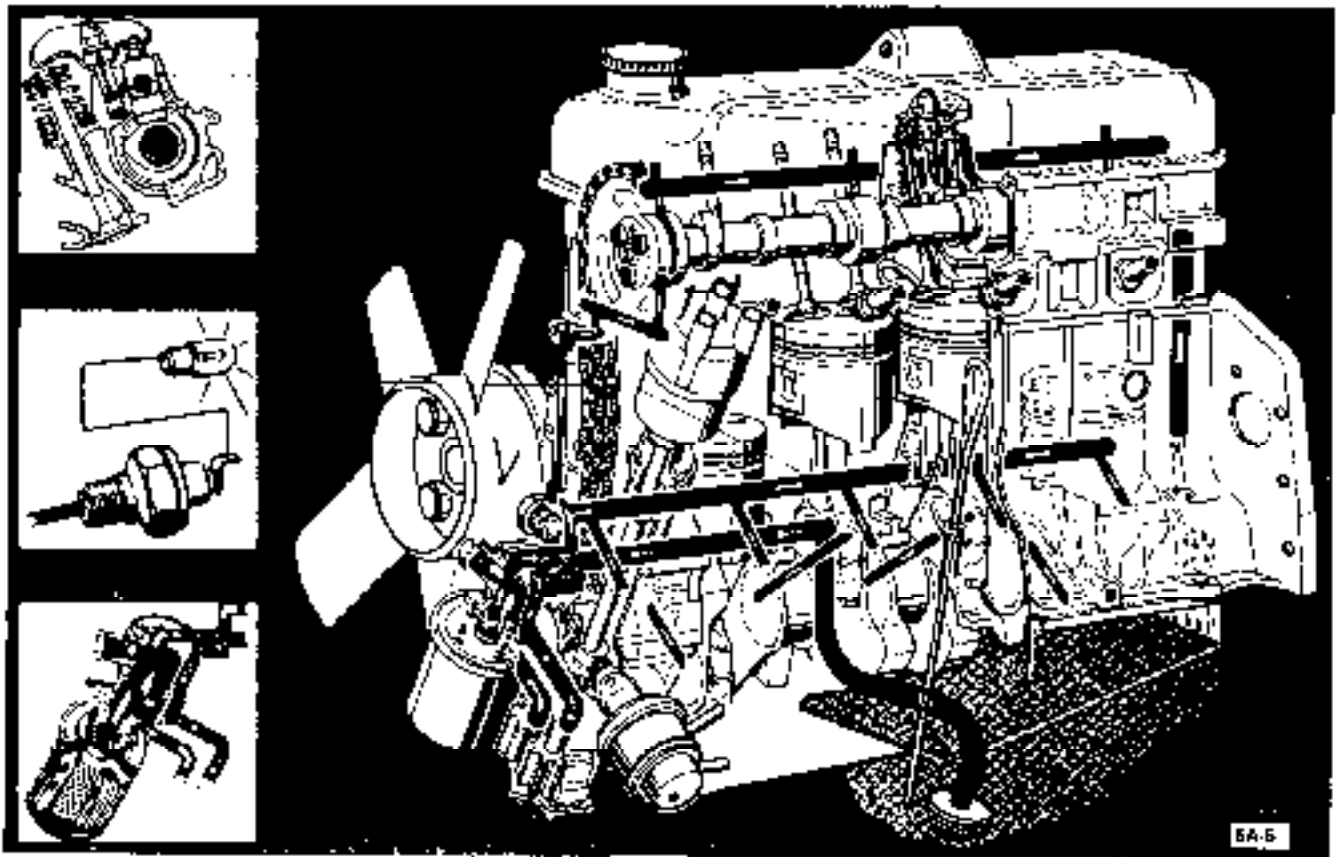


Figure 6A-5 Engine Lubrication System



## DIAGNOSIS

### EXCESSIVE OIL CONSUMPTION

Condition	Correction
External Oil Leaks at: Rocker Arm Covers Crankcase Front Cover Oil Pan and Gasket	Tighten attaching bolts. If leaks persist, remove cover (or pan), check sealing surfaces for burrs or scoring, replace gasket, and seal bolts with <b>silastic</b> sealer or equivalent. Make sure oil level is not overfull.
Improper Reading of Dip-Stick	Car may not be level when taking <b>Insufficient</b> oil "drain-back" time after stopping engine (three minutes must be allowed). Dipstick may not be completely pushed down against stop. Dipstick may be bent.
Oil Viscosity Too Light	Use recommended SAE viscosity for prevailing temperatures.
Continuous High-Speed Driving	At speeds above 60 mph, increased consumption can be expected with any. Inform customer of this fact.
High-Speed Driving Following Normal Slow Speed City Driving	When principal use of automobile is city driving, crankcase dilution and condensation occurs. High speed and temperatures will remove water, resulting in what appears to be rapid lowering of oil level. Inform customer of this fact.
Piston Rings Not "Broken In"	Allow engine to accumulate at least <b>4,000</b> miles before attempting any engine disassembly to correct for oil consumption.

### NOISY VALVES AND LIFTERS

The noise level of the valve mechanism cannot be properly judged where the engine is below operating temperature when the hood is raised, or when the valve rocker arm covers are removed.

Before attempting to judge valve noise level, the engine must be thoroughly warmed up (at least 20 minutes of operation at 1200 to 1500 RPM) to **stabilize** oil and coolant temperatures and bring all engine parts to a normal state of expansion. When the engine is warmed up, listen for engine noise while **sitting** in the driver's seat with the hood closed. Run the engine at idle and at various higher speeds.

If the preceding check indicates valve mechanism is abnormally noisy, remove the rocker arm cover so that the various conditions that cause noise may be checked. A piece of heater hose of convenient length may be used to pick out the particular valves or valve linkages **that** are causing abnormal noise. With the engine running **at** a speed where the noise is pronounced; hold the **end** of hose to an ear and hold other end about 1/2 inch from point of contact **between** rocker arm and valve stem. Mark or record the noisy valves for investigation of following causes:

1. **Sticking, Warped, or Eccentric Valves, Worn Guides** Sticking valves will cause irregular engine operation or missing on a low speed pull and will usually cause intermittent noise.

Pour penetrating oil over the valve spring cap and allow it to drain down the valve stem. Apply pressure to the one side of the valve spring and then the other, and then rotate the valve spring about 1/2 turn. If these operations affect the valve noise, it may be assumed that valves should be reconditioned.

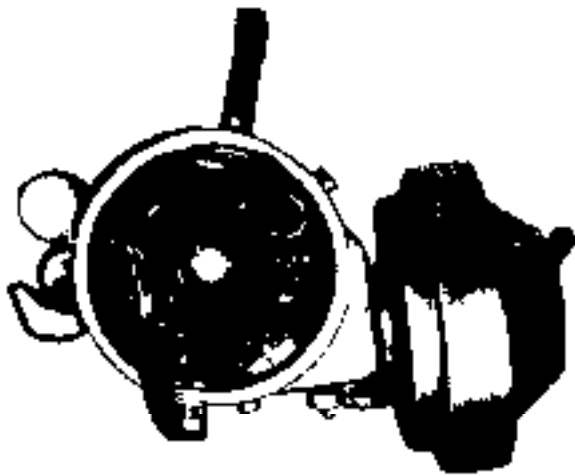
2. **Worn or Scored Parts in the Valve Train** Inspect rocker arms, push rod ends for scoring. Check push rods for bends, valve lifters, and camshaft surfaces for scoring. Replace faulty parts.

**MAINTENANCE AND ADJUSTMENTS**

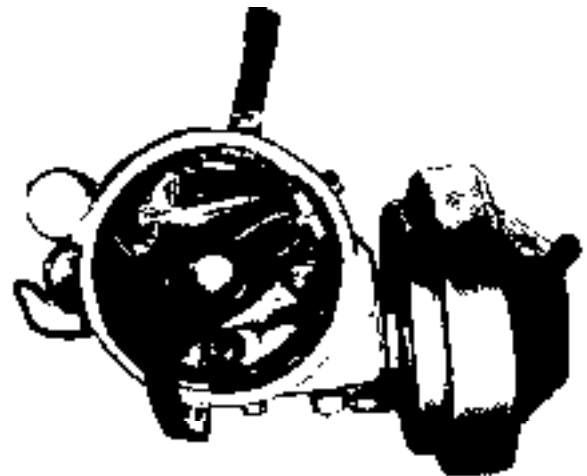
**VALVE LIFTER ADJUSTMENT**

Perform hydraulic valve lifter adjustment with the

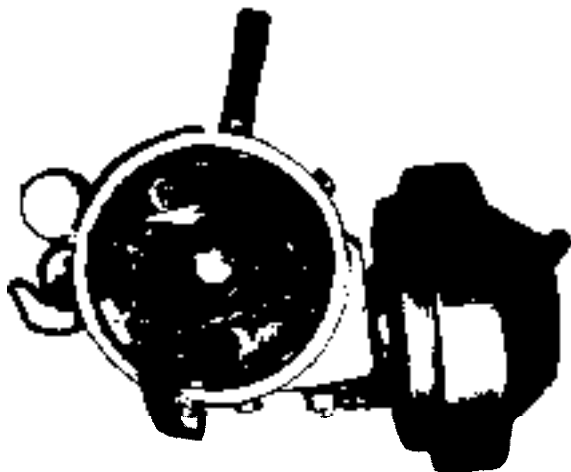
engine off. It makes no difference whether the engine is cold or is at operating temperature. Set piston of the respective cylinder to upper top center on the firing stroke. This can be accomplished by removing the distributor cap and observing the rotor. Check position of the rotor and follow spark path for the rotor tip through the distributor cap, high tension wire to spark plug. This determines which cylinder is at upper top center on the firing stroke. Adjust the hydraulic lifters of the two valves for that cylinder at this time. When they are adjusted, turn engine so that another cylinder is at upper top center on the firing stroke and adjust the two valve lifters for that cylinder. Repeat process until all valves are adjusted. See Figure 6A-6 for correct rotor position for each cylinder.



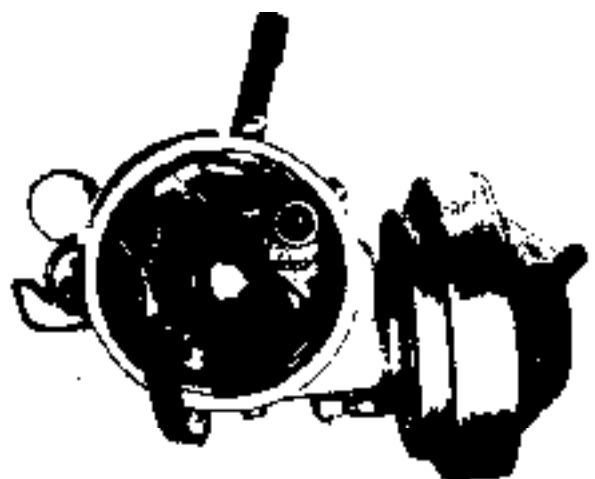
CORRECT ROTOR POSITION TO ADJUST VALVES ON CYLINDER NO. I



CORRECT ROTOR POSITION TO ADJUST VALVES ON CYLINDER NO. II



CORRECT ROTOR POSITION TO ADJUST VALVES ON CYLINDER NO. III



CORRECT ROTOR POSITION TO ADJUST VALVES ON CYLINDER NO. IV

Figure 6A-6 Rotor Positions for Valve Lifter Adjustment

Actual adjustment is made by backing off adjusting nut at the rocker arm until clearance exists between the valve stem, rocker arm, and lifter. Then slowly tighten adjusting nut until clearance is eliminated. When clearance is eliminated, turn adjusting nut one full turn (clockwise). This positions the hydraulic piston of the hydraulic lifter mid-point in its total available travel, and no further adjustment is required.

**MAJOR REPAIR**

**ENGINE ASSEMBLY REMOVAL AND INSTALLATION**

**Removal (Opel 1900 and Manta)**

The engine assembly on the Opel 1900 and Manta can be removed together with the transmission through the top of the engine compartment.

1. Remove hood (scribe hood hinge to hood mounting location).
2. Disconnect battery negative cable.
3. Drain coolant at lower radiator hose.
4. Remove upper and lower radiator hoses.
5. Remove radiator and fan shroud.
6. Disconnect heater hoses.
7. Disconnect brake booster vacuum hose.
8. Remove air cleaner.
9. Disconnect electrical connections and accelerator linkage.
10. Remove console.
11. Remove shift lever boot, plate, and shift lever.
12. Raise car on hoist.
13. Disconnect fuel line at pump.
14. Remove front stone shield.
15. Disconnect speedo-cable, back-up light switch, and clutch cable.
16. Remove drive shaft.
17. Disconnect exhaust pipe and bell housing support.
18. Disconnect transmission support. See Figure 6A-7.

19. Remove engine mount bolts. See Figure 6A-8.
20. Attach hoist chains.
21. Lift engine and transmission assembly out of car.

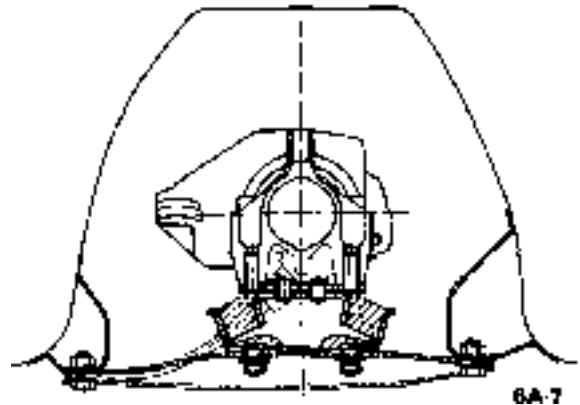


Figure 6A-7 Transmission Support Bolts - Opel 1900 and Manta Series



Figure 6A-8 Engine Mount Bolts - Opel 1900 and Manta Series

**Removal (GT)**

The removal and installation of the 1.9 liter engine is only possible towards the floor and from below respectively.

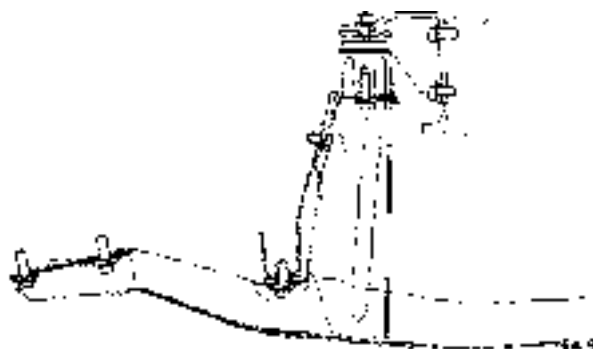


Fig. 6A-9 Left Front Engine Suspension with Cross Member (GT)

The engine **does not rest on** the front suspension cross member as in the Opel 1900 and Manta but on a separate cross member. On removal and installation of the engine the front suspension cross member need not be detached.

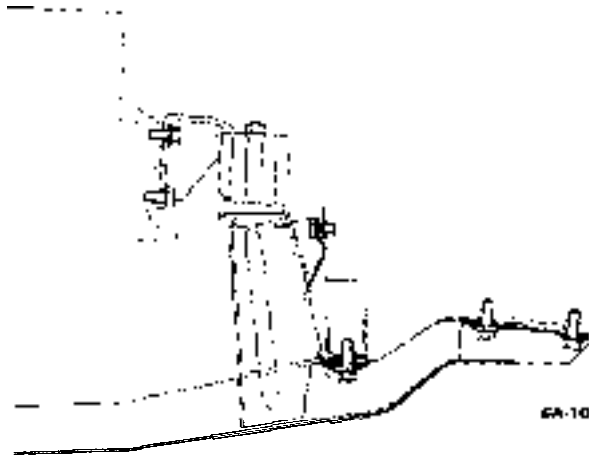


Fig. 6A-10 Right Front Engine Suspension with Cross Member (GT)

1. Disconnect battery negative cable,
2. Remove air cleaner.
3. Drain radiator coolant by disconnecting lower radiator hose. Disconnect upper radiator hose. See Figure 6A-11. Radiator need not be disconnected.
4. Disconnect all electrical connections:
  - a. Coil wire to distributor.
  - b. Wires from alternator. Remove unit and bracket.
  - c. Battery positive cable at starter switch.
  - d. Oil pressure switch wires at cylinder block.
  - e. Wires from starter solenoid.
5. Remove vacuum hoses at tee mounted to intake manifold. Remove tee from manifold to avoid interference during engine lowering.
6. Remove throttle linkage and carburetor.
7. Disconnect heater hoses.
8. Disconnect water valve bracket to manifold,
9. Remove gear shift lever.
10. Using suitable equipment lift up engine so that front engine mounts are somewhat relieved.



Figure 6A-11 Radiator Hose Clamp Location

11. Raise vehicle, both front and rear end. A two post axle type hoist is recommended for this operation.
12. Disconnect fuel line at fuel pump and plug. Be sure fuel line is disconnected from any engine and transmission clips.
13. Disconnect speedometer cable from transmission.
14. Disconnect clutch cable.
15. Disconnect drive shaft at rear universal joint and remove.
16. Disconnect exhaust at manifold.
17. Remove tailpipe and muffler hangers.
18. Remove ground strap from engine to side rail.
19. Detach transmission cross member from transmission and frame. See Figure 6A-12.
20. Detach engine cross member from engine and frame.
21. Carefully lower engine **and** transmission and remove from underneath vehicle.



Fig. 6A-12 Transmission Cross Member

**Installation (Opel 1900 and Manta)**

1. Lower engine and transmission assembly into car.
2. Install components as *removed* in steps 1 through 19 above.

**Installation (GT)**

1. Install bell housing, transmission and starter.
2. Using suitable equipment raise assembly into vehicle.
3. Install components as removed in steps 1 thru 21.

**ENGINE OIL PAN REMOVAL AND INSTALLATION**

**Removal (Opel 1900 and Manta)**

To remove the engine oil pan, a device similar to the one illustrated in Figure 6A-14 can be made and used to support the front of the engine. This particular device was made up using hardwood, bolts, and chain.

1. Assemble chains to engine.

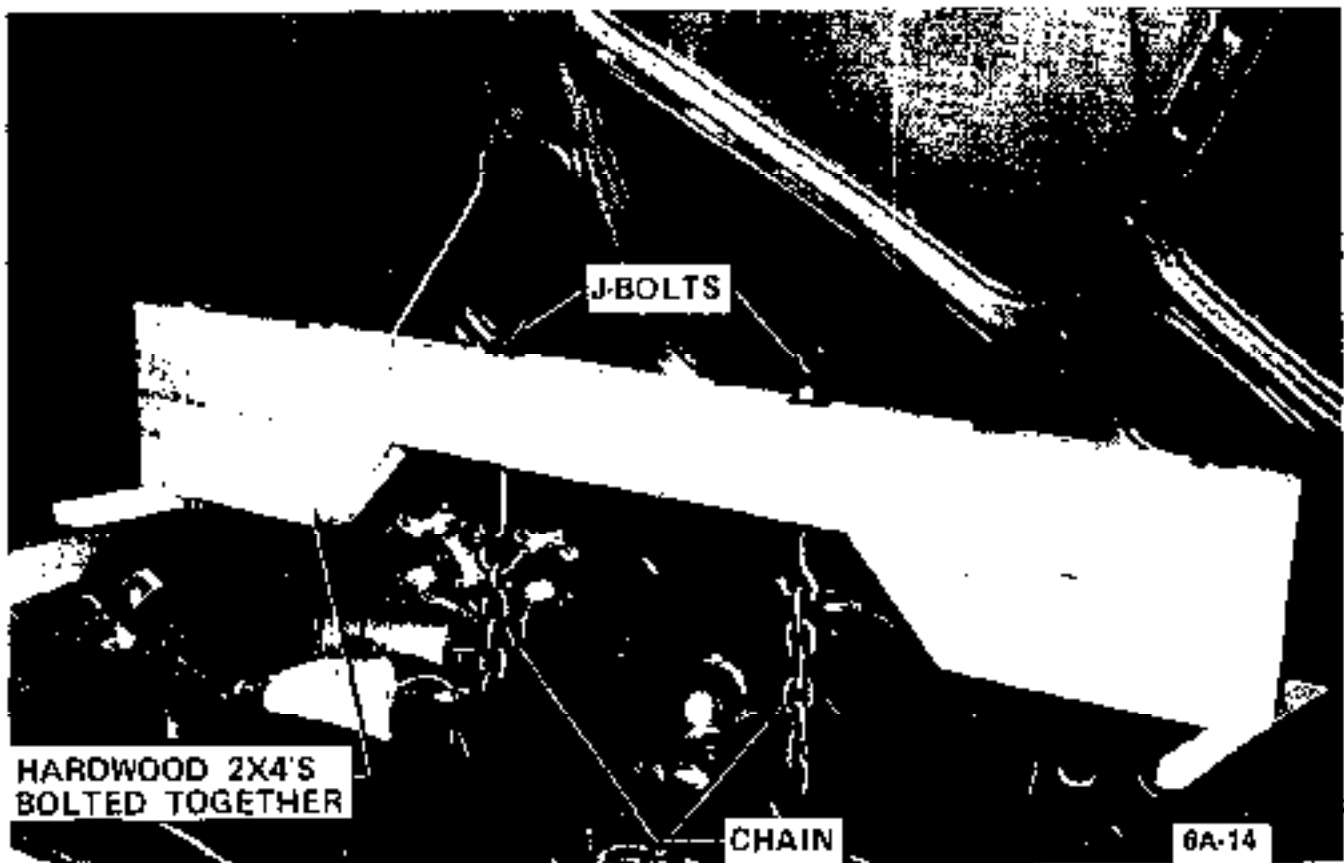


Figure 6A-14 Engine Support Tool - Opel 1900 and Manta.

- a. Attach left chain to alternator support rear bolt.
- b. Bolt right chain to existing threaded hole at lower right front of engine.

2. Assemble loose ends of chain to support device J-bolts and adjust to remove engine weight from motor mounts.

3. Remove the two motor mount bracket to motor mount retaining nuts.

4. Remove the two front suspension to frame rail bolt retaining nuts.

5. Remove nut and bolt at lower end of steering shaft U-joint.

6. With a floor jack under the center of the front suspension cross member, raise car high enough for wheels and suspension assembly to be rolled from under car.

7. Position jack stands under both front jack brackets on underbody to support car in this position.

8. Remove both front cross member support to frame attaching bolts.

9. Remove brake pipe to brake hose retaining clips at frame rails and disconnect brake hose from brake pipes. Use an absorbent material or suitable container for the brake fluid that will drain out.

10. Lower the front suspension assembly and remove from under car.

11. Drain engine oil and remove oil pan and gasket.

#### Installation (Opel 1900 and Manta)

1. Apply a light bead of sealer to the clean sealing surfaces of the oil pan and affix a new gasket.

2. Bolt oil pan and gasket assembly to engine block.

3. Roll front suspension and floor jack under car and raise into position careful to pilot the cross member to frame rail attaching bolts and steering shaft to their respective locations.

4. Install cross member support to frame attaching bolts and torque to 22 lb.ft.

5. Connect brake hose to brake pipes and install retaining clips.

6. Bleed front brake system. Maintain brake fluid level.

7. Remove jack stands and lower car.

8. Install suspension to frame rail bolt retaining nuts.

9. Release and remove engine supporting device.

10. Install motor mount bracket to motor mount retaining nuts.

11. Install steering shaft U-joint lower bolt and nut.

12. Replace engine oil.

#### Removal (GT Series)

1. Support engine in vehicle using Tool J-23375. See Figure 6A- 15.



Figure 6A-15 Engine Holding Fixture

Install tool by removing upper engine mount nut and installing fixture. Replace nut and tighten. The engine will now be supported by the tool, between the frame rails. The front suspension need not be removed on GT Models.

2. Drain oil.

3. Remove oil pan bolts and remove oil.

#### Installation (GT Series)

1. Replace oil pan and bolts.

2. Remove engine holding fixture and replace engine mounts.

3. Replace engine oil.

## INTAKE AND EXHAUST MANIFOLD REMOVAL AND INSTALLATION

### Removal

1. Disconnect battery.
2. Remove air cleaner.
3. Disconnect throttle linkage at carburetor.
4. Disconnect vacuum advance line at carburetor.
5. Remove fuel line at carburetor inlet.
6. Remove positive crankcase ventilation hose at rocker arm cover.
7. Disconnect E.G.R. lines from carburetor and intake manifold.
8. Disconnect exhaust pipe.
9. Remove six bolts attaching manifold assembly to cylinder head and remove manifold and carburetor as an assembly. Discard manifold gasket.

To separate intake and exhaust, manifold, remove carburetor and four bolts using Tool J-23016, attaching intake manifold to exhaust manifold. Always install a new manifold intermediate gasket when the manifolds are separated.

### Installation

1. Install new manifold **gasket** and place manifold in position.
2. Install manifold bolts. New manifold to cylinder head gasket must be installed whenever a manifold is removed.
3. When installing the manifold, start with the No. 1 and No. 2 bolts. See Figure 6A-16. Gradually tighten both bolts until snug. Then continue with the rest of the bolts in the sequence illustrated in Figure 6A-16. Torque bolts to 33 lb. ft.



Figure 6A-16 Manifold Bolt Tightening Sequence

4. Connect parts removed in Steps 1 thru 8 above.

## CYLINDER HEAD REMOVAL AND INSTALLATION

### Removal

1. Drain coolant from radiator and block. Loosen drain plug on right side of engine to avoid coolant entering into **cylinder bores**. Drain plug is located on the right rear of cylinder block above oil pressure switch.
2. Remove hoses from thermostat housing. Collect coolant as it contains anti-freeze.
3. Remove 6 intake and exhaust manifold attaching bolts and swing assembly aside.
4. Remove spark plug wires from plugs.
5. Remove bracket bolt holding spark plug wires away from cylinder head.
6. Remove rocker arm cover.
7. Remove 10 cylinder head bolts using 12 MM serrated drive J-22915, and 2 cylinder head to timing chain cover bolts with a 6MM hex head wrench. See Figure 6A-17.

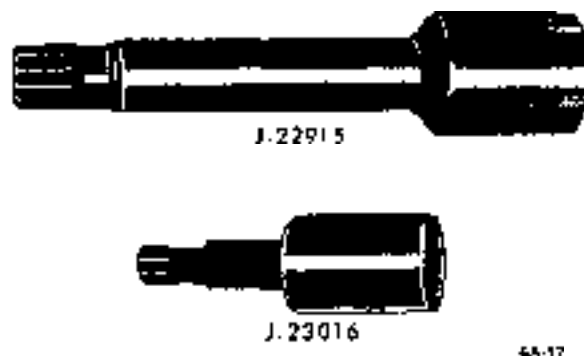


Figure 6A-17 Serrated Bits

8. Remove three bolts attaching plate to front of cylinder head.
9. Remove plastic screw from end of camshaft.
10. Remove 3 bolts attaching camshaft sprocket to cylinder head. Slide sprocket off of camshaft and remove head. Place head on bench supported at each end by a block of wood to prevent damage to valves.

### Installation

1. Install in reverse procedure to removal, paying particular attention to the following:

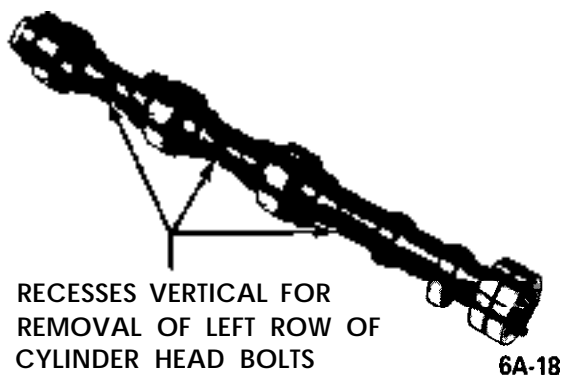
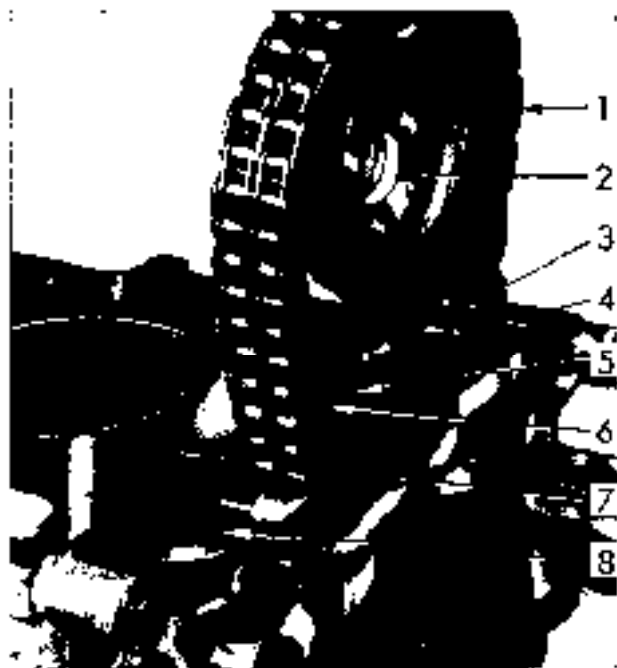


Figure 6A-18 Recesses in Camshaft

2. Clean piston tops and combustion chambers. Thoroughly clean all gasket surfaces on the cylinder block and cylinder head.

3. Lightly lubricate cylinder walls with engine oil. Install coolant passage rubber gasket ring in timing case. See Figure 6A-19.



1. TIMING CHAIN
2. CAMSHAFT SPROCKET
3. SPROCKET TIMING MARK
4. TIMING CASE
5. SUPPORT TIMING MARK
6. SUPPORT
7. CYLINDER BLOCK
8. RUBBER GASKET RING

6A-19

Figure 6A-19 Coolant Passage Rubber Gasket Ring in Timing Case

4. Apply silastic sealer or equivalent to both sides of the cylinder head gasket where the gasket mates with the timing chain cover, place new cylinder head gasket onto cylinder block.

5. Install cylinder head. Be careful to place head squarely over guide pins.

Rotate camshaft so that recesses are in vertical position to allow installation of left row of bolts.

6. Install 10 head bolts. Tighten the bolts a little at a time in the sequence shown in Figure 6A-20. Give bolts a final torque in the same sequence. Torque to 72 lb. ft. (cylinder head cold). Use same procedure for cylinder head to timing chain cover bolts with final torque at 17 lb.ft. See Figure 6A-20. These torques apply to lightly oiled threads.

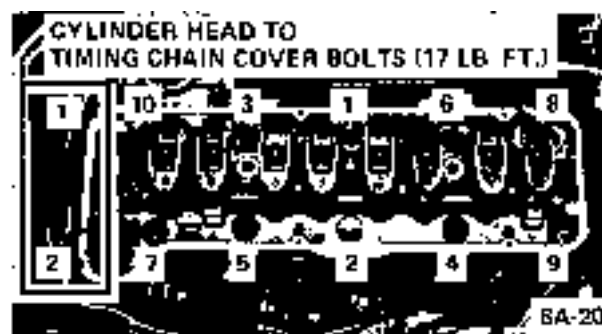


Figure 6A-20 Cylinder Head Bolt Tightening sequence

7. Slide camshaft sprocket with assembled chain onto camshaft and guide pin and fasten with bolts. Install nylon adjusting screw. After sprocket has been attached to camshaft, recheck alignment to see that chain has not slipped. Close front access hole.

8. Check camshaft end clearance between cover and nylon screw with feeler gauge. Clearance should be .004" - .008" Excess clearance can be eliminated by carefully readjusting cover with a suitable drift.

#### Reconditioning Valves and Guides

1. Remove cylinder head. Place on clean surface. Place head on bench supported at each end by a block of wood to prevent damage to valves.

2. Using suitable spring compressor, such as J-8062, compress valve spring and remove cap retainers. Release tool and remove spring and cap. See Figure 6A-21.

3. Remove valves. Place valves in numerical order so that they can be reinstalled in original location.

4. Remove all carbon from combustion chambers, piston heads, and valves. When using scrapers or



wire brushes for removing carbon, avoid scratching valve seats and valve faces. A soft wire brush such as J-8089 is suitable for this purpose.

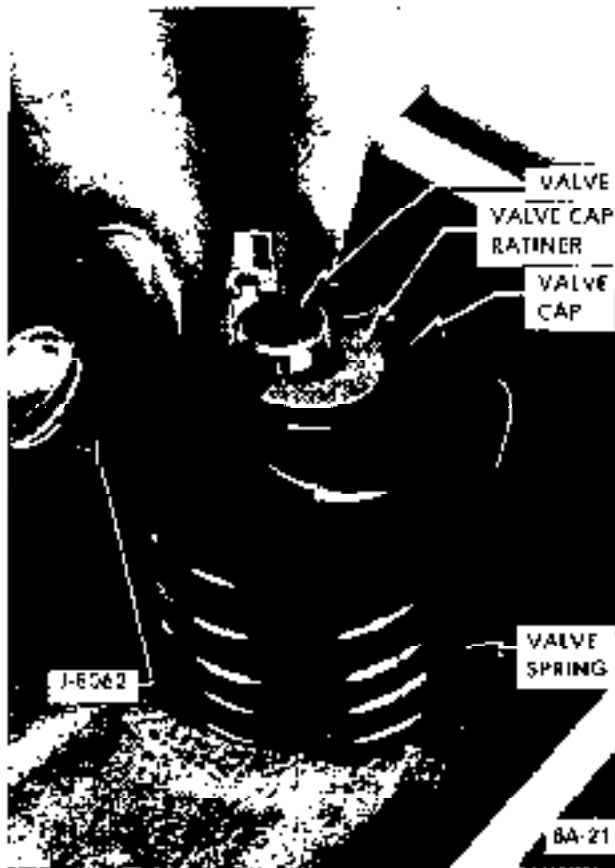


Figure 6A-21 Removing Valve Cap Retainers

5. Clean carbon and gum deposits from valve guide bores.

6. Inspect valve faces and seats for pits, burned spots or other evidences of poor seating. If a valve head must be ground until the outer edge is sharp in order to true up the face, discard the valve because the sharp edge will run too hot.

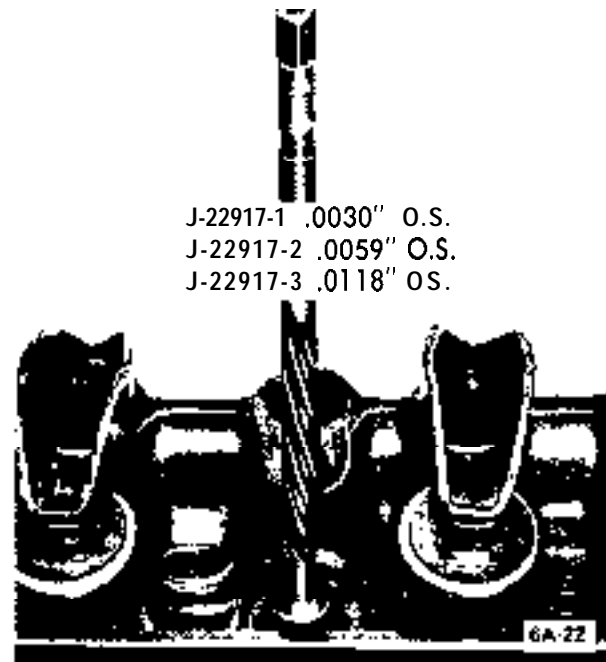


Figure 6A-22 Reaming Valve Guide

SIZE IN.		VALVE GUIDE DIA. IN	CORRESPONDING VALVE STEM DIA.		OVERSIZE MARK
			INTAKE VALVE IN.	EXHAUST VALVE IN.	
PRODUCTION	STANDARD	.3553 - .3562	.3538 - .3543	.3524 - .3528	-
PRODUCTION AND SERVICE	OVERSIZE .0030	.3582 - .3592	.3567 - .3572	.3553 - .3559	1
	OVERSIZE .0059	.3615 - .3622	.3597 - .3602	.3583 - .3588	2
SERVICE	OVERSIZE .0118	.3671 - .3681	.3656 - .3661	.3642 - .3647	A

Figure 6A-23 Valve Guides and Corresponding Valves

***New inlet valves must not be refaced or lapped with grinding compound. The correct angle for the intake and exhaust valve head is 44 degrees.***

7. Inspect valve guides. Worn or pitted guides can be reamed to accept valves with oversize stems. Oversize valves are occasionally used in production. Oversize valves are marked "1", "2" or "A" and are stamped into the valve stem end and also stamped near spark plug hole. See Figure 6A-22.

8. Reseat valve seats in cylinder head in the following sequence:

#### **Intake**

With 45 degrees cutter, remove burnt structure until a metallic bright seat is obtained. Lightly coat valve head with red lead, insert it into guide and turn it under light pressure several times back and forth. Thereby a contact pattern is obtained and the seat width can be measured. If valve does not seat perfectly all around, lightly recut valve seat to the established seat width of .049" - .059" with 30 degrees correction cutter.

#### **Exhaust**

The directions for reconditioning intake valve seats apply in principle also to exhaust valve seat reconditioning with the exception that the valve seat width should be .063-.073 in. and different cutters are employed.

**NOTE: : Use new valve seals whenever valves are reconditioned.**

9. Lube valves with engine oil and reinstall valves, valve springs, caps and cap retainers using J-8062. Install valve spring with closely wound coils toward cylinder head. See Figure 6A-24.

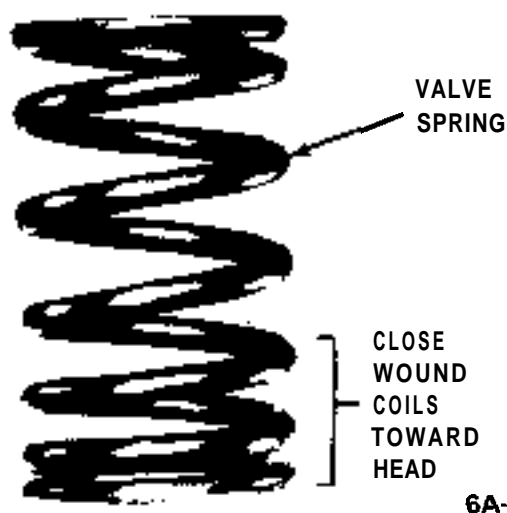


Figure 6A-24 Valve Spring

10. Install cylinder head.

11. Adjust valve clearance. See MAINTENANCE AND ADJUSTMENTS.

#### **Replacing Rocker Arm Studs**

1. When replacing rocker arm studs become necessary, remove air cleaner, rocker arm cover and rocker arm.

**NOTE: The rocker arm studs are screwed into the cylinder head. A tapered part of the stem serves to a void stud loosening.**

2. Attach vise grip pliers to stud being removed and remove from cylinder head.

3. Screw in new stud. Seat tapered part of stud by striking stud end with a rubber hammer.

4. Place two turned down rocker arm nuts on threaded part of stud.

5. Torque stud into cylinder head to 29 lb.ft.

#### **Valve Lifter Service**

The valve lifters can be removed after removing rocker arm cover and **rocker arms**.

No oversize lifters have been released due to the insignificant wear of the valve lifters and cylinder head guides.

Amplify oil respective parts and install in reverse sequence to removal.

Carry out hydraulic valve lifter adjustment as outlined in MAINTENANCE AND ADJUSTMENTS.

#### **CONNECTING ROD BEARINGS**

A connecting rod bearing consists of two halves or shells which are alike and interchangeable in rod and cap. When the shells are placed in rod and cap the ends extend slightly beyond the parting surfaces so that when rod bolts are tightened the shells will be clamped tightly in place to insure positive seating and to prevent turning. **The ends** of shells must never be tiled flush with parting surface of rod or cap.

If a precision type connecting rod bearing becomes noisy or is worn so that clearance on **crankpin** is excessive, a new bearing of proper size must be selected and installed since no provision is made for adjustment. Under no circumstances **should the connecting rod or cap** be filed to adjust the bearing clearance.

### Inspection of Connecting Rod Bearings and Crankshaft Journals

Remove oil pan.

After removal of oil pan, disconnect two connecting rods at a time from crankshaft and inspect the bearings and crankpin journals. While turning crankshaft it is necessary to temporarily reconnect the rods to crankshaft to avoid possibility of damaging the journals through contact with loose rods.

If connecting rod bearings are chipped or scored they should be replaced. If bearings are in good physical condition check for proper clearance on crankpins as described under, checking clearance and selecting replacement connecting rod bearings.

If crankpin journals are scored or ridged, the crankshaft must be replaced, or reground for undersize bearings, to insure satisfactory life of connecting rod bearings. Slight roughness may be polished out with fine grit polishing cloth thoroughly wetted with engine oil. Burrs may be honed off with a fine oil stone.

Use an outside micrometer to check crankpins for out-of-round. If crankpins are more than .002" out-of-round, satisfactory life of new bearings cannot be expected.

### Checking Clearance and Selecting Replacement Connecting Rod Bearings

Service bearings are furnished in standard size and several undersizes. The clearance of connecting rod (and crankshaft) bearings may be checked by use of Plastigage, Type PG-1 (green), or equivalent, which is soluble in oil.

1. Remove connecting rod cap with bearing shell. Wipe off oil from bearing and crankpin journal, also blow oil out of hole in crankshaft.
2. Place a piece of the plastic-type gauge material

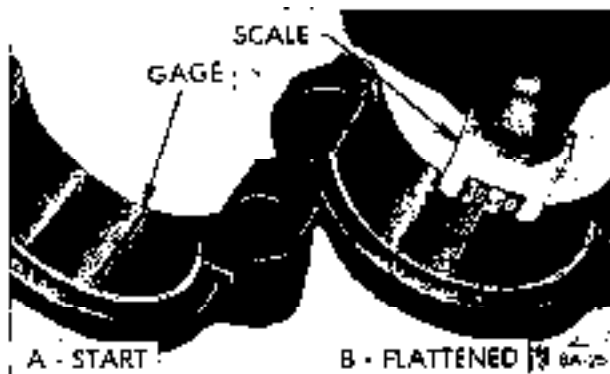


Figure 6A-25 Checking Bearing Clearance With Plastic-Type Gauge

lengthwise along the bottom center of the lower bearing shell (Figure 6A-25, view A), then install cap with shell and tighten nuts to 36 lb. ft. Do not turn crankshaft with gauge type material in bearing.

3. Remove bearing cap with bearing shell, the flattened piece of gauge will be found adhering to either the bearing shell or the crankpin. Do not remove it.
4. Using the scale printed on the envelope, measure the flattened piece of gauge at its widest point. The number within the graduation which closely corresponds to the width of the gauge, indicates the bearing clearance in thousandths of an inch. See Figure 6A-25, View B.
5. The desired clearance with a new bearing is .0006"-.0025". If bearing has been in service it is advisable to install a new bearing if the clearance exceeds .003", however if bearing is in good condition and is not being checked because of bearing noise, it is not necessary to replace the bearing.
6. After the proper size bearing has been selected, clean off the gauge, oil thoroughly, reinstall cap with bearing shell and tighten nuts to 36 lb. ft.

### CRANKSHAFT BEARINGS AND SEALS

#### Replacement of Crankshaft Bearings

A crankshaft bearing consists of two halves or shells which are identical and are interchangeable in cap and crankcase. All crankshaft bearings except the rear main bearing are identical. The crankshaft end thrust is taken up the rear (No. 5) main bearing.

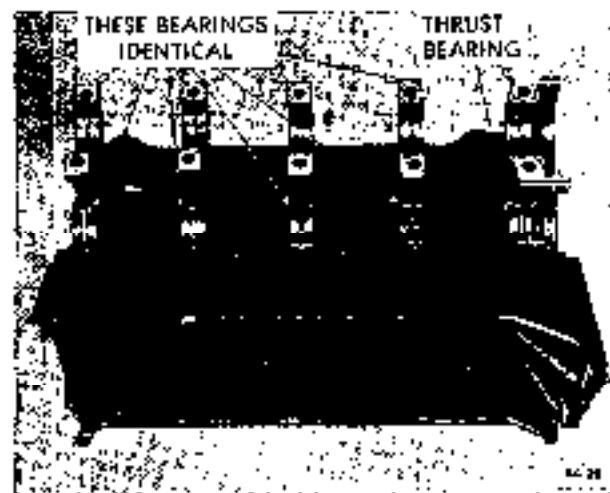


Figure 6A-26 Engine Crankshaft Bearings

When the shells are placed in crankcase and bearing cap, the ends extend slightly beyond the parting surfaces so that when cap bolts are tightened the shells will be clamped tightly in place to insure positive

seating and to prevent turning. The **ends of shells must never be tiled flush with parting surface of crankcase or bearing cap.**

Crankshaft bearings are the precision type which do not require reaming to size. Shims are not provided for adjustment since worn bearings are readily replaced with new bearings of proper size. Bearings for service replacement are furnished in standard size and undersizes. **Under no circumstances should crankshaft bearing caps be filed to adjust for wear in old bearings.**

After removal of oil pan, pipe and screen assembly, perform the following removal, inspection and installation operations on each crankshaft bearing in turn so that the crankshaft will be well supported by the other bearings.

If crankshaft has been removed to check straightness the following procedure is suggested. Rest crankshaft on "V-blocks" at number one and number live main bearing journals. Check indicator **runout** at No. 3 main bearing journal. Total indicator reading should not exceed **.0012"**.

1. Since any service condition which affects the crankshaft bearings may also affect the connecting rod bearings, it is advisable to inspect connecting rod bearings **first**. If crankpins are worn to the extent that crankshaft should be replaced or reground, replacement of crankshaft bearings only will not be satisfactory.

If replacement of cylinder block or crankshaft is required, always check main bearing clearance with plastic-type gauge to obtain specified limits.

2. Remove one bearing cap, then clean and inspect lower bearing shell and the crankshaft journal. If journal surface is scored or ridged, the crankshaft must be replaced or reground to insure satisfactory operation with new bearings. Slight roughness may be polished out with fine grit polishing cloth thoroughly wetted with engine oil, and burrs may be honed off with a fine stone.

3. If condition of lower bearing shell and crankshaft journal is satisfactory, check the bearing clearance with a plastic-type gauge.

4. When checking a crankshaft bearing with **plastic-type** gauging material, turn crankshaft so that oil hole is up to avoid dripping of oil on the gauge material. Place paper shims in lower halves of adjacent bearings and tighten cap bolts to take the weight of crankshaft off **the lower shell of bearing being checked.**

5. If bearing clearance exceeds **.003"**, it is advisable to install a new bearing; however, if bearing is in good condition and **is** not being checked because of

bearing noise, it is not necessary to replace the bearing.

6. Loosen all crankshaft bearing cap bolts 1/2 turn, and remove cap of bearing to be replaced.

7. Remove upper bearing shell by inserting Bearing Shell Remover and Installer J-8080 in oil hole in crankshaft, then slowly turning crankshaft so that the tool rotates the shell out of place by pushing against the end without the tang. See Figure 6A-27.

When turning crankshaft with rear bearing cap removed hold oil seal to prevent it from rotating out of position in crankcase.

8. The crankshaft journal cannot be measured with an outside micrometer when shaft is in place; however, when upper bearing shell is removed the journal may be checked for out-of-round by using a special crankshaft caliper and inside micrometer.

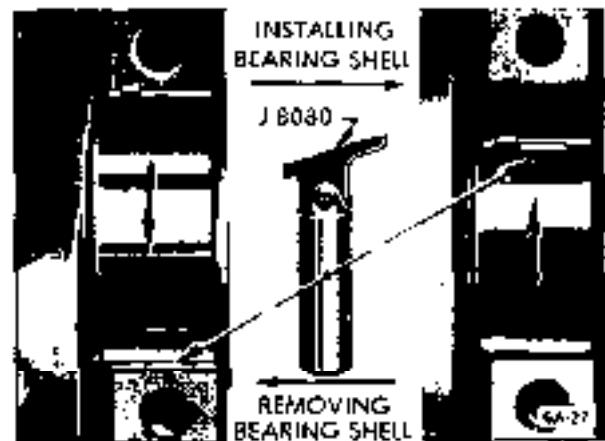


Figure 6A-27 Removing and Installing Crankshaft Bearing Upper Shell

The caliper should not be applied to journal in line with oil hole.

If crankshaft journal is more than **.0012"** out-of-round, the crankshaft should be replaced since the full mileage cannot be expected from bearings used with an excessively out-of-round crankshaft.

9. Before installation of bearing shells make sure that crankshaft journal and the bearing seats in crankcase and cap are thoroughly cleaned.

10. Coat inside surface of upper bearing shell with engine oil and place shell against crankshaft journal so that tang on shell will engage notch in crankcase when shell is rotated into place.

11. Rotate bearing shell into place as far as possible by hand, then insert Installer J-8080 in crankshaft oil hole and rotate crankshaft to push shell into place. Bearing shell should move into place with very little

pressure. If heavy pressure is required, shell was not started squarely and will be distorted if force into place.

12. Place lower bearing shell in bearing cap, then check clearance **with** plastic-type gauge, as previously described.

13. The desired clearance with a new bearing is .0009" to .0025". If this clearance cannot be obtained with a standard size bearing, insert an undersize bearing and check again **with** plastic-type gauge material.

14. When the proper size bearing has been selected, clean out all plastic gauge material, oil the lower shell and reinstall bearing cap. Clean the bolt holes and lube bolts, then torque cap bolts to 72 lb. ft. The crankshaft should turn freely at flywheel rim; however, a very slight drag is permissible if an undersize bearing is used.

15. If the thrust bearing shell is disturbed or replaced it is necessary to line up the thrust surfaces of the bearing shell before the cap bolts are tightened. To do this, move the crankshaft fore and aft the limit of its travel several times (last movement fore) with the thrust bearing cap bolts finger tight.

16. After bearing is installed and tested, loosen all bearing cap bolts 1/2 turn and continue with other bearings. When bearings have been installed and tested, tighten all bearing cap bolts to 72 lb. ft.

17. Replace rear bearing oil seals.

18. Install pipe and screen assembly and oil pan.

**Installation of Rear Bearing Oil Seals (Engine in Vehicle)**

1. Remove transmission, bell housing and clutch. Refer to appropriate section for removal procedures.



Figure 6A-28 Removing Rear Main Oil Seal

2. Remove flywheel.

3. Punch a hole into oil seal and screw in a sheet metal screw and pull out oil seal. See Figure 6A-28.

4. To insure proper sealing, lubricate seal with a suitable protective grease and install on taper ring J-22928. Turn seal to ensure lip of seal is not turned back. See Figure 6A-27.

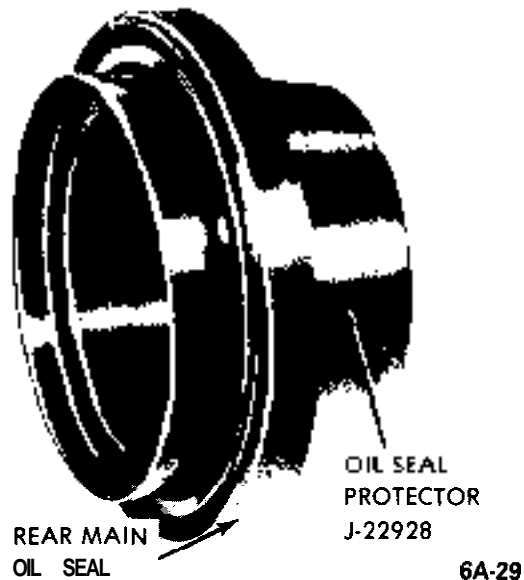


Figure 6A-29 Installing Oil Seal on Tool J-22928

5. Place tapered ring with oil seal on crankshaft flange and move lip of seal **over** rear of crankshaft. Be careful not to tilt seal.

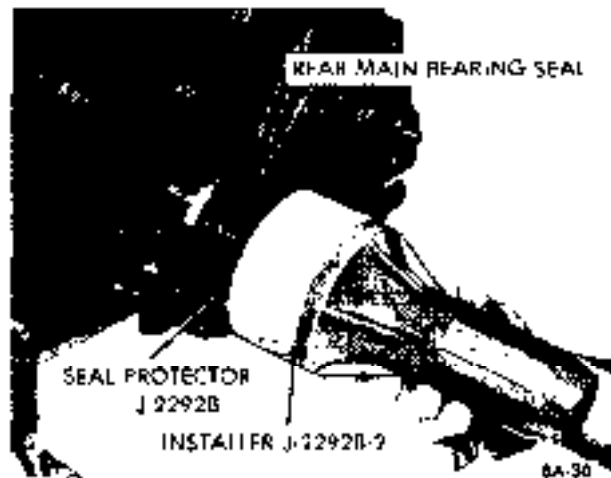


Figure 6A-30 Installing Rear Main Bearing Oil Seal

6. Drive in oil seal using Tool J-22928-2. See Figure 6A-30.

7. Install flywheel, clutch, bell housing and transmis-

sion. When replacing flywheel use new bolts and torque to 43 lb.ft.

### PISTON, RINGS AND CONNECTING RODS

#### Removal and Disassembly of Piston and Rod Assemblies

1. Drain oil.
2. Remove oil pan.
3. Remove cylinder head.
4. Examine the cylinder bores above the ring travel. If bores are worn so a ridge exists, remove the ridges with a ridge reamer to avoid damaging rings or cracking ring lands in pistons during removal.
5. Mark the cylinder number on all pistons, connecting rods and caps. Starting at the front end of the crankcase, the cylinders are numbered 1-2-3-4.
6. Remove cap and bearing shell from number 1 connecting rod.
7. Push the piston and rod assembly up and out of top cylinder. Then reinstall cap and bearing shell on rod.
8. Remove other rod and piston assemblies in the same manner.
9. Remove compression rings and oil rings.
10. Remove piston pin in following manner:
  - a. Position base support J-6047 on hydraulic press.
  - b. Place tool J-23436-2 in base support with large diameter bore facing upward. See Figure 6A-31.
  - c. Position piston and rod assembly on tool J-23436-2 making certain the pin is aligned on tool.
  - d. Position tool J-23436-4 in opposite end of piston pin and press pin out.

#### Inspection of Cylinder Bores

Inspect cylinder walls for scoring, roughness, or ridges which indicate excessive wear. Check cylinder bores for taper and out-of-round with an accurate cylinder gage at top, middle and bottom of bore, both parallel and at right angles to the centerline of the engine. The diameter of the cylinder bores at any point may be measured with an inside micrometer or by setting the cylinder gage dial at "0" and measuring across the gauge contact points with outside micrometer while the gauge is at the same "0" setting.

If a cylinder bore is moderately rough or slightly scored but is not out-of-round or tapered, it is possible to repair the bore by honing to accept a standard service piston. If cylinder bore is very rough or deeply scored, it may be necessary to rebore the cylinder to fit an oversize piston in order to insure satisfactory results.

If a cylinder bore is tapered .0005" or more, or is out-of-round .0005" or more, it is advisable to hone or rebore for the smallest possible oversize piston and rings.

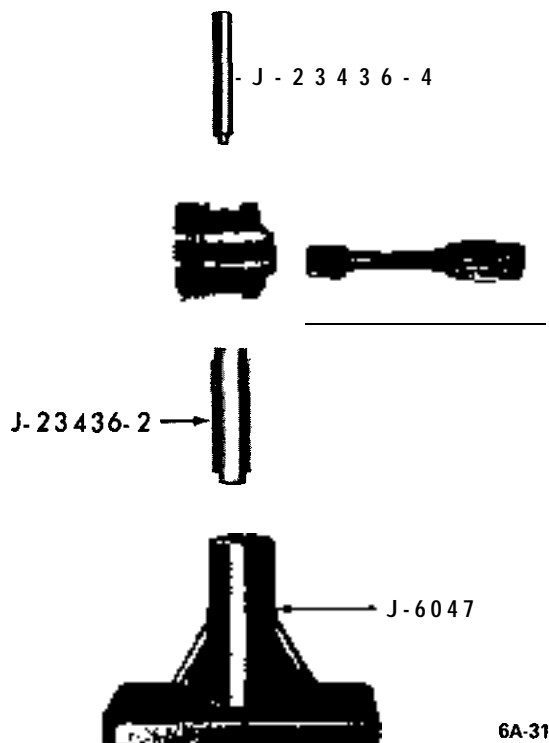
#### Visual Inspection of Pistons, Rings, and Pins

Clean carbon from piston surfaces and under side of piston heads. Clean carbon from ring grooves with a suitable tool and remove any gum or varnish from piston skirts with suitable solvent.

Carefully examine pistons for rough or scored bearing surfaces, cracks in skirt, head cracked or broken ring lands, and chipping or uneven wear which would cause rings to seat improperly or have excessive clearance in ring grooves. Damaged or faulty pistons should be replaced.

#### Fitting Pistons to Cylinders

The pistons are cam ground, which means that the



6A-31

Figure 6A-3 1 Piston Pin Removal Tool Layout - 1 .9 Engine

diameter at the right angle to the piston pin is greater than the diameter parallel to the piston pin. When a piston is checked for size, it must be measured with micrometers applied to the skirt at points 90 degrees to the piston pin. See Figure 6A-32. The piston should be measured (for fitting purposes) 2 1/2 inches below the top of piston.

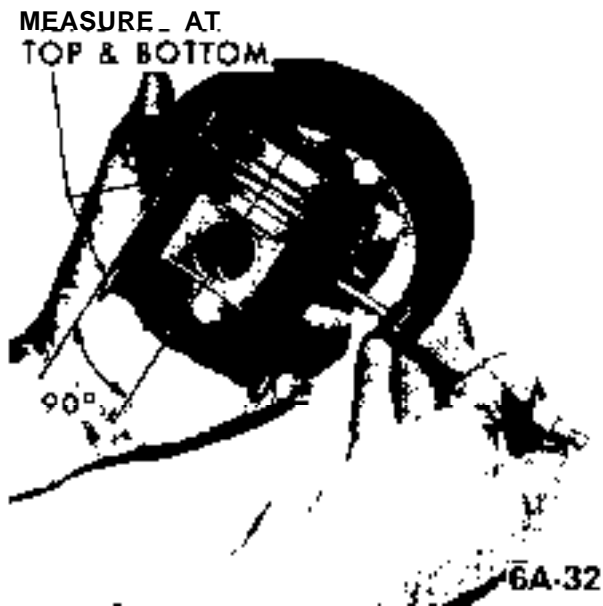


Figure 6A-32 Measuring Piston

Inspect bearing surfaces of piston pins. Check for wear by measuring worn and unworn surfaces with micrometers. Rough or worn pins should be replaced. Check fit of piston pins in piston **bosses**. Occasionally pins will be found tight due to gum or varnish deposits. This may be corrected by removing the deposit with a suitable **solvent**. If piston bosses are worn out-of-round or oversize, the piston and pin assembly must be replaced. Oversize pins are not practical because the pin is a press fit **in** the **connecting rod**. Piston pins must fit the piston with **.0004"** to **.0007"** clearance.

Examine all piston rings for scores, chips or cracks. Check compression rings for tension by comparing with new rings. Check gap of compression rings by placing rings in bore at bottom of ring travel. Measure gap with feeler gage. Gap should be between **.011"** and **.021"**. If gaps are excessive (over **.021"**) it indicates the rings have worn considerably and should **be** replaced.

*No attempt should be made to cut down oversize pistons to fit cylinder bores. This practice will destroy the surface treatment and affect the weight. The smallest possible oversize service pistons should be used and the cylinder bores should be honed to size for proper clearance.*

1. Before installing piston, piston rings, or reboring cylinders, observe the following:

Cylinder bores may not be the same size. Standard replacement piston sizes are in the midpoint of the cylinder bore size range. Therefore, it may be necessary to hone cylinders for correct piston fit. **Out-of-round** on cylinder bore must not exceed **.0005"** maximum with a taper of not over **.0005"**.

Before the honing or reboring operation is started, measure all new pistons with micrometer contacting at points exactly 90 degrees to piston pin (Figure 6A-32) then select the smallest piston for the first fitting. The slight variation usually found between pistons in **a set** may provide for correction if the **first** piston has excessive clearance.

If wear of cylinder does not exceed **.005"** honing is recommended for truing the bore. If wear or **out-of-round** exceeds these limits, the bore should be trued up with a fly cutter boring **bar** and then finish honed.

When reboring cylinders, all crankshaft bearing caps must be in place and tightened to proper torque to avoid distortion of **bores** in final assembly. Always be certain the crankshaft is out of the way of the boring cutter when boring each cylinder. When making the **final** cut with boring bar, leave **.001"** on the diameter for finish honing to give the required clearance specified.

When honing cylinders, use clean sharp stones of proper grade for the required amount of metal to be removed, in accordance with instructions of the hone manufacturer. Dull or dirty stones cut unevenly and generate excessive heat. When using coarse or medium grade stones use care to leave sufficient metal so that all stone marks may be removed with the **fine** stones used for finishing in order to maintain proper clearance.

When finish honing, pass the hone through the entire length of cylinder at the rate of approximately 60 cycles per minute. This should produce the desired 45 degree cross hatch pattern on cylinder walls which will insure maximum ring life and minimum oil consumption.

It is of the greatest importance that refinished cylinder bores have not over **.0005"** out-of-round or tapered. Each bore must be **final** honed to remove all stone or cutter marks and provide a smooth surface. **During final** honing, each piston must be fitted individually to the bore in which it will be installed and should be marked to insure correct installation.

After **final** honing and before the piston is checked for fit, each cylinder bore must be **thoroughly** washed to remove all traces of abrasive and then dried. The dry bore should then be brushed clean with a power-driven **fibre** brush. If all traces of abrasive are not removed, rapid wear of new pistons and rings will result. Fit new pistons in the following manner:

2.. Expand a telescope gage to fit the cylinder bore at right angles to the piston pin 2-1/2" from top. See Figure 6A-33.

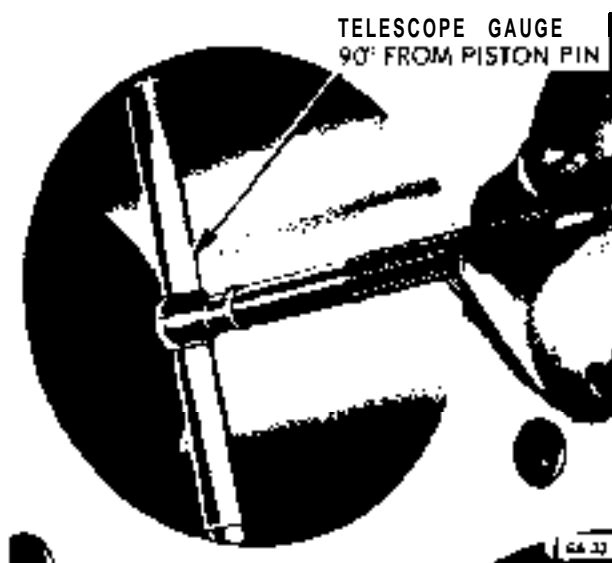


Figure 6A-33 Checking Cylinder Bores

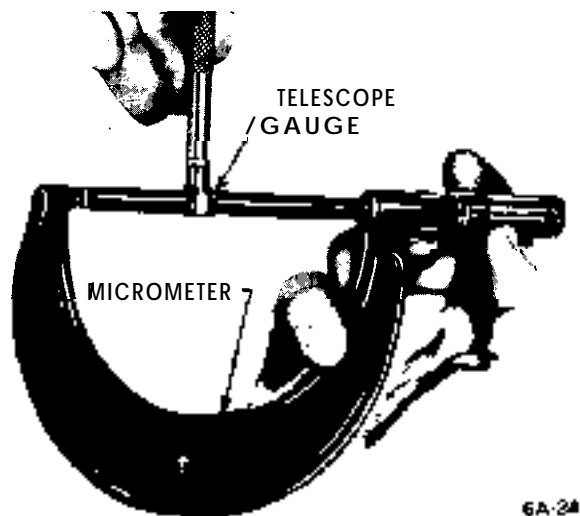


Figure 6A-34 Measuring Telescope Gage

3. Measure the piston to be installed. See Figure 6A-32. The piston must be measured at right angles to the piston pin 2-1/2" below the top of piston. The piston must be between .0008" and .0012" smaller than the cylinder bore.

Both block and piston must be at approximately the same temperature when measurements are made or expansion errors will occur. A difference of 10 degrees F between parts is sufficient to produce a variation of .0005".

### Fitting New Piston Rings

When new piston rings are installed without reboring

cylinders, the glazed cylinder walls should be slightly dulled without increasing the bore diameter by means of the finest grade honing stones.

New piston rings must be checked for clearance in piston grooves and for gap in cylinder bores; however, the flexible oil rings are not checked for gap. The cylinder bores and piston grooves must be clean, dry, and free of carbon and burrs.

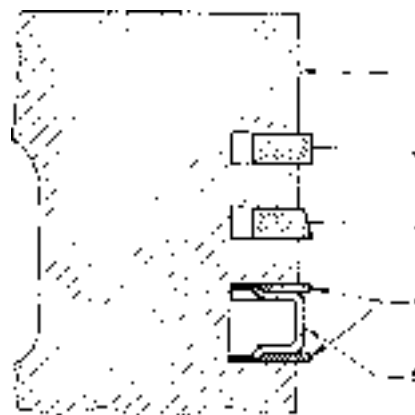
To check the end gap of compression rings, place the ring in the cylinder in which it will be used and square it in the bore by tapping with the lower end of a piston. Measure the gap with feeler gages.

Piston ring end gap should be .014" - .022" (top) and .014" - .022" (2nd) and the oil ring end gap should be .015" - .055".

If gap is less than specified, file the ends of rings carefully with a smooth tile to obtain proper gap.

Install piston rings as follows:

1. Upper ring is chrome plated and can be installed either way up. Number two (2) ring has to be installed with the marking "top" up. Oil ring can be installed either way up. See Figure 6A-35.



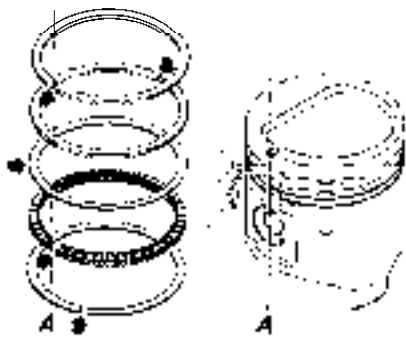
1. PISTON
2. NO. 1 COMPRESSION RING - INSTALLED WITH EITHER SIDE UP.
3. NO. 2 COMPRESSION RING - INSTALLED WITH "TOP" MARKING TOWARDS THE TOP.
4. UPPER AND LOWER STEEL BAND RING - INSTALLED WITH EITHER SIDE UP.
5. INTERMEDIATED RING - INSTALLED WITH EITHER SIDE UP.

6A-35

Figure 6A-35 Arrangement of Piston Rings

2. Install piston rings so gaps are positioned as shown in Figure 6A-36.





1. NO. 1 COMPRESSION - GAP IN FRONT
  2. NO. 2 COMPRESSION - GAP IN REAR
  3. UPPER STEEL BAND - | - 2 IN. TOWARDS THE LEFT OF INTERMEDIATE RING GAP
  4. INTERMEDIATE RING - GAP IN FRONT
  5. LOWER STEEL BAND - | - 2 IN. TOWARDS THE RIGHT OF INTERMEDIATE RING GAP.
- "A" VERTICAL LINE FOR PISTON AND RINGS, FRONT
- 6A-36

Figure 6A-36 Location of Piston Ring Gaps

With rings installed on piston, check clearance in grooves by inserting feeler gages between each ring and its *lower* land. Any wear that occurs forms a step at inner portion of the lower land. If the piston grooves have worn to the extent that relatively high steps exist on the lower lands, the piston should be replaced since steps will interfere with the operation of new rings causing ring clearances to become excessive. Piston rings are not furnished in oversize widths to compensate for ring groove wear.

When fitting new rings to new pistons, the side clearance of the compression rings should be .0024" - .0034" (top) and .0013" - .0024" (2nd), and the oil ring clearance should be .0013" - .0024".

### Assembly of Piston and Connecting Rod

**NOTE:** *Connecting rods may be out of alignment due to shipping or handling. Always check a new rod before installing piston and pin.*

Inspect piston pin bores and piston pins for wear. Piston pin bores and piston pins must be free of varnish or scuffing when being measured. The piston pin should be measured with a **micrometer** and the piston pin bore should be measured with a dial bore gage or an inside micrometer. If clearance is in excess of the .001" wear limit, the piston and piston pin assembly should be replaced.

1. Lubricate piston pin holes in piston and connecting rod to facilitate installation of pin.
2. Install pin in following manner:
  - a. Position base support J-6047 on hydraulic press.

- b. Place tool J-23436-1 in support J-6047 with small diameter bore facing upward.

- c. Place small end of tool J-23436-3 in bore of tool J-23436-1.

- d. Position piston, rod, and pin guide J-23436-3.

- e. Line up pin on piston, and using tool J-23436-4 press pin into piston. See Figure 6A-37.

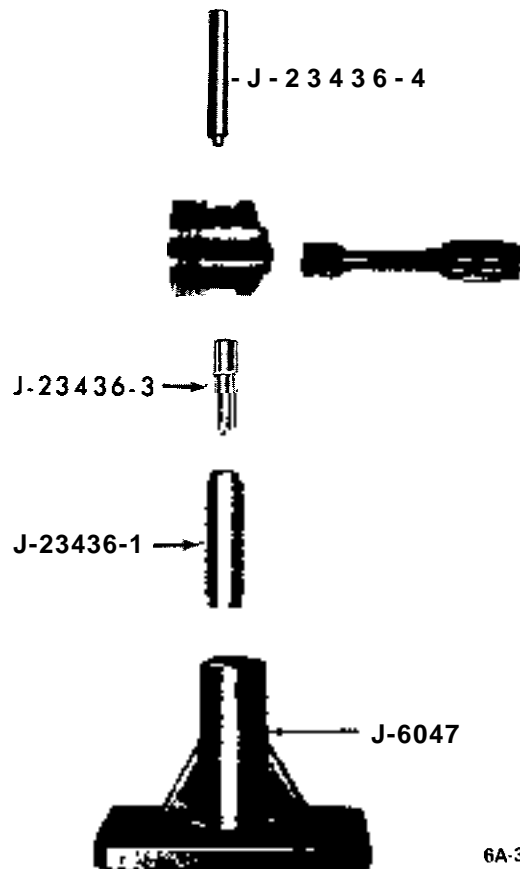


Figure 6A-37 Piston Pin Installation Tool Layout - 1.9 Engine

3. Remove installer from connecting rod and piston assembly and check piston for freedom of movement on piston pin.

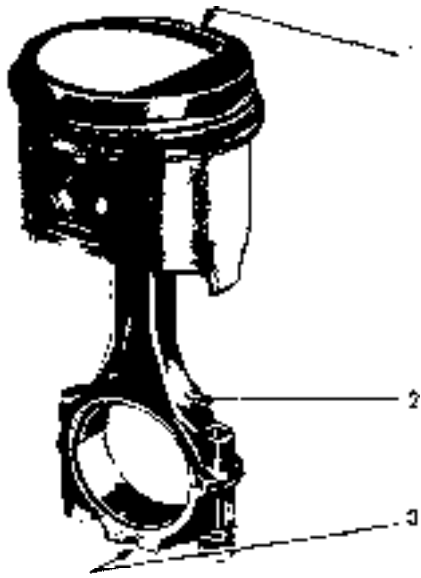
4. Make sure cylinder bores, pistons, connecting rod bearings and crankshaft journals are absolutely clean, then coat all bearing surfaces with engine oil.

5. Before installation of a piston and rod assembly in its bore, position the **crankpin** straight down.

6. Remove connecting rod cap.

7. Make sure the gap in the oil ring rails and the gaps of the compression rings are positioned correctly.

8. Lubricate the piston and rings and install in bore



1. NOTCH IN PISTON HEAD POINTING TOWARD THE FRONT
2. OIL HOLE IN CONNECTING ROD POINTING TOWARD THE RIGHT (MANIFOLD SIDE)
3. NOTCH IN CONNECTING ROD CAP POINTING TOWARD THE REAR

6A-38

Figure 6A-38 Piston and Rod Assembly

by **compressing** the rings with a "wrap around" compressor.

9. Select a new connecting rod bearing, if necessary. Otherwise install cap with bearing lower shell on rod and tighten bolt nuts to 36 **lb.ft.** torque.

10. Install all other piston and rod assemblies in same manner. When piston and rod assemblies are properly installed, the oil spurt holes in the connecting rods will be facing right.

11. Check end clearance between connecting rods in each **crankpin** using feeler gages. Clearance should be between .0043" and .0095".

12. Install cylinder head. Torque 10 cylinder head bolts to 72 **lb.ft** (cold), and 2 cylinder head to timing chain cover bolts to 17 **lb.ft.**

13. Install new oil pan gasket by **first** installing flange gasket with tabs in slots in rear main bearing cap **and** engine front cover. Then install rubber strips in grooves in rear main bearing cap and engine front cover. Install oil pan, torquing bolts to 5 **lb.ft.**

14. Install (Opel 1900 and Manta) front suspension assembly. (GT) Install engine suspension cross member.

After installation of new pistons and rings, care should be used in starting the engine and in running it for the first hour. Avoid high speeds until the parts have had a reasonable amount of break-in so that **scuffing** will not occur.

## TIMING CHAIN COVER AND TIMING CHAIN

### Timing Chain Cover Removal

1. Support engine in vehicle as outlined under Engine Oil Pan Removal and Installation.
2. Remove radiator and shroud assembly
3. Remove cylinder head.
4. Remove alternator belt and remove alternator mounting bracket.
5. Remove fuel pump
6. Remove ignition distributor.
7. Remove chain tensioner assembly out of timing cover.
8. Remove crankshaft pulley bolt and remove pulley.
9. Remove water pump assembly.
10. Remove oil pan
11. Remove timing chain cover bolts. One bolt is covered by the water pump. See Figure 6A-39.
12. Pull off sprockets with chain. Put a paint mark



Figure 6A-39 Bolt Behind Water Pump

on front side of timing chain to permit reinstallation in original position.

**Timing Chain Cover and Timing Chain installation**

Reinstall timing chain cover by reversing removal procedures, pay particular attention to the following points.

1. Clean all parts, check for wear and replace as required. The Parts Department supplies either the two sprockets complete with chain or the chain alone. It is not permissible to replace sprockets alone. The chain tensioner is, with the, exception of the tensioner body, only available as a complete unit.

2. Turn crankshaft so that key for sprocket is on top and vertical. Assemble chain, with camshaft sprocket, then put chain on crankshaft sprocket already installed. Be sure paint dot on chain is in front so that chain moves in same direction as prior to disassembly.

3. Make sure camshaft sprocket mark is in alignment with mark on support and chain in parallel with damper block.

4. To install new timing case oil seal, drive out oil seal from the rear using a drift. Coat circumference of oil seal sparingly with suitable sealer and press seal in, using tool J-22924. Take care not to damage timing case. See Figure 6A-40.

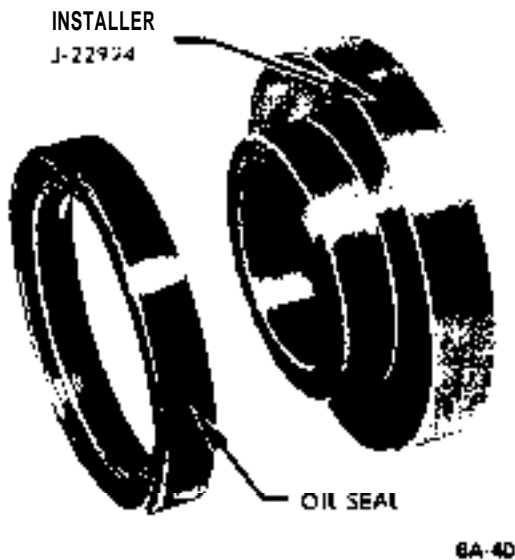


Figure 6A-40 Installing Timing Cover Oil Seal on Protector

It is not necessary to use crankshaft bolt to install seal when cover is off engine.

5. Inspect chain tensioner for proper operation and reusability.

6. Install timing case rubber gaskets to cylinder block. Stick on with grease as necessary. Gaskets will somewhat overlap with oil pan gasket.

7. Position timing cover onto guide pin in upper left corner of cylinder block and insert centering bolt through timing chain cover into lower right corner of cylinder block. See Figure 6A-40A. No sealing is required.

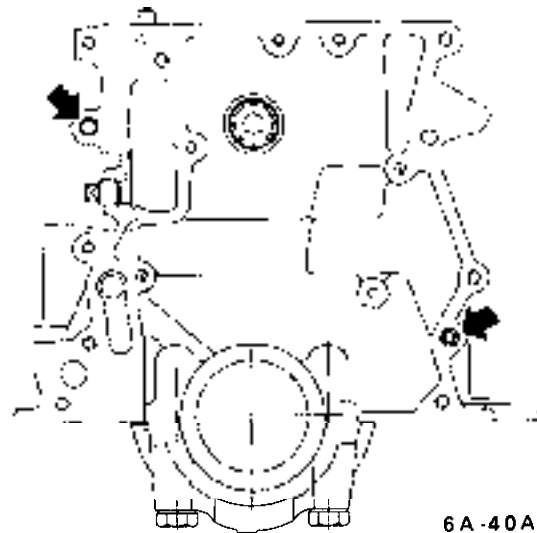


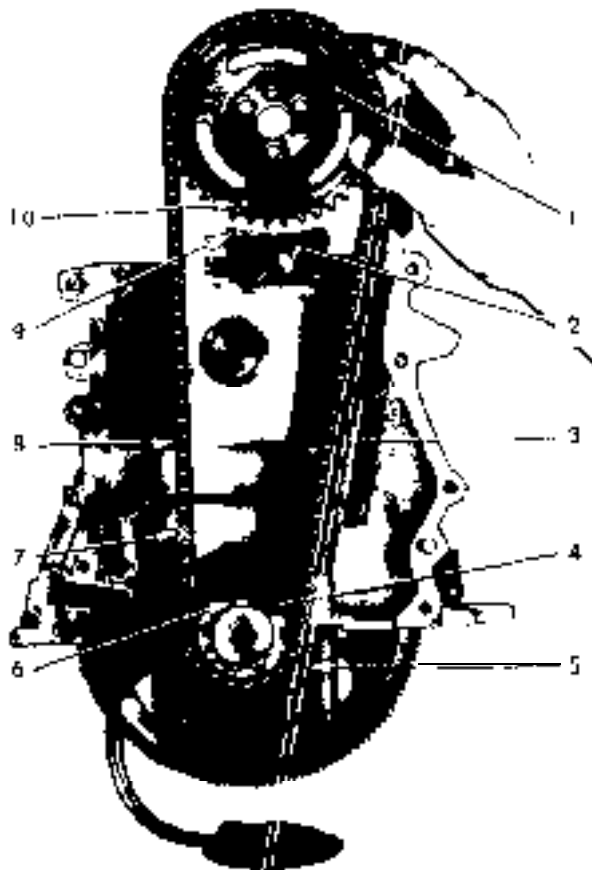
Figure 6A-40A Installing Timing Chain Cover

8. Install cylinder head

After sprocket has been attached to camshaft, re-check alignment to see that chain has not slipped. At this time both No. 1 and No. 4 pistons will be at TDC position. No. 4 piston will be in firing position and No. 1 piston up on exhaust stroke. To time engine to fire on No. 1 cylinder, rotate crankshaft 360 degrees. This will position the timing mark 180 degrees from original alignment of camshaft sprocket and support bracket, and will completely close No. 1 intake and exhaust valves. Also, the timing mark on the fly-wheel (ball) and cylinder block (pointer) will coincide. See Figure 6A-41.

**Replacing Timing Cover Oil Seal (Engine Installed)**

1. Remove fan belts.
2. Remove crankshaft pulley bolt and remove pulley.
3. Insert screwdriver behind seal and rest screwdriver on crankshaft pin. Pry out oil seal.



1. CAMSHAFT SPROCKET
2. CAMSHAFT SPROCKET SUPPORT
3. LONG DAMPER BLOCK
4. CRANKSHAFT SPROCKET
5. CHAIN AND DAMPER BLOCK IN PARALLEL
6. CRANKSHAFT KEY
7. PAINT MARK ON FRONT
8. TIMING CHAIN
9. MARK ON CAMSHAFT SPROCKET SUPPORT
10. MARK ON CAMSHAFT SPROCKET

6A-41

Figure 6A-4 1 Valve Timing Marks

4. Lubricate new oil seal and place on installer J-22924.

5. Place installer J-22924 on crankshaft. Using crankshaft bolt and washer install seal into cover. See Figure 6A-42.

6. Install crankshaft pulley, bolt and washer. Torque bolt to 72 lb.ft.

7. Install belts and torque to proper tension 45 lb.ft.

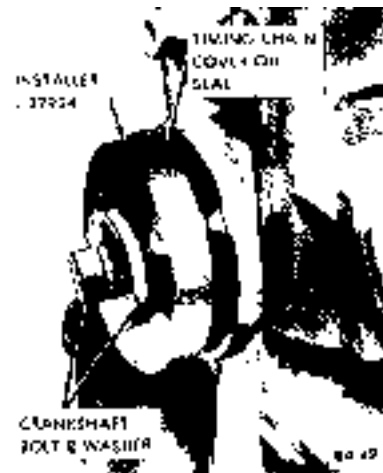


Figure 6A-42 Installing Timing Chain Cover Oil Seal

### Replacing Distributor Drive Gear On Crankshaft

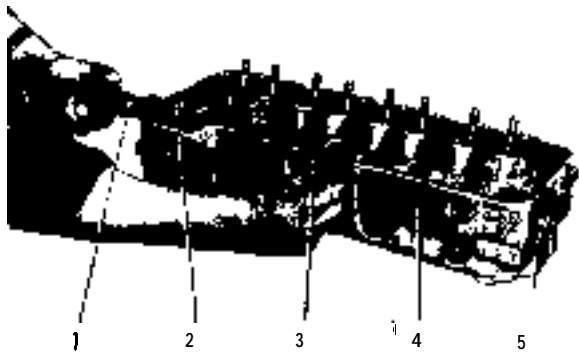
1. Remove fan belt.
2. Remove fuel pump. Plug end of fuel line with a suitable stop.
3. Remove spark plug wires, distributor hold down clamp. Remove distributor.
4. Turn crankshaft so key is on top.
5. Pry oil seal out of timing chain cover.
6. Insert a screwdriver through opening for fuel pump and push out distributor drive gear, which has a push fit on crankshaft, through oil seal seat in timing cover.
7. Install new gear. Be sure key tits in keyway. When installing components, use new gaskets as required.
8. Install new oil seal.
9. Connect parts removed in steps 1 thru 3.

### CAMSHAFT

#### Removal

1. Remove cylinder head.
2. Loosen self-locking rocker arm nuts and swing rocker arms off valve lifters.
3. Remove valve lifter. Place lifters in a suitable holding fixture so that they may be reinstalled in original position.
4. Remove cover from access hole on left side and

rear of cylinder head. Remove camshaft toward front, supporting camshaft with one hand through access hole and taking care not to damage bearing surfaces. See Figure 6A-43.



1. CAMSHAFT
2. FRONT ACCESS HOLE
3. LATERAL ACCESS HOLE
4. CYLINDER HEAD
5. REAR ACCESS HOLE

6A-43

Figure 6A-43 Removing Camshaft

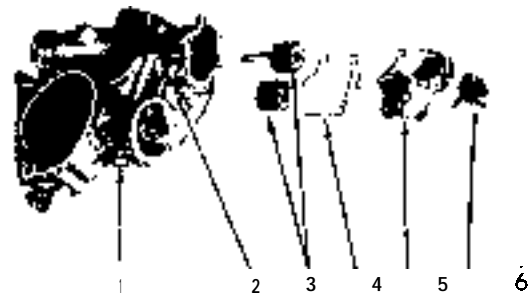
Installation

1. Liberally lubricate camshaft journals and install camshaft from front into cylinder head. Support shaft through access hole in left side of head to prevent damaging bearings.
2. Reinstall valve lifters, rocker arms and self-locking rocker arm nuts.
3. Install rear and side access plates.
4. Reinstall cylinder head.

OIL PUMP COVER AND GEARS

Removal and Installation of Oil Pump Cover and Gears

1. Remove screws attaching oil pump cover assembly to timing chain cover. Remove cover assembly and slide out oil pump gears. See Figure 6A-44.
2. Wash off gears and inspect for wear, scoring, etc. Replace any gears not found serviceable. Discard pump covers scored by gear action. If pump housing or distributor drive shaft bushing are worn (this is only possible after a long service life), the timing case together with all exchangeable pump parts have to be discarded.



- |                                       |                           |
|---------------------------------------|---------------------------|
| 1. OLD PRESSURE RELIEF VALVE ASSEMBLY | 4. COVER GASKET           |
| 2. TIMING CASE                        | 5. COVER & VALVE ASSEMBLY |
| 3. OIL PUMP GEARS                     | 6. COVER ATTACHING SCREWS |

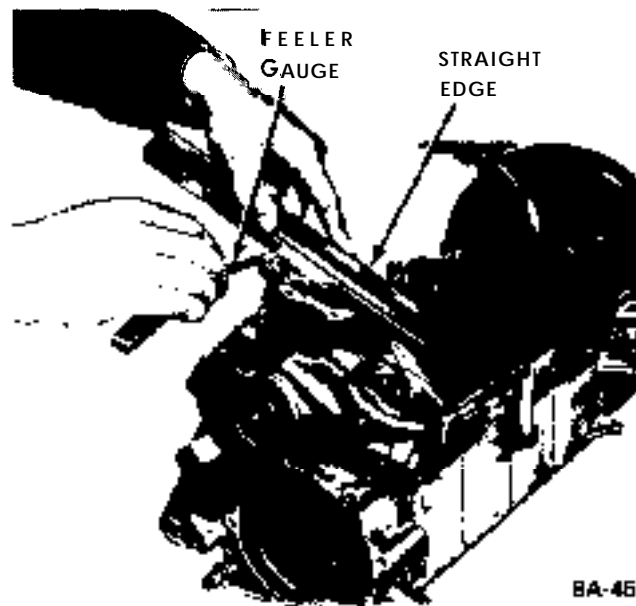
6A-44

Figure 6A-44 Oil Pump Components

In isolated cases, timing cases are installed in production having .008 in. oversize bores for pump gears and shafts. Oversize bores may exist either for one or both gears; these timing cases are identified by the number "0.2" stamped into pump flange on left and/or right-hand side. Oversize replacement gears should be selected according to Part Catalog specifications.

3. Liberally lubricate spindles and gear teeth and use new cover gasket. Install oil pump cover.

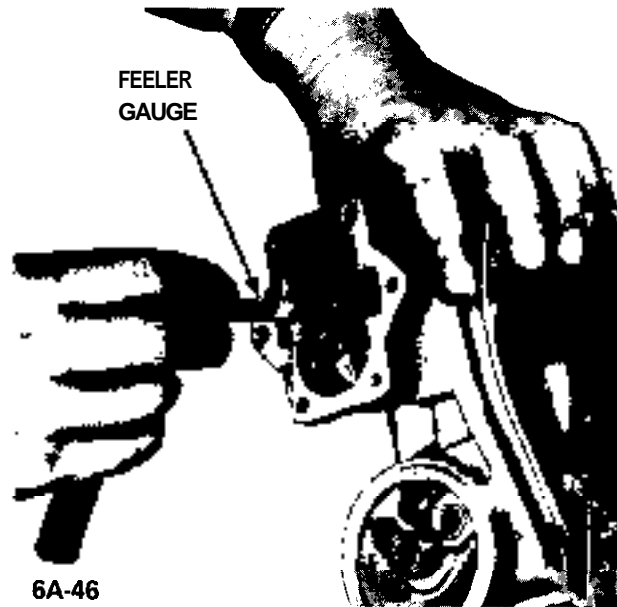
If new gears are installed, their end clearance in a dry pump housing should be checked with a straight edge and a feeler gauge. The gears must not protrude more than .004 in. over pump housing. See Figure 6A-45.



6A-45

Figure 6A-45 Checking Oil Pump Gear End Clearance

With feeler gauge, check gear backlash. It should be between .004 in. and .008 in. See Figure 6A-46.



6A-46

Figure 6A-46 Measuring Oil Pump Gear Backlash

#### Checking Oil Pump Relief Valve For Proper Functioning

1. Unscrew plug and check spring and relief valve plunger in oil pump cover for dirt particles and free operation. If required, carefully clean plunger and seat. Pressure relief plunger sticking as a result of foreign material or sludge build-up in the oil pump cover can cause loss of oil pressure.

#### Removal and Inspection of Oil Pump Pipe and Screen Assembly

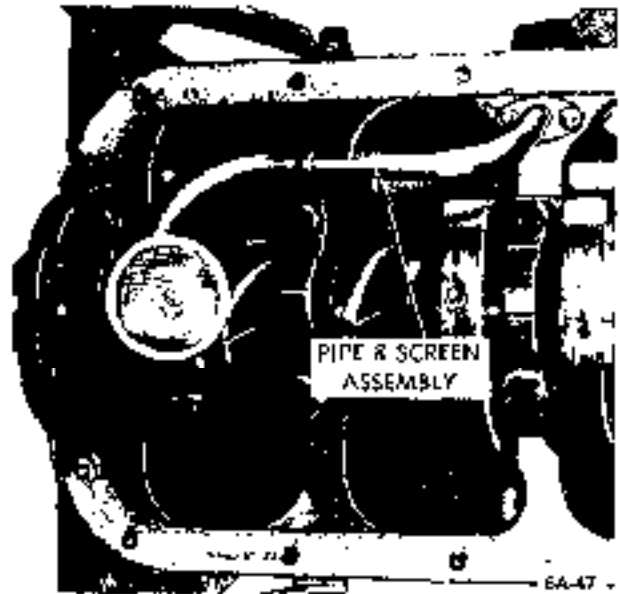
1. Remove oil pan.
2. Clean oil pan. Make sure the gasket surfaces and pan and block are clean.

## SPECIFICATIONS

### BOLT TORQUE SPECIFICATIONS

Use a reliable torque wrench to tighten all parts listed, to insure proper tightness without straining or distorting parts. These specifications are for clean and lightly-lubricated threads only; dry or dirty threads produce increased friction which prevents accurate measurement of tightness.

3. Remove (2) bolts holding pipe and screen assembly to cylinder block. See Figure 6A-47.



6A-47

Figure 6A-47 Installation of Pipe and Screen Assembly

4. Clean the screen and housing thoroughly in solvent and blow dry with air stream.

#### Installation of Oil Pump and Screen Assembly

Install by reversing removal procedures, paying particular attention to the following points.

1. Make sure oil pump pipe flange gasket surface of block is smooth and free of dirt.
2. Use a new gasket and install assembly.
3. Tighten pan bolts evenly. Do not over-tighten. Torque to 5 lb. ft.

Part	Torque Lb.Ft.
Connecting Rod Bolts .....	36
Crankshaft Main Bearing Bolts .....	72
Flywheel to Crankshaft Attaching Bolts .....	43
Cylinder Head Attaching Bolts .... Cold 72 -Warm 58	
Camshaft Sprocket Attaching Bolts .....	18
Generator Bracket to Cylinder Block Attaching Bolts .....	29
Generator Bracket to Timing Case Attaching Bolts ...	29
Crankshaft Pulley Attaching Bolts .....	72
Rocker Arm Stud in Cylinder Head .....	29
Spark Plugs .....	30
Clutch Housing to Cylinder Block Attaching Bolts .....	36
Timing Case to Cylinder Block Attaching Bolts .....	14
Water Pump to Timing Case Attaching Bolts .....	11
Engine Support to Cylinder Block Attaching Bolts .....	40
Rear Engine Suspension to Transmission Rear Bearing Retainer Bolts .....	22
Transmission to Clutch Housing Attaching Bolts .....	29
Starter to Clutch Housing Attaching Bolts .....	40
Support to Starter Attaching Nut .....	4
Intake and Exhaust Manifold to Cylinder Head Attaching Bolts .....	33

Unless Otherwise Noted:

10 MM Bolt (15 MM Head) .....	30
8 MM Bolt (13 MM Head) .....	15
6 MM Bolt (10 MM Head) .....	30 Lb.In.

**GENERAL SPECIFICATIONS**

Type - No. of Cylinders	In line 4
Valve Arrangement .....	In head
Bore and Stroke	3.66 x 2.75
Piston Displacement Cu. In.	115.8
Compression Ratio .....	7.6:1
Octane Requirement .....	Regular - Low Lead
Firing Order .....	1-3-4-2
Cylinder Block Material .....	Cast Iron
Crankshaft Bearings Number and Type	5 Removable Steel Backed
In-Metal Babbitts	
Bearing Which Takes End Thrust .....	5
Connecting Rod Bearing Material	Steel Backed Tri-Metal Babbitts
Piston Material and Surface .....	Aluminum Alloy, Lead Coated
Piston Pin Offset .....	.031 In. to the Right
Compression Rings Material and Surface Treatment	
No. 1 .....	Chrome-plated, Cast Iron - Rectangular
No. 2 .....	Cast Iron - Tapered
Oil Ring .....	Chrome-plated, Cast Iron
Location of All Piston Rings .....	Above Piston Pin
Camshaft Material .....	Alloy Cast Iron
Camshaft Drive .....	Chain
Number and Type of Camshaft Bearings	4 Steel-Backed Babbitt
Valve Lifter Type .....	Hydraulic
Oiling System Type .....	Circulating High Pressure
Oil supplied to:	
Bearing Surfaces, Crankshaft, Camshaft and Connecting Rods .....	Pressure Vapor
Piston, Pins .....	Nozzle Spray
Cylinder Walls .....	Pressure
Rocker Arms .....	3 1/4 With Dry Filter
Oil Reservoir Capacity - Quarts .....	Throw Away Element
Oil Filter - Type .....	

Cooling System - Type .....	Liquid Cooling With Circulating Pump
Filler Cap Type - Pressure .....	13.2-15.2 PSI
Water Temperature Control .....	Thermostat and Bypass
Thermostat Open At .....	189 F.
Cooling System Capacity .....	6 Qts.
Fan Drive .....	Water Pump Shaft

**ENGINE DIMENSIONS AND FITS**

**Cylinder, Crankcase, Pistons, Cylinder Head, Valves**

Cylinder Bore Limits for Standard Size Pistons:	
Size 1 .....	3.659-3.660 In.
Size 2 .....	3.661-3.663 In.
Size 3 .....	3.664-3.668 In.
Cylinder Bore Limits for Oversize Pistons, .02 In.	
Oversize .....	3.679-3.681 In.
Max. Permissible Cylinder Bore Out-of-Roundness .....	.0005 In.
Max. Permissible Cylinder Bore Taper .....	.0005 In.
Piston Clearance, Nominal (on skirt bottom) .....	.0014 In.
No. 1 Compression Ring Side Clearance in Piston Groove .....	.0024-.0034 In.
No. 2 Compression Ring Side Clearance in Piston Groove .....	.0013-.0024 In.
Oil Control Ring Side Clearance in Piston Groove .....	.0013-.0024 In.
Piston Ring Gap:	
No. 1 Compression Ring .....	.014-.022 In.
No. 2 Compression Ring .....	.014-.022 In.
Oil Control Ring .....	.015-.055 In.
Piston Pin in Connecting Rod .....	Press Fit

	Intake	Exhaust
Valve Spring Pressure		
Valve Closed .....	1.57 In. at 93 Lbs.	1.36 In. at 97 Lbs.
Valve Open .....	1.18 In. at 182 Lbs.	.96 In. at 180 Lbs.
Valve Stem Diameters		
Standard Size .....	.3538-.3543 In.	.3524-.3528 In.
.003 In. Oversize .....	.3567-.3572 In.	.3553-.3559 In.
.0059 In. Oversize .....	.3597-.3602 In.	.3583-.3588 In.
.O 1 18 In. Oversize .....	.3656-.3661 In.	.3642-.3647 In.
Valve Length, Nominal .....	4.843 In.	4.92 In.
Valve Head Diameter .....	1.574 In.	1.34 In.
Valve Guide Bore in Cylinder Head (Intake and Exhaust)		
Standard Size .....	.3553-.3562 In.	
.003 in Oversize .....	.3582-.3592 In.	
.006 in Oversize .....	.3615-.3622 In.	
.0118 in Oversize .....	.3671-.3681 In.	
Valve Stem Clearance		
Intake .....	.001-.0029 In.	
Exhaust .....	.0039 In.	
Max. Permissible Head to Stem Runout		
Intake .....	.0016 In.	
Exhaust .....	.0019 In.	



## Valve Seat and Correction Angle in Cylinder Head

## Intake

Valve Seat Angle ..... 45°

Outer Correction ..... 30°

## Exhaust

Valve Seat Angle ..... 45°

Outer Correction ..... 30°

Valve Face Angle ..... 44°

## Valve Seat Width in Cylinder Head

Intake ..... .049-.059 In.

Exhaust ..... .063-.073 In.

Valve Head Contact Area ..... Aim at Centricity

Valve Clearance at 176°F. Coolant and 140°F. to 176°

## Oil Temperature

Intake and Exhaust ..... Zero Plus One Turn

## Cranking Mechanism

Max. Permissible Out-of-Roundness of Connecting Rod Bearing  
Journals ..... .0002 In.Max. Permissible Taper of Connecting Rod and Crankshaft Bearing  
Journals ..... .0004 In.Max. Permissible Radial **Runout** of Center Main Bearing  
Journals When Supported in End Bearings ..... .0012 In.Max. Permissible **Unparallelism** of Connecting Rod Bearing  
Journals When Crankshaft is Placed in V-Blocks so That  
Main Bearing Journals Next to Each Other Are Supported ..... .0005 In.Max. Permissible **Runout** of Crankshaft to Flywheel  
Contact Area ..... .0008 In.

Crankshaft End Play ..... .0017-.0061 In.

Main Bearing Clearance ..... .0009-.0025 In.

Connecting Rod Bearing Clearance ..... .0006-.0025 In.

Connecting Rod End Play on Bearing Journal ..... .0043-.0095 In.

Connecting Rod Bearing Length ..... .7785-.7992 In.

Crankshaft Thrust Bearing Length ..... 1.08 In.

## Valve Mechanism

Camshaft Bearing Clearance ..... .001-.003 In.

Camshaft End Play ..... .004-.008 In.

Max. Permissible Radial **Runout** of Camshaft Center Bearing  
▪ Camshaft Supported in Outer Bearings ..... .001 In.

Valve Lifter Clearance in Cylinder Head Bore ..... .0003-.0013 In.

## Engine Lubricating System

Oil Pump Gear Backlash ..... .004-.008 In.

Oil Pump Gear End Play in Housing ..... Gears Protruding Over Edge  
of Housing: Not More Than .004 In.Clearance of Spindle in Bore of Oil Pump Driven  
Gear ..... .0003-.0015 In.Clearance Between Oil Pump Drive Gear and  
Bushing ..... .00035-.0015 In.Oil Pump Relief Valve Spring Pressure at a Spring Length  
of .8 In. .... .44-.66 Lbs.

	CRANKSHAFT MAIN BEARING JOURNALS			CONNECTING ROD WRAPING JOURNALS (ALL)		CONNECTING ROD WIDTH, (ALL)
	NO. 1, 2, 3 & 4 BEARING DIAMETER	BEARING NO. 5 (PICT BEARING)		WIDTH	DIAMETER	
		WIDTH	DIAMETER			
AVAILABLE SIZES OF CONNECTING ROD AND CRANKSHAFT BEARING SHELLS AS WELL AS CONNECTING RODS.	INCHES	INCHES	INCHES	INCHES	INCHES	INCHES
DIMENSIONS FOR STANDARD (PRODUCTION) SIZE CRANKSHAFT USE OPEL BEARING PART NOS. 618096, 618710, 622711	2.2892 ± .003	1.9819 ± .0012	2.2832 ± .0003	.4954 ± .0015	2.0464 ± .0003	.9789 ± .0010
DIMENSIONS FOR GRINDING CRANKSHAFTS FOR USE WITH .010 INCH UNDERSIZE BEARINGS USE OPEL BEARING PART NOS. 618161, 618735, 622941	2.2724 ± .0002	1.9898 ± .0012	2.2733 ± .0002	.4958 ± .0015	2.0306 ± .0003	.9789 ± .0010
DIMENSIONS FOR GRINDING CRANKSHAFTS FOR USE WITH .020 INCH UNDERSIZE BEARINGS. USE OPEL BEARING PART NOS. 618330, 618709, 622778	2.2635 ± .0002	1.9977 ± .0012	2.2835 ± .0002	.4937 ± .0015	2.0207 ± .0003	.9861 ± .0010

# COOLING SYSTEM

## CONTENTS

Subject	Page No.
<b>DESCRIPTION AND OPERATION:</b>	
Cooling System and Water Pump .....	6B-32
<b>DIAGNOSIS: (Not Applicable)</b>	
<b>MAINTENANCE AND ADJUSTMENTS:</b>	
Checking and Filling Cooling System .....	6B-32
Draining and Flushing Cooling System .....	6B-32
Conditioning the Cooling System .....	6B-33
Using and Testing Anti-Freeze Solutions .....	6B-33
Fan Belt Adjustment or Replacement .....	6B-33
Radiator Thermostat Inspection and Test .....	6B-33
<b>MAJOR REPAIR:</b>	
Water Pump Removal .....	6B-34
Radiator Removal .....	6B-34
<b>SPECIFICATIONS:</b>	
Cooling System Capacities .....	6B-35

## DESCRIPTION AND OPERATION

### COOLING SYSTEM AND WATER PUMP

The cooling system is of the conventional pressurized type. A centrifugal pump arranged in timing case serves to circulate the coolant.

When the thermostat is closed, the coolant will return to the pump via a by-pass for swift and uniform warming up of the engine the coolant circulates through the radiator, only when the engine has reached normal operating temperature.

The heater system branches off the cooling system ahead of thermostat in flow direction so that the heater is in operation before engine has reached full operating temperature.

### MAINTENANCE AND ADJUSTMENTS

#### Checking and Filling Cooling System

The coolant level should be checked only when the engine is cold and only enough coolant should be added to bring the level halfway between core and

tank top. It is unnecessary and undesirable to remove the radiator cap and check the coolant level each time the car stops at a filling station for gasoline or oil, since the engine is usually hot at such times.

**WARNING:** *Never remove the radiator cap quickly when engine is HOT Sudden release of cooling system pressure may cause the coolant to boil and some of it may be ejected from the radiator filler neck, resulting in injury to persons or damage to the car finish.*

If it is necessary at any time to remove the radiator cap when engine is hot, rotate the cap counterclockwise until first stop is reached. Leave cap in this position until all pressure in cooling system has been released, then turn cap past the first stop and remove it.

#### Draining and Flushing Cooling System

The cooling system should be completely drained and the recommended coolant installed every two (2) years.

To drain the cooling system, remove radiator cap, remove lower radiator hose from the lower tank and

remove drain plug on **right side** of cylinder block. Set heater temperature control valve at full heat position. After the cooling system is drained, and plugs reinstalled, fill the system with clean water. Run the engine long enough to open the thermostat for complete circulation through the system, then completely drain the cooling system before sediment has a chance to settle.

#### Conditioning the Cooling System

"Rust Inhibitor and Stop Leak", or equivalent listed under Group 8.800 is recommended for use in the cooling system, particularly when preparing for installation of anti-freeze solution. This material stops small seepage leaks, has rust preventive properties and its soluble oil is effective in eliminating a squealing noise which sometimes develops at the water pump seal washer. Instructions for its application are printed on the conditioner bottle.

It is very important to make certain that the cooling system is properly prepared before an anti-freeze solution is installed, otherwise loss of solution through leakage may occur or seepage may result in damage to the engine. The cooling system should be drained and flushed as described under Draining and Flushing Cooling System. All joints should be checked for leakage and corrected, and the conditioner described above should be added with the anti-freeze solution.

Inspect the water pump, radiator core, heater and defroster cores, water jacket plugs, and edge of cylinder head gaskets for evidence of water leaks. Tighten all hose clamps in the cooling and heating systems and replace any deteriorated hoses.

#### Using and Testing Anti-Freeze Solutions

Inhibited year around (ethylene glycol type) engine coolant solution which is formulated to withstand two full calendar years of normal operation without draining or adding inhibitors should be used at all times. Freeze protection should be provided to protect against corrosion. When adding solution due to loss of coolant for any reason or in areas where temperatures lower than minus 20 degrees F. may be encountered, a sufficient amount of any of the several brands of year around coolant (Ethylene Glycol base) compatible to GM Specification 1899-M available on the market should be used. Water or alcohol base coolants are not recommended for this vehicle at any time.

If for any reason water only is used as a coolant in an emergency, it is extremely important that Buick Heavy Duty Cooling System Protector and Water Pump Lubricant or equivalent be added to the cooling system as soon as possible. If any other cooling System protector is used, be certain it is labeled to

indicate that it meets General Motors Specification GM 1894-M. It should be recognized that this is only a temporary measure. The manufacture intends that permanent type coolant solution be used year around in the cooling system.

The cooling system should be completely drained and the recommended coolant installed every two (2) years.

It is advisable to test the anti-freeze solution at intervals during the winter to make certain that the solution has not been weakened. Use only hydrometers which are calibrated to read both the specific gravity and the temperature, and have a table or other means of converting the freezing point at various temperatures of solution. Disregarding the temperature of the solution when making the test may cause an error as large as 30 degrees F. Care must be exercised to use the correct float or table for the particular type of anti-freeze being tested.

#### Fan Belt Adjustment or Replacement

A tight fan belt will cause rapid wear of the alternator and water pump bearings. A loose belt will slip and wear excessively and will cause noise, engine over-heating, and unsteady alternator output. A fan belt which is cracked or frayed, or which is worn so that it bottoms in the pulleys should be replaced. The fan belt may be replaced by loosening the alternator brace at alternator, slightly loosening the alternator mounting bolts and moving alternator inward to provide maximum slack in the belt.

The alternator must be moved outward to adjust the fan belt. After the generator brace and mounting bolts are securely tightened, the fan belt tension should be 45 lb. using Tensioner J-23600.

**WARNING: *Zfa fan blade is bent or damaged in any way, no attempt should be made to repair and reuse the damaged part. A bent or damaged fan assembly should always be replaced with a new fan assembly. It is essential that fan assemblies remain in proper balance and proper balance cannot be assured once a fan assembly has been bent or damaged. A fan assembly that is not in proper balance could fail and fly apart during subsequent use creating an extremely dangerous condition.***

#### Radiator Thermostat Inspection and Test

A sticking radiator thermostat will prevent the cooling system from functioning properly. If the thermostat sticks in the open position, the engine will warm up very slowly. If the thermostat sticks in the closed position, the engine will overheat.

The thermostat may be removed for inspection and

test by partially draining the cooling system and disconnecting the water outlet housing from the thermostat housing which is mounted on the right front side of cylinder head.

The standard thermostat valve should start to open at 189 degrees **F** and fully open at approximately 212 degrees **F**. If thermostat does not operate at specified temperatures, it should be replaced as it cannot be repaired.

## MAJOR REPAIR

### WATER PUMP REPAIRS

The water pump bearing outer race is shrunk fit into the water pump cover. For this reason the cover, shaft bearing, and hub are not repairable.

#### Water Pump Removal

Opel radiators do not have a drain plug. Drain radiator by first, loosening radiator cap, then remove lower hose from lower radiator tank.

1. Drain coolant into a clean container. Remove radiator and shroud.
2. Remove fan belt.
3. Remove fan blade and pulley on water pump shaft.
4. Disconnect inlet hose and heater hose from water pump. Remove bolts, pump assembly and gasket from timing chain cover.
5. Check pump shaft bearing for end play or roughness in operation. If bearings are not in serviceable condition, the assembly must be replaced.

#### Water Pump Installation

1. Make sure the gasket surfaces on pump and timing chain covers are clean. Install pump assembly with new gasket. Bolts must be tightened uniformly. Torque to 11 lb. ft.
2. Install radiator and shroud. Connect radiator hose to pump inlet and heater hose to nipple.
3. Install fan pulley and fan blade, tighten attaching bolts securely. Install belts and adjust for proper tension.

4. Fill cooling system and check for leaks at pump and hose joints.

## RADIATOR REMOVAL AND INSTALLATION

### Removal

1. Loosen radiator cap, then remove lower radiator hose and drain radiator coolant into suitable container.
2. On vehicles with automatic transmission, unscrew oil lines from connectors on lower radiator tank and plug lines. On GT models with automatic transmission the lines have to be disconnected at the coupling before removing from the tank. It is essential that no dirt enters the oil lines. When unscrewing oil lines, hold connectors on lower radiator tank with pliers to avoid leakages. Ensure that no dirt enters oil cooler.
3. Remove lower attaching **nut** and slide radiator upward and out of engine compartment.

### Installation

1. Install **radiator** into engine compartment and secure lower attaching nut.
2. On vehicles with automatic transmissions, fasten oil cooler lines to lower radiator tank. It is essential that no dirt enters the oil lines. When tightening oil lines, hold connectors on lower radiator tank with pliers to avoid leakages. Ensure that no dirt enters oil cooler. Torque to 1 I-15 **lbs.ft.**
3. Install lower radiator hose and add collected coolant.

All Opels are provided with a radiator initial fill of an antifreeze solution containing corrosion inhibitor. The antifreeze has either a glycol or glycerin base and protects the engine against freezing, down to minus 22 degrees **F**. (minus 30 degrees **C**.). Before the start of the cold season, coolant must be checked with a hydrometer and if necessary, brought to the necessary specific gravity by **adding** anti-freeze with a glycol or glycerin base. As the specific gravities of all anti-freeze solutions having a glycol or glycerin base are practically the same, the hydrometer can **be** used for all these types. Because of the tolerances of the hydrometer, or slight differences in specific gravity, variations of plus or minus 5 degrees can be expected. Coolant must be checked at a temperature of plus 68 degrees **F**. (plus 20 degrees **C**.)

## SPECIFICATIONS

### 1973 COOLING SYSTEM CAPACITIES

Cooling System • Type .....	Liquid Cooling With Circulating Pump
Filler Cap Type • Pressure .....	13.2-15.2 PSI
Water Temperature Control .....	Thermostat and Bypass
Thermostat Open At .....	189 F.
Cooling System Capacity .....	6 Qts.
Fan Drive .....	Water Pump Shaft

# FUEL SYSTEM

## ALL MODELS

### CONTENTS

Subject	Page No.
<b>DESCRIPTION AND OPERATION:</b>	
Fuel Pump .....	6C-36
Evaporation Control System .....	6C-37
<b>DIAGNOSIS: (Not Applicable)</b>	
<b>MAINTENANCE AND ADJUSTMENTS:</b>	
Cleaning Fuel Pump Strainer .....	6C-37
Evaporation Control System .....	6C-38
<b>MAJOR REPAIR:</b>	
Fuel Tank .....	6C-39
Fuel Lines and Fuel Tank Gauge Units .....	6C-41
<b>SPECIFICATIONS:</b>	
Fuel System Specifications .....	6C-41

### DESCRIPTION AND OPERATION

#### FUEL PUMP

The 1.9 liter engine uses a push rod type fuel pump.

The push rod is actuated by an eccentric on the distributor shaft. The push rod is held in contact with the eccentric at all times by a push rod spring. Each time the push rod is on the high part of the eccentric, the lighter diaphragm spring will push the diaphragm to replace any fuel used in the carburetor. The diaphragm seldom operates through a full stroke; under normal driving conditions, the diaphragm moves only a few tenths of an inch.

Fuel pump pressure is determined by the compression of the diaphragm spring. Low pressure or pressure leak-down generally indicates a leaky diaphragm or check valves.

Two holes in the lower part of the fuel pump serve to ventilate the space below the diaphragm and to drain any fuel which may have entered. If any fuel comes from these holes, this indicates a defective diaphragm.

When replacing the fuel pump, make sure the asbestos spacer is in place with a gasket on each side. See Figure 6C-1. Because of the location of the fuel pump eccentric on the distributor shaft, the fuel pump

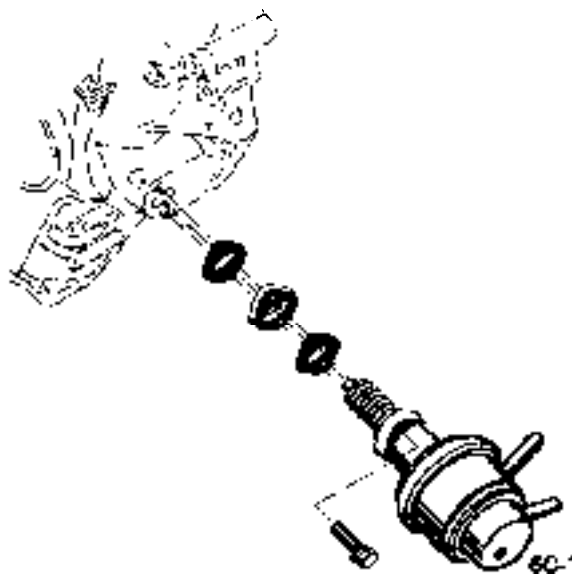


Figure 6C-1 Installing Push Rod Type Fuel Pump

must always be removed before the distributor can be removed.

**EVAPORATION CONTROL SYSTEM**

1. The function of the fuel evaporation control system is to absorb the fuel vapors developing in the fuel tank, especially when vehicle is parked, due to atmospheric pressure and temperature influences, and to release these fuel vapors during vehicle operation.

2. This system utilizes the property of the activated carbon to absorb and expel fuel vapors. The activated carbon container is installed on the left front side of the engine compartment. The fuel tank has a non-vented tiller cap. Vent hoses are joined in the area of the tank. A plastic evaporation line leads from there along vehicle underbody to the activated carbon container.

3. A small tube above the throttle valve body connects the carburetor to the activated carbon container. In this way, the fuel vapor collected in the activated carbon container is fed through the carburetor into the combustion chambers during engine operation.

4. The carburetor is provided with an internal and outside ventilation, the activated carbon container is also connected to the outside ventilation (only effective when engine is idling). In this way, the fuel vapors escaping to the outside during engine idle are collected by the activated carbon container and fed into the combustion chambers.

5. The vent lines are connected to the upper part of the activated carbon container. Fresh air enters through a foam rubber filter at the lower part and



Figure 6C-2 Carbon Canister

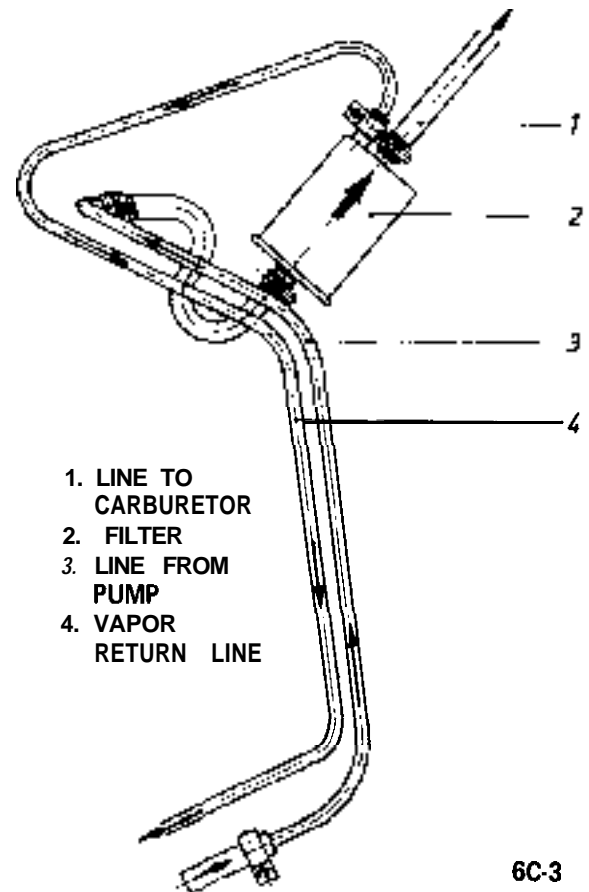
flows, together with the fuel vapor, to the carburetor. Metered bores in the hose fittings of the fuel tank control the air and fuel vapor flow through the activated carbon container to the carburetor, and the pressure release in the fuel tank and ensure complete purging of the carbon container.

Care must be taken not to mix up lines at the activated carbon container. See Figure 6C-2.

6. The metered bores in the fuel tank fitting and an overflow protection in the fuel tank, which prevents a complete filling of the tank, prevents fuel flows into the activated carbon container rendering it useless.

**FUEL FILTER**

An AC fuel filter type (GF 423) is being used on all 1973 Opels. A vapor return line returns vapors in the fuel line back to the fuel tank. Proper installation of the filter is essential. The vapor return line connector must be on top (highest point) for proper operation. See Figure 6C-3.



6C-3

Figure 6C-3 Fuel Filter

**MAINTENANCE AND ADJUSTMENTS**

**CLEANING FUEL PUMP STRAINER**



**CAUTION:** *Because the fuel pump is below fuel tank level, fuel will drain from the tank when the supply line is disconnected from the fuel pump.*

1. Pull fuel supply line and rubber connector from fuel pump. Plug rubber connector to prevent fuel loss.
2. Remove fuel pump cap, gasket and plastic strainer.
3. Cover center opening in sediment bowl with finger and blow out sediment bowl with compressed air.
4. Wash plastic strainer in solvent; if strainer does not clean-up or is damaged, replace strainer.
5. Install clean parts, noting the following:

(a) Strainer must be properly seated with projections facing upward.

(b) A new cap gasket must be positioned over strainer.

(c) Sealing ring must be in place on cap retaining screw.

6. Reconnect fuel supply line. Start engine and check for leaks.

#### EVAPORATION CONTROL SYSTEM

Proper performance of the system requires the use of a non-vented fuel tank cap, hose connections be **leak-free**, and all hoses routed correctly to avoid a pinched or blocked line.

Maintenance requirements demand only that the accumulator purge air filter, an oiled foam filter assembled in the bottom of the canister, be replaced at 12,000 mile intervals. Under extremely dusty conditions, more frequent attention may be required.

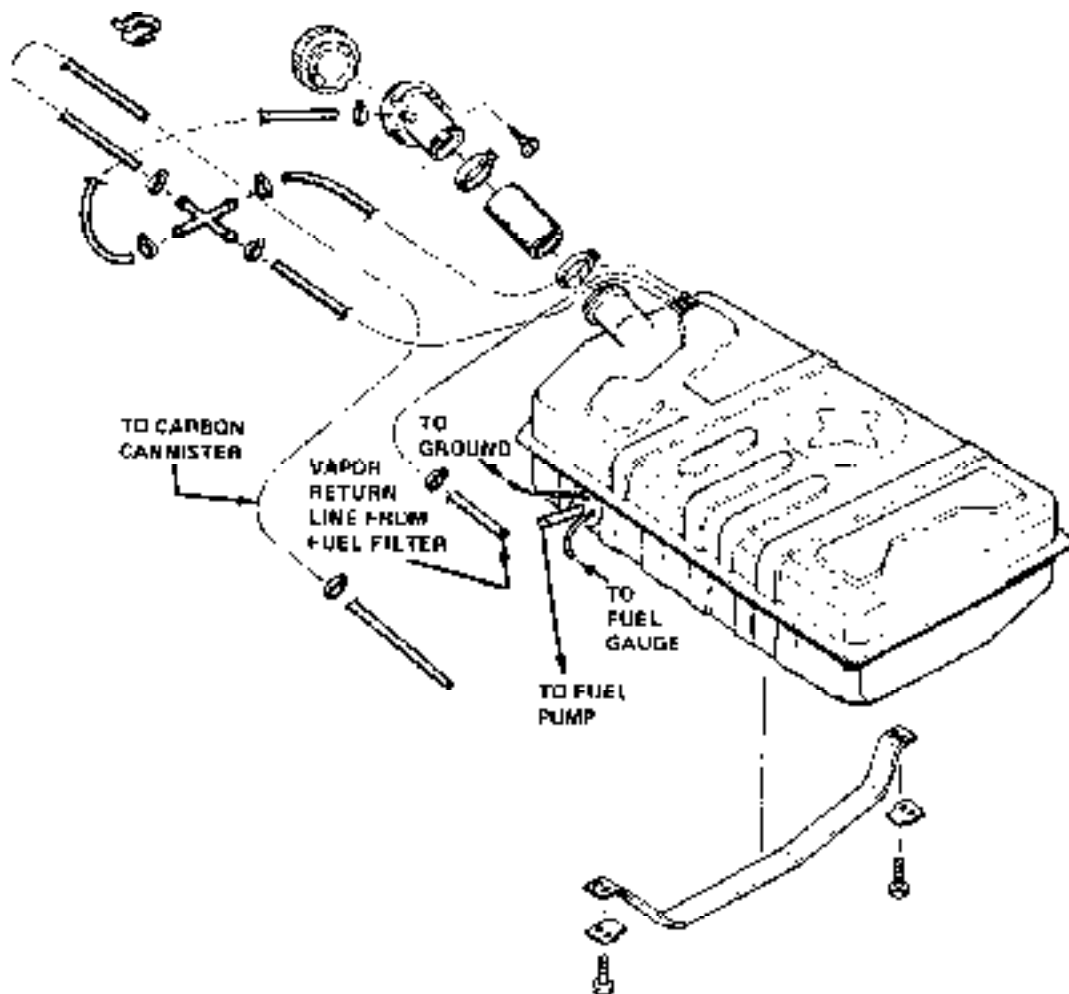


Figure 6C-4 Exploded View of Opel 1900 and Manta Fuel Tank

## MAJOR REPAIR

### FUEL TANK OPEL 1900 AND MANTA

The fuel tank is located below the luggage compartment floor panel and is attached with a strap.

The plastic tank vent hoses join in a connector from where the fuel vapors escape through a fourth hose attached to the upper flange of the tank.

On all vehicles, the vent hose is connected to an activated carbon container mounted to the front wheel house panel.

#### Removal

1. With a pinch clamp, close connecting hose between tank and fuel line. After loosening hose clamp, pull hose off fuel line. See Figure 6C-5.



Figure 6C-5

2. Take off tiller cap and unscrew tiller neck from side panel. Pull off fuel **tank** hose and plug connecting tubes on tank. See Figures 6C-4 and 6C-6.

3. With a jack and suitable support (wooden board 12 x 12"), support fuel tank **and unscrew** strap. Lower fuel tank. See Figure 6C-7.

#### Installation

1. Raise tank into position and install strap.
2. Install 4 filler neck to side panel attaching screws and filler cap.



6C-6

Figure 6C-6



Figure 6C-7

3. Install **tank** vent hoses and fuel line, taking care not to kink lines.

4. Remove pinch clamp from fuel line.

### FUEL TANK (GT MODELS)

#### Removal

1. Disconnect battery.
2. Remove rubber cap, unscrew fuel line from tank, and drain fuel. See Figure 6C-8.
3. Remove spare tire and **jack**.
4. Remove spare tire hold-down and brackets. See Figure 6C-9.
5. Remove spare tire support panel.



Figure 6C-8 Fuel Line Attachment at Tank

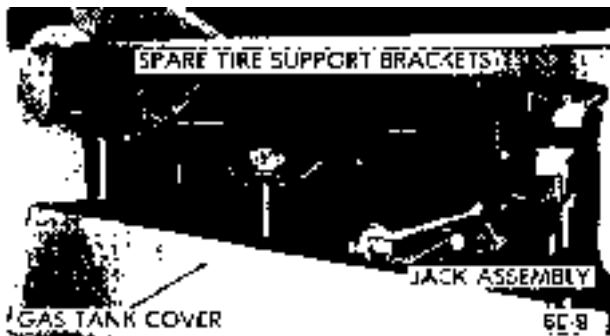


Figure 6C-9 Spare Tire Hold-Down and Brackets

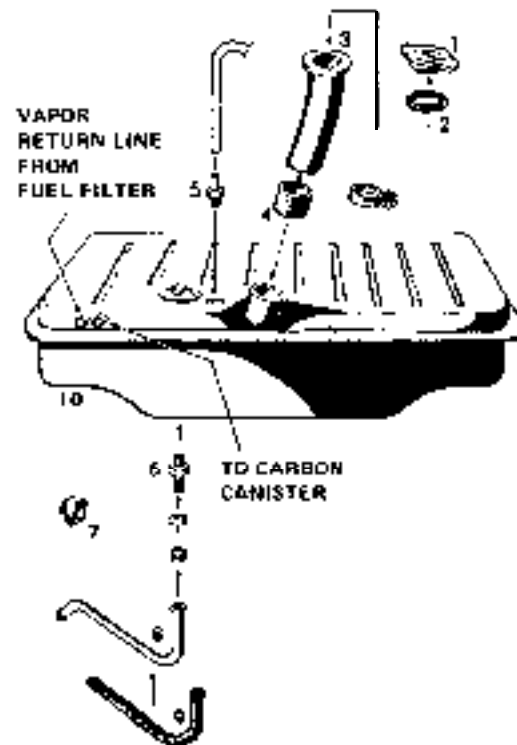


Figure 6C-10 Support Attachments

6. Remove spare tire support attaching brackets. Spare tire hold-down and support attaching brackets are attached to the rear wheel house panel and are



Figure 6C-11 Tank Vent and Filler Hoses



G.T. - FUEL SYSTEM

KEY	DESCRIPTION
1	CAP, FUEL TANK
2	GASKET, FUEL TANK CAP
3	FILLER NECK, FUEL TANK
4	HOSE, FILLER NECK
5	FITTING, FUEL TANK VENT
5	THREADED CONNECTOR, FUEL TANK
7	MOUNTING CLAMP, FUEL VENT HOSE
8	PIPE, FUEL LINE
9	CONNECTING HOSE
10	FUEL TANK, LESS GAUGE

Figure 6C-12 Exploded View of GT Gas Tank

covered with sound deadening compound. See Figure 6C-10.

7. Remove fuel tank vent hose and tiller hose. See Figure 6C- 11.

8. Remove fuel tank attaching bolts and gauge wire and remove tank.

**Installation**

1. Install tank and tighten attaching bolts.
2. Replace gauge wire. Install vent hose, making certain it is not kinked and seal vent hose hole in floor.
3. Install spare tire support attaching brackets, support panel, hold-down, and brackets.
4. Install spare tire and jack.
5. Install fuel line and rubber cap.
6. Connect battery.

**FUEL LINES. FUEL GAUGE TANK UNITS**

All fuel lines are plastic and have an outside diameter of .240 inches. Unlike metal lines, plastic lines are not flared.

When replacing a plastic line, place the line in hot water to make it flexible. Using the old line as a pattern, form the new line. Let the line cool completely, then route it in the same location as the old line. To prevent chafing against the underbody, nine (9) rubber grommets are placed at points on the line between the fuel tank and the fuel pump. When replacing fuel gauge tank units, coat gasket on both sides and first threads of attaching screws with sealing compound.

**CLEANING FUEL TANK**

1. Remove fuel tank.
2. Empty fuel tank through filler neck.
3. Remove fuel gauge tank unit, together with suction tube and screen. Clean screen and blow out from cover side. Flush fuel tank.

**SPECIFICATIONS**

Fuel Tank Capacity (Gallons)	
Opel 1900 and Manta .....	11.9
GT .....	13.2
Fuel Gauge Type .....	Electrical
Fuel Pump Type .....	Mechanical
Fuel Pump Drive .....	Eccentric on Camshaft
Fuel Pump Pressure at 1950 (RPM) .....	3.1 to 3.7 P.S.I.
Fuel Filter .....	In-Line Filter

# EXHAUST SYSTEMS

## ALL MODELS

### CONTENTS

Subject	Page No.
<b>DESCRIPTION AND OPERATION: (Not Applicable)</b>	
<b>DIAGNOSIS: (Not Applicable)</b>	
<b>MAINTENANCE AND ADJUSTMENTS: (Not Applicable)</b>	
<b>MAJOR REPAIR:</b>	
Exhaust System (All Models) .....	6D-42
<b>SPECIFICATIONS:</b>	
Torque Specifications .....	6D-42

#### MAJOR REPAIR

##### EXHAUST SYSTEM (ALL MODELS)

###### Removal

1. Remove exhaust pipe from exhaust manifold.
2. Loosen front exhaust pipe to muffler clamp and pull exhaust pipe out of muffler.
3. Remove muffler damper rings.
4. Remove center exhaust pipe clamp. Remove rear muffler and tail pipe(s) as an assembly. See Figure 6D-1.
5. Remove front exhaust pipe clamp, and remove front muffler and center exhaust pipe as an assembly, then remove center exhaust pipe from front muffler.

The front muffler and center exhaust pipe are one piece on production-built cars but are separate items for service, the tail pipe of the Rallye and GT, has a dual pipe with one resonator.

###### Installation

Check rubber damper rings for muffler and tail pipe hanger and replace as necessary.

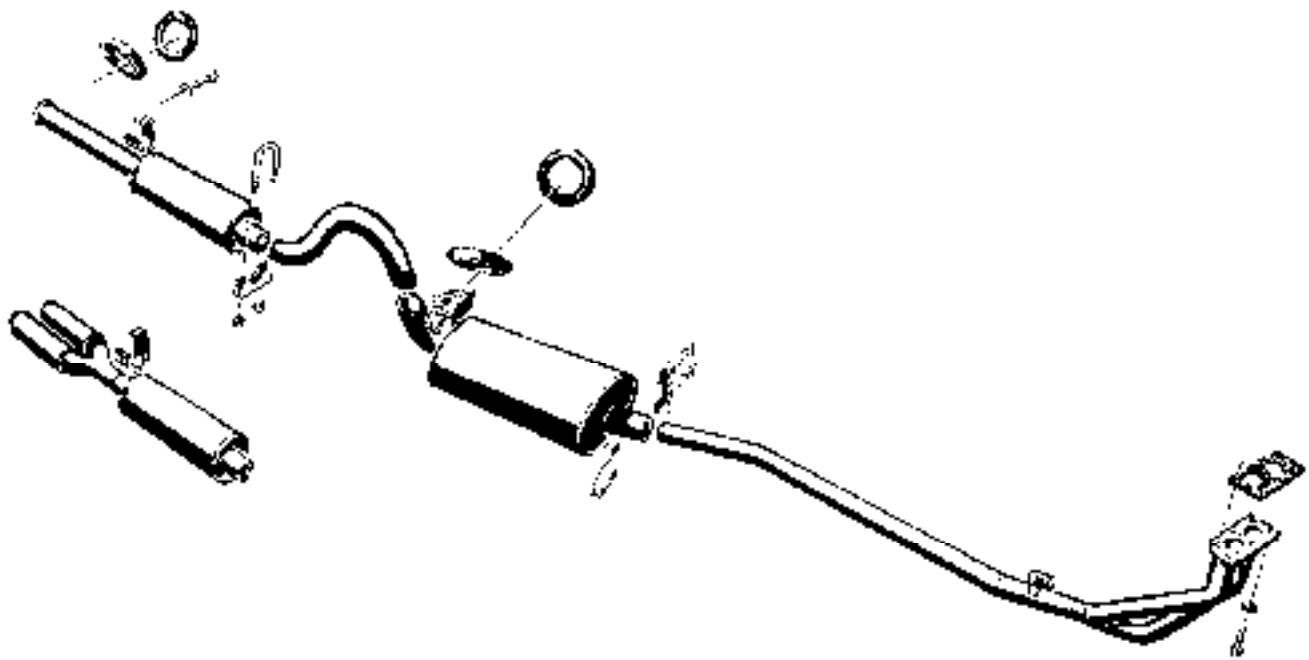
1. Coat I.D. of rear muffler inlet neck and O.D. of center exhaust pipe outlet (rear of pipe) with exhaust sealer compound (several brands are currently available on the market).

2. Insert center exhaust pipe into rear muffler and tighten clamp.
3. Coat I.D. of front muffler outlet neck and O.D. of center exhaust pipe inlet (front of pipe) with exhaust sealer compound.
4. Insert center exhaust pipe into front muffler and tighten clamp.
5. Install muffler and tail pipe assembly on rubber damper rings and tighten hangers. See Figures 6D-1 and 6D-2.
6. Install front exhaust pipe into muffler. Do not tighten clamp.
7. Be sure to install gasket between exhaust manifold and exhaust pipe. Using bolts with washers, attach the exhaust pipe to the exhaust manifold. Torque to 15 lb.ft.
8. Align exhaust system and tighten all clamps.
9. Check alignment of exhaust system; make sure that the exhaust system components have at least 3/4" clearance from the floor pan to avoid possible overheating of the floor pan.

#### SPECIFICATIONS

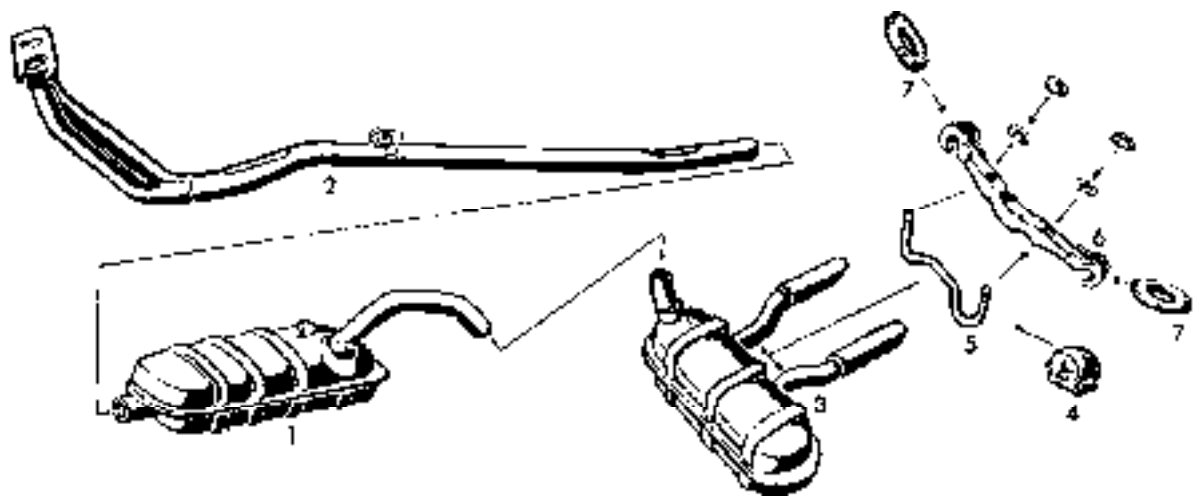
##### TORQUE SPECIFICATIONS

Exhaust Pipe to Exhaust Manifold • 15 lb.ft.



6D-4

Figure 6D-1 Opel 1900 and Manta Exhaust System



**G.T. — EXHAUST SYSTEM**

**KEY**

DESCRIPTION

- 1 MUFFLER, FRT. **W/CTR.** EXHAUST
- 2 PIPE, FRT. EXHAUST
- 3 MUFFLER, RR. W/TAIL PIPE
- 4 BUMPER, MUFFLER SUSPENSION **RR.**
- 5 BOW, MUFFLER SUSPENSION **RR.**
- 6 BRACKET, MUFFLER SUSPENSION **RR.**
- 7 DAMPER RING, MUFFLER SUSPENSION **FRONT AND REAR.**

6D-5

Figure 6D-2 GT Exhaust System

# CARBURETOR AND THROTTLE LINKAGE

## ALL MODELS

### CONTENTS

Subject	Page No.
<b>DESCRIPTION AND OPERATION:</b>	
Carburetor .....	6E-44
<b>DIAGNOSIS:</b>	
Carburetor .....	6E-49
<b>MAINTENANCE AND ADJUSTMENTS:</b>	
Idle Speed and Mixture Adjustments .....	6E-50
Fast Idle Speed Adjustment .....	6E-51
Throttle Linkage Adjustment .....	6E-51
<b>MAJOR REPAIR:</b>	
Remove and Install Carburetor .....	6E-52
Throttle Linkage Removal .....	6E-53
Overhaul Carburetor .....	6E-53
<b>SPECIFICATIONS:</b>	
Carburetor Specifications .....	6E-58

## DESCRIPTION AND OPERATION

### CARBURETOR

The two-barrel carburetor for all 1973 Opel 1900, Manta and GT models is a down-draft carburetor with two barrels of 1.25 inch diameter each. It has an automatic choke and a secondary valve operated by a vacuum diaphragm, except when installed in an Opel GT. In the GT, the secondary throttle valve is operated by mechanical linkage from the primary throttle valve.

The two-barrel carburetor consists of three main parts - throttle body, float chamber and air horn. Each barrel is a separate system, but both barrels discharge into a common inlet in the intake manifold. The secondary barrel does not have a choke valve or an accelerator pump. See Figure 6E-2.

The throttle valve of the primary barrel is opened through the throttle linkage. When the primary throttle valve is almost open, at approximately half of the maximum engine RPM, the secondary throttle

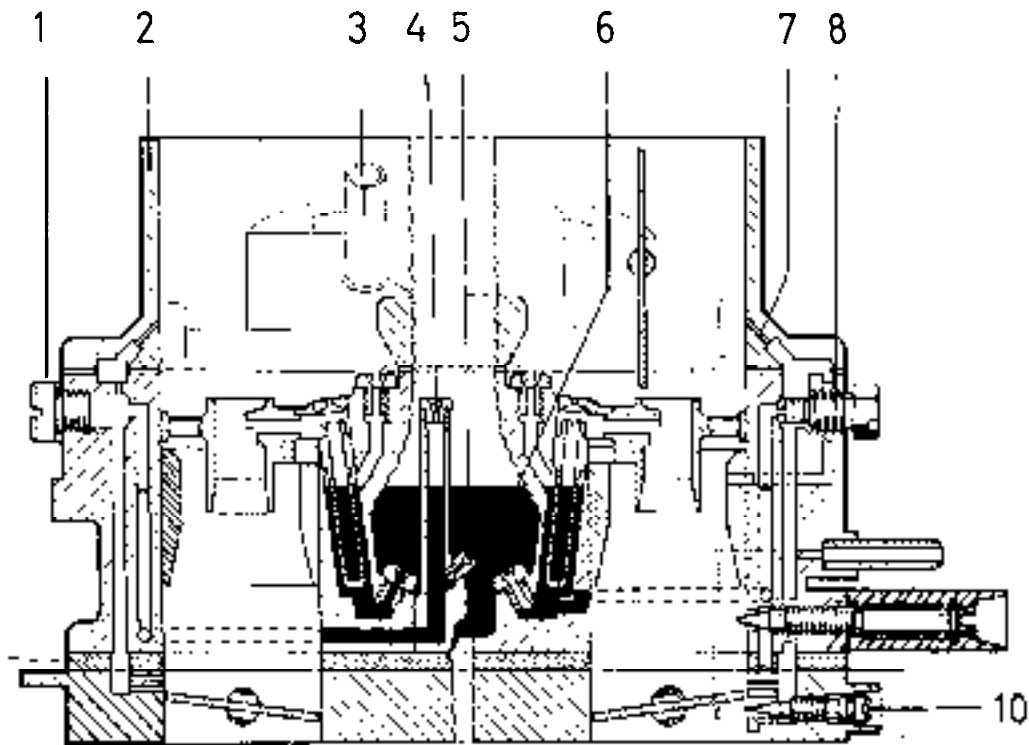
valve is opened by vacuum applied through a vacuum diaphragm case. See Figure 6E-3. The secondary throttle valve on the GT model is opened by mechanical linkage from the primary throttle shaft.

### Choke System

The automatic choke is operated by a bi-metal spring. The tension of the spring - depending on temperature of the heater coil - decreases with rising temperature and the choke valve opens progressively until it is completely opened at engine operating temperature. The choke valve is off-set so that choke valve opening increases as air flow increases.

If the choke valve is closed, the throttle valve is opened slightly to provide a fast idle speed. This is done through a cam, abutment lever and throttle connecting link. With the throttle valve opened slightly, the vacuum during cranking can take effect up to the choke valve, thereby drawing ample fuel out of the main nozzle. See Figure 6E-4.

With rising temperature of the heater coil, the choke



Sectional View Of 19 US Carburetor (both barrels)

- |  |                            |
|--|----------------------------|
| 1 Plug (transition channels, secondary barrel) | 6 Float chamber            |
| 2 Carburetor cover                             | 7 Idle air passage         |
| 3 Vent tube                                    | 8 Idle air jet             |
| 4 Transition jet                               | 9 Idle air adjusting screw |
| 5 Transition air jet                           | 10 Mixture adjusting screw |

6E-1

Figure 6E-1 Sectional View of Primary and Secondary Barrels

valve gradually opens **and the** mixture becomes leaner. During this process, the abutment lever changes position on the fast idle cam, further closing the throttle valve until, the engine is at normal operating temperature, the choke valve is wide open and the throttle valve is in slow idle position.

A choke diaphragm is connected to the intermediate lever of the choke valve spindle through a pull rod. The vacuum, which develops below the throttle valve, takes effect on the diaphragm through a vacuum passage. See Figure 6E-4. As soon as the engine starts, this vacuum pulls the choke valve slightly open; the amount of choke valve opening depends on the amount of vacuum, which depends on the engine load. Therefore, with a light engine load, the choke valve will open slightly; with a heavy engine load, the valve will close slightly to give a richer mixture as required for this engine load.

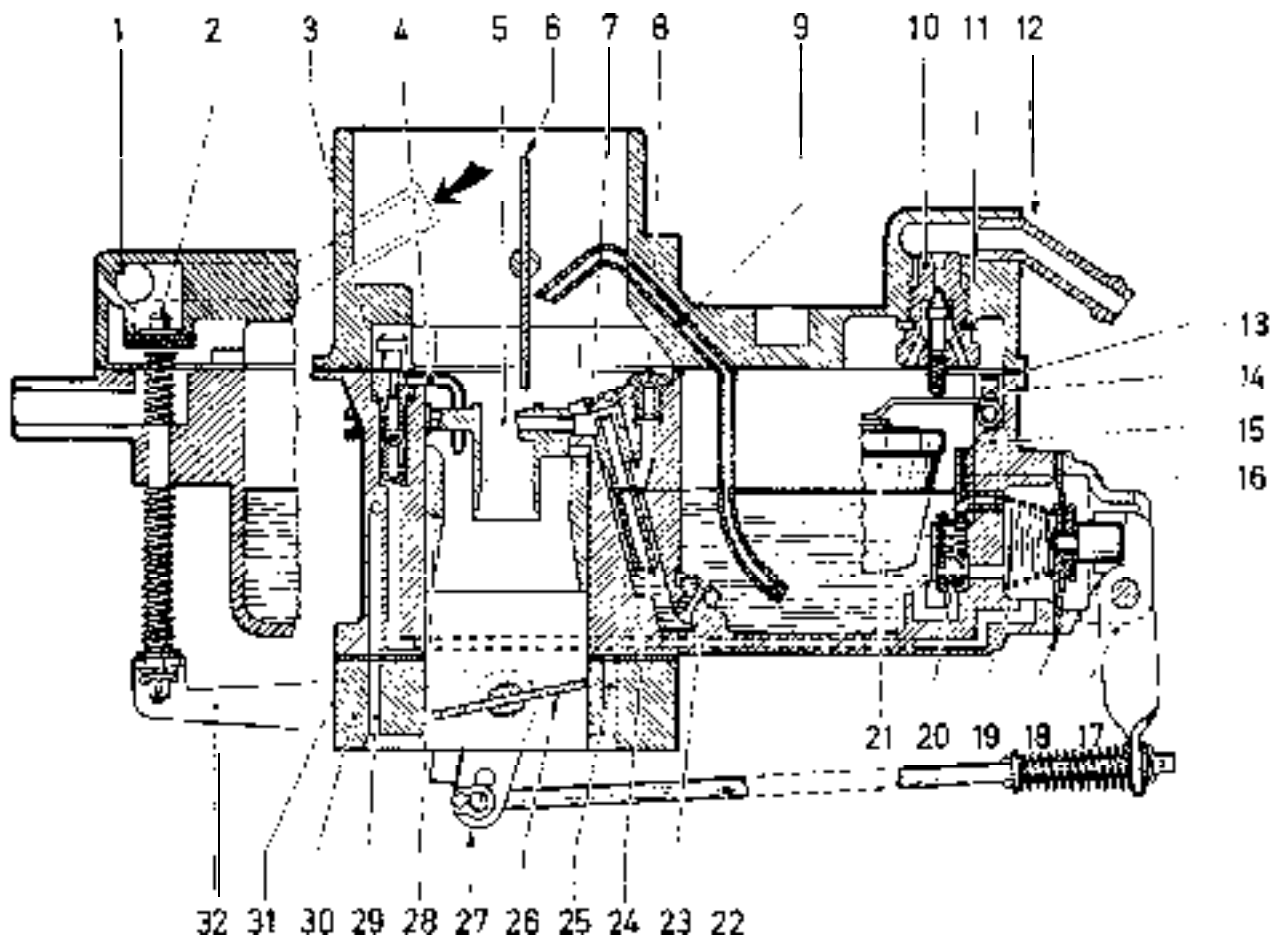
Before starting a cold engine slowly, depress the **accelerator** pedal three times before engaging the starter.

**Idle and Part Throttle System**

At engine idle **and** during low speed (part throttle) operation, fuel is drawn from the emulsion tube bore, controlled by the idle jet and mixed with air entering **through** idle air **bleeds** (Figure 6E-1) **and** ports in the throttle body. This mixture is drawn downward to the three ports near the throttle valve. When the throttle valve is closed, the mixture is drawn from the lowest port and mixed with air by-passing the throttle valve to form the idle mixture.

Turning the idle mixture screw (Figure 6E-1) inward results in a leaner mixture, and turning it out results





Sectional View Of Carburetor

- |                                 |                                       |
|---------------------------------|---------------------------------------|
| 1 Carburetor cover              | 17 Pump lever                         |
| 2 Vent valve                    | 18 Diaphragm                          |
| 3 Ball valve (pressure valve)   | 19 Diaphragm spring                   |
| 4 Injection tube                | 20 Ball valve (suction valve)         |
| 5 Primary venturi               | 21 Float                              |
| 6 Choke valve                   | 22 Pump connecting rod                |
| 7 Vent jet                      | 23 Metering jet                       |
| 8 Air correction jet            | 24 Emulsion tube                      |
| 9 Enrichment                    | 25 Bore without function              |
| 10 Float needle valve           | 26 Throttle valve                     |
| 11 Float needle valve seal ring | 27 Intermediate lever                 |
| 12 Fuel line connecting tube    | 28 Main venturi                       |
| 13 Carburetor cover gasket      | 29 Vacuum passage for automatic choke |
| 14 Leaf spring                  | 30 Throttle valve body                |
| 15 Float chamber                | 31 Gasket                             |
| 16 Pressure reduction valve     | 32 Vent valve lever                   |

Figure 6E-2 Sectional View of Carburetor

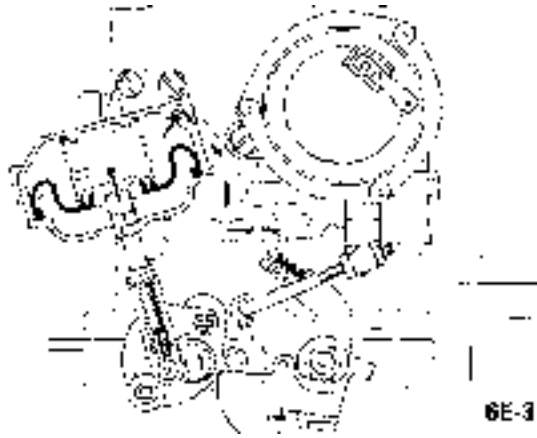


Figure 6E-3 Secondary Vacuum Diaphragm

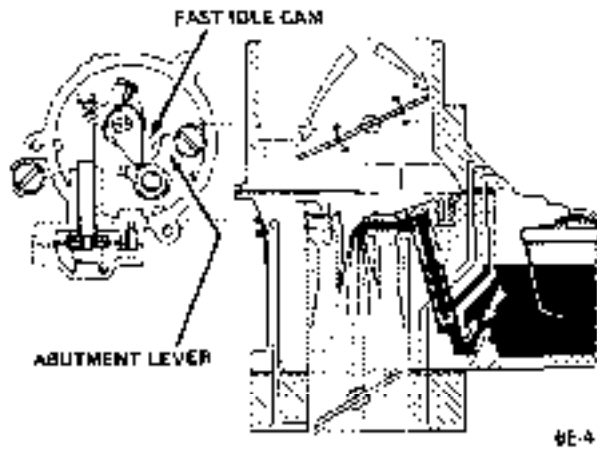


Figure 6E-4 Automatic Choke System

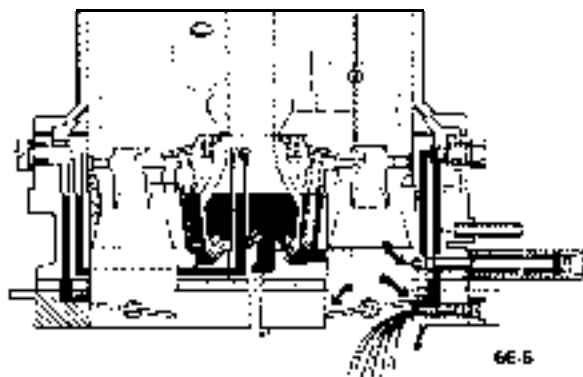


Figure 6E-5 Idle System

in a richer mixture. When the throttle valve is opened, fuel is also drawn from the upper ports, providing a good transfer from the idle system to the main metering jet system. See Figure 6E-5.

**Main Metering Jet System**

During high-speed operation, fuel is drawn from the float chamber through the main metering jet (Figure 6E-2) into the emulsion tube bore. The emulsion tube, which is provided with transverse bores, is inserted in the emulsion tube bore. Vacuum in the primary venturi (Figure 6E-2) draws fuel from the main nozzle. As the vacuum increases, the tendency is to draw too much fuel from the main nozzle, making the mixture too rich. To compensate for this tendency, the fuel level drops in the emulsion tube bore and more emulsion tube transverse bores are exposed. Air from the high speed air jet (Figure 6E-2) enters the emulsion tube through these transverse bores and mixes with the fuel. The more the fuel level drops, the more the transfer bores are exposed. This causes the air-fuel ratio to remain constant over the whole engine speed range. See Figure 6E-6.

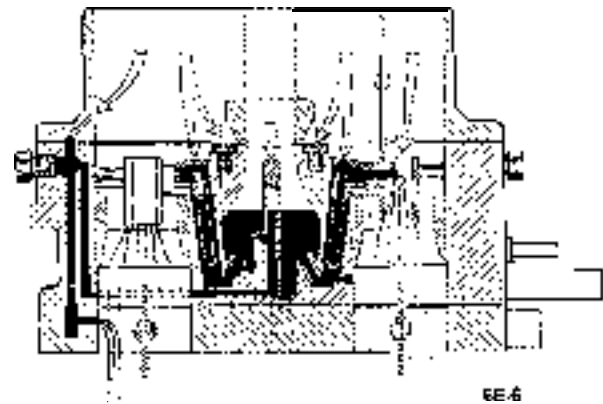


Figure 6E-6 High Speed System

The secondary valve diaphragm is operated by vacuum taken from the mixing chamber of the primary barrel on the Opel 1900 and Manta only. With the primary throttle valve almost open and with engine speed at approximately half of the maximum engine RPM, vacuum increases to such an extent that the secondary throttle valve starts opening from vacuum applied in the vacuum diaphragm case acting through a connecting rod and throttle valve lever. See Figure 6E-3.

**Primary to Secondary Transfer System**

In order to have a smooth engagement of the second-

ary barrel, it is provided with a transfer system. When the secondary throttle valve starts to open, two ports (which are normally just above the closed valve) are uncovered, causing fuel to feed into the secondary bore just before the secondary nozzle starts feeding. This provides for an additional enrichment of the air-fuel mixture at the beginning of full throttle operation. See Figure 6E-7.

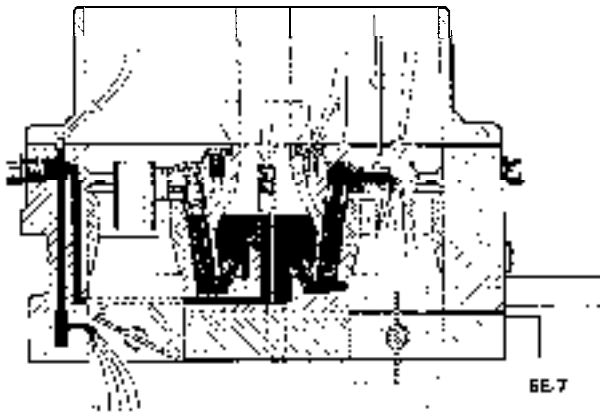


Figure 6E-7 Primary to Secondary Transfer System

### Full Throttle Enrichment System

If the secondary throttle valve is fully opened, the vacuum in the throttle valve area is reduced so that the transfer ports (mentioned above) stop feeding. However, the vacuum increases greatly in the secondary venturi area. An enrichment tube which protrudes into the primary venturi area, feeds fuel continuously during full throttle operation. See Figure 6E-2.

### Acceleration System

Whenever the throttle is closing, the suction stroke of the diaphragm pump causes fuel to flow from the float chamber through the inlet ball valve into the pump chamber. When the throttle valve is opened the diaphragm is moved inward by the pump connecting rod **and** the pump lever. Fuel is injected into the primary bore through the injector tube. The amount of fuel is determined by the pump stroke.

The inlet ball valve in the pump chamber prevents fuel from flowing back into the float chamber during the pressure stroke of the pump. The outlet ball valve prevents air from being drawn into the injector tube during the suction stroke of the pump. See Figure 6E-8.

### Float Bowl Ventilation

While driving, the float bowl is ventilated from inside

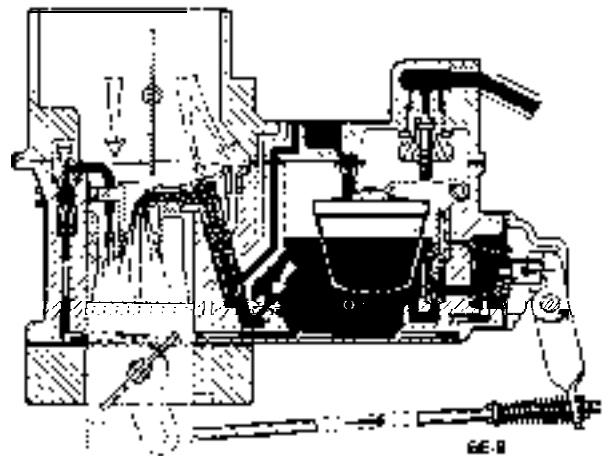


Figure 6E-8 Acceleration System

the carburetor. That is, the float bowl is connected through the vent valve with the area under the air cleaner.

When the engine is idling or off, the ventilation from inside is cut off and ventilation from the charcoal canister is cut in. The upper spring now seats the valve on the upper seat. See Figure 6E-9.

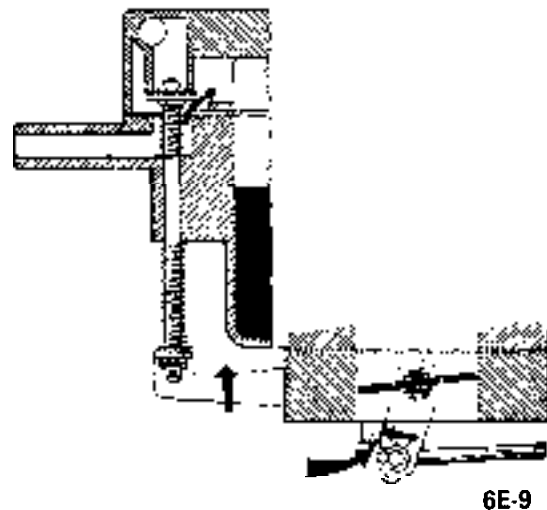


Figure 6E-9 Float Bowl Ventilation

The advantage of an inside vent while driving is that air cleaner restriction does not **enrichen** the air fuel mixture. The purpose of the charcoal canister vent while idling or after shutting-off a hot engine, is to prevent **excess** fuel vapors from entering **the intake manifold** and outside air. Excess fuel vapors may cause an idling engine to stall, or may make it difficult to restart a hot engine.

**DIAGNOSIS**

**CARBURETOR**

Condition I

*Hesitation or Stall Upon Light Acceleration*

Correction

1. Check spark plugs and plug gap. Plug gap should be .030 in.
2. Check dwell and timing.
3. Adjust carburetor.
4. Accelerator pump should discharge fuel between throttle plate and venturi wall with engine off. If aim is not correct, use needlenose pliers to slightly bend nozzle so proper aim is achieved. See Figure 6E- 10.

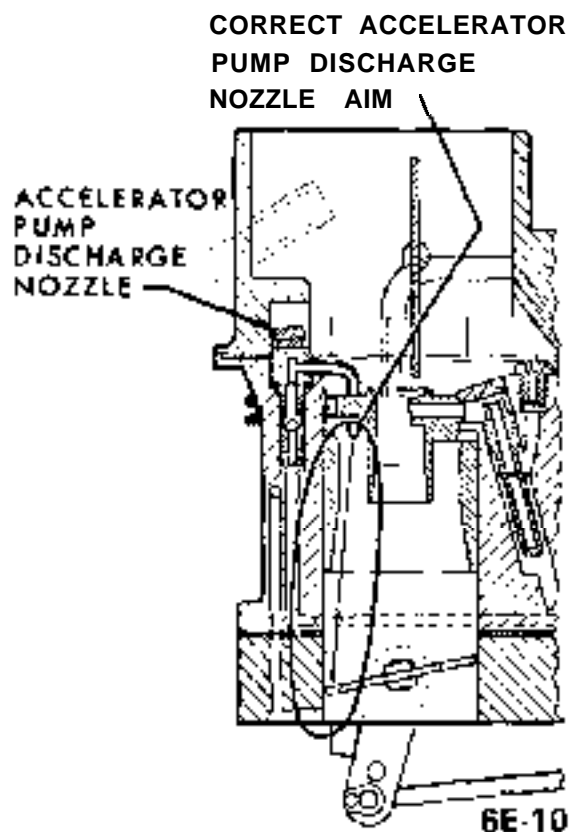


Figure 6E-10 Pump Shot Aim

*Road test car. If hesitation still exists, check for the following:*

1. Plugged accelerator pump discharge nozzle.

2. Dirt in accelerator pump circuit.
3. Defective inlet check ball.
4. Defective accelerator pump pressure relief valve.
5. Defective accelerator pump diaphragm.
6. Maladjusted accelerator pump linkage.

**Condition II**

*Hard Start After Hot Soak*

Correction

Perform Steps 1-4 in Condition I.

**Condition III**

*Hard Start When Engine Is Cold*

Correction

1. Align groove on choke cover with pointer on choke housing. See Figure 6E-17.
2. Set fast idle.
3. Replace distributor points if pitted.
4. Check spark plugs and gap at .030.
5. Set dwell and timing.

If above procedure does not correct problem, replace with new automatic choke assembly.

**Condition IV**

*Rough, Erratic, or No Idle*

Correction

1. Check spark plugs and gap at .030.
2. Check dwell angle and ignition timing.
3. Clean idle jet and passages with air hose. See Figure 6E-5.
4. Check manifold to head bolt torque. Should be 33 lb.ft.
5. Check automatic choke linkage alignment.
6. Adjust carburetor.

## MAINTENANCE AND ADJUSTMENTS

### IDLE SPEED ADJUSTMENT

**Note:** Idle speeds of 600 to 800 R.P.M. are normal for engines with less than 3,000 miles.

Prior to making any adjustment to the carburetor, the following items must be checked for proper operation and/or setting:

1. Valve Adjustment (Hydraulic lifters can be improperly adjusted.)
2. Dwell Angle.
3. Ignition Timing.
4. Spark Plug Gap.
5. Exhaust Gas Recirculation Valve (See "Checking" under EXHAUST GAS RECIRCULATION SYSTEM.)

After it has been ascertained that the above items are properly adjusted and operating correctly and idle R.P.M. is still not within specifications, proceed as follows:

1. With air cleaner installed, run engine until normal operating temperature is reached.
2. Remove plastic caps from the idle mixture screw and air speed screw. See Figure 6E-11.

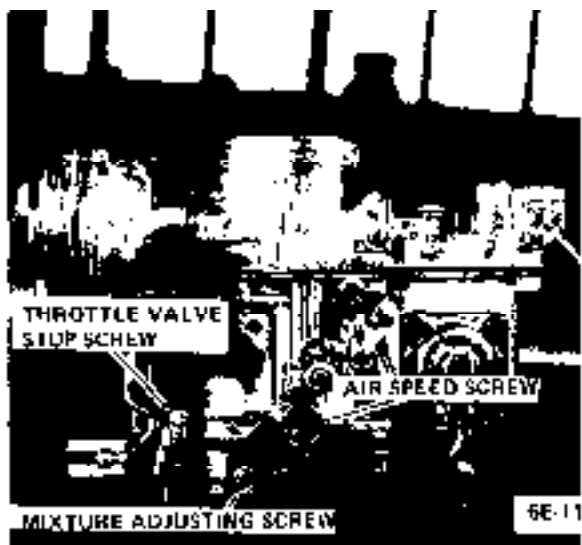


Figure 6E-11 Carburetor Adjusting Screws

3. To raise R.P.M., turn air speed screw counter-clockwise. To lower R.P.M., turn air speed screw clockwise, thereby reducing the amount of air going through the system.

4. Adjust idle mixture screw until highest R.P.M. is obtained. Alternately adjust idle mixture screw and air speed screw until R.P.M. is obtained that is 50 R.P.M. higher than the desired final setting. This is to be accomplished with the idle mixture screw at best idle.

5. Turn idle mixture screw clockwise (lean) until a decrease of 50 R.P.M. is obtained. The idle R.P.M. will now be within specifications and proper emission control maintained.

6. Install red plastic caps over the air speed screw and idle mixture screw.

### Basic Idle Adjustment

A basic idle adjustment is to be made only if engine idle R.P.M. correction does not result in correct idle R.P.M. setting and engine has more than 3,000 miles of operation. If necessary, proceed as follows:

1. Remove plastic cap from the throttle valve stop screw. See Figure 6E-11.

2. Place the Manometer (J-23951) in a vertical position. Turn the 2 vents on top open to equalize pressure and balance gauge to read zero. With engine idling, unplug the vacuum advance hose from the carburetor and connect the manometer hose in its place. See Figure 6E-12.

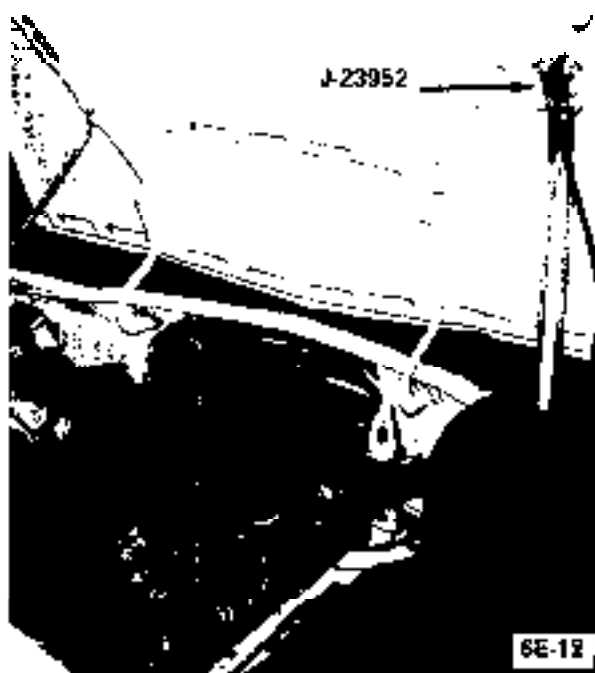


Figure 6E-12 Throttle Plate Calibrator J-23951 Installed

3. If the manometer does not read 1 to 8 inches of

water, adjust the throttle stop screw to read 6 inches of water (3 inches down and 3 inches up).

4. Disconnect manometer and reconnect the vacuum advance hose.

5. Adjust idle air speed screw and mixture screw to obtain maximum idle at 850 to 900 R.P.M. (automatic transmission) or 900 to 950 R.P.M. (manual transmission).

6. Make final adjustment by turning idle mixture screw in to reduce idle speed 50 R.P.M.

7. Install red plastic caps over the air speed screw and idle mixture screw. Replace plastic cap over the throttle valve stop screw and secure in place with Loctite.

### Fast Idle Speed Adjustment

1. Remove air cleaner cover.
2. With engine off, open the throttle halfway and close the choke valve, release the throttle, then release the choke.
3. Start engine without moving the throttle. Adjust to 3200 to 3300 R.P.M. using 2 nuts on fast idle rod. See Figures 6E-13 and 6E-14.



Figure 6E-13 Decreasing Fast Idle Speed

### CARBURETOR LINKAGE ADJUSTMENT

#### GT Series

1. Remove air cleaner.
2. Have helper depress accelerator pedal to floor and check to see if wide open throttle is reached at carburetor.
3. If adjustment is necessary, proceed as follows:



Figure 6E-14 Increasing Fast Idle Speed

- (a) Unhook accelerator pedal return spring.
- (b) Remove lock spring at upper end of vertical control rod and detach rod.
- (c) Lengthen or shorten control rod so that wide open throttle is obtained at the carburetor when accelerator pedal is 1/4" + 1/2" from floor mat.
- (d) Reinstall rod, lock spring and pedal return spring.

#### Opel 1900 and Manta Series

The carburetor **bowden** control wire is properly adjusted if, with correctly-adjusted engine idle speed, engine at operating temperature and accelerator pedal at an angle of 25 degrees to the vertical plane, the ball (A) of the carburetor **bowden** control wire rests against the accelerator pedal lever. See Figure 6E-15.

1. Position accelerator pedal at an angle of 25 degrees to the vertical plane. To do this, loosen lock nut of adjusting bolt (c) and **unscrew** adjusting bolt a few turns.

Squeeze a 1 3/8" wood block (D) between accelerator pedal and dash panel. See Figure 6E-15.

Screw in adjusting bolt until the accelerator pedal lever releases the wood block (D). Tighten lock nut.

2. Adjust **bowden** control wire at adjuster. See Figure 6E-16. Prior to doing this, adjust engine idle speed with engine at operating temperature.

Set carburetor **bowden** control wire adjuster at the bracket so that the ball (A) of the control wire rests against part (B) of the accelerator pedal lever and the wire core between bracket and segmental disc is not sagging.

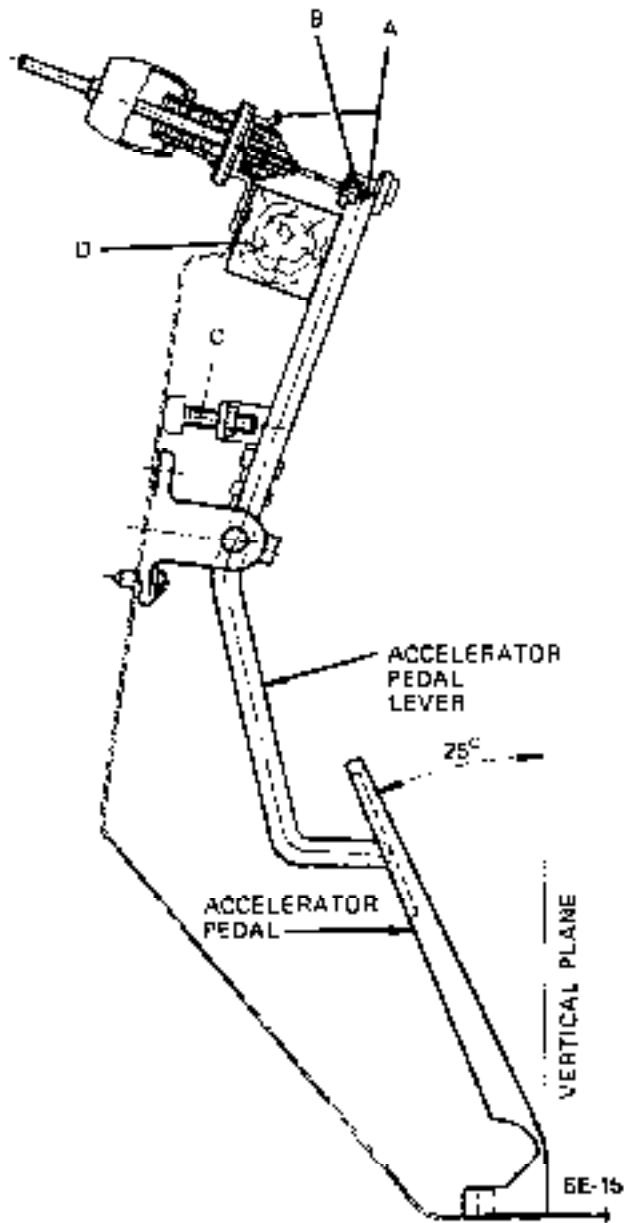


Figure 6E-15 Adjusting Accelerator Cable

Depress accelerator pedal until pedal lever touches floor mat. The carburetor throttle valve must now be completely opened.

## MAJOR REPAIR

### REMOVE AND INSTALL CARBURETOR

1. Remove air cleaner.
2. Remove fuel and vacuum hoses from carburetor fittings.
3. Remove choke wire.

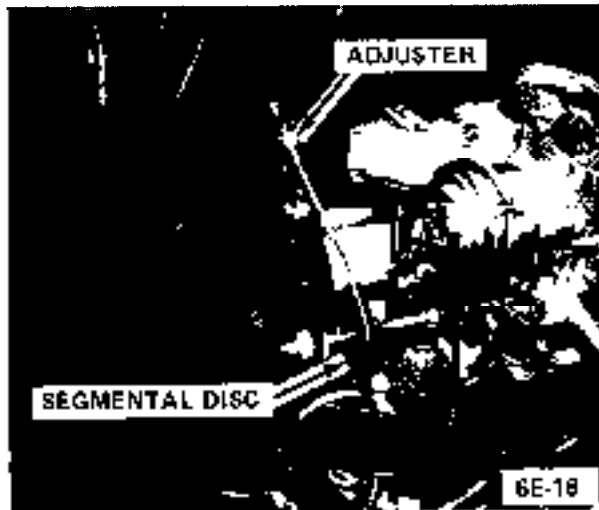


Figure 6E-16 Bowden Control Wire Adjuster and Segmental Disc

4. Disconnect throttle linkage by removing lock pin and unsnapping ball socket from ball on end of throttle shaft.
5. Remove carburetor by removing four nuts and lockwashers.

Install in reverse order, noting the following:

1. Prior to carburetor installation, place a new gasket on intake manifold.
2. Make certain that all nuts and screws on the carburetor are securely tightened.
3. Make sure that choke housing is set on index and that choke valve is nearly closed at room temperature. See Figure 6E-17. Make sure choke valve is free in all positions.

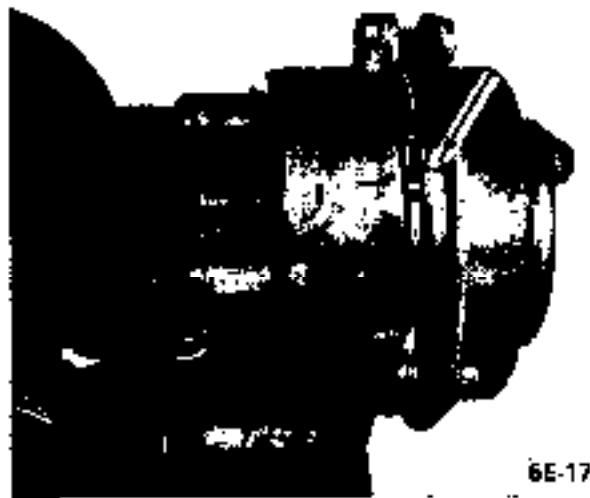


Figure 6E-17 Choke Housing Set on Index

- Adjust engine idle speed and mixture

**CAUTION:** : *Make sure choke valve opens fully before starting idle adjustment.*

### THROTTLE LINKAGE REMOVAL

#### Removal

#### *Opel 1900 and Manta Series*

- Remove control wire from bracket and unhook it from segmental disc. See Figure 6E-16.
- In passenger compartment, unhook wire with ball and plastic bushing from accelerator pedal lever. See arrow in Figure 6E-18.



Figure 6E-18 Unhook Wire in Passenger Compartment

- In engine compartment, pull bowden control wire out of bracket on dash panel.

If bowden control wire is kinked or damaged in any way, it must be replaced.

#### Installation

- Feed ball and plastic bushing from engine compartment through opening in dash panel and hook in accelerator pedal lever. See Figure 6E-19.
- Lightly pull wire core so that the plastic bushing slips into bore of accelerator pedal lever.
- Hook bowden control wire in segmental disc and attach control wire to bracket.

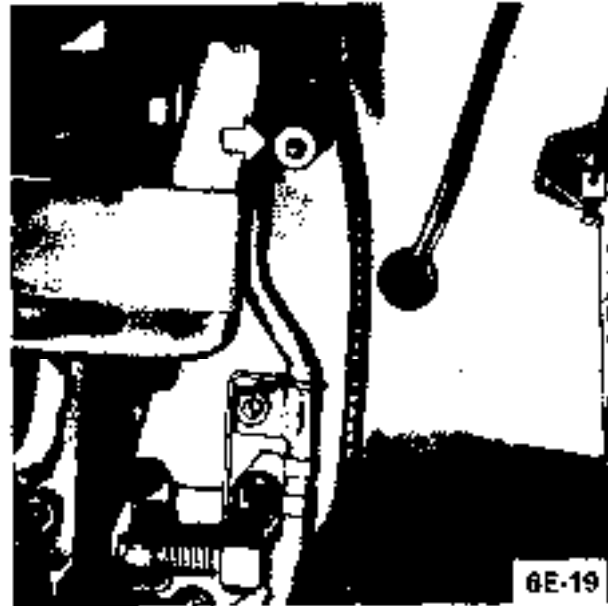


Figure 6E-19 Installing Ball and Plastic Bushing

- Adjust control wire.

### OVERHAUL CARBURETOR

#### Disassembly

- Remove outer nut from end of throttle lever to choke link. See Figure 6E-20.

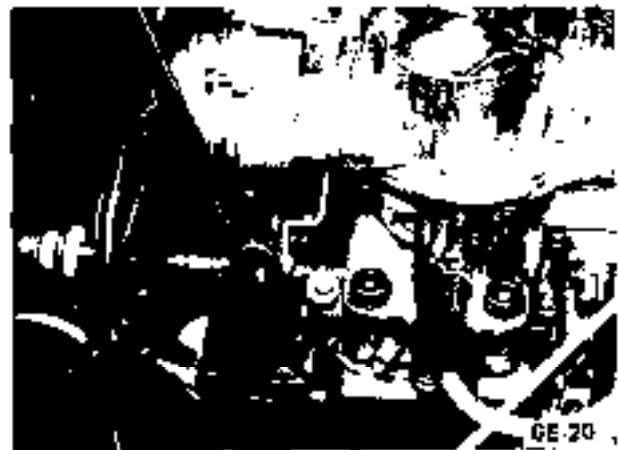


Figure 6E-20 Removing Choke Link

- Pry off vacuum case connecting lever. See Figure 6E-21.
- Unscrew carburetor cover.
- Screw float needle valve out of carburetor cover and take off copper seal ring.



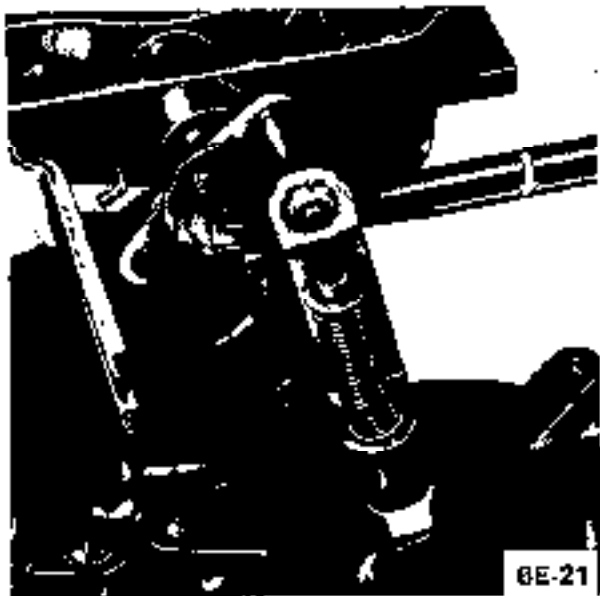


Figure 6E-21 Removing Vacuum Case Lever



Figure 6E-23 Removing Vacuum Case Reduction Jet

5. Unscrew vacuum diaphragm cover from choke housing. See Figure 6E-22.

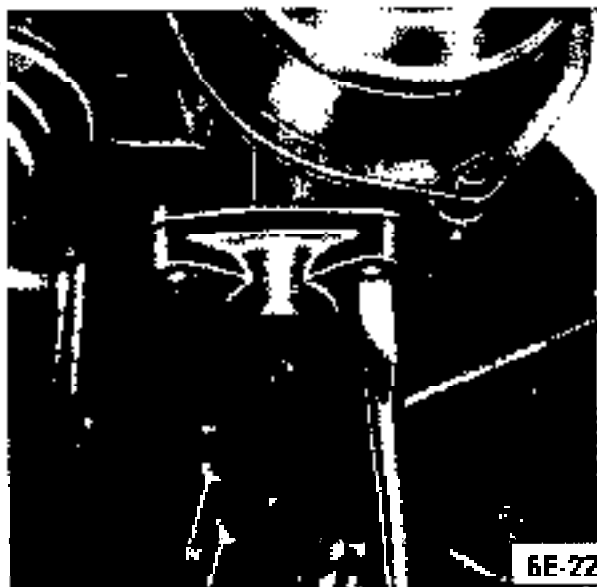


Figure 6E-22 Removing Vacuum Diaphragm Cover

6. Unscrew retaining ring from automatic choke body and take off cover.

7. Unscrew vacuum diaphragm case from carburetor cover. Remove reduction jet. See Figure 6E-23.

8. Take float together with spindle and leaf spring from float chamber.

9. Pull accelerator pump discharge nozzle assembly

out of carburetor housing. Nozzle is press fitted. See Figure 6E-24.

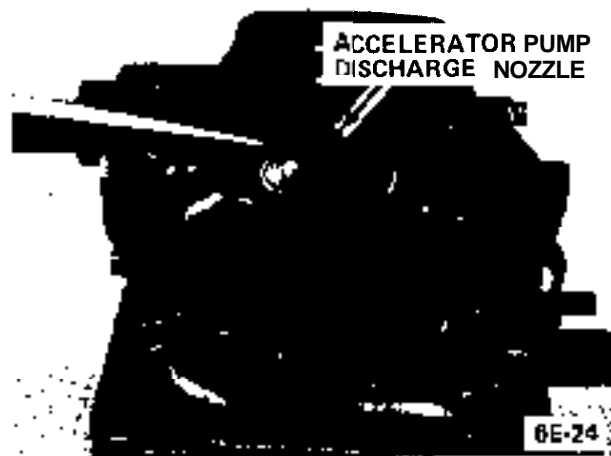


Figure 6E-24 Removing Accelerator Pump Discharge Nozzle

10. Remove primary idle jets and secondary idle plug. Remove primary and secondary high-speed air jets.

11. Remove primary and secondary main metering jets.

12. Remove cotter pin from pump connecting rod. Remove accelerator pump.

13. Remove idle mixture adjusting screw from throttle valve body. Remove idle air adjusting screw from

float chamber. Clean all parts and blow out with compressed air. Replace gaskets and seal rings.

14. Check actuating parts in automatic choke body, including diaphragm, for wear. Check pull rod for free operation. See Figure 6E-25.

15. Remove choke assembly by removing choke valve and 2 choke housing - to - carburetor screws.

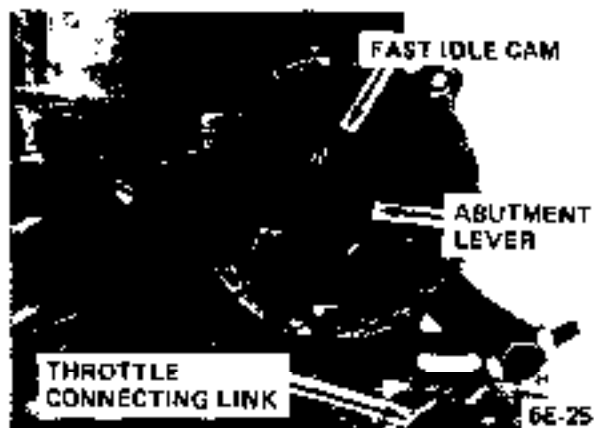


Figure 6E-25 Checking Automatic Choke Parts

16. Check vacuum case assembly. If bushing is worn, replace vacuum case assembly. See Figure 6E-27.



Figure 6E-27 Checking Vacuum Case Brass Bushings

17. Install secondary vacuum diaphragm case assembly. See Figure 6E-28.

18. Install gasket and shield between automatic choke cover and automatic choke body.



Figure 6E-28 Installing Vacuum Case Assembly

19. Install automatic choke cover so that the catch of the bi-metal spring is positioned onto bent end of the intermediate lever. See Figure 6E-29.



Figure 6E-29 Installing Automatic Choke Cover

20. Align and tighten automatic choke cover. Choke valve should be nearly closed at room temperature.

21. Check vent valve for free operation. Valve rod must not be bent.

22. Screw in jets according to calibration table. Never interchange parts of the primary and secondary barrel. See Figure 6E-37.

23. Install the throttle body to the bowl, using new throttle body gasket. Adjust secondary throttle valve gap by loosening lock nut on the secondary throttle

valve stop screw. Loosen the stop screw until the valve is completely closed. Turn the screw in 1/4 turn from **closed** position, hold, and tighten lock nut. This is done to insure that the throttle blade will not stick closed. See Figure 6E-30.



Figure 6E-30 Adjusting Secondary Throttle Valve Gap

24. Install accelerator pump connecting rod in lower hole of primary throttle shaft lever and cotter pin in outboard hole at accelerator pump actuating lever end. Paying attention to proper arrangement of cotter pin and washers. See Figure 6E-2.

25. With throttle plate completely closed, there should be no clearance between the pump lever and the pump plunger rod.

26. If a clearance is present, loosen 4 accelerator

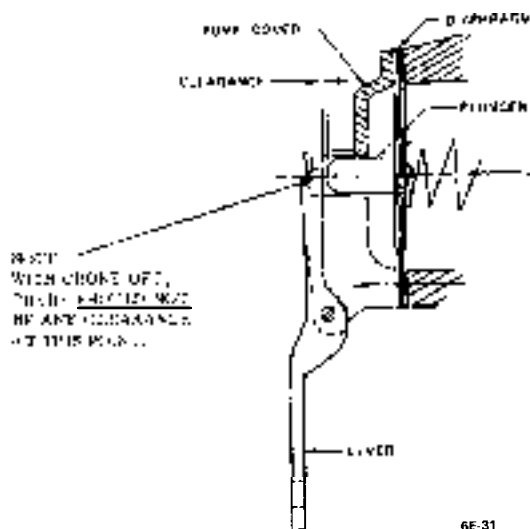


Figure 6E-31 Accelerator Pump Cover

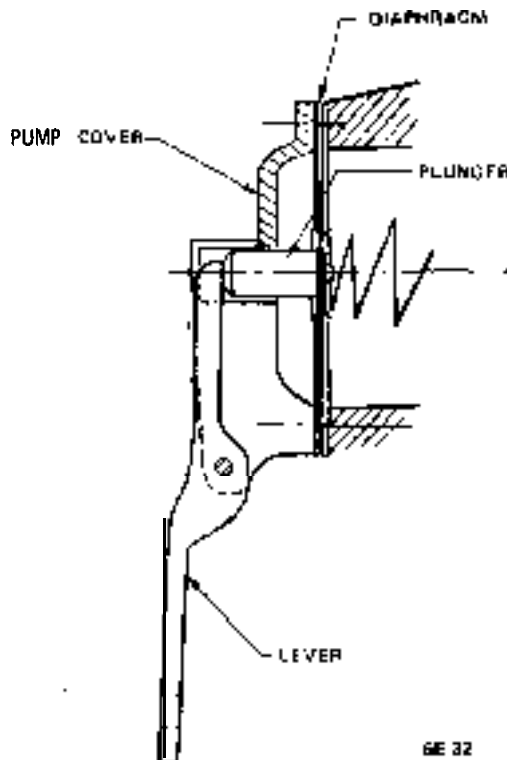


Figure 6E-32 Accelerator Pump Cover

pump cover retaining screws and allow the diaphragm spring to push plunger against lever so that a zero clearance exists. Then retighten the screws. See Figures 6E-31 and 6E-32.

27. Insert accelerator pump discharge nozzle so that the bent tube end points into suction channel of the primary barrel.

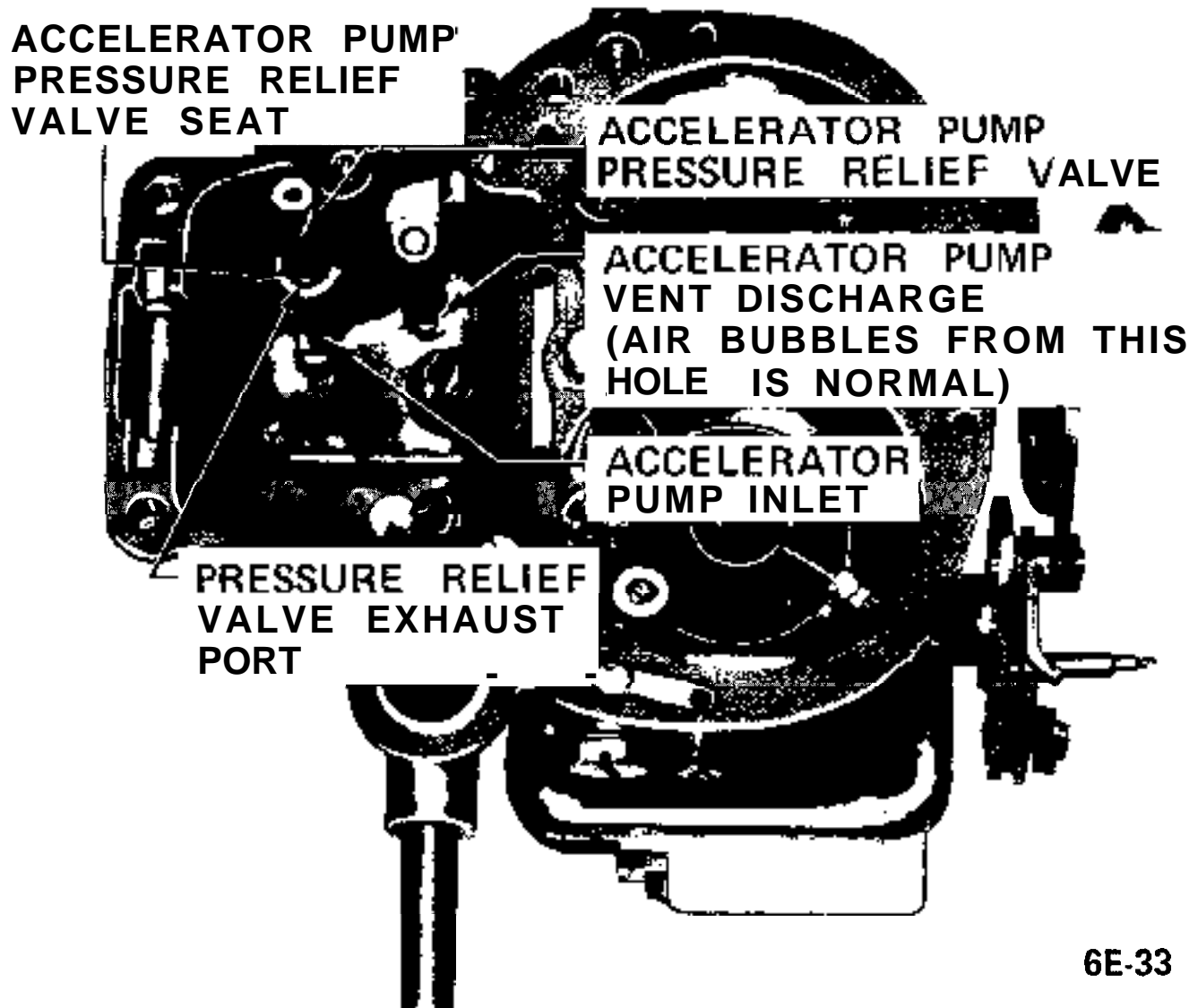
28. Fill the bowl with fuel.

29. With fuel in bowl, slowly open the throttle and observe the accelerator pump pressure relief valve exhaust ports and where it seats into the bowl. See Figure 6E-33. Fuel should not be bleeding back into the bowl from the exhaust ports or where the relief valve seats, but a steady stream of fuel should discharge from the discharge nozzle.

30. With fuel in bowl, rapidly open the throttle and observe the exhaust ports of the pressure relief valve. See Figure 6E-33. **Fuel should exhaust from** the accelerator pump pressure relief valve exhaust ports.

31. If the pressure relief valve malfunctions, remove it and replace with a new one.

32. No float adjustment is possible, so check position of float arm by comparing with a new float of the same carburetor type. If float arm is bent, replace float.



6E-33

Figure 6E-33 Carburetor Fuel Bowl

33. Install float and pivot rod making sure rod is seated in casting.

34. Install leaf spring so that spring ends rest on float spindle. See Figure 6E-34.

35. Screw in float needle valve together with copper seal ring (.08 in. thick).

36. Install new air horn gasket so that the holes in the gasket coincide with the screw holes in carburetor housing. See Figure 6E-35.

37. On vent valve, pay attention to cotter pin position and arrangement of washers.

38. Basic adjustment of idle mixture adjusting screw is 5 turns open.



Figure 6E-34 Leaf Spring Installed

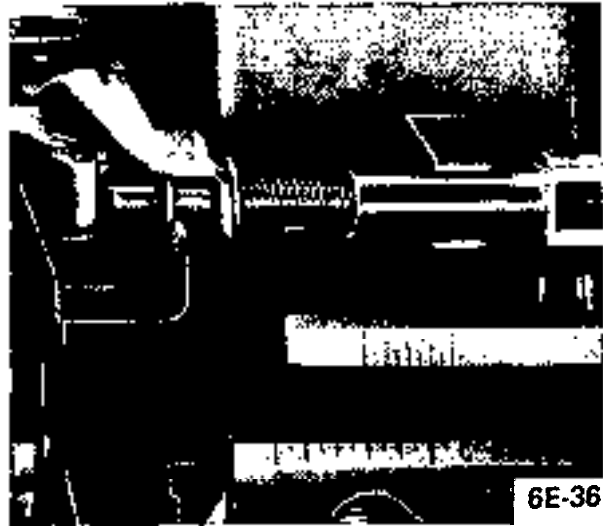


Figure 6E-36 Checking Vent Valve Adjustment



Figure 6E-35 Installing Cover Gasket

39. Check compression of vent valve lower spring. It should be compressed 1/4 inch with throttle valve completely closed. See Figure 6E-36.

40. Correct by bending valve lever.

## SPECIFICATIONS

### GENERAL SPECIFICATIONS

Compression Ratio .....	7.6 to 1
Fuel Required .....	Low Lead
Fuel Tank Capacity (Gallons)	
Opel 1900 and Manta.. .....	11.9
GT.. .....	13.2
Fuel Gauge Type .....	Electrical
Fuel Pump Type .....	Mechanical
Fuel Pump Drive .....	Eccentric on Camshaft
Fuel Pump Pressure at 1950 RPM .....	3.1 to 3.7 psi
Fuel Filter .....	In-Line Filter
Carburetor Make and Type .....	1-Solex 2 BBL Automatic Choke
Air Cleaner Element Type .....	Fiber Mesh • Paper

1970 OPT. CARBURETOR SPECIFICATIONS

	Manta & 1966 Monza Transmission	Manta & 1966 Automatic Transmission	C. T. Manual Transmission	G. T. Automatic Transmission
Carburetor Tag No.	3441475	3441496	3441426	3441827
Primary Main Metering Jet	X122.5	X122.5	X120	X120
Secondary Main Metering Jet	X155	X155	X157.5	X157.5
Primary Air Correction Jet	120	120	120	119
Secondary Air Correction Jet	80	80	120	120
Idle Jet	47.5	47.5	45	45
Accelerator Pump Discharge Nozzle	50	50	50	50
Fast Idle Setting	3200-3300 R. P. M.	3200-3300 R. P. M.	2275-2300 R. P. M.	3200-3300 R. P. M.
Primary Venturi	.94 (24)	.94 (24)	.94 (24)	.94 (24)
Secondary Venturi	1.10 (28)	1.10 (28)	1.10 (28)	1.10 (28)

6E-57

Figure 6E-37 Carburetor Specifications

# EMISSION CONTROL SYSTEMS

## ALL MODELS

### CONTENTS

Subject	Page No.
<b>DESCRIPTION AND OPERATION:</b>	
Description and Operation of O.E.C.S. ....	6F-60
Exhaust Gas Recirculation System .....	6F-62
<b>DIAGNOSIS:</b>	
Testing Thermo Air Cleaner Operation .....	6F-62
Exhaust Gas Recirculation System .....	6F-63
<b>MAINTENANCE AND ADJUSTMENTS:</b>	
Exhaust GAS Recirculation System .....	6F-63
<b>MAJOR REPAIR:</b>	
Removal and Replacement of O.E.C.S. Units .....	6F-63
<b>SPECIFICATIONS:</b>	
Opel Emission Control System Specifications .....	6F-64

## DESCRIPTION AND OPERATION

### OPEL EMISSION CONTROL SYSTEM (O.E.C.S.)

All 1973 cars must be capable of passing certain tests which measure the quantity of unburned impurities in the exhaust system. Federal law places a limit on the hydrocarbon and carbon monoxide emissions from the exhaust system. The purpose of this law is to keep the atmosphere cleaner, particularly in populous areas where these impurities add to the smog problem. Basically, excessive exhaust emissions are caused by incomplete combustion of the air-fuel mixture in the cylinders.

The basic components of the OECS on the 1.9 liter engines are (1) leaned out carburetion, (2) heated air (except GT), and (3) tuned spark timing.

(1) The carburetor idle system is leaned out and special features are incorporated into the carburetors to make possible additional idle mixture adjustments over and above those manufactured into the carburetors.

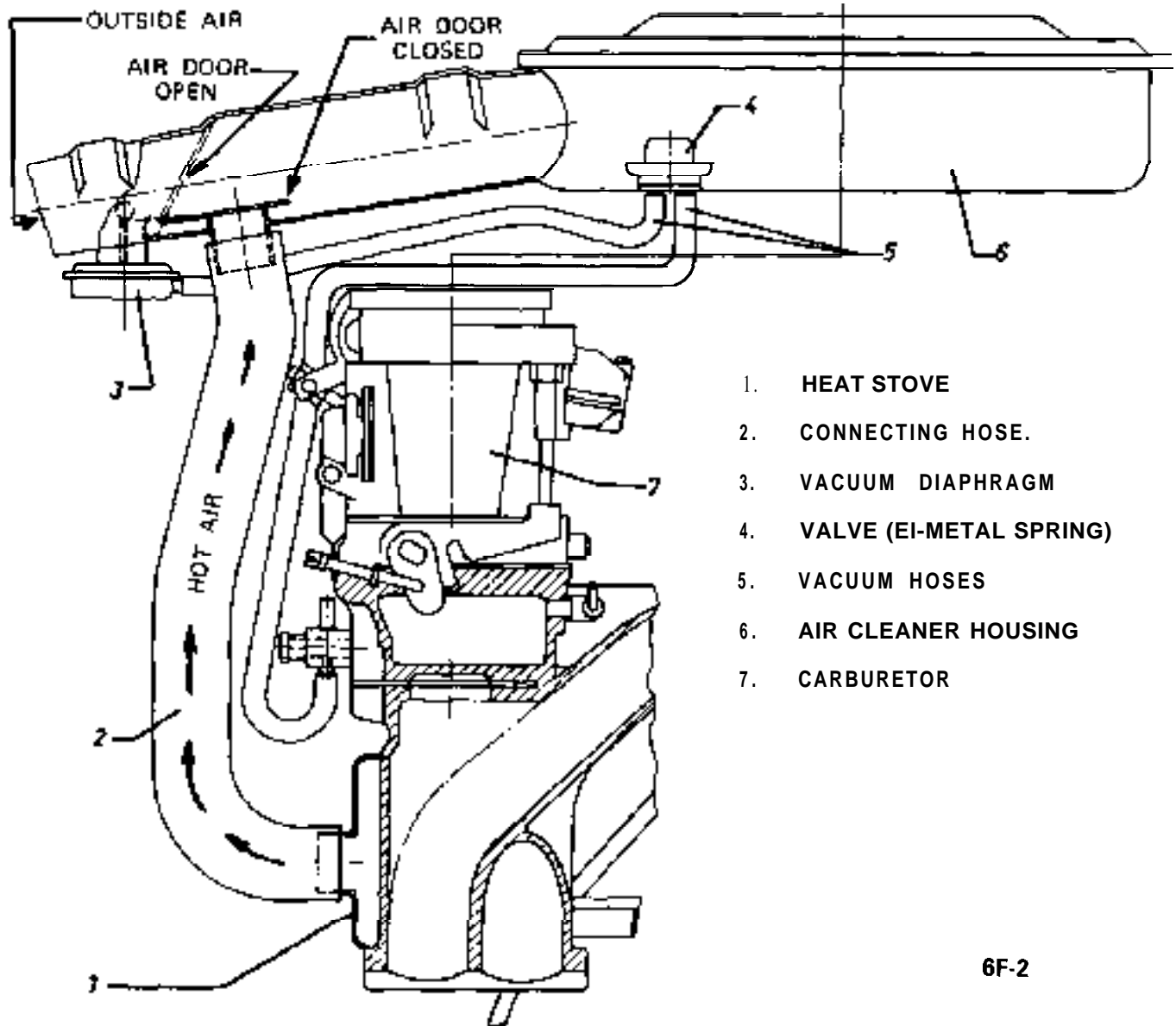
(2) The heated air package consists of a heat stove, a corrugated paper heated air pipe, and an air cleaner

containing a temperature controlled door operated by vacuum through a temperature sensor. See Figure 6F-1.

The heat stove is a sheet metal cover, shaped to and bolted onto the exhaust manifold. Air drawn in along



Figure 6F-1 Heated Air System Installed



1. HEAT STOVE
2. CONNECTING HOSE.
3. VACUUM DIAPHRAGM
4. VALVE (EI-METAL SPRING)
5. VACUUM HOSES
6. AIR CLEANER HOUSING
7. CARBURETOR

6F-2

Figure 6F-2 Heated Air System

the lower edge of the stove passes across the manifold surface, picking up heat. The heated air is drawn out from the upper end of the manifold, through the heated air pipe into the snorkel of the air cleaner. See Figure 6F-2.

The temperature control air cleaner is designed to mix this heated air with cold air from under the hood so that carburetor inlet air temperature averages about 115 degrees. This mixing is done by an air door located in the air cleaner snorkel. Most of the time, the door will be partially open, as required, to control the temperature. When the underhood temperature reaches about 135 degrees, the door will close tight, not allowing any more warm air from the manifold to enter the snorkel of the air cleaner. Obviously, if underhood temperatures rise above 135 degrees, the

air cleaner will no longer be able to control **temperature** and the inlet air temperature will rise with **underhood** temperature.

The temperature door is moved by a diaphragm type vacuum motor. When there is no vacuum present in the motor, the diaphragm spring forces the door closed. Whenever the engine is running, the amount of vacuum present in the vacuum motor depends on the temperature sensor in the air cleaner which is located in the vacuum line between the intake manifold and the vacuum motor. In the sensor, a bi-metal temperature sensing spring starts to open a valve to bleed more air into the vacuum line whenever the temperature in the air cleaner rises above about 115 degrees. Whenever the temperature falls below about 115 degrees, the sensing spring starts to close the air



bleed into the **vacuum** line, allowing more manifold vacuum to reach the vacuum motor. Whenever there is nine inches or more of vacuum in the vacuum motor, the diaphragm spring is compressed, the door is opened.

When the engine is not running, the diaphragm spring will always hold the door closed. However, when the engine is running, the position of the door depends on the air temperature in the air cleaner.

When starting a cold engine (air cleaner temperature under 85 degrees), the air door will open immediately. This is because the air bleed valve in the sensor is closed so that full manifold vacuum, is applied in the vacuum motor. As soon as the air cleaner starts receiving hot air from the heat stove, the sensor will cause the air door to close partially, mixing cold air with the hot air as necessary to regulate air cleaner temperature within 20 degrees of the ideal 115 degrees air inlet temperature.

If underhood air temperature rises to 135 degrees, the air bleed valve in the sensor will be wide open so that vacuum to the vacuum motor approaches zero. The diaphragm spring in the vacuum motor will hold the air door closed tightly. If underhood temperature rises above 135 degrees, carburetor inlet air temperature will also rise above 135 degrees.

While air cleaner temperature is being regulated, accelerating the engine hard will cause the vacuum level in the intake manifold and in the vacuum motor to drop. Whenever vacuum drops below 5 inches, the diaphragm spring will close the air **door** in order to get the **maximum** outside air flow required for maximum acceleration.

The carburetor is set by the manufacturer for 800-850 RPM (automatic transmission) or 850-900 RPM (manual transmission) and 1.5 to 2.5 percent CO.

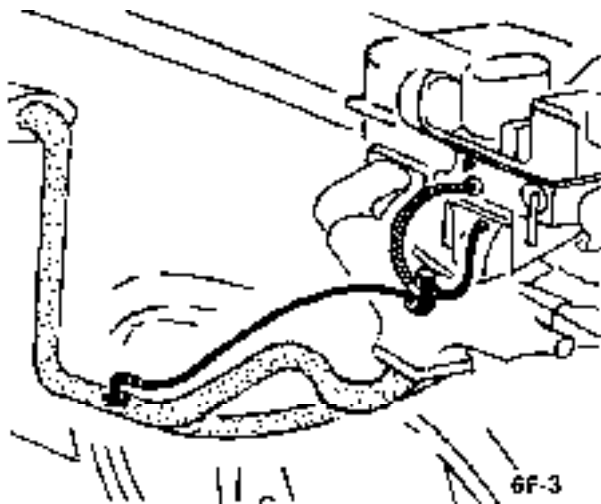


Figure 6F-3 E.G.R. System

## EXHAUST GAS RECIRCULATION SYSTEM

All 1973 Opel 1900's, Manta's and GT's are equipped with an exhaust gas recirculation (E.G.R.) system. See Figure 6F-3.

The E.G.R. system consists of a pipe connected to the center of the front exhaust pipe, an E.G.R. valve, a short pipe from the valve to the intake manifold and a short vacuum hose from the E.G.R. valve to the base of the carburetor. See Figure 6F-4.

The system does not receive sufficient vacuum at idle to operate, but will operate during acceleration and part throttle providing sufficient intake manifold vacuum is present.

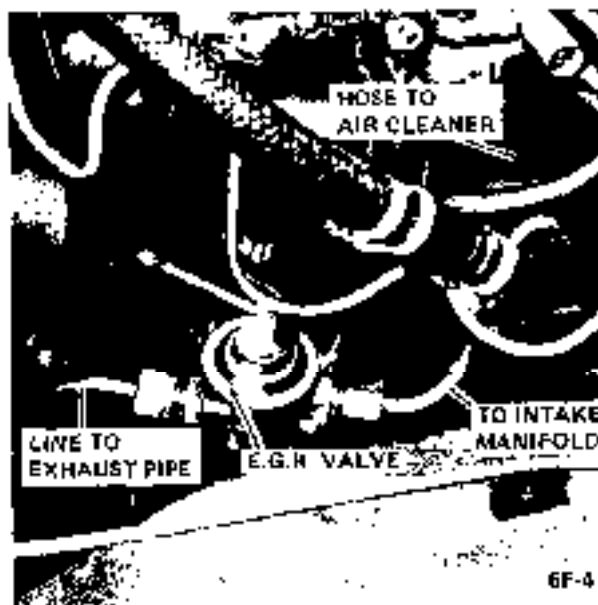


Figure 6F-4 E.G.R. Valve Location

## DIAGNOSIS

### TESTING THERMO AIR CLEANER OPERATION

Since failure of the **thermo** air cleaner will generally result in the snorkel air door staying open, failure will probably go unnoticed in warm or hot weather. In cold weather, however, owners will complain of **leaness**, hesitation, sag, surge, or stalling. When any type of lean operation complaint is received, always test the thermo air cleaner for **proper** functioning before doing any work on the carburetor.

Always perform checks in the same order as listed below.

### Vacuum Motor Check

1. Check all hoses for proper hookup. Check for kinked, plugged, or damaged hoses.

2. With the engine "OFF", observe damper door position through snorkel opening. If position of snorkel makes observation difficult "se the aid of a mirror. At this point damper door should be in such a position that the heat stove passage is covered (snorkel passage open). If not, check for binds in linkage.

3. Apply at least nine in. Hg. of vacuum to diaphragm assembly through hose disconnected at sensor "nit. This can be done by mouth. Damper door should completely close snorkel passage when vacuum is applied. If not, check to see if linkage is hooked up correctly and for a vacuum leak.

4. With vacuum applied, bend or clamp hose to trap vacuum in diaphragm assembly. Damper door should remain in position (closed snorkel passage). If it does not, there is a vacuum leak in diaphragm assembly. Replace diaphragm assembly.

#### Sensor Check

##### Quick Check of System:

1. Start test with engine cold, air cleaner at a temperature below 85 degrees. If the engine has been in recent "se, allow it to cool.
2. Observe the air door before starting the engine: it should be closed.
3. Start the engine and allow it to idle. Immediately after starting the engine, the air door should open.
4. As the engine warms up, the air door should start to close, and the air cleaner should become warm to the hand.
5. The system is operating normally as described above. If the air cleaner fails to operate as above or if correct operation of the air cleaner is still in doubt, proceed to the thermometer check.

##### Thermometer Check of Sensor:

1. Start test with air cleaner temperature below 85 degrees. IF ENGINE HAS BEEN RUN RECENTLY, ALLOW IT TO COOL DOWN. While engine is cooling, remove air cleaner cover and install a temperature gage such as J- 22973 as close as possible to sensor. Reinstall air cleaner cover. Let car stand idle for 1/2 hour or more before proceeding to step 2.
2. Start the engine. Air door should open immediately if engine is cool enough. When air door starts to close (in a few minutes), remove air cleaner cover and read temperature gage. It must read 115 degrees plus or minus 20 degrees.
3. If air door does not start to close at temperature

indicated, temperature sensor is defective and must be replaced.

#### EXHAUST GAS RECIRCULATION SYSTEM

##### Testing

The exhaust gas recirculation valve is to be checked at 12,000 mile intervals "sing the following procedure:

1. With engine at operating temperature, connect a tachometer to engine and note R.P.M. at idle.
2. Disconnect vacuum hose at the intake manifold that goes to the air cleaner.
3. Disconnect vacuum hose for exhaust gas recirculation valve from the throttle valve and connect it to the intake manifold where vacuum hose to air cleaner was connected.
4. Engine speed should decrease between 100-240 R.P.M. from previously noted R.P.M.
5. If the R.P.M. decrease is less than 100 R.P.M., the exhaust gas recirculation valve and fitting going into the intake manifold must be removed, cleaned, and reinstalled.

#### MAINTENANCE AND ADJUSTMENTS

##### EXHAUST GAS RECIRCULATION SYSTEM

##### Cleaning

Clean the exhaust gas recirculation valve and fitting with a piece of stiff wire removing all exhaust deposits.

**CAUTION:** *Do not soak in solvent. After reinstalling the valve and fitting, check operation as outlined under "Testing". If valve does not operate properly after a thorough cleaning, replace it.*

#### MAJOR REPAIR

##### REMOVAL AND REPLACEMENT OECS UNITS

The damper door is not serviceable. The air cleaner assembly must be replaced if the damper door is defective.

##### R And R Vacuum Motor

1. Remove vacuum motor retainer spring. See Figure 6F-5.



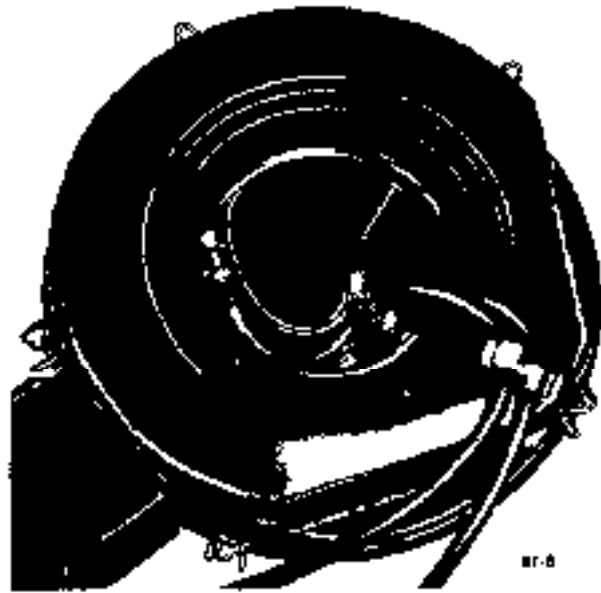
6F-5

Figure 6F-5 Replacing Vacuum Motor Assembly

2. Lift vacuum motor, cocking it to one side to unhook motor linkage at the control door.
3. Install in reverse sequence.

**R And R Air Cleaner Sensor**

1. Remove sensor retaining clips by prying. See Figure 6F-6.
2. Pull vacuum hoses from sensor.
3. Note carefully the installed position of the sensor



6F-6

Figure 6F-6 Replacing Sensor Assembly

- so that you can install new sensor in same position. Then remove sensor.
4. Install sensor and gasket assembly in air cleaner in same position as noted in Step 3. This is to eliminate the possibility of interference with the air filter element. See Figure 6F-4.
  5. Install sensor retaining clip. Meanwhile supporting sensor around the outside rim to prevent damage to the temperature sensing spring.
  6. Reinstall vacuum hoses.

**SPECIFICATIONS**

**EMISSION CONTROL SYSTEM SPECIFICATIONS**

Carburetor Inlet Air Regulated Temperature .....	115" ± 20
Idle Mixture Setting (Lean From Best Idle) .....	50 RPM
<b>Thermo</b> Vacuum Switch Operating Temperature .....	220
Engine Thermostat Operating Temperature .....	189

# TUNE-UP

## ALL MODELS

### CONTENTS

Subject	Page No.
<b>DESCRIPTION AND OPERATION:</b>	
Purpose of a Tune-Up .....	<b>6G-65</b>
<b>DIAGNOSIS: (Not Applicable)</b>	
<b>MAINTENANCE AND ADJUSTMENTS:</b>	
Engine Tune-Up Mechanical Operations .....	<b>6G-65</b>
Engine Tune-Up Instrument Checks .....	<b>6G-67</b>
<b>MAJOR REPAIR: (Not Applicable)</b>	
<b>SPECIFICATIONS:</b>	
Tune-Up Specifications and Adjustments .....	<b>6G-68</b>

### DESCRIPTION AND OPERATION

#### PURPOSE OF TUNE-UP

The purpose of an engine tune-up is to restore power and performance that may have been lost through, loss of adjustment, wear, corrosion, or deterioration of one or more parts or units. In the normal operation of an engine, these changes take place gradually at quite a number of points so that it is seldom advisable to attempt an improvement in performance by correcting one or two items only. Time will be saved and more lasting results will be assured by following a definite and thorough procedure of analysis and correction of all items affecting power and performance. Because of Federal laws, limiting exhaust emissions, it is even more important that the engines tune-up is done accurately, using the specifications listed and the tune-up sticker found in each engine compartment.

Economical, trouble free operation can better be assured if a complete tune-up is performed at first 4 months or 6,000 miles of operation - then at 12 month or 12,000 mile intervals.

The parts or units which affect power and performance may be divided, into three groups (1) compression, (2) ignition and (3) carburetion. The tune-up procedure should cover these groups in the order given. While the items affecting compression and ignition may be handled according to individual preference, correction of items in the carburetion

group should not be attempted until all items in compression and ignition have been satisfactorily corrected.

### MAINTENANCE AND ADJUSTMENTS

#### ENGINE TUNE-UP OPERATIONS

##### Compression

To make sure hydrocarbon and carbon monoxide emissions will be within limits, it is very important that the adjustments be followed exactly.

The suggested procedure for engine tune-up *is* as follows:

1. Remove all spark plugs.
2. Position throttle and choke valve in full open position.
3. Connect jumper wire between distributor terminal of coil and ground on engine to avoid high tension sparking while cranking engine.
4. Hook up starter remote control cable and turn ignition switch to "on" position.
5. Firmly insert compression gage in spark plug port. Crank engine to obtain highest possible reading.

6. Check compression of each cylinder. **Repeat** compression check and record highest reading obtained on each cylinder during the two pressure checks.

The recorded compression pressures are to be considered normal if the lowest reading cylinder is more than 75 percent of the highest reading cylinder. See the following example and the "Compression Pressure Limit Chart." See Figure 6G-2.

Seventy-five percent of 140 (highest) is 105. Thus, cylinder No. 4 is less than 75 percent of No. 3. This condition, accompanied by low speed missing, indicates an improperly seated valve or worn or broken piston ring. See Figure 6G-1.

CYLINDER NO.	PRESSURE (PSI)
2	129
3	135
4	140
	100

6G-1

Figure 6G-1 Example of Compression Check

7. If one or more cylinders read low, inject about a tablespoon of engine oil on top of pistons in low reading cylinders through spark plug port. Repeat compression check on these cylinders.

- a. If compression improves considerably, rings are worn.
- b. If compression does not improve, valves are sticking or seating poorly.
- c. If two adjacent cylinders indicate low compression and injecting oil does not increase compression, the cause may be the head gasket leaking between the cylinders. Engine coolant **and/or** oil in cylinders could result from this defect.

**Compression Pressure Limit Chart**

This chart may be used when checking cylinder compression pressures. It has been calculated so that the lowest reading number is 75 percent of the highest reading number. See Figure 6G-2.

**EXAMPLE:** After checking the compression pressures in all cylinders, it was found that the highest pressure obtained was 182 psi. The lowest pressure reading was 145 psi. By locating 182 in the maximum column, it is seen that the minimum allowable pressure

MAXIMUM PRESSURE POUNDS/SQ. INCH	MINIMUM PRESSURE POUNDS/SQ. INCH	MAXIMUM PRESSURE POUNDS/SQ. INCH	MINIMUM PRESSURE POUNDS/SQ. INCH
134	101	188	141
136	102	190	142
138	104	192	144
140	105	194	145
142	107	196	147
146	110	198	148
148	111	200	150
150	113	202	151
152	114	204	153
154	115	206	154
156	117	208	156
158	118	210	157
160	120	212	158
162	121	214	160
164	123	216	162
166	124	218	163
168	126	220	165
170	127	222	166
172	129	224	168
174	131	226	169
176	132	228	171
178	133	230	172
180	135	232	174
182	136	234	175
184	138	236	177
186	140	238	178

6G-2

Figure 6G-2 Compression Pressure Limit Chart

is 136 psi. Since the lowest reading obtained was 145 psi, the car is within limits and the compression is considered satisfactory.

**Spark Plugs**

1. Inspect, clean and regap or replace spark plugs as required. Correct gap is .030.
2. Install spark plugs. Tighten to 30 lb.ft.

**Secondary Ignition System**

1. Inspect ignition cables for broken, swollen or deteriorated insulation.
2. Check terminal ends and condition of rubber boots. Replace as required.
3. Inspect the condition of the distributor cap and rotor.
4. Clean the ignition coil and inspect for cracks or carbon paths which could cause high voltage leakage.

**Distributor Contact Points**

1. Inspect distributor contact points and replace or adjust as necessary (.016 gap).

2. If inspection of contact points indicates excessive burning, pitting or wear, check condenser and replace if necessary.

3. Inspect all connections and wires in the primary ignition circuit. Correct any abnormal conditions found.

#### Carburetor

1. Clean fuel strainer in fuel pump. To prevent fuel leakage in pump, disconnect "IN" line from pump and raise end above fuel level. The in-line fuel filter should be replaced every 12,000 miles or every 12 months.

2. Check for freedom of choke valve operation and clean shaft if necessary, with suitable solvent.

3. Inspect throttle cable or linkage bracket and return spring for wear. With helper depressing accelerator pedal to floor, check for wide open throttle. Adjust accelerator pedal height so wide open throttle is obtained when pedal is within 1/2 inch from floor. Lubricate linkage pivot points with engine oil.

#### Air Cleaner

Check paper element every 6,000 miles and replace every 24,000 miles. If a vehicle is operated in dusty territory, check condition of air cleaner element more frequently and replace if necessary.

#### Fan Belt

1. Inspect belt for wear, cracks or frayed points. Replace and/or adjust as necessary. Specified tension for belt using Gauge J-23600 is 45 lbs.

#### Cooling System

1. Inspect the radiator, water pump, cylinder head areas and all radiator and heater hose connections for evidence of engine coolant leaks.

2. Inspect all hoses for deterioration from gas and oil contact. Correct as required.

Inspection should be made with engine operating at normal temperature, cooling system completely filled, temperature control lever fully open and normal pressure in the system. Normal pressure should be 13.2 to 15.2 psi.

#### Engine Lubrication System

Inspect engine for evidence of oil leakage. Correct

any abnormal condition with sealastic or new seals and gaskets.

#### Battery

1. Inspect battery, battery mount and cables and check electrolyte level. Proper level should be just above the cell plates.

**CAUTION:** *Do not over fill.*

2. Determine the serviceability of the battery by applying the 421 Battery Test.

#### Positive Crankcase Ventilation

Clean crankcase ventilator metered orifice in the intake manifold fitting every 6,000 miles. Also all hoses and fittings should be inspected, cleaned and replaced, if necessary.

To clean, remove rubber hose from metered orifice and apply air pressure to orifice to remove any foreign particles that may be trapped.

#### Valve Lifter Adjustment

Refer to Engine Mechanical and Mounts section for valve lifter adjustment procedure.

#### Engine Tune-Up Instrument Checks

The following instrument checks and adjustments serve as a final check on engine condition. These checks may discover some new problems that may not have been obvious before. The engine is also given its final adjustments that will assure maximum performance, reliability, and proper emission control.

Refer to Electrical Group for checking procedures of the following:

Cranking Voltage Check

Ignition Timing

Distributor Advance

Ignition Output

Secondary Resistance

Current Output and Voltage Setting

#### Idle Speed and Mixture Adjustments

Refer to carburetor section.

## SPECIFICATIONS

### TUNE-UP SPECIFICATIONS AND ADJUSTMENTS

#### Voltage Regulator

Voltage Regulator Setting in Volts at 2500 Engine RPM ..... 14± .5

#### Ignition Coil

Ignition Coil Current Draw, Amperes at 12.5 Volts

Engine Stopped ..... 3.8  
 Engine Idling ..... 2.3

#### Distributor

Total Advance (Centrifugal and Vacuum), Engine Degrees at 3600 Engine RPM ..... 29-38  
 Centrifugal Advance, Engine Degrees and RPM  
     Start Advance, at RPM ..... 1000-1200  
     Medium Advance, Degrees at RPM ..... 7.5-15 at 1400  
     Maximum Advance, Degrees at RPM ..... 28-32 at 3600  
 Vacuum Advance, Engine Degrees and In. of Vacuum  
     Start Advance.. ..... - 5 at 2.9-4.1 In.  
     Maximum Advance.. ..... 1-5 at 4.5-5.0 In.  
 Vacuum Retard, Engine Degrees at Closed Throttle ..... - 5  
 Condenser Capacity in **MicroFarads** ..... .23-.32  
 Breaker Spring Tension in Ounces ..... 14 to 19  
 Breaker Point Gap in Inches ..... .016  
 Dwell Angle in Engine Degrees ..... 50 ± 3  
 Firing Order ..... 1-3-4-2  
 Spark Plug or Coil Cable, Max. Resistance in Ohms ..... 10,000

#### Spark Plugs

Make and Model Production ..... AC42FS  
 Make and Model Replacement ..... AC42FS  
     If carbon fouling occurs, use ..... AC43FS  
 Spark Plug Torque in **Lb.Ft.** ..... .30  
 Spark Plug Gap in Inches ..... .030

#### Valve Lifter Adjustment

One full turn (clockwise) after zero clearance is obtained - refer to Valve Adjustment Procedure

#### Ignition Timing

Align timing marks with distributor retard hose disconnected and plugged

---

**GROUP 7**

**TRANSMISSION**

<b>Section</b>	<b>Title</b>	<b>Page No.</b>
<b>7A</b>	Clutch .....	<b>7A- 1</b>
<b>7B</b>	Manual Transmission	<b>7B-12</b>
<b>7C</b>	Automatic Transmission	<b>7C-36</b>



---

# CLUTCH

## CONTENTS

Subject	Page No.
<b>DESCRIPTION AND OPERATION:</b>	
Clutch and Clutch Pedal Mechanisms .....	7A-1
<b>DIAGNOSIS:</b>	
Clutch .....	7A-2
<b>MAINTENANCE AND ADJUSTMENTS:</b>	
Clutch Lash Adjustment (GT Only) .....	7A-4
Clutch Adjustment (All 1.9 Engines Except GT) ....	7A-4
Control Cable Adjustment .....	7A-4
<b>MAJOR REPAIR:</b>	
Clutch Removal and Installation .....	1A-5
Clutch Control Cable .....	7A-7
<b>SPECIFICATIONS:</b>	
Specifications .....	7A-7

## DESCRIPTION AND OPERATION

### CLUTCH PEDAL MECHANISM

#### GT Only

The pedal lever pivots on a tubular steel shaft and operates the clutch release yoke thru a sheathed cable attached directly to the upper end of the pedal lever. Pedal return is accomplished thru the cable by the clutch yoke return spring at the transmission. The pedal return stop is a nonadjustable rubber bumper inserted through the upper end of the pedal lever just below the cable attaching point. The clutch cable is sheathed in woven steel and weather protected by a plastic and fabric covering. An eyelet is wedged on the upper end and fits over a formed hook on the upper end of the pedal. The lower end is provided with a swedged ball stud arrangement that slips into a slot in the clutch release lever. See Figure 7A-6.

#### Opel 1900 and Manta

The pedal lever pivots on a tubular steel shaft and operates the clutch release yoke through a sheathed cable attached directly to the upper end of the pedal lever. Pedal return is accomplished through a spring attached to the pedal below the pivot shaft and to the pedal assembly mounting bracket at the bulkhead.

Clutch actuation works without pedal-free travel and a warning device is provided which actuates an indicator lamp in the instrument panel indicating necessity of clutch adjustment. The clutch cable is sheathed in **woven** steel and weather protected by a plastic fabric covering. An eyelet is wedged on the upper end and fits over a formed hook on the upper end of the pedal. The lower end is provided with a wedged ball stud arrangement that slips into a slot in the clutch release lever. See Figure 7A-7.

#### Clutch Mechanism

The clutch assembly is enclosed in the bell housing.

The clutch release bearing and release fork are of conventional design, with the fork pivoting on a ball stud located opposite the control cable attaching point. The bearing flange tits over two vertical pins which are riveted to and extend into the eye of the yoke.

The clutch pressure plate is similar in design to the Buick Century pressure plate. A radially slotted diaphragm pivoting on two steel wire rings is retained to the clutch cover by eight rivets. The clutch driven member is a 6-3/4 inches diameter single plate dry disc with torsional damper springs and spring leaves between facings to cushion application. Dampener springs in clutch disc assembly are preloaded.

## DIAGNOSIS

## CLUTCH TROUBLE DIAGNOSIS

Condition	Possible Cause	Correction
Fails to release (pedal pressed to floor - shift lever does not move freely in and out of "Reverse" gear.	1. Improper cable adjustment.	1. Adjust cable.
	2. Faulty pilot bearing.	2. Replace bearing.
	3. Faulty driven plate.	3. Replace driven plate.
	4. Yoke off ball stud.	4. Install properly.
	5. Clutch driven plate hub binding on main drive gear spline.	5. Repair or replace main drive gear.
Slipping	1. Improper adjustment (no lash).	1. Adjust cable.
	2. Oil-soaked driven plate.	2. Install new driven plate and correct oil leak at its source.
	3. Worn facing or facing torn from driven plate.	3. Replace driven plate.
	4. Warped pressure plate or flywheel.	4. Replace same.
	5. Weak diaphragm spring.	5. Replace cover assembly.
	6. Driven plate not seated in.	6. Make 20-50 normal starts.
	7. Driven plate overheated.	7. Allow to cool - check lash.
Grabbing	1. Oil on facing or burned or glazed facings.	1. Repair oil leak and install new driven plate.
	2. Worn splines on main drive gear.	2. Replace transmission main drive gear.
	3. Loose engine mountings.	3. Tighten or replace mountings.
	4. Warped pressure plate or flywheel.	4. Replace pressure plate or flywheel.
	5. Burned or smeared resin on flywheel or pressure plate.	5. Sand off if superficial, replace burned or heat checked parts.

Condition	Possible Cause	Correction
Rattling ▪ Transmission Click	1. Yoke loose on ball stud in bearing groove.	1. Check ball stud and <b>retaining</b> spring and replace if necessary.
	2. Oil in driven plate damper.	2. Replace driven plate.
	3. Driven plate damper spring failure.	3. Replace driven plate,
Throw-out bearing noise with clutch fully engaged.	1. Improper adjustment.	1. Adjust cable.
	2. Throw-out bearing <b>bind-</b> ing on transmission bearing retainer.	2. Clean, relubricate, check for <b>burrs</b> , nicks, etc.
	3. <b>Insufficient</b> tension between yoke and ball stud.	3. Replace yoke.
	4. Yoke improperly installed.	4. Install properly.
	5. Weak linkage return spring.	5. Replace spring.
Noisy	1. Worn throw-out bearing.	1. Replace bearing.
	2. Fork off ball stud (heavy clicking).	2. Install properly.
Pedal stays on floor when disengaged.	1. Bind in cable.	1. Lubricate and free up cable.
	2. Spring weak in pressure plate.	2. Replace
	3. Weak linkage return spring.	3. Replace
High Pedal Effort	1. Bind in cable.	1. Lubricate and free up cable.
	2. Driven plate worn.	2. Replace driven plate.
Clutch facings worn near rivets.	1. Normal wear.	1. Replace driven plate assembly only, and readjust clutch pedal and cable.
Pressure plate assembly friction surface badly scored or rough.	1. Improper clutch pedal lash causing pressure plate to come in contact with rivets.	1. If roughness can be smoothed with fine emery cloth, do not replace pressure plate assembly; if it cannot, replace the pressure plate and driven plate assembly. Adjust clutch.

Condition	Possible Cause	Correction
Heat-blued driven plate and pressure <b>plate</b> assembly.	1. Improper pedal adjustment.	1. Replace <b>only</b> driven <b>plate</b> , and <b>adjust</b> clutch pedal and cable.
Grab and chatter with oil present on clutch assembly.	1. Oil leak.	1. Correct oil leakage, clean pressure plate in solvent, replace driven plate and adjust pedal lash.

## MAINTENANCE AND ADJUSTMENTS

### CLUTCH LASH ADJUSTMENT

#### GT

Pedal lash, free pedal travel must be adjusted occasionally to compensate for normal wear of the clutch facings. As the driven plate wears thinner, pedal lash decreases. Adjust clutch pedal free travel only with ball stud located on right side of clutch housing if cable length is not to be changed. To adjust pedal lash proceed as follows:

1. Loosen lock nut on ball stud end located to the right of the transmission on the clutch housing. Position ball stud so that the outer end protrudes  $\frac{3}{4}$  inches out of housing and finger tighten lock nut. See Figures 7A-1 and 7A-6.
2. Adjust ball stud, pivoting clutch release fork, to obtain  $\frac{3}{4}$  to 1- $\frac{1}{4}$  inches pedal lash, free pedal. See Figure 7A-6.

#### Opel 1900 and Manta

The clutch actuation works without clutch pedal free travel. A readjustment of the clutch is only required if the indicator lamp at the instrument panel lights up.

In synchronism with the gradual wear of the clutch linings the clutch pedal travels from its basic **adjustment** position upwards, *i.e.*, towards driver. If the clutch lining wear has reached such an extent that the clutch pedal rests against switch, the indicator lamp at the instrument panel lights up.

This is an indication that the clutch pedal position has to be corrected to ensure proper clutch operation.

To ensure proper clutch operation, observe the following adjustment instructions. For all adjustment dimensions, refer to Figure 7A-7.

1. If the parking brake is provided with an indicator lamp, the parking brake has to be disengaged, other-

wise the same indicator lamp as for the clutch lights up.

2. Carry out adjustment only with ball stud on clutch **housing** whereby the distance (Item 20, Figure 7A-7) between clutch housing contacting surface and clutch release lever has to be adjusted in the rear to 4  $\frac{1}{4}$  inches.

#### Clutch Control Cable Adjustment(Only on Installation of a New Clutch Disc or Bowden Control Wire)

#### GT

1. Adjust ball stud so that outer end protrudes approximately  $\frac{3}{4}$  inches out of clutch housing.
2. Adjust distance between release lever and clutch housing face at eye for control cable to approximately 4  $\frac{1}{4}$  inches. See Figure 7A-6. Hold cable in this position and place E-ring two grooves ahead of washer on rubber grommet. Clutch pedal free travel is now between  $\frac{3}{4}$  and 1  $\frac{1}{4}$  inches and clutch release **bearing** has proper clearance from pressure plate.

#### Opel 1900 and Manta

1. Adjust ball stud on clutch housing to basic dimension of approximately  $\frac{3}{4}$  inch. With lower end of **bowden** control wire unhooked, push clutch release lever towards the front so that the clutch release bearing rests against clutch spring. Now, adjust ball stud so that the dimension (Item 20, Figure 7A-7) between clutch housing contacting surface and clutch release lever amounts in the rear to 4  $\frac{1}{4}$  inches.

2. Pull reattached **bowden** control wire out of dash panel so that clutch pedal rests against switch (indicator lamp lights up).

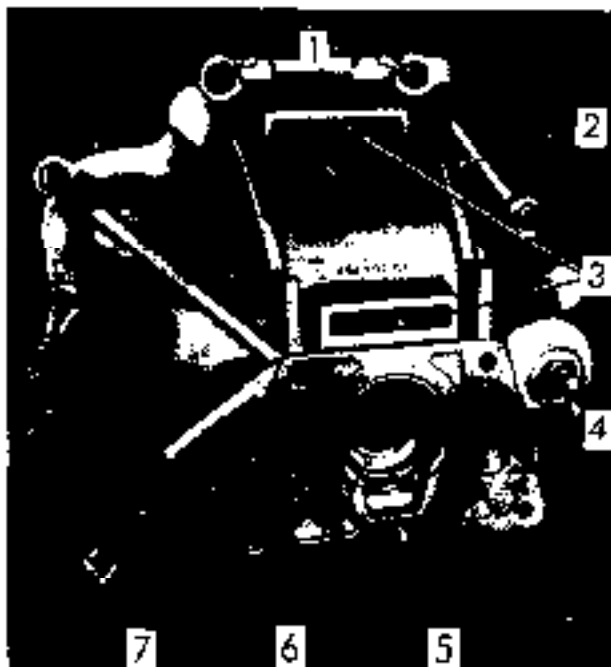
3. In this position, install lockwasher at upper control wire attachment three grooves towards the front, thereby completing control wire adjustment.

## MAJOR REPAIR

### CLUTCH REMOVAL AND INSTALLATION

#### Remove Clutch

1. Remove transmission. Refer to Manual Transmission for removal procedure.
2. Remove bolts from engine support **brackets**, both sides. Let brackets hang by front bolts.
3. Remove flywheel cover pan.
4. Remove flywheel housing to engine attaching bolts and pry housing from locating pins. See Figure 7A-1.

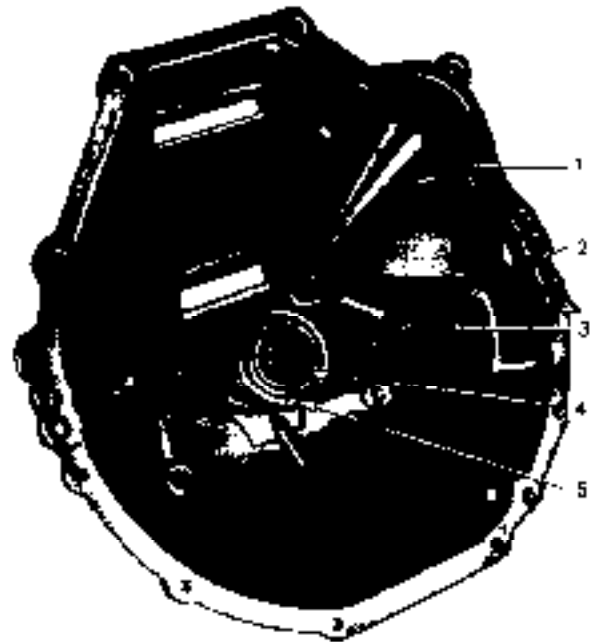


1. UPPER ATTACHING BOLTS
2. FLYWHEEL HOUSING
3. VENT HOLES
4. CLUTCH RELEASE LEVER BALL STUD AND LOCK NUT
5. RECESS IN FLYWHEEL HOUSING
6. CLUTCH RELEASE BEARING SLEEVE
7. CLUTCH RELEASE LEVER AND BOOT

7A-1

Figure 7A-1

5. To remove release bearing from clutch fork, slide lever off ball stud against spring action. Remove ball stud lock nut and remove stud from housing. See Figure 7A-2.



1. FLYWHEEL HOUSING
2. CLUTCH RELEASE LEVER
3. RELEASE LEVER BOOT
4. RELEASE BEARING SLEEVE
5. CLUTCH RELEASE BEARING

7A-2

Figure 7A-2

6. If assembly marks on clutch assembly and flywheel have **become** indistinct, renew with paint or centerpunch.

7. Loosen clutch cover to flywheel attaching bolts one turn at a time to avoid bending of clutch cover flange until spring pressure is released.

8. Support the pressure plate and cover assembly while removing last bolt, then remove pressure plate and clutch driven plate assemblies. Clutch cover, spring, and pressure plate must not be disassembled. If necessary, replace complete assembly.

#### Inspection of Clutch

Wash all metal parts of clutch, except release bearing and driven plate, in suitable cleaning solution to remove dirt and grease. Soaking release bearing in cleaning solution would permit solution to seep into bearing and destroy the lubricant. Soaking driven plate in cleaning solution would damage the facings.

### 1. Flywheel and Pressure Plate

Examine friction surfaces of flywheel and pressure plate for scoring or roughness. Slight roughness may be smoothed with fine emery cloth, but if surface is deeply scored or grooved the part should be replaced.

### 2. Clutch Driven Plate

Inspect driven plate for condition of facings, loose rivets, broken or very loose torsional springs.

If facings are worn down near rivets or are oily, the plate assembly should be replaced. A very slight amount of oil on clutch facings will cause clutch grab and chatter. A large amount of oil on facings will cause slippage. Removal of oil by solvents or by buffing is not practical since oil will continue to bleed from facing material when hot.

When oil is found on driven plate facings, examine transmission drainback hole, pilot bushing, engine rear main bearing and other points of possible oil leakage.

Test the fit of driven plate hub on transmission main drive gear for an easy sliding fit.

Regardless of whether the old plate or a new one is to be installed, the plate should be checked for run-out. Lateral run-out measured at disc circumference should not exceed .016 inch.

### 3. Bearings

Inspect clutch release bearing for scoring or excessive wear on front contact face. Test for roughness of balls and races by pressing and turning front race slowly. Inspect main drive gear pilot bushing in crankshaft. If bushing is rough or worn it should be

replaced. If replacement is necessary, remove bearing with Tool J-21718 and Slide Hammer J-7004-1. Install new bearing using J-21706. See Figure 7A-3 for removal procedure and Figure 7A-4 for installation.

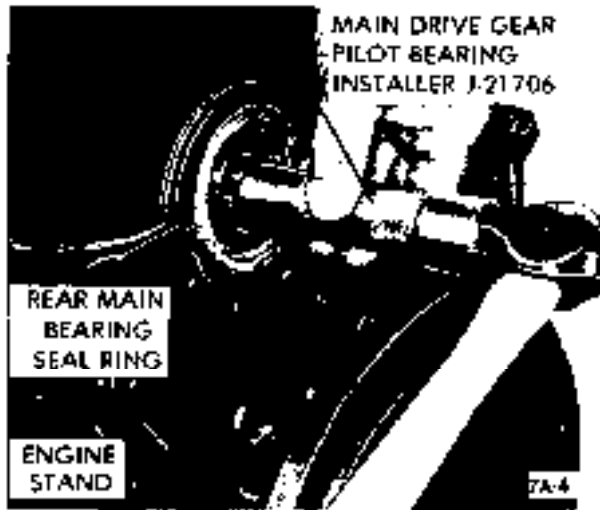


Figure JA-4

#### Installation of Clutch

1. Index alignment marks on clutch assembly and flywheel. Place driven plate on pressure plate with long end of splined hub facing **forward** toward the flywheel. See Figure 7A-5.
2. Insert alignment Tool J-22934 through clutch cover and driven plate.
3. Hold complete assembly against flywheel while inserting end of Tool J-22934 into pilot bearing in crankshaft.
4. Index the alignment marks and install four (4) clutch cover to flywheel bolts finger tight. Complete torquing bolts alternately and evenly one at a time.
5. Torque attaching bolts to 36 lb.ft. and remove alignment tool.
6. Install release bearing.
7. Install flywheel housing and torque lower bolts to 36 lb.ft.
8. Install flywheel housing lower cover.
9. Install clutch return spring and control cable.
10. Install transmission. See Manual Transmission Section for procedure.
11. Adjust clutch control cable. Refer to paragraph 7A-3.



Figure JA-3



- 1. FLYWHEEL
- 2. CLUTCH ASSEMBLY
- 3. ASSEMBLY MARKS
- 4. CLUTCH ALIGNING  
ARBOR J-22934

7A-5

Figure 7A-5 Clutch Installation

CLUTCH CONTROL CABLE REMOVAL AND INSTALLATION  
(SEE FIGURE 7A.6 OR 7A-7)

If a new cable was installed or the cable adjustment was changed during an operation, x-adjust cable afterwards.

Removal

1. Disconnect return spring and cable with ball end from release lever. Slide control cable out of eye in clutch housing.
2. With a screwdriver, pry E-ring out of groove in control cable, at tirewall, and disconnect cable from clutch pedal.
3. Pull cable out of retainer on dash panel and remove washers and rubber grommet.

Installation

1. Slide control cable ball end through eye in clutch housing. Connect to lever and (on GT) install return spring.
2. Replace washers and rubber grommet, slide cable through retainer on dash panel, and connect to clutch pedal. To adjust, refer back to Clutch Adjustment paragraph c or d.

SPECIFICATIONS

GENERAL SPECIFICATIONS

Clutch Specifications

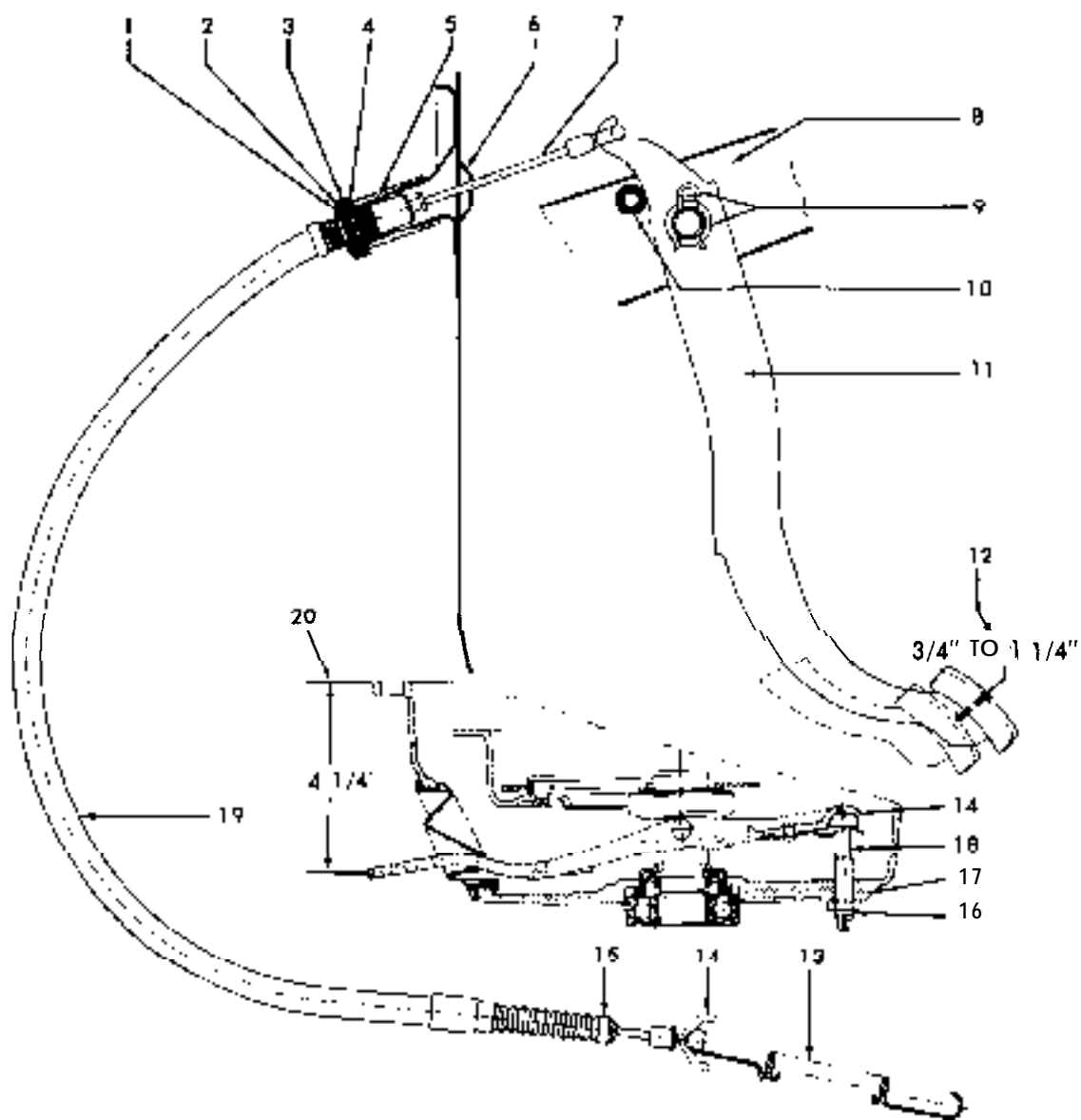
Type .....	Single Plate • Dry Disc
Pedal Lash • 3/4" to 1-1/4"	
Driven Plate Diameter .....	6-3/4"
Driven Plate Facings .....	Woven Asbestos
Number of Facings .....	2
Facing Attachment .....	Riveted
Vibration Dampening .....	4 Torsional Springs

E-1 5:15/3

Bolt Tightening Specifications

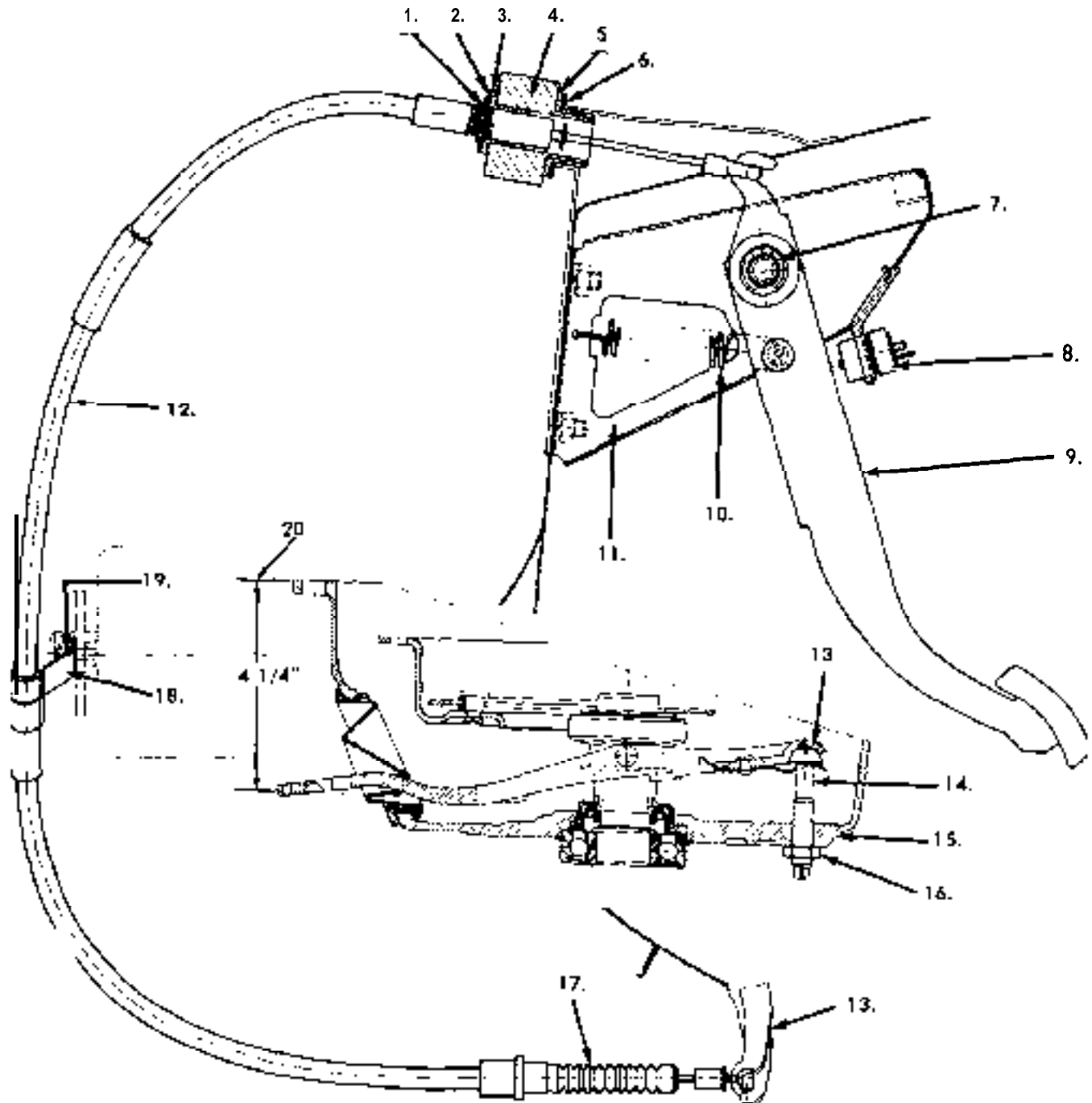
Part	Location	Torque Lbs.Ft.
Bolt	Flywheel to Crankshaft .....	43
Bolt	Clutch Cover to Flywheel .....	36
Bolt	Transmission to Clutch Housing .....	32.36
Bolt	Starter to Clutch Housing .....	40
Nut	Support to Clutch Housing .....	4
Bolt	Intake and Exhaust Manifold to Cylinder Head .....	33





- |                         |  |
|-------------------------|--|
| 1. E-RING               | 12. CLUTCH PEDAL FREE TRAVEL-<br>3/4" TO 1 1/4"          |
| 2. WASHER               | 13. RETURN SPRING  |
| 3. RUBBER GROMMET       | 14. RELEASE LEVER  |
| 4. WASHER               | 15. RUBBER BELLOWS                                       |
| 5. SLEEVE               | 16. BALL STUD LOCK NUT                                   |
| 6. DASH PANEL           | 17. CLUTCH HOUSING                                       |
| 7. BOWDEN CONTROL CABLE | 18. BALL STUD  |
| 8. BRACKET              | 19. BOWDEN CONTROL CABLE                                 |
| 9. WASHER, HAIRPIN CLIP | 20. DISTANCE BETWEEN RELEASE<br>LEVER AND CLUTCH HOUSING |
| 10. RUBBER STOP         |  |
| 11. CLUTCH PEDAL        |  |

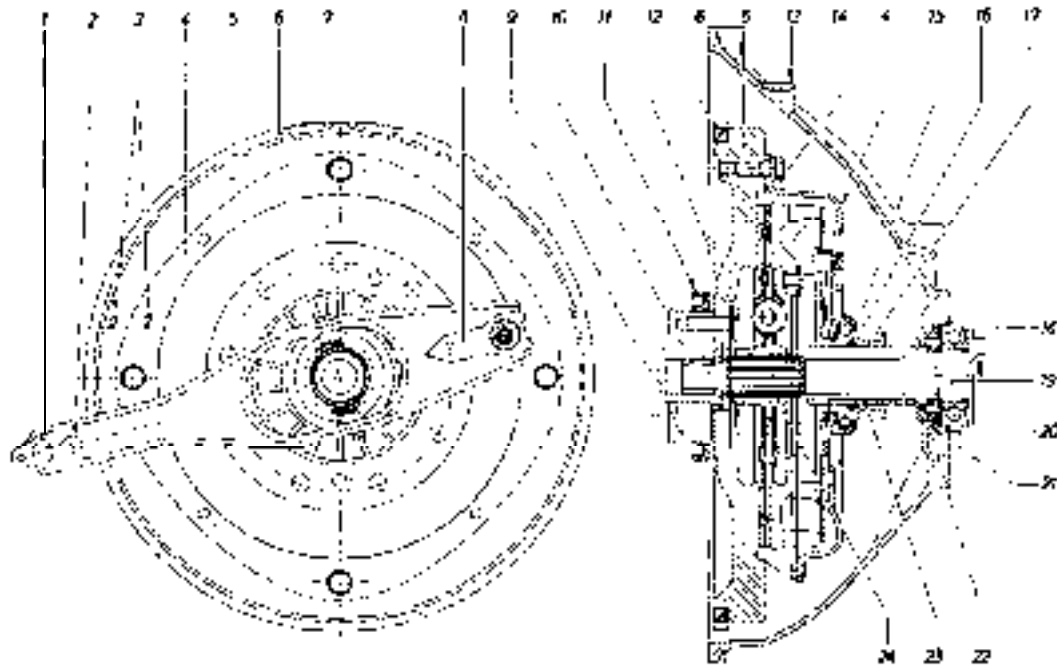
Figure 7A-6 Clutch Pedal Lash - GT Model



- |                            |  |
|----------------------------|--|
| 1. "E" RING                | 11. BRACKET  |
| 2. WASHER                  | 12. CABLE  |
| 3. RUBBER GROMMET          | 13. RELEASE LEVER  |
| 4. CLUTCH OPERATING DAMPER | 14. BALL STUD  |
| 5. GROMMET                 | 15. CLUTCH HOUSING                                       |
| 6. WASHER                  | 16. BALL STUD LOCK NUT                                   |
| 7. "E" RING                | 17. RUBBER BELLOWS                                       |
| 8. ADJUSTMENT SWITCH       | 18. CABLE SUPPORT BRACKET                                |
| 9. CLUTCH PEDAL            | 19. NUT, CABLE SUPPORT BRACKET                           |
| 10. RETURN SPRING          | 20. DISTANCE BETWEEN RELEASE<br>LEVER AND CLUTCH HOUSING |

JA-7

Figure JA-7 Clutch Pedal Adjustment - Opel 1900 and Manta



Arrangement Of Clutch

- |  |  |
|--|--|
| 1 Clutch release lever                     | 14 Clutch assy. bolt, lockwasher                                       |
| 2 Slot in lever for control cable boll end | 15 Hollow space under felt ring filled with molybdenum disulfide paste |
| 3 Assembly marks                           | 16 Felt ring   |
| 4 Clutch assembly                          | 17 Clutch release bearing  |
| 5 Flywheel                                 | 18 Clutch gear ball bearing  |
| 6 Flywheel ring gear                       | 19 Clutch gear   |
| 7 Thrust pin                               | 20 Snap ring   |
| 8 Retaining spring                         | 21 Paper gasket  |
| 9 Crankshaft                               | 22 Clutch gear oil seal  |
| 10 Clutch gear pilot bushing               | 23 Clutch release bearing sleeve                                       |
| 11 Oil seal                                | 24 Clutch disc, long end of hub facing forward.                        |
| 12 Flywheel bolt                           |  |
| 13 Clutch housing                          |  |

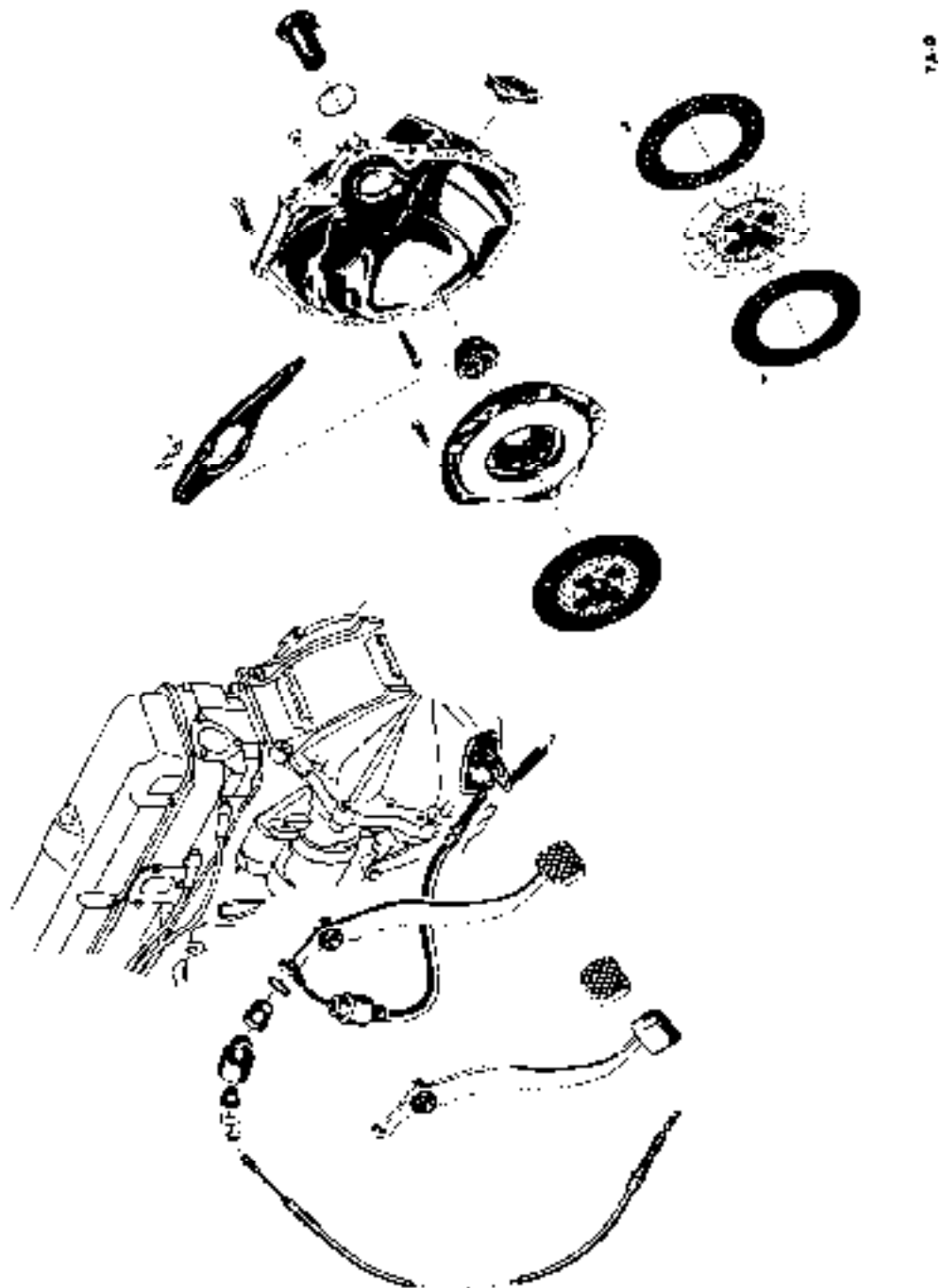


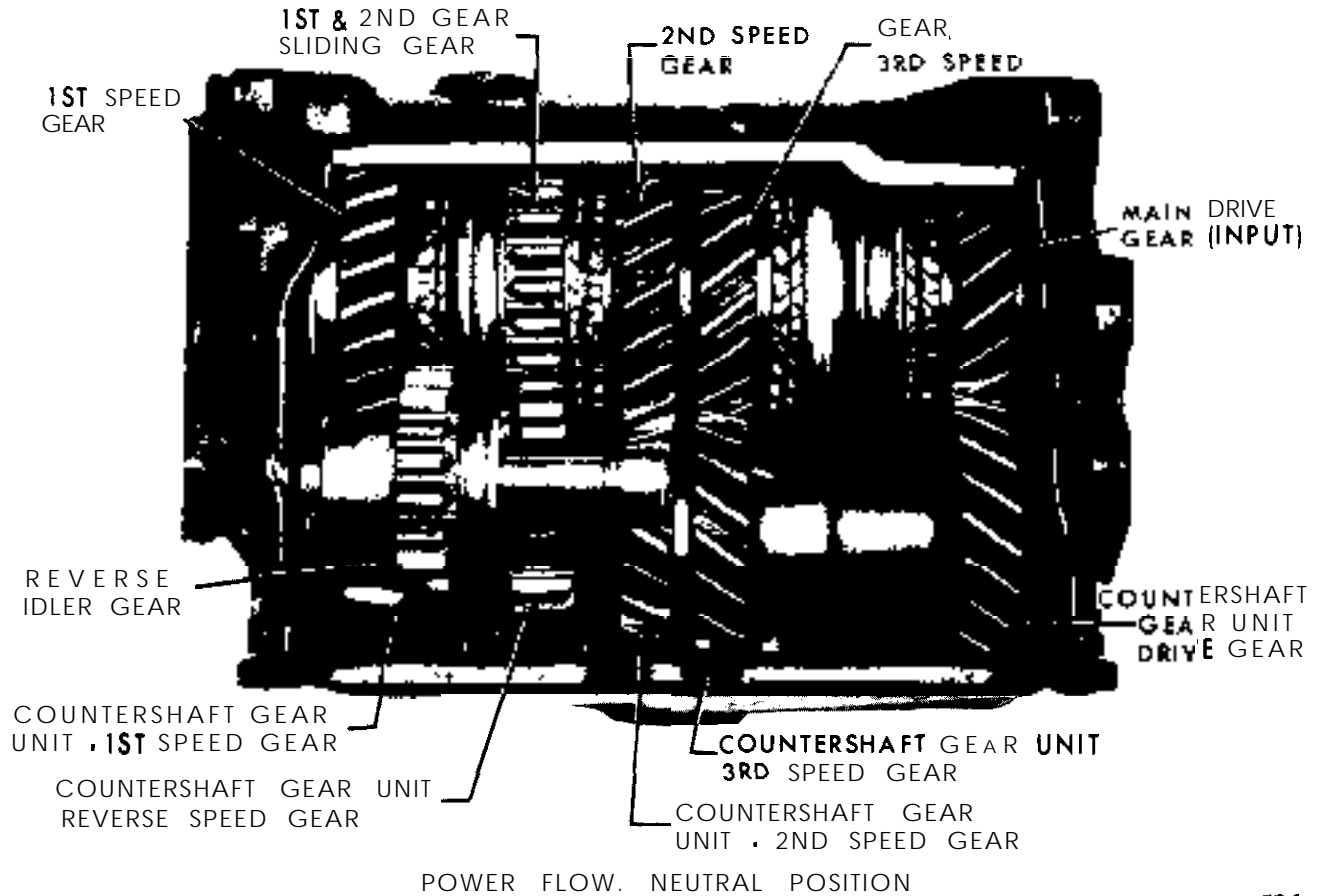
Figure 7A-9 Exploded View of Clutch Pedal and Housing

# MANUAL TRANSMISSION

## CONTENTS

Subject	Page No.
<b>DESCRIPTION AND OPERATION:</b>	
Description .....	7B-12
Power Flow .....	7B-13
<b>DIAGNOSIS: (Not Applicable)</b>	
<b>MAINTENANCE AND ADJUSTMENTS:</b>	
Adjusting Reverse Gearshift Blocker .....	7B-19
Shift Lever Installation .....	7B-19
Servicing Gearshift Lever .....	7B-19
<b>MAJOR REPAIR:</b>	
Transmission Removal .....	7B-22
Installation of Transmission .....	7B-22
Removing and Installing Speedo Driven Gear (Transmission Removed) .....	7B-23
Replacing Bushing in Selector Lever .....	7B-23
Transmission Disassembly .....	7B-23
Transmission Reassembly .....	7B-28
<b>SPECIFICATIONS:</b>	
Specifications .....	7B-33

POWER FLOW

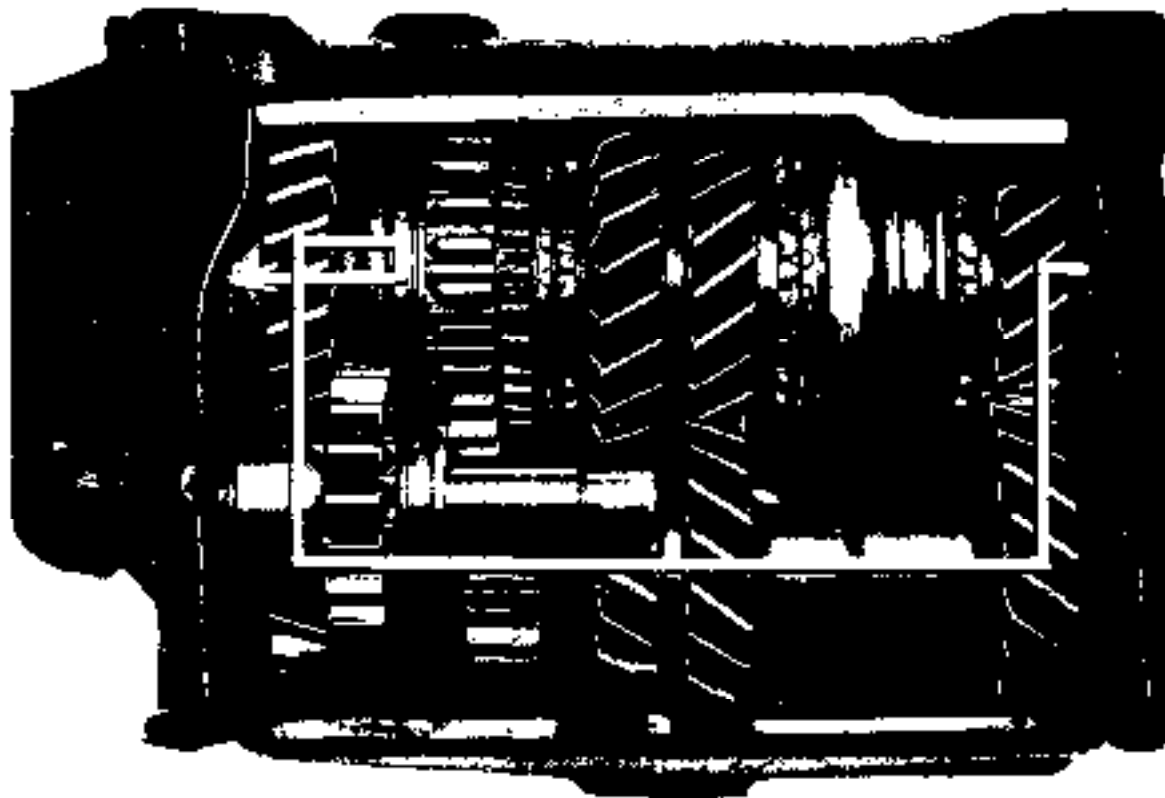


7B-1

Figure 7B-1

Neutral Position

The countershaft gear unit and the mainshaft 1st, 2nd, and 3rd speed gears are all idling in "Neutral" position. The reverse idler gear is not engaged or in mesh with any gear and, therefore, it is idle.



POWER FLOW - 1st SPEED

MAIN DRIVE GEAR (INPUT)	COUNTERSHAFT GEAR UNIT DRIVE GEAR
COUNTERSHAFT GEAR UNIT 1st SPEED GEAR	1st SPEED GEAR
1st SPEED GEAR	1st AND 2nd GEAR SLIDING GEAR
1st AND 2nd GEAR SLIDING GEAR	1st AND 2nd SPEED SLIDING GEAR GUIDE UNIT
1st AND 2nd SPEED SLIDING GEAR GUIDE UNIT	MAINSHAFT (OUTPUT)

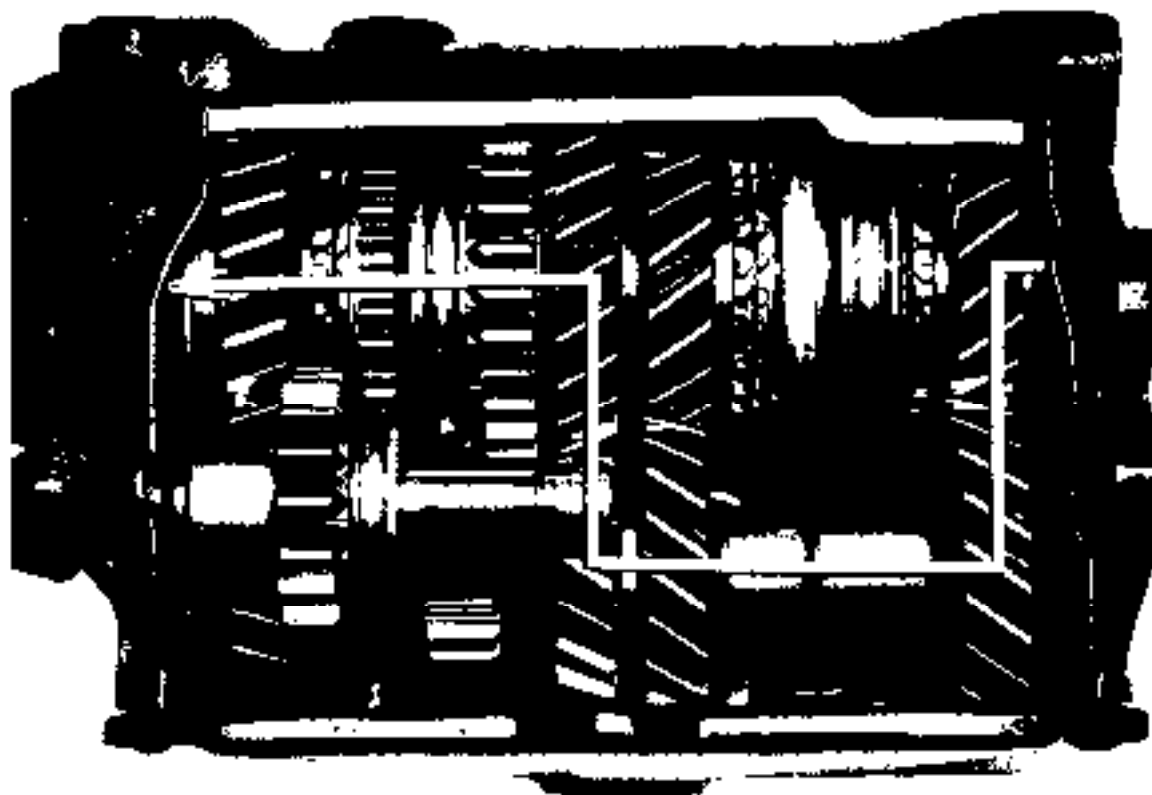
7B-2

Figure 7B-2

### First Speed

After synchronizing the speeds of the mainshaft and the 1st speed gear, the 1st and 2nd gear sliding gear shifts to the rear of the transmission and locks the 1st speed gear to the mainshaft through the 1st and 2nd speed sliding gear guide unit. This 1st and 2nd speed sliding gear guide unit is internally splined to the 1st and 2nd gear sliding gear and is **externally** splined to the mainshaft. Both the 3rd speed gear and the 2nd speed gear are idling. The reverse idler gear is *not* engaged with any gear and, therefore, it is idle.

With a 1st speed gear ratio of 3.428:1, the main drive gear (input) must turn 3.428 revolutions for every one revolution of the main shaft (output).



POWER FLOW. 2nd SPEED

MAIN DRIVE GEAR (INPUT)  
 COUNTERSHAFT GEAR UNIT 2nd SPEED GEAR  
 2nd SPEED GEAR  
 1st AND 2nd GEAR SLIDING GEAR  
 1st AND 2nd SPEED SLIDING GEAR GUIDE UNIT

COUNTERSHAFT GEAR UNIT DRIVE GEAR  
 2nd SPEED GEAR  
 1st AND 2nd GEAR SLIDING GEAR  
 1st AND 2nd SPEED SLIDING GEAR GUIDE UNIT  
 MAINSHAFT (OUTPUT)

7B-3

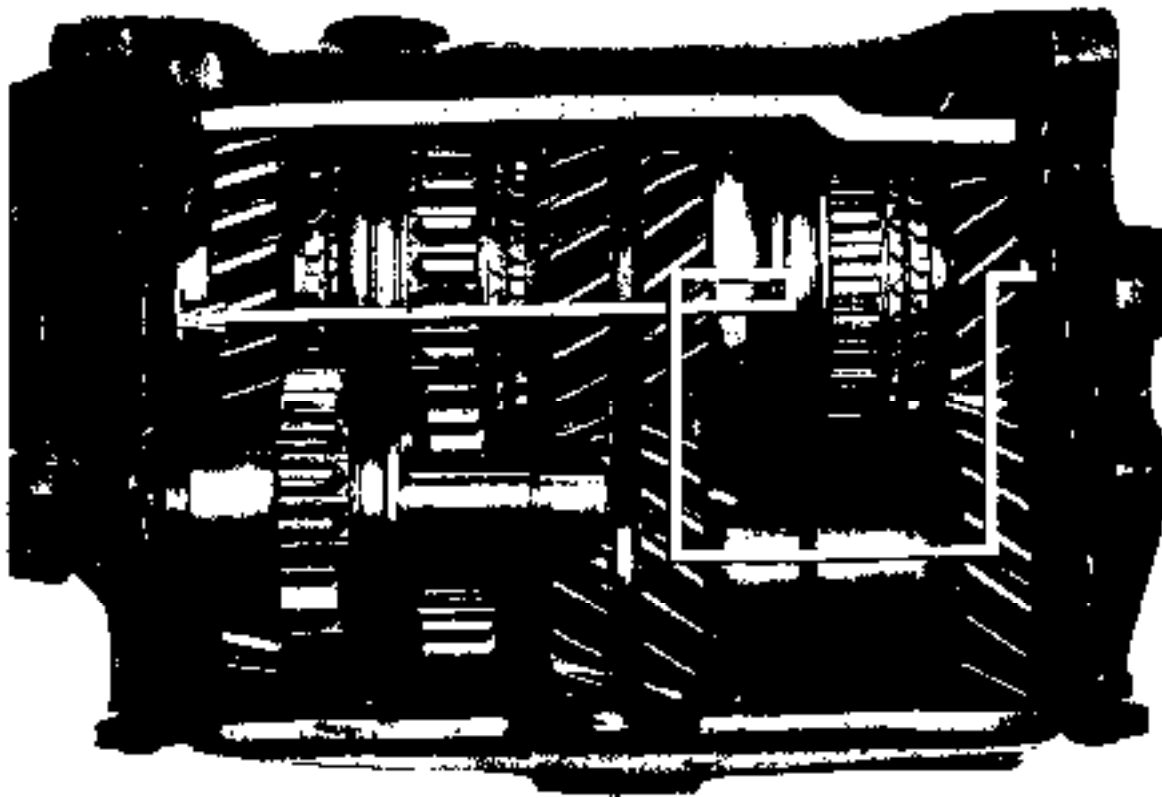
Figure 7B-3

### Second Speed

After synchronizing the speeds of the mainshaft and the 2nd speed gear, the 1st and 2nd gear sliding gear shifts toward the front of the transmission and locks the 2nd speed gear to the mainshaft through the 1st and 2nd speed sliding gear guide unit. This 1st and 2nd speed sliding gear guide unit is internally splined to the 1st and 2nd gear sliding gear and is externally splined to the mainshaft. Both the 3rd speed gear and the 1st speed gear are idling. The reverse idler gear is not engaged with any gear and, therefore, it is idle.

With a 2nd speed gear ratio of 2.156:1, the main drive gear (input) must turn 2.156 revolutions for every one revolution of the mainshaft (output).





POWER FLOW - 3rd SPEED

MAIN DRIVE GEAR (INPUT)  
 COUNTERSHAFT GEAR UNIT 3rd SPEED GEAR  
 3rd SPEED GEAR  
 GEAR SHIFTER SLEEVE  
 GEAR SHIFTER SLEEVE CARRIER

COUNTERSHAFT GEAR UNIT GEAR DRIVE  
 3rd SPEED GEAR  
 GEAR SHIFTER SLEEVE  
 GEAR SHIFTER SLEEVE CARRIER  
 MAIN SHAFT (OUTPUT)

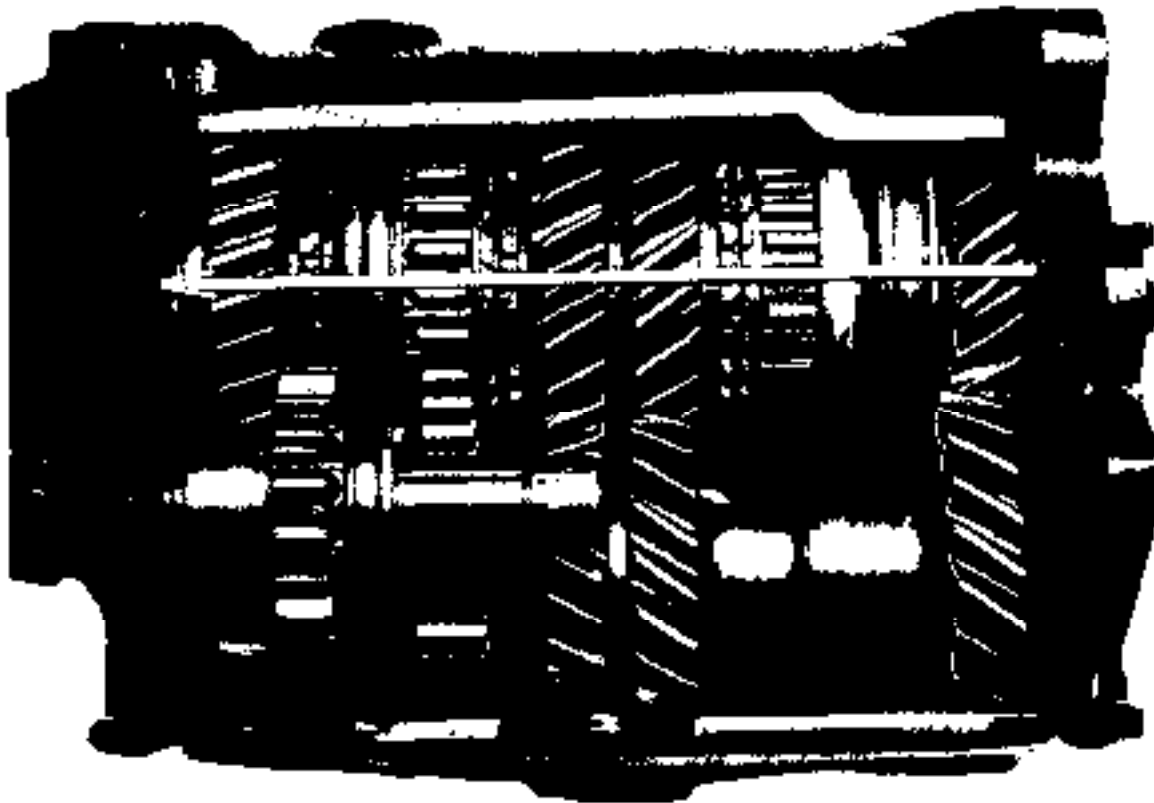
7B-4

Figure 7B-4

### Third Speed

After synchronizing the speeds of the mainshaft **and** the 3rd speed gear, the gear shifter sleeve shifts to the rear of the transmission and locks the 3rd speed gear to the mainshaft through the gear shifter sleeve carrier. This gear shifter sleeve carrier is internally splined to the gear shifter sleeve and is externally splined to the mainshaft. Both the 1st speed gear and the 2nd speed gear are idling. The reverse idler gear is *not* engaged with any gear and, therefore, it is idle.

With a 3rd speed gear ratio of 1.366:1, the main drive gear (input) must turn 1.366 revolutions for every one revolution of the mainshaft (output).



POWER FLOW • 4th SPEED

MAIN DRIVE GEAR (INPUT)  
 GEAR SHIFTER SLEEVE  
 GEAR SHIFTER SLEEVE CARRIER

GEAR SHIFTER SLEEVE  
 GEAR SHIFTER SLEEVE CARRIER  
 MAIN SHAFT (OUTPUT)

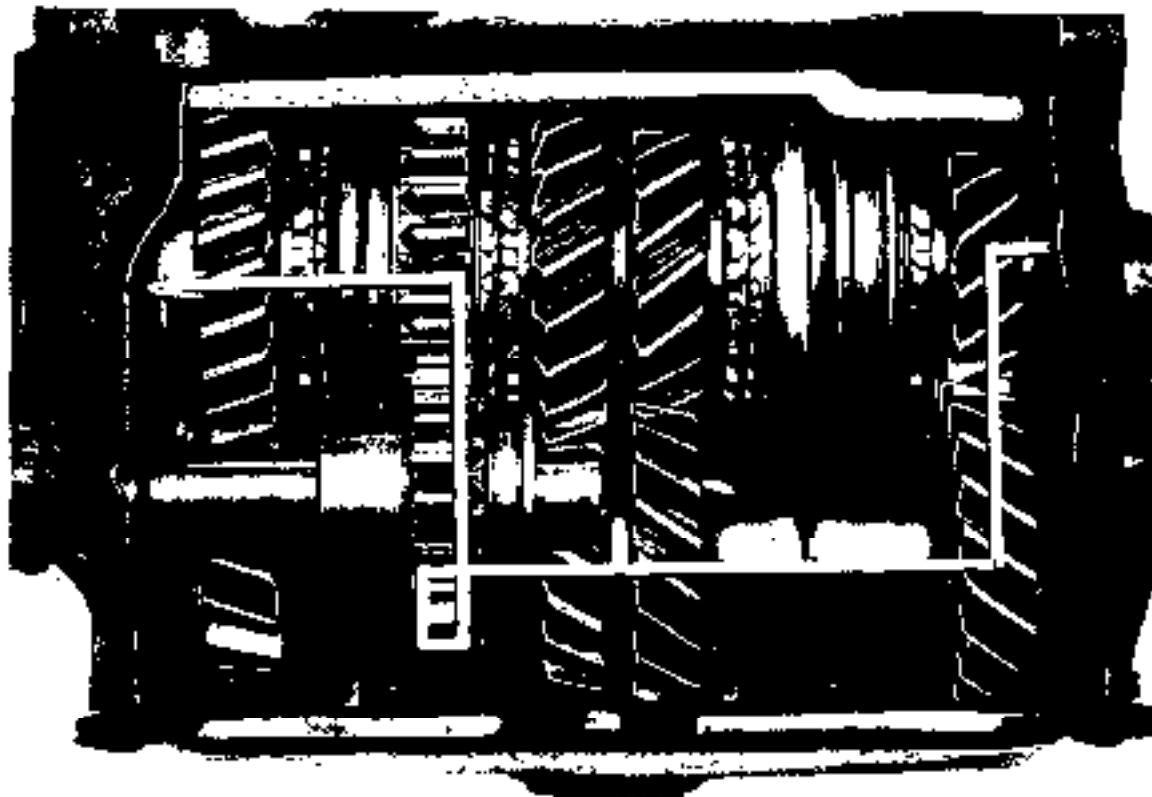
7B-5

Figure 7B-5

#### Fourth Speed

After synchronizing speeds of the main drive gear and mainshaft, the gear shifter sleeve shifts forward and locks the main drive gear to the mainshaft through the gear shifter sleeve carrier. This carrier is internally splined to the gear shifter sleeve and is externally splined to the mainshaft. The 3rd speed gear, 2nd speed gear, and the 1st speed gear are all idling. The reverse idler gear is *not* engaged with any gear and, therefore, it is idle.

With a 4th speed gear ratio of 1.000: 1, the main drive gear (input) must turn 1.000 revolutions for every one revolution of the mainshaft (output).



POWER FLOW - REVERSE SPEED

- |   |   |
|---|---|
| MAIN DRIVE GEAR (INPUT)                   | COUNTERSHAFT GEAR UNIT DRIVE GEAR         |
| COUNTERSHAFT GEAR UNIT REVERSE SPEED GEAR | REVERSE IDLER GEAR                        |
| REVERSE IDLER GEAR                        | 1st AND 2nd GEAR SLIDING GEAR             |
| 1st AND 2nd GEAR SLIDING GEAR             | 1st AND 2nd SPEED SLIDING GEAR GUIDE UNIT |
| 1st AND 2nd SPEED SLIDING GEAR GUIDE UNIT | MAINSHAFT (OUTPUT)                        |

7B-6

Figure 7B-6

Reverse Speed

Through the engagement of the reverse idler gear with the 1st and 2nd gear sliding gear (mainshaft) and the countershaft gear unit reverse speed gear, the drive is bridged between the countershaft gear unit and the mainshaft through the guide unit. The direction of the mainshaft is reversed. The guide unit is located between the 1st and 2nd gear sliding gear and the mainshaft. The guide unit is internally splined to the 1st and 2nd gear sliding gear, and it is externally splined to the mainshaft. The 3rd speed gear, 2nd speed gear, and the 1st speed gear are all idling. With a reverse speed gear ratio of -3.317: 1, the main drive gear (input) must turn 3.317 revolutions for every one revolution of the mainshaft (output). The "-" sign indicates that the direction of rotation of the mainshaft is opposite that of the main drive gear.

**DIAGNOSIS**

**MANUAL TRANSMISSION DIAGNOSIS**

Condition	Possible Cause
Noisy in Forward Speeds	<ol style="list-style-type: none"> <li>1) Low lubricant level.</li> <li>2) Incorrect lubricant.</li> <li>3) Transmission misaligned or loose.</li> <li>4) Front main bearing worn or damaged.</li> <li>5) Mainshaft bearing worn or damaged.</li> <li>6) Countergear or bearings worn or damaged,</li> <li>7) Main drive gear worn or damaged.</li> <li>8) Synchronizers worn or damaged.</li> </ol>
Noisy in "Reverse"	<ol style="list-style-type: none"> <li>1) Reverse sliding gear or shaft, worn or damaged</li> </ol>
Hard Shifting	<ol style="list-style-type: none"> <li>1) Clutch improperly adjusted.</li> <li>2) Shift shafts, or forks worn.</li> <li>3) Incorrect lubricant.</li> <li>4) Synchronizers worn or broken.</li> </ol>
Jumping Out of Gear	<ol style="list-style-type: none"> <li>1) Partial engagement of gear.</li> <li>2) Transmission misaligned or loose.</li> <li>3) Worn pilot bearing.</li> <li>4) End play in main drive gear (bearing retainer loose or broken, loose or worn bearings on main drive gear and mainshaft).</li> <li>5) Worn clutch teeth on main drive gear and/or worn clutch teeth on synchronizer sleeve.</li> <li>6) Worn or broken blocking rings.</li> <li>7) Bent mainshaft.</li> </ol>
Sticking in Gear	<ol style="list-style-type: none"> <li>1) Clutch not releasing fully.</li> <li>2) Low lubricant level.</li> <li>3) Incorrect lubrication.</li> <li>4) Defective (tight) main drive gear pilot bearing.</li> <li>5) Frozen blocking ring on main drive gear cone.</li> <li>6) Burred or battered teeth on synchronizer sleeve and/or main drive gear.</li> </ol>

**MAINTENANCE AND ADJUSTMENTS**

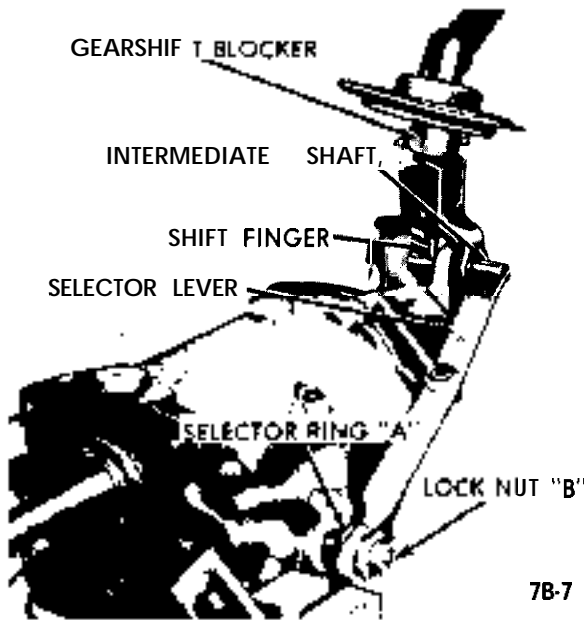
**ADJUSTING REVERSE GEARSHIFT BLOCKER**

1. Engage second speed.
2. Adjust selector ring (a) so that ball on lower end of shift finger has an equal clearance on both sides when seated into the transmission case extension bolt hole. See Figure 7B-7.
3. Back off selector ring an additional 1/4 of a turn and tighten lock nut (B). See Figure 7B-7.

**SERVICING GEARSHIFT LEVER**

**Removal**

1. Unscrew console from floor panel, on small console remove three (3) attaching screws, on large console remove four (4) attaching screws. The fourth screw is accessible after removal of the ash tray. See Figure 7B-8.
2. Remove rubber bellows from cover plate and from below unbutton protective cap arranged around intermediate shift lever.



7B-7

Figure 7B-7 Reverse Gearshift Blocker Adjustment

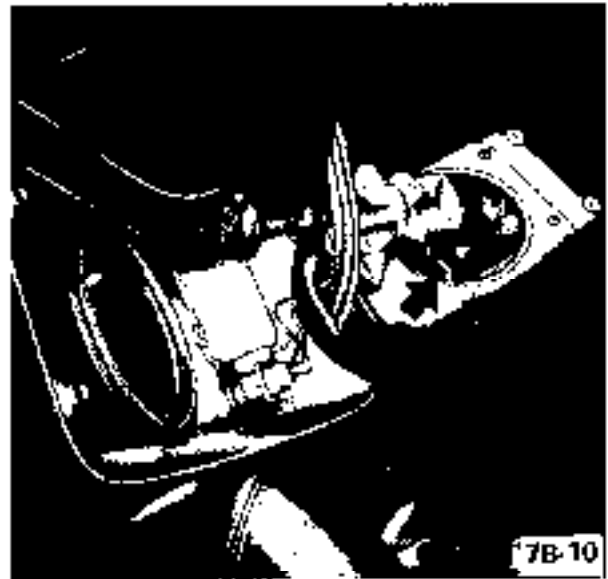


Figure 7B-10

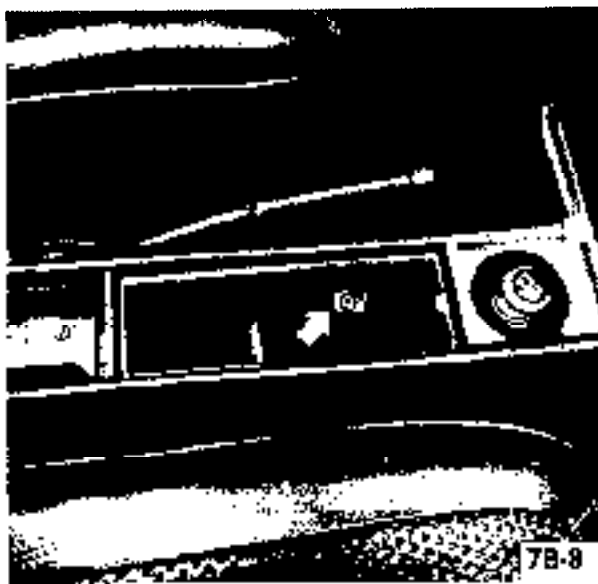
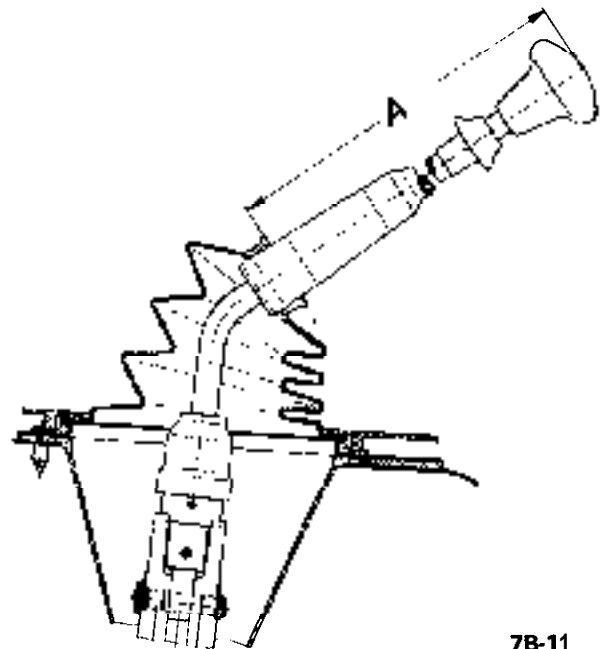


Figure 7B-8

3. Unhook tension spring of gearshift lever and, after removal of retaining washer, push pivot pin out of intermediate shift lever. See Figure 7B-10.

**Installation**

1. Prior to installation, grease support and spherical end of shift finger with protective grease.
2. Replace lever, pivot pin, retaining washer, and tension spring. Reposition protective cap and bellows and button cap from below. Replace console.
3. In Figure 7B-11, distance A = 8.07".



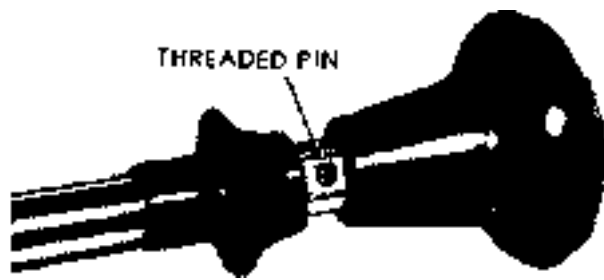
7B-11

Figure 7B-11

4. After installation, check as to whether pull ring can be lifted up approximately .04 to .08", whereby the stop sleeve must still rest against intermediate shift lever. Otherwise, loosen threaded pin for Bowden control wire attachment. See Figure 7B-12. Adjust distance B = free travel = by lifting up pull ring, and retighten threaded pin. See Figure 7B-13.

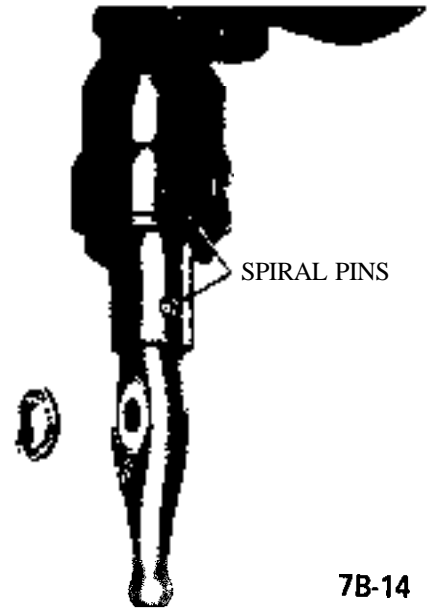
**REPLACING BOWDEN CONTROL WIRE IN GEARSHIFT LEVER**

1. Remove gearshift lever.



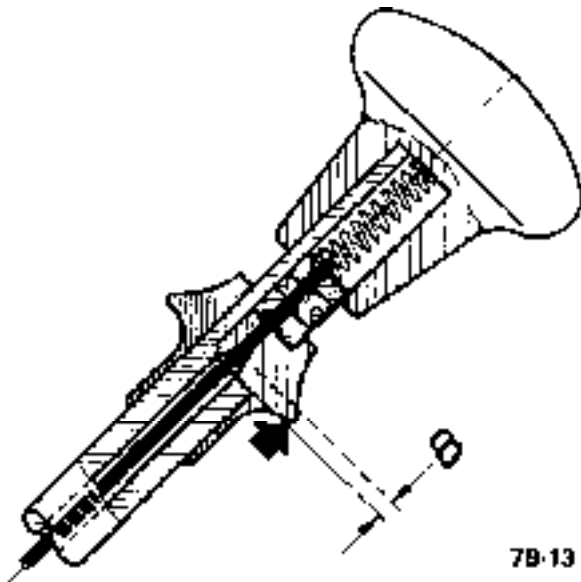
7B-12

Figure 78-1 2



7B-14

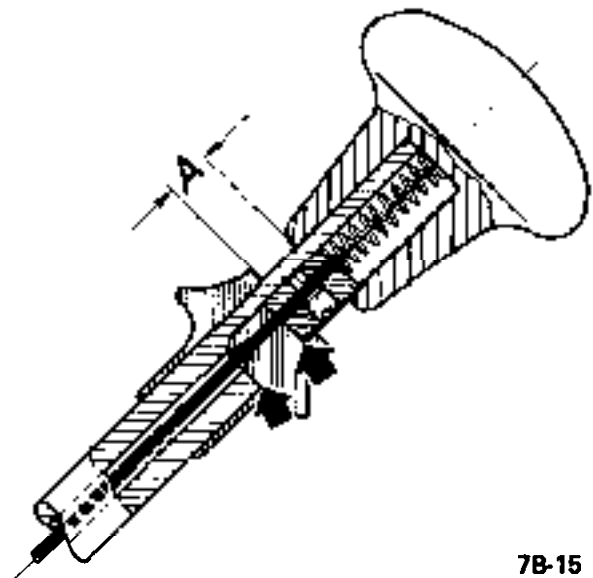
Figure 71-14



7B-13

Figure 7B-13

8. Heat up new gearshift lever knob in boiling water to 176 degrees F. and push it onto lever tube. Observe distance A = .3", see Figure 7B-15. The gearshift lever tube end is provided with transverse grooves for which reason the old button can no longer be used.



7B-15

Figure 7B-15

2. Knock off gearshift lever button and loosen threaded pin for Bowden control wire attachment. See Figure 7B-12.

3. Drive spiral pin and clamping sleeve out of shift finger tube and stop sleeve. See Figure 7B-14.

4. Remove shift finger and pull Bowden control wire, together with thrust spring, out of gearshift lever.

5. Oil sliding surface of stop sleeve on shift finger tube with clutch oil.

6. After installation of thrust spring, attach new Bowden control wire first with clamping sleeve. When doing this, the cutout of stop sleeve in installation position shows to the left. The spiral pins must not protrude on either side.

7. Clamp tight Bowden control wire with threaded pin. Prior to tightening, pull ring must rest on gearshift lever tube and clamping block on pull ring.

9. Attach shift finger with spiral pin and install gearshift lever.

#### REPLACING GEARSHIFT LEVER BELLOWS

1. Remove gearshift lever.

2. Knock off gearshift lever button and pull off bellows over pull ring.

3. Install new bellows. Adhere to distance A = 8.07". See Figure 7B-11.
4. Heat up new gearshift lever knob in boiling water to 176 degrees F. and push it onto gearshift lever tube. Adhere to distance A .3", see Figure 7B-15. The gearshift lever tube end is provided with transverse grooves for which reason the old button cannot be reused. Install gearshift lever.

### REPLACING RUBBER DAMPENING PARTS IN GEARSHIFT LEVER

1. Remove gearshift lever.
2. Knock off gearshift lever button and loosen threaded pin for Bowden control wire attachment.
3. Remove lower snap ring from gearshift lever tube and pull tube off shift finger.
4. Take off and replace rubber dampening parts.
5. After installation of tube, tighten Bowden control wire with threaded pin. Prior to tightening, pull ring must rest on gearshift lever tube and clamping block on pull ring. See Figure 7B-15.
6. Heat up new gearshift lever knob in boiling water to 176 degrees F. and push it onto gearshift lever tube. Adhere to distance A = .3", see Figure 7B-15. The gearshift lever tube end is provided with transverse grooves for which reason the old button cannot be reused.
7. Install gearshift lever.

## MAJOR REPAIR

### TRANSMISSION REMOVAL

1. Remove air cleaner. Remove throttle rod from carburetor and rear support and disconnect battery.
2. Remove screws from fan shroud.
3. Remove gearshift lever (refer to paragraph on servicing gearshift lever).
4. Support car with frame or wheel stands in the front or frame stands in the rear.
5. Loosen front exhaust pipe to manifold flange.
6. Remove clutch cable from fork by pushing fork to disengage the clutch and unsnap cable from slot.
7. Disconnect both wires from backup lamp switch.

8. Disconnect speedometer cable from transmission case extension housing.
9. Unhook parking brake cable return spring and remove cable adjusting nut, equalizer, and spacer. See Figure 7B-16.

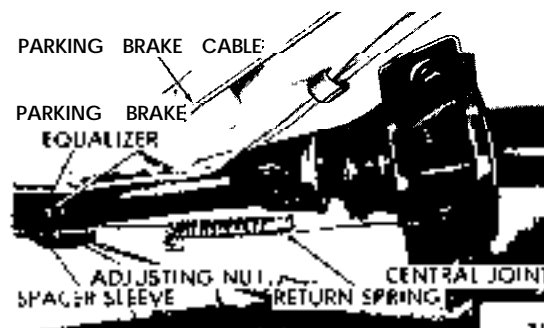


Figure 7B-16 Parking Brake Equalizer and Return Spring

9. Disconnect drive shaft at central joint and remove as follows: See Figure 7B-16.
  - a. Disconnect parking brake cable equalizer from rod.
  - b. Mark the mating parts of U-Joint and the drive pinion extension shaft flange.
  - c. Loosen bolt locks and remove bolts or nuts.
  - d. Work propeller shaft slightly forward, lower rear end of shaft and slide assembly rearward. Remove thrust spring.
  - e. Install a plug in the rear of the transmission to prevent loss of lubricant.
10. Remove rear engine mount bolts and lower transmission as far as possible.
11. Remove transmission case to clutch housing attaching bolts and remove transmission.

### INSTALLATION OF TRANSMISSION WITH ENGINE IN CAR

1. Make certain main drive gear splines are clean and dry. Also, make certain the transmission is in Neutral so that the main drive gear splines may be indexed when making the installation.
2. Install transmission and support weight while installing transmission case to clutch housing bolts.
3. Install rear engine mount.
4. Install propeller shaft, align, and tighten U-Joint to pinion flange U-Bolt nuts and torque to 11 lb. ft.

5. Attach clutch cable.
6. Perform clutch lash adjustment. See Clutch, Sections A and B for adjustment procedure.
7. After overhaul of transmission, refill with 2- 1/2 pints of SAE 80 or SO-90 multi-purpose gear lubricant.

**REMOVING AND INSTALLING SPEEDO DRIVEN GEAR  
(WITH TRANSMISSION REMOVED)**

**Removing Speedo Driven Gear Assembly**

1. Use wrench to unscrew speedo angular drive holding nut and remove speedo angular drive.
2. With Special Tool J-22926 and Slide Hammer J-7004- 1, remove speedo driven gear lock pin which retains speedo driven gear assembly in transmission case extension housing.
3. Using Special Tool J-22929 and Slide Hammer J-7004- 1, remove speedo driven gear assembly. Tool J-22929 screws onto the speedo driven gear guide making it possible to remove the guide and assembly without damage to the transmission case extension housing.

**Installation of Speedo Driven Gear Assembly**

1. Using Special Tool J-22929 install speedo driven gear assembly into transmission case extension housing. It may be necessary to tap lightly on tool J-22929 when installing assembly. Be sure speedo driven gear lock pin hole on guide lines up with hole in transmission case extension housing. Also, rotate mainshaft at output end when inserting speedo driven gear assembly to insure that driven gear meshes properly with speedo drive gear on mainshaft.
2. Install speedo driven gear lock pin into transmission case extension housing by tapping pin lightly.
3. Install speedo angular drive by tightening speedo angular drive to holding nut.

**REPLACING BUSHING IN SELECTOR LEVER  
(TRANSMISSION AND GEARSHIFT LINKAGE REMOVED)**

**Removal**

1. Remove snap ring from bushing. See Figure 7B-17.
2. Using a suitable brass drift drive out bushing from snap ring side. See Figure 7B-19.

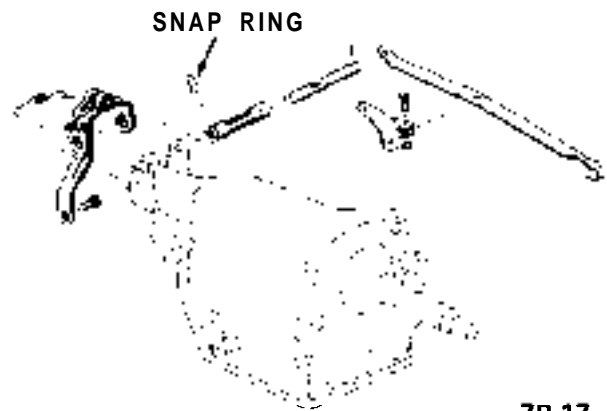


Figure 7B-17 Snap Ring on Selector Intermediate Lever Bushing

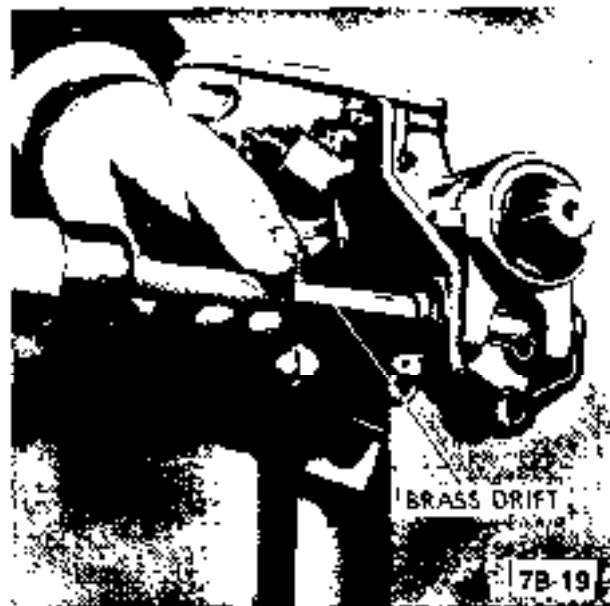


Figure 7B-19 Removing Bushing From Selector Intermediate Lever

**Installation**

1. Using a suitable tool drive in bushing up to stop. Install bushing in opposite direction of removal with the cutout in the bushing facing upwards. See Figure 7B-19.
2. Install snap ring onto bushing.

**TRANSMISSION DISASSEMBLY**

Maintain the respective positions of all mating parts during overhaul.



### Removing Shifter Shaft

1. Remove cotter pins that secure each end of shifter shaft. See Figure 7B-20.

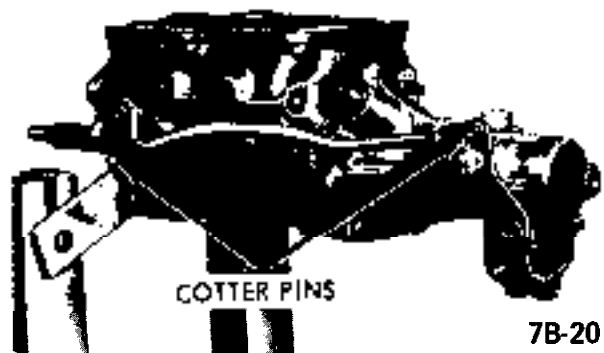


Figure 7B-20 Cotter Pin Locations on Shifter Shaft

2. Remove shifter shaft with washer and spring washer at each end.

### Removing Selector Lever

1. With punch, drive out pin securing selector lever to transmission case extension bolt. See Figure 7B-21.

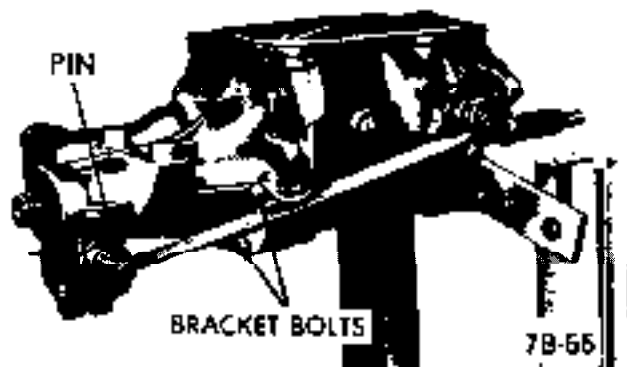


Figure 7B-21 Pin and Bracket Securing Selector Lever to Intermediate Shaft and Rear Bearing Retainer

2. Remove the two (2) bolts and spring washers from the transmission case extension housing which secure selector lever bracket. See Figure 7B-2 1.
3. Remove selector lever and bracket. Selector lever will just slip off selector ring.
4. Remove lock nut and selector ring.
5. Remove transmission case extension bolt. See Figure 7B-21.

### Removing Transmission Case Cover

1. Remove ten (10) transmission case cover bolts, cover, and gasket.
2. Invert transmission to drain oil.

### Removing Countergear

1. Remove remaining three transmission case extension housing to case attaching bolts and spring washers.
2. Turn transmission case extension housing until gear unit countershaft is exposed. See Figure 7B-22.

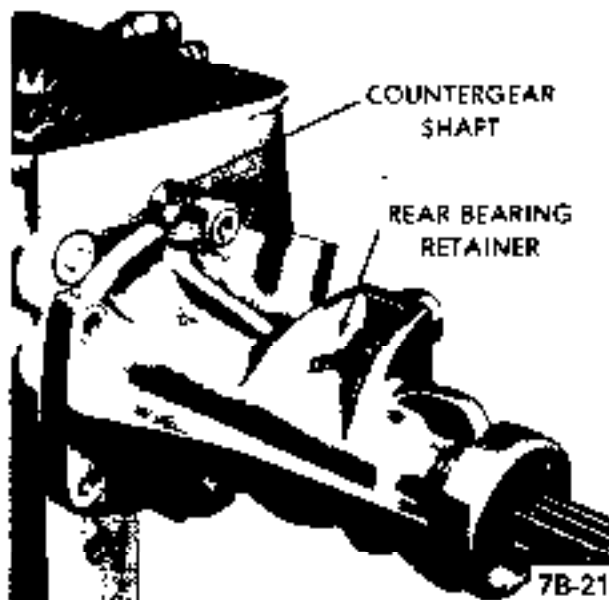


Figure 7B-22 Position of Rear Bearing So Countergear Can Be Removed

3. From the front of the transmission, using Special Tool J-2291 1, drive out shaft. Ensure that lock ball is not lost. See Figure 7B-23.

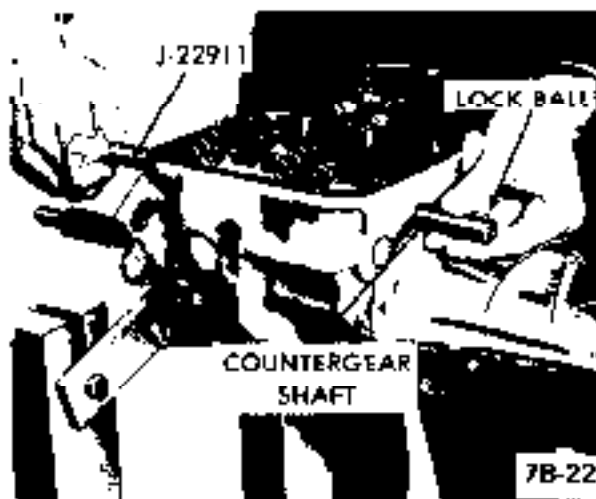


Figure 7B-23 Removing Countergear Shaft

4. With Special Tool J-2291 1 inserted, take counter-shaft gear unit out of transmission case. Remove both thrust washers.

**Removing Selector Shaft and Intermediate Levers**

1. Drive out reverse intermediate lever bedding bolt and remove reverse speed shifter intermediate lever. See Figure 7B-24.

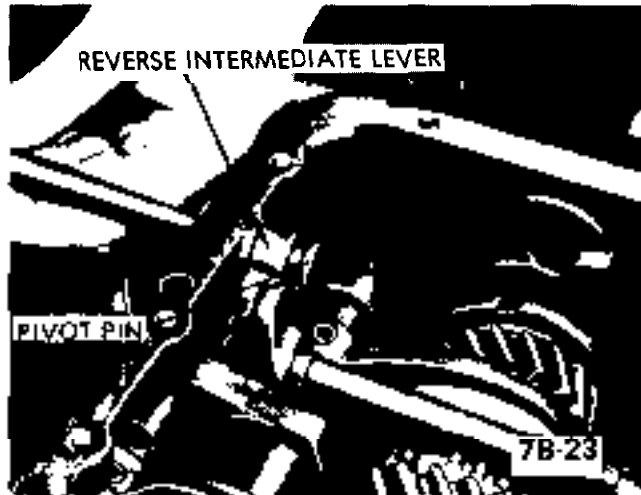


Figure 7B-24 Driving Out Reverse Intermediate Lever Pin

2. To remove all pins, use a 1/8 inch pin punch. Turn the selector shaft so that lock pins are in vertical position. First, drive lock pins out of third and fourth speed intermediate lever and then out of first and second speed intermediate lever. See Figure 7B-25.

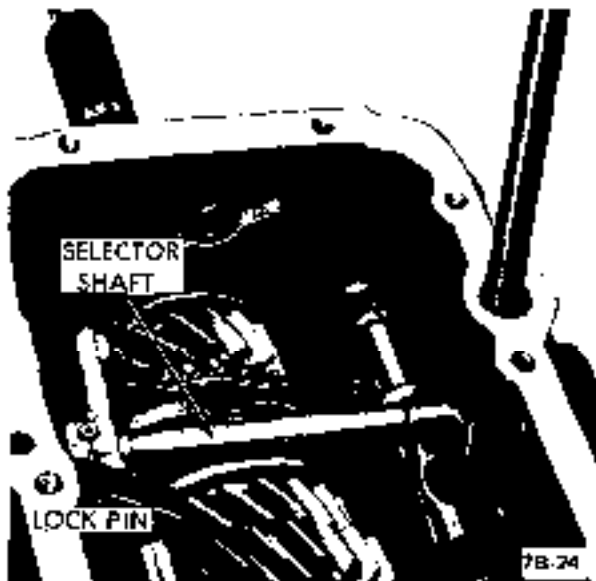


Figure 7B-25 Removing Lock Pins from Selector Shaft

3. Push selector shaft out of case and remove intermediate levers.

4. With screwdriver, pry out selector shaft oil seals on transmission case.

**Removing First and Second Gear Shifter Shaft, Yoke, and Cam**

1. Pull out both lock ball plugs using Tool J- 21715 with Slide Hammer J-7004-1. Remove thrust springs.

2. With transmission in first gear, drive lock pins out of shifter yokes and shifter shaft cam. See Figure 7B-26.

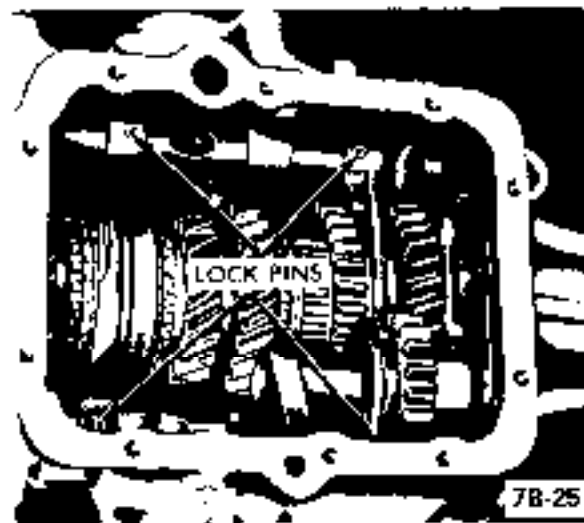


Figure 7B-26 Position of Lock Pins for Shifter Forks and Selector Dogs

3. Turn extension housing until shifter shaft is exposed. From the rear of transmission, drive out first and second speed shifter shaft. Use suitable brass drift. See Figure 7B-27.

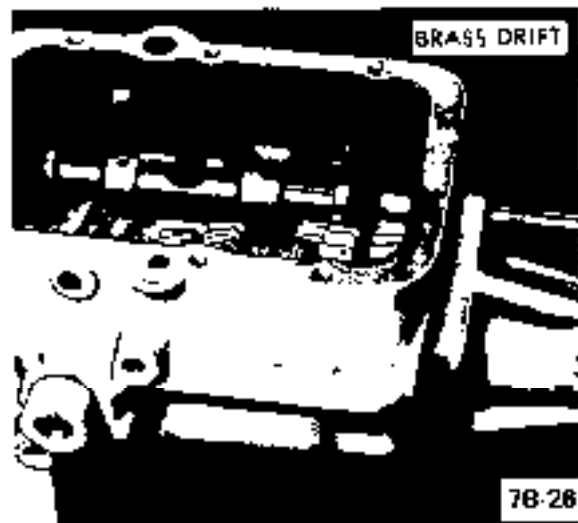


Figure 7B-27 Removing Shifter Shafts

4. Remove both first and second speed shifter yoke and shifter shaft cam.

**Removing Main Drive Gear and Mainshaft Assembly**

1. From front of transmission, pull main drive gear and needle bearing out of transmission. (May be necessary to rock main drive gear.)
2. From rear of transmission, pull mainshaft assembly and transmission case extension housing out of transmission. Gear shifter sleeve will be pulled off gear shifter sleeve carrier by the third and fourth speed shifter yoke. Remove sleeve from yoke and keep sleeve with mainshaft assembly. (Make sure third and fourth speed shoes are not lost.)

**Removing Third and Fourth Gear Shifter Shaft.**

1. With main shaft assembly out of transmission case, drive third and fourth gear shifter shaft out through hole in front of case with brass drift from rear of transmission through mainshaft assembly hole in case.
2. Remove third and fourth speed yoke.

**Removing Reverse Gear Shifter Shaft and Reverse Idler Gear**

1. Using a brass drift and from the front of the transmission, drive out reverse gear shifter shaft and plug. See Figure 7B-28. The reverse speed shifter yoke will remain in transmission case.



Figure 7B-28 Removing Reverse Shifter Shaft

2. With Special Tool J-22923 push reverse idler gear shaft from front toward the rear. Ensure that lock ball is not lost. See Figure 7B-29.

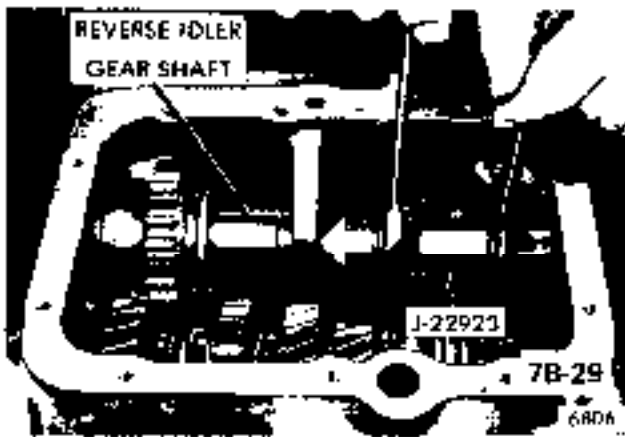


Figure 7B-29 Removing Reverse Idler Gear Shaft

3. Take shaft, reverse idler gear and reverse speed shifter yoke out of transmission case.

**Disassembling Mainshaft Assembly**

1. Remove mainshaft bearing snap ring from transmission case extension housing groove and remove mainshaft assembly from housing. See Figure 7B-30.



Figure 7B-30 Removing Snap Ring From Rear Bearing Retainer

2. Remove loose parts such as mainshaft needle bearing, mainshaft front ring, synchronizer cover, gear shifter sleeve, shoes, and front synchronizer spring. The gear shifter sleeve carrier and the first and second speed sliding gear guide unit and their respective gear shifter sleeve and first and second gear sliding gear are selected assemblies and should be kept together as originally assembled. See Figure 7B-31.

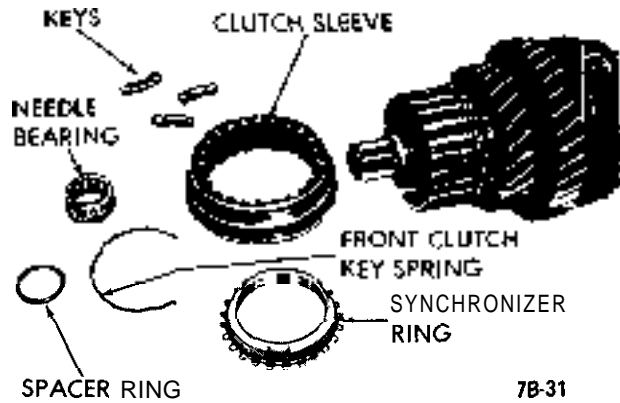


Figure 7B-31

3. Remove snap ring from in front of clutch hub. See Figure 7B-32.

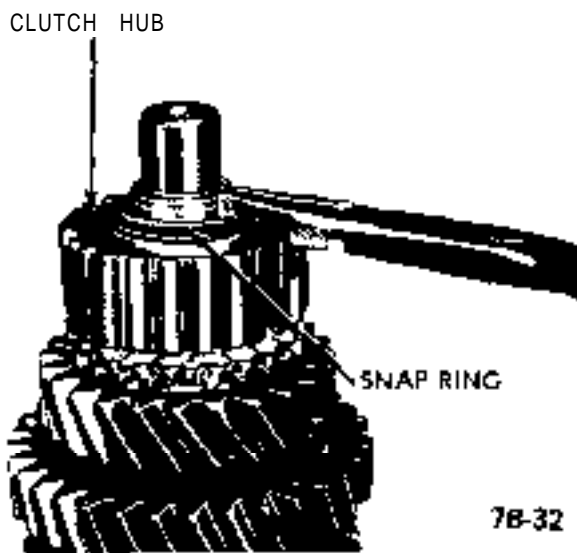


Figure 7B-32 Removing Snap Ring In Front of Clutch Hub

4. Using Tru-arc pliers, remove snap ring behind speedometer drive gear. See Figure 7B-33. Remove speedo drive gear spring washer and speedo drive gear spring worm gear.

5. Remove drive gear lock ball from mainshaft. See Figure 7B-34.

6. Press mainshaft inner bearing from mainshaft using Special Tool J-21684, Press Plate, as shown in Figure 7B-35 and then, by hand, remove all loose parts such as mainshaft washer, transmission case extension housing gear snap ring, first speed gear, first speed needle bearing, synchronizer cover, first and second gear sliding gear, shoes, and rear synchronizer spring. See Figure 7B-37.

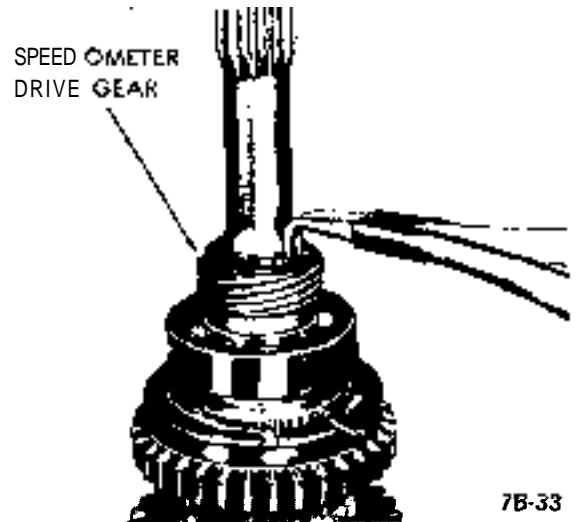


Figure 7B-33 Removing Snap Ring Behind Speedometer Drive Gear

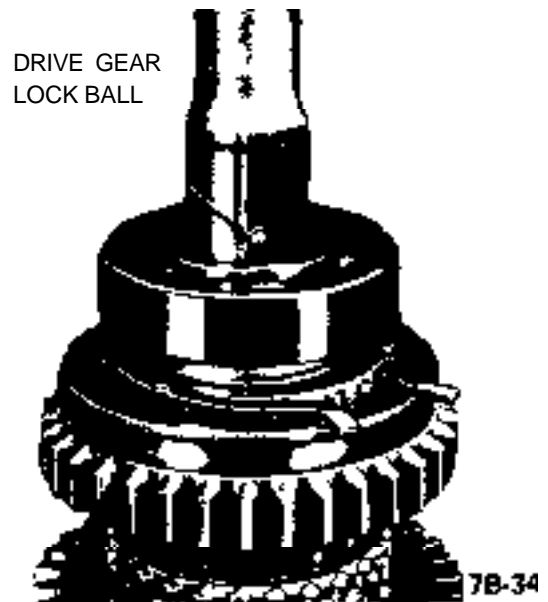


Figure 7B-34 Speedo Drive Gear Lock Ball on Mainshaft

J-21 684

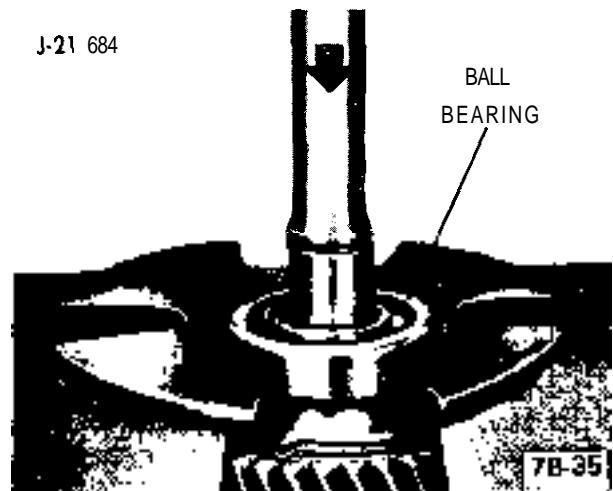


Figure 7B-35 Removing Rear Bearing From Mainshaft

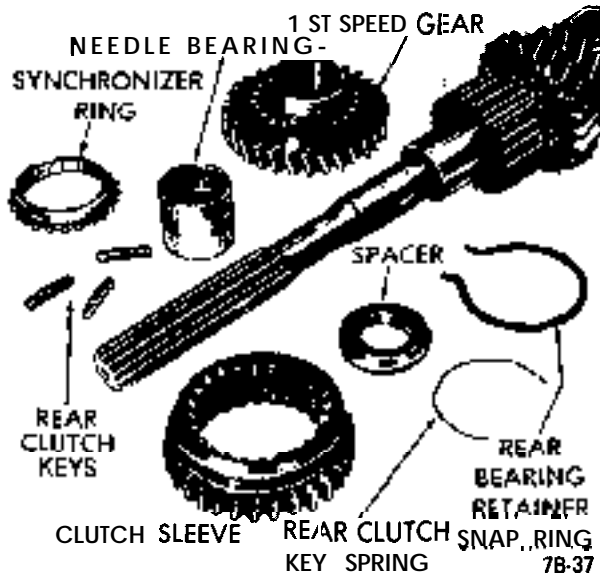


Figure 70-37

7. With Special Tool J-21684, Press Plate, located below third speed gear, press out gear shifter sleeve carrier. See Figure 7B-38.

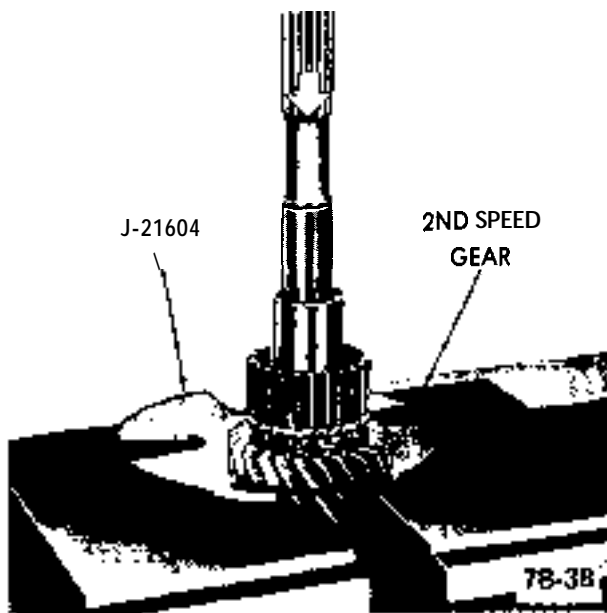


Figure 7B-38 Pressing Off Large Clutch Hub and Needle Bearing Inner Sleeve

8. With Special Tool J-21684, Press Plate, located below second speed gear, press out gear shifter sleeve carrier. See Figure 7B-39.

**TRANSMISSION REASSEMBLY**

**A. Assembling Mainshaft**

1. From front of the mainshaft install third speed gear onto mainshaft. Gear must turn freely on mainshaft.

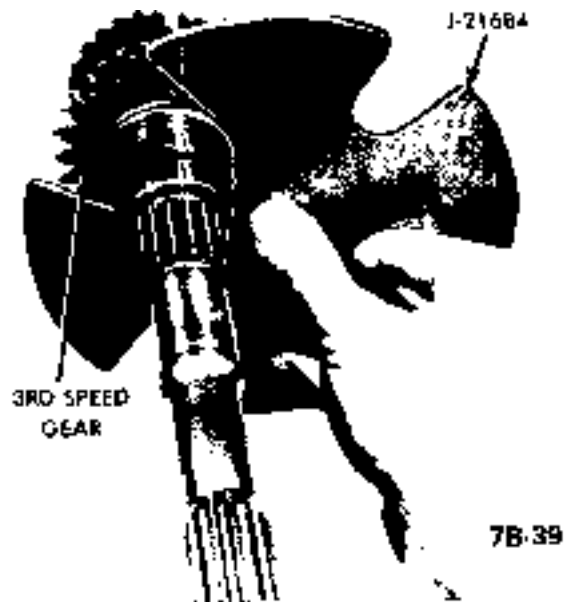


Figure 7B-39 Pressing Off Small Clutch Hub

2. Install third speed synchronizer cover onto third speed gear cone.

3. Install rear synchronizer spring into rear side of gear shifter sleeve carrier so that hooked spring end rests in one of the slots.

4. Using Press Plate J-21684, press gear shifter sleeve carrier onto mainshaft so that original tooth contact is obtained. The rear side of gear shifter sleeve carrier with installed spring should be toward third speed gear. This rear side of carrier is recessed more than front side to allow carrier to be pressed almost flush with synchronizer cover. See Figure 7B-40.

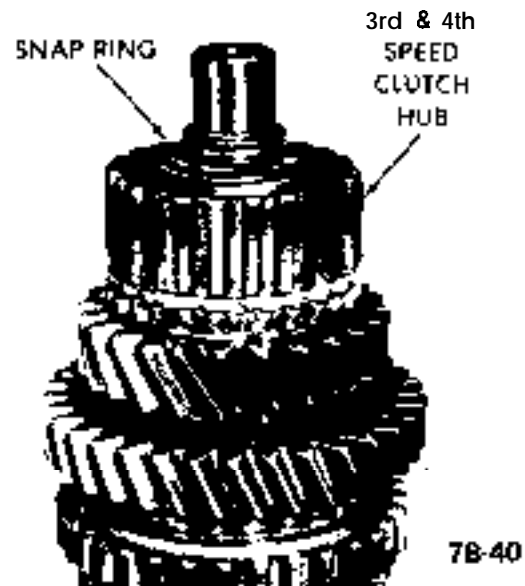


Figure 7B-40 Securing Third and Fourth Speed Clutch Hub on Mainshaft With Snap Ring

5. Using external snap ring pliers, secure gear shifter sleeve carrier on mainshaft with snap ring. See Figure 7B-40.
6. From rear of mainshaft, slide second speed gear onto mainshaft. Gear must turn freely on mainshaft. See Figure 7B-41.

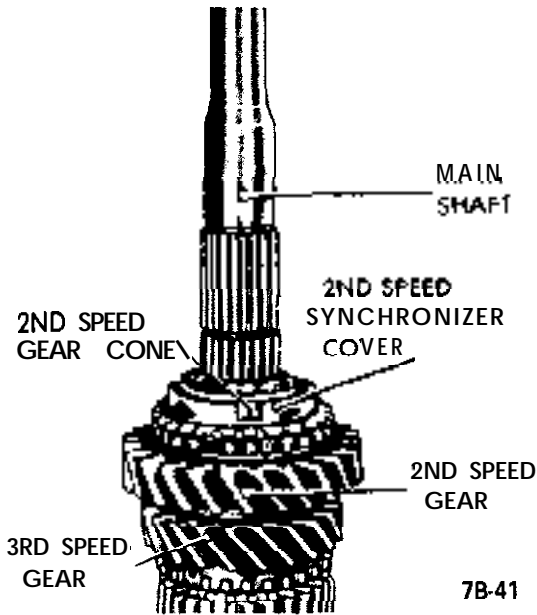


Figure 7B-41 Second Speed Gear and Synchronizer Ring Installed

7. Place second speed synchronizer cover onto second speed gear cone. See Figure 7B-41.
8. Install both synchronizer springs into first and second speed sliding gear guide unit so that hooks of both springs rest in the same guide unit shoe slot and the other spring ends are positioned opposite to each other. See Figure 7B-42.
9. Press first and second speed sliding gear guide unit onto mainshaft so that the original tooth contact is obtained.
10. Using Tool J-22913, press first speed gear needle bearing inner sleeve onto mainshaft.
11. Using Tool J-22913, install first and second speed shoes (long style) and install first and second gear sliding gear (forked groove to rear) onto first and second speed sliding gear guide unit.
12. Slide first speed gear needle bearing, synchronizer cover, first speed gear, mainshaft washer (chamfer toward rear), and mainshaft bearing snap ring onto mainshaft.
13. Press on mainshaft inner bearing using Tool J-22913. See Figure 7B-43.



Figure 7B-42 Both Clutch Key Springs Installed

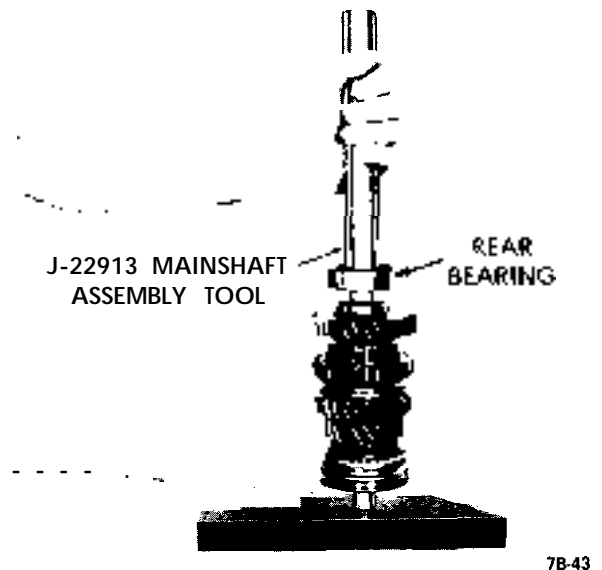


Figure 7B-43 Pressing on Rear Bearing Using Tool J-22913

14. Insert lock ball in place in mainshaft and place speedo drive worm gear and speedo drive gear spring washer on mainshaft. Secure with speedo drive gear snap ring.
15. Place mainshaft assembly into transmission case extension housing up to its stop. Secure with mainshaft bearing snap ring. See Figure 7B-44.

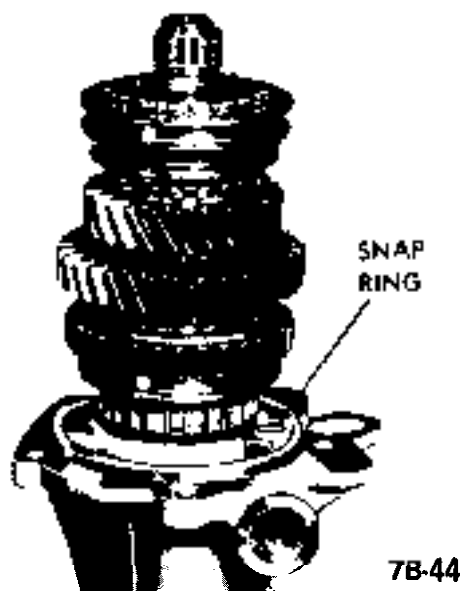


Figure 7B-44 Mainshaft Assembly Secured Into Rear Bearing Retainer by Snap Ring

16. Place front synchronizer spring in the gear shifter sleeve carrier. Install (3) third and fourth speed shoes (short design) and gear shifter sleeve over gear shifter sleeve carrier along with synchronizer cover. Arrows on shoes point toward rear of mainshaft. Gear shifter sleeve yoke groove should be toward front.

17. With sealer, install new gasket onto transmission case extension housing.

#### Installing Reverse Idler Gear and Reverse Gear Shifter Shaft

1. Inspect shafts carefully for burrs, and remove with emery cloth. Burrs on shifter shaft will prevent easy installation of shifter yoke. Lightly oil with transmission oil prior to installation. Place lock ball into reverse idler gear shaft and push shaft through hole in rear of case and on through reverse idler gear which should have groove end toward front. See Figure 7B-46.

Continue to drive reverse idler gear shaft forward with plastic hammer until rear end of shaft is flush with rear case face.

2. Position reverse speed shifter yoke in groove of reverse idler gear and install reverse gear shifter shaft from rear of case with notches up, pushing it through reverse speed shifter yoke. See Figure 7B-47.

3. Install spiral pin to secure yoke to shifter shaft and drive plug into hole in rear of case.

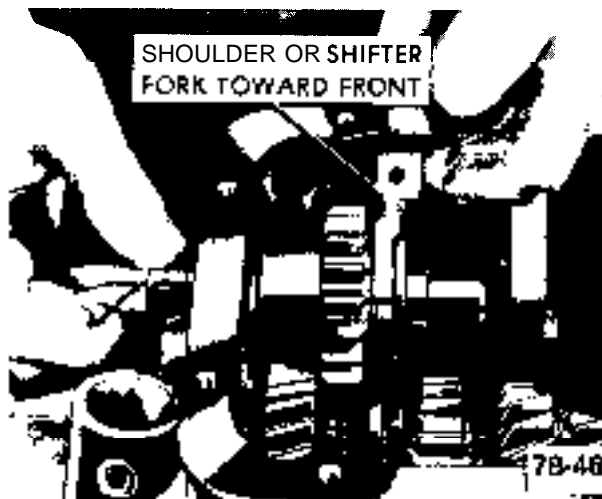


Figure 7B-46 Installing Reverse Shifter Fork

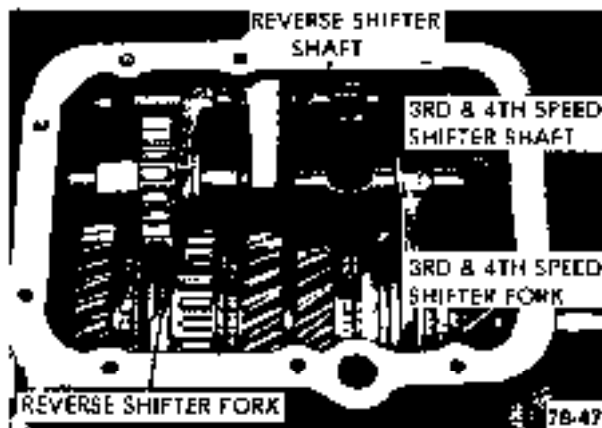


Figure 7B-47 Third and Fourth Speed Shifter Shaft Installed

#### Installing Mainshaft Assembly and Main Drive Gear

1. Slide mainshaft assembly into transmission case from rear.

2. From the front, slide mainshaft front ring and the mainshaft needle bearing onto the mainshaft. See Figure 7B-48.

3. Install main drive gear through front of transmission case until main drive (standard part) snap ring is flush with case.

#### Installing Third and Fourth Gear Shifter Shaft

1. Position third and fourth speed yoke onto gear shifter sleeve. See Figure 7B-47.

2. Insert third and fourth gear shifter shaft through hole in front of case with notches down, pushing it through third and fourth speed yoke. Third and

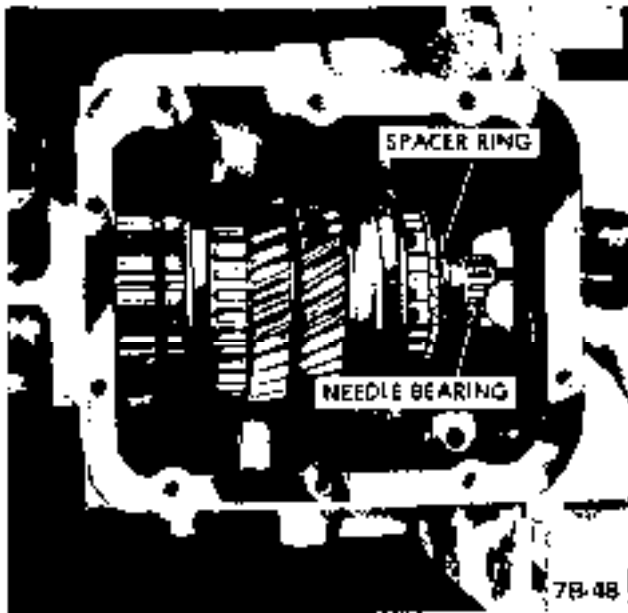


Figure 7B-48 Installing Spacer Ring and Needle Bearing Onto Mainshaft

fourth speed yoke should be positioned with rounded notch at shaft hole portion of yoke toward rear. See Figure 7B-47.

3. Install spiral pin, allowing 1/16" to 5/64" of pin to protrude.

#### Installing First and Second Gear Shifter Shaft

1. Inspect shifter shaft carefully for burrs, and remove with emery cloth. Burrs on shifter shaft will prevent easy installation of shifter yoke and cam. Lightly oil with transmission oil prior to installation. Insert first and second gear shifter shaft through hole in rear of case with three notches down and toward rear of transmission, pushing shaft first through first and second gear shifter yoke, which should be positioned on first and second gear sliding gear with shoulder toward front of case. To position first and second gear shifter yoke on first and second gear sliding gear, push reverse idler gear forward, engaging the idler gear with the first and second gear sliding gear. This will make room for positioning first and second gear shifter yoke. See Figure 7B-49.

2. Continue to drive first and second gear shifter shaft through shifter shaft cam, which should be positioned as shown in Figure 7B-50.

3. Install spiral pins to secure shifter yoke and shifter shaft cam to first and second gear shifter shaft.

#### Installing Selector Shaft

1. Inspect selector shaft carefully for burrs, and

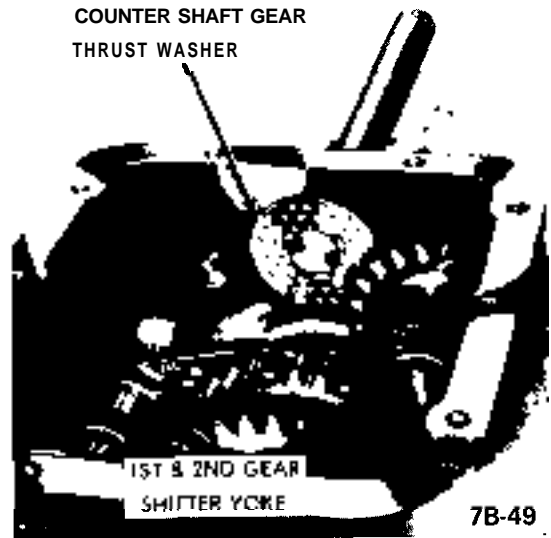


Figure 7B-49 Countergear Thrust Washers Installed

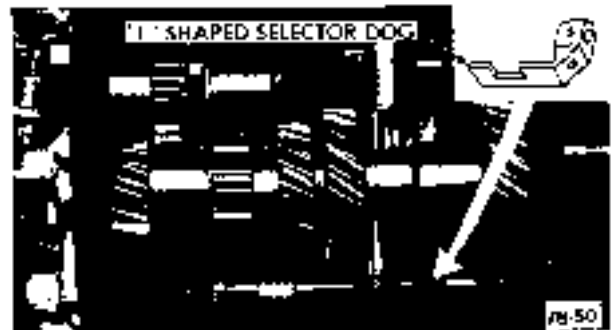
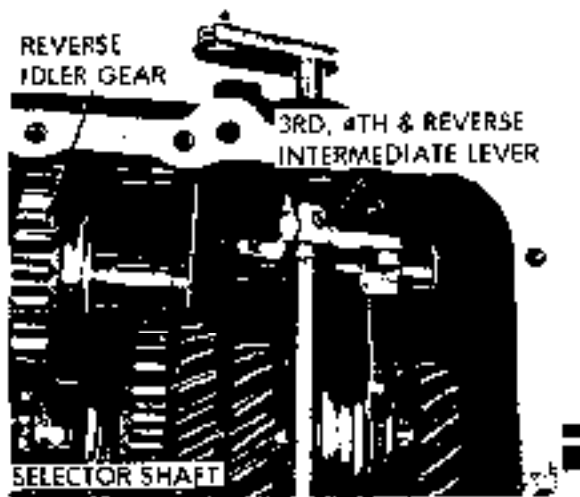


Figure 7B-50 Position of "L" Shaped Selector Dog

remove with emery cloth. Burrs on shaft will prevent easy installation of intermediate levers. Lightly oil with transmission oil prior to installation. Insert new selector shaft oil seals in holes on both sides of transmission case and insert selector shaft into case and through third, fourth, and reverse intermediate lever. Third, fourth, and reverse intermediate lever should be positioned on selector shaft, as shown in Figure 7B-51.

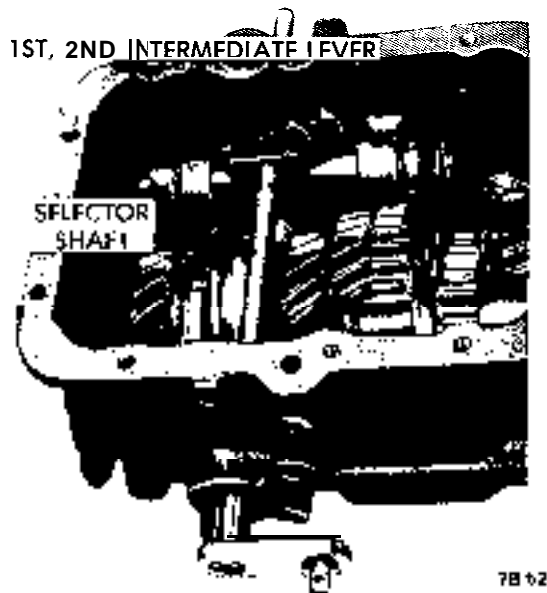
2. Continue to push selector shaft through first and second intermediate lever and through other side of case. First and second intermediate lever should be positioned on selector shaft, as shown in Figure 7B-52. Selector shaft is rotated counterclockwise (when looking from lever end of selector shaft) from working position to have spiral pin holes in shaft vertical and in line with pin holes in intermediate levers. To rotate selector shaft in this manner, the reverse gear shifter shaft and its reverse speed shifter yoke must be pushed rearward so that the reverse idler gear is against rear of case.





7B-51

Figure 7B-51 Position of Third, Fourth, and Reverse Intermediate Lever on Selector Shaft



7B-52

Figure 7B-52 Position of First and Second Intermediate Lever on Selector Shaft

3. Install spiral pins to secure both intermediate levers to the selector shaft. Spiral pins should not be flush with lever surface, but rather should extend up between  $1/16$  and  $5/64$  inches.

#### Installing Reverse Speed Shifter Intermediate Lever and Interlock Balls, Springs, and Plugs

1. Engage reverse speed shifter intermediate lever with third, fourth, and reverse intermediate lever **and also** in slot in reverse gear shifter shaft, and install

bedding bolt through reverse speed shifter intermediate lever and into case. Reverse speed shifter intermediate lever end play on bolt should be between .004 and .012 inches.

2. Insert both interlock balls and then springs, and drive both interlock plugs into case holes until they bottom in interlock plug hole seats. Grooves in plugs will be showing.

#### Installing Countershaft Gear Unit

1. Coat thrust washers with ball and roller bearing grease and stick to transmission case. Lugs of thrust washers must fit into transmission case slots. See Figure 7B-49.

2. Turn transmission case extension housing until gear unit countershaft bore is completely exposed.

3. Place lock ball into shaft and from the rear of the transmission insert shaft so that thrust washer is held in position. Hold opposite thrust washer in position by using a short drift.

4. Insert countershaft gear unit into transmission case. Be sure all needle bearings and both needle bearing washers are in place.

5. Insert gear unit countershaft into gear unit and drive shaft into transmission case while driving out Special Tool J-2291 1. Pay attention to lock ball. See Figure 7B-53.



Figure 7B-53 Installing Countergear Shaft

#### Installing Transmission Case Extension Housing

1. Align transmission case extension housing and gasket and torque (3) bolts with spring washers to 21 lb. ft.

**Installing Gearshift Interlock Ball and Gearshift Thrust Spring**

1. Install gearshift interlock ball into top transmission bore and then install gearshift thrust spring.

**Installing Transmission Case Cover**

1. Install case cover gasket, cover, and tighten screws.

**Installing Gearshift Linkages**

1. Install selector ring and lock nut onto selector shaft.

2. Holding selector lever and support in place, torque (2) bracket bolts and spring washers to 14.5 lb. ft. See Figure 7B-55.

3. Install pin securing selector lever to transmission case extension bolt.

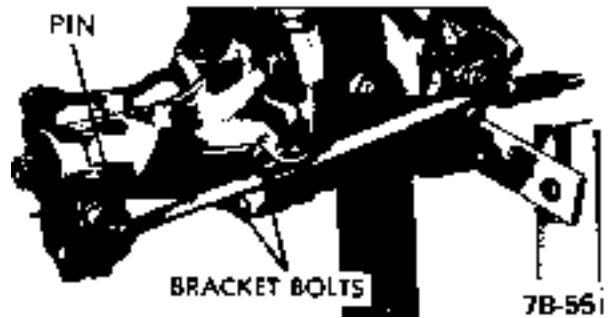


Figure 7B-55 Pin and Bracket Securing Selector Lever to Intermediate Shaft and Bearing Retainer

4. Install shifter shaft with spring washers on inside of shifter shaft ends and flat washers on outside of shaft.

5. Secure each end of shifter shaft and washers with new cotter pins.

**SPECIFICATIONS**

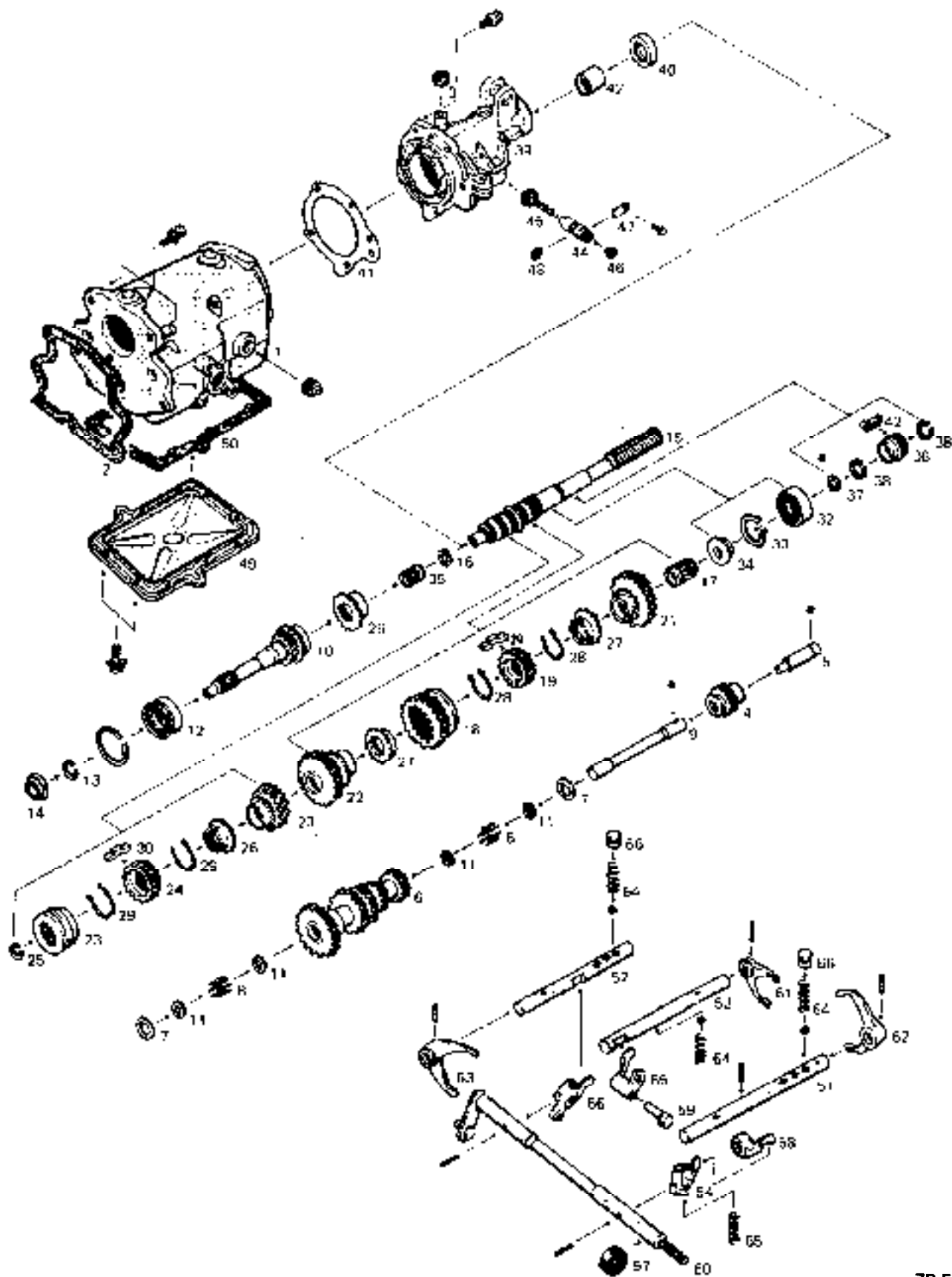
**TRANSMISSION SPECIFICATIONS**

**General Specifications**

Type .....	Manual Shift 4 Speeds Forward • 1 Reverse
Synchronization .....	Fully Synchronized All Forward Speeds
Gear Ratios:	
1st Gear .....	3.428
2nd Gear .....	2.156
3rd Gear .....	1.366
4th Gear .....	1.000
Reverse .....	3.317
Lubricant Capacity .....	2.5 pints
Lubricant Type .....	SAE 80 or SO-90 Multi-Purpose Gear Lubricant

**Torquing Specifications**

Part	Location	Torque Lbs.Ft.
Bolt	Transmission to Flywheel	32-36
Bolt	(3) Rear Bearing Retainer to Transmission Case (M8x25)	21
Bolt	(2) Rear Bearing Retainer to Transmission Case (M8x30)	14.5
Bolt	Rear Engine Mount to Underbody	22



1.9 Engine Transmission

Figure 7B-57 Exploded View of Manual Transmission

1 Case, Transmission	35	Bearing, Trans. Main Shaft Needle • Right
2 Gasket, Trans. Case to Clutch Housing	36	Gear, Speedometer Drive
3 Cap, Ventilator	37	Washer, Speedo Drive Gear
4 Gear, W/Bushings, Reverse Idler	38	Ring, Speedo Drive Gear Snap
5 Shaft, Reverse Idler Gear	39	Retainer, R.R. Bearing
6 Cluster Gear, Countershaft	40	Oil Seal, Trans. R.R.
7 Washer, Trans. Counter Gear Thrust	41	Gasket, R.R. Bearing Retainer
8 Roller. Trans. Counter Gear Bearing	42	Bushing. Trans. Main Shaft • R.R.
9 Countershaft. Cluster Gear	43	Clip, Speedo Gear
10 Gear, Main Drive	44	Guide, Speedo Drive
11 Spacer Ring, Trans. Counter Gear Bearing Roller	45	Gear, Speedo Driven
12 Bearing, Trans. Main Shaft Pilot	46	Seal, Speedo • Shaft Sleeve
13 Ring, Trans. Main Drive Gear Ball Bearing Lock	47	Bracket, Speedo and Guide on Trans.
14 Seal Ring, Main Drive Gear to Clutch	48	Seal Ring, Speedo Drive Guide
15 Shaft, Main	49	Cover, Trans. Case
16 Ring, Trans. Main Shaft Snap Front	50	Gasket, Trans. Case Cover
17 Needle Bearing, 1st Speed Gear on Main Shaft	51	Shifter Shaft, 1st and 2nd Speed
18 Sliding Gear, 1st and 2nd Speed	52	Shifter Shaft, 3rd and 4th Speed
19 Guide Unit, 1st and 2nd Speeding Sliding Gear	53	Shaft, Reverse Speed Shifter
20 Gear. 3rd Speed	54	Intermediate Lever, 1st and 2nd Speed
21 Gear, 1 st Speed	55	Shifter
22 Gear, 2nd Speed	56	Lever, Reverse Shifter Intermediate
23 Sleeve, Trans. Gear Shifter	57	Lever, Intermediate 3rd. 4th and Reverse
24 Carrier, Trans. Gear Shifter Sleeve	58	Seal, Shifter Shaft Oil in Trans.
25 Snap Ring, Trans. Gear Shifter Sleeve	59	Cam. on Shifter Shaft
26 Cone, Trans. 3rd and 4th Speed Synchronizer	60	Shifter Shaft, Intermediate Lever Reverse
27 Cone, Trans. 1st and 2nd Speed Synchronizer	61	Shaft, W/Lever and Bolt, in Trans.
28 Spring, Synchronizer (1st and 2nd Speed)	62	Fork (Yoke), Reverse Speed Shifter
29 Spring, Synchronizer	63	Yoke, Trans. Shifter (1st and Reverse)
30 Shoe, 1st and 2nd Speed Shifter	64	Fork (Yoke), Trans. 2nd and 3rd Speed
31 Shoe, 3rd and 4th Speed Shifter	65	Spring, Trans. Gearshift Interlock Thrust
32 Bearing, Trans. Main Shaft R.R.	66	Detent Spring, Reverse Speed Gearshift
33 Snap Ring, Trans. Main Shaft Ball Bearings		Interlock
34 Washer, Main Shaft Between Inner Ball Bearing and 1st Speed Gear		Plug, Gearshift Interlock Detent

# AUTOMATIC TRANSMISSION

## CONTENTS

Subject	Page No.
<b>DESCRIPTION AND OPERATION:</b>	
Description of the Opel Three-Speed Automatic Transmission .....	7C- 37
Principles of Operation .....	7C- 38
Component Operation and Location .....	7C- 44
Mechanical Operation .....	7C- 48
Hydraulic Control Units and Valves .....	7C- 48
Hydraulic Operation .....	7C- 64
<b>DIAGNOSIS:</b>	
Sequence for Trouble Diagnosis .....	7C- 81
Checking Procedures .....	7C- 81
External Oil Leaks .....	7C- 81
Trouble Diagnosis Chart .....	7C- 82
Hydraulic Pressure Checks .....	7C- 87
<b>MAINTENANCE AND ADJUSTMENTS:</b>	
Detent Cable Adjustment .....	7C- 91
Servicing Selector Lever .....	7C- 93
<b>MAJOR REPAIR:</b>	
<b>Transmission Removal and Installation</b>	
All Models .....	7C- 94
Removal of Oil Pan .....	7C- 99
Removal of Valve Body .....	7C- 99
Removal of Servo Piston .....	7C-100
Removal of Selector Lever and Shaft .....	7C-100
Removal of Modulator Assembly .....	7C-101
Removal of Detent Valve Assembly .....	7C-102
Removal of Extension Housing .....	7C-102
Removal of Speedometer Drive Gear, Governor Body and Governor Hub .....	7C-103
Removal of Converter Housing, Oil Pump, Reverse and Second Clutch Assembly .....	7C-103
Removal of Third Clutch Assembly, Planetary Carrier Assembly, Reaction Sun Gear and Drum Assembly and Low Bank .....	7C-104
Disassembly, Inspection and Reassembly of Converter Housing, Oil Pump and Reverse Clutch	7C-105
Disassembly, Inspection and Reassembly of Second Clutch .....	7C-111
Disassembly, Inspection and Reassembly of Third Clutch .....	7C-114
Disassembly, Inspection and Reassembly of Planetary Carrier .....	7C-118

Disassembly, Inspection and Reassembly of Reaction Sun Gear and Drum .....	7C-118
Disassembly, Inspection and Reassembly of Governor Body .....	7C-119
Disassembly, Inspection and Reassembly of Governor Hub .....	7C-120
Disassembly, Inspection and Reassembly of Extension Housing .....	7C-120
Disassembly, Inspection and Reassembly of Servo Piston .....	7C-120
Disassembly, Inspection and Reassembly of Valve Body .....	7C-121
Disassembly, Inspection and Reassembly of Case .....	7C-124
Inspecting and Testing Converter .....	7C-125
Installation of Selector Lever and Shaft .....	7C-125
Installation of Low Band .....	7C-125
Installation of Reaction Sun Gear and Drum .....	7C-127
Installation of Output Shaft and Planetary Carrier .....	7C-127
Installation of Second and Third Clutch Assemblies Into Case .....	7C-127
Installation of Reverse Clutch .....	7C-128
Determining Selective Washer Size .....	7C-129
Installation of Converter Housing, Oil Pump and Clutch Assembly .....	7C-129
Installation of Governor Assembly .....	7C-129
Installation of Extension Housing .....	7C-130
Installation of Speedometer Driven Gear .....	7C-131
Installation of Detent Valve, Modulator Valve and Modulator Assembly .....	7C-131
Installation and Adjustment of Servo .....	7C-131
Installation of Valve Body .....	7C-132
Installation of Oil Pan and Gasket .....	7C-133
Torque Converter .....	7C-134
<b>SPECIFICATIONS:</b>	
General Specifications .....	7C-134

## DESCRIPTION AND OPERATION

### DESCRIPTION

The Opel Three-Speed Automatic is a fully automatic unit utilizing a torque converter and a Ravig-

neaux planetary gear set, with three multiple disc clutches and a single band to provide three forward speeds and reverse. See Figure 7C-71. Automatic upshifts and downshifts are controlled by road speed, engine vacuum and an accelerator pedal connection to the transmission.



Figure 7C-1 Quadrant In Park Position - Opel 1900 and Manta

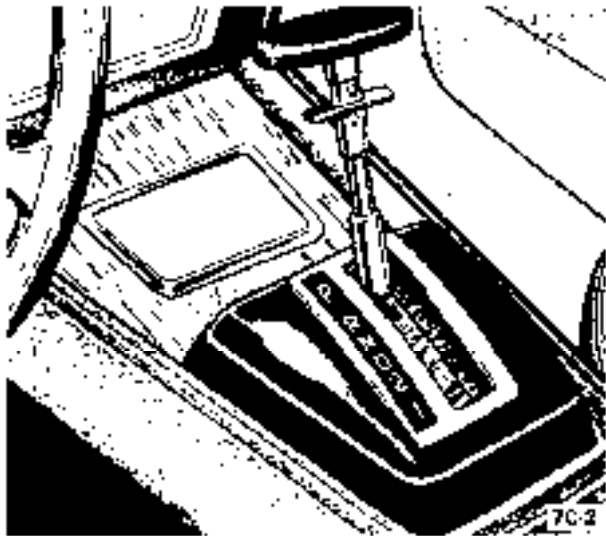


Figure 7C-2 Quadrant in Park Position - GT Models

The quadrant has six positions indicated in the following order: (Opel 1900 and Manta) P,R,N,D,S, and L (Figure 7C-1); and (GT) P,R,N,D,2, and 1 (Figure 7C-2).

**P** - Park position enables the transmission output shaft to be locked - thus preventing the vehicle from rolling either forward or backward. Because the output shaft is mechanically locked by a parking pawl anchored in the extension housing, the park position should not be selected until the vehicle has come to a stop. The engine may be started in the Park position.

**R** - Reverse enables the vehicle to be operated in a reverse direction.

**N** - Neutral position enables the engine to be started and operated without driving the vehicle.

**D** - Drive range is used for all normal driving conditions and maximum economy and has three gear ratios. Downshifts are available for passing by depressing the accelerator partially at lower car speeds and through the "detent" at higher car speeds.

**S or 2** - Second range adds new performance for hilly terrain. It has the same starting ratio as Drive range, but prevents the transmission from shifting above second gear to retain second gear for acceleration or engine braking as desired. Second range can be selected at any vehicle speed, but should not be used above the speed shown in the Owner's Manual. This is to prevent over-speeding the engine. The transmission will shift to second gear immediately and remain in second until the vehicle speed or the throttle position is changed to obtain first gear operation in the same manner as in Drive range.

**L or 1** - Lo range can be selected at any vehicle speed, but should not be used above the speed shown in the Owner's Manual. The transmission will shift to low (1st) gear immediately and remain in 1st gear regardless of vehicle speed or throttle position. This is particularly beneficial for maintaining maximum engine braking.

## PRINCIPLES OF OPERATION

### Torque Converter

The torque converter acts as a coupling to transmit engine torque, through oil, to the transmission power train. It also multiplies the torque from the engine under certain conditions of input and output speed.

The torque converter used in the Opel three speed automatic transmission consists of three basic elements: the pump (driving member), the turbine (driven or output member) and the stator (reaction member). See Figure 7C-3. The converter cover is welded to the pump to seal all three members in an oil filled housing.

Whenever the engine is running, the converter pump turns at engine speed and acts as a centrifugal pump, picking up oil at its center, adding energy, and discharging the oil at its outer rim between the blades. The shape of the converter pump shells and blades cause the oil to leave the pump spinning in a clockwise direction toward the blades of the turbine. As there is no mechanical connection between converter pump and turbine, the oil is the only driving force and strikes the blades of the turbine, transferring the



7c.3

Figure 7C-3 Torque Converter Assembly

energy of the oil to the turbine. See Figure 7C-1. The driven member, or turbine is splined to the transmission input shaft to transmit turbine torque to the transmission gear train.

When the engine is idling, the converter pump is being driven slowly. The energy of the oil leaving the pump is very low, therefore there is very little torque imparted to the turbine. For this reason, the engine can idle and the car will have little or no tendency to "Creep."

As the throttle is opened and pump speed increases, the force of the oil leaving the pump increases and the resultant torque is absorbed by the turbine.

After the oil has imparted its force to the turbine member, oil leaving the turbine follows the contour of the turbine blades so that it leaves the turbine spinning counterclockwise. Since the turbine member has absorbed the energy required to reverse the direction of the oil, the turbine now has greater force or torque than is being delivered by the engine, and the process of torque multiplication has begun.

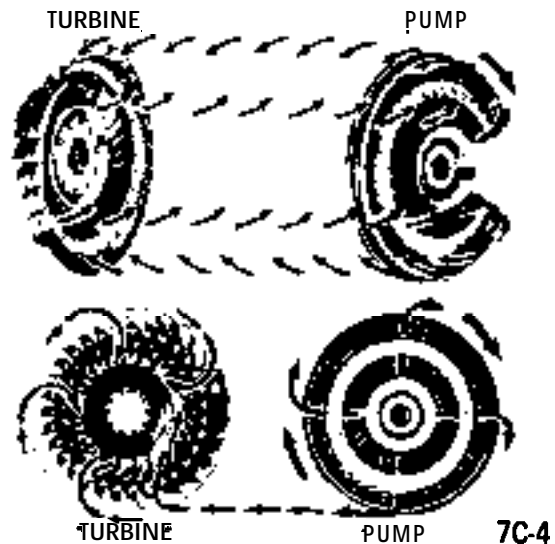


Figure 7C-4 Oil Flow Without Stator

If the counterclockwise spinning oil were allowed to return directly to the converter pump, the oil would strike the inner section of the pump blades in a direction that would hinder its rotation, cancelling out any gains in torque that have been obtained. To prevent this, a stator assembly is added, and is located between the converter pump and turbine. See Figure 7C-5.

The stator redirects the oil returning to the pump member of the converter and changes its direction of rotation to that of the pump. Since the direction of the oil leaving the stator is not opposing the rotation of the pump, the energy or torque of the engine is added to the oil as it passes through the pump and the entire cycle repeats. See Figure 7C-6.

The force of the returning oil from the turbine tends to rotate the stator in a counterclockwise direction, the stator is mounted on a one-way or roller clutch which allows it to turn clockwise but not counterclockwise. Therefore, at low turbine speeds, the returning oil from the turbine striking the stator blades in a counterclockwise direction causes the roller clutch to "lockup," and prevent the stator from turning.

As the turbine speed increases, the direction of the oil leaving the turbine changes and flows against the stator blades in a clockwise direction. Since the stator would now be hindering the smooth flow of returning oil to the pump, the roller clutch releases, and the stator rotates freely on its shaft. With this condition, the stator becomes ineffective and no further multiplication of engine torque is produced within the converter. At this point the converter acts



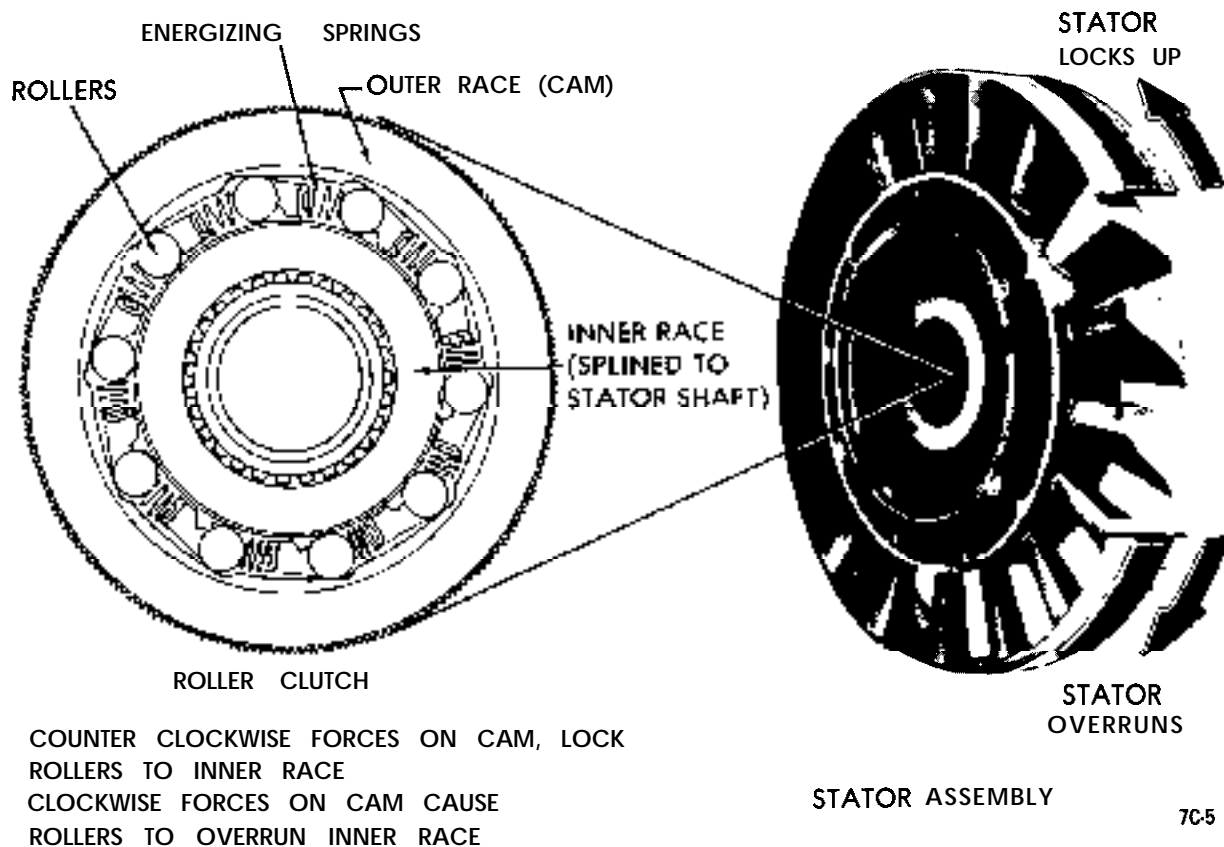


Figure 7C-5 Roller Clutch And Stator Assembly

as a fluid coupling, since both the converter pump and turbine are turning at the same speed, or at a 1:1 ratio.

The torque converter and input shaft actually form a simple transmission in themselves, however, since the requirements of an automobile transmission are greater, some means of providing additional torque, neutral and reverse, are required. For this reason a gear set is added behind the torque converter.

### Planetary Gears

Planetary gears are used in automatic transmissions as the basic means of multiplying the twisting force or torque from the engine. They are so named because of their physical arrangement and are used because they permit constant mesh operation, cannot clash, operate in a minimum of space and distribute the load over several gears. The simplest planetary gear set consists of a center or sun gear, internal or ring gear and a planetary gears called planetary pinions. See Figure 7C-9. The sun gear meshes with the

planetary pinions which rotate freely on their shafts attached to the planetary carrier. The ring gear surrounds the assembly and meshes with the planetary pinions. Power flow through the planetary gear set is accomplished by applying power to one member, holding another member thus making it a reaction member and obtaining the transmitted power from the third member, which can result in any of the following conditions:

1. Increase torque with a proportional decrease in output speed.
2. Increase speed with a proportional decrease of output torque.
3. Reverse direction of rotation.
4. Act as a direct connection for direct drive.

The gear set used in the Opel Three Speed Automatic transmission is known as a **Ravigneaux** planetary

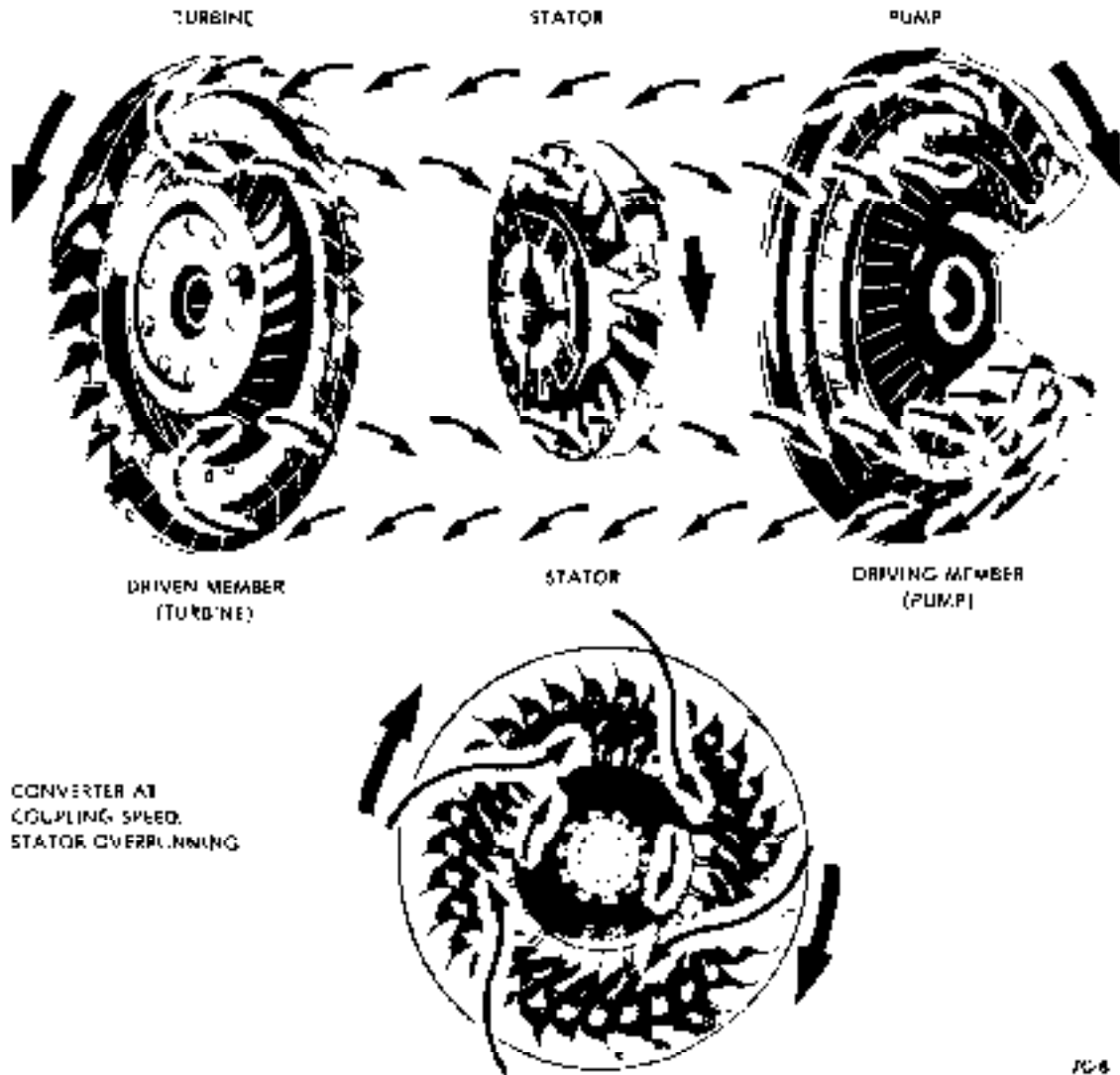


Figure 7C-6 Oil Flow With Stator Active

gear set and utilizes two sets of planetary pinions in one planet carrier, two sun gears and one ring gear. See Figure 7C-8.

The short planetary pinions are in constant mesh with both the input (front) sun gear and the long planetary pinions. The long planetary pinions are in **constant** mesh with the reaction (rear) sun gear, the short planetary pinions and the ring gear.

In the **first** gear the reaction (rear) sun gear is held stationary. The input (front) sun gear rotates in a

clockwise direction (when viewed from the front) turning the short planet pinions counterclockwise and the long planet pinions clockwise. The long planet pinions turn the ring gear clockwise and walk around the held reaction (rear) sun gear driving the planet carrier and output shaft assembly in a clockwise direction. See Figure 7C-10.

In second gear the reaction (rear) sun gear is again held **stationary**. The ring gear is the input and is driven in a clockwise direction turning the long planetary pinions clockwise which walk around the stationary reaction (rear) sun gear, driving the planet

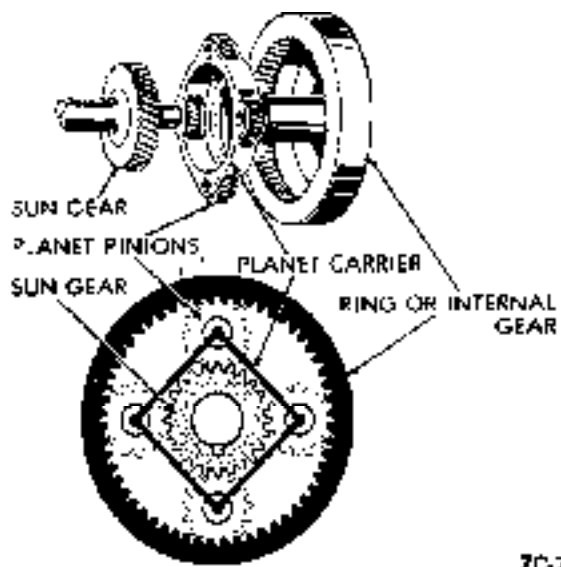


Figure 7C-7 Planetary Gears

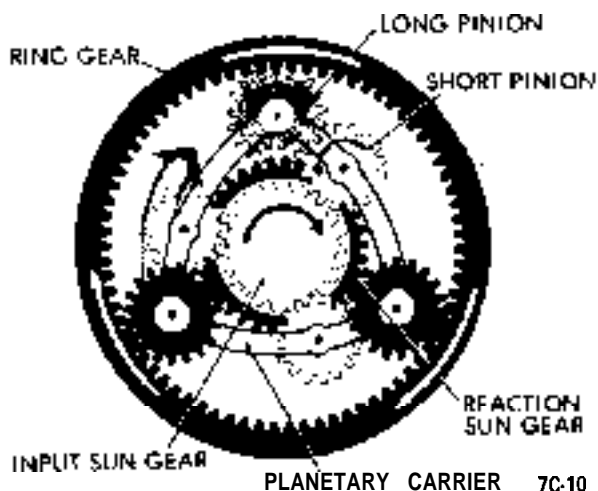


Figure 7C-10 First Gear

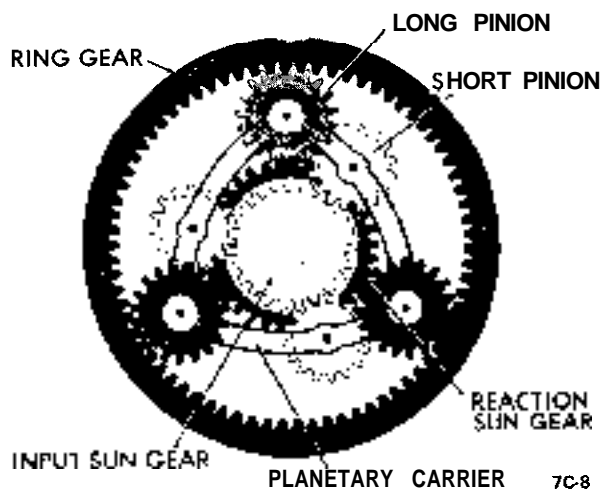


Figure 7C-8 Ravigneaux Planetary Gears

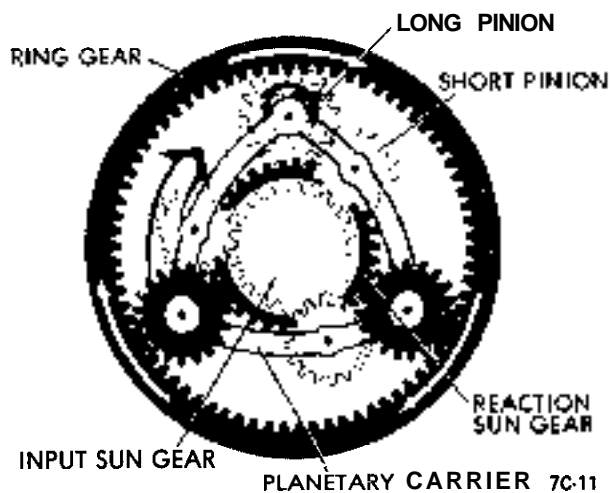


Figure 7C-11 Second Gear

carrier assembly and output shaft in a clockwise direction. See Figure 7C-11.

In the third gear, the ring gear is driven in a clockwise direction and the input (front) sun gear is also driven in the same direction. The long and short planetary pinions cannot rotate on their shafts in this situation, thus causing the planetary carrier, output shaft and gears to rotate clockwise as a solid unit to provide direct drive. See Figure 7C-12.

In reverse, the ring gear is held and the input (front) sun gear is driven in a clockwise direction. This causes the short planet pinions to turn counterclockwise, turning the long planetary pinions clockwise. The pinions then walk around the inside of the stationary ring gear, driving the planet carrier assembly and output shaft in a counterclockwise direction. See Figure 7C-13.

In order to provide the necessary input and reaction functions to produce the various ranges, the Opel

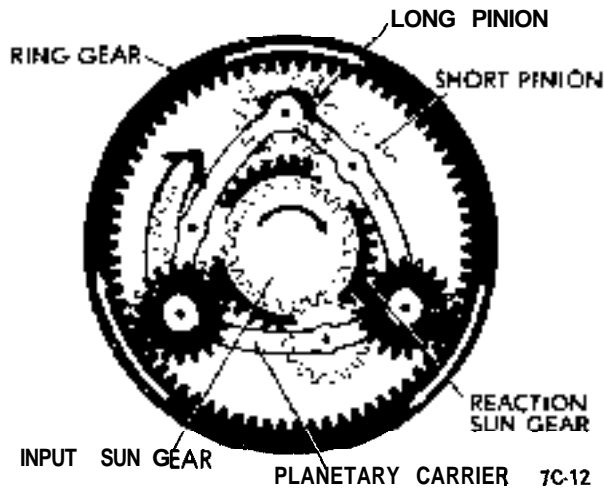


Figure 7C-12 Third Gear

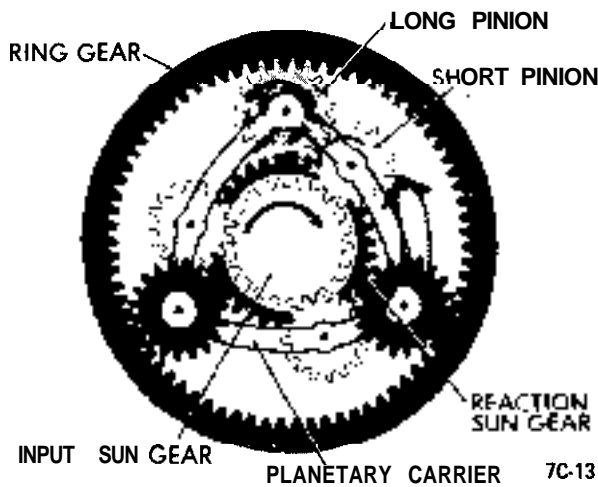


Figure 7C-13 Reverse

Three Speed automatic transmission has three disc clutches, a band and a sprag (overrunning) clutch.

Disc Clutch

A disc clutch serves to connect or disconnect a rotating member with another rotating member or a stationary member. A clutch of this type can have one or more discs or plates depending on the desired capacity.

A disc clutch consists of drive plates, driven plates, a hub and a drum or housing (depending on whether the rotating member is being clutched to another rotating member or a stationary member). The

method of apply in an automatic transmission is a hydraulic piston.

One set of plates is lined with friction material and the other plates are steel. Whether the plates are designated as "drive" or "driven" plates depends on the power flow through the clutch.

One set of plates is splined to the drum or housing. With the piston in the released position, the hub with its plates are free to rotate relative to the drum or housing. When hydraulic pressure is applied behind the piston, the piston forces the drive and driven plates together, thus causing the hub to rotate with the drum or remain stationary with the housing. See Figure 7C- 12.

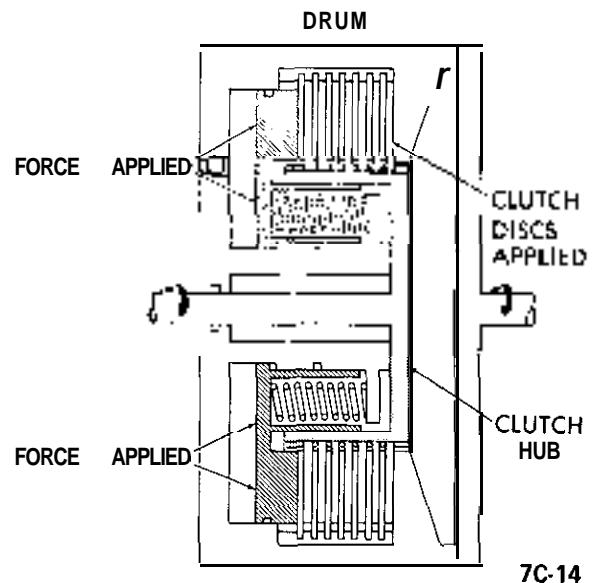


Figure 7C-14 Clutch Applied

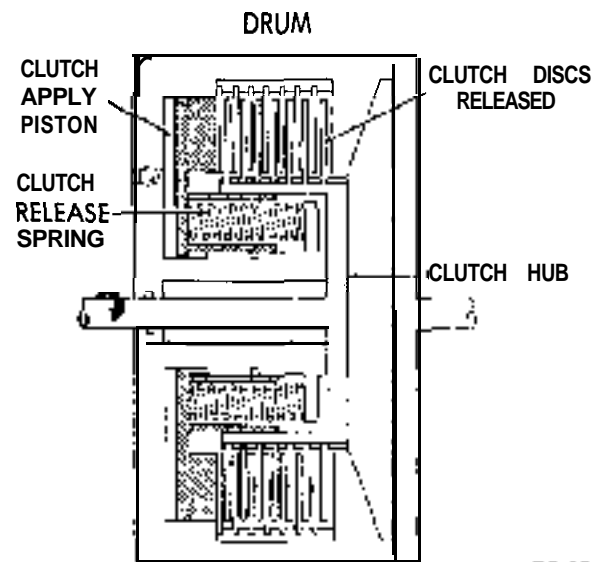
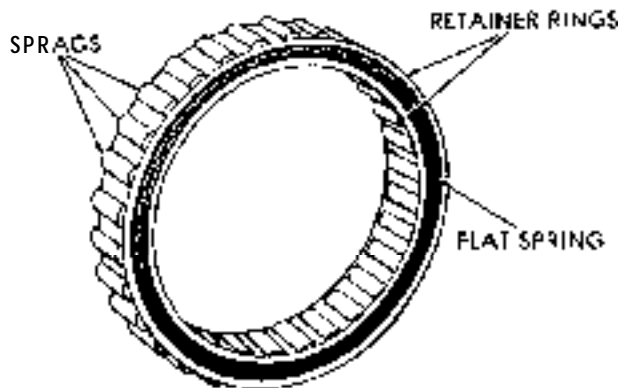


Figure 7C-15 Clutch Released

The clutch is released by exhausting the oil from behind the piston. The release springs push the piston to the released position, thereby removing the force from the plates. See Figure 7C-16.



7C-16

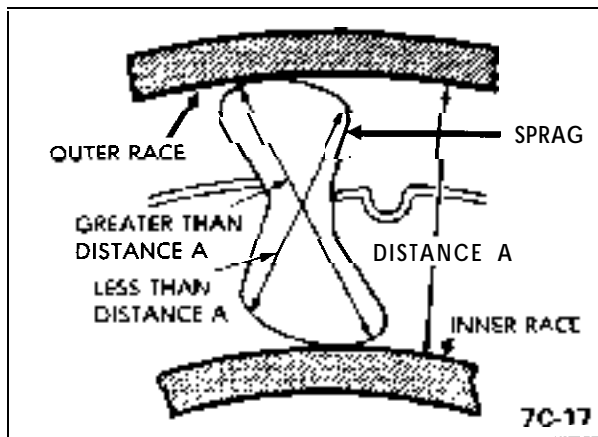
Figure 7C-16 Sprag Cage Assembly

**Sprag Clutch**

A sprag clutch is an overrunning clutch which allows rotation in one direction only and consists of an inner race, an outer race and the sprag assembly.

The sprag assembly itself consists of sprags, retainer rings and a spring. See Figure 7C-16. The sprags are mounted at intervals between the two concentric retaining rings. The spring is located between the rings and surrounds the narrow portion of the sprags.

One diagonal dimension of each sprag is greater than the distance between the inner and outer race, while the other diagonal is less. See Figure 7C-17. This



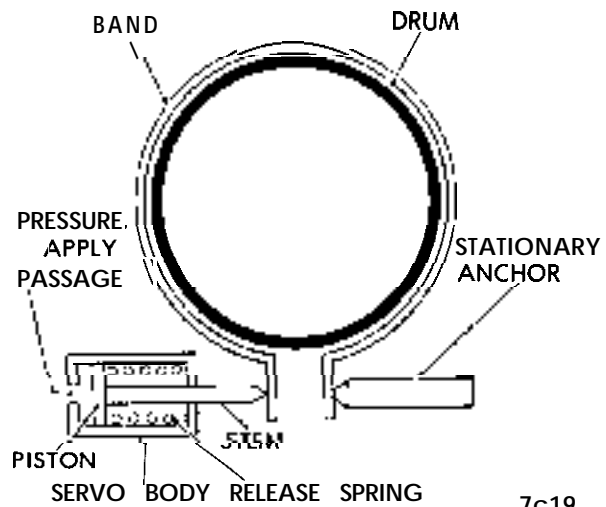
7C-17

Figure 7C-17 Sprag Operational Schematic

causes the sprags to wedge and prevent rotation in one direction, and to allow free rotation in the opposite direction.

**Band**

A band is used to hold one planetary member stationary with relation to the other planetary members. See Figure 7C-19. The band is connected to the transmission case (stationary anchor) and is operated by a servo piston. One band is used in the Opel Three: Speed Automatic Transmission and holds the reaction sun gear and drum stationary in first and second gear.



7c19

Figure 7C-19 Band Application

**COMPONENT OPERATION AND LOCATION**

The power flow and principles of operation of the Opel Three Speed Automatic Transmission power train are most easily understood when each unit is considered separately with a part by part build up of the unit.

The torque converter is connected to the engine by means of a flex plate which is bolted directly to the engine crankshaft and to the converter cover. The converter cover is welded to the converter pump member which provides a direct connection of the engine to the converter. The converter pump hub tits into the transmission oil pump driving the oil pump whenever the engine is operating. See Figure 7C-20.

The input shaft is splined into the hub of the turbine, delivering the converter's output torque to the transmission gear train. See Figure 7C-21.



7C-20

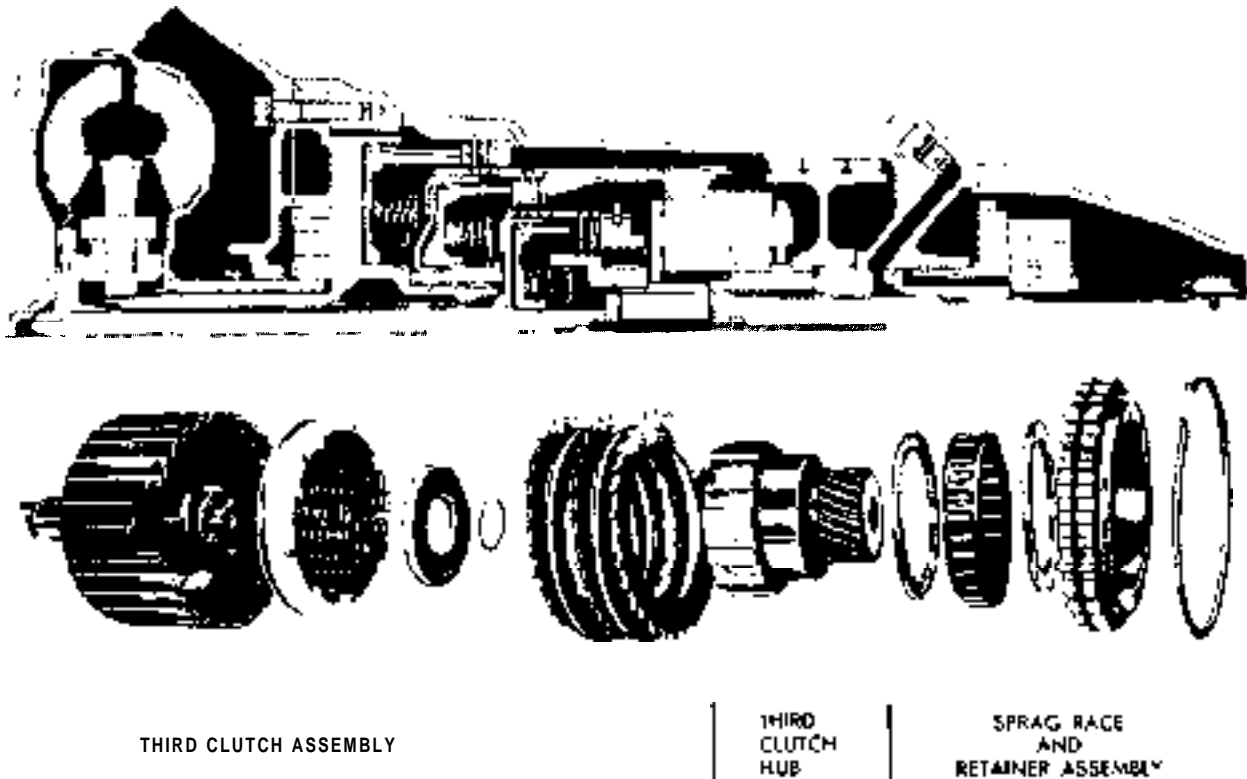
Figure 7C-20 Converter. Converter Housing And oil Pump



7C-21

INPUT SHAFT AND THIRD CLUTCH DRUM

Figure 7C-21 Input Shaft And 3rd Clutch Drum



7C-22

Figure 7C-22 Third Clutch Drum, Piston and Springs, Clutch Plates, Input Sun Gear, Sprag Race And Retainer Assembly

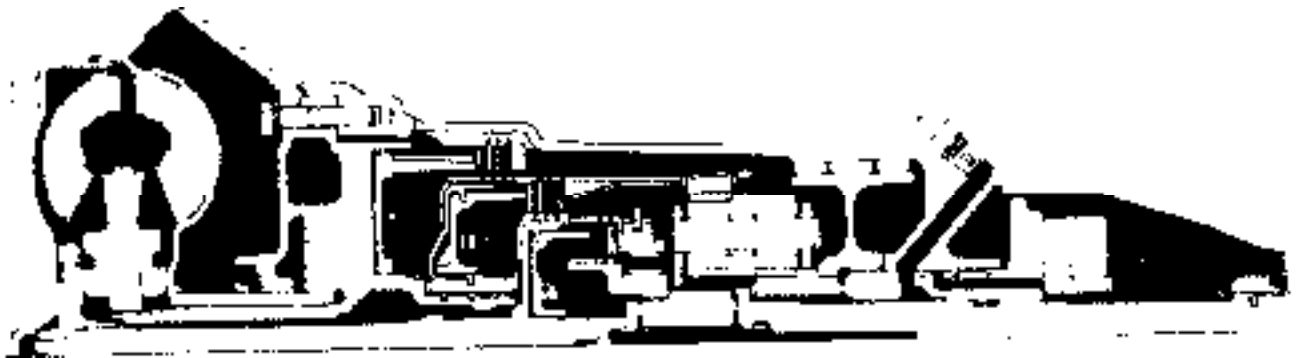
The stator shaft is an integral part of the transmission oil pump and supports the stator assembly at the inner race of the roller clutch assembly.

The input shaft is welded to the third clutch drum. The sprag outer race is splined to the third clutch drum and the inner race is splined to the input sun gear. See Figure 7C-22.

The second clutch assembly is supported by the oil pump hub. The second clutch composition plates are splined to the outside of the third clutch drum, making the third clutch drum the hub for the second clutch. The ring gear is splined to the second clutch drum. See Figure 7C-23.

The reverse clutch piston assembly is housed on the back side of the oil pump body. The reverse clutch steel plates are splined to the transmission case and the composition plates are splined to the outside of the second clutch drum. See Figure 7C-24. The reverse clutch serves to hold the 2nd clutch drum and ring gear stationary in reverse range.

The ring gear surrounds the planetary carrier and the teeth mesh with the front portion of the long pinions. The reaction sun gear is pressed into the reaction sun gear drum. See Figure 7C-25. The low band is wrapped around the reaction sun gear drum to function as the holding member for the reaction sun gear.



SECOND CLUTCH ASSEMBLY

7C-23

Figure 7C-23 Second Clutch Drum, Piston, Springs, Clutch Plates, Spacer And Ring Gear



REVERSE CLUTCH ASSEMBLY

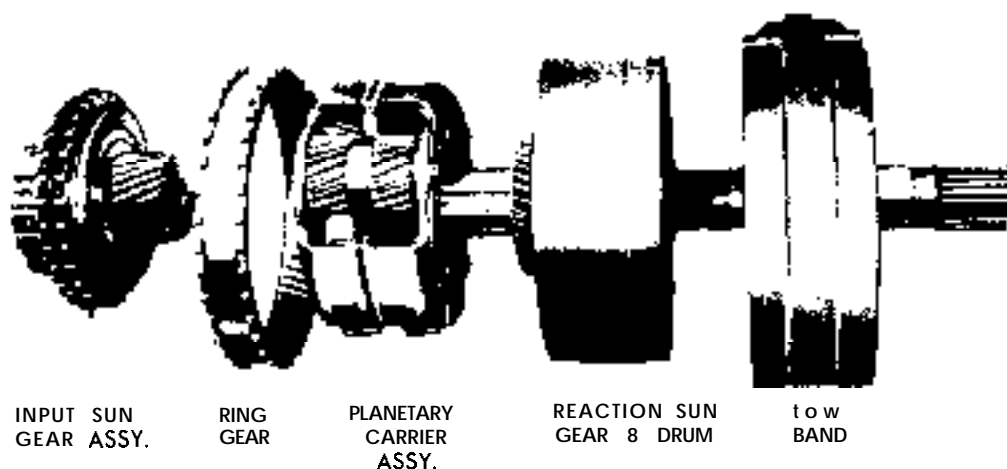
SECOND CLUTCH DRUM

SECOND CLUTCH DRUM

7C-24

Figure 7C-24 Oil Pump, Reverse Clutch Piston, Springs, Clutch Plates and Second Clutch Drum



INPUT SUN  
GEAR ASSY.RING  
GEARPLANETARY  
CARRIER  
ASSY.REACTION SUN  
GEAR 8 DRUMLOW  
BAND

7C-25

Figure 7C-25 Planetary Gears

The planetary pinion shafts which support the planetary pinions are secured to the planetary carrier by means of a lock plate at the rear of the planetary carrier preventing the pinion shafts from rotating or working loose. The lock plate is secured to the carrier by screws.

The planetary carrier is welded to the output shaft, therefore, the directional movement of the carrier delivers the transmission's torque to the output shaft.

The governor hub is splined to, and driven by, the output shaft. See Figure 7C-26. A governor body is bolted to the governor hub. The speedometer drive gear is also driven by the output shaft, and is secured to the shaft by a retaining clip.

## MECHANICAL OPERATION

The following information describes how engine torque is transmitted through the Opel Three Speed automatic transmission for each selected position on the quadrant. In every case, with the engine running, torque is transmitted via the flex plate and converter

cover to the pump member of the converter. The converter is always filled with oil from the transmission's oil pump, and the converter pump member transmits the torque through oil to the driven member of the converter. Power to the transmission is then transmitted via the input shaft and third clutch drum. See Figures 7C-48 through 7C-52.

## HYDRAULIC CONTROL UNITS AND VALVES

Previously, the mechanical aspects of the transmission operation have been described, including reference to various clutches and the low band being applied. The following describes, in detail, the hydraulic system that applies the clutches and band, and which controls the manually selected and automatic shifts.

A hydraulic pressure system requires a source of clean hydraulic fluid and a pump to pressurize the fluid. Opel Three Speed Automatic transmission uses a gear type pump which draws oil through a screen located in the sump. See Figure 7C-29. Since the pump drive gear is keyed to the converter pump hub, it turns whenever the engine is operating and turns the driven gear, which causes the oil to be lifted from

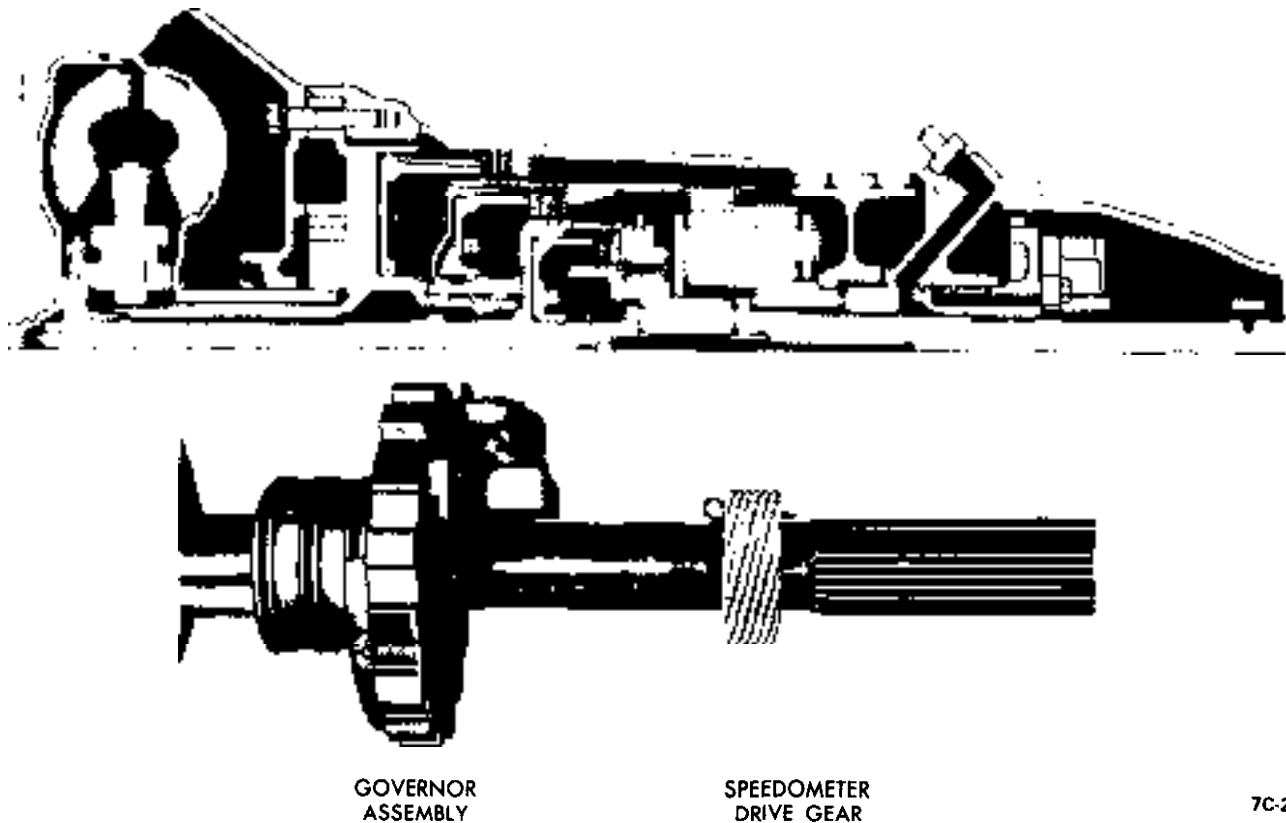
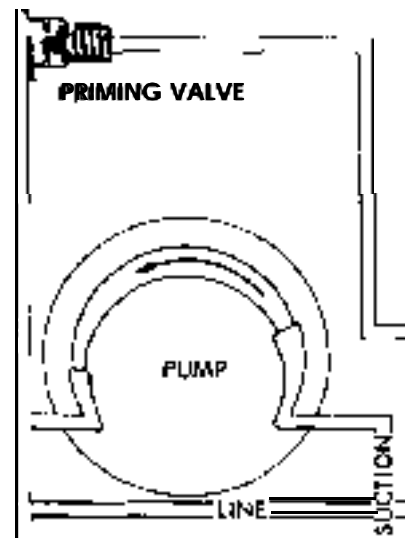


Figure 7C-26 Governor Assembly And Speedometer Drive Gear

the sump. The oil is carried past the crescent section of the pump, beyond which the gear teeth begin to come together, pressurizing the oil as it is squeezed from between the gear teeth. The pressurized oil is then delivered through the pump outlet to the hydraulic control system.

1. Main pressure regulator valve.
2. Modulator valve.

If the vehicle has not been operated for a while, the oil in the pump cavity tends to drain and leak back to the sump. With the pump cavity filled with air, the pump cannot develop enough suction to lift the oil from the sump. For this reason, a priming valve is located in the pump pressure passage. As the air in the pump is compressed by the gears, it is forced out through the bleed orifice in the priming valve and into the exhausted cavity behind the reverse piston. This permits the pump to prime and draw oil from the sump. As soon as the hydraulic pressure reaches 15 P.S.I. the valve is forced over closing off the bleed orifice.



In the hydraulic control circuit, there are four major types of control elements. These categories along with the specific items are listed below.

- A. Pressure regulating valves.

Figure 7C-29 Oil Pump and Priming Valve

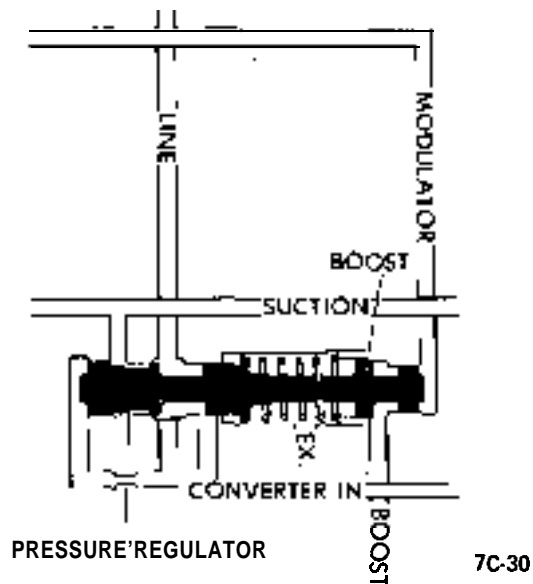
3. Detent pressure regulator valve.
  4. 1 - 2 Accumulator valve.
  5. Governor.
- B. Selector valves (manually and hydraulically controlled).
1. Manual valve.
  2. Detent valve.
  3. 1 - 2 Shift valve.
  4. 2 - 3 Shift valve.
  5. 3 - 2 Downshift control valve.
  6. Manual low and reverse control valve.
  7. Boost control valve.
- C. Timing Valves.
1. Low speed downshift timing valve.
  2. High speed downshift timing valve.
  3. Second clutch orifice valve.
- D. Accumulators.
1. 1 - 2 Accumulator.
  2. Low servo piston.

**Main Pressure Regulator Valve**

Oil pressure from the pump is delivered to the "line" port of the main regulator valve. See Figure 7C-30. The port is connected through a damping orifice, to the regulator port at the end of the regulator valve. As the pressure in this port increases, it moves the valve against the spring force until the second spool of the valve just opens to the "line" port. This permits the pump pressure to be by-passed into the pump suction passage. Therefore, the valve will regulate at a fixed minimum pressure as determined by the spring force, and all excess pump delivery will be by-passed back into the pump suction passage.

In moving from the "bottomed" to the regulating position, the valve also opens line pressure to the converter feed passage. This oil is directed to and through the converter, through the oil cooler, to the gear box lubrication system, then back to the sump.

In order to provide the required capacity in the band and clutches, it is desirable to have a variable line pressure that will increase with engine torque. This



**Figure 7C-30 Pressure Regulator Valve**

is accomplished by introducing a "modulator" pressure on the end of the boost valve. The force of the boost valve acts against the end of the regulator valve and increases the line pressure above the base pressure as established by the spring force. By introducing line pressure to the stepped area between the spools of the boost valve, an additional pressure increase over and above that described above is obtained.

The regulated line pressure is then fed to:

- Manual valve.
- Modulator valve
- Detent pressure regulator valve

**Modulator Valve and Vacuum Modulator**

Line pressure is directed to the second port of the modulator valve. See Figure 7C-31. This pressure passes between the spools of the valve and into the modulator port. The modulator port is connected to the regulating port at the end of the valve through a damping orifice. As the pressure in the regulating port increases, it moves the valve outward against the spring force of the modulator assembly until the end spool just closes the line port. If excess pressure has built up in the regulating port the valve will continue to move till the second spool just opens to the exhaust port. In other words, the valve tends to regulate between the line and exhaust ports.

Even though the modulator spring force may be constant, thereby causing the modulator valve to regulate at a fixed pressure, the pressure requirements

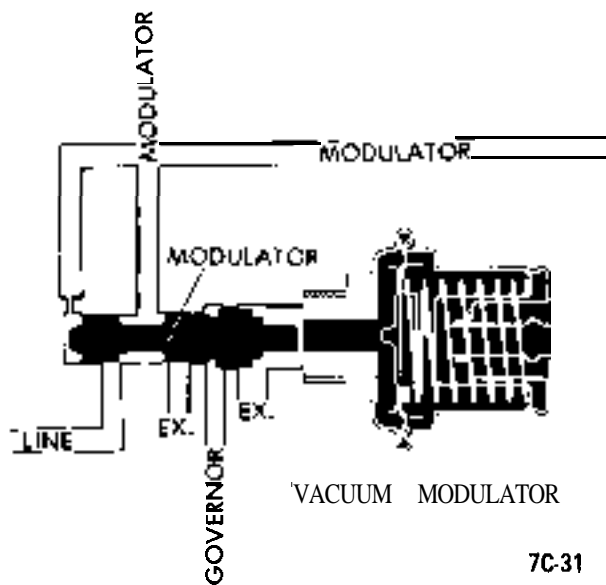


Figure 7C-31 Vacuum Modulator and Modulator Valve

decrease as car speed increases. For this reason, governor pressure (which is a function of car speed) is directed to the area between the two different diameter spools at the outboard end of the valve. As governor pressure increases, it creates an outward force on the modulator valve and in effect reduces the spring force of the modulator assembly.

The modulator assembly consists of two chambers separated by a diaphragm. The chamber toward the valve is open to atmosphere and the other chamber is connected to engine vacuum. The vacuum chamber also contains a spring. When there is no vacuum (0" of mercury), the full spring force bears against the diaphragm and is transmitted to the valve through a plunger. This is the spring force which establishes the regulated pressure of the modulator valve. As the vacuum in the outer chamber increases, an outward force is created on the diaphragm which cancels out some of the spring force. This continues up to 16" of vacuum, at which point the diaphragm force cancels out the spring force and the modulator pressure becomes zero.

In summary, the following indicates the function of the total modulator system in combination with the pressure regulator system.

In addition, higher car speeds will produce a somewhat lower modulator and line pressure for any given vacuum by virtue of the governor pressure acting on the modulator valve.

Engine Torque	Vacuum	Modulator Pressure	Line
Low	High	Low	LOW
High	Low	High	High

Modulator pressure is then directed to:

Pressure regulator boost valve.

1 - 2-Shift control.

2 - 3-Shift control valve by way of the 3 - 2 control valve.

Detent Valve.

1 - 2 Accumulator Valve.

Low Speed Downshift Timing Valve.

**Detent Pressure Regulator Valve**

The regulating action of the Detent Pressure Regulator Valve is essentially the same as for the Modulator Valve, except that it regulates a constant pressure. See Figure 7C-32. The feed port, regulating port and exhaust port all function in the same manner as the Modulator Valve. Since the force set up by the pressure in the regulating port acts only against a fixed spring force, the resulting detent pressure is constant. The detent regulator pressure is directed to the Detent Valve and to the Manual Low and Reverse Control Valve.

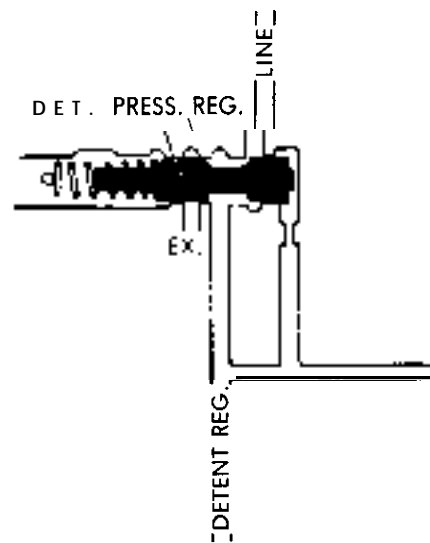
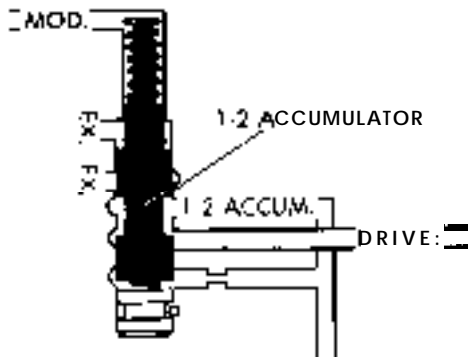


Figure 7C-32 Detent Pressure Regulator Valve

**1-2 Accumulator Valve**

The 1 2 Accumulator Valve, Figure 7C-33, is used to establish a desired pressure to ultimately control the rate of apply of the second clutch during a 1 to 2 upshift. Here again, the regulating action is essentially the same as for the Modulator Valve or Detent Pressure Regulator Valve.



7633

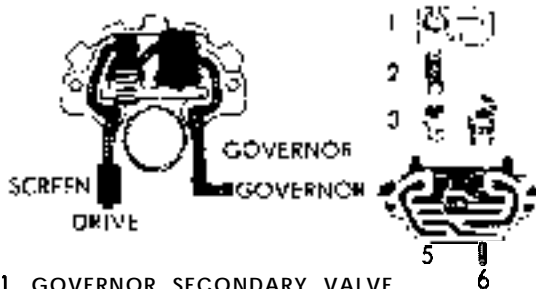
Figure 7C-33 1 • 2 Accumulator Valve

The ports and spools operate as previously described. However, for increased engine torque, it is necessary to increase the accumulator pressure. This is accomplished by introducing modulator pressure to the small end of the 1-2 accumulator valve. As the modulator pressure increases, it adds to the spring force and increases the 1-2 accumulator pressure.

The 1-2 accumulator pressure is fed to the bottom (spring loaded side) of the 1-2 accumulator piston.

**Governor**

The Governor is mounted on the output shaft and contains two interconnected regulating valves See Figure 7C-34. Its purpose is to supply an oil pressure



- 1. GOVERNOR SECONDARY VALVE SPRING RETAINER
- 2. GOVERNOR SECONDARY VALVE SPRING
- 3. GOVERNOR SECONDARY VALVE
- 4. GOVERNOR PRIMARY VALVE
- 5. GOVERNOR BODY
- 6. ROLL PIN

7C-34

Figure 7C-34 Governor Assembly

that is a function of output shaft or car speed. Line pressure is supplied to the governor from the Manual Valve (to be covered later). The governor operates on the principle of centrifugal force. That is, as an object spins off center at changing speeds, its outward force is a function of the rotating speed.

Line pressure is directed to the outer-most port of the secondary valve. The secondary spring holds the valve in an outward position so that the outer spool of the valve is open to "line". As the line pressure builds up between the spools, it exerts a force on the larger diameter inner spool to start counteracting the spring. When the hydraulic force is large enough, it moves the valve inward against the spring force until the outer spool closes the line port. If the pressure between the spools still creates a force larger than the spring force, the valve will continue to move inward until the excess pressure opens to the exhaust port. The valve then regulates between the line and exhaust port.

A fixed governor pressure in the secondary valve has now been established with no rotation of the output shaft. As the governor begins to rotate, the outward force (due to the weight of the secondary valve) is added to the force of the spring. Therefore, as the speed increases, the outward force and in turn the secondary valve pressure increases.

The secondary valve pressure is directed to the feed port of the primary valve. With no rotation of the governor, the pressure acts against the large inner spool and forces it to open to the exhaust port. Since there is no spring force on the primary valve, it will continue to keep the feed port closed and the exhaust port open. The final governor pressure is then zero. As the governor begins to rotate, the weight of the primary valve creates an outward force working against the oil pressure. The pressure in the primary valve port now increases as a function of speed. This continues up to the speed where the outward force finally holds the primary valve outward, keeping the feed port open.

In summary, at zero speed, the governor pressure is zero. As the speed increases, the governor pressure will increase as dictated by the primary valve until the speed is great enough to hold the primary valve all the way out. At speeds above this point, the governor pressure is established by the secondary valve.

Governor pressure is then directed to:

Modulator Valve.

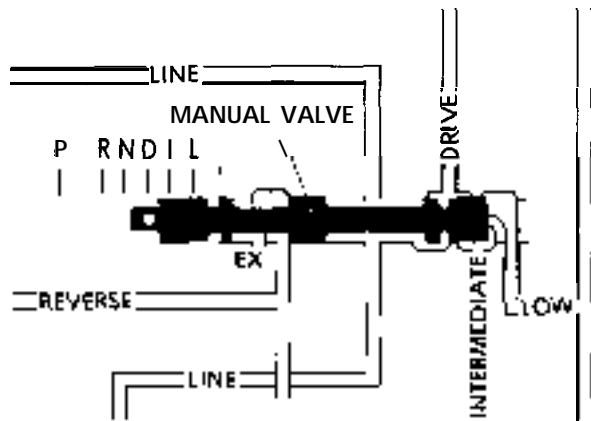
- 1 • Two Shift Valve.
- 2 • Three Shift Valve.
- 3 High Speed Downshift Timing Valve.

**Manual Valve**

The manual valve is mechanically connected to the shift lever. Its function is to direct hydraulic pressure to the various circuits to establish the base hydraulic range of the transmission.

Line pressure is fed to the manual valve. See Figure 7C-35. In "Park" and "Neutral", the valve seals line pressure from entering any of the circuits. At the same time all circuits are open to exhaust so that the transmission remains in a neutral condition.

In "Reverse", line pressure is directed to the reverse clutch piston, boost control valve and the reverse and manual control valve. All other manual control circuits are open to exhaust.



7C-35

Figure 7C-35 Manual Valve

In "Drive" the manual valve directs oil to the governor, 1 - 2 shift valve, 1 2 accumulator valve, and to the apply side of the low servo piston by way of the high speed downshift timing valve. The "Reverse", "Second", and "Low" ports are exhausted.

In "Second" the "Drive" circuits remain pressurized. In addition, pressure is supplied to the boost control valve and to the 2 - 3 shift valve. The "Reverse" and "Low" ports are exhausted.

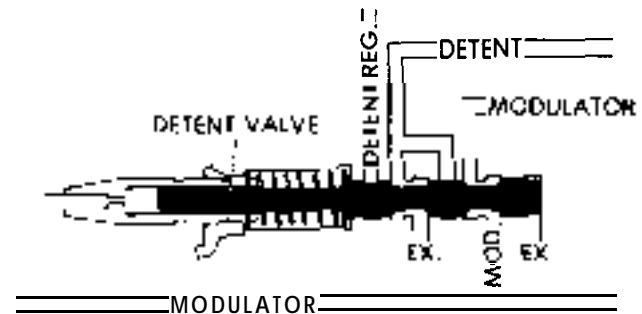
In "Low", pressure is supplied to the 1 - 2 shift valve and to the reverse and manual control valve in addition to the circuits already pressurized in "Drive" and "Second". The "Reverse" port is exhausted.

**Detent Valve**

The function of the detent valve is to cause the trans-

mission to shift to a lower gear for additional performance when the accelerator is depressed all the way.

The detent valve is mechanically connected to the throttle linkage. A spring holds the detent valve in a retracted position. See Figure 7C-37. Two pressures, "detent regulator" and "modulator", are supplied to the detent valve.



7C-37

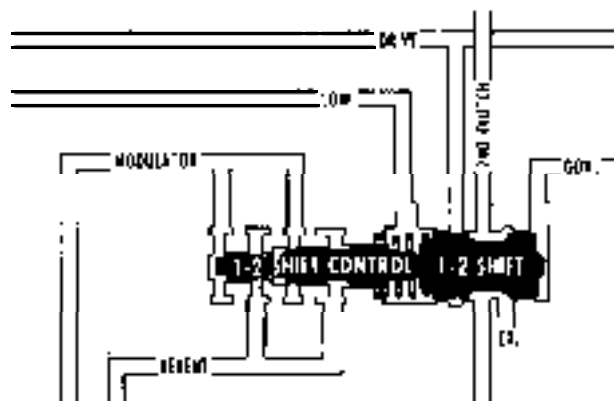
Figure 7C-37 Detent Valve

In the retracted or "part throttle" position, the detent valve directs modulator pressure to the 1 2 and 2 3 shift control valves and to the 3 2 control valve. In the "through detent" or full throttle position, modulator pressure is blocked and the passages previously receiving modulator pressure now receive detent regulator pressure. In this position, detent regulator pressure is also supplied to additional ports of the 1 - 2 and 2 3 shift control valves and the 3 2 control valve.

**1 2 Shift Valve**

The 1 - 2 Shift and Shift Control Valves determine whether the transmission is in first or second gear. See Figure 7C-38. With the shift valve bottomed in its bore, the valve blocks "Drive" or line pressure and the second clutch is open to exhaust. The valve is held in this position by a spring and any modulator pressure that may be acting against the two end spools of the 1 - 2 shift control valve.

As the car speed and governor pressure increase, a force is developed on the end of the shift valve. When this force is great enough to overcome the spring and the force of the 1 2 shift control valve, the shift valve moves, closing the exhaust and opening the line pressure port to the second clutch port.



7C-38

Figure 7C-38 1 2 Shift Valve

To prevent a "hunting" condition of the shift valve, modulator pressure supply to the second spool of control valve is cut off as the shift valve opens line pressure to the second clutch. The oil in this pocket is exhausted out through the detent passage. An additional force keeping the valve in an "upshifted" position is obtained by line pressure acting on the larger diameter second spool of the shift valve. Because of this, even though the governor pressure might be maintained at a constant pressure after the valve upshifts, a higher modulator pressure is required to cause the valve to downshift.

If the accelerator is depressed to the point where the detent spring force is felt, the vacuum will drop and the modulator pressure will increase. If the spring force plus the modulator pressure acting against the end spool of the shift control valve is great enough to overcome the governor and line pressure acting on the shift valve, a "part throttle" forced downshift will occur. If not, the transmission will remain in the higher gear.

If the accelerator is depressed through the detent, the detent valve supplies detent regulator pressure to all three spools of the shift control valve, a higher downshifting force is obtained as compared to the part throttle condition. Because of this, a "through detent" forced downshift can be obtained at a speed higher than for the "part throttle" condition. However, there is still a limiting speed at which a "through detent" forced downshift will occur.

If the selector lever is placed in "Manual Low", line pressure is supplied directly to the spring pocket between the valves. Since line pressure can never be less than governor pressure, the force established by line pressure on the shift valve plus the spring force

will move the shift valve to a downshifted position regardless of car speed.

### 2 3 Shift Valve and 3 • 2 Control Valve

The function and operation of the 2 3 Shift and Shift Control Valves is the same as for the 1 2 valve except as described below. See Figure 7C-39.

The downshifted position establishes "second" gear, and the upshifted position establishes "third" or "high" gear.

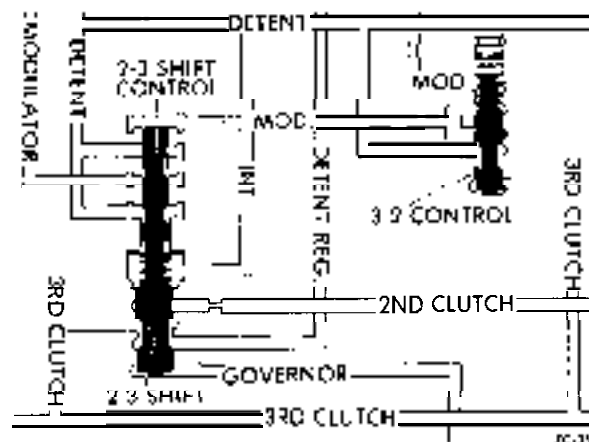


Figure 7C-39 2 3 Shift Valve and 3 2 Control Valve

Modulator pressure is supplied to the end spool of the 2 • 3 control valve through the 3 • 2 control valve. When the shift valve moves to the upshifted position, line pressure is introduced to the third clutch circuit. The third clutch circuit also directs pressure to the end spool of the 3 • 2 control valve.

At light throttle conditions, third clutch pressure acting on the end of the 3 • 2 control valve moves the valve against the spring and the force established by the modulator pressure. This exhausts the modulator pressure from behind the end spool of the 2 • 3 control valve and the spring is the only remaining force acting on the shift valve to produce a downshift. In this condition, it is not possible to obtain a "part throttle" forced downshift.

If the accelerator is depressed far enough to cause a substantial drop in vacuum, the increased modulator pressure on the 3 • 2 control valve plus the spring will overcome the force of the third clutch pressure. This feeds modulator pressure back to the 2 • 3 control valve and a "part throttle" forced downshift will occur. As with the 1 2 shift valve, there is a limiting speed at which this can occur.

When the selector lever is placed in "Second", line pressure is directed to the spring pocket between the 2 • 3 Shift and Shift Control Valves and the shift

valve will be held in downshifted, or second gear, condition regardless of car speed.

Manual Low and Reverse Control Valve

As described in the text on "Mechanical Operation", the third clutch is applied in manual "Low" and in "Reverse" to prevent a free wheeling condition. In "Drive" range third gear, third clutch pressure is also directed to the release side of the low servo (to be covered later). This is the pressure which causes the low band to release during a 2-3 upshift. However, in manual low, the band must remain applied even though the third clutch is on.

The above conditions are achieved by routing third clutch pressure to the release side of the low servo through the manual low and reverse control valve. See Figure 7C-40. In "Drive" range, the spring holds the valve in its "bottomed" position and permits the third clutch pressure to be directed to the servo release circuit.

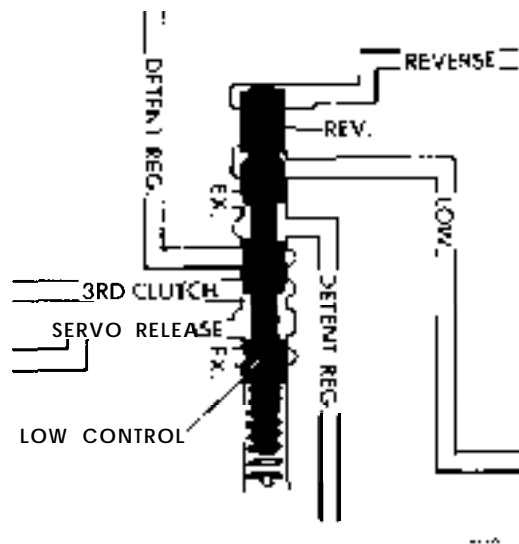


Figure 7C-40 Manual Low and Reverse Control Valve

When the selector lever is placed in manual "Low", line pressure is introduced between the manual low and reverse control valves. This forces the low control valve over against the spring. In this position, third clutch pressure is cut off from servo release and servo release is opened to exhaust. The third clutch exhaust passage is now open to detent regulator pressure which applies the third clutch since the shift valve is in the "downshifted" position. Because the servo release passage is open to exhaust, the low band will remain applied.

When the selector lever is placed in "Reverse," line pressure acts on the end of the reverse control valve

and forces the low control valve into the same position as in manual "Low". This causes the third clutch to be applied.

Boost Control Valve

To obtain the required pressure increase previously described for "Second" "Low" and "Reverse", line pressure is introduced to the stepped area between the two spools of the pressure regulator boost valve. In "Second" or "Low", some means has to be provided to prevent the pressure to the boost valve from being exhausted through the reverse passage. It is also necessary to prevent reverse pressure from being exhausted through the intermediate passage when in "Reverse".

The boost control valve consists of a steel ball in a flow and pressure sensitive chamber. See Figure 7C-41. Where the reverse passage is pressurized, the pressure and flow seat the ball against the intermediate passage and the pressure is directed to the boost passage. In "Second" or manual "Low", the ball is seated against the reverse passage and the pressure is directed to the boost passage.

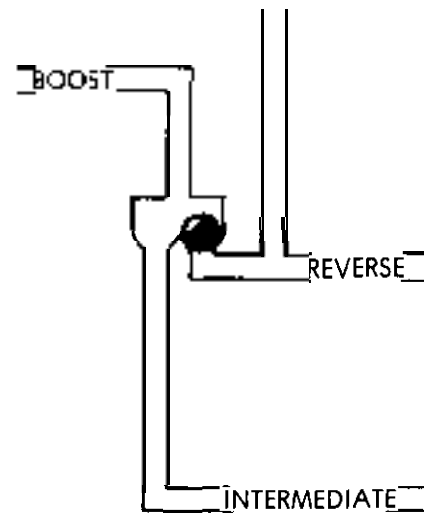


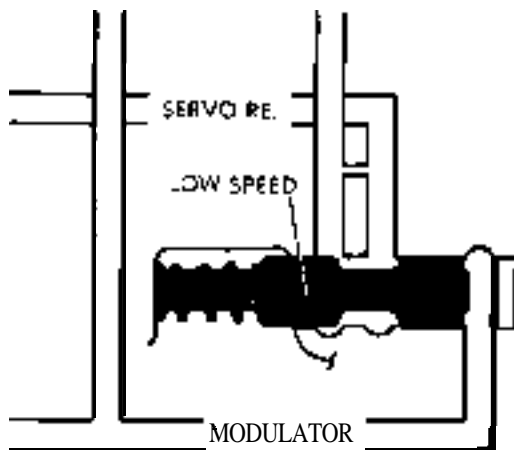
Figure 7C-41 Boost Control Valve

7C-41

Low Speed Downshift Timing Valve

When the vehicle is coasting to a stop, and a 3-2 downshift takes place, it is necessary to delay the application of the band while the third clutch is being released. This is accomplished by directing the servo release pressure through the coast downshift timing valve. See Figure 7C-42.





7C-42

Figure 7C-42 Low Speed Downshift Timing Valve

During a "coast" condition, the vacuum is high and the modulator pressure is zero. The spring holds the timing valve in a bottomed position and the servo release pressure is exhausted through a restricting orifice, thus delaying the apply of the servo.

During a "power on" 3-2 downshift at lower car speeds, the servo must be applied rapidly. During such a shift, the vacuum will be somewhat lower and the resulting modulator pressure will force the valve over against the spring. This provides an unrestricted passage for servo release, thus permitting rapid apply of the servo.

#### High Speed Downshift Timing Valve

When a 3-2 downshift is "forced" at high car speeds, the application of the band must be delayed. Servo apply pressure is directed through the high speed downshift timing valve. See Figure 7C-43.

The timing valve is held in a bottomed position by the spring at lower car speeds. This permits an unrestricted flow for servo apply. At higher car speeds, approximately 25 to 35 MPH, (depending on axle ratio and engine), governor pressure forces the valve over against the spring. This closes off the direct feed to servo apply and the feed is controlled by a fixed orifice.

While it may outwardly appear that the functions of the two downshift timing valves are contradictory, whether or not the application of the band is delayed during a 3-2 downshift is a combined function of car speed and throttle position.

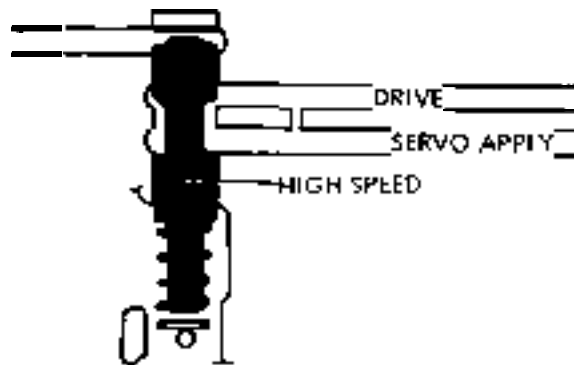
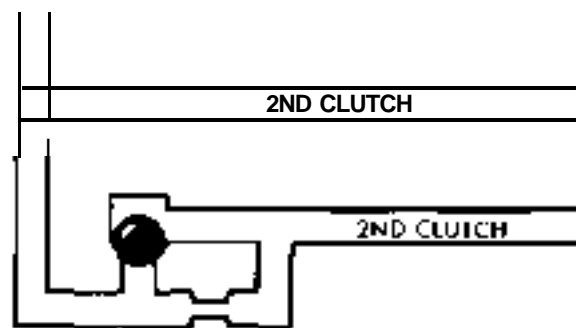


Figure 7C-43 High Speed Downshift Timing Valve

#### Second Clutch Orifice Valve

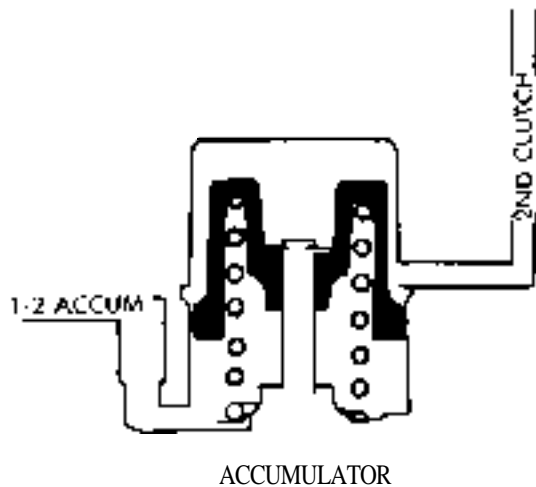
For reasons of shift timing, it is necessary to have different restricting orifice sizes for the feed and exhaust of the second clutch. This is accomplished by introducing a "one way" ball check in the second clutch circuit. See Figure 7C-44.



7C-44

Figure 7C-44 Second Clutch Orifice Valve

When the second clutch is being applied, the apply pressure seats the ball and the feed is directed through a single orifice. During the release of the clutch, the ball is unseated and the clutch can exhaust at a faster rate through the two orifices.

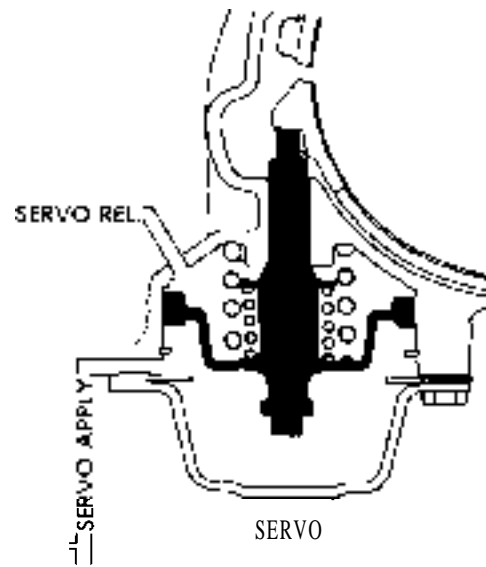


7C-46

Figure 7C-46 1-2 Accumulator

#### 1-2 Accumulator

In order to obtain a smooth 1-2 upshift, it is necessary to control the rate of pressure build-up in the second clutch. This is accomplished by introducing a hydraulic modulator in the clutch circuit. Prior to the second clutch being applied, the spring holds the accumulator piston in an upward position. When line pressure is introduced to the second clutch circuit by way of the 1-2 shift valve, the pressure in the second clutch will be permitted to build up rapidly until the clutch pressure acting on the accumulator piston is sufficient to overcome the accumulator spring. As the clutch pressure increases on the top side of the accumulator piston, the piston will start to move against the spring force until the piston is forced all the way down. This provides a time delay for the apply of the second clutch before the pressure reaches its maximum value. When upshifts are made at heavier throttle, it is necessary to increase the pressure at which this time delay occurs. This is accomplished by introducing a vacuum sensitive pressure from the 1-2 accumulator valve to the bottom side of the accumulator piston. This pressure assists the spring and the clutch pressure will have to build up to a higher value before the accumulator piston will move. See Figure 7C-46.



7C-47

Figure 7C-47 Low Servo

#### Low Servo

The low servo provides a dual function. See Figure 7C-47. It is the means by which the band is applied and it provides an accumulator action for the third clutch during a 2-3 upshift.

In first and second gear, servo apply pressure acting on the bottom side of the low servo piston moves the piston against the spring force and applies the band. During a 2-3 upshift, third clutch pressure is introduced to the top side of the servo piston. When third clutch pressure, acting on the top side of the piston and assisted by the servo release spring, is sufficient to overcome the servo apply force, the servo will move downward. This removes the apply force from the band and the band will release while the clutch is being applied. During the downward movement of the piston, a time interval occurs which cushions the apply of the third clutch in the same manner that the 1-2 accumulator cushions the apply of the second clutch. It is because of this accumulator action that the band adjustment is so critical. The main function of the band adjustment is to control the servo release spring load rather than to control band clearance.

## a. NEUTRAL &amp; PARK · ENGINE RUNNING

Neutral · Engine Running

Reverse Clutch. Released

Third Clutch · Released

Second Clutch. Released

Low Band . Released

Sprag · Locked

In neutral, the low band and all clutches are released. With this condition, no member of the planetary gear set is held and there is no reaction member. All gears are free to rotate around their own axis and no torque is transmitted to the planet carrier assembly and output shaft.

Park · Engine Running

The same power flow conditions in the neutral position are in effect in the park position. Additionally, mechanical linkage actuates a parking pawl which engages with the splines in the periphery of the governor assembly. Since the governor assembly is splined to the output shaft, the parking pawl holds the output shaft locked to the extension, preventing the vehicle from rolling.

7C-48

Figure 7C-48 Neutral and Park Engine Running

b. DRIVE RANGE . FIRST GEAR



Drive Range . First Gear

Reverse Clutch Released

Third Clutch. Released

Second Clutch. Released

Low Band - Applied

Sprag Locked

In Drive Range - First Gear, the low band is applied and all clutches are released.

The low band holds the reaction sun gear and drum stationary, which serves as the reaction member of the planetary gear set in first gear. The input shaft drives the third clutch drum in a clockwise direction, which turns the sprag race and retainer assembly clockwise. The sprags wedge and drive the input sun gear.

The power is then transmitted through the gear set to the output shaft as outlined in "Principles of Operation". The ratio in first gear is 2.40:1.

Low Range

In Low Range, the third clutch is applied together with the low band. The input power flow is exactly the same as drive range first gear except that the third clutch is engaged and prevents the sprag from overrunning, thus providing engine braking when coasting in Low Range.

7C-49

Figure 7C-49 Drive Range First Gear

## c. DRIVE RANGE. SECONO GEAR

Drive Range . Second Gear

Reverse Clutch • Released

Third Clutch • Released

Second Clutch -Applied

Low Band -Applied

Sprag • Overrunning

In Drive Range. Second Gear, the low band and second clutch are applied.

The input shaft drives the third clutch drum and the second clutch composition plates. When the second clutch piston is applied, the rotating second clutch composition plates are locked to the second clutch steel plates. Since the second clutch drum is now rotating in a clockwise direction, the ring gear is driven clockwise. As described in "Principles of Operation", the carrier is driven in a clockwise direction. The long planet pinions also drive the short planet pinions, which drive the input sun gear clockwise, causing the sprag assembly to overrun. The ratio is 1.48:1.

second Range

In Second Range, the Power flow is exactly the same as drive range • second gear.

7c50

Figure 7C-50 Drive Range • Second Gear

d. DRIVE RANGE . THIRD GEAR



Drive Range . Third Gear

Reverse Clutch . Released

Third Clutch -Applied

Second Clutch. Applied

Low Band . Released

Sprag . Locked

In Drive Range . Third Gear, the low band is released and both the second and third clutches are applied.

In this condition, the ring gear is locked to the input sun gear. With two planetary members connected in this manner, the entire planetary system will rotate as a solid unit and provide a direct drive with a ratio of 1 to 1. The input is split between the ring gear end input sun, and the carrier is the output member.

Figure 7C-5 1 Drive Range Third Gear

e. REVERSE RANGE



Third Clutch - Applied

Low Band - Released







a. Operation of Controls in Neutral Engine Running

Reverse Clutch Released

Third Clutch Released

Second Clutch Released

Low Band Released

Sprag Locked

Whenever the engine is running with the selector lever in Neutral, oil is pulled from the sump into the oil pump and is dispensed from the pump under pressure. The pressurized line oil is directed to the priming valve which bleeds off the air. Line oil is directed to the vacuum modulator valve, to the pressure regulator valve and to the manual valve. The converter is fed through the pressure regulator valve, the return oil from the converter being directed through the cooler and back into the transmission's lubricating system.

Line oil directed to the vacuum modulator valve becomes regulated to modulator oil and acts on the pressure regulator boost valve, the low speed downshift timing valve, the 1 2 accumulator valve, and the detent valve. The modulator oil passes through the detent valve to act on the 1 2 shift control valve, the 3 2 control valve and the 2 3 shift control valve. Line oil passes through the manual valve, and is regulated at the detent pressure regulator valve before being directed to the Reverse and Low control valve.

Summary

The converter is filled. the clutches and low band are released. The transmission is in Neutral.

7C-54



b. Operation of Controls in Drive Range - First Gear

Reverse Clutch - Released

Third Clutch - Released

Second Clutch - Released

Low Band - Applied

Spring - Locked

When the selector lever is moved to the "Drive" position on the quadrant, the manual valve is positioned to allow line oil to enter the drive circuit and is directed to the 1 - 2 shift valve, the governor, the 1 - 2 shift valve, the governor, the 1 - 2 accumulator valve and the high speed downshift timing valve.

The drive oil directed to the 1 - 2 accumulator valve is regulated and directed to fill the bottom portion of the accumulator. The drive oil also passes through end orifice of the high speed downshift timing valve and passes through the valve to apply the low band servo.

Drive oil at the governor is regulated to a variable pressure which increases with vehicle speed and acts on the ends of the 1 - 2, 2 - 3 shift valves, high speed downshift timing valve, and the vacuum modulator valve.

Summary

The clutches are off, the low band is applied, the transmission is in drive range - first gear.

TC-67

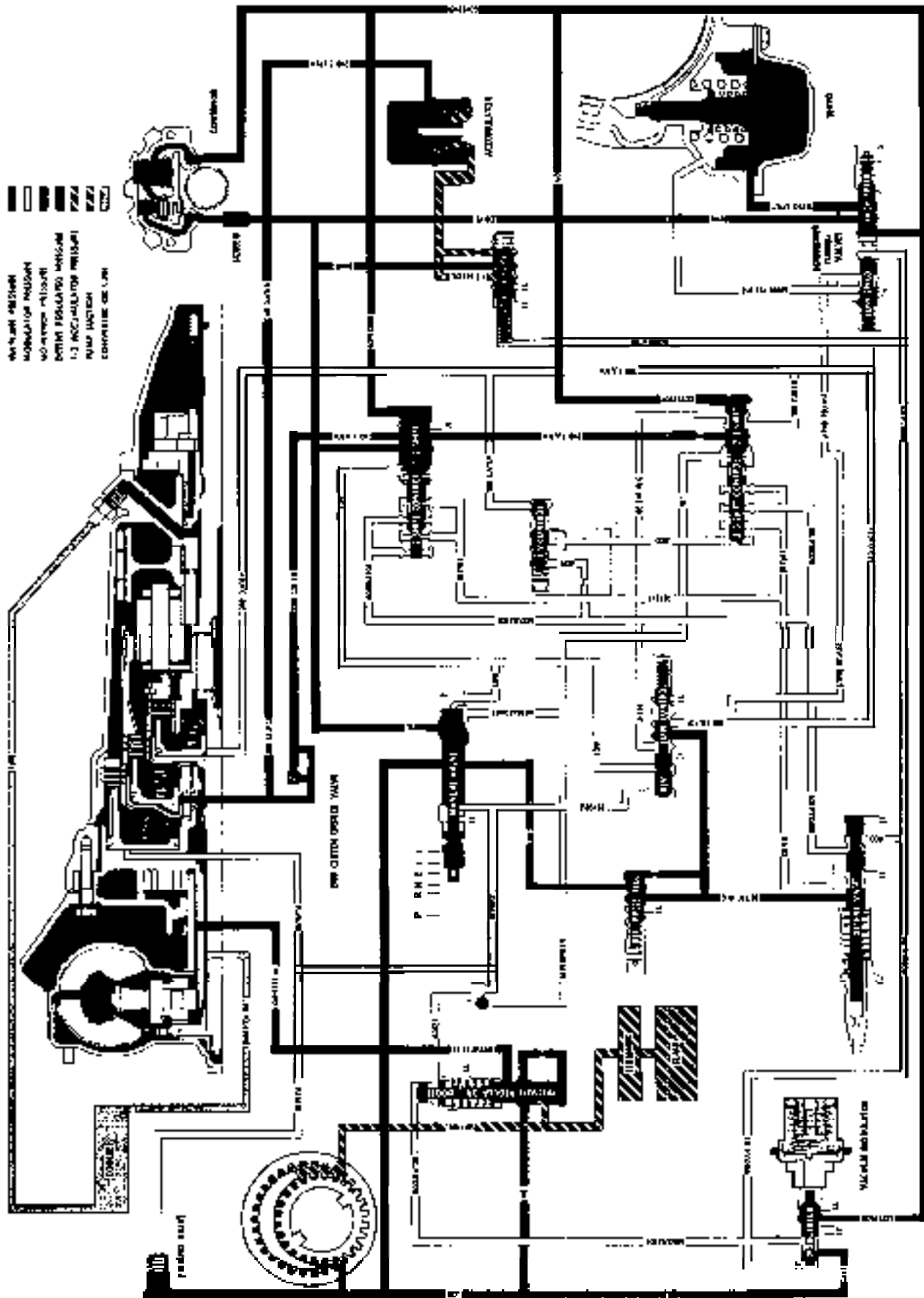


Figure 7C-58 - Transmission Oil Flow Drive Range, Second Gear

c. Operation of Controls in Drive Range Second Gear

Reverse Clutch Released

Third Clutch Released

Second Clutch Applied

Low Band Applied

Sprag Over Running

As the vehicle increases speed, the governor allows more drive oil to pass through, and this increased pressure, acting on the end of the 1 2 shift valve, overcomes the 1 2 shift valve spring pressure and allows drive oil to pass through the valve to feed the second clutch oil passages.

Second clutch oil passes through the second clutch orifice control valve, seating the ball and is metered to the second clutch piston to begin to apply the second clutch, while portion of the oil is directed to the accumulator. As the upper portion of the accumulator fills with second clutch oil, it overcomes the lesser pressure of 1 2 accumulator oil and spring at the bottom of the accumulator piston, forcing the piston downward. The upper portion of the accumulator is now filled, allowing full oil pressure to the second clutch piston for the final apply. The accumulator, therefore, acts as a reservoir to produce a damping effect for a smooth second clutch apply and the 1 2 shift.

Second clutch oil from the 1 2 shift valve is simultaneously directed to the 2 3 shift valve to be used as the oil source for the 2 3 shift.

Summary

The second clutch is on, the band is on, the transmission is in drive range - second gear.



#### d. Operation of Controls in Drive Range Third Gear

Reverse Clutch Released

Third Clutch-Applied

Second Clutch Applied

Low Band Released

Sprag Locked

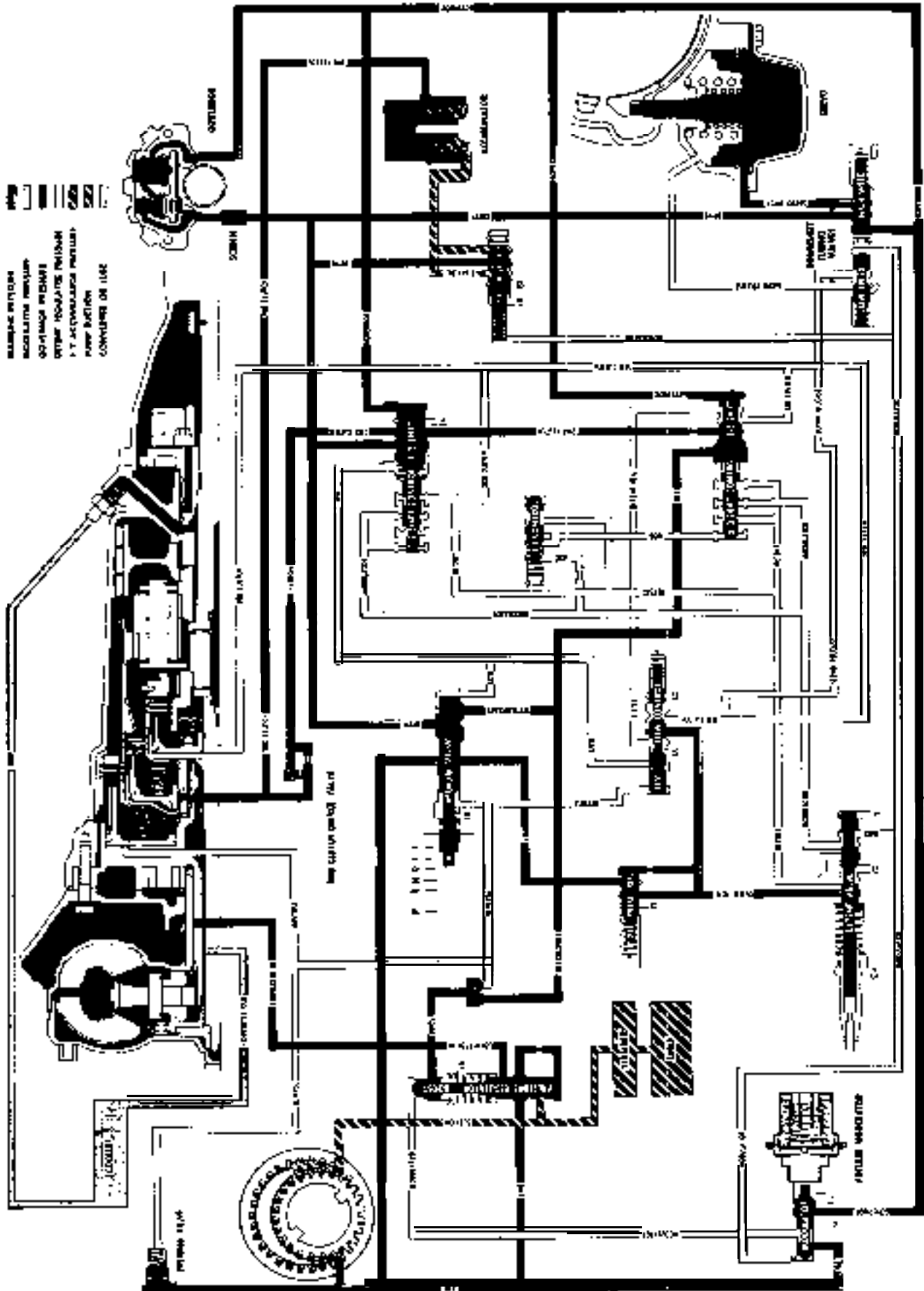
As vehicle speed increases, the governor allows more oil to pass through to act against the spring at the 2-3 shift valve. This allows the second clutch oil at the 2-3 shift valve to be released and pass through the valve as third clutch oil, directed to the third clutch piston to apply third clutch. At the same time, third clutch oil is directed to the 3-2 control valve, acting against the spring and modulator oil, cutting off modulator oil pressure to the 2-3 shift control valve. Third control oil also is directed to the Reverse and Low control valve and passes through the valve as servo release oil to the low speed downshift timing valve. The low speed downshift timing valve is held open against the spring by increased modulator oil pressure. The oil passes through the valve and is directed to the top of the low band servo, to act with the servo piston spring and force the servo piston downward, releasing the low band.

#### Summary

The second clutch is on, the third clutch is on, the band is released. The transmission is in drive range third gear.

7C-61





Flow, Second Range, Second Gear

Figure 7C-62

#### g. Operation of Controls in Second Range Second Gear

Reverse Clutch Released

Third Clutch Released

Second Clutch Applied

Low Band Applied

#### Sprag Over Running

The selector lever is moved to the Intermediate position on the quadrant. the manual valve is positioned to allow drive oil and Intermediate oil to pass through the valve. Intermediate oil is directed to the pressure regulator boost control cavity, seating the check ball at the reverse passage. Intermediate oil is then directed to the pressure regulator valve downward to increase the oil pressure in the circuit. At the same time. the intermediate oil from the manual valve is directed to the 2 3 shift valve train closing off the supply of third clutch oil in the circuit, which is exhausted through the Reverse and Low control valve.

#### Summary

With third clutch oil exhausted. the third clutch is off, the second clutch is on, the low band servo is applied. The transmission is in second Range Second Gear.

7C-63

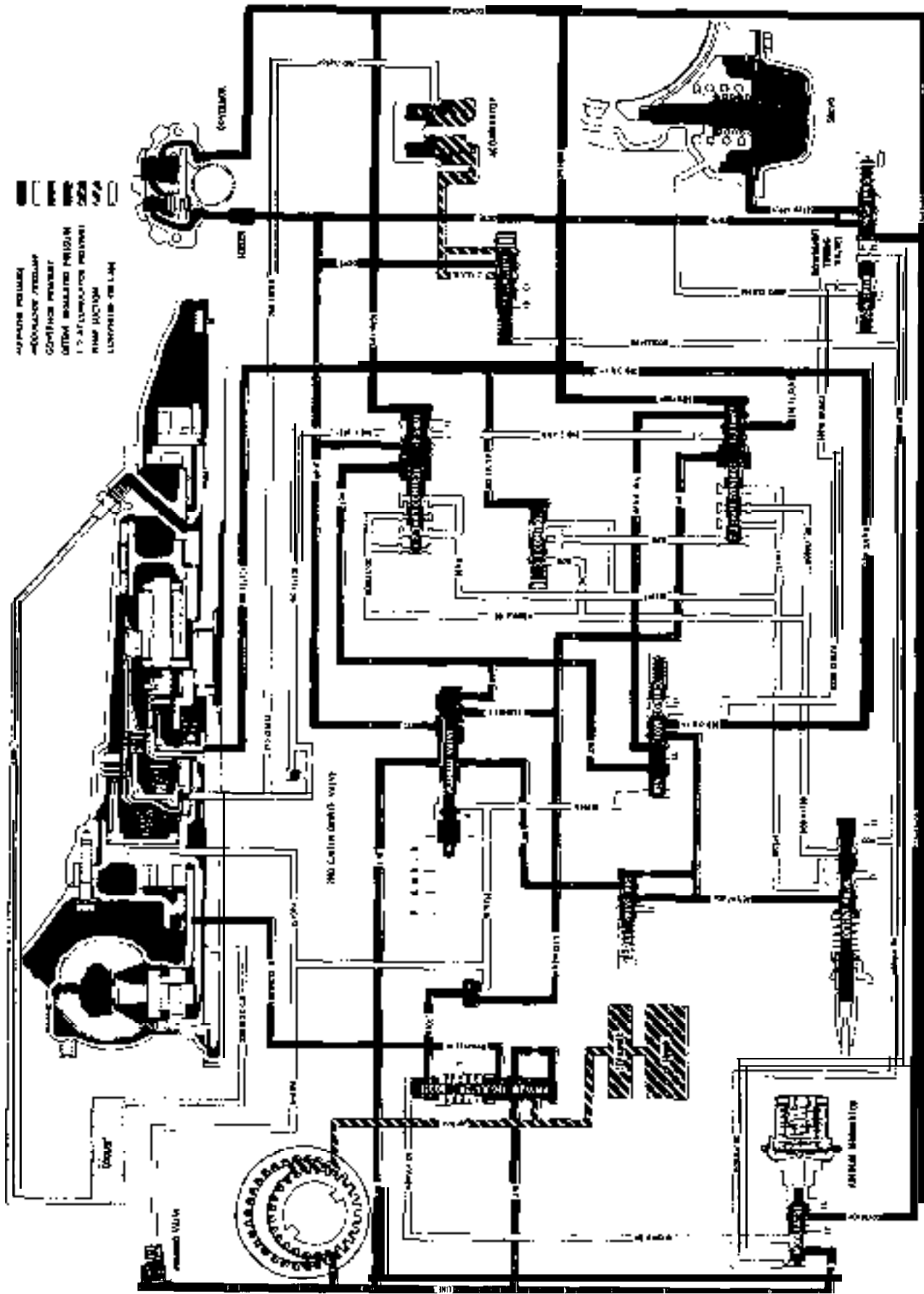


Figure 7C 65 - Transmission Oil Flow, 1st Range, 1st Gear

f. Operation of Controls in Low Range First Gear

Reverse Clutch Released

Third Clutch Applied

Second Clutch Released

Low Band Applied

Sprag Locked

When the selector lever is moved to the low position on the quadrant, the manual valve is positioned to allow drive oil, intermediate oil and low oil to pass through the valve. Low oil is directed to the 1-2 shift valve train which acts with the 1-2 shift valve spring against governor oil pressure to close off drive oil from passing into the second clutch passage. At the same time, low oil is directed to the Reverse and Low control valve and acts against the spring to allow detent regulated oil at the Reverse and Low control valve to flow to the 2-3 shift valve, which is bottomed in its bore by intermediate oil pressure and the valve spring. The detent oil passes through the 2-3 shift valve and into the third clutch oil passages to apply the third clutch and to close off modulator oil pressure from the 3-2 control valve to the 2-3 shift control valve. Third control oil is also directed to the Reverse and Low control valve, which is held open against its spring by low oil pressure, and closes off the source of supply to the servo release passage, to allow the servo to apply the low band. Intermediate oil seats the check ball at the Reverse passage at the pressure regulator boost valve cavity and continues to the pressure regulator valve to increase oil pressure in the circuit.

Summary

The third clutch is on, the band is on. The transmission is in Low Range First Gear

7C-66



### g. Operation of Controls in Reverse

Reverse Clutch -Applied

Third Clutch. Applied

Second Clutch Released

Low Band - Released

Sprag Locked

When the selector lever is moved to the Reverse position on the quadrant, the manual valve is positioned to allow Reverse oil to pass through the manual valve into the Reverse oil passage. The reverse oil applies the reverse clutch, and a portion is directed to the priming valve which acts as a damper until the line is filled. to effect a smooth and firm apply of the reverse clutch. At the same time, reverse oil is directed to the pressure regulator boost control valve cavity to seat the check ball and prevent reverse oil passing into the intermediate oil passage. It is then directed to the pressure regulator boost valve forcing

Reverse oil is also directed to act on the end of the Reverse and Low control valve against the spring to allow detent regulated oil to pass through the valve to the 2 3 shift valve. The detent regulated oil passes through the 2 3 shift valve and into the third clutch oil passages to apply the third clutch. The third clutch oil also acts on the end of the 3 2 control valve against the spring and modulator oil pressure, closing off the supply of modulator oil to the 2 3 shift control valve. Third clutch oil at the reverse and low control valve is closed off from passing through the valve, and into the servo release passage.

#### Summary

The reverse clutch is on and the third clutch is on. The transmission is in Reverse Range.

7C-68

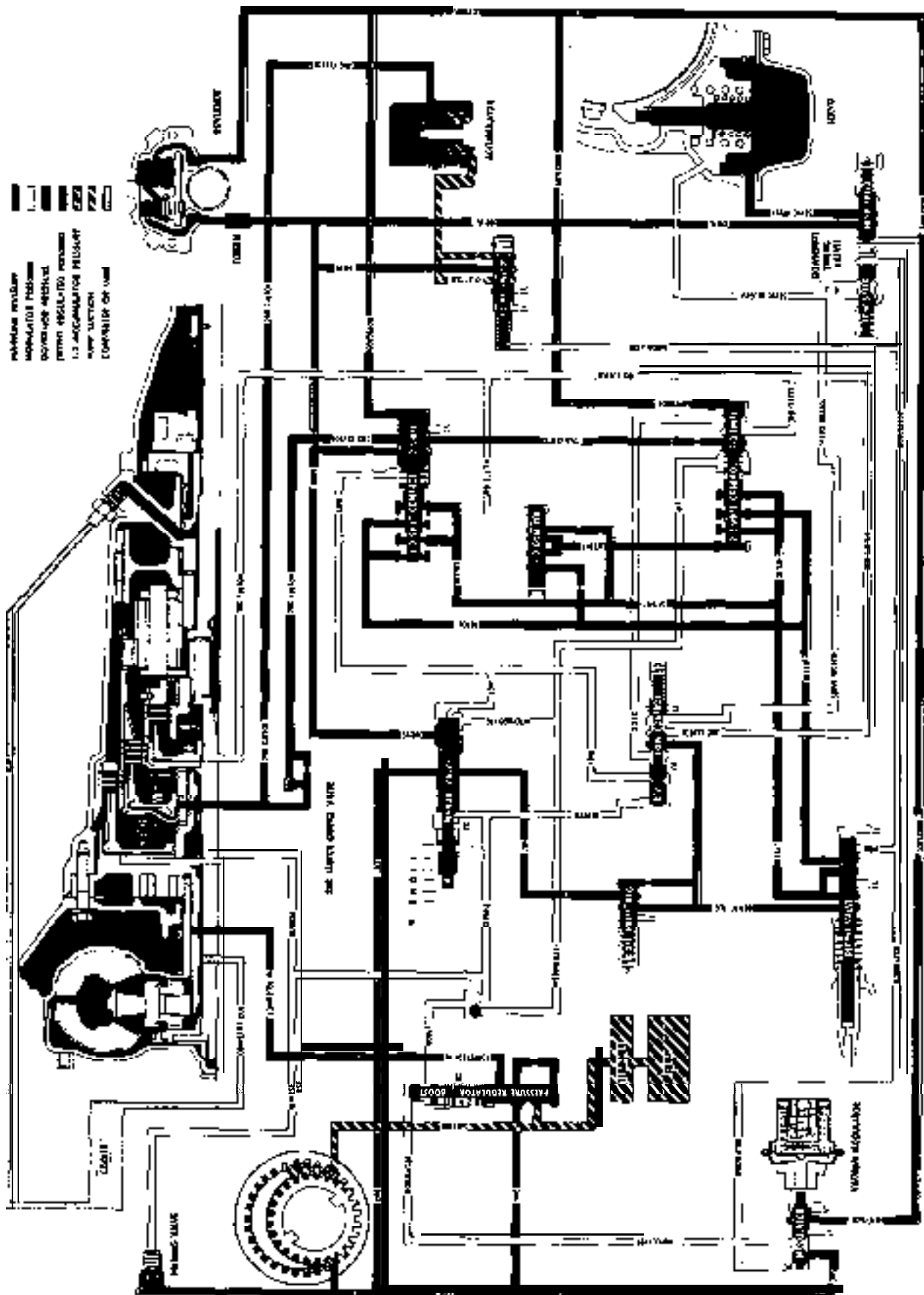


Figure 7C-69 - Transmission Oil Flow, Deten: Downshift

h. Operation of **Controls** during Detent Downshift Valves in **Second** Gear Position

Reverse Clutch Released

Third Clutch Released

Second Clutch Applied

Low Band Applied

Sprag Over Running

With the selector in the Drive position, detent downshifts are **possible** by fully depressing the accelerator pedal. This **causes** the mechanical linkage to the detent **valve** to move the detent valve, cutting off moduaroh oil to the 3 2 control valve, the 1 2 shift control valve, the 1 2 accumulator valve and the 2 • 3 shift control **valve**.

The mechanical linkage holding the detent **valve** open allows the detent regulated oil to pass into the detent oil **passage** and is directed to the 2 3 shift control **valve**, acting against the spring and governor oil pressure. It is also directed to the 3 2 control **valve**, acting against the spring, allowing detent oil to pass through the valve and act on the end of the 2 3 shift control valve to keep the valve bottomed in its bore **against** governor oil pressure. Second clutch oil et the 2 3 shift **valve** is closed off from passing into the third clutch **passages** by the detent oil pressure holding the 2 3 shift **valve** bottomed in its bore.

Summary

The second clutch is on, the low band is on. The valves are in **second** gear position under detent conditions.

7C-70



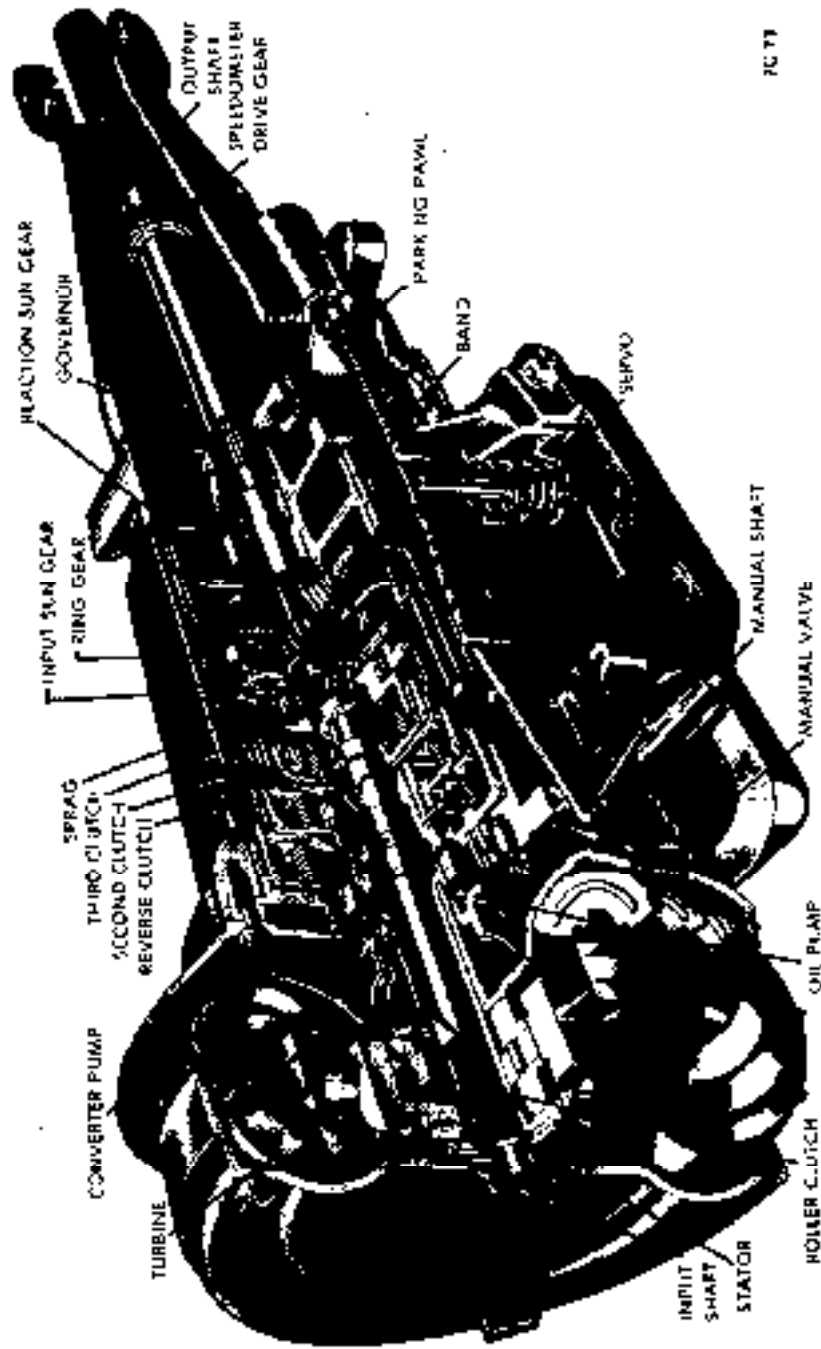


Figure 7C-71 of

## DIAGNOSIS

### SEQUENCE

1. Check and correct oil level. Refer to Specifications for checking and refill procedures.
2. Check and correct vacuum line and fittings.
3. Check and correct manual linkage.
4. Road test car using all selective ranges, noting when discrepancies in operation occur.
5. If engine performances indicates an engine tuneup is required, this should be performed before road testing is completed or transmission correction attempted. Poor engine performance can result in rough shifting or other malfunctions.

### CHECKING PROCEDURES

Before diagnosis of any transmission complaint is attempted, there must be an understanding of oil checking procedure and what appearance the oil should have. Many times a transmission malfunction can be traced to low oil level, improper reading of dipstick, or oil appearances; therefore, a careful analysis of the condition of oil and the level may eliminate needless repairs.

When checking oil level in the Opel Three Speed Automatic Transmission, the procedure outlined in Specifications should be followed to obtain the most accurate reading.

Also when the dipstick is removed, it should be noted whether the oil is devoid of air bubbles or not. Oil with air bubbles gives an indication of an air leak in the suction lines, which can cause erratic operation and slippage. Water in the oil imparts a milky, pink cast to the oil and can cause spewing.

### EXTERNAL OIL LEAKS

#### Determining source of oil leak

Before attempting to correct an oil leak, the actual source of the leak must be determined. In many cases, the source of the leak can be deceiving due to "wind flow" around the engine and transmission. The suspected area should be wiped clear of all oil before inspecting for the source of the leak. Red dye

is used in the transmission oil at the assembly plant and will indicate if the oil leak is from the transmission.

**The use** of a "Black Light" to locate the point at which the oil is leaking is helpful. Comparing the oil from the leak to that on the engine or transmission dipstick, when viewed by Black Light, will determine the source of the leak-engine or transmission.

Oil leaks around the engine and transmission are generally carried toward the rear of the car by air stream. For example, a transmission oil filler tube to case leak will sometimes appear as a leak at the rear of the transmission. In determining the source of a leak, proceed as follows:

1. Degrease underside of transmission.
2. Road test to get unit at operating temperature.
3. Inspect for leak with engine running.
4. With engine off, check for oil leaks due to the raised oil level caused by drain back.

#### Case Porosity Repair

Opel Three-Speed Automatic Transmission external oil leaks caused by case porosity can be successfully repaired with the transmission in the car by using the following recommended procedures:

1. Road test and bring the transmission to operating temperature, approximately 180 degrees F.
2. Raise car on a hoist or jack stand, engine running, and locate source of oil leak. Check for oil leaks in low, drive, and reverse.
3. Shut engine off and thoroughly clean area to be repaired with a suitable cleaning solvent and a brush- air dry. A clean, dry soldering acid brush can be used to clean the area and also to apply the epoxy cement.
4. Using instructions of the manufacturer, mix a sufficient amount of epoxy, BUICK Group 0.423, Part No. 1360016, or equivalent, to make the repair. Observe cautions of manufacturer in handling.
5. While the transmission case is still HOT, apply the epoxy to the area to be repaired. Make certain the **area** to be repaired is fully covered.
6. Allow cement to cure for 3 hours before starting engine.
7. Road test and check for leaks.

## AUTOMATIC TRANSMISSION TROUBLE DIAGNOSIS CHART

Condition	Cause
<b>Concerns Transmission Oil</b>	
1. Low oil level.	<ul style="list-style-type: none"> <li>a) Oil coming out of oil filler tube.</li> <li>b) External oil leak.</li> <li>c) Failed vacuum modulator.</li> </ul>
2. Oil coming out of oil filler tube.	<ul style="list-style-type: none"> <li>a) Oil level too high.</li> <li>b) Coolant in transmission oil.</li> <li>c) External vent clogged with mud.</li> <li>d) Leak in oil pump suction circuit.</li> </ul>
3. External oil leaks in the area of the torque converter housing.	<ul style="list-style-type: none"> <li>a) Leaking torque converter.</li> <li>b) Converter housing seal.</li> <li>c) Sealing washers under converter housing to case bolts.</li> <li>d) Sealing washers under converter housing to pump bolts.</li> <li>e) Converter housing to case seal.</li> <li>f) Loose attaching bolts on front of transmission.</li> </ul>
4. External oil leaks in the area of transmission case and extension.	<ul style="list-style-type: none"> <li>a) Shifter shaft seal.</li> <li>b) Extension seal.</li> <li>c) Oil pan gasket.</li> <li>d) Extension to case gasket.</li> <li>e) Vacuum modulator gasket.</li> <li>f) Drain plug gasket.</li> <li>g) Cooler line fittings.</li> <li>h) Oil filler tube seal ring.</li> <li>i) Detent cable seal ring.</li> <li>j) Line pressure gauge connection.</li> </ul>
5. Low oil pressure.	<ul style="list-style-type: none"> <li>a) Low oil level.</li> <li>b) Clogged suction screen.</li> <li>c) Leak in oil pump suction circuit.</li> <li>d) Leak in oil pressure circuit.</li> <li>e) Priming valve stuck.</li> <li>f) Pressure regulator valve malfunction.</li> <li>g) Sealing ball in valve body dropped out.</li> </ul>
6. High oil pressure.	<ul style="list-style-type: none"> <li>a) Modulator vacuum line leaky or <b>interrupted</b>.</li> <li>b) Failed vacuum modulator.</li> <li>c) Leak in any part of engine or accessory vacuum system.</li> <li>d) Pressure regulator valve malfunction.</li> </ul>
7. Excessive smoke coming from exhaust.	<ul style="list-style-type: none"> <li>a) Failed vacuum modulator.</li> <li>b) Oil from vent valve or leak on hot exhaust pipe.</li> </ul>

Condition	Cause
<b>Starting</b>	
1. No <b>starting in any</b> drive range.	<ul style="list-style-type: none"> <li>a) Low oil level.</li> <li>b) Clogged suction screen.</li> <li>c) Manual valve linkage or inner transmission selector lever disconnected.</li> <li>d) Input shaft broken.</li> <li>e) Pressure regulator valve stuck in open position.</li> <li>f) Failed oil pump.</li> </ul>
2. No starting in any drive range for a time. Driving possible only after repeatedly moving selector lever to and fro.	<p>Manual valve position does not coincide with valve body channels:</p> <ul style="list-style-type: none"> <li>a) Selector lever shaft retaining pin dropped out.</li> <li>b) Connecting rod to manual valve shifting.</li> <li>c) Selector lever shaft nut loose.</li> </ul>
3. No starting after shifting lever from "P" to "D", "S", or "L" (inadequate engine acceleration).	<ul style="list-style-type: none"> <li>a) Parking <b>pawl</b> does not disengage.</li> </ul>
4. Sudden starting only after increase of engine RPM.	<ul style="list-style-type: none"> <li>a) Band servo piston jamming.</li> <li>b) Low oil level.</li> <li>c) Oil pump defective.</li> <li>d) Oil screen missing.</li> <li>e) Sealing ball in valve body dropped out</li> </ul>
5. Heavy jerking when starting.	<ul style="list-style-type: none"> <li>a) Low oil pressure.</li> <li>b) Wrong modulator valve.</li> <li>c) Pressure regulator valve stuck.</li> <li>d) Sealing ball in valve body dropped out.</li> </ul>
6. No starting in "D" or "S" range, but in "L" and "R" range.	<ul style="list-style-type: none"> <li>a) Input sprag installed backwards.</li> <li>b) Input sprag failure.</li> </ul>
7. No starting in "D" or "S" and "L" (proper driving in "R"; see also point 9).	<ul style="list-style-type: none"> <li>a) Band worn, does not grip.</li> <li>b) Band servo piston jamming.</li> <li>c) Excessive leak in band servo.</li> <li>d) Parking <b>pawl</b> does not disengage.</li> </ul>

Condition	Cause
8. No starting in "R" range (proper driving in all other ranges).	a) Reverse clutch failure.
9. Drive in selector lever position "N".	a) Inadequate selector lever linkage. b) Planetary gear set broken. c) Improper adjustment of band.
<b>Gear Change</b>	
1. No 1-2 upshift in "D" and "S" (transmission remains in 1st gear at all speeds).	a) Governor valves stuck. b) 1-2 shift valve stuck in 1st gear position. c) Seal rings (oil pump hub) leaky. d) Large leak in governor pressure circuit. e) Governor screen clogged.
2. No 2-3 upshift in "D" (transmission remains in 2nd gear at all speeds).	a) 2-3 shift valve stuck. b) Large leak in governor pressure circuit.
3. Upshifts in "D" and "S" only at full throttle.	a) Failed vacuum modulator. b) Modulator vacuum line leaky or interrupted. c) Leak in any part of engine or accessory vacuum system. d) Detent valve or cable stuck.
4. Upshifts in "D" and "S" only at part throttle (no detent upshift).	a) Detent pressure regulator valve stuck. b) Detent cable broken or misadjusted.
5. Driving only in 1st gear of "D" and "S" range (transmission blocks in 2nd gear and "R").	a) "L" and "R" control valve stuck in "L" or "R" position.
6. No part throttle 3-2 downshift at low vehicle speeds.	a) 3-2 downshift control valve stuck.
7. No forced downshift.	a) Detent cable broken or improperly adjusted. b) Detent pressure regulator valve stuck.

Condition	Cause
8. After full throttle upshifting transmission shifts immediately into lower gear upon easing off accelerator pedal.	<ul style="list-style-type: none"> <li>a) Detent valve stuck in open position,</li> <li>b) Detent cable stuck.</li> <li>c) Modulator vacuum line interrupted.</li> </ul>
9. At higher speeds, transmission shifts into lower gear.	<ul style="list-style-type: none"> <li>a) Retaining pin of selector lever shaft in transmission dropped out.</li> <li>b) Loose connection of selector lever linkage to manual valve.</li> <li>c) Pressure loss at governor.</li> </ul>
10. Hard disengagement of selector lever from "P" position.	<ul style="list-style-type: none"> <li>a) Steel guide bushing of parking pawl actuating rod missing.</li> <li>b) Manual selector lever stuck.</li> </ul>
<b>Shifts</b>	
1. Slipping 1-2 upshifts (engine flares).	<ul style="list-style-type: none"> <li>a) Low oil pressure.</li> <li>b) Sealing ball in valve body dropped out.</li> <li>c) Second clutch piston seals leaking.</li> <li>d) Second clutch piston centrifugal ball stuck open.</li> <li>e) Second clutch piston cracked or broken.</li> <li>f) Second clutch plates worn.</li> <li>g) Seal rings of oil pump hub leaky.</li> </ul>
2. Slipping 2-3 upshifts (engine flares).	<ul style="list-style-type: none"> <li>a) Low oil pressure.</li> <li>b) Band adjustment loose.</li> <li>c) Third clutch piston seals leaking.</li> <li>d) Third clutch piston centrifugal ball stuck open.</li> <li>e) Third clutch piston cracked or broken.</li> <li>f) Wear of input shaft bushing.</li> <li>g) Sealing ball in valve body dropped out</li> </ul>
3. Abrupt 1-2 upshift.	<ul style="list-style-type: none"> <li>a) High oil pressure.</li> <li>b) 1-2 accumulator valve stuck.</li> <li>c) Spring cushion of second clutch broken,</li> <li>d) Second gear ball valve missing.</li> </ul>
4. Abrupt 2-3 upshift.	<ul style="list-style-type: none"> <li>a) High oil pressure</li> <li>b) Incorrect band adjustment.</li> </ul>
5. Abrupt 3-2 detent downshift at high speed.	<ul style="list-style-type: none"> <li>a) High speed downshift valve stuck open.</li> <li>b) Band adjustment.</li> </ul>

Condition	Cause
6. Abrupt 3-2 coast downshift.	a) Low speed downshift timing valve stuck open.
7. Flare on high speed forced downshift.	a) Low oil pressure. b) Band adjustment loose
8. Flare on low speed forced downshift.	a) Low oil pressure. b) Band adjustment loose. c) High speed downshift timing valve stuck in closed position. d) <b>Sprag</b> race does not grip on <b>3-1</b> down shifting

**Engine Braking**

1. No engine braking in "L" range.	a) Selector lever linkage improperly adjusted. b) Manual low control valve stuck.
2. No engine braking in "S" range.	a) Selector lever linkage improperly adjusted.
3. No park.	a) Selector lever linkage improperly adjusted. b) Parking lock actuator spring. c) Parking <b>pawl</b> . d) Governor hub.

**Noises**

1. Excessive noises in all drive ranges.	a) Too much backlash between sun gear and planetary gears. b) Lock plate on planetary carrier loose. c) Thrust bearing defective. d) Bearing bushings worn. e) Excessive transmission axial play. f) Unhooked parking pawl spring contacts governor hub. g) Converter balancing weights loose. h) Converter housing attaching bolt loose and contacting converter.
2. <b>Screaching</b> noise when starting.	a) Converter failure.
3. Short vibrating, hissing noise shortly before 1-2 upshift.	a) Dampening cushion of reverse clutch wearing into transmission case.

**Abrasive**

1. Excessive amount of iron dust (can be picked up by magnet in oil pan).	a) Oil pump. b) Governor hub. c) Second clutch hub
2. Excessive amount of aluminum dust (cannot be picked up by magnet) in oil <b>pan</b> .	a) Thrust face in case. b) Rear bore of case. c) <b>Stator</b> thrust washer - check converter end clearance.

HYDRAULIC PRESSURE CHECK SHIFT POINTS

SPECIFICATIONS

HYDRAULIC PRESSURE CHECKS

SHIFT POINTS

MODEL	OPERATING CONDITIONS	SHIFT POINTS (M.P.H. APPROX.)						DRIVE RANGE	
		D 1-2	D 2-3	D 3-2	D 2-1	S 1-2	S 2-1	L M.P.H.	S M.P.H.
1800 & MANTA	Min. Throttle Valve Opening	12-15	15-18	14-16	11-13	12-15	10-12		
	Detent Touch	42-47	56-61	34-40	19-22	42-47	17-20		
	Through Detent	40-48	65-71	68-64	32-38	40-46	25-33		
	Top Speed							43	68
	Detent Downshift Possible Below Approx			56-62	31-37		25-31		
G.T.	Min. Throttle Valve Opening	12-14	16-18	14-16	12-13	12-14	10-12		
	Detent Touch	42-47	56-61	45-50	20-21	42-47	18-19		
	Through Detent	40-48	65-71	58-65	32-39	40-46	24-33		
	Top Speed							43	68
	Detent Downshift Possible Below Approx;			59	34		34		

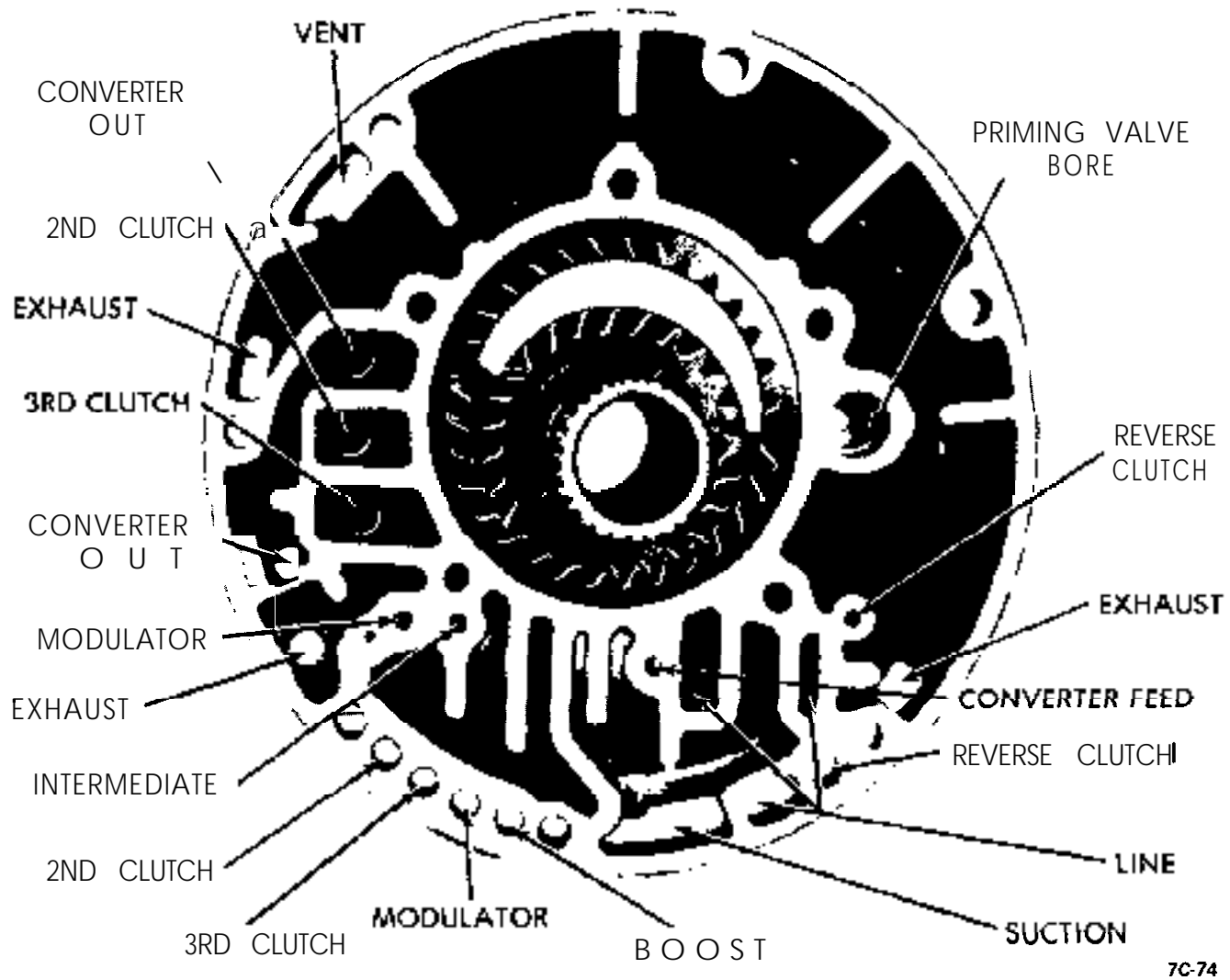
NOTE: ON REPLACING PLUG, TORQUE TO 6.7 LEFT.

4. After pressure gage and hose is install, replace rear crossmember and side bolts and proceed with pressure checking procedure.

NOTE: PRESSURES ARE OFF OF THE SERVO APPLY.

D \_\_\_\_\_ 65  
 S \_\_\_\_\_ 65  
 L \_\_\_\_\_ 80





7C-74

Figure 7C-74 Oil Pump Passages

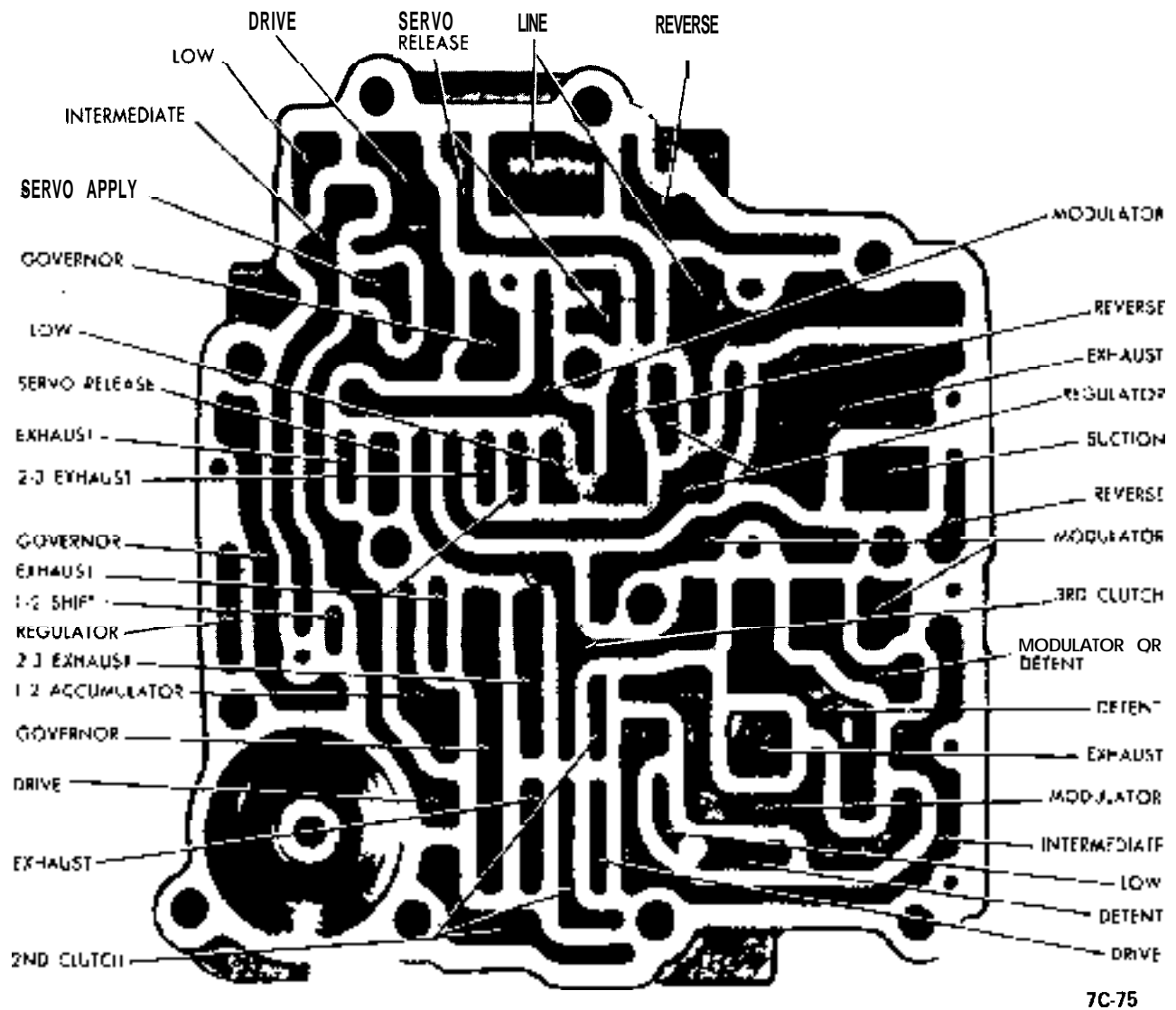
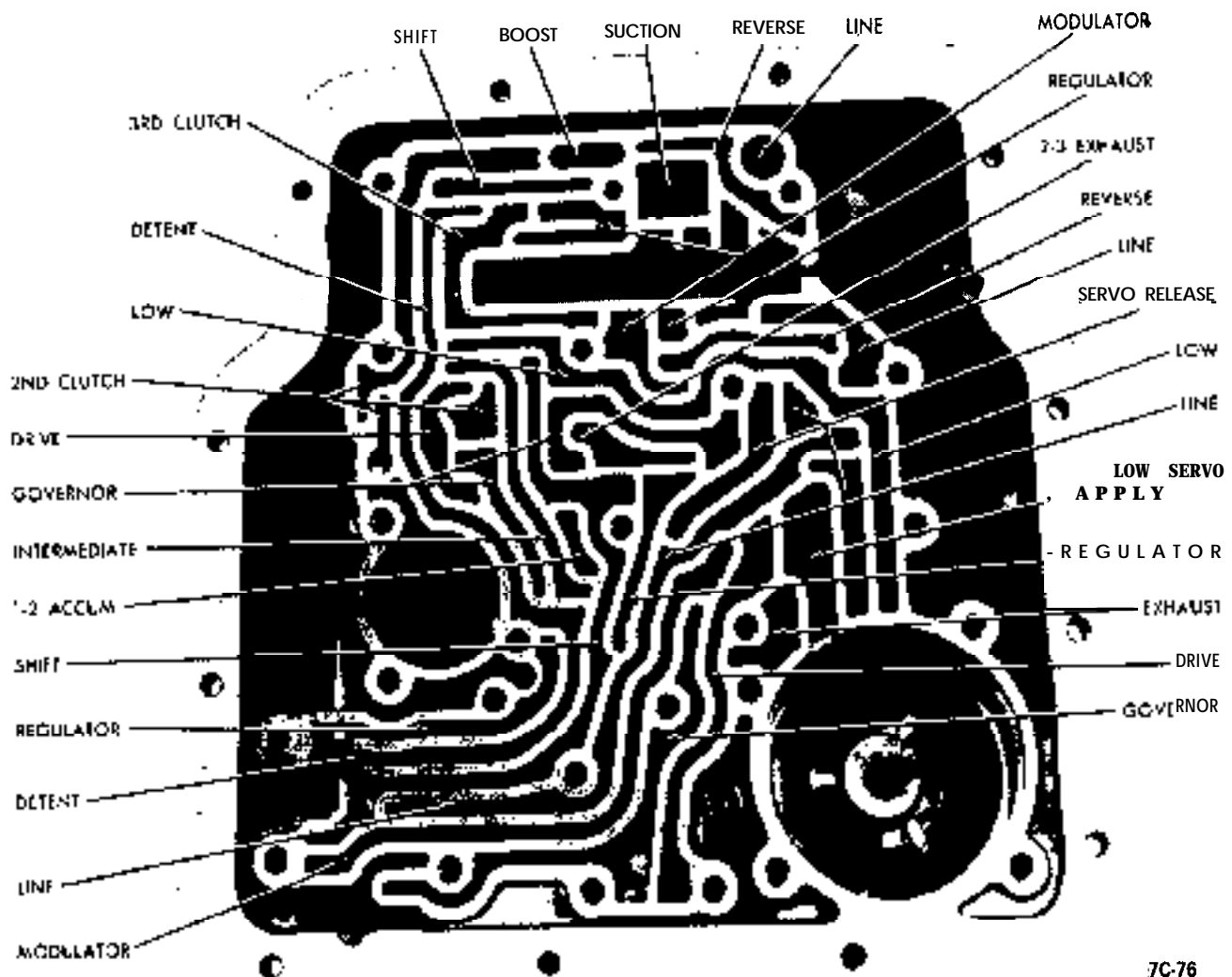


Figure 7C75 Valve Body Top



7C-76

Figure 7C-76 Case Bottom

**MAINTENANCE AND ADJUSTMENTS**

**DETENT CABLE REPLACEMENT AND ADJUSTMENT**

The reliability of the detent bowden control cable is greatly dependent upon the proper adjustment of the wire whenever installation is being made. It is important to remember that the free end of the wire is not kinked, as individual strands will break due to the continuous bending during operation. To avoid this situation, it is important that the bowden control cable be properly installed. Although replacement and adjustment procedures on various models are identical, the location of the upper, or throttle, end of the detent cable may vary. For proper model identification, see Figures 7C-61, 7C-62, 7C-63, and 7C-64.

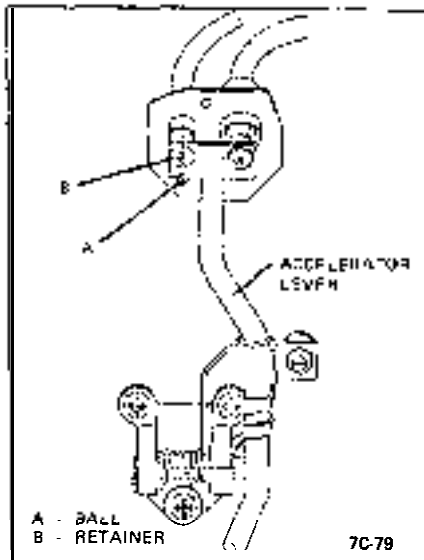


Figure 7C-79 Opel 1900 and Manta



Figure 7C-80 Opel 1900 and Manta

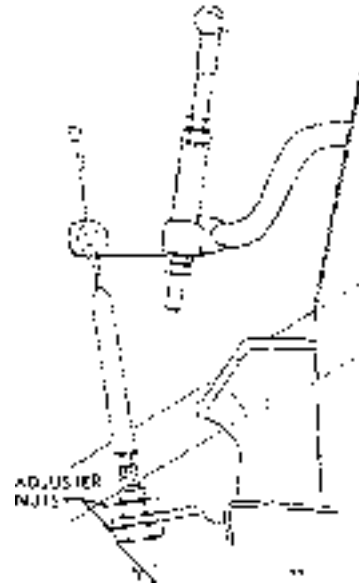


Figure 7C-81 GT Models

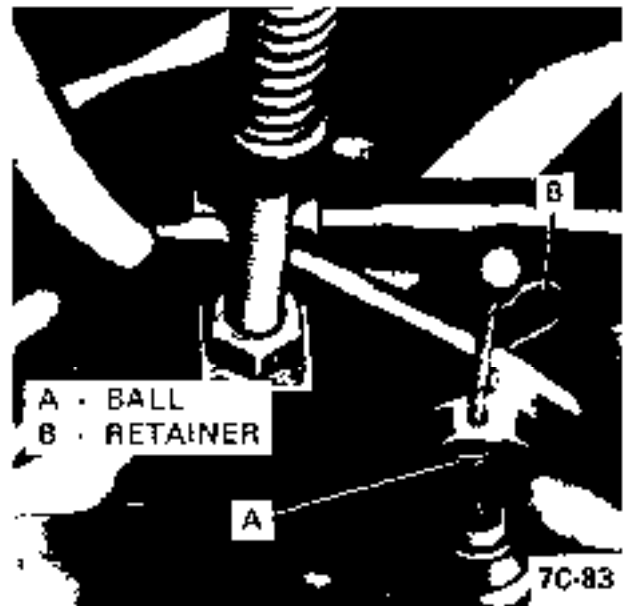


Figure 7C-83 GT Models

**Removal**

1. Detach retainer at detent cable to accelerator linkage.
2. Loosen rear transmission crossmember from body and remove right side bolt. See Figure 7C-84, Callout "A"
3. Insert block of wood between floor pan and right rear corner of transmission to expose detent cable bracket at transmission. See Figure 7C-85.
4. Unscrew detent cable connecting retainer from transmission and pull cable out of transmission. See Figure 7C-86.



Figure 7C-84

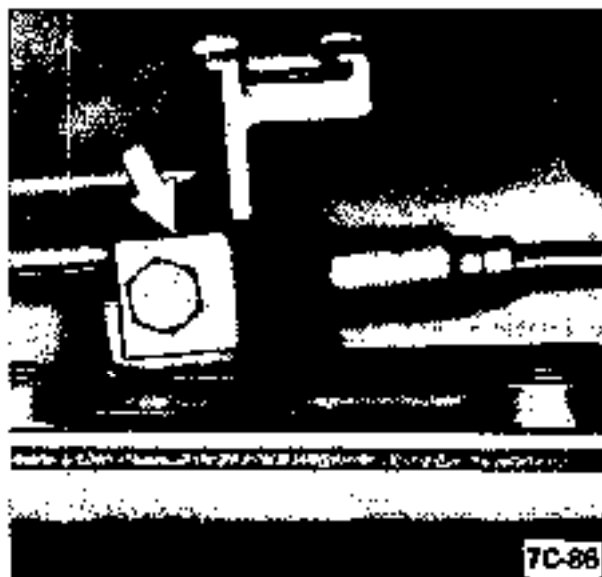


Figure 7C-86

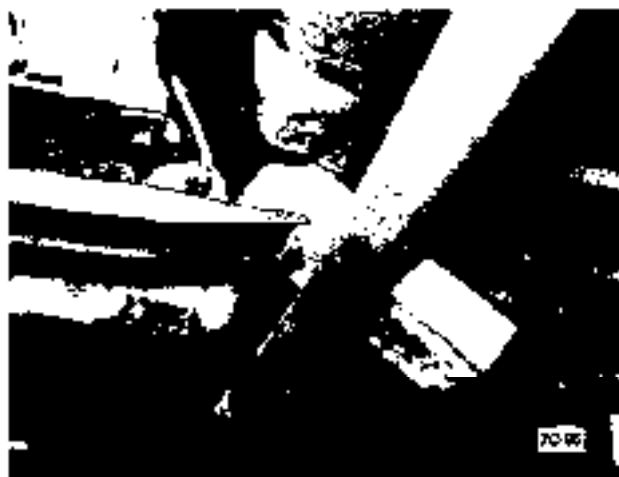


Figure 7C-85

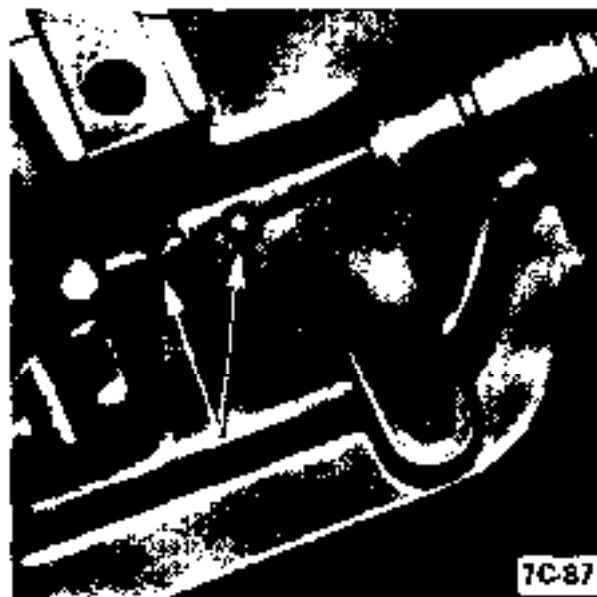


Figure 7C-87

5. Unhook detent cable from detent valve. See Figure 7C-87.

6. Pry detent cable pipe out of retainers.

7. Unscrew upper and lower adjuster nuts and remove detent cable (on Manta models, loosen lock nut and screw adjuster out of bulkhead).

#### Installation

1. Route cable and place in retainers,
2. Place cable in upper bracket and install upper **and** lower adjuster nuts and retainer (on Manta models, screw adjuster into bulkhead).
3. Hook detent cable to valve and install retainer.

#### Adjustment

Before carrying out any adjustment to the detent cable, it is essential that the throttle control linkage is correctly adjusted so that full throttle opening is obtained at the carburetor.

After the throttle control linkage has been set, the adjustment for the detent cable may be checked as follows:

1. Position accelerator to full throttle (pedal is *not* fully depressed at full throttle) and loosen and tighten upper and lower adjuster nuts of detent cable

(on Manta models, turn adjuster) until ball end of cable rests firmly against lever.

2. At this point, measure length of exposed detent inner cable. Depress accelerator pedal *fully*, and again measure inner cable. If correctly adjusted, detent cable should move approximately 3/8 inch.

**Servicing Selector Lever**

1. Unscrew console from floor panel, on small console remove three (3) attaching screws and on large console remove four (4) screws. The fourth screw is accessible after removal of ash tray. See Figure 7C-88.

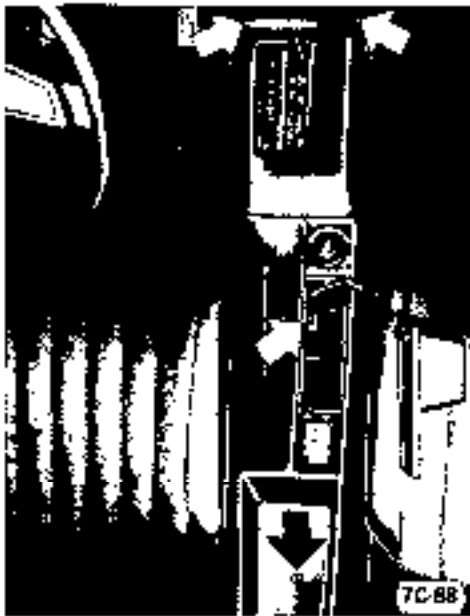


Figure 7C-88



Figure 7C-89

2. Unplug cigar lighter and lamps from console and remove console.

3. From below vehicle, remove selector rod from intermediate selector lever.

4. Remove neutral start switch (A) and remove support housing attaching bolts. See Figure 7C-89.

5. Remove support housing and, from the underside of support housing, remove three (3) support attaching bolts. See Figure 7C-90.

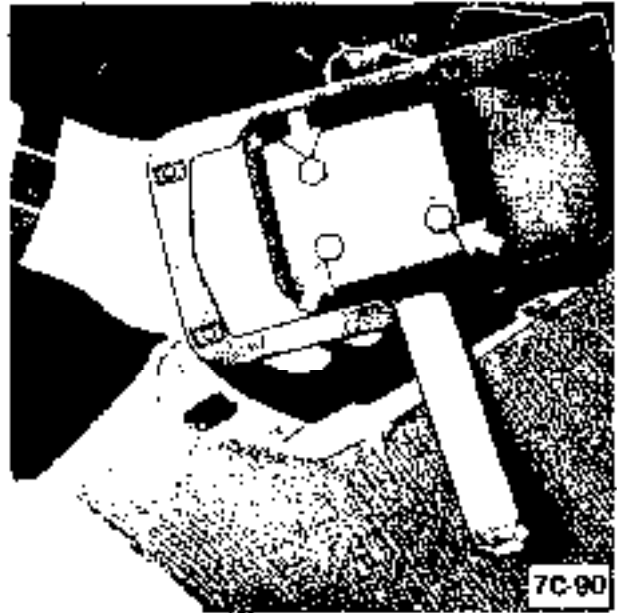


Figure 7C-90

6. Remove intermediate selector lever (B) from shaft and remove assembly from support housing. See Figure 7C-92.

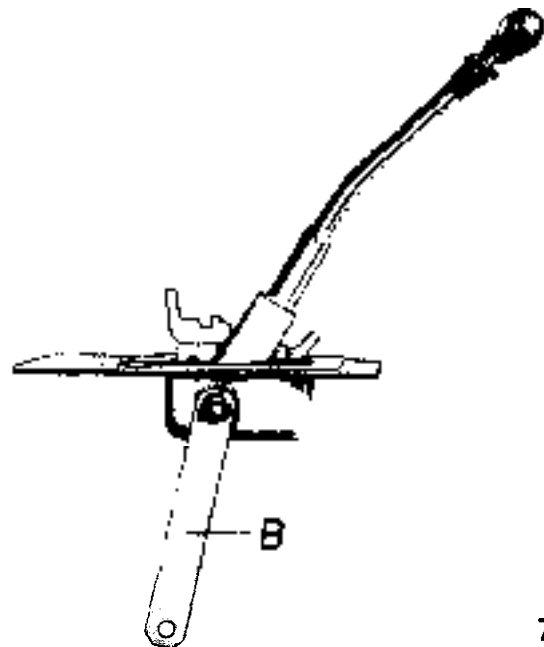


Figure 7C-92

7. Drive out retaining pin and shaft and remove selector detent. See Figure 7C-93.

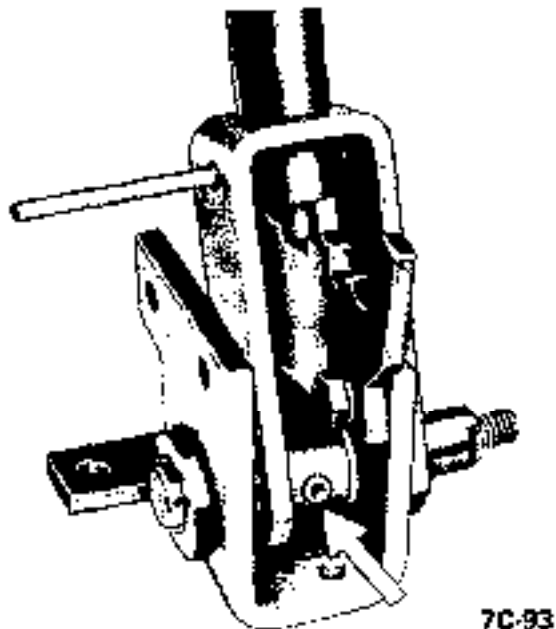


Figure 7C-93

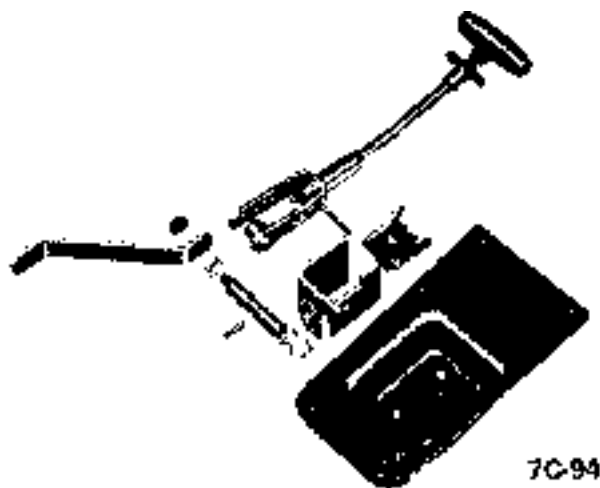


Figure 7C-94 • Exploded View of Selector Lever

8. To replace bowden cable in selector lever, knock off selector handle, remove screws from clamping piece and pull knob.

9. Remove pull knob and bowden cable, taking care not to lose lock bolt bushing, thrust springs, and washer.

10. Place thrust spring, bushing, washer, and thrust spring onto new bowden cable, in that order, and insert cable into selector lever.

11. Slide pull onto selector lever and clamping piece onto cable.

12. Heat up new selector lever handle in water to 176 degrees F. and push onto selector lever.

13. Set dimension between pull knob and selector lever handle at .4 inch and tighten set screws.

14. Lubricate selector lever detent and shaft. Install detent, align selector lever with support, install shaft, and drive in new retaining pin.

15. Install assembly to support housing and install intermediate selector lever.

16. Install assembly to vehicle and install neutral start switch.

17. Install console lights and cigar lighter connections to console and install console to vehicle.

18. Lubricate and connect selector rod to intermediate selector lever and adjust according to Figure 7C-198.

## MAJOR REPAIR

### REMOVAL AND INSTALLATION OF AUTOMATIC TRANSMISSION

Removal • Opel 1900 and Manta

1. Disconnect battery.
2. Remove dipstick.
3. Remove screws from fan shroud.
4. Remove 2 upper starter bolts.
5. Raise car and provide support for front and rear and drain oil.
6. Remove bolts from engine support brackets, both sides. Let brackets hang by front bolts. See Figure 7C-105.
7. Remove flywheel cover pan.
8. Remove exhaust pipe from manifold and unhook rubber tailpipe suspension.
9. Remove drive shaft. Do not misplace thrust spring in spline.
10. Disconnect cooler lines at flexible hoses.

II. Detach both stabilizer supports from crossmember to body supports and loosen stabilizer bolts in lower control arms. See Figure 7C-84, Callout "B".

12. Place suitable jack under transmission and remove transmission support bolts.

13. Lower transmission enough to remove detent cable and modulator vacuum line.

14. Remove speedometer cable.

15. Remove selector lever.

16. Mark flywheel and converter for reassembly in same position, and remove converter to flywheel bolts. See Figure 7C-106.

17. Remove converter housing to engine bolts and tiller tube.

18. Pry transmission loose from engine.

19. Keep rear of transmission lower than front to prevent converter from falling and install converter holding fixture J-21366. Lower transmission and move to bench.

#### Installation. Opel 1900 and Manta

1. Assemble transmission to suitable jack and raise transmission into position. Rotate converter to permit coupling of fly wheel and converter with original relationship. Remove J-21366.

2. Install tiller tube and converter housing to engine block bolts. Torque to 35 lb. ft. DO NOT over torque.

3. Install flywheel to converter bolts. Torque to 30 lb. ft.

4. Install detent cable to transmission.

5. Connect oil cooler lines.

6. Install lower bolt on starter. Torque to 40 lb. ft.

7. Connect shift linkage to transmission.

8. Connect modulator line.

9. Connect speedometer cable.

10. Install transmission support.

11. Install drive shaft. Torque U-Bolts to 18 lb. ft.

12. Install flywheel cover pan. Torque to 15 lb. ft.

13. Install engine support brackets.

14. Reconnect exhaust system.

15. Attach stabilizer supports and tighten stabilizer bolts in lower control arms.

16. Lower car.

17. Install starter bolts. Torque to 40 lb. ft.

18. Reconnect battery.

19. Fill transmission with fluid as described in Specifications. Check selector lever and detent cable adjustment.

#### Removal GT

1. Disconnect battery.

2. Remove dipstick.

3. Pull throttle control rod off ball pin.

4. Remove screws from fan shroud.

5. Raise car and provide support for front and rear.

6. Remove heat protection shield from right side to make room for exhaust pipe removal.



Figure 7C-95

7. Detach exhaust pipe from manifold flange.

8. Unhook damper rings on front muffler and tail pipe from brackets on body floor panel. Place exhaust pipe assembly onto rear axle. See Figure 7C-96.

9. Remove propeller shaft. Make sure that spring in front universal joint does not get lost.





Figure 7C-96

10. Detach rear engine support from transmission crossmember. See Figure 7C-97.



Figure 7C-98

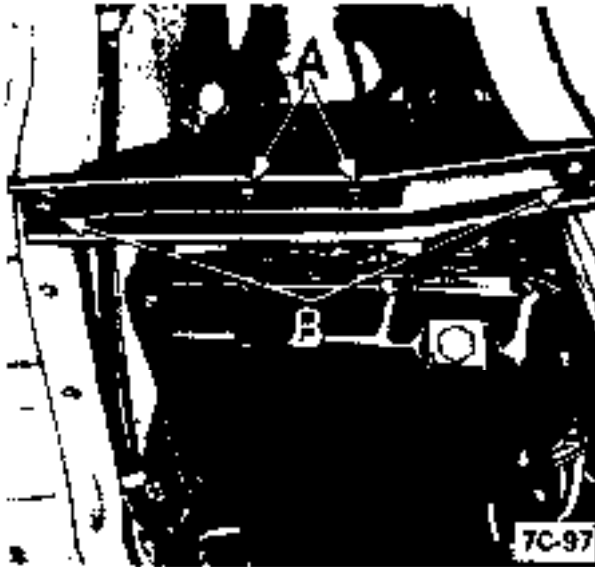


Figure 7C-97

11. Support transmission below oil pan with a suitable jack.

12. Unscrew transmission crossmember from side members. See Figure 7C-97.

13. Lower transmission as far as possible,

14. Drain transmission oil.

15. Detach selector rod from ball pin of the outer transmission selector lever on right transmission side. See Figure 7C-98.

16. Unscrew oil cooler pipes from transmission counter holding with a second wrench. Then plug oil cooler pipes. See Figures 7C-99 and 7C-101.



Figure 7C-99

17. Pull modulator line off diaphragm.

18. Unscrew detent cable retainer from transmission, pull cable out of transmission, and unhook from detent valve. See Figures 7C-102, 7C-103, and 7C-104.



Figure 7C-101

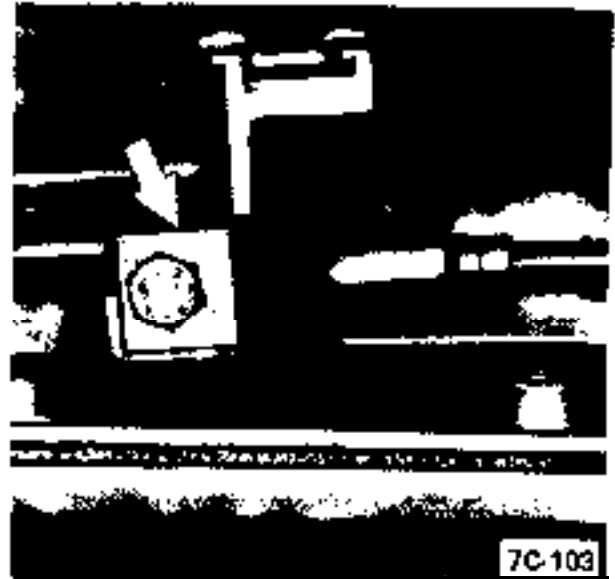


Figure 7C-103

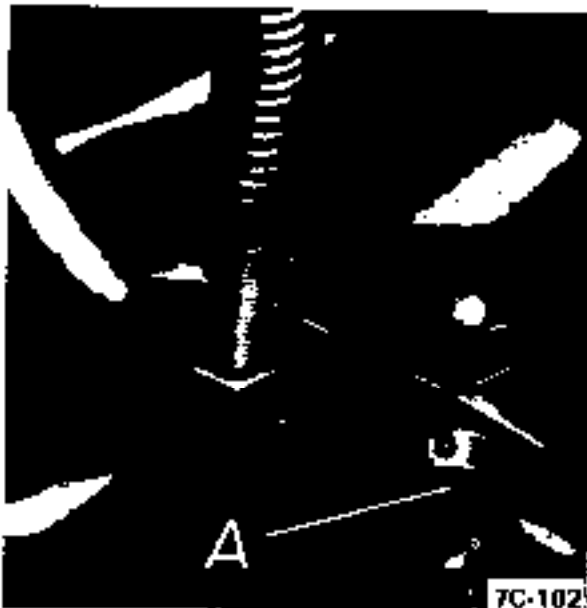


Figure 7C-102

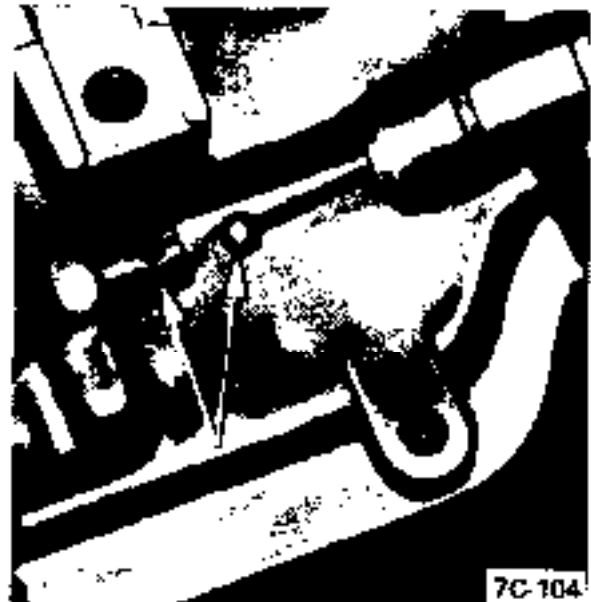


Figure 7C-104

19. Pry detent cable and oil cooler pipes out of retainers on transmission oil pan.

20. Unscrew **speedometer cable** and pull it out of speedometer driven gear housing.

21. On both engine sides unscrew engine support brackets from torque converter housing. Slacken front attaching bolt only. See Figure 7C-105.

22. Remove torque converter housing cover plate.

23. Mark flex plate and converter for reassembly in same position.

24. Unscrew the three torque converter to flex plate attaching bolts. See Figure 7C-106.

25. Pry transmission loose from engine.

26. Move transmission rearward to provide clearance between converter and flex plate to install converter holding tool J-21366. Lower transmission and move to bench.



Figure 7C-105

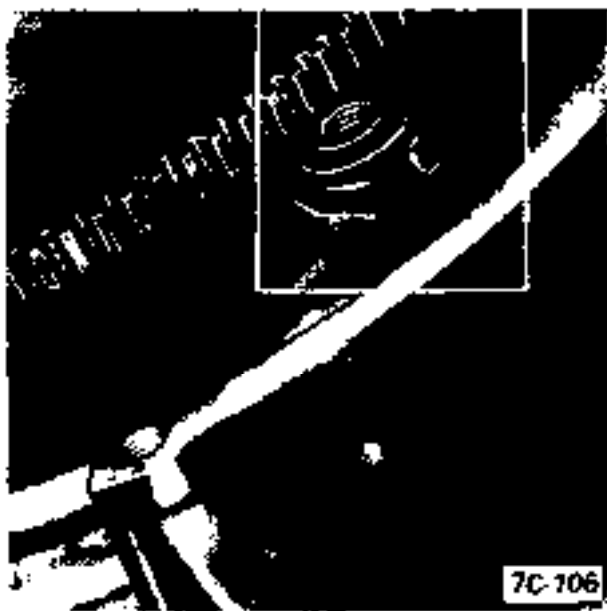


Figure 7C-106

Installation **GT**

1. Assemble transmission to suitable jack and raise into position. Rotate converter to permit coupling with flywheel in original relationship. Remove holding fixture.
2. Install tiller tube and converter housing to engine bolts. Torque to 35 lb.ft.
3. Install flywheel to converter bolts. Torque to 30 lb.ft.
4. Install detent cable.
5. Connect oil cooler lines.

6. Install lower bolt on starter. Torque to 40 lb.ft.
7. Connect modulator line.
8. Connect speedometer cable.
9. Connect shift linkage.
10. Install transmission support.
11. Install drive shaft. Torque U-bolts to 18 lb.ft.
12. Install flywheel cover pan.
13. Reconnect exhaust system and heat shield.
14. Install engine support brackets.
15. Lower car,
16. Install starter bolts, Torque to 40 lb.ft.
17. Connect battery.
18. Fill transmission with fluid, as described in Specifications. Check selector lever and detent cable adjustment.

**DISASSEMBLY, INSPECTION AND REASSEMBLY**

**Transmission Installation Into Holding Fixture**

- I. Remove transmission tiller tube.
2. With transmission on cradle of portable jack, remove converter assembly by pulling straight out. Converter contains a large amount of oil.
3. Install holding fixture, J-8763-01, on transmission.
4. Install holding fixture and transmission into holding **base** tool J-3289-20 with bottom pan up. See Figure 7C-107. **Do** not overtighten.



Figure 7C-107

**Converter Housing Oil Seal**

With transmission on portable jack and converter removed, converter housing oil seal may be removed without disassembling transmission using tool J-23129, and slide hammer J-7004.

2. Using tool J-23129 remove oil seal with slide hammer.
3. Install new oil seal using installer J-21359.

**Removal of Oil Pan**

This operation can be performed with transmission in vehicle.

1. Remove the twelve oil pan attaching bolts.
2. Remove oil pan and gasket. See Figure 7C-108.

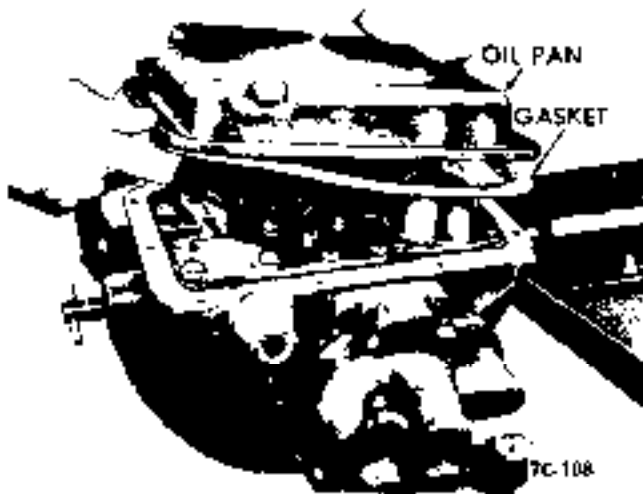


Figure 7C-108

**REMOVAL OF VALVE BODY**

**8 Removal of Valve Body**

This operation can be performed with transmission in vehicle

1. Remove the manual detent roller and spring, retained by two bolts. See Figure 7C-110,
2. Remove the three attaching bolts holding the strainer assembly to the valve body and remove. Discard gasket.
3. Remove the eight bolts from transfer plate reinforcement and remove reinforcement. See Figure 7C-111.

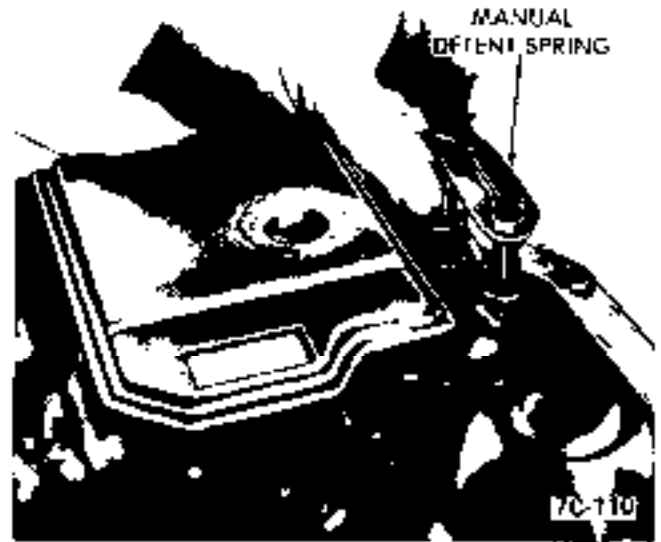


Figure 7C-1 10



Figure 7C-1 11

4. Remove the four servo cover attaching bolts and remove servo cover and gasket. See Figure 7C-112.

5. Remove remaining eight bolts attaching valve body to case. Carefully remove valve body with gasket and transfer plate. See Figure 7C-113.

Care must be taken so that manual valve and manual valve link "A" are not damaged or lost during removal of valve body from the case.



Figure 7C-112

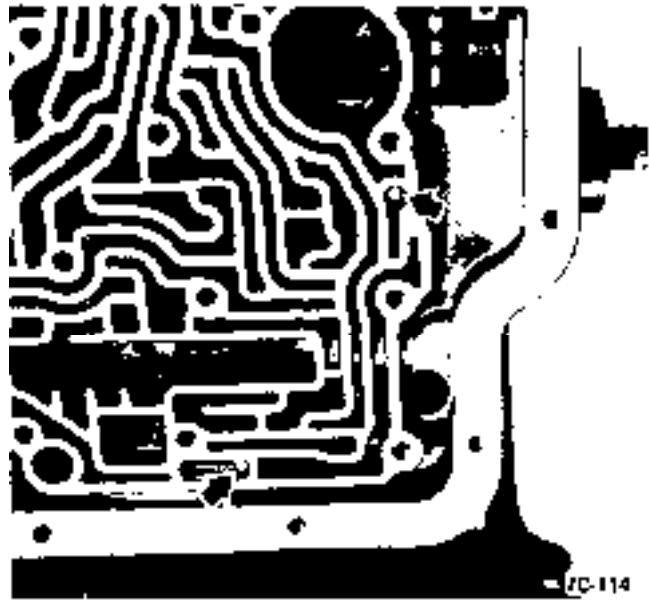


Figure 7C-114



Figure 7C-113

6. Remove the two check balls located in the oil passages in the transmission case. See Figure 7C-114. Location of these check balls must be noted so that they are installed correctly.

**Removal of Servo Piston**

This operation can be performed with transmission in vehicle

1. Compress servo piston using servo piston compressor tool J-23075.

2. Using pliers, remove servo piston snap ring. See Figure 7C-115.

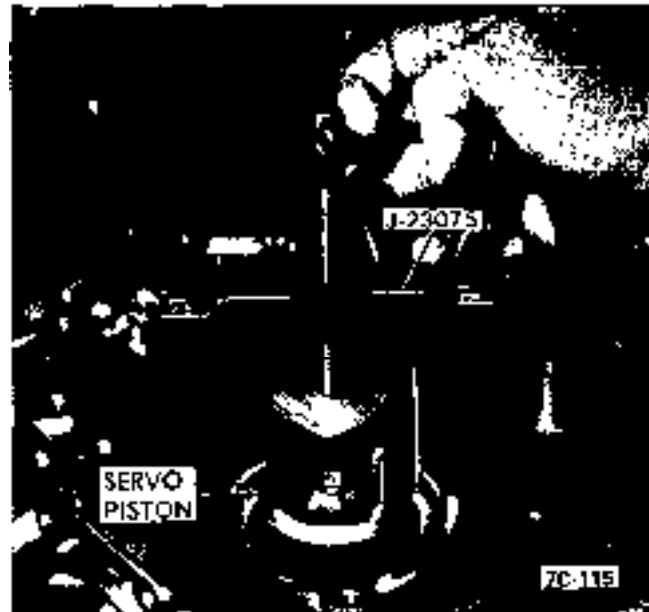


Figure 7C-115

3. Loosen servo piston compressor tool J-23075 slowly as servo is under high spring tension. Remove tool and servo piston assembly. See Figure 7C-116.

**Removal of Selector Lever and Shaft**

Note at this point that the selector lever (on GT models only) is on the opposite side from all other models, and that the selector shaft passes through the case. See Figures 7C-117 and 7C-118. Note also

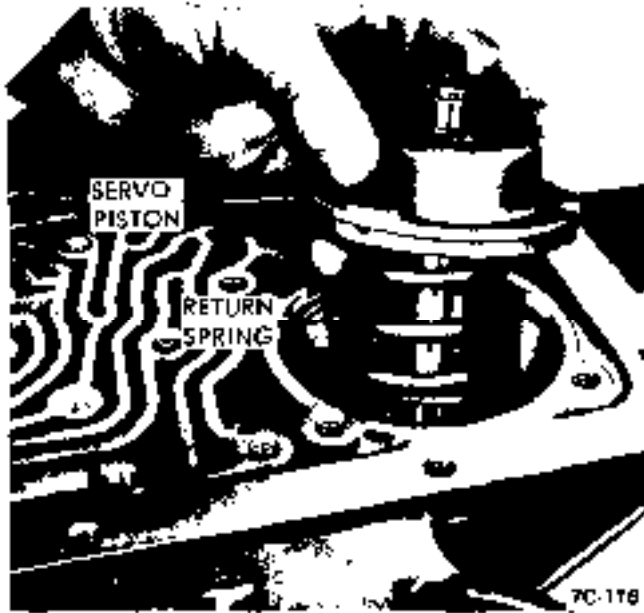


Figure 7C-116



Figure 7C-118 GT Models



Figure 7C-117 GT Models

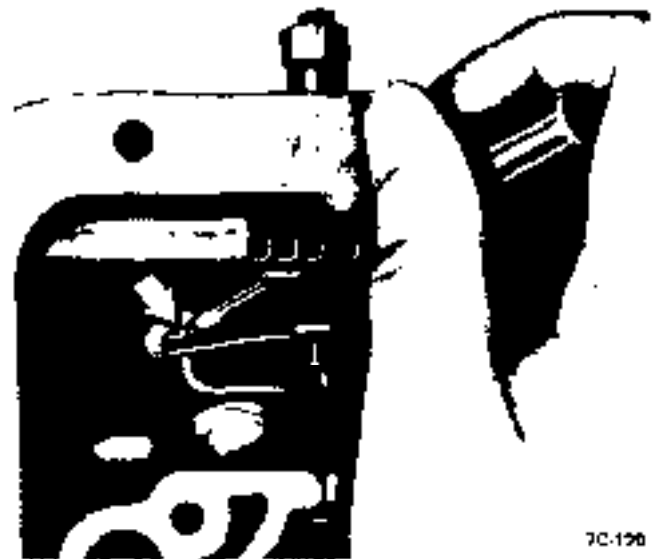


Figure 7C-119

that one case services both models and is machined to accept selector lever on either side with the unused hole being plugged.

1. Remove retaining ring From parking actuator rod to selector inner lever. See Figure 7C-119.
2. Remove selector inner lever locking nut from selector lever shaft.
3. Remove selector inner lever from selector lever shaft.
4. Remove selector lever shaft spring pin by pulling upwards with small pliers.

5. Remove selector lever shaft. See Figure 7C-120.
6. Remove selector lever shaft oil seal and discard.

#### Removal of Modulator Assembly

This operation can be performed with transmission in vehicle using tool J-23 100.

1. Remove vacuum modulator From transmission case. See Figure 7C-94. Care should be taken not to lose the modulator plunger.

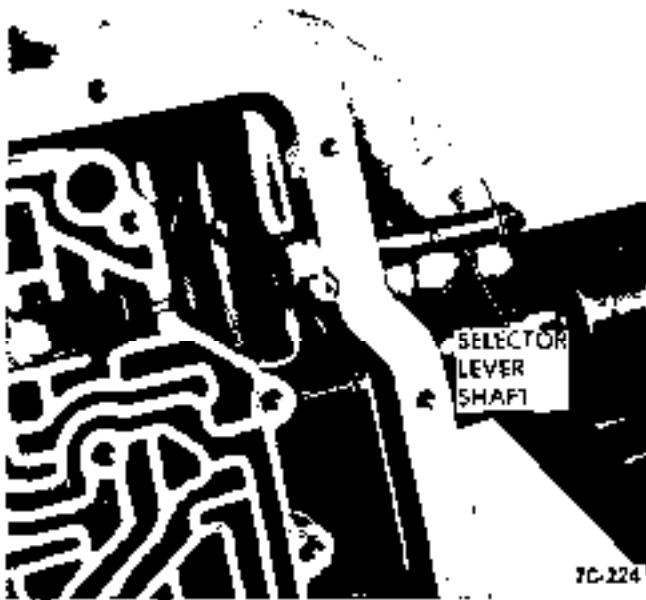


Figure 7C-120

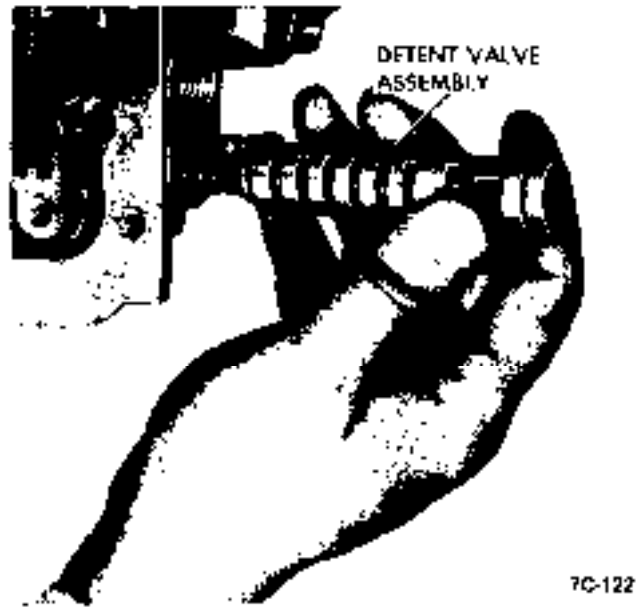


Figure 7C-122

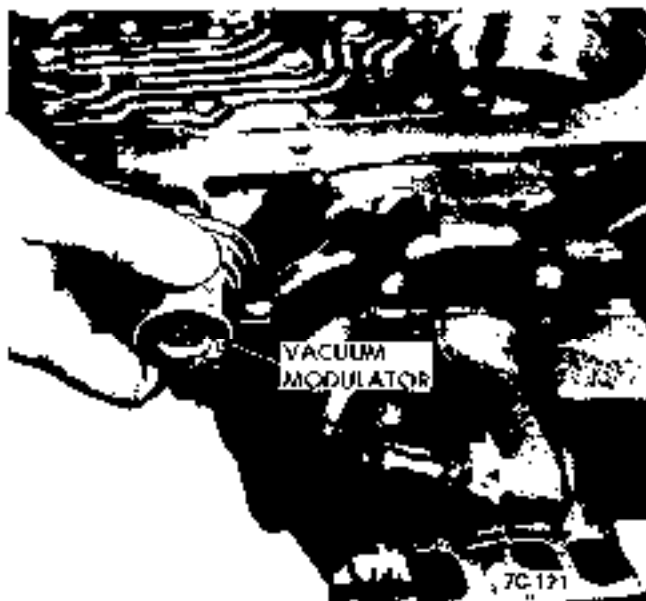


Figure 7C-121

2. Remove modulator valve and sleeve from transmission case.

#### Removal of Detent Valve Assembly

This operation can be performed with transmission in vehicle

1. Remove spring pin by pulling upward with pliers.
2. Lightly tap detent valve assembly from front of case and remove detent valve, sleeve, spring, and spring seat from rear of case. See Figure 7C-122.

#### Removal of Extension Housing

This operation can be performed with transmission in vehicle

1. Remove bolt holding speedometer driven gear housing retainer and carefully remove retainer and pull speedometer driven gear assembly from extension housing. See Figure 7C-123.



Figure 7C-123

2. Remove the seven attaching bolts from extension housing to case.

3. Remove extension housing and gasket. See Figure 7C-124.

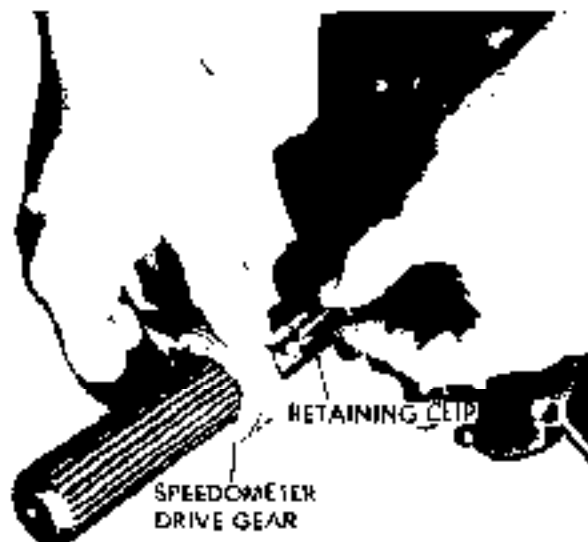


Figure 7C-124

4. Remove parking pawl actuator rod from transmission case.

**Removal of Speedometer Drive Gear, Governor Body and Governor Hub**

1. Depress speedometer drive gear retaining clip and remove speedometer drive gear by sliding off output shaft. See Figure 7C-125.



7C-125

Figure 7C-125

2. Remove the four (4) attaching bolts from the governor body and remove governor and gasket. See Figure 7C-126.

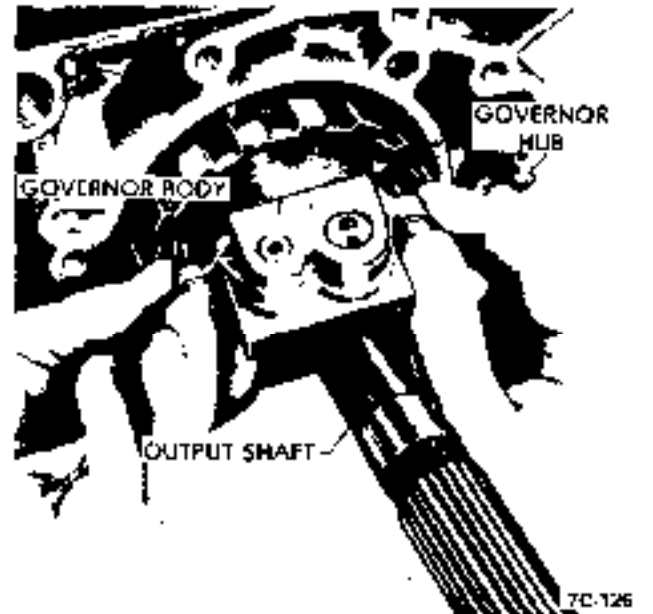


Figure 7C-126

3. Remove governor hub snap ring from output shaft using snap ring pliers, such as J-8059. See Figure 7C-128.

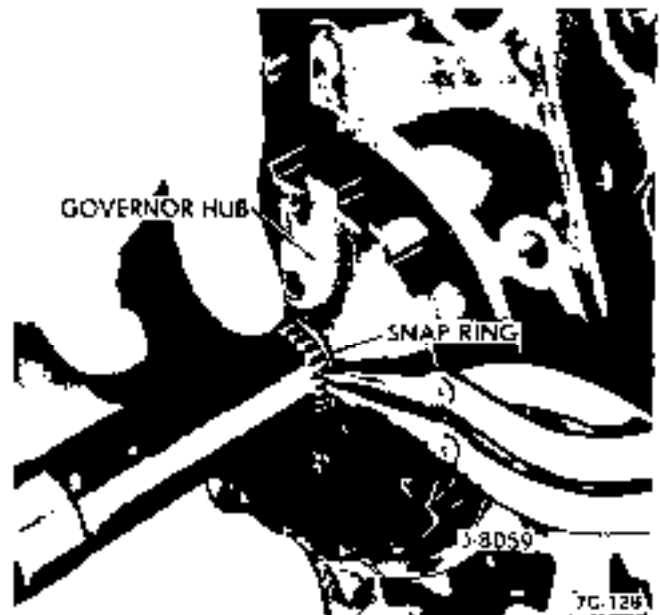


Figure 7C-128

4. Slide governor hub off the output shaft

**Removal of Converter Housing, Oil Pump, Reverse and Second Clutch Assembly**

1. Turn transmission in holding fixture so that converter housing is facing up.
2. Remove the seven converter housing attaching



bolts which are the outer bolts in the housing. See Figure 7C-129.

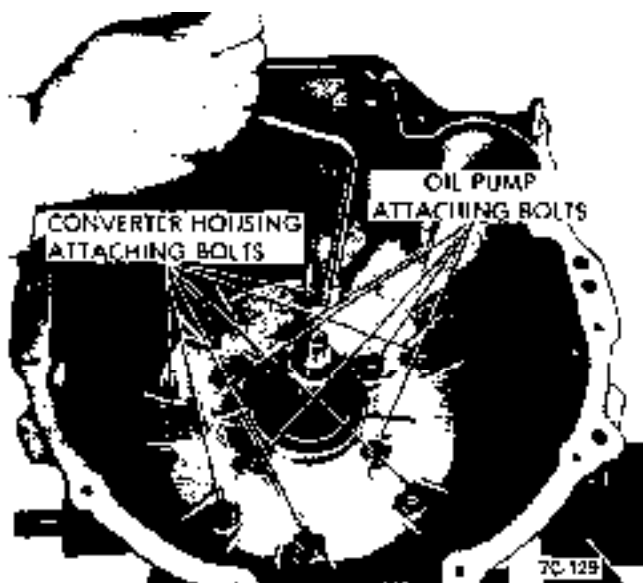


Figure 7C-129

3. Remove **converter** housing with oil pump, reverse and second clutch assemblies. Do not lose selective thrust washer. See Figure 7C-130. Second clutch assembly may remain in case. If so, remove with reverse clutch plates.

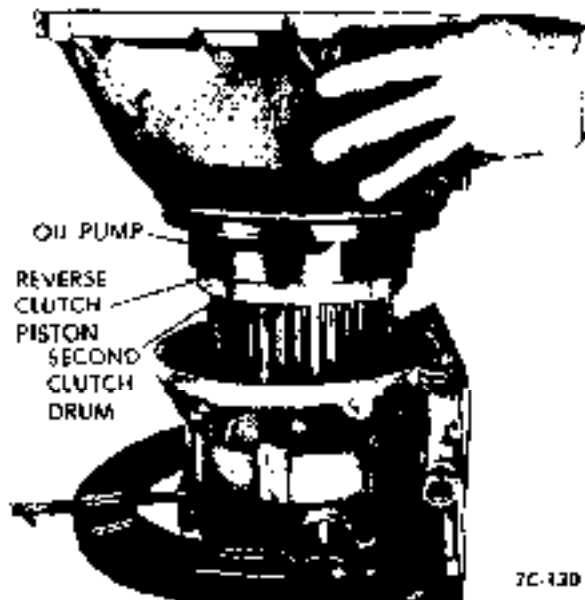


Figure 7C-130

4. Remove reverse clutch plates from transmission case, See Figure 7C-131.

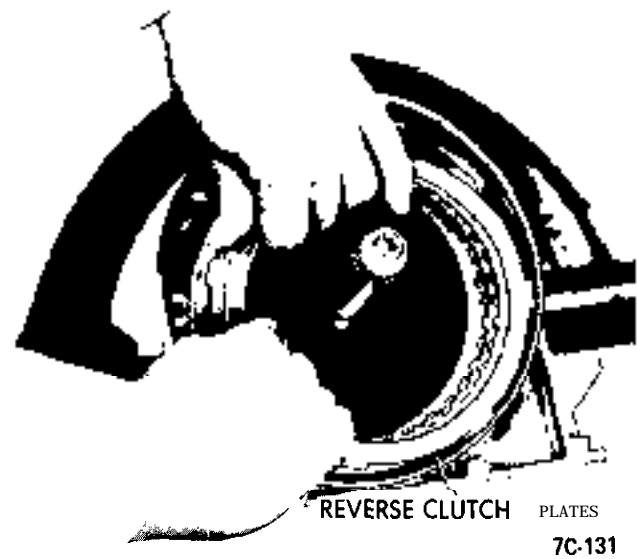


Figure 7C-131

Removal of Third Clutch Assembly. Planetary Carrier Assembly, Reaction Sun Gear and Drum Assembly and Low Band

1. Remove third clutch assembly. See Figure 7C-132.

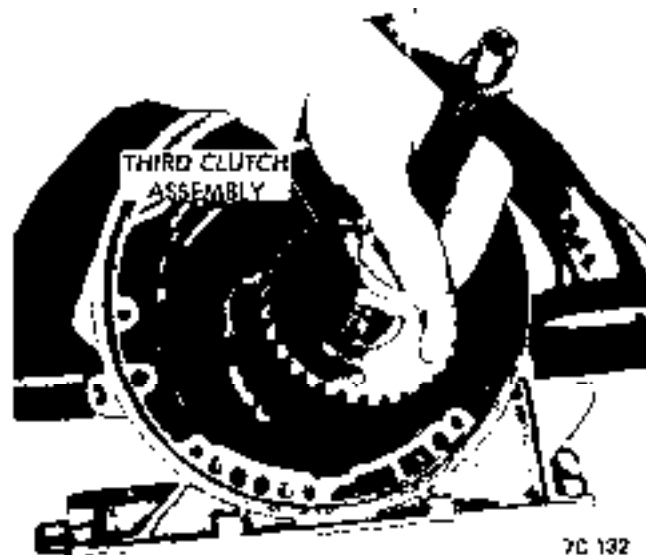


Figure 7C-132

2. Remove planetary carrier and output shaft by sliding out through front of case. See Figure 7C-133. Care should be taken not to lose the needle thrust bearing and race in the planetary carrier assembly.

3. Remove reaction sun gear and drum with needle

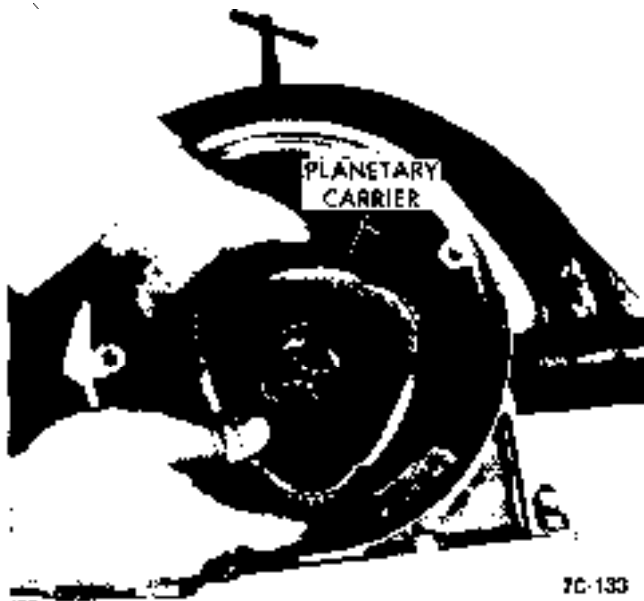


Figure 7C-133

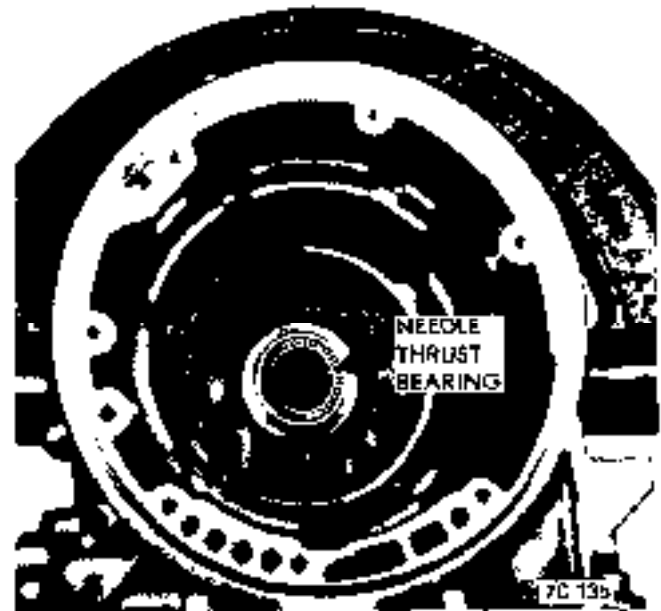


Figure 7C-135

thrust bearing and race from case by pulling straight out. See Figure 7C-134.

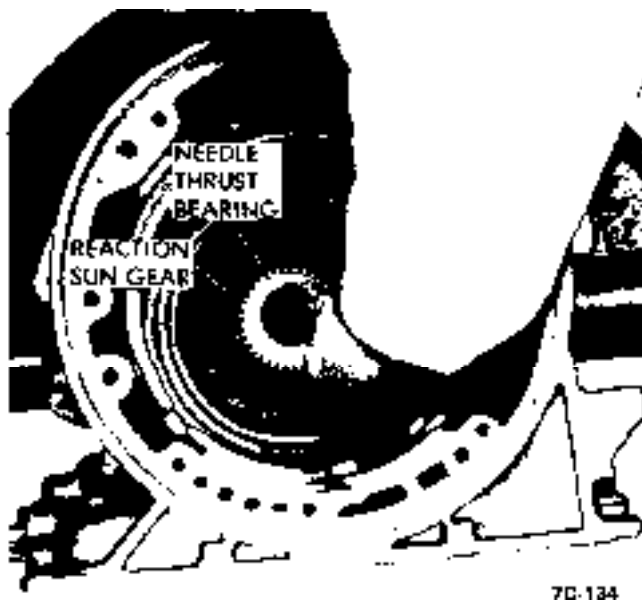


Figure 7C-134

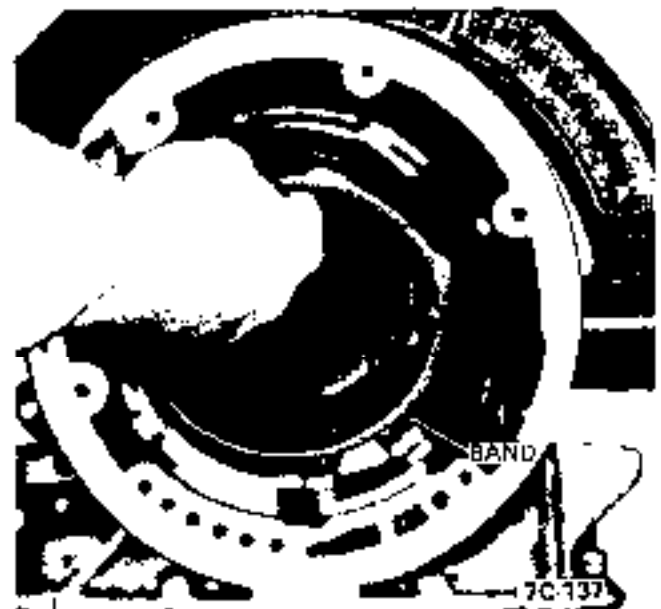


Figure 7C-137

4. Remove needle thrust bearing and race from rear of case. See Figure 7C-135.

6. If necessary to remove case vent, install new case vent. Do not attempt to reinstall old vent.

5. Remove low band by slightly compressing band and pulling straight out. See Figure 7C-137.

#### Disassembly, Inspection and Reassembly of Converter Housing, Oil Pump and Reverse Clutch

1. Remove second clutch assembly from oil pump shaft. See Figure 7C-138.



Figure 7C-138

2. Remove selective washer from oil pump shaft. See Figure 7C-138.
3. Remove the oil pump outer oil seal and discard. See Figure 7C-139.

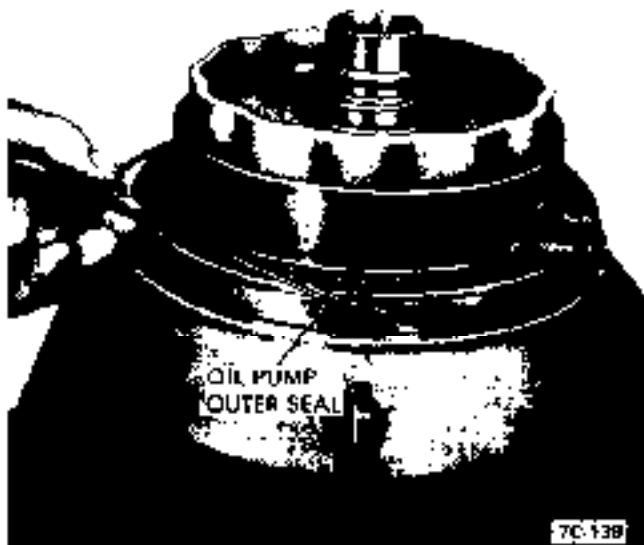


Figure 7C-139

4. Remove the five bolts holding the converter housing to the oil pump.
5. Remove the converter housing. See Figure 7C-140.
6. Remove oil pump wear plate "A". See Figure 7C-140.

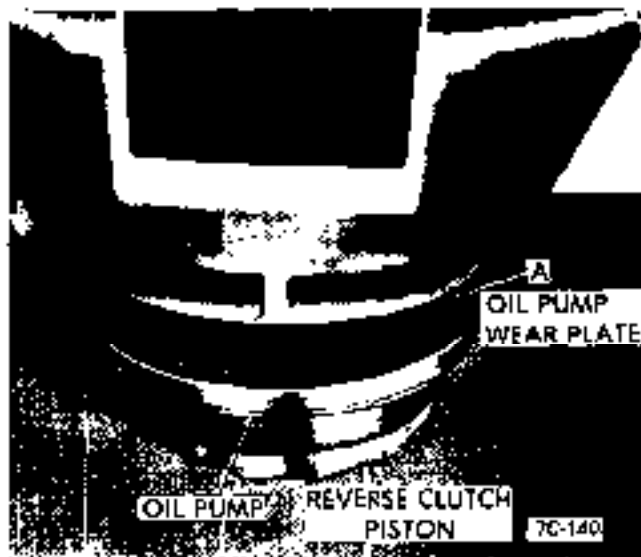


Figure 7C-140

7. Inspect front face of converter housing for oil leak. See Figure 7C-141. If problem is diagnosed as a front seal leak (presence of red oil coming from bottom of converter housing), remove front oil seal.

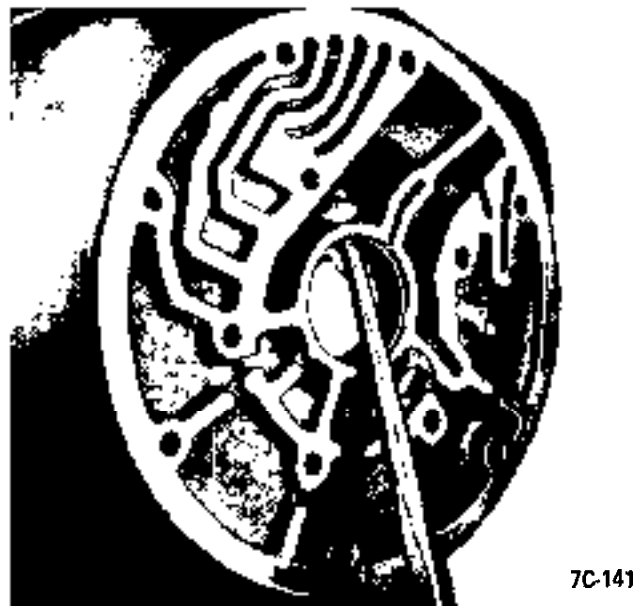
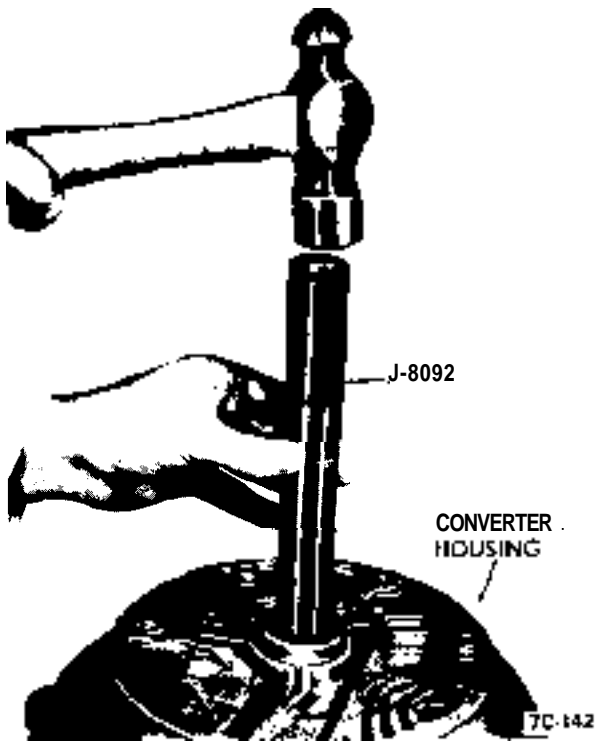


Figure 7C-141

8. Inspect converter housing bushing. If worn, remove bushing using tool J-21465-17 with drive handle J-8092 from converter **side** of housing.
9. Clean converter housing thoroughly. Install converter housing bushing flush with front face of housing using tool J-21465-17 with driver handle J-8092. See Figure 7C-142.



**Figure 7C-142**

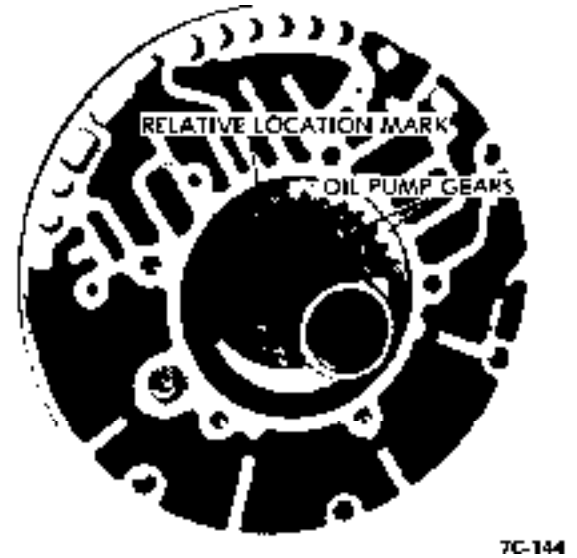
10. Install new converter housing oil seal using tool J-21359. See Figure 7C-143.



**Figure 7C-143**

11. Check converter pump hub for nicks, burrs or damage which could have caused oil seal to leak or have worn bushing. Remove nicks and burrs.

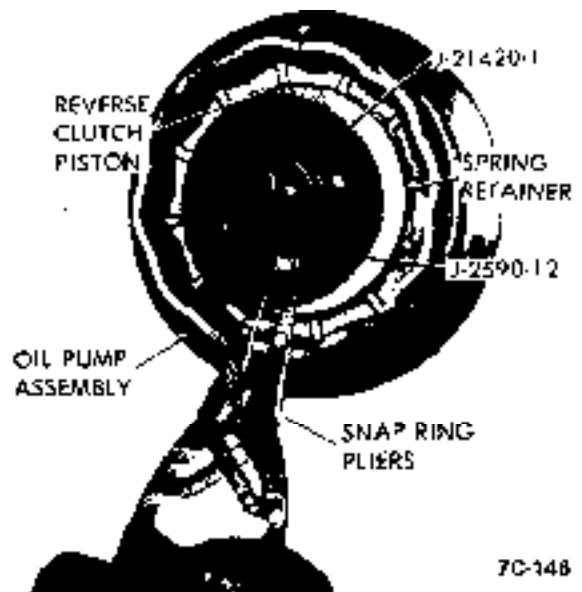
12. Mark relative location of oil pump gears and remove oil pump gears. See Figure 7C-144.



**Figure 7C-144**

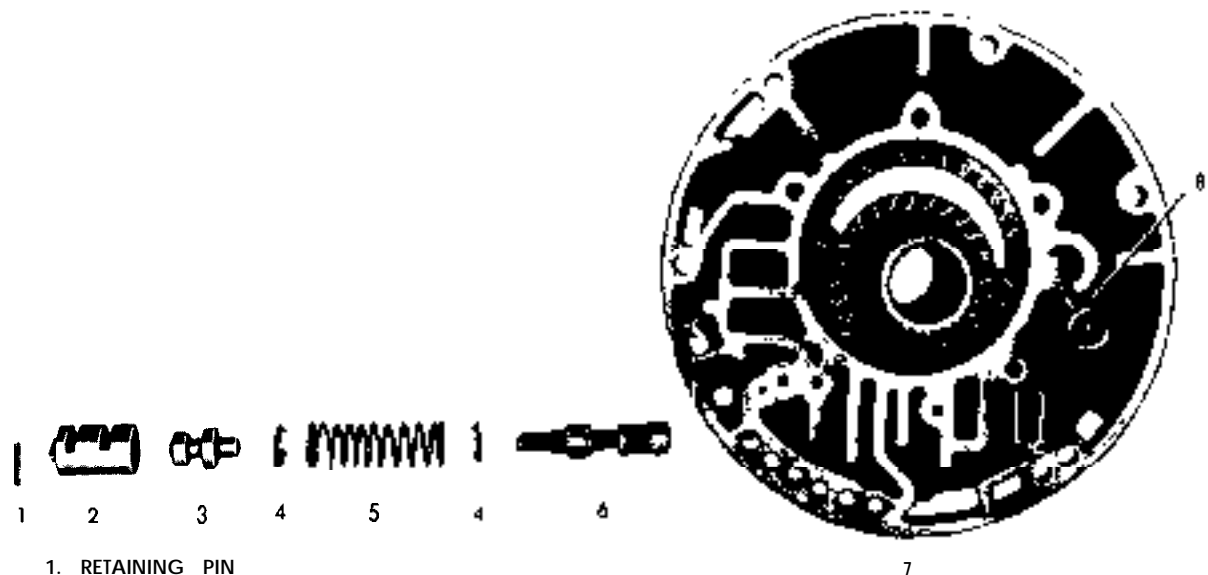
13. Using compressor tool J-2590-12 with adapter J-21420-1 on reverse clutch retaining seat, compress clutch return springs. See Figure 7C-146.

14. Remove snap ring using snap ring pliers such as J-8059. See Figure 7C-146.



**Figure 7C-146**

15. Loosen compressor tool J-2590-12 and remove reverse clutch retaining ring and 24 reverse clutch springs.



- 1. RETAINING PIN
- 2. PRESSURE REGULATOR BOOST VALVE SLEEVE
- 3. PRESSURE REGULATOR BOOST VALVE
- 4. PRESSURE REGULATOR VALVE SPRING SEAT
- 5. PRESSURE REGULATOR VALVE SPRING
- 6. PRESSURE REGULATOR VALVE
- 7. OIL PUMP BODY
- 8. OIL PUMP PRIMING VALVE, SPRING & SPRING SEAT

7C-147

16. Remove reverse clutch piston.

17. Remove priming valve from oil pump body **by** lightly tapping with a drift through the hole at the rear of oil pump. (Only if diagnosis requires removal or if excessive dirt has passed through transmission.)

18. Pressure regulator and boost valve may be removed by using a pair of wire cutters to remove the retaining pin. Due to the difficulty of removing the retaining pin, it is not recommended that the pressure regulator valve and boost valve be disassembled during overhaul, unless it was determined by oil pressure checks to have been malfunctioning prior to tear down.

19. Remove pressure regulator boost valve sleeve, spring, pressure regulator valve and two washers. See Figure 7C-147.

20. Inspect and if necessary replace the oil pump hub bushing **by** threading a 3/4" standard pipe tap such as tool J-23130-5 into bushing. See Figure 7C-148.

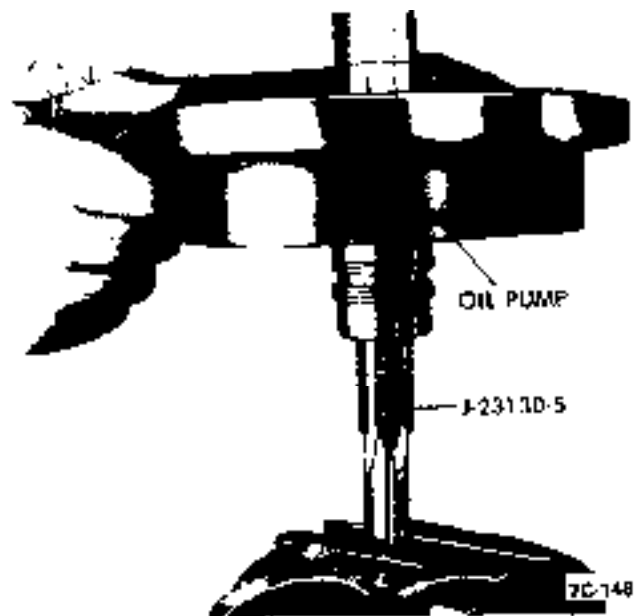


Figure 7C-148

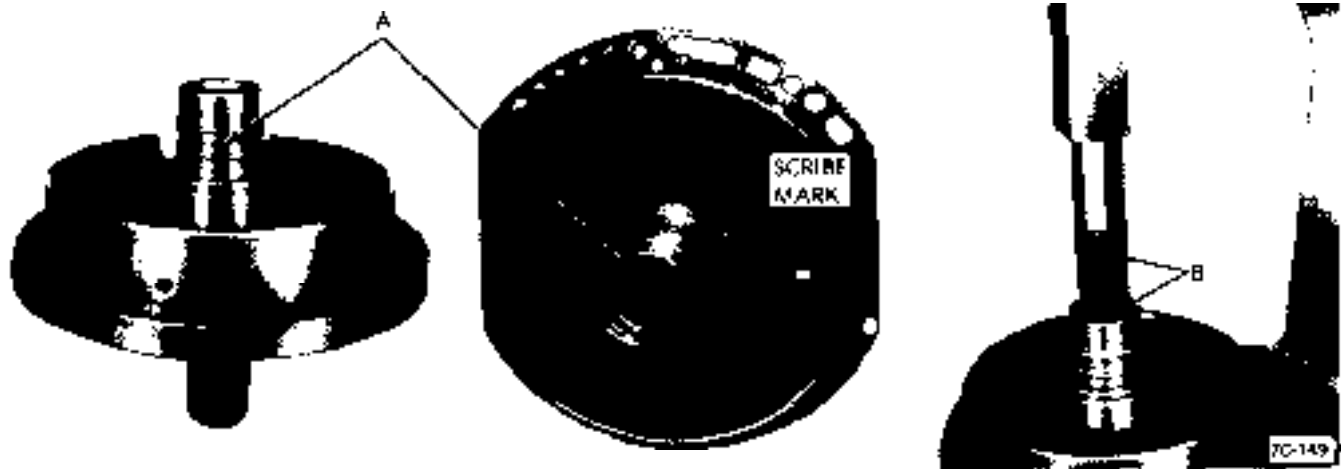


Figure 7C-149

21. Using a drift on tap, press out oil pump bushing with arbor press. Use rag or cloth to protect oil pump face.

22. Install new oil pump hub bushing with arbor press using tool J-23130-1. See Figure 7C-149. Clean pump body, including all holes and pockets thoroughly. With oil pump shaft hole "A" facing downward, scribe an aligning mark on oil pump shaft inner diameter at the center of the oil groove to the right of hole "A". Scribe mark on outer edge of bushing through the centers of the small and large drilled holes "B". Place bushing into oil pump shaft with small hole up, and align scribe marks on bushing with those made in oil pump shaft. Use arbor press to drive bushing into oil pump shaft until seated in the bore. Care must be taken so that bushing is pressed in straight, using the scribe marks as a guide until firmly seated.

23. Inspect and thoroughly clean the pressure regulator and priming valve assemblies. Immerse all valves in transmission fluid before installing in bores.

24. Install pressure regulator valve in oil pump body bore. See Figure 7C-150.

25. Install pressure regulator valve, two spring seats, spring, boost valve and sleeve in oil pump body bore.

26. Depress pressure regulator boost valve sleeve until backend lines up with pin hole and insert pin to secure.

27. Install priming valve assembly from front face of pump. Priming valve retainer should be pressed in flush with surface of oil pump body. See Figure 7C-151.

28. Inspect oil pump hub oil seal rings. Replace if damaged or side wear is noted. See Figure 7C-152.

29. Inspect reverse clutch piston for damage, Replace if necessary.

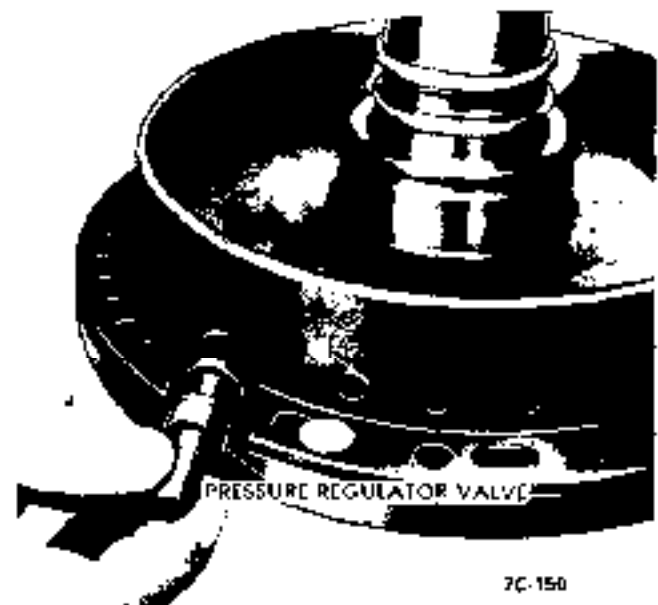


Figure 7C-150

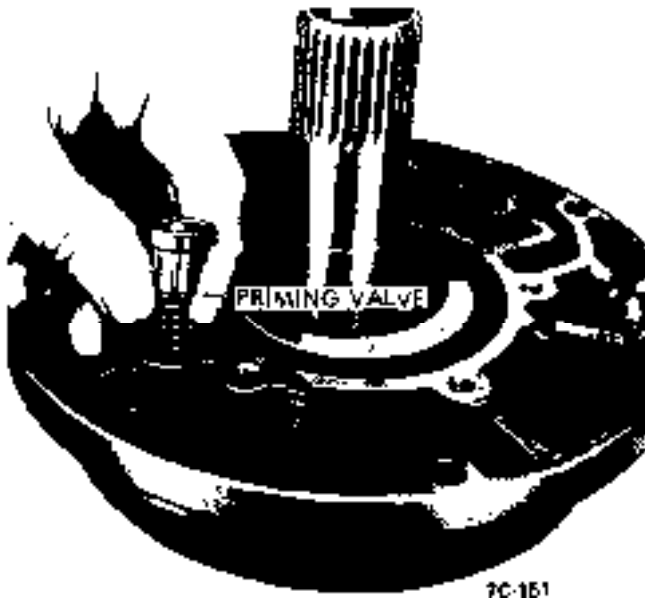


Figure 7C-151

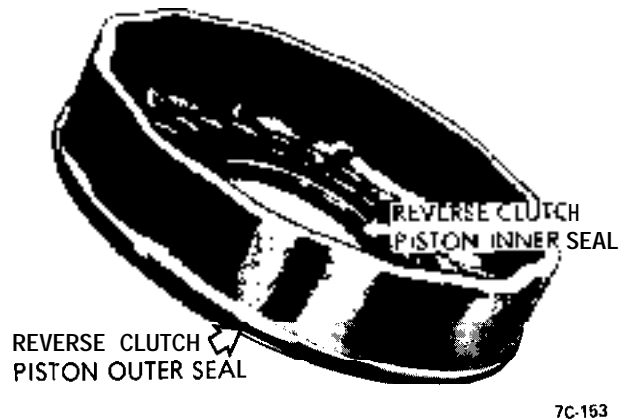


Figure 7C-153

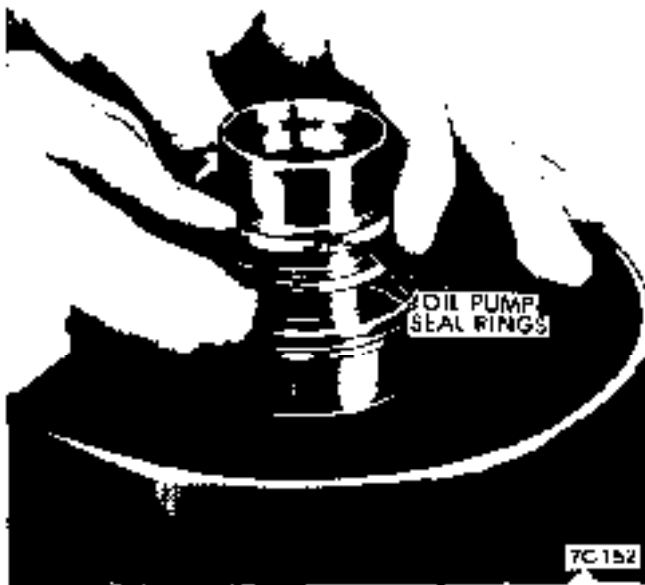


Figure 7C-152

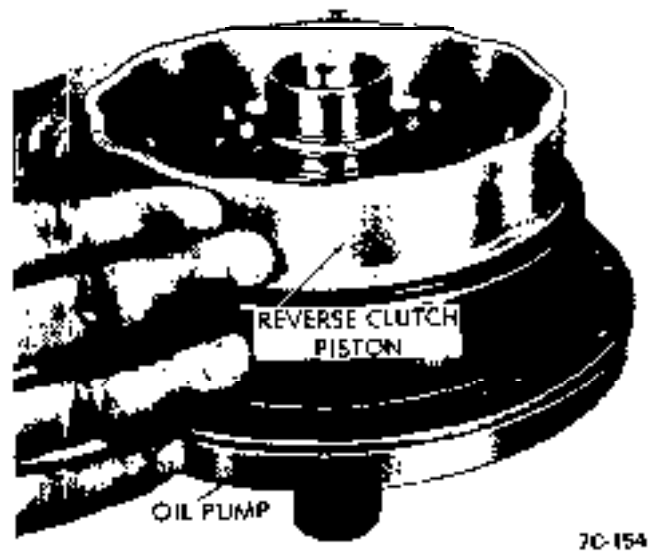


Figure 7C-154

30. Install new oil seals on reverse clutch piston. See Figure 7C-153.

31. Install reverse clutch piston onto rear face of oil pump using liberal amount of transmission fluid. See Figure 7C-154.

32. Inspect reverse clutch piston springs. Evidence of extreme heat or burning in the area of the clutch may have caused the springs to take a heat set and would justify replacement of the springs.

33. Install the twenty-four reverse clutch piston return springs.

34. Install retaining seat.

35. Compress return springs using second and reverse clutch piston spring compressor tool J-2590-12 with adapter J-21420-1. Care should be taken not to damage retainer should retainer catch in snap ring groove. See Figure 7C-155.

36. Install snap ring using snap ring pliers such as J-8059. See Figure 7C-155. Do not air check reverse clutch as the clutch is not complete and damage to the return spring retaining seat may occur.

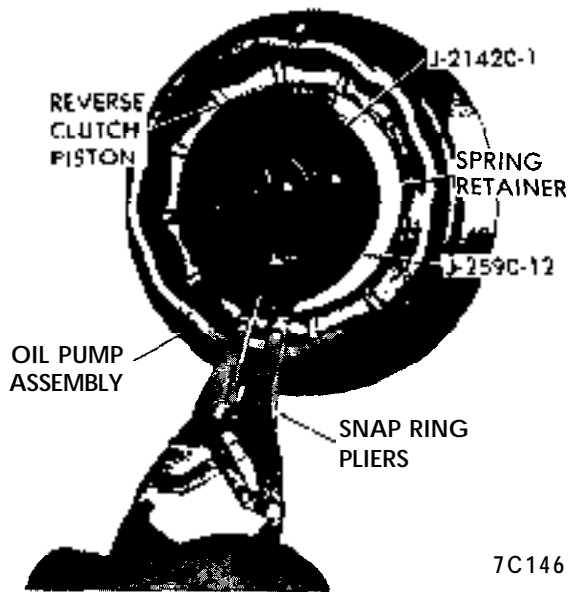


Figure 7C-155

37. Turn oil pump and reverse clutch assembly so that oil pump face is facing up.

38. Install oil pump gears using the location mark made before disassembly.

39. Check the end clearance of both gears to the oil pump face. Clearance should be between .0005 to .0035. See Figure 7C-156.

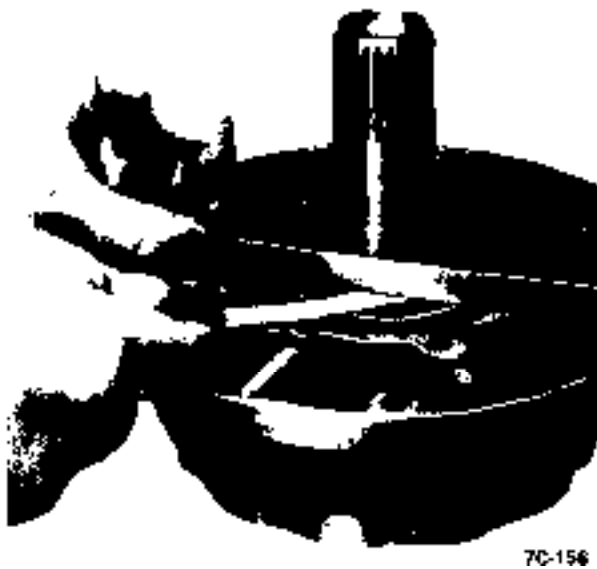


Figure 7C-156

41. Replace the oil pump assembly if the end clearance is not within specifications.

**Disassembly, Inspection and Reassembly of Second Clutch**

1. Remove ring gear retaining ring from second clutch drum. See Figure X-157.

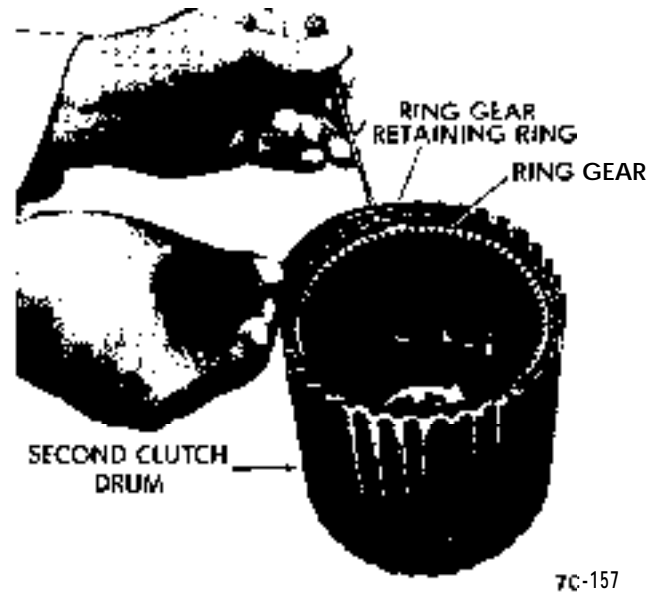


Figure 7C-157

2. Remove ring gear. See Figure 7C-158.

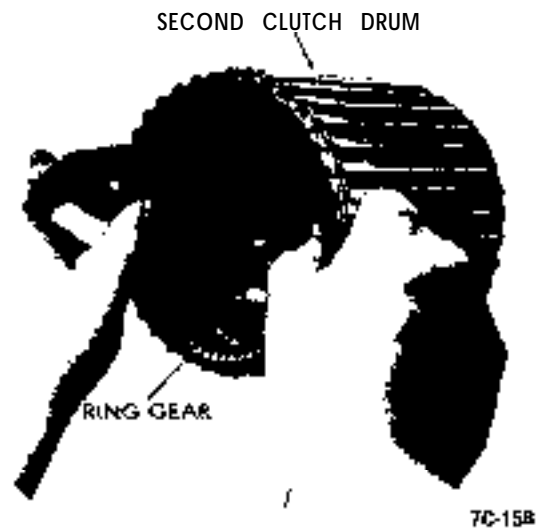


Figure 7C-158

3. Remove second clutch spacer plate retaining ring.

4. Remove second clutch spacer plate. See Figure 7C-159.



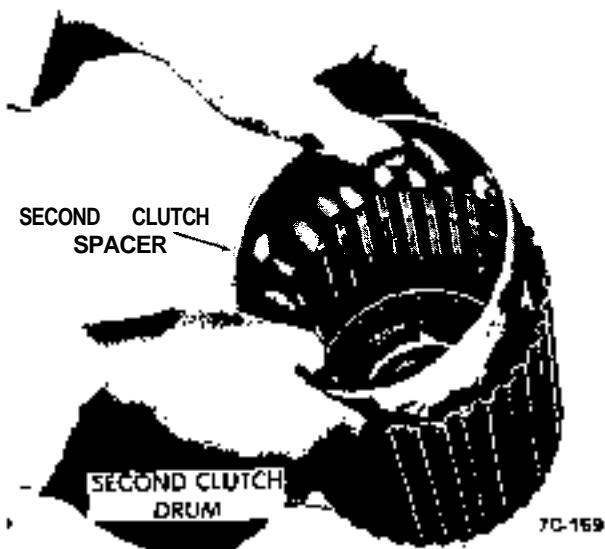


Figure 7C-159

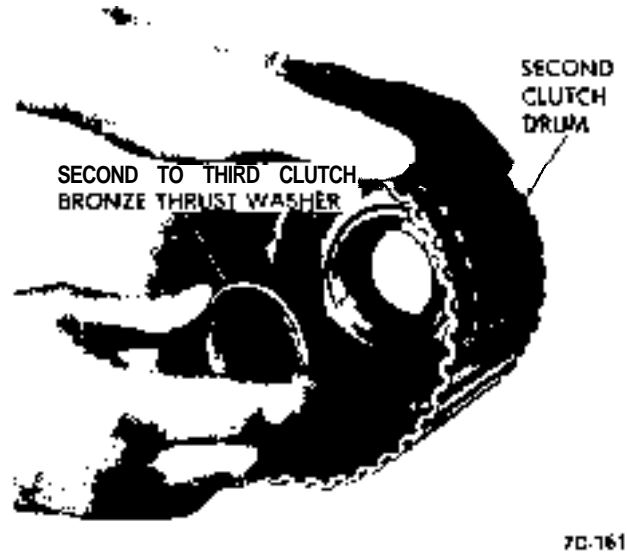


Figure 7C-161

5. Remove second clutch steel and composition plates. The plates should be kept in the same sequence as they were installed in the clutch. See Figure 7C-160.

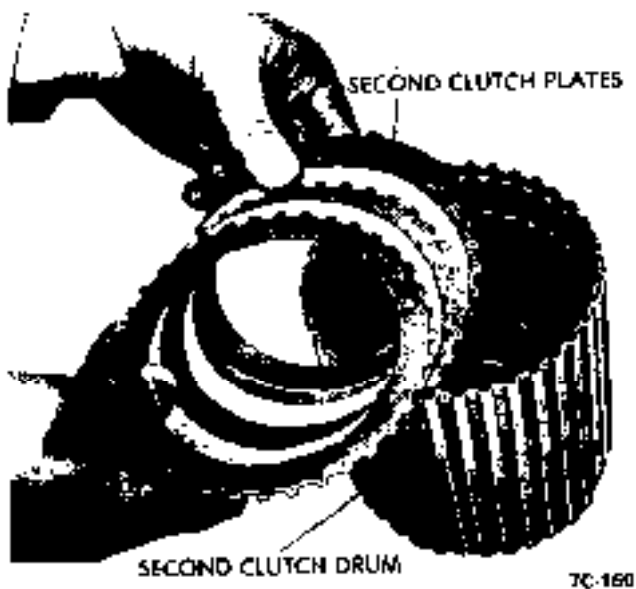


Figure 7C-160

6. Remove second clutch assembly to third clutch assembly bronze thrust washer. See Figure 7C-161.

7. Install second and reverse clutch spring compressor tool J-2590-12 with adapter J-21420-1 on second clutch piston return spring retainer and compress second clutch piston return springs.

8. Remove snap ring using snap ring pliers such as J-8059. See Figure 7C-162.

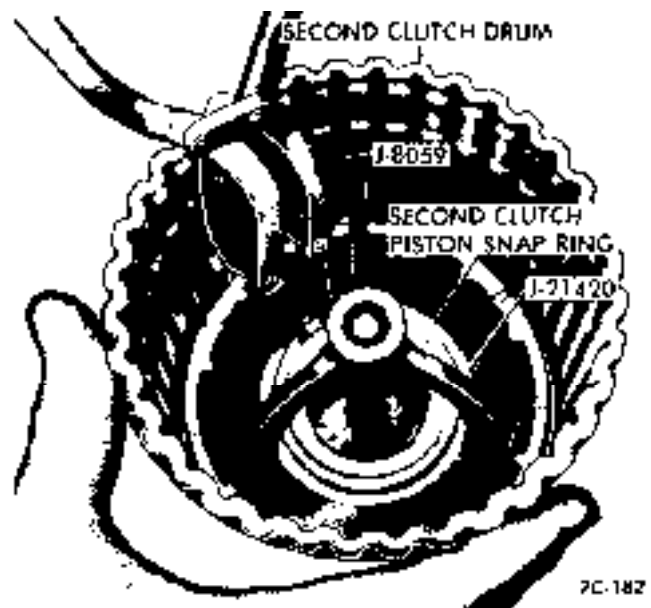


Figure 7C-162

9. Remove second clutch retaining seat and 22 return springs.

10. Remove second clutch piston.

11. Inspect second clutch piston. See Figure 7C-163. If piston is damaged or if check ball falls out upon inspection, replace piston. Install two new piston lip seals.

12. Inspect the piston return springs. Evidence of extreme heat or burning in the area of the clutch may have caused the springs to take a heat set and would justify replacement of the springs.

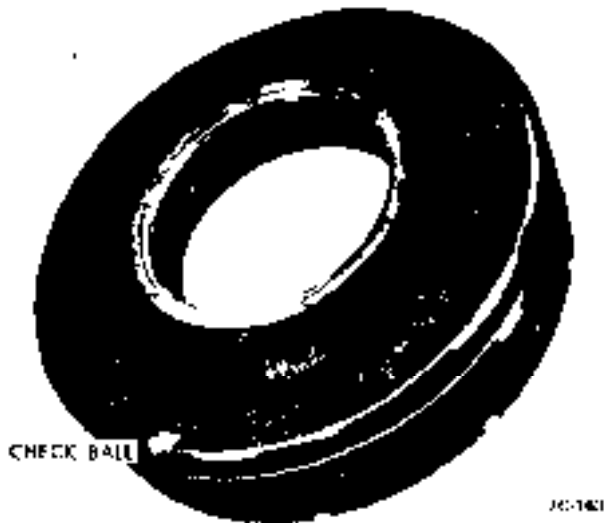


Figure 7C-163

13. Inspect second clutch hub bushing for scoring or wear.

14. If necessary, remove second clutch hub bushing using remover and installer J-23130-6 with driver handle J-8092. See Figure 7C-164.

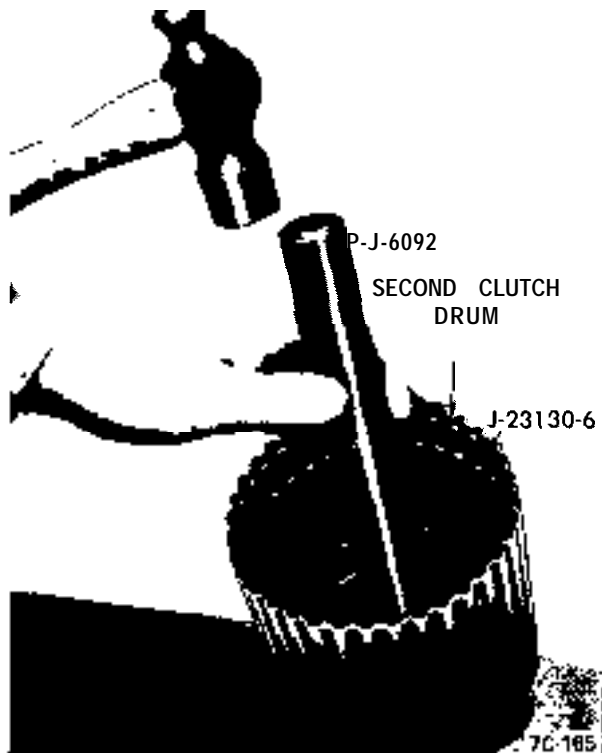


Figure 7C-164

15. Clean in solvent to remove any foreign matter. Install new second clutch hub bushing using tool J-23130-6 and driver handle J-8092. Bushing must be driven in until tool bottoms on bench. See Figure 7C-164.

16. To install second clutch piston into second clutch drum, use installer tool J-23080 so as not to damage lip seal. See Figure 7C-165. Use liberal amount of transmission fluid for ease of installation and to prevent seal damage.

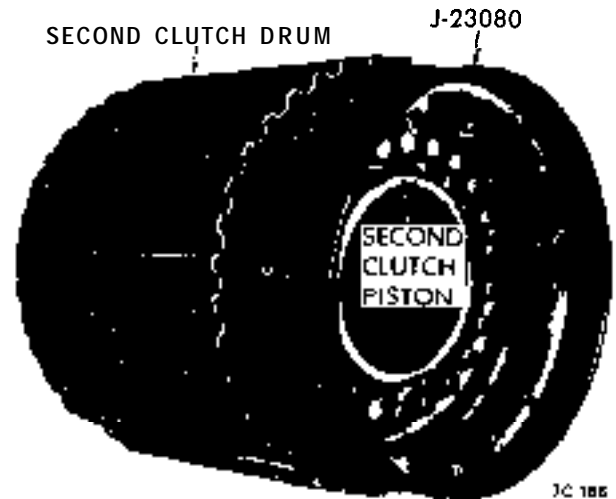


Figure 7C-165

17. Remove second clutch piston and seal installer J-23080.

18. Install 22 springs and retaining seat on second clutch piston.

19. Using spring compressor tool J-2590-12 with adapter J-21420-1 on retaining seat, compress second clutch piston return springs. Care should be taken so that retainer does not catch in snap ring groove and damage retainer.

20. Install snap ring with snap ring pliers such as J-8059.

21. Install bronze thrust washer so that the tang seats in the slot of the second clutch hub. Secure with petroleum jelly (unmedicated).

22. Inspect condition of composition and steel plates. *Do not diagnose a composition drive plate by color.*

A. Dry composition plates with compressed air and inspect the composition surface for:

1. Pitting and flaking
2. Wear
3. Glazing

- 4. Cracking
- 5. Charring
- 6. Chips or metal particles imbedded in lining

If a composition drive plates exhibits any of the above conditions, replacement is required.

B. Wipe steel plates dry and check for heat discoloration. If the surface is smooth and an even color smear is indicated, the plates should be reused. If severe heat spot discoloration or surface scuffing is indicated, the plates must be replaced.

23. Install second clutch plates into second clutch drum with cushion plate (wave washer) first, then steel plate, composition plate, steel plate, etc. Use liberal amount of transmission fluid. See Figure 7C-166.

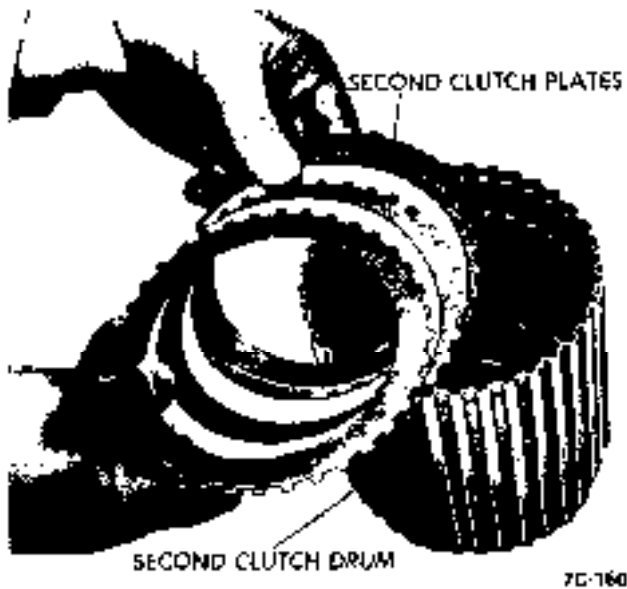


Figure 7C-166

24. Install second clutch spacer plate into second clutch drum. If necessary, expand spacer plate with screw driver until ends of spacer are evenly butted together seating tightly into drum. See Figure 7C-159.

25. Install second clutch spacer retaining ring

26. Install ring gear into second clutch drum.

27. Install ring gear retaining ring.

28. Air check second clutch assembly. See Figure 7C-167.

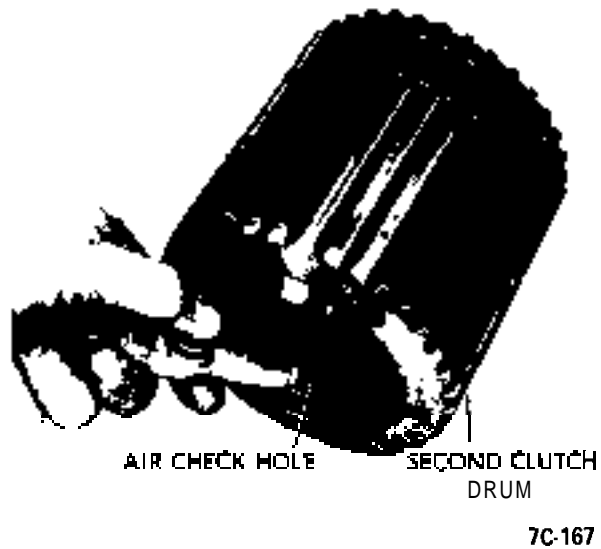


Figure 7C-167

**Disassembly, Inspection and Reassembly of Third Clutch**

1. Compress third clutch sprag race and retainer assembly retaining ring, and remove assembly from third clutch drum. See Figure 7C-168. Third clutch hub and input sun gear assembly will be removed at the same time.

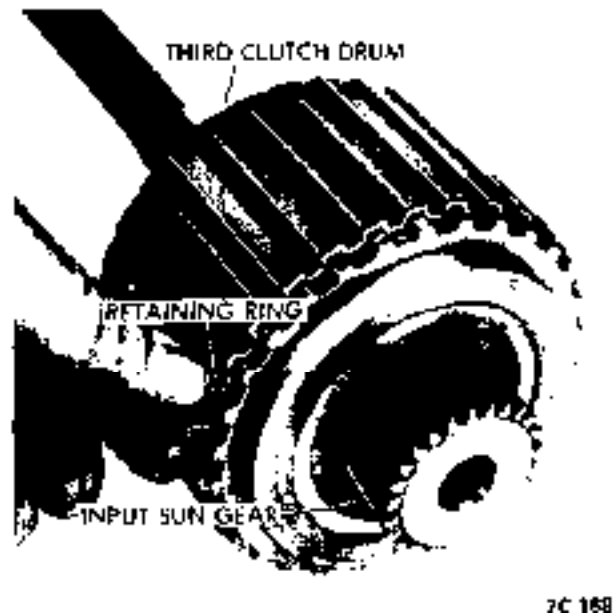


Figure 7C-168

2. Remove input sprag race and retainer assembly from third clutch hub and input sun gear assembly. See Figure 7C-169.

INPUT SPRAG RACE & RETAINER ASSEMBLY

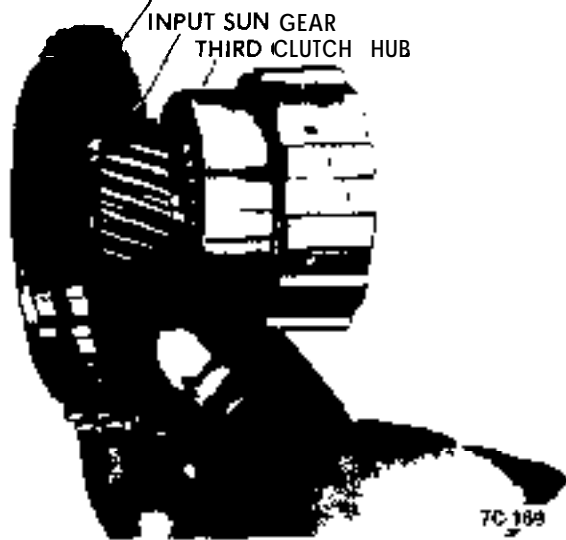


Figure 7C-169

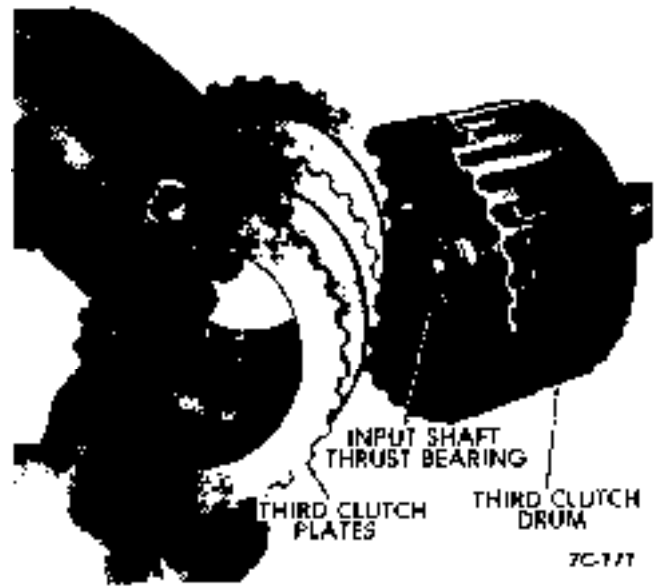


Figure 7C-171

3. Push sprag assembly and retaining rings from sprag race and retainer. See Figure 7C-170.

7. Remove snap ring using snap ring pliers such as J-8059. See Figure 7C-172.

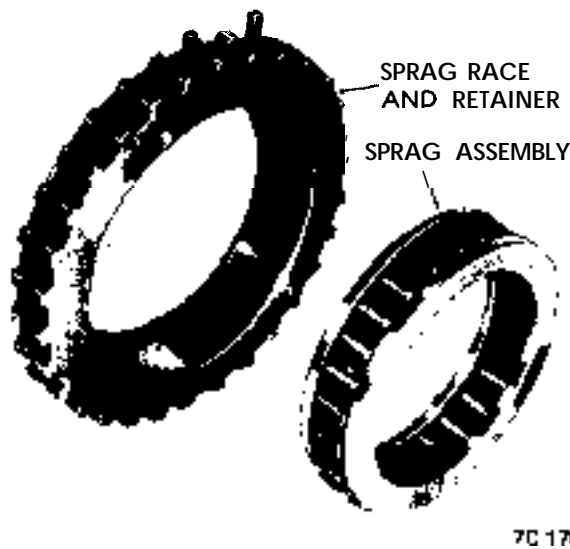


Figure 7C-170

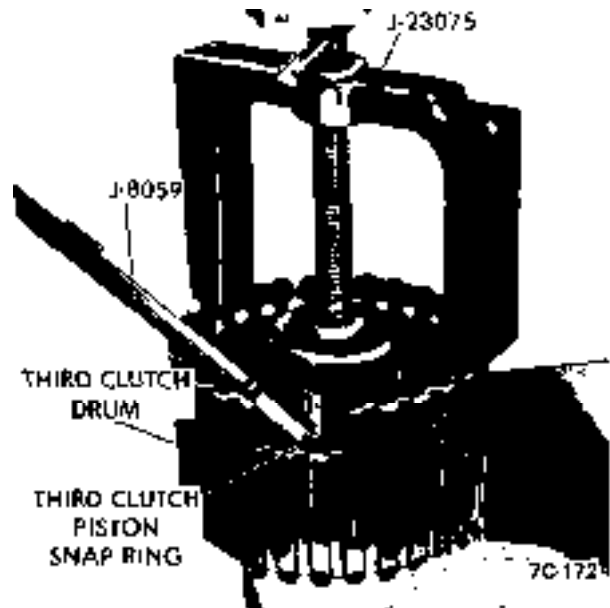


Figure 7C-172

4. Remove third clutch plates from third clutch drum. See Figure 7C-171. The plates should be kept in the same sequence as they were installed in the clutch.

8. Remove the retaining seat and 12 return springs.

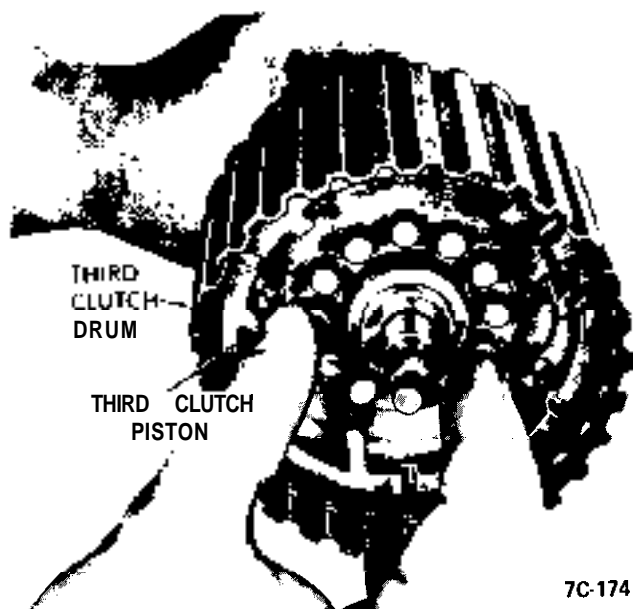
5. Remove input shaft thrust washer and needle thrust bearing. See Figure 7C-171.

9. Remove third clutch piston from third clutch drum. See Figure 7C-174.

6. Using compressor tool J-23075 on third clutch piston retaining seat, compress third clutch piston return springs using arbor press.

10. Inspect third clutch piston return springs. have caused the springs to take a heat set and would justify replacement of the springs.

11. Inspect check ball in third clutch piston. If ball is missing or falls out upon inspection or piston is



7C-174

Figure 7C-174



7C-176

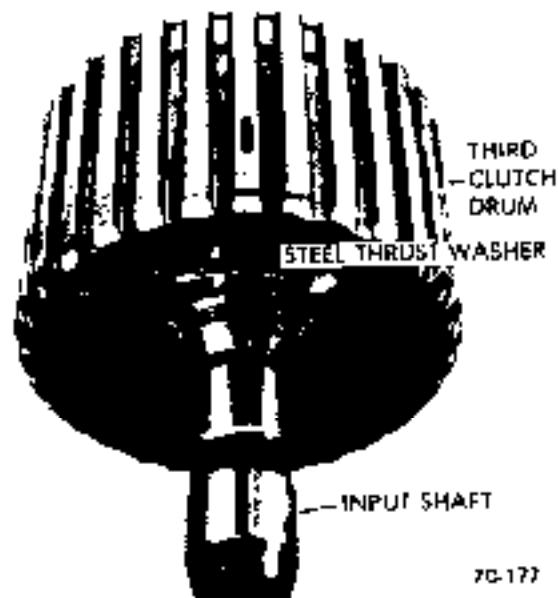
Figure 7C-176

damaged, replace piston. Install new lip seal on piston. See Figure 7C-175.



7C-175

Figure 7C-175



7C-177

Figure 7C-177

12. Install new oil lip seal on input shaft inside of third clutch drum. See Figure 7C-176.

13. Inspect steel thrust washer on front face of third clutch drum. Replace if scored or damaged. See Figure 7C-177.

14. Install third clutch piston into third clutch drum using a .020 music wire crimped into a piece of copper tubing and a liberal amount of transmission fluid

so that lip seal is not damaged upon installation. See Figure 7C-178.

15. Install the 12 third clutch piston return springs onto piston.

16. Install retaining seat.

17. Using compressor tool J-23075 on retaining seat, compress piston return springs. Care must **be** taken so that retaining seat does not catch in snap ring groove and damage retainer.

18. Install snap ring using snap ring pliers such as J-8059.

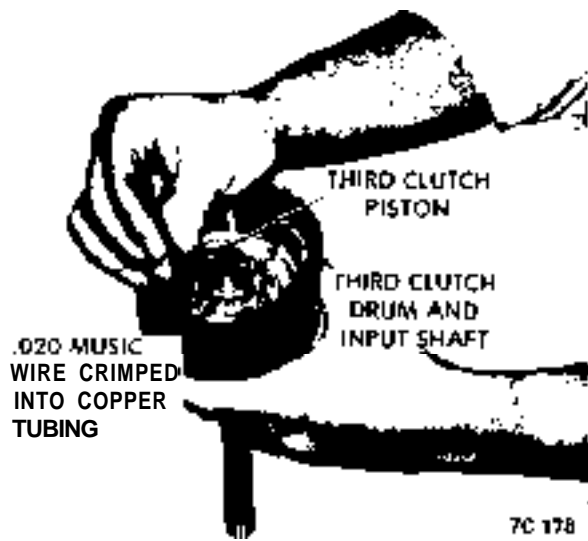


Figure 7C-178

19. Inspect condition of the third clutch composition and steel plates. **Do not diagnose a composition drive plate by color,**

A. Dry composition plates with compressed air and inspect the composition surface for:

1. Pitting and flaking
2. Wear
3. Glazing
4. Cracking
5. Charring
6. Chips or metal particles imbedded in lining

If a composition drive plate exhibits any of the above conditions, replacement is required.

B. Wipe steel plates dry and check for heat discoloration. If the surface is smooth and an even color smear is indicated, the plates should be reused. If severe heat spot discoloration or surface scuffing is indicated, the plates must be replaced.

20. Install third clutch plates into third clutch drum beginning with a steel plate, composition plate, steel plate, composition plate, etc. Use a liberal amount of transmission fluid.

21. Inspect thrust washer and needle thrust bearing for damage. Replace if necessary.

22. Install thrust washer and bearing onto input shaft. Secure with petroleum jelly (unmedicated).

23. Inspect sprag assembly for wear, damage or sprags that freely fall out of cage. Inspect input sun gear for chipped or nicked teeth or abnormal wear. Replace part if necessary.

24. Install sprag onto third clutch hub with groove on sprag cage outer diameter toward input sun gear. See Figure 7C-179.

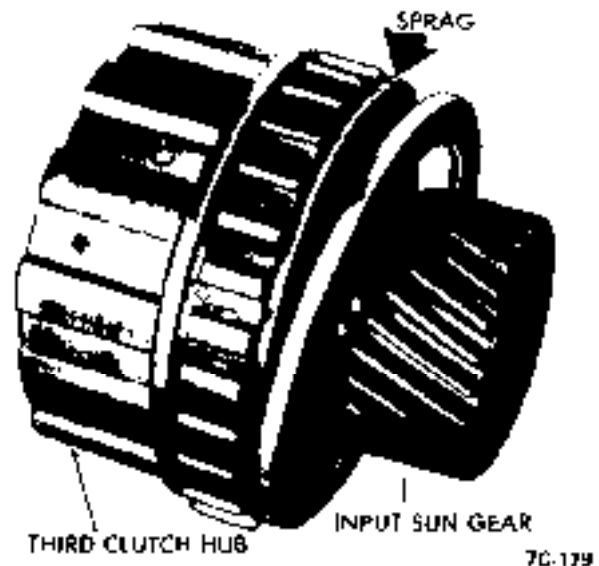


Figure 7C-179

25. Install sprag race and retainer assembly over sprag assembly. Holding input sun gear with left hand, sprag race and retainer assembly should "lock up" when turned with right hand in a clockwise direction and should rotate freely when turned counterclockwise. See Figure 7C-180.



Figure 7C-180

26. Align third clutch composition plates and install third clutch hub to index with the third clutch plate splines. Input sprag, race, and retainer assembly must also spline into third clutch drum. See Figure 7C-181.

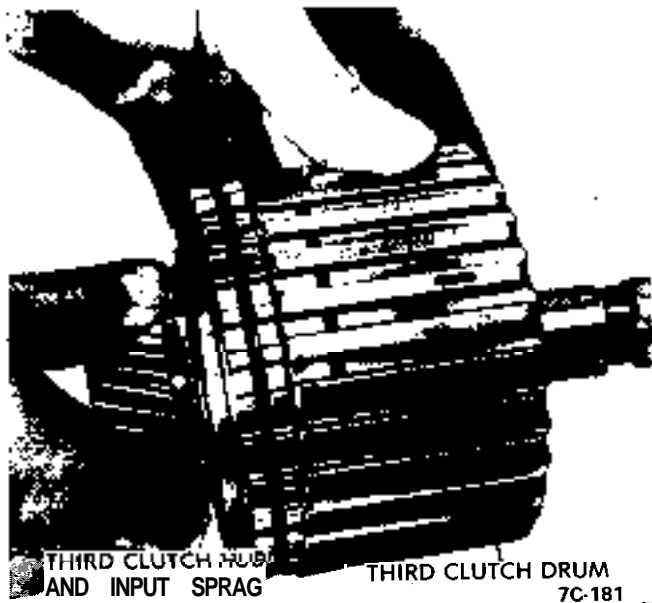
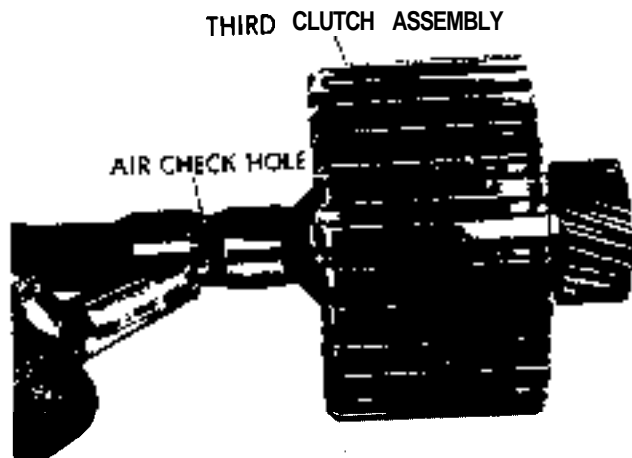


Figure 7C-181

27. Compress retaining ring and seat input sprag race assembly into third clutch drum.

28. Air check the 3rd clutch piston assembly. See Figure 7C-183.

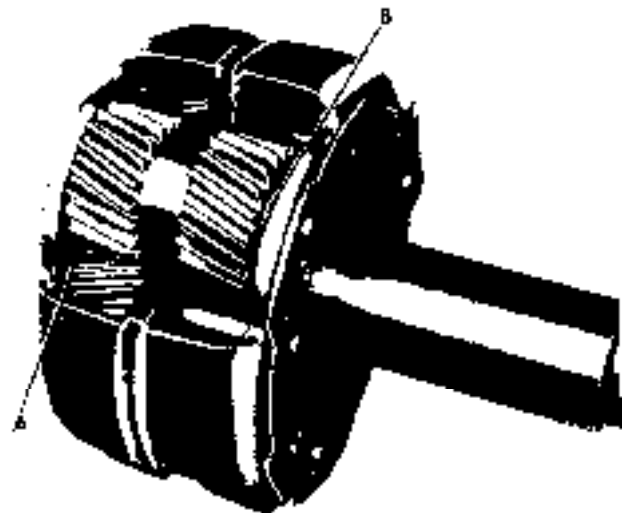


7C-183

Figure 7C-183

### Disassembly, Inspection and Reassembly of Planetary Carrier

1. Inspect the planetary carrier and output shaft for distortion or damage.
2. Inspect the planetary pinions for excessive wear or damage, such as chipped teeth.
3. Check the end clearance of all planetary pinions with feeler gauge at points "A" "B". Clearance should be between .005" and .035". See Figure 7C-184.



7C-184

Figure 7C-184

4. Replace entire assembly if damage or excessive wear is noted.
5. Tighten planetary carrier lock plate retaining screws to 20-35 lbs. in.

### Disassembly, Inspection and Reassembly of Reaction Sun Gear and Drum

1. Inspect reaction sun gear for chipped or nicked teeth and inspect sun gear for scoring. If necessary, replace entire assembly.
2. Inspect reaction sun gear, drum, and bushing.
3. If necessary to replace bushing, use a chisel such as tool J-8400-1. Remove bushing from sun gear drum at bushing joint. See Figure 7C-185.
4. Thoroughly clean drum. Install new bushing using installer tool J-23130-2 with driver handle J- 8092. Bushing should be installed flush with rear face of sun gear drum hub. See Figure 7C-186.

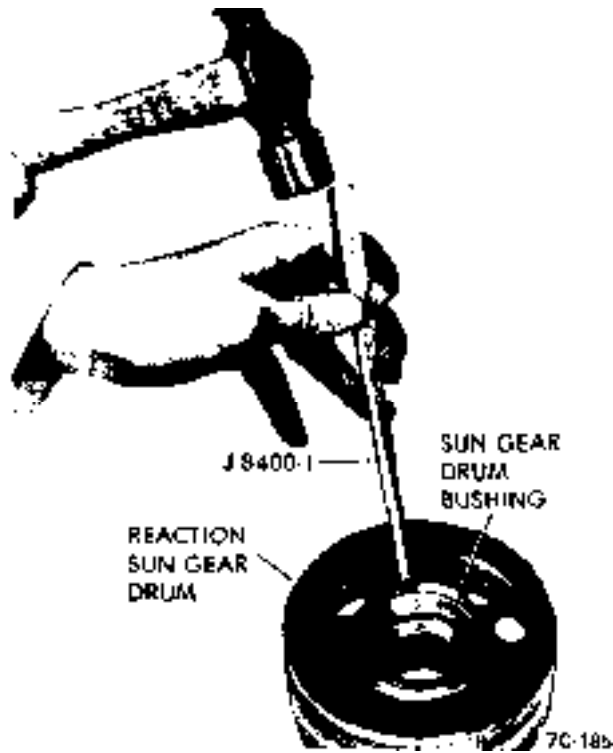


Figure 7C-185

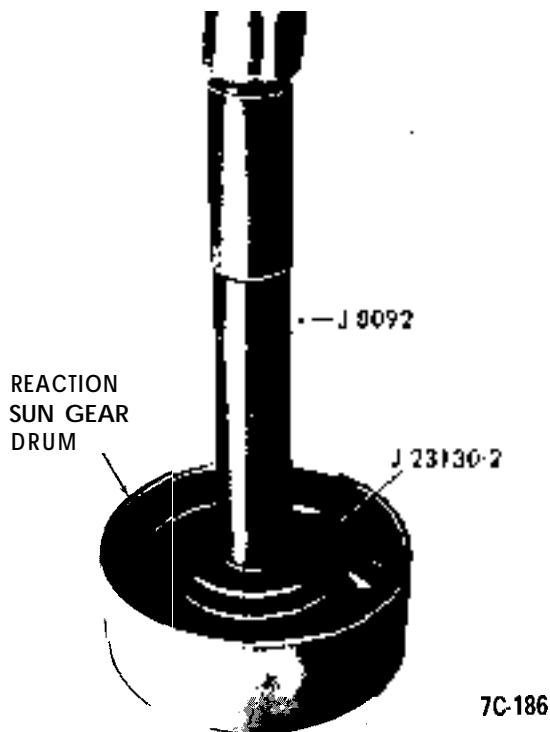


Figure 7C-186

Disassembly, Inspection and Reassembly of Governor Body

1. Depress secondary valve spring with small screw

driver and remove secondary valve spring retainer. See Figure 7C-187.

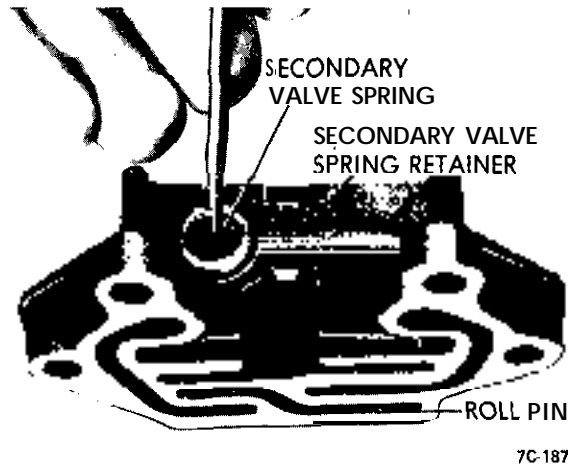
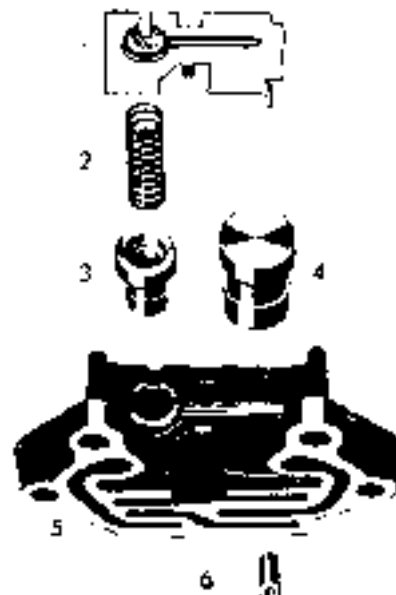


Figure 7C-187

2. Remove secondary valve spring, secondary valve, primary valve, and roll pin from governor body. See Figure 7C-188.



1. GOVERNOR SECONDARY VALVE SPRING RETAINER
2. GOVERNOR SECONDARY VALVE SPRING
3. GOVERNOR SECONDARY VALVE
4. GOVERNOR PRIMARY VALVE
5. GOVERNOR BODY
6. ROLL PIN

7C-188

Figure 7C-188 Governor Body Exploded View

3. Inspect the primary and secondary valve for nicks, burrs, etc. If necessary, use crocus cloth to remove small burrs. Do not remove the sharp edges of the valve since these edges perform a cleaning action with the valve bore.



4. Inspect the secondary valve spring for distortion or breakage.
5. Clean in solvent, air clean, and blow out all oil passages. Inspect all oil passages, valve bores for nicks, burrs or varnish in governor body. Replace if necessary.
6. Install roll pin flush to .010" below the front face.
7. Install primary valve in governor placing the small portion of the valve in **first**. Use liberal amount of transmission fluid. There is no spring for the primary valve.
8. Install secondary valve with small spool portion of valve in **first**.
9. Install secondary valve spring.
10. Depress secondary valve spring with small screw driver and install retainer.

**Disassembly, Inspection and Reassembly of Governor Hub**

1. Inspect the three oil seal rings. See Figure 7C-189.



Figure 7C-189

2. Remove governor hub oil screen. Inspect screen and clean with solvent and air dry. Replace if necessary. See Figure 7C-191.
3. Install oil screen flush to governor hub.
4. Inspect governor hub splines for cracks or chipped teeth in splines. Replace governor hub if required.

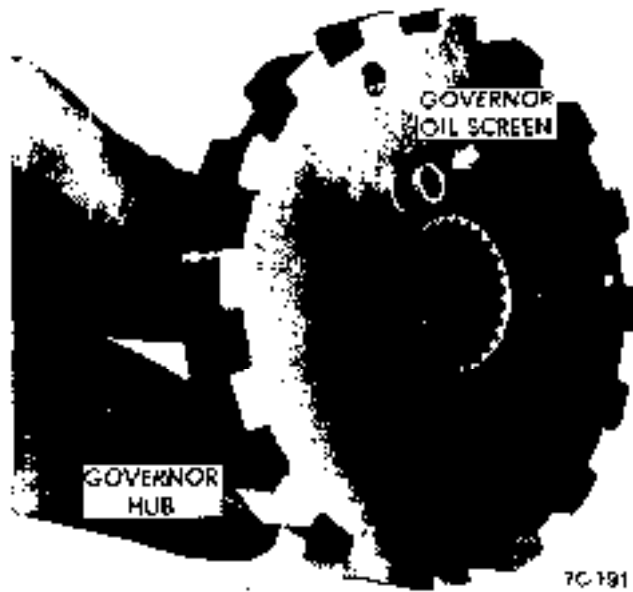


Figure 7C-191

**Disassembly, Inspection and Reassembly of Extension Housing**

1. Inspect extension housing for damage. Replace housing if necessary.
2. Inspect parking pawl and spring for damage. Replace if necessary.
3. If lubricant **leakage was noted** prior to removal of U-Joint from extension housing, extension housing rear seal should be replaced.
4. Use screw driver to pry out extension housing seal.
5. Inspect extension housing bushing. If worn, scored or damaged, bushing can be removed with remover and installer tool J-21424-9 used with driver handle J- 8092. See Figure 7C-192.
6. Clean extension housing of dirt and foreign matter. Install new extension housing bushing using remover/installer tool J-21424-9 with driver handle J- 8092. Bushing must be installed flush to shoulder of extension housing. See Figure 7C-192.
7. Install new extension housing seal using installer tool J-21426. See Figure 7C-193.

**Disassembly, Inspection and Reassembly of Servo Piston**

1. Remove servo piston apply rod
2. Holding servo piston sleeve at flat portion of sleeve with wrench, loosen the adjusting bolt lock nut and remove. See Figure 7C-194.

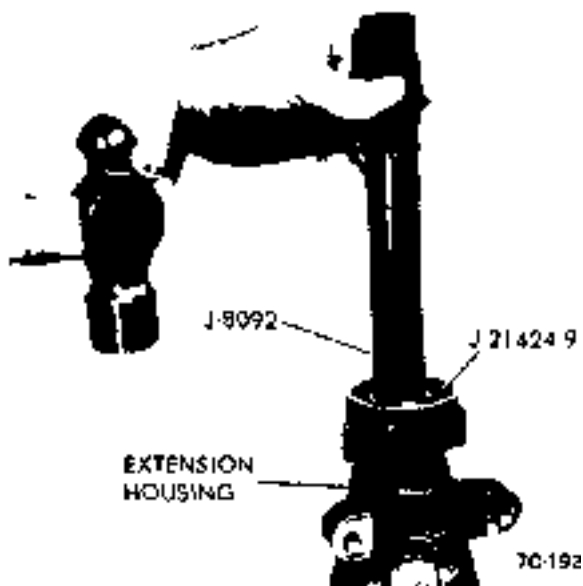


Fig 7C-192

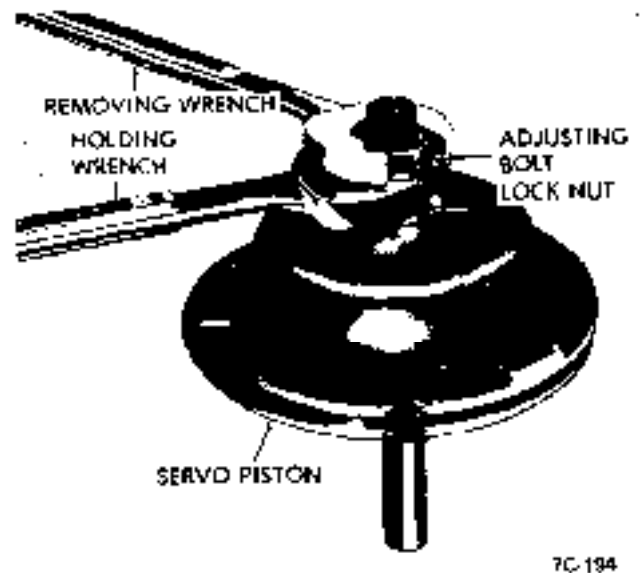


Figure 7C-194

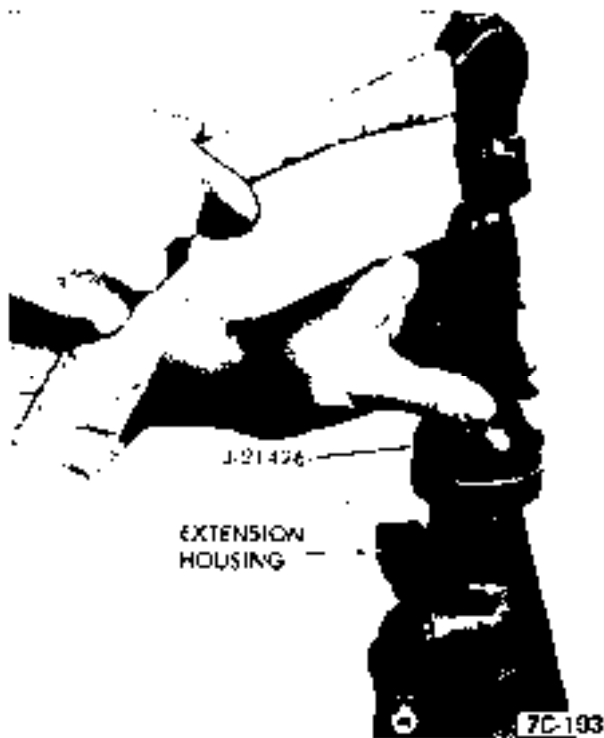


Figure 7C-193

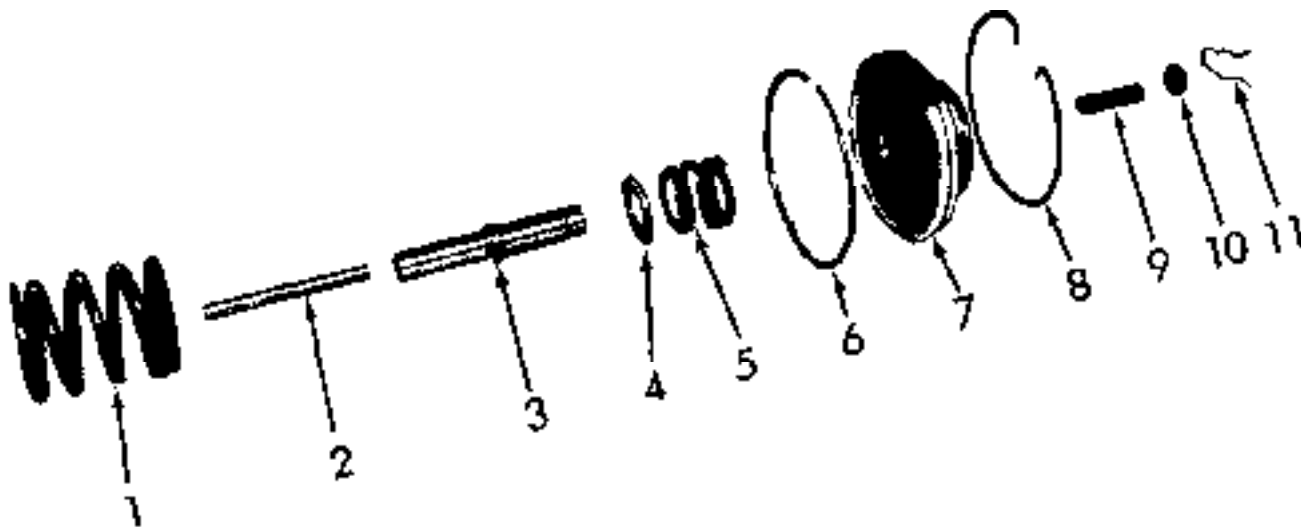
3. Depress servo piston sleeve and remove piston sleeve retaining ring.
4. Push sleeve through piston and remove cushion spring and spring retainer.
5. Remove servo piston ring

6. Inspect cushion spring, adjusting bolt, and piston sleeve for damage. Inspect piston for damage and piston ring for side wear, replace if necessary.

7. Reassemble servo piston, reversing disassembly procedure.

#### Disassembly, Inspection and Reassembly of Valve Body

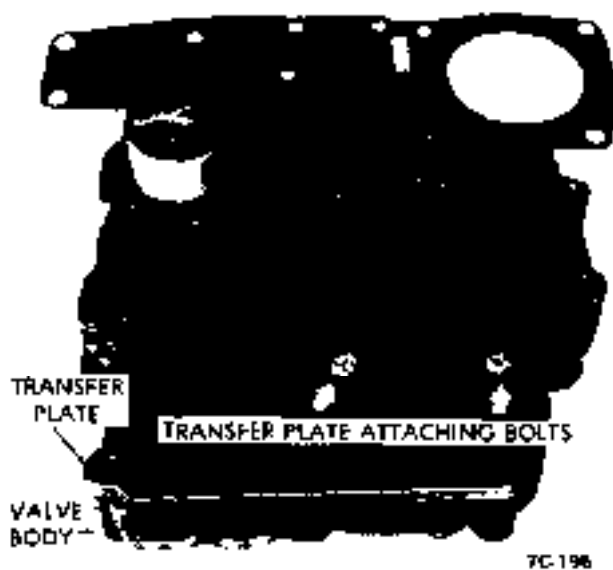
1. Remove the manual valve and manual valve link from the valve body.
2. Turn the valve body so that the transfer plate is facing upward and remove the two bolts holding the transfer plate to the valve body. See Figure 7C-196.
3. Remove transfer plate and gasket.
4. Using small C-clamp on valve body, compress accumulator piston.
5. Remove the accumulator piston retaining ring with screw driver. See Figure 7C-198.
6. Carefully loosen C-clamp as accumulator piston is under spring tension.



- |                                     |                                     |
|-------------------------------------|-------------------------------------|
| 1. SERVO PISTON RETURN SPRING       | 7. SERVO PISTON                     |
| 2. SERVO PISTON APPLY ROD           | 8. SERVO PISTON RETAINING RING      |
| 3. SERVO PISTON ADJUSTING SLEEVE    | 9. SERVO PISTON ADJUSTING BOLT      |
| 4. SERVO PISTON CUSHION SPRING SEAT | 10. SERVO PISTON ADJUSTING BOLT NUT |
| 5. SERVO PISTON CUSHION SPRING      | 11. SERVO PISTON RETAINER           |
| 6. SERVO PISTON RING                |                                     |

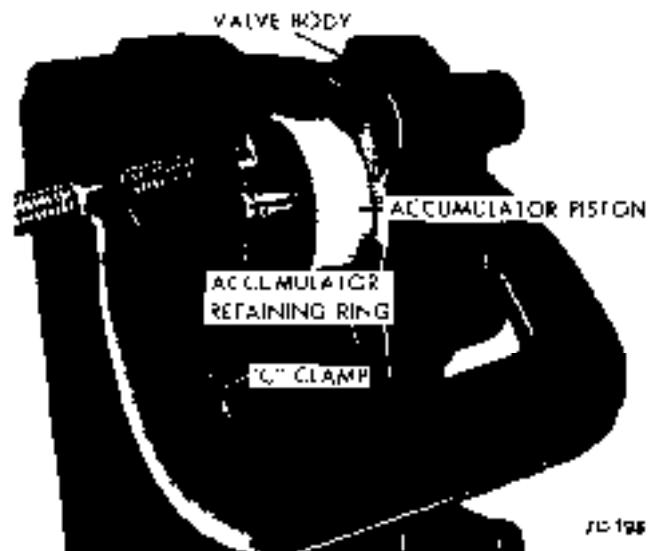
7C-195

Figure 7C-195 Servo Piston - Exploded View



7C-196

Figure 7C-196



7C-198

Figure 7C-198

7. Remove accumulator piston, oil ring, and spring. See Figure 7C-200.

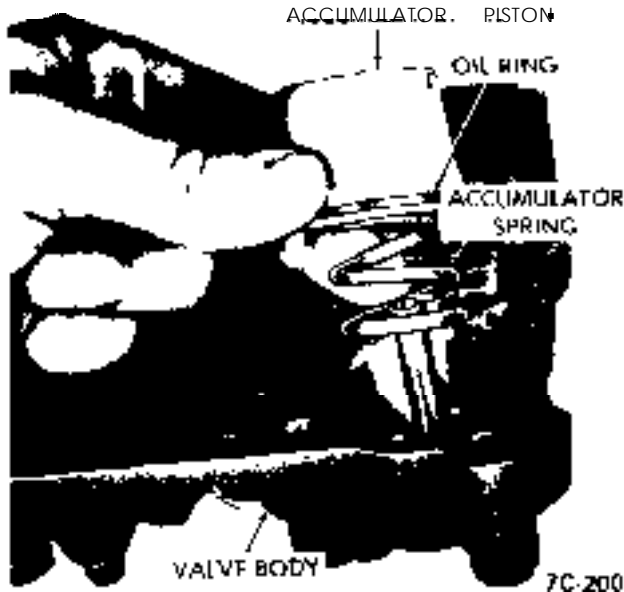


Figure 7C-200

8. Inspect accumulator oil ring for damage or edge wear and piston for damage. Replace if necessary. For steps 9 through 21 refer to Figure 7C-201.

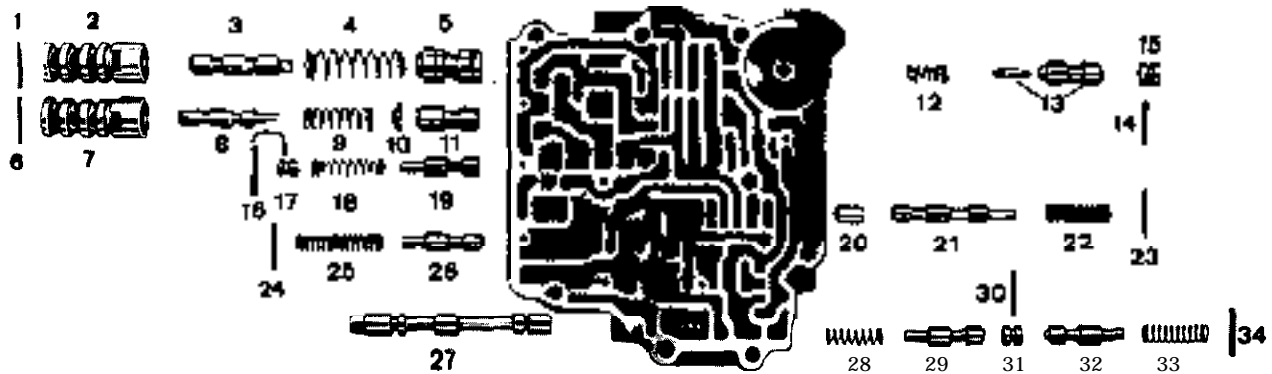
9. Remove 1-2 Shift control valve retaining pin, 1-2 shift control valve sleeve, control valve, 1-2 shift valve spring and valve. It may be necessary to remove burrs in valve body bore made by retaining pin prior to removal of the sleeves and valves.

10. Remove the 2-3 Shift control valve retaining pin and sleeve. Also, remove the 2-3 shift control valve, spring seat, spring and 2-3 shift valve.

11. Remove the 3-2 control valve retaining pin and plug. Remove 3-2 control valve spring and control valve.

12. Remove the detent pressure regulator valve retaining pin, spring, and detent pressure regulator valve.

13. Remove the high speed downshift timing valve retaining pin and spring and remove valve.



- |   |  |
|---|--|
| 1. RETAINING PIN                        | 19. 3-2 CONTROL VALVE                        |
| 2. 1-2 SHIFT CONTROL VALVE SLEEVE       | 20. REVERSE CONTROL VALVE                    |
| 3. 1-2 SHIFT CONTROL VALVE              | 21. MANUAL LOW CONTROL VALVE                 |
| 4. 1-2 SHIFT CONTROL VALVE SPRING       | 22. MANUAL LOW CONTROL VALVE SPRING          |
| 5. 1-2 SHIFT VALVE                      | 23. RETAINING PIN                            |
| 6. RETAINING PIN                        | 24. RETAINING PIN                            |
| 7. 2-3 SHIFT CONTROL VALVE SLEEVE       | 25. DETENT PRESSURE REGULATOR VALVE SPRING   |
| 8. 2-3 SHIFT CONTROL VALVE              | 26. DETENT PRESSURE REGULATOR VALVE          |
| 9. 2-3 SHIFT CONTROL VALVE SPRING       | 27. MANUAL VALVE                             |
| 10. 2-3 SHIFT CONTROL VALVE SPRING SEAT | 28. LOW SPEED DOWNSHIFT TIMING VALVE SPRING  |
| 11. 2-3 SHIFT VALVE                     | 29. LOW SPEED DOWNSHIFT TIMING VALVE         |
| 12. 1-2 ACCUMULATOR VALVE SPRING        | 30. RETAINING PIN                            |
| 13. 1-2 ACCUMULATOR VALVE               | 31. TIMING AND CONTROL VALVE PLUG            |
| 14. RETAINING PIN                       | 32. HIGH SPEED DOWNSHIFT TIMING VALVE        |
| 15. 1-2 ACCUMULATOR VALVE PLUG          | 33. HIGH SPEED DOWNSHIFT TIMING VALVE SPRING |
| 16. RETAINING PIN                       | 34. RETAINING PIN                            |
| 17. 3-2 CONTROL VALVE PLUG              |  |
| 18. 3-2 CONTROL VALVE SPRING            |  |

7C-201

14. Remove the downshift timing valve plug retaining pin and remove downshift timing valve plug. Remove the low speed downshift timing valve and spring.

15. Remove the manual low and reverse control valve retaining pin. Remove the spring and the manual low control valve and the reverse control valve.

16. Remove the 1-2 accumulator valve retaining pin and remove the 1-2 accumulator valve plug, 1-2 accumulator valve and spring.

17. A clean work area which is free of dirt and dust should be used to inspect, clean and install the valves in the valve body. Handle valve components with clean hands and tools. Since most valve failures are caused initially by dirt or other foreign matter preventing a valve from functioning properly, a thorough cleaning of all the components with a cleaning solvent is essential. Do not use paraffin to

clean out the valve body passages and valve bore. Compressed air may be used to blow out the passages.

18. Inspect each valve for free movement in its respective bore in the valve body. If necessary, use crocus cloth to remove small burrs on a valve. Do not remove the sharp edges of the valves as these edges perform a cleaning action within the bore.

19. Inspect the valve springs for distortion or collapsed coils. Replace the entire valve body assembly if any parts are damaged.

20. Inspect the transfer plate for dents or distortion. Replace transfer plate if necessary.

21. Reassemble the valves, springs, plugs and retaining pins in their proper location and order into the valve body using a liberal amount of transmission fluid. See the spring data chart which includes the spring identification sizes in the event springs have been disarranged.

**SPRING IDENTIFICATION CHART**

Location	Application	Free Height	Outer Diameter
Pump	Pressure Regulator Valve .....	2.756	.760
Pump	Priming Valve .....	1.043	.320
Valve Body	1-2 Shift Valve .....	2.467	.720
Valve Body	2-3 Shift Valve .....	1.769	.700
Valve Body	Detent Pressure Regulator Valve .....	1.625	.474
Valve Body	High-Speed Timing Valve .....	1.349	.406
Valve Body	Low-Speed Timing Valve .....	1.380	.406
Valve Body	Reverse and Low Control Valve .....	1.343	.406
Case	Detent Valve .....	2.569	.675
Valve Body	1-2 Accumulator Valve .....	1.072	.520
Valve Body	3-2 Control Valve .....	1.853	.406
Gov. Body	Secondary Governor Valve .....	1.317	.406
Valve Body	Accumulator Piston .....	1.917	1.224
Case	Servo Return .....	2.240	1.850
Servo	Servo Cushion .....	1.039	1.267
Clutch Pack	Clutch Return (All) .....	1.050	.424

22. Install spring and accumulator piston in valve body.

23. Compress accumulator piston with C-clamp and install retaining ring.

24. Install new valve body gasket.

25. Bolt the transfer plate and gasket to the valve body. Torque to 6-8 lbs. ft.

**Disassembly, Inspection and Reassembly of Case**

1. Inspect case for damage. See Figure 7C-202.

2. Inspect and clean oil passages with cleaning solvent and air.

3. Check for good retention of band anchor pins.

4. Inspect all threaded holes for thread damage.

5. Inspect detent valve and modulator valve bores for scratches or scoring.

6. Inspect case bushing inside of case at rear. If damaged, remove bushing with remover and installer tool J-23 130-3 and driver handle J-8092. See Figure 7C-203.

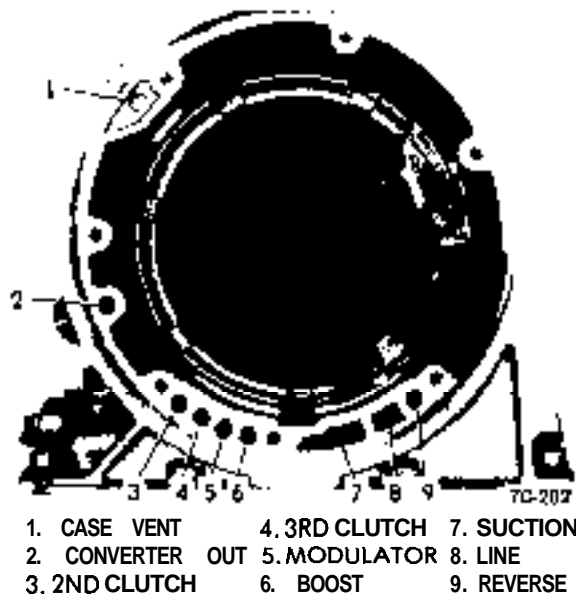


Figure 7C-202 Case Front View Oil Passage Identification

7. Inspect reaction sun gear drum bushing sleeve inside case at rear for scoring. If necessary, replace sleeve before installing rear case bushing.

8. Remove sleeve by grinding. Care must be used in order that aluminum case is not damaged when grinding sleeve.

9. Install new sleeve using installer tool J-23130-7 and driver handle J-8092.

10. Install new case bushing using remover and installer tool J-23130-3 and driver handle J-8092. Bushing should be installed flush with case at rear. See Figure 7C-203.

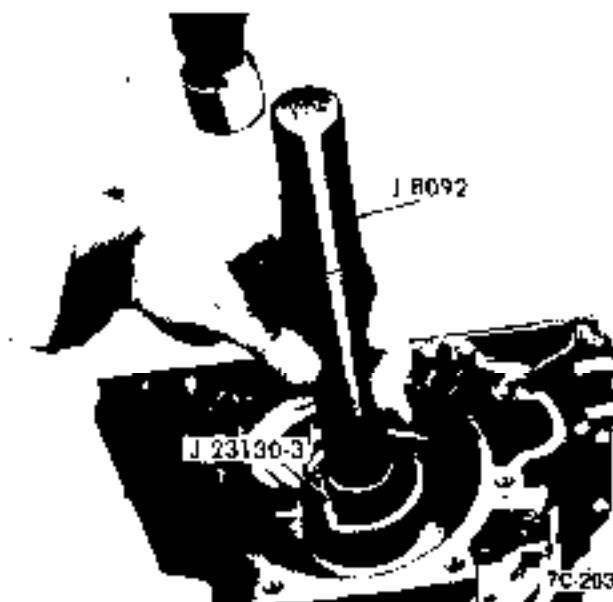


Figure 7C-203

1. Drain Converter. If clutch disc material or foreign matter has been found while draining converter, replace entire converter assembly as it can not be cleaned properly.

2. Air check converter for leaks using converter checking tool J-21369. Install tool and tighten. Apply 80 psi air pressure to tool. See Figure 7C-204.

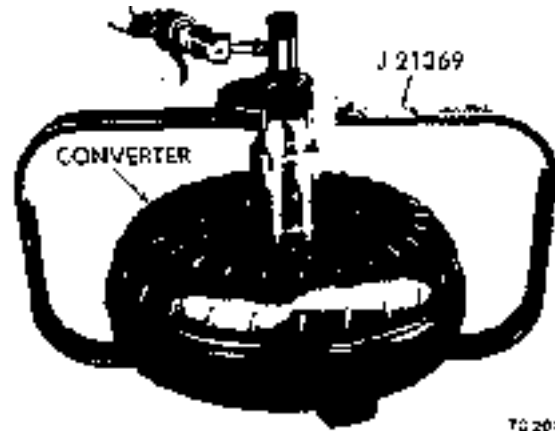


Figure 7C-204

3. Submerge in water and check for leaks.

4. Check converter hub surfaces for scoring or wear.

#### Installation of Selector Lever and Shaft

1. Install new selector lever shaft oil seal in case. Insert selector lever shaft through case from outside. Care should be exercised so that oil seal is not damaged. See Figure 7C-206.

2. Insert spring pin in case to secure selector lever shaft.

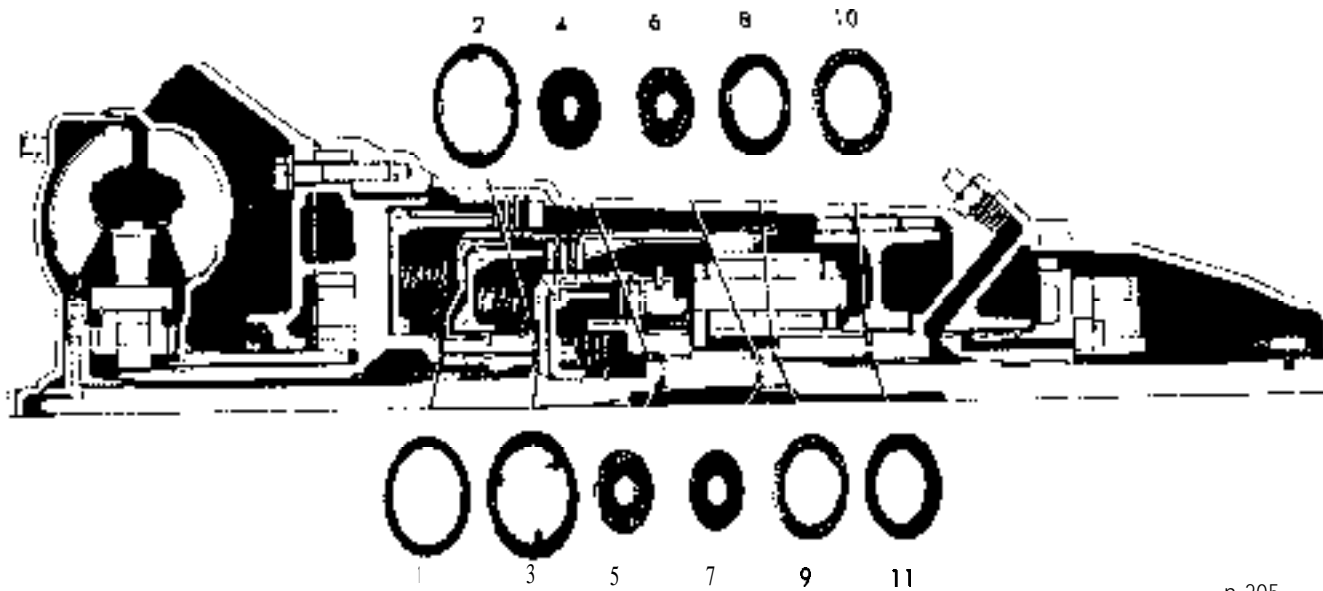
3. Guide selector lever over shaft and secure with lock nut.

4. Insert parking pawl actuator rod from front of the case and through hole in case at rear. See Figure 7C-207.

5. Install parking pawl actuator rod retaining ring.

#### Installation of Low Band

1. Turn transmission case so that front of case is upward.



- |   |   |
|---|---|
| <ul style="list-style-type: none"> <li>1. CLUTCH ASSEMBLY THRUST WASHER</li> <li>2. 2ND CLUTCH ASSEMBLY TO 3RD CLUTCH ASSEMBLY BRONZE THRUST WASHER</li> <li>3. 2ND CLUTCH ASSEMBLY TO 3RD CLUTCH ASSEMBLY STEEL THRUST WASHER</li> <li>4. INPUT SHAFT TO SUN GEAR THRUST WASHER</li> <li>5. INPUT SUN GEAR ASSEMBLY BEARING</li> </ul> | <ul style="list-style-type: none"> <li>6. INPUT SUN GEAR ASSEMBLY BEARING</li> <li>7. INPUT SUN GEAR ASSEMBLY TO PLANETARY CARRIER ASSEMBLY WASHER</li> <li>9. REACTION SUN GEAR BEARING ASSEMBLY</li> <li>10. REACTION SUN GEAR 8 BEARING ASSEMBLY</li> <li>11. REACTION SUN GEAR &amp; DRUM ASSEMBLY THRUST WASHER</li> </ul> |
|---|---|

n-205

Figure 7C-205 Location of Bearings And Washers

2. Inspect band for cracks, flaking, burring or looseness. Replace if required.

3. Place band in case and locate band onto the anchor pins in case. See Figure 7C-208.

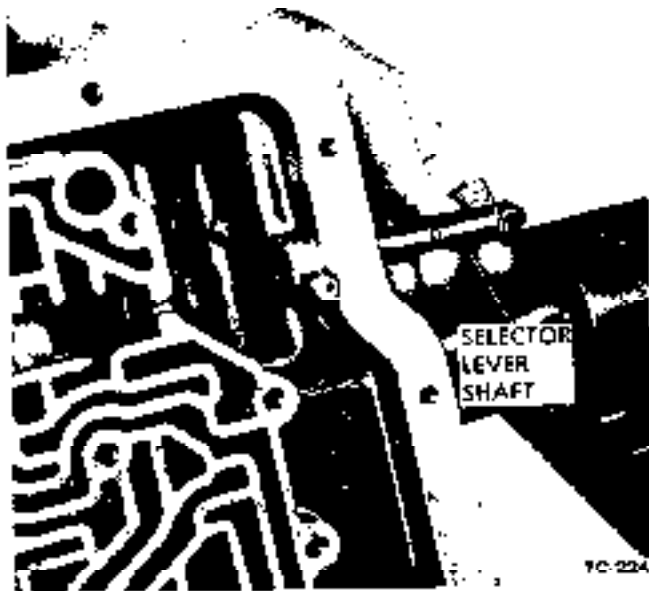


Figure 7C-206

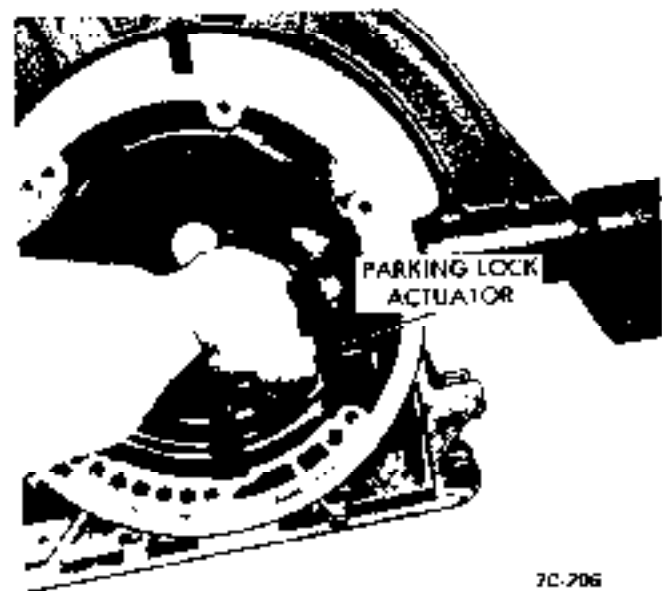


Figure 7C-207

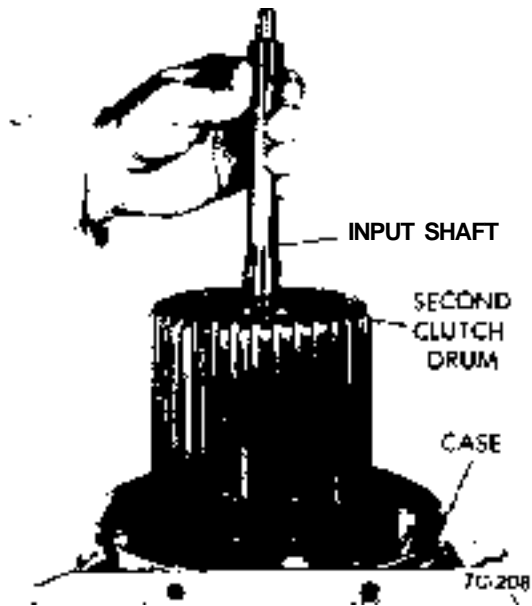


Figure 7C-208

1. Place needle thrust bearing race on rear of case around the case bushing. Secure with petroleum jelly (unmedicated).
2. Place needle thrust bearing on race. See Figure 7C-209. Secure with petroleum jelly (unmedicated).

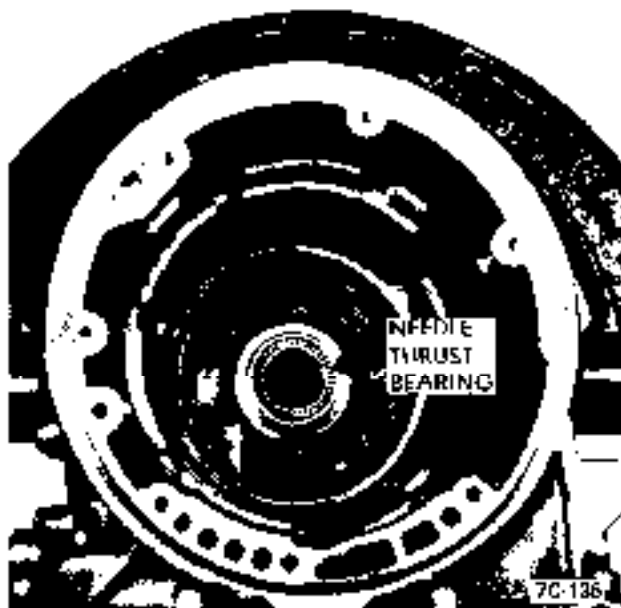


Figure 7C-209

3. Insert reaction sun gear and drum into band with reaction sun gear facing upward.
4. Place needle bearing on first then race on front face of reaction sun gear. See Figure 7C-210. Secure with petroleum jelly (unmedicated).

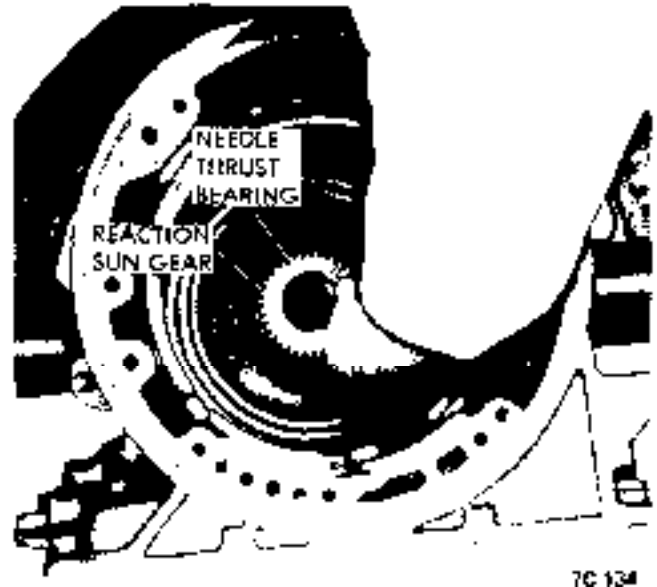


Figure 7C-210

#### Installation of Output Shaft and Planetary Carrier

1. Install input sun gear to planetary carrier washer and bearing into carrier. Secure with petroleum jelly (unmedicated).
2. Insert output shaft and planetary carrier assembly from front of case to spline with reaction sun gear. See Figure 7C-211.



Figure 7C-211

#### Installation of 2nd and 3rd Clutch Assemblies Into Case

1. With second clutch assembly on bench, align second clutch drive plates in second clutch drum.



2. Insert third clutch drum and input shaft through top of second clutch drum seating third clutch drum splines into the second clutch plate splines. See Figure 7C-212.

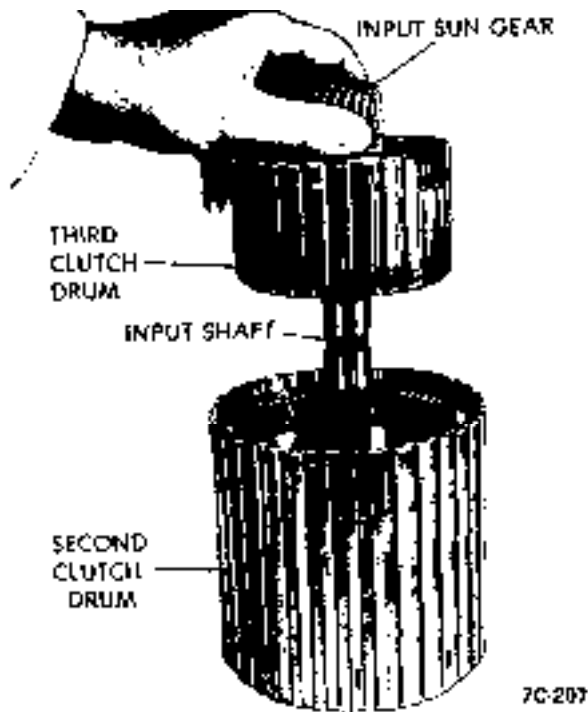


Figure 7C-2 12

3. Holding second and third clutch assemblies by the input shaft, lower into transmission case, indexing ring gear in second clutch drum with long planetary pinion gear teeth. See Figure 7C-213.

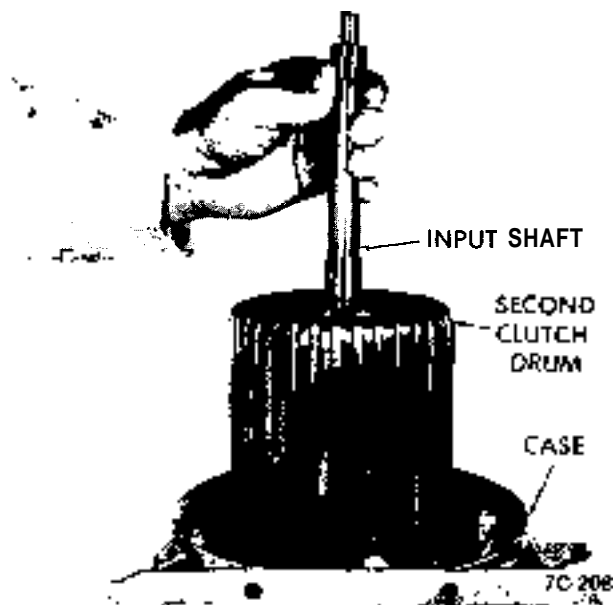


Figure 7C-213

### Installation of Reverse Clutch

1. Inspect condition of the composition and steel plates. *Do not diagnose a composition drive plate by color.*

A. Dry composition plates with compressed air and inspect the composition surface for:

1. Pitting and flaking
2. Wear
3. Glazing
4. Cracking
5. Charring
6. Chips or metal particles imbedded in lining

If a composition drive plate exhibits any of the above conditions, replacement is required.

B. Wipe steel plates dry and check for heat discoloration. If the surface is smooth and an even color smear is indicated, the plates should be reused. If severe heat spot discoloration or surface scuffing is indicated, the plates must be replaced.

2. Install the steel reaction plate into the case. See Figure 7C-214.

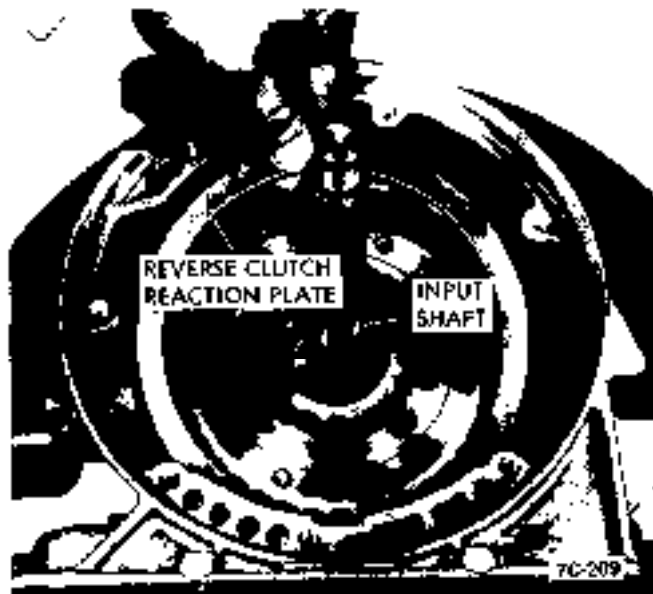


Figure 7C-2 14

3. Install reverse clutch steel plate, composition plate, steel plate, composition plate, etc., into case. Use a liberal amount of transmission fluid.

4. Install reverse clutch cushion plate (wave washer) into case.

**Determining Selective Washer Size**

1. Place gauging tool J-23085 on case flange and against input shaft. See Figure 7C-215.

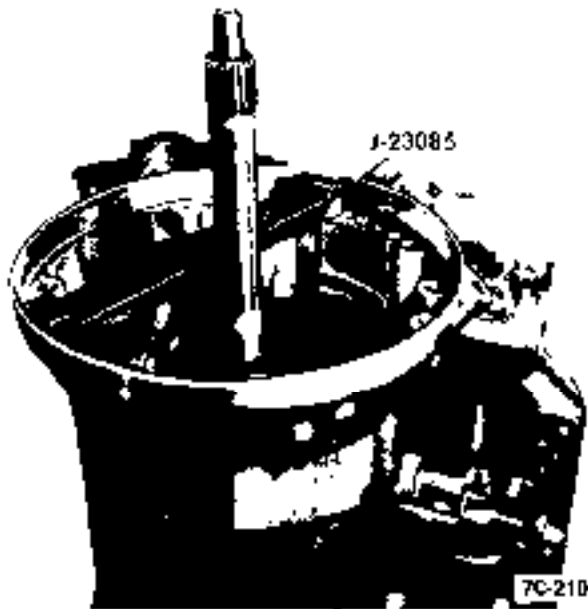


Figure 7C-2 15

2. Loosen thumb screw on tool to allow inner shaft to drop on second clutch drum hub.
3. Tighten thumb screw and remove tool J-23085.
4. Place selective washer removed from transmission against inner shaft of tool J-23085. Selective washer should be flush with top face of shaft. If not flush, select next larger or smaller washer until correct size is obtained. The washer selected should be exactly flush or slightly below inner shaft for correct end play in transmission. Selective washer removed from transmission may be oil soaked and discolored.

Color	Thickness
ID	
Yellow	.070-.074
Blue	.076-.080
Red	.081-.085
Brown	.086-.090
Green	.091-.095
Black	.097-.101

**Installation of Converter Housing, Oil Pump and Reverse Clutch Assembly**

1. Install oil pump wear plate onto oil pump.

2. Insert guide pin into oil pump for alignment of converter housing and lower housing onto pump.

3. Install new oil seal washers on converter housing to oil pump bolts, and loosely install bolts into converter housing.

4. Use converter housing to oil pump aligning tool J-23082 to align converter housing to pump. See Figure 7C-216. Tool should bottom on oil pump gear.



Figure 7C-2 16

5. Tighten the five bolts. Torque to 13-17 lbs. ft. and remove aligning tool J-23082.
  6. Install new converter housing to case rubber oil seal.
  7. Install new pump flange gasket.
  8. Place selective washer, previously determined, onto the oil pump shaft and retain with petroleum jelly (unmedicated).
  9. Install two guide pins in case and lower converter housing and oil pump into case. See Figure 7C-217.
  10. Bolt converter housing to case using new oil seal washers on all seven bolts. Torque to 13-17 lbs. ft.
- I I. Check for correct assembly by turning input shaft by hand.

**Installation of Governor Assembly**

1. Turn case so that bottom of transmission is facing upward.
2. Slide governor hub along output shaft and seat

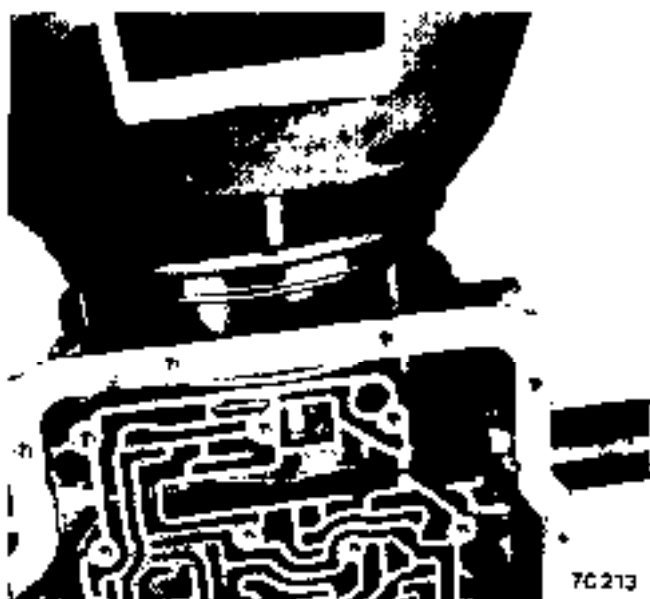


Figure 7C-217

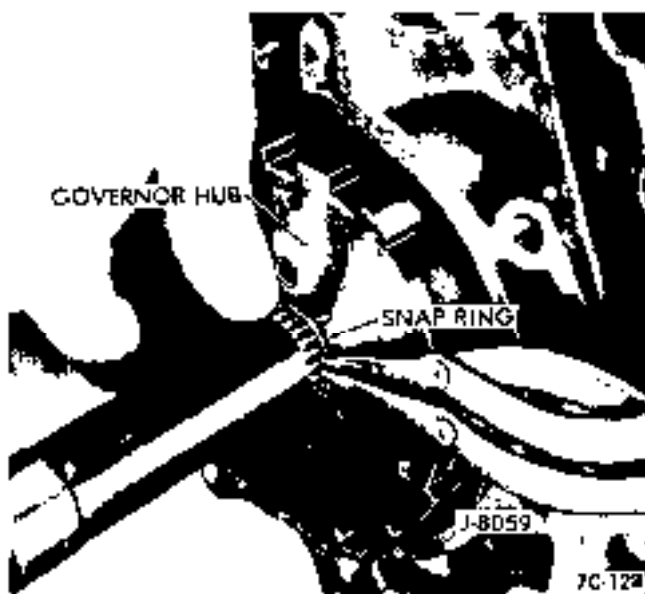


Figure 7C-219

into case. See Figure 7C-218. Use liberal amount of transmission fluid on oil seal rings.

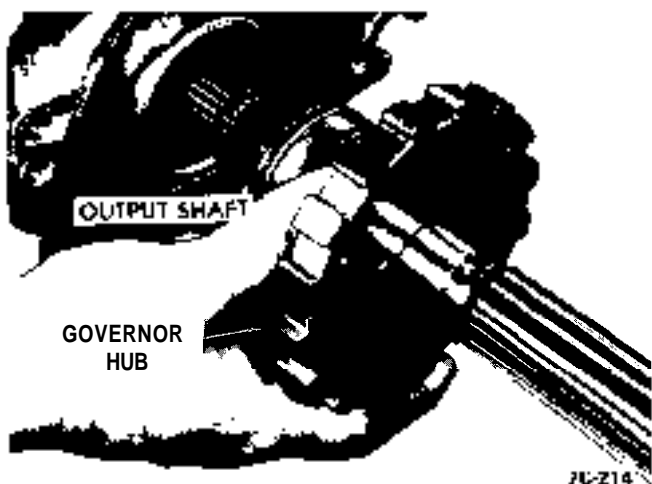


Figure 7C-218

3. Install snap ring over output shaft using snap ring pliers such as J-8059. See Figure 7C-219.

4. Install new governor body gasket.

5. Bolt governor body to governor hub. Torque to 6-8 lbs. ft. The two governor valves should move freely after governor body is torqued.

6. Install speedometer drive gear retaining clip into output shaft. See Figure 7C-220.

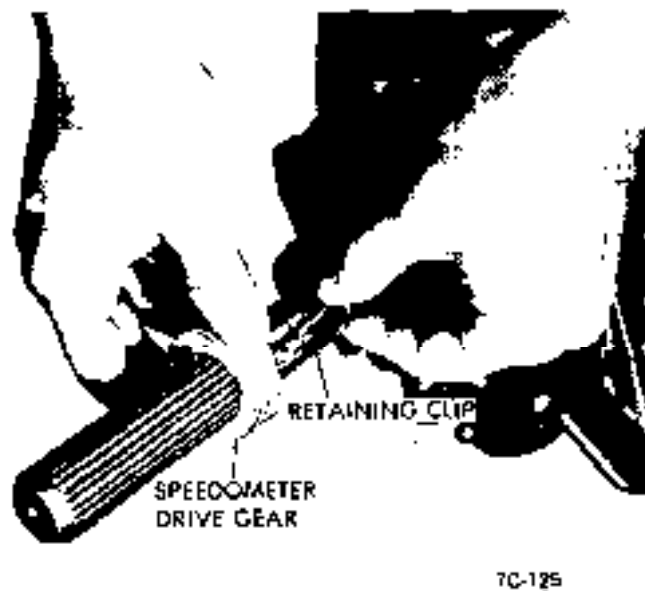


Figure 7C-220

7. While depressing retaining clip, slide speedometer gear over output shaft and install gear and retaining clip.

#### Installation of Extension Housing

1. Install new extension housing gasket.

2. Slide extension housing over output shaft and align holes.

3. Align parking pawl shaft into extension housing.

4. Bolt extension housing to rear of case. Torque to 20-30 lbs. ft. See Figure 7C-221.



Figure 7C-221

#### Installation of Speedometer Driven Gear

1. Install speedometer driven gear and housing into extension housing. See Figure 7C-222.



Figure 7C-222

2. Install **speedometer** driven gear housing retainer into slot provided in speedometer driven gear housing. Bolt retainer to extension housing. Torque to 6-8 lbs. ft. See Figure 7C-223.

#### Installation of Detent Valve, Modulator Valve, Modulator Assembly

1. **Inspect** detent valve sleeve oil seal and replace if necessary.



Figure 7C-223

2. Install detent valve, sleeve, **spring**, and **spring seat** into case bore using liberal **amount** of **transmission** fluid.

3. Depress detent valve spring and insert spring pin to secure detent valve assembly. Detent valve sleeve must be installed with slots facing oil pan. Care should be taken so that spring pin is inserted into the groove provided in sleeve and not into one of the oil passage slots in the sleeve.

4. Install modulator valve and sleeve into case with small end of modulator valve first.

5. Using new modulator assembly gasket, install plunger and thread modulator into case and tighten to 12-15 lbs. ft. using tool J-23100. See Figure 7C-224.

#### Installation and Adjustment of Servo

Adjustment of servo can be performed with **transmission** in vehicle.

1. Install servo apply rod, spring and piston into case, using liberal amount of transmission fluid.

2. Compress servo piston spring using compressor tool J-23075, lightly tapping servo piston while compressing until piston is seated to avoid damage to the oil seal ring.

3. Install servo retaining ring. See Figure 7C-225. Remove compressor tool J-23075.

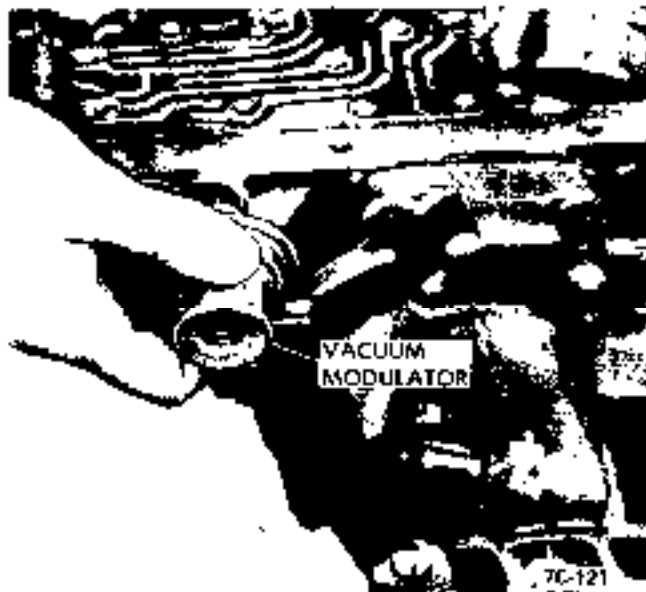


Figure 7C-224

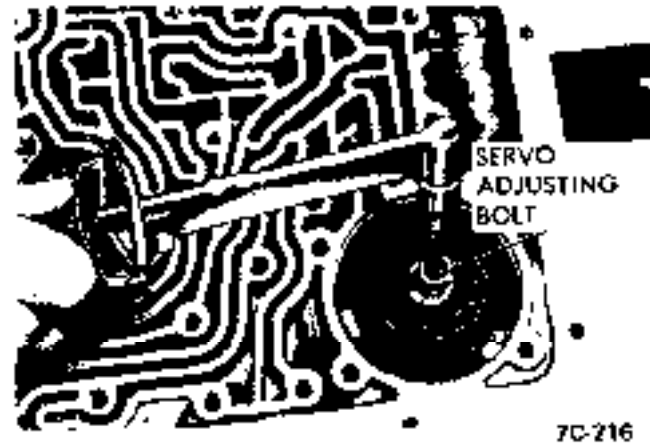


Figure 7C-226

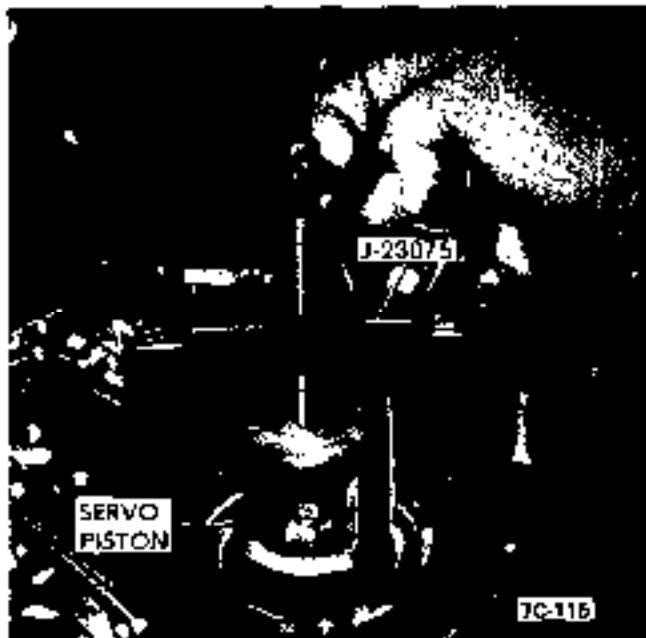


Figure 7C-225

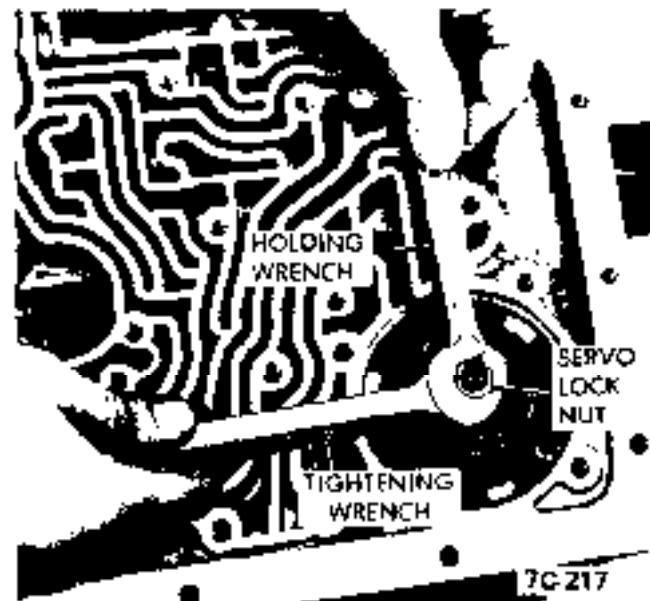


Figure 7C-227

4. Using 3/16" hex head wrench on servo adjusting bolt, adjust servo apply rod by tightening adjusting bolt to 40 lbs. in. Back off bolt five (5) turns. *exactly*. See Figure 7C-226.

5. Tighten lock nut holding adjusting bolt and sleeve firm with hex head wrench. See Figure 7C-227.

**installation of Valve Body**

1. *Install* steel balls in oil passages in case. See Figure 7C-228.

2. Install new case to transfer plate **gasket**.

3. Locate guide pins in transmission case for correct alignment of valve body and transfer plate. See Figure 7C-229.

4. Install manual valve into valve body bore using liberal amount of transmission fluid.

5. Install long side of manual valve link pin into manual valve. See Figure 7C-230.

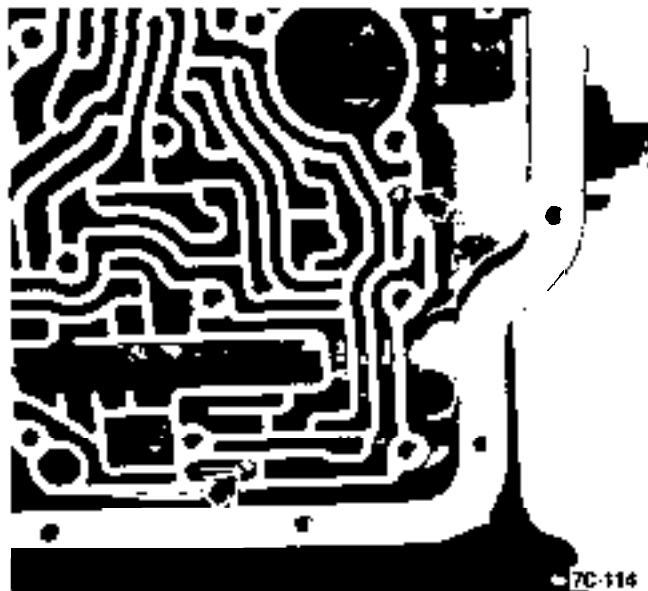


Figure 7C-228

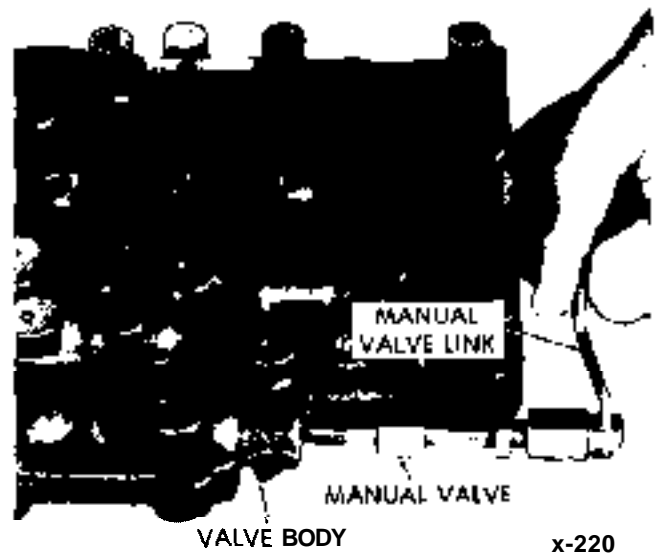


Figure 7C-230

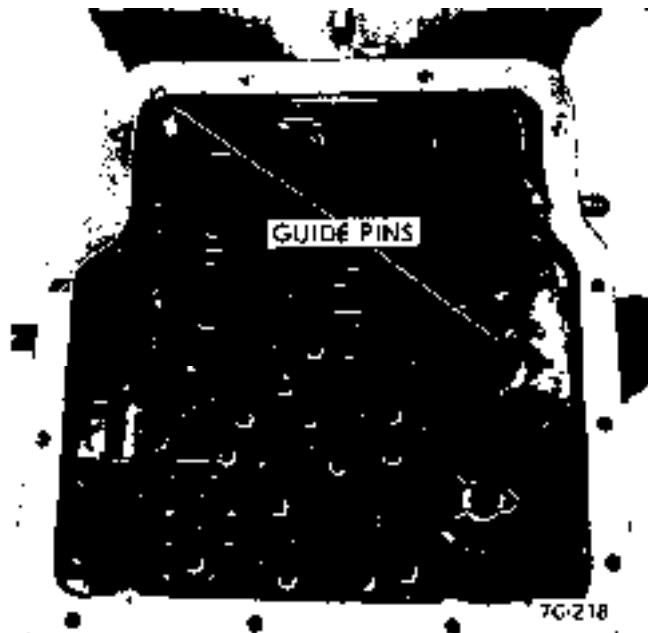


Figure 7C-229

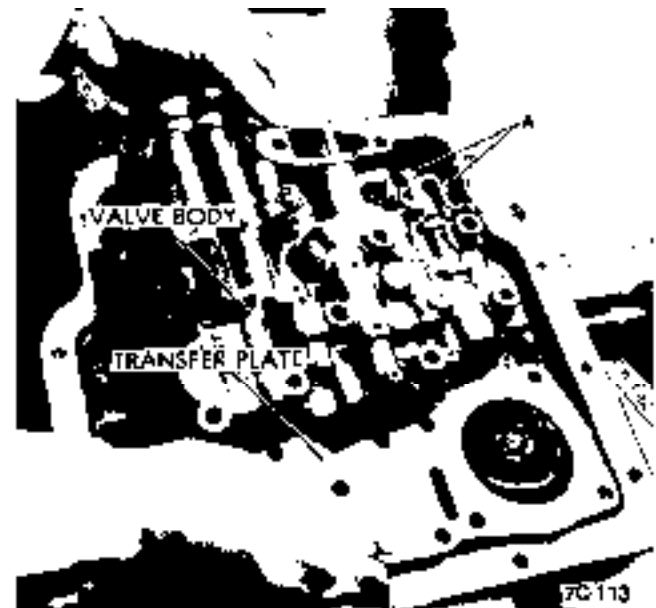


Figure 7C-231

6. Install small end of manual valve link "A" into selector lever and install valve body and transfer plate assembly over guide pins. See Figure 7C-231.

7. Install selector lever roller spring and retainer. Torque to 13-15 lbs. ft. The valve body bolts should be **torqued** starting in the center of the valve body and working outward. Torque to 13-15 lbs. Ft.

8. Install reinforcement plate to case. Torque to 13-15 lbs. ft.

9. Inspect oil strainer. If foreign matter is present, install new strainer.

10. Install oil strainer assembly using new gasket. Torque to 13-15 lbs. ft.

11. Install new servo cover gasket.

12. Install servo cover. Torque to 17-19 lbs. ft.

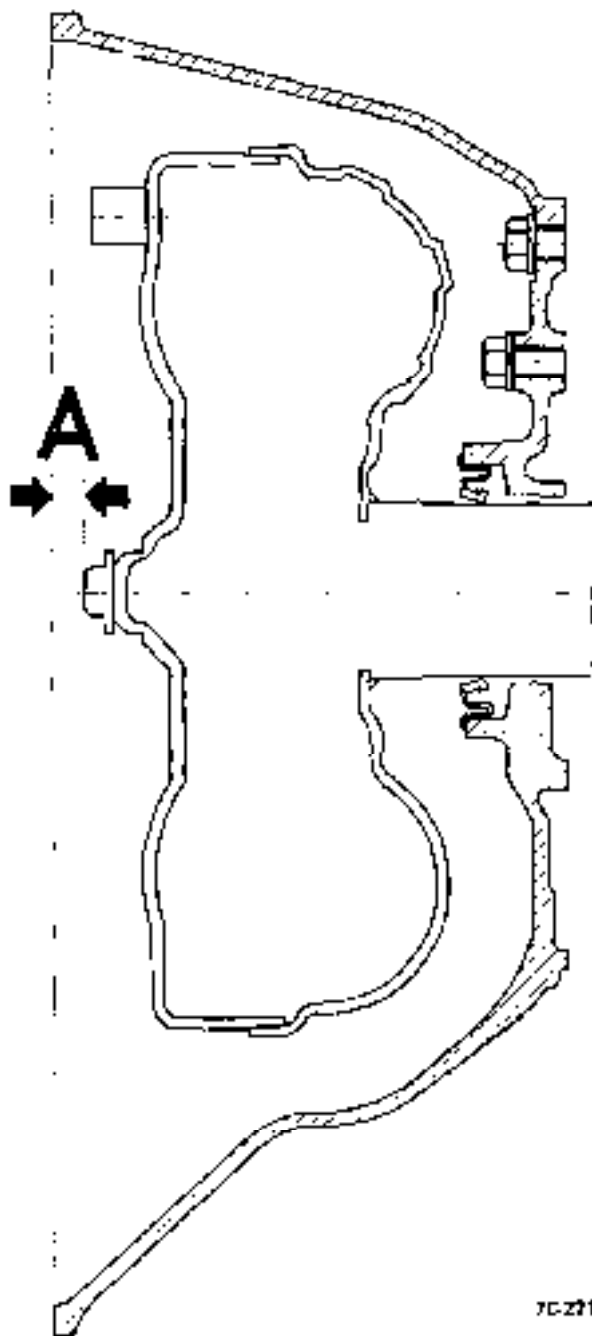
#### Installation of Oil Pan and Gasket

1. Install new oil pan gasket.

2. Bolt oil pan to transmission case. Torque to 7-9 lbs. ft.

## Torque Converter

1. Place transmission on portable jack
2. Slide torque converter over stator shaft and input shaft.
3. Be sure that converter pump hub keyway is seated into oil pump drive lugs and the distance "A" is .20" to .28". See Figure 7C-232.



7C-231

Figure 7C-232

4. Rotate converter to check for free movement.

## SPECIFICATIONS

## GENERAL SPECIFICATIONS

## Opel Three-Speed Automatic Transmission Fluid Recommendations

Use DEXRON Automatic Transmission Fluid *only* in all 1972 model Opel Automatic Transmissions (GM part No. 1050568-69-70 or any other fluid having DEXRON identifications).

DEXRON is an especially formulated automatic transmission fluid designed to improve transmission operation.

The oil pan should be drained and the strainer replaced every 24,000 miles and fresh fluid added to obtain the proper level on the dipstick. See subparagraph 2 for proper refill procedures. For cars subjected to heavy city traffic during hot weather, or in commercial use, when the engine is regularly idled for long periods, the oil pan should be drained and the strainer replaced every 12,000 miles.

## 1. Checking and Adding Fluid

The Opel three-speed automatic is designed to operate at the full mark on the dipstick at normal operating temperature (180 degrees F.) and should be checked under these conditions. The normal operating temperature is obtained only after at least 15 miles of highway type driving or the equivalent of city driving.

Fluid level should be checked at every engine oil change. *The "Full" and "Add" marks on the transmission dipstick indicate one (1) pint difference.* To determine proper fluid level, proceed as follows:

To determine proper level, proceed as follows:

1. With manual control lever in Park position start engine. DO NOT RACE ENGINE. Move manual control lever through each range.
2. Immediately check fluid level with selector lever in Park, **engine running**, and vehicle on LEVEL surface.

At this point, when a reading is made, fluid level on the dipstick should be at the "FULL" mark.

3. If additional fluid is required, add fluid to the "FULL" mark on the dipstick.

If the vehicle cannot be driven sufficiently to bring the transmission to operating temperature and it

becomes necessary to check the fluid level, the transmission may be checked at room temperature (70 degrees F.) as follows:

1. With manual control lever in Park position start engine. **DO NOT RACE ENGINE.** Move manual control lever through each range.

2. Immediately check fluid level with selector lever in Park, engine running, and vehicle on **LEVEL surface.**

At this point, when a reading is made, fluid level on the dipstick should be 1/4" below the "ADD" mark.

3. If additional fluid is required add fluid to bring level to 1/4" below the "ADD" mark on the dipstick.

If transmission fluid level is correctly established at 70 degrees F. it will appear at the "FULL" mark on the dipstick when the transmission reaches normal operating temperature (180 degrees F.) The fluid level is set 1/4" below the "ADD" mark on the dipstick to allow for expansion of the fluid which occurs as transmission temperatures rise to normal operating temperature of 180 degrees F.

Do not overfill, as foaming and loss of fluid through the vent pipe might occur as fluid heats up. If fluid is too low especially when cold, complete loss of drive may result which can cause transmission failure.

## 2. *Draining oil pan and replacing strainer assembly.*

(a) Raise car on hoist or *place on jack stands*, and provide container to collect draining fluid.

(b) Remove oil pan and gasket. Discard gasket.

(c) Drain fluid from oil pan. Clean pan with solvent and dry thoroughly with clean compressed air.

(d) Remove strainer assembly, strainer gasket and discard.

(e) Install new oil strainer gasket. Install new strainer assembly.

(f) Install new gasket on oil pan and install pan. Tighten attaching bolts to 7-10 lb. ft.

(g) Lower car and add approximately three (3) pints of transmission fluid through **filler** tube.

(h) With manual control lever in Park position, start engine. **DO NOT RACE ENGINE.** Move manual control lever through each range.

(i) Immediately check fluid level with selector lever

in Park, engine running, and vehicle on **LEVEL surface.**

(j) Add additional fluid to bring level to 1/4" below the "ADD" mark on the dipstick. Do not overfill.

## 3. *Adding Fluid to Fill Dry Transmission and Converter Assembly*

The fluid capacity of the Opel Three Speed Automatic transmission and converter assembly is approximately 10-1/2 pints, but correct level is determined by the mark on the dipstick rather than by amount added. In cases of transmission overhaul, when a complete fill is required, including a new converter proceed as follows:

(a) Add approximately 10-1/2 pints of transmission fluid through tiller tube.

The converter should be replaced on any major failure, such as a clutch or **gearsset**, and an excessive amount of foreign material is indicated in the pan. If installation of a new converter is not required add approximately five (5) pints of transmission fluid.

(b) With manual control lever in Park position start engine and run at 1000 RPM. **DO NOT RACE ENGINE.** Move manual control lever through each range.

(c) Immediately check fluid level with selector lever **in** Park, engine running, and vehicle on **LEVEL surface.**

(d) Add additional fluid to bring level to 1/4" below the "ADD" mark on the dipstick. Do not overfill.

## **Opel Three Speed Automatic Transmission Towing Instructions**

If an Opel equipped with an automatic transmission must be towed, the following precautions must be observed:

The car may be towed safely on its rear wheels with the shift lever in neutral position at speeds of 35 miles per hour or less under most conditions.

However, the drive shaft must be disconnected or the car towed on its front wheels if:

- a. Tow **speeds** in excess of 35 mph are necessary.
- b. Car must be towed for extended distances (over 50 miles).
- c. Transmission is not operating properly.

If car is towed on its front wheels, the steering wheel



should be secured to keep the front wheels in a straight-ahead position.

**Rocking Car**

If it becomes necessary to rock the car to free it from

sand, mud, or snow, move the selector lever from "D" to "R" in a repeat pattern while simultaneously applying moderate pressure to the accelerator. Do not race engine. Avoid spinning wheels when trying to free the car.

**Model Designations**

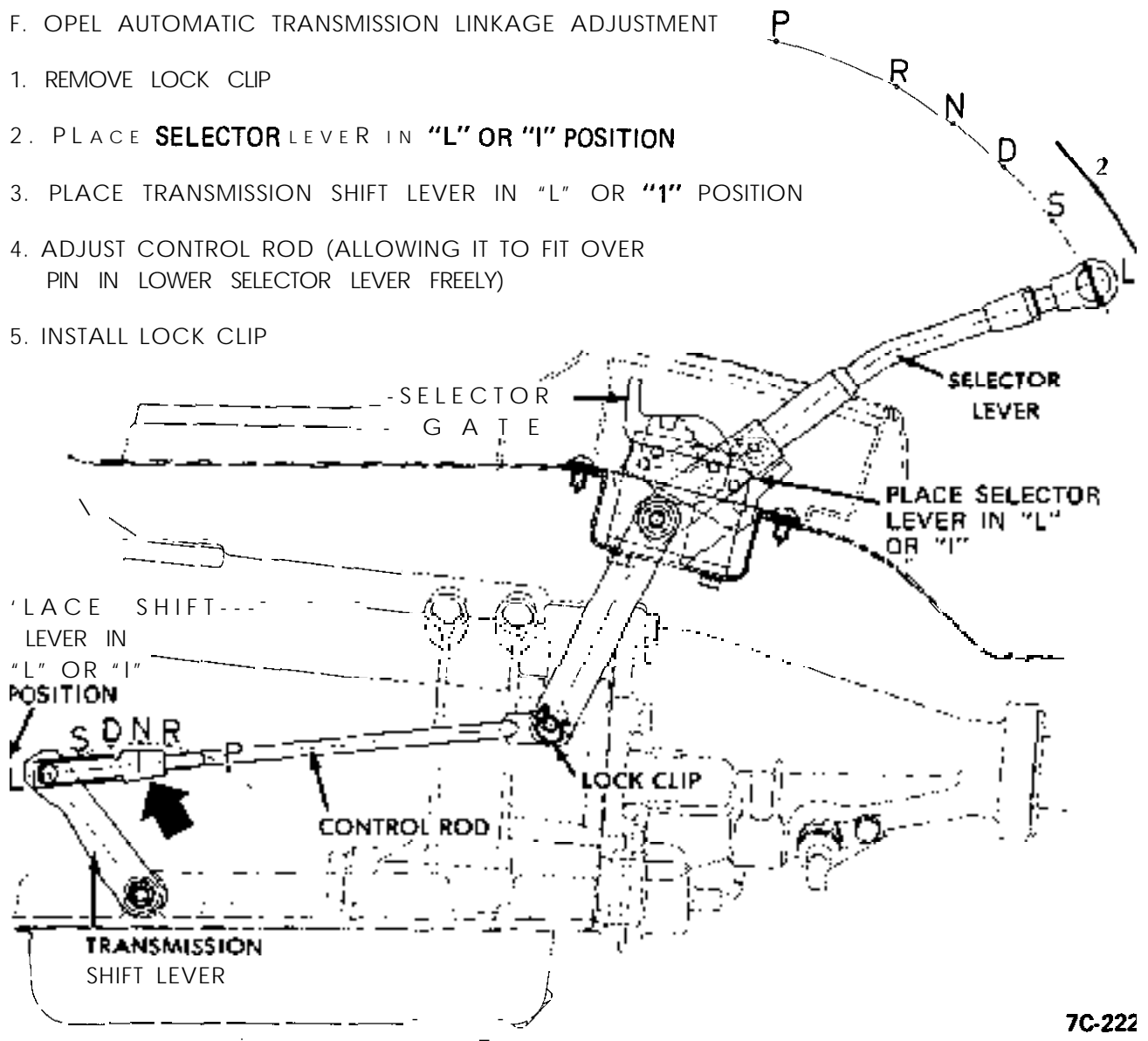
Trans.	converter	Reverse Clutch	2nd Gear Clutch	3rd Gear Clutch
Model	Assembly	Plates Required	Plates Required	Plates Required
	Information			
Opel 1900	Green	Drive (Composition Faced) 3	Drive (Composition Faced) 3	Drive (Composition Faced) 3
OG	Dot of	Driven (Steel) 4	Driven (Steel) 4	Driven (Steel) 4
GT QH	Paint	Waved Pressure 1 1	Waved Pressure 1 1	Waved. Pressure 1 1

**Bolt Torque Specifications**

Location	Torque Lb.Ft.	Thread Size
Oil Pan to Case .....	7-10	5/16-18
Transfer Plate to Valve Body .....	6-8	1/6-20
Reinforcement Plate to Case .....	13.15	5/16-18
Valve Body to Case .....	13.15	5/16-18
Servo Cover to Case .....	16-19	5/16-18
Modulator Assembly .....	12-15	
Converter Housing to Oil Pump .....	13.17	5/16-18
Converter Housing to Case .....	22.26	5/16-18
Selector Lever Jam Nut .....	8-1	
Governor Body to Governor .....	6-8	1/4-20
Extension Housing to Case .....	20.30	3/8-16
Servo Adjusting Bolt Lock Nut .....	12.15	
Planetary Carrier Lock Plate .....	20.35	
Oil Pressure Check Plug .....	5-7	
Flex Plate to Crankshaft .....	36-51	
Converter to Flex Plate .....	38.42	
Converter Housing to Cylinder Block .....	38.42	
intermediate Selector Lever to Console		
Selector Lever Shaft .....	18.20	
Rear Engine Support to Transmission		
Case Extension .....	18.22	
Outer Transmission Selector Lever to		
Transmission Selector Lever Shaft .....	13.16	
Oil Cooler Line Connector .....	10-13	
Oil Cooler Line to Connector .....	11-15	
Oil Cooler Line to Oil Cooler Hose .....	11-15	
Oil Cooler Hose to Oil Cooler .....	11.15	

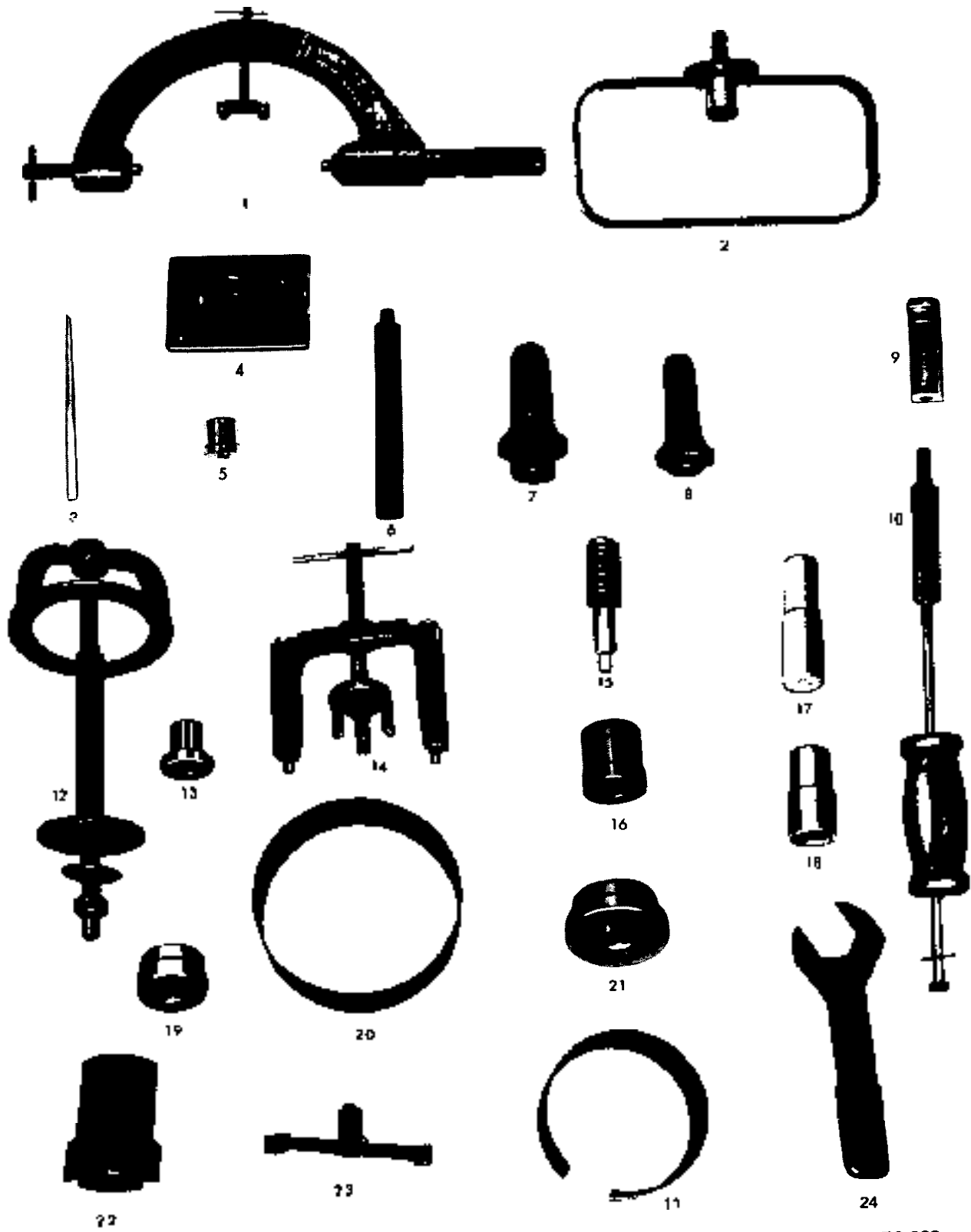
F. OPEL AUTOMATIC TRANSMISSION LINKAGE ADJUSTMENT

1. REMOVE LOCK CLIP
2. PLACE **SELECTOR** LEVER IN "L" OR "1" POSITION
3. PLACE TRANSMISSION SHIFT LEVER IN "L" OR "1" POSITION
4. ADJUST CONTROL ROD (ALLOWING IT TO FIT OVER PIN IN LOWER SELECTOR LEVER FREELY)
5. INSTALL LOCK CLIP



7C-222

Figure 7C-233 Adjusting Selector Lever



7C-223

Figure 7C-234 Special Tools - Automatic Transmission

**SPECIAL TOOLS**

1. J-8763-01 Transmission Holding Fixture
2. J-21369 **Converter** Leak Test Fixture
3. J-8400-1 Cape Chisel
4. J-3289-20 Holding Fixture Base
5. J-23130-3 Rear Case Bushing Remover and Installer
6. J-8092 Driver Handle
7. J-21359 Converter Housing Oil Seal Installer
8. J-21426 Extension Housing Oil Seal Installer
9. J-23129 Converter Housing Seal Remover • Without Disassembling Transmission  
(Use With J-7004)
10. J-7004 Slide Hammer
11. J-2590-12 2nd and Reverse Clutch Piston Spring Compressor
12. J-21420-1 Clutch Piston Compressor Adapter
13. J-23130-7 Reaction Sun Gear Drum Bushing Sleeve Installer
14. J-23075 Servo and 3rd Clutch Piston Spring Compressor
15. J-23 130-S Oil Pump Bushing Remover
16. J-231306 2nd Clutch Drum Bushing Remover and Installer
17. J-23130-1 Oil Pump Bushing Installer
18. J-21424-9 Extension Housing Bushing Remover and Installer (Use with J-8092  
Driver Handle)
19. J-21465-17 Converter Housing Bushing Remover and Installer (Use With J-8092)
20. J-23080 2nd Clutch Piston Seal Installer
21. J-23 130-2 Reaction Sun Gear Drum Bushing Installer
22. J-23082 Converter to Oil Pump Alignment Tool
23. J-23085 Oil Pump to 2nd Clutch Drum Gauging Tool
24. J-23 100 Vacuum Modulator Wrench



J-7004-1  
SLIDE HAMMER



J-2291 3  
MAIN SHAFT ASSEMBLY TOOL



J-22922  
TRANSMISSION CASE EXTENSION  
HOUSING SEAL INSTALLER



J-22929  
SPEEDOMETER DRIVEN GEAR  
REMOVER AND INSTALLER



J-22926  
SPEEDOMETER DRIVEN  
GEAR PIN REMOVER



J-21715  
DETENT PIN PLUG REMOVER



J-22934  
CLUTCH PLATE ALIGNING ARBOR



TRU-ARC PLIERS



J-21 684  
BEARING PRESS PLATE



J-22923  
REVERSE IDLER SHAFT REMOVER



J-2291 1  
NEEDLE BEARING LOADER

Figure 7C-235 Special Tools. Manual Transmission

---

GROUP 8

**HOOD,  
FENDERS,  
AND  
GRILLE**

Section	Title	Page No.
<b>8A</b>	Hood Fenders, Grille.	and <b>8A-2</b>

# HOOD, FENDERS, AND GRILLE

## CONTENTS

Subject	Page No.
<b>DESCRIPTION AND OPERATION:</b>	
GT Headlamp Operation .....	8A-2
<b>DIAGNOSIS: (Not Applicable)</b>	
<b>MAINTENANCE AND ADJUSTMENTS</b>	
GT Headlamp Mechanism .....	8A-2
<b>MAJOR REPAIR:</b>	
<b>Removal and Installation</b>	
Hood (1900 - Manta) .....	8A-3
Fender (1900 - Manta) .....	8A-3
Headlamp Covering (1900 - Manta) .....	8A-4
Headlamp Assembly (GT) .....	8A-4
Headlamp Cable Assembly (GT) .....	8A-6
Grille .....	8A-6
<b>SPECIFICATIONS: (Not Applicable)</b>	

### DESCRIPTION AND OPERATION

#### DESCRIPTION AND OPERATION OF GT HEADLAMP MECHANISM

The concealed headlamps are moved mechanically. Pushing actuating lever on left side of console opens headlamps, pulling lever closes headlamps. Two meshing gear segments convert the movement of the lever to a rotation of 180 degrees. The pivots of the headlamps lie below the centerline so that with headlamps in closed position the headlamp housing is flush with front sheet metal.

A white indicator lamp in the instrument panel lights if the headlamps are not completely opened and locked. The switches of the headlamp electrical system are located behind the left headlamp operating mechanism.

### MAINTENANCE AND ADJUSTMENTS

#### ADJUSTMENT OF HEADLAMP MECHANISM

Both headlamp assemblies must operate in unison in order to lock in either the open or closed position.

1. Adjust headlamps to be parallel in any position by changing length of right headlamp operating rod. For adjustment loosen clamp bolt (A). See Figure 8A-1.



Figure 8A-1 Headlamp Operation Adjustments

2. Adjust headlamps to lock or unlock simultaneously by adjusting lock nut (B). See Figure 8A-1.

3. Adjust headlamp assembly in opening as follows:

a. To align front of assembly vertically or horizontally, loosen bolts indicated (A) in Figure 8A-2.

b. To align front of assembly longitudinally, loosen lock nut (B) in Figure 8A-2 and bolts marked (B) in Figure 8A-3.

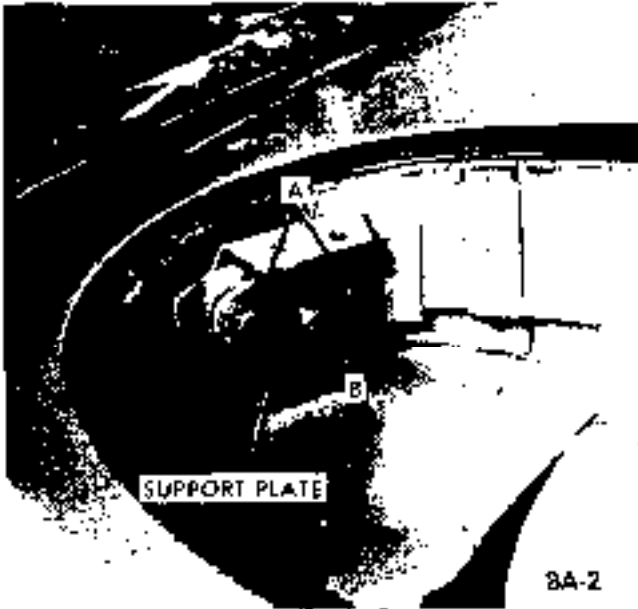


Figure 8A-2 Headlamp Assembly Front Adjustment Location

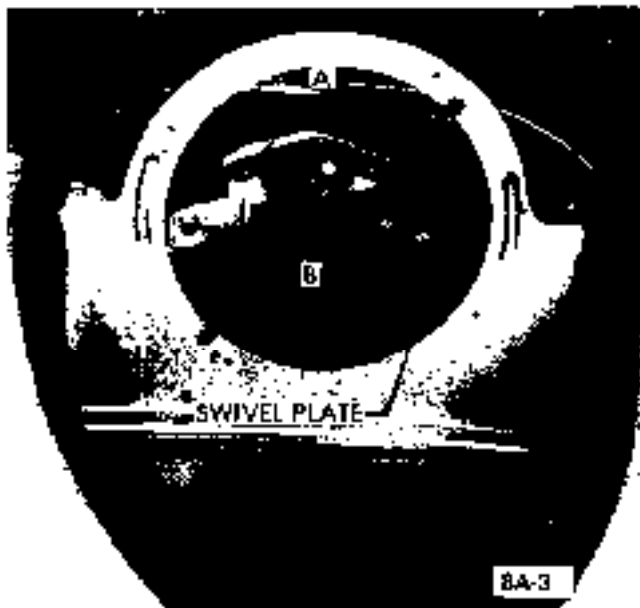


Figure 8A-3 Headlamp Assembly Rear Adjustment Location

c. To align rear of assembly vertically loosen bolts indicated (A) in Figure 8A-3.

## MAJOR REPAIR

### REMOVAL AND INSTALLATION OF HOOD

1. With a pencil, mark hinge positions on engine hood. See Figure 8A-4.



Figure 8A-4 Marking Hinge Position

2. Unscrew engine hood bolts from hinges. Hood must be aligned so that the distances to the adjacent surfaces are almost equal all around.

### REMOVAL AND INSTALLATION OF FENDER (OPEL 1900. MANTA)

1. Remove and install front bumper.
2. Remove and install radiator grille.
3. Remove and install headlamp covering.
4. Remove and install side panel trim pad.
5. Remove and install hood catch.
6. Remove and install rubber bumper (hood rest).
7. If required, remove and install direction signal lamp.
8. Unscrew attaching bolts at fender circumference and remove fender. See Figure 8A-5.



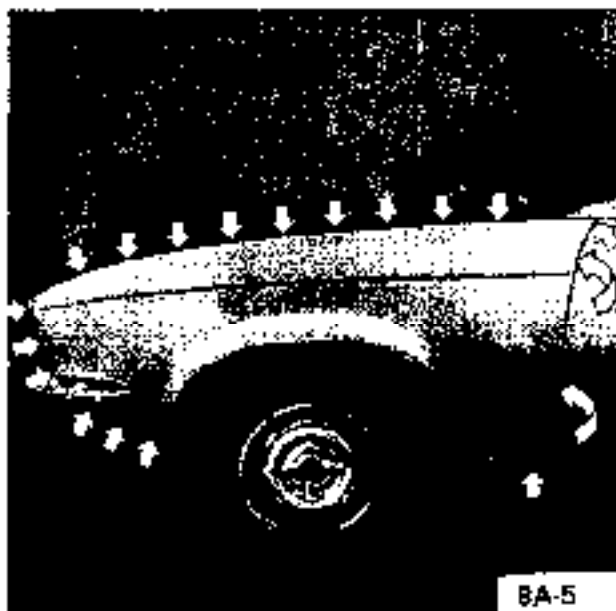


Figure 8A-5 Location of Fender Attaching Bolts

9. Fit new fender **and** apply a sealing compound, as required, to joint. See Figure 8A-6.



Figure 8A-6 Sealing Location

10. Coat fender inside with a dampening compound.

#### REMOVAL AND INSTALLATION OF HEADLAMP COVERING (OPEL 1900 - MANTA)

##### Removal

1. Remove radiator grille.

2. In engine compartment unscrew headlamp covering. See Figure 8A-7.



Figure 8A-7 Headlamp Covering Attaching Bolts

##### Installation

1. Install headlamp covering. See Figure 8A-7.
2. Install radiator grille.

#### REMOVAL AND INSTALLATION OF HEADLAMP ASSEMBLY (GT)

1. Move headlamp to open position and remove headlamp cover. See Figure 8A-8.

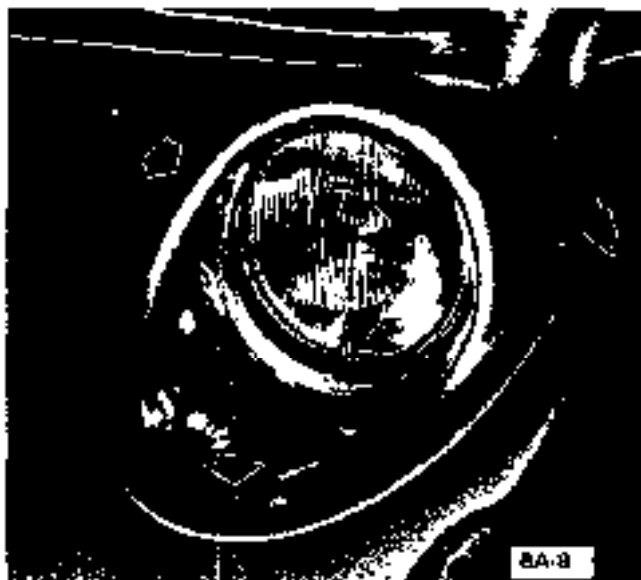


Figure 8A-8 Removing Headlamp Cap

2. Remove headlamp assembly and remove multiple plug from wire set.

3. Disconnect Bowden control wire(B). Loosen linkage at the clamp screw (A) and disconnect linkage in direction of arrows. See Figure 8A-9.



Figure 8A-9 Disconnecting Linkage

4. Mark support plate at its circumference and remove it. The marking facilitates the adjustment on reinstallation. See Figure 8A-2.

5. Mark swivel plate at its circumference and remove it. See Figure 8A-3.



Figure 8A-10 Removing Headlamp Assembly

6. To avoid damage cover headlamp upper and lower edges with tape.

Turn headlamp 90 degrees and carefully remove headlamp housing in direction of arrow. See Figure 8A-10.

7. Through access hole on fender underside, remove the two attaching screws and the screw at the upper deflector panel. See Figure 8A-11.

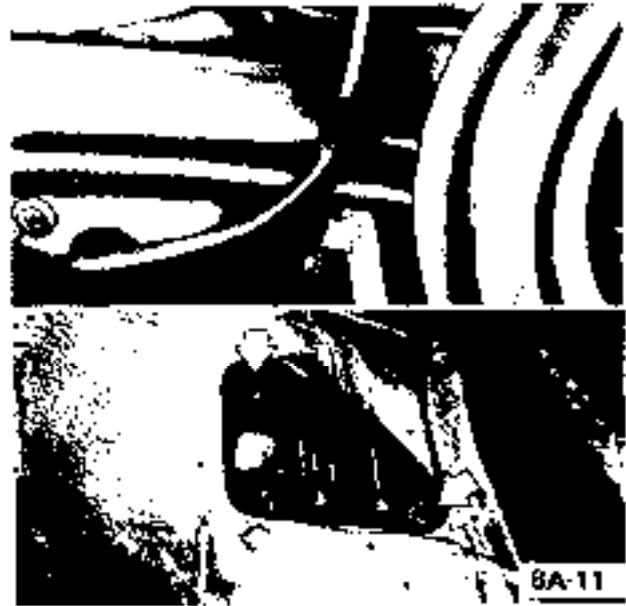


Figure 8A-1 1 Locking Mechanism Attaching Screws

8. Prior to removing, mark the individual single plugs (left headlamp only) and remove lock assembly. See Figure 8A-12.

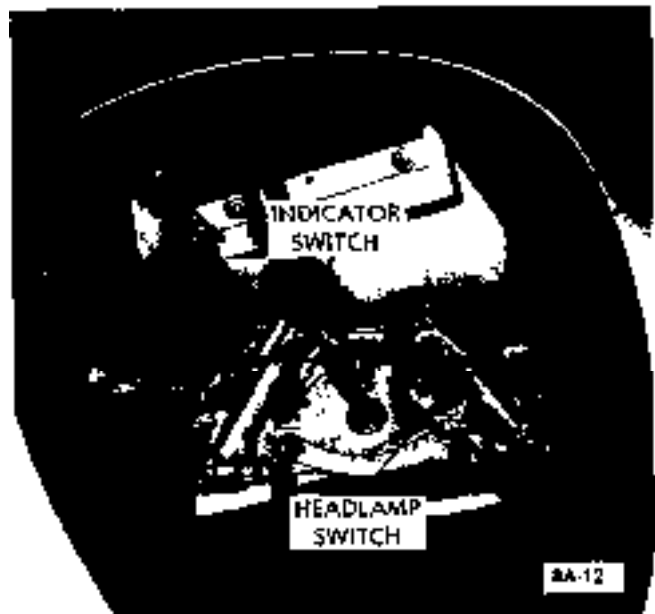


Figure 8A-1 2 Headlamp and Headlamp Indicator Switches

9. On installation make sure that the gaps between headlamp housing in closed position and headlamp opening is equal all round and housing is flush in its height with the body.

**REMOVAL AND INSTALLATION OF HEADLAMP CABLE ASSEMBLY**

**Removal**

1. Remove cotter pin. See Figure 8A-13 "C."
2. Remove trunion block and nut. See Figure 8A-13 "D."
3. Remove outer adjusting nut and pull cable through bearing. See Figure 8A-13 "B."
4. Pull cable through front chassis support.
5. Hoist car.
6. Remove wire clip and unsnap ball seat at control lever. See Figure 8A-14 "A."
7. Remove ball-socket and lock nut. See Figure 8A-14 "B."
8. Remove rear adjusting nut. See Figure 8A-14 "C."
9. Remove cable from retainers.



Figure 8A-14 Removing Ball Seat at Control Lever

11. Install adjusting lock nut approximately 1/2" on thread. See Figure 8A-13 "B."
12. Install lock nut and ball stud on end of cable. See Figure 8A-14 "B."
13. Connect ball stud to control lever with clip. See Figure 8A-14 "A."
14. Adjust lock nut under vehicle for maximum cable length. See Figure 8A-14 "C."
15. Thread cable through proper openings in body and install adjusting lock nut, trunion lock nut, trunion, and lock clip.
16. Adjust cable length for proper headlight operation.

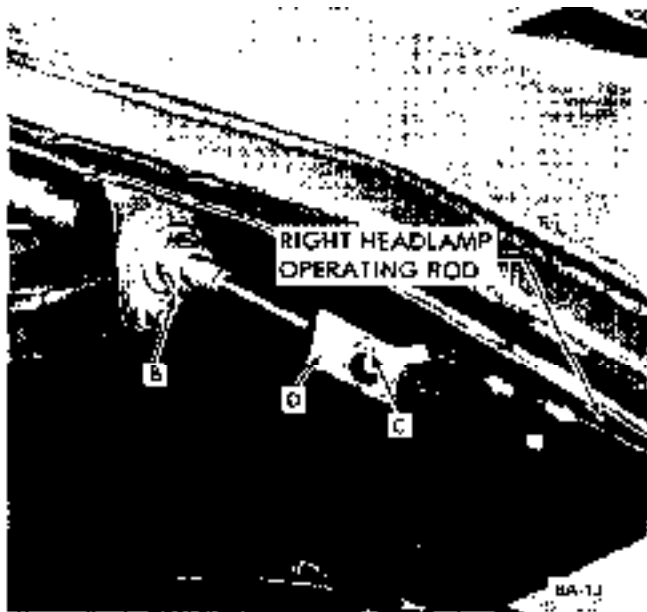


Figure 8A-13 Removing Headlamp Trunion Block

**Installation**

10. Thread cable through bearing and clip retainers.

**REMOVAL AND INSTALLATION OF RADIATOR GRILLE (GT)**

**Removal**

Remove screws securing grille screen to opening.

**Installation**

Install grille screen to opening and secure with screws.

**REMOVAL AND INSTALLATION OF RADIATOR GRILLE EXTENSIONS (GT)**

**Removal**

1. Remove hex head screw and washer holding grille extension to baffle plate.

2. Remove two plastic caps and phillips screws from outer end of grille extension.
3. Remove grille extension,

Installation

1. Install grille extension and secure with Phillips screws and two (2) plastic caps.
2. Install hex head screw and washer holding grille extension to baffle plate.

**REMOVAL AND INSTALLATION OF RADIATOR GRILLE (OPEL 1900. MANTA)**

**A. Removal (Model 57)**

1. Remove the five (5) radiator grille attaching screws. See Figure 8A-15.



Figure 8A-15 Radiator Grille Attaching Screws

2. Remove radiator grille towards the top so that the lower guide pins do not break off. See Figure 8A-16.

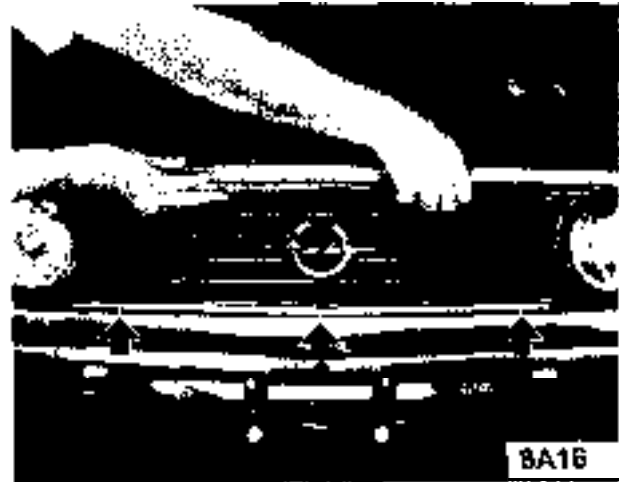


Figure 8A-16 Removing Radiator Grille

**Installation (Model 57)**

1. Install radiator grille, aligning guide pins into lower panel. See Figure 8A-16.
2. Secure grille with five (5) attaching screws. See Figure 8A-2.

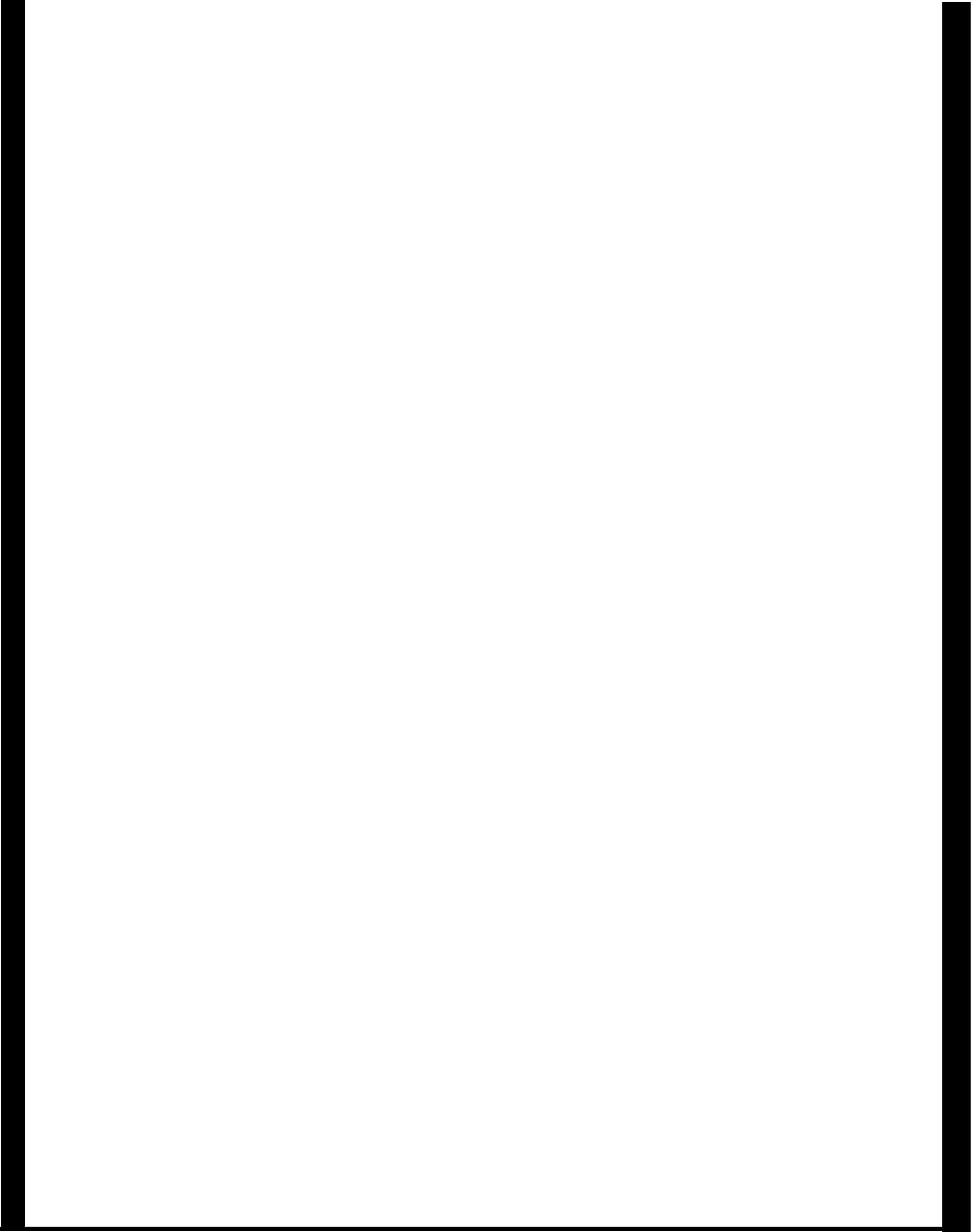
**Removal (Models 51.53, and 54)**

1. Remove the three (3) radiator grille attaching screws. See Figure 8A-17.



Figure 8A-17 Location of Radiator Grille Attaching Screws

2. Remove radiator grille towards the top so that the lower guide pins do not break off.



---

**GROUP 9**

**ACCESSORIES**

Section	Title	Page No.
<b>9A</b>	HEATER	
	GT. Opel 1900—Manta.	9A- 2 9A- 10
<b>9B</b>	AIR CONDITIONING	
	Refrigerant C o m p o n e n t s	9B- 17
	Air Conditioner System Opel 1900—Manta.	9B- 90
	Air Conditioner System G T .	9B- 97
<b>9C</b>	RADIO	
	GT..... Opel 1900—Manta.	9C-105 9C-109

## HEATER SYSTEM - GT

### CONTENTS

Subject	Page No.
<b>DESCRIPTION AND OPERATION:</b>	
Flow-Through Ventilation System .....	9A-2
Heater System Description .....	9A-2
Heater System Operation .....	9A-4
<b>DIAGNOSIS:</b>	
Heater and Defroster .....	9A-4
<b>MAINTENANCE AND ADJUSTMENTS:</b>	
Control Cable Adjustment .....	9A-4
<b>MAJOR REPAIR:</b>	
Removal & Installation Instrument Panel	
Fresh Air Outlet .....	9A-5
Removal & Installation Kick Panel Fresh	
Air Outlet .....	9A-5
Removal & Installation Blower Switch .....	9A-5
Removal & Installation Heater .....	9A-5
Removal & Installation Defroster Outlet .....	9A-8
Removal & Installation Heater Valve .....	9A-9
<b>SPECIFICATIONS:</b>	
Specifications .....	9A-9

### DESCRIPTION AND OPERATION

#### FLOW-THROUGH VENTILATION SYSTEM

A separate ventilation system for direct intake of outside air is controlled by two plastic fresh air inlet nozzles in the side kick panels and two lever operated inlet nozzles located on either end of the instrument panel assembly.

The air allowed to enter the passenger compartment will exit through outlets on both sides of the back glass. See Figure 9A-1.

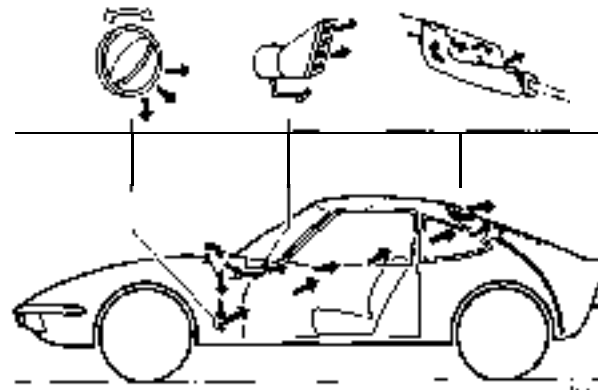
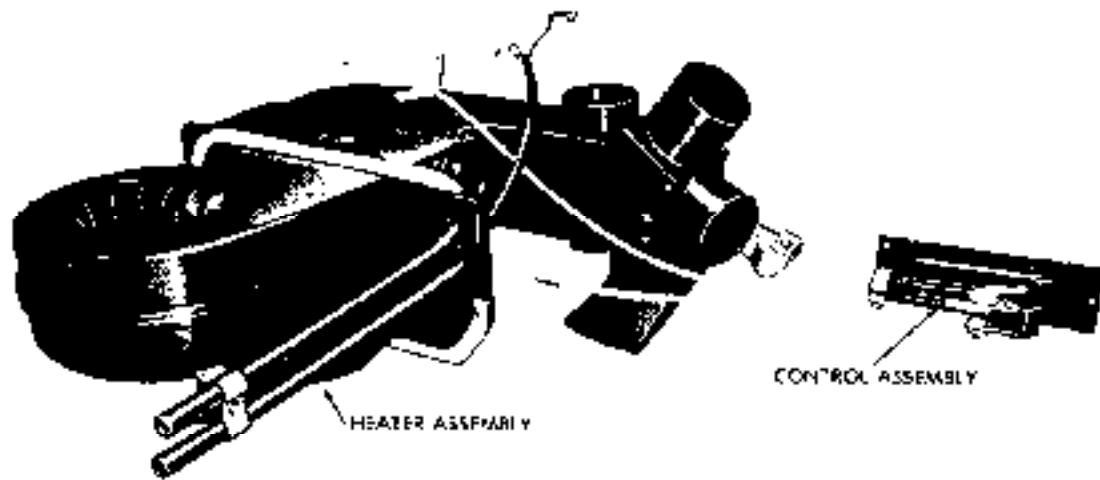


Figure 9A-1 GT Air Flow

#### HEATER SYSTEM DESCRIPTION

The GT heater system consists of two components assemblies: (1) heater assembly, and (2) control assembly. The heater assembly consists of the heater housing and air valves; heater core and blower motor and fan assembly.

The flow of air enters the car through the cowl; passes through the blower fan, through or around the heater core, past the air inlet door and is then directed to either the floor outlets or defroster outlets or both depending on the position of the defroster door.



9A-2

Figure 9A-2 Heater Assembly-Rear View

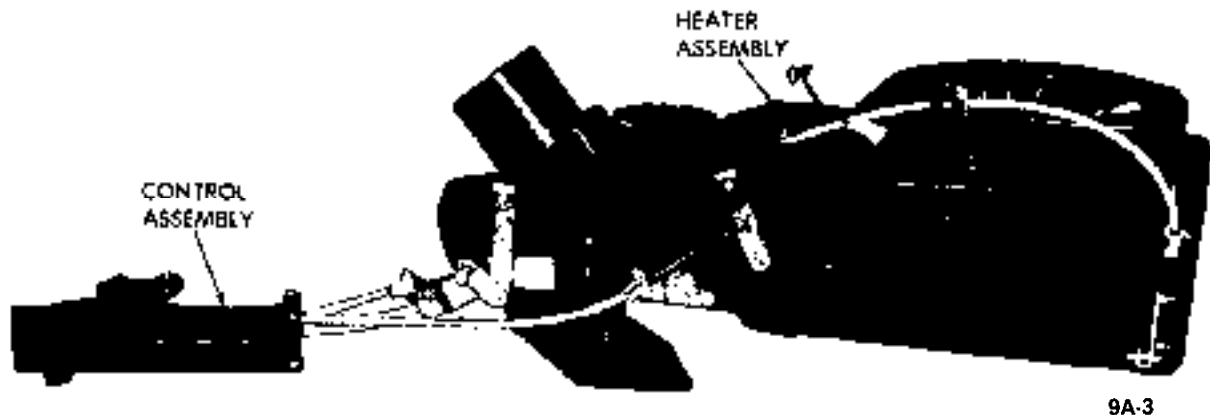
The heater-defroster air door directs the air to the floor outlets, defroster outlets, or apportions the air flow to both outlets depending on the position of the door. A manual water valve regulates the flow of coolant through the heater core, thereby varying the temperature of the air flow past the core. The blower motor is located in the forward portion of the heater housing. See Figure 9A-2.

Opening and closing of the heater defroster air door and manual water valve is accomplished by bowden cables connected to the heater control. The heater controls function as follows:

**Air Inlet-Defroster Control (Upper Lever)** This

control (See Figure 9A-4) opens and closes the air inlet and heater-defroster air door which channels the air flow to either the heater outlets or to defroster outlets, or to both outlets simultaneously, depending on the position of the control.

**Temperature Control (Lower Lever)** • This lever regulates the flow of coolant through the heater core and the amount of air that can by-pass heater core thereby increasing or decreasing the air temperature proportionate to its travel (toward red square-warm; toward blue square-cold). Unheated air may be circulated through the car by leaving the temperature control in the OFF position (blue square).



9A-3

Figure 9A-3 Heater Assembly-Front View





Figure 9A-4 Heater Control

**Blower Switch** - This switch actuates blower motor to low or high blower speed.

#### HEATER SYSTEM OPERATION

To operate heater proceed as follows:

1. Position air inlet, heater-defroster control as desired.

White arrow head pointing down--air out of heater outlets. White arrow head pointing up--air out of defroster outlets.

Between lower and upper position--air to both heater and defroster outlets.

2. Position temperature control as desired to increase or decrease temperature of air flow.
3. Position blower switch as desired to operate blower at low or high speed.

### DIAGNOSIS

#### HEATER SYSTEM TROUBLE DIAGNOSIS

##### TROUBLE

Temperature of heated air at outlets too low.

##### CAUSE AND CORRECTION

Check radiator cap for proper sealing action-- replace if necessary.

Check for adequate coolant supply. If level is down, correct cause of coolant loss and **refill** radiator.

Inspect hose for kinks--relieve kink or replace hoses.

Check thermostat operation by measuring temperature of coolant at radiator. Temperature should be within 5 degrees F. of thermostat rated value (189 degrees F.).

Check that air doors and water temperature control valve are operating properly.

Check for plugged heater core--backflush heater core as necessary.

##### TROUBLE

Inadequate defrosting action.

##### CAUSE AND CORRECTION

Examine heater-defroster door for proper operations--adjust **bowden cable** as required so that door is fully closed in FULL DEFROST position.

Check that air hoses connecting to defroster outlets are secure.

Check for air leaks around edges of heater air distributor housing--seal leaks as necessary with body sealer. Check for body air leaks and seal as necessary with body sealer.

##### TROUBLE

Blower inoperative.

##### CAUSE AND CORRECTION

Check blower fuse--replace if necessary, fuse position 3 - amperage 8.

Check wiring for open circuit--correct as required.

Inspect for defective component (i.e., blower switch or blower motor)--replace or repair as necessary.

### MAINTENANCE AND ADJUSTMENTS

#### CONTROL CABLE ADJUSTMENT

Adjustment of control cables is accomplished by positioning of the jacket or sheath of the control cable as held by the clamps on the control assembly and heater case.

To adjust control cables, loosen clamps and move cable sheath in or out as required to obtain full travel of lever or of door or both.

## MAJOR REPAIR

### REMOVAL AND INSTALLATION INSTRUMENT PANEL FRESH AIR OUTLET

#### Removal

1. Remove instrument panel cover assembly. Refer to Group 1.
2. Snap grille out of outlet.
3. Remove knob from lever and remove outlet.

#### Installation

1. Install outlet and knob onto lever.
2. Snap grille into outlet.
3. **Install** instrument panel cover assembly. Refer to Group 1.

### REMOVAL AND INSTALLATION KICK PANEL FRESH AIR OUTLET

#### Removal

Using a screwdriver, carefully pry out outlet.

#### Installation

Install outlet.

### REMOVAL AND INSTALLATION BLOWER SWITCH

#### Removal

1. Remove instrument panel assembly. Refer to Group 1.
2. Unscrew switch assembly from panel.

#### Installation

1. Screw switch assembly to instrument panel.
2. Install instrument panel assembly. Refer to Group 1.

### REMOVAL AND INSTALLATION HEATER

#### Removal

1. Remove lower radiator hose, drain, and collect coolant.

2. Detach coolant feed (A) and return (B) hoses, in engine compartment from heater core. See Figure 9A-5.

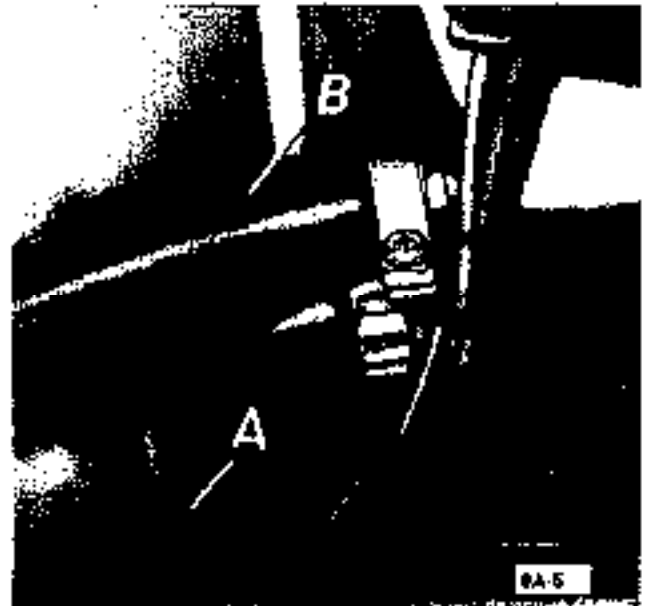


Figure 9A-5 Heater Hose Connections

3. In engine compartment remove hood lock control cable retaining clip and cable from lock bar. See Figure 9A-6.



Figure 9A-6 Hood Release Control Cable

4. Remove console shift cover between seats using the following instructions:
  - a. Remove ash tray and remove two screws under it.

b. Remove retaining screw in headlamp lever handle and remove handle.

c. Console cover is held in place by four push button type studs, unsnap studs by prying cover up and work cover upwards over shift lever and rubber shift lever boot.

5. Remove left cover and right plug in instrument panel cover and through openings remove instrument panel attaching screws (points A and B). See Figures 9A-7 and 9A-8. At this point it will be necessary to lower the steering column, refer to Group 3 for this procedure.

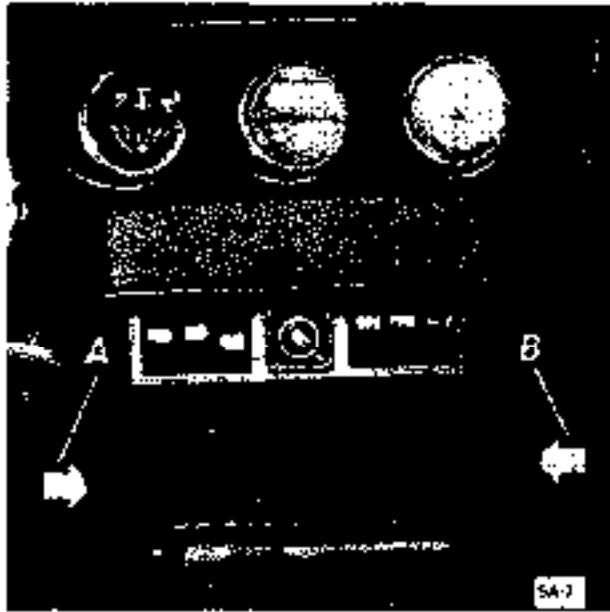


Figure 9A-7 Instrument Panel Cover Screw Cover and Plug Locations

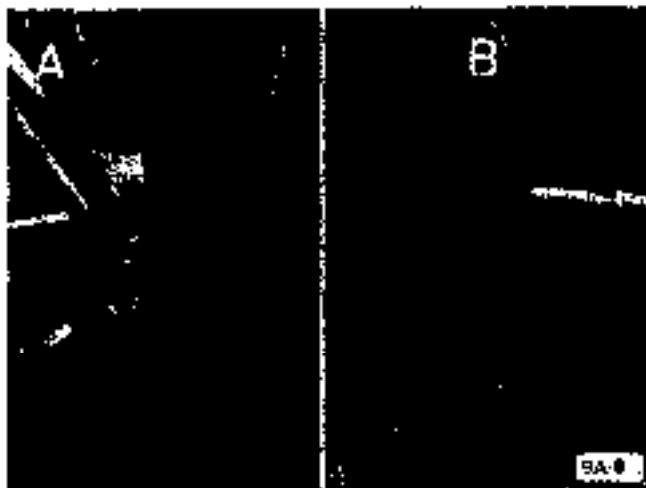


Figure 9A-8 Location of Hidden Screws

6. Remove two multiple wire plug connectors from steering column harness.

7. Detach speedo cable

8. Remove directional signal flasher unit. See Figure 9A-9.



Figure 9A-9 Directional Flasher Unit

9. Remove 6 instrument cluster retaining screws. See Figure 9A-10.



Figure 9A-10 Removing Instrument Cluster retaining Screws

10. Grasp instrument cluster and pull straight back, being careful of wires, etc. See Figure 9A-11.

11. Unscrew heater controls (A) and support bracket (B). See Figure 9A-12.

12. Disconnect heater and defroster duct hoses from instrument panel. See Figure 9A-13.



Figure 9A-11 Removing Instrument Cluster



Figure 9A-12 Heater Control Screws and Support Bracket



Figure 9A-13 Heater and Defroster Duct Hoses

13. Remove all screws from instrument panel padding and remove it from instrument panel. Arrow in Figure 9A-14 show location at left side of dash panel and windshield. Screws are located in same areas on right side.



Figure 9A-14 Instrument Panel Padding Screws

14. Remove one bolt at top of heater blower case and two nuts from bottom of the case, and remove heater blower and case assembly. See Figure 9A-15.



Figure 9A-15 Location of Heater blower Case Bolt and Screws

15. On removed heater assembly check relative position of mixed air door so that on installation of unit hand control levers can be positioned according to unit settings, either opened or closed position.

**Installation**

1. Install heater blower and case assembly, securing with one (1) bolt at the top and two (2) nuts from the bottom. See Figure 9A-15.
2. Install instrument panel padding and connect heater and defroster duct hoses, making sure hoses are properly positioned and connected. See Figure 9A-16.

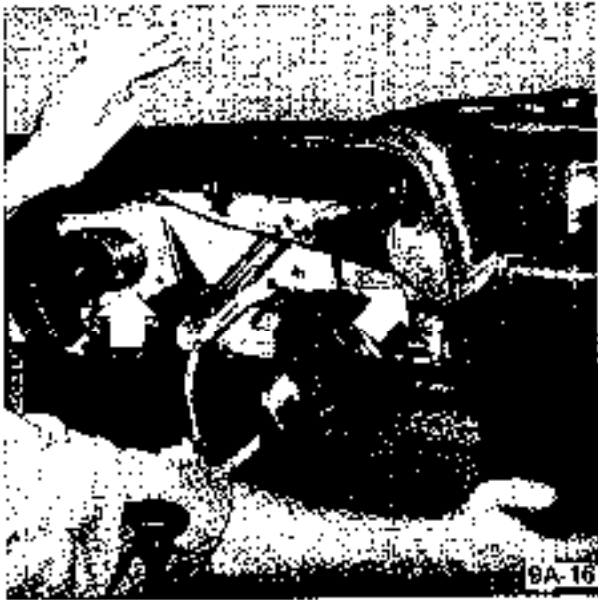


Figure 9A-16 Heater and Defroster Duct Hoses

3. Install support bracket (B) and heater control (A). See Figure 9A-12.
4. Carefully push cluster back into instrument panel housing, making sure electrical wires, etc., are not pinched.
5. Install six (6) cluster retaining screws. See Figure 9A-10.
6. Install directional signal flasher. See Figure 9A-9.
7. Attach speedometer cable.
8. Attach two (2) multiple wire plug connectors in steering column harness.
9. Install steering column. Refer to Group 90.
10. Install instrument panel cover and attach through openings (points A and B). See Figures 9A-7 and 9A-8.
11. Install right and left opening covers.

12. Install the console shift cover between the seats using the following instructions:
  - a. Install console cover over shift lever and rubber shift lever boot.
  - b. Install cover by pushing down until cover snaps into the four (4) push button type studs.
  - c. Install two (2) screws under ash tray opening and install ash tray.
13. In engine compartment, install hood lock control cable to lock bar using retaining clip. See Figure 9A-6.
14. Attach return hoses (B) and coolant feed hoses (A) to heater core. See Figure 9A-5.
15. Attach lower radiator hose and add collected coolant.
16. Check for proper operation and leaks in system.

**REMOVAL AND INSTALLATION DEFROSTER OUTLET**

**Removal**

1. Remove instrument panel cover assembly. Refer to Group 1.
2. Remove screws securing outlet to cover assembly.

**Installation**

1. Install defroster outlet, securing with screws.
2. Install instrument panel cover assembly. Refer to Group 1.

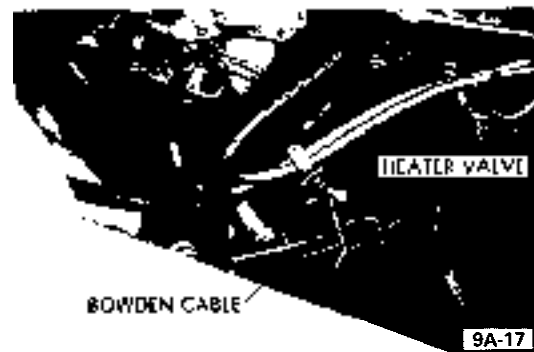


Figure 9A-17 Heater Valve

**REMOVAL AND INSTALLATION HEATER VALVE**

**Removal**

1. Remove lower radiator hose and drain and collect coolant.
2. Disconnect control cable.
3. Loosen heater hose clamps and remove valve from hoses. See Figure 9A-17.

**Installation**

1. Install valve into heater hoses and install hose clamps.
2. Connect control cable.
3. Install lower radiator hose and add collected coolant.

**SPECIFICATIONS**

Engine		
Recommended Coolant .....	Ethylene-Glycol	Base
Thermostat Opens At (Degrees) F. ....		189
Cooling System Capacity (With Heater) .....		6 Qt.
Blower Motor Type .....		12 VDC
Blower Fan Type .....	Squirrel	Cage

# HEATER SYSTEM

## OPEL 1900 - MANTA

### CONTENTS

Subject	Page No.
<b>DESCRIPTION AND OPERATION:</b>	
Heater System .....	<b>9A-10</b>
Function of the Heater and Ventilation System .....	<b>9A-11</b>
<b>DIAGNOSIS:</b>	
Heater System Trouble Diagnosis .....	<b>9A-11</b>
<b>MAINTENANCE AND ADJUSTMENTS:</b>	
Control Cable Adjustment .....	<b>PA-12</b>
<b>MAJOR REPAIR:</b>	
Removal & Installation Heater Housing, .....	<b>PA-12</b>
Removal & Installation Defroster Jets .....	<b>9A-13</b>
Removal & Installation Heater Control Housing . . .	<b>9A-14</b>
Removal & Installation Heater Motor .....	<b>9A-15</b>
<b>SPECIFICATIONS:</b>	
Specifications .....	<b>9A-16</b>

## DESCRIPTION AND OPERATION

### HEATER SYSTEM

The temperature of the air entering the vehicle is regulated by the heater valve and the blower. The distribution of this air is controlled by the heater air distributor housing under the instrument panel.

Moving the upper control lever from the left towards the right opens the heater valve. This lever regulates the flow of coolant through the heater core and thereby increases or decreases the air temperature proportionate to its travel. See Figure 9A-30.

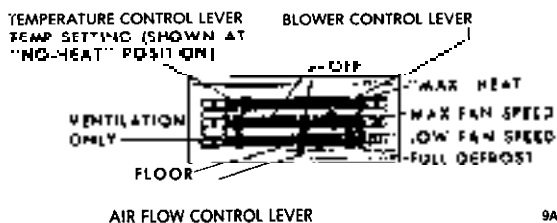


Figure 9A-30 Heater Control Assembly

The connectors for water inlet and outlet are located on the left side of the heater core, viewed in driving direction. The coolant flow is shown in the drawing. See Figure 9A-31.

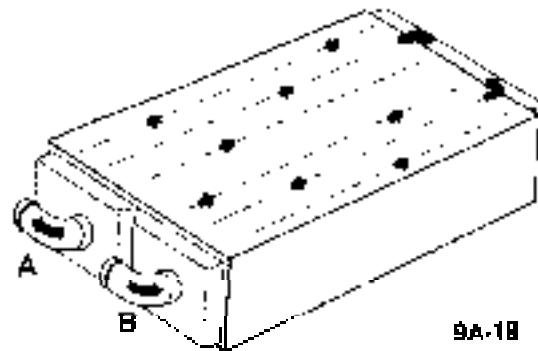


Figure 9A-31 Coolant Flow in Heater Core

Due to the separation of the inflowing and outflowing water in the heater core, an even heating of the

air is attained, as the water does not cool down in the second part of the core.

A Water Outlet

B Water Inlet

The center lever actuates the two-stage blower motor.

Lever positions:

Left to Center - Motor Switched Off

Right of Center - **Lo** Blower

Right - **Hi** Blower

The lower lever opens and closes the air door which channels the air flow to either the lower heater outlets or to the defroster outlets.

In the left lever position, the air inlet is closed. Up to the center position, the air is directed to the lower heater outlets.

When moving the lever from center position towards the right, the air flow to the lower **heater** outlets is reduced and increased to the defroster outlets.

With the lever in its right position, the air is directed to the defroster outlets only. For windshield defrosting, all levers have to be moved to the right.

### FUNCTION OF THE HEATER AND VENTILATION SYSTEM

The engine hood is provided with slots in front of the windshield. The air is directed through the slots into the heater housing located in the engine compartment, flows into the air distributor housing, and from there to the lower heater outlets and/or defroster outlets, depending on the position of the control.

The two-stage blower motor is arranged in the heater housing above the heater core and actuated by the center control. The blower motor draws in the air entering through the slots, blows the air through the heater core into the air distributor housing, and from there to the lower heater outlets and/or defroster outlets, depending on the position of the lower control. See Figure 9A-32.

The heater valve regulates the flow of coolant through the heater core, thereby varying the temperature of the air flow past the core.

The ventilation of vehicle interior is completed by a draft-free air circulation pattern. Vent slots are arranged below the back window which are connected through channels to the rear quarter side panel. From here, the inside air escapes into the open. The

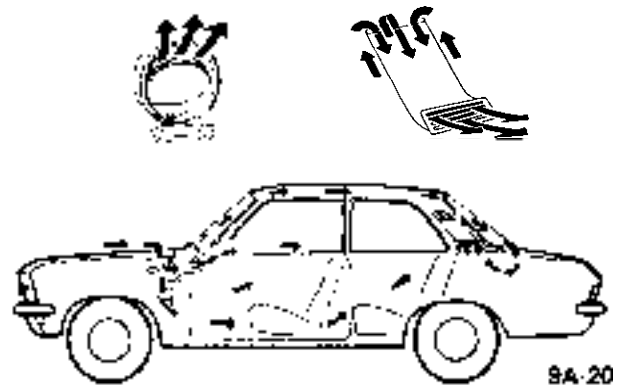


Figure 9A-32 Air Flow

head wind (caused by the car traveling down the road) promotes this process so that there is always fresh air in vehicle interior.

On the Model 54 Station Wagon, there will be no air outlets in the rear. For adequate flow-through type ventilation, it will be necessary to open a rear window.

Aside from the fresh air admission through the heater system, two fresh air inlet nozzles are arranged in the center of the instrument panel. These nozzles can be turned to direct the air flow in the desired direction. In addition, rotary flaps allow the regulation of the entering air or to shut off the air completely.

These nozzles admit unheated fresh air only and operate independent of the heater and defroster system.

## DIAGNOSIS

### HEATER SYSTEM TROUBLE DIAGNOSIS

#### TROUBLE

Temperature of heated air at outlets too low.

#### CAUSE AND CORRECTION

Check radiator cap for proper sealing action. Replace, if necessary.

Check for adequate coolant supply. If level is down, correct cause of coolant loss and refill radiator.

Inspect hose for kinks. Relieve kink or replace hoses.

Check thermostat operation by measuring temperature of coolant at radiator. Temperature should be within 5 **degrees** F. of thermostat rated value (189 degrees F.).



Check that air doors and water temperature control valve are operating properly.

Check for plugged heater core-backflush heater core as necessary.

### TROUBLE

Inadequate defrosting action.

### CAUSE AND CORRECTION

Examine heater-defroster door for proper operation. Adjust **bowden** cable so that door is fully closed in FULL DEFROST position.

Check that air hoses connecting to defroster outlets are secure.

Check for air leaks around edges of heater air distributor housing. Seal leaks, as necessary, with body sealer. Check for body air leaks and seal, as necessary, with body sealer.

### TROUBLE

Blower inoperative.

### CAUSE AND CORRECTION

Check blower fuse. Replace, if necessary, fuse position 4 - amperage 15.

Check wiring for open circuit. Correct, as required.

Inspect for defective component, (i.e., blower switch or blower motor) - replace or repair as necessary.

### MAINTENANCE AND ADJUSTMENTS

#### CONTROL CABLE ADJUSTMENT

Adjustment of control **cables** is accomplished by positioning of the **jacket** or sheath of the control cable, as held by the clamps on the control assembly and heater case or by loosening screws and sliding **bowden** wire to obtain desired door or water valve position.

### MAJOR REPAIR

#### REMOVING AND INSTALLING HEATER HOUSING

##### Removal

1. Unscrew hood lock together with ground wire

(ground wire only on vehicles with radio interference suppression). See Figure 9A-33.

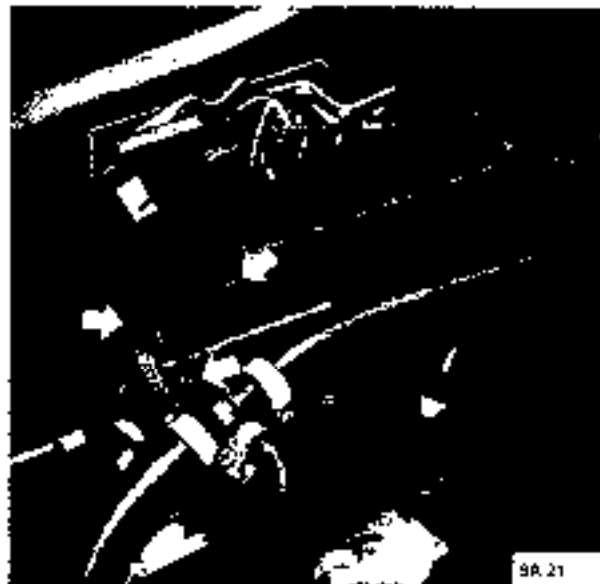


Figure 9A-33 Hood Lock Attachments

2. Unscrew heater housing cover.
3. Pull hose of windshield washer system off jet and take jet out of housing cover.
4. Unscrew **bowden** control wire from heater valve.
5. Unscrew heater housing from dash panel and pull it off carefully. See Figure 9A-34.

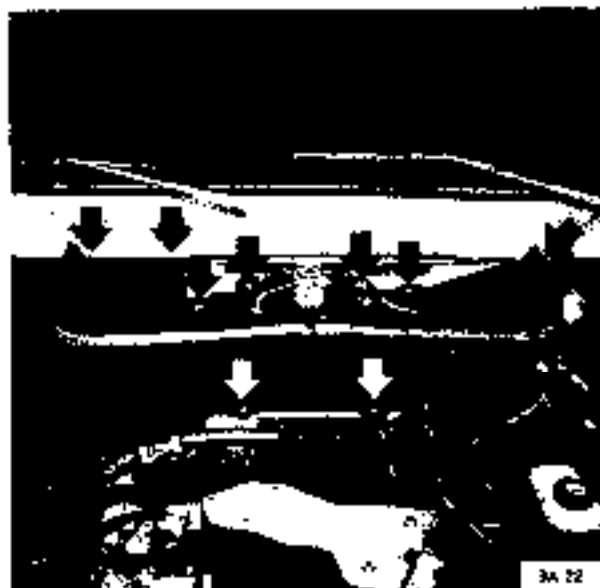
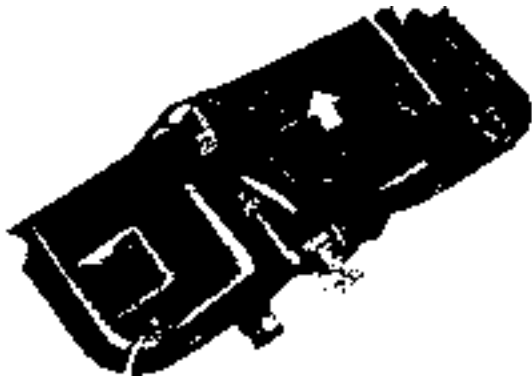


Figure 9A-34 Heater Housing Attachments

6. Remove **water** hoses from heater core and pull heater core out of heater housing. See Figure 9A-35.



9A-23

Figure 9A-23 Heater Core

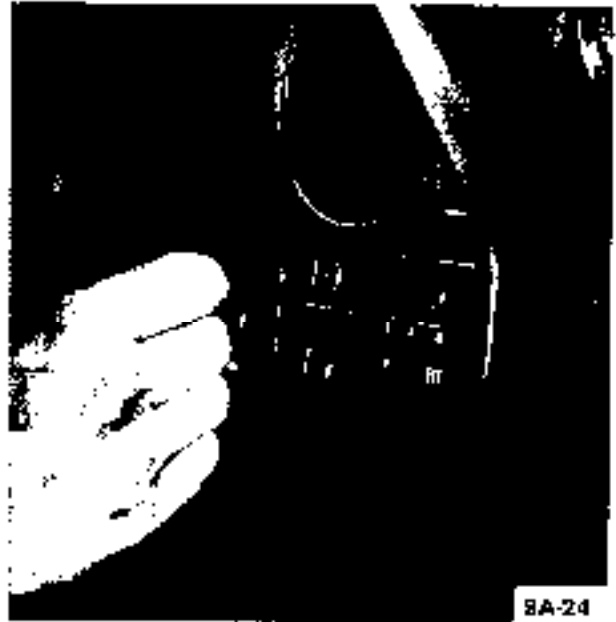
#### Installation

1. Apply sealing compound between heater housing and dash panel.
2. Install heater core into heater housing and attach water hoses. See Figure 9A-35.
3. Install heater housing to dash panel. See Figure 9A-44.
4. Install bowden control wire to heater valve.
5. Install windshield washer jet into housing cover and attach hose.
6. Install heater housing cover, and seal with a sealing compound.
7. Install hood lock, together with ground wire (ground wire only on vehicles with radio interference suppression).

#### REMOVING AND INSTALLING DEFROSTER OUTLETS

##### Removal

1. Pull out heater switch lever. See Figure 9A-36.
2. Remove instrument cover.
3. Unscrew bowden control wires from heater valve and air distributor housing and pull out heater controls.
4. Remove glove compartment.

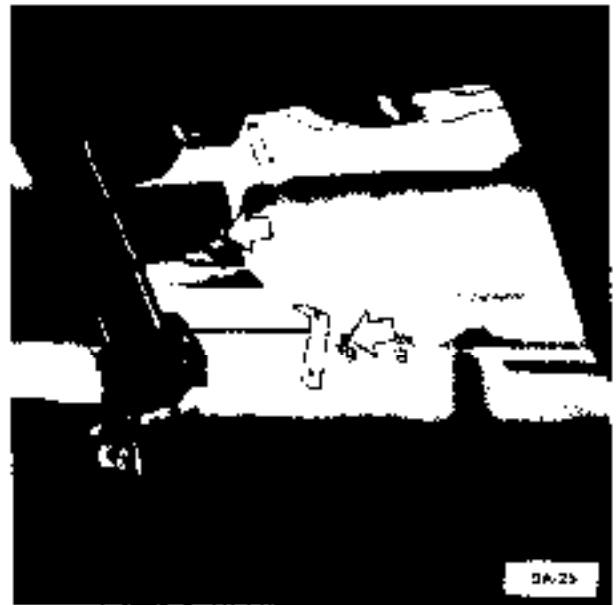


9A-24

Figure 9A-24 Removing Heater Switch Lever

5. Remove radio.

6. On right side, viewed in driving direction, remove air distributor housing attaching screws. See Figure 9A-37



9A-25

Figure 9A-25 Air Distributor Housing Attaching Screws

7. On left side, viewed in driving direction, remove upper attaching screw through opening for heater control housing and lower attaching screw below instrument panel. See Figure 9A-38.

8. Pull air distributor housing off dash panel

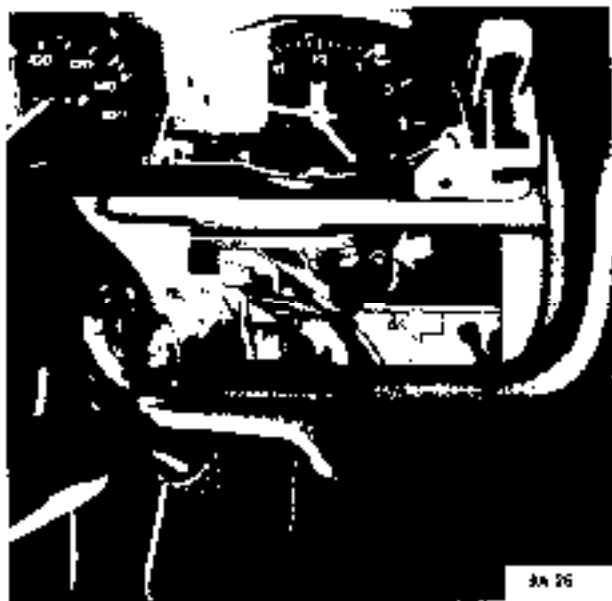


Figure 9A-38 Upper Attaching Screw

9. Pull defroster outlets downwards and remove outlets through glove compartment opening. See Figure 9A-39.



Figure 9A-39 Removing Defroster Jets

#### Installation

1. Apply sealing compound between air distributor housing and dash panel.
2. Install defroster outlets, securing with two (2) clips at the instrument panel. See Figure 9A-39.
3. Install air distributor housing to dash panel,
4. On left side, viewed in driving direction, install

upper attaching screw through opening for heater control housing and lower attaching screw below instrument panel. See Figure 9A-38.

5. On right side, viewed in driving direction, install air distributor housing attaching screws. See Figure 9A-37.
6. Install radio.
7. Install glove compartment.
8. Install **bowden** control wires to heater valve and air distributor housing.
9. Install instrument cover.
10. Install heater switch lever.

#### REMOVAL AND INSTALLATION OF HEATER CONTROL HOUSING

##### Removal

1. Remove instrument panel cover • refer to operation, **Removing and Installing Instrument Housing.**
2. Remove two sheet metal screws for control housing attachment. See Figure 9A-40.

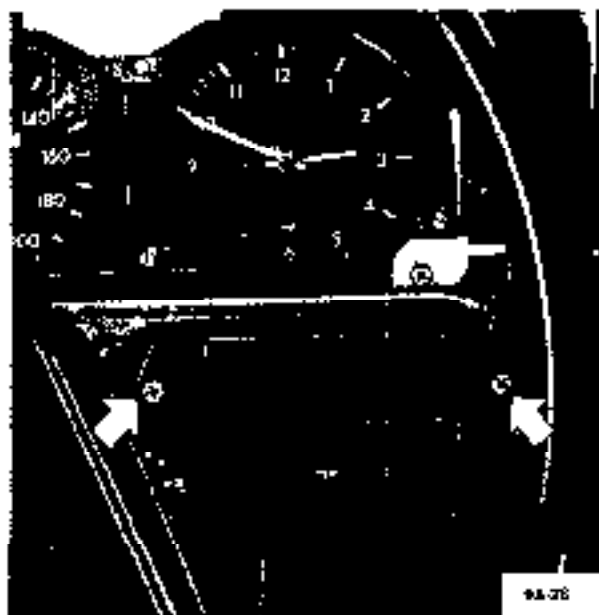


Figure 9A-40 Control Housing Attaching Screws

3. In engine compartment, detach **bowden** control wire from heater valve. See Figure 9A-41.
4. Detach **bowden** control wire from air distribution flap. See Figure 9A-42.
5. Pull wires off blower switch. See Figure 9A-43.

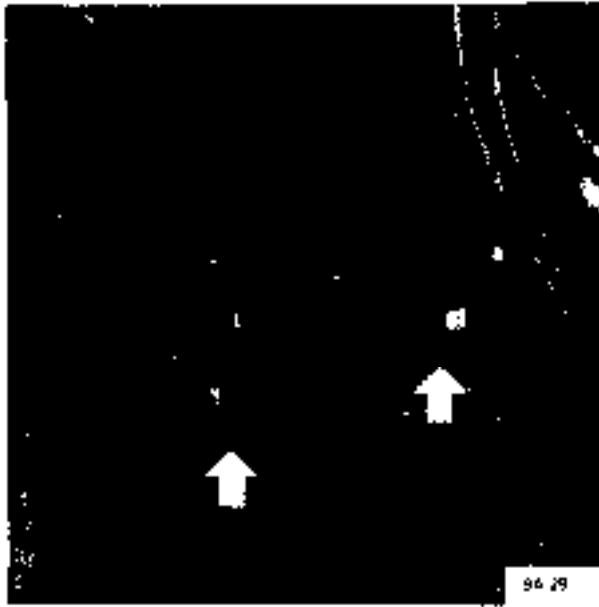


Figure 9A-41 Bowden Wire Attachment

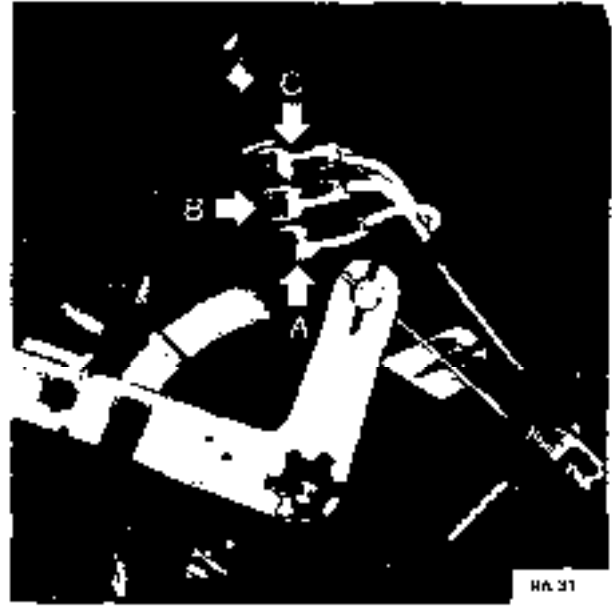


Figure 9A-43 Blower Switch Wires



Figure 9A-42 Control Wire to Distribution Door Attachment

- A • Yellow Wire
- B • Grey Wire
- C • Brown Wire

6. Remove heater control housing.

Installation

1. Install heater control housing,
2. Install wires onto blower switch. See Figure 9A-53.

- A • Yellow Wire
- B • Grey Wire
- C • Brown Wire

3. Attach bowden control wire to air distribution flap. See Figure 9A-42.

4. In engine compartment, attach bowden control wire to heater valve. See Figure 9A-41.

5. Install two (2) sheet metal screws for control housing attachment. See Figure 9A-40.

6. Install instrument panel cover.

7. Adjust bowden control wires.

REMOVAL AND INSTALLATION OF HEATER MOTOR

Removal

1. In engine compartment, remove five (5) shroud cover attaching screws. See Figure 9A-44.
2. Carefully remove cover
3. Pull water hose off windshield wiper jet.
4. Disconnect wires to heater motor. For this purpose, disconnect multiple plug connection on left side of shroud. See Figure 9A-45.
5. Remove three (3) heater motor attaching screws. See Figure 9A-46.
6. Take off motor.

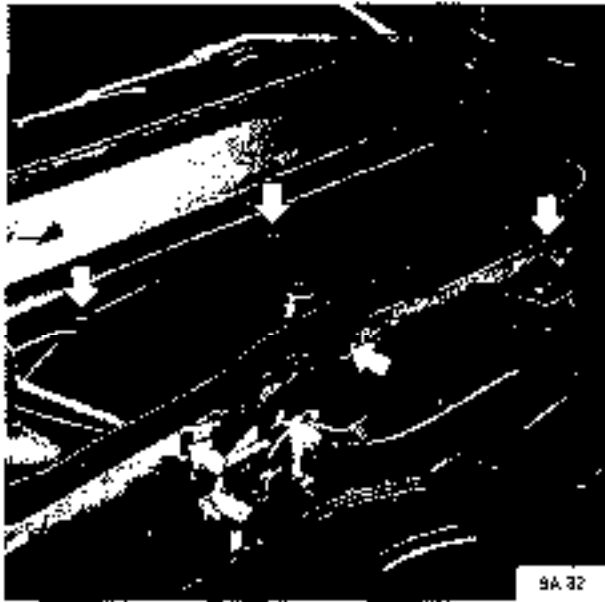


Figure 9A-44 Shroud Cover Attachments

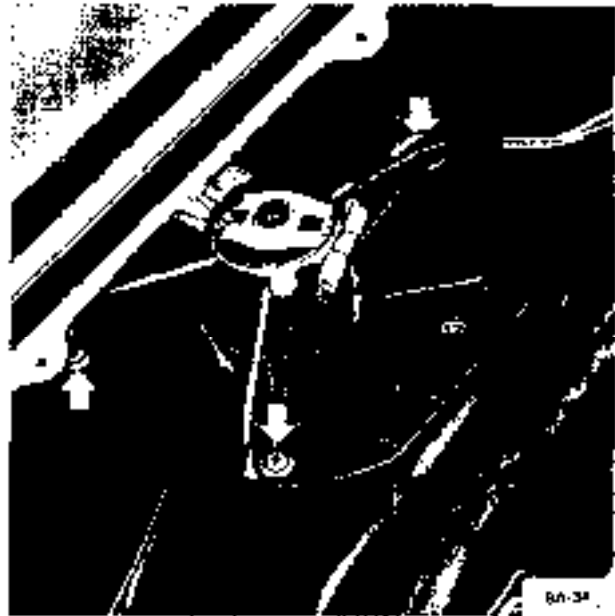


Figure 9A-46 Heater Motor Attaching Screws

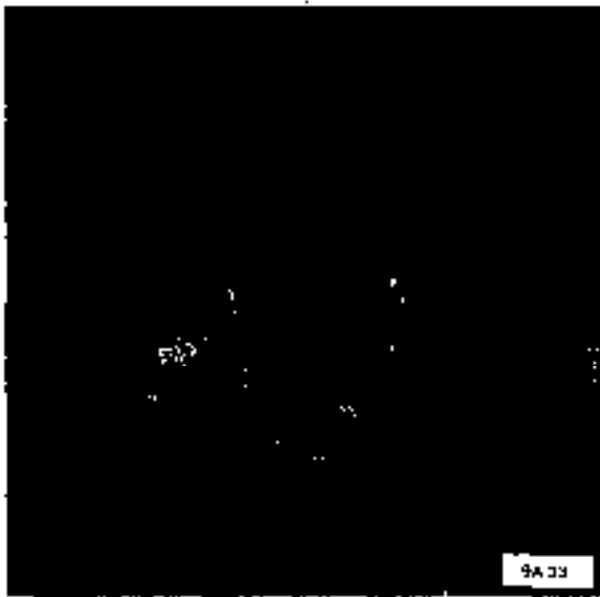


Figure 9A-45 Heater Motor Wires



Figure 9A-47 Sealing Shroud

**Installation**

1. Install heater motor, attaching with three (3) screws. See Figure 9A-46.
2. Connect multiple plug on left side of shroud. See Figure 9A-45.

3. Seal shroud cover front and rear contacting areas with sealing cement. See Figure 9A-47.
4. Install shroud cover, attaching with five (5) screws.

**SPECIFICATIONS**

**Engine**

Recommended Coolant .....	Ethylene-Glycol	Base
Thermostat Opens At (Degrees) F. ....		189
Cooling System Capacity (With Heater) .....		6 Qt.
Blower Motor Type .....		12 VDC
Blower Fan Type .....		Blade
Number of Fan Blades .....		7

# REFRIGERANT COMPONENTS

## ALL MODELS

### CONTENTS

Subject	Page No.
<b>DESCRIPTION AND OPERATION:</b>	
Fundamental Principles of Refrigeration .....	9B-18
Description of Air Conditioning Components .....	9B-33
<b>DIAGNOSIS:</b>	
General Information .....	9B-38
Leak Testing System .....	9B-39
Functional Testing System .....	9B-39
Diagnosis Guide .....	9B-40
<b>MAINTENANCE AND ADJUSTMENTS:</b>	
General Service Information and Safety Precautions; .....	9B-41
Charging and Discharging System .....	9B-41
Adding Oil to the System .....	9B-47
Flushing the System .....	9B-48
<b>MAJOR REPAIR:</b>	
Removal and Installation Compressor	
Opel 1900 . Manta .....	9B-48
GT .....	9B-56
Removal and Installation Condenser	
Receiver-Dehydrator	
Assembly - GT .....	9B-62
Receiver-Dehydrator . Opel 1900 . Manta .....	9B-49
GT .....	90-58
Removal and Installation Evaporator and Expansion Valve - Opel 1900 . Manta .....	9B-52
GT .....	9B-59
Disassembly and Reassembly of Clutch Drive	
Plate and Shaft Seal .....	9B-63
Disassembly and Reassembly of Pulley Assembly and Coil and Housing Assembly .....	9B-67
Disassembly and Reassembly of Internal Parts of Compressor and Leak Testing	
Compressor .....	9B-69
<b>SPECIFICATIONS:</b>	
Specifications.. .....	9B-82

## DESCRIPTION AND OPERATION

## FUNDAMENTAL PRINCIPLES OF REFRIGERATION

We all know **what** air conditioning does for us, **but** very few understand how or why it works. An air conditioner is functionally very similar to a refrigerator, so let's take a look at refrigeration. A refrigerator is a simple mechanism which, surprisingly enough, works quite a bit like a tea-kettle boiling on a stove. That may sound far-fetched, but there is more similarity between the two than most of us would suspect. In fact, a modern refrigerator can make ice-cubes and keep food cool and fresh only because a liquid called the refrigerant boils inside the freezer. Of course everyone knows a boiling tea-kettle is "hot" and a refrigerator is "cold". However, this is where most of us are apt to get confused. We usually think of "cold" as a definite, positive condition. Actually though, there is no such thing as "cold". The only way we can define it is in a rather negative sort of way by saying "cold" is simply the lack of heat just as darkness is the lack of light. We can't make things cold directly. All we can do is remove some of the heat they contain and they will become cold as a result. And that is the main job of any ice-box or refrigerator. Both are simply devices for removing heat.

All substances contain some heat. Theoretically, the lowest temperature that any substance could obtain is 459 degrees Fahrenheit below Zero. This may be called "Cold", and anything warmer than this contains heat. Since man has never succeeded in getting all the heat out of an object, we must think about the transfer of heat from one object to another when talking about controlling temperatures.



Figure 9B-1 Transfer of Heat

## Transfer of Heat

The only thing that will attract heat is a colder ob-

ject. Like water, which always flows down-hill, heat always flows down a temperature scale - from a warm level down to a colder one. When we hold our hands out toward the fireplace, heat flows from the hot fire out to our cold hands (Fig. 9B-1). When we make a snowball, heat always flows from our warm hands to the colder snow. In an ice-box, the ice always is colder than the stored food, so heat naturally is drawn out of the warm food by the colder ice.

## Measurement of Heat

Everyone thinks he knows how heat is measured. Thermometers are used in most homes. Whenever we speak of temperature from now on, we will mean Fahrenheit. They can tell how hot a substance is, but they can't tell us everything about heat.

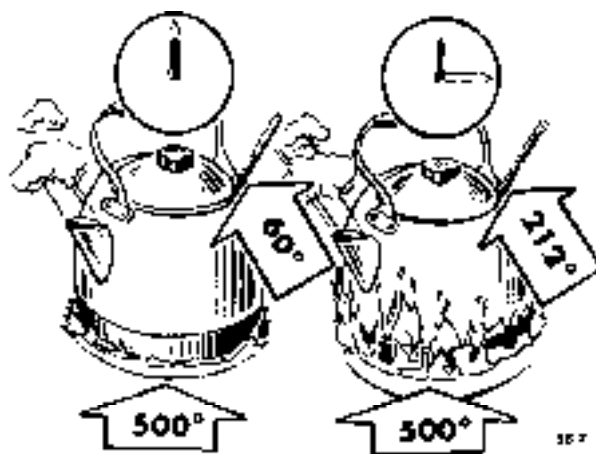


Figure 9B-2 Applied Temperature Alone is Not the Sole Measurement of Heat

When we put a tea-kettle on a stove, we expect it to get hotter and hotter until it finally boils. All during the process, we can tell exactly how hot the water is by means of a thermometer (Fig. 9B-2). However, our thermometer will show us that the flame is just as hot when we first put the tea-kettle on the stove as it is when the water finally boils. Why doesn't the water boil immediately then? Also, why does it take longer to boil a quart of water than a cupful? Obviously temperature isn't the only measurement of heat.

Even though heat is intangible, it can be measured by quantity as well as intensity. It is recognized that thermometers indicate only the intensity of heat. The unit for measuring quantity of heat is specified as that amount necessary to make 1 pound of water 1 degree warmer (Fig. 9B-3). We call this quantity of heat a British Thermal Unit. Often it is abbreviated to Btu.

Perhaps we can get a better idea of these two charac-

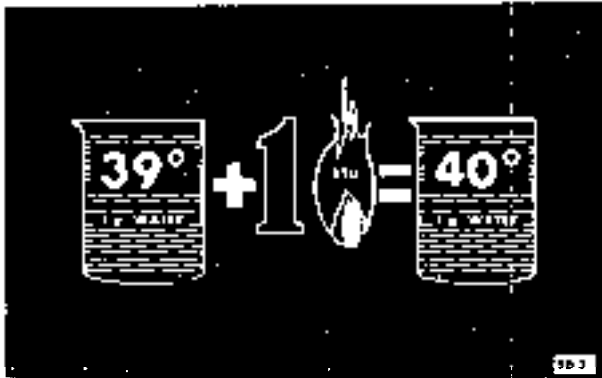


Figure 9B-3 Effect of One B.T.U. on One Pound of water

teristics of heat if we think of heat as a sort of coloring dye. If we add one drop of red dye to a glass of water, it will turn slightly pink. Another drop will make the water more reddish in color (Fig. 9B-4). The more drops of dye we add, the redder the water will get. Each drop of dye corresponds to 1 Btu and the succeeding deeper shades of red are like increases in temperature.

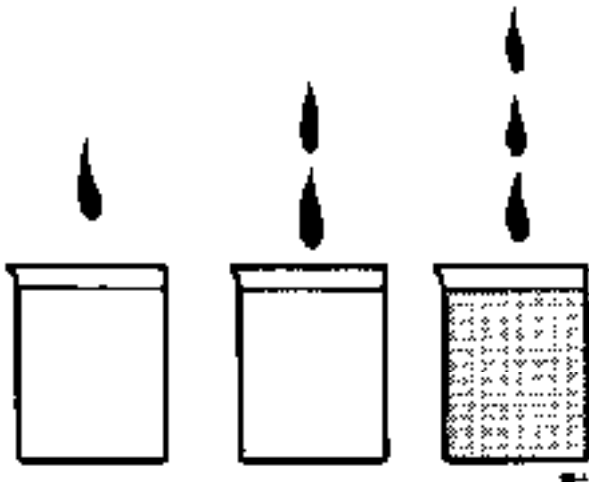


Figure 9B-4 Addition of B.T.U. Heats Water

It may seem a little puzzling to talk about heat in a story on air conditioning but, when you stop to think about it, we are handling heat exclusively. Although we ordinarily think of an air conditioner as a device for making air cold, it doesn't do that directly. What it does is take heat away from the incoming air and transfer that heat outside the vehicle.

We know now that cold is nothing more than the absence of heat, and that heat always flow from a warm object to a colder one. We also have a clearer idea of how heat is measured.

From everything we've learned about heat so far, it seems to behave in a perfectly normal manner. Yet

sometimes heat will disappear without leaving a single clue.

#### Ice vs. Water for Cooling

Every once in a while in the old days, the ice-man would forget to refill the ice-box. Occasionally, as the last sliver of ice melted away, somebody would come up with a bright idea. He would remember that the water in the drain-pan always felt ice-cold when he had emptied it other times. So, he would get the thermometer out and check its temperature. Sure enough, it usually was about as cold as the ice. Why not put the drain-pan back in the ice compartment to keep things cold until the iceman returned the next day

It was a good idea, but it never worked. For some strange reason the ice-box never stayed cold. The drain water soon got quite warm and in a couple of hours, the butter in the ice-box would begin to melt, the milk would start to sour, and the vegetables would wilt.

Why did this happen? The drain water was only a few degrees warmer than the ice yet it didn't draw nearly as much heat out of the stored foods. However, the difference between the behavior of cold drain water and ice is the real secret as to how any refrigerator works and we can easily learn the answer by using an ordinary thermometer.

When we put a drain pan full of cold water into the ice compartment, we expect the heat to flow from the warm foods to the colder water. Remember, that heat always flows from a warm object to a colder object and when we add heat to water, it gets warmer. Each Btu of heat added to a pound of water makes it one degree warmer.

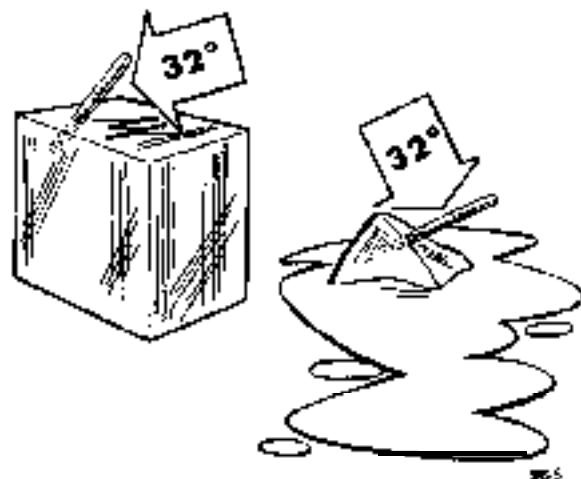


Figure 9B-5 Melting Ice Remains at 32 Degrees



If we were to put a thermometer in the cold drain water, we would see the temperature gradually creep upwards. That is to be expected because heat is flowing into the cold water making it warmer. Before long the water would be as warm as the stored foods. Then the water could no longer attract heat because heat will not flow from one warm object to another equally warm object. Since we no longer can draw heat out of the foods we no longer are cooling them.

Now, let's see what happens when we put ice instead of cold water into the ice-box. This time, we'll set the thermometer on top of the ice (Fig. 9B-5). When we first look at the thermometer, it reads 32 degrees. A couple of hours later, we open the ice compartment door. The ice block is smaller because some of the ice has already melted away • but the thermometer still reads 32 degrees. Again, still later, even more of the ice has melted, yet the thermometer continues to read 32 degrees. So long as any ice remains, no matter how much of it has melted away, the temperature of the ice stays right at 32 degrees.

All this time the ice has been soaking up heat, yet it never gets any warmer no matter how much heat it **draws** from the stored food. On the other hand, the cold drain water got progressively warmer as it soaked up heat. Why is it the addition of heat will make water warmer yet won't raise the temperature of ice above the 32 degrees mark? If we fill one drinking glass with ice and another with cold water, and put both glasses in the same room where they could absorb equal amounts of heat from the room air, we will find it takes much, much longer for the ice to melt and reach room temperature than it did for the water in the other glass to reach the same temperature. Obviously, most of the heat was being used to melt the ice. But it was the heat that apparently disappeared or went into hiding because it couldn't be located with a thermometer. To best describe this disappearing heat, scientists turned to Latin for the right word. They chose the word "latent" which means hidden.

#### Latent Heat

So latent heat is nothing more nor less than hidden heat which can't be found with a thermometer.

What happens to the latent heat? Where does it disappear to? At **first** it was thought it was in the **water** that melted from the ice. But that wasn't exactly the right answer because, upon checking water temperature as it melts from ice, it will be found that it is only a shade warmer than the ice itself. It is not nearly warm enough to account for all the heat the ice had absorbed. The only possible answer is that the latent heat had been **used** up to change the ice from a solid into a liquid.

Many substances can be either a solid, or a liquid, or

a gas. It just depends on the temperature whether water for example was a liquid, or a solid (ice), or gas (steam) (Fig. 9B-6).

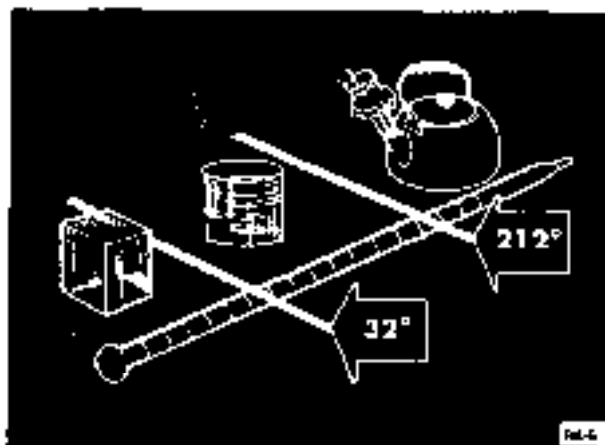


Figure 9B-6 Temperature Determines State of Water

If we put some water in a tea-kettle, set it over a fire and watch the thermometer as the water gets hotter and hotter, the mercury will keep rising until the water starts to boil. Then the mercury seems to stick at the 212 degrees mark. If we put more wood on the fire, despite all the increased heat, the mercury will not budge **above** the 212 degree mark (Fig. 9B-7).



Figure 9B-7 Boiling Water Never Exceeds 212 Degrees

Even though many housewives won't believe it, no matter how large or hot you make the flame, you can't make water hotter than 212 degrees. As a liquid changes into a gas, it absorbs abnormally great amounts of heat without getting any hotter. Here is another instance where heat disappears.

Now we have two different kinds of latent heat, which are quite alike. To keep their identities separate, the **first** one is called latent heat of fusion. Since fusion means the same as melting, it is a good descriptive name. The other kind is called latent heat of vaporization because that means the same as evaporation.

It may seem as though we have drifted into a story

about heat instead of refrigeration. But in doing so, we have learned how a simple ice-box works. It's because the magic of latent heat of fusion gives ice the ability to soak up quantities of heat without getting any warmer.

Therefore, since it stays cold, it can continue to draw heat away from stored foods and make them cooler. The latent heat of vaporization can be an even better "magnet" because it will soak up even more heat.

Whenever we think of anything boiling, we instinctively think of it being very hot. However, that's not true in every case. Just because water boils at 212 degrees doesn't mean that all other substances will boil at the same temperature. Some would have to be put into a blast furnace to make them bubble and give off vapor. On the other hand, others will boil violently while sitting on a block of ice.

And so each substance has its own particular boiling point temperature. But regardless of whether it is high or low, they all absorb unusually large quantities of heat without getting any warmer when they change from a liquid into a vapor.

Consequently, any liquid that will boil at a temperature below the freezing point of water, will make ice cubes and keep vegetables cool in a mechanical refrigerator.

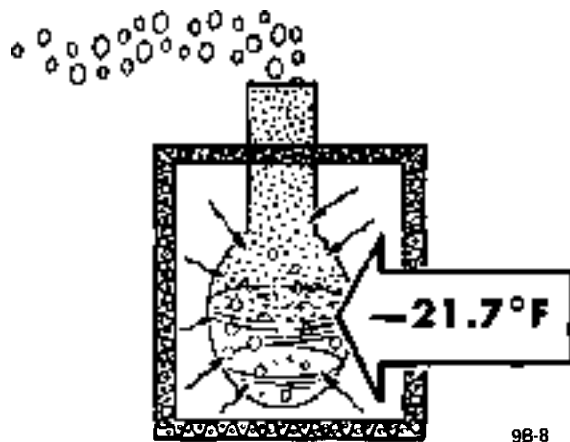


Figure 9B-10 Simple R-12 Refrigerator

#### Refrigerant • 12

Refrigerant-12 is used in the air conditioning system and boils at 21.7 degrees below zero. Maybe that doesn't mean very much until we picture a flask of R-12 sitting at the North Pole boiling away just like a tea-kettle on a stove. No one would dare pick up the flask with his bare hands because, even though boiling, it would be so cold and it would be drawing heat away from nearby objects so fast that human flesh would freeze in a very short time. If we were to

put a flask of R-12 inside a refrigerator cabinet, it would boil and draw heat away from everything surrounding it (Fig. 9B-10). So long as any refrigerant remained in the flask, it would keep on soaking up heat until the temperature got down to 21.7 degrees below zero.

Now we can begin to see the similarity between a boiling tea-kettle and a refrigerator. Ordinarily we think of the flame pushing heat into the tea-kettle. Yet, it is just as logical to turn our thinking around and picture the tea-kettle pulling heat out of the flame. Both the tea-kettle and the flask of refrigerant do the same thing they draw in heat to boil although they do so at different temperature levels.

There also is another similarity between the ice-box and the mechanical refrigerator. In the ice-box, water from melting ice literally carried heat out of the cabinet. In our simple refrigerator, rising vapors do the same job.

#### Re-Using Our R-12

Water is so cheap that we could afford to throw it away. But R-12, or any other refrigerant, is too expensive just to let float away into the atmosphere. If there was some way to remove the heat from the vapor and change it back into a liquid, it could be returned to the flask and used over again (Fig. 9B-11).

There is a way, and that is where we find the biggest difference between the old ice-box and the modern refrigerator. We used to put in new ice to replace that lost by melting. Now we use the same refrigerant over and over again.

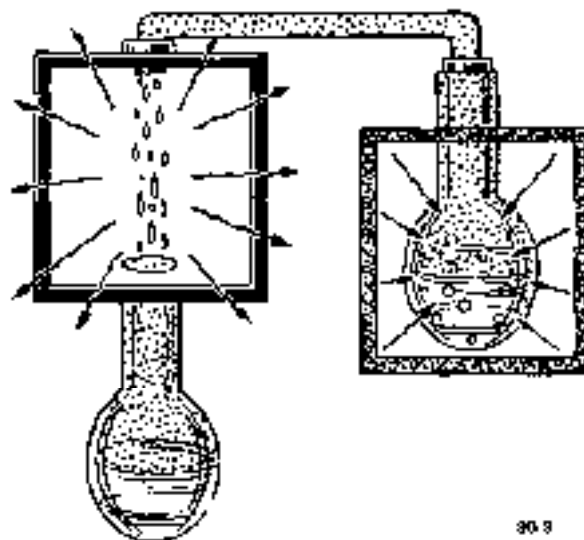


Figure 9B-11 Re-Using Refrigerant

We can change a vapor back into a liquid by chilling it, or do the same thing with pressure. When we condense a vapor we **will find** that the heat removed just exactly equals the amount of heat that was necessary to make the substance vaporize in the **first** place.

At last the lost is found! The latent heat of vaporization the heat that apparently disappeared when a liquid boiled into a vapor again reappears on the scene when that same vapor reverts back into a liquid. It is just like putting air into a balloon to expand it and then letting the same amount of air out again to return the balloon to its original condition.

We know that any substance will condense at the same temperature at which it boiled. This temperature point is a clear-cut division like a fence. On one side, a substance is a liquid. Immediately on the other side it is a vapor. Whichever way a substance would go, from hot to cold or cold to hot, it will change its character the moment it crosses over the fence.

But pressure moves the fence! Water will boil at 212 **degrees** under normal conditions. Naturally, we expect steam to condense at the same temperature. But whenever we put pressure on steam, it doesn't! It will condense at some temperature higher than 212 degrees. The greater the pressure, the higher the boiling point and the temperature at which a vapor will condense. This is the reason why pressure cookers cook food faster, since the pressure on the water permits it to boil out at a higher temperature. We know that R-12 boils at 21.7 degrees below zero. A thermometer will show us that the rising vapors, even though they have soaked up lots of heat, are only slightly warmer. But the vapors must be made warmer than the room air if we expect heat to flow out of them. Also, the condensing point temperature must be above that of room air or else the vapors won't **condense**.

This is where pressure comes to the rescue. With pressure, we can compress the vapor, thereby concentrating the heat it contains. When we concentrate heat in a vapor that way, we increase the intensity of the heat or, in other words, we increase the **temperature**, because temperature is merely a measurement of heat intensity. And the most amazing part of it all is that we've made the vapor hotter without actually adding any additional quantity of heat (Fig. 9B-12).

#### Use of Pressure in Refrigeration

Because we must live by pressures and gauges in air conditioning work, the following points are mentioned so that we will all be talking about the same thing when we speak of pressures.

All pressure, regardless of how it is produced, is measured in pounds per square inch (psi).

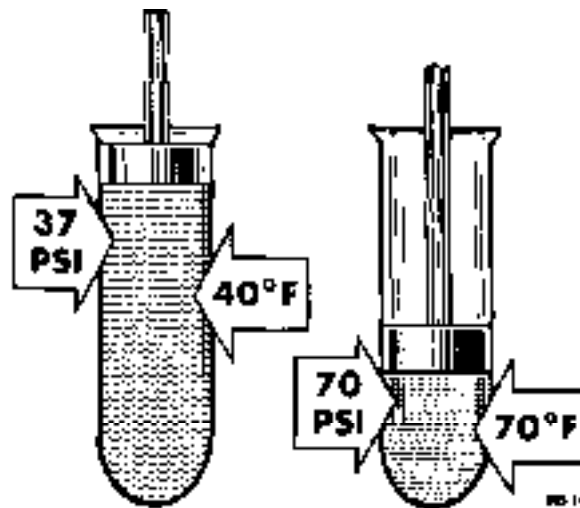


Figure 9B-12 Compressing a Vapor Concentrates its Heat

Atmospheric Pressure is pressure exerted in every direction by the weight of the atmosphere. At higher altitudes air is **rarified** and has less weight. At sea level atmospheric pressure is 14.7 psi.

Any pressure less than atmospheric is known as a partial vacuum or commonly called a vacuum. A perfect vacuum or region of no pressure has never been mechanically produced. Gauge pressure is used in refrigeration work. Gauges are calibrated in pounds (psi) of pressure and inches of Mercury for vacuum. At sea level "0" lbs. gauge pressure is equivalent to 14.7 lbs. atmospheric pressure. Pressure greater than atmospheric is measured in pounds (psi) and pressure below atmospheric is measured in inches of vacuum. The "0" on the gauge will always correspond to the surrounding atmospheric pressure, regardless of the elevation where the gauge is being used.

#### Basic Refrigerator Operation

We've now covered all the ground-rules that apply to refrigeration. Most likely they still are a little hazy, but it is easy enough to remember these main points. All liquids soak up lots of heat without getting any warmer when they boil into a vapor, and, we can use pressure to make the vapor condense back into a liquid so it can be used over again. With just that amount of knowledge, here is how we can build a refrigerator.

We can place a flask of refrigerant in an ice-box. We know it will boil at a very cold temperature and will draw heat away from everything inside the cabinet (Fig. 9B-13).

We can pipe the rising vapors outside the cabinet and thus provide a way for carrying the heat out. Once

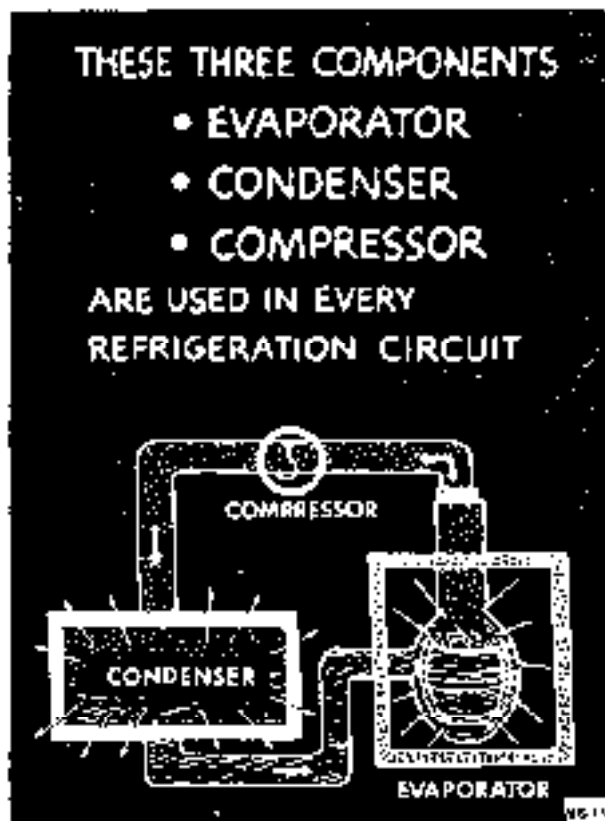


Figure 9B-13 Basic Refrigerant Circuit

we get the heat-laden vapor outside, we can compress it with a pump. With enough pressure, we can squeeze the heat out of "cold" vapor even in a warm room. An ordinary radiator will help us get rid of heat.

By removing the heat, and making the refrigerant into a liquid, it becomes the same as it was before. So, we can run another pipe back into the cabinet and return the refrigerant to the flask to be used over again.

That is the way most mechanical refrigerators work today. Now, let's look at an air conditioning unit to see how closely it resembles the refrigerator we have just described.

#### Basic Air Conditioner

When we look at an air conditioning unit, we will always find a set of coils or a tinned radiator core through which the air to be cooled passes. This is known as the "evaporator" (Fig. 9B-14). It does the same job as the flask of refrigerant we spoke about earlier. The refrigerant boils in the evaporator. In boiling, of course, the refrigerant absorbs heat and changes into a vapor. By piping this vapor outside the car we can bodily carry out the heat that caused its creation.

Once we get vapor out of the evaporator, all we have



Figure 9B-14 Evaporator Assembly

to do is remove the heat it contains. Since heat is the only thing that expanded the refrigerant from a liquid to a vapor in the first place, removal of that same heat will let the vapor condense into a liquid again. Then we can return the liquid refrigerant to the evaporator to be used over again.

Actually, the vapor coming out of the evaporator is very cold. We know the liquid refrigerant boils at temperatures considerably below freezing and that the vapors arising from it are only a shade warmer even though they do contain quantities of heat. Consequently, we can't expect to remove heat from sub-freezing vapors by "cooling" them in air temperatures that usually range between 60 and 100 degrees heat refuses to flow from a cold object toward a warmer object.

But with a pump, we can squeeze the heat-laden vapor into a smaller space. And, when we compress the vapor, we also concentrate the heat it contains. In this way, we can make the vapor hotter without adding any heat. Then we can cool it in comparatively warm air.

That is the only responsibility of a compressor in an air conditioning system (Fig. 9B-15). It is not intended to be a pump just for circulating the refrigerant. Rather, its job is to exert pressure for two reasons. Pressure makes the vapor hot enough to cool off in warm air. At the same time, the compressor raises the refrigerant's pressure above the condensing point at the temperature of the surrounding air so it will condense.

As the refrigerant leaves the compressor, it is still a vapor although it is now quite hot and ready to give up the heat that is absorbed in the evaporator. One of the **easiest** ways to help refrigerant vapor discharge its heat is to send it through a radiator-like contrivance known as a condenser (Fig. 9B-16).

The condenser really is a very simple device having no moving parts. It does exactly the same job as the radiator in a typical steam-heating system. There, the steam is nothing more than water vapor. In passing through the radiator, the steam gives up its heat and condenses back into water.

The same action takes place in an air conditioning



Figure 9B-15 Compressor Assembly - GT Shown



Figure 9B-16 Condenser Assembly

condenser. The refrigerant vapor gives up its heat, which is quickly and easily radiated into the surrounding air through the large finned surfaces of the condenser. In giving up its heat, the refrigerant vapor condenses back into liquid which collects in a pool at the bottom of the condenser.

As we have said before, when the refrigerant condenses into a liquid, it again is ready for boiling in the evaporator. So, we can run a pipe from the condenser back to the evaporator.

### Main Units of the System

These three units then; the evaporator, the compressor, and the condenser are the main working parts of any typical air conditioning system. We have the evaporator where the refrigerant boils and changes into a vapor, absorbing heat as it does so. We have the pump or compressor to put pressure on the refrigerant so it can get rid of its heat. And we have a condenser outside the car body to help discharge the heat into the surrounding air.

### Pressure and Flow

There is one more unit that co-operates with these

three. It doesn't do any real work, **but** it does act as sort of a **traffic** officer in controlling the flow of the refrigerant through the system. To get a better idea of what this does, let's first do a **little experimenting** with an ordinary tire pump.

When we use a **tire pump** to **inflate** an automobile tire, we are creating pressure only because we are "pushing" against the air already entrapped inside the tire. If you question this, just try pumping up a tire that has a large puncture in it. You **could** pump all day, and still not be able to build up any pressure. As fast as you would pump the air in, it would leak out through the puncture. **About** all you would be doing would be circulating nice fresh air through the tire. **Unless** you have something **to** push against - to block the **flow** of air - you can't create more than a mere semblance of pressure.

The same situation holds **true** in an air conditioning system. The compressor can pump refrigerant vapor through the system, but unless it has something to push against, it cannot build up pressure. All the compressor would be doing would be to circulate the vapor without increasing its **pressure**.

Yet we can't just block the flow through the system entirely. All we want to do is put pressure on the refrigerant vapor so it will condense at normal temperatures. What's more, this **must** be done some time after the vapor leaves the evaporator and before it returns again as a liquid. We can't have high pressure in the evaporator because that would slow down the boiling of the refrigerant and thus penalize the refrigerating effect.

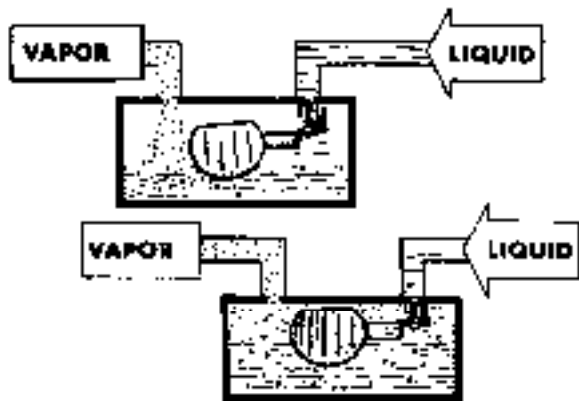
### Controlling Pressure and Flow

Pressure and flow can be controlled with a **float** valve, or with a pressure-regulating valve. They do the same **job**, **but** in a different way.

Since the float valve type will give us a better idea of pressure and flow control, let's look at it first (Fig. 9B-17).

It consists simply of a float that rides on the surface of the liquid refrigerant. As the refrigerant liquid boils and passes off as a vapor, naturally the liquid level drops lower and lower. Correspondingly, the float, because it rides on the surface of the refrigerant, also drops lower and lower as the liquid goes down.

By means of a simple system of mechanical linkage, the downward movement of the float opens a valve to let refrigerant in. The incoming liquid raises the fluid level and, of course, the float rides up with it. When the surface level of the refrigerant liquid reaches a desired height, the float will have risen far



9B-15

Figure 9B-17 Float Type Flow Valve

enough to close the valve and stop the flow of refrigerant liquid.

For the sake of simplicity, we have described the float and valve action as being in a sort of definite wide open or tight shut condition. Actually, though, the liquid level falls rather slowly as the refrigerant boils away. Likewise, the float goes down gradually and gradually opens the valve just a crack. New refrigerant liquid barely seeps in through the "cracked" valve. At such a slow rate of flow, it raises the liquid level in the evaporator very slowly.

With that in mind, it is easy to see **how it** would be possible for a stabilized condition to exist. By that, we mean a condition wherein the valve would be

opened barely enough to allow just exactly the right amount of refrigerant liquid to enter the freezer to take the place of that leaving as a vapor.

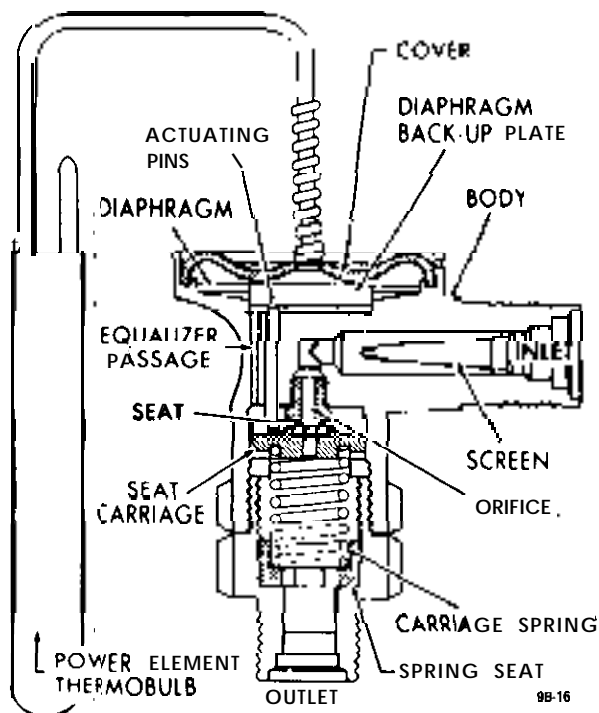
### Thermostatic Expansion Valve

Automotive air conditioning systems use a thermostatic expansion valve in place of the float system.

Figure 9B-18 shows a cross-section of the valve which consists primarily of the gas-filled power element, body, actuating pins, seat and orifice. At the high pressure liquid inlet is a fine mesh screen which prevents dirt, tilings or other foreign matter from entering the valve orifice.

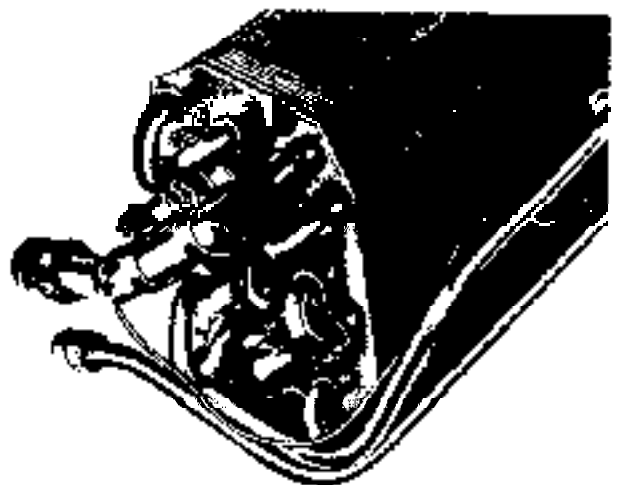
When the valve is connected in the system, the high pressure liquid refrigerant enters the valve through the screen from the receiver-dehydrator (which acts as a storage tank for the condensed refrigerant as it leaves the condenser) and passes on to the seat and orifice. Upon passing through the orifice the high pressure liquid becomes low pressure liquid. The low pressure liquid leaves the valve and flows into the evaporator core where it absorbs heat from the evaporator core and changes to a low pressure vapor, and leaves the evaporator core as such. The power element bulb is clamped to the low pressure vapor line just beyond the outlet of the evaporator (Fig. 9B-20).

The operation of the valve is quite simple. It is a matter of controlling opposing forces produced by a spring and the refrigerant pressures. For example: The pressure in the power element is trying to push the seat away from the orifice, while the spring is trying to force the seat toward the orifice. These opposing pressures are established in the design of the valve so that during idle **periods, i.e.** when the system is not operating, the spring force and the refrigerant pressure in the cooling coil are always



9B-16

Figure 9B-18 Thermostatic Expansion Valve



9B-17

Figure 9B-20 Expansion Valve Bulb Location

greater than the opposing pressure in the power element. Therefore, the valve remains closed. When the compressor is started, it will reduce the pressure and temperature of the refrigerant in the cooling coil to a point where the vapor pressure in the power element becomes the stronger. The seat then moves off the orifice and liquid starts to flow through the valve orifice into the cooling coil.

The purpose of the power element is to help determine the quantity of liquid that is being metered into the cooling coil. As the temperature of the low pressure line changes at the bulb, the pressure of the vapor in the power element changes, resulting in a change of the position of the seat. For example, if the cooling coil gets more liquid than is required, the temperature of the low pressure line is reduced and the resultant lowering of the bulb temperature reduces the pressure of the vapor in the power element, allowing the seat to move closer to the orifice. This immediately reduces the amount of liquid leaving the valve. Under normal operation, the power element provides accurate control of the quantity of refrigerant to the cooling coil.

To employ our tire pump analogy once more for clarity, it is the same situation that would exist if you were inflating a tire with a very slow leak. Providing you pumped the air into the tire as fast as it leaked out, you would be able to maintain pressure even though the air would merely be circulating through the tire and leaking out through the puncture.

### To Sum Up

So far, we've discussed only what each unit in an air conditioning system does. We've learned that the evaporator is the unit in which liquid refrigerant soaks up heat from the air, the compressor is a pump for squeezing this heat out of the vapor, the condenser is a radiator for getting rid of the heat, and the thermostatic expansion valve is a device for regulating the pressure on the refrigerant. Now, let's find out how the temperature of the cooled air is controlled.

### METHOD OF TEMPERATURE CONTROL

To achieve temperature control, the compressor is run intermittently, automatically turning on and off as necessary to maintain proper temperature.

#### Thermostatic Switch

The compressor can be started and stopped automatically through the use of an electro-magnetic clutch and a thermostat affected by variations of temperature.

The job is usually done by a gas bulb thermostat (Fig. 9B-21).

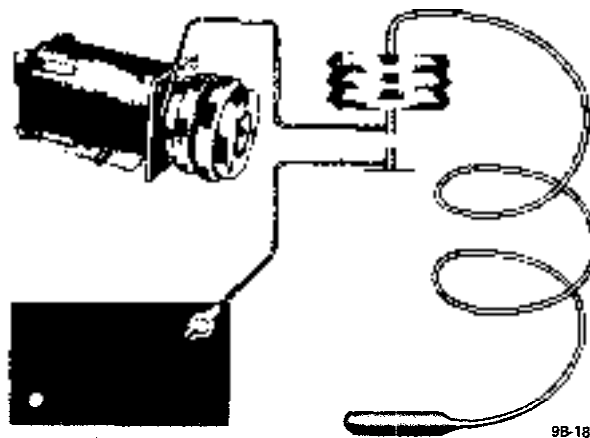


Figure 9B-21 Thermostatic Switch Schematic

With the gas bulb type of thermostat, a highly expansive gas is sealed into a metallic bulb which is located in the air stream as it leaves the evaporator. A small tube leads from the bulb to a bellows operated switch. As air temperature rises, the gas inside the bulb expands, travels through the tube to the bellows and closes the electrical switch that engages the compressor clutch.

Of course, as soon as the compressor starts running, the temperature begins to go down. As the air being cooled gets colder, the gas in the thermostat bulb begins to reduce the pressure on the switch bellows.

This flips "off" the switch and disengages the compressor clutch.

### REFRIGERANTS

No matter how scientifically refrigerating machinery is built or how efficiently it runs, it alone cannot remove heat. The only thing that carries heat out of a refrigerator cabinet or an automobile is the substance we call the refrigerant.

There are many refrigerants known to man. In fact, any liquid that can boil at temperatures somewhere near the freezing point of water can be used.

But a boiling point below the temperature at which ice forms is not the only thing that makes a good refrigerant. A refrigerant should also be non-poisonous and non-explosive to be safe. Besides that, we want a refrigerant that is non-corrosive and one that will mix with oil.

Since Nature did not provide an ideal refrigerant, chemists went to work to see if they could do any better. They did! But it wasn't as simple as that.

At first, they tried to improve existing natural refrigerants. But after exploring innumerable trails along

that line, they still hadn't gotten anywhere. So, they started from scratch and juggled molecules around to make an entirely new refrigerant. Eventually they succeeded by remodeling the molecules in carbon tetrachloride. This is the same fluid that is used in fire extinguishers and dry-cleaners' solvents.

From this fluid, the chemists removed two chlorine atoms and replaced them with two fluorine atoms. This newly-formed fluid carried the technical chemical name of dichlorodifluoromethane. Today, we know it as Refrigerant-12 or R-12.

Fluorine is an extremely temperamental substance. Under most conditions it is toxic and highly corrosive, and after it is manufactured, it has to be stored in special containers because it will eat through glass and will dissolve most metals in short order.

Despite its rambunctious character though, fluorine is completely tamed when it is combined with the other substances that go to make up the refrigerant. Each is non-toxic, non-inflammable, non-explosive, and non-poisonous; however, breathing large quantities of R-12 should be avoided.

#### Pressure. Temperature Relationship of R-12

A definite pressure and temperature relationship exists in the case of liquid refrigerants and their saturated vapors. Increasing the temperature of a substance causes it to expand. When the substance is confined in a closed container, the increase in temperature will be accompanied by an increase in pressure, even though no mechanical device was used. For every temperature, there will be a corresponding pressure within the container of refrigerant. A table of the temperature-pressure relationship of R-12 is presented below. Pressures are indicated in gauge pressure, either positive pressure (above atmospheric) in pounds or negative pressure (below atmospheric) in inches of vacuum.

°F	#Pressure	°F	#Pressure
-40	11.0*	50	46.1
-35	8.3*	50	52.0
-30	5.5*	60	57.7
-25	2.3*	65	63.7
-20	0.6	70	70.1
-15	2.4	75	76.9
-10	4.5	85	84.1
-5	6.8	90	99.6
0	9.2	95	116.9
5	11.8	100	136.0
10	14.7		
15	17.7	105	126.2
20	21.1	110	136.0
25	24.6	115	146.5
30	28.5	120	157.1
32	30.1	125	167.5
35	32.6	130	179.0
40	37.0	140	204.5
45	41.7	150	232.0

\*Inches of Vacuum.

Thus if a gauge is attached to a container of R-12 and the room temperature is 70 degrees, the gauge will register 70 psi pressure; in a 100 degrees room the pressure will be 117 psi.

#### AIR CONDITIONING

Because air conditioning has always been very closely allied with mechanical refrigeration, most of us are apt to think of it only as a process for cooling room air.

But true air conditioning goes beyond the mere cooling of the air. It controls the humidity, cleanliness, and circulation of the air as well.

Whenever it gets warm and muggy in the summertime, someone is almost sure to say, "It's not the heat it's the humidity." But that is only partly right. Actually it is a combination of the two that makes us feel so warm temperature alone is not the only thing that makes us uncomfortable.

Humidity is nothing more nor less than the moisture content of the air. To a certain extent, it is tied in with the temperature of the air. Warm air will hold more moisture than will cold air. When air contains all the moisture it can hold, we say it is saturated, and the relative humidity is 100 percent. If the air contains only half as much water as it could possibly hold at any given temperature, we say that the relative humidity is 50 percent. If it contains only a fifth of its maximum capacity, we say that the relative humidity is 20 percent and so on. This amount of water vapor, or relative humidity, affects the way we perspire on hot days.

Nature has equipped our bodies with a network of sweat glands that carry perspiration to the skin surfaces. Normally, this perspiration evaporates and, in doing so, absorbs heat just like a refrigerant absorbs heat when it is vaporized in a freezer. Most of the heat thus absorbed is drawn from our bodies, giving us a sensation of coolness. A drop of alcohol on the back of your hand will demonstrate this principle very convincingly. Because it is highly volatile, alcohol will evaporate very rapidly and absorb quite a bit of heat in doing so, thereby making the spot on your hand feel unusually cool.

The ease and rapidity with which evaporation takes place, whether it be alcohol or perspiration, governs our sensation of coolness and to a certain extent, independently of the temperature. Of even more importance, the ease and rapidity of the evaporation are directly affected by the relative humidity or comparative dampness of the air. When the air is dry, perspiration will evaporate quite readily. But when the air contains a lot of moisture, perspiration will evaporate more slowly; consequently less heat is carried away from our body.



Thus, from the standpoint of comfort, complete air conditioning should control the relative humidity of the air as well as its temperature.

By reducing the humidity, we sometimes can be just as "cool" in a higher room temperature than otherwise would be comfortable. Laboratory tests have shown that the average person will feel just as cool in a temperature of 79 degrees when the relative humidity is down around 30 percent as he will in a cooler temperature of 72 degrees with a high relative humidity of 90 percent.

There are practical limits though within which we **must** stay when it comes to juggling humidity. For human comfort, we can't go much below a relative humidity of 30 percent because anything lower than that would cause an unpleasant and unhealthy dryness in the throat and nasal passages.

Summertime temperatures of 85 degrees sometimes bring with them relative humidities around 75 to 80 percent. Some coastal cities have relative humidities averaging as high as 87 percent. To gain maximum human comfort, an air conditioning system should cool the air down and reduce the humidity to comfortable limits.

The cooling job usually is done just as it is in a refrigerator. A compressor sends refrigerant through a chilling unit where it absorbs heat. The heat is drawn out of the air which circulates through the chilling unit. Along with the cooling job it **does, the** evaporator unit also removes much of the moisture from the air. Everyone is familiar with the sight of thick frost on the freezer of a refrigerator. That frost is simply frozen moisture that has come out of the air.

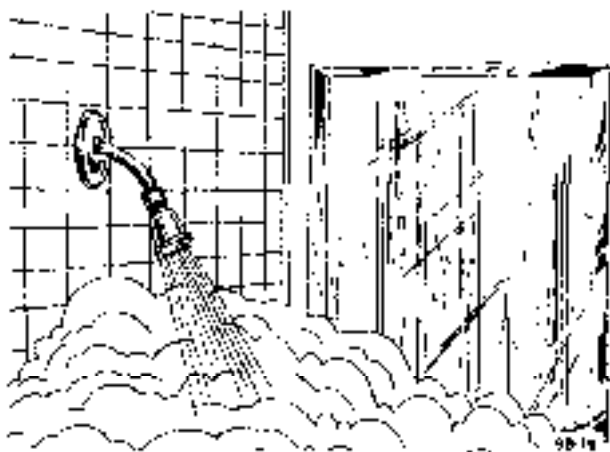


Figure 9B-22 Condensation

The evaporator unit in an air-conditioning system does the same thing with this one exception. Because

its temperature is above the freezing point, the moisture does not collect in the form of ice or frost. Instead, the moisture remains fluid and drips off the chilling unit. This action is similar to what occurs on the cool bathroom mirror when a hot shower is turned on (Fig. 9B-22). A further advantage of air conditioning is that dust and pollen particles are trapped by the wet surfaces of the evaporator core and then drained off with the condensed moisture. This provides very clean, pure air for breathing, and is of great benefit to those who suffer from asthma or allergies such as hay fever.

### Basic Refrigeration Cycle

Let's review the basic refrigeration cycle. Keep this basic cycle in mind because knowledge of the cycle, knowledge of the particular system you are working on and proper use of the gauges will permit quick, accurate diagnosis of problems as they arise.

Any refrigeration system takes advantage of the principles just described. The air conditioning system illustrated in Fig. 9B-23 contains **five** basic parts; a compressor, a condenser, a receiver, an expansion valve and an evaporator. Assuming R-12 as our refrigerant, let us follow through the refrigeration cycle.

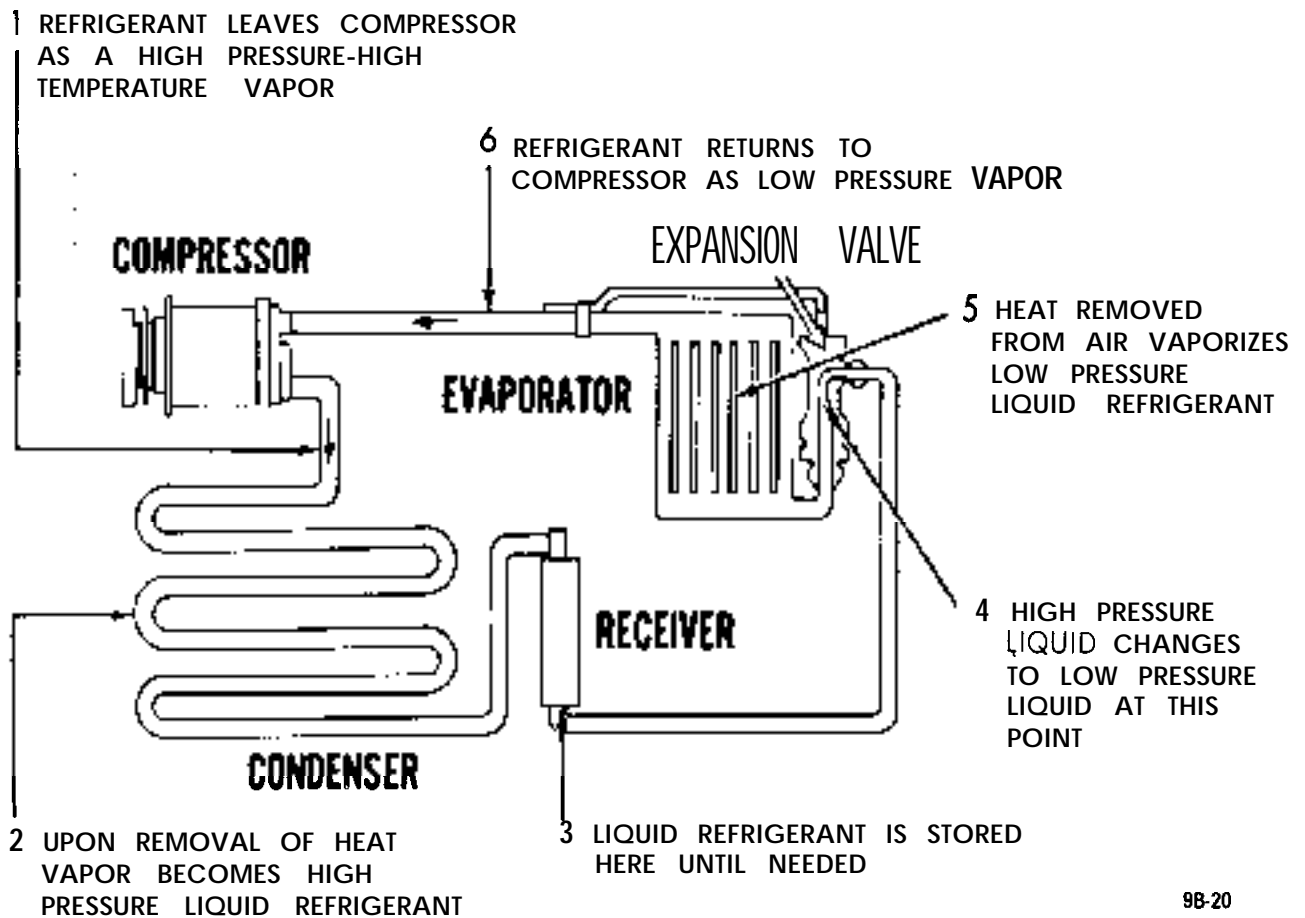
Refrigerant gas under low pressure is drawn into the compressor where it is compressed to a high pressure. During compression, the refrigerant gas is heated. When sufficient pressure is built up, the hot gas passes into the condenser where it cools by giving off heat to the air passing over the condenser surfaces.

As the refrigerant gas cools, it condenses into a liquid at high pressure and accumulates in the receiver. The high pressure liquid refrigerant passes to the expansion valve at the entrance to the evaporator. At the valve orifice the pressure is lowered and the refrigerant enters the evaporator core as a low pressure liquid. When the refrigerant is exposed to the **lower** evaporator pressure, it begins to boil and is changed to a vapor state. As the refrigerant passes through the evaporator, it continues to boil by absorbing heat from the air passing over the evaporator surfaces until it is completely vaporized. From the evaporator the cool low pressure refrigerant gas is drawn back to the compressor and the cycle repeated.

Thus the air passing over the evaporator surfaces is cooled simply by giving up heat to the refrigerant during the boiling process.

### CHEMICAL INSTABILITY AND REFRIGERATING SYSTEM FAILURES

A sealed refrigerating system is a complex **physical-chemical** combination which is designed for stability



9B-20

Figure 9B-23 Basic Refrigeration Cycle

within certain operating limits. If these limits are exceeded, many physical and chemical reactions occur. Since the results of these reactions within the system cannot be easily removed, they build up into a constantly accelerating vicious circle to eventually fail the system.

#### CHEMICAL INGREDIENTS OF AN AUTOMOTIVE AIR CONDITIONING SYSTEM

All systems involve metals, refrigerant, and oil which are basic and essential. The desiccant, or dehydrating agent, **and** another chemical ingredient, synthetic rubber, makes it even more complex.

All of these ingredients have chemical properties which are entirely different from each of the others. In **spite of** these differences, by proper selection of the ingredients and controlled processes in manufacture, plus careful servicing procedures they can be combined so that they "live together" to provide many years of satisfactory and trouble-free operation.

If, however, only one undesirable element is added or

is allowed to enter the system, it can start a chain of chemical reactions which upsets stability and interferes with the operation of the unit.

#### Metals

In most cases, metals contribute to the decomposition of R-12 and oil in varying amounts. All are attacked by acids.

Each of the metals in common use in a system has been selected for a specific reason; heat conductivity, durability, strength, and chemical composition.

Under favorable conditions, the amounts of decomposition of Refrigerant-12 and oil produced by these metals is negligible and allowable. However, if undesirable substances are added and the temperature is increased, the rate of decomposition and the production of harmful acids increases proportionally.

#### Refrigerant

The chemical properties of refrigerants are very important factors in the stability of a system since the

refrigerant penetrates to every nook and cranny of the unit.

Among the many desirable properties of R-12, is its stability under operating conditions. However, while more stable than the other refrigerants under the same conditions, it, too, can be caused to form harmful acids which will eventually fail the system.

## Oil

Oil is the most complex of all of the organic chemicals. Its stability in a refrigerating system is dependent upon the source of crude oil and its method of refining. A good refrigerating oil must be free of sludge and gum-forming substances and free of harmful impurities, such as sulphur. It must also be stabilized to resist oxidation and must have a high degree of resistance to carbonization.

The chemical properties of the lubricating oil form another very important consideration in the chemical stability within the system. Like the refrigerant, it travels to every nook and cranny of the unit.

The factory obtains the finest oils which have been refined from the most desirable crudes. It is reprocessed at the factory before it is charged into a system or poured into a container for resale. Its viscosity and flash point are checked and it is forced through many sheets of filtering paper.

**Even** the containers in which it is poured for resale are processed. As you **receive** it for field service it is the cleanest, **driest**, and purest oil that is humanly possible to make. Leaving the container uncapped even for a few minutes allows the oil to absorb moisture from the air. Many system failures have been caused by chemical reactions which were started by servicemen adding contaminated oil.

## Desiccants (Dehydrating Agent)

Over the years the industry has spent hundreds of thousands of dollars in finding and developing chemical substances which are suitable for use in refrigerating systems. An ideal desiccant must have the following characteristics:

1. High capacity.
2. High efficiency.
3. Low tendency to powder.
4. Absorb moisture without reacting chemically with it.
5. Allow refrigerant to flow through it with minimum restriction.
6. Retain moisture at high temperature.

This has been a difficult combination to find. While some desiccants excel in several of the desirable characteristics, they are unsatisfactory in others.

Activated Silica Alumina, used in current receiver-dehydrators, is a most satisfactory desiccant. However, its ability to retain moisture is affected by its temperature. As the temperature increases, its ability decreases. This means that moisture which is retained at a lower temperature may be put back into the system at a higher temperature.

## MAINTAINING CHEMICAL STABILITY IN THE REFRIGERATION SYSTEM

The metal internal parts of the refrigeration system and the refrigerant and oil contained in the system are designed to remain in a state of chemical stability as long as pure R-12 plus refrigeration oil is used in the system. However, when abnormal amounts of foreign materials, such as dirt, air or moisture are allowed to enter the system, the chemical stability may be upset (Fig. 9B-24).



Figure 9B-24 System Contaminants

When accelerated by heat, these contaminants may form acids and sludge and eventually cause the breakdown of components within the system. In addition, contaminants may affect the temperature pressure relationship of R-12, resulting in improper operating temperature and pressures and decreased efficiency of the system.

The following general practices **should** be observed to maintain chemical stability in the system:

Whenever it becomes necessary to disconnect a refrigerant or gauge line, it should be immediately capped. Capping the tubing will also prevent dirt and foreign matter from entering.

Tools should be kept clean and dry. This also includes the gauge set and replacement parts.

When adding oil, the container should be exceptionally clean and dry due to the fact that the refrigeration oil in the container is as moisture-free as it is possible to make it. Therefore, it will quickly absorb any moisture with which it comes in contact. For this same reason the oil container should not be opened until ready for use and it should be capped immediately after use.

When it is necessary to open a system, have everything you will need ready and handy so that as little time as possible will be required to perform the operation. Don't leave the system open any longer than is necessary.

Finally, after the operation has been completed and the system sealed again, air and moisture should be evacuated from the system before recharging.

## THE PRIMARY CAUSES OF SYSTEM FAILURES

### Leaks

A shortage of refrigerant causes oil to be trapped in the evaporator. Oil may be lost with the refrigerant at point of leakage. Both of these can cause compressor seizure.

Oil circulates in the system with the refrigerant; in solution with the liquid and in globules with the vapor. It leaves the compressor by the action of the pistons and mixes with the refrigerant liquid in the condenser. The oil then enters the evaporator with the liquid and, with the evaporator properly flooded, is returned to the compressor through the low pressure line. Some of the oil returns as globules in the vapor, but more important, it is swept as a liquid along the walls of the tubing by the velocity of the vapor. If the evaporator is starved, the oil cannot return in sufficient quantities to keep the compressor properly lubricated.

### High Temperature and Pressure

An increase in temperature causes an increase in pressure. This accelerates chemical instability due to existing contaminants in the system, and initiates chemical instability in clean systems. Other results are brittle hoses, "O" ring gaskets, and valve diaphragms with possible decomposition, broken compressor discharge reeds, and seized compressor bearings.

A fundamental law of nature accounts for the fact that when a substance, such as a refrigerant, is increased in temperature, its pressure is also increased.

Any chemical reactions caused by contaminants already in the system are greatly accelerated as the temperature increases. A 15 degree rise in temperature doubles the chemical action. Even in a good

clean system, heat alone can start a chain of harmful chemical reactions.

While temperature alone can cause the synthetic rubber parts to become brittle and possibly to decompose, the increased pressure can cause them to rupture or blow.

As the temperature and pressure increases the stress and strain on the compressor discharge reeds also increases. This can result in broken reeds. Due to the effect of the contaminants caused by high temperature and pressure, compressor bearings can be caused to seize.

High temperature and pressure are also caused by air in the system.

### Air in the System

Air results from a discharged system or careless servicing procedures. This reduces system capacity and efficiency and causes oxidation of oil into gum and varnish.

When a leak causes the system to become discharged, the resulting vacuum within the system will cause air to be drawn in. Air in the system is a non-condensable gas and will build up in the condenser as it would in an air compressor tank. The resultant heat produced will contribute to the conditions discussed previously.

Many systems are contaminated and also reduced in capacity and efficiency by servicemen who either do not know or are careless regarding proper servicing procedures.

Too frequently, systems which have been open to the atmosphere during service operations have not been properly purged or evacuated. Air is also introduced into the system by unpurged gauge and charging lines. Remember that any air in the system is too much air.

### Poor Connections

Hose clamp type fittings must be properly made. Hoses should be installed over the sealing flanges and with the end of the hose at the stop flange. The hose should never extend beyond the stop flange. Locate the clamp properly and torque as recommended. Be especially careful that the sealing flanges are not nicked or scored or a future leak will result.

When compression fittings are used, over tightening can cause physical damage to the "O" ring gasket and will result in leaks. The use of torque and backing wrenches is highly recommended. When making a connection with compression fittings, the gaskets should always be first placed over the tube before

inserting it in the connection. Another precaution - inspect the fitting for burrs which can cut the "O" ring.

#### Restrictions

Restrictions may be due to powdered desiccant or dirt and foreign matter. This may result in starved evaporator and loss of cooling, or a seized compressor.

When the amount of moisture in a system sufficiently exceeds the capacity of the desiccant, it can break down the desiccant and cause it to powder. The powder passes through the dehydrator screen with the refrigerant liquid and is carried to the expansion valve screen. While some of it may pass through the valve screen into the evaporator, it may quickly build up to cause a restriction.

Due to the fact that sufficient oil can not be returned to the compressor, it may seize.

#### Dirt

Dirt, which is any foreign material, may come from cleaner residues, cutting, machining, or preserving oils, metal dust or chips, lint or dust, loose rust, soldering or brazing fluxes, paint or loose oxide scale. These can also cause seized bearings by abrasion or wedging, discharge and expansion valve failure, decomposition of refrigerant and oil, or corrosion of metal parts.

#### Corrosion

Corrosion and its by-products can restrict valve and drier screens, rough bearing surfaces or rapid fatiguing of discharge reeds. This can result in high temperature and pressure, decomposition or leaks. In any event, this means a wrecked compressor.

From this, we can see the vicious circle that can be produced in a refrigerating system to cause its failure. Corrosion can be the indirect cause of leaks, and leaks can be the direct cause of corrosion. We can also see the important role we as servicemen play in maintaining chemical stability.

The major cause of corrosion is moisture.

#### Moisture

Moisture is the greatest enemy of refrigerating systems. Combined with metal, it produces oxide, Iron Hydroxide and Aluminum Hydroxide. Combined with R-12 it produces Carbonic acid, Hydrochloric acid, and Hydrofluoric acid. Moisture can also cause freeze-up of expansion valve and powdered desiccant.

Although high temperature and dirt are responsible for many difficulties in refrigerating systems, in most instances it is the presence of moisture in the system that accelerates these conditions. It can be said, therefore, that moisture is the greatest enemy of all. The acids that it produces, in combination with both the metals and the refrigerant, cause damaging corrosion. While the corrosion may not form as rapidly with R-12 as with some other refrigerants, the eventual formation is as damaging.

If the operating pressure and temperature in the evaporator is reduced to the freezing point, moisture in the refrigerant can collect at the orifice of the expansion valve and freeze. This temporarily restricts the flow of liquid causing erratic cooling.

As previously mentioned, moisture in excess of the desiccant's capacity can cause it to powder.

#### YOU SHOULD KNOW AND REMEMBER..

That the inside of the refrigeration system is completely sealed from the outside world. And if that seal remains broken at any point - the system will soon be destroyed. That complete and positive sealing of the entire system is vitally important and that this sealed condition is absolutely necessary to retain the chemicals and keep them in a pure and proper condition.

That all parts of the refrigeration system are under pressure at all times, whether operating or idle, and that any leakage points are continuously losing refrigerant and oil.

That the leakage of refrigerant can be so silent that the complete charge may be lost without warning.

That refrigerant gas is heavier than air and will rapidly drop to the floor as it flows from a point of leakage.

That the pressure in the system may momentarily become as high as 400 lbs. per square inch, and that under such pressure the molecules of refrigerant are forced out through the smallest opening or pore.

That the compressor is continually giving up some lubricating oil to the circulating refrigerant and depends upon oil in the returning refrigerant for continuous replenishment. Any stoppage or major loss of refrigerant will therefore be fatal to the compressor.

That the extreme internal dryness of a properly processed system is a truly desert condition, with the drying material in the receiver holding tightly on to the tiny droplets of residual moisture.

That the attraction of the drying material for moisture is so powerful that if the receiver is left open, moisture will be drawn in from the outside air.

That just one drop of water added to the refrigerant will start chemical changes that can result in corrosion and eventual breakdown of the chemicals in the system. Hydrochloric acid is the result of an R-12 mixture with water.

That the smallest amount of air in the refrigeration system may start reactions that can cause malfunctions.

That the drying agent in the receiver-dehydrator is Activated Silica Alumina (silica-gel).

That the inert gas in the expansion valve capillary line is carbon dioxide.

## DESCRIPTION OF AIR CONDITIONING COMPONENTS

### Compressor

The compressor is located in the engine compartment. The purpose of the unit is to draw the low pressure gas from the evaporator and compress this gas into a high temperature, high pressure gas. This action will result in the refrigerant having a higher temperature than the surrounding air.

The compressor is of basic double action piston design. Three horizontal double acting pistons make up a six cylinder compressor (See Figure 9B-162). The pistons operate in 1-1/2 inch bore and have a 1-1/8 inch stroke. A swash plate keyed to the shaft drives the pistons. The shaft is belt driven through a magnetic clutch and pulley arrangement. An oil pump mounted at the rear of the compressor picks up oil from the bottom of the compressor and lubricates the bearings and other internal parts of the compressor.

Reed type valves at each end of the compressor open or close to control the flow of incoming and outgoing refrigerant. Two gas tight passages interconnect chambers of the front and rear heads so that there is one common suction port, and one common discharge port. The internal parts of the compressor function, as follows:

1. Suction Valve Reed Discs and Discharge Valve Plates • The two suction valve reed discs and two discharge valve plates (see Figure 9B-25) operate in a similar but opposite manner. The discs are composed of three reeds and function to open when the pistons are on the intake portion of their stroke (downstroke), and close on the compression stroke. The reeds allow low pressure gas to enter the cylinders. The discharge valve plates also have three reeds, however, they function to open when the pis-

tons are on the compression portion of their stroke (upstroke), and close on the intake stroke. High pressure gas exits from discharge ports in the discharge valve plate. Three retainers riveted directly above the reeds on the valve plate serve to limit the opening of the reeds on the compression stroke.

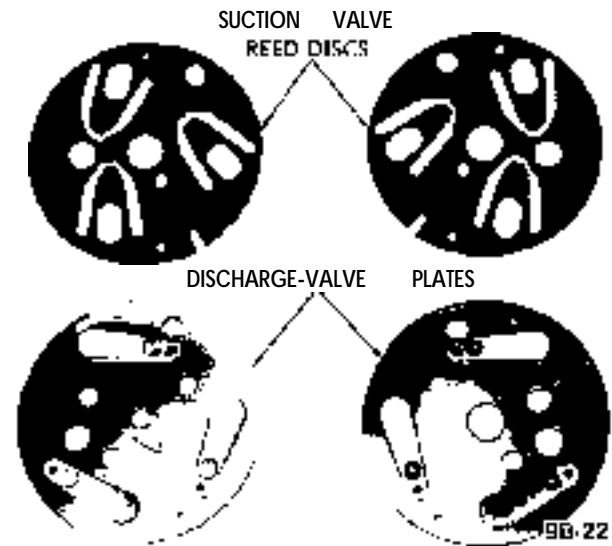
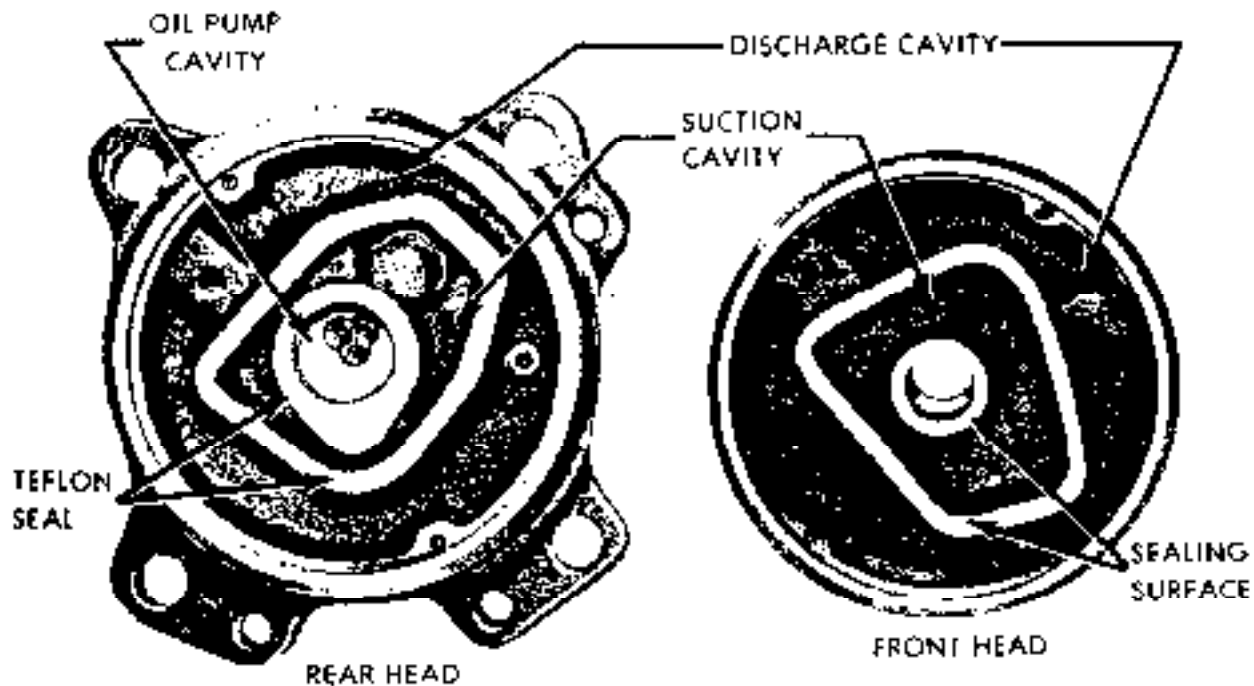


Figure 9B-25 • Compressor Suction Valve Reed Discs and Discharge Valve Plates

2. Front and Rear Heads • The front and rear heads (Figure 9B-26) serve to channel the refrigerant into and out of the cylinders. The front head is divided into two separate passages and the rear head is divided into three separate passages. The outer passage on both the front and rear heads channels high pressure gas from the discharge valve reeds. The middle passage of the rear head also contains the port opening to the superheat switch cavity. This opening in the rear head permits the superheat switch to be affected by suction gas pressure and suction gas temperature for the operating protection of the compressor. The inner passage on the rear head houses the oil pump inner and outer rotors. A Teflon sealing material is bonded to the sealing surfaces separating the passages in the rear head. "O" rings are used to affect a seal between the mating surfaces of the heads and the shell. The front head suction and discharge passages are connected to the suction and discharge passages of the rear head by a discharge tube and suction passage in the body of the cylinder assembly. A screen located in the suction port of the rear head prevents foreign material from entering the circuit.

3. Oil Pump • An internal tooth outer rotor and external tooth inner rotor comprise the oil pump. The pump works on the principle of a rotary type pump. Oil is drawn up from oil reservoir in underside of shell through the oil inlet tube (see Figure 9B-27)



9B-23

Figure 9B-26 Compressor Front and Rear Heads

and circulated through the system via a 3/16 inch diameter oil passage through the shaft center and also four 5/64 inch diameter holes drilled perpendicular to the shaft. The inner rotor is driven by the shaft.

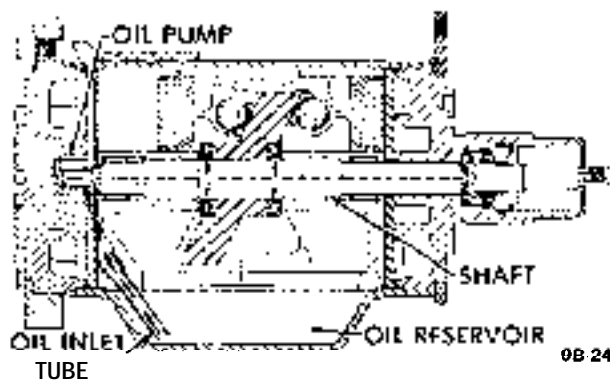


Figure 9B-27 Compressor Oil Flow

4. Shaft and Swash Plate Assembly • The shaft and swash plate assembly (see Figure 9B-162) consists of an elliptical plate positioned obliquely to the shaft. As the plate and shaft rotate, the surface of the plate moves to and fro lengthwise relative to the centerline of the shaft. This reciprocating motion is transmitted to the pistons which contact the surface of the swash plate. A woodruff key locks the swash plate onto the

shaft. The swash plate and shaft are serviced as an assembly. The shaft is driven by a pulley when the magnetic clutch is energized. A needle thrust bearing and a mainshaft bearing support the shaft horizontally and vertically.

5. Needle Thrust Bearing and Races • Two needle thrust bearings, each “sandwiched” between two races are located on either side of the swash plate hub. The front needle thrust bearing and races provide 0.010” to 0.015” clearance between the top of the pistons and the rear side of the front suction valve reed disc (see Figure 9B-28). The rear needle thrust bearings and races provide 0.0005” to 0.0015” clearance between the hub of the swash plate and the rear hub of the rear cylinder. Races of various thicknesses are provided for service replacement to achieve required clearances when rebuilding units.

6. Cylinder Assembly and service Pistons (Factory installed pistons are ringless) -The cylinder assembly (front cylinder and rear cylinder) is serviced only as a matched set. Alignment of the two halves is maintained by two dowel (locater) pins.

The double ended pistons are made of cast aluminum. There are two grooves on each end of the service piston. The outer grooves will receive a piston ring. The inner grooves act as oil scraper grooves to collect any excess oil. Two oil return holes are drilled

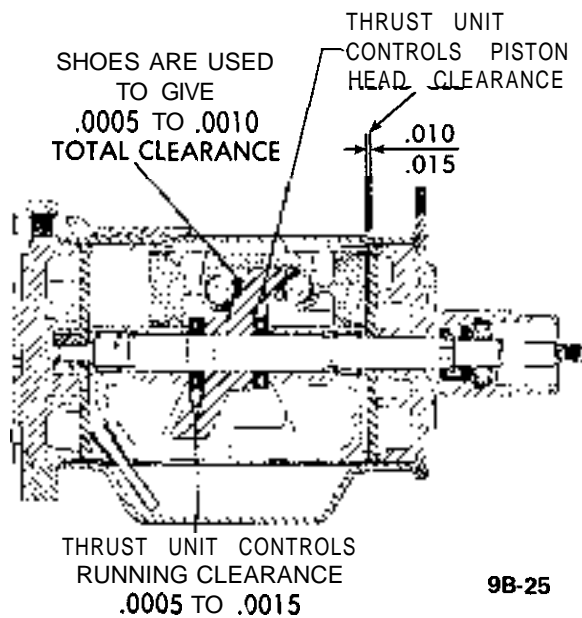


Figure 9B-28 Compressor Needle Thrust Bearings and Races

into the scraper grooves and allow oil to drain back into the reservoir.

7. Shoe Discs • The shoe discs are made of bronze and act as a bearing between the ball and the swash plate. An oil circulation hole is provided through the center of each shoe for lubrication purposes. These shoes are of various thicknesses and are provided in 0.0005 inch increments. Ten sizes are available for service replacement. A basic "zero" shoe size is available for preliminary gauging procedures when rebuilding a cylinder assembly.

8. Suction Passage Cover-The suction passage cover fits over a suction passage (see Figure 9B-30) in the body of the cylinder assembly. Low pressure vapor

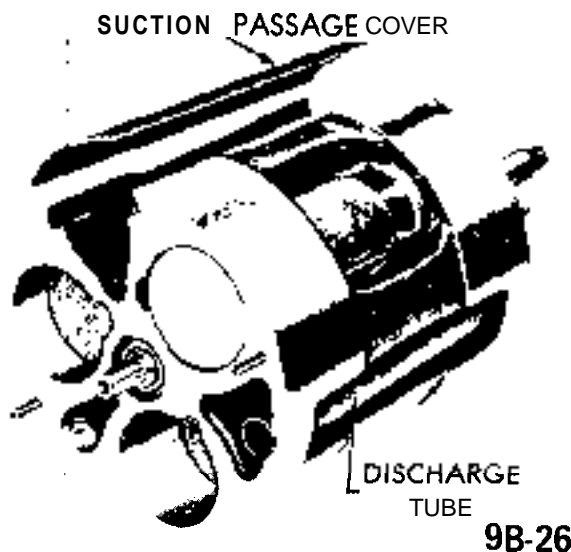


Figure 9B-30 Suction Passage and Discharge Tube

flows from the suction port through the suction passage in the cylinder assembly, and into the suction cavity of the front head.

9. Discharge Tube • The discharge tube is used to connect the discharge cavity in the front head with the discharge cavity in the rear head. High pressure vapor discharge is channeled via the tube to the discharge cavity and port. A slightly modified discharge tube is provided to be used as a service replacement (see Figure 9B-31). The service replacement tube has a reduced end and a built up shoulder to accommodate an "O" ring and bushing. These added parts achieve the necessary sealing of the high pressure vapor within the compressor.

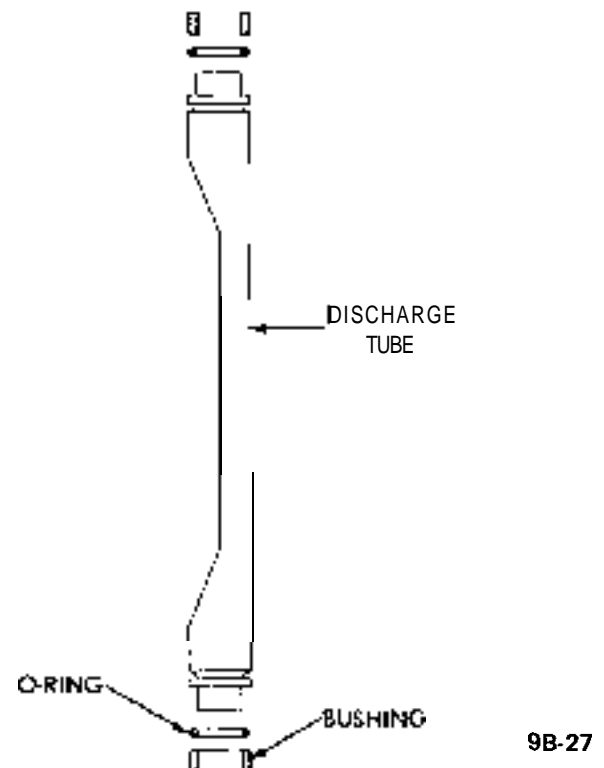


Figure 9B-31 Service Replacement Discharge Tube

10. Pressure Relief Valve • The purpose of the pressure relief valve is to prevent the discharge pressure from exceeding 440 psi. Opening of the pressure relief valve will be accompanied by a loud popping noise and the ejection of some refrigerant from the valve. If the pressure relief valve is actuated due to excessive pressures in the compressor, the cause of the malfunction should be corrected immediately. The pressure relief valve is located on the rear head of the compressor.

11. Shell and Oil Drain Screw • The shell of the compressor contains a reservoir which furnishes a continuous supply of oil to the moving parts of the compressor. A baffle plate covers the reservoir and



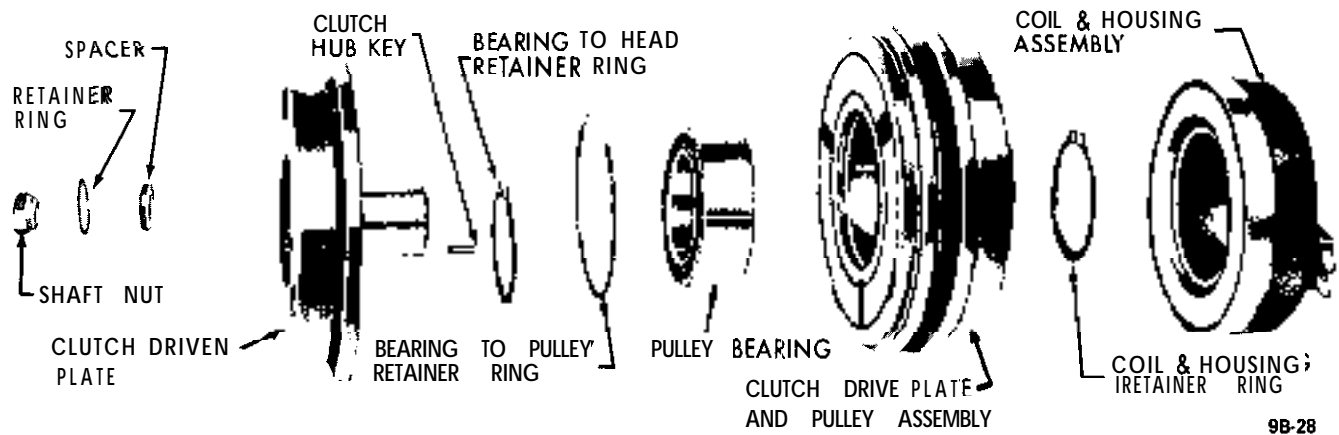


Figure 9B-32 Magnetic Clutch and Pulley Assembly

is tack-welded to the inside of the shell. In addition, an oil drain screw and gasket are located on the side of the reservoir and are provided for draining or adding of oil to system. To add oil, compressor must be removed from car. The necessity to add oil should only be required when the system has ruptured violently and oil has been lost along with refrigerant. Under controlled conditions or slow leak conditions it is possible to lose only a small amount of oil with the refrigerant gas. The serial number, part or model number, and rating of the compressor is stamped on name plates located on top of shell.

12. Magnetic Clutch and Pulley Assembly - The magnetic clutch and pulley assembly (see Figure 9B-32) together transmit power from the engine crankshaft to the compressor. The magnetic clutch is **actuated** when the air conditioning temperature switch and the fan switch located on the evaporator cover assembly are closed. When the switches are closed, the coil sets up a magnetic field and attracts the armature plate (movable element of the clutch driven plate). The armature plate portion of the **clutch driven** plate moves forward and contacts the friction surface of the pulley assembly, thereby mechanically linking the compressor to the engine. The compressor will operate continuously whenever the air conditioner clutch compressor switch and the fan switch are closed. When one or both of the switches are open the armature plate will be released due to spring tension and move away from the pulley assembly. This allows the pulley to rotate without driving the shaft. It should be noted that if the air conditioner system was in use when the engine was turned off, the armature plate may remain in contact with the pulley due to residual magnetism. When the engine is started the armature plate will separate from the pulley assembly. The coil is rated at 3.85 ohms (85 degrees F.) and will **draw 3.2 amperes at 12 volts D.C.**

### Condenser

The condenser which is made of aluminum is located

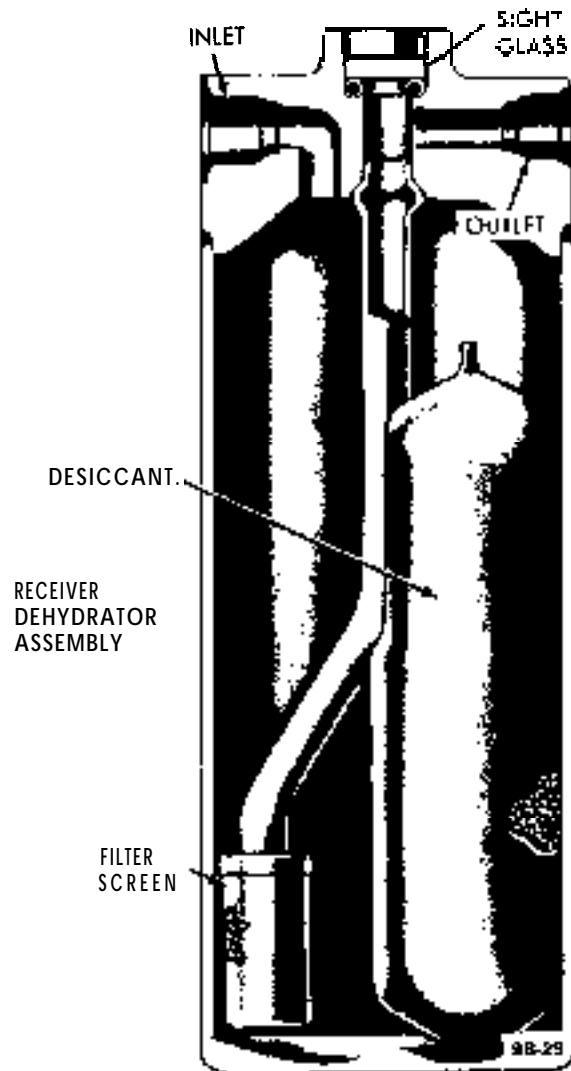


Figure 9B-33 Receiver Dehydrator Assembly

in front of the radiator so that it receives a high volume of air flow. Air passing **over** the condenser **absorbs** the heat from the high pressure gas and causes the refrigerant to condense into a high pressure liquid.

### Receiver. Dehydrator

The receiver-dehydrator is located in the engine compartment. The purpose of the receiver dehydrator is two fold: the unit insures a solid column of liquid refrigerant to the expansion valve at all times, and also absorbs any moisture in the system that might be present. A bag of desiccant (moisture absorbing material) is provided to absorb moisture. A sight glass (see Figure 9B-33) permits visual checking of the refrigerant flow for bubbles or foam. The continuous appearance of bubbles or foam above an ambient temperature of 70 degrees F. usually indicates an inadequate refrigerant charge. Bubbles or foam appearing at ambient temperatures below 70 degrees F. do not necessarily indicate an inadequate charge and may appear even when the system is operating properly. A filter screen in the unit prevents foreign material from entering the remainder of the system.

### Expansion Valve

The expansion valve is mounted on the evaporator core inside the passenger compartment. The function of the expansion valve is to automatically regulate

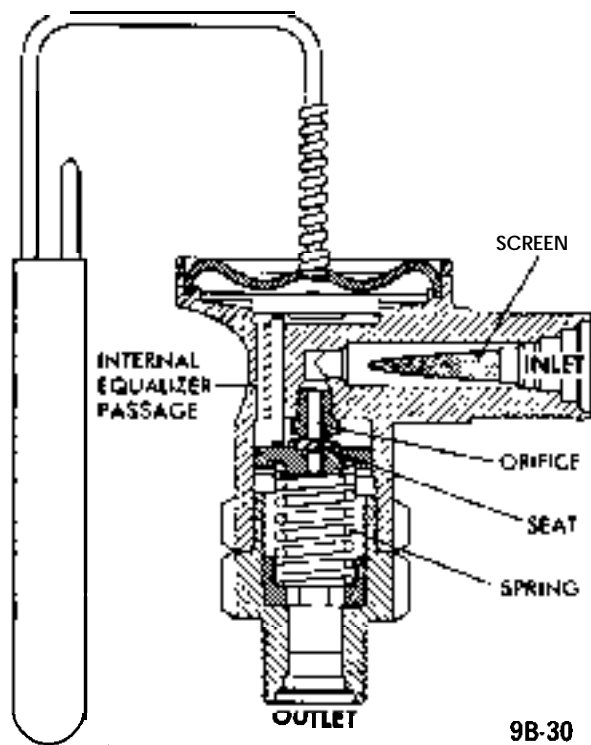


Figure 9B-34 Expansion Valve

the flow of refrigerant into the evaporator. The expansion valve is the dividing point in the system between the high and low pressure liquid refrigerant. A temperature sensing bulb is connected by a capillary tube to the expansion valve (see Figure 9B-34). The temperature sensing bulb (clamped to the outlet pipe on the evaporator) measures the temperature of the evaporator outlet pipe and transmits the temperature variations to the expansion valve (see Figure 9B-34). The capillary tube and bulb are filled with carbon dioxide and sealed to one side of the expansion valve diaphragm.

An increase in temperature will cause the carbon dioxide in the bulb and capillary tube to expand, overcoming the spring pressure and pushing the diaphragm against the operating pins (see Figure 9B-34). This in turn will force the valve off its seat. When the refrigerant low pressure gas flowing through the outlet pipe of the evaporator becomes more than 6 degrees higher or warmer than the temperature at which it originally began to vaporize or boil, the expansion valve will automatically allow more refrigerant to enter evaporator. If the temperature of the low pressure gas decreases to less than 6 degrees above the temperature at which it originally began to vaporize or boil, the expansion valve will automatically reduce the flow of refrigerant. Thus, an increase or decrease in the flow of refrigerant through the evaporator will result in an increase or decrease in the cooling by the evaporator. The temperature, humidity and volume of the air passing over the evaporator affects the rate of absorption of heat by the evaporator. As the ambient temperature bulb calls for more or less refrigerant will increase or decrease. When the air is very warm, the heat transfer from the air to the refrigerant is great and a greater quantity of refrigerant is required to maintain the temperature at the evaporator pipe at the predetermined value. Conversely, cool days will result in less heat transfer and thereby require lesser quantities of refrigerant to maintain the predetermined temperature of the evaporator outlet pipe.

### Evaporator

The function of the evaporator is to cool and dehumidify the air flow in the passenger compartment. The evaporator assembly consists of an aluminum core enclosed in a reinforced plastic housing. Two (2) water drain ports are located in the bottom of the housing. Two refrigerant lines are connected to the side of the evaporator core: one at the bottom and one at the top. The expansion valve is attached to the lower (inlet) pipe, the outlet pipe is attached to the upper pipe. The temperature sensing bulb of the expansion valve is clamped to the outlet pipe of the evaporator core. The high pressure liquid refrigerant, after it is metered through the expansion valve, passes into the evaporator core where it is allowed to expand under reduced pressure. As a result of the reduced pressure the refrigerant begins to

expand and return to the original gaseous state. To accomplish this transformation it begins to boil.

The boiling action of the refrigerant demands heat. To satisfy the demand for heat, the air passing over the core gives up heat to the evaporator and is subsequently cooled.

## DIAGNOSIS

### GENERAL INFORMATION

The following is a brief description of the type of symptom each refrigerant component will evidence if a malfunction occurs:

#### Compressor

Compressor malfunction will appear in one of four ways: noise, seizure, leakage, or low discharge pressure.

Resonant compressor noises are not cause for alarm; however, irregular noise or rattles may indicate broken parts or excessive clearances due to wear. To check seizure, de-energize the magnetic clutch and check to see if drive plate can be rotated. If rotation is impossible, compressor is seized. Low discharge pressure may be due to a faulty internal seal of the compressor, or a restriction in the compressor.

Low discharge pressure may also be due to an insufficient refrigerant charge or a restriction elsewhere in the system. These possibilities should be checked prior to servicing the compressor. If the compressor is inoperative; but, is not seized, check to see if current is being supplied to the magnetic clutch coil terminals.

#### Condenser

A condenser may malfunction in two ways: it may leak, or it may be restricted. A condenser restriction will result in excessive compressor discharge pressure. If a partial restriction is present, sometimes ice or frost will form immediately after the restriction as the refrigerant expands after passing through the restriction. If air flow through the condenser or radiator is blocked, high discharge pressures will result. During normal condenser operation, the outlet pipe will be slightly cooler than the inlet pipe.

#### Receiver-Dehydrator

A receiver-dehydrator may fail due to a restriction inside body of unit. A restriction at the inlet to the receiver-dehydrator will cause high head pressures. Outlet tube restrictions will be indicated by low head

pressures. Outlet tube restrictions will be indicated by low head pressures and little or no cooling. An excessively cold receiver-dehydrator outlet may be indicative of a restriction.

#### Expansion Valve

Expansion valve failures usually will be indicated by low suction and discharge pressures, and insufficient evaporator cooling. The failure is generally due to malfunction of the power element and subsequent closing of the valve. A less common cause of the above symptom is a clogged inlet screen.

#### Evaporator

When the evaporator malfunctions, the trouble will show up as inadequate supply of cool air. A partially plugged core due to dirt or a faulty blower will generally be the cause.

#### Refrigerant Line Restrictions

Restrictions in the refrigerant lines will be indicated as follows:

1. Suction Line - A restricted suction line will cause low suction pressure at the compressor, low discharge pressure and little or no cooling.
2. Discharge Line - A restriction in the discharge line generally will cause the pressure relief valve to open.
3. Liquid Line - A liquid line restriction will be evidenced by low discharge and suction pressure, and insufficient cooling.

#### Use of Receiver-Dehydrator Sight Glass for Diagnosis

At temperatures higher than 70 degrees F, the sight glass may indicate whether the refrigerant charge is sufficient. A shortage of liquid refrigerant is indicated after about five minutes of compressor operation by the appearance of slow-moving bubbles (vapor) or a broken column of refrigerant under the glass. Continuous bubbles may appear in a properly charged system on a cool day. This is a normal situation. If the sight glass is generally clear and performance is satisfactory, occasional bubbles do not indicate refrigerant shortage.

If the sight glass consistently shows foaming or a broken liquid column, it should be observed after partially blocking the air to the condenser. If under this condition the sight glass clears and the performance is otherwise satisfactory, the charge shall be considered adequate.

In all instances where the indications of refrigerant shortage continues, additional refrigerant should be added in 1/4 lb. increments until the sight glass is clear. An additional charge of 1/4 lb. should be added as a reserve. In no case should the system be overcharged.

#### LEAK TESTING SYSTEM

The following two methods are recommended when attempting to locate refrigerant leaks in the system. Loss of refrigerant is always indicative of a leak since refrigerant is not consumed and does not wear out.

1. Open Flame Method • This method utilizes a gas operated torch type leak detector (J-6084). Use of this method is recommended when checking for leaks in confined areas. To perform test, light torch and adjust to obtain a pale blue flame, approximately 3/8 inch in height, in burner.

Explore for leaks by moving end of search tube around suspected area. Check bottom of connections since Refrigerant-12 is heavier than air and will be

more apparent at underside of fittings. The flame color will turn yellow-green when a small leak is detected. Large leaks will turn the flame blue or purple.

**WARNING: Do not breathe fumes resulting from burning of refrigerant gas. These fumes are extremely poisonous.**

2. Liquid Leak Detectors • This method utilizes a solution which will bubble (soap solution) to signify a gas leak. Use of this method of checking is recommended for locating small leaks.

#### FUNCTIONAL TESTING SYSTEM

Functional testing is a measurement of the air conditioner system performance to determine if discharge air temperature, pressure in suction line, and pressure in discharge line are within specific limitations.

To perform Functional test proceed as follows:

1. Remove protective caps from the compressor adapter fittings located on compressor.

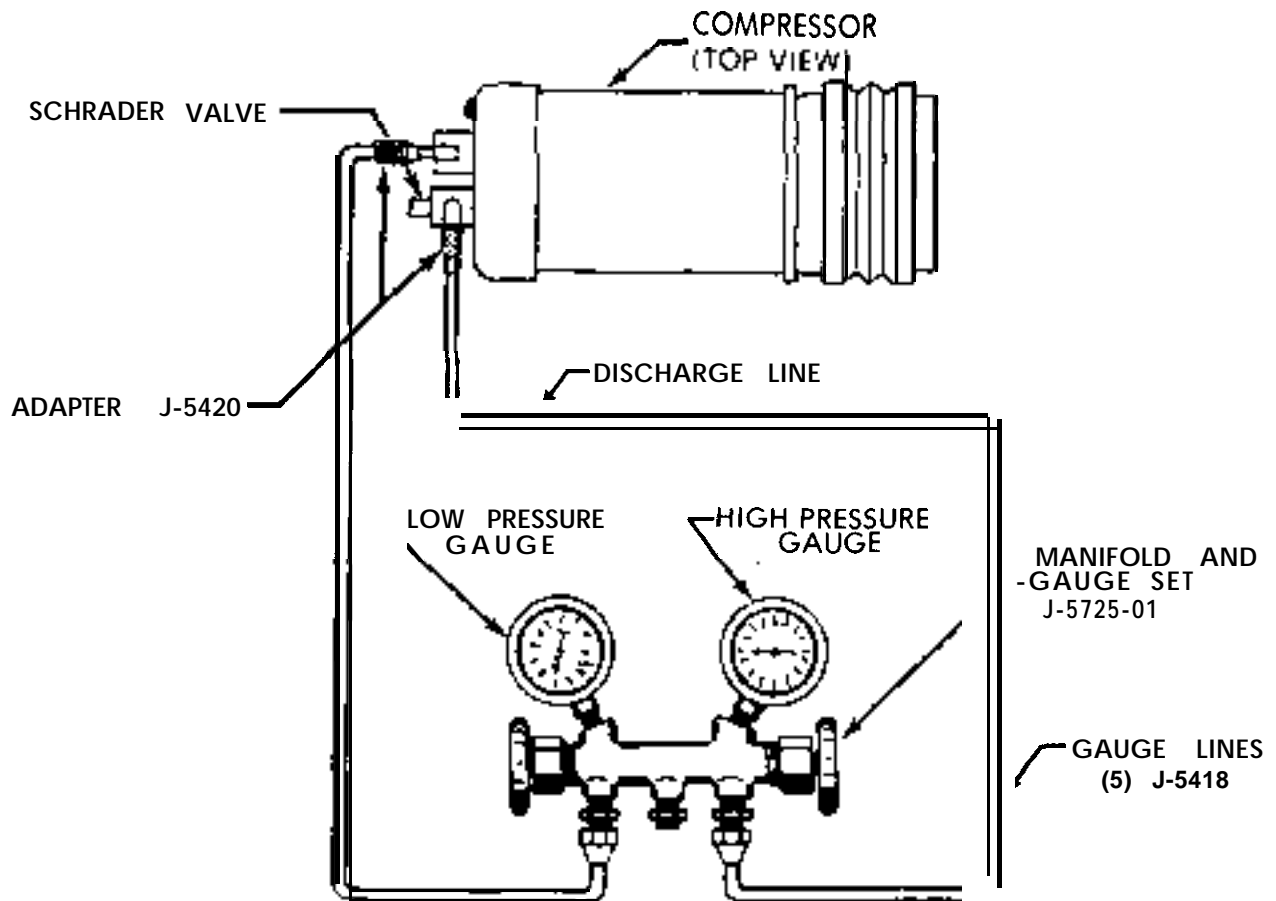


Figure 9B-40 Functional Test Set-Up

2. Interconnect manifold and gage set (J-5725-01), gage charging lines (J-5418) and gage adapters (J-5420) to air conditioning system as shown in Figure 9B-40.
3. Place transmission in "Park" for automatics and in neutral for manuals. Apply hand brake.
4. Turn blower switch to the "Hi" position.
5. Turn temperature switch to "Max" position.
6. Run engine at 2000 RPM for ten (10) minutes with car doors and windows closed and the hood up. Place a high volume industrial type fan in front of radiator if head pressure should exceed 250 psi and also at high ambients to bring the pressures to within the limits specified in the Functional Charts in Division V.

In the case of the Opel 1900 and the Manta, a thermometer should be placed in a position to read the temperature of the air discharging from the right-hand A/C outlet. In case of the GT, a thermometer should be placed in a position to read the temperature of the air discharging from the left-rear A/C outlet.

#### HEATER-AIR CONDITIONER REFRIGERANT CIRCUIT TROUBLE DIAGNOSIS GUIDE

Insufficient Cooling (Check Air Flow)

Normal Air Flow (Inspect system for visual defects. Run functional tests.)

**Discharge Air - Normal Temp** Check for air leaks through dash, car body, windows, or from heater or ventilators.

**Discharge Air - High Temp** Check sight glass for foaming and compressor clutch for engagement.

**No Compressor Clutch Engagement** Check connections at clutch switch, harness connectors, and check clutch switch.

No **Foaming** Compare evaporator pressure to that on functional test table.

**Foaming** System is probably low on refrigerant. Check for leaks, repair, *evacuate*, and charge. If foaming still occurs, check for restriction in refrigerant lines between condenser and receiver dehydrator.

**Evaporator Pressure Normal** Compare head pressure to pressure on functional test table.

**Evaporator Pressure Low** Ice may be forming on evaporator. Low volume of air discharging at A/C outlet after system has been running above idle con-

dition for approximately 15-30 minutes. Discharging air gradually elevating in temperature. Check expansion valve. If valve isn't permitting flow of liquid, this will be indicated by a warm pipe out of the evaporator. This may be caused by: 1) Clogged or Plugged inlet screen in the expansion valve; 2) Broken capillary line; or 3) Discharged temperature bulb. If the valve is okay, the pipe out of the evaporator will be cold.

**Evaporator Pressure High** Check the expansion valve to determine if the bulb is making good contact and is properly insulated. Operate engine at 2000 RPM with maximum air conditioning setting. If evaporator pressure remains high, feel suction line. If line feels frosty or extremely cold with relative high ambient conditions, then partially cover the condenser to obtain head pressures from 265 psi to 280 psi maximum. If evaporator pressure rises above 30 psi, change the expansion valve.

Also, check if compressor may be the cause due to some internal or external mechanical trouble which prevents reduction of pressure. Check for external troubles, slipping belt, bad clutch and/or pulley, or improper clutch engagement, before investigating the compressor internally.

**Head Pressure High** Check for the following: Condenser air flow low, air in system, excessive refrigerant in system, restriction in condenser.

**Head Pressure Low** Restriction in flow of refrigerant to evaporator, or expansion valve plugged or defective.

Low Air Flow (Check blower operation and evaporator. Check operation of controls.)

**Ice Blocking Evaporator** Run functional test. If evaporator pressure is low, ice may form on evaporator and reduce air flow.

**Evaporator Pressure Low** Ice may be forming on evaporator. Low volume of air discharging at A/C outlet after system has been running above idle condition for approximately 15-30 minutes. Discharging air gradually elevating in temperature. Check expansion valve. If valve isn't permitting flow of liquid, this will be indicated by a warm pipe out of the evaporator. This may be caused by: 1) Clogged or plugged inlet screen in the expansion valve; 2) Broken capillary line, or 3) Discharged temperature bulb. If the valve is okay, the pipe out of the evaporator will be cold.

**Blower Not Operating** Check for the following: Fuse blown, blower switch defective, wire broken or loose connection, poor ground connection, or blower motor defective.

**Blower Operating Normal** Check for the following: Restriction or leakage in air ducts, A/C outlets not opening.

## MAINTENANCE AND ADJUSTMENTS

### GENERAL SERVICE INFORMATION AND SAFETY PRECAUTIONS

#### General Information

All subassemblies are shipped sealed and dehydrated. They are to remain sealed until just prior to making connections, and should be at room temperature before uncapping. This prevents condensation of moisture from air that enters the system.

All precautions should be taken to prevent damage to fittings or connections. Even minute damage to a connection could cause it to leak. Any fittings with grease or dirt on them should be wiped clean with a cloth dipped in alcohol.

Do not clean fitting or hoses with solvents because they are contaminants. If dirt, grease or moisture gets inside the pipes or hoses and cannot be removed, the pipe or hose is to be replaced. Use a small amount of clean refrigeration oil on all tube and hose connecting joints, and lubricate the "O" ring gasket with this oil before assembling the joint. The oil will help in effecting a leak-proof joint and assist the "O" ring to slip into the proper location without being cut or damaged. Always use new "O" rings.

When tightening joints, use a second wrench to hold the stationary part of the connection to prevent twisting and to prevent hose kinking. Kinked hoses are apt to transmit noise and vibration. Tighten all connections in accordance with recommended torques (see Division VI, Specifications).

Do not connect receiver-dehydrator assembly until all other connections have been made. This is necessary to insure maximum moisture removal from system.

It is important that air conditioning hoses do not rest on or contact body sheet metal except where necessary. Because of the high frequency at which the compressor operates, the passenger compartment is susceptible to transfer of noise.

#### Safety Precautions

The following safety precautions should always be followed when servicing refrigerant charged components:

1. Do not leave Refrigerant-12 cylinder uncapped.

2. Do not carry cylinder in passenger compartment of car.

3. Do not subject cylinder to high temperatures.

4. Do not weld or steam clean on or near cylinder.

5. Do not fill cylinder completely.

6. Do not discharge vapor into area where flame is exposed or directly into engine air intake.

7. Do not expose eyes to liquid - WEAR SAFETY GOGGLES whenever discharging, charging or leak testing system.

### CHARGING AND DISCHARGING SYSTEM

Removal of any part in the refrigerant circuit will require discharging of the entire system.

#### Discharging the System

1. Remove caps from gauge fittings on the compressor adapter fitting on the compressor.

2. With both valves on manifold gauge set (J-5725-04) closed (clockwise), attach manifold to the compressor adapter fitting on the compressor, using J-5420 valve adapter at suction gauge fitting and J-9459 valve adapter at discharge gauge fitting. See Figure 9B-41.

3. Fully open high pressure valve on manifold gauge set to allow escape of refrigerant from system through the manifold gauge set and out the center fitting and hose. (Place end of hose in clean container to collect oil loss due to rapid discharge of system).

4. When hissing ceases, indicating all refrigerant has escaped, close high pressure valve on manifold gauge set by turning valve clockwise.

#### Evacuating the System

When the refrigeration system is depressurized and opened for service, some air will enter the lines, regardless of how quickly openings are capped. In order to remove this air and as much as possible of the moisture it contains, the complete system must be evacuated. Evacuating is merely the process of removing all air from the system, thereby creating a vacuum in the system.

Under no circumstances should alcohol be used in the system in an attempt to remove moisture, regardless of the successful use of alcohol in other refrigeration systems.

#### Preparations for Evacuating Complete System

1. Check the low pressure gauge for proper calibration.

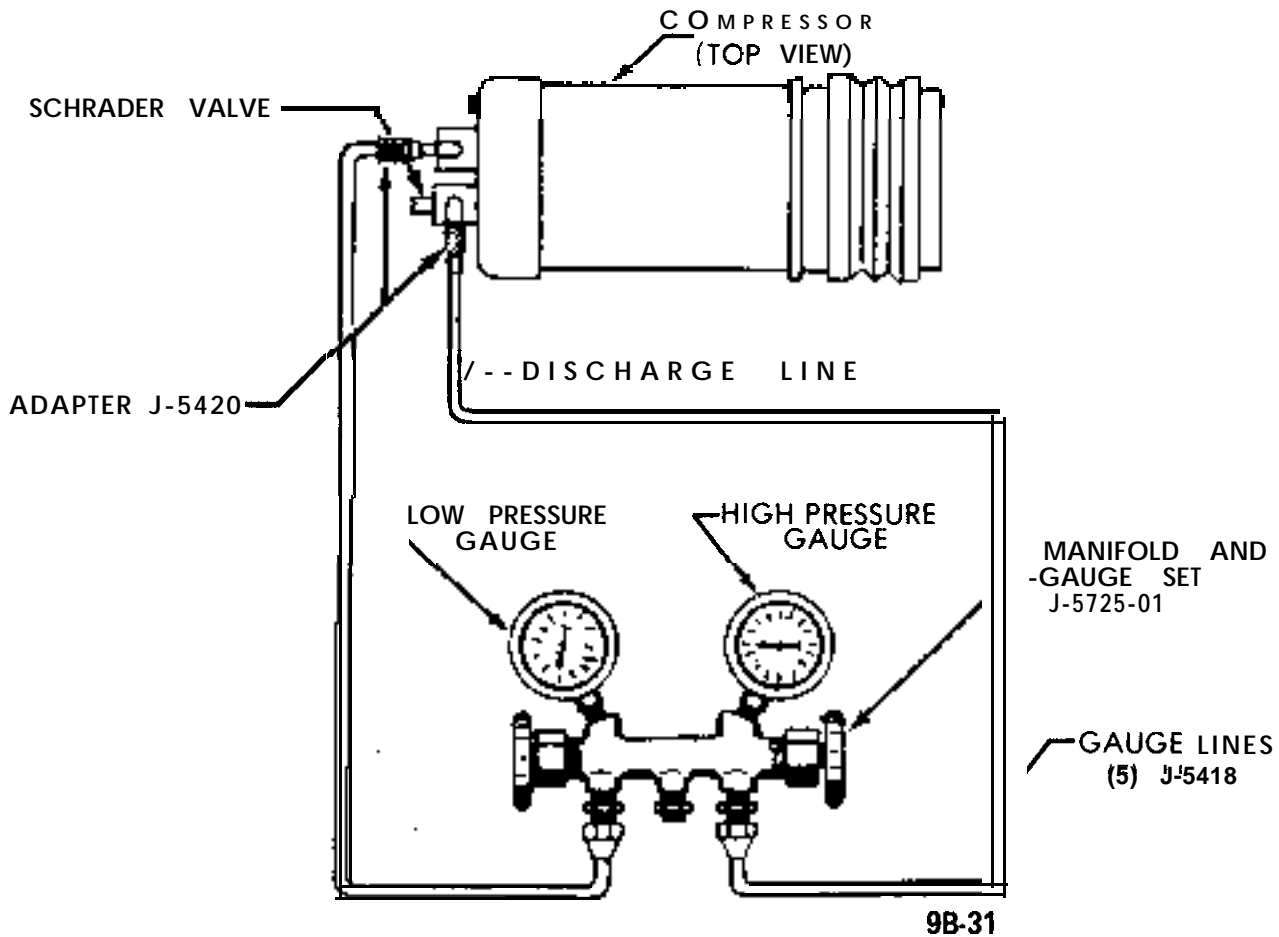


Figure 9B-41 Set-Up For Discharging System

tion. With the gauge disconnected from the refrigeration system, be sure that the pointer indicates to the center of zero. Lightly tap gauge a few times to be sure pointer is not sticking. If necessary, calibrate as follows:

A. Remove cover from gauge.

B. Holding gauge pointer adjusting screw firmly with one hand, carefully force pointer in the proper direction in proper amount to position pointer through the center of "O" position. Tap gauge a few times to be sure pointer is not sticking. Replace gauge cover.

2. If gauge is not already connected to compressor, connect as follows:

A. Close hand shut-off valves on gauge set by turning clockwise.

B. Remove caps from gauge fittings on the compressor adapter fitting.

C. Attach valve adapter (J-5420) to end of the hose

from the low pressure gauge and connect this adapter fitted hose to suction gauge fitting.

D. Attach valve adapter (J-9459) to end of hose from the high pressure gauge and connect this adapter fitted hose to the discharge fitting.

3. Attach a flexible gauge hose to center fitting of the gauge set and attach the other end of this hose to vacuum pump (J-5428-03).

#### Evacuating Complete System

1. Turn hand shut-off valve on low pressure gauge of gauge set to full clockwise position.

2. Slowly turn valve on high pressure gauge counterclockwise from full clockwise position, letting any pressure build-up escape completely. Close high pressure valve.

3. Check oil level in vacuum pump and, if necessary, add refrigeration oil. Make sure dust cap on discharge side of pump has **been** removed.

4. Start the vacuum pump and slowly open low and high pressure sides of manifold gauge set to avoid forcing oil out of refrigeration system and pump. Pressure is **now** being reduced on both sides of the refrigeration system. If oil is blown from the vacuum pump, it should be refilled to the proper level.

5. Observe low pressure gauge and operate vacuum pump until gauge shows 28-29 inches vacuum. In all evacuating **procedures**, specifications of 28-29 inches of vacuum is used. This evacuation can only be attained at or near sea level.

For each 1000 feet **above** sea level where this operation is being performed, the specification should be lowered by one inch of mercury vacuum. At 5000 feet elevation, only 23 inches to 24 inches of vacuum can normally **be** obtained.

If vacuum cannot be pulled to the minimum specification for the respective altitude, it indicates a leak in the system or gauge connections or a defective vacuum pump. In this case, it will be necessary to check for leaks as described under "Leak Testing Refrigerant System".

When specified vacuum level (28-29 inches at sea level) is obtained, continue to run vacuum pump for ten (10) additional minutes. During these ten (10) minutes:

A. Prepare for charging the system. If using a charging station, till charging cylinder. If using manifold gauge set, make all preparations for charging system as described under "Disposable Can Method" or "Refrigerant Drum Method".

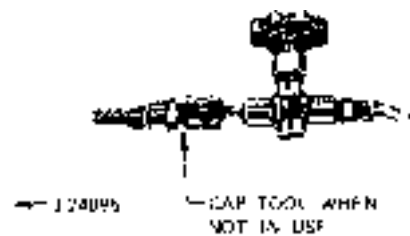
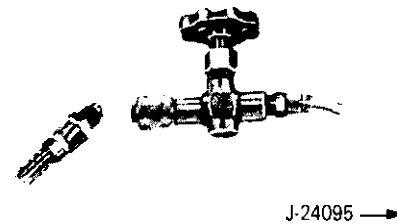
B. Measure oil loss collected as a result of rapid discharge.

C. Uncap compressor oil injector (J-24095) and open valve. Flush J-24095 with refrigerant, close valve and insert pick-up tube into graduated container of clean refrigerant oil.

D. Connect J-24095 to suction fitting at the compressor adapter fitting. When valve on J-24095 is opened, the vacuum applied to the discharge side of the system will suck oil into system from container. Therefore, close observation of oil level in the container is necessary.

E. Note level of oil in container. Open valve on J-24095 until oil level in container is reduced by an amount equal to that lost during discharge of system, then shut valve. Take care not to add more oil than was lost.

F. Disconnect J-24095 and attach pick-up tube fitting to **schraeder** fitting to cap tool. See Figure 9B-42.



9B-32

Figure 9B-42 Oil Injector J-24095

6. Turn hand shut-off valves at low and high pressure gauges of gauge set to full clockwise position with vacuum pump operating, then stop pump. Carefully check low pressure gauge approximately for two (2) minutes to see that vacuum remains constant. If vacuum reduces, it indicates a leak in the system or gauge connections.

### Charging the System

The system should be charged only after being evacuated as outlined in "Evacuating the System".

### Refrigerant Drum Method

1. Connect center **flexible** line of gauge set to refrigerant drum.
2. Place refrigerant drum in a pail of water which has been heated to a maximum of 125 degrees F.

**WARNING: Do not allow temperature of water to exceed 125 degrees F. High temperature will cause excessive pressure and possible softening of fusible safety plugs in the refrigerant drum. It may not be necessary to use hot water if a large drum is used (over approximately 100 lbs.).**

3. Place refrigerant drum (in pail of water) on scales (bathroom or commercial, **preferably** commercial).



Do not turn refrigerant drum upside down, as this would allow liquid refrigerant to enter compressor which may cause damage.

4. If line at center gauge fitting has not been purged of air, loosen line at center fitting on gauge set and crack valve on refrigerant drum to blow air from line. Retighten line at center fitting and record exact weight of refrigerant tank in water on the scales.

5. Open valve on refrigerant drum and **both valves** on gauge set to allow refrigerant to flow into system. Continue charging until the scales show that 2 lbs. Opel 1900 - Manta and 2 1/4 lbs. GT, of refrigerant have been transferred from refrigerant drum to system.

If full charge cannot be obtained, close both valves on gauge set, start engine, and set temperature control knob to full cold position with blower in Max Hi. Open low pressure valve on gauge set slowly and leave open until full charge is added.

**WARNING: Observe high pressure gauge while charging with compressor running. Shut off engine if pressure exceeds 250 psi. A large fan placed in front of the car will help reduce excessively high head pressure.**

6. Close both valves on gauge set (high pressure valve will already be closed if charging was completed by running compressor) and close valve on refrigerant drum.

If the engine was used to complete the charge into the system, close valve on refrigerant drum to permit compressor to draw any refrigerant left in the line from the drum to the center fitting of the gauge set, then close the low pressure valve on the gauge set.

7. Operate engine at 2000 RPM with temperature control knob at full cold, blower speed in Max Hi. After ten minutes of operation, observe appearance of refrigerant in receiver-dehydrator. If bubbles are observed, open low pressure gauge valve and valve on refrigerant drum to allow more refrigerant to enter system. Close valve when receiver-dehydrator clears up.

If an air inlet temperature is below 70 degrees F. when this check is made, bubbles may appear, even though the proper amount of refrigerant is in the system. Air inlet temperature must be 70 degrees F. or above to make an accurate check.

8. When refrigerant has been installed, continue to operate system and test for proper operation as outlined under "Operational Test".

9. When satisfied that air conditioning system is operating properly, stop engine, remove gauge set and replace protective caps on compressor fittings.

**WARNING: A considerable amount of refrigerant will collect in the high pressure line, since some of this refrigerant will have condensed into liquid refrigerant. Wrap the high pressure gauge fitting at the compressor with a shop cloth before disconnecting the valve from the gauge fitting, to prevent injury to personnel!**

10. Using leak detector, check complete system for leaks.

#### Disposable Can Method

After having depressurized, repaired (if necessary) and evacuated the refrigerant system, the system may be charged as follows using refrigerant in disposable cans:

1. Obtain three (3) 1 lb. cans or one 12 lb. can of refrigerant.

2. If using 1 lb. cans, **mount two (2) cans** in J-6272-02 (Multi-opener) or attach J-6271 (single-can opener valve) on one can. If using the 12 lb. disposable can, attach J-23390 (disposable can control valve) on can.

**WARNING: Make sure outlet valve on opener is closed (clockwise) before installing opener.**

A. If the J-6272-02 multi-opener is used, raise locking lever, position three (3) cans of refrigerant and force locking lever down to secure cans and at same time puncture top of can to make it ready for charging.

B. If the J-6271 valve is used, back off the valve from the can top retainer, slip the valve onto the can and turn the valve into retainer until tight. **DO NOT** open outlet valve during this operation, as turning the valve into the retainer punctures top of can to make it ready for charging.

3. Connect center flexible line of gauge set to fitting on a can opener valve. If the line at center gauge fitting has not been purged of air, loosen line at center fitting on gauge set and "crack" valve at can opener (for a second or two) to force air from the line. Retighten line at center fitting.

4. Open valve at refrigerant source and at low and high pressure valves on manifold gauge set. Leave valve open at refrigerant source until all refrigerant (when using 1 lb. can) has entered the refrigeration system or system is fully charged. Close valve on can.

A. If the system is charged using 1 lb. cans and the J-6271 valve, disconnect valve from can. Leave valve closed to flexible line to the center fitting of the manifold gauge set. Install valve on a new and full disposable can of refrigerant.

**B.** If system is charged using J-6272-02, close the valve of opener after all cans are empty. Release the locking lever and discard the three (3) empty cans. If this tool will be used to complete the charge with additional cans to provide the required refrigerant charge, leave the empty cans in position, locate one full can and lock the lever into place. These empty cans balance the assembly and prevent the loss of refrigerant through the open "series" passage. Align the pierced hole in the empty can with the punch in the cover of the tool.

If the J-6271 valve for single cans is available, complete charging as explained in 4a above.

5. Close high side valve on manifold gauge set,

**WARNING:** *Prior to starting up engine, the high side valve on the charging manifold must be closed due to excessive pressure build-up which can result in bursting of the container(s) causing serious injury. If you are inexperienced in the use of this procedure, seek professional assistance.*

6. Operate engine at 2000 RPM with temperature control knob at full cold position and blower speed on Max Hi. If air inlet temperature at the condenser is below 70 degrees F. when this check is made, bubbles may appear, even though the proper amount of refrigerant is in the system. Air inlet temperature must be 70 degrees F. or above to make an accurate check.

7. When refrigerant has been installed, continue to operate system and test for proper operation as outlined under "Operational Test".

8. When satisfied that the air conditioning system is operating properly, stop engine, remove gauge set and replace protective caps on suction and discharge fittings.

**WARNING:** *A considerable amount of refrigerant will collect in the high pressure line, since some of this refrigerant will have condensed into liquid refrigerant. Wrap the high pressure fitting at the compressor with a shop cloth before disconnecting the valve from the gauge fitting to prevent damage or injury to personnel.*

9. Using a leak detector, check complete system for leaks.

### Charging Station Method

#### INSTALLING J-8393-02

1. Be certain compressor hand shut-off valves to gauge fittings are closed (counterclockwise).

2. Be certain all valves on charging station are closed.

3. Connect high pressure gauge line to compressor high pressure gauge fitting.

4. Turn high pressure hand shut-off valve one turn clockwise, and high pressure control one turn counterclockwise (open). Crack open low pressure control and allow refrigerant gas to hiss from low pressure gauge line for three seconds, then connect low pressure gauge line to low pressure gauge fitting on compressor adapter fitting. (Place J-9459 adapter on hose, then attach adapter to gauge fitting.)

#### FILLING CHARGING CYLINDER

1. Open Control valve on refrigerant container.

2. Open valve on bottom of charging cylinder, allowing refrigerant to enter cylinder.

3. Bleed charging cylinder to valve (behind control panel) only as required to allow refrigerant to enter cylinder. When refrigerant reaches desired charge level, close valve at bottom of charging cylinder and be certain cylinder bleed valve is closed securely.

While filling the cylinder, it will be necessary to close the bleed valve periodically to allow boiling to subside so that refrigerant level in the charging cylinder can be accurately read.

#### CHARGING THE SYSTEM USING J-8393-02

1. With charging station connected, as previously described, remove low pressure gauge line at compressor adapter fitting.

2. Crack open high and low pressure control valves on station and allow refrigerant gas to purge from system. Purge slowly enough so, that oil does not escape from system along with refrigerant.

3. When refrigerant flow nearly stops, connect low pressure gauge line to compressor adapter fitting.

4. Turn on vacuum pump and open vacuum control valve.

5. With system purged as above, run pump until 26-28 inches of vacuum is obtained. Continue to run pump for 15 minutes after the system reaches 26-28 inches vacuum.

In all evacuating procedures, the specification of 26-28 inches of mercury vacuum is used. These figures are only attainable at or near sea level. For each 1000 feet above sea level where this operation is being performed, the specifications should be lowered by 1 inch. For example, at 5000 feet elevation, only 21 to 23 inches vacuum can normally be obtained.

6. If 26-28 inches vacuum (corrected to sea level) cannot be obtained, close vacuum control valve and

shut off vacuum pump. Open refrigerant control valve and allow some refrigerant to enter system. Locate and repair all leaks.

7. After evacuating for 15 minutes, add 1/2 lb. of refrigerant to system. Purge this 1/2 lb. and reevacuate for 15 minutes. This second evacuation is to be certain that as much contamination is removed from the system as possible.

8. Only after evacuating as above, system is ready for charging. Note reading on sight glass of charging cylinder. If it does not contain a sufficient amount for a full charge, till to proper level.

9. Close low pressure valve on charging station. Fully open station refrigerant control valve and allow all liquid refrigerant to enter system. When full charge of refrigerant has entered system, turn off refrigerant control valve and close both hand shut-off valves.

10. If full charge of refrigerant will not enter system, close high pressure control and refrigerant control valves. Start engine and run at low idle with compressor operating. Crack refrigerant control valve and low pressure control on station. Watch low side gauge and keep gauge below 50 psi by regulating refrigerant control valve. Closing valve will lower pressure. This is to prevent liquid refrigerant from reaching the compressor while the compressor is operating. When required charge has entered system, close refrigerant control valve and close low pressure control.

11. System is now charged and should be performance- tested before removing gauges.

#### Adding Refrigerant

The following procedure should be used in adding small amounts of refrigerant that may have been lost by leaks or while opening system for servicing the compressor. Before adding refrigerant to replace that lost by leaks, check for evidence of oil loss and add oil if necessary.

This procedure will only apply if the air inlet temperature is above 70 degrees F. at the condenser.

1. Remove caps from compressor gauge fittings. Attach gauge set to gauge fittings, making sure adapter (J- 5420) is between low pressure gauge hose and suction gauge fitting, and J-9459 is between high pressure gauge hose and discharge gauge fitting.

2. Start engine, turn air conditioning temperature control knob to full cold position, blower switch to Max Hi. Operate for ten (10) minutes at 2000 RPM to stabilize system.

3. Observe the refrigerant through the sight glass

cover of receiver-dehydrator with the system operating, to see if there are any bubbles evident.

a. If no bubbles are evident, then bleed system slowly through the discharge valve until bubbles appear in the receiver-dehydrator. Add 1 lb. of refrigerant as explained under "Charging the System".

b. If bubbles are visible in the receiver-dehydrator with the temperature control knob in the full cold position and the blower at MAX speed, it indicates a partial or complete plug in a line, a shortage of refrigerant, or both. Correct condition. Add refrigerant until the sight glass clears, then add another 1 lb. of refrigerant.

4. Attach flexible hose from center fitting of gauge set loosely to refrigerant drum or on disposable can valves. Open high and low pressure valves on the gauge set slightly to purge pressure gauge lines of air. Tighten fitting of refrigerant drum or can when satisfied that all air has been removed from gauge lines. Close (clockwise) both hand shut-off valves or gauge set.

5. Partially charge system.

#### REFRIGERANT DRUM METHOD:

A. Place pail containing hot water that does not have a temperature exceeding 125 degrees F. on scales, place refrigerant drum in pail containing water, note weight and only open low pressure valve on gauge set.

B. Start engine, turn temperature control knob to full cold position and place blower switch in Max Hi. Operate engine for 10 minutes at 2000 RPM to stabilize system.

C. With compressor operating, slowly open valve on refrigerant drum and allow refrigerant to flow into system (through manifold gauge set) until liquid indicator clears up and immediately shut off valve at gauge set or on refrigerant drum. Check weight of refrigerant drum and pail of water. Then slowly open valve on gauge set (or refrigerant drum) and add one more lb. of refrigerant. Note total amount of refrigerant added.

#### DISPOSABLE CAN METHOD:

A. Make sure the outlet valve on the J-6271 valve is fully clockwise and attach the J-6271 to a 1 lb. can of refrigerant by backing off the valve from the top of the retainer, slipping the valve onto the can and turning the valve into the retainer until tight. DO NOT accidentally open outlet valve during this operation, as turning the valve into the retainer punctures the top of the can to make it ready for charging.

**B. Connect** center flexible line of gauge set to the fitting on the valve.

C. Start engine, turn temperature control knob to full cold position, set blower switch to Max Hi. Operate engine for 10 minutes at 2000 RPM to stabilize system.

D. With compressor operating, slowly open valve on refrigerant can and allow refrigerant to flow into system (through manifold gauge set) until liquid indicator clears up and immediately shut off valve at gauge set and on refrigerant can. Check weight of can and valve assembly and record.

E. Add an additional 1 lb. of refrigerant by adding refrigerant from the can just weighed until can is empty. Attach another can and add refrigerant until can and valve assembly weigh the same as recorded.

6. Close valves at refrigerant drum or can.

7. Test for leaks and make operational check of system.

**ADDING OIL TO THE SYSTEM (MAJOR OVERHAUL)**

The oil in the refrigeration system does not remain in the compressor during system operation, but cir-

culates throughout the system. The compressor is initially charged with 10 oz. of 525 viscosity oil. After system has been in operation the oil content in the compressor will vary depending on the engine RPM and air conditioning load. At higher engine RPM's a lesser amount of oil will be retained in the compressor reservoir. It is important that the total system oil content does not vary from a total of 10-1/2 oz. Excessive oil content will reduce cooling capacity. Inadequate oil content may result in damage to compressor moving parts.

The refrigeration system will not require adding of oil unless there is an oil loss because of a ruptured line, badly leaking compressor seal, replacement of evaporator, compressor, receiver-dehydrator, or loss due to a collision. Oil is generally added to the system via the oil drain hole in the lower side of the compressor for this condition. To add oil to the system via the compressor, the compressor must be removed. If no major loss of oil has occurred and a component (condenser, receiver-dehydrator or evaporator) is removed for servicing, the oil may be added directly to the component. To add oil to a component removed for servicing and when no major loss has occurred, drain and measure oil in component, then replace with a like amount. To add oil to the system when a major loss of oil is evidenced, or when the compressor is being serviced, remove compressor, drain and measure oil, and replace oil amount specified in the Oil Replacement Table.

**OIL REPLACEMENT TABLE**

Condition	Amount of Oil Drained From Compressor	Amount of 525 Oil to Install In Compressor
1. Major loss of oil and a component (condenser, receiver-dehydrator, or evaporator) has to be replaced.	a. More than 4 oz.	a. Amount drained from compressor, plus amount for component being replaced. Evaporator - Add 2 oz. Condenser - Add 1 oz. Receiver-Dehydrator - Add 1 oz.
	b. Less than 4 oz.	b. Install 6 oz., plus amount for component being replaced as shown above.
2. Compressor being replaced with a service replacement compressor - no major oil loss.	a. More than 1 1/2 oz.	a. Same amount as drained from compressor being replaced.
	b. Less than 1 1/2 oz.	b. Install 6 oz

Condition	Amount of Oil Drained From Compressor	Amount of 525 Oil to Install In Compressor
3. Compressor being replaced with a service replacement compressor major oil loss evident.	a. More than 4 oz.	a. Same amount as drained from compressor being replaced.
	b. Less than 4 oz.	b. Install 6 oz.
4. Compressor being rebuilt or repaired - no major oil loss evident.	a. More than 1 1/2 oz.	a. Same amount as drained from compressor, plus 1 oz. additional.
	b. Less than 1 1/2 oz.	b. Install 7 oz.
5. Compressor being rebuilt or repaired major loss of oil evident.	a. More than 4 oz.	a. Same amount as drained from compressor, plus 1 oz. additional.

If foreign material is noted in oil drained from system or evidence of moisture is obvious in the components removed, it is recommended that the entire system be flushed and the receiver-dehydrator be replaced. A full oil charge of 10 oz. of 525 viscosity refrigeration oil should be replaced in the system. It should be noted that all service replacement compressors will be supplied with 10 oz. of oil. In most cases it will be necessary to drain oil from service replacement compressor and refill it with amount as specified in the Oil Replacement Table.

#### FLUSHING THE SYSTEM

Flushing of the system may involve all the components of the system or individual components in the system. The components may be flushed while mounted in the engine compartment or may be removed for flushing. When a component is not removed, disconnect all refrigerant lines or hoses attached to component. To perform flushing operation, connect a cylinder of refrigerant-12 to the component to be flushed, then invert the cylinder and open the cylinder valve so that the liquid refrigerant pours out and through the component. When liquid Refrigerant-12 reaches atmospheric pressure, it immediately drops to minus 21.7 degrees F. Insure that area immediately surrounding outlet of component is clear of anything that may be damaged by contact because of the sudden drop in temperature.

In all cases where a complete system flushing operation is performed, the receiver-dehydrator and the

filter screen on the expansion valve should be replaced. If the evaporator assembly is flushed while installed in the car, the temperature bulb on the evaporator outlet pipe must be disconnected to keep the expansion valve from closing at the inlet source.

It is recommended that dry nitrogen be used as a flushing agent due to the low cost involved. In addition, dry nitrogen will not cause a temperature drop, as in the case of refrigerant-12, which results in thickening of refrigerant oil. Dry nitrogen has the additional advantage of removing moisture from the system.

#### MAJOR REPAIR

##### REMOVAL AND INSTALLATION OF COMPRESSOR - OPEL 1900 - MANTA

###### Removal

1. Remove negative battery cable from battery.
2. Remove air cleaner and heat pipe. Cover the carburetor to keep out dirt etc.
3. Discharge system. Refer to DISCHARGING SYSTEM.
4. While system is discharging remove sheet metal cover. See Figure 9B-50.

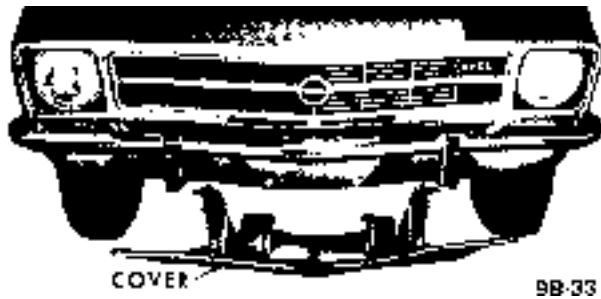


Figure 9B-50 Sheet Metal Cover Removed

5. Unplug compressor clutch electrical plug, and remove idler pulley bracket assembly and ground wire. See Figure 9B-51. Radiator hose is removed for photographic reasons only.

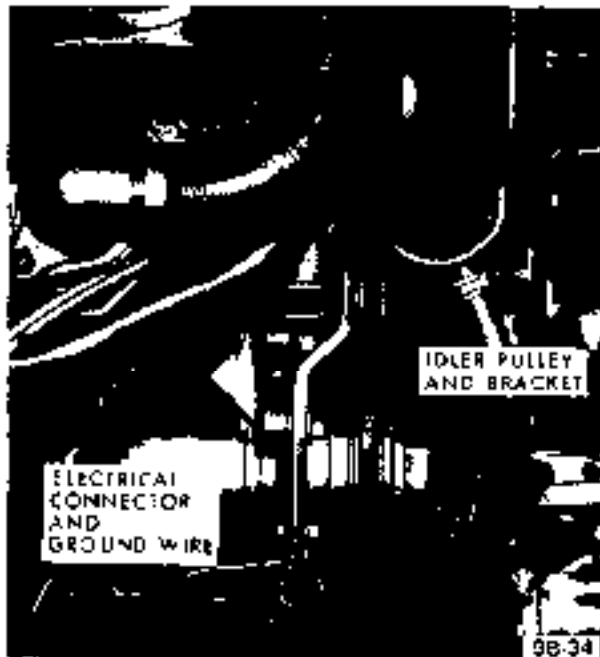


Figure 9B-51 Location of Idler Pulley, Bracket and Ground Wire Opel 1900 Manta

6. After system is completely discharged, remove refrigerant hoses from compressor adapter fitting and cap hoses and adapter fitting to keep contaminants from entering.

7. Support compressor from underneath and remove three (3) compressor mounting support bolts and support bracket. Carefully lower compressor. See Figure 9B-52. During removal, maintain the compressor position so that the sump is downward. Do not rotate compressor shaft.



Figure 9B-52 Location of Compressor Mounting Support Bolts Opel 1900 Manta

### Installation

1. Support compressor from underneath and install into position from **under** car. Insure that compressor has sufficient oil charge.
2. Install three (3) compressor mounting support bolts. See Figure 9B-52.
3. Install compressor support bracket. Torque bolts to 20 lb.ft. See Figure 9B-53.
4. Install idler pulley, fan belt, bracket assembly and ground wire. Plug in compressor clutch electrical plug. See Figure 9B-54.
5. Install refrigerant hoses and evacuate system. Refer to **EVACUATING THE SYSTEM**.
6. While system is being evacuated install sheet metal cover. See Figure 9B-50.
7. Install air cleaner and heat pipe.
8. Install negative battery cable and charge system. See **CHARGING THE SYSTEM**.

### REMOVAL AND INSTALLATION OF RECEIVER-DEHYDRATOR ASSEMBLY - OPEL 1900 MANTA

#### Removal

1. Discharge system. Refer to **DISCHARGING THE SYSTEM**.

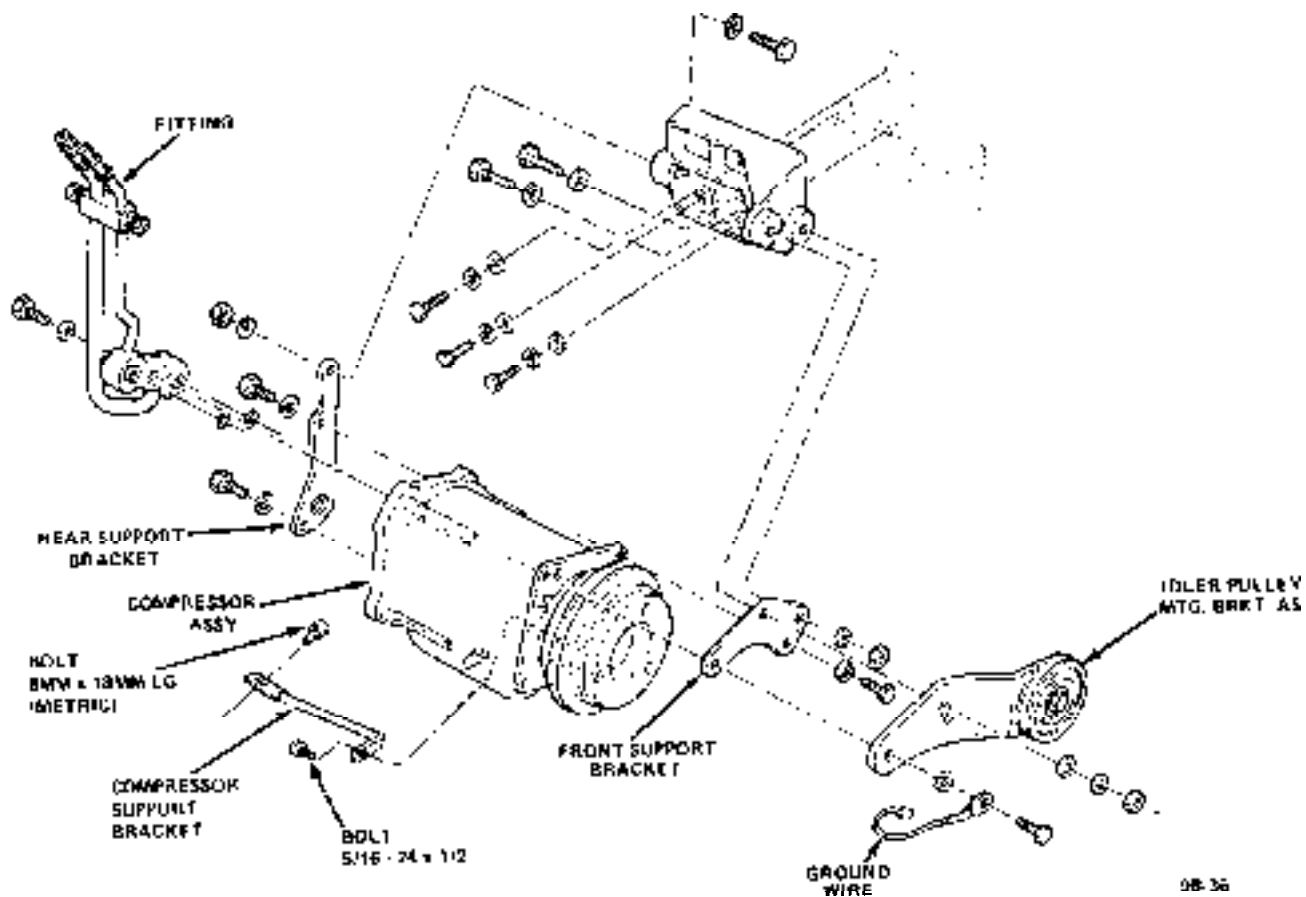


Figure 9B-53 Compressor Installation Opel 1900 Manta

2. Disconnect refrigerant lines to both ends of receiver-dehydrator and tape closed open ends of refrigerant lines, and also the open ends of the inlet and outlet pipes of the receiver-dehydrator.

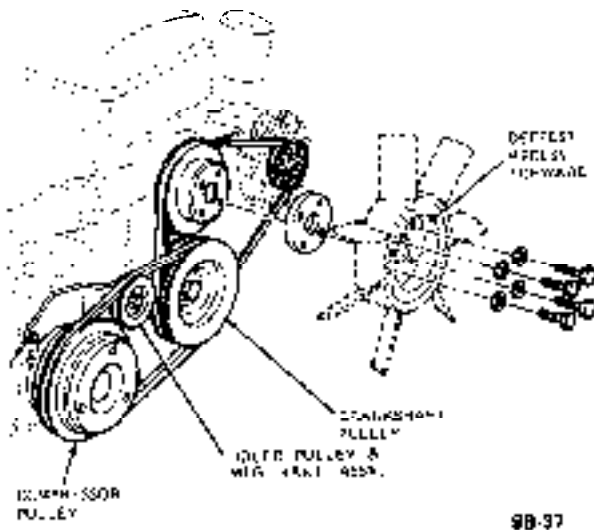
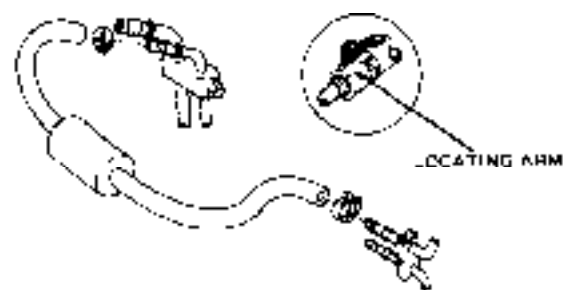


Figure 9B-54 Compressor Pulley, Idler Pulley and Mounting Bracket Assembly • Opel 1900 Manta



AFTER INSTALLATION OF ALL CLAMP CONNECTIONS, BE CERTAIN END OF CLAMPS CAN NOT CAUSE DAMAGE TO ADJACENT HOSES.

9B-38

Figure 9B-55 Hose and Clamp Installation • Opel 1900 Manta

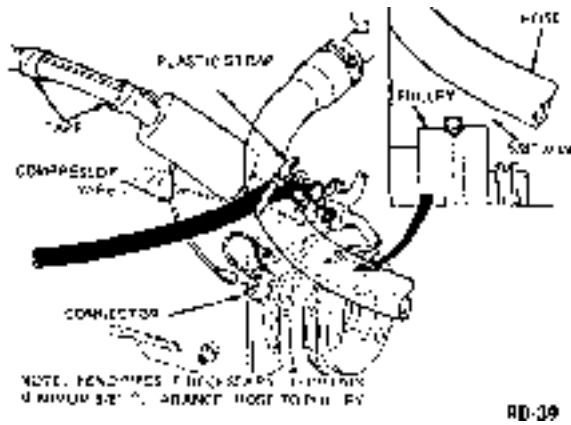


Figure 9B-56 Pipes, Hoses and Compressor Wire Location - Opel 1900 Manta

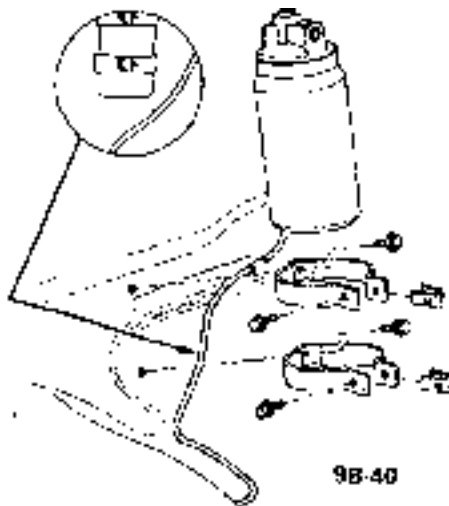


Figure 9B-57 Receiver Dehydrator Support Bracket. Opel 1900 - Manta

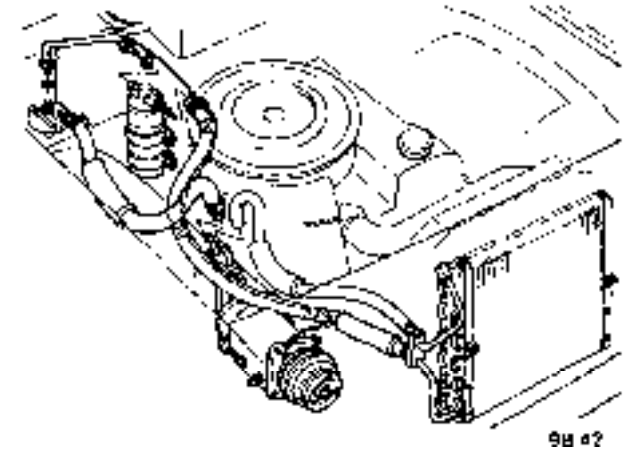


Figure 9B-60 Receiver Dehydrator Hoses and O-Rings Opel 1900 Manta

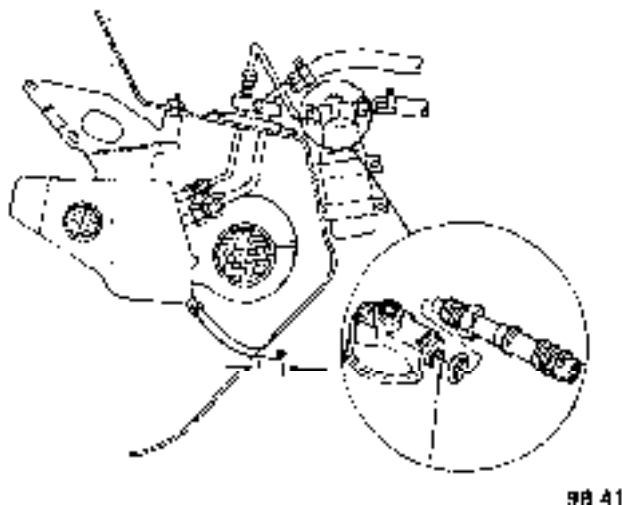


Figure 9B-58 Receiver Dehydrator O-Ring and Drain Hose Location - Opel 1900 - Manta

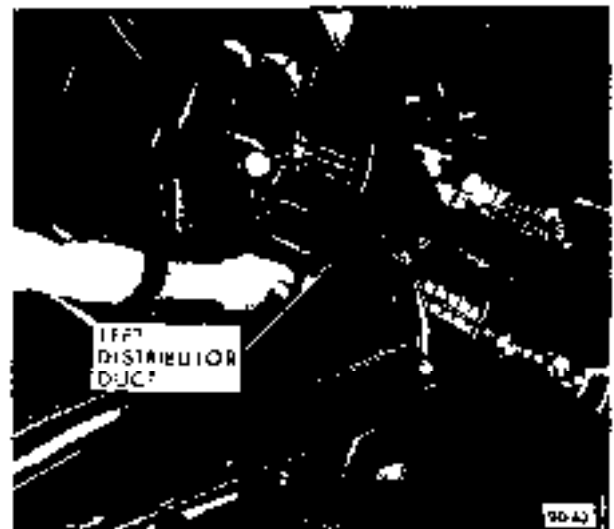


Figure 9B-61 Removing Left Side Distributor Duct

3. Remove two (2) screws securing receiver-dehydrator within support bracket and lift out receiver-dehydrator.

**Installation**

If the receiver-dehydrator has been exposed to the atmosphere for any amount of time, (more than five (5) minutes), the receiver-dehydrator should be replaced, since the life of the dessicant is probably expended.

1. Install receiver-dehydrator. Using new o-rings during installation. Lubricate o-rings prior to installation using No. 525 viscosity oil.

2. Evacuate and charge system. Refer to CHARGING AND DISCHARGING SYSTEM.



REMOVAL AND INSTALLATION OF EVAPORATOR AND EXPANSION VALVE. OPEL 1900 • MANTA

Removal

1. Remove negative battery cable from battery.
2. Remove left side of distributor duct, and in line fuse. See Figure 9B-61.
3. Remove glove box. See Figure 9B-62.

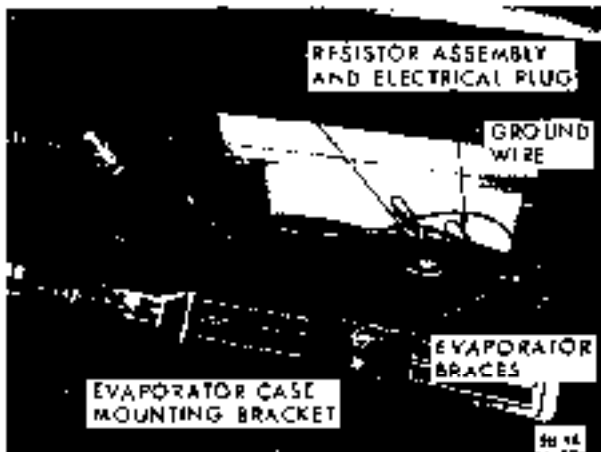


Figure 9B-62 Glove Box Removed

4. Discharge refrigerant from system. (Refer to DISCHARGING SYSTEM) and disconnect refrigerant hose from evaporator outlet and pipe from evaporator inlet and tape the open ends of the refrigerant lines and evaporator pipes. See Figure 9B-63.

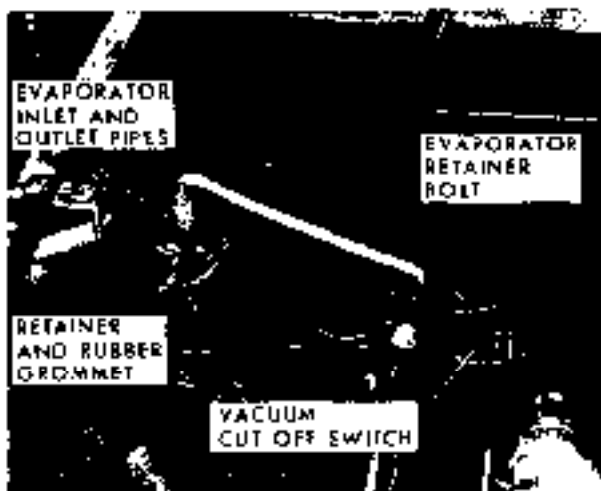


Figure 9B-63 Location of Refrigerant Hoses, Pipes, Vacuum Cut Off Switch and Evaporator Attaching Bolt (Left Side) • Opel 1900 • Manta

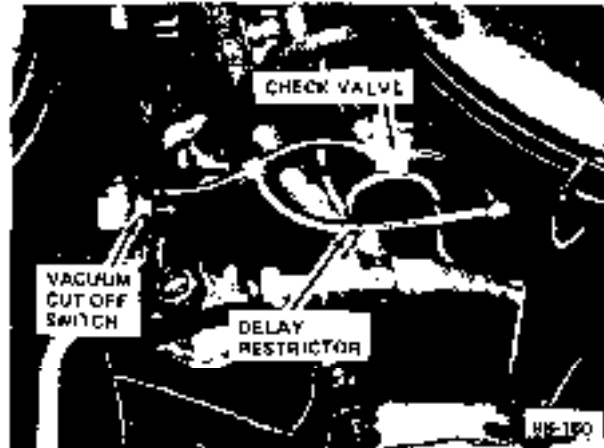


Figure 9B-64 Delay Restrictor and Check Valve Hose Assembly Location

5. Disconnect the delay restrictor and check valve hose assembly from the vacuum cut-off switch and disconnect the electrical wiring. See Figures 9B-63 and 64.

6. Remove evaporator inlet and outlet pipes retainer and rubber grommet. See Figure 9B-65.

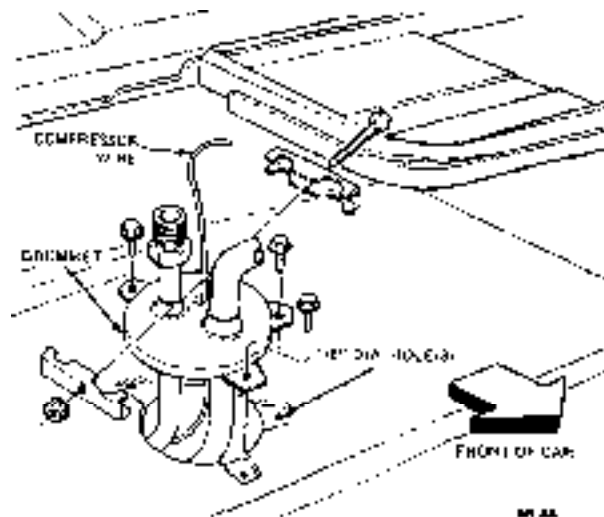


Figure 9B-65 Inlet and Outlet Pipes retainer and Rubber Grommet-Opel 1900 • Manta



Figure 9B-66 Location of Upper Evaporator Attaching Bolt (Right Side) - Opel 1900 • Manta

7. Remove two (2) upper evaporator attaching nuts. See Figures 9B-66 and 9B-67.
8. Remove two (2) attaching case mounting bracket to instrument panel screws. See Figure 9B-67.

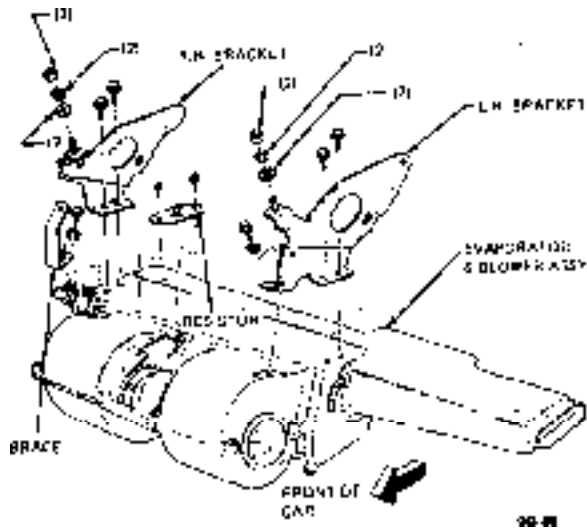


Figure 9B-67 Evaporator and Blower Assembly Brackets and Attachments - Opel 1900 - Manta

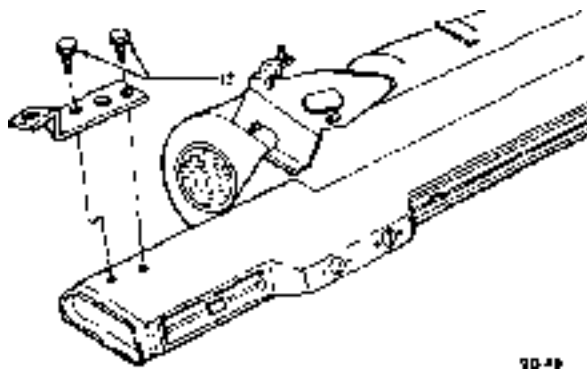


Figure 9B-68 Evaporator and Blower Assembly Center Support Bracket-Opel 1900 Manta

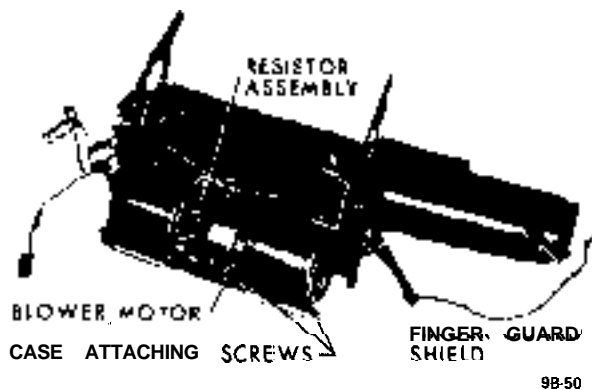


Figure 9B-69 Assembly Removed - Opel 1900 Manta

9. From underneath evaporator case, disconnect two (2) drain hoses.

10. Carefully remove assembly from car. See Figure 9B-69.

11. Disconnect resistor electrical connector and remove resistor assembly. See Figure 9B-69.

12. Remove blower case and blower motor attaching screws and remove assembly. See Figure 9B-69.

13. Remove all remaining attaching screws and remove evaporator assembly. See Figure 9B-70.

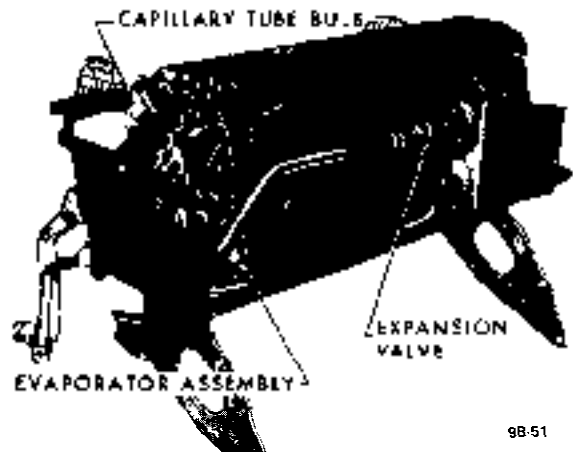


Figure 9B-70 Evaporator and Expansion Valve Assembly - Opel 1900 Manta

14. Disconnect expansion valve capillary tube bulb attached to the outlet pipe of the evaporator. See Figure 9B-70.

15. Disconnect inlet and outlet ends of expansion valve from refrigerant lines, and tape closed open ends of refrigerant lines and inlet and outlet ports of expansion valve.

**Installation**

If expansion valve or refrigerent lines have been exposed to the atmosphere for any amount of time and moisture may have entered the valve or the system, flush the system and install new receiver-dehydrator or valve as necessary.

Due to the possible adjustment difficulties involved if the expansion valve is disassembled, disassembly of the valve is not recommended. The valve may be cleaned by submerging it in a bath of trichlorethylene, alcohol, or similar solvent. Dry by blowing filtered compressed air through the outlet port of the

valve. The filter screen at the inlet port may be replaced. Remove screen by threading a 10-32 NF screw into old filter screen. With a washer and a nut on the screw arranged to work as a puller screw, hold the body of the screw and turn the nut. Insert the new filter screen into the inlet port and lightly tap screen only enough to seat.

1. Install expansion valve using new o-rings during installation. Lubricate o-rings prior to installation using No. 525 viscosity oil.

2. Install evaporator assembly and case attaching screws. See Figure 9B-70.

3. Install blower motor assembly into case and secure with attaching screws. See Figure 9B-69.

4. Install finger guard shields and fan housing case. See Figure 9B-69.

5. Install resistor assembly and electrical connector. Install blower motor connector. See Figure 9B-69.

6. Install assembly into car carefully guiding evaporator pipes up through cowl opening. See Figure 9B-71.

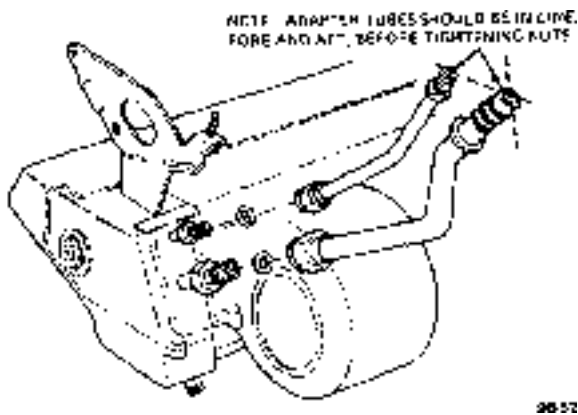


Figure 9B-71 Inlet and Outlet Pipes and O-Rings - Opel 1900 Manta

7. Install two (2) upper attaching evaporator attaching nuts. See Figures 9B-66 and 9B-67.

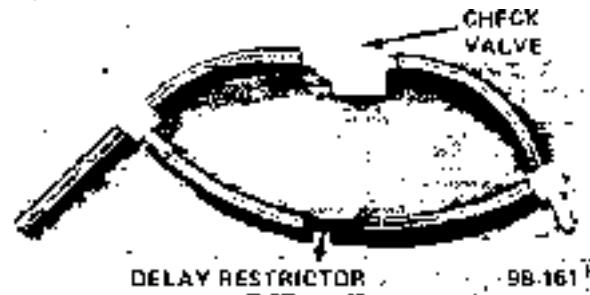
8. Install two (2) attaching case mounting bracket to instrument panel screws. See Figure 9B-67.

9. Connect two (2) drain hoses underneath evaporator.

10. Install evaporator inlet and outlet pipes retainer and rubber grommet. See Figure 9B-65.

11. Connect vacuum cut-off switch and electrical wiring, making sure the delay restrictor and check

valve hoses are installed correctly. See Figures 9B-63 and 64.



9B-72 Delay Restrictor and Check Valve Hose Assembly

12. Install refrigerant hoses and pipes using new o-rings on line fittings and evacuate system. Refer to EVACUATING SYSTEM.

13. While system is being evacuated, install in-line fuse and left side of distributor duct. See Figure 9B-61.

14. Install glove box.

15. Install negative battery cable and charge system. Refer to CHARGING SYSTEM.

#### REMOVAL AND INSTALLATION OF CONDENSER ASSEMBLY -OPEL 1900. MANTA

##### Removal

1. Remove negative battery cable from battery.
2. Remove air cleaner.
3. Discharge system. Refer to DISCHARGING SYSTEM.

4. While system is discharging, remove lower radiator hose from radiator and drain coolant into a suitable container.

5. Remove fan shroud.

6. On vehicles with automatic transmission, unscrew oil lines from connectors on lower radiator tank and plug lines. It is essential that no dirt enters the oil lines. When unscrewing oil lines, hold connectors on lower radiator tank with pliers to avoid leakages. Ensure that no dirt enters oil cooler.

7. Remove upper radiator hose from radiator.

8. Remove lower attaching nut and slide radiator upward and out of engine compartment.

9. Remove inlet and outlet hoses from condenser

pipes and tape closed the open ends of refrigerant lines, and also the open ends of the inlet and outlet pipes of the condenser.

10. Remove two (2) top retaining screws.

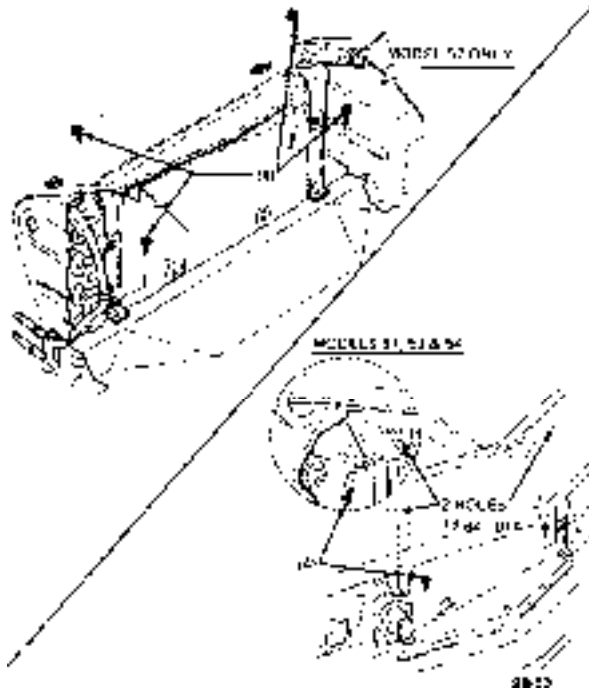


Figure 9B-73 Condenser Retaining Screws - Opel 1900 - Manta

11. Remove radiator grille and two (2) condenser to body mounting screws. See Figure 9B-74.



Figure 9B-74 Condenser Assembly and Attachments. Opel 1900 - Manta

12. Remove condenser.

**Installation**

If refrigerant circuit or condenser has been exposed to the atmosphere and moisture may be present in the circuit, the system and/or component must be

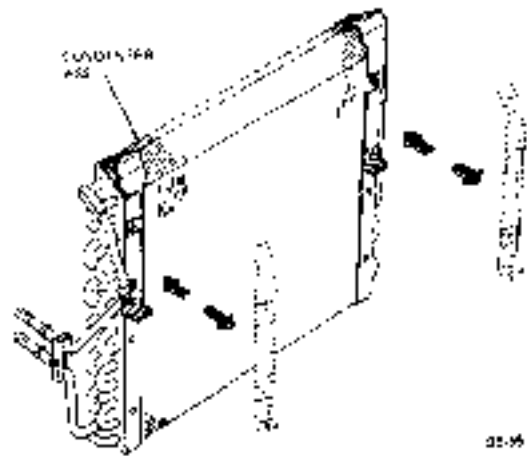


Figure 9B-75 Condenser Assembly Mounting Brackets Opel 1900 Manta

flushed prior to installation. Refer to FLUSHING THE SYSTEM.

1. Install condenser into car and install 2 condenser to body mounting screws. See Figure 9B-74. Install radiator grill.

2. Install 2 top retaining screws.

3. Remove tape from the condenser pipes and refrigerant hoses and install hoses using new o-rings on lines lubricated with No. 525 viscosity oil.

4. Evacuate system. Refer to EVACUATING SYSTEM.

5. While system is being evacuated, install radiator into engine compartment and secure lower attaching nut.

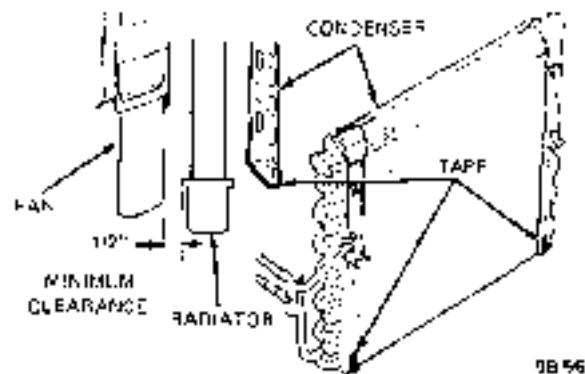


Figure 9B-76 Clearance Between Lower Radiator Tank and Fan Blades - Opel 1900 Manta

6. On vehicles with automatic transmissions, fasten

oil cooler lines to lower radiator tank. It is essential that no dirt enters the oil lines. When tightening oil lines hold connectors on lower radiator tank with pliers to avoid leakages. Ensure that no dirt enters oil cooler. Torque to 11-15 lbs. ft.

7. Install fan shroud.
8. Install upper radiator hose.
9. Install lower radiator hose and add collected coolant.

All Opel 1900's and Manta's are provided with a radiator initial fill of an anti-freeze solution containing corrosion inhibitor. The anti-freeze has either a glycol or glycerin base and protects the engine against freezing, down to minus 22 degrees F. (minus 30 degrees C.). Before the start of the cold season, coolant must be checked with a hydrometer and if necessary, brought to the necessary specific gravity by adding anti-freeze. Anti-freeze added, must have a glycol or glycerin base. As the specific gravities of all anti-freeze solutions having a glycol or glycerin base are practically the same, the hydrometer can be used for all these types. Because of the tolerances of the hydrometer, or slight differences in specific gravity, variations of plus or minus 5 degrees can be expected. Coolant must be checked at a temperature of plus 68 degrees F. (plus 20 degrees C.).

- IO. Install negative battery cable and air cleaner.
11. Charge system. Refer to CHARGING SYSTEM.

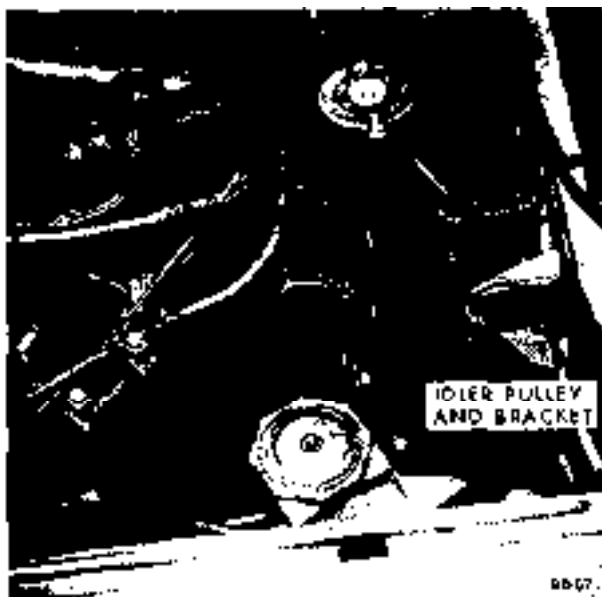


Figure 9B-80 Location of Idler Pulley and Bracket Assembly • GT

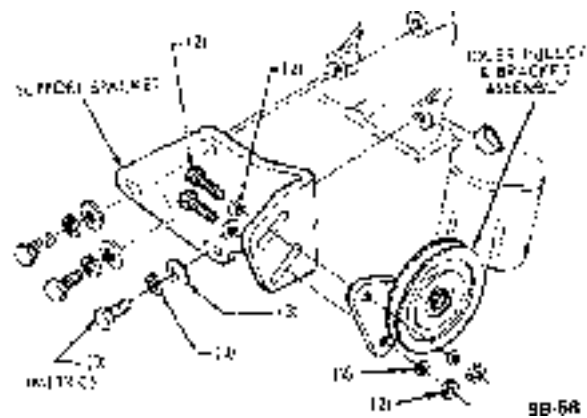


Figure 9B-81 Idler Pulley and Bracket Assembly and Support Bracket GT

REMOVAL AND INSTALLATION OF COMPRESSOR. GT

Removal

1. Remove negative battery cable from battery.

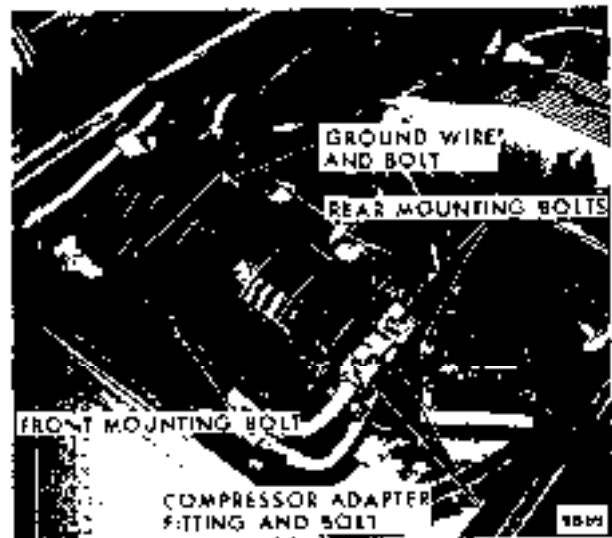


Figure 9B-82 Compressor Adapter Fitting, Ground Wire, and Front and Rear Mounting Bolts • GT

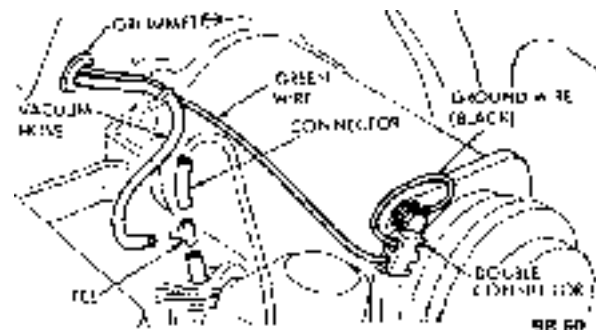


Figure 9B-83 Electrical Connector and Ground Wire GT

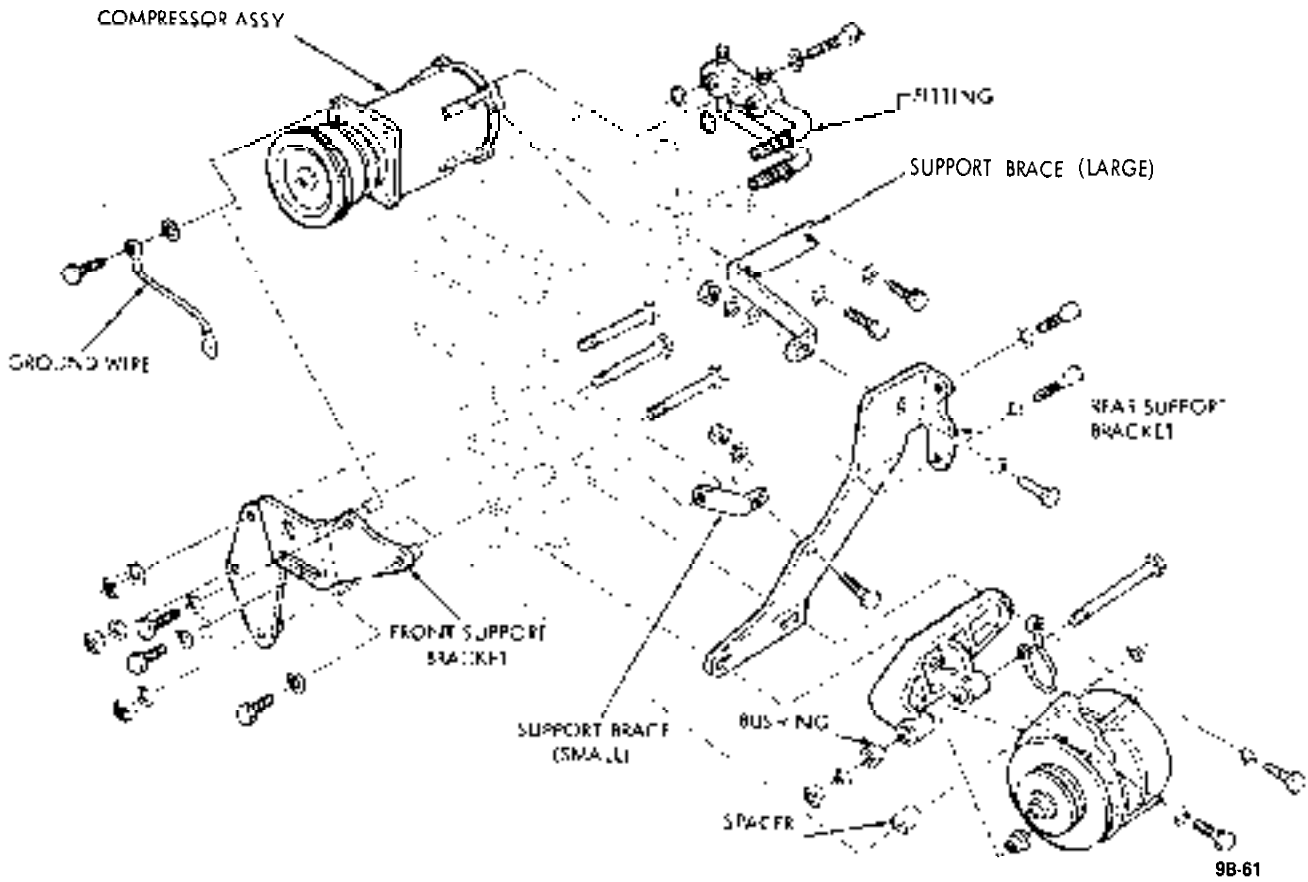


Figure 9B-84 Compressor Installation GT

**2. Discharge system.** Refer to DISCHARGING SYSTEM.

3. While system is discharging remove air cleaner and loosen idler pulley and bracket assembly. See Figure 9B-80.

4. Remove bolt holding compressor adapter fitting into rear head. Disengage from compressor and tape closed openings in both lines and ports in rear head. It is important to seal compressor ports to avoid a loss of refrigeration oil and also to prevent foreign material and moisture from entering compressor. See Figure 9B-82.

5. Remove bolt and ground wire, unplug electrical connector, and remove 2 rear compressor mounting bolts. See Figure 9B-82.

6. Remove 2 front compressor mounting bolts, clutch drive belt, and lift out compressor. During removal, maintain the compressor position so that the sump is downward. Do not rotate compressor shaft. See Figure 9B-84.

**Installation**

1. Install compressor into mounting brackets and secure with 4 mounting bolts. See Figure 9B-84.

2. Untape lines and ports, and install compressor adapter fitting and bolt using new o-rings. See Figure 9B-82.

3. Evacuate system. Refer to, EVACUATING SYSTEM.

4. While system is being evacuated, install drive belt and tighten idler pulley. See Figure 9B-80.

5. Install bolt and ground wire and plug in electrical connector. See Figure 9B-83.

6. Install air cleaner and negative battery cable.

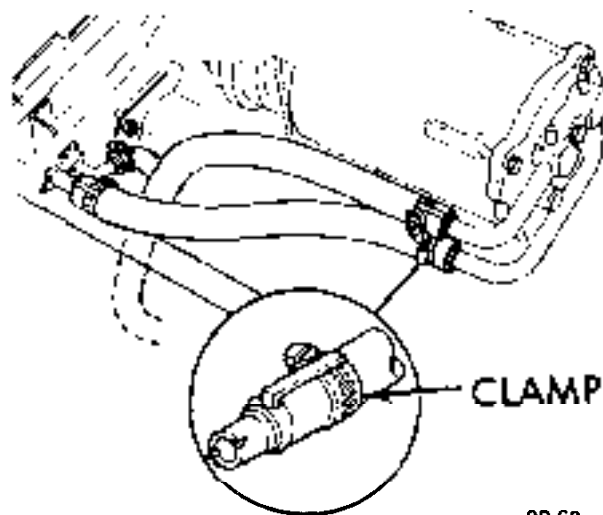
7. Charge system. Refer to, CHARGING SYSTEM.

**REMOVAL AND INSTALLATION OF RECEIVER-DEHYDRATOR ASSEMBLY. GT**

**Removal**

1. Discharge system. Refer to DISCHARGING SYSTEM.

2. Disconnect refrigerant lines to both ends of receiver-dehydrator and tape closed open ends of re-



9B-62

**Figure 9B-85 Refrigeration Hose Clamps Installation GT**

frigerant lines, and also the open ends of the inlet and outlet pipes of the receiver-dehydrator. See Figure 9B-86.



**Figure 9B-86 Receiver-Dehydrator GT**

3. Remove 2 screws securing receiver-dehydrator and clamps to support bracket and lift out receiver dehydrator. See Figure 9B-86.

**Installation**

1. Install receiver-dehydrator using new o-rings during installation. Lubricate o-rings prior to installation using No. 525 viscosity oil.

2. If the receiver-dehydrator has been exposed to the atmosphere for any amount of time, (more than 5 minutes), the receiver-dehydrator should be replaced, since the life of the dessicant is probably expended.

3. Evacuate and charge system. Refer to CHARGING AND DISCHARGING SYSTEM.

#### REMOVAL AND INSTALLATION OF EVAPORATOR AND EXPANSION VALVE. GT

##### Removal

1. Disconnect negative battery cable.
2. Discharge system. Refer to, DISCHARGING SYSTEM.
3. While system is discharging, remove attaching screws and lift out luggage tray. See Figure 9B-87.



Figure 9B-87 Luggage Tray

4. Remove all evaporator cover screws and remove cover. See Figure 9B-88.

5. Remove electrical plug connector from the resistor assembly and unplug blower motor connection and remove ground wire. See Figure 9B-90.

6. From underneath evaporator housing, disconnect two (2) drain hoses. See Figure 9B-91.

7. From under car remove 4 nuts securing evapora-



Figure 9B-88 Evaporator Cover Assembly and Attaching Screws GT

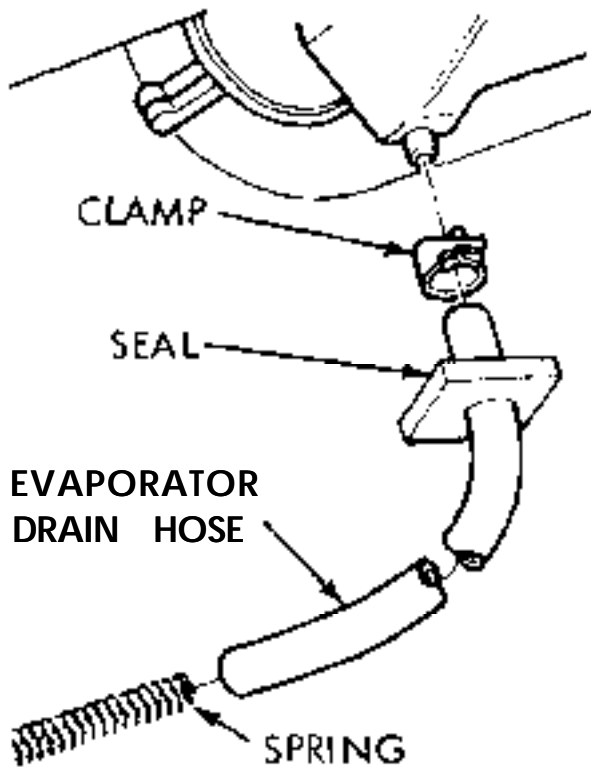


Figure 9B-90 Electrical Connections, Ground Wire GT

tor mounting bracket to floor. See Figures 9B- 92 and 9B-93.

8. Remove inlet and outlet pipes from evaporator and tape closed the refrigerant lines and also the open ends of the inlet and outlet pipes of the evaporator. See Figure 9B-94.





9B-87

Figure 9B-91 Drain Hose GT

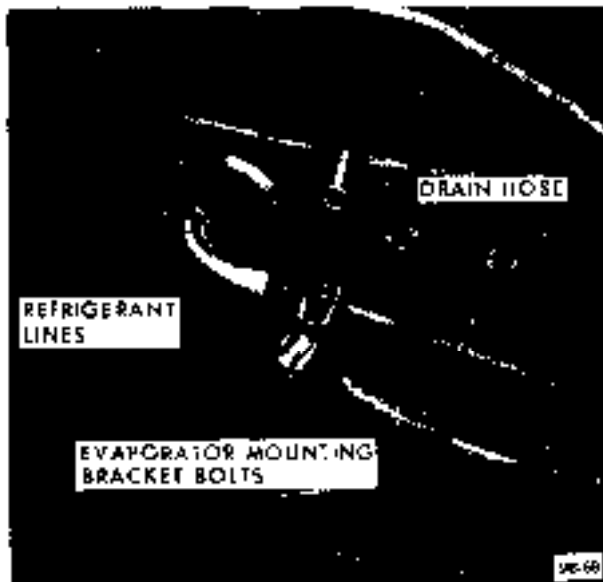


Figure 9B-92 Evaporator Mounting Bracket Bolts Driver Side GT

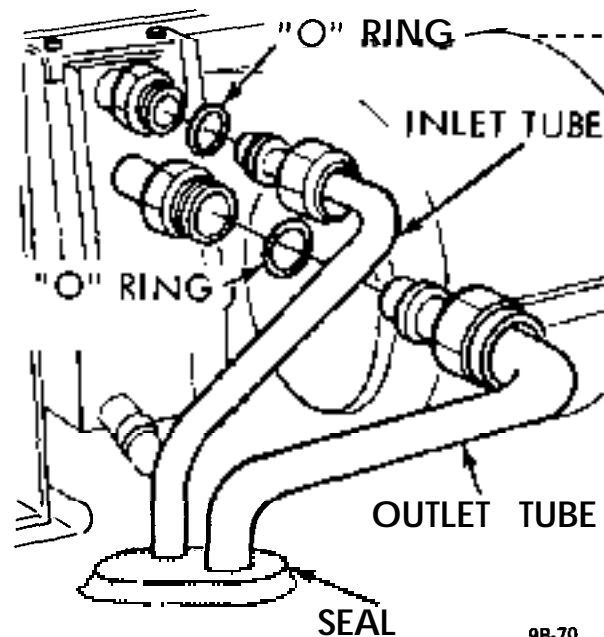
9. Lift off the mounting bracket and remove the evaporator assembly from the car.

10. Remove the resistor assembly. See Figure 9B-90.



9B-69

Figure 9B-93 Evaporator Mounting Bracket Bolts Passenger Side - GT



9B-70

Figure 9B-94 Inlet and Outlet Pipes and O-Rings GT

11. Remove blower case and blower motor attaching screws and remove assembly.

12. Remove all remaining attaching screws and remove evaporator assembly. See Figure 9B-95.

13. Disconnect expansion valve capillary tube bulb attached to the outlet pipe of the evaporator. See Figure 9B-95.

14. Disconnect inlet **and** outlet ends of expansion

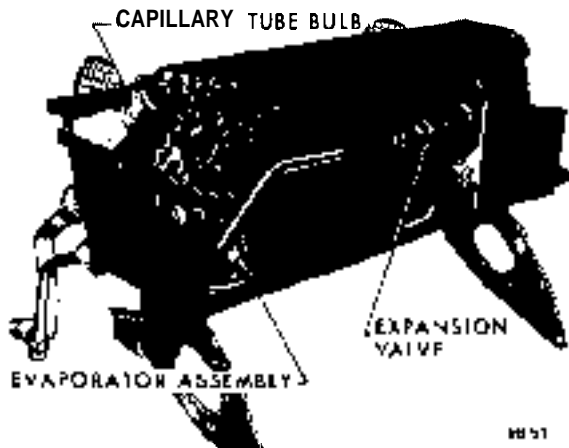


Figure 9B-95 Evaporator and Expansion Valve Assembly - GT

valve from refrigerant lines, and tape closed open ends of lines and inlet and outlet ports of expansion valve.

#### Installation

If expansion valve or refrigerant lines have been exposed to the atmosphere for any amount of time and moisture may have entered the valve or the system, flush the system and install new receiver-dehydrator or valve as necessary.

Due to the possible adjustment difficulties involved if the expansion valve is disassembled, disassembly of the valve is not recommended. The valve may be cleaned by submerging it in a bath of trichlorethylene, alcohol, or similar solvent. Dry by blowing filtered compressed air through the outlet port of the valve. The filter screen at the inlet port may be replaced. Remove screen by threading a 10-32 NF screw into old filter screen. With a washer and a nut on the screw arranged to work as a puller screw, hold the body of the screw and turn the nut. Insert the new filter screen into the inlet port and lightly tap screen only enough to seat.

1. Install expansion valve using new o-rings during installation. Lubricate o-rings prior to installation using No. 525 viscosity oil.

2. Install evaporator assembly and case attaching screws.

3. Install blower motor assembly into case and secure with attaching screws.

4. Install finger guard shields and fan housing case.

5. Install resistor assembly.

6. Install evaporator assembly into car and install mounting bracket. See Figure 9B-96.

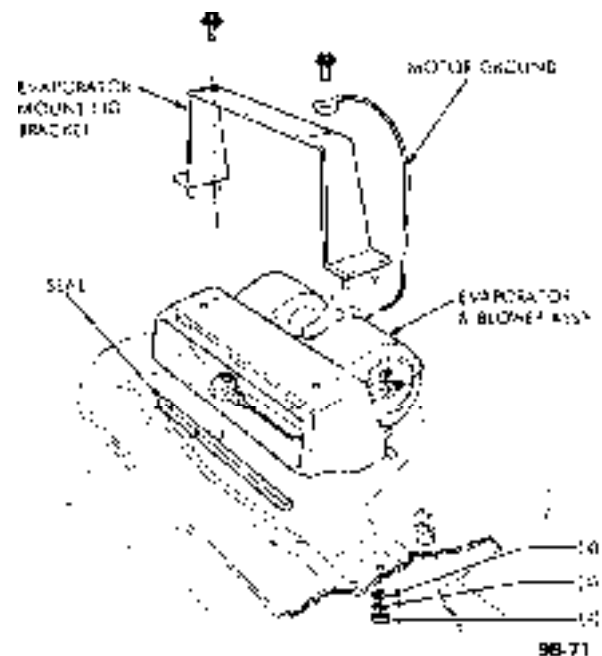


Figure 9B-96 Evaporator and Blower Assembly - GT

7. Untape the refrigerant lines and the inlet and outlet pipes from the evaporator and install using new o-rings on line fittings.

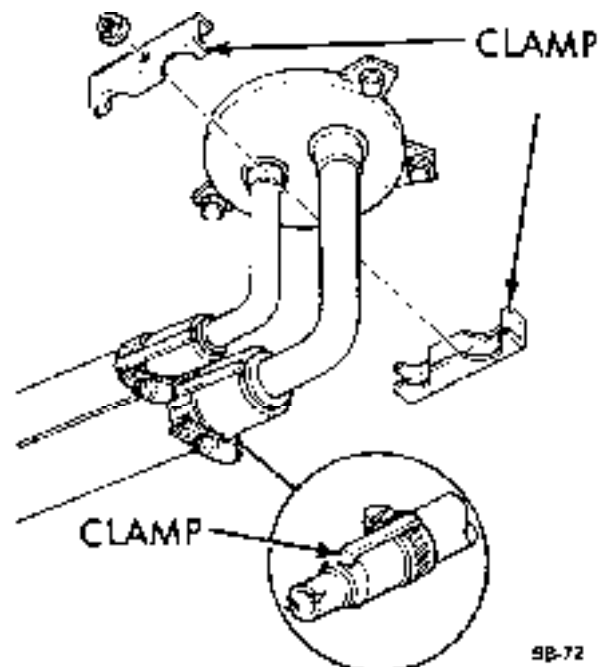


Figure 9B-97 Refrigerant Hoses and Hose Clamps Under Car - GT

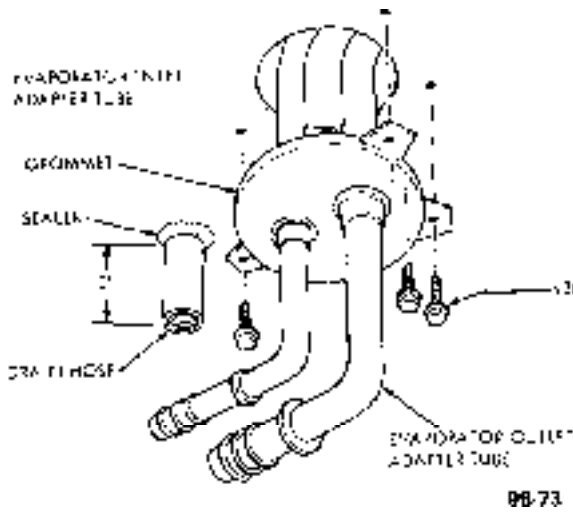


Figure 9B-98 Refrigerant Hoses Retainer Grommet - Under Car - GT

8. From under car install four (4) nuts securing evaporator mounting bracket to floor. See Figures 9B-92 and 9B-93.



Figure 9B-100 Refrigerant Hoses - Under Car GT

9. Evacuate system. Refer to EVACUATING SYSTEM.

10. While system is being evacuated, connect drain hoses underneath evaporator housing.

11. Plug in the resistor assembly electrical connector plug and connect the blower motor connection and install ground wire and 2 mounting brackets to case screws using the rearward holes. See Figure 9B-90.

12. Install the evaporator cover and all cover screws. See Figure 9B-88.

13. Install luggage tray and attaching screws. See Figure 9B-87.

14. Connect the negative battery cable.

15. Charge system. Refer to CHARGING SYSTEM.

### REMOVAL AND INSTALLATION OF CONDENSER RECEIVER-DEHYDRATOR ASSEMBLY - GT

#### Removal

1. Disconnect negative battery cable.

2. Discharge system. Refer to DISCHARGING SYSTEM.

3. While the system is discharging, remove the charcoal cannister, washer jar, battery and battery tray. Battery needs only to be set up out of the way and not removed from the car.

4. Disconnect inlet and outlet pipes of condenser receiver-dehydrator and tape closed the open ends of refrigerant lines, and also the open ends of the inlet and outlet pipes of the condenser. See Figure 9B-101.

5. Disconnect discharge line from condenser and tape closed open ends of discharge pipe and condenser inlet.

6. Remove 4 condenser attaching screws and lift out condenser. See Figure 9B-101.

7. Remove 2 screws retaining receiver-dehydrator to condenser and remove.

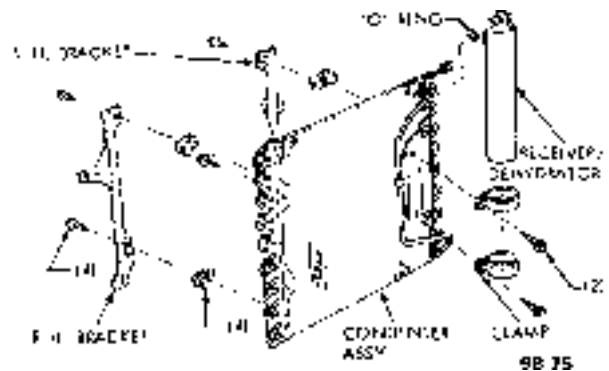


Figure 9B-101 Receiver - Dehydrator. Condenser Attaching Screws and Brackets - GT

#### Installation

If refrigerant circuit or condenser has been exposed to the atmosphere and moisture may be present in the circuit, the system and/or component must be flushed prior to installation. Refer to FLUSHING THE SYSTEM.

1. Install receiver-dehydrator to condenser and fasten with 2 clamps and 2 screws.

2. Install condenser into car and secure with 4 attaching screws. See Figure 9B-101.
3. Untape discharge line and pipe and install using new o-rings lubricated with No. 525 viscosity oil.

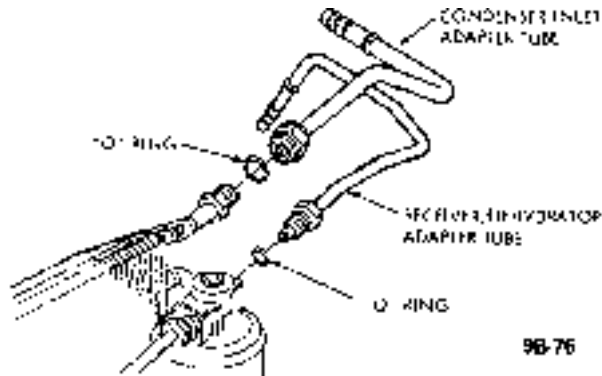


Figure 9B-102 Condenser • Receiver • Dehydrator O-Rings. GT

4. Untape and install inlet and outlet pipes into the receiver-dehydrator using new o-rings lubricated with No. 525 viscosity oil.

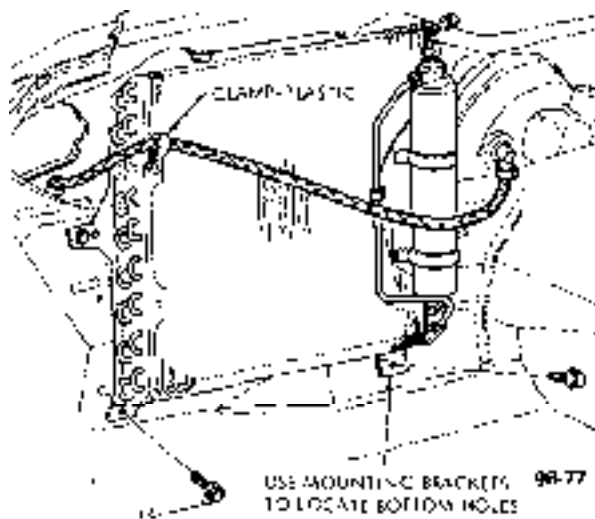


Figure 9B-103 Condenser Assembly • GT

5. Evacuate system. Refer to EVACUATING SYSTEM.
6. While system is being evacuated, install the charcoal cannistor, washer jar, battery tray and battery and connect negative battery cable.
7. Charge system. Refer to CHARGING SYSTEM.

**DISASSEMBLY AND REASSEMBLY OF CLUTCH DRIVE PLATE AND SHAFT SEAL**

It is not necessary to remove the compressor or dis-

connect refrigerant lines to remove or install clutch parts on the GT, however, the compressor must be removed from the Opel 1900 • Manta.

**Disassembly**

1. Firmly clamp holding fixture (J-9396) in a vise and attach compressor assembly to fixture (see Figure 9B-104).

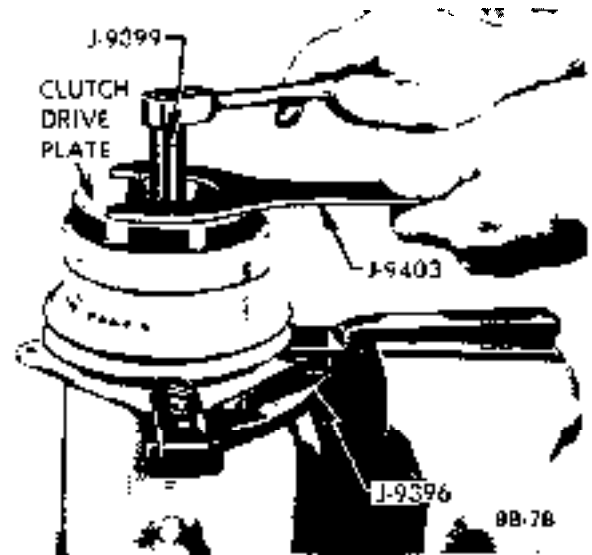


Figure 9B-104 Removing or Installing Shaft Nut

2. Hold hub of clutch drive plate with wrench (J-9403). Using special thin wall 9/16 inch socket (J-9399) and 3/8 inch drive, remove shaft nut.
3. Install threaded hub puller (J-9401) onto hub of clutch drive plate (see Figure 9B-105). Hold body of hub puller with wrench, tighten center screw of hub puller, and lift off clutch drive plate and woodruff key.

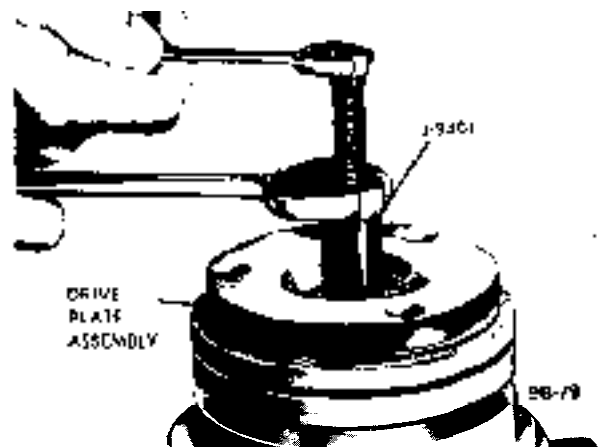


Figure SE-105 Removing Clutch Drive Plate

4. Using No. 21 Truarc pliers (J-5403) take out retainer ring from hub of clutch drive plate (see Figure 9B-106). Lift out spacer.

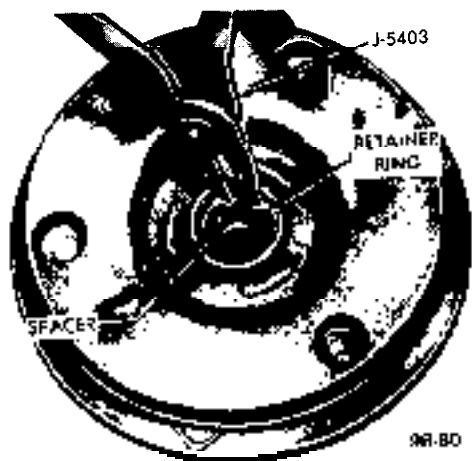


Figure 9B-106 Removing or Installing Retainer Ring in Clutch Drive Plate

5. If compressor has an absorbent sleeve in the neck, pry out the sleeve retainer and remove the sleeve. Remove the seal seat retainer ring, using No. 21 Truarc pliers, Tool J-5403, (see Figure 9B-107).

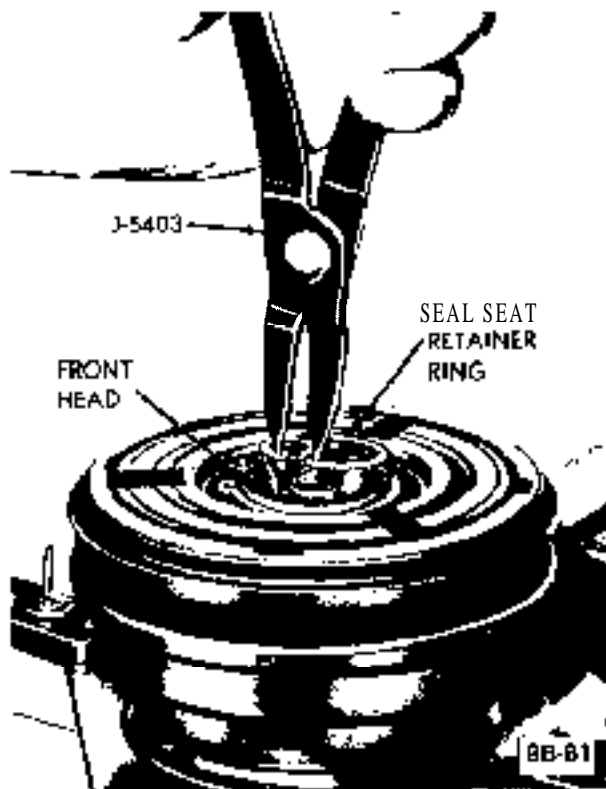
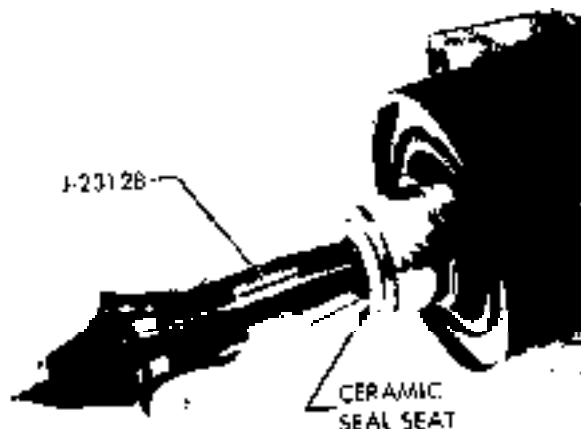


Figure 9B-107 Removing or Installing Shaft Seal Seat Retaining Ring

6. Thoroughly clean the area inside the compressor neck surrounding the shaft, the exposed portion of the seal seat and the shaft itself of any dirt or foreign material. This is absolutely necessary to prevent any such material from getting into the compressor.

7. Remove the seal seat (see Figure 9B-108) using Tool J-23128. Insert Tool J-23128 into seal seat and tighten, using a twisting motion remove the seal seat.



9B-82

Figure SE-108 Removing or Installing Ceramic Shaft Seal seat

8. Remove the seal assembly, using Tool J-9392. Press tool downward on seal while twisting it clockwise to engage the tabs of the seal assembly. Gently but firmly, pull tool straight out (see Figure 9B-109).

9. Remove the seal seat "O" ring, using Tool J-9553 (see Figure 9B-110).

10. Recheck the inside of the compressor neck and the shaft. Be sure these areas are perfectly clean before installing new parts.

#### Reassembly

1. Coat the new seal seat "O" ring with clean refrigeration oil and install it in its groove in the compressor neck. Tool J-21508 may be used to accomplish this. (See Figure 9B-111)

2. Coat the "O" ring and seal face of the new seal assembly with clean refrigeration oil. Carefully mount the seal assembly to Tool J-9392 by engaging the tabs of the seal with the tangs of the tool.

3. Place seal protector, Tool J-22974, over end of shaft and carefully slide the new seal assembly onto the shaft. Gently twist the tool clockwise while pushing the seal assembly down the shaft until the seal

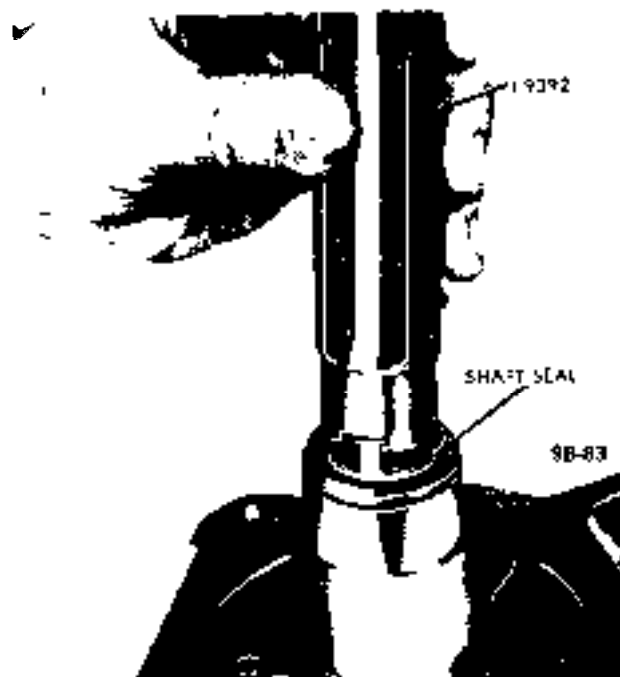


Figure 9B-109 Removing or Installing Shaft Seal

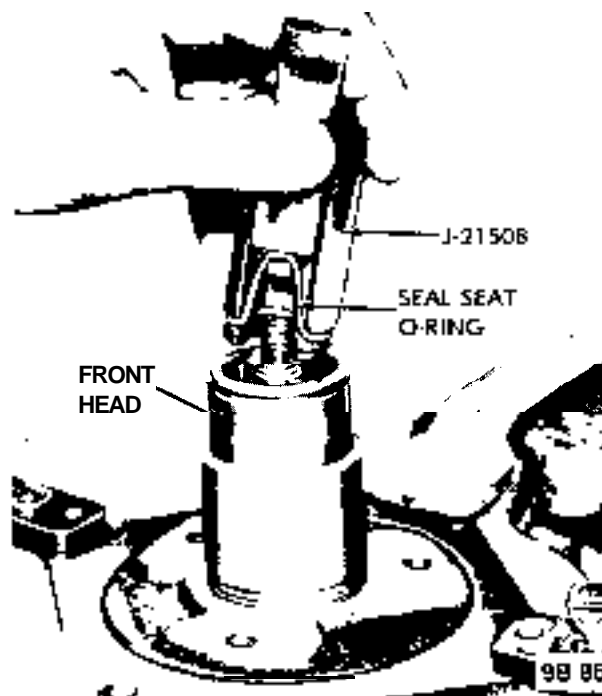


Figure 9B-111 Installing Seal Seat O-Ring

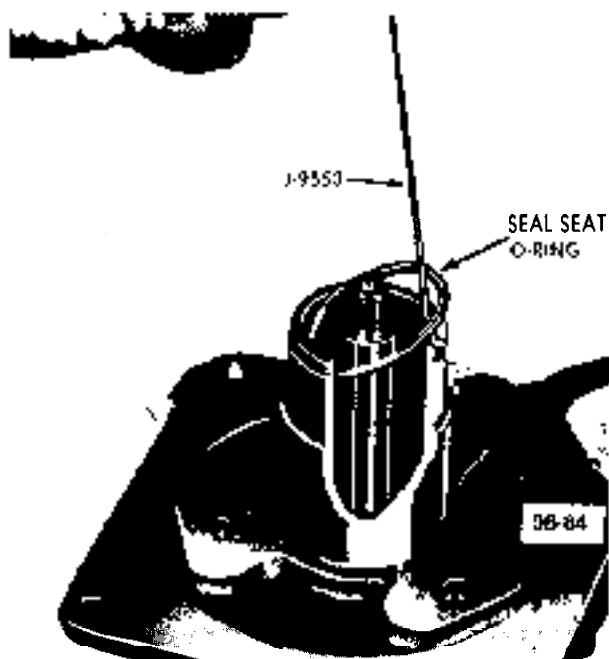


Figure 9B-110 Removing Seal Seat O-Ring

assembly engages the flats on the shaft and is seated in place. Disengage the tool by pressing downward and twisting tool counterclockwise.

4. Coat the seal face of the new seal seat with clean refrigeration oil. Mount the seal seat on Tool J-9393 and install it in the compressor neck, taking care not to dislodge the seal seat "O" ring and being sure the seal seat makes a good seal with the "O" ring.

5. Install the new seal seat retainer ring with its flat side against the seal seat, using No. 21 Truarc pliers (J-5403). Use the sleeve from Tool J-9393 to press in on the seal seat retainer ring so that it snaps into its groove. Remove seal protector J-22974 from the end of the shaft.

6. Install Compressor Leak Test Fixture (J-9625) on rear head of compressor and connect gage charging lines as shown in Figure 9B-112. Pressurize suction side of compressor with Refrigerant-12 vapor to drum pressure. Temporarily install the shaft nut and, with compressor horizontal and oil sump down, rotate the compressor shaft in normal direction of rotation several times by hand. Leak, test the seal with a propane torch type leak detector, in good condition. Correct any leak found. Remove and discard the shaft nut.

7. Remove any excess oil, resulting from installing the new seal parts, from the shaft and inside the compressor neck.

8. Install the new absorbent sleeve by rolling the material into a cylinder, overlapping the ends, and slipping it into the compressor neck with the overlap at the top of the compressor. Using a small screwdriver or similar instrument, carefully spread the sleeve so that in its final position, the ends butt together at the top vertical centerline. Install the new sleeve retainer so that its flange face will be against the front end of the sleeve. Using the sleeve from Tool J-9393, press and tap with a mallet, setting the retainer and sleeve into place, until the outer edge of

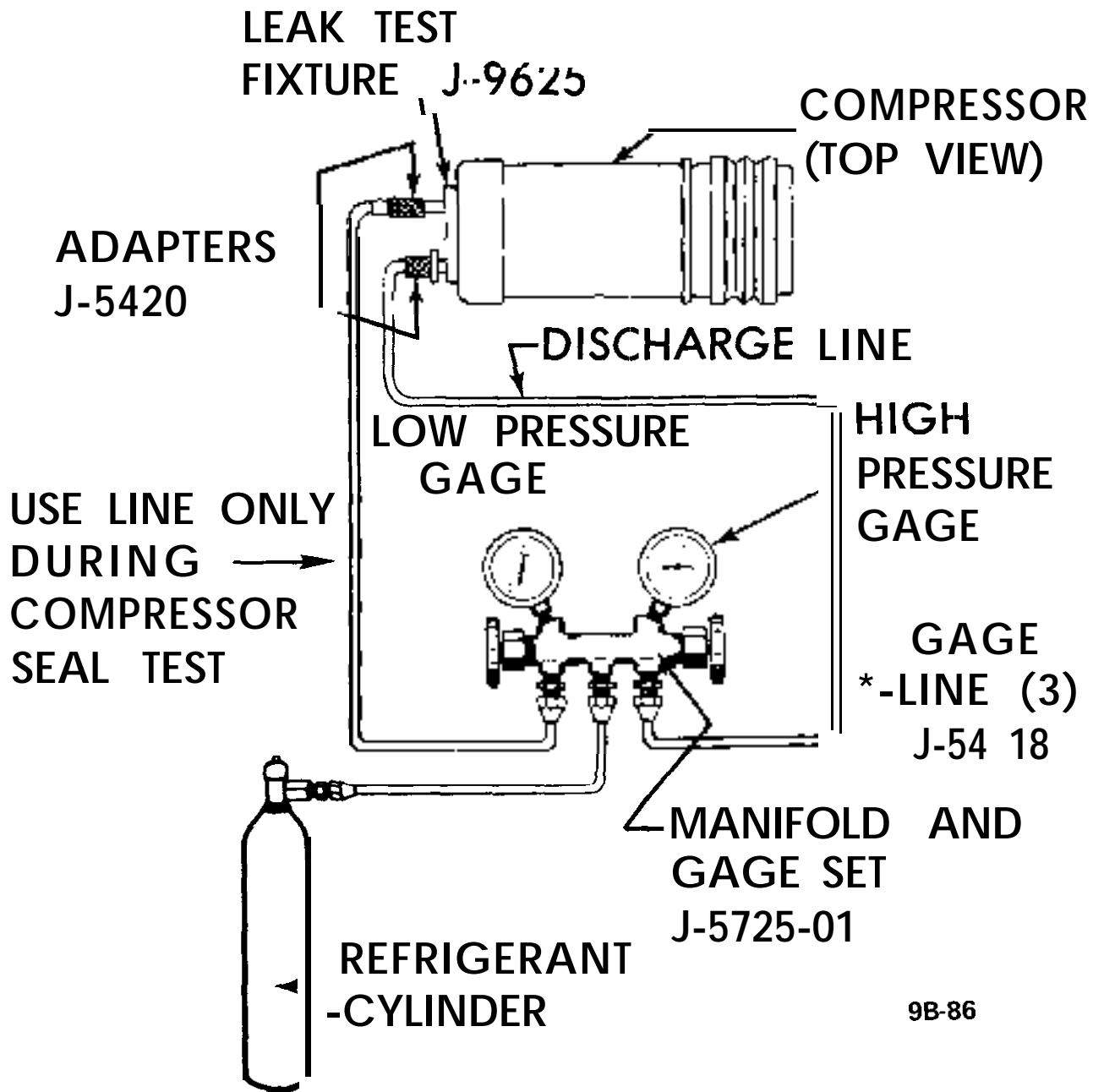


Figure 9B-112 Leak Testing Shaft Seal and Seal Seat O-Ring

the sleeve retainer is recessed approximately  $1/32$ " from the face of the compressor neck.

9. Insert woodruff key into hub of clutch drive plate so that it projects out approximately  $3/16$  inch (see Figure 9B-113) and position clutch drive plate onto shaft.

10. Using drive plate installer (J-9480), screw installer on end of shaft as shown in Figure 9B-114. Hold nut and turn bolt until clutch drive plate is pressed within  $3/32$  inch of the pulley assembly.

11. Reassembly spacer into hub of clutch drive plate.

12. Reassemble retainer ring into hub of clutch drive plate (see Figure 9B-106) using No. 21 **truarc** pliers (J-5403).

13. Thread on new shaft nut using special thin wall  $9/16$  inch socket (J-9399) and  $3/8$  inch drive. Hold **clutch** drive plate secure using Wrench (J-9403) and torque nut to 15 lb. ft. The air gap between the friction surfaces of the pulley assembly and clutch

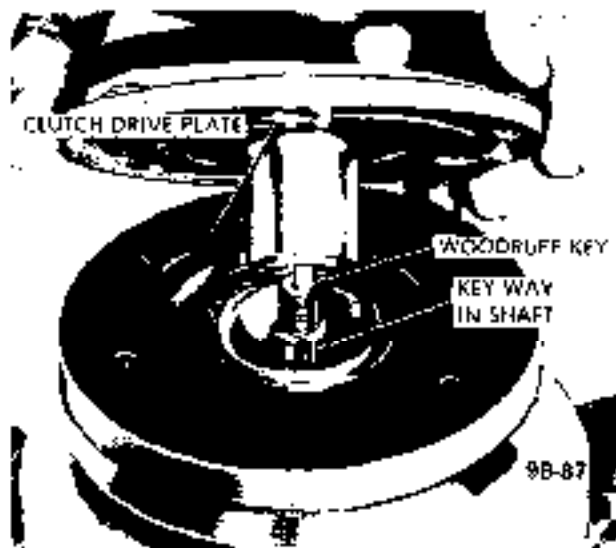


Figure 9B-113 Positioning Clutch Drive Plate on Shaft

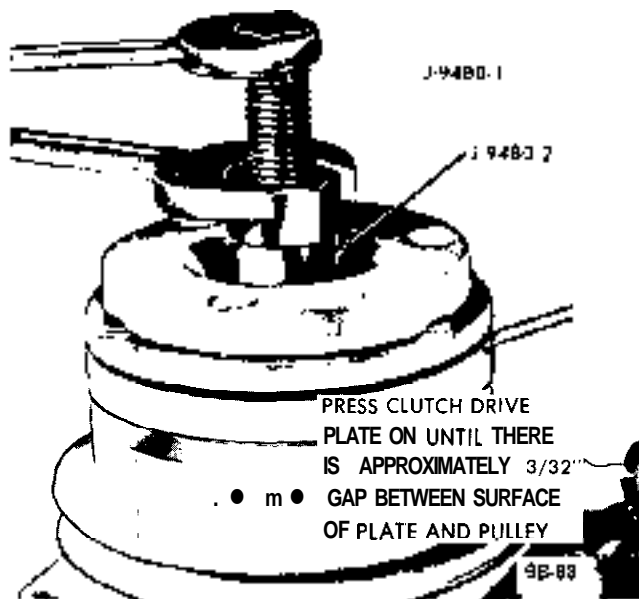


Figure 9B-114 Installing Clutch Drive Plate

drive plate should be approximately 1/32 to 1/16 inch (see Figure 9B-115).

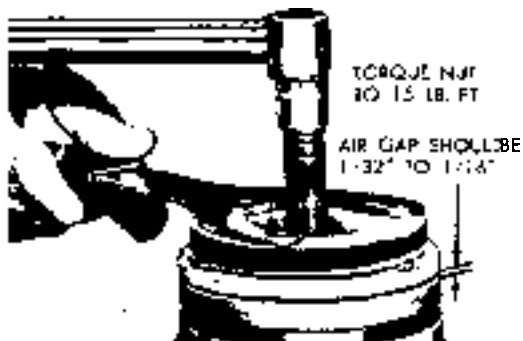


Figure 9B-116 Torquing Shaft Nut

## DISASSEMBLY OF PULLEY ASSEMBLY, AND COIL AND HOUSING ASSEMBLY

It is not necessary to remove the compressor or disconnect refrigerant lines to remove or install clutch parts on the GT, however, the compressor must be removed from the Opel 1900 • Manta.

### Disassembly

1. Disassemble clutch drive plate.
2. Using No. 26 Truarc pliers (J-6435) remove bearing to head retainer ring (see Figure 9B-116).

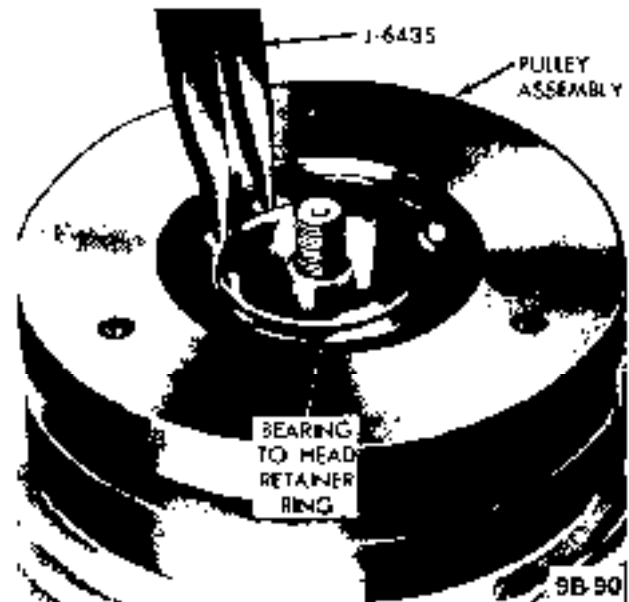


Figure 9B-116 Removing or Installing Bearing to Head Retainer Ring

3. Place puller pilot (J-9395) on hub of front head and take off pulley assembly (see Figure 9B-117), using pulley puller (J-8433).

Puller pilot (J-9395) must be used. If force is exerted on shaft, damage will result to the internal parts of the compressor.

4. Remove bearing to pulley retaining ring with a small screwdriver (see Figure 9B-118).

5. Drive out bearing (see Figure 9B-119) by use of puller Pilot (J-9398) and Handle (J-8092).

Do not take out pulley bearing unless it is going to be replaced as removal may damage bearing.

6. Mark position of coil and housing assembly in relationship to shell of compressor, remove coil and housing retainer ring (see Figure 9B-120) using No.



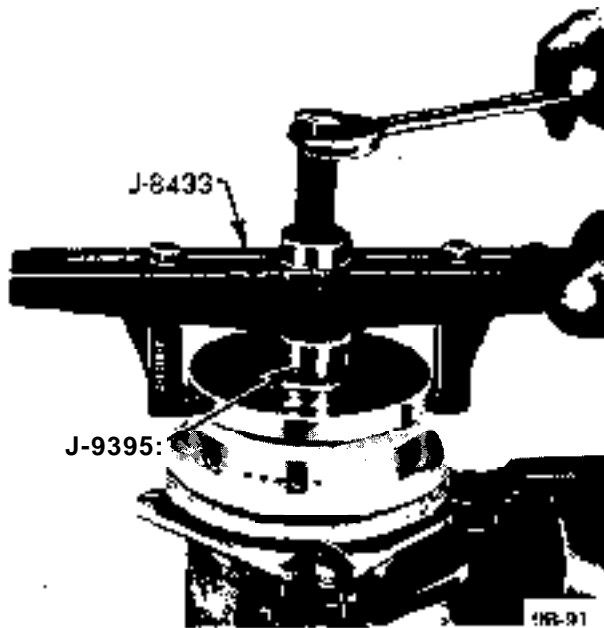


Figure 9B-117 Removing Pulley Assembly

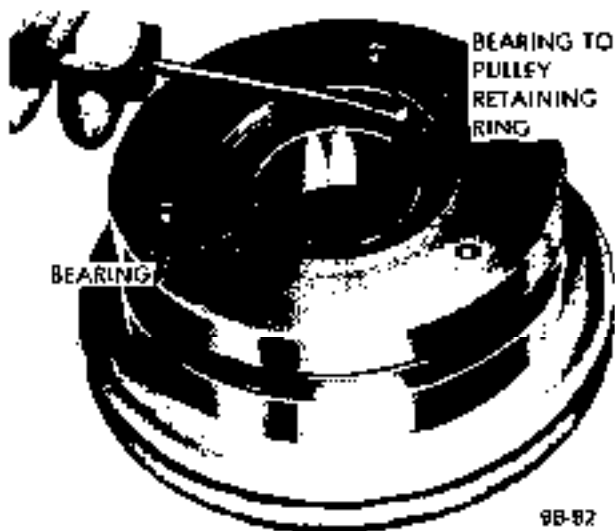


Figure 9B-118 Removing Pulley Bearing Retainer

26 truarc pliers (J-6435), and lift out coil and housing assembly.

**Reassembly**

1. Reassemble coil and housing assembly reverse of disassembly.
2. Drive new bearing into pulley assembly (see Figure 9B-121) with installer (J-9481) and handle (J-8092).
3. Lock bearing in position with bearing to pulley retainer ring (see Figure 9B-118).
4. Drive pulley assembly onto hub of front head (see

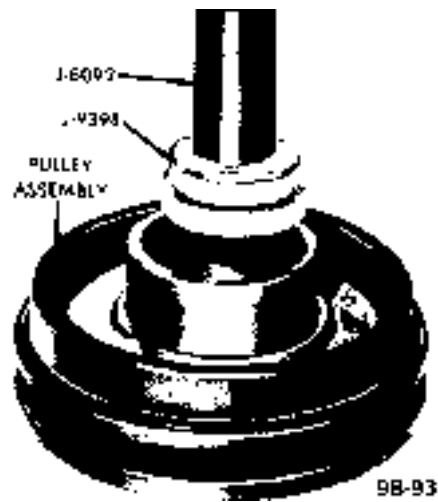


Figure 9B-119 Removing Bearing From Pulley Assembly

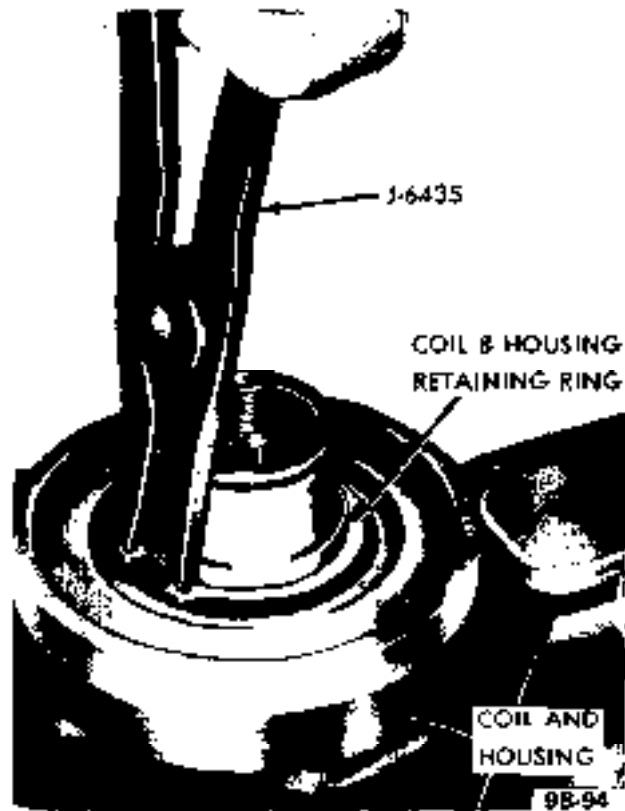


Figure 9B-120 Removing or Installing Coil and Housing Retainer Ring

Figure 9B-122) using installer (J-9481) and handle (J-8092).

If the pulley assembly is going to be reused, clean the friction surface with trichlorethylene, alcohol, or a similar solvent.

5. Lock pulley assembly in position with bearing to head retainer ring (flat side of retainer ring downward) using No. 26 Truarc pliers (J-6435). (See Figure 9B-116).

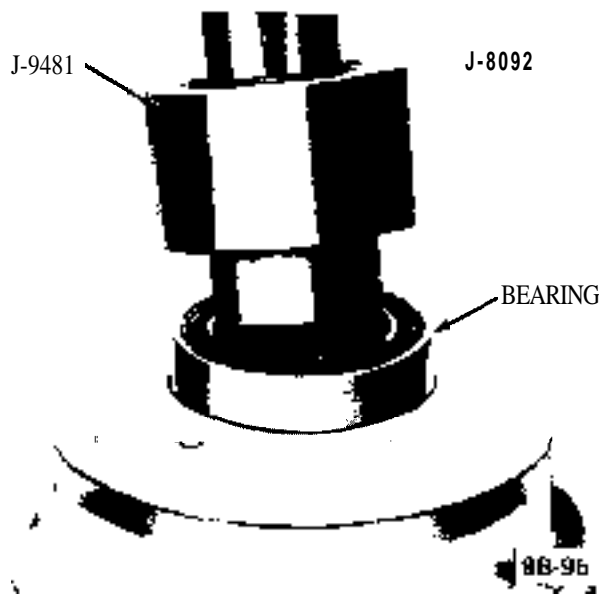


Figure 9B-121 Installing Bearing into Pulley Assembly

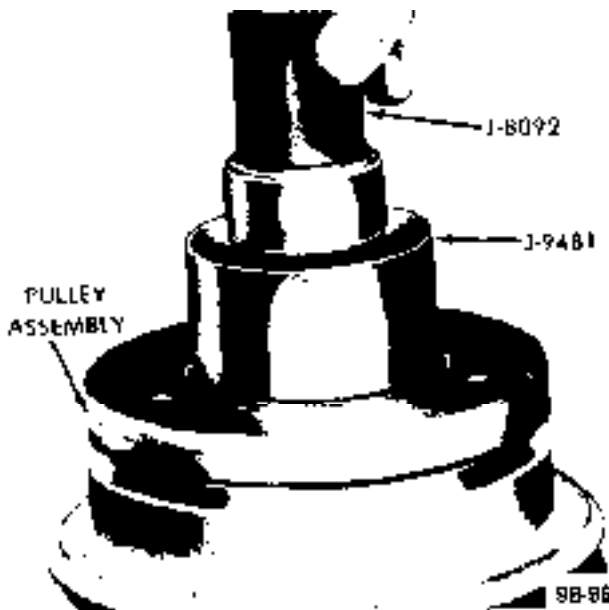


Figure SB-122 Installing Pulley Assembly

6. Reassemble clutch drive plate.

#### DISASSEMBLY AND REASSEMBLY OF INTERNAL PARTS OF COMPRESSOR AND LEAK TESTING COMPRESSOR

A clean work area and a place for each part removed is required to properly disassemble and reassemble compressor. The internal parts of the compressor must be kept free of dirt or foreign material.

When working with compressor, under no circumstances should compressor be rested on pulley end.

#### Disassembly of Rear Head, Oil Pump, Rear Discharge Valve Plate, and Rear Suction Valve Reed Disc

If compressor is not going to be disassembled any further than removal of rear head, oil pump, rear discharge valve plate, or rear suction valve reed disc, omit Steps "1, 2 and 4".

1. Disassemble clutch drive plate and shaft seal.
2. Disassemble pulley assembly, and coil and housing assembly.
3. Clean surface of compressor shell and dry with compressed air.
4. Remove compressor from holding fixture (J-9396), unscrew drain screw. Drain, measure and record amount of oil in compressor.
5. Reinstall compressor in holding fixture (J-9396) positioned as shown in Figure 9B-123.

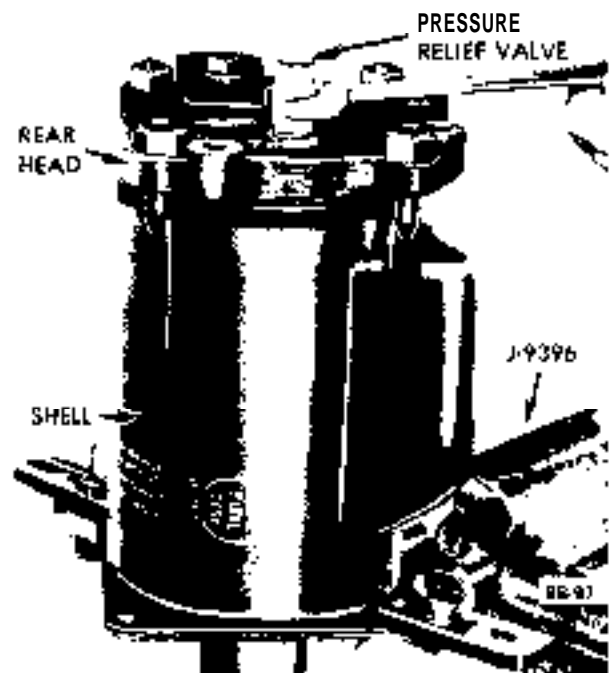


Figure 9B-123 Compressor Installed in Holding Fixture

6. Unscrew and discard four lock nuts from rear of compressor, and lift off rear head by tapping it with a mallet. If Teflon sealing surface is damaged (see Figure 9B-124), replace rear head. Clean or replace suction screen as necessary.
7. Pencil mark top side of both oil pump rotors and lift out rotors. Replace both oil pump inner and outer rotors if one or both are damaged or worn.

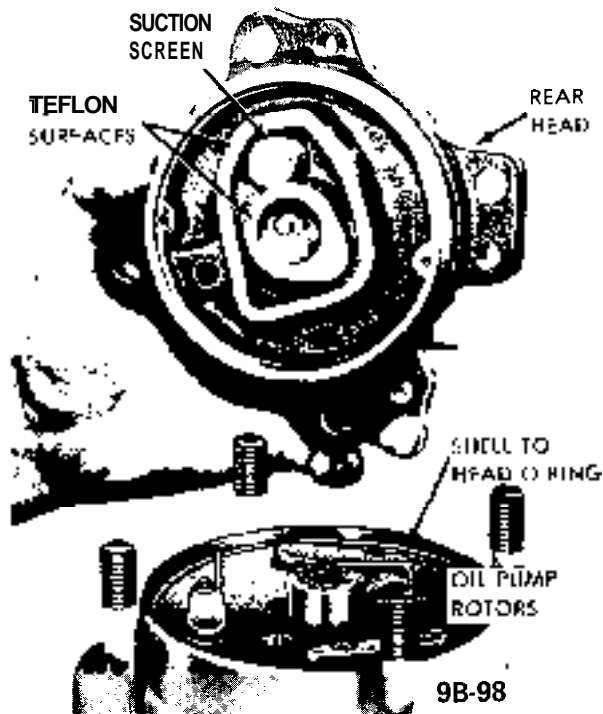


Figure 9B-98 Rear Head Removal

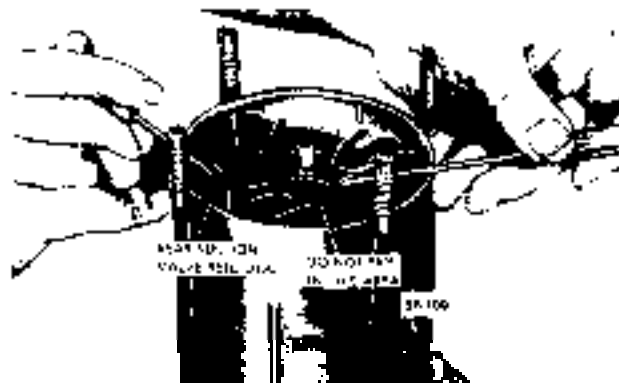


Figure 96-I 26 Removing Rear Suction Valve Reed Disc

8. Take out and discard shell to head "O" ring.
9. Carefully pry out rear discharge valve plate and rear suction valve reed disc with screwdrivers (see Figures 9B-125 and 9B-126). Check both pieces and replace as necessary.

During disassembly, the disc generally adheres to the plate and both pieces lift out together.

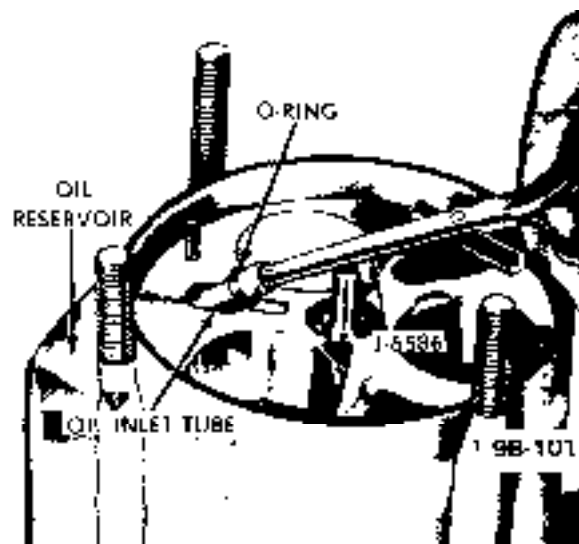


Figure 9B-127 Removing Oil Inlet Tube

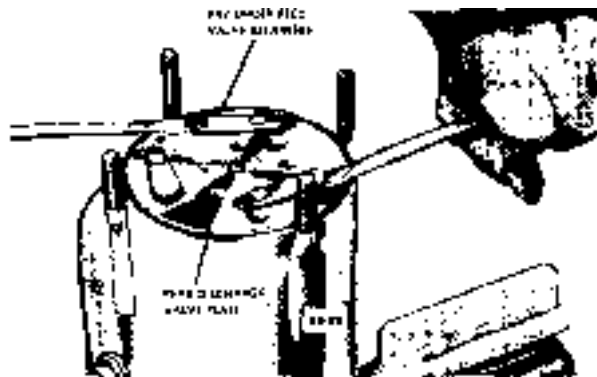


Figure 96-I 25 Removing Rear Discharge Valve Plate

**Removing Cylinder Assembly, and Disassembly of Front Suction Valve Reed Disc, Front Discharge Valve Plate, and Front Head**

1. Pull out oil inlet tube (see Figure 9B-127) and oil inlet tube "O" ring using Remover (J-6586).

2. Push shaft upward from front head and lift out cylinder assembly (see Figure 9B-128), front suction valve reed disc, and front discharge valve plate.

When lifting out the cylinder assembly, the front suction valve reed disc and the front discharge valve plate generally adhere to the cylinder assembly and lift out with it. Check and replace if necessary.

Depending on wear or damage to cylinder assembly, it may be advisable to replace complete cylinder assembly. If service replacement cylinder is **used** omit following steps and continue on with subparagraph entitled "FINAL REASSEMBLY OF CYLINDER ASSEMBLY".

3. Disassemble front head from shell by tapping front head with a mallet to unseat head, and lifting straight out through rear of shell the front head and shell to head "O" ring (see Figure 9B-130). Discard "O" ring.

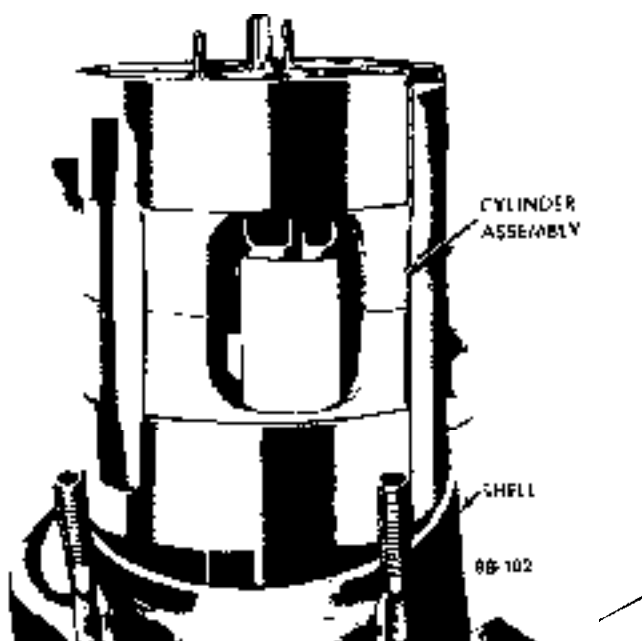


Figure 9B-128 Removing Internal Cylinder Assembly

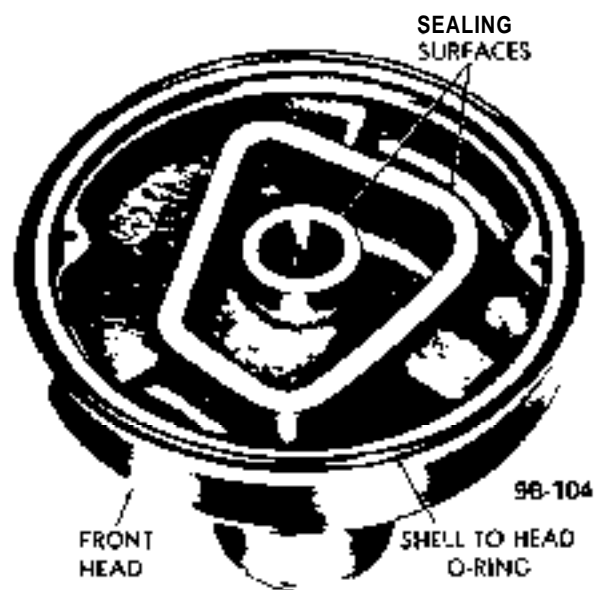


Figure 9B-131 Front Head Sealing Surfaces

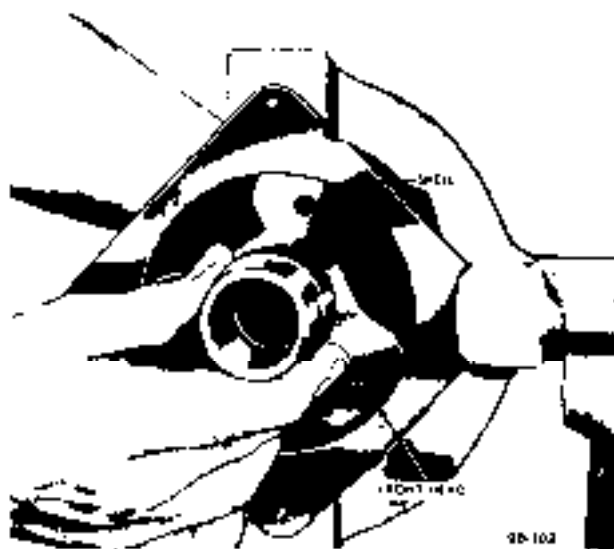


Figure 9B-130 Removing Front Head

If sealing surfaces of front head (see Figure 9B-131) are damaged, replace front head. There is no Teflon on front head sealing surface.

#### Disassembly of Cylinder Assembly

1. Pry off suction pass cover using screwdriver (see Figure 9B-132).

2. Place cylinder assembly (front end downward) on top of compressing fixture (J-9397), number pistons and cylinders "1, 2 and 3" to facilitate reassembly (see Figure 9B-133), and separate cylinder halves using a hard rubber mallet or hammer and wood block.

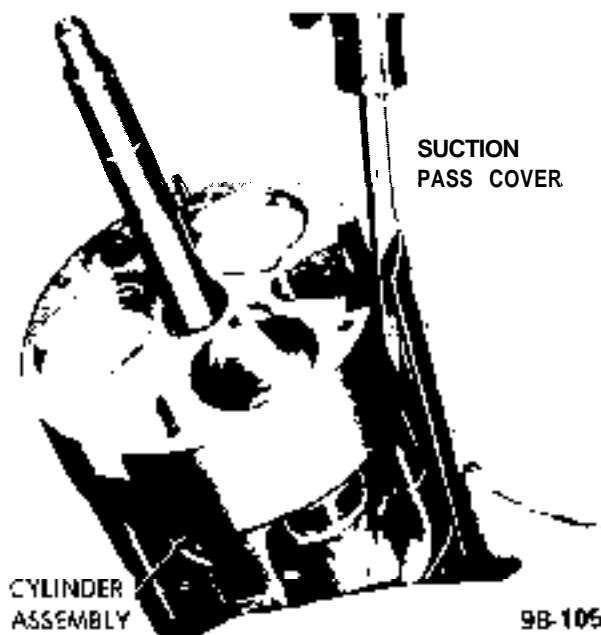


Figure 9B-132 Removing Suction Pass Cover

3. Disassemble rear cylinder half and discharge tube from cylinder assembly and discard discharge tube.

Depending on whether or not discharge tube comes out with rear cylinder half or remains in front cylinder half it may be necessary to rotate shaft and swash plate assembly (using a 9/16 inch opened wrench on shaft seal portion of shaft) to achieve necessary clearance.

4. Carefully disassemble from cylinder assembly (see Figure 9B-134) and lay in respective place on

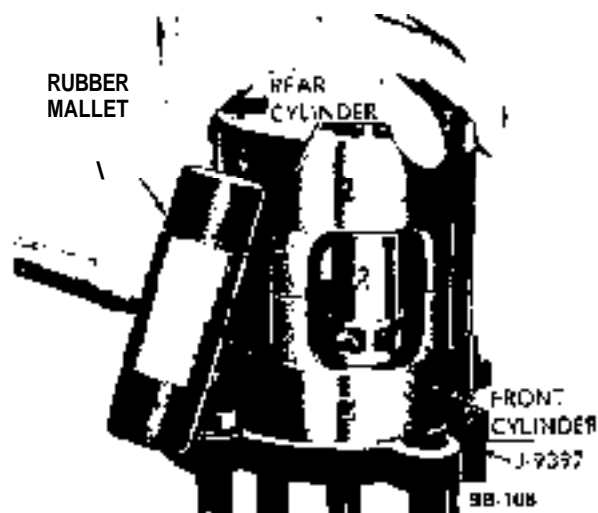


Figure 9B-133 Separating Cylinder Halves

parts tray (J-9402) the following: number "1, 2 and 3" pistons, piston drive balls, and (if service pistons) piston rings. To disassemble rotate swash plate until piston is at highest point, raise swash plate approximately 1/2 inch and lift out piston and related parts one at a time. Discard shoe discs and rear needle thrust bearing and races.

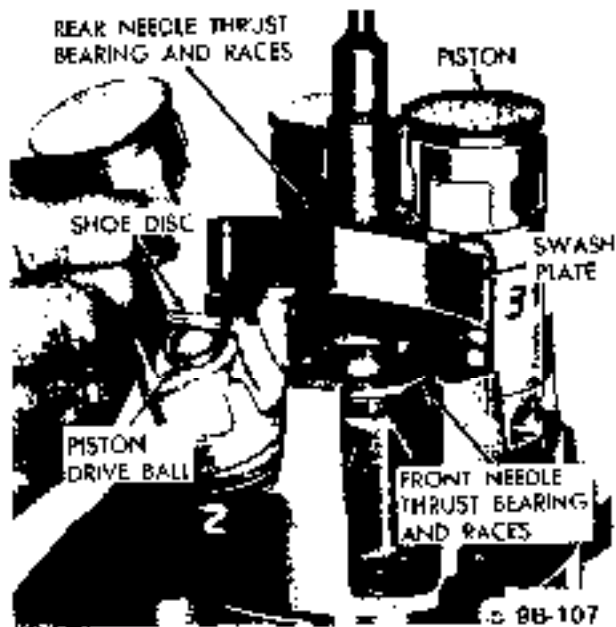


Figure 9B-134 Disassembly of Cylinder Assembly - Service Pistons Shown

Examine piston drive balls and replace if necessary. The front end of the piston may be identified by a recessed notch (see Figure 9B-135).

5. Lift out shaft and swash plate assembly and front needle thrust bearing races. Discard front needle thrust bearing and races.

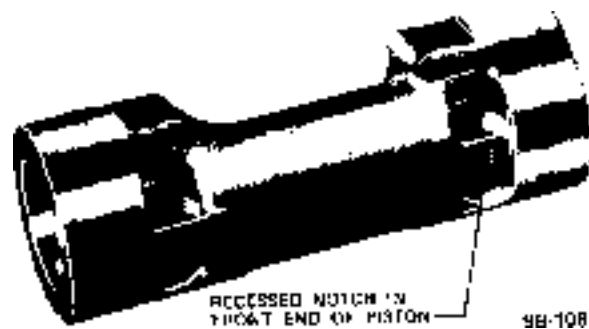


Figure 9B-135 Piston Identification Ringless

Examine shaft and swash plate assembly and replace as necessary.

6. Wash all salvaged parts of cylinder assembly in bath of trichlorethylene, alcohol, or similar solvent and dry parts with filtered, dry compressed air.

Examine front and rear cylinder halves, front and rear main shaft bearings, and replace as necessary. If bearings are to be replaced, drive out of cylinder halves with suitable socket or punch. Install new bearing (lettering on bearing edge facing outward) using bearing installer (J-9432). See Figure 9B-136.

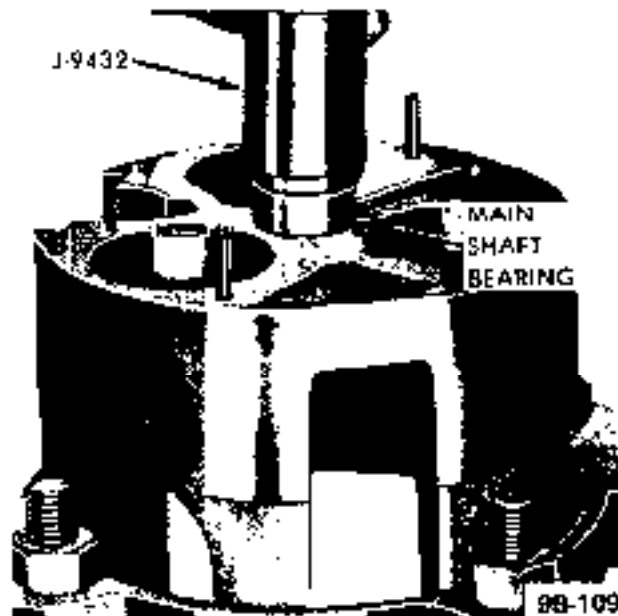


Figure 9B-136 Installing Main Shaft Bearing

Partial Reassembly of Cylinder Assembly, and Gaging of Piston Play and Shaft End Play

1. Obtain from parts stock four "zero" thrust races, two needle thrust bearings, and three "zero" shoe discs.

2. Place front cylinder on top of compressing fixture (J-9397) as shown in Figure 9B-137).

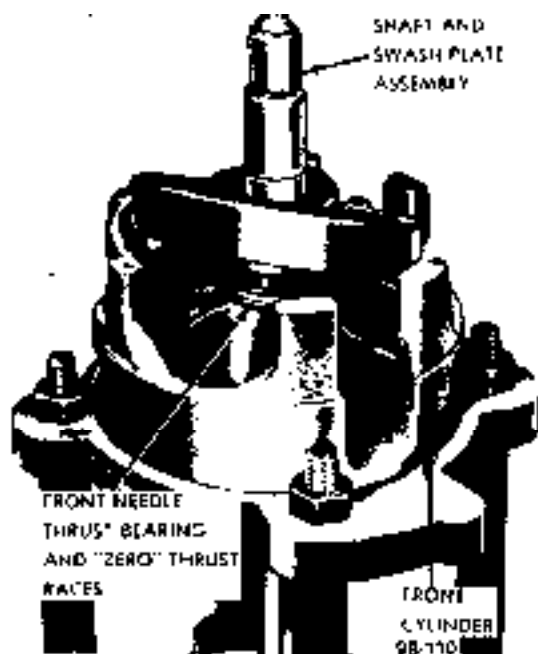


Figure 9B-137 Shaft and Front Needle Thrust Bearing in Cylinder Half

3. Generously coat with clean petroleum jelly two "zero" thrust races, and a new needle thrust bearing. Assemble races and bearing to front end of shaft and swash plate assembly and insert assembly into front cylinder (see Figure 9B-137).

4. Assemble two additional "zero" thrust races and a new needle thrust bearing to rear end of shaft and swash plate assembly.

5. Lightly coat ball pockets of the three pistons with clean petroleum jelly and place a piston drive ball in each pocket.

6. Lightly coat the three "zero" shoe discs with clean petroleum jelly and place a disc on only the piston drive ball at the front of each piston.

Do not place shoe discs on rear piston drive balls. Do not reassemble piston rings on pistons (if service pistons) at this time. Use lubricant in sufficient quantity so that piston drive balls and shoe discs stick to piston.

7. Rotate shaft and swash plate assembly until high point of swash plate is over No. "1" cylinder bore. Position No. "1" piston onto swash plate (see Figure 9B-137) and lower the piston and swash plate so the front end (notched end - see Figure 9B-138) of the piston enters the cylinder bore.

In order to fit the piston onto the swash plate, the shaft and swash plate assembly must be raised approximately 1/2 inch, and also the front needle thrust bearing and races must be held up against the hub of the swash plate.

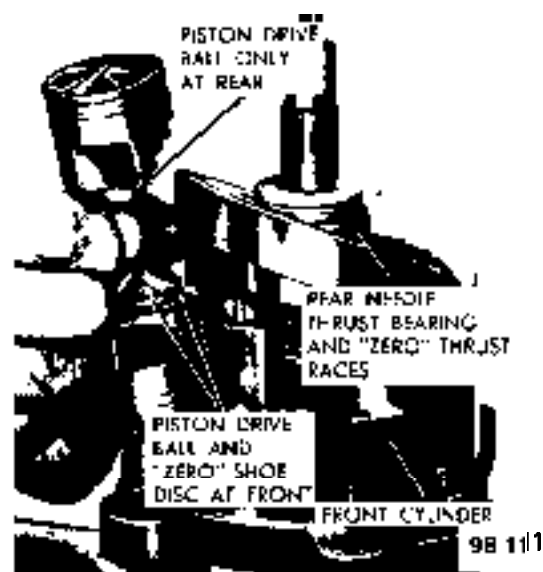


Figure 9B-138 Installing Piston Into Cylinder Half Service Piston Shown

8. Repeat preceding step for reassembly of pistons No. "2" and No. "3".

9. Reassemble rear cylinder onto front cylinder using wood block and mallet (see Figure 9B-140).

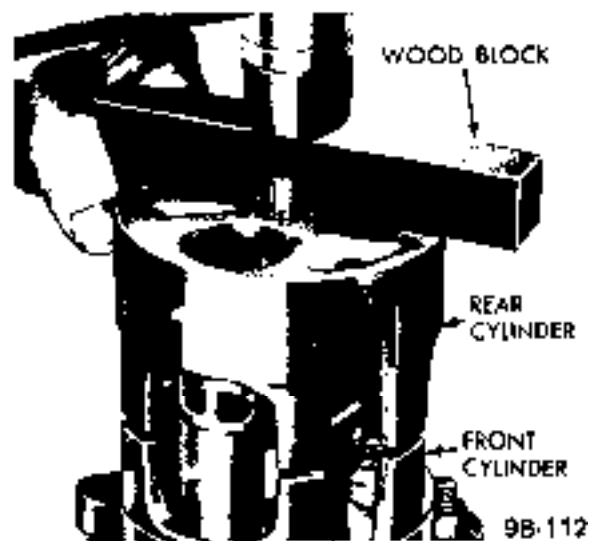
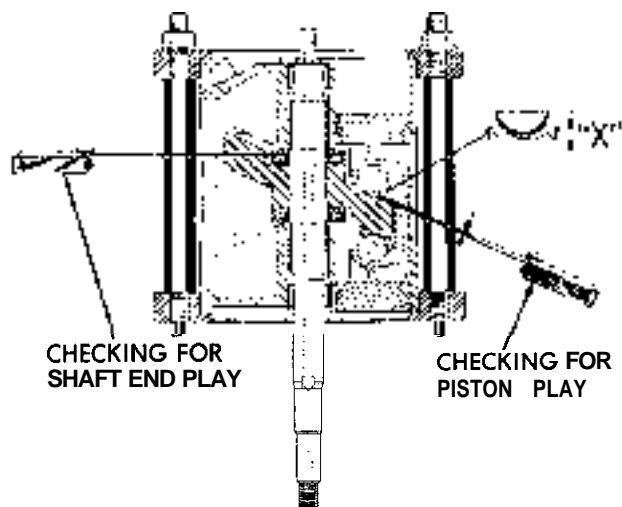


Figure 9B-140 Assembling Rear Cylinder Half

10. Remove cylinder assembly from on top of compressing fixture (J-9397), position assembly inside fixture so that discharge tube opening in cylinder halves is located between fixture legs, and front of cylinder assembly is downward. Install and torque fixture nuts to 15 lb. ft.

11. Gage piston play as follows:

(a) Using a feeler gage, select a leaf or combination of leaves which result in satisfactory "feel" when inserted between rear piston drive ball and swash plate (see Figures 9B-141 and 9B-142).



9B-113

Figure 9B-141 Checking Piston and Shaft End Play

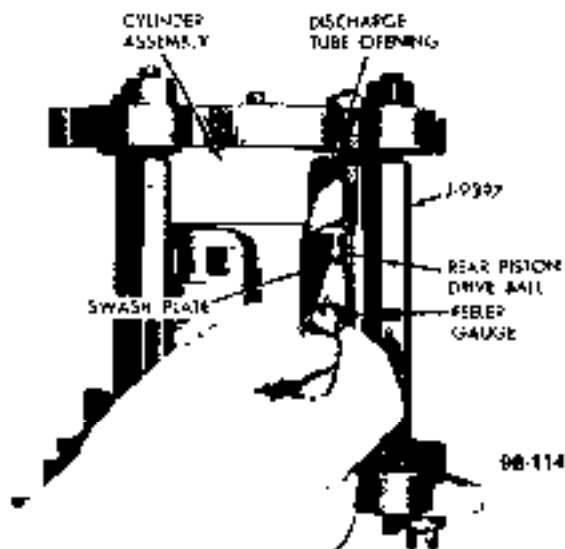
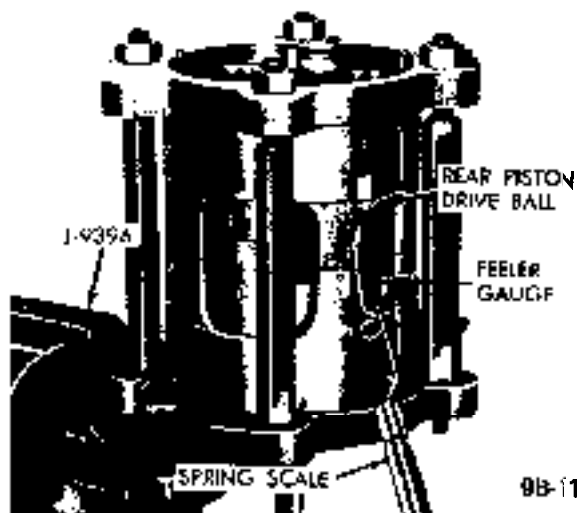


Figure 9B-142 Checking Clearance Between Rear Piston Drive Ball and Swash Plate

(b) Remove selected leaf or leaves from feeler gage and attach **end of** spring scale that is calibrated in ounces. (A generator brush spring scale (J-5 184) or the spring scale for checking distributor point setting may be used for this step).

(c) Reinsert feeler gage leaf or leaves between rear

piston drive ball and **swash** plate and draw leaf or leaves out again, simultaneously measuring "drag" on leaf or leaves (see Figure 9B-143). If correct leaf (leaves) has been selected, spring scale will read between 4 to 8 ounces pull (the higher **reading** is desired). To perform this step correctly, feeler gage leaf (leaves) must be withdrawn straight out with a steady even motion, and all surfaces involved must be coated with No. 525 viscosity oil. Record gage dimension.



9B-115

Figure 9B-143 Checking Drag on Selected Feeler Gage Leaf with Spring Scale

Use of the spring scale establishes a standard of measurement of the amount of feeler gage leaf "drag" required.

(d) Rotate the shaft and **swash** plate assembly 120 degrees **and** perform a second check (Steps "a, b and c") between same piston drive ball and **swash** plate. Record gage dimension.

(e) Rotate shaft and **swash** plate again approximately 120 degrees and repeat third check (Steps "a, b and c") between same piston drive ball and **swash** plate. Record gage dimension.

(f) From the three recorded checks (Steps "c, d and e") select minimum feeler gage reading and obtain from **stock** (ref. to the Shoe Disc Table for part number of shoe disc) one shoe disc corresponding to the minimum gage reading (ref. example below). Place shoe disc in respective position on parts tray (J-9402).

## Shoe Disc Table

SERVICE ID. NO.  
PART NO. STAMPED

	SHOE DISC
6557000	0 ("Zero" Shoe Disc)
6556175	17 1/2
6556180	
6556185	1 8 %
6556190	19
6556195	19 1/2 20
6556200	20 1/2
6556210	21
6556215	21 1/2
6556220	22

## EXAMPLE

Piston' No.	1st Check	2nd Check	3rd Check
1	.019 (Select No. 19 - Shoe Disc)	.020	.019
2	.020 (Select No. 19 - Shoe Disc)	.020	.019
3	.021 (Select No. 20 Shoe Disc)	.020	.021

(g) Repeat Steps "c, d, e and f" for other two pistons and obtain two more selected shoe discs for other two pistons. In the rebuilt cylinder assembly, each piston will have one selected shoe disc and one "zero" shoe disc.

12. Gage shaft end play as follows:

(a) Using a feeler gage, select a leaf or combination of leaves which result in satisfactory "feel" when inserted between rear needle thrust bearing and outer rear thrust race (see Figure 9B-144).

(b) Remove selected leaf or leaves from feeler gage. Attach to end of spring scale calibrated in ounces. (A generator brush spring scale (J-5184) or the spring scale for checking distributor point setting may be used for this step).

(c) Reinsert feeler gage leaf (leaves) between rear needle thrust bearing and outer rear thrust race and draw leaf (leaves) out again, this time simultaneously noting the "drag" or pull on the leaf (leaves) as measured by the spring scale (see Figure 9B-145). If correct leaf (leaves) have been selected, spring scale will read between 4 to 8 ounces pull (the higher reading is desired). To perform this step correctly, the feeler gage leaf (leaves) must be withdrawn straight out with a steady, even motion. All **contact-**

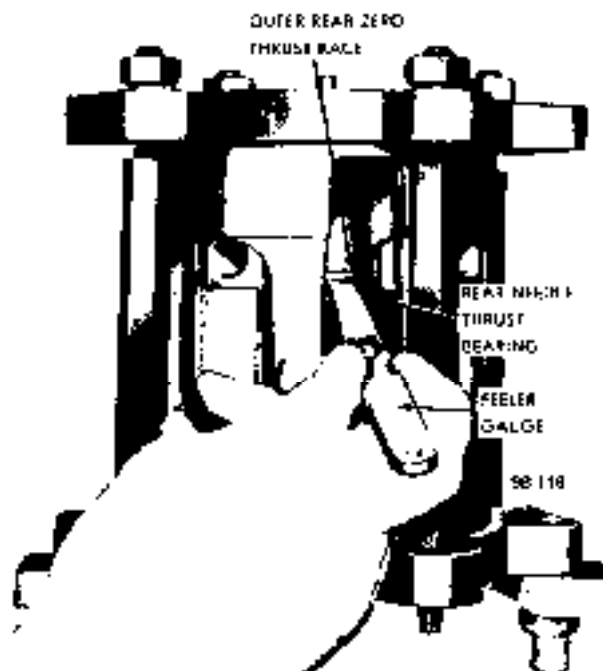


Figure 9B-144 Gaging Clearance Between Rear Needle Thrust Bearing and Outer Rear Thrust Race

ing surfaces involved in gaging operation must be coated with No. 525 viscosity oil.

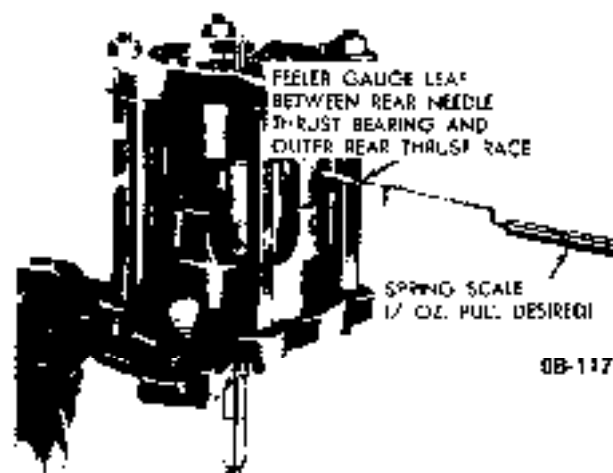


Figure 9B-145 Checking Drag on Selected Feeler Gage Leaf with Spring Scale

The measurement for selection of the thrust race needs to be performed at only one place on the shaft and swash plate assembly.

(d) Select from stock one thrust race (ref. Thrust Race Table for part number of thrust race) corresponding to the feeler gage reading determined in step "c", and place the selected thrust race in the parts tray slot designated for the outer rear thrust



race. If, for example a feeler gage reading of 0.009 inch results, a thrust race with a number "9", stamped on it should be selected.

**Thrust Race Table**

SERVICE PART NO.	ID NO. ON RACE	THICK-NESS
6556000	0	.0920
6556050	5	.0965
6556055	5 1/2	.0970
6556060	6	.0975
6556065	6 1/2	.0980
6556070	7	.0985
6556075	7 1/2	.0990
6556080	8	.0995
6556085	8 9	.1000
6556090	1/2	.1005
6556095	9	.1010
<b>6556100</b>	10	.1015
6556105	10 1/2	.1020
6556110	11	.1025
6556115	11 1/2	.1030
6556120	12	.1035

The selected thrust race will replace only the "zero" outer rear thrust race. The remaining three "zero" thrust races will remain as part of the cylinder assembly.

13. Remove cylinder assembly from inside compressing fixture (J-9397), place on top of compressing fixture (see Figure 9B-133) and disassemble rear cylinder from front cylinder using rubber mallet or hammer and wood block.

14. Carefully disassemble one piston at a time from front cylinder and lay piston, front and rear piston drive balls and front "zero" shoe disc in respective slot of parts tray (J-9402). To disassemble, rotate swash plate until piston is at highest point, raise a swash plate approximately 1/2 inch and lift out piston and related parts, one at a time.

15. Remove outer rear "zero" thrust race from shaft and set it aside for future gaging procedures.

16. Remove previously selected outer rear thrust race from parts tray, lightly coat with clear petroleum jelly and assemble onto shaft.

**Final Reassembly of Cylinder Assembly**

1. Reassemble piston rings (if service pistons) onto pistons (ring scraper groove toward center of piston) and rotate ring so that break or gap in ring can be squeezed together when piston is being inserted into cylinder bore.

2. Reassemble piston drive balls, "zero" and se-

lected shoe discs onto No. "1" piston, and apply clear petroleum jelly to piston pockets and shoe discs so that balls and discs stick to piston. BE SURE to reassemble balls and shoe discs into their specific positions on front and rear of piston.

3. Rotate shaft and swash plate assembly until high point of swash plate is over No. "1" cylinder bore. Position No. "1" piston onto swash plate (see Figure 9B-146) and lower the piston and swash plate so that the front end (notched end) of the piston enters the cylinder bore.

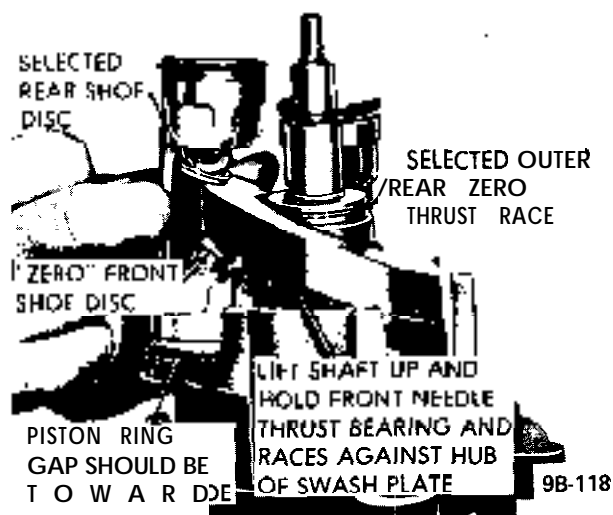


Figure 9B-146 Installing Piston Assembly in Front Cylinder Half - Service Pistons Shown

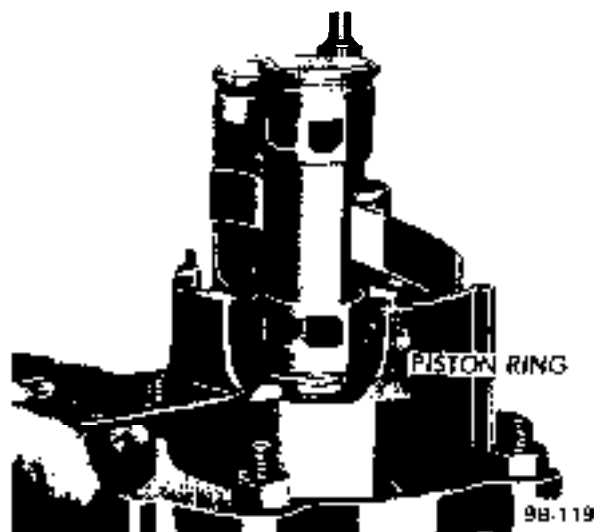


Figure 9B-147 Compressing Front Piston Rings - Service Pistons

In order to tit the piston onto the swash plate and into the cylinder bore, the swash plate must be raised approximately 1/2 inch, the front needle thrust bearing and races must be held up against the hub of the swash plate, and the service piston rings must be squeezed together (see Figure 9B-147). Lubricate cylinder bore, piston assembly and wash plate with No. 525 viscosity oil to facilitate reassembly.

4. Repeat procedure in Steps 1 and 2 for installation of No. 2 and No. 3 pistons.

5. Obtain new service replacement discharge tube and assemble into front cylinder (see Figure 9B-148).

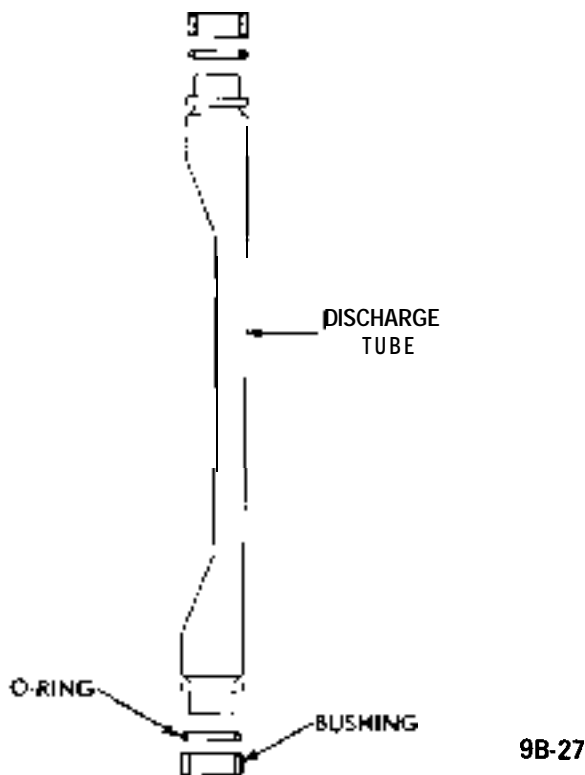


Figure 9B-148 Service Replacement Discharge Tube

6. Liberally lubricate cylinder bores of rear cylinder with No. 525 viscosity oil and reassemble rear cylinder onto front cylinder being sure to compress service piston rings. Align discharge tube and dowel pins, and tap cylinder halves together. Check for free rotation of shaft.

If pistons are positioned in a "stair-step" arrangement (see Figure 9B-150), installation of rear cylinder will be facilitated. In addition once the service piston and ring are started into the cylinder, slight rotation of the shaft to and fro will work the ring into the bore.

7. Liberally lubricate with No. 525 viscosity oil,

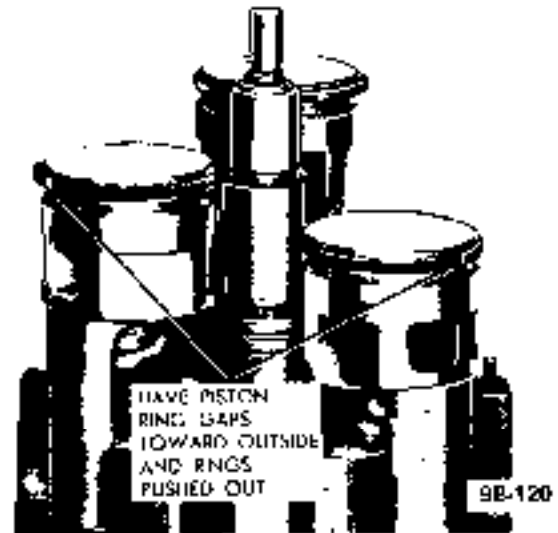


Figure SE-150 Pistons Positioned in Stair-Step Arrangement - Service Pistons Shown

suction pass cover and lips of suction passage in body of cylinder assembly, and reassemble suction pass cover over suction passage (see Figure 9B-151).

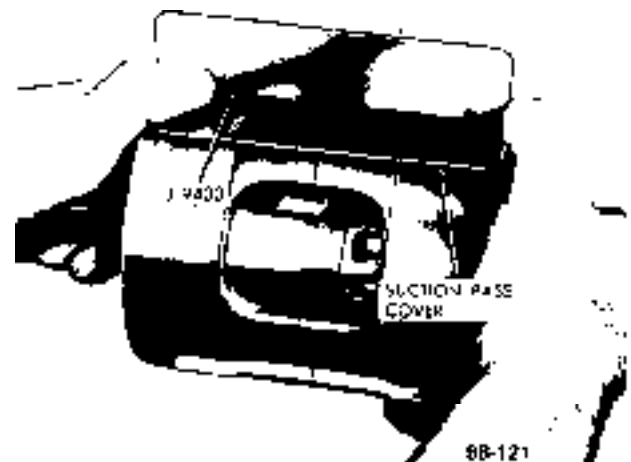


Figure 9B-151 Installing Suction Pass Cover

8. Assemble both service replacement discharge tube "O" rings and bushings (see Figure 9B-152) onto cylinder assembly.

**Reassembly of Front Suction Valve Reed Disc, Front Discharge Valve Plate, Front Head, and Installing of Cylinder Assembly**

1. Assemble suction reed valve disc to front of cylin-

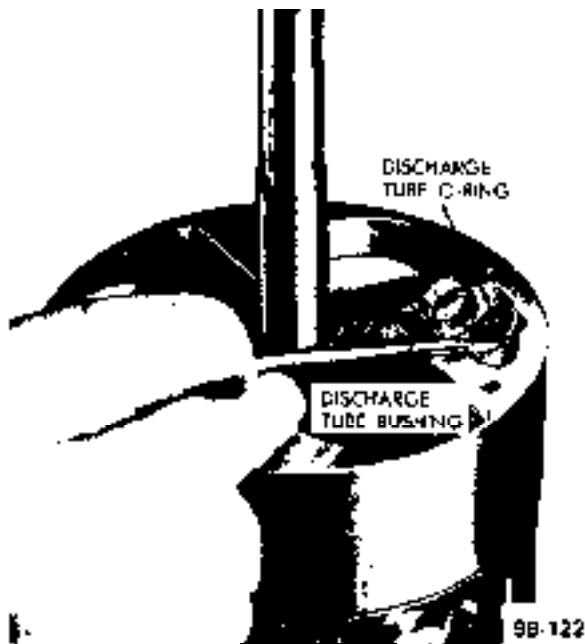


Figure 9B-152 Installing Discharge Tube O-Ring and Bushing

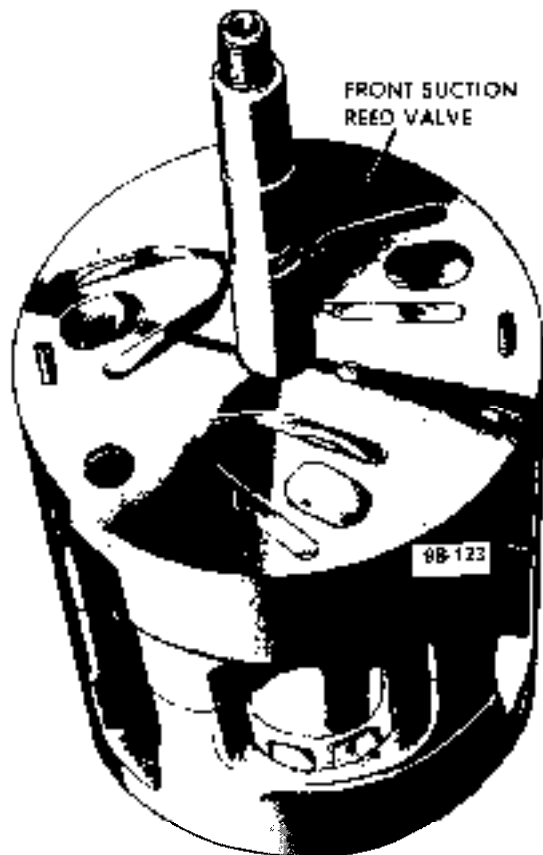


Figure 9B-153 Front Suction Valve Reed Disc installed

der assembly and align with dowel pins, suction port and discharge port (see Figure 9B-153).

2. Assemble front discharge valve plate to front of cylinder assembly and align with dowel pins.

3. Coat sealing surfaces on front head (see Figure 9B-154) with No. 525 viscosity oil.

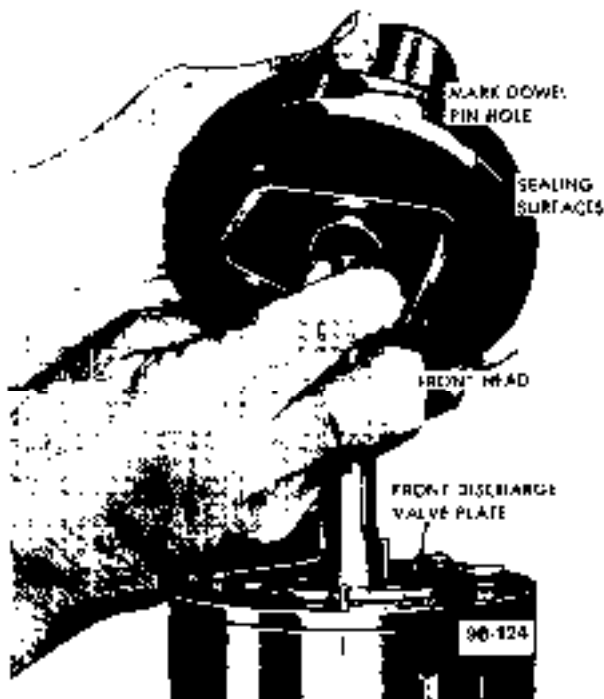


Figure 9B-154 Placing Front Head on Cylinder Assembly

4. Mark with pencil on side of front head the location of dowel pin holes (see Figure 9B-154), align front head with dowel pins, and tap head lightly with mallet to seat on cylinder assembly.

5. Place new shell to head "O" ring on shoulder of front head (see Figure 9B-155) and liberally coat "O" ring and front head sealing surface with No. 525 viscosity oil.

6. Install shell in holding fixture (J-9396) and position so that rear studs of shell are up. Coat inside surface of shell with No. 525 viscosity oil.

7. Reassemble, as a unit, cylinder assembly and front head into the shell. See Figure 9B-156. Extreme care must be used to prevent shell to head "O" ring seal from being damaged.

**Reassembly of Rear Suction Valve Reed Disc, Rear Discharge Valve Plate, Oil Pump and Rear Head**

1. Rotate the cylinder assembly and front head until



Figure 9B-155 Shell To Front Head O-Ring Installment

the hole for the oil inlet tube in the cylinder assembly is aligned with the reservoir hole in the shell, and reassemble the oil inlet tube and "O" ring.

2. Assemble suction reed valve disc to rear of cylinder assembly and align with dowel pins, suction port, and discharge port of cylinder assembly.

3. Assemble rear discharge valve plate to rear of cylinder assembly and align with dowel pins.

4. Reassemble inner and outer oil pump rotors so that the sides previously identified are in their original location, and then position oil pump outer rotor as shown in Figure 9B-157.

5. Generously coat with No. 525 viscosity oil new shell to head "O" ring and install in shell (see Figure 9B-157).

6. Coat Teflon sealing surface of rear head with No. 525 viscosity oil, mark with pencil on side of rear head the location of the dowel pin holes and reassemble onto compressor.

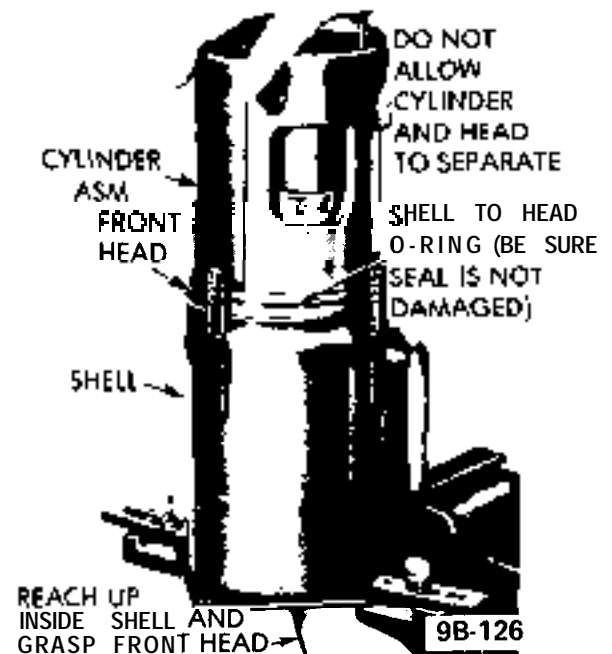


Figure 9B-126 Installing Front Head and Cylinder Assembly in Shell

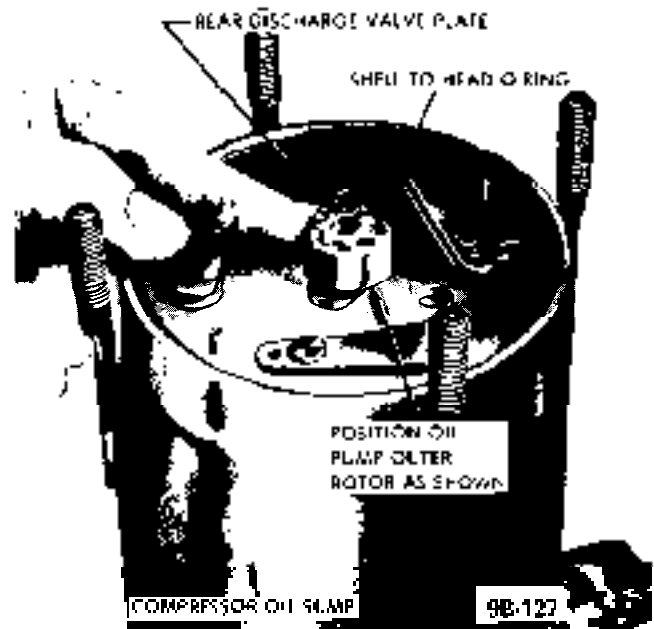


Figure 9B-157 Positioning Oil Pump Outer Rotor

It may be necessary to reposition oil pump outer rotor slightly in order to install rear head. In addition, if dowel pins do not engage holes in rear head, grasp front head and rotate cylinder assembly slightly (see Figure 9B-158).

7. Assemble new nuts to threaded shell studs and torque to 10 lb. ft. If pressure relief valve has been removed, reassemble using a new pressure relief valve gasket.

8. Reassemble new lubricated suction and discharge

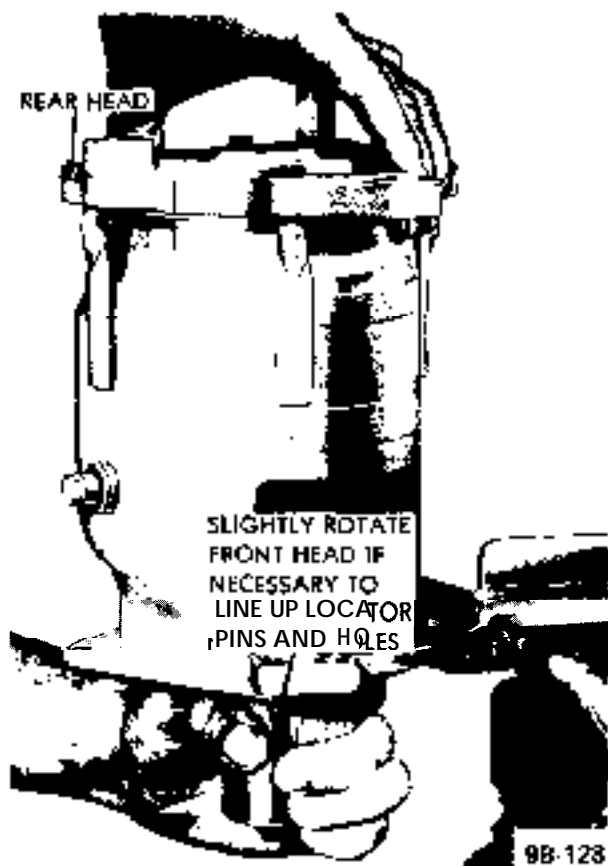


Figure 9B-158 Installing Rear Head

“O” rings into suction and discharge ports of rear head.

9. Reassemble shaft seal onto front of shaft and swash plate assembly. Do not reassemble clutch drive plate at this time.

#### Leak Testing Compressor

1. After the shaft seal pressure test has been performed, change the test circuit to the configuration shown in Figure 9B-160.

2. With hose attached only to high pressure side of Leak Test Fixture J-9625, open high pressure valve to charge high pressure side of compressor. As soon as high pressure gage stabilizes reading, close valve. If high pressure gage drops back immediately when valve is closed, an internal leak is indicated. Correct leak as necessary.

If an internal leak is indicated, the leak may exist about the head sealing surface or Teflon seal, discharge tube, shell to head “O” rings, or suction valve reed discs.

3. Remove drain screw from shell and add No. 525 viscosity oil as specified.

4. Reassemble pulley assembly, and coil and housing assembly onto hub of front head.

5. Complete reassembly by installing clutch drive plate onto hub of front head. See Figure 9B-164 disassembled view of compressor.

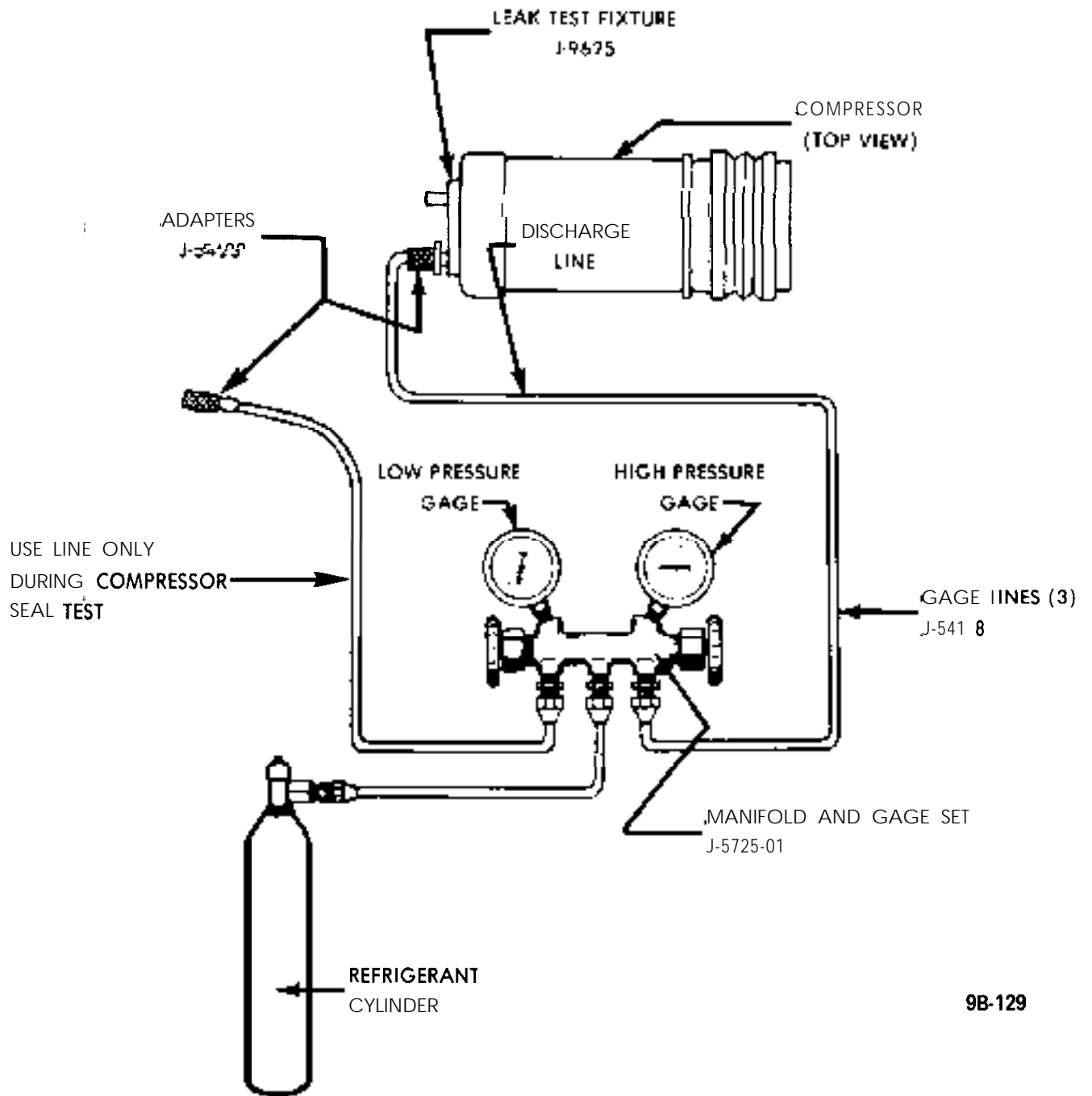


Figure 9B-160 Compressor Infernal Leak Test

## SPECIFICATIONS

### Tightening Specifications

Part	Location	Torque Lb. Ft.
Nut	Drive Plate Nut to Compressor Shaft .....	15
Nut	Rear Head to Shell .....	21
Cap	Schrader Service Valve .....	5

### Compressor Specifications

Type .....	Six Cylinder Axial Opposed
Make .....	Frigidaire
Effective Displacement (Cu. In.) .....	9.2
Oil .....	525 Viscosity
Oil Content (New) .....	10 Fl. Oz.
Air Gap Between Clutch Drive Plate and Pulley .....	0.022 to 0.057 In.
Clutch Type .....	Magnetic
Belt Tension .....	1 10-125 Lbs. Irritrial
.....	80 Lbs. Retension

### Pipe and Hose Connection Torque Chart

Metal Tube Outside Dia.	Thread and Fitting Size	Steel Tubing Torque Lb. Ft.	Aluminum or Copper Tubing Torque Lb. Ft.	Nominal Torque Wrench Span
1/4	7/16	10-15	5-7	5/8
3/8	5/8	30-35	11-13	3/4
5/8	7/8	30-35	21-27	1 1/16
3/4	1 1/16	30-35	28-33	1 1/4

### General Specifications

Thermostat Opening Temperature .....	189
Capacity of Cooling System With Air Conditioner (Quarts) .....	6 (Approx.)
Type of Refrigerant .....	Refrigerant 12
Refrigerant Capacity (Fully Charged)	
Opel 1900 • Manta .....	2 Lbs.
GT .....	2 1/4 Lbs.

### Functional Test Procedures

1. Place transmission in park for automatics and in neutral for manuals. Apply hand brake.
2. Turn blower switch to HI position,
3. Turn temperature switch to MAX position
4. Run engine at 2000 RPM for ten (10) minutes with car doors and windows closed and the hood up. Place a commercial high volumn fan in front of condenser if head pressure should exceed 250 psig.

A commercial high volumn fan should be placed in front of the condenser at high ambients to bring the pressures to within the limits specified in the Functional Charts. When testing the Opel 1900 and Manta, a thermometer should be placed in a position to read the temperature of the air discharging from the right-hand A/C outlet. When testing the GT, a thermometer should be placed in a position to read the temperature of the air discharging, from the left-rear A /C outlet.

### FUNCTIONAL TEST . OPEL 1900. MANTA

Temp. of Air Entering Cond.	70	80	90	100	110
Engine RPM	2000	2000	2000	2000	2000
<b>Comp. Head Pressure*</b>	155.165	195.205	200-210	<b>250-260</b>	270.280
Suction Press.†	19	22	22	27	29
Discharge Air Temperature*	38-43	40.45	42-47	<b>45-50</b>	47-52

\*When compressor clutch disengages,

### FUNCTIONAL TEST . GT

Temp. of Air Entering Cond.	70	80	90	100	110
Engine RPM	2000	2000	2000	2000	2000
<b>Comp. Head Pressure†</b>	125.135	145.155	180-190	210-220	150.260
Suction Press.†	17	20	20	22	24
<b>Discharge Air Temperature*</b>	37-42	<b>38-43</b>	39-44	<b>40-45</b>	<b>45-50</b>

†When compressor clutch disengages



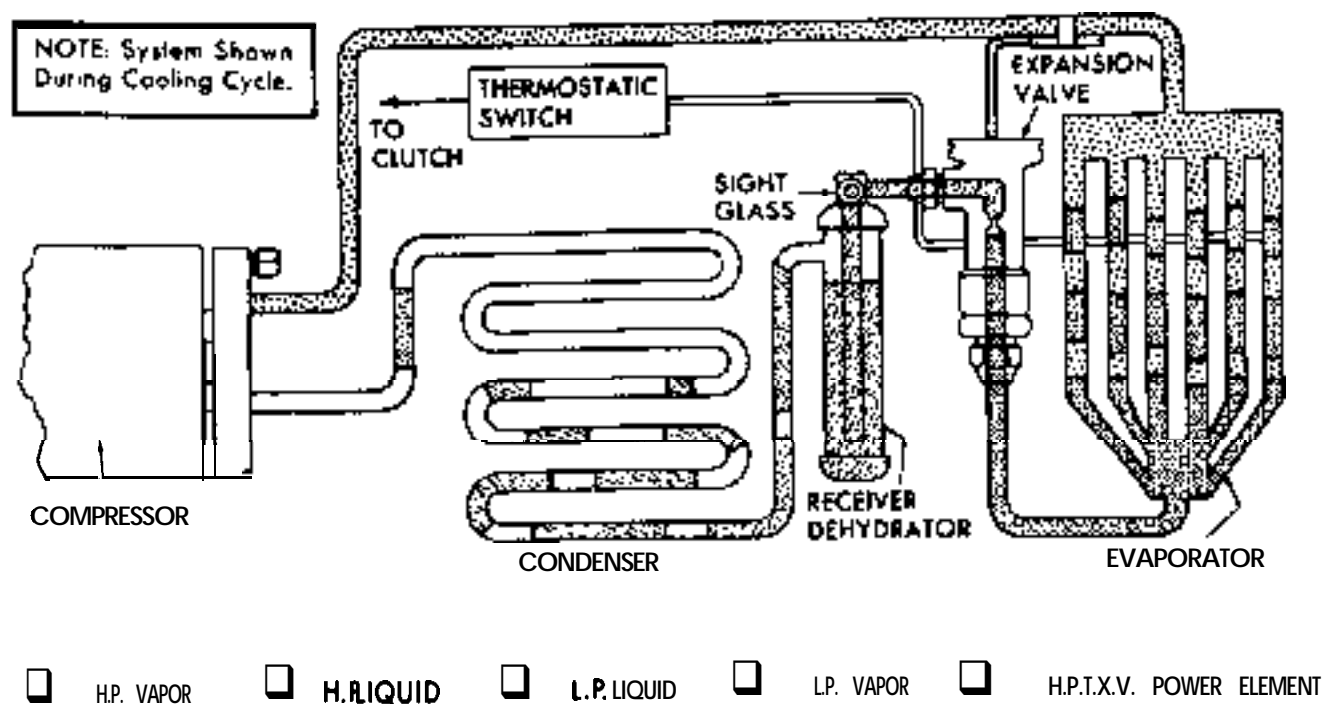
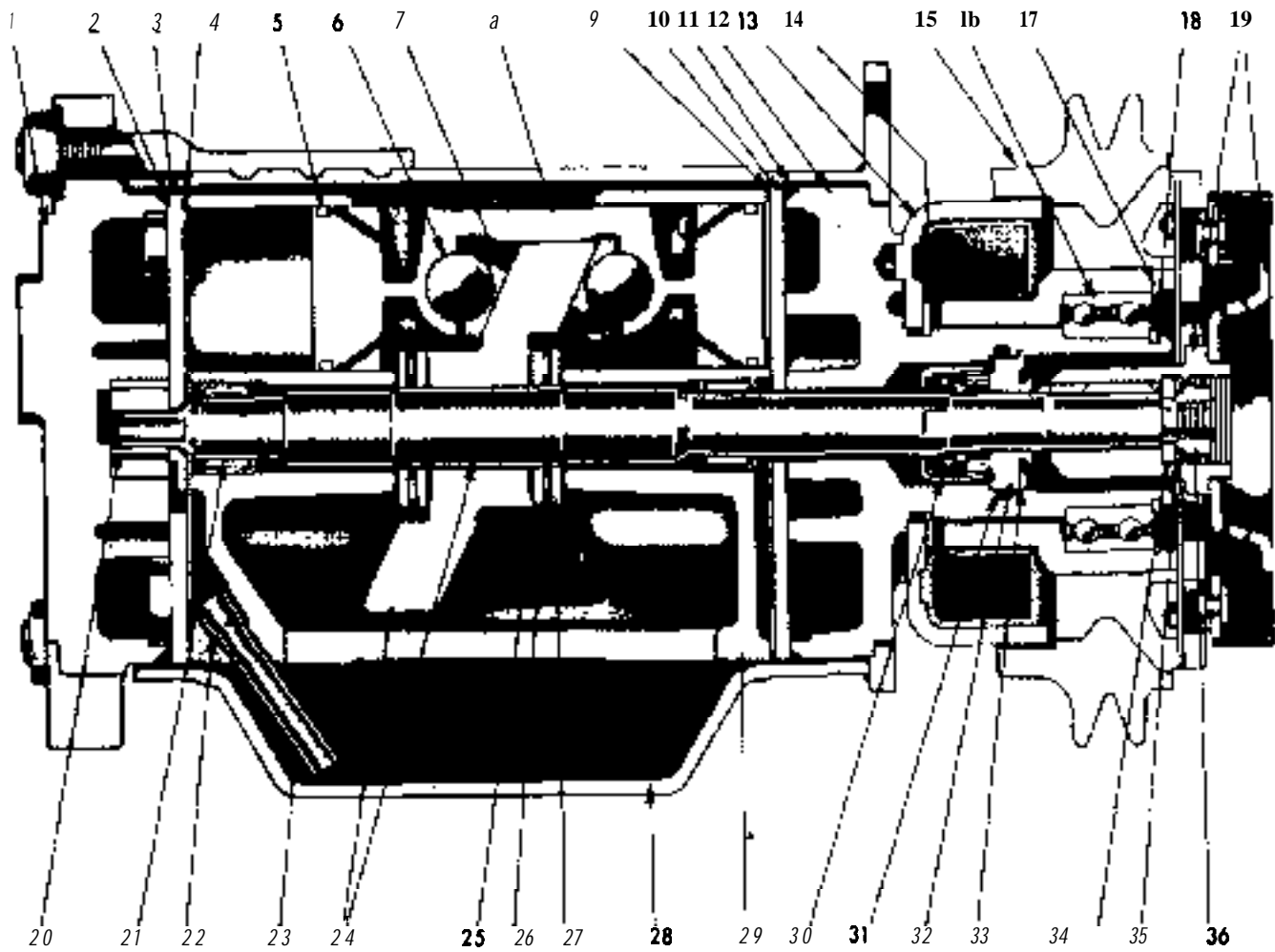


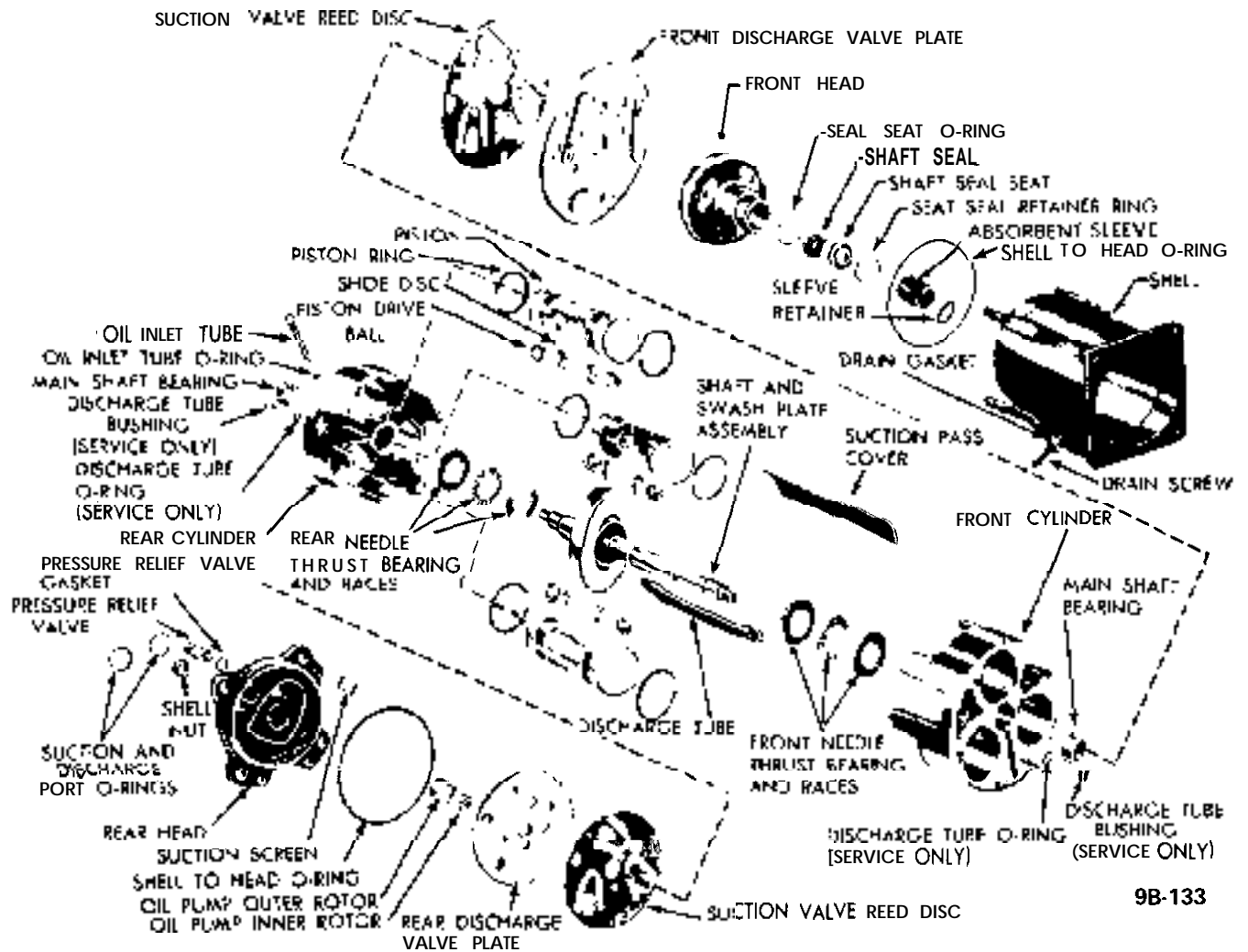
Figure 96-I 61 Cycle of Operation



- |                                  |   |                                   |
|----------------------------------|---|-----------------------------------|
| 1. Rear Head                     | 13. Coil and Housing Assembly                   | 25. Thrust Race                   |
| 2. Rear Head to Shell "O" Ring   | 14. Coil Housing Retaining Ring                 | 26. Thrust Bearing                |
| 3. Rear Discharge Valve Plate    | 15. Pulley and Bearing Assembly                 | 27. Thrust Race                   |
| 4. Rear Suction Reed Plate       | 16. Pulley Bearing                              | 28. Compressor Shell              |
| 5. Piston Ring                   | 17. Pulley Bearing Retainer Ring                | 29. Cylinder Assembly             |
| 6. Piston Drive Ball             | 18. Pulley and Bearing Retainer Ring            | 30. Shaft Seal                    |
| 7. Ball Seat (Shoe Disc)         | 19. Clutch Hub and Drive Plate Assembly         | 31. Shaft Seal Seat "O" Ring      |
| 8. Piston                        | 20. Oil Pump Gears                              | 32. Shaft Seal Seat               |
| 9. Front Suction Reed Plate      | 21. Mainshaft Bearing (Rear)                    | 33. Shaft Seal Seat Retainer Ring |
| 10. Front Discharge Valve Plate  | 22. Oil Inlet Tube "O" Ring                     | 34. Spacer                        |
| 11. Front Head to Shell "O" Ring | 23. Oil Inlet Tube                              | 35. Clutch Hub Retainer Ring      |
| 12. Front Head                   | 24. Wobble (Swash) Plate and Mainshaft Assembly | 36. Shaft Nut                     |

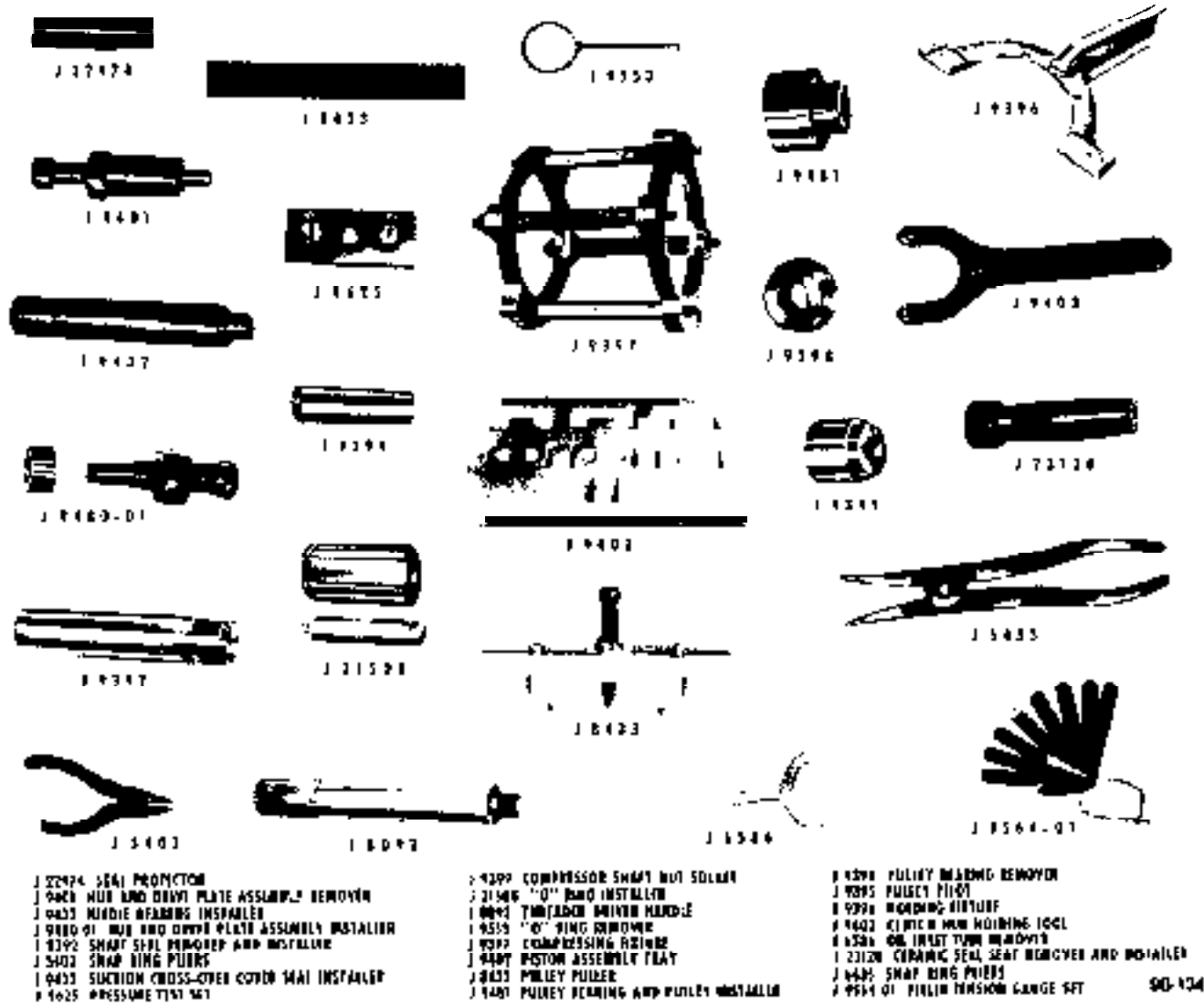
9B-131

Figure 9B-162 Compressor Section View



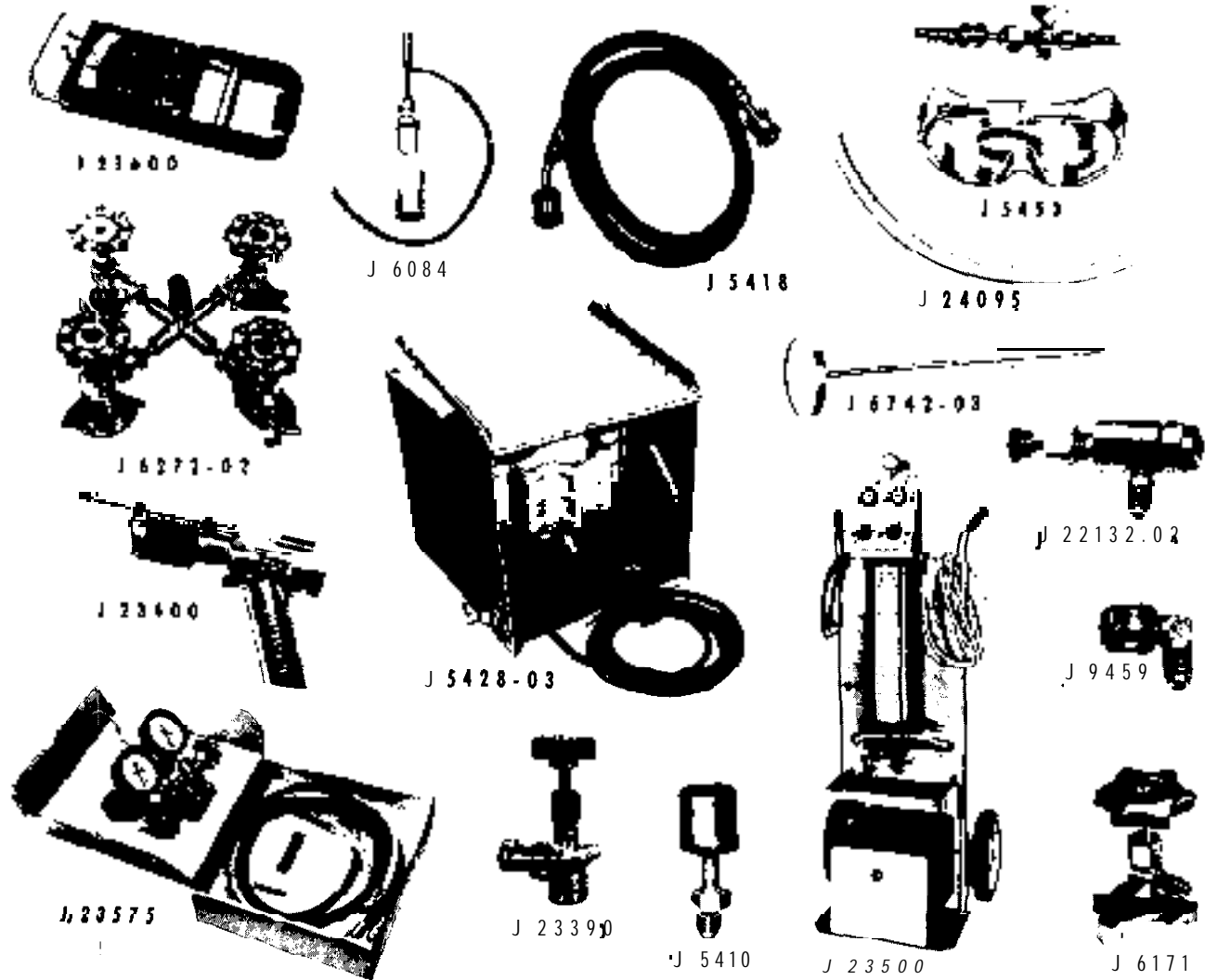
9B-133

Figure 96-1 64 Compressor Exploded View



- J 22974 SEAL PROMOTOR
- J 9428 HUB AND DRIVE PLATE ASSEMBLY REMOVER
- J 9433 MIDDLE BEARINGS INSTALLER
- J 9880-01 HUB AND DRIVE PLATE ASSEMBLY INSTALLER
- J 8392 SHAP SEAL REMOVER AND INSTALLER
- J 5402 SNAP RING Pliers
- J 9435 SUCTION CROSS-OVER COUPLER SEAL INSTALLER
- J 9425 PRESSURE TEST KIT
- J 9399 COMPRESSOR SHAFT NUT SOLDER
- J 21546 "O" RING INSTALLER
- J 9843 TIMING/DRIVER HANDLE
- J 9515 "O" RING REMOVER
- J 9397 COMPRESSING RINGS
- J 9407 PISTON ASSEMBLY TRAY
- J 8433 PULLEY PULLER
- J 9401 PULLEY BEARING AND PULLEY INSTALLER
- J 9394 PULLEY BEARING REMOVER
- J 9395 PULLEY FITTER
- J 9398 HOODING AIRTUBE
- J 9402 CENTRIC HUB HOUSING TOOL
- J 8526 OIL INLET TUBE REMOVER
- J 23128 CERAMIC SEAL SEAT REMOVER AND INSTALLER
- J 9434 SNAP RING Pliers
- J 9554-01 PULLEY TENSION GAUGE SET

Figure 9B-165 Special Tools



- J 23600 BELT TENSION GAUGE
- J 6212.01 #4 MULTI-OPENER . 4 CAN REFRIGERANT OPENER
- J 23400 ELECTRONIC LEAK DETECTOR
- J 23575 COMPLETE MANIFOLD ASSEMBLY
- J 6084 LEAK DETECTOR
- J 5428-03 VACUUM PUMP
- J 23390 12 LB. DISPOSABLE REFRIGERANT CAN CONTROL VALVE
- J 5420 GAUGE ADAPTER
- J 5453 GOGGLES
- J 24095 COMPRESSOR OIL INJECTOR
- J 6742-03 THERMOMETER - DIAL TYPE (25° -125°)

- J 5418-36B GAUGE CHARGING LINE 36" BLUE
- J 5418 -36R " " " -36" RED
- J 5418-48W " " " 48" WHITE
- J 5418-72B " " " 72" BLUE
- J 5418-72R " " " 72" RED
- J 5418-72W " " " 72" WHITE
- J 23500 PORTABLE AIR CONDITIONER SERVICE STATION
- J 22132-02 SCHRADER VALVE CORE REMOVER AND INSTALLER
- J 9459 90' GAUGE ADAPTER
- J 6271 FITS-ALL VALVE

Figure 9B-1 66 Special Tools

# AIR CONDITIONER SYSTEM

## OPEL 1900 - MANTA

### CONTENTS

Subject	Page No.
<b>DESCRIPTION AND OPERATION:</b>	
General Description of System .....	9B-90
Operation of Controls .....	9B-90
<b>DIAGNOSIS:</b>	
Diagnosis Guide .....	9B-90
<b>MAINTENANCE AND ADJUSTMENT:</b>	
Adjustment of Thermostatic Switch .....	9B-91
<b>MAJOR REPAIR:</b>	
Removal & Installation Blower Switch .....	9B-92
Removal & Installation Temperature Control Switch .....	9B-92
Removal & Installation Resistor Assembly .....	9B-92
Removal & Installation Blower Motor Assembly . .	9B-92
<b>SPECIFICATIONS:</b>	
Specifications .....	9B-96

### DESCRIPTION AND OPERATION

#### GENERAL DESCRIPTION OF SYSTEM

The air conditioner is intended to give maximum cooling comfort within the vehicle. To do this, careful attention must be given to the following Sections. The system operates on recirculated air only and is entirely independent of the vehicle heater.

Recirculated inside air is drawn into the unit, passed through the evaporator core and into the car through the adjustable outlets in the evaporator case.

#### Operation of Controls

System controls are the AIR knob controlling the three speed blower motor switch and the TEMP knob which controls the setting of the thermostatic switch. When operating this system, the heater must be off for maximum cooling.

#### Air Knob

Turning the AIR knob clockwise operates the three-speed blower motor.

#### Temp Knob

This knob may be regulated to control the degree of cooling desired. Fully clockwise provides maximum cooling; however, turning the knob to the center detent position provides adequate cooling for highway operation.

When maximum cooling is required, outside air should not be admitted to the car.

When the unit is set for maximum cooling and the vehicle is being driven continuously at highway speeds or at elevations of 4,000 ft. or more, there is a possibility of the formation of ice on the evaporator core fins.

### DIAGNOSIS

#### TROUBLE DIAGNOSIS GUIDE

#### Insufficient Cooling

#### CHECK AIR FLOW

FAN DOES NOT RUN Correct electrical fault.

FAN RUNS - Check air velocity.

NOT OK Clean evaporator inlets.

Clean evaporator core.

Clean evaporator outlets.

OK Check refrigeration (refer to Refrigeration Diagnosis Guide).

## MAINTENANCE AND ADJUSTMENTS

### ADJUSTMENT OF THERMOSTATIC SWITCH

The system makes use of a thermostatic switch with a self-supporting air sensing capillary. This capillary controls the switch by sensing the temperature of the air leaving the evaporator fins.

#### Checking for Proper Operation

1. Install the gauge set and set up the vehicle as described under FUNCTIONAL TESTING SYSTEM in Refrigerant Components Section.
2. Movement of the temperature control knob should result in a definite change in suction pressure and cycling of the compressor clutch.
3. If compressor continues to operate regardless of the knob adjustment, it indicates that the switch points are fused, which will lead to evaporator freeze-up. The switch should be replaced.

#### Adjusting Switch

If, after the foregoing checks, the switch seems to be operating correctly, adjust for proper setting if necessary, as follows:

1. Set up car as described in FUNCTIONAL TESTING SYSTEM in Refrigerant Components Section.
2. The suction side of the system, read on the low pressure gauge, should pull down to the pressure shown in the chart in SPECIFICATIONS in Refrigerant Components Section.
3. Remove the face plate retaining screws and remove face plate assembly noting the position of the air sensing capillary so that it can be reinstalled in the same location as when removed. See Figure 9B-170.

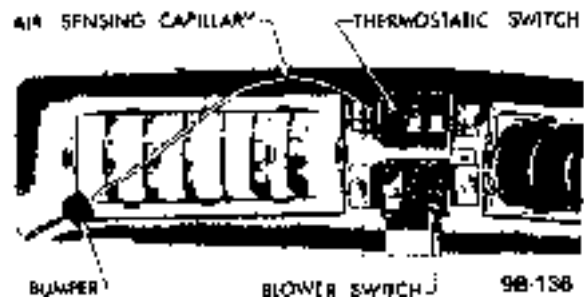


Figure 9B-170 Location of Air Sensing Capillary

4. Remove the thermostatic switch retaining screws and remove switch. Remove the non-metal end plate from the switch to gain access to the switch adjusting screw. Check the screw for stripped or otherwise damaged threads.

5. If the low side pressure was less than the prescribed pressure at the end of each cooling cycle, turn the adjusting screw a partial turn clockwise. See Figure 9B-171.



Figure 9B-17 1 Adjusting Thermostatic Switch

6. If the pressure was more than the prescribed value, turn the adjusting screw counter-clockwise.

7. Reinstall switch end plate and install switch in face plate. Install face plate on evaporator assembly assuring that the air sensing capillary has been replaced properly.

8. Check system performance. If further adjustment is needed, repeat steps 3 thru 7 until the correct pressure is reached.

Do not attempt to run a performance test with the face plate and switch removed from the evaporator assembly - inaccurate reading, will result. Always replace the switch and face plate assemblies before checking the system performance.

## MAJOR REPAIR

### REMOVAL AND INSTALLATION OF BLOWER SWITCH

#### Removal

1. Remove the face plate retaining screws and remove the face plate assembly. See Figure 9B-172.

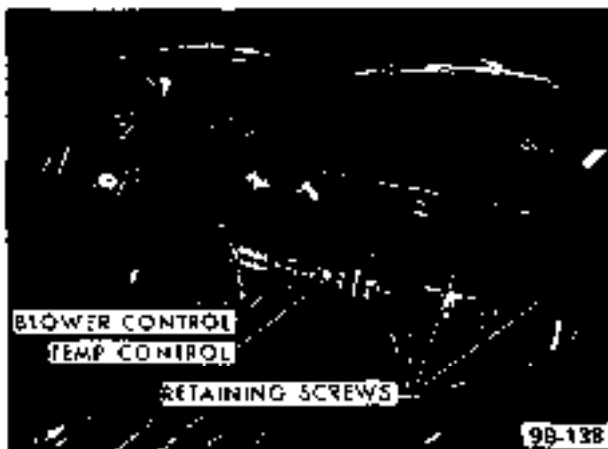


Figure SE-172 Face Plate Retaining Screws and Controls

2. Remove the blower switch retaining screws and remove switch.

#### Installation

1. Install the blower switch and retainer screws.
2. Install the face plate and secure with the retainer screws. See Figure 9B-172.

### REMOVAL AND INSTALLATION OF TEMPERATURE CONTROL SWITCH

#### Removal

1. Remove the face plate retaining screws and remove the face plate assembly noting the position of the air sensing capillary so that it can be reinstalled in the same location as when removed. See Figure 9B-173.

2. Remove the temperature control switch retaining screws and remove switch.

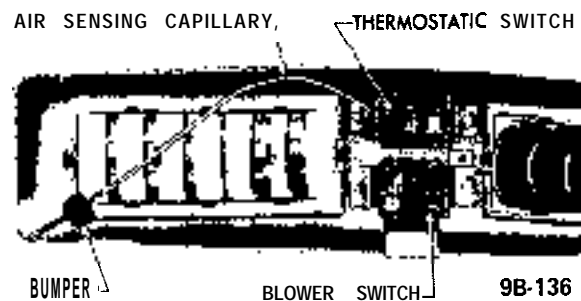


Figure SB-173 Location of Air Sensing Capillary

#### Installation

1. Install the temperature control switch and secure with the retaining screws.
2. Position the air sensing capillary in the exact location as was noted when removing.
3. Install the face plate and secure with the retaining screws. See Figure 9B-172.

### REMOVAL AND INSTALLATION OF RESISTOR ASSEMBLY

#### Removal

1. Disconnect the negative battery cable.
2. Remove the glove box assembly.
3. Disconnect the electrical plug from the resistor assembly. See Figure 9B-176.
4. Remove two (2) screws and remove resistor assembly.

#### Installation

1. Install the resistor assembly and secure with two (2) screws.
2. Install the electrical plug onto the resistor assembly. See Figure 9B-176.
3. Install the glove box assembly.
4. Connect the negative battery cable.

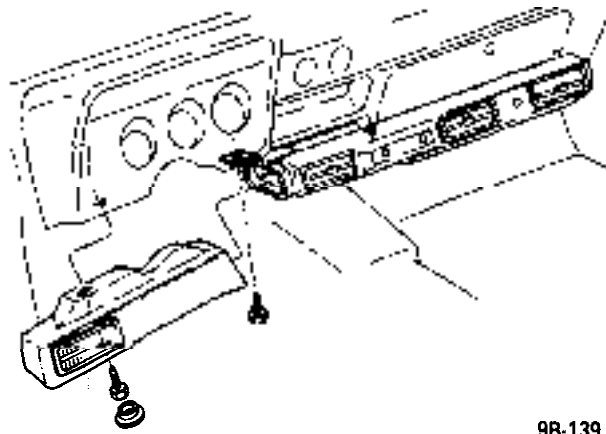
### REMOVAL AND INSTALLATION OF BLOWER MOTOR ASSEMBLY

#### REMOVAL

1. Remove the negative battery cable from the battery.



2. Remove the left side of distributor duct, and the in-line fuse. See Figure 9B-174.



9B-139

Figure SB-174 Location of Distributor Duct (Left Side) Retaining Screws



Figure 9B-175 Removing Left Side Distributor Duct

3. Remove the glove box assembly. See Figure 9B-176.

4. Discharge refrigerant from system, (refer to DISCHARGING SYSTEM) and disconnect refrigerant hose from evaporator outlet and pipe from evaporator inlet and tape the open ends of the refrigerant lines and evaporator pipes. See Figure 9B-178.

5. Disconnect the delay restrictor and check valve hose assembly from the vacuum cut-off switch and disconnect the electrical wiring. See Figure 9B-180.

6. Remove evaporator inlet and outlet pipes retainer and rubber grommet. See Figure 9B-178.

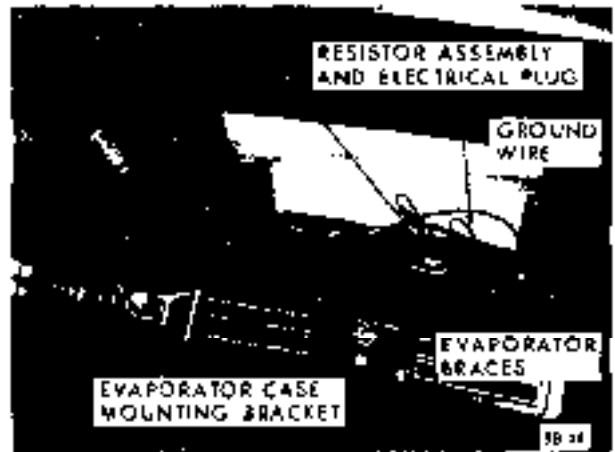


Figure 9B-176 Glove Box Removed

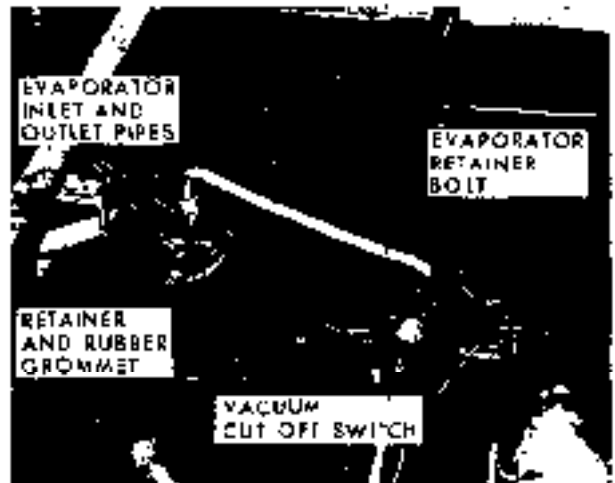


Figure SB-178 Location of Refrigerant Hoses, Pipes, Vacuum Cut Off Switch and Evaporator Attaching Bolt (Left Side)

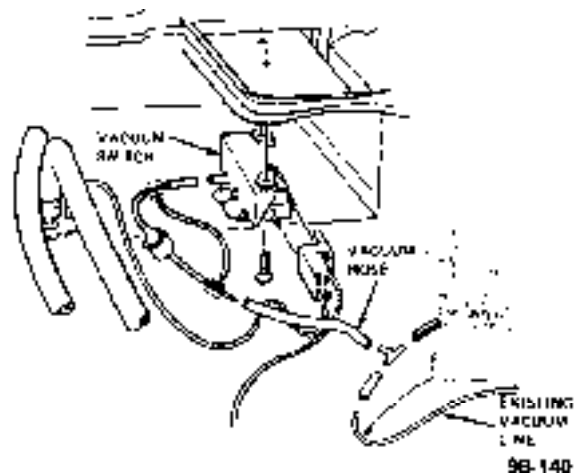


Figure 9B-180 Vacuum Hoses and Wiring

7. Remove 2 upper evaporator attaching nuts. See Figures 9B-178 and 9B-181.



Figure 9B-181 Location of Upper Evaporator Attaching Bolt (Right Side)

8. Remove 2 attaching case mounting bracket to instrument panel screws. See Figure 9B-182.

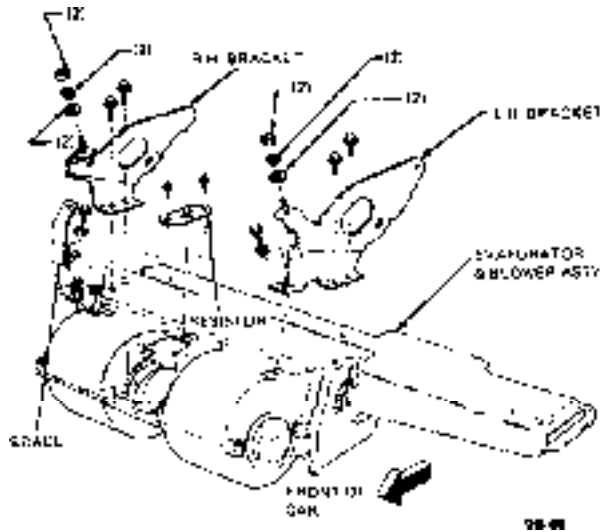


Figure 9B-182 Evaporator and Blower Assembly Brackets and Attachments

9. From underneath evaporator case, disconnect two (2) drain hoses.

10. Carefully remove assembly from car. See Figure 9B-184.

11. Disconnect resistor electrical connector and remove resistor assembly. See Figure 9B-184.

12. Remove the blower case and blower motor attaching screws and remove assembly. See Figure 9B-184.

**Installation**

1. Install the blower motor assembly into case

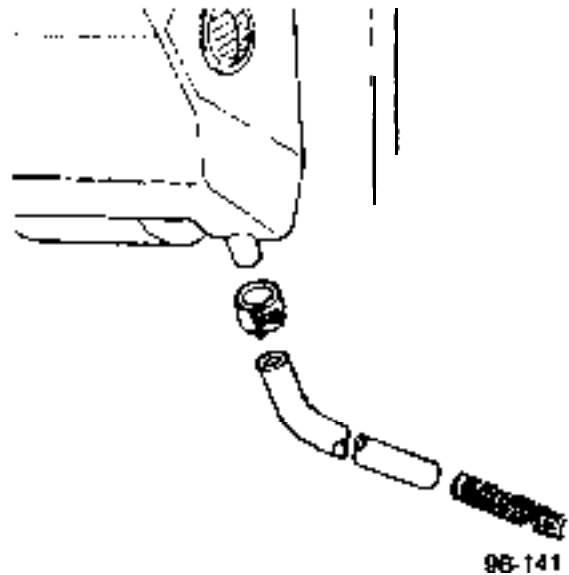


Figure 9B-183 Drain Hose

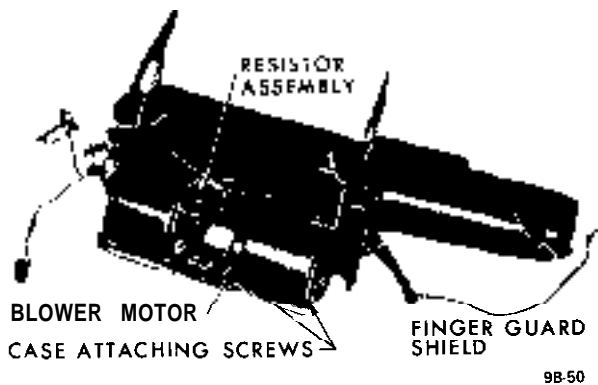


Figure 9B-184 Assembly Removed

bracket with the electrical connector side of the motor to the right side of the bracket. Attach the mounting strap.

2. Assemble the case halves and attach the cover plate.

3. Install the resistor assembly and electrical connector. Install blower motor connector. See Figure 9B-184.

4. Install assembly into car carefully guiding evaporator pipes up through cowl opening. See Figure 9B-185.

5. Install 2 upper evaporator attaching nuts. See Figures 9B-178 and 9B-181.

6. Install 2 attaching case mounting bracket to instrument panel screws. See Figure 9B-182.

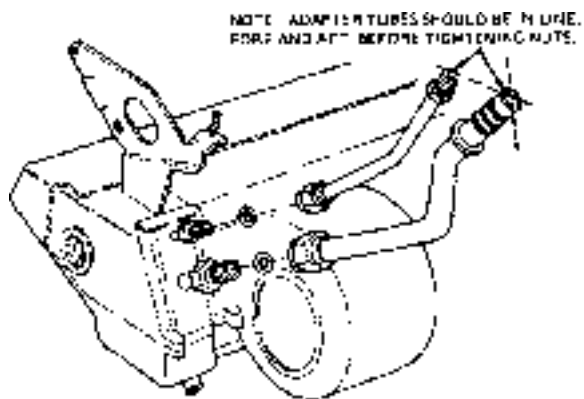


Figure 9B-185 Evaporator Inlet and Outlet Pipes and O-Rings

7. Connect the 2 drain hoses underneath evaporator.

8. Install evaporator inlet and outlet pipes retainer and rubber grommet. See Figure 9B-178.

9. Connect vacuum cut-off switch and electrical wiring,, making sure the delay restrictor and check valve hose are installed correctly. See Figure 9B-180.

10. Install refrigerant hoses and pipes using new o-rings on line fittings and evacuate system. Refer to EVACUATING SYSTEM.

11. While system is being evacuated install the in-line fuse and left side of distributor duct. See Figure 9B-174.

12. Install the glove box.



Figure 9B-186 Delay Restrictor and Check Valve Hose Assembly

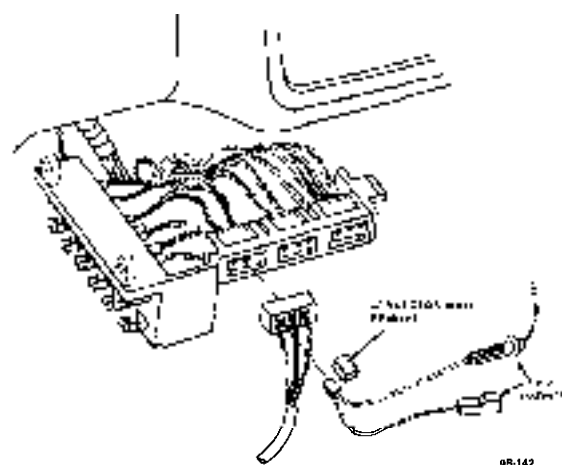


Figure 9B-187 Fuse Block Connections

13. Install negative battery cable and charge the system. Refer to CHARGING SYSTEM.

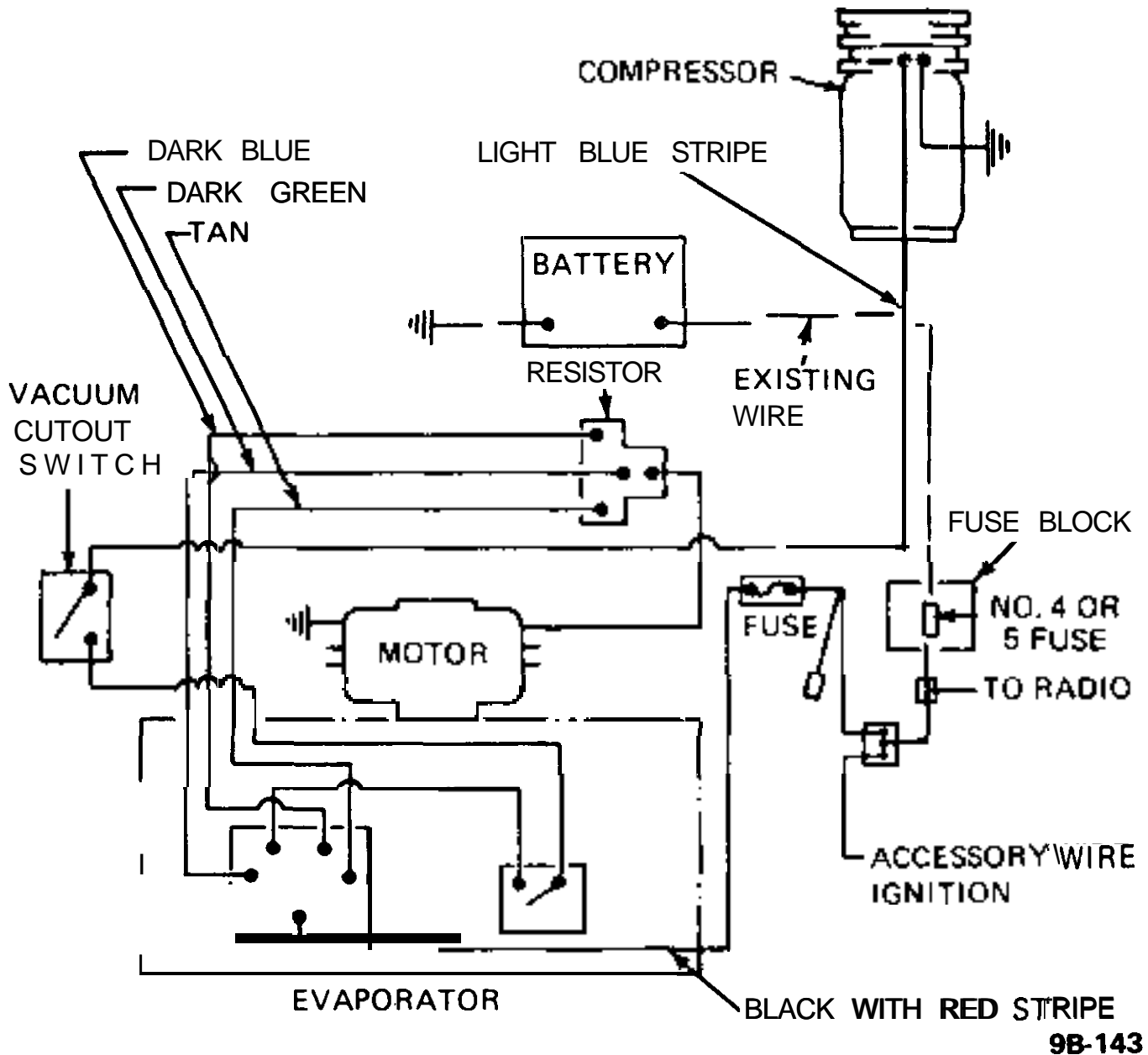


Figure 9B-188 Wiring Schematic

**SPECIFICATIONS**

Blower Motor Type .....  
 Blower Fan Type .....

12 VDC  
 Squirrel Cage

# AIR CONDITIONER SYSTEM

## GT

### CONTENTS

Subject	Page No.
<b>DESCRIPTION AND OPERATION:</b>	
General Description of System .....	9B- 97
Operation of Controls .....	9B- 97
<b>DIAGNOSIS:</b>	
Diagnosis Guide .....	9B- 98
<b>MAINTENANCE AND ADJUSTMENTS:</b>	
Adjustment of Thermostatic Switch .....	9B- 98
<b>MAJOR REPAIR:</b>	
Removal & Installation of Vacuum Switch.	9B: 99
Removal & Installation Blower Switch .....	9B- 99
Removal & Installation Temperature Control Switch	9B- 99
.....	
Removal & Installation Resistor Assembly .....	9B-100
Removal & Installation Blower Motor Assembly . .	9B-101
<b>SPECIFICATIONS:</b>	
Specifications .....	9B-104

## DESCRIPTION AND OPERATION

### GENERAL DESCRIPTION OF SYSTEM

The air conditioner is intended to give maximum cooling comfort within the vehicle. To do this, careful attention must be given to the following sections. The system operates on recirculated air only and is entirely dependent of the vehicle heater.

Recirculated inside air is drawn into the unit, passed through the evaporator core and into the car through the adjustable outlets in the duct assembly.

### CONTROLS

System controls are the AIR knob controlling the three speed blower motor switch and the TEMP knob which controls the setting of the thermostatic switch. When operating this system, the heater must be off for maximum cooling.

#### Air Knob

Turning the AIR knob clockwise operates the three-speed blower motor.

#### Temp Knob

This knob may be regulated to control the degree of cooling desired. Fully clock-wise provides maximum cooling; however, turning the knob to the center detent position provides adequate cooling for highway operation.

When maximum cooling is required, outside air should not be admitted to the car.

When the unit is set for maximum cooling and the vehicle is being driven continuously at highway speeds or at elevations of 4,000 ft. or more, there is a possibility of the formation of ice on the evaporator core tins.

## DIAGNOSIS

### TROUBLE DIAGNOSIS GUIDE

#### Insufficient Cooling

#### CHECK AIR FLOW

FAN DOES NOT RUN • Correct electrical fault.

FAN RUNS • Check air velocity.

NOT OK • Clean evaporator inlets.

Clean evaporator core.

Clean evaporator outlets.

OK • Check refrigeration (refer to Refrigeration Diagnosis Guide).

## MAINTENANCE AND ADJUSTMENTS

### ADJUSTMENT OF THERMOSTATIC SWITCH

The system makes use of a thermostatic switch with a self-supporting air sensing capillary. This capillary controls the switch by sensing the temperature of the air leaving the evaporator tins.

#### Checking for Proper Operation

1. Install the gauge set, and set up the vehicle as described under FUNCTIONAL TESTING SYSTEM in Refrigerant Components Section.

2. Movement of the temperature control knob should result in a definite change in suction pressure and cycling of the compressor clutch.

3. If compressor continues to operate regardless of the knob adjustment it indicates that the switch points are fused, which will lead to evaporator freeze-up. The switch should be replaced.

#### Adjusting Switch

If after the foregoing checks, the switch seems to be operating correctly, adjust for proper setting if necessary, as follows:

1. Set up car as described in FUNCTIONAL TESTING SYSTEM in Refrigerant Components Section.

2. The suction side of the system, read on the low

pressure gauge, should pull down to the pressure shown in the chart in SPECIFICATIONS in Refrigerant Components Section.

3. Remove the duct assembly retaining screws and remove the duct assembly noting the position of the air sensing capillary so that it can be reinstalled in the same location as when removed. See Figure 9B-190.



Figure 9B-190 Duct Assembly and Retaining Screws

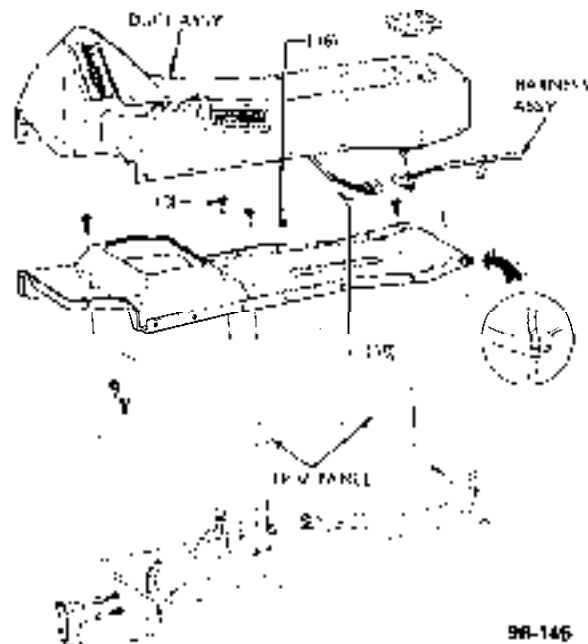


Figure 9B-191 Duct Assembly

4. Remove the thermostatic switch retaining screws and remove switch. Remove the non-metal end plate from the switch to gain access to the switch adjusting screw. Check the screw for stripped or otherwise damaged threads.

5. If the low side pressure was less than the prescribed pressure at the end of each cooling cycle, turn the **adjusting screw a partial turn clockwise**. See Figure 9B-192.

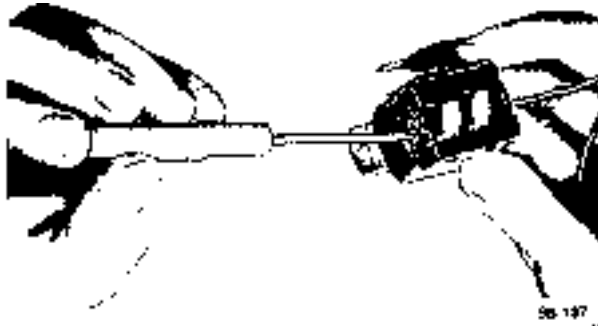


Figure 9B-192 Adjusting Thermostatic Switch

6. If the pressure was more than the prescribed value, turn the **adjusting screw counter-clockwise**.

7. Reinstall switch end plate and install switch in face plate. **Install** face plate on evaporator assembly assuring that the air sensing capillary has been replaced properly.

8. Check system performance. If further adjustment is needed, repeat steps 3 thru 7 until the correct pressure is reached.

Do not attempt to run a performance test with the duct assembly and switch removed from the evaporator assembly - inaccurate readings will result. Always replace the switch and duct assemblies before checking the system performance.

## MAJOR REPAIR

### REMOVAL AND INSTALLATION OF VACUUM SWITCH,

#### Removal

1. Remove right trim pad below instrument panel.
2. Remove two (2) screws and unplug the vacuum hose and electrical connector. See Figure 9B-193.

#### Installation

1. Install two (2) screws and plug in electrical connector and connect the delay restrictor and check valve hose assembly.
2. Install right trim pad.

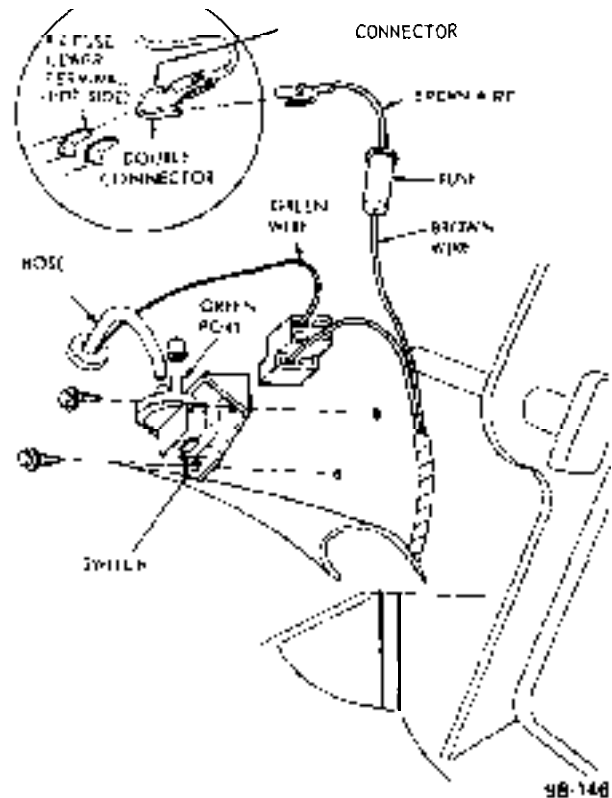


Figure 9B-193 Vacuum Switch

### REMOVAL AND INSTALLATION OF BLOWER SWITCH

#### Removal

1. Remove the **negative cable from the battery**
2. Remove the retaining screws from the duct assembly. See Figure 9B-190.
3. Remove 2 blower switch retaining screws and remove blower switch.

#### Installation

1. Install the blower switch and secure with two (2) retaining screws.
2. Install the duct assembly retaining screws.
3. Install the negative battery cable.

### REMOVAL AND INSTALLATION OF TEMPERATURE CONTROL SWITCH

#### Removal

1. Remove the negative battery cable.

2. Remove the retaining screws from the duct assembly. See Figure 9B-190.

3. Lift up duct assembly and note the position of the air sensing capillary so that it can be reinstalled in the same location as when removed.

4. Remove the temperature control switch retaining screws and remove switch.

**Installation**

1. Install the temperature control switch and secure with the retainer screws.

2. Position the air sensing capillary in the exact location as was noted when removing.

3. Install the duct assembly retaining screws.

4. Install the negative battery cable.

**REMOVAL AND INSTALLATION OF RESISTOR ASSEMBLY**

**Removal**

1. Remove the negative battery cable from the battery.

2. Remove the luggage tray attaching screws and lift out tray. See Figure 9B-194.



Figure 9B-194 Luggage Tray

3. Remove all evaporator cover attaching screws and remove cover. See Figure 9B-195.



Figure 9B-195 Evaporator Cover Assembly and Attaching Screws

4. Remove the electrical plug connector from the resistor assembly.

5. Remove 2 resistor attaching screws and remove resistor assembly. See Figure 9B-197.

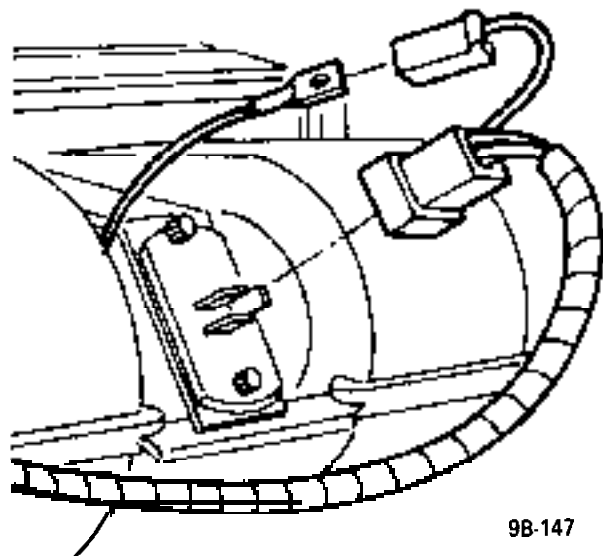


Figure 9B-196 Resistor and Blower Motor Connections





Figure 9B-197 Electrical Connections

**Installation**

1. Install the resistor assembly and two (2) attaching screws. See Figure 9B-198.

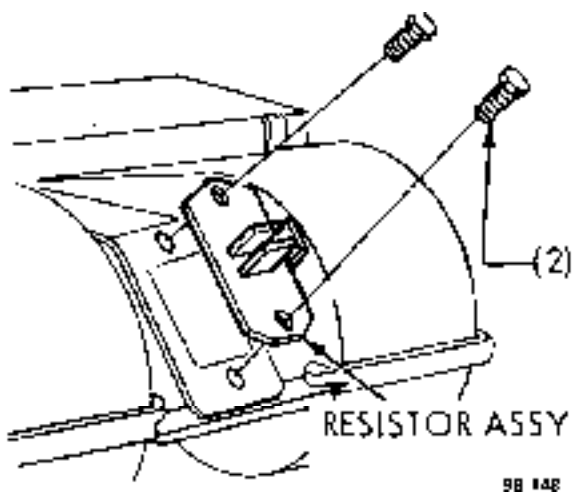


Figure 9B-198 Resistor Assembly Attaching Screws

2. Install the electrical plug connector.
3. Install the evaporator cover and attaching screws. See Figure 9B-195.
4. Install the luggage tray and attaching screws. See Figure 9B-194.
5. Install the negative battery cable

**REMOVAL AND INSTALLATION OF BLOWER MOTOR ASSEMBLY**

**Removal**

1. Disconnect the negative battery cable from the battery.



Figure 9B-200 Luggage Tray



Figure 9B-201 Evaporator Cover Assembly and Attaching Screws

2. Discharge system. Refer to DISCHARGING SYSTEM in Refrigerant Components Section.

3. While system is discharging remove the luggage tray attaching screws and lift out tray. See Figure 9B-200.

4. Remove all evaporator cover screws and remove cover. See Figure 9B-201.

5. Remove the electrical plug connector from the resistor assembly, and unplug blower motor connection and remove ground wire. See Figure 9B-203.

6. From underneath evaporator housing, disconnect 2 drain hoses. See Figure 9B-204.

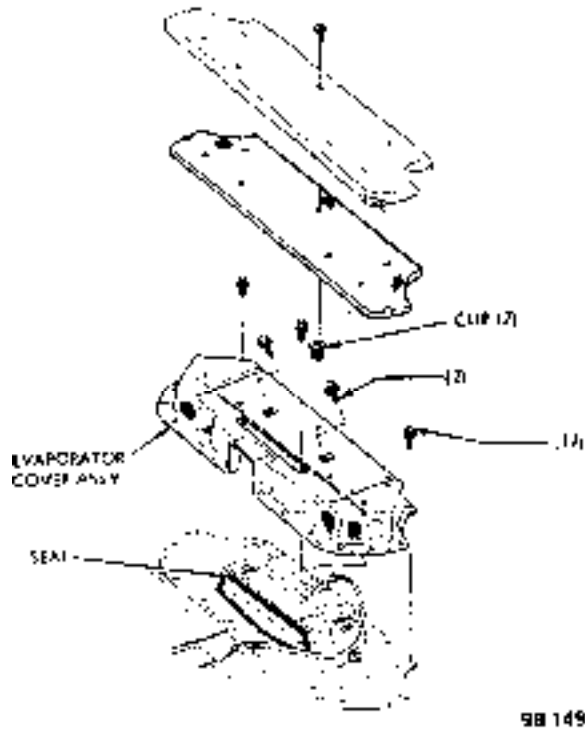


Figure 9B-202 Evaporator Cover and Luggage Tray

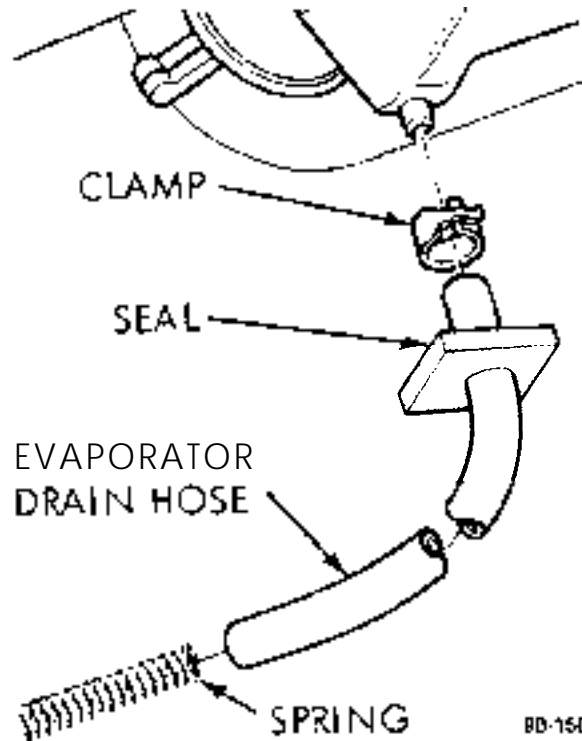


Figure 9B-204 Drain Hose

7. From under car remove 4 nuts securing evaporator mounting bracket to floor. See Figure 9B-205 and 9B-206.

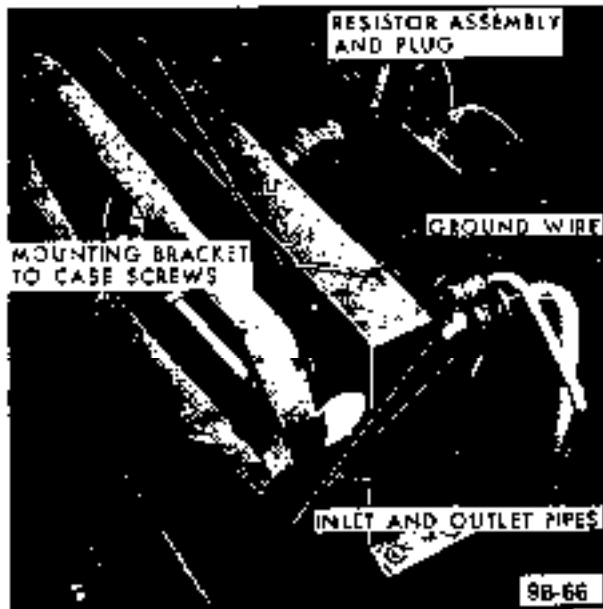


Figure 9B-203 Electrical Connections and Ground Wire

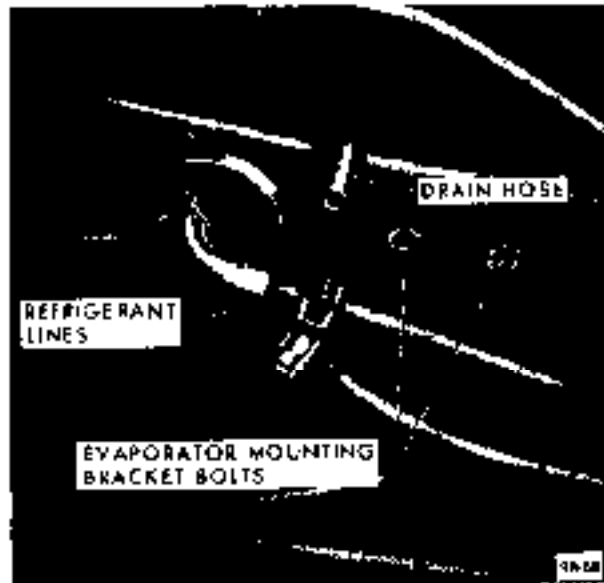


Figure 9B-205 Evaporator Mounting Bracket Bolts - Driver Side

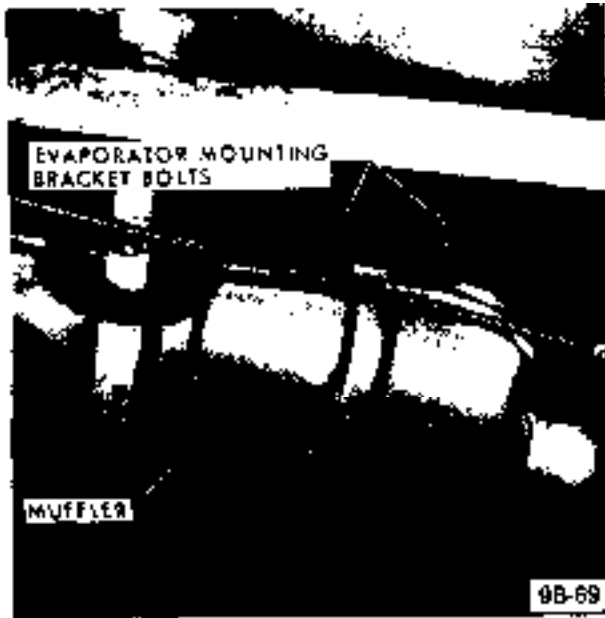


Figure 9B-206 Evaporator Mounting Bracket Bolts Passenger Side

8. Remove inlet and outlet pipes from evaporator and tape closed the refrigerant lines and also the open ends of the inlet and outlet pipes of the evaporator. See Figure 9B-208.

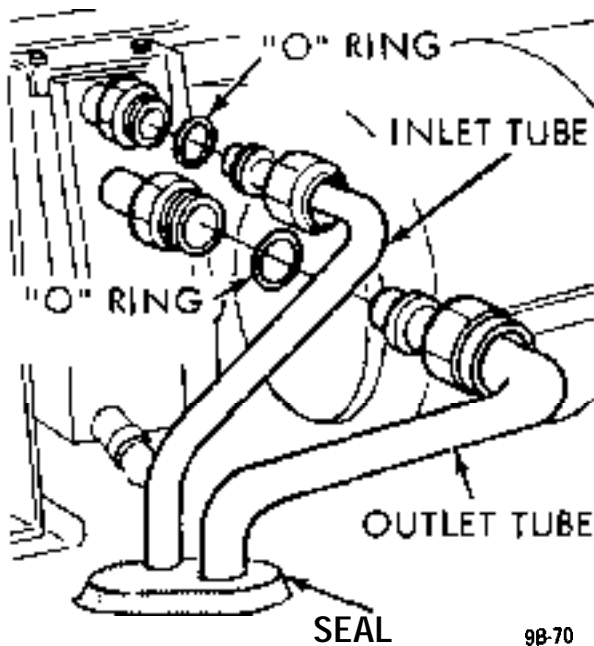


Figure 9B-208 Inlet and Outlet Pipes and O-Rings

9. Lift off the mounting bracket and remove the evaporator assembly from the car.

10. Remove the resistor assembly. See Figure 9B-203.

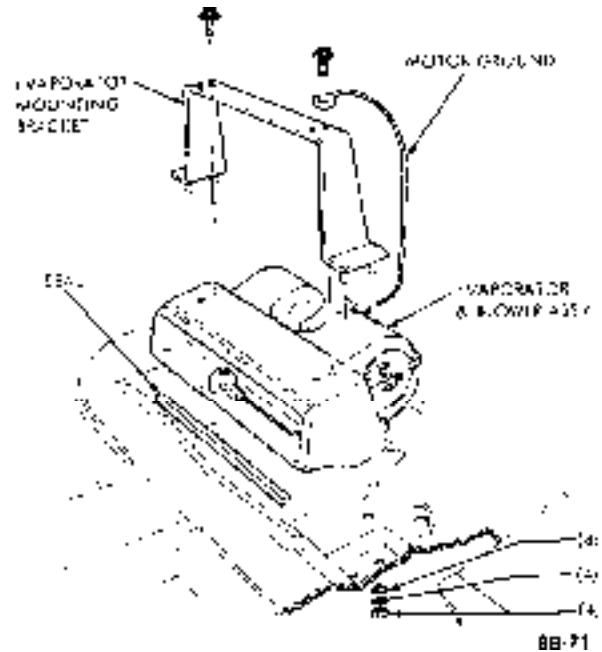


Figure 9B-209 Evaporator and Blower Assembly

11. Remove blower case and blower motor attaching screws and remove assembly.

**Installation**

1. Install blower motor assembly in the bracket with

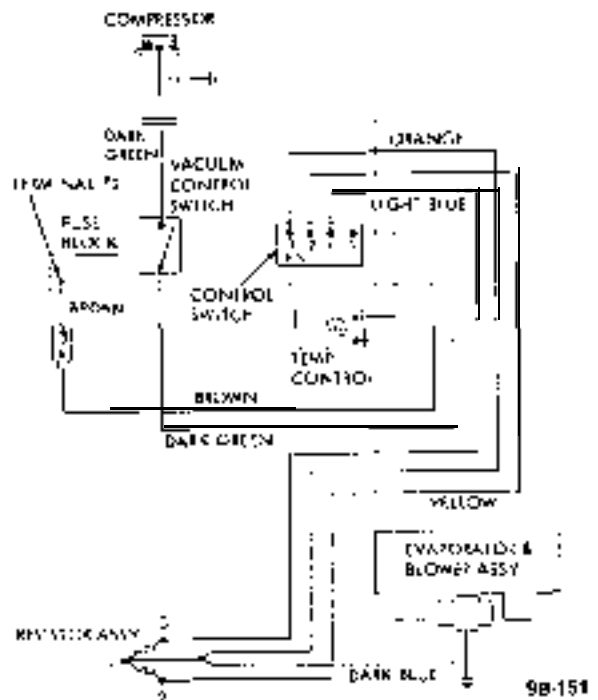


Figure 9B-210 Electrical Schematic

the electrical connector side of the motor to the right side of the bracket.

2. Assemble the fan housing case halves and attach the cover plate.
3. Install the resistor assembly.
4. Install the evaporator assembly into the car and install mounting bracket. See Figure 9B-209.
5. Untape the refrigerant lines and the inlet and outlet pipes from the evaporator and install using new o-rings on line fittings.
6. From under the car, install 4 nuts securing evaporator mounting bracket to floor. See Figures 9B-205 and 9B-206.
7. Evacuate system. Refer to EVACUATING SYSTEM in REFRIGERANT COMPONENTS Section.

8. While system is being evacuated:
9. Connect 2 drain hoses underneath the evaporator housing.
10. Plug in the resistor assembly electrical connector plug and connect the blower motor connection and install ground wire and 2 mounting bracket to case screws using the rearward holes. See Figure 9B-209.
11. Install the evaporator cover and all cover screws. See Figure 9B-202.
12. Install luggage tray and attaching screws. See Figure 9B-202.
13. Connect the negative battery cable.
14. Charge system. Refer to CHARGING SYSTEM in Refrigerant Components Section.

## **SPECIFICATIONS**

Blower Motor Type ..... 12 VDC  
Blower Fan Type ..... Squirrel Cage

# RADIO

## GT

### CONTENTS

Subject	Page No.
<b>DESCRIPTION AND OPERATION: (Not Applicable)</b>	
<b>DIAGNOSIS:</b>	
Radio Trouble Diagnosis .....	<b>9C-105</b>
<b>MAINTENANCE AND ADJUSTMENTS:</b>	
Antenna Trimmer Adjustment .....	<b>9C-106</b>
<b>MAJOR REPAIR:</b>	
Removing and Installing Radio .....	<b>9C-107</b>
<b>SPECIFICATIONS: (Not Applicable)</b>	

## DIAGNOSIS

### RADIO TROUBLE DIAGNOSIS

Because radio problems are most often repaired at United Delco authorized warranty repair stations, the tendency for many dealer servicemen is to remove the set when a problem is reported, without any preliminary diagnosis. This results in a large number of radios showing up as "NO TROUBLE FOUND" units when received by the warranty repair stations. This indicates that the trouble can often be corrected without removal of the radio.

The inconvenience to an owner of driving without a radio while his set is being serviced at a warranty station can frequently be avoided if the following quick checks are used to eliminate external radio system problems before removing the radio for repair.

Always determine from the owner the exact nature of the radio problem as an aid to diagnosis. Knowing whether the condition is intermittent or constant, whether it occurs with engine off or running, with car stationary or moving, will help to pinpoint the problem. Never turn on radio with speaker disconnected.

#### Radio Is Inoperative

1. Turn on the radio. The dial should light and a thump should be heard from the speaker.

a. If a thump is heard, go to Step No. 2 for antenna check.

b. If no thump is heard, check the fuse.

(1) If fuse is bad, replace and try radio again. Race engine and, if fuse blows again, remove the radio and speaker assembly for repair by a trained radio technician.

(2) If fuse is good, check to see that the speaker-to-receiver interconnecting cable is connected securely. If there is still no thump when the radio is turned on, remove the receiver and speaker for repair.

2. Check the antenna by substituting with one held out the car window.

a. If radio is still dead with substitute antenna, remove the receiver and speaker for repair.

b. If radio operates near normal with substitute antenna, some part of the car antenna or lead-in is at fault.

#### Radio Reception Is Weak

1. Check to see if antenna trimmer is peaked.

a. Position antenna at a height of 31 inches.

b. Tune radio to weak station at or near 1400 KHz on the dial, and turn volume control to maximum.

- c. Adjust trimmer screw for maximum volume.
  - d. If antenna trimmer does not have a definite peak, check for defective antenna by substitution.
2. Check that the speaker connection is plugged in securely.
  3. If the radio is still weak, remove the receiver and speaker assembly for repair.

### Radio Is Noisy

1. Radio is noisy all the time:
  - a. Check for defective antenna by striking antenna with hand. If static is heard while tapping, replace antenna.
  - b. If antenna is not defective, remove receiver and speaker for repair.
2. Radio is noisy only when jarred:
  - a. Check antenna as in Step No. 1 above.
  - b. Check speaker connection. If speaker connection is not at fault, remove receiver and speaker for repair.
3. Radio is noisy when engine is running:
  - a. Check noise suppressor by substituting on generator with known good one.
  - b. Check to see that antenna is mounted securely, grounding the antenna base to the fender. The antenna lead-in wire is shielded and the shield should have good ground connection at the receiver and the antenna base.
  - c. Check for other car wiring, passing too close to radio receiver case.
  - d. If engine noise is still present, remove receiver and speaker for repair.
4. Radio is noisy when car equipment is operated, such as directional lights or brake lights:

Check for defective antenna lead-in wire or, loose antenna mounting, as in Step No. 3b above.

## MAINTENANCE AND ADJUSTMENTS

### ANTENNA TRIMMER ADJUSTMENT

An antenna trimmer adjustment screw is provided for matching of the antenna coil in the receiver to the car

antenna. This adjustment must always be made after installation of a receiver or an antenna, or after repair to these units. This adjustment should also be performed whenever radio reception is unsatisfactory.

1. Position antenna to a height of 31 inches.
2. Tune receiver to a weak station at or near 1400 KHz that can barely be heard with volume turned fully up.
3. Insert a small-bladed screwdriver in antenna trim-



Figure 9C-1 Location of Access Trim Plug



Figure 9C-2 Removing Hex Head Screw

mer screw and rotate screw until maximum volume is achieved.

## MAJOR REPAIR

### REMOVING AND INSTALLING RADIO

#### Removal

1. Disconnect battery.
2. Remove access trim plug from right side of console. See Figure 9C-1.

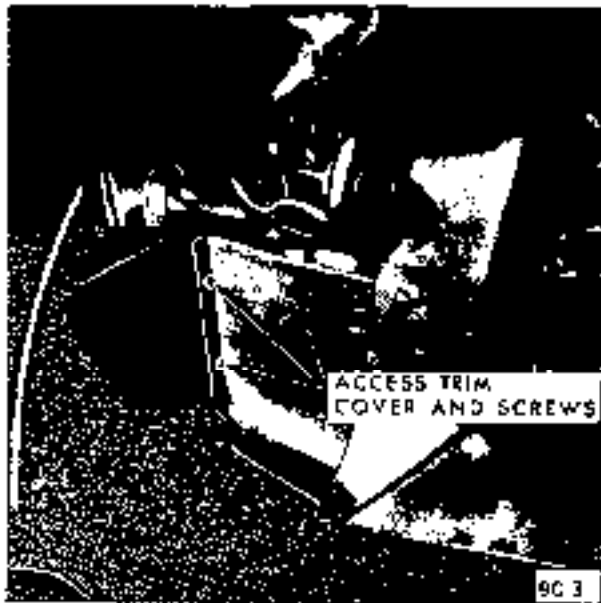


Figure 9C-3 Location of Access Trim Cover



Figure SC-4 Location of Hex Head Screw and Flasher Unit

3. Using a 8mm socket, remove hex head screw. See Figure 9C-2.

4. Remove access trim cover on left side of console. See Figure 9C-3.

5. Using a 4mm socket, remove hex head screw. See Figure 9C-4.

6. Remove tear lock bolts by first drilling a 3/16 inch pilot hole and, using a 1/4 inch bolt extractor, remove bolts. See Figure 9C-5.

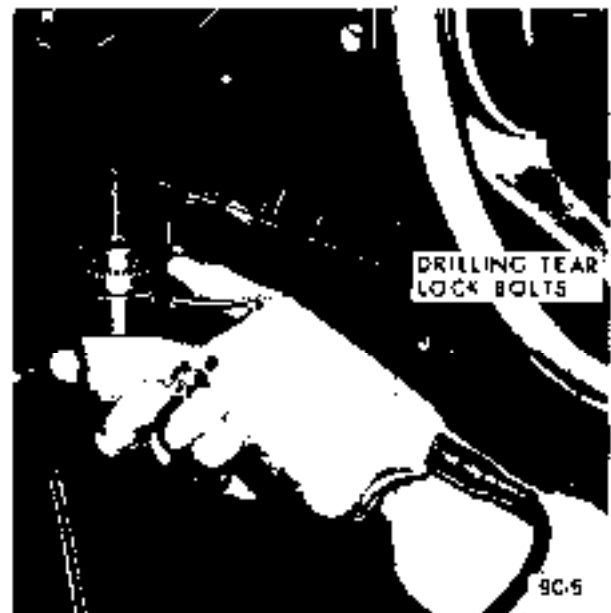


Figure 9C-5 Drilling Pilot Hole Into Tear Lock Bolts

7. Disconnect ignition (white) and direction signal (black) wire set plugs.

8. Support steering column assembly and remove both hex head bolts.

9. Disconnect speedometer cable.

10. Remove 6 instrument cluster retaining screws. See Figure 9C-6.



Figure SC-6 Removing Instrument Cluster Retaining screws

11. Grasp instrument cluster and pull straight **back**, being careful of wires, etc. See Figure 9C-7.



Figure 9C-7 Removing Instrument Cluster

12. Disconnect radio harness plug and antenna lead-in cable from back of radio. See Figure 9C-8.



Figure 9C-8 Removing Radio Harness Plug

13. Remove radio knobs from radio.

14. While supporting radio, remove radio shaft retaining nuts. Remove radio. See Figure 9C-10.

### Installation

**CAUTION:** Fasteners in Installation are important attaching parts in that they could affect the performance of vital components and systems, and/or could result in major repair expense. They must be replaced with one of the same part number or with an equivalent part, if replacement becomes necessary. Do not use a replacement part of lesser quality or substitute design. Torque values must be used as specified during reassembly to assure proper retention of these parts.



Figure 9C-10 Removing Radio Shaft Retaining Nuts

1. Install radio into instrument cluster and secure with retaining nuts. See Figure 9C-10.
2. Plug radio harness and lead-in cable into radio. See Figure 9C-8.
3. Install radio knobs and carefully push cluster back into instrument panel housing, making sure electrical wires, etc., are not pinched. See Figure 9C-7.
4. Install six (6) cluster retaining screws. See Figure 9C-6.
5. Support column assembly and install ground wire and hex head bolts, torquing to 14 lb.ft.
6. Install NEW tear bolts and tighten until head of bolt is twisted off.
7. Connect ignition and directional signal wire plugs.
8. Connect speedometer cable.
9. Install flasher unit and hex head screw. See Figure 9C-4.
10. Install hex head screw through opening on right side and install trim plug. See Figure 9C-2.
11. Install trim cover on left side. See Figure 9C-3.



# RADIO

## OPEL 1900 - MANTA

### CONTENTS

Subject	Page No.
<b>DESCRIPTION AND OPERATION: (Not Applicable)</b>	
<b>DIAGNOSIS:</b>	
Radio Trouble Diagnosis .....	<b>9C-109</b>
<b>MAINTENANCE AND ADJUSTMENTS:</b>	
Antenna Trimmer Adjustment .....	<b>9C-110</b>
<b>MAJOR REPAIR:</b>	
Removal & Installation Radio .....	<b>9C-111</b>
Removal & Installation Antenna .....	<b>9C-111</b>
<b>SPECIFICATIONS:</b>	

### DIAGNOSIS

#### RADIO TROUBLE DIAGNOSIS

**Because** radio problems are most often repaired at United Delco authorized warranty repair stations, the tendency for many dealer servicemen is to remove the set when a problem is reported, without any preliminary diagnosis. This results in a large number of radios showing up as "NO TROUBLE FOUND" units when received by the warranty repair stations. This indicates that the trouble can often time be corrected without removal of the radio.

The inconvenience to an owner of driving without a radio while his set is being serviced at a warranty station can frequently be avoided if the following quick checks are used to eliminate external radio system Problems **before** removing the radio for repair.

Always determine from the owner the exact nature of the radio problem as an aid to diagnosis. Knowing whether! the condition is intermittent or constant, **whether** it occurs with engine off or running, with car **stationary** or moving, will help to pinpoint the problem: Never turn on radio with speaker **disconnected**.

#### Radio Is Inoperative

1. Turn on the radio. The dial should light and a thump should be heard from the speaker.

a. If a thump is heard, go to Step No. 2 for antenna check.

b. If no thump is heard, check the fuse.

(1) If fuse is bad, replace and try radio again. Race engine and, if fuse blows again, remove the radio and speaker assembly for repair by a trained radio technician.

(2) If fuse is good, check to see that the speaker to receiver interconnecting cable is connected securely. If there is still no thump when the radio is turned on, remove the receiver and speak+ for repair.

2. Check the antenna **by** substituting with one held out the car window.

a. If radio is still dead with substitute antenna, remove the receiver and speaker for repair.

b. If radio operates near **normal** with **substitute antenna**, some part of the car antenna or lead-in is at fault.

#### Radio Reception Is Weak

1. Check to see if antenna trimmer is peaked.

a. Position antenna at a **height** of 31 inches.

b. Tune radio to weak station **at** or near 1400 KHz on the dial, and turn volume control to maximum.

- c. Adjust trimmer screw for maximum volume,
  - d. If antenna trimmer does not have a definite peak, check for defective antenna by substitution.
2. Check that the speaker connection is plugged in securely.
3. If the radio is still weak, remove the receiver and speaker assembly for repair.

**Radio Is Noisy**

1. Radio is noisy all the time:
- a. Check for defective antenna by striking antenna with hand. If static is heard while tapping, replace antenna.
  - b. If antenna is not defective, remove receiver and speaker for repair.
2. Radio is noisy only when jarred:
- a. Check antenna as in Step No. 1 above.
  - b. Check speaker connection. If speaker connection is not at fault, remove receiver and speaker for repair.
3. Radio is noisy when engine is running:
- a. Check noise suppressor by substituting on generator with known good one.
  - b. Check to see that antenna is mounted securely, grounding the antenna base to the fender. The antenna lead-in wire is shielded and the shield should have good ground connection at the receiver and the antenna base.
- c. Check for other car wiring passing too close to radio receiver case.
- d. If engine noise is still present, remove receiver and speaker for repair.
4. Radio is noisy when car equipment is operated, such as directional lights or brake lights:

Check for defective antenna lead-in wire or loose antenna mounting, as in Step No. 3b above.

5. Radio is noisy only on dry days when car is moving:

Wheel and tire static will occur only during dry weather. To check to see if noise is wheel static or tire static, drive car until noise is noticed. Touch the brake. If noise disappears, it is wheel static. If noise persists, it is tire static. Static may be eliminated in two ways:

a. Wheel static may be eliminated by installation of static collectors in the front wheels. It is important to make sure the button on the end of the spiral collector rides evenly in the spindle. Grease and dirt can cause poor contact between static collector and the cap, which would result in wheel static, even with the collectors installed.

b. Tire static is eliminated by injecting graphite tire static powder in all five (5) tires. Either a special gun or a plastic squeeze bottle can be used to insert powder.

**MAINTENANCE AND ADJUSTMENTS**

**ANTENNA TRIMMER ADJUSTMENT**

An antenna trimmer adjustment screw is provided for matching of the antenna coil in the receiver to the car antenna. This adjustment must always be made after installation of a receiver or an antenna, or after repair to these units. This adjustment should also be performed whenever radio reception is unsatisfactory.

- 1. Position antenna to a height of 31 inches.
- 2. Tune receiver to a weak station at or near 1400 KHz that can barely be heard with volume turned fully up.
- 3. Insert a small-bladed screwdriver in antenna trimmer screw and rotate screw until maximum volume is achieved.



Figure 9C-15 Radio Control Knobs

## MAJOR REPAIR

### REMOVING AND INSTALLING RADIO

#### Removal

1. Remove control knobs and ornamental cover plate. See Figure 9C-15.
2. Unscrew two (2) hex. nuts behind and remove ornamental cover plate.
3. Unscrew support bracket from back of radio housing and air distribution housing. See Figure 9C-16.



Figure 9C-16 Support Bracket

4. Remove radio.

#### Installation

1. Install in reverse sequence to removal.
2. Trim radio.

### REMOVAL AND INSTALLATION OF ANTENNA

#### Removal

1. Pull antenna cable out of radio socket.
2. Pull rubber grommet and antenna cable out of cowl panel. See Figure 9C-17.
3. Unscrew antenna from fender.

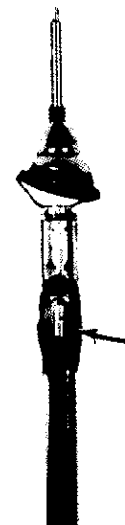
#### Installation

1. Install in reverse sequence to removal.



Figure 9C-17 Antenna and Cable - Under Fender

2. Seal antenna lead-in to antenna mast area with silastic sealer or equivalent. See Figure 9C-18.

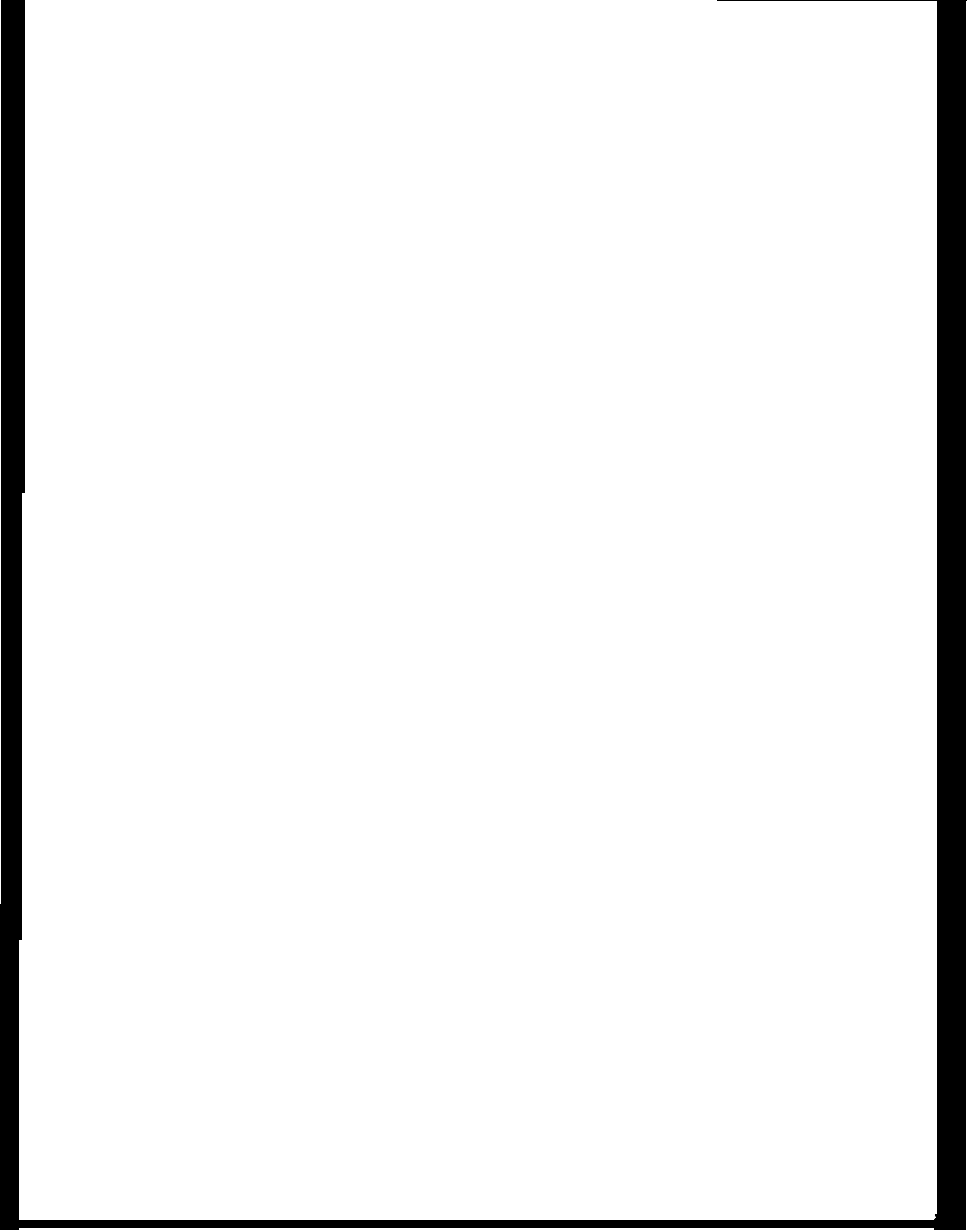


OPEL RADIO ANTENNA  
SEALING PROCEDURE

9C-13

Figure 9C-18 Sealing Antenna Lead-in to Antenna Mast

3. Clean antenna contacting area at fender underside to a bright surface.
4. After installation of antenna, protect fender against corrosion by spraying with a rustproof paint or similar product.
5. Trim radio.



# INDEX

Subject	Page Number	Subject	Page Number
<b>A</b>			
Air Conditioning		Bolt Torque Specifications	
Refrigerant Components .....	9B-17	Engine .....	6A-27
Opel 1900 & Manta-In Car Components .....	9B-90	Transmission, Manual .....	7B-33
GT-In Car Components .....	9B-97	3 Speed Automatic .....	7C-136
Alignment		Clutch .....	7A-7
Opel 1900 & Manta .....	3C-22	Body .....	2A-4
GT-Opel .....	3C-22	Brakes	
Alternator		Brake Drum, Shoes & Linings .....	5C-28
Description .....	1D-28	Hydraulic Wheel Cylinder .....	5C-30
Specifications. ....	1 D-35	Hydraulic Master Cylinder .....	5A-2
Overhaul K-I .....	1D-30	Parking Brake Cables .....	5C-33
Removal & Installation .....	1D-30	Standard Brakes .....	5C-22
Testing .....	1D-29	Disc Brakes .....	5B-10
Wiring Diagrams		Brake Booster and Vacuum Control Valve .....	5A-5
Manta .....	1 J-105	Bumpers, Front and Rear .....	2H-33
Opel 1900 .....	1J-103		
GT .....	1J-107	<b>C</b>	
AM Radio-GT .....	9C-105	Camshaft, 1.9L Engine .....	6A-25
AM Radio-Opel 1900 & Manta .....	9C-109	Car Model Identification .....	0A-1
Antenna, Installation .....	9C-111	Carburetor .....	6E-44
Antenna Trimmer .....	9C-110	Trouble Diagnosis .....	6E-49
Assembly of Transmission from Major Units		Description .....	6E-44
Manual .....	7B-23	Overhaul .....	6E-53
3 Speed Automatic .....	7C-103	Adjust .....	6E-50
Axle, Rear, Disassembly .....	4B-11	Removal & Installation .....	6E-52
		Specifications .....	6E-58
<b>B</b>			
Balance, Wheel and Tire .....	3G-62	Charging System	
Ball Joint Upper .....	3A-7	Description .....	1 D-28
Lower .....	3A-7	Specifications. ....	1D-35
Battery		Testing .....	1D-29
Specifications .....	1A-9	Wiring Diagrams	
Testing .....	1A-6	Manta .....	1J-105
Charging .....	1A-9	Opel 1900 .....	1J-103
Trouble Diagnosis .....	1A-4	GT .....	1J-107
Battery Test 421 .....	1A-6	Chart Lubrication .....	0C-5
Belt Tensions .....	6B-33	Chassis Springs, Front. ....	3A-15
Blower and Air Inlet Assembly,		Clutch, Second-Automatic Transmission .....	7C-103
Removal and Installation		Clutch Adjustment .....	7A-4
Opel 1900 & Manta .....	9A-15	Control Arm Front	
GT .....	9A-5	Upper .....	3A-10
Body		Lower .....	3A-11
Name Plate .....	0A-1	Converter Checking Procedure .....	7C-125
Style Numbers .....	0A-2	Coolant Flow .....	6B-32
Windows and Weatherstrips .....	2C-9	4 Speed Manual Transmission .....	7B-12
Doors .....	2D-13	Cranking System. See Starting System	
Interior Trim and Headlining .....	2G-33	Crankshaft .....	6A-16
Seats .....	2G-33	Cylinder Head .....	6A-12
Roof&d Sunroof-Opel 1900 & Manta .....	2F.24		
		<b>D</b>	
		Description	
		3-Speed Automatic .....	7C-37

Subject	Page Number
4-Speed Manual	7B-12
Clutch	7A-1
Detent Cable Adjustment	7C-91
Differential	4B-7
Directional Signal Switch	
Repair Opel 1900 & Manta	3E-39
Repair GT	3E-48
Disassembly of 4-Speed Manual Transmission	7B-23
Distributor	
Specifications	1C-26
Point Replacement	1C-20
<b>E</b>	
Electrically Heated Rear Window	1H-57
Engine	
General Description	6A-2
Cooling System	6B-32
Lubrication System	6A-4
Trouble Diagnosis	6A-6
Exhaust Manifold	6A-12
Exhaust System	
Removal and Installation	6D-42
External Oil Leaks,	
Opel 3 Speed Automatic	7C-81
<b>F</b>	
Fast Idle Adjustment	6E-51
Filter-Engine Oil	oc-7
Fluid Checking Procedure Transmission	
Opel 3-Speed Automatic	7C-81
Frame-Opel 1900 & Manta	2B-8
Frame GT-Opel	2B-7
Servo	
Opel 3-Speed Automatic	7C-100
Front Suspension	
Opel 1900 & Manta	3A-2
GT	3A-2
Front Wheel Alignment	3C-22
Front Wheel Bearing Adjustment	
All Series	3A-4
Fuel Gauge	
Trouble Diagnosis	
Opel 1900 & Manta	11-65
GT	11-67
Fuel Pump Operation	6C-36
Fuel System	
Fuel Tank (Opel 1900 & Manta)	6C-39
Fuel Lines (Opel 1900 & Manta)	6C-41
Fuel Tank (GT)	6C-39
Fuel Gauge Tank Unit (GT)	6C-41
Fuel Lines (GT)	6C-41
Fuel Tank Removal and Installation	6C-39
Cleaning Tank	6C-41

Subject	Page Number
Function of Valves and Hydraulic Control Units	
Opel 3-Speed Automatic	74-21
Fuse Chart	1G-56
Fusible Link	1A-8
<b>G</b>	
Gas Tank See Fuel Tank	
General Specifications	
Engine	6A-28
Opel 3-Speed Automatic	7C-134
Transmission, Manual,	7B-33
Clutch	7A-7
Body	2A-4
Governor Drive Gear	
Opel 3-Speed Automatic	7C-103
Grille	
Opel 1900 & Manta	8A-7
GT	8A-6
<b>H</b>	
Hazard Warning Flasher	1G-55
Headlamp Aiming	1F-46
Headlamp Switch	
Opel 190.0 & Manta	1F-46
Headlamp Mechanism GT	8A-2
Heater System Opel 1900 & Manta	
Trouble Diagnosis	9A-11
Description and Operation	9A-10
Adjustments and Minor Service	9A-12
Removal and Installation	9A-12
Specifications	9A-16
Heater System GT	
Trouble Diagnosis	9A-4
Description and Operation	9A-2
Adjustments and Minor Service	9A-4
Removal and Installation	9A-5
Specifications	9A-9
Horn	
Operation	1G-54
Hydraulic Operation	
Opel 3-Speed Automatic	7C-64
<b>I</b>	
Identification Number Vehicle	0A-1
Idle Adjustment	6E-51
Inflation Pressures, Tires	3G-62
Ignition Coil	
Specifications	1C-26
Identification, Engine	0A-1
Ignition System	
Timing	1C-20
Instrument Panel Parts Removal	

Subject	Page Number
Opel 1900 & Manta .....	1H-59
GT .....	1H-63
Intake Manifold, 1.9L Engine .....	6A-12

### J

Joint, Ball	
Upper .....	3A-7
Lower .....	3A-7

### K

Keys and Locks .....	0A-1
----------------------	------

### L

Low Servo Cover .....	7C-100
Lubrication	
Engine Oil Change Interval .....	0C-7
Oil Viscosity Chart .....	0C-7
Fluid Capacities .....	0C-5
Lubrication System, Engine .....	6A-4

### M

Mainshaft Assembly 4-Speed	
Manual Transmission .....	7B-26
Manifold	
Intake .....	6A-12
Exhaust .....	6A-12
Master Cylinder, Brake .....	5A-2
Model Designation (Body Style) .....	0A-2
Mountings, Engine, GT .....	2B-6
Opel 1900 & Manta .....	2B-6

### O

Oil Change Interval .....	0C-7
Oil Filter, Engine .....	0C-7
Oil Flow Circuits, Automatic Transmission .....	7C-64
Oil Pan, Engine .....	6A-10
Oil Pump, Engine .....	6A-26
Oil Pump, Transmission .....	7C-103
Oil Recommendations, Engine .....	0C-7
Oil Strainer-Transmission .....	7C-99
Oil Viscosity Chart .....	0C-7
Opel Emission Control System (OECS)	
Specifications .....	6F-64
Service Procedures .....	6F-63
Trouble Diagnosis .....	6F-62

### P

Parking Brake .....	5C-33
Piston, Pin Rings .....	6A-19
Planetary Gear Set .....	7C-118
Power Unit Brake .....	5A-5
Propeller Shaft .....	4A-2
Pump, Oil Engine .....	6A-26

Subject	Page Number
---------	-------------

### R

Radiator	
Radiator All Models .....	6B-32
Radio	
Antenna Trimmer Adjustment GT .....	9C-1 06
Antenna Trimmer Adjustment	
Opel 1900 & Manta .....	9C-1 10
Removal and Installation Opel	
1900 & Manta .....	9C-1 11
Removal and Installation GT .....	9C-107
Trouble Diagnosis GT .....	9C-105
Trouble Diagnosis - Opel 1900 & Manta .....	9C-109
Reverse Clutch .....	7C-103
Rings, Piston, 1.9L Engine .....	6A-19
Rocker Arm Assembly, 1.9L Engine..	6A-12

### S

Sequence for Transmission Diagnosis .....	7C-81
Service Procedures Clutch .....	7A-5
Shift Linkage Adjustments	
4-Speed Manual .....	7B-19
3-Speed Automatic .....	7C-93
Shock Absorber, Rear	
All Series .....	3F-51
Spark Plug	
Specifications .....	6G-68
Clean & Adjust. ....	1C-22
Installation .....	1C-22
Wires .....	1C-21
Specifications	
Engine .....	6A-27
Front Wheel Alignment .....	3C-22
Speedometer Installation	
Opel 1900 & Manta .....	1I-68
GT .....	1I-70
Spring	
Rear Suspension	
All Series .....	3F-52
Front Suspension	
Opel 1900 & Manta .....	3A-16
GTO Opel .....	3A15
Starting Motor	
Description .....	1E-1 0
Specifications .....	1B-1 7
Repairs .....	1B-13
Removal .....	1B-1 3
Steering Columns	
Service Procedures -Opel 1900 &Manta ....	3E-36
Service Procedures - GT .....	3E-44
Steering Gear Adjustment. ....	3D-27
Steering Gear Disassembly and Reassembly .....	3D-30
Steering Gear Removal and Install&ion .....	3D-28
Steering Linkage .....	3B-19
Suspension	
Front .....	3A-2
Rear .....	3F-51

Subject Page Number

Subject Page Number

T

Throttle Linkage Adjustment ..... 6E-51  
 Timing Chain Cover ..... 6A-23  
 Timing Chain and Sprocket ..... 6A-23  
 Tires ..... 3G-55  
 Inflation ..... 3G-62  
 Rotation ..... 3G-57  
 Sizes. .... 3G-62  
 Track Rod ..... 3F-53  
 Transmission Oil Pan  
 Automatic Transmission ..... 7C-99  
 Transmission Reassembly  
 4 Speed Manual. 1.9 ..... 7B-28  
 Transmission Removal and Installation  
 4 Speed Manual  
 Removal ..... 7B-22  
 Installation ..... 76-22  
 Auto & tic ..... 7C-94  
 Tune Up Procedure ..... 6G-65  
 Torque Specifications. Engine ..... 6A-27  
 Turn Signal See Directional Signal

U

Universal Joints ..... 4A-3

V

Vacuum Modulator... 7C-101  
 Valve Body Transmissior 7C-99  
 Valve and Seat Reconditioning Engine 6A-12

W

Water Pump Engine  
 1.9L Engine 6B-34  
 Wheels 3G-55  
 Wheel Alignment 3C-22  
 Wheel Bearing, Adjustment, 3A-4  
 Windshield Wiper and Washer:  
 Trouble Diagnosis 1 E-37  
 Description and Operation 1 E-37  
 Removal and Installation 1 E-38  
 Specifications 1 E-43  
 Wiring Diagrams Complete  
 Opel 1900 ... 1 J-I 03  
 Maintenance 1 J-I 05  
 G T 1J-107



# Credits

Opel enthusiasts worldwide would like to thank General Motors Corporation for granting permission to reproduce electronically the contents of the 1973 Opel Shop Manual.	
<a href="#"><u>Wayne Torman</u></a>	Sacrificed his near mint 1973 Shop Manual for the project
<a href="#"><u>Mark Wootton</u></a>	Scanning and conversion to PDF
<a href="#"><u>Senen Racki</u></a>	Hyperlinks, bookmarks, and touch-ups