

HANDBOOK



PEUGEOT 508





# On-line handbook

Select one of the following means of access to view your handbook on-line...

This personal space offers advice and other useful information for the care and maintenance of your vehicle.

Find your handbook on the Peugeot Ot website, under "MyPeugeot Ot".

Scan this code for direct access to your handbook.



If the "MyPeugeot Ot" function is not available on the Peugeot Ot public website for your country, you can find your handbook at the following address:

<http://public.servicebox.peugeot.com/ddb/>

Select:

- > the language,
- > the vehicle, its body style,
- > the print edition of your handbook appropriate for the date of registration of your vehicle.

Referring to the handbook on-line also gives you access to the latest information available, easily identified by the bookmark, associated with this symbol:



# Welcome

## Thank you for choosing a 508, a symbol of confidence, passion and inspiration

This handbook has been designed to help to make the most of your 508 in all circumstances and in complete safety.

Take the time to read through it so as to familiarise yourself with your vehicle.

This handbook covers all of the variations in equipment available across the whole 508 range.

Your vehicle will be fitted with only some of the equipment described in this document, depending on its trim level, version and the specification for the country in which it was sold.

The descriptions and illustrations are given as indications only. Automobiles Peugeot reserves the right to modify the technical characteristics, equipment and accessories without having to update this edition of the handbook.

This document forms an integral part of your vehicle. Remember to pass it on to the new owner in the event of the sale of the vehicle.

## Key

### Warning:

This symbol marks warnings which it is essential to observe for your own safety, for the safety of others or to avoid any risk of damaging your vehicle.

### Protection of the environment:

This symbol accompanies advice relating to protection of the environment.

For any work on your vehicle, use a qualified workshop that has the technical information, competence and equipment required, which a Peugeot dealer is able to provide.



### We draw your attention to the following points:

- The fitting of electrical equipment or accessories not listed by Peugeot may cause faults and failures with the electrical system of your vehicle. Contact a Peugeot dealer or a qualified workshop for information on the range of recommended accessories.
- Any modification or adaptation not intended or authorised by Automobiles Peugeot or carried out without meeting the technical requirements defined by the manufacturer would lead to the suspension of the new vehicle warranty.

### Information:

This symbol draws your attention to additional information for better use of your vehicle.

### Page reference:

This symbol invites you to refer to the pages which provide details of the function.

<p>Overview</p>	<p>Access</p>	<p>Driving</p>
<p>eco-driving</p>	<p>2</p>	<p>4</p>
<p>Monitoring</p>	<p>Access</p>	<p>Driving</p>
<p>Instrument panel 12</p> <p>Indicator and warning lamps 14</p> <p>Gauges and indicators 26</p> <p>Trip computer 31</p> <p>Touch screen 35</p> <p>Setting the date and time 39</p>	<p>Remote control key 41</p> <p>Alarm 52</p> <p>electric windows 54</p> <p>Boot 56</p> <p>Motorised tailgate (SW) 57</p> <p>Sunroof 60</p> <p>Panoramic sunroof (SW) 62</p> <p>Fuel tank 63</p> <p>Diesel misfuel prevention 64</p>	<p>Starting-switching off the engine 100</p> <p>electric parking brake 103</p> <p>Manual parking brake 109</p> <p>Manual gearbox 110</p> <p>gear shift indicator 111</p> <p>Automatic gearbox 112</p> <p>electronic gearbox 116</p> <p>Stop &amp; Start 120</p> <p>Hill start assist 123</p> <p>Head-up display 124</p> <p>Blind spot sensors 126</p> <p>Speed limiter 130</p> <p>Cruise control 132</p> <p>Parking sensors 134</p> <p>Reversing camera 137</p>
<p>Front seats 66</p> <p>Rear seats 71</p> <p>Mirrors 73</p> <p>Steering wheel adjustment 75</p> <p>Interior fittings 76</p> <p>Boot fittings (Saloon) 79</p> <p>Boot fittings (SW) 80</p> <p>Heating and Ventilation 84</p> <p>Manual air conditioning 87</p> <p>Dual-zone digital air conditioning 89</p> <p>Quad-zone digital air conditioning 92</p> <p>Switching off the air conditioning may result in some discomfort (humidity, misting). 93</p> <p>Front demist - defrost 97</p> <p>Rear screen demist - defrost 97</p> <p>Programmable Heating / Ventilation 98</p>	<p>Comfort</p>	<p>Visibility</p>
	<p>3</p>	<p>5</p>
		<p>Lighting controls 138</p> <p>Automatic illumination of headlamps 143</p> <p>Headlamp adjustment 146</p> <p>Additional headlamps 147</p> <p>Wiper controls 149</p> <p>Automatic rain sensitive wipers 151</p> <p>Courtesy lamps 153</p> <p>Interior mood lighting 154</p>

## Child safety

**6**

Child seats	155
Deactivating the passenger's front airbag	158
ISOFIX child seats	164
Child lock	170

## Safety

**7**

Direction indicators	171
Emergency or assistance call	172
Horn	172
Warning triangle	173
Tyre under-inflation detection	174
eSC system	176
Seat belts	179
Airbags	182

## Practical information

**8**

Temporary puncture repair kit	186
Changing a wheel	192
Snow chains	199
Changing a bulb	200
Changing a fuse	207
12 V battery	211
Removing - refitting the battery	215
Energy economy mode	219
Changing a wiper blade	220
Towing the vehicle	221
Towing a trailer	223
Fitting roof bars	225
Very cold climate screen	226
Accessories	227

## Checks

**9**

Opening the bonnet	230
Running out of fuel (Diesel)	231
Petrol engines	232
Diesel engines	234
BlueHDi Diesel engines	236
Checking levels	237
Checks	240
AdBlue <sup>®</sup> additive and SCR system (BlueHDi Diesel)	242

## Technical data

**10**

Petrol engines	250
Petrol weights	252
Diesel engines	254
Diesel weights	258
Dimensions	262
Identification markings	264

## Audio equipment and telematics

Emergency or assistance	265
JBL equipment	267
7-inch touch screen	269
Audio system	341

## Visual search

## Alphabetical index

## exterior

### Electronic key: Keyless Entry and Starting

This system allows you to unlock, lock and start your vehicle while keeping the key on your person and in the recognition zone around the vehicle.

▶ 44, 101



### Stop & Start

This system puts the engine temporarily into standby during stops in the traffic (red lights, traffic jams, etc...). The engine restarts automatically as soon as you want to move off. The Stop & Start system reduces fuel consumption and exhaust emissions, and offers the comfort of complete silence when stationary.

▶ 120



### Panoramic sunroof (SW)

The glass roof makes the passenger compartment brighter and is fitted with an electric blind.

▶ 62

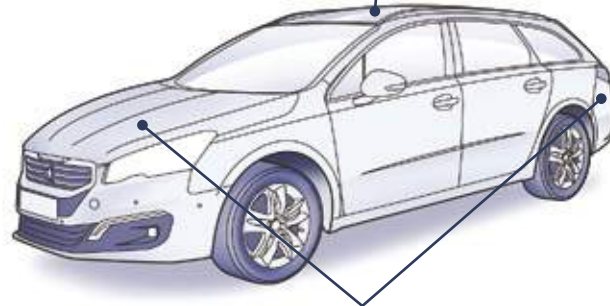

### AdBlue® additive (BlueHDi Diesel engines)

This system uses a catalytic converter which turns up to 85% of nitrous oxides (NOx) into nitrogen and water, harmless to health and the environment.

The AdBlue® additive is held in a tank located under the boot at the rear of the vehicle.

Its capacity is 17 litres, which gives a driving range of approximately 12 000 miles (20 000 km).

▶ 242

## exterior

### Front and rear parking sensors

This system provides a warning when manoeuvring forwards and backwards by detecting obstacles located in front of or behind the vehicle.

▶ 134

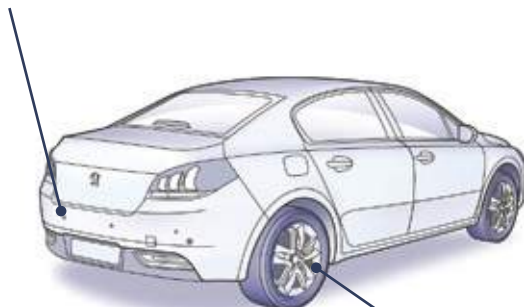

### Motorised tailgate (SW)

This system provides motorised opening and closing of the tailgate, by pressing a button.

▶ 57



### Temporary puncture repair kit

This kit is a complete system consisting of a compressor and a sealant cartridge, to allow the temporary repair of a tyre.

▶ 186

# Interior

## Head-up display

This system projects speed and cruise control/speed limiter information onto a smoked strip in the driver's field of vision, so that they do not need to take their eyes off the road.

▶ 124

## Interior mood lighting

This subdued passenger compartment lighting improves visibility inside the vehicle in low lighting conditions.

▶ 154

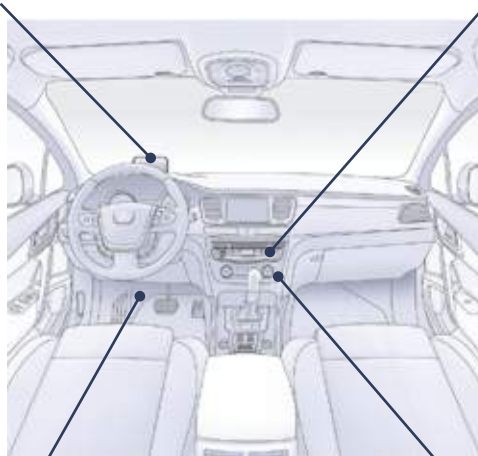

## Audio and communication systems

These systems benefit from the latest technology: MP3 compatible audio systems, USB player, Bluetooth hands-free system, satellite navigation system with colour screen, auxiliary inputs, Hi-Fi audio system, ...

### Touch screen

▶ 269

### Audio system

▶ 341



If your vehicle is fitted with a JBL Hi-Fi audio system, this is designed specifically for the passenger compartment of your vehicle.

Refer to the "Audio and telematics" section.

## Digital air conditioning

After setting the desired level of comfort, the system then automatically controls this level according to the ambient conditions.

### Manual

▶ 87

### Dual-zone

▶ 89

### Quad-zone

▶ 92



## Switch panels\*



Lighting of the indicator lamp indicates the state of the corresponding function.



Massage.

▶ 70



Adaptive lighting.

▶ 144



Alarm.

▶ 52



Blind spot monitoring.

▶ 126



electric parking brake.

▶ 103



Starting/stopping using the electronic key.

▶ 101



Opening the boot.

▶ 44, 56, 57



Opening the fuel filler flap.

▶ 63



Deactivation of the DSC/ASR system.

▶ 178



electric child lock.

▶ 170



Programmable heating warning lamp.

▶ 98



Deactivation of parking sensors.

▶ 135



Deactivation of Stop & Start.

▶ 122



Head-up display  
(on/off, settings).

▶ 124

\* Depending on version.

## Instruments and controls

1. Cruise control / speed limiter controls.
2. Headlamp height adjustment.
3. Lighting and direction indicator stalk
4. Instrument panel.
5. Driver's airbag.  
Horn.
6. Gear lever.
7. 12 V accessory socket  
USB port / auxiliary socket.
8. Bonnet release lever.
9. Fusebox.
10. Front door window demisting/defrosting vent.
11. Windscreen demisting/defrosting vent.
12. Steering lock and starting with the key.
13. Starting using the electronic key.
14. Audio equipment steering wheel controls.
15. Wiper / screenwash / trip computer stalk.
16. Central locking and hazard warning buttons.
17. touch screen (depending on version).
18. Central adjustable air vents.
19. Passenger's airbag.
20. Side adjustable air vents.
21. Glove box / Passenger's airbag deactivation.
22. electric parking brake.
23. Central armrest with storage.
24. Storage.
25. Audio system.
26. Heating / air conditioning controls.

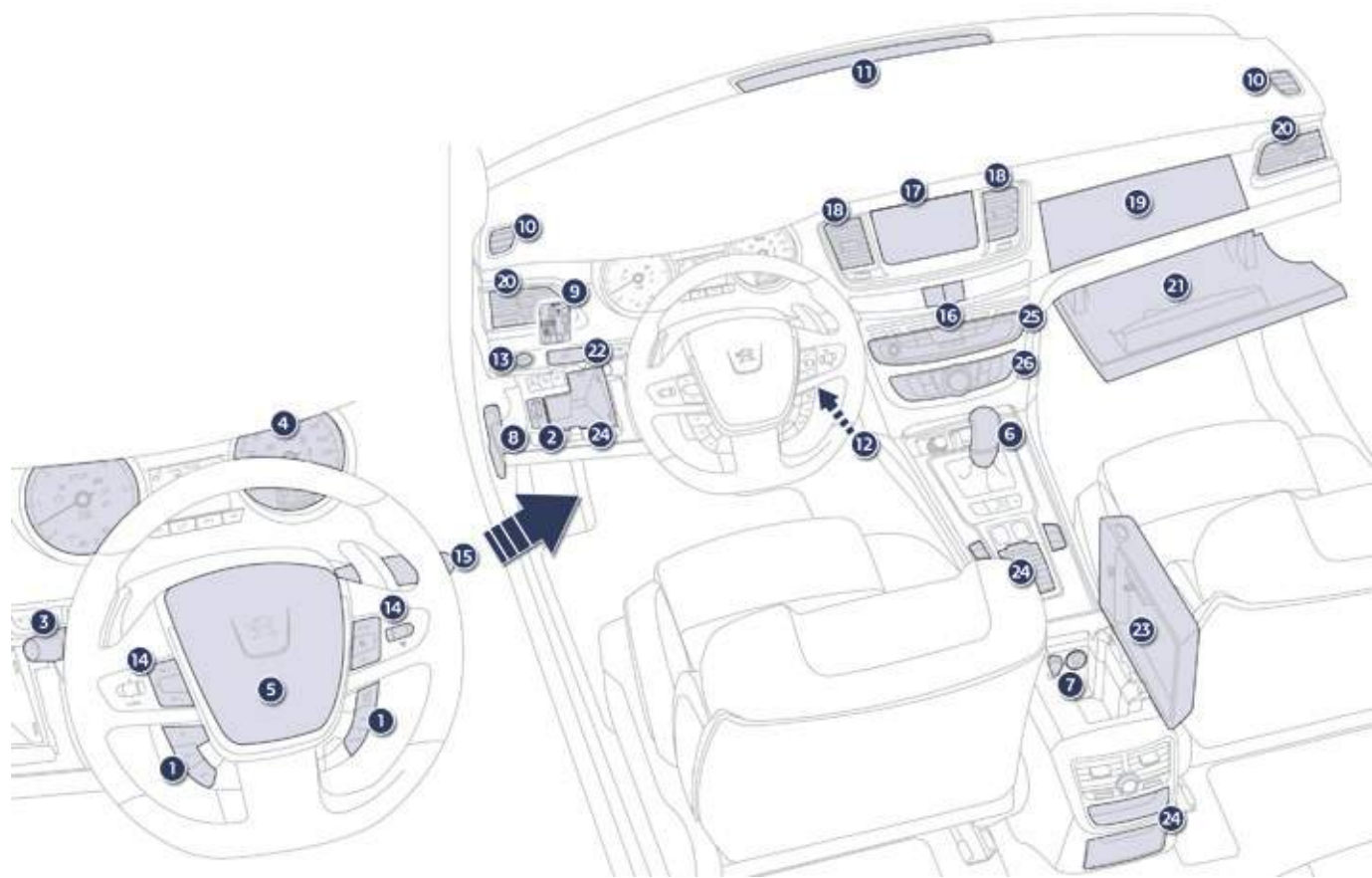

## eco-driving

eco-driving is a range of everyday practices that allow the motorist to optimise their fuel consumption and CO<sub>2</sub> emissions.

### Optimise the use of your gearbox

With a manual gearbox, move off gently and change up without waiting. During acceleration change up early.

With an automatic or electronic gearbox, give preference to automatic mode and avoid pressing the accelerator pedal heavily or suddenly.

The gear shift indicator invites you to engage the most suitable gear: as soon as the indication is displayed in the instrument panel, follow it straight away.

For vehicles fitted with an electronic or automatic gearbox, this indicator appears only in manual mode.

### Drive smoothly

Maintain a safe distance between vehicles, use engine braking rather than the brake pedal, and press the accelerator progressively. These practices contribute towards a reduction in fuel consumption and CO<sub>2</sub> emissions and also help to reduce background traffic noise.

If your vehicle has cruise control, make use of the system at speeds above 25 mph (40 km/h) when the traffic is flowing well.

### Control the use of your electrical equipment

Before moving off, if the passenger compartment is too warm, ventilate it by opening the windows and air vents before using the air conditioning. Above 30 mph (50 km/h), close the windows and leave the air vents open.

Remember to make use of equipment that can help keep the temperature in the passenger compartment down (sunroof and window blinds...).

Switch off the air conditioning, unless it has automatic regulation, as soon as the desired temperature is attained.

Switch off the demisting and defrosting controls, if not automatic.

Switch off the heated seat as soon as possible.

Switch off the headlamps and front foglamps when the level of light does not require their use.

Avoid running the engine before moving off, particularly in winter; your vehicle will warm up much faster while driving.

As a passenger, if you avoid connecting your multimedia devices (film, music, video game...), you will contribute towards limiting the consumption of electrical energy, and so of fuel.

Disconnect your portable devices before leaving the vehicle.

## Limit the causes of excess consumption

Spread loads throughout the vehicle; place the heaviest items in the bottom of the boot, as close as possible to the rear seats.

Limit the loads carried in the vehicle and reduce wind resistance (roof bars, roof rack, bicycle carrier, trailer...). Use a roof box in preference. Remove roof bars and roof racks after use.

At the end of winter, remove snow tyres and refit your summer tyres.

## Observe the recommendations on maintenance

Check the tyre pressures regularly, when cold, referring to the label in the door aperture, driver's side.

Carry out this check in particular:

- before a long journey,
- at each change of season,
- after a long period out of use.

Don't forget the spare wheel and the tyres on any trailer or caravan.

Have your vehicle serviced regularly (engine oil, oil filter, air filter, passenger compartment filter...) and observe the schedule of operations recommended in the warranty and maintenance record.

When refuelling, do not continue after the third cut-off of the nozzle to avoid any overflow.

At the wheel of your new vehicle, it is only after the first 1 800 miles (3 000 kilometres) that you will see the fuel consumption settle down to a consistent average.

# Instrument panel

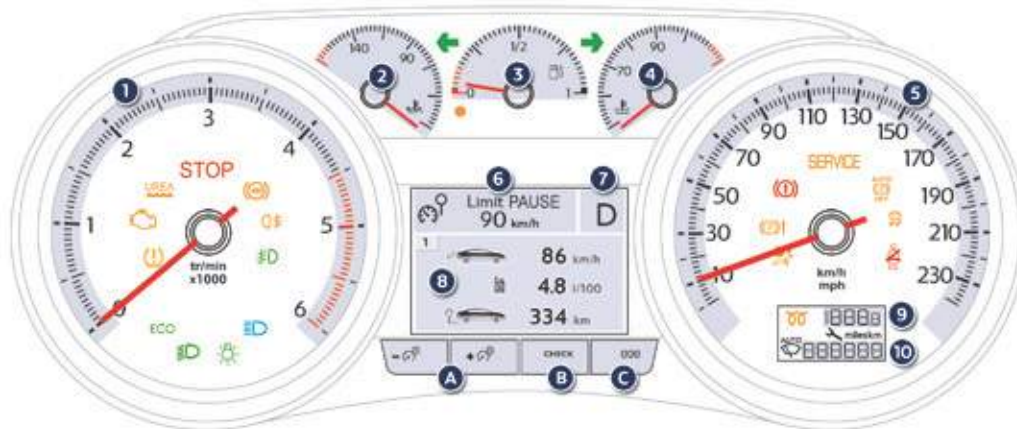

## Dials and screens

1. Rev counter (x 1 000 tr/min or rpm), graduation according to engine (petrol or Diesel).
2. engine oil temperature gauge.
3. Fuel gauge.
4. engine coolant temperature gauge.
5. Speedometer (mph or km/h).
6. Cruise control or speed limiter settings.
7. gear shift indicator for a manual gearbox or gear lever position and gear for an electronic or automatic gearbox.

8. Display zone: alert messages or state of functions, trip computer.
9. trip distance recorder (miles or km).
10. Automatic wipers  
Service indicator (miles or km) then, total distance recorder.  
These two functions are displayed successively when switching on the ignition.

## Control buttons

- A. Main lighting dimmer.
- B. Display of alert log.  
Recall of information:
  - on servicing,
  - on driving range for the emissions control additive (AdBlue®).
- C. Reset the trip distance recorder.

## Instrument panel screen

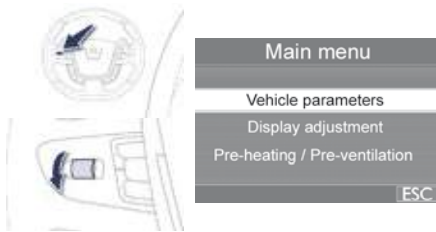

With the vehicle stationary, use the left hand thumb wheel to move through the menus, so as to configure the vehicle settings (driving and comfort systems, ...).

- Press: **Main menu**, confirm the selection,
- Rotate (other than menu): scroll through the list of active functions available,
- Rotate (in a menu): move up or down in the menu.

## Main menu\*

### 1 Vehicle parameters

#### 2 Driving position setting

#### 2 Access to the vehicle

3 u nlocking boot only

#### 2 Driving assistance

3 Speeds memorised

3 Rear wipe in reverse gear

3 Parking brake automatic

#### 2 Lighting

3 Welcome lighting

3 Follow-me-home headlamps

3 Directional headlamps

### 1 Screen settings

#### 2 Choice of color schemes

#### 2 Choice of language

#### 2 Choice of units

3 Fuel consumption

3 t emperature

### 1 Preheating / Preventilation

#### 2 Parameters

\* Depending on version.

## Indicator and warning lamps

Visual indicators informing the driver that a system is in operation, switched off or has a fault.

### When the ignition is switched on

Certain warning lamps come on for a few seconds in the instrument panel and/or instrument panel screen when the vehicle's ignition is switched on.

When the engine is started, these same warning lamps should go off.

If they remain on, before moving off, refer to the information on the warning lamp concerned.

## Associated warnings

The switching on of certain warning lamps may be accompanied by an audible signal and a message in the instrument panel screen.

The warning lamps may come on continuously (fixed) or flash.









Certain warning lamps may come on in one of two modes. Only by relating the type of lighting to the operating status of the vehicle can it be ascertained whether the situation is normal or whether a fault has occurred.





## Operation indicator lamps



If one of the following indicator lamps comes on in the instrument panel and/or instrument panel screen, this confirms that the corresponding system has come into operation.

Warning / indicator lamp		State	Cause	Action / Observations
	Left-hand direction indicator	flashing with buzzer.	the lighting stalk is pushed down.	
	Right-hand direction indicator	flashing with buzzer.	the lighting stalk is pushed up.	
	Sidelamps	fixed.	the lighting stalk is in the "Sidelamps" position.	
	Dipped beam headlamps	fixed.	the lighting stalk is in the "Dipped beam headlamps" position.	
	Main beam headlamps	fixed.	the lighting stalk is pulled towards you.	Pull the stalk to return to dipped beam headlamps.
	Front foglamps	fixed.	the front foglamps are switched on.	turn the ring on the stalk rearwards twice to switch off the front foglamps.
	Rear foglamps	fixed.	the rear foglamps are switched on.	turn the ring on the stalk rearwards to switch off the rear foglamps.



For more information on the lighting controls, refer to the corresponding section.

Warning / indicator lamp		State	Cause	Action / Observations
	<b>Diesel engine pre-heating</b>	fixed.	t he <b>START/STOP</b> switch has been pressed (ignition on).	Wait until the warning lamp goes off before starting. Once it goes off, starting is immediate, on condition that the brake pedal remains pressed with an automatic or electronic gearbox, or the clutch pedal is pressed fully down with a manual gearbox. t he period of illumination of the warning lamp is determined by the ambient conditions (up to about thirty seconds in severe winter conditions). If the engine does not start, switch the ignition off and then on, wait until the warning lamp goes off again, then start the engine.
	<b>Parking brake</b>	fixed.	t he parking brake is applied or not properly released.	Release the parking brake to switch off the warning lamp, keeping your foot on the brake pedal. Observe the safety recommendations. For further information on the parking brake, refer to the "Parking brake" section.
	<b>Deactivation of the automatic functions of the electric parking brake</b>	fixed.	t he "automatic application" (on switching off the engine) and "automatic release" functions are deactivated or faulty.	Activate the function (according to country) via the vehicle configuration menu or contact a Peugeot dealer or a qualified workshop if automatic application / release is not possible. For more information on the electric parking brake, refer to the corresponding section.

Warning / indicator lamp	State	Cause	Action / Observations
 <b>Automatic wiping</b>	fixed.	the wiper control is pushed downwards.	Automatic front wiping is activated. to deactivate automatic wiping, operate the control stalk downwards or put the stalk into another position.
 <b>Passenger's airbag system</b>	fixed in the seat belt and passenger's front airbag warning lamps display.	the control switch, located in the glove box, has been placed in the "ON" position. the passenger's front airbag is activated. In this case, do not install a "rear facing" child seat.	Move the control switch to the "OFF" position to deactivate the passenger's front airbag. In this case, you can install a "rear facing" child seat.
 <b>Stop &amp; Start</b>	fixed.	When the vehicle stops (red lights, traffic jams, ...) the Stop & Start system has put the engine into St OP mode.	the warning lamp goes off and the engine restarts automatically in St ARt mode, as soon as you want to move off.
	flashes for a few seconds, then goes off.	St OP mode is temporarily unavailable. or St ARt mode is invoked automatically.	For more information on special cases with St OP mode and St ARt mode, refer to the "Stop & Start" section.

## Deactivation indicator lamps

If one of the following indicator lamps comes on, this confirms that the corresponding system has been switched off intentionally. This may be accompanied by an audible signal and a message in the instrument panel screen.





Warning / indicator lamp		State	Cause	Action / Observations
	<b>Passenger's airbag system</b>	fixed in the instrument panel and/or seat belt and front passenger's airbag warning lamps display.	<p>The control switch, located in the glove box, is set to the <b>OFF</b> position.</p> <p>The passenger's front airbag is deactivated.</p>	<p>Set the control to the <b>"ON"</b> position to activate the passenger's front airbag.</p> <p>In this case, do not fit a child seat in the rear-facing position.</p>





## Warning lamps

When the engine is running or the vehicle is being driven, illumination of one of the following warning lamps indicates a fault which requires action on the part of the driver.

Any fault resulting in the illumination of a warning lamp must be investigated further by reading the associated message in the instrument panel screen. If you encounter any problems, contact a Peugeot dealer or a qualified workshop.



Warning / indicator lamp		State	Cause	Action / Observations
<b>STOP</b>	<b>STOP</b>	fixed, associated with another warning lamp, accompanied by an audible signal and a message in the screen.	Illumination of this warning lamp is related to a serious fault with the braking system, power steering, the engine oil pressure or engine coolant temperature or a major electrical fault.	Stop as soon as it is safe to do so as the engine may cut out. Park, switch off the ignition and call a Peugeot dealer or a qualified workshop.
<b>SERVICE</b>	<b>Service</b>	on temporarily.	Minor faults have occurred for which there is no specific warning lamp.	Identify the fault by reading the message shown in the screen, such as, for example: <ul style="list-style-type: none"> <li>- the engine oil level,</li> <li>- saturation of the particle emissions filter (Diesel).</li> <li>- the power steering,</li> <li>- a minor electrical fault.</li> <li>- ...</li> </ul> For any other faults, contact a Peugeot dealer or a qualified workshop.
		fixed.	Major faults have occurred for which there is no specific warning lamp.	Identify the fault by reading the message shown in the screen and then contact a Peugeot dealer or qualified workshop.



Warning / indicator lamp		State	Cause	Action / Observations
	<b>Electric parking brake</b>	flashing.	<p>the electric parking brake is not applied automatically.</p> <p>the application/release is faulty.</p>	<p>You must stop as soon as it is safe to do so.</p> <p>Park on flat level ground, engage a gear (or place the lever in position <b>P</b> for an automatic gearbox), switch off the ignition and contact a Peugeot dealer or a qualified workshop.</p>
	<b>Electric parking brake fault</b>	fixed.	the electric parking brake has a fault.	<p>Contact a Peugeot dealer or a qualified workshop without delay.</p> <p>For more information on the electric parking brake, refer to the corresponding section.</p>
	<b>Deactivation of the automatic functions of the electric parking brake</b>	fixed.	<p>the "automatic application" (on switching off the engine) and "automatic release" functions are deactivated or faulty.</p>	<p>Activate the function (according to country) via the vehicle configuration menu or contact a Peugeot dealer or a qualified workshop if automatic application / release is not possible.</p> <p>For more information on the electric parking brake, refer to the corresponding section.</p>
	<b>Braking</b>	fixed.	the brake fluid level has dropped significantly.	<p>You must stop as soon as it is safe to do so.</p> <p>top up with brake fluid listed by Peugeot.</p> <p>If the problem persists, have the system checked by a Peugeot dealer or a qualified workshop.</p>
		fixed, associated with the ABS warning lamp.	the electronic brake force distribution (eBFD) system has a fault.	<p>You must stop as soon as it is safe to do so.</p> <p>Have it checked by a Peugeot dealer or a qualified workshop.</p>





Warning / indicator lamp		State	Cause	Action / Observations
	<b>Anti-lock Braking System (ABS)</b>	fixed.	t he anti-lock braking system has a fault.	t he vehicle retains conventional braking. Drive carefully at reduced speed and contact a Peugeot dealer or a qualified workshop without delay.
	<b>Dynamic stability control (DSC/ASR)</b>	flashing.	t he DSC/ASR regulation is operating.	t he system optimises traction and improves the directional stability of the vehicle in the event of loss of grip or trajectory.
		fixed.	t he DSC/ASR system has a fault.	Have it checked by a Peugeot dealer or a qualified workshop.
	<b>Engine autodiagnosis system</b>	flashing.	t he engine management system has a fault.	Risk of destruction of the catalytic converter. Have it checked by a Peugeot dealer or a qualified workshop.
		fixed.	t he emission control system has a fault.	t he warning lamp should go off when the engine is started. If it does not go off, contact a Peugeot dealer or qualified workshop without delay.
	<b>Low fuel level</b>	fixed with the needle in the red zone.	When it first comes on there remains approximately <b>7 litres</b> of fuel in the tank. At this point, you begin to use the fuel reserve.	Refuel as soon as possible to avoid running out of fuel. t his warning lamp will come on every time the ignition is switched on, until a sufficient addition of fuel is made. Never continue to drive until you run out of fuel, as this could damage the emission control and injection systems.

Warning or indicator lamp in the instrument panel		State	Cause	Action / Observations
UREA   + SERVICE	<b>AdBlue® additive (BlueHDi Diesel)</b>	fixed, on switching on the ignition, accompanied by an audible signal and a message indicating the remaining driving range.	the remaining driving range is between 350 miles (600 km) and 1500 miles (2400 km).	Have the AdBlue® additive tank topped up as soon as possible: go to a dealer Peugeot or a qualified workshop, or carry out this operation yourself by referring to the corresponding section.
		flashing associated with the SeRVICe warning lamp, accompanied by an audible signal and a message indicating the remaining driving range.	the remaining driving range is between 0 and 375 miles (600 km).	You must <b>top-up the AdBlue® additive tank to avoid a breakdown</b> : go to a dealer Peugeot or a qualified workshop, or carry out this operation yourself by referring to the corresponding section.
		flashing, associated with the SeRVICe warning lamp, accompanied by an audible signal and a message indicating that starting is prevented.	the AdBlue® tank is empty: the starting inhibition system required by legislation prevents starting of the engine.	to be able to start the engine, you must <b>top-up the AdBlue® additive tank</b> : go to a dealer Peugeot or a qualified workshop, or carry out this operation yourself by referring to the corresponding section. It is <b>essential</b> to add at least 3.8 litres of AdBlue® to the tank.



Warning or indicator lamp in the instrument panel		State	Cause	Action / Observations
 +  + 	<b>SCR emissions control system (BlueHDi Diesel)</b>	fixed, on switching on the ignition, associated with the SeRVICe and engine diagnostic warning lamps, accompanied by an audible signal and a message indicating an emissions control fault.	A fault with the SCR emissions control system has been detected.	this alert disappears once the exhaust emissions return to normal levels.
		flashing, on switching on the ignition, associated with the SeRVICe and engine diagnostic warning lamps, accompanied by an audible signal and a message indicating the remaining driving range.	the remaining driving range is between 0 and 650 miles (1 100 km).	Contact a Peugeot dealer or a qualified workshop <b>without delay, to avoid a breakdown.</b>
		flashing, on switching on the ignition, associated with the SeRVICe and engine diagnostic warning lamps, accompanied by an audible signal and a message indicating that starting is prevented.	You have exceeded the authorised driving limit: the starting inhibition system prevents starting of the engine.	to be able to start the engine, you <b>must</b> call on a Peugeot dealer or a qualified workshop.

Warning or indicator lamp in the instrument panel		State	Cause	Action / Observations
	<b>Engine oil pressure</b>	fixed.	t here is a fault with the engine lubrication system.	You must stop as soon it is safe to do so. Park, switch off the ignition and contact a Peugeot Ot dealer or a qualified workshop.
	<b>Battery charge</b>	fixed.	t he battery charging circuit has a fault (dirty or loose terminals, slack or cut alternator belt, ...).	t he warning lamp should go off when the engine is started. If it does not go off, contact a Peugeot Ot dealer or a qualified workshop.
	<b>Door(s) open</b>	fixed, associated with a message identifying the door, if the speed is below 6 mph (10 km/h).	A door or the boot is still open.	Close the door or boot.
		fixed, associated with a message identifying the door, and accompanied by an audible signal if the speed is above 6 mph (10 km/h).		

Warning / indicator lamp		State	Cause	Action / Observations
	<b>Seat belt(s) not fastened / unfastened</b>	fixed then flashing accompanied by an increasing audible signal.	A seat belt has not been fastened or has been unfastened.	Pull the strap then insert the tongue in the buckle.
	<b>Airbags</b>	on temporarily.	t his lamp comes on for a few seconds when you turn on the ignition, then goes off.	t his lamp should go off when the engine is started. If it does not go off, contact a Peugeot dealer or a qualified workshop.
		fixed.	One of the airbag or seat belt pretensioner systems has a fault.	Have it checked by a Peugeot dealer or a qualified workshop.
	<b>Directional headlamps</b>	flashing.	t he directional headlamps system has a fault.	Have it checked by a Peugeot dealer or a qualified workshop.
	<b>Under-inflation</b>	fixed.	t he pressure in one or more wheels is too low.	Check the pressure of the tyres as soon as possible. t his check should preferably be carried out when the tyres are cold.
		flashing then fixed, accompanied by the Service warning lamp.	t he tyre pressure monitoring system has a fault or no sensor is detected on one of the wheels.	under-inflation detection is not assured. Have the system checked by a Peugeot dealer or a qualified workshop.
<b>+ SERVICE</b>				

## Coolant temperature gauge



With the engine running, when the needle is:

- in zone **A**, the temperature is correct,
- in zone **B**, the temperature is too high; the central **STOP** warning lamp comes on, accompanied by an audible signal and a message in the instrument panel screen.

**You MUST stop as soon as it is safe to do so.**

Wait a few minutes before switching off the engine.

Contact a Peugeot dealer or a qualified workshop.

After driving for a few minutes, the temperature and pressure in the cooling system increase.

To top up the level:

- ☞ wait for the engine to cool,
- ☞ unscrew the cap by two turns to allow the pressure to drop,
- ☞ when the pressure has dropped, remove the cap,
- ☞ top up the level to the "MAX" mark.

**!** Be aware of the risk of burns when topping up the cooling system. Do not fill above the maximum level (indicated on the reservoir).

## Engine oil temperature gauge



On switching on the ignition or when driving, it indicates the engine oil temperature.

With the needle in zone **C**, the temperature is correct.

With the needle in zone **D**, the temperature is too high.

Slow down to lower the oil temperature.

## CHECK (vehicle autotest)

### Automatic CHECK

With the key in the ignition on position, all of the warning lamps for the functions tested are displayed. They are switched off after a few seconds. At the same time, an automatic CHECK (vehicle autotest) is carried out.

If no "major" fault is found, you can start your vehicle.

### In the presence of a fault

A "minor" fault has been detected: the warning lamp(s) are displayed then go off.

You can start your vehicle; however, contact a Peugeot dealer or a qualified workshop as soon as possible.

A "major" fault has been detected: the associated warning lamp(s) remain on accompanied by the STOP or SERVICE warning lamp.

Do not start your vehicle.

Call a Peugeot dealer or a qualified workshop without delay.

### Manual CHECK



Pressing the "CHECK" button on the instrument panel starts the manual CHECK (vehicle autotest).

This function enables you to recall at any time (with the key in the ignition on position or with the engine running), the alerts present.

**With the engine running and the vehicle moving, the instrument panel displays the warning lamps (in the event of a fault).**

**i** The passenger's airbag deactivated warning lamp\* remains on while the airbag is deactivated.

**i** If your vehicle has a BlueHDi engine, pressing the "CHECK" button gives you the distance that can be travelled before engine starting is prevented automatically. For more information on the AdBlue® additive, refer to the corresponding section.

## Lighting dimmer control



With the headlamps on, press button **B** to increase the brightness of the instruments and controls and the interior mood lighting or button **A** to reduce it.

As soon as the lighting reaches the required level of brightness, release the button.

\* According to country.

## Service indicator

This is a check against the planned servicing intervals in the manufacturer's servicing schedule.

It is calculated from the last service indicator reset according to the number of miles travelled and the time elapsed since the last service. For BlueHDi Diesel versions only (depending on country of sale), the level of deterioration of the engine oil is also taken into account.



**i** With BlueHDi Diesel versions the **Service** warning lamp may come on as soon as the ignition is switched on.

### More than 1 800 miles (3 000 km) remain before the next service is due

When the ignition is switched on, no service information appears in the screen.

### Between 600 miles (1 000 km) and 1 800 miles (3 000 km) remain before the next service is due

For 5 seconds after the ignition is switched on, the spanner symbolising the service operations comes on. The distance recorder display line indicates the distance remaining before the next service is due.

**Example:** 1 700 miles (2 800 km) remain before the next service is due.

For 5 seconds after the ignition is switched on, the screen indicates:



5 seconds after the ignition is switched on, **the spanner goes off**; the distance recorder resumes its normal operation. The screen then indicates the total and trip distances.



### Less than 600 miles (1 000 km) remain before the next service is due

**Example:** 560 miles (900 km) remain before the next service is due.

For 5 seconds after the ignition is switched on, the screen indicates:



5 seconds after the ignition is switched on, the distance recorder resumes its normal operation. **The spanner remains on** to indicate that a service must be carried out soon.



**i** Illumination of the key is accompanied by a message in the instrument panel screen.

## Service overdue

For 5 seconds after the ignition is switched on, **the spanner flashes** to indicate that the service must be carried out as soon as possible.

**Example:** the service is overdue by 186 miles (300 km).

For 5 seconds after the ignition is switched on, the screen indicates:



5 seconds after the ignition is switched on, the distance recorder resumes its normal operation.

**The spanner remains on.**



**i** t he spanner may also come on if you have exceeded the period since the last service, as indicated in the maintenance and warranty guide. With BlueHDi Diesel versions, the spanner can also come on in advance of the service interval, according to the level of deterioration of the engine oil, which depends on the driving conditions in which the vehicle is used.

## Service indicator zero reset



After each service, the service indicator must be reset to zero.

If you have carried out the service on your vehicle yourself:

- ☞ switch off the ignition,
- ☞ press and hold the trip distance recorder zero reset button,
- ☞ switch on the ignition; the distance recorder display begins a countdown,
- ☞ when the display indicates "**=0**", release the button; the spanner disappears.

**i** Following this operation, if you wish to disconnect the battery, lock the vehicle and wait at least five minutes for the zero reset to be registered.

## Retrieving the service information

You can access the service information at any time.

- ☞ Press the trip distance recorder zero reset button.
- t he service information is displayed for a few seconds, then disappears.

## Engine oil level indicator\*

On versions fitted with an electric oil level indicator, the state of the engine oil level is displayed in the instrument panel for a few seconds, after the servicing information.

**i** The level read will only be correct if the vehicle is on level ground and the engine has been off for more than 30 minutes.

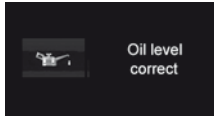

### Oil level correct

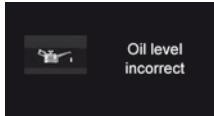

### Oil level incorrect

This is indicated by the display of the message "Oil level incorrect" in the instrument panel screen, accompanied by the service warning lamp and an audible signal.

If the low oil level is confirmed by a check using the dipstick, the level must be topped up to avoid damage to the engine.

**i** Refer to the "Checking levels" section.



### Oil level indicator fault

This is signalled by the display of the message "Oil level measurement invalid" in the instrument panel. Contact a Peugeot dealer or a qualified workshop.

In the event of a fault with the electric indicator, the oil level is no longer monitored.

If the system is faulty, you must check the engine oil level using the manual dipstick located under the bonnet.

**i** Refer to the "Checking levels" section.

\* Depending on version.

## Mileage recorder



The total mileage is displayed in zone A of the screen and the trip mileage in zone B.

## Trip recorder zero reset



With the trip mileage displayed, press the button for a few seconds.



# trip computer

System which provides current information concerning the trip (range, fuel consumption...).

## Instrument panel screen



## Information display



☞ Press the **steering mounted control** to display the various trip computer tabs in succession.

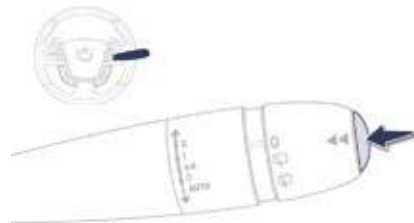

☞ Or on the end of the wiper stalk.

- the current information tab with:
  - the range,
  - the current fuel consumption,
  - the Stop & Start time counter.

1

- the trip "1" tab with:
  - the average speed, for the first trip,
  - the average fuel consumption,
  - the distance travelled.

2

- the trip "2" tab with:
  - the average speed, for the second trip,
  - the average fuel consumption,
  - the distance travelled.

## Trip reset

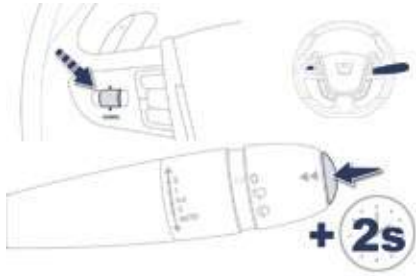

☞ When the trip required is displayed, press the control for more than two seconds or make a long press on the left hand thumb wheel of the steering mounted controls.

Trips "1" and "2" are independent but their use is identical.

For example, trip "1" can be used for daily figures, and trip "2" for monthly figures.

## Information display



the information is accessible in the "Driving" menu.

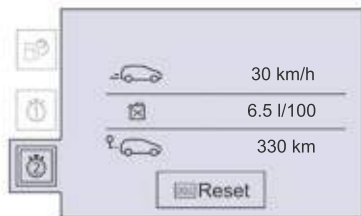

Permanent display:

- ☞ Select the "Driving" menu.

the trip computer information is displayed in the primary page of the menu.

- ☞ Press one of the buttons to display the desired tab.

Temporary display in a new window:

- ☞ Press the end of the wiper control stalk for access to the information and display the different tabs.



the current instantaneous fuel

consumption tab with:

- the range,
- the current fuel consumption,
- the Stop & Start time counter.



the trip "1" tab with:

- the distance travelled.
- the average fuel consumption,
- the average speed, for the first trip.



the trip "2" tab with:

- the distance travelled.
- the average fuel consumption,
- the average speed, for the second trip.

## Trip reset

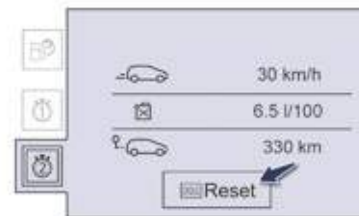

- ☞ When the desired trip is displayed, press the reset button or on the end of the wiper control stalk.

trips "1" and "2" are independent but their use is identical.

For example, trip "1" can be used for daily figures, and trip "2" for monthly figures.

## Trip computer, a few definitions...



### Range

(miles or km)

This indicates the distance which can still be travelled with the fuel remaining in the tank in relation to the average fuel consumption over the last few miles (kilometres) travelled.

This value may vary following a change in the style of driving or the relief, resulting in a significant change in the current fuel consumption.

When the range falls below 20 miles (30 km), dashes are displayed. After filling with at least 5 litres of fuel, the range is recalculated and is displayed when it exceeds 60 miles (100 km).

If dashes are displayed continuously while driving in place of the digits, contact a Peugeot dealer or a qualified workshop.



### Current fuel consumption

(mpg or l/100 km or km/l)

This is the average fuel consumption during the last few seconds.

This function is only displayed from 20 mph (30 km/h).



### Average fuel consumption

(mpg or l/100 km or km/l)

This is the average fuel consumption since the last trip computer zero reset.



### Average speed

(mph or km/h)

This is the average speed calculated since the last trip computer zero reset (ignition on).



### Stop & Start time counter

(minutes / seconds or hours / minutes)

If your vehicle is fitted with Stop & Start, a time counter calculates the time spent in St OP mode during a journey. It resets to zero every time the ignition is switched on with the key.

## touch screen

It gives access to:

- menus for adjusting settings for vehicle functions and systems,
- audio and display configuration menus,
- audio system and telephone controls and the display of associated information.

And, depending on equipment, it allows:

- the display of alert messages and the visual parking sensors information,
- access to the controls for the navigation system and Internet services, and the display of associated information.

**!** For reasons of safety, the driver should only carry out operations that require close attention, with the vehicle stationary.

Some functions are not accessible when driving.

## General operation

### Recommendations

It is necessary to press firmly, particularly for "flick" gestures (scrolling through lists, moving the map...).

A light wipe is not enough.

The screen does not recognise pressing with more than one finger.

This technology allows use at all temperatures and when wearing gloves.

Do not use pointed objects on the touch screen.

Do not touch the touch screen with wet hands.

Use a soft clean cloth to clean the touch screen.

### State of indicator lamps

Some buttons contain an indicator lamp that gives the state of the corresponding function.

Green indicator: you have switched on the corresponding function.

Orange indicator: you have switched off the corresponding function.

## Principles

Press the virtual buttons in the touch screen. Each menu is displayed over one or two pages (primary page and secondary page).



Use this button to go to the secondary page.



Use this button to return to the primary page.



After a few moments with no action on the secondary page, the primary page is displayed automatically.



Use this button for access to additional information and to the settings for certain functions.



Use this button to confirm.



Use this button to quit.

## Menus



Press this button for access to the main menu or press one of the buttons on the control panel for direct access to a particular menu.



### Navigation.

Depending on trim level, navigation can be not available, an option or standard.

NAV

See the "Audio equipment and telematics" section.



### Radio Media.

See the "Audio equipment and telematics" section.

MEDIA



### Settings.

Allows configuration of the display and the system.

SETUP



### Internet.

These services are available as standard or as an option.

WEB

See the "Audio equipment and telematics" section.



### Telephone.

See the "Audio equipment and telematics" section.

TEL



### Driving

gives access to the trip computer and, depending on version, allows settings to be adjusted for certain functions.

DRIVE









See the corresponding section.



1. Volume / mute.  
See the "Audio equipment and telematics" section.



## "Settings" menu

The functions available through this menu are detailed in the table below.

Button	Corresponding function	Comments
	<b>Audio settings</b>	Adjustment of volume, balance...
	<b>Color schemes</b>	Choice of color scheme.
	<b>Turn off screen</b>	Turn off the display in the the touch screen (black screen). Pressing the black screen restores the display.
	<b>System Settings</b>	Choice of units: <ul style="list-style-type: none"> <li>- temperature (°Celsius or °Fahrenheit)</li> <li>- distance and fuel consumption (l/100 km, mpg or km/l).</li> </ul>
	<b>Time/Date</b>	Setting the date and time.
	<b>Languages</b>	Choice of language used: French, english, Italian, Spanish, german, Dutch, Portuguese, Polish, turkish, Russian.
	<b>Screen settings</b>	Adjustment of the display settings (scrolling of text, animations...)
	<b>Calculator</b>	Display the calculator.
	<b>Calendar</b>	Display the calendar.

 **"Driving" menu**

the systems with settings that can be adjusted (depending on version) are detailed in the table below.

Button	Corresponding function	Comments
	<b>Parking sensors</b>	Deactivation of the function.
	<b>Blind spot sensors</b>	Activation of the function.



# Setting the date and time

## Audio system without touch screen



Using the arrows, select "**Personalisation-configuration**" and confirm.



Select the setting to be modified. Confirm by pressing **OK**, then make the change and confirm again to save the modification.



Press **MENU**.

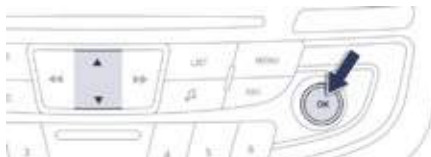

Using the arrows, select "**Display configuration**" and confirm.

Using the arrows, select "**Date and time adjustment**" and confirm.

Adjust the settings one by one, confirming by pressing the **OK** button. Next select the "**OK**" tab on the screen then confirm to exit from the "**Date and time adjustment**" menu.

## Audio system with touch screen



### SETUP

- ☞ Select the **"Settings"** menu.



- ☞ In the secondary page, press on **"Time/Date"**.



- ☞ Select **"Adjust time"** or **"Adjust date"** and modify the settings using the numeric keypad, then confirm.



- ☞ Press **"Confirm"** to quit.



# Remote control key

System which permits central unlocking or locking of the vehicle using the lock barrel or from a distance. It is also used to locate and start the vehicle, as well as providing protection against theft.



## Unfolding the key

☞ First press this button to unfold the key.



## Folding the key

☞ First press this button to fold the key.  
If you do not press the button when folding the key, there is a risk of damage to the mechanism.

## "Keyless entry and Starting" system



System that allows the opening, closing and starting of the vehicle while keeping the electronic key on your person. It can also be used as a remote control.

### Unlocking the vehicle Complete unlocking

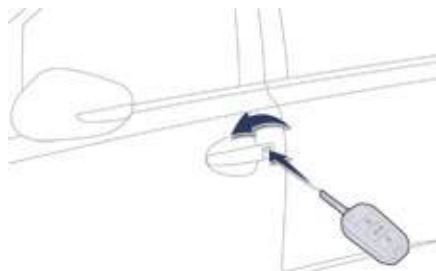

#### Using the key

☞ Turn the key to the front of the vehicle to unlock the vehicle.

#### Using the remote control



☞ Press the open padlock to unlock the vehicle.



#### Using the electronic key

☞ With the electronic key on your person and in the recognition zone, pass your hand behind the door handle to unlock the vehicle, then pull on the handle to open the door.

Your passengers can also open their doors with the exception of the boot, as soon as the electronic key is in the recognition zone around the vehicle.

**i** For reasons of safety and theft protection, do not leave your electronic key in the vehicle, even when you are close to it. It is recommended that you keep it on your person: in a pocket, bag, ...



Holding this button down opens the windows automatically.

To avoid inadvertently locking the vehicle with the windows open, contact a Peugeot dealer to deactivate this function.

**i** Unlocking is confirmed by rapid flashing of the direction indicators for approximately two seconds. According to version, the door mirrors unfold at the same time.

**!** Accumulations (water, dust, grime, salt...) on the inner surface of the door handle may affect detection. If cleaning the inner surface of the door handle using a cloth does not restore detection, contact a Peugeot dealer or a qualified workshop. A sudden splash of water (stream of water, high pressure jet washer, ...) may be identified by the system as the desire to open the vehicle.

## Selective unlocking



This is set via the instrument panel screen configuration menu. Complete unlocking is activated by default.

## Using the remote control



To unlock the driver's door only, press the open padlock once.

To unlock the other doors and the boot, press the open padlock again.

## Using the electronic key

- To unlock only the driver's door with the electronic key on your person, pass your hand behind the driver's door handle then pull the handle to open the door.
- To unlock the vehicle completely, pass your hand behind one of the passenger door handles, on the side of the vehicle where the electronic key is located, then pull the door handle.

**i** Each unlocking is confirmed by rapid flashing of the direction indicators for approximately two seconds. According to version, the door mirrors unfold at the same time as the first unlocking action.

## Unlocking the boot

### Using the remote control



- ☞ Press this button to unlock the vehicle and open the boot.



### Using the electronic key

- ☞ With the electronic key in the recognition zone, press button **1** (Saloon) or lift lever **2** (SW) to unlock the vehicle and open the boot.

### Boot only function activated



- ☞ This is set in the instrument panel configuration menu.

This function is deactivated by default.

- ☞ Use of the remote control or the electronic key then unlocks and/or opens only the boot.

**!** Don't forget to lock your boot afterwards.

## Locking the vehicle

### Normal locking

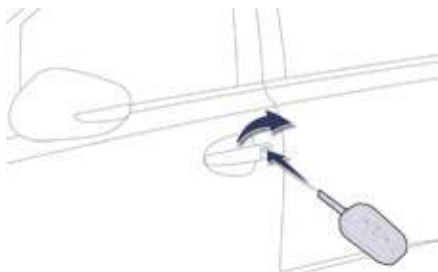

### Using the key

- ☞ Turn the key towards the rear of the vehicle to lock the vehicle completely.

### Using the remote control



- ☞ Press the closed padlock to lock the vehicle completely.

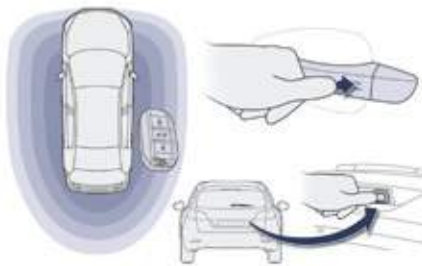

### Using the electronic key

- ☞ With the electronic key in the recognition zone, press with a finger on the door handle (at the markings) to lock the vehicle.
- ☞ From the boot (SW only), with the electronic key in the recognition zone, press a button to lock the vehicle.

i



Maintaining the locking action (remote control or manual key) automatically closes the windows and sunroof.



Contact a Peugeot Ot for deactivation of this function.

i

Locking is confirmed by fixed lighting of the direction indicators for approximately two seconds. According to version, the door mirrors fold at the same time.

**!** If one of the doors or the boot is still open or if the key for Keyless entry and Starting system has been left inside the vehicle or if the ignition is on, the central locking does not take place. When the vehicle is locked, if it is unlocked inadvertently, it will lock itself again automatically after about thirty seconds unless a door is opened. If the alarm was previously activated, it will not be reactivated automatically. The folding and unfolding of the door mirrors by the remote control can be deactivated by a Peugeot Ot dealer or a qualified workshop.

**i** As a safety measure (children on board), never leave the vehicle without taking the key for the Keyless entry and Starting system, even for a short period. Guard against theft when the key for the Keyless entry and Starting system is in the recognition zone with the vehicle unlocked. In order to preserve the charge of the cell battery in the remote control, the "hands-free" functions go into extended stand-by after 21 days of non-use. To restore these functions, press one of the remote control buttons or start the engine with the electronic key in the reader.



## Deadlocking

- !** Deadlocking renders the exterior and interior door controls inoperative. It also deactivates the manual central control button.
- Therefore, never leave anyone inside the vehicle when it is deadlocked.

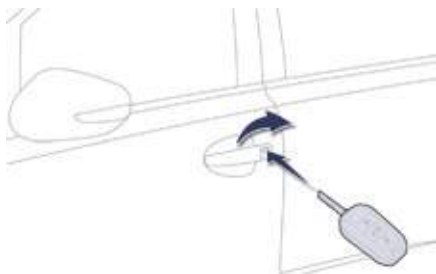

### Using the key

- Turn the key to the rear in the driver's door lock to lock the vehicle completely.
- Turn the key to the rear again within five seconds to deadlock the vehicle.

### Using the remote control



- Press the closed padlock to lock the vehicle completely or press the closed padlock for more than two seconds to close the windows automatically in addition to locking.
- Press the closed padlock again within five seconds to deadlock the vehicle.



### Using the electronic key

By the doors:

- With the electronic key in the recognition zone, press a finger on the door handle (at the markings) to lock the vehicle.
- Within five seconds, press the door handle again to deadlock the vehicle.

By the tailgate (SW only):

- With the electronic key in the recognition zone, press the button to lock the vehicle.
- Within five seconds, press the button to deadlock the vehicle.

**i** Deadlocking is confirmed by fixed lighting of the direction indicators for approximately two seconds.

## Locking/ unlocking from the inside

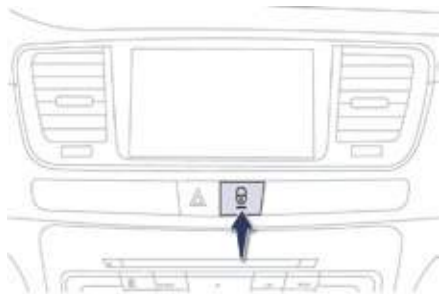

☞ Press the button.

This allows the doors and the boot to be locked or unlocked.

**!** If the vehicle is deadlocked or locked with the remote control or the door handles, the button is not active. In this case, use the key or the remote control to unlock.

**i** When carrying large objects with the boot open, you can press this button to inhibit the boot open alert signal. When locking from inside, the door mirrors do not fold.

### Automatic central locking of the doors

The doors can lock automatically while driving (speed above 6 mph (10 km/h)).

To activate or deactivate this function, press and hold the button until a message appears in the screen.

**!** Driving with the doors locked may make access to the passenger compartment by the emergency services more difficult in an emergency.

### Locating your vehicle



☞ Press the closed padlock to locate your locked vehicle in a car park.

This is indicated by lighting of the courtesy lamps and flashing of the direction indicators for a few seconds.

## emergency procedure

### Emergency unlocking/ locking using the electronic key

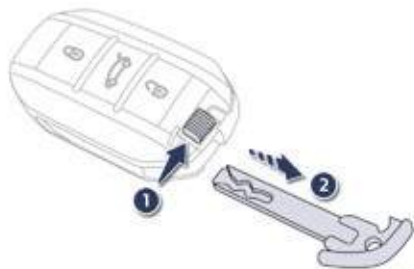

The integral key is used to lock and unlock the vehicle when the electronic key cannot operate:

- cell battery flat, vehicle battery discharged or disconnected, ...
  - vehicle located in an area with strong electromagnetic emissions.
- ☞ Pull on button 1, to extract the integral key 2.
- ☞ unlock or lock the vehicle using the key.

### Manual locking

#### Driver's door

Insert the key in the lock to lock or unlock the door.



#### Passenger doors

- ☞ On the rear doors, check that the child lock is not on.
- ☞ Remove the black cap located on the edge of the door, using the key.
- ☞ Insert the key into the aperture without forcing, then without turning, move the latch sideways towards the inside of the door.
- ☞ Remove the key and refit the cap.

### Remote control problem

Following disconnection of the vehicle battery, replacement of the remote control battery or in the event of a remote control malfunction, you can no longer unlock, lock or locate your vehicle.

- ☞ First of all, use the key in the lock to unlock or lock your vehicle.
  - ☞ Then, reinitialise the remote control.
- If the problem persists, contact a Peugeot Ot dealer or a qualified workshop as soon as possible.

#### Reinitialisation with the remote control

- ☞ Switch on the ignition.
  - ☞ Immediately press one of the remote control buttons for a few seconds.
  - ☞ Switch off the ignition.
- The remote control is fully operational again.

## Reinitialisation with the electronic key

- ☞ Switch of the ignition.
  - ☞ Immediately press one of the remote control buttons for a few seconds.
  - ☞ Switch on the ignition
- the electronic key is fully operational again.

## Changing the battery of the key



Battery ref.: CR2032 / 3 volts.

This replacement battery is available from a Peugeot Ot dealer or a qualified workshop. A message appears in the instrument panel screen when replacement of the battery is needed.

- ☞ Unclip the cover using a small screwdriver at the cutout.
- ☞ Lift off the cover.
- ☞ Remove the flat battery from its location.
- ☞ Fit the new battery into its location observing the original direction of fitment.
- ☞ Clip the cover onto the casing.



Do not throw the remote control batteries away, they contain metals which are harmful to the environment. Take them to an approved collection point.

## Changing the battery of the electronic key



Battery ref.: CR2032 / 3 volts.

This replacement battery is available from a Peugeot Ot dealer or a qualified workshop. A message is displayed in the instrument panel screen when replacement of the battery is needed.

- ☞ Unclip the cover using a pointed object at the key ring.
- ☞ Slide the flat battery out of its location.
- ☞ Slide the new battery into its location observing the original direction of fitment.
- ☞ Clip the cover in place starting at the front.
- ☞ Reinitialise the electronic key.

## **!** Lost keys, remote control, electronic key

Visit a Peugeot dealer with the vehicle's V5 registration document and your personal identification documents. The Peugeot dealer will be able to retrieve the key code and the transponder code required to order a replacement.

### **Remote control**

The high frequency remote control is a sensitive system; do not operate it while it is in your pocket as there is a possibility that it may unlock the vehicle, without you being aware of it.

Do not repeatedly press the buttons of your remote control out of range and out of sight of your vehicle. You run the risk of stopping it from working and the remote control would have to be reinitialised.

The remote control does not operate when the key is in the ignition, even when the ignition is switched off.

### **Locking the vehicle**

Driving with the doors locked may make access to the passenger compartment by the emergency services more difficult in an emergency. As a safety precaution (with children on board), remove the key from the ignition or take the electronic key when you leave the vehicle, even for a short time.

### **Electrical interference**

The Keyless entry and Starting electronic key may not operate if close to certain electronic devices: telephone, laptop computer, strong magnetic fields, ...

### **Anti-theft protection**

Do not make any modifications to the electronic engine immobiliser system; this could cause malfunctions. Don't forget to turn the steering to engage the steering lock.

### **When purchasing a second-hand vehicle**

Have the key codes memorised by a Peugeot dealer, to ensure that the keys in your possession are the only ones which can start the vehicle.

# Alarm



System which protects and provides a deterrent against theft and break-ins. It provides the following types of monitoring:

## - Exterior perimeter

The system checks for opening of the vehicle. The alarm is triggered if anyone tries to open a door, the boot or the bonnet...

## - Interior volumetric

The system checks for any variation in the volume in the passenger compartment. The alarm is triggered if anyone breaks a window, enters the passenger compartment or moves inside the vehicle.

## - Tilt

The system checks for any change in the attitude of the vehicle. The alarm is triggered if the vehicle is lifted, moved or knocked.

## ! Self-protection function

The system checks for the putting out of service of its components. The alarm is triggered if the battery, the central control unit or the wires of the siren are put out of service or damaged.

For all work on the alarm system, contact a Peugeot dealer or a qualified workshop.

## Locking the vehicle with full alarm system

### Activation

- ☞ Switch off the ignition and get out of the vehicle.
- ☞ Press the locking button on the remote control or lock the vehicle using the Keyless entry and Starting system.



The monitoring system is active: the indicator lamp on the button flashes once per second. After the locking button on the remote control is pressed or the vehicle locked using the Keyless entry and Starting system, the exterior perimeter monitoring is activated after a delay of 5 seconds, the interior volumetric monitoring after 45 seconds and anti-tilt monitoring after 90 seconds.

If an opening (door, boot...) is not closed fully, the vehicle is not locked but the exterior perimeter monitoring will be activated after a delay of 45 seconds.

## Deactivation of the volumetric monitoring



- ☞ Press the unlocking button on the remote control or unlock the vehicle using the Keyless entry and Starting system.



The volumetric protection system is deactivated: the indicator lamp in the button goes off.

## Locking the vehicle with exterior perimeter monitoring only

Deactivate the interior volumetric and anti-lift monitoring to avoid unwanted triggering of the alarm in certain cases such as:

- leaving a window partially open,
- washing your vehicle,
- changing a wheel,
- having your vehicle towed,
- transportation by sea.

## Deactivation of the interior volumetric and anti-tilt monitoring



- ☞ Switch of the ignition and within ten seconds, press this button until the indicator lamp is on continuously.
- ☞ get out of the vehicle.



- ☞ Press the locking button on the remote control immediately or lock the vehicle using the Keyless entry and Starting system.

The exterior perimeter monitoring alone is activated: the indicator lamp in the button flashes once per second.

To be effective, this deactivation must be carried out each time the ignition is switched off.

## Reactivation of the interior volumetric and anti-tilt monitoring



- ☞ Press the unlocking button on the remote control or unlock the vehicle using the Keyless entry and Starting system to deactivate the exterior perimeter monitoring.



- ☞ Press the locking button on the remote control or lock the vehicle using the Keyless entry and Starting system to activate all the monitoring functions.



The indicator lamp in the button again flashes once per second.

## Triggering of the alarm

This is indicated by sounding of the siren and flashing of the direction indicators for thirty seconds.

The monitoring functions remain active until the alarm has been triggered eleven times in succession.



When the vehicle is unlocked using the remote control or unlocked using the Keyless entry and Starting system, rapid flashing of the indicator

lamp in the button informs you that the alarm was triggered during your absence. When the ignition is switched on, this flashing stops immediately.

## Failure of the remote control

To deactivate the monitoring functions:

- ☞ unlock the vehicle using the key in the driver's door lock.
- ☞ Open the door; the alarm is triggered.
- ☞ Switch on the ignition; the alarm stops. The indicator lamp in the button switches off.

## Locking the vehicle without activating the alarm

- ☞ Lock or deadlock the vehicle using the key in the driver's door lock.

## Operating fault

When the ignition is switched on, fixed illumination of the indicator lamp in the button indicates a fault in the system.

Have it checked by a Peugeot dealer or a qualified workshop.

## Automatic activation\*

2 minutes after the last door or the boot is closed, the system is activated automatically.

- ☞ To avoid triggering the alarm on entering the vehicle, first press the unlocking button on the remote control or unlock the vehicle using the Keyless entry and Starting system.

\* According to country.

## electric windows

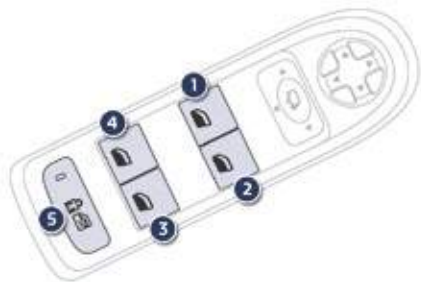

1. Left hand front electric window switch.
2. Right hand front electric window switch.
3. Right hand rear electric window switch.
4. Left hand rear electric window switch.
5. Deactivating the rear electric window switches, locking the rear doors (child lock).

### Manual operation

To open or close the window, press or pull the switch gently. The window stops as soon as the switch is released.

### Automatic operation (depending on version)

To open or close the window, press or pull switch fully: the window opens or closes completely when the switch is released. Pressing the switch again stops the movement of the window.

The electric window switches remain operational for approximately one minute after the key has been removed from the ignition. Once this time has elapsed, the electric windows will not operate. To reactivate them, switch the ignition on again.

### Safety anti-pinch

When the window rises and meets an obstacle, it stops and immediately partially lowers again. In the event of unwanted opening of the window on closing, press the switch until the window opens completely, then pull the switch immediately until the window closes. Continue to hold the switch for approximately one second after the window has closed.

The safety anti-pinch function is not active during this operation.

### Deactivating the rear window controls

For the safety of your children, press switch 5 to prevent operation of the rear windows irrespective of their position.

The interior controls for the rear doors are also deactivated.

When the button is pressed down, the warning lamp is on, the switches are deactivated. When the button is raised, the switches are active, the warning lamp is off.



## Reinitialisation of the electric windows

Following reconnection of the battery, the safety anti-pinch function must be reinitialised. The safety anti-pinch function is not active during these operations:

- lower the window completely, then raise it, it will rise in steps of a few centimetres each time the switch is pressed. Repeat the operation until the window closes completely,
- continue to press the switch for at least one second after reaching this position, window closed.

**!** Always remove the key from the ignition when leaving the vehicle, even for a short time.

In the event of contact during operation of the windows, you must reverse the movement of the window. To do this, press the switch concerned.

When operating the passenger electric window switches, the driver must ensure that no one is preventing correct closing of the windows.

The driver must ensure that the passengers use the electric windows correctly.

Be aware of children when operating the windows.

## Boot Opening



### Saloon

- ☞ After unlocking the vehicle completely using the remote control or the key, press this button.



### SW

- ☞ After unlocking the vehicle completely using the remote control or the key, press at the top (on lever A), and raise the tailgate.



### From the inside

- ☞ Hold this button down until unlocking of the boot is heard.

## Closing

- ☞ Lower the tailgate using the interior grab handle.

If the tailgate is not closed correctly:



- **when the engine is running**, this warning lamp and a message in the instrument panel screen appear for a few seconds,
- **when the vehicle is moving** (speed above 6 mph (10 km/h)), this warning lamp and a message, accompanied by an audible signal, appear in the instrument panel screen for a few seconds.

# Motorised tailgate (SW)

## Opening



### Vehicle locked/deadlocked



- ☞ Press this button **A** on the remote control.



### Vehicle unlocked

- ☞ Press button **A** on the remote control, or press the push button **B** on the tailgate.



### From the inside

- ☞ Press this button to unlock and open the tailgate.



Check that there is no obstacle in the way when opening the tailgate by remote control.

## Closing



☞ Press this button **C** to close the tailgate electrically.

Do not hinder closing of the tailgate: any obstacle to closing causes the tailgate to stop and rise a few centimetres automatically. To close the tailgate manually: move the tailgate slightly up then down to disengage it from its drive then lower it until closed.



**To avoid the risk of injury, ensure that no one is close to the rear of the vehicle when opening or closing the tailgate.**

## Stopping the opening or closing

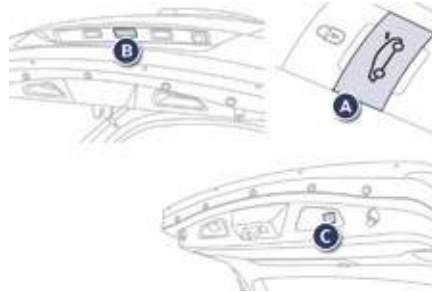

While electric opening or closing of the tailgate is in progress, you can stop its movement at any time:

☞ press the interior button or button **A** on the remote control or button **B** or **C** on the tailgate.

## Adjusting the opening height

The maximum opening height of the tailgate can be set and memorised (restricted overhead clearance, ...).

This memorisation is done in two steps, by successive presses on button **C**:

- during opening, a first press stops the tailgate at the desired height,
- a second maintained press memorises the position of the tailgate; an audible signal confirms the memorisation.

To delete this memorisation, make a new maintained press until the audible signal is heard.

## "Boot open" warning

With the engine running or when the vehicle is moving, if the tailgate is not properly closed, a message accompanied by an audible signal (from 6 mph (10 km/h)) is displayed in the instrument panel screen.

## Emergency release (Saloon and SW)

System for mechanical unlocking of the boot in the event of a battery or central locking fault.



### Unlocking

- ☞ Fold back the rear seats to gain access to the lock from inside the boot.
- ☞ Insert a small screwdriver into hole **A** of the lock, then move the lever to the left to unlock the boot.

# Sunroof

Your vehicle is fitted with an opening sunroof which increases the light and visibility in the passenger compartment.

## Opening



Turn the dial to the left to slide the sunroof (several possible opening settings).

## Closing

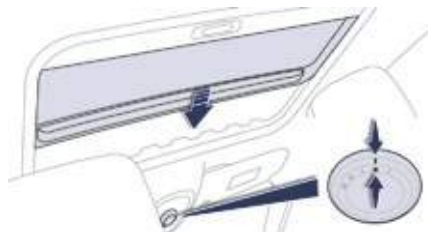

Return the dial to the initial position. If the position of the glass panel does not agree with the position indicated by the dial, press the ring of the dial to open the sunroof to this position.

## Blind

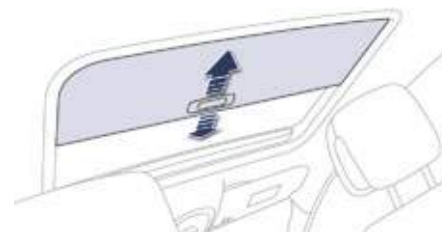

The blind improves thermal and acoustic comfort.

The blind is opened automatically when the sunroof is opened. It must be closed manually after closing the sunroof.

## Raising the rear of of the sunroof



Turn the dial to the right to raise the rear of the sunroof.

## Safety anti-pinch

An anti-pinch system stops the closing of the roof, whether sliding or from the raised at the rear position. If the sunroof encounters an obstacle it partially opens again.

If the sunroof fails to close at a second attempt, it may be necessary to force the closing of the sunroof using the reinitialisation procedure.

## Reinitialising the system

Following reconnection of the battery, or in the event of a malfunction in its operation, it may be necessary to reinitialise the system:

- ☞ turn the dial to the right to raise the sunroof at the rear,
- ☞ wait until the sunroof is fully up at the rear,
- ☞ then immediately press the dial for at least 3 seconds.

If the sunroof opens on its own when closing, as soon as possible after the sunroof stops:

- put the dial in the fully closed position,
- press the dial,
- maintain pressure on the dial until the sunroof closes.

**The anti-pinch function is inoperative during these operations.**

**!** The driver should ensure that passengers use the sunroof correctly. Be aware of children when operating the sunroof.

## Panoramic sunroof (SW)



Your vehicle is fitted with a tinted glass panoramic sunroof which increases the light and visibility in the passenger compartment. Its electric blind helps control the temperature and noise level in the passenger compartment.

### Electric blind

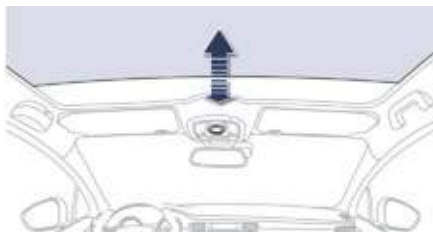

The blind is controlled electrically by a rotary opening dial.

### Opening

Turn the dial to the left (several possible opening settings).

### Closing

Return the dial to the initial position.

If the position of the blind does not agree with the position indicated by the dial, press the dial to open the blind to this position.

### Safety anti-pinch

If the blind encounters an obstacle during closing, it stops and partially opens again to the 2nd position.

If the blind fails to close at a second attempt, it may be necessary to force the closing of the blind using the reinitialisation procedure.

### Reinitialising the system

Following reconnection of the battery, or in the event of a malfunction in its operation, it may be necessary to reinitialise the system:

- ☞ turn the dial to the fully open position,
- ☞ wait until the blind is fully open,
- ☞ then immediately press the dial for at least 3 seconds,

If the blind opens on its own when closing, as soon as possible after the blind stops:

- put the dial in the fully closed position,
- press the dial,
- maintain pressure on the dial until the blind closes.

**The anti-pinch function is inoperative during these operations.**



In the event of contact during operation of the blind, you must reverse its movement. To do this, turn the dial. When the driver operates the dial, they must ensure that nothing prevents the blind from closing correctly. The driver must ensure that the passengers use the blind correctly. Be aware of children during operation of the blind.



# Fuel tank

Capacity of the tank: approximately 72 litres (or 55 litres according to version).

## Opening



- Press the switch. This control remains active for a few minutes after switching off the ignition. If necessary, switch the ignition on again to reactivate it.



With Stop & Start, never refuel with the system in St OP mode; you must switch off the ignition with the key.

## Refuelling



- Additions of fuel must be of at least 5 litres to be registered by the fuel gauge. Opening the filler cap may result in an inrush of air. This vacuum is entirely normal and results from the sealing of the fuel system.
- ☞ Take care to select the pump that delivers the correct fuel type for your vehicle's engine (reminder on a label on the inside of the filler flap).
  - ☞ Open the filler cap by turning it a 1/4 turn to the left.
  - ☞ Remove the filler cap and hang it on its carrier (on the filler flap).

- ☞ Introduce the nozzle and push it in fully (pushing on the the metal non-return valve A).
- ☞ Fill the tank. Do not continue past the third cut-off of the nozzle, as this may cause malfunctions.
- ☞ Refit the filler cap turning it a 1/4 turn to the right.
- ☞ Push the filler flap to close it.

Your vehicle is fitted with a catalytic converter, a device which helps to reduce the level of harmful emissions in the exhaust gases.

**For petrol engines, you must use unleaded fuel only.**

The filler neck is narrower, admitting petrol nozzles only.



**If you have put in the wrong fuel for your vehicle, you must have the tank drained and refilled with the correct fuel before you start the engine.**

## Low fuel level



When the low fuel level in the tank is reached, this warning lamp comes on in the instrument panel, accompanied by an audible warning and a message in the instrument panel screen.

When it first comes on, around 7 litres of fuel remain in the tank.

You must refuel as soon as possible to avoid running out.

## Fuel supply cut-off

Your vehicle is equipped with a safety device which cuts off the fuel supply in the event of a collision.

# Diesel misfuel prevention

Mechanical device which prevents filling the tank of a Diesel vehicle with petrol. It avoids the risk of engine damage that can result from filling with the wrong fuel.

Located in the filler neck, the misfuel prevention device appears when the filler cap is removed.

## Operation

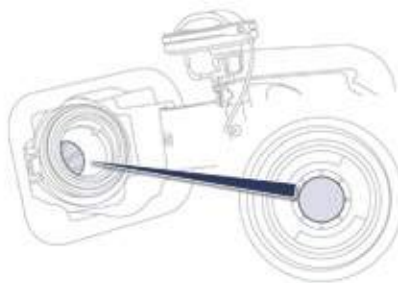

When a petrol filler nozzle is introduced into the fuel filler neck of your Diesel vehicle, it comes into contact with the flap. The system remains closed and prevents filling.

**Do not persist but introduce a Diesel filler nozzle.**

**i** It is still possible to use a fuel can to fill the tank but this must be done slowly. In order to ensure a good flow of fuel, do not place the nozzle of the fuel can in direct contact with the flap of the misfuel prevention device.

## Travelling abroad

As Diesel fuel pump nozzles may be different in other countries, the presence of the misfuel prevention device may make refuelling impossible.

Before travelling abroad, we recommend that you check with the Peugeot dealer network, whether your vehicle is suitable for the fuel pumps in the country in which you want to travel.

## Fuel used for petrol engines

The petrol engines are compatible with E10 type petrol biofuels (containing 10 % ethanol), conforming to European standards EN 228 and EN 15376.

E85 type fuels (containing up to 85 % ethanol) are reserved exclusively for vehicles marketed for the use of this type of fuel (BioFlex vehicles). The quality of the ethanol must comply with European standard EN 15293.

## Fuel used for Diesel engines

The Diesel engines are compatible with biofuels which conform to current and future European standards (Diesel fuel which complies with standard EN 590 mixed with a biofuel which complies with standard EN 14214) available at the pumps (containing up to 7 % Fatty Acid Methyl ester).

The B30 biofuel can be used in certain Diesel engines; however, this use is subject to strict application of the special servicing conditions indicated in the warranty and maintenance record. Contact a Peugeot dealer or a qualified workshop.

The use of any other type of (bio)fuel (vegetable or animal oils, pure or diluted, domestic fuel...) is strictly prohibited (risk of damage to the engine and fuel system).

SP95

SP95  
E10

SP98

DIESEL

# Front seats

## Manual adjustments

**1. Adjustments to the height and angle of the head restraint**

To raise it, pull upwards.  
To lower it, hold the button in and press on the head restraint (pushing to go past the stiff point of the button).

**2. Adjustment of the backrest angle**

Operate the control lever and adjust the position of the backrest to the front or to the rear.

**3. Adjustment of the seat height**

Raise or lower the control lever the number of times required to obtain the desired position.

**4. Adjustment of the lumbar support**

This system allows the height and depth of the lumbar support to be adjusted separately.

- ☞ Forwards or backwards to increase or decrease the lumbar support.
- ☞ Upwards or downwards to raise or lower the lumbar contact zone.

**5. Forwards-backwards adjustment of the seat position**

Lift the control bar and slide the seat forwards or backwards.

**6. Adjusting the cushion**

Pull the handle to adjust the length of the cushion.



**!** Before moving the seat backwards, ensure that there is nothing that might prevent the full travel of the seat, so as to avoid the risk of jamming the seat caused by the presence of objects on the floor behind the seat or rear passengers. If the seat jams, stop the movement immediately.

## Electric adjustments

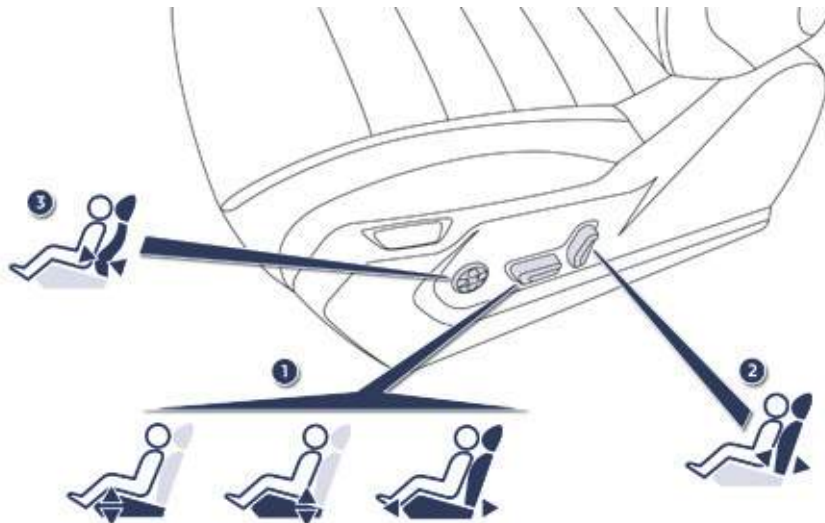

### 1. Adjustment of the seat cushion angle and height, and forwards-backwards adjustment

- ☞ Raise or lower the front of the control to adjust the seat cushion angle.
- ☞ Raise or lower the rear of the control to raise or lower the seat.
- ☞ Simultaneously raise or lower the front and rear of the control in order to raise or lower the entire seat.

### 2. Adjustment of the backrest angle

Move the control forwards or backwards to adjust the backrest angle.

### 3. Adjustment of lumbar support

This function allows you to independently adjust the height and level of lumbar support.

Move the control:

- ☞ Forwards or backwards to increase or reduce the lumbar support.
- ☞ Upwards or downwards to raise or lower the lumbar support zone.

**i** Switch on the ignition or start the engine if the vehicle has gone into economy mode.

The electric functions of the driver's seat are active for about a minute after opening the front door. They are deactivated about a minute after switching off the ignition and in economy mode.

To reactivate them, switch on the ignition.

**!** Before moving the seat backwards, ensure that there is nothing that might prevent the full travel of the seat, so as to avoid the risk of jamming the seat caused by the presence of objects on the floor behind the seat or rear passengers. If the seat jams, stop the movement immediately.

## Storing driving positions

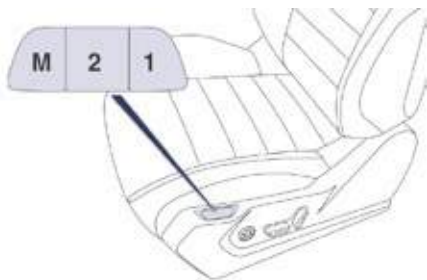

System which stores the electrical settings of the driver's seat and door mirrors as well as the head-up display settings. It enables you to store up to two positions using the buttons on the side of the driver's seat.

### Storing a position using buttons M / 1 / 2

- ☞ Switch on the ignition.
- ☞ Adjust your seat, the door mirrors and the head-up display.
- ☞ Press button **M**, then press button **1** or **2** within four seconds.  
An audible signal indicates that the position has been stored.

Storing a new position cancels the previous position.

### Recalling a stored position

#### Ignition on or engine running

- ☞ Briefly press button **1** or **2** to recall the corresponding position.

An audible signal indicates the end of the adjustment.

You can interrupt the current movement by pressing button **M**, **1** or **2** or by using one of the seat controls.

A stored position cannot be recalled while driving.

Recalling stored positions is deactivated 45 seconds after switching off the ignition.

## Welcome function

The welcome function assists entry and leaving the vehicle.

After switching off the ignition and opening the driver's door, the seat moves back automatically and then stays in this position, ready for the next entry to the vehicle.

When switching on the ignition, the seat moves forward to the stored driving position.

When moving the seat, take care that no person or object hinders the automatic movement of the seat.



This function can be activated or deactivated via the vehicle configuration menu.

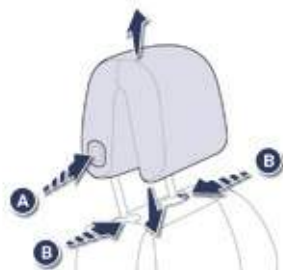

## Head restraint height and angle adjustment

- ☞ To lower the head restraint, press the lug **A** and, going beyond the stiff point, guide the head restraint downwards, then release the button at the desired position.
- ☞ To raise the head restraint, guide it upwards to the desired position.
- ☞ To remove the head restraint, press the two lugs **B** and pull the head restraint upwards.
- ☞ To put the head restraint back in place, engage the head restraint stems in the openings keeping them in line with the seat back. Check that it has engaged by pulling it upwards.

**!** The head restraint is fitted with a locking mechanism which prevents it from lowering; this is a safety device in case of impact.

**The adjustment is correct when the upper edge of the head restraint is level with the top of the head.**

Never drive with the head restraints removed; they must be in place and adjusted correctly.

## Heated seats control



With the engine running, the front seats can be heated separately.

- ☞ Use the adjustment wheel to switch on and select the level of heating required:

- 0:** Off.
- 1:** Low.
- 2:** Medium.
- 3:** High.

## Massage function



This function provides the driver with a back massage. It only operates when the engine is running as well as in St OP mode of the Stop & Start system.

### Activation



Press this button.

The warning lamp comes on and the massage function is activated for a period of 1 hour. During this time, massage is performed in cycles of 6 minutes (4 minutes of massage followed by 2 minutes break). In total, the system will perform 10 cycles. After one hour, the function is deactivated, the warning lamp goes off.

### Deactivation



You can deactivate the massage function at any time by pressing this button.



## Rear seats

Bench seat the left-hand (1/3) or right-hand (2/3) section of which can be folded to adapt the boot load space.

### Outer rear seat head restraints

These have a high position (comfort and safety), a low position (rear visibility) and can also be removed.

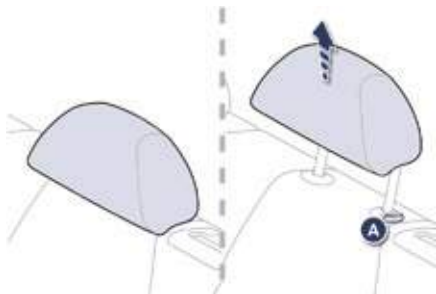

To remove a head restraint:

- ☞ pull the head restraint fully upwards,
- ☞ then, press the lug **A**.

**!** Never drive with rear passengers when the head restraints are removed; the head restraints must be in place and in the high position.

### Folding the seat from the boot (SW)

Each section of the bench seat (1/3 or 2/3) has its own control to release the seat back and its seat cushion from the boot.



- ☞ Check that nothing is preventing the seat back from folding (head restraint, seat belts, ...),
- ☞ check also that no object on or under the seat could hinder its movement,



- ☞ pull the control from the boot and push the seat backrest.

## Folding the seat from the rear

Check that no object, either on or underneath the seat, could hinder its movement.

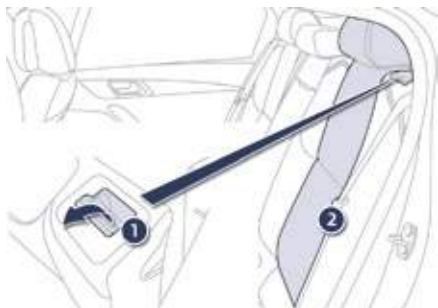

- ☞ Move the corresponding front seat forwards if necessary,
- ☞ check that the seat belt is positioned correctly on the side of the seat back,
- ☞ place the head restraints in the low position or remove them if necessary,

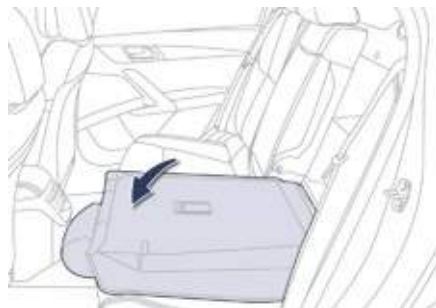

- ☞ pull the control 1 forwards to release the seat backrest 2 then fold it forwards.

## Returning the seat back to its original position

When returning the rear seat back to its original position, take care not to trap the seat belts and ensure that their buckles are positioned correctly.

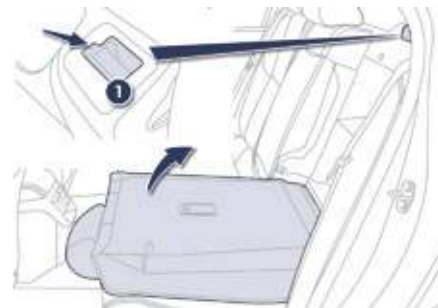

- ☞ Put the seat back in the upright position and secure it, the seat cushion also returns to its original position,
- ☞ check that the red indicator, located at the control 1, is no longer visible,
- ☞ refit the head restraints or put them back in place.

# Mirrors

## Door mirrors

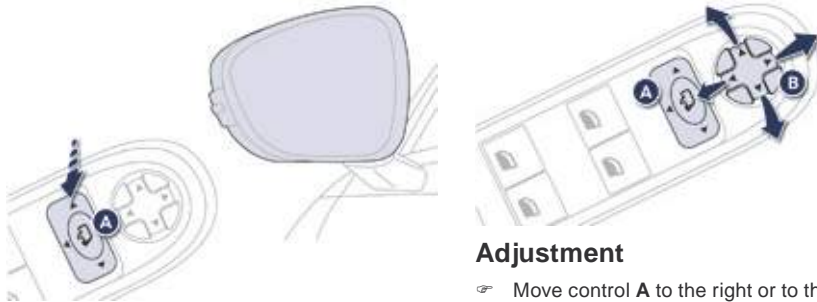

each fitted with an adjustable mirror glass providing the lateral rearward vision necessary for overtaking or parking. They can also be folded for parking in confined spaces.

### Demisting - Defrosting

Demisting-defrosting of the door mirrors operates with the engine running, by switching on the heated rear screen.

Refer to the "Rear screen demist-defrost" section.

### Adjustment

- ☞ Move control **A** to the right or to the left to select the corresponding mirror.
- ☞ Move control **B** in all four directions to adjust.
- ☞ Return control **A** to the central position.

**!** As a safety measure, the mirrors should be adjusted to reduce the "blind spots".

**i** The objects observed are, in reality, closer than they appear. Take this into account in order to correctly judge the distance of vehicles approaching from behind.

### Folding

- Automatic: lock the vehicle using the remote control or the key.
- Manual: with the ignition on, pull control **A** rearwards.

**i** If the mirrors are folded using control **A**, they will not unfold when the vehicle is unlocked. Pull again on control **A**.

### Unfolding

- Automatic: unlock the vehicle using the remote control or the key.
- Manual: with the ignition on, pull control **A** rearwards.

**i** The folding and unfolding of the door mirrors using the remote control can be deactivated by a Peugeot dealer or a qualified workshop. Fold the mirrors when putting your vehicle through an automatic car wash.

**i** If necessary, it is possible to fold the mirrors manually.

## Automatic tilting in reverse gear

System which provides a view of the ground during parking manoeuvres in reverse gear.



## Programming

- ☞ With the engine running, engage reverse gear.
  - ☞ Select and adjust the left-hand and right-hand mirrors in succession.
- The adjustment is stored immediately.

## Switching on

- ☞ With the engine running, engage reverse gear.
  - ☞ Move control **A** to the right or to the left to select the corresponding mirror.
- The glass of the mirror selected tilts downwards, in accordance with its programming.

## Switching off

- ☞ Exit reverse gear and wait ten seconds.
- or
- ☞ Return control **A** to the central position.
- The mirror glass returns to its initial position. The mirror glass also returns to its initial position:
- if the speed exceeds 6 mph (10 km/h),
  - if the engine is switched off.

## Rear view mirror

Adjustable mirror providing a central rearward view.

equipped with an anti-dazzle system, which darkens the mirror glass and reduces the nuisance to the driver caused by the sun, headlamps from other vehicles...



### Manual day/night model

#### Adjustment

- ☞ Adjust the mirror so that the glass is directed correctly in the "day" position.

#### Day / night position

- ☞ Pull the lever to change to the "night" anti-dazzle position.
- ☞ Push the lever to change to the normal "day" position.



### Automatic day/night model

By means of a sensor, which measures the light from the rear of the vehicle, this system automatically and progressively changes between the day and night uses.

**i** In order to ensure optimum visibility during your manoeuvres, the mirror lightens automatically when reverse gear is engaged.

## Steering wheel adjustment



- ☞ **When stationary**, lower the control lever to release the steering wheel adjustment mechanism.
- ☞ Adjust the height and reach to suit your driving position.
- ☞ Pull the control lever to lock the steering wheel adjustment mechanism.

**!** As a safety precaution, these operations should only be carried out while the vehicle is stationary.

## Interior fittings

### 1. Cooled glove box

It has a ventilation nozzle (delivering cool air) which can be closed\* using a thumb wheel, as well as a USB port\* for the 3g key.

### 2. Storage

#### 3. Retractable cup holder

Press the cover to open the cup holder

#### 4. Removable ashtray

Press the lid to open the ashtray. To empty it, pull it out by pulling it upwards.

### 5. Controls\*

Massage, Adaptive lighting, Blind spot monitoring, Alarm, Peugeot Connect SOS, Peugeot Connect Assistance.

### 6. Storage with sliding cover

### 7. Front armrest

### 8. 12 V accessory socket (120 W)\*

Observe the maximum power rating to avoid damaging your accessory

### 9. PEUGEOT Connect USB

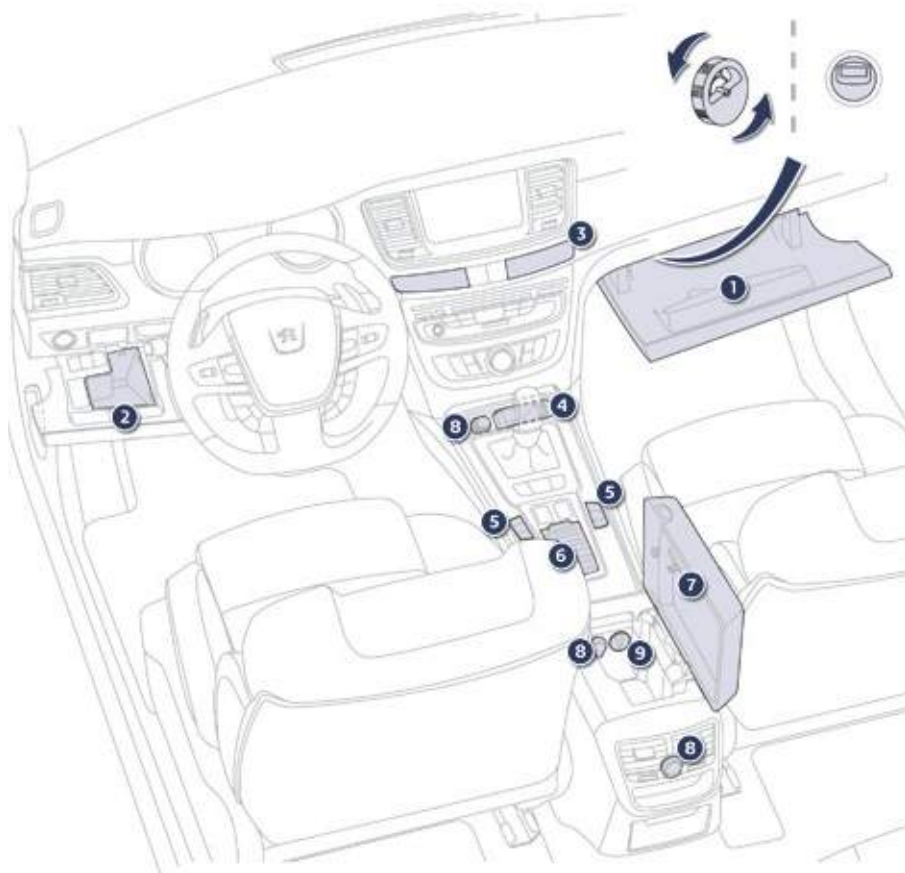

\* Depending on version.

## Mats

Removable carpet protection.

### Fitting

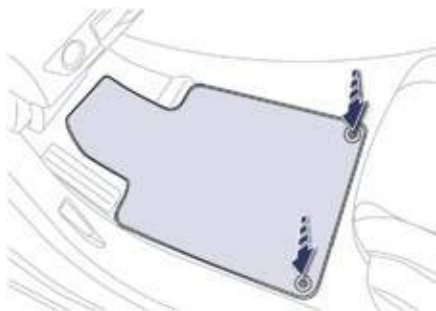

When fitting the mat for the first time, on the driver's side use only the fixings provided in the wallet attached.

For other mats simply place them on the carpet.

### Removal

To remove the mat on the driver's side:

- ☞ move the seat as far back as possible,
- ☞ unclip the fixings,
- ☞ remove the mat.

### Refitting

To refit the mat on the driver's side:

- ☞ position the mat correctly,
- ☞ refit the fixings by pressing,
- ☞ check that the mat is secured correctly.



To avoid any risk of jamming of the pedals:

- only use mats which are suited to the fixings already present in the vehicle; these fixings must be used,
- never fit one mat on top of another.

The use of mats not approved by Peugeot Ot may interfere with access to the pedals and hinder the operation of the cruise control / speed limiter.

The mats approved by Peugeot Ot have two fixings located below the seat.

## Rear armrest



- ☞ Lower the rear armrest for a more comfortable position.

It may be fitted with cup holders and also gives access to the ski flap.

# 3

## Ski flap

Facility for storing and transporting long objects.



### Opening

- ☞ Lower the armrest.
- ☞ Press the flap opening control.
- ☞ Lower the flap.
- ☞ Load the objects from inside the boot.

**i** Do not leave the flap open when not transporting long objects.

## Peugeot Connect u SB



This connection box comprises a JACK auxiliary socket and a u SB port. It permits the connection of portable device, such as a digital audio player of the iPod® type or a u SB memory stick.

It reads the audio file formats (MP3, Ogg, WMA, WAV, ...) which are transmitted to your audio equipment and played via the vehicle's speakers.

You can manage these files using the steering mounted controls or the audio system control panel and display them in the instrument panel screen.



When the u SB port is used, the portable device charges automatically.

While charging, a message is displayed if the current consumption of the portable device exceeds the current delivered by the vehicle.

**i** For more information on the use of this system, refer to the "Audio equipment and telematics" section.



## Boot fittings (Saloon)

1. **Retractable hooks**
2. **Storage pockets**  
With towing eye, a wheel chock and a temporary puncture repair kit (according to destination country and equipment).
3. **Stowing rings**
4. **Retaining straps**
5. **Boot lamp**
6. **Boot floor**  
For access to the storage compartments or the spare wheel (according to destination country), raise the floor
7. **Adjustable divider**

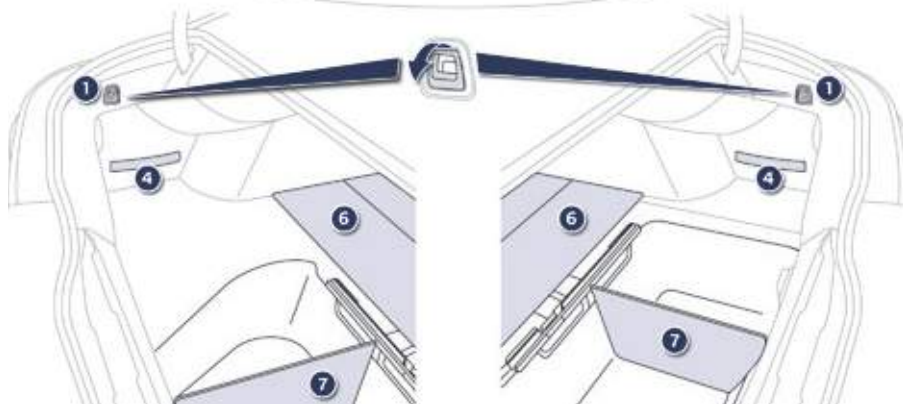
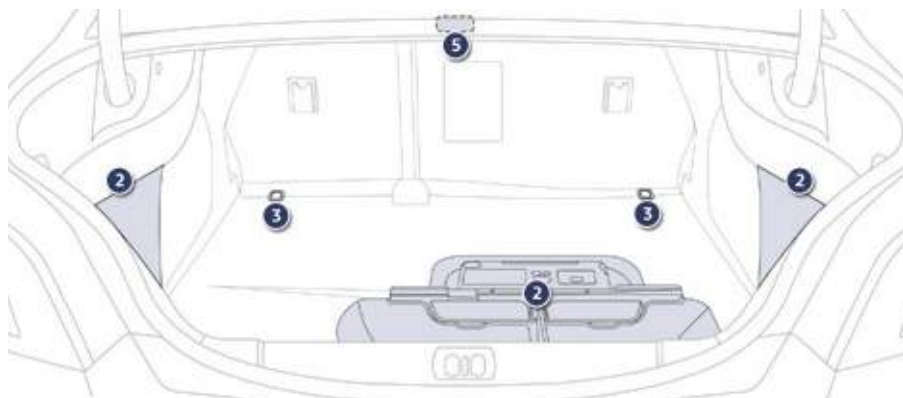

3

## Boot fittings (SW)

1. **Boot lamps**
2. **Rear seats folding controls**
3. **Retractable hooks**
4. **12 V accessory socket (120 W max)**
5. **Storage pockets**

With towing eye, a wheel chock and a temporary puncture repair kit (according to destination country and equipment).

6. **Stowing rings**
7. **Load space cover**  
(see following page)

### 8. **Boot floor**

For access to the storage compartments or the spare wheel (according to destination country), position the floor vertically in its guide.

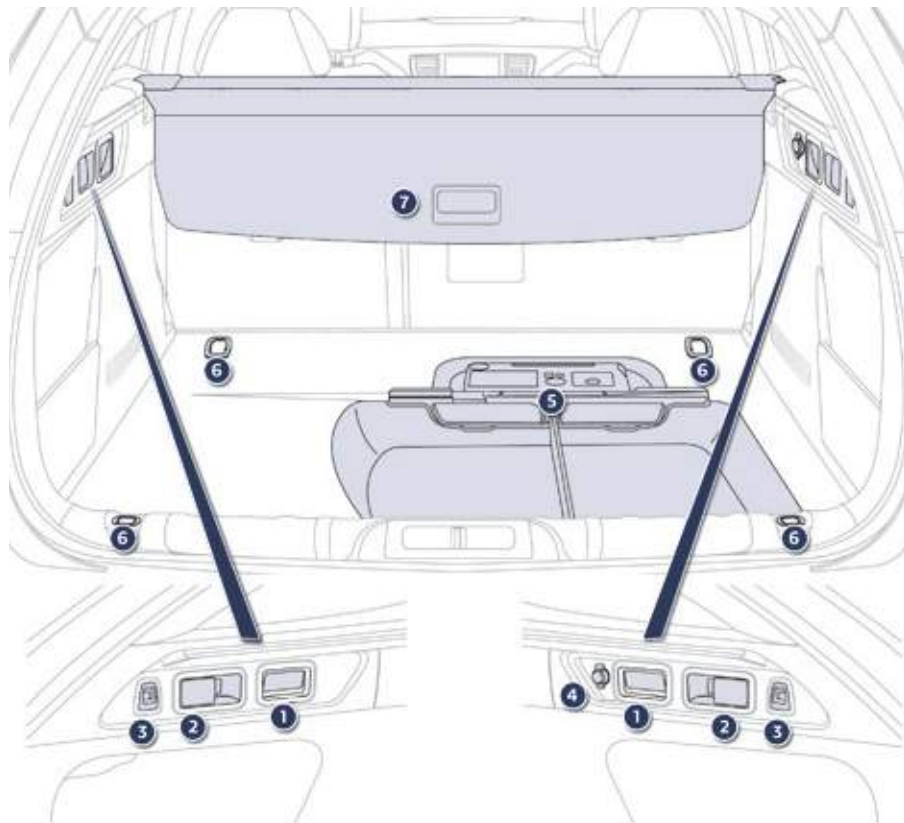
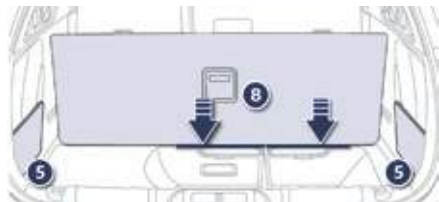

## Luggage cover (SW)

### To reel in



- ☞ Gently push on the (PReSS) handle, the luggage cover reels in automatically. The moving part **A** can be folded against the rear bench seat backrest.

### To remove

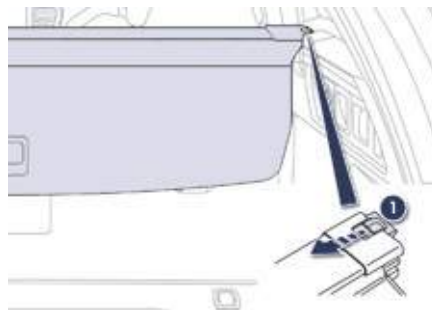

- ☞ Compress the control **1** and lift the luggage cover on the right then on the left to remove it.

### To install



- ☞ Position the left-hand end of the luggage cover roller in its location **B** behind the rear bench seat.
- ☞ Compress the roller control **1** and put the roller in place in its location **C** on the right.
- ☞ Release the control to secure the luggage cover.
- ☞ Unreel it to its fastening on the rear pillar.

# 3

## High load retaining net (SW)

Hooked onto the special upper and lower fixings, this allows the use of the entire loading volume up to the roof:

- behind the front seats (row 1) when the rear seats are folded.
- behind the rear seats (row 2).

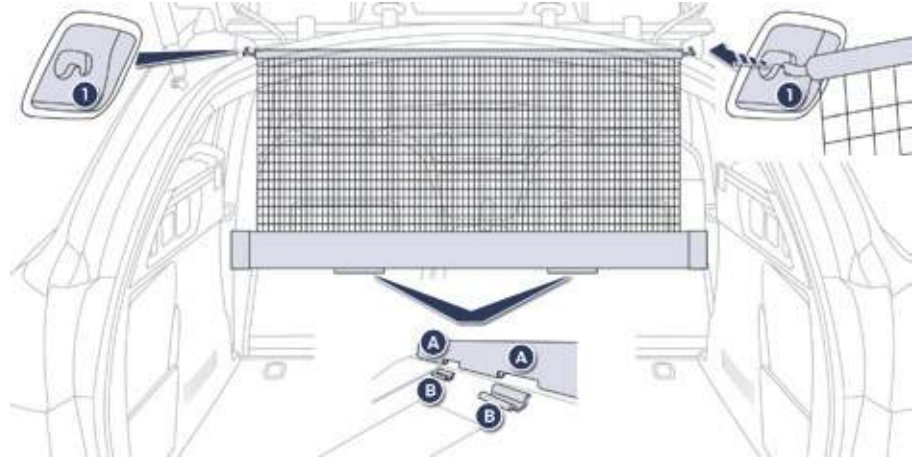

**i** Never reposition the rear seats if the net's roller is attached to the backs of the folded seats.

### Row 1

- ☞ position the net's roller above the two rails (located on the back of the folded rear seats),
- ☞ the two grooves **A** must be placed above the two rails **B**. Slide the two rails **B** in the grooves **A** and push the roller (lengthwise) from right to left to secure it,
- ☞ check that the net is hooked and tightened correctly,
- ☞ fold the rear seats,
- ☞ unroll the high load retaining net without stretching it,
- ☞ position one of the ends of the net's metal bar in the corresponding upper fixing **1**,
- ☞ pull the net's metal bar to position the other end in the other upper fixing **1**.

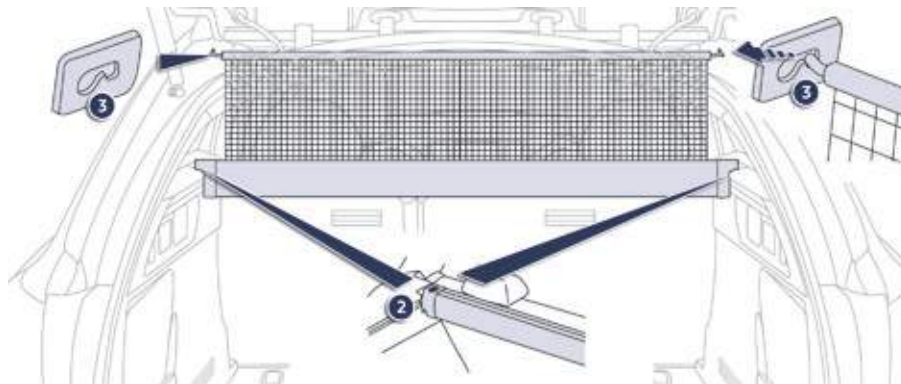

3

## Row 2

- ☞ reel in then remove the load space cover,
- ☞ position the left hand end of roller 2 in the load space cover support,
- ☞ position the right hand end of roller 2 in the load space cover support, then lock the position (red indicator),
- ☞ from the rear bench seat, unroll the high load retaining net by pushing to disengage the retaining hooks,
- ☞ position one of the ends of the net's metal bar in the corresponding upper fixing 3,
- ☞ pull on the net's metal bar to position the other end in the other upper fixing 3,
- ☞ check that the net is hooked and tensioned correctly.

## Heating and Ventilation

System which creates and maintains good conditions of comfort and visibility in the vehicle's passenger compartment.

### Air intake

The air circulating in the passenger compartment is filtered and originates either from the outside via the grille located at the base of the windscreen or from the inside in air recirculation mode.

### Controls

The incoming air follows various routes depending on the controls selected by the driver, the front passenger and rear passengers, according to the level of equipment.

The temperature control enables you to obtain the level of comfort required by mixing the air of the various circuits.

The air distribution control enables you to select the air vents used in the passenger compartment by the combined use of the associated buttons.

The air flow control enables you to increase or reduce the speed of the ventilation fan.



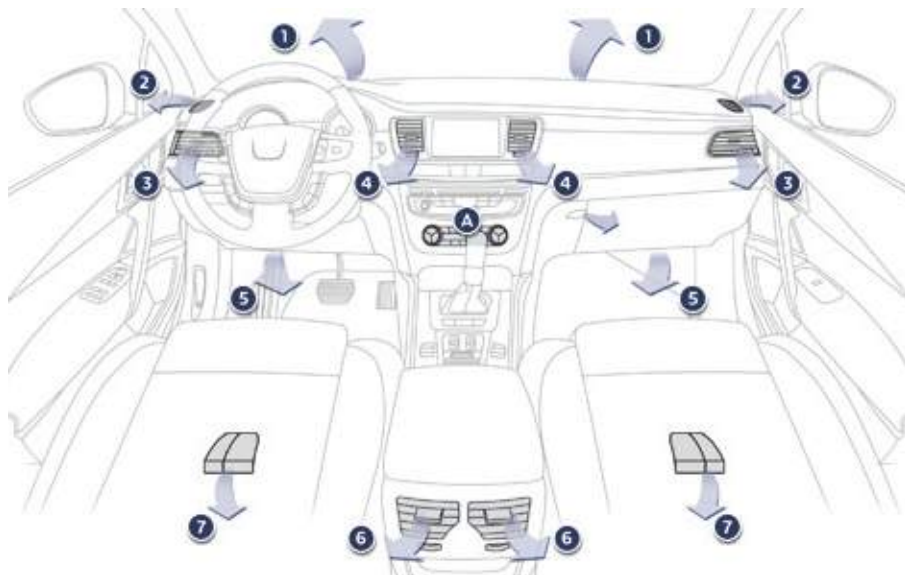









These controls are grouped together on control panel **A** on the centre console.



### Air distribution

1. Windscreen demisting/defrosting vents.
2. Front side window demisting/defrosting vents.
3. Side adjustable air vents.
4. Central adjustable air vents.
5. Air outlets to the front footwells.
6. Adjustable air vents for the rear passengers.
7. Air outlets to the rear footwells.

## Recommended interior settings

I require...	Heating or Manual air conditioning				
	Air distribution	Air flow	Air recirculation/Intake of exterior air	Temperature	Manual AC
HOT					
COLD					<b>ON</b>
DEMISTING DEFROSTING					<b>ON</b>

**Digital air conditioning:** use fully automatic operation in preference, by pressing the "AUTO" button.

## Recommendations for ventilation and air conditioning

- i** In order for these systems to be fully effective, follow the operation and maintenance guidelines below:
- ☞ If the interior temperature remains very high after the vehicle has been parked in the sun for a considerable time, first ventilate the passenger compartment for a few minutes. Place the air flow control at a sufficient level to provide an adequate renewal of air in the passenger compartment.
  - ☞ To obtain an even air distribution, take care not to obstruct the exterior air intake grilles located at the base of the windscreen, the nozzles, the vents and the air outlets, as well as the air extractor located in the boot.
  - ☞ Use in preference the intake of exterior air as prolonged use of the air recirculation may cause misting of the windows and side windows.
  - ☞ Do not cover the sunshine sensor, located on the dashboard; this is used for regulation of the automatic air conditioning system.
  - ☞ Operate the air conditioning system for 5 to 10 minutes, once or twice a month to keep it in good working order.
  - ☞ Ensure that the passenger compartment filter is in good condition and have the filter elements replaced regularly (refer to the "Checks" section).  
We recommend the use of a combined passenger compartment filter. Thanks to its second special active filter, it contributes to the purification of the air breathed by the occupants and the cleanliness of the passenger compartment (reduction of allergic symptoms, bad odours and greasy deposits).
  - ☞ The air conditioning uses power from the engine while operating. This results in an increase in the vehicle's fuel consumption.  
When towing at or near maximum capacity or on steep slopes in high ambient temperatures, switching off the air conditioning saves engine power and so improves towing capacity.  
Condensation created by the air conditioning results in a discharge of water under the vehicle when stationary, which is perfectly normal.
  - ☞ To ensure correct operation of the air conditioning system, you are also advised to have it checked regularly.
  - ☞ If the system does not produce cold air, do not use it and contact a Peugeot dealer or a qualified workshop.



The air conditioning system does not contain chlorine and does not present any danger to the ozone layer.



# Manual air conditioning

Manual air conditioning can only operate with the engine running.

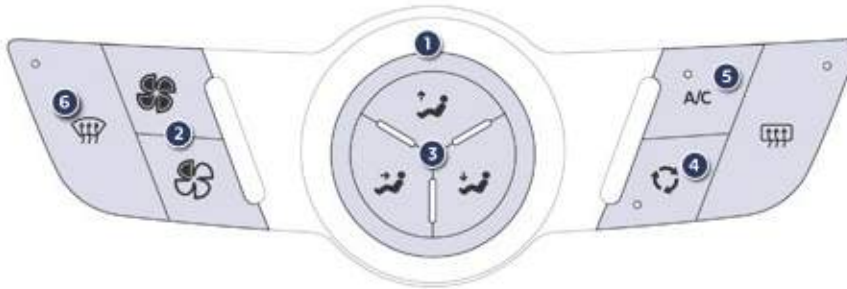

## 1. Temperature adjustment



Turn the dial from left (cold) to right (hot) to adjust the temperature to your requirements.

## 2. Air flow adjustment



Press the "full fan" button to increase the air flow. According to the value selected, the associated line of LEDs fills progressively.



Press the "empty fan" button to reduce the air flow.

## 3. Air distribution adjustment

Press the corresponding button for:



Windscreen and side windows.



Central and side vents.



Footwells.



Depending on your requirements, you can combine two distribution buttons or select the three distribution modes simultaneously.

## 4. Air intake / Air recirculation

The intake of exterior air prevents the formation of mist on the windscreen and side windows. The recirculation of interior air isolates the passenger compartment from exterior odours and smoke.

Return to exterior air intake as soon as possible to prevent deterioration of the air quality and the formation of mist.



☞ Press this button to recirculate the interior air. The indicator lamp comes on to confirm this.



☞ Press the button again to permit the intake of exterior air. The indicator lamp goes off to confirm this.

## 5. Air conditioning On / Off

**A/C**

The air conditioning is designed to operate effectively in all seasons, with the windows closed.

It enables you to:

- lower the temperature, in summer,
- increase the effectiveness of the demisting in winter, above 3°C.

### Switching on

☞ Press the "**A/C**" button, its indicator lamp comes on.

The air conditioning does not operate when the air flow adjustment is set to off.

**i** To obtain cool air sooner, you can use recirculation of the interior air for a few moments. Then return to the intake of exterior air.

### Switching off

☞ Press the "**A/C**" button again, its indicator lamp goes off.

Switching off may result in some discomfort (humidity, misting).

## 6. Automatic visibility programme



See "Front demisting - Defrosting".

# Dual-zone digital air conditioning

The air conditioning can only operate with the engine running.

## Automatic operation

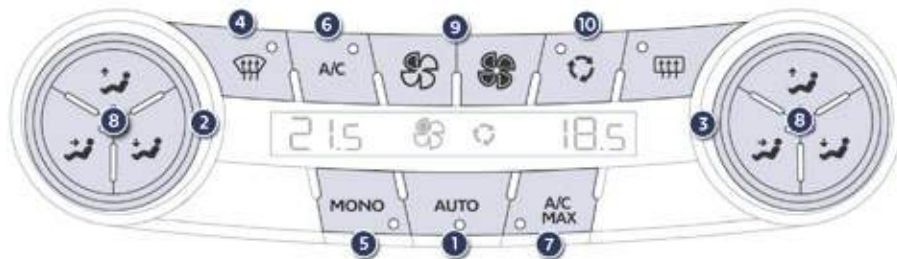

### 1. Automatic comfort programme

#### AUTO

☞ Press this "AUTO" button. The indicator lamp comes on.

We recommend that you use this mode. It automatically adjusts all settings to provide optimum operation for the comfort level chosen: passenger compartment temperature, air flow, air distribution and air recirculation. This system is designed to operate effectively in all seasons, with the windows closed.

**i** When the engine is cold, to prevent too great a distribution of cold air, the air flow will reach its optimum level gradually. In cold weather, it favours the distribution of warm air to the windscreen, side windows and footwells only.

### 2 - 3. Driver-passenger side adjustment

The driver and front passenger can each adjust the temperature to their requirements.

The value indicated on the display corresponds to a level of comfort and not to a temperature in degrees Celsius or Fahrenheit.



☞ Turn control **2** or **3** to the left (blue) or to the right (red) respectively to decrease or increase this value.

A setting around the value 21 provides optimum comfort. However, depending on your requirements, a setting between 18 and 24 is normal.

It is recommended that the difference between left and right should not be greater 3.

**i** On entering the vehicle, if the interior temperature is much colder or warmer than the comfort value, there is no need to change the value displayed in order to obtain the comfort required. The system corrects the difference in temperature automatically and as quickly as possible.

#### 4. Automatic visibility programme



See "Front demisting-defrosting".

**i** With Stop & Start, when demisting has been activated, the St OP mode is not available.

#### 5. Mono-zone / Dual-zone



☞ Press this button to equalise the comfort value on the passenger's side with that on the driver's side (mono-zone). The indicator lamp in the button comes on.

#### 6. Air conditioning On / Off



The air conditioning is designed to operate effectively in all seasons, with the windows closed.

It allows you:

- in summer, to lower the temperature,
- in winter, above 3°C, to improve demisting performance.

##### Switching on

☞ Press the "A/C" button, the associated green indicator lamp comes on.

**The air conditioning does not operate when the air flow control is set to off.**

##### Switching off

☞ Press the "A/C" button again, the associated green indicator lamp goes off. Switching off the air conditioning may result in some discomfort (humidity, misting).

#### 7. Maximum air conditioning



If you want to temporarily refresh the air in the passenger compartment, press this button and "LO" is displayed.

To return to the previous settings, press the button again.

#### Manual operation

If you wish, you can change one of settings provided by the system. The other functions will still be controlled automatically.

☞ Pressing the "AUTO" button returns the system to completely automatic operation.

**i** For maximum cooling or heating of the passenger compartment, it is possible to exceed the minimum value 14 or the maximum value 28.

☞ Turn control **2** or **3** to the left until "LO" is displayed or to the right until "HI" is displayed.

## 8. Air distribution adjustment

☞ Press the corresponding button for:



Windscreen and side windows.



Centre and side vents.



Footwells.



To suit your requirements, you can combine two distribution buttons or select the three distribution modes simultaneously.

## 9. Air flow adjustment



☞ Press this "**full fan**" button to increase the air flow.

When the air flow symbol, the fan, fills progressively according to the value requested.



☞ Press "**empty fan**" button to reduce the air flow.

## Switching the system off



☞ Press this "**empty fan**" air flow button until the fan symbol disappears and "--" appears.

This action switches off all of the functions of the air conditioning system.

Temperature related comfort is no longer guaranteed but a slight flow of air, due to the forward movement of the vehicle, can still be felt.

## 10. Air intake / Air recirculation



☞ Press this button for recirculation of the interior air. The indicator lamp on the button comes on.

Air recirculation enables the passenger compartment to be isolated from exterior odours and smoke. It is activated automatically when operating the screenwash.

☞ As soon as possible, press this button again to permit the intake of outside air and prevent the formation of condensation. The indicator lamp in the button goes off.



Avoid driving for long periods with the system off (risk of condensation and deterioration of the air quality).

Pressing the "**full fan**" button reactivates the system with the values in use at the time it was switched off.

# Quad-zone digital air conditioning

The air conditioning can only operate with the engine running.

## Automatic operation

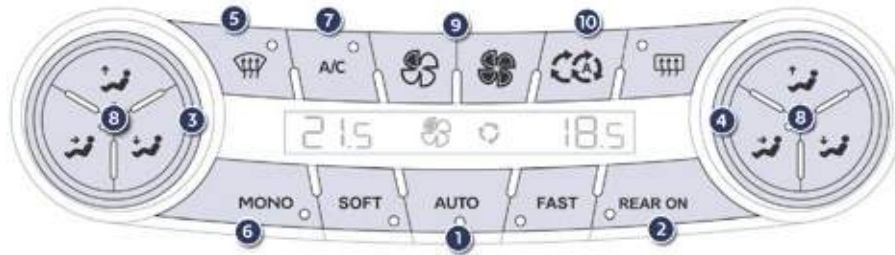

### 1. Automatic comfort programme

The Soft/Auto/Fast modes allow the driver and front seat passenger to select their desired comfort settings for the passenger compartment:

**SOFT** Favours optimum gentle and silent operation by limiting the air flow.

**AUTO** Offers the best compromise between thermal comfort and silence of operation.

**FAST** Favours dynamic and effective air flow.

### 2. Activating/deactivating the rear air conditioning

**REAR ON** Press this button to deactivate the rear air conditioning and lock the system. A padlock appears in the LCD screen. When the rear system is reactivated, automatic mode is selected with the last temperature settings used.

### 3 - 4. Driver-passenger side adjustment

The driver and front passenger can each adjust the temperature to their requirements.

The value indicated on the display corresponds to a level of comfort and not to a temperature in degrees Celsius or Fahrenheit.



Turn control **3** or **4** to the left (blue) or to the right (red) respectively to decrease or increase this value.

A setting around the value 21 provides optimum comfort. However, depending on your requirements, a setting between 18 and 24 is normal.

It is recommended that the difference between left and right should not be greater 3.

**i** On entering the vehicle, if the interior temperature is much colder or warmer than the comfort value, there is no need to change the value displayed in order to obtain the comfort required. The system corrects the difference in temperature automatically and as quickly as possible.

## 5. Automatic visibility programme



See "Front demisting-defrosting".

**i** With Stop & Start, when demisting has been activated, the Stop mode is not available.

## 6. Mono-zone / Quad-zone

**MONO**

Press this button to apply the driver's comfort setting value to the front and rear passengers (mono-zone). The indicator lamp on the button comes on.

## 7. Air conditioning On / Off

**A/C**

The air conditioning is designed to operate effectively in all seasons, with the windows closed.

It allows you:

- in summer, to lower the temperature,
- in winter, above 3°C, to improve demisting performance.

### Switching on

- ☞ Press the "A/C" button, the associated green indicator lamp comes on.

**The air conditioning does not operate when the air flow control is set to off.**

### Switching off

- ☞ Press the "A/C" button again, the associated green indicator lamp goes off.

Switching off the air conditioning may result in some discomfort (humidity, misting).

## Manual operation

If you wish, you can change one of settings provided by the system. The other functions will still be controlled automatically. Press one of the Soft/Auto/Fast buttons to return to fully automatic operation.

- i** For maximum cooling or heating of the passenger compartment, it is possible to exceed the minimum value 14 or the maximum value 28.
- ☞ Turn the dial **3** or **4** to the left until "LO" is displayed or to the right until "HI" is displayed.

## 8. Air distribution adjustment

☞ Press the corresponding button for:



Windscreen and side windows.



Centre and side vents.



Footwells.



To suit your requirements, you can combine two distribution buttons or select the three distribution modes simultaneously.

## 9. Air flow adjustment



☞ Press this "**full fan**" button to increase the air flow.

The symbol for air flow, the fan, fills progressively according to the value requested.



☞ Press "**empty fan**" button to reduce the air flow.

### Switching the system off



☞ Press this "**empty fan**" air flow button until the fan symbol disappears and "-" appears.

This action switches off all of the functions of the air conditioning system. Temperature related comfort is no longer assured but a slight flow of air, due to the forward movement of the vehicle, can still be felt. Avoid driving for long periods with the system off (risk of condensation and deterioration of the air quality). Pressing the "**full fan**" button reactivates the system with the values in use at the time it was switched off.

## 10. Air intake / Air recirculation



### Automatic air intake mode

It is activated by default with automatic comfort regulation.

Air recirculation enables the passenger compartment to be isolated from exterior odours and smoke. It is activated automatically when operating the screenwash. It is inactive when the ambient temperature is below 5°C to guard against the risk of misting in the vehicle.

☞ As soon as possible, press this button again to permit the intake of outside air and prevent the formation of condensation. The indicator lamp in the button goes off.



## Adjusting the rear passenger comfort level

The rear air conditioning controls only operate if, from the front:

- the **REAR** button is activated,
- the automatic visibility programme is not activated.



### 1. Automatic comfort programme

**AUTO**

- ☞ Press the "**AUTO**" button. The lamp in the button comes on.

We recommend that you use this mode. It automatically adjusts all settings to provide optimum operation for the comfort level chosen: passenger compartment temperature, air flow and air distribution.

This system is designed to operate effectively in all seasons, with the windows closed.

### 2. Air distribution adjustment

Press the corresponding button successively for:

-  - Footwell and centre vent.
-  - Centre vent.
-  - Automatic control of air distribution.

### 3. Temperature adjustment, left and right

The left and rear passengers can each adjust their temperature setting independently.

The value indicated in the screen is a level of comfort and not a temperature in degrees Celsius or Fahrenheit.



- ☞ Turn the dial to the left to lower the value and to the right to raise it.

A setting around 21 provides an optimum level of comfort. However, depending on your requirements, a setting between 18 and 24 is normal.

It is recommended that the difference between left and right should not be greater than 3. Ensure that the air grilles and vents on the floor are not obstructed.

## 4. Air flow adjustment



- ☞ Press this "full fan" button to increase the air flow.

At the air flow symbol, the fan, fills progressively as the fan speed increases.



- ☞ Press this "empty fan" button to reduce the air flow.

## Deactivating the system



- ☞ Press the "empty fan" air flow button until the fan disappears and "- -" appears.

This action stops all of the functions of the air conditioning system.

Thermal comfort is no longer controlled.

However, a slight air flow may still be felt, resulting from the forward movement of the vehicle.

## Front demist - defrost

### With manual air conditioning



- Select this programme to demist or defrost the windscreen and side windows as quickly as possible.

The system automatically manages the air conditioning, air flow and air intake, and provides optimum distribution towards the windscreen and side windows.

Adjust the temperature control to quickly demist/defrost the windows.

To switch it off, press the "visibility" button again, the warning lamp in the button goes off and the system reverts to the previous settings.

### With dual-zone and quad-zone digital air conditioning

#### Automatic visibility programme



- Select this programme to demist or defrost the windscreen and side windows as quickly as possible.

The system automatically manages the air conditioning, air flow and air intake, and provides optimum distribution towards the windscreen and side windows.

With the quad-zone digital air conditioning, pressing this button deactivates and locks the rear air conditioning.

- To stop the programme, press either the "visibility" button again or "AUTO", the warning lamp on the button goes off and the warning lamp in the "AUTO" button comes on.

The system reverts to the previous settings.

**i** With Stop & Start, when demisting has been activated, the St OP mode is not available.

## Rear screen demist - defrost

The rear screen demist - defrost can only operate when the engine is running.



The control button is located on the air conditioning system control panel.

### Switching on

- Press this button to demist/defrost the rear screen and, depending on version, the door mirrors. The indicator lamp associated with the button comes on.

### Switching off

The demist/defrost switches off automatically to prevent an excessive consumption of current.

- It is possible to stop the demist/defrost operation before it is switched off automatically by pressing the button again. The indicator lamp associated with the button goes off.



- Switch off the demist/defrost of the rear screen and door mirrors as soon as it is no longer needed as lower current consumption results in reduced fuel consumption.

# Programmable Heating / Ventilation



## Programmable heating mode

This is an additional and separate system which heats the engine hot water circuit to improve defrosting and to preheat the passenger compartment.



This indicator lamp comes on only when if the system is programmed in programmable heating mode.

## Programmable Ventilation mode

This mode allows ventilation of the passenger compartment with exterior air to improve the temperature experienced on entering the vehicle in summer.

## Programming



With the ignition on, press the left hand steering mounted thumb wheel for access to the main menu.

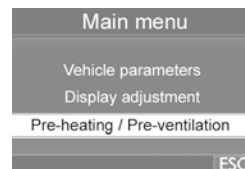

- In the "Main menu", select "Pre-heating / Pre-ventilation".

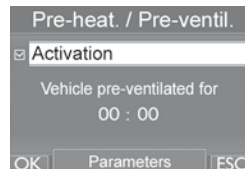

- Select "Activation" and if necessary for programming, "Parameters".



- Select "Heating" to preheat the engine or passenger compartment or "Ventilation" to ventilate the passenger compartment.

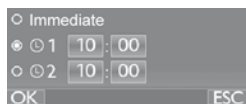

Select:

- immediate to start the heating or ventilation (once confirmed "OK"),
- the first clock to programme/store your departure time,
- the second clock to programme/store a second departure time.

Depending on the departure time chosen, the system calculates automatically the optimum time to start operating.

The immediate or programmed activation of Ventilation mode depends on the temperatures inside and outside the vehicle.

Using these two clocks and according to season you can, for example, select one or the other departure time. A message in the instrument panel screen confirms your choice.

Only one programmed or immediate preheating/preventilation can be activated between two starts of the vehicle.

The heating and the ventilation in immediate or programmable mode is not activated when:

- the fuel level is too low,
- the battery is not sufficiently charged.

To programme the heating and the ventilation, it is necessary to first **deactivate** the alarm volumetric and tilt monitoring (see the "Alarm" section).

Always switch off the programmable heating while refuelling to avoid any risk of fire or explosion. To avoid the risk of intoxication and asphyxiation, the programmable heating must not be used, even for short periods, in an enclosed area such as a garage or workshop not equipped with exhaust gas extraction. Do not park the vehicle on an inflammable surface (dry grass, dead leaves, paper...), there is a risk of fire.

# Starting-switching off the engine

With a **manual gearbox**, put the gear lever in neutral.

With an **electronic gearbox**, put the gear lever in **N**.

With an **automatic gearbox**, put the gear lever in **P** or **N**.

**i** To ensure the correct operation and durability of the engine and gearbox, when the ambient temperature is below  $-23^{\circ}\text{C}$ , it is necessary to leave the engine running at idle for four minutes.

## Starting using the key

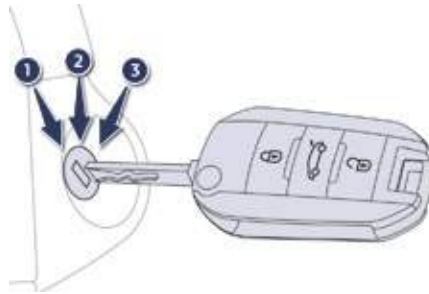

- ☞ Insert the key in the ignition switch.
- ☞ Turn the key fully towards the dashboard to position **3 (Starting)**.
- ☞ When the engine starts, release the key.

## Switching off using the key

- ☞ Immobilise the vehicle.
- ☞ Turn the key fully towards you to position **1 (Stop)**.
- ☞ Remove the key from the ignition switch.

### **i** Key left in the ignition

If the key is left in the ignition switch, there is an audible signal on opening the driver's door.

**!** Switching off the engine leads to a loss of braking assistance.

## Starting using the electronic key

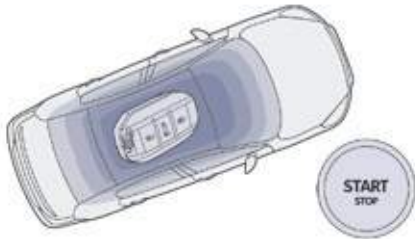

- ☞ With the electronic key inside the vehicle, press the brake pedal on vehicles with automatic or electronic gearbox, or depress the clutch pedal fully on vehicles with a manual gearbox, then maintain pressure until the engine starts.



- ☞ Press the "START/STOP" button.

**i** If one of the starting conditions is not met, a reminder message appears in the instrument panel screen. In some circumstances, it is necessary to turn the steering wheel slightly while pressing the "St ARt /St OP" button to assist unlocking of the steering; a message warns you when this is needed.

## Switching off using the electronic key

- ☞ Immobilise the vehicle.



- ☞ With the electronic key inside the vehicle, press the "START/STOP" button.

When the engine stops and the steering column is locked.

**i** If the vehicle is not immobilised, the engine will not stop.

### Accessory position

With the electronic key inside the vehicle, press the "St ARt /St OP" button, with no action on the pedals, to switch the ignition on or off and so activate accessories.



For Diesel vehicles, in very cold weather the engine will not start until the pre-heater warning lamp has gone off.

## Anti-theft protection

### Electronic engine immobiliser

The keys contain an electronic chip which has a secret code. When the ignition is switched on, this code must be recognised in order for starting to be possible.

This electronic engine immobiliser locks the engine management system a few minutes after the ignition is switched off and prevents starting of the engine by anyone who does not have the key.

In the event of a malfunction, you are informed by a message in the instrument panel screen. In this case, your vehicle does not start; contact a Peugeot dealer as soon as possible.

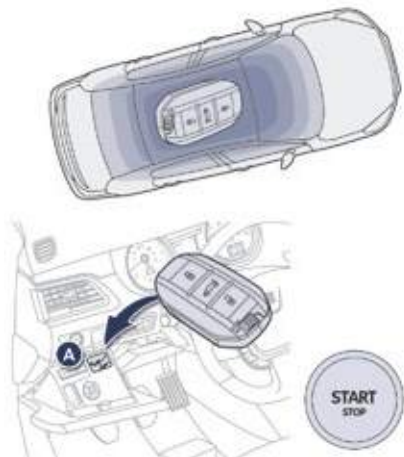

### Emergency starting with the electronic key

When the electronic key is in the recognition zone and your vehicle does not start after pressing the "St ARt /St OP" button:

- ☞ Open the housing below the "St ARt /St OP" button.
- ☞ Insert the electronic key in the location **A**.
- ☞ Press the "St ARt /St OP" button.

**i** Once the engine has started, you can remove the electronic key and close the housing.



### Emergency switch-off using the electronic key

In the event of an emergency only, the engine can be switched off without conditions. To do this, press and hold the "St ARt /St OP" button for about 3 seconds.

In this case the steering column locks as soon as the vehicle stops.

If the electronic key is no longer in the recognition zone when you request switching off the engine, a message appears in the instrument panel.

- ☞ Press and hold the "St ARt /St OP" button for about 3 seconds if you want to force switching off the engine (note that restarting will not be possible without the key).

**!** The electronic key must always remain inside the vehicle while in use.



# electric parking brake



The electric parking brake combines 2 operating modes:

- **Automatic Application/Release**  
Application is automatic when the engine stops, release is automatic on use of the accelerator (this mode is activated by default),
- **Manual Application/Release**  
Manual application of the parking brake is by pulling control lever **A**.  
Manual release is by pushing and releasing the control lever, while pressing the brake pedal.

When the driver's door is opened, there is an audible signal and a message is displayed if the brake is not applied.

## Programming the mode

Depending on the country of sale of the vehicle, the automatic application when the engine is switched off and the automatic release when you press the accelerator can be deactivated.



Activation / deactivation is done via the menu in the instrument panel screen.

The parking brake is then applied and released manually.



If this warning lamp comes on in the instrument panel, the automatic mode is deactivated.



It is recommended that you do not apply the parking brake in very cold conditions (ice) and during towing (breakdown, caravan...). Deactivate the automatic functions and release the parking brake manually.

## Manual application

With the vehicle stationary, to apply the parking brake whether the engine is running or off, **pull** control lever **A**.

The application of the parking brake is confirmed by:

- lighting of the braking warning lamp and of the **P** warning lamp in the control lever **A**,
- display of the message "Parking brake on".



When the driver's door is opened with the engine running, there is an audible signal and a message is displayed if the parking brake has not been applied, unless the gear lever is in position **P** (Park) in the case of an automatic gearbox.



Before leaving the vehicle, check that parking brake warning lamps in the instrument panel and the control lever **A** are on, not flashing.

## Manual release



With the ignition on or the engine running, to release the parking brake, **press the brake pedal, pull** then release control lever **A**. The full release of the parking brake is confirmed by:

- the braking warning lamp and the **P** warning lamp in the control lever **A** going off,
- display of the message "Parking brake off".

If you pull the control lever **A** without pressing the brake pedal, the parking brake will not be released and a message appears in the instrument panel.

## Maximum application

If necessary, you can make a **maximum application** of the parking brake. It is obtained by means of a **long pull** on control lever **A**, until you see the message "Parking brake applied fully" and an audible signal is heard.

### Maximum application is essential:

- in the case of a vehicle towing a caravan or a trailer, if the automatic functions are activated but you are applying the parking brake manually,
- when the slope you are parked on may vary (e.g. on a ferry, on a lorry, during towing).

**i** In the case of towing, a loaded vehicle or parking on a gradient, make a maximum application of the parking brake then turn the front wheels towards the pavement and engage a gear when you park. After a maximum application, the release time will be longer.

## Automatic application, engine off

With the vehicle stationary, the parking brake **is automatically applied when the engine is switched off**.

The application of the parking brake is confirmed by:

- illumination of the braking warning lamp and of the **P** warning lamp in the control lever **A**,
- display of the message "Parking brake on".





Before leaving the vehicle, check that parking brake warning lamps in the instrument panel and in the control lever **A** are on fixed (not flashing). Never leave a child alone inside the vehicle with the ignition on, as they could release the parking brake.

## Automatic release

The electric parking brake **releases automatically and progressively** when you press the accelerator:

- ☞ **Manual gearbox:** press down fully on the clutch pedal, engage first gear or reverse, press on the accelerator pedal and move off.
- ☞ **Electronic gearbox:** select position **A**, **M** or **R** then press on the accelerator pedal.
- ☞ **Automatic gearbox:** select position **D**, **M** or **R** then press on the accelerator pedal.

Full release of the parking brake is confirmed by:



-  - the braking warning lamp and the **P** warning lamp in the control lever **A** going off,
-  - display of the message "Parking brake off".

**!** When stationary, with the engine running, do not press the accelerator pedal unnecessarily, as you may release the parking brake.

## Immobilising the vehicle, engine running

With the engine running and the vehicle stationary, in order to immobilise the vehicle it is essential to **manually** apply the parking brake by **pulling** control lever **A**.

The application of the parking brake is confirmed by:

-  - illumination of the braking warning lamp and of the **P** warning lamp in the control lever **A**,
-  - display of the message "Parking brake on".

When the driver's door is opened, a loud beep is heard and a message is displayed if the parking brake has not been applied, unless the gear lever is in position **P** (Park) in the case of an automatic gearbox.

**!** Before leaving the vehicle, check that parking brake warning lamps in the instrument panel and the control lever **A** are on fixed, not flashing.

## Particular situations

In certain situations (e.g. starting the engine), the parking brake can automatically alter its force. This is normal operation.

To advance your vehicle a few centimetres without starting the engine, but with the ignition on, press on the brake pedal and release the parking brake **by pushing** then **releasing** control lever **A**. The full release of the parking brake is confirmed by the warning lamps in the control lever **A** and in the instrument panel going off and display of the message "Parking brake off".

If a parking brake fault occurs **while applied** or if the battery runs flat, an emergency release is always possible.

In order to ensure correct operation and so your safety, the number of successive application/release operations of the parking brake is limited to eight.

In the event of abuse, you are alerted by a message "Parking brake faulty" and a warning lamp flashes.

## Emergency braking



In the event of a failure of the main service brake, a continuous pull on the control lever **A** will stop the vehicle.

The dynamic stability control provides stability during emergency braking.

If the emergency braking malfunctions, the message "Parking brake control faulty" will be displayed.



If a failure of the DSC system is signalled by the lighting of this warning lamp, then braking stability is not guaranteed.

In this event, stability must be assured by the driver by repeating alternate "pull-release" actions on the control lever **A**.

! The emergency braking must only be used in exceptional circumstances.



! In the event of a battery failure, the parking brake can no longer be operated.





As a safety measure, if the parking brake is not applied, immobilise the vehicle by engaging a gear or by placing a chock against one of the wheels.

Contact a Peugeot dealer or a qualified workshop.

## Operating faults

If the electric parking brake fault warning lamp comes on together with one or more of the warning lamps presented in these tables, place the vehicle in a safe condition (on level ground, gear engaged) and contact a Peugeot dealer or a qualified workshop without delay.

Situations	Consequences
<p>Display of the message <b>"Parking brake fault"</b> and of the following warning lamps:</p> 	<ul style="list-style-type: none"> <li>- the automatic functions are deactivated.</li> <li>- Hill start assist is not available.</li> <li>- the electric parking brake can only be used manually.</li> </ul>
<p>Display of the message <b>"Parking brake fault"</b> and of the following warning lamps:</p> 	<ul style="list-style-type: none"> <li>- Manual release of the electric parking brake is only available by pressing the accelerator pedal and releasing the control lever.</li> <li>- Hill start assist is not available.</li> <li>- the automatic functions and the manual application are still available.</li> </ul>
<p>Display of the message <b>"Parking brake fault"</b> and of the following warning lamps:</p> 	<ul style="list-style-type: none"> <li>- the automatic functions are deactivated.</li> <li>- Hill start assist is not available.</li> </ul>

Situations	Consequences
<p>  </p> <p>and possibly</p> <p>  </p> <p>flashing.</p>	<p>to apply the electric parking brake:</p> <ul style="list-style-type: none"> <li>☞ immobilise the vehicle and switch off the ignition.</li> <li>☞ pull the control for at least 5 seconds or until application is complete.</li> <li>☞ switch on the ignition and check that the electric parking brake warning lamps come on.</li> </ul> <p>the application is slower than during normal operation.</p> <p>to release the electric parking brake:</p> <ul style="list-style-type: none"> <li>☞ switch on the ignition.</li> <li>☞ push the control lever and hold it for approximately 3 seconds then release it.</li> </ul> <p>If the braking warning lamp is flashing or if the warning lamps do not come on with the ignition on, these procedures will not work. Place the vehicle on level ground and have it checked by a Peugeot dealer or a qualified workshop.</p>
<p>Display of the message "<b>Parking brake fault</b>" and of the following warning lamps:</p> <p>  </p> <p>and possibly</p> <p>  </p> <p>flashing.</p>	<ul style="list-style-type: none"> <li>- Only the automatic application on switching off the engine and automatic release on acceleration functions are available.</li> <li>- the manual application/release of the electric parking brake and the emergency braking are not available.</li> </ul>
<p>Display of the message "<b>Battery charge fault</b>".</p> <p>  </p>	<ul style="list-style-type: none"> <li>- You must stop as soon as it is safe to do so. Switch off and immobilise your vehicle (if necessary, place the a chock under a wheel).</li> <li>- Apply the electric parking brake before switching off the engine.</li> </ul>

# Manual parking brake



## Application

- ☞ With your foot on the brake pedal, pull the parking brake lever up to immobilise your vehicle.

## Release

- ☞ With your foot on the brake pedal, pull the parking brake lever up gently, press the release button then lower the lever fully.



When the vehicle is being driven, if this warning lamp and the **STOP** warning lamp come on, accompanied by an audible signal and a message, indicating that the parking brake is still on or has not been fully released.



When parking on a slope, direct your wheels against the kerb, apply the parking brake, engage a gear with a manual gearbox or position **P** with an automatic gearbox and switch off the ignition.



Pressing the brake pedal makes it easier to apply or release the manual parking brake.

## 6-speed manual gearbox

### Engaging 5<sup>th</sup> or 6<sup>th</sup> gear

- ☞ Move the lever fully to the right to engage 5<sup>th</sup> or 6<sup>th</sup> gear.

**!** Failure to observe this procedure may cause permanent damage to the gearbox (engaging 3<sup>rd</sup> or 4<sup>th</sup> gear by mistake).

### Engaging reverse gear

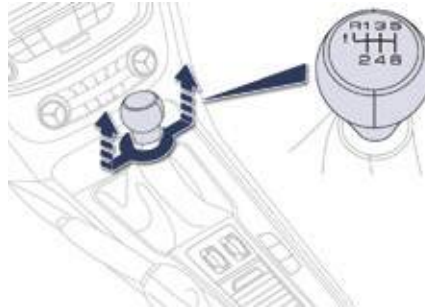

- ☞ Raise the ring under the knob and move the gear lever to the left then forwards.

**!** Only engage reverse gear when the vehicle is stationary with the engine at idle.

**i** As a safety precaution and to facilitate starting of the engine:

- always select neutral,
- press the clutch pedal.

When driving on flooded roads or when crossing a ford, drive at walking speed.

**!** When traversing a flooded road or a ford, drive at walking pace.



# gear shift indicator\*

System which reduces fuel consumption by advising the driver to change up.

## Operation

The system intervenes only when driving economically.

Depending on the driving situation and your vehicle's equipment, the system may advise you to skip one or more gears. You can follow this instruction without engaging the intermediate gears.

The gear engagement recommendations must not be considered compulsory. In fact, the configuration of the road, the amount of traffic and safety remain determining factors when choosing the best gear. Therefore, the driver remains responsible for deciding whether or not to follow the advice given by the system.

This function cannot be deactivated.

**i** With an electronic or automatic gearbox, the system is only active in manual mode.

example:



- You are in third gear.



- You press the accelerator pedal moderately.



- The system may suggest that you engage a higher gear, if appropriate.

The information appears in the instrument panel in the form of an arrow accompanied by the suggested gear.

**i** In the case of driving which makes particular demands on the performance of the engine (firm pressure on the accelerator pedal, for example, when overtaking...), the system will not recommend a gear change.

The system never suggests:

- engaging first gear,
- engaging reverse gear,
- engaging a lower gear.

\* Depending on engine.

# "Porsche Tiptronic System" automatic gearbox

Six speed automatic gearbox which offers a choice between the comfort of fully automatic operation, enhanced by sport and snow programmes, or manual gear changing. Four driving modes are offered:

- **automatic** operation for electronic management of the gears by the gearbox,
- **sport** programme for a more dynamic style of driving,
- **snow** programme to improve driving when traction is poor,
- **manual** operation for sequential changing of the gears by the driver.

## Gear lever



1. "S" (sport) programme switch.
2. "❄️" (snow) programme switch.

## Gear selection gate

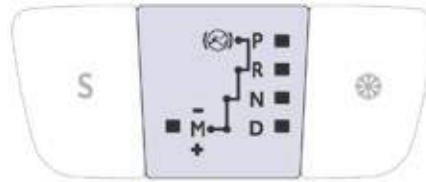

### P. Park.

- Immobilisation of the vehicle, parking brake on or off.
- Starting the engine.

### R. Reverse.

- Reversing manoeuvres, vehicle stationary, engine at idle.

### N. Neutral.

- Immobilisation of the vehicle, parking brake on.
- Starting the engine.

### D. Automatic operation.

### M.+ / - Manual operation with sequential changing of the six gears.

- ☞ Pull backwards to change up through the gears.

or

- ☞ Push forwards to change down through the gears.

## Steering mounted controls



### + Control paddle to change up, to the right of the steering wheel.

- ☞ Press the back of "+" steering mounted paddle to change up.

### - Control paddle to change down, to the left of the steering wheel.

- ☞ Press the back of the "-" steering mounted paddle to change down.

**i** The steering mounted control paddles cannot be used to select neutral or to select or come out of reverse.

## Displays in the instrument panel

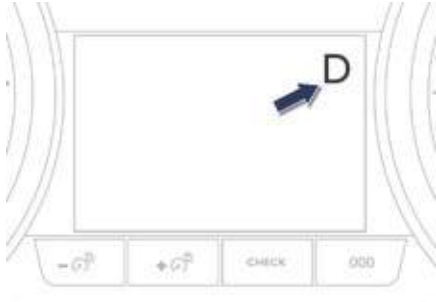

When you move the lever in the gate to select a position, the corresponding indicator comes on in the instrument panel.

- P.** Park
- R.** Reverse
- N.** Neutral
- D.** Drive (Automatic driving)
- S.** **Sport** programme
- ⊛ **Snow** programme
- 1 to 6.** gear engaged during manual operation
- .
 Invalid value during manual operation

## Moving off

- ☞ With your foot on the brake, select position **P** or **N**.
- ☞ Start the engine.

If this procedure is not followed, an audible signal is heard, accompanied by a message in the instrument panel screen.

- ☞ With the engine running, press the brake pedal.
- ☞ Release the parking brake, unless it is programmed to automatic mode.
- ☞ Select position **R**, **D** or **M**,
- ☞ gradually release the brake pedal.

The vehicle moves off immediately.

**i** If position **N** is engaged inadvertently while driving, allow the engine to return to idle then engage position **D** to accelerate.

**!** When the engine is running at idle, with the brakes released, if position **R**, **D** or **M** is selected, the vehicle moves even without the accelerator being pressed. When the engine is running, never leave children in the vehicle without supervision. When carrying out maintenance with the engine running, apply the parking brake and select position **P**.

## Automatic operation

- ☞ Select position **D** for **automatic** changing of the six gears.

The gearbox then operates in auto-adaptive mode, without any intervention on the part of the driver. It continuously selects the most suitable gear according to the style of driving, the profile of the road and the load in the vehicle.

For maximum acceleration without touching the lever, press the accelerator pedal down fully (kick down). The gearbox changes down automatically or maintains the gear selected until the maximum engine speed is reached. On braking, the gearbox changes down automatically to provide efficient engine braking.

If you release the accelerator sharply, the gearbox will not change to a higher gear for safety reasons.



Never select position **N** while the vehicle is moving.

Never select positions **P** or **R** unless the vehicle is completely stationary.

## Sport and snow programmes

These two special programmes supplement the automatic operation in very specific conditions of use.

### Sport "S"

- ☞ Press the "S" switch, after starting the engine.

The gearbox automatically favours a dynamic style of driving.



"S" appears in the instrument panel.

### Snow "❄"

- ☞ Press the "❄" switch, after starting the engine.

The gearbox adapts to driving on slippery roads.

This programme improves starting and drive when traction is poor.



"❄" appears in the instrument panel.

## Return to automatic operation

- ☞ At any time, press the button selected (**S** or "❄") again at any time to quit the programme engaged and return to auto-adaptive mode.

## Creep function (moving without using the accelerator)

This function provides great flexibility in manoeuvring the vehicle at low speed (when parking, in traffic jams, ...).

With the engine at idle, parking brake released and position **D**, **M** or **R** selected, the **vehicle moves** as soon as you take your foot off the brake pedal (even without pressing the accelerator).

For your safety, this function will be activated only if you press the brake pedal when changing from forward drive to reverse.

It is deactivated on opening the driver's door. Closing the door then pressing the brake or accelerator pedal, reactivates the function.



Never leave children inside the vehicle without supervision when the engine is running.

## Manual operation

- ☞ Select position **M** for **sequential** changing of the six gears.
- ☞ Pull the lever towards the **+** sign to change up a gear.
- ☞ Push the lever towards the **-** sign to change down a gear.

It is only possible to change from one gear to another if the vehicle speed and engine speed permit; otherwise, the gearbox will operate temporarily in automatic mode.



**D** disappears and the gears engaged appear in succession in the instrument panel.

If the engine speed is too low or too high, the gear selected flashes for a few seconds, then the actual gear engaged is displayed.

It is possible to change from position **D** (automatic) to position **M** (manual) at any time. When the vehicle is stationary or moving very slowly, the gearbox selects gear **M1** automatically.

The sport and snow programmes do not operate in manual mode.

## Invalid value during manual operation



This symbol is displayed if a gear is not engaged correctly (selector between two positions).

## Stopping the vehicle

Before switching off the engine, you can engage position **P** or **N** to place the gearbox in neutral. In both cases, apply the parking brake to immobilise the vehicle, unless it is programmed to automatic mode.

**i** If the lever is not in position **P**, when the driver's door is opened or approximately 45 seconds after the ignition is switched off, there is an audible signal and a message appears.

- ☞ Return the lever to position **P**; the audible signal stops and the message disappears.

## Operating fault

**SERVICE** When the ignition is on, a message appears in the instrument panel screen to indicate a gearbox fault.

In this case, the gearbox switches to back-up mode and is locked in 3rd gear. You may feel a substantial knock when changing from **P** to **R** and from **N** to **R**. This will not cause any damage to the gearbox.

Do not exceed 60 mph (100 km/h), local speed restrictions permitting.

Have it checked by a Peugeot Ot dealer or a qualified workshop.



You risk damaging the gearbox:

- if you press the accelerator and brake pedals at the same time,
- if you force the lever from position **P** to another position when the battery is flat.



To reduce fuel consumption when stationary for long periods with the engine running (traffic jam...), position the gear lever at **N** and apply the parking brake, unless it is programmed in automatic mode.

## electronic gearbox

Six-speed electronic gearbox which offers a choice between the comfort of fully automatic operation or the pleasure of manual gear changing.

There are two driving modes:

- **automated** mode for automatic control of the gears by the gearbox,
- **manual** mode for sequential gear changing by the driver.

In automated mode, it remains possible to change gear manually by using the steering mounted control paddles when required, when overtaking, for example.

This gearbox provides you with the benefit of additional functions:

- hill start assist,
- the creep function (movement of the vehicle on releasing the brake pedal) in automated mode or reverse.

### Gear lever

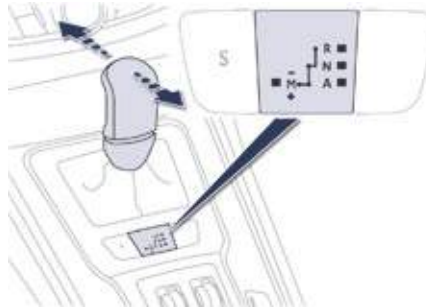

- R.** Reverse.
  - ☞ With your foot on the brake, lift the lever and push forwards.
- N.** Neutral.
  - ☞ With your foot on the brake, select this position to start.
- A.** Automated mode.
  - ☞ Move the lever backwards to select this mode.
- M.** Manual mode with sequential gear changing.
  - ☞ Move the lever to the left to select this mode, then use the steering mounted control paddles to change gear:

### Steering mounted control paddles



- + Change up paddle to the right of the steering wheel.
  - ☞ Press the back of the "+" steering mounted paddle to change up a gear.
- Change down paddle to the left of the steering wheel.
  - ☞ Press the back of the "-" steering mounted paddle to change down a gear.

**i** The steering mounted paddles cannot be used to select neutral or to engage or disengage reverse gear.

## Displays in the instrument panel



### Gear lever positions

**N.** Neutral

**R.** Reverse

**1, 2, 3, 4, 5, 6.** gears in manual mode

**A.** It comes on when the automatic mode is selected. It switches off on changing to manual mode.



- ☞ Place your **foot on the brake** when a message appears in the instrument panel screen.

**i** engagement of reverse gear is accompanied by an audible signal.

## Moving off

- ☞ Select position **N**.
- ☞ Press the brake pedal down fully.
- ☞ Start the engine.

**N** **N** appears in the instrument panel screen.

**i** **N** flashes in the instrument panel, accompanied by an audible signal and a message in the instrument panel screen, if the gear lever is not in position **N** on starting.

**Foot on brake** flashes on the instrument panel, accompanied by an audible signal and a message in the instrument panel screen, if the brake pedal is not pressed on starting.

- ☞ Select first gear (position **M** or **A**) or reverse (position **R**).
- ☞ Release the parking brake unless it is programmed to automatic mode.
- ☞ Take your foot off the brake pedal, then accelerate.

**R** **A** and **1** or **R** appears in the instrument panel screen.

## Automated mode

- ☞ After starting the vehicle, select position **A** for enter automated mode.

**A<sup>1</sup>** **A** and the gear engaged appear in the instrument panel screen.

The gearbox is then operating in auto-active mode, without any action on the part of the driver. It continuously selects the most suitable gear, depending on the:

- style of driving,
- profile of the road.

**i** For optimum acceleration, for example when overtaking another vehicle, press the accelerator pedal firmly past the point of resistance.

# 4

## Manual gear changing



This selective gear change mode enables you to overtake, for example, while still remaining in automatic mode.

Operate the + or - steering mounted control paddle.

The gearbox engages the gear requested if the engine speed permits. **A** is still displayed in the instrument panel.

After a few moments without any action on the controls, the gearbox resumes automatic control of the gears.

## Manual mode

- When the vehicle has moved off, select position **M** to change to manual mode.
  - Pull the lever towards the + sign to change up a gear.
  - Push the lever towards the - sign to change down a gear.



**A** disappears and **M** appears with the gears engaged successively, in the instrument panel screen.

The gear change commands are only carried out if the engine speed permits.

It is not necessary to release the accelerator during gear changes.

When braking or slowing down, the gearbox changes down automatically to permit acceleration in the correct gear.

**i** At very low speed, if reverse gear is requested, this will only be taken into account when the vehicle is immobilised. A warning lamp appears in the instrument panel screen.

**!** On sharp acceleration, the gearbox will not change up unless the driver acts on the gear lever or the steering mounted paddles. Never select neutral **N** while the vehicle is moving. Only engage reverse gear **R** when the vehicle is immobilised with the brake pedal pressed.



## Creep function (moving without pressing the accelerator)

This function greatly facilitates manoeuvring of the vehicle at low speed (when parking, in a traffic jam...).

With the engine at idle, parking brake released and position **A**, **M** or **R** selected, the **vehicle moves** as soon as you take your foot off the brake pedal (even without pressing the accelerator pedal).

For your safety, this function is only activated if you press the brake pedal when changing to forward drive or reverse.

It is deactivated on opening the driver's door. Closing the door and then pressing the brake or accelerator pedal reactivates the function.

**i** The vehicle does not move without pressing the accelerator pedal if the lever stays in position **N** for more than **2 seconds** with the engine running, and the brake pedal is not pressed before selecting position **A**, **M** or **R**.

**!** Never leave children inside the vehicle without supervision when the engine is running.

## Stopping the vehicle

Before switching off the engine, you can choose to:

- move to position **N** to engage neutral,
- leave the gear engaged; in this case, it will not be possible to move the vehicle.

In both cases, you must apply the parking brake to immobilise the vehicle.

**!** When immobilising the vehicle, with the engine running, you must place the gear lever in neutral **N**. Before carrying out any work in the engine compartment, check that the gear lever is in neutral **N** and that the parking brake is applied.

## Operating fault

**SERVICE** With the ignition on, the flashing of this warning lamp, accompanied by an audible signal and a message in the instrument panel screen, indicates a malfunction of the gearbox. Have it checked by Peugeot or a qualified workshop.

**!** You must press the brake pedal when starting the engine. Whatever the circumstances, you must manually apply the parking brake when parking, unless the parking brake is programmed in automatic mode.

# Stop & Start

The Stop & Start system puts the engine temporarily into standby - St OP mode - during stops in the traffic (red lights, traffic jams, or other...). The engine restarts automatically - St ART mode - as soon as you want to move off. The restart takes place instantly, quickly and silently. Perfect for urban use, the Stop & Start system reduces fuel consumption and exhaust emissions as well as the noise level when stationary.

## Operation

### Going into engine STOP mode



The "ECO" indicator lamp comes on in the instrument panel and the engine goes into standby:

- **with a manual gearbox**, at speeds below 12 mph (20 km/h), or vehicle stationary with the e-t HP 165 version, when you put the gear lever into neutral and release the clutch pedal,
- **with an electronic gearbox**, at speeds below 5 mph (8 km/h), when you press the brake pedal or you put the gear selector in position **N**,
- **with an automatic gearbox**, vehicle stationary, when you press the brake pedal or you put the gear selector in position **N**.

If your vehicle is fitted with the system, a time counter calculates the sum of the periods in St OP mode during a journey. It rests itself to zero every time the ignition is switched on with the key.

**i** For your comfort, during parking manoeuvres, St OP mode is not available for a few seconds after coming out of reverse gear. St OP mode does not affect the functionality of the vehicle, such as for example, braking, power steering...

**!** Never refuel with the engine in St OP mode; you must switch off the ignition with the key.

### Special cases: STOP mode not available

St OP mode is not invoked when:

- the driver's door is open,
- the driver's seat belt is not fastened,
- the vehicle has not exceeded 6 mph (10 km/h) since the last engine start using the key,
- the vehicle is stopped on a steep slope (up or down),
- the electric parking brake is applied or being applied,
- the engine is needed to maintain a comfortable temperature in the passenger compartment,
- demisting is active,
- some special conditions (battery charge, engine temperature, braking assistance, ambient temperature...) where the engine is needed to assure control of a system.



In this case, the "ECO" indicator lamp flashes for a few seconds then goes off.

**This operation is perfectly normal.**

## Going into engine START mode

**ECO** The "ECO" indicator lamp goes off and the engine starts automatically:

- **with a manual gearbox**, when you fully depress the clutch pedal,
- **with an electronic gearbox**:
  - gear selector in position **A** or **M**, when you release the brake pedal,
  - or gear selector in position **N** and brake pedal released, when you put the gear selector in position **A** or **M**,
  - or when you engage reverse gear.
- **with an automatic gearbox**:
  - gear selector in position **D** or **M**, when you release the brake pedal,
  - or gear selector in position **N** and brake pedal released, when you put the gear selector in position **D** or **M**,
  - or when you engage reverse gear.

## Special cases: START invoked automatically

Start mode is invoked automatically when:

- the driver's door is open,
- the driver's seat belt is not fastened,
- the speed of the vehicle exceeds 18 mph (25 km/h) with a manual gearbox, 2 mph (3 km/h) with the t HP 165 version), 7 mph (11 km/h) with an electronic gearbox or 2 mph (3 km/h) with an automatic gearbox,
- the electric parking brake is being applied,
- some special conditions (battery charge, engine temperature, braking assistance, ambient temperature...) where the engine is needed for control of a system.

**ECO** In this case the "ECO" indicator lamp flashes for a few seconds, then goes off.

**This operation is perfectly normal.**

## Deactivation



At any time, press the "ECO OFF" switch to deactivate the system.

This is confirmed by the indicator lamp in the switch coming on accompanied by a message in the screen.

**i** If the system has been deactivated in Start mode, the engine restarts immediately.

## Reactivation

Press the "ECO OFF" switch again. The system is active again; this is confirmed by the indicator lamp in the switch going off and a message in the screen.

**i** The system is reactivated automatically at every new start using the key.

## Operating fault



In the event of a fault with the system, the indicator lamp in the "ECO OFF" switch flashes then comes on continuously. Have it checked by a Peugeot Ot dealer or a qualified workshop.

In the event of a fault in St OP mode, the vehicle may stall: all the instrument panel warning lamps come on. It is then necessary to switch off the ignition and start the engine again using the key.

**!** When driving on flooded roads or crossing a ford, switch off the Stop & Start and drive at walking speed.

## Maintenance

**!** Before doing anything under the bonnet, deactivate the Stop & Start system to avoid any risk of injury resulting from automatic operation of St ARt mode.

This system requires a 12 V battery with a special specification and technology (reference numbers available from Peugeot Ot dealers). Fitting a battery not listed by Peugeot Ot introduces the risk of malfunction of the system.

To charge the battery, use a 12 V charger and observe the polarity.

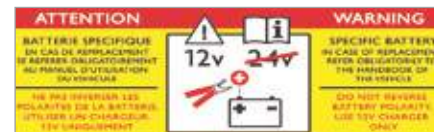

**!** The Stop & Start system makes use of advanced technology. For any work on the system go to a qualified workshop with the skills and equipment required, which a Peugeot Ot dealer is able to provide.

## Hill start assist

System which keeps your vehicle immobilised temporarily (approximately 2 seconds) when starting on a gradient, the time it takes to move your foot from the brake pedal to the accelerator pedal.

This system only operates when:

- the vehicle is completely stationary, with your foot on the brake pedal,
- in particular conditions on a slope,
- with the driver's door closed.

The hill start assist system cannot be deactivated.

### Operation

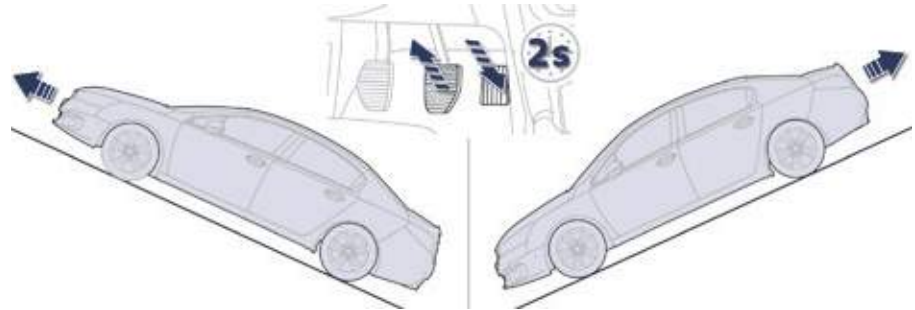

**On an ascending slope, with the vehicle stationary, the vehicle is held for a momentarily when you release the brake pedal:**

- provided you are in first gear or neutral on a manual gearbox,
- provided you are in position **A** or **M** on an electronic gearbox,
- provided you are in position **D** or **M** on an automatic gearbox.

**On a descending slope, with the vehicle stationary and reverse gear engaged, the vehicle is held momentarily when you release the brake pedal.**

### Operating fault



**SERVICE**

If a fault in the system occurs, these warning lamps come on. Contact a Peugeot dealer or a qualified workshop to have the system checked.

**!** Do not exit the vehicle while it is being held in the hill start assist phase. If you need to exit the vehicle with the engine running, apply the parking brake manually then ensure that the parking brake warning lamp (and the warning lamp **P** in the lever of the electric parking brake) are on fixed (not flashing).

# Head-up display

System which projects various information onto a smoked strip in the field of vision of the driver so that they do not have to take their eyes off the road.

This system operates when the engine is running and the settings are stored when the ignition is switched off.



## Buttons

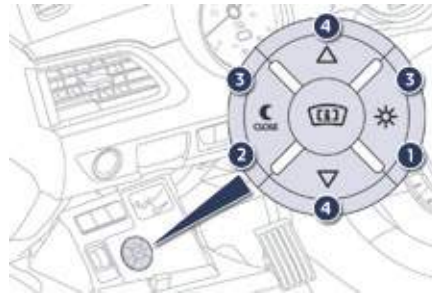

1. Head-up display on.
2. Head-up display off (long press).
3. Brightness adjustment.
4. Display height adjustment.

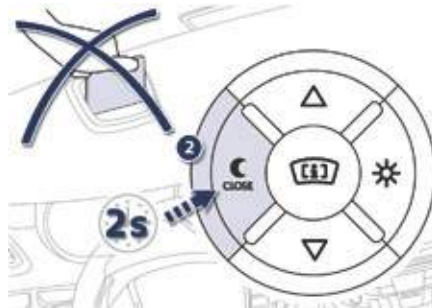

## Displays during operation



Once the system has been activated, the following information is grouped together in the head-up display:

- A. The speed of your vehicle.
- B. Cruise control/speed limiter information.
- C. Navigation information (according to version).

**i** For more information on the navigation system, refer to the "Audio and telematic" section.

## Activation / Deactivation



- ☞ With the engine running, press button **1** to activate the system and deploy the strip.
  - ☞ Press and hold button **2** to deactivate the system and retract the strip.
- The activated/deactivated state is saved and restored on restarting the engine.

## Height adjustment

- ☞ With the engine running, adjust the display to the desired height using buttons **4**:
  - up to move the display up,
  - down to move the display down.

## Brightness adjustment



- ☞ With the engine running, adjust the brightness of the information displayed using buttons **3**:
  - the "sun" to increase the brightness,
  - the "moon" to decrease the brightness.

**!** We recommend that adjustments are made using these buttons only when the vehicle is stationary. When stationary or while driving, no objects should be placed around the strip (or in its recess) so as to not impede deployment of the strip and its correct operation.

**i** In certain extreme weather conditions (rain and/or snow, bright sunshine, ...) the head-up display may not be legible or may suffer temporary interference. Some sunglasses may hamper reading of the information. To clean the strip, use a clean, soft cloth (such as a spectacles cloth or microfibre cloth). Do not use a dry or abrasive cloth or detergent or solvent products as these could scratch the strip or damage the non-reflective coating.

## Blind spot sensors

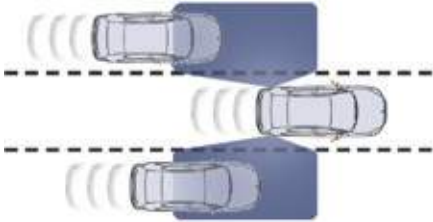

This driving assistance system warns the driver of the presence of another vehicle in the blind spot angle of their vehicle (areas masked from the driver's field of vision), as soon as this presents a potential danger.

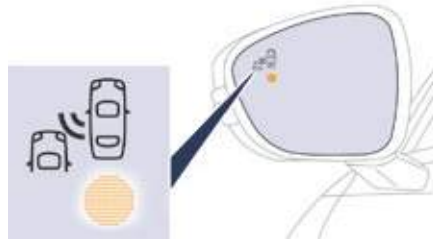

A warning lamp appears in the door mirror on the side in question:

- immediately, when being overtaken,
- after a delay of about one second, when overtaking a vehicle slowly.

**!** This system is designed to improve safety when driving and is in no circumstances a substitute for the use of the interior rear view mirror and door mirrors. It is the driver's responsibility to constantly check the traffic, to assess the distances and relative speeds of other vehicles and to predict their movements before deciding whether to change lane.

The blind spot sensor system can never replace the vigilance and responsibility of the driver.



## Operation



With audio system or for HYbrid4 version



With touch screen



- On switching on the ignition, or engine running, press this button to activate the function; the warning lamp comes on.

Sensors fitted in the front and rear bumpers monitor the blind spots.

The alert is given by a warning lamp which comes on in the door mirror on the side in question as soon as a vehicle - car, lorry, cycle - is detected and the following conditions are fulfilled:

- all the vehicles must be moving in the same direction,
- the speed of your vehicle is between 7 and 75 mph (12 and 140 km/h),
- the difference in speed between your vehicle and the other vehicles must be less than 6 mph (10 km/h),
- the traffic must be flowing normally,
- in the case of an overtaking manoeuvre, if this is prolonged and the vehicle being overtaken remains in the blind spot,
- you are driving on a straight or slightly curved road,
- your vehicle is not pulling a trailer, a caravan...

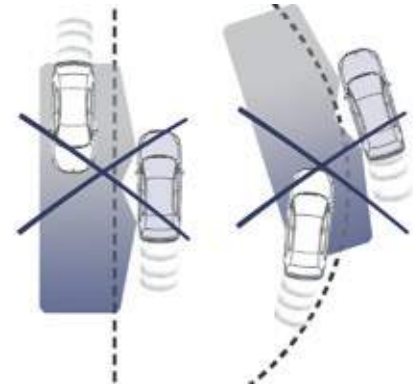

No alert will be given in the following situations:

- in the presence of stationary objects (parked vehicles, barriers, street lamps, road signs...),
- with vehicles moving in the opposite direction,
- driving on a sinuous road or a sharp corner,

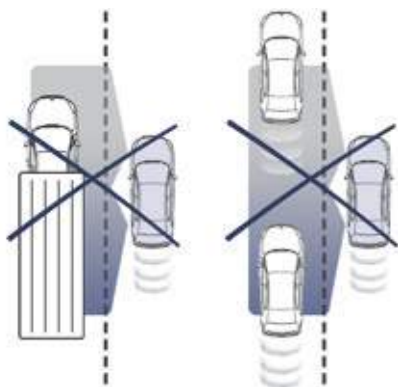

- when overtaking (or being overtaken by) a very long vehicle (lorry, coach...) which is at the same time detected at the rear in the blind spot angle and present in the driver's forward field of vision,
- in very heavy traffic: vehicles detected in front and behind are confused with a lorry or a stationary object,
- when overtaking quickly.



To deactivate the system, press this button again; the warning lamp goes off.

The state of the system remains in memory on switching off the ignition.



The system is automatically deactivated when towing with a towbar approved by Peugeot.

## Operating fault



In the event of a fault, the warning lamp in the button flashes then goes off.

Have it checked by a Peugeot dealer or a qualified workshop.



The system may suffer temporary interference in certain weather conditions (rain, hail...). In particular, driving on a wet surface or moving from a dry area to a wet area can cause false alerts (for example, the presence of a fog of water droplets in the blind spot angle is interpreted as a vehicle). In bad or wintry weather, ensure that the sensors are not covered by mud, ice or snow. Take care not to cover the warning zone in the door mirrors or the detection zones on the front and rear bumpers with adhesive labels or other objects; they may hamper the correct operation of the system.

# Memorising speeds

This memorising of speeds applies to both the speed limiter and the cruise control.

## Operation



You can memorise up to 5 speeds in the system.

By default, some speeds are already memorised.

- ☞ go to the "**Main menu**" in the instrument panel screen by pressing the "**CONFIG**" button.
- ☞ Select the "**Vehicle parameters**" menu and confirm.
- ☞ Select the "**Driving assistance**" line and conform.
- ☞ Select the "**Speeds memorised**" line and confirm.

- ☞ Select "**Activation**" to use the memorised speeds.
- ☞ Select the speed **M1** to **M5** that you want to use.
- ☞ Move the cursor to the desired value then press "**CONFIG**" to modify it.
- ☞ Select "**OK**" and confirm to save the modifications.



For safety reasons, the driver must carry out these operations when stationary, using the instrument panel screen.  
These operations are only possible when stationary.

## Selection



To select a memorised speed:

- ☞ press and hold the "+" or "-" button; the system stops at the nearest memorised speed,
- ☞ press and hold again the "+" or "-" button to select another memorised speed.

A reminder of the speed and the state of the system (on / off) is displayed in the instrument panel.

# 4

## Speed limiter

System which prevents the vehicle from exceeding the speed programmed by the driver.

When the programmed speed limit is reached, pressing the accelerator pedal no longer has any effect unless it is pressed firmly, which allows you to temporarily exceed the programmed speed.

To return to the programmed speed, simply slow down to a speed below the programmed speed by releasing the accelerator.

The speed limiter is **switched on** manually: it requires a programmed speed of at least 20 mph (30 km/h).

The speed limiter is **switched off** by manual operation of the control.

The programmed speed remains in the memory when the ignition is switched off.

**i** The speed limiter cannot, in any circumstances, replace the need to observe speed limits, nor can it replace the need for vigilance and responsibility on the part of the driver.

### Steering mounted controls

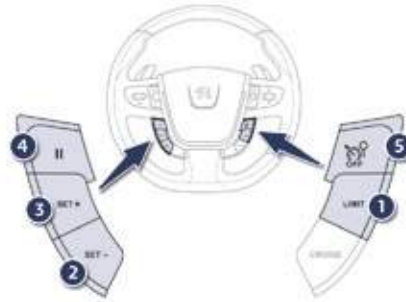

1. Speed limiter mode selection button
2. Programmed value decrease button
3. Programmed value increase button
4. Suspend/restore speed limiter (pause)
5. Speed limiter off button

### Displays in the instrument panel



The programmed information is grouped together in the instrument panel screen.

**i** This information also appears in the head-up display. For more information, refer to the "Head-up display" section.



- A. Speed limiter on / pause indication
- B. Speed limiter mode selection indication
- C. Programmed speed value

## Programming

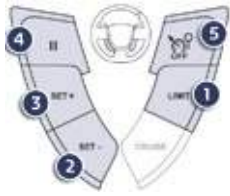

- ☞ Press **1**, the speed limiter mode is activated but remains paused.
- You do not have to switch the speed limiter on in order to set the speed.
- ☞ Set the speed value by pressing button **2** or **3** (e.g.: 55 mph (90 km/h)).

You can then change the programmed speed using buttons **2** and **3**:

- by + or - 1 mph (km/h) = short press,
- by + or - 5 mph (km/h) = long press,
- in steps of + or - 5 mph (km/h) = maintained press.
- ☞ Switch the speed limiter on by pressing button **4**.
- ☞ Suspend the speed limiter by pressing button **4**: the screen confirms the suspension with "Pause".
- ☞ Switch the speed limiter back on by pressing button **4** again.

## Exceeding the programmed speed

Pressing the accelerator pedal to exceed the programmed speed will not have any effect unless you press the pedal **firmly** past the **point of resistance**.

The speed limiter is deactivated temporarily and the programmed speed, which is still displayed, flashes.

Returning to the programmed speed, by means of intentional or unintentional deceleration of the vehicle, automatically cancels the flashing of the programmed speed.

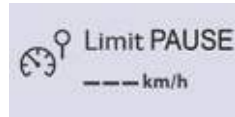

## Off / Return to normal driving

- ☞ Press **5**, the speed limiter is deactivated.

## Operating fault



In the event of a speed limiter fault, the speed is cleared resulting in flashing of the dashes. Have it checked by a Peugeot Ot dealer or a qualified workshop.

- ! On a steep descent or in the event of sharp acceleration, the speed limiter will not be able to prevent the vehicle from exceeding the programmed speed. The use of mats not approved by Peugeot Ot may adversely affect the normal operation of the accelerator pedal and impede the operation of the speed limiter. Mats approved by Peugeot Ot have a third fixing in the area of the pedals to avoid any risk of interference with the pedals.

# Cruise control

System which automatically maintains the speed of the vehicle at the value programmed by the driver, without any action on the accelerator pedal.

The cruise control is **switched on** manually: it requires a minimum vehicle speed of 25 mph (40 km/h) and the engaging:

- 4th gear or higher with a manual gearbox,
- 2nd gear or higher with an electronic or automatic gearbox,
- position **A** with an electronic gearbox or **D** with an automatic gearbox.

The cruise control is **switched off** manually or by pressing the brake or clutch pedal or on triggering of the eSC system for safety reasons.

It is possible to exceed the programmed speed temporarily by pressing the accelerator pedal. To return to the programmed speed, simply release the accelerator pedal.

Switching off the ignition cancels any programmed speed value.

## Steering mounted controls

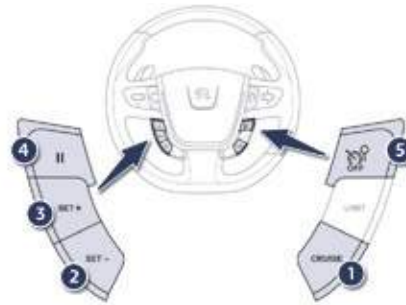

1. Cruise control mode selection button
2. Speed programming / programmed value decrease button
3. Speed programming / programmed value increase button
4. Cruise control suspension / resume button (pause)
5. Cruise control off button

**i** The cruise control cannot, in any circumstances, replace the need to observe speed limits, nor can it replace the need for vigilance and responsibility on the part of the driver.

## Displays in the instrument panel



The programmed information is grouped together in the instrument panel screen.

**i** This information also appears in the head-up display. For more information, refer to the "Head-up display" section.



- A. Cruise control on / pause indication
- B. Cruise control mode selection indication
- C. Programmed speed value

## Programming



- ☞ Press **1**, the cruise control is activated but remains paused.
- ☞ Set the programmed speed by accelerating to the required speed, then press button **2** or **3** (e.g.: 70 mph (110 km/h)).

You can then change the programmed speed using buttons **2** and **3**:

- by + or - 1 mph (km/h) = short press,
- by + or - 5 mph (km/h) = long press,
- in steps of + or - 5 mph (km/h) = maintained press.
  - ☞ Pause the cruise control by pressing button **4**: the screen confirms the suspension with "Pause".
  - ☞ Switch the cruise control back on by pressing button **4** again.

## Exceeding the programmed speed

Intentional or unintentional exceeding of the programmed speed results in flashing of this speed on the display.

Return to the programmed speed, by means of intentional or unintentional deceleration of the vehicle, automatically cancels the flashing of the speed.

## Off / Return to normal driving

- ☞ Press **5**; cruise control mode is deactivated and the screen returns to the distance recorder.



## Operating fault



In the event of a cruise control fault, the speed is cleared resulting in flashing of the dashes. Have it checked by a Peugeot Ot dealer or a qualified workshop.

**!** When the cruise control is switched on, be careful if you maintain the pressure on one of the programmed speed changing buttons: this may result in a very rapid change in the speed of your vehicle.

Do not use the cruise control on slippery roads or in heavy traffic.

On a steep descent, the cruise control will not be able to prevent the vehicle from exceeding the programmed speed. To avoid any risk of jamming of the pedals:

- ensure that the mat is positioned correctly,
- never fit one mat on top of another.

## Parking sensors

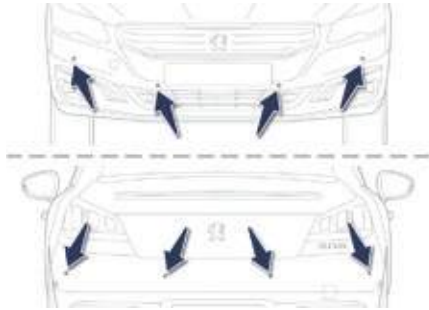

This system indicates the proximity of an obstacle (person, vehicle, tree, gate, etc.) which comes within the field of detection of sensors located in the bumper. Certain types of obstacle (stake, roadworks cone, etc.) detected initially will no longer be detected at the end of the manoeuvre due to the presence of blind spots.

**!** This function cannot, in any circumstances, take the place of the vigilance and responsibility of the driver.

### Rear parking sensors

The system is switched on by engaging reverse gear. This is accompanied by an audible signal. The system is switched off when you come out of reverse gear.

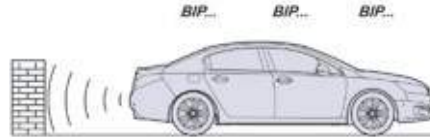

### Audible assistance

The proximity information is given by an intermittent audible signal, the frequency of which increases as the vehicle approaches the obstacle.

The sound emitted by the speaker (right or left) indicates the side on which the obstacle is located.

When the distance between the vehicle and the obstacle becomes less than approximately thirty centimetres, the audible signal becomes continuous.



### Visual assistance

This supplements the audible signal by displaying bars in the multifunction screen which move progressively nearer to the vehicle. When the obstacle is near, the "Danger" symbol is displayed in the screen.



## Front parking sensors

In addition to the rear parking sensors, the front parking sensors are triggered when an obstacle is detected in front and the speed of the vehicle is still below 6 mph (10 km/h).

The front parking sensors are interrupted if the vehicle stops for more than three seconds in forward gear, if no further obstacles are detected or when the speed of the vehicle exceeds 6 mph (10 km/h).

**i** The sound emitted by the speaker (front or rear) indicates whether the obstacle is in front or behind.

## Deactivation / Activation of the front and rear parking sensors



**With audio system or for HYbrid4 version**

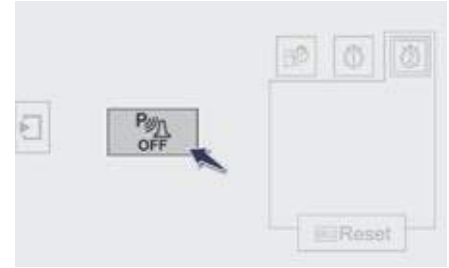

**With touch screen**

The function is deactivated by pressing this button. The indicator lamp in the button comes on. Pressing this button again reactivates the function. The indicator lamp in the button goes off.

**i** The function will be deactivated automatically if a trailer is being towed or a bicycle carrier is fitted (vehicle fitted with a towbar or bicycle carrier recommended by Peugeot Ot ).

## Operating fault

### SERVICE

In the event of a malfunction of the system, when reverse gear is engaged this warning

lamp is displayed in the instrument panel and/or a message appears in the screen, accompanied by an audible signal (short beep). Contact a Peugeot dealer or a qualified workshop.

**i** In bad weather or in winter, ensure that the sensors are not covered with mud, ice or snow. When reverse gear is engaged, an audible signal (long beep) indicates that the sensors may be dirty. Certain sound sources (motorcycle, lorry, pneumatic drill, etc.) may trigger the audible signals of the parking sensor system.

## Reversing camera



The reversing camera is activated automatically when reverse gear is engaged. Depending on version, the image is displayed in the touch screen or the instrument panel.

The reversing camera function completes the parking assistance.

**i** The reversing camera cannot in any circumstances be a substitute for the vigilance and responsibility of the driver.



**i** The superimposed representation of guide lines helps with the manoeuvre. They are represented by lines marked "on the ground" and do not allow the position of the vehicle to be determined relative to tall obstacles (for example: other vehicles, ...).

The blue lines represent the general direction of the vehicle (the difference corresponds to the width of your vehicle without the mirrors).

The red lines represent a distance of about 30 cm beyond the edge of your vehicle's rear bumper.

The green lines represent distances of about 1 and 2 metres beyond the edge of your vehicle's rear bumper.

The turquoise blue curves represent the maximum turning circle.

Opening the boot causes the display to disappear.

**i** Clean the reversing camera regularly using a soft, dry cloth.

### High pressure jet washing

When washing your vehicle, do not direct the lance within 30 cm of the camera lens.

# Lighting controls

Controls for selection and operation of the various front and rear lamps providing the vehicle's lighting and signalling.

## Main lighting

There are various lamps on the vehicle:

- sidelamps, to be seen,
- dipped beam headlamps to see without dazzling other drivers,
- main beam headlamps to see clearly when the road is clear,
- directional headlamps for improved visibility when cornering.

## Additional lighting

Other lamps are installed to fulfil the requirements of particular driving conditions:

- rear foglamps to better signal the presence of the vehicle in foggy conditions,
- front foglamps for better visibility in foggy conditions and to improve lighting at intersections and when parking,
- daytime running lamps to be seen during the day.

## Automatic lighting functions

Various automatic lighting functions are also available depending on options:

- guide-me-home lighting,
- main additional lighting,
- secondary additional lighting,
- welcome lighting,
- daytime running lamps,
- automatic illumination of headlamps,
- adaptive lighting.

## Selection ring for main lighting mode

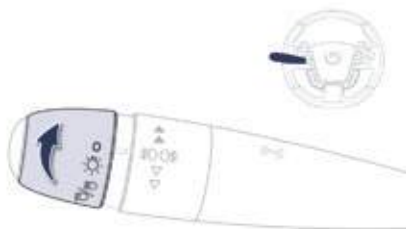

Turn the ring to position the symbol required facing the mark.

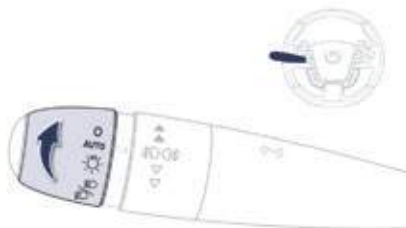

### Model without AUTO lighting



### Model with AUTO lighting

- O** Lighting off.
- AUTO** Automatic illumination of headlamps.
-  Sidelamps only.
-  Dipped or main beam headlamps.

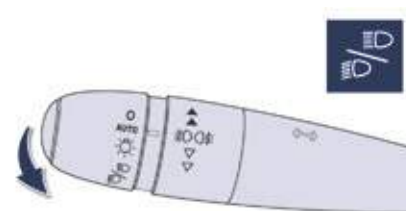

5

## Dipping the headlamps

Pull the stalk to switch the lighting between dipped / main beam headlamps.

In the lighting off and sidelamps modes, the driver can switch on the main beam headlamps temporarily ("headlamp flash") by maintaining a pull on the stalk.

## Displays

Illumination of the corresponding indicator lamp in the instrument panel confirms the lighting switched on.

## Foglamp selection ring

The foglamps operate with dipped and main beam headlamps.

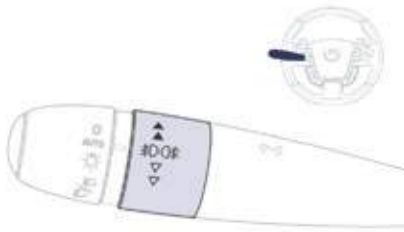

### Front and rear foglamps

Rotate and release the ring:

- ☞ forwards a first time to switch on the front foglamps,
- ☞ forwards a second time to switch on the rear foglamps,
- ☞ rearwards a first time to switch off the rear foglamps,
- ☞ rearwards a second time to switch off the front fog lamps.

When the headlamps switch off with automatic illumination of headlamps (AutO model) or when the dipped beam headlamps are switched off manually, the foglamps and sidelamps remain on.

- ☞ Turn the ring rearwards to switch off the foglamps, the sidelamps will then switch off.

**!** In good or rainy weather, both day and night, the front foglamps and the rear foglamps are prohibited. In these situations, the power of their beams may dazzle other drivers. They should only be used in fog or snow. In these weather conditions, it is your responsibility to switch on the foglamps and dipped headlamps manually as the sunshine sensor may detect sufficient light. Do not forget to switch off the front foglamps and the rear foglamps when they are no longer needed.

### **i** Lighting left on audible signal

An audible signal when a front door is opened warns the driver that the vehicle's exterior lighting is on, with the ignition off and in manual lighting mode. In this case, switching off the lighting stops the audible signal.

With the ignition off, if the dipped headlamps remain on, the vehicle goes into "eCO" mode to avoid discharging the battery.

The lighting goes off when you switch off the ignition, but you can always switch it on again using the lighting control stalk.

**i** In some weather conditions (e.g. low temperature or humidity), the presence of misting on the internal surface of the glass of the headlamps and rear lamps is normal; it disappears after the lamps have been on for a few minutes.

## Daytime running lamps

Daytime lighting, compulsory in certain countries, which comes on automatically when the engine is started making the vehicle more visible to other road users.

This function is assured:

- in countries where it is imposed by regulations, by illumination of the dipped beam headlamps with the sidelamps and number plate lamps.
- for other countries where it is provided, by the use of dedicated lamps.

# 5

## Manual guide-me-home lighting

temporarily keeping the dipped beam headlamps on after the ignition has been switched off makes the driver's exit easier when the light is poor.

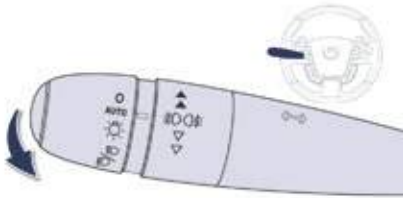

### Switching on

- ☞ Within 30 seconds or a minute after switching of the ignition (according to the lighting duration programmed in the main menu of the instrument panel), "flash" the headlamps using the lighting stalk.
- ☞ A further "headlamp flash" switches the function off.

### Switching off

The manual guide-me-home lighting switches off automatically after about 30 seconds.

## Programming



The duration of the guide-me-home lighting is set in the **Main menu** of instrument panel screen.

Select "**Vehicle parameters**" then "**Lighting**", then change the lighting duration.

## Parking lamps

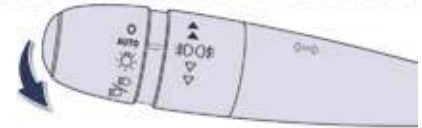

Side markers for the vehicle by illumination of the sidelamps on the traffic side only.

- ☞ Within one minute of switching off the ignition, operate the lighting control stalk up or down depending on the traffic side (for example: when parking on the left; lighting control stalk upwards; the right hand sidelamps are on).

This is confirmed by an audible signal and illumination of the corresponding direction indicator warning lamp in the instrument panel. To switch off the parking lamps, return the lighting control stalk to the middle position or switch on the ignition.



## Automatic illumination of headlamps

The sidelamps and dipped beam headlamps are switched on automatically, without any action on the part of the driver, when a low level of external light is detected or in certain cases of activation of the windscreen wipers.

As soon as the brightness returns to a sufficient level or after the windscreen wipers are switched off, the lamps are switched off automatically.

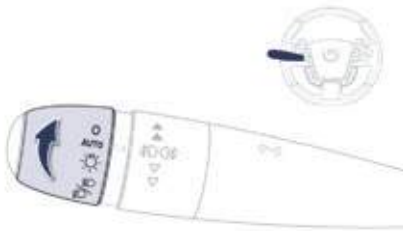

### Activation

- ☞ Turn the ring to the "AUTO" position. The automatic illumination of headlamps is accompanied by a message in the instrument panel screen.

### Deactivation

- ☞ Turn the ring to another position. Deactivation is accompanied by a message in the instrument panel screen.

## Association with automatic guide-me-home lighting

Association with automatic illumination of headlamps provides the guide-me-home lighting with the following additional options:

- selection of the lighting duration of 15, 30 or 60 seconds,
- automatic activation of guide-me-home lighting when the automatic illumination of headlamps is in operation.

## Operating fault

### SERVICE

In the event of a fault with the sunshine sensor, the lighting comes on, this warning lamp is displayed in the instrument panel and/or a message appears in the instrument panel screen, accompanied by an audible signal. Contact a Peugeot Ot dealer or a qualified workshop.



In fog or snow, the sunshine sensor may detect sufficient light. In this case, the lighting will not come on automatically.

Do not cover the sunshine sensor, coupled with the rain sensor and located in the centre of the windscreen behind the rear view mirror; the associated functions would no longer be controlled.

## Adaptive lighting

System which automatically changes between dipped and main beam according to the driving conditions, using a sensor in the rear view mirror.

The system is active from 15 mph (25 km/h) and is deactivated below 9 mph (15 km/h).



### Switching on

☞ Put the lighting control stalk on the "Aut O" or "Dipped/main beam headlamps" position.



☞ Press this button, the indicator lamp comes on.

### Switching off

The driver can take over at any time, if the circumstances dictate:



☞ Press this button, the indicator lamp goes off,

or

☞ Dipping the headlamps manually using the lighting control stalk, whether in the "Aut O" or "Dipped/main beam headlamps" position.

**i** Flashing the headlamps does not deactivate the system. The state of the system is stored in memory when switching off the ignition. This automatic headlamp dipping system is a driving aid. The driver remains responsible for the vehicle's lighting and its correct use for the prevailing conditions of light, visibility and traffic.

**i** The system may suffer interference or not work correctly:

- under conditions of poor visibility (for example, snowfall, heavy rain or thick fog, ...),
- if the windscreen is dirty, misted or obscured (by a sticker, ...) in front of the sensor,
- if the vehicle is facing highly reflective signs.

The system is not able to detect:

- road users that do not have their own lighting, such as pedestrians,
- road users whose lighting is obscured, such as vehicles running behind a safety barrier (on a motorway, for example),
- road users at the top or bottom of a steep slope, on twisty roads, on crossroads.

## exterior welcome lighting

Remote switching on of the lighting makes your approach to the vehicle easier in poor light. It is activated according to the level of light detected by the sunshine sensor.

### Switching on



Press the open padlock on the remote control.

The dipped beam headlamps and the sidelamps come on; your vehicle is also unlocked.

### Switching off

The exterior welcome lighting switches off automatically after a set time, when the ignition is switched on or on locking the vehicle.

### Programming



The activation/deactivation and lighting duration are set in the **Main menu** of instrument panel screen. Select "**Vehicle parameters**" then "**Lighting**", then change the lighting duration.

## Door mirror spotlamps



To make your approach to the vehicle easier, these illuminate:

- the zones facing the driver's and passenger's doors,
- the zones forward of the door mirrors and rearward of the front doors.

### Switching on

The spotlamps come on:

- when you unlock the vehicle,
- when you remove the key from the ignition,
- when you open a door,
- when you use the remote control.

### Switching off

They are timed to go off automatically.

## Manual adjustment of halogen headlamps



To avoid causing a nuisance to other road users, the beams of the halogen headlamps should be adjusted according to the load in the vehicle.

- 0 Driver or driver + front passenger.
- Driver + front passenger + rear passengers.
- 1 5 people.
- 5 people + a load in the boot.
- 2 Driver + a load in the boot.

**i** The initial setting is position "0".

## Automatic adjustment of "full LeD" technology headlamps

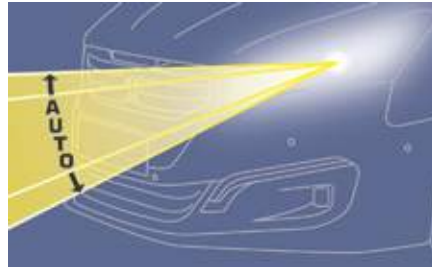

In order to avoid causing a nuisance to other road users, this system corrects the height of the "full LeD" headlamps beam automatically, in relation to the load in the vehicle.

### SERVICE

If a fault occurs, this warning lamp is displayed in the instrument panel, accompanied by an audible signal and a message in the instrument panel screen. The system then places your headlamps in the lowest position.

**!** If a fault occurs, do not touch the "full LeD" bulbs. Contact a Peugeot dealer or a qualified workshop.

### **i** Travelling abroad

The design of the dipped beam headlamps allows, without modification, driving in a country that drives on the other side of the road to the country in which your vehicle was sold.

## Additional headlamps

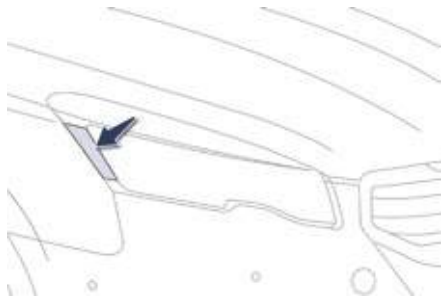

With dipped or main beam on, this system uses LeDs (light-emitting diodes) to illuminate the inside of a bend.

The speed of the vehicle must be below 75 mph (120 km/h).

This function is available only with "full-LeD" headlamps.

### Operation

This system operates from a certain angle of rotation of the steering wheel.

### System inactive

The system does not operate:

- below a certain angle of rotation of the steering wheel,
- above 75 mph (120 km/h),
- when reverse gear is engaged.

## Secondary additional headlamps

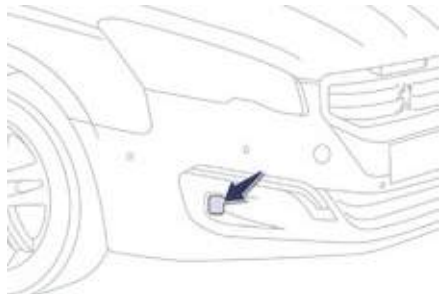

With dipped or main beams, this function makes use of the beam from a front foglamp to illuminate the inside of a bend, when the vehicle speed is below 25 mph (approximately 40 km/h).

This additional lighting is particularly useful in town, at intersections, on very winding roads, when parking, ...

### Switching on

This function starts

- when the direction indicator is switched on (the foglamp on the same side is switched on),  
or
- from a certain angle of rotation of the steering wheel.

### Switching off

The system is deactivated:

- below a certain angle of rotation of the steering wheel,
- when switching off the direction indicator,

### Programming

The system is activated or deactivated in the **Main menu**, select "**Vehicle parameters**", then "**Lighting**", then activate/deactivate the system is activated by default.

# Wiper controls

The vehicle's front and rear wipers are designed to improve the driver's visibility progressively according to the climatic conditions.

## Programming

Various automatic wiper control modes are also available according to the following options:

- automatic rain sensitive windscreen wipers,
- rear wiper on engaging reverse gear.

## Manual controls

The wipers are controlled directly by the driver.

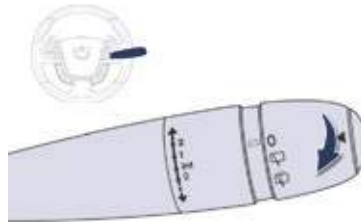

### Model with manual wiping (intermittent)

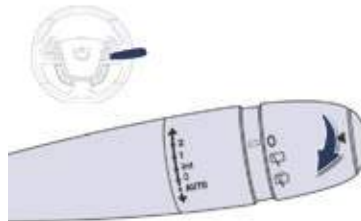

### Model with AUTO wiping

## Windscreen wipers

Wiping speed:

- 2** fast (heavy rain),
- 1** normal (moderate rain),
- I** intermittent (proportional to the speed of the vehicle),
- 0** park,
- ↓** single wipe (press down and release),
- AUTO ↓** automatic (press down and release),  
single wipe (pull the stalk briefly towards you).

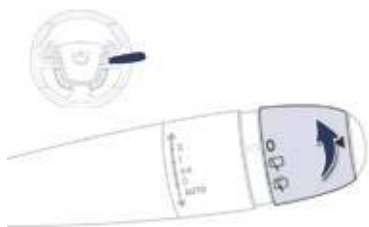

## Rear wiper

Rear wiper selection ring:

**!** If a significant accumulation of snow or ice is present, or when using a bicycle carrier on the boot, deactivate the automatic rear wiper via the instrument panel screen configuration menu.



park,



intermittent wipe,



wash-wipe (set duration).

## Reverse gear

When reverse gear is engaged, the rear wiper will come into operation if the windscreen wipers are operating.

## Programming



This function is activated or deactivated via the instrument panel screen configuration menu.

This function is activated by default.

## Windscreen and headlamp wash

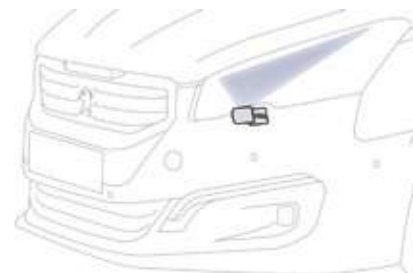

Pull the windscreen wiper stalk towards you for a few seconds. The windscreen wash then the windscreen wipers operate for a fixed period. The headlamp washers only operate when **the dipped beam headlamps are on** and the vehicle is moving.



## Screenwash/headlamp wash level low

### SERVICE

In the case of vehicles fitted with headlamp washers, when the fluid reservoir low

level is reached this warning lamp comes on in the instrument panel, accompanied by an audible signal and a message in the instrument panel screen.

The warning lamp comes on when the ignition is switched on, or every time the stalk is operated, until the reservoir is refilled.

Next time you stop, refill the screenwash / headlamp wash reservoir.

## Automatic rain sensitive windscreen wipers

The windscreen wipers operate automatically, without any action on the part of the driver, if rain is detected (sensor behind the rear view mirror), adapting their speed to the intensity of the rainfall.

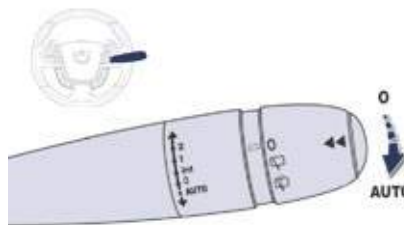

### Switching on



Briefly push the control stalk downwards.

A wiping cycle confirms that the instruction has been accepted.

This warning lamp comes on in the instrument panel and a message is displayed.

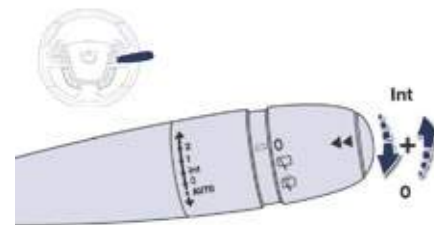

### Switching off



Briefly push the control stalk downwards again, or place the control stalk in another position (Int, 1 or 2).

This warning lamp goes off in the instrument panel and a message is displayed.

**i** The automatic rain sensitive windscreen wipers must be reactivated by pushing the control stalk downwards, if the ignition has been off for more than one minute.

## Operating fault

If a fault occurs with the automatic rain sensitive wipers, the wipers will operate in intermittent mode.

Have it checked by Peugeot dealer or a qualified workshop.

**!** Do not cover the rain sensor, linked with the sunshine sensor and located in the centre of the windscreen behind the rear view mirror.

Switch off the automatic rain sensitive wipers when using an automatic car wash. In winter, it is advisable to wait until the windscreen is completely clear of ice before activating the automatic rain sensitive wipers.

## Special position of the windscreen wipers



This position permits release of the windscreen wiper blades.

It is used for cleaning or replacement of the blades. It can also be useful, in winter, to detach the blades from the windscreen.

- ☞ Any action on the wiper stalk in the minute after switching off the ignition places the blades vertically on the screen.
- ☞ To park the blades again, switch on the ignition and operate the wiper stalk.

**i** To maintain the effectiveness of the "flat-blade" type of wiper blades, it is advisable to:

- handle them with care,
- clean them regularly using soapy water,
- avoid using them to retain cardboard on the windscreen,
- replace them at the first signs of wear.

# Courtesy lamps



1. Front courtesy lamp
2. Front map reading lamps
3. Rear map reading lamps
4. Interior mood LEDs

## Front courtesy lamps



In this position, the courtesy lamp comes on gradually:

- when the vehicle is unlocked,
- when the key is removed from the ignition,
- when opening a door,
- when the remote control locking button is activated, in order to locate your vehicle.

It switches off gradually:

- when the vehicle is locked,
- when the ignition is switched on,
- 30 seconds after the last door is closed.



Permanently off.



Permanent lighting.



With the "permanent lighting" mode, the lighting time varies according to the circumstances:

- with the ignition off, approximately ten minutes,
- in energy economy mode, approximately thirty seconds,
- with the engine running, unlimited.

## Front and rear map reading lamps

☞ With the ignition on, press the corresponding switch.

When the front courtesy lamp is on "permanent lighting", the rear map reading lamp comes on as well, unless it is "permanently off".

From the front, you can deactivate the rear map reading lamps so as to not disturb sleeping rear passengers, for example. However, the rear passengers can force the illumination of a lamp.

5



Take care to avoid leaving anything in contact with the courtesy lamps.

## Interior mood lighting

The dimmed passenger compartment lighting improves visibility in the vehicle when the light is poor.



### Switching on

At night, interior mood light emitting diodes - LEDs come on automatically when the sidelamps are switched on.

### Switching off

The interior mood lighting switches off automatically when the sidelamps are switched off.

It can be switched off manually by adjusting the instrument panel lighting dimmer button to the lowest setting.

## General points relating to child seats

Although one of Peugeot's main criteria when designing your vehicle, the safety of your children also depends on you.

For maximum safety, please observe the following recommendations:

- in accordance with European regulations, **all children under the age of 12 or less than one and a half metres tall must travel in approved child seats suited to their weight**, on seats fitted with a seat belt or ISOFIX mountings\*,
- **statistically, the safest seats in your vehicle for carrying children are the rear seats,**
- **a child weighing less than 9 kg must travel in the "rearward facing" position both in the front and in the rear.**

- i** **PEUGEOT recommends** that children should travel in the **outer rear seats** of your vehicle:
- **"rearward facing"** up to the age of 3,
  - **"forward facing"** over the age of 3.

\* The rules for carrying children are specific to each country. Refer to the legislation in force in your country.

## Child seat at the rear

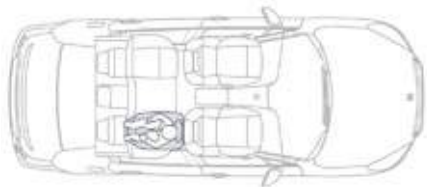

### "Rearward facing"

When a "rearward facing" child seat is installed **on a rear passenger seat**, move the vehicle's front seat forwards and straighten the backrest so that the "rearward facing" child seat does not touch the vehicle's front seat.

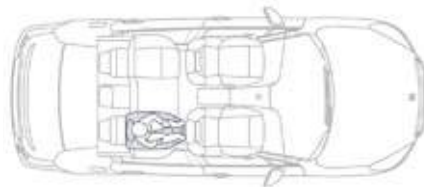

### "Forward facing"

When a "forward facing" child seat is installed **on a rear passenger seat**, move the vehicle's front seat forwards and straighten the backrest so that the legs of the child in the "forward facing" child seat do not touch the vehicle's front seat.

### Centre rear seat

A child seat with a support leg must never be installed on the **centre rear passenger seat**.

**i** ensure that the seat belt is correctly tensioned.  
For child seats with a support leg, ensure that this is in firm contact with the floor. If necessary, adjust the front seat of the vehicle.

## Child seat in the front\*



### "Rearward facing"

When a "rearward facing" child seat is installed on the **front passenger seat**, adjust the seat to the fully back and highest position, with the backrest straightened.

The passenger airbag must be deactivated.

Otherwise, **the child would risk being seriously injured or killed if the airbag were to inflate.**



### "Forward facing"

When a "forward facing" child seat is installed on the **front passenger seat**, adjust the vehicle's seat to the fully back and highest position with seat backrest straightened and leave the passenger's airbag activated.

**i** ensure that the seat belt is correctly tensioned.  
For child seats with a support leg, ensure that the support leg is in firm and stable contact with the floor. If necessary, adjust the passenger seat.

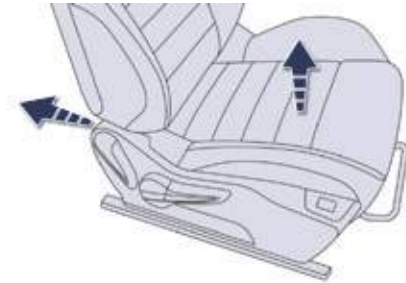

**Passenger seat in the fully back and highest position.**

# 6

\* Refer to the legislation in force in your country before carrying your child in this seating position.

# Deactivating the passenger's front airbag

**!** Never install a rearward facing child restraint system on a seat protected by an active front airbag. This could cause the death of the child or serious injury.

The warning label present on both sides of the passenger's sun visor repeats this advice. In line with current legislation, the following tables contain this warning in all of the languages required.



**Passenger airbag OFF**



**i** For information on deactivating the passenger's front airbag, refer to the "Airbags" section.



AR	لا يجب أبدا تركيب نظام لإجلال الطفل الوجه باتجاه الراء على مقعد سيارة مجهز بوسادة أمان هوائية أمامية مغلقة، فقد يؤدي هذا إلى التسبب بموت الطفل أو بإصابات خطيرة لديه .
Bg	НИКОГА НЕ инсталирайте детско столче на седалка с АКТИВИРАНА предна ВЪЗДУШНА ВЪЗГЛАВНИЦА. Това може да причини СМЪРТ или СЕРИОЗНО НАРАНЯВАНЕ на детето.
CS	NIKDY neumisťujte dětské zádržné zařízení orientované směrem dozadu na sedadlo chráněné AKTIVOVANÝM čelním AIRBAGEM. Hrozí nebezpečí SMRTI DÍTĚTE nebo VÁŽNĚHO ZRANĚNÍ.
DA	Brug ALDRIG en bagudvendt barnestol på et sæde, der er beskyttet af en AKT IV AIRBag . BARNet risikerer at blive ALVORLigt KVÆSt et eller DRÆBt .
De	Montieren Sie auf einem Sitz mit AKT IVleRt eM Front-Airbag NleMALS einen Kindersitz oder eine Babyschale entgegen der Fahrtrichtung, das Kind könnte schwere oder sogar tödliche Verletzungen erleiden.
eL	Μη χρησιμοποιείτε ΠΟΤΕ παιδικό κάθισμα με την πλάτη του προς το εμπρός μέρος του αυτοκινήτου, σε μια θέση που προστατεύεται από ΜΕΤΩΠΙΚΟ αερόσακο που είναι ΕΝΕΡΓΟΣ. Αυτό μπορεί να έχει σαν συνέπεια το ΘΑΝΑΤΟ ή το ΣΟΒΑΡΟ ΤΡΑΥΜΑΤΙΣΜΟ του ΠΑΙΔΙΟΥ
eN	Ne VeR use a rearward facing child restraint on a seat protected by an ACt IVe AIRBag in front of it, De At H or Se RIoU S INJu RY to the CHILD can occur
eS	NO INST ALAR Nu NCA un sistema de retención para niños de espaldas al sentido de la marcha en un asiento protegido mediante un AIRBAG frontal ACTIVADO, ya que podría causar lesiones GRAVES o incluso la MUERTE del niño.
et	Ärge Mitte Ku Nag I paigaldage "seljaga sõidusuunas" lapseisteti juhi kõrvalistmele, mille eSitu RVAPADI on AKt IVeeRItu D. t urvapadja avanemine võib last t ÖSISeLt või eLu OHt LIKuLt vigastada.
FI	ÄLÄ KOSKAAN aseta lapsen turvavaihtuina selkä ajosuuntaan istuimelle, jonka edessä suojana on käyttöön aktivoitu tu RVAt YYNY. Sen laukeaminen voi aiheuttaa LAPSeN Ku OLeMAN tai VAKAVAN LOu KKAANt u MISEN.
FR	NE JAMAIS installer de système de retenue pour enfants faisant face vers l'arrière sur un siège protégé par un COUSSIN GONFLABLE frontal ACTIVE. Cela peut provoquer la MORT de l'eNFANT ou le BLeSSeR g RAVeMeNt
HR	NIKADA ne postavljati dječju sjedalicu leđima u smjeru vožnje na sjedalo zaštićeno UKLJUČENIM prednjim ZRAČNIM JASTUKOM. To bi moglo uzrokovati SMRT ili TESKU OZLJEDU djeteta.
Hu	SOHA ne használjon menetiránynak háttal beszerelt gyermekülést AKTIVÁLT (BEKAPCSOLT) FRONTLÉGZSÁKKAL védett ülésen. Ez a gyermek HALÁLÁT vagy SÜLYÖS SÉRÜLÉSÉT okozhatja.
It	NON installare MAI seggiolini per bambini posizionati in senso contrario a quello di marcia su un sedile protetto da un AIRBAG frontale At t IVAt O. Ciò potrebbe provocare la MORT e o FeRIt e g RAVI al bambino.

Lt	NIEKADA neįrenkite vaiko prilaikymo priemonės su atgal atgrežtu vaiku ant sėdynės, kuri saugoma VEIKIANČIOS priekinės ORO PAGALVĖS. Išsiskleidus oro pagalvei vaikas gali būti MIRTINAI arba SUNKIAI TRAUMUOTAS.
LV	NEKAD NEUZstādiēt uz aizmuguri vērstu bērnu sēdekļi priekšējā pasažiera sēdvietā, kurā ir AKTIVIZĒTS priekšējais DROŠĪBAS GAISA SPILVENS. Tas var izraisīt BĒRNA NĀVI vai radīt NOPIETNUS IEVAINOJUMUS.
Mt	Qatt m'ghandek thalli tifel/tifla marbut f'siggu dahru lejn l-Airbag attiva, ghaliex tista' tikkawza korriment serju jew anke mewt lit-tifel/tifla
NL	Plaats NOOI t een kinderzitje met de rug in de rijrichting op een zitplaats waarvan de AIRBAG is ING eSCHAKeLD. Bij het afgaan van de airbag kan het KIND LeVeNSg eVAARLIJK ge WOND RAKeN
NO	Installer ALDRI et barnesete med ryggen mot kjøretretningen i et sete som er beskyttet med en frontal AKt IVeRt KOLLISJONSPu te , BARNet risikerer å bli DRePt eller HARDt SKADet .
PL	NIGDY nie instalować fotelika dziecięcego w pozycji "tyłem do kierunku jazdy" na siedzeniu wyposażonym w CZŁOWA PODUSZKE POWIETRZNA w stanie AKTYWNYM. Może to doprowadzić do ŚMIERCI DZIECKA lub spowodować u niego POWAŻNE OBRAŻENIA CIAŁA.
Pt	Nu NCA instale um sistema de retenção para crianças de costas para a estrada num banco protegido por um AIRBAG frontal ACt IVADO. Esta instalação poderá provocar FERIMENTOS GRAVES ou a MORTE da CRIANÇA.
RO	Nu instalati NICIODaT A un sistem de retinere pentru copii, dispus cu spatele in directia de mers, pe un loc din vehicul protejat cu AIRBAG frontal ACt IVAt . Aceasta ar putea provoca MOARt e A COPILu Lu l sau RANIReA lui g RAVA.
Ru	ВО ВСЕХ СЛУЧАЯХ ЗАПРЕЩАЕТСЯ использовать обращенное назад детское удерживающее устройство на сиденье, защищенном ФУНКЦИОНИРУЮЩЕЙ ПОДУШКОЙ БЕЗОПАСНОСТИ, установленной перед этим сиденьем. Это может привести к ГИБЕЛИ РЕБЕНКА или НАНЕСЕНИЮ ЕМУ СЕРЬЕЗНЫХ ТЕЛЕСНЫХ ПОВРЕЖДЕНИЙ
SK	NIKDY neinštalujte detské zádržné zariadenie orientované smerom dozadu na sedadlo chránené AKTIVOVANÝM čelným AIRBAGOM. Mohlo by dôjsť k SMRTELNEMU alebo VÁZNEMU PORANENIU DIETATA.
SL	NIKOLI ne nameščajte otroškega sedeža s hrbtom v smeri vožnje, če je VARNOSTNA BLAZINA pred sprednjim sopotnikovim sedežem AKTIVIRANA. Takšna namestitve lahko povzroči SMRT OTROKA ali HUDE POŠKODBE.
SR	NIKADA ne koristite dečje sedišta koje se okreće unazad na sedištu zaštićenim AKTIVNIM VAZDUŠNIM JASTUKOM ispred njega, jer mogu nastupiti SMRT ili OZBILJNA POVREDA DETETA.
SV	Passagerarkrockkudden fram MÅSt e vara avaktiverad om en bakåtvänd bilbarnstol installerad på denna plats. Annars riskerar barnet att DÖDAS eller SKADAS ALLVARLig t .
t R	KESINLKLE HAVA YASTIĞI AKTİF olan ön koltuğa yüzü arkaya dönük bir çocuk koltuğu yerleştirmeyiniz. Bu ÇOCUĞUN ÖLMESİNE veya ÇOK AĞIR YARALANMASINA sebep olabilir.





# Child seats recommended by Peugeot Ot

Peugeot Ot offers a range of recommended child seats which are secured using a **three point seat belt**.

Group 0+: from birth to 13 kg	Group 1: from 9 to 18 kg
 <p data-bbox="389 384 756 458"><b>L1</b> "RÖMeR/BRIt AX Baby-Safe Plus". Installed in the rearward-facing position.</p>	 <p data-bbox="1131 397 1390 444"><b>L2</b> "RÖMeR Duo Plus ISOFIX".</p>
Groups 2 and 3: from 15 to 36 kg	
 <p data-bbox="397 612 750 713"><b>L5</b> "KLIPPAN Optima". From the age of approximately 6 years (22 kg), the booster is used on its own.</p>	 <p data-bbox="1067 600 1458 726"><b>L6</b> "RÖMeR KIDFIX" Can be secured using the vehicle's ISOFIX mountings. The child is restrained by the seat belt.</p>

## Installing child seats attached using the seat belt

In accordance with european regulations, this table indicates the options for installing child seats secured using a seat belt and universally approved (a) in accordance with the weight of the child and the seat in the vehicle.

Weight of the child and indicative age					
Seat		Under 13 kg (groups 0 (b) and 0+) u p to approx 1 year	From 9 to 18 kg (group 1) 1 to 3 years approx	From 15 to 25 kg (group 2) 3 to 6 years approx	From 22 to 36 kg (group 3) 6 to 10 years approx
Front passenger seat (c) with height adjuster		U (R)	U (R)	U (R)	U (R)
Front passenger seat (c) without height adjuster		U	U	U	U
<b>Saloon</b>					
Outer rear seats		U	U	U	U
Centre rear seat		X	X	X	X
<b>SW</b>					
Outer rear seats		U	U	U	U
Centre rear seat		X	X	X	X

- a:** universal child seat, child seat that can be installed in all vehicles using a seat belt.
- b:** group 0, from birth to 10 kg. Shells seats and baby carriers cannot be installed in the front passenger seat. When installed in the 2<sup>nd</sup> row, they may prevent the use of the other seats.
- c:** consult the legislation in force in your country before installing your child on this seat.
- U:** seat suitable for the installation of a child seat secured using a seat belt and universally approved, "rearward facing" and/or "forward facing".
- U (R):** idem **U**, with the vehicle's seat adjusted to the highest position and as far back as possible.
- X:** seat position not suitable for installation of a child seat for the weight class indicated.

**!** Remove and stow the head restraint before installing a child seat with a backrest on a passenger seat. Refit the head restraint once the child seat has been removed.

## "ISOFIX" mountings

Your vehicle has been approved in accordance with the **latest ISOFIX regulations**.

The seats, represented below, are fitted with regulation ISOFIX mountings.

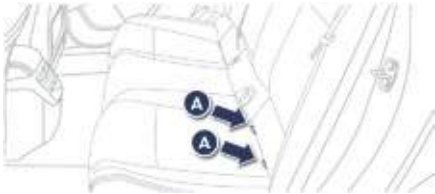

There are three rings for each seat.

- Two rings **A**, located between the vehicle seat back and cushion, indicated by a label.
- A ring **B**, behind the seat, referred to as the **TOP TETHER** for fixing the upper strap.

The TOP TETHER is used to secure the upper strap of child seats that have one.

This arrangement reduces forward tipping of the child seat in the event of a front impact.

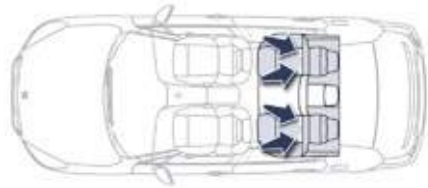

Saloon

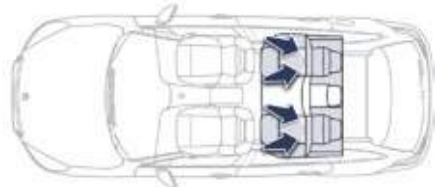

SW



This ISOFIX mounting system provides fast, reliable and safe fitting of the child seat in your vehicle.

The **ISOFIX child seats** are fitted with two latches which are easily secured on the two rings **A**.

Some also have an **upper strap** which is attached to ring **B**.

To attach this strap, raise the vehicle seat's head restraint then pass the hook between its rods. Then fix the hook on ring **B** and tighten the upper strap.

**!** The incorrect installation of a child seat in a vehicle compromises the child's protection in the event of an accident.

**!** Follow strictly the instructions for fitting child seats contained in their manufacturer's installation guide.

For information regarding the ISOFIX child seats which can be installed in your vehicle, refer to the table showing the locations for installing ISOFIX child seats.

## ISOFIX child seats recommended by Peugeot and approved for your vehicle

"RÖMER Duo Plus ISOFIX" (size category B1)

Group 1: from 9 to 18 kg



Is installed only in the forward facing position.  
 Is attached to the anchorage rings **A** and the upper anchorage ring **B**, referred to as the top tether, using an upper strap.  
 Three seat body angles: sitting, reclining, lying down.  
 We recommend the lying down position.

6

**i** This seat can be used on seats not equipped with ISOFIX mountings.  
 In this case, it must be attached to the vehicle's seat using the three-point seat belt.  
 Adjust the front seat of the vehicle so that the child's feet do not touch the backrest.

**Follow the instructions for fitting child seats contained in the seat manufacturer's installation guide.**

**Baby P2C Mini and its ISOFIX base (size category: E)**

**Group 0+: from birth to 13 kg**



Installed "rearward facing" using an ISOFIX base which is attached to the anchorage rings **A**.  
The base has a support leg, adjustable for height, which sits on the vehicle's floor.  
This seat can also be secured with a seat belt. In this case only the seat shell is used.

**"Baby P2C Midi" and its ISOFIX base (size categories: D, C, A, B, B1)**

**Group 1: from 9 to 18 kg**



Installed "rearward facing" using an ISOFIX base which is attached to the anchorage rings **A**.  
The base has a support leg, adjustable for height, which sits on the vehicle's floor.  
This child seat can also be used "forward facing".  
This seat can **not** be secured with a seat belt.  
We recommend that you use the seat in the "rearward facing" position up to the age of 3 years.



**Follow the instructions for fitting child seats contained in the seat manufacturer's installation guide.**





The ISOFIX BABY P2C base must be installed in a way that the ISOFIX latches 3, 4 and 5 are visible. And the support leg must have 6 holes visible.



# Locations for installing ISOFIX child seats

In accordance with European Regulations, this table indicates the options for installing ISOFIX child seats on seats in the vehicle fitted with ISOFIX mountings.

In the case of universal and semi-universal ISOFIX child seats, the ISOFIX size category, determined by a letter from **A** to **G**, is indicated on the child seat next to the ISOFIX logo.

	Weight of the child / indicative age									
	Less than 10 kg (group 0) up to approx. 6 months		Less than 10 kg (group 0) Less than 13 kg (group 0+) up to approx. 1 year			From 9 to 18 kg (group 1) From approx. 1 to 3 years				
Type of ISOFIX child seat	Shell		"rearward facing"			"rearward facing"		"forward facing"		
ISOFIX size category	F	G	C	D	E	C	D	A	B	B1
Front passenger seat 	Not Isofix									
<b>Saloon</b>										
Outer rear seats 	X		IL-SU			IL-SU		IUF IL-SU		
Centre rear seat 	Not Isofix									
<b>SW</b>										
Outer rear seats 	X		IL-SU			IL-SU		IUF IL-SU		
Centre rear seat 	Not Isofix									

**IUF:** seat suitable for the installation of an Isofix **U**niversal seat, "**F**orward facing" secured using the top belt.

**IL-SU:** seat suitable for the installation of an Isofix **S**emi-**U**niversal seat either:

- "rearward facing" fitted with a top belt or a support leg,
- "forward facing" fitted with a support leg,
- a shell seat fitted with an upper strap or a support leg.

For advice on securing of the top belt, refer to the "Isofix mountings" section.

**X:** seat not suitable for the installation of a child seat or shell for the weight group indicated.

# Recommendations

## ! Child seats

The incorrect installation of a child seat in a vehicle compromises the child's protection in the event of an accident.

Check that there is no seat belt or seat belt buckle under the child seat as this could destabilise it.

Remember to fasten the seat belts or the child seat harnesses **keeping the slack** in relation to the child's body **to a minimum**, even for short journeys.

For the installation of a child seat using a seat belt, ensure that this is well tensioned on the child seat and that it is holding the child seat firmly against the seat of your vehicle. If your front passenger seat is adjustable, move it forward if necessary.

At the rear seats, always leave sufficient space between the front seat and:

- a rearward facing child seat,
- the feet of a child seated in a forward facing child seat.

For this, move the front seat forward and if necessary straighten its backrest.

For optimum installation of the "forward facing" child seat, ensure that the back of the child seat is as close as possible to the backrest of the vehicle's seat, or in contact if possible. The head restraint must be removed before installing a child seat with a backrest on the passenger seat.

Ensure that the head restraint is stowed or attached securely so that it is not thrown around the vehicle in the event of sharp braking.

Refit the head restraint as soon as the child seat is removed.

## Children at the front

The legislation on carrying a child on the front passenger seat is specific to each country. Refer to the legislation in force in the country in which you are driving.

Deactivate the passenger's front airbag when a "rearward facing" child seat is installed on the front passenger seat.

Otherwise, the child would risk being seriously injured or killed if the airbag were deployed.

## Installing a booster cushion

The chest part of the seat belt must be positioned on the child's shoulder without touching the neck.

Ensure that the lap part of the seat belt passes correctly over the child's thighs.

Peugeot recommends the use of a booster seat which has a back, fitted with a seat belt guide at shoulder level.

As a safety precaution, do not leave:

- one or more children alone and unsupervised in a vehicle,
- a child or an animal in a vehicle which is exposed to the sun, with the windows closed,
- the keys within reach of children inside the vehicle.

To prevent accidental opening of the doors, use the "Child lock".

Take care not to open the rear windows by more than one third.

To protect young children from the rays of the sun, fit side blinds on the rear windows.

## electric child lock

Remote control system to prevent opening of the rear doors using their interior controls and use of the rear electric windows.

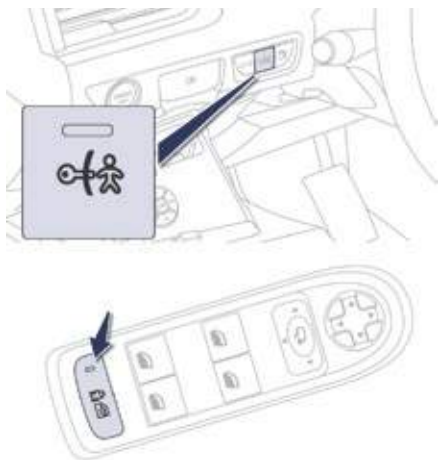

### Switching on

☞ With the ignition on, press this button. The indicator lamp in the button comes on, accompanied by a message to confirm that the child lock is on. This indicator lamp remains on until the child lock is switched off. It is still possible to open the doors from the outside and operate the rear electric windows from the driver's control panel.

### Switching off

☞ With the ignition on, press this button again. The indicator lamp in the button goes off, accompanied by a message to confirm that the child lock is off. This indicator lamp remains off while the child lock is switched off.

! Any other status of the indicator lamp indicates a fault with the electric child lock. Have it checked by a Peugeot Ot dealer or a qualified workshop.

! This system is independent and in no circumstances does it take the place of the central locking control. Check the status of the child lock each time you switch on the ignition. Always remove the key from the ignition when leaving the vehicle, even for a short time. In the event of a serious impact, the electric child lock is switched off automatically to permit the exit of the rear passengers.

## Direction indicators

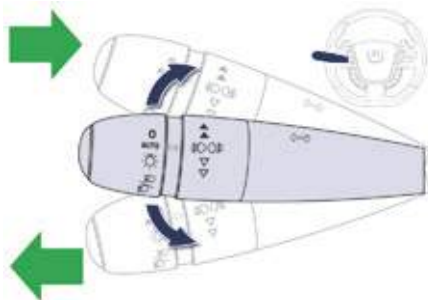

- ☞ Lower the lighting control stalk fully when moving to the left.
- ☞ Raise the lighting control stalk fully when moving to the right.

**i** If you forget to cancel the direction indicators for more than twenty seconds, the volume of the audible signal will increase if the speed is above 40 mph (60 km/h).

### Three flashes

Move the stalk briefly upwards or downwards, without going beyond the point of resistance; the corresponding direction indicators will flash 3 times.

**i** This function can be used at any speed, but it is particularly useful for changing lane on fast roads.

## Hazard warning lamps

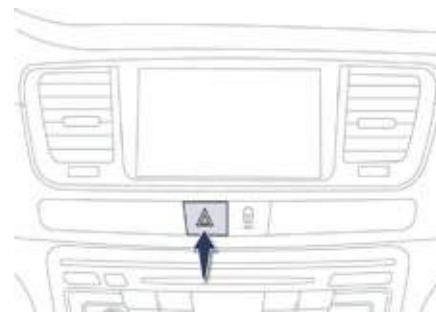

Press the button, the direction indicators flash. They can operate with the ignition off.

### Automatic operation of hazard warning lamps

When braking in an emergency, depending on the rate of deceleration, as well as when the ABS regulation is invoked or in the event of an impact, the hazard warning lamps come on automatically.

They switch off automatically the first time you accelerate.

- ☞ You can also switch them off by pressing the button.

## emergency or assistance call

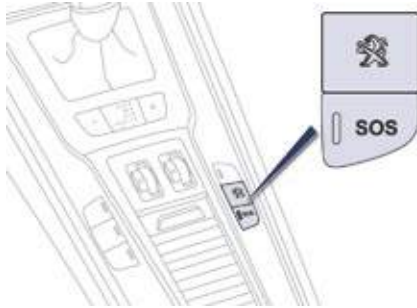

This system allows you to make an emergency or assistance call to the emergency services or to the dedicated Peugeot Ot service.

**i** For more information on the use of this function, refer to the "Audio equipment and telematics" section.

## Horn

Audible warning system to alert other road users to an imminent danger.



☞ Press the central part of the multifunction steering wheel.

**i** Use the horn moderately and only in the following circumstances:

- immediate danger,
- overtaking a cyclist or pedestrian,
- approaching a location lacking visibility.

## Warning triangle

This safety device should be used in addition to the hazard warning lamps.

Its presence in the vehicle is mandatory.

**i** The location for stowing a folded triangle is in the inner trim panel of the boot lid.

**!** Before leaving your vehicle to set up and install the triangle, switch on the hazard warning lamps and put on your high visibility vest.

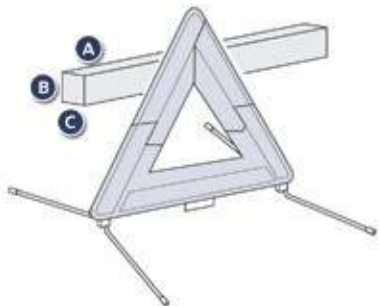

The dimensions of the triangle (once folded) or its storage box must be:

- A: length = 438 mm,
- B: height = 56 mm,
- C: width = 38 mm.

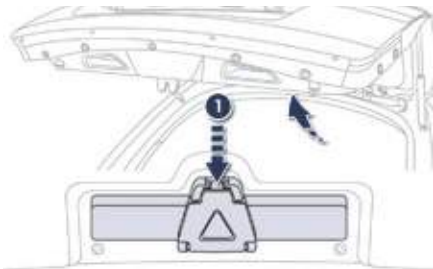

### Saloon

- ☞ Press the lug 1 and pull the assembly towards you.

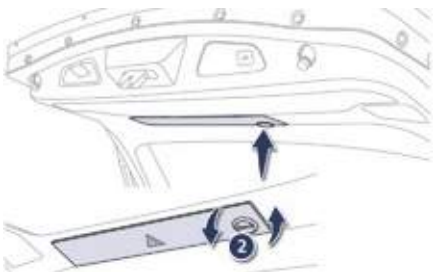

### SW

- ☞ Turn the knob 2 to remove the cover.
- ☞ Hold the cover and the triangle so that they do not fall.

## Placing the triangle in the road

- ☞ Place the triangle behind the vehicle, as required by the legislation in force in your country.

**i** Refer to the manufacturer's instructions on unfolding and installing supplied with the triangle.

**i** The triangle is available as an accessory; contact a Peugeot Ot dealer or a qualified workshop.

## Tyre under-inflation detection

System which automatically checks the pressures of the tyres while driving.

The system continuously monitors the pressures of the four tyres, as soon as the vehicle is moving.



A pressure sensor is located in the valve of each tyre (except the spare wheel).

The system triggers an alert if a drop in pressure is detected in one or more tyres.

The tyre under-inflation detection system is an aid to driving which does not replace the need for the driver to be vigilant or to drive responsibly.

This system does not avoid the need to check the tyre pressures regularly (including the spare wheel) and before a long journey.

Driving with under-inflated tyres adversely affects road holding, extends braking distances and causes premature tyre wear, particularly under arduous conditions (vehicle loaded, high speed, long journey).



Driving with under-inflated tyres increases fuel consumption.



The tyre pressures for your vehicle can be found on the tyre pressure label (see the "Identification markings" section).

The tyre pressures must be checked when the tyres cold (vehicle stopped for 1 hour or after driving for less than 6 miles (10 km) at moderate speed). Otherwise, add 0.3 bar to the values indicated on the label.



## Under-inflation alert



The alert is given by the fixed illumination of this warning lamp, accompanied by an audible signal, and depending on equipment, the display of a message.

In the event of a problem on one of the tyres, the symbol or the message appears, according to equipment, to identify it.

- ☞ Reduce speed, avoid sudden steering movements or harsh brake applications.
  - ☞ Stop as soon as it is safe to do so.
- ☞ If you have a compressor (the one in the temporary puncture repair kit for example), check the four tyre pressures when cold. If it is not possible to check the tyre pressures at the time, drive carefully at reduced speed.
- or
- ☞ In the event of a puncture, use the temporary puncture repair kit or the spare wheel (according to equipment).



The loss of pressure detected does not always lead to visible deformation of the tyre. Do not rely on just a visual check.



The alert is maintained until the tyre or tyres concerned is reinflated, repaired or replaced.  
The spare wheel (space-saver type or a steel rim) does not have a sensor.

## Operating fault



The flashing and then fixed illumination of the under-inflation warning lamp accompanied by the illumination of the "service" warning lamp indicates a fault with the system.

### SERVICE

In this case, monitoring of the tyre pressures is not assured.

This alert is also displayed when one or more wheels is not fitted with a sensor (for example, a space-saver or steel spare wheel).



Go to a Peugeot dealer or a qualified workshop to have the system checked or, following the repair of a puncture, to have the original wheel, equipped with a sensor, refitted.



Any tyre repair or replacement on a wheel fitted with this system must be carried out by a Peugeot dealer or a qualified workshop.

If after changing a tyre, a wheel is not detected by your vehicle (fitting snow tyres for example), you must have the system reinitialised by a Peugeot dealer or a qualified workshop.

# electronic stability control (eSC)

electronic Stability Control (eSC) incorporating the following systems:

- the anti-lock braking system (ABS) and the electronic brake force distribution (eBFD),
- the emergency braking assistance,
- the anti-slip regulation (ASR) or traction control,
- the dynamic stability control (DSC).

## Definitions

### Anti-lock braking system (ABS) and electronic brake force distribution (EBFD)

This system improves the stability and manoeuvrability of your vehicle when braking and provides improved control in corners, in particular on poor or slippery road surfaces.

The ABS prevents wheel lock in the event of emergency braking.

The electronic brake force distribution system manages the braking pressure wheel by wheel.

### Emergency braking assistance

In an emergency, this system enables you to reach the optimum braking pressure more quickly and therefore reduce the stopping distance.

It is triggered according to the speed at which the brake pedal is pressed. This is felt by a reduction in the resistance of the pedal and an increase in the effectiveness of the braking.

### Anti-slip regulation (ASR)

The ASR system (also known as Traction Control) optimises traction in order to limit wheel slip by acting on the brakes of the driving wheels and on the engine. It also improves the directional stability of the vehicle on acceleration.

### Dynamic stability control (DSC)

If there is a difference between the path followed by the vehicle and that required by the driver, the DSC monitors each wheel and automatically acts on the brake of one or more wheels and on the engine to return the vehicle to the required path, within the limits of the laws of physics.

## Snow driving assistance (Intelligent Traction Control)

Your vehicle has a system to help driving on snow: **Intelligent Traction Control**.

This automatic system continuously checks for situations of difficult surface adhesion that could make it difficult to move off or make progress on deep fresh snow or compacted snow.

In these situations, **Intelligent Traction Control** limits the amount of wheel slip to provide the best traction and trajectory control. In extremely severe conditions (deep snow, mud...), it can be useful to temporarily deactivate the **wheel anti-slip regulation** system to allow a degree of wheel spin and so recover grip.

It is recommended that the system be reactivated as soon as possible.

Snow tyres are strongly recommended on surfaces offering low levels of adhesion.

## Operation

### Anti-lock braking system (ABS) and electronic brake force distribution (EBFD)



When this warning lamp comes on, accompanied by an audible signal and a message, it indicates that there is a fault with the ABS, which could cause loss of control of the vehicle when braking.



When this warning lamp comes on, coupled with the **STOP** warning lamp, accompanied by an audible signal and a message, it indicates that there is a fault with the electronic brake force distribution (eBFD), which could cause loss of control of the vehicle when braking. **You must stop as soon as it is safe to do so.** In both cases, contact a Peugeot dealer or a qualified workshop.

**i** When changing wheels (tyres and rims), make sure that these are approved for your vehicle. Normal operation of the ABS may make itself felt by slight vibrations of the brake pedal.

**!** In emergency braking, press very firmly without releasing the pressure.

# Anti-slip regulation (ASR)



## Activation

This system is activated automatically each time the vehicle is started. It comes into operation in the event of a problem of grip.



This is indicated by flashing of this warning lamp in the instrument panel.

## Deactivation

In exceptional conditions (starting a vehicle which is bogged down, stuck in snow, on soft ground...), it may be advisable to deactivate the ASR system, so that the wheels can turn freely and regain grip.



Press the "ASR OFF" button.



The indicator lamp in the button comes on and the following message appears in the instrument panel screen "ASR deactivated\*": the ASR system no longer acts on the operation of the engine.

## Reactivation

The system is reactivated automatically each time the ignition is switched back on or from 12 mph (20 km/h).

Press the "ASR OFF" button again to reactivate it manually.

## Operating fault



If this warning lamp comes on, accompanied by an audible signal and a message in the instrument panel screen, this indicates a fault with the system.

Contact a Peugeot dealer or a qualified workshop to have the system checked.

\* Depending on version.

# Seat belts

## Front seat belts



The front seat belts are fitted with a pretensioning and force limiting system. This system improves safety in the front seats in the event of a front or side impact. Depending on the severity of the impact, the pretensioning system instantly tightens the seat belts against the body of the occupants. The pretensioning seat belts are active when the ignition is on. The force limiter reduces the pressure of the seat belt on the chest of the occupant, so improving their protection.

## Rear seat belts



The rear seats are each fitted with a seat belt, three-point anchorages with inertia reel and force limiter (except for the centre rear seat).



### Fastening

- ☞ Pull the strap, then insert the tongue in the buckle.
- ☞ Check that the seat belt is fastened correctly by pulling the strap.

### Unfastening

- ☞ Press the red button on the buckle.
- ☞ Guide the seat belt as it reels in.

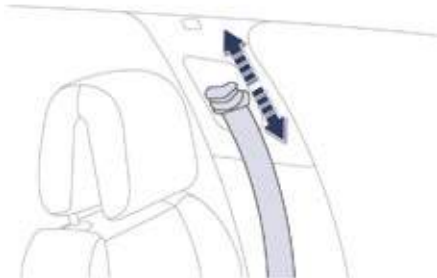

### Front seat belt height adjustment

To adjust the anchorage point, squeeze the control and slide it until you find a notch.



### Seat belt not fastened / unfastened warning lamps

1. Front and/or rear seat belts not fastened / unfastened warning lamp in the instrument panel.
2. Front left seat belt warning lamp.
3. Front right seat belt warning lamp.
4. Rear right seat belt warning lamp.
5. Rear centre seat belt warning lamp.
6. Rear left seat belt warning lamp.



From approximately 12 mph (20 km/h), the warning lamp(s) flash for two minutes accompanied by an audible signal. Once these two minutes have elapsed, the warning lamp(s) remain on until the driver or one or more passengers fasten their seat belt.

### Front and rear seat belt warning lamps



On switching on the ignition, warning lamp 1 comes on in the instrument panel and the corresponding warning lamp (2 to 6) comes on in red in the passenger's seat belt and front airbag warning lamp display if the corresponding seat belt is not fastened or is unfastened.

**i** The driver must ensure that passengers use the seat belts correctly and that they are all restrained securely before setting off. Wherever you are seated in the vehicle, always fasten your seat belt, even for short journeys. Do not interchange the seat belt buckles as they will not fulfil their role fully. The seat belts are fitted with an inertia reel permitting automatic adjustment of the length of the strap to your size. The seat belt is stowed automatically when not in use. Before and after use, ensure that the seat belt is reeled in correctly. The lower part of the strap must be positioned as low as possible on the pelvis. The upper part must be positioned in the hollow of the shoulder. The inertia reels are fitted with an automatic locking device which comes into operation in the event of a collision, emergency braking or if the vehicle rolls over. You can release the device by pulling firmly on the strap and releasing it so that it reels in slightly.

In order to be effective, a seat belt must:

- be tightened as close to the body as possible,
- be pulled in front of you with a smooth movement, checking that it does not twist,
- be used to restrain only one person,
- not bear any trace of cuts or fraying,
- not be converted or modified to avoid affecting its performance.

In accordance with current safety regulations, for all repairs on your vehicle, go to a qualified workshop with the skills and equipment needed, which a Peugeot dealer is able to provide. Have your seat belts checked regularly by a Peugeot dealer or a qualified workshop, particularly if the straps show signs of damage. Clean the seat belt straps with soapy water or a textile cleaning product, sold by Peugeot dealers. After folding or moving a seat or rear bench seat, ensure that the seat belt is positioned and reeled in correctly.

## Recommendations for children

Use a suitable child seat if the passenger is less than 12 years old or shorter than one and a half metres. Never use the same seat belt to secure more than one person. Never allow a child to travel on your lap.

## In the event of an impact

### Depending on the nature and seriousness of the impact,

the pretensioning device may be deployed before and independently of the airbags. Deployment of the pretensioners is accompanied by a slight discharge of harmless smoke and a noise, due to the activation of the pyrotechnic cartridge incorporated in the system.

In all cases, the airbag warning lamp comes on.

Following an impact, have the seat belts system checked, and if necessary replaced, by a Peugeot dealer or a qualified workshop.

## Airbags

System designed to maximise the safety of the occupants (with the exception of the rear centre passenger) in the event of violent collisions. The airbags supplement the action of the force-limiting seat belts (with the exception of the centre rear passenger).

If a collision occurs, the electronic detectors record and analyse the front and side impacts sustained in the impact detection zones:

- in the case of a serious impact, the airbags are deployed instantly and contribute towards better protection of the occupants of the vehicle (with the exception of the rear centre passenger); immediately after the impact, the airbags deflate rapidly so that they do not hinder visibility or the exit of the occupants,
- in the case of a minor or rear impact or in certain roll-over conditions, the airbags will not be deployed; the seat belt alone contributes towards ensuring your protection in these situations.

### **!** The airbags do not operate when the ignition is switched off.

This equipment will only deploy once. If a second impact occurs (during the same or a subsequent accident), the airbag will not be deployed again.

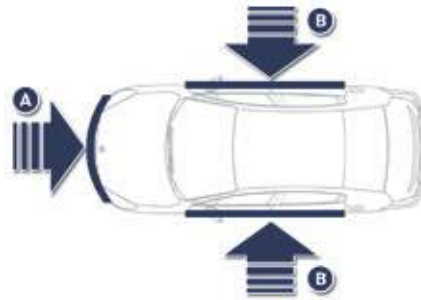

### Impact detection zones

- A. Front impact zone.
- B. Side impact zone.

**i** Deployment of the airbag(s) is accompanied by a slight emission of smoke and a noise, due to the activation of the pyrotechnic cartridge incorporated in the system. This smoke is not harmful, but sensitive individuals may experience slight irritation. The noise of the detonation may result in a slight loss of hearing for a short time.

## Front airbags

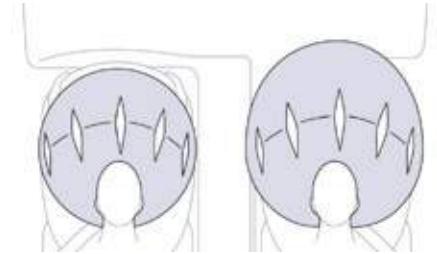

System which protects the driver and front passenger in the event of a serious front impact in order to limit the risk of injury to the head and thorax.

The driver's airbag is fitted in the centre of the steering wheel; the front passenger's airbag is fitted in the dashboard above the glove box.

### Deployment

The airbags are deployed, except the passenger's front airbag if it is deactivated, in the event of a serious front impact to all or part of the front impact zone A, in the longitudinal centreline of the vehicle on a horizontal plane and directed from the front to the rear of the vehicle. The front airbag inflates between the thorax and head of the front occupant of the vehicle and the steering wheel, driver's side, and the dashboard, passenger's side to cushion their forward movement.



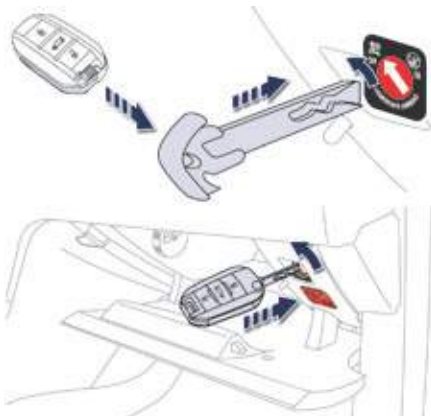

## Deactivation

Only the passenger's front airbag can be deactivated:

- ☞ insert the key in the passenger airbag deactivation switch,
- ☞ turn it to the "OFF" position,
- ☞ then, remove the key keeping the switch in the new position.



According to version, this warning lamp comes on either in the instrument panel or in the seat belt and passenger's front airbag warning lamp display when the ignition is on and until the airbag is reactivated.



To assure the safety of your child, the passenger's front airbag must be deactivated when you install a "rear facing" child seat on the front passenger seat. Otherwise, the child would risk being seriously injured or killed if the airbag were deployed.

## Reactivation

When you remove the child seat, **with the ignition off**, turn the switch to the "ON" position to reactivate the airbag and so assure the safety of your front passenger in the event of an impact.



With the ignition on, this warning lamp comes on in the seat belt and passenger's front airbag warning lamp display for approximately one minute, if the passenger's front airbag is activated.

## Operating fault



If this warning lamp comes on in the instrument panel, accompanied by an audible warning and a message in the instrument panel screen, contact a Peugeot dealer or a qualified workshop to have the system checked. The airbags may no longer be deployed in the event of a serious impact.

## Lateral airbags



System which protects the driver and front passenger in the event of a serious side impact in order to limit the risk of injury to the chest, between the hip and the shoulder. Each lateral airbag is fitted in the seat backrest frame, door side.

### Deployment

The lateral airbags are deployed unilaterally in the event of a serious side impact applied to all or part of the side impact zone **B**, perpendicular to the longitudinal centreline of the vehicle on a horizontal plane and directed from the outside towards the inside of the vehicle. The lateral airbag inflates between the hip and shoulder of the front occupant of the vehicle and the corresponding door trim panel.

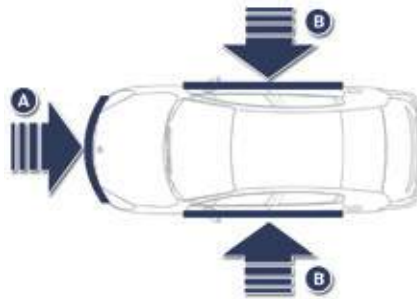

### Impact detection zones

- A. Front impact zone.
- B. Side impact zone.

## Curtain airbags

System which protects the driver and passengers (with the exception of the rear centre passenger) in the event of a serious side impact in order to limit the risk of injury to the side of the head. Each curtain airbag is built into the pillars and the upper passenger compartment area.

### Deployment

The curtain airbag is deployed at the same time as the corresponding lateral airbag in the event of a serious side impact applied to all or part of the side impact zone **B**, perpendicular to the longitudinal centreline of the vehicle on a horizontal plane and directed from the outside towards the inside of the vehicle. The curtain airbag inflates between the front or rear occupant of the vehicle and the windows.

### Operating fault



If this warning lamp comes on in the instrument panel, accompanied by an audible signal and a message in the instrument panel screen, contact a

Peugeot dealer or a qualified workshop to have the system checked. The airbags may no longer be deployed in the event of a serious impact.

**!** In the event of a minor impact or bump on the side of the vehicle or if the vehicle rolls over, the airbag may not be deployed. In the event of a rear or front collision, the curtain airbag is not deployed.

## **!** For the airbags to be fully effective, observe the following safety rules:

Sit in a normal upright position.

Wear a correctly adjusted seat belt.

Do not leave anything between the occupants and the airbags (a child, pet, object...). This could hamper the operation of the airbags or injure the occupants.

After an accident or if the vehicle has been stolen or broken into, have the airbag systems checked.

All work on the airbag system must be carried out by a Peugeot dealer or a qualified workshop.

Even if all of the precautions mentioned are observed, a risk of injury or of minor burns to the head, chest or arms when an airbag is deployed cannot be ruled out. The bag inflates almost instantly (within a few milliseconds) then deflates within the same time discharging the hot gas via openings provided for this purpose.

### **Front airbags**

Do not drive holding the steering wheel by its spokes or resting your hands on the centre part of the wheel.

Passengers must not place their feet on the dashboard.

Do not smoke as deployment of the airbags can cause burns or the risk of injury from a cigarette or pipe.

Never remove or pierce the steering wheel or hit it violently.

Do not fit or attach anything to the steering wheel or dashboard, this could cause injuries with deployment of the airbags.

### **Lateral airbags**

Use only approved covers on the seats, compatible with the deployment of the lateral airbags. For information on the range of seat covers suitable for your vehicle, you can contact a Peugeot dealer.

Refer to the "Accessories" section.

Do not fix or attach anything to the seat backs (clothing...). This could cause injury to the chest or arms if the lateral airbag is deployed.

Do not sit with the upper part of the body any nearer to the door than necessary.

### **Curtain airbags**

Do not fix or attach anything to the roof. This could cause injury to the head if the curtain airbag is deployed.

If fitted on your vehicle, do not remove the grab handles installed on the roof, they play a part in securing the curtain airbags.

## Temporary puncture repair kit

Complete system consisting of a compressor and a sealant cartridge which permits **temporary repair** of a tyre so that you can drive to the nearest garage.

It is designed to repair most punctures which could affect the tyre, located on the tyre tread or shoulder.

### Access to the kit



This kit is installed in the storage box, under the boot floor.



### List of tools

All of these tools are specific to your vehicle and can vary according to equipment. Do not use them for other purposes.

1. 12 V compressor.  
Contains a sealant cartridge for the temporary repair of a tyre and can also be used for adjusting tyre pressures.
2. One chock\* to block one of the front wheels of the vehicle.
3. Removable towing eye.  
See the "Towing the vehicle" section.

**i** The vehicle's electric system allows the connection of a compressor for long enough to inflate a tyre after a puncture repair or for inflating a small inflatable accessory.

\* Depending on destination country or equipment.

## Description of the kit



- A. "Sealant" or "Air" position selector.
- B. On "I" / off "O" switch.
- C. Deflation button.
- D. Pressure gauge (in bar and p.s.i.).
- E. Compartment housing:
  - a cable with adaptor for 12 V socket,
  - various inflation adaptors for accessories, such as balls, bicycle tyres...



- F. Sealant cartridge.
- G. White pipe with cap for repair.
- H. Black pipe for inflation.
- I. Speed limit sticker.

**i**t the speed limit sticker I must be affixed to the vehicle's steering wheel to remind you that a wheel is in temporary use. Do not exceed a speed of 50 mph (80 km/h) when driving with a tyre repaired using this type of kit.

## Repair procedure



### 1. Sealing

- ☞ Switch off the ignition.
- ☞ Turn the selector **A** to the "sealant" position.
- ☞ Check that the switch **B** is in position "O".



**i** Avoid removing any foreign bodies which have penetrated into the tyre.

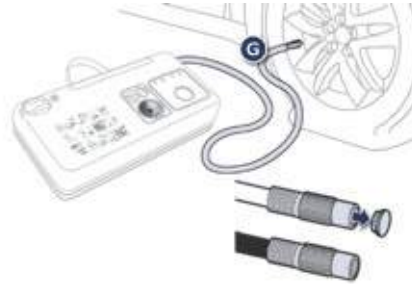

- ☞ Uncoil the white pipe **G** fully.
- ☞ Unscrew the cap from the white pipe.
- ☞ Connect the white pipe to the valve of the tyre to be repaired.

**!** Take care, this product is harmful (e.g. ethylene-glycol, colophony...) if swallowed and causes irritation to the eyes. Keep this product out of the reach of children.



- ☞ Connect the compressor's electric plug to the vehicle's 12 V socket.
- ☞ Start the vehicle and leave the engine running.

**!** Do not start the compressor before connecting the white pipe to the tyre valve: the sealant product would be expelled through the pipe.

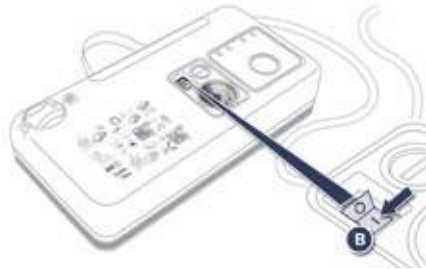

- ☞ Switch on the compressor by moving the switch **B** to position "I" until the tyre pressure reaches 2.0 bars. The sealant is injected into the tyre under pressure; do not disconnect the pipe from the valve during this operation (risk of splashing).

**i** If after around 5 to 7 minutes the pressure is not attained, this indicates that the tyre is not repairable; contact a Peugeot dealer or a qualified workshop for assistance.

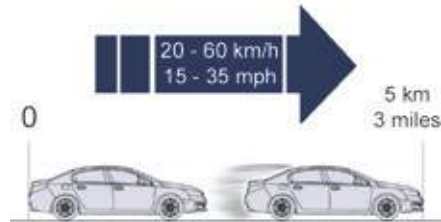

- ☞ Remove the kit and screw the cap back on the white pipe. Take care to avoid staining your vehicle with traces of fluid. Keep the kit to hand.
- ☞ Drive immediately for approximately three miles (five kilometres), at reduced speed (between 15 and 35 mph (20 and 60 km/h)), to plug the puncture.
- ☞ Stop to check the repair and the tyre pressure using the kit.

### **i** Tyre under-inflation detection

If the vehicle is fitted with tyre under-inflation detection, the under-inflation warning lamp will remain on after the wheel has been repaired until the system is reinitialised by a Peugeot dealer or a qualified workshop.



## 2. Inflation

- ☞ Turn the selector **A** to the "air" position.
- ☞ Uncoil the black pipe **H** fully.
- ☞ Connect the black pipe to the valve of the wheel.



- ☞ Connect the compressor's electric plug to the vehicle's 12 V socket.
- ☞ Start the vehicle again and leave the engine running.

**!** As soon as possible, go to a Peugeot dealer or a qualified workshop. You must inform the technician that you have used this kit. After inspection, the technician will advise you on whether the tyre can be repaired or if it must be replaced.



- ☞ Adjust the pressure using the compressor (to inflate: switch **B** in position "I"; to deflate: switch **B** in position "O" and press button **C**), in accordance with the vehicle's tyre pressure label (located on the left hand door aperture).  
A loss of pressure indicates that the puncture has not been fully plugged; contact a Peugeot dealer or qualified workshop for assistance.
- ☞ Remove and stow the kit.
- ☞ Drive at reduced speed (50 mph [80 km/h] max) limiting the distance travelled to approximately 120 miles (200 km).



## Removing the cartridge



- ☞ Stow the black pipe.
- ☞ Detach the angled base from the white pipe.
- ☞ Support the compressor vertically.
- ☞ unscrew the cartridge from the bottom.

**!** Beware of discharges of fluid.  
 The expiry date of the fluid is indicated on the cartridge.  
 The sealant cartridge is designed for single use; even if only partly used, it must be replaced.  
 After use, do not discard the cartridge into the environment, take it to an authorised waste disposal site or a Peugeot dealer.  
 Do not forget to obtain a new sealant cartridge, available from Peugeot dealers or from a qualified workshop.

## Checking tyre pressures / inflating accessories



You can also use the compressor, without injecting any product, to:

- check or adjust the pressure of your tyres,
- inflate other accessories (balls, bicycle tyres...).

- ☞ Turn the selector **A** to the "Air" position.
- ☞ Uncoil the black pipe **H** fully.
- ☞ Connect the black pipe to the valve of the wheel or accessory.  
 If necessary, fit one of the adaptors supplied with the kit first.



- ☞ Connect the compressor's electrical connector to the vehicle's 12 V socket.
- ☞ Start the vehicle and let the engine run.
- ☞ Adjust the pressure using the compressor (to inflate: switch **B** in position "I"; to deflate: switch **B** in position "O" and press button **C**), according to the vehicle's tyre pressure label or the accessory's pressure label.
- ☞ Remove the kit then stow it.

# Changing a wheel

Procedure for changing a faulty wheel for the spare wheel using the tools provided with the vehicle.

## Access to the tools



The tools are installed in the boot under the floor.

To gain access to them:

- 1. open the boot,
- 2. position the floor vertically (SW: in its guide) for access to the tools.

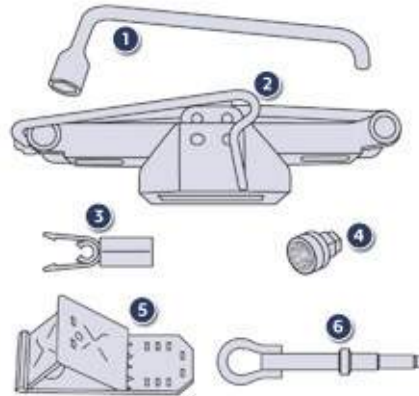

## List of tools

All of these tools are specific to your vehicle and can vary according to the level of equipment. Do not use them for other purposes.

1. Wheelbrace.  
For removing the wheel trim and removing the wheel bolts.
2. Jack with integral handle.  
For raising the vehicle.

3. "Bolt cover" tool.  
For removing the bolt protectors (covers) on alloy wheels.
4. Socket for the security bolts (located in the glove box).  
For adapting the wheelbrace to the special "security" bolts.
5. A wheel chock for immobilising the vehicle\*.
6. towing eye.  
See "towing the vehicle".

\* Depending on country of sale or equipment.

## **i** Wheel with trim

**When refitting the wheel**, refit the trim starting by placing its notch facing the valve and press around its edge with the palm of your hand.

## Access to the spare wheel

The spare wheel is located in the boot under the floor.

According to country, the spare wheel may be steel, alloy or of the "space-saver" type. To gain access to it, refer to the "Access to the tools" section.



Depending on your vehicle's equipment, the spare wheel is secured either by a strap or a central bolt. For the bolt, the procedure is given below.

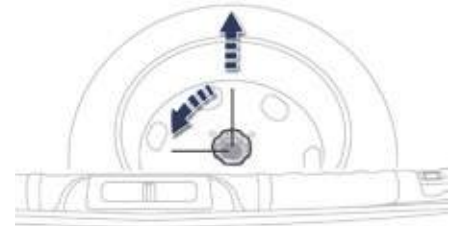

## Taking out the wheel

- ☞ unscrew the (coloured) central bolt.
- ☞ Raise the spare wheel towards you from the rear.
- ☞ take the wheel out of the boot.



### Putting the wheel back in place

- ☞ Put the wheel back in its housing.
- ☞ Unscrew the (coloured) central bolt by a few turns then put it in place in the centre of the wheel.
- ☞ Tighten fully until the central bolt clicks to retain the wheel correctly.

- ☞ Put the box back in place in the centre of the wheel and clip it.
- ☞ Put the polystyrene storage box back in place.

### **i** Tyre under-inflation detection

The spare wheel (space-saver or steel rim) does not have a sensor. The punctured wheel must be repaired by a Peugeot dealer or a qualified workshop.

## Removing a wheel

### **i** Parking the vehicle

Immobilise the vehicle where it does not block traffic: the ground must be level, stable and not slippery.

Apply the parking brake unless it has been programmed to automatic mode, switch off the ignition and block the wheels:

- engage first gear with a manual gearbox,
- place the lever in position **R** with an electronic gearbox,
- place the lever in position **P** with an automatic gearbox.

Check that the braking warning lamp and the **P** warning lamp in the parking brake control lever come on. The occupants must get out of the vehicle and wait where they are safe. Never go underneath a vehicle raised using a jack; use an axle stand.

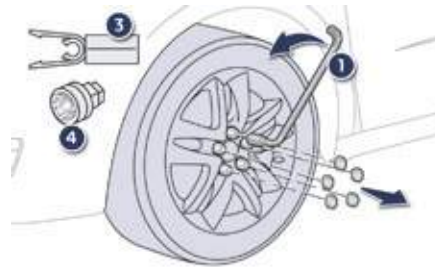

### List of operations

- ☞ Remove the bolt cover from each of the bolts using the tool **3** (according to equipment).
- ☞ Fit the security socket **4** on the wheelbrace **1** to slacken the security bolt (if fitted).
- ☞ Slacken the other bolts using the wheelbrace **1** only.

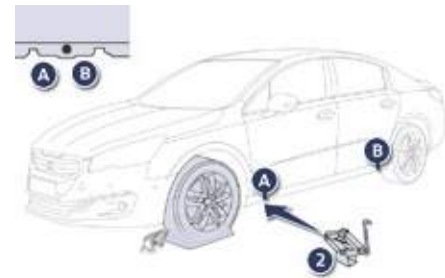

- ☞ Place the foot of the jack **2** on the ground and ensure that it is directly below the front **A** or rear **B** jacking point provided on the underbody, whichever is closest to the wheel to be changed.

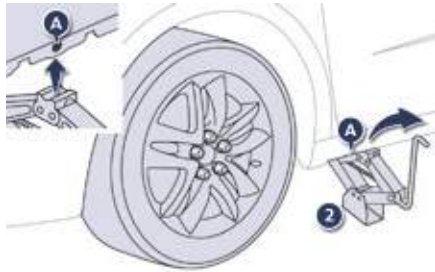

- ☞ extend the jack **2** until its head comes into contact with the jacking point **A** or **B** used; the vehicle's contact surface at **A** or **B** must engage with the central part of the head of the jack.

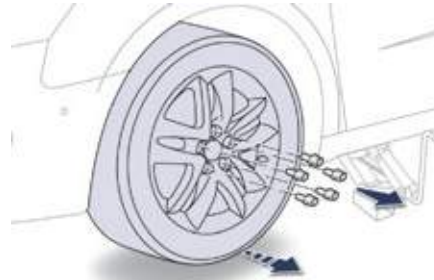

- ☞ Raise the vehicle until there is sufficient space between the wheel and the ground to admit the spare (not punctured) wheel easily.
- ☞ Remove the bolts and store them in a clean place.
- ☞ Remove the wheel.

**!** ensure that the jack is stable. If the ground is slippery or loose, the jack might slip or drop - Risk of injury!  
Take care to position the jack only at one of the vehicle's jacking points **A** or **B** under the vehicle, ensuring that the contact surface of the vehicle's jacking point is centred on the head of the jack. Otherwise there is a risk of damage to the vehicle and/or that the jack might drop - Risk of injury!

## Fitting a wheel



### **i** Fitting the "space-saver" spare wheel

If your vehicle is fitted with alloy wheels, when tightening the bolts on fitting, it is normal to notice that the washers do not come into contact with the "space-saver" spare wheel. The wheel is secured by the conical surface of each bolt.

### After changing a wheel

To store the punctured wheel in the boot correctly, first remove the central cover.

When using the "space-saver" type spare wheel, do not exceed 50 mph (80 km/h).

Have the tightening of the bolts and the pressure of the spare wheel checked by a Peugeot dealer or a qualified workshop without delay.

Have the punctured wheel repaired and refitted to the vehicle as soon as possible.

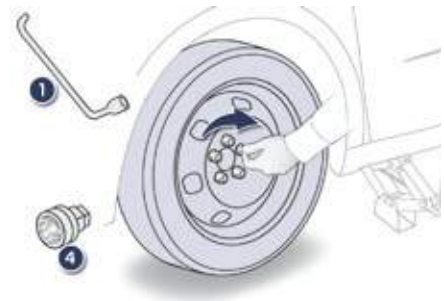

### List of operations

- ☞ Put the wheel in place on the hub.
- ☞ Screw in the bolts fully by hand.
- ☞ Pre-tighten the security bolt using the wheelbrace 1 fitted with the security socket 4.
- ☞ Pre-tighten the other bolts using the wheelbrace 1 only.

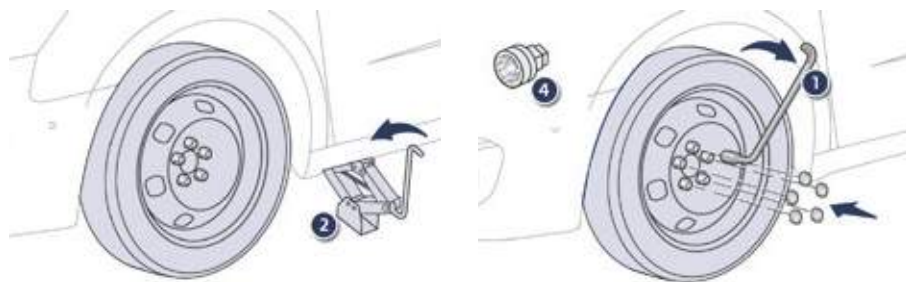

- ☞ Lower the vehicle fully.
- ☞ Fold the jack 2 and detach it.

- ☞ Tighten the security bolt using the wheelbrace 1 fitted with the security socket 4.
- ☞ Tighten the other bolts using the wheelbrace 1 only.
- ☞ Refit the bolt covers on each of the bolts (according to equipment).
- ☞ Store the tools in the box.



# Snow chains

In wintry conditions, snow chains improve traction as well as the behaviour of the vehicle when braking.

**i** The snow chains must be fitted only to the front wheels. They must never be fitted to "space-saver" type spare wheels.

Take account of the legislation in force in your country on the use of snow chains and the maximum running speed authorised.

Use only the chains designed to be fitted to the type of wheel fitted to your vehicle:

Original tyre size	Chain specification
215/60R16 215/55R17 225/55 R17	Maximum link size: 9 mm
135/80R18 235/45R18 245/45R18 235/40R19	Cannot be fitted with chains

**!** It is strongly recommended that before you leave, you practise fitting the snow chains on a level and dry surface.

**i** For more information on snow chains, contact a Peugeot dealer or a qualified workshop.

## Advice on installation

- ☞ If you have to fit the chains during a journey, stop the vehicle on a flat surface on the side of the road.
- ☞ Apply the parking brake and position any wheel chocks to prevent movement of your vehicle.
- ☞ Fit the chains following the instructions provided by the manufacturer.
- ☞ Move off gently and drive for a few moments, without exceeding 30 mph (50 km/h).
- ☞ Stop your vehicle and check that the snow chains are correctly tightened.

**i** Avoid driving with snow chains on roads that have been cleared of snow, to avoid damaging your vehicle's tyres and the road surface. If your vehicle is fitted with alloy wheels, check that no part of the chain or its fixings is in contact with the wheel rim.

# Changing a bulb

## Front lamps

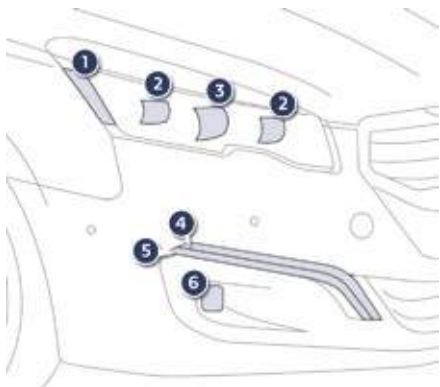

### Model with "full LED" technology headlamps

1. Additional lighting.
2. Dipped beam headlamps.
3. Main beam headlamps.
4. Daytime running lamps.
5. Direction indicators / Sidelamps.
6. Front foglamps.

**i** All of these lamps use light-emitting diodes - LeDs.

**i** For the replacement of these light-emitting diode (LeD) lamps, contact a Peugeot dealer or a qualified workshop.

**i** In some weather conditions (e.g. low temperature or humidity), the presence of misting on the internal surface of the glass of the headlamps and rear lamps is normal; it disappears after the lamps have been on for a few minutes.

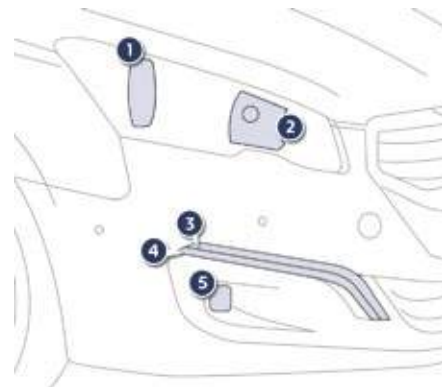

### Model with halogen headlamps

1. Dipped beam headlamps (H7-55W).
2. Main beam headlamps (H7-55W).
3. Daytime running lamps (LEDs).
4. Direction indicators / Sidelamps (LEDs).
5. Foglamps (LEDs).

For H7 type bulbs with lugs, take care to observe their correct installation so as to ensure the best lighting performance.

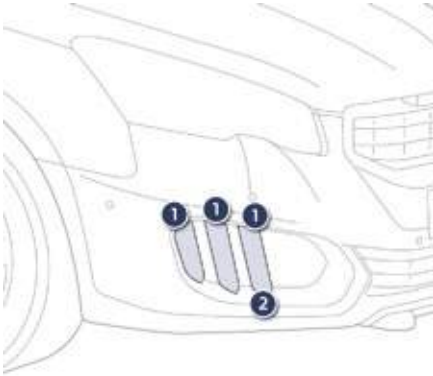

### RHX internal combustion model (lower part)

1. Daytime running lamps / sidelamps (LEDs).
2. Direction indicators (LEDs).

- !** The headlamps are fitted with polycarbonate glass with a protective coating:
- ☞ **do not clean them using a dry or abrasive cloth, nor with a detergent or solvent product,**
  - ☞ use a sponge and soapy water or a pH neutral product,
  - ☞ when using a high pressure washer on persistent marks, do not keep the lance directed towards the lamps or their edges for too long, so as not to damage their protective coating and seals.

Changing a bulb should only be done after the headlamp has been switched off for several minutes (risk of serious burns).

- ☞ Do not touch the bulb directly with your fingers, use a lint-free cloth.

It is imperative to use only anti-ultraviolet (u V) type bulbs to avoid damaging the headlamp.

Always replace a failed bulb with a new bulb with the same type and specification.

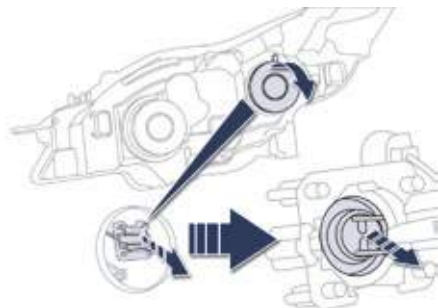

## Halogen model

### Dipped beam headlamp

- ☞ Remove the protective plastic cover by pulling on the tab.
- ☞ unclip the bulb connector.
- ☞ extract the bulb by pulling and change it.

For reassembly, carry out these operations in reverse order.

**i** For the left hand headlamp, it is necessary to remove the battery. Refer to the corresponding section.

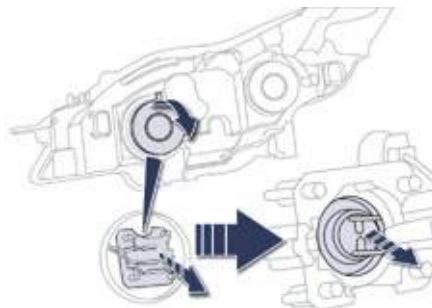

### Main beam headlamps

- ☞ Remove the protective plastic cover by pulling on the tab.
- ☞ unclip the bulb connector.
- ☞ Remove the bulb by pulling it out and change it.

For reassembly, carry out these operations in reverse order.

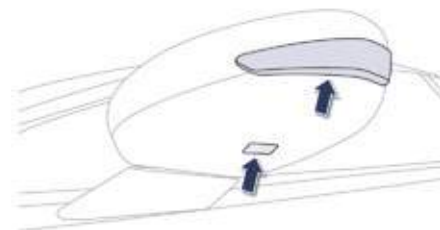

## Door mirror spotlamps

You should contact a Peugeot dealer or a qualified workshop for the replacement of the light emitting diode - LeD.

## Integrated direction indicator side repeaters

You should contact a Peugeot dealer or a qualified workshop for the replacement of these bulbs.

## Rear lamps (Saloon)

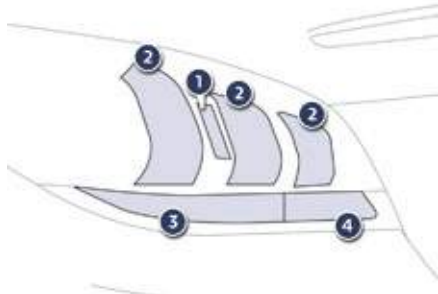

1. Brake lamps  
(light emitting diodes - LEDs).
2. Sidelamps  
(light emitting diodes - LEDs).
3. Direction indicators  
(PY21W amber).
4. Foglamps  
(light-emitting diodes) /  
Reversing lamps (W16W).

### **i** Light emitting diodes-LEDs

For replacement, contact a Peugeot dealer or qualified workshop.

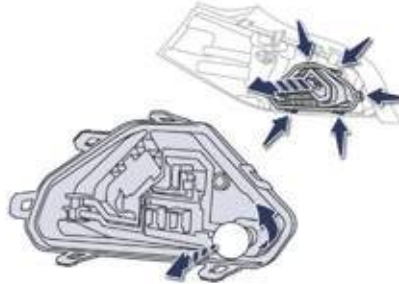

## Direction indicators and reversing lamp

### Direction indicators

- ☞ Open the boot, then the plastic cover.
- ☞ Remove the two lamp unit fixing nuts.
- ☞ extract the lamp unit carefully from the outside.
- ☞ Disconnect the electrical connector.
- ☞ Spread the tabs and remove the bulb holder.
- ☞ turn the bulb a quarter of a turn and pull it out.

For reassembly, carry out these operations in reverse order.



### Reversing lamp

- Remove the direction indicator bulb holder, as described above.
- turn the bulb a quarter of a turn and change it.

To reassemble, carry out these operations in reverse order.

## Rear lamps (SW)

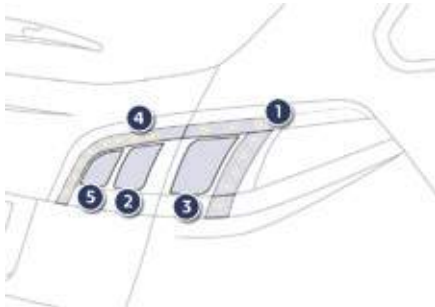

1. Brake lamps (light emitting diodes - LEDs).
2. Reversing lamps (W19W).
3. Direction indicators (PY21W amber).
4. Sidelamps (light emitting diodes - LEDs).
5. Foglamps (light emitting diodes - LEDs).

### **i** Light emitting diodes-LEDs

For replacement, contact a Peugeot Ot dealer or qualified workshop.

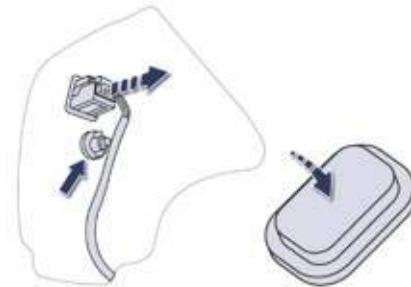

## Direction indicators (on the wings)

- ☞ Open the boot then remove the access cover.
- ☞ Remove the sealing foam.
- ☞ Disconnect the lamp connector.
- ☞ Remove the lamp fixing nut.

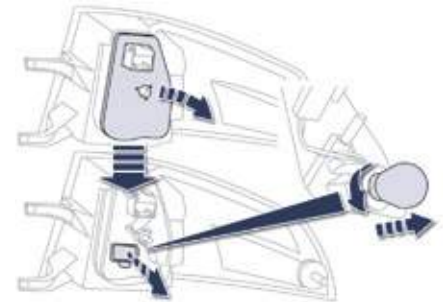

- ☞ Carefully remove the lamp unit from outside.
- ☞ Remove the sealing foam.
- ☞ Unclip the bulb holder.
- ☞ Turn the bulb a quarter of a turn and pull it out.

For reassembly, carry out these operations in reverse order.

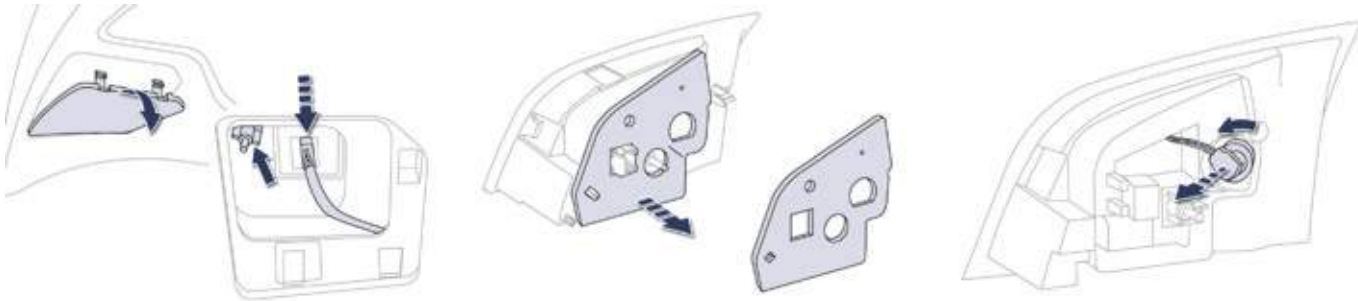

### Reversing lamp (tailgate)

- ☞ Open the tailgate and then remove the access cover.
- ☞ Disconnect the lamp connector.
- ☞ Remove the lamp fixing nut.

- ☞ Carefully remove the lamp from the outside.
- ☞ Remove the sealing foam.

- ☞ Turn the bulb holder a quarter of a turn and pull it out.
- For reassembly, carry out these operations in reverse order.



### Third brake lamp (light emitting diodes - LEDs)

Contact a Peugeot dealer or qualified workshop.

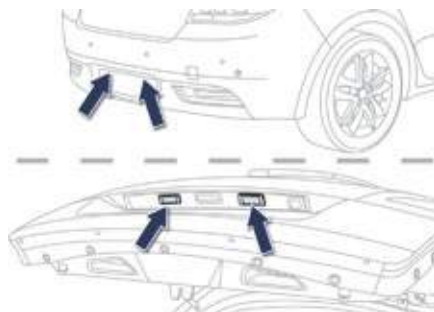

### Number plate lamps

- ☞ Insert a thin screwdriver into one of the outer holes of the lens.
- ☞ Push it outwards to unclip.
- ☞ Disconnect the lamp connector.
- ☞ Remove the lens.
- ☞ Pull the bulb out and change it.



# Changing a fuse

Procedure for replacing a failed fuse with a new fuse to rectify a failure of the corresponding function.

## Access to the tools

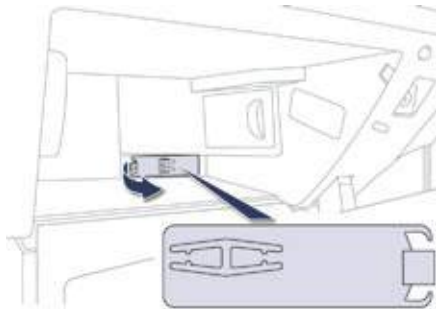

The extraction tweezers and spare fuses are located in the glove box.

## Changing a fuse

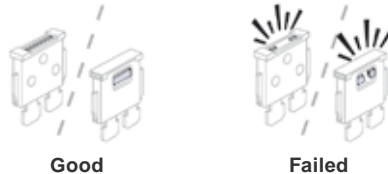

Before changing a fuse, the cause of the failure must be identified and rectified.

- ☞ Identify the failed fuse by checking the condition of its filament.
- ☞ Use the special tweezers to extract the fuse from its housing.
- ☞ Always replace the faulty fuse with a fuse of the same rating.
- ☞ Check that the number marked on the fusebox, the rating marked on the fuse and the following tables all agree.

## **i** Installing electrical accessories

Your vehicle's electrical system is designed to operate with standard or optional equipment.  
Before installing other electrical equipment or accessories on your vehicle, contact a Peugeot Ot dealer or a qualified workshop.

- !** Peugeot Ot will not accept responsibility for the cost incurred in repairing your vehicle or for rectifying malfunctions resulting from the installation of accessories not supplied and not recommended by Peugeot Ot and not installed in accordance with its instructions, in particular when the combined consumption of all of the additional equipment connected exceeds 10 milliamperes.

## Dashboard fuses



The fusebox is placed in the lower dashboard (left-hand side).

### Access to the fuses

- ☞ Open the hinged panel, then apply light force to bypass the stops.

Fuse N°	Rating (A)	Functions
F6 A or B	15	Audio system.
F8	3	Alarm.
F13	10	Front cigar lighter.
F14	10	Front 12 V socket.
F16	3	Rear courtesy lamp, rear map reading lamps.
F17	3	Front courtesy lamp, courtesy mirror.
F28 A or B	15	Audio system.
F30	20	Rear wiper.
F32	10	Audio amplifier.

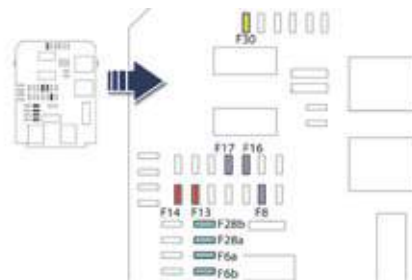

## Fuses behind the glove box

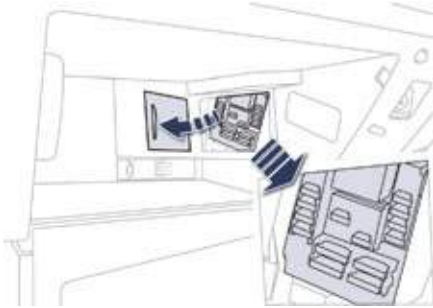

Fuse N°	Rating (A)	Functions
F3	15	Driver's electric window panel, 12 V socket for rear seats.
F4	15	12 V socket in boot.
F5	30	One-touch rear window.
F6	30	One-touch front window.
F11	20	t railer unit.
F12	20	Audio amplifier.
F15	20	Panoramic sunroof blind (SW).
F16	5	Driver's electric window switch panel.

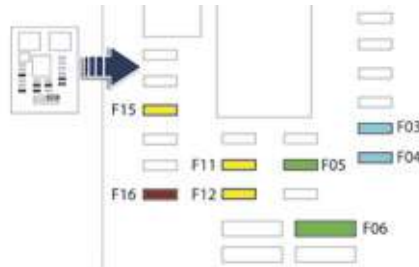

## Engine compartment fuses

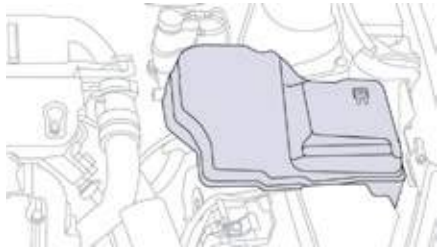

The fusebox is placed in the engine compartment near the battery.

Fuse N°	Rating (A)	Functions
F20	15	Front / rear screenwash pump.
F21	20	Headlamp wash pump.
F22	15	Horn.
F23	15	Right-hand main beam headlamp.
F24	15	Left-hand main beam headlamp.
F27	5	Left hand lamp mask.
F28	5	Right hand lamp mask.

### Access to the fuses

- 🔧 unclip the cover.
- 🔧 Change the fuse (see corresponding paragraph).
- 🔧 When you have finished, close the cover carefully to ensure correct sealing of the fusebox.

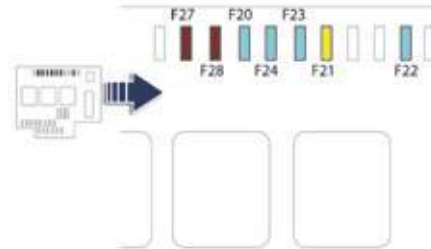



## Disconnecting the (+) cable

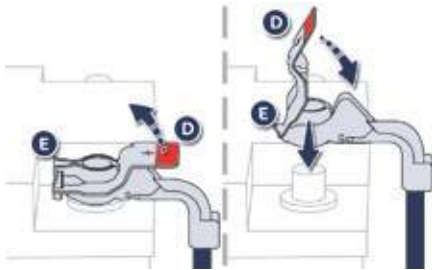

- ☞ Raise the locking tab **D** fully to release the cable terminal clamp **E**.

## Reconnecting the (+) cable

- ☞ Position the open clamp **E** of the cable on the positive post (+) of the battery.
- ☞ Press vertically on the clamp **E** to position it correctly on the battery.
- ☞ Lock the clamp by spreading the positioning lug and then lowering the tab **D**.

**!** Do not apply excessive force on the tab as locking will not be possible if the clamp is not positioned correctly; start the procedure again.

## Starting using another battery

When your vehicle's battery is discharged, the engine can be started using a slave battery (external or on another vehicle) and jump lead cables.

**!** First check that the slave battery has a nominal voltage of 12 V and a capacity at least equal to that of the discharged battery.  
Do not try to start the engine by connecting a battery charger.  
Do not disconnect the (+) terminal when the engine is running.

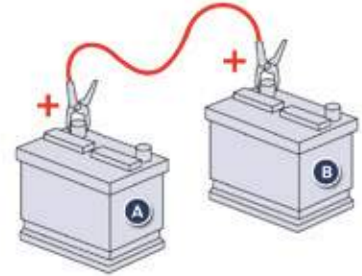

- ☞ Remove the plastic cover from the (+) terminal, if your vehicle has one.
- ☞ Connect the red cable to the positive terminal (+) of the flat battery **A**, then to the positive terminal (+) of the slave battery **B**.

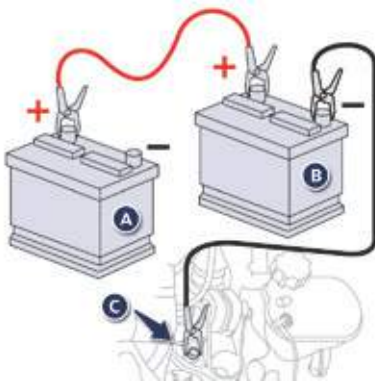

- ☞ Connect one end of the green or black cable to the negative terminal (-) of the slave battery **B** (or earth point on the other vehicle).
- ☞ Connect the other end of the green or black cable to the earth point **C** on the broken down vehicle (or on the engine mounting).
- ☞ Start the engine of the vehicle with the good battery and leave it running for a few minutes.

- ☞ Operate the starter on the broken down vehicle and let the engine run. If the engine does not start straight away, switch off the ignition and wait a few moments before trying again.
- ☞ Wait until the engine returns to idle then disconnect the jump lead cables in the reverse order.
- ☞ Refit the plastic cover to the (+) terminal, if your vehicle has one.

**i** Some functions are not available if the battery is not sufficiently charged.

## Before disconnecting the battery

Wait 2 minutes after switching off the ignition before disconnecting the battery. Close the windows and the doors before disconnecting the battery.

## Following reconnection of the battery

Following reconnection of the battery, switch on the ignition and wait 1 minute before starting to permit initialisation of the electronic systems. However, if problems remain following this operation, contact a Peugeot dealer or a qualified workshop.

Referring to the corresponding section, you must yourself reinitialise (depending on version):

- the remote control key,
- the electric blind(s),
- ...

## Charging the battery using a battery charger

**i** With Stop & Start, the battery does not have to be disconnected for charging.

- ☞ Disconnect the battery from the vehicle.
- ☞ Follow the instructions for use provided by the manufacturer of the charger.
- ☞ Connect the battery starting with the negative terminal (-).
- ☞ Check that the terminals and connectors are clean. If they are covered with sulphate (whitish or greenish deposit), remove them and clean them.

**☘** The batteries contain harmful substances such as sulphuric acid and lead. They must be disposed of in accordance with regulations and must not, in any circumstances, be discarded with household waste. Take used remote control batteries and vehicle batteries to a special collection point.

**i** It is advisable to disconnect the battery if the vehicle is to be left unused for more than one month.

**!** Protect your eyes and face before handling the battery. All operations on the battery must be carried out in a well ventilated area and away from naked flames and sources of sparks, so as to avoid the risk of explosion or fire.

Do not try to charge a frozen battery; the battery must first be thawed out to avoid the risk of explosion. If the battery has been frozen, before charging have it checked by a Peugeot dealer or a qualified workshop who will check that the internal components have not been damaged and the casing is not cracked, which could cause a leak of toxic and corrosive acid.

Do not reverse the polarity and use only a 12 V charger.

Do not disconnect the terminals while the engine is running.

Do not charge the batteries without disconnecting the terminals first.

Wash your hands afterwards.

**!** Do not push the vehicle to start the engine if you have an electronic or automatic gearbox.



# Removing - refitting the battery\*

This procedure allows you to safely remove the battery when needed to change a failed bulb.

**i** You can also call on a Peugeot dealer or a qualified workshop to carry out this procedure.

## Before removal

- Place the vehicle in a ventilated location, with free access and preferably on a level surface.
- Apply the parking brake.
- Put the gear lever into neutral (position **N** for an automatic or electronic gearbox).
- If the vehicle has an alarm, leave the bonnet open to avoid triggering the alarm.
- Leave at least one window open if in a secure location, otherwise lock all the doors and the boot.
- If the vehicle has a motorised tailgate, it will not be possible to open it after disconnecting the battery.
- Switch off the ignition and remove the key.
- If the vehicle has Keyless entry and Starting, take the remote control at least 3 metres away from the vehicle.
- Wait about 4 minutes (or 12 minutes with an automatic or electronic gearbox) before disconnecting the battery.

## Removal

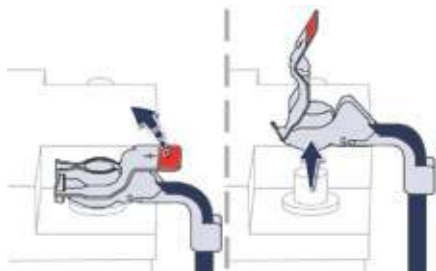

- Disconnect the positive (+) terminal from the battery.



- Remove the battery cover **1**.



- Release **2** then disconnect the negative (-) terminal from the battery.
- unclip the wiring harnesses **3**.
- unclip and move aside the wiring harness **4**.
- Remove the nut **5** from the positive (+) cable.
- Move aside wiring harness **6**.



- using a screwdriver, unclip the clips 7 and 8.
- Raise the power shut-off unit 9.
- Move this unit forward out of the way.



- unclip the clips.
- Remove the battery cover 10.



- using a screwdriver, lever the fixing 11 aside and remove the battery.

## Refitting

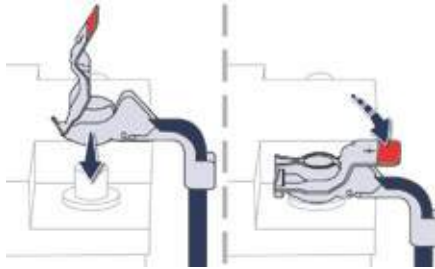

To reassemble, carry out the removal operations in reverse order, connecting the positive (+) terminal last.

## After refitting

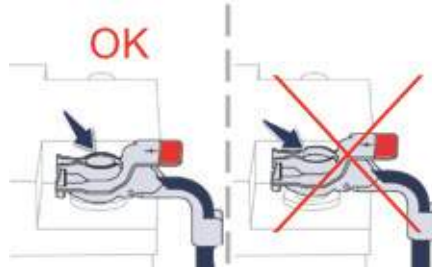

- Check that the battery terminals are secure.
- Switch on the ignition, without starting the engine.
- Check that there are no error messages or warning lamps on. If necessary contact a Peugeot dealer or a qualified workshop to have the system reset.
- Check the correct operation of all doors and windows.
- After refitting, wait around 1 minute (or 2 minutes for an automatic or electronic gearbox).
- Start the engine.
- Check the correct operation of anti-pinch systems: electric windows, opening roof, panoramic sunroof.

- If the vehicle has an electric parking brake, check that it is working correctly by releasing and applying it.
- Switch the ignition off.
- Get out of the vehicle then check that the remote control works correctly.
- Set: the time, the preset radio stations and the audio settings.

**i** After refitting the battery, some systems may be temporarily unavailable: Stop (Stop & Start), Air conditioning, Navigation.

**i** In all cases, contact a Peugeot dealer or a qualified workshop if there are any faults after refitting the battery.

## Load reduction mode

System which manages the use of certain functions according to the level of charge remaining in the battery.

When the vehicle is being driven, the load reduction function temporarily deactivates certain functions, such as the air conditioning, the heated rear screen...

The deactivated functions are reactivated automatically as soon as conditions permit.

## energy economy mode

System which manages the duration of use of certain functions to conserve a sufficient level of charge in the battery.

After the engine has stopped, you can still use functions such as the audio and telematics system, windscreen wipers, dipped beam headlamps, courtesy lamps, etc. for a maximum combined duration of about forty minutes.

### Switching to economy mode

A message then appears in the instrument panel screen indicating that the vehicle has switched to economy mode and the active functions are put on standby.

If a telephone call is being made at this time, it will be maintained for around 10 minutes with the Bluetooth hands-free system of your audio system.

### Exiting economy mode

These functions are reactivated automatically next time the vehicle is driven.

In order to restore the use of these functions immediately, start the engine and let it run:

- for less than ten minutes, to use the equipment for approximately five minutes,
- for more than ten minutes, to use the equipment for up to approximately thirty minutes.

Let the engine run for the duration specified to ensure that the battery charge is sufficient.

Do not repeatedly and continuously restart the engine in order to charge the battery.

A flat battery prevents the engine from starting (refer to the "Battery" section).



## Changing a wiper blade



### Before removing a front wiper blade

- ☞ Within one minute after switching off the ignition, operate the wiper stalk to position the wiper blades vertically on the windscreen.

### Fitting

- ☞ Put the corresponding new wiper blade in place and clip it.
- ☞ Fold down the wiper arm carefully.

### Removing

- ☞ Raise the corresponding wiper arm.
- ☞ unclip the wiper blade and remove it.

### After fitting a front wiper blade

- ☞ Switch on the ignition.
- ☞ Operate the wiper stalk again to park the wiper blades.

# towing the vehicle

Procedure for having your vehicle towed or for towing another vehicle using a removable towing eye.

## Access to the tools



The towing eye is installed in the boot under the floor.

To gain access to it:

- ☞ open the boot,
- ☞ position the floor vertically,
- ☞ remove the towing eye.

## Towing your vehicle



- ☞ On the front bumper, unclip the cover by pressing at the bottom.
- ☞ Screw the towing eye in fully.
- ☞ Install the towing bar.
- ☞ Switch on the hazard warning lamps on the towed vehicle.

**i** Put the gear lever into neutral (position **N** for an electronic or automatic gearbox). Failure to follow this instruction could lead to damage to certain components (brakes, transmission, ...) and the absence of braking assistance on restarting the engine.

## Towing another vehicle



- ☞ On the rear bumper, unclip the cover by pressing at the bottom.
- ☞ Screw the towing eye in fully.
- ☞ Install the towing bar.
- ☞ Switch on the hazard warning lamps on the towed vehicle.

### ! General recommendations

Observe the legislation in force in your country.

ensure that the weight of the towing vehicle is higher than that of the towed vehicle.

the driver must remain at the wheel of the towed vehicle and must have a valid driving licence.

When towing a vehicle with all four wheels on the ground, always use an approved towing arm; rope and straps are prohibited.

the towing vehicle must move off gently.

When towing a vehicle with the engine off, there is no longer any power assistance for braking or steering.

In the following cases, you must always call on a professional recovery service:

- vehicle broken down on a motorway or fast road,
- four-wheel drive vehicle,
- when it is not possible to put the gearbox into neutral, unlock the steering, or release the parking brake,
- towing with only two wheels on the ground,
- where there is no approved towing arm available...



## towing a trailer



towbar suitable for the attachment of a trailer or installation of a bicycle carrier, with additional lighting and signalling.

Your vehicle is primarily designed for transporting people and luggage, but it may also be used for towing a trailer.

### Blanking cover



When towing, you must remove the blanking cover if your vehicle has one. Contact a Peugeot dealer or a qualified workshop for this.

**i** We recommend the use of genuine Peugeot towbars and their harnesses that have been tested and approved from the design stage of your vehicle, and that the fitting of the towbar is entrusted to a Peugeot dealer or a qualified workshop. If the towbar is not fitted by a Peugeot dealer, it is imperative that it is fitted in accordance with the vehicle manufacturer's instructions.

**!** Driving with a trailer places greater demands on the towing vehicle and the driver must take particular care.

## Driving advice

### Distribution of loads

- ☞ Distribute the load in the trailer so that the heaviest items are as close as possible to the axle and the nose weight approaches the maximum permitted without exceeding it.

Air density decreases with altitude, thus reducing engine performance. Above 1 000 metres, the maximum towed load must be reduced by 10 % for every 1 000 metres of altitude.

Refer to the "technical data" section for details of the weights and towed loads which apply to your vehicle.

### Side wind

- ☞ Take into account the increased sensitivity to side wind.

### Cooling

Towing a trailer on a slope increases the temperature of the coolant.

As the fan is electrically controlled, its cooling capacity is not dependent on the engine speed.

- ☞ To lower the engine speed, reduce your speed.

The maximum towed load on a long incline depends on the gradient and the ambient temperature.

In all cases, keep a check on the coolant temperature.



- ☞ If the warning lamp and the **STOP** warning lamp come on, stop the vehicle and switch off the engine as soon as possible.

### Braking

Towing a trailer increases the braking distance. To avoid overheating of the brakes on a long mountain type of descent, the use of engine braking is recommended.

### Tyres

- ☞ Check the tyre pressures of the towing vehicle and of the trailer, observing the recommended pressures.

### Lighting

- ☞ Check the electrical lighting and signalling on the trailer.

**i** The rear parking sensors will be deactivated automatically if a genuine Peugeot towbar is used.

## Fitting roof bars

When fitting transverse roof bars, take care to position them correctly:

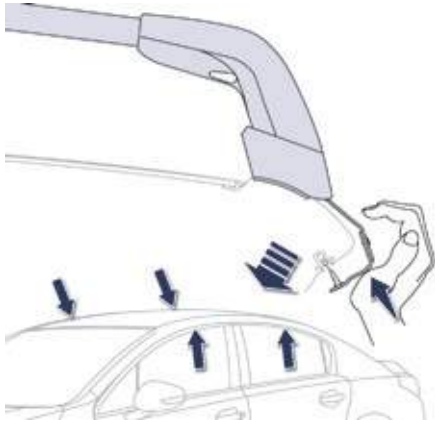

- Saloon: there are retaining pins in the door apertures.



- SW: there are markings on each of the longitudinal bars.

**!** use accessories recommended by Peugeot observing the manufacturer's recommendations and fitting instructions so as to avoid the risk of damaging the body (deformation, scratches, ...).

**i** Maximum authorised weight on the roof bars, for a loading height not exceeding 40 cm (with the exception of bicycle carriers):

- Saloon: **70 kg**
- SW: **100 kg**

If the height exceeds 40 cm, adapt the speed of the vehicle to the profile of the road to avoid damaging the roof bars and the fixings on the roof.

Be sure to refer to national legislation in order to comply with the regulations for transporting objects which are longer than the vehicle.

## Very cold climate screen

Removable protective screen which prevents the accumulation of snow at the radiator cooling fan.

- ! Before fitting or removing the screen, ensure that the engine is off and the cooling fan has stopped. It is recommended that the screen be fitted and removed by a Peugeot dealer or a qualified workshop.

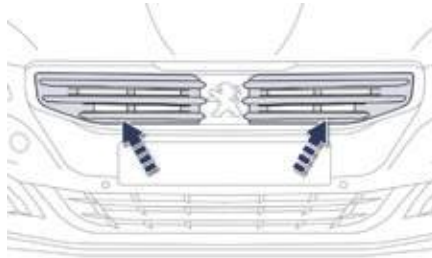

### Fitting

- ☞ Offer up the screen to the front of the top section of the front bumper upper grille.
- ☞ Press on the screen to engage its fixing clips.

### Removal

- ☞ Use a screwdriver as a lever to unclip each retaining clip in turn.

- ! Do not forget to remove the very cold climate screen:
  - when the ambient temperature exceeds 10° C (for example: in summer, ...),
  - when towing,
  - at speeds above 75 mph (120 km/h).

# Accessories

A wide range of accessories and genuine parts is available from the Peugeot dealer network. These accessories and parts have been tested and approved for reliability and safety. They are all suitable for your vehicle and benefit from Peugeot's recommendation and warranty.

## "Comfort":

cool box, smoker's kit, 230 V socket, torch...

## "Style":

spoiler, front and rear mud flaps, aluminium gear lever knob, alloy wheels (16, 17, 18 and 19 inch), body kit, door mirror shells, door air deflectors, ...

## "Protection":

mats\*, seat covers, vehicle covers, sun blinds, boot net, load protection net, dog guard, door and boot sill protectors, resin side rubbing strips...

## "Transport solutions":

booster seats and child seats, boot tray, roof box, ski carrier, towbar-mounted bicycle carrier, towbars (swan-neck, quickly detachable ball, folding), harnesses, sliding floor, utility vehicle conversion kit, ...

The trailer towbar and its harness should preferably be fitted by a Peugeot dealer.

## "Safety and security":

speed limiter/cruise control, anti-theft alarm, microwave unit, window etching, wheel security bolts, breathalyser, first aid kit, warning triangle, high visibility vest, stolen vehicle tracking system, winter equipment (17 inch wheels for snow chains), reversing camera, front and rear parking sensors, boot spacers...

- \* To avoid any risk of jamming of the pedals:
- ensure that the mat is positioned and secured correctly,
  - never fit one mat on top of another.

## "Multimedia":

audio systems, portable navigation system, t akara/Sony portable video screen, Bluetooth system, speakers, DVD player, Wi-Fi, driving aids, video support, microwave unit...

You can also obtain products for cleaning and maintenance (exterior and interior) and topping up fluids (screenwash, ...), as well as refills (cartridge for temporary tyre repair kit...) from Peugeot dealers.

### **i** Installation of radio communication transmitters

Before installing any after-market radio communication transmitter, you can contact a Peugeot dealer for the specification of transmitters which can be fitted (frequency, maximum power, aerial position, specific installation requirements), in line with the Vehicle electromagnetic Compatibility Directive (2004/104/eC).

**i** Depending on the legislation in force in the country, certain safety equipment may be compulsory: high visibility safety vests, warning triangles, breathalyzers, spare bulbs, spare fuses, a fire extinguisher, a first aid kit, mud flaps at the rear of the vehicle.

**!** The fitting of electrical equipment or accessories which are not recommended by Peugeot may result in a failure of your vehicle's electronic system and excessive electrical consumption. Please note this precaution. You are advised to contact a Peugeot representative to be shown the range of recommended equipment and accessories.



- ▶ 208 HYbrid FE, a technology demonstrator with exceptional characteristics: 1.9 l/100 km (148.7 mpg) and 0 to 100 km/h (0 to 62 mph) in 8 seconds.

## Peugeot & Total AL, A PARTNERSHIP TO DELIVER BETTER PERFORMANCE!

### *Innovation, the key to success*

The Total AL Research and Development and Peugeot teams work together to develop high quality lubricants that meet the requirements of Peugeot vehicles. For you, this is the assurance that the performance of your engine is optimised while also ensuring its durability.

The 208 HYbrid FE demonstrates the ability of Peugeot and Total AL to develop innovative technologies and provide other ways of moving towards the future.

### *Reduced exhaust emissions, a true reality*

Total AL lubricants are formulated to optimise the efficiency of engines and the protection of the emissions post-treatment systems. It is important to observe the servicing recommendations made by Peugeot to assure correct operation.

PEUGEOT RECOMMENDS TOTAL



OFFICIAL PARTNERS

# Opening the bonnet

**!** Before doing anything under the bonnet, switch off the Stop & Start system to avoid any risk of injury resulting from an automatic change to St ARt mode.

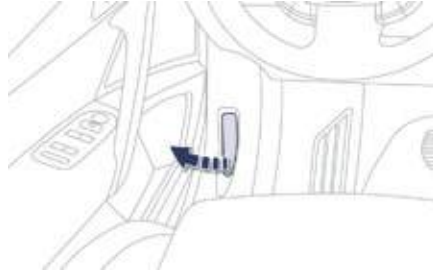

## Opening

☞ **From inside:** pull the release lever, located on the left below the dashboard, towards you.

☞ **From the outside:** lift the safety catch and raise the bonnet. A bonnet strut opens the bonnet and holds it open.

## Closing

☞ Lower the bonnet and release it at the end of its travel.  
☞ Check that it is latched correctly.

**!** **The cooling fan may start after switching off the engine: take care with articles and clothing that might be caught by the fan blades.**

**!** Because of the presence of electrical equipment under the bonnet, it is recommended that exposure to water (rain, washing, ...) be limited.



# Running out of fuel (Diesel)

On vehicles fitted with HDi engines, the fuel system must be primed if you run out of fuel; refer to the corresponding engine compartment view.

**i** If the tank on your vehicle is fitted with a misfuel prevention device, refer to the "Misfuel prevention (Diesel)" section.

**!** If the engine does not start first time, don't keep trying but start the procedure again from the beginning.

## 2 litre BlueHDi engine

- ☞ Fill the fuel tank with at least five litres of Diesel.
- ☞ Switch on the ignition (without starting the engine).
- ☞ Wait around 6 seconds and switch off the ignition.
- ☞ Repeat the operation 10 times.
- ☞ Operate the starter to run the engine.

## 1.6 litre HDi engine



- ☞ Fill the fuel tank with at least five litres of diesel.
- ☞ Open the bonnet.
- ☞ If necessary, unclip the styling cover for access to the priming pump.
- ☞ Squeeze and release the priming pump repeatedly until resistance is felt (there may be resistance at the first press).
- ☞ Operate the starter until the engine starts (if the engine does not start at the first attempt, wait around 15 seconds before trying again).
- ☞ If the engine does not start after a few attempts, operate the priming pump again then start the engine.
- ☞ Clip the styling cover back in place.
- ☞ Close the bonnet.

## 2 litre and 2.2 litre HDi engines



- ☞ Fill the fuel tank with at least five litres of Diesel.
- ☞ Open the bonnet.
- ☞ If necessary, unclip the style cover for access to the priming pump.
- ☞ Squeeze and release the priming pump repeatedly until fuel appears in the transparent pipe.
- ☞ Operate the starter until the engine starts (if the engine does not start at the first attempt, wait around 15 seconds before trying again).
- ☞ If the engine does not start after a few attempts, operate the priming pump again then start the engine.
- ☞ Put the style cover back in position and clip it in place.
- ☞ Close the bonnet.

## Petrol engines

The various caps and covers allow access for checking the levels of the various fluids and for replacing certain components.

1. Power steering reservoir.
2. Screenwash and headlamp wash reservoir.
3. Coolant reservoir.
4. Brake fluid reservoir.
5. Battery / Fuses.
6. Fusebox.
7. Air filter.
8. engine oil dipstick.
9. engine oil filler cap.

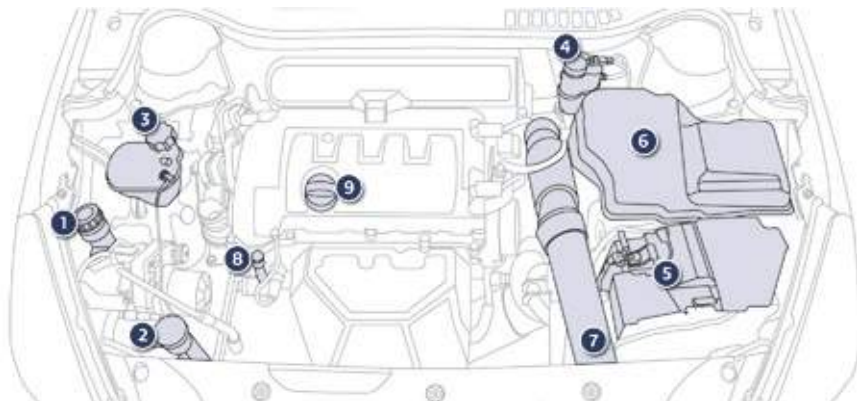

1.6 litre 16V VTi 120 hp

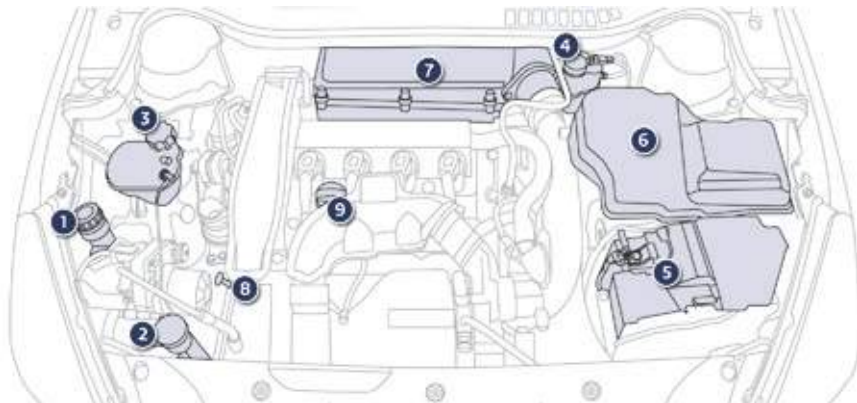

1.6 litre 16V THP 155 hp

## Petrol engines

Most of the various caps and covers allow access for checking the levels of the various fluids and for replacing certain components.

1. Power steering reservoir.
2. Screenwash and headlamp wash reservoir.
3. Coolant reservoir.
4. Brake fluid reservoir.
5. Battery / Fuses.
6. Fusebox.
7. Air filter.
8. engine oil dipstick.
9. engine oil filler cap.

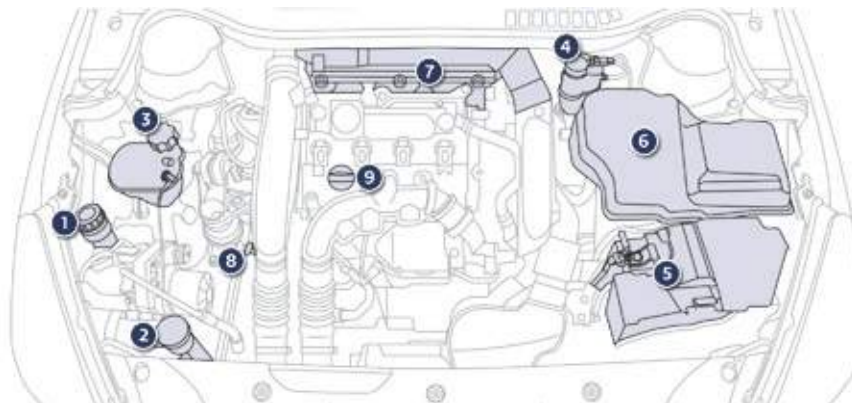

1.6 litre 16V e-THP 165 hp

## Diesel engines

The various caps and covers allow access for checking the levels of the various fluids, for replacing certain components and for priming the fuel system.

1. Power steering reservoir.
2. Screenwash and headlamp wash reservoir.
3. Coolant reservoir.
4. Brake fluid reservoir.
5. Battery / Fuses.
6. Fusebox.
7. Air filter.
8. engine oil dipstick.
9. engine oil filler cap.
10. Priming pump\*.
11. Bleed screw\*.

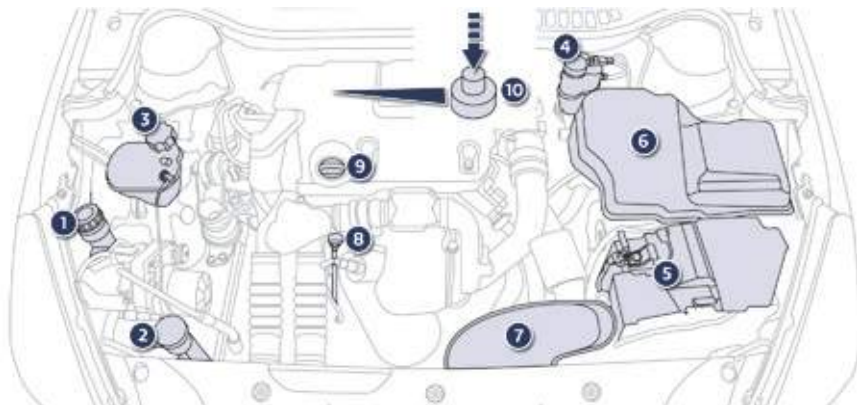

1.6 litre HDi 115 hp

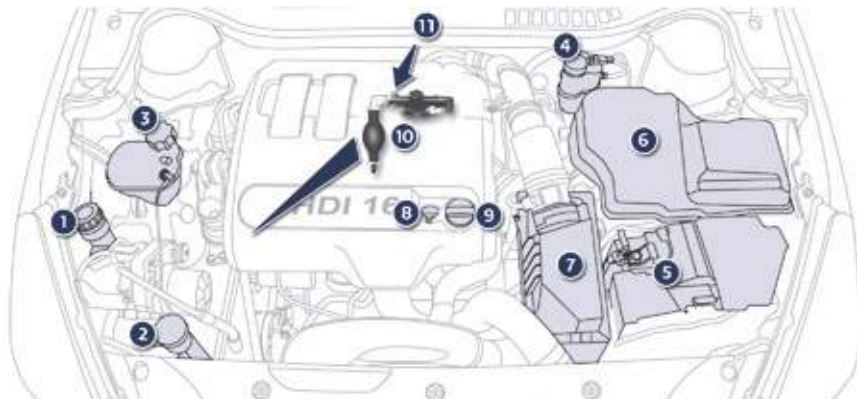

2.0 litre HDi 140 hp

\* According to engine.

## Diesel engines

the various caps and covers allow access for checking the levels of the various fluids, for replacing certain components and for priming the fuel system.

1. Power steering reservoir.
2. Screenwash and headlamp wash reservoir.
3. Coolant reservoir.
4. Brake fluid reservoir.
5. Battery / Fuses.
6. Fusebox.
7. Air filter.
8. engine oil dipstick.
9. engine oil filler cap.
10. Priming pump\*.
11. Bleed screw\*.

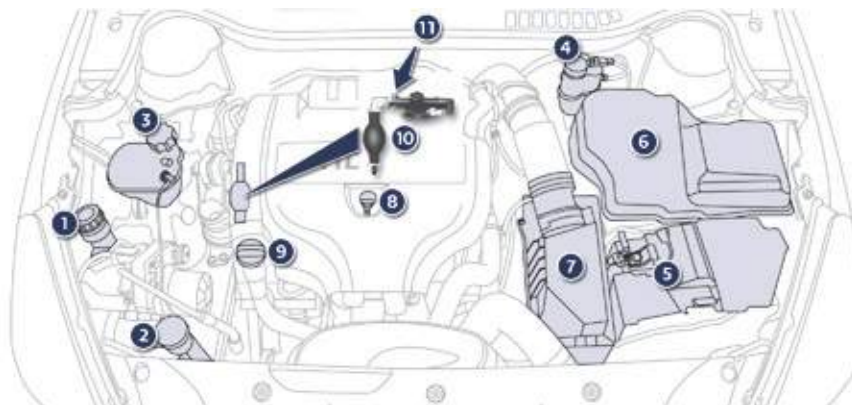

2.0 litre HDi 160 hp

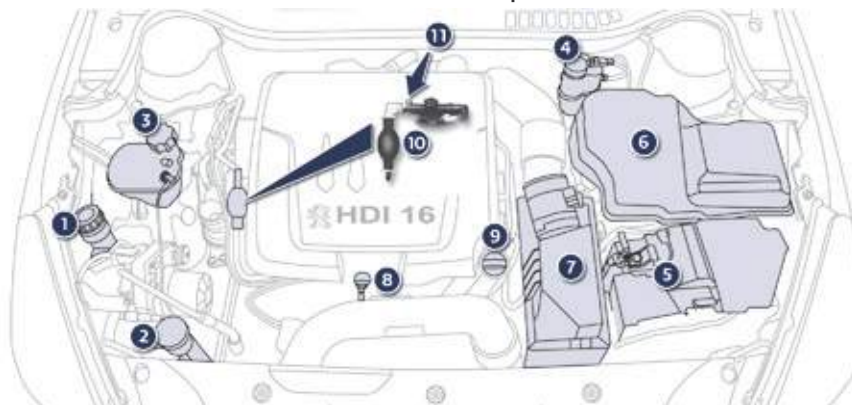

2.2 litre HDi 200 hp

\* According to engine.

## BlueHDi Diesel engines

The various caps and covers allow access for checking the levels of the various fluids, for replacing certain components and for priming the fuel system.

1. Power steering reservoir.
2. Screenwash and headlamp wash reservoir.
3. Coolant header tank.
4. Brake fluid reservoir.
5. Battery / Fuses.
6. Fusebox.
7. Air filter .
8. engine oil dipstick.
9. engine oil filler cap.

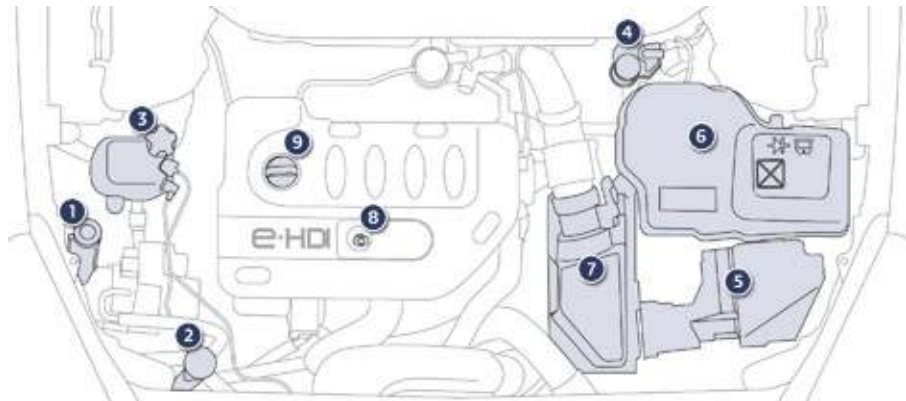

**2.0 litre Blue HDi 150 hp**  
**2.0 litre Blue HDi 180 hp**

## Checking levels

Check all of these levels regularly, in line with the warranty and maintenance record. Top them up if necessary, unless otherwise indicated. If a level drops significantly, have the corresponding system checked by a Peugeot dealer or a qualified workshop.

**!** Take care when working under the bonnet, as certain areas of the engine may be extremely hot (risk of burns) and the cooling fan could start at any time (even with the ignition off).

### Engine oil level



The check is carried out either when the ignition is switched on using the oil level indicator in the instrument panel for vehicles with an electric oil level gauge, or using the dipstick.

**i** To ensure that the reading is correct, your vehicle must be parked on a level surface and the engine having been off for more than 30 minutes.

It is normal to top up the oil level between two services (or oil changes). Peugeot recommends that you check the level, and top up if necessary, every 3 000 miles (5 000 kms).

### Checking using the dipstick

Refer to the "Petrol engine" or "Diesel engine" section for the location of the dipstick in the engine compartment of your vehicle.

- ☞ Take the dipstick by its coloured grip and remove it completely.
- ☞ Wipe the end of the dipstick using a clean non-fluffy cloth.
- ☞ Refit the dipstick and push fully down, then pull it out again to make the visual check: the correct level is between the marks **A** and **B**.

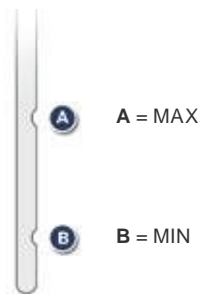

If you find that the level is above the **A** mark or below the **B** mark, **do not start the engine**.

- If the level is above the **MAX** mark (risk of damage to the engine), contact a Peugeot dealer or a qualified workshop.
- If the level is below the **MIN** mark, you must top up the engine oil.

### Oil grade

Before topping-up the oil or changing the oil, check that the oil is the correct grade for your engine and conforms to the manufacturer's recommendations.

## Topping up the engine oil level

Refer to the "Petrol engine" or "Diesel engine" section for the location of the oil filler cap in the engine compartment of your vehicle.

- ☞ Unscrew the oil filler cap to reveal the filler aperture.
- ☞ Add oil in small quantities, avoiding any spills on engine components (risk of fire).
- ☞ Wait a few minutes before checking the level again using the dipstick.
- ☞ Add more oil if necessary.
- ☞ After checking the level, carefully refit the oil filler cap and the dipstick in its tube.

After topping up the oil, the check when switching on the ignition with the oil level indicator in the instrument panel is not valid during the 30 minutes after topping up.

## Engine oil change

Refer to the warranty and maintenance record for details of the interval for this operation.

In order to maintain the reliability of the engine and emission control system, the use of additives in the engine oil is prohibited.

## Brake fluid level



The brake fluid level should be close to the "MAX" mark. If it is not, check the brake pad wear.

## Changing the fluid

Refer to the warranty and maintenance record for details of the interval for this operation.

## Fluid specification

The brake fluid must conform to the manufacturer's recommendations.

## Power steering fluid level



The power steering fluid level should be close to the "MAX" mark. With the engine cold, unscrew the cap to check the level.



## Coolant level



The coolant level should be close to the "MAX" mark but should never exceed it.

When the engine is warm, the temperature of the coolant is regulated by the fan.

**!** The cooling fan may start after switching off the engine: take care with articles and clothing that might be caught by the fan blades.

In addition, as the cooling system is pressurised, wait at least one hour after switching off the engine before carrying out any work.

To avoid any risk of scalding, unscrew the cap by two turns to allow the pressure to drop. When the pressure has dropped, remove the cap and top up the level.

## Changing the coolant

The coolant does not have to be replaced at routine services.

## Fluid specification

The coolant must conform to the manufacturer's recommendations.

## Screenwash and headlamp wash fluid



In the case of vehicles fitted with headlamp washers, the low fluid level is indicated by an audible signal and a message in the instrument panel screen.

Top up the reservoir when you next stop the vehicle.

## Fluid specification

For optimum cleaning and to avoid freezing, this fluid must not be topped up with or replaced with plain water.

**i** In wintry conditions, the use of an ethyl alcohol or methanol base fluid is recommended.

## Diesel additive level (Diesel engine with particle filter)

A low additive level is indicated by illumination of the service warning lamp, accompanied by an audible warning and a message in the instrument panel screen.

## Topping up

This additive must be topped up by a Peugeot dealer or a qualified workshop without delay.

## Used products

**!** Avoid prolonged contact of used oil or fluids with the skin. Most of these fluids are harmful to health or indeed very corrosive.



Do not discard used oil or fluids into sewers or onto the ground. Take used oil to a Peugeot dealer or a qualified workshop (France) or to an authorised waste disposal site.

## Checks

Unless otherwise indicated, check these components in accordance with the warranty and maintenance record and according to your engine. Otherwise, have them checked by a Peugeot dealer or a qualified workshop.

### 12 V battery



The battery does not require any maintenance. However, check that the terminals are clean and correctly tightened, particularly in summer and winter.

When carrying out work on the battery, refer to the "12 V battery" section for details of the precautions to be taken before disconnecting the battery and following its reconnection.



The presence of this label, in particular with the Stop & Start system, indicates the use of a specific 12 V lead-acid battery with special technology and specification. The involvement of a Peugeot dealer or a qualified workshop is essential when replacing or disconnecting the battery.

### Air filter and passenger compartment filter



Refer to the warranty and maintenance record for details of the replacement intervals for these components.

Depending on the environment (e.g. dusty atmosphere) and the use of the vehicle (e.g. city driving), **replace them twice as often if necessary.**

A clogged passenger compartment filter may have an adverse effect on the performance of the air conditioning system and generate undesirable odours.

### Oil filter



Replace the oil filter each time the engine oil is changed. Refer to the warranty and maintenance record for details of the replacement interval for this component.

### Particle filter (Diesel)

#### SERVICE

The start of saturation of the particle filter is indicated by the temporary illumination of this warning lamp accompanied by a message in the multifunction screen.

**i** As soon as the traffic conditions permit, regenerate the filter by driving at a speed of at least 40 mph (60 km/h) until the warning lamp goes off. If the warning lamp stays on, this indicates a low additive level.

On a new vehicle, the first particle filter regeneration operations may be accompanied by a "burning" smell, which is perfectly normal. Following prolonged operation of the vehicle at very low speed or at idle, you may, in exceptional circumstances, notice the emission of water vapour at the exhaust on acceleration. This does not affect the behaviour of the vehicle or the environment.

## Manual gearbox



The gearbox does not require any maintenance (no oil change). Refer to the warranty and maintenance record for the details of the level checking interval for this component.

## Electronic gearbox



The gearbox does not require any maintenance (no oil change). Refer to the warranty and maintenance record for details of the checking interval for this component.

## Automatic gearbox



The gearbox does not require any maintenance (no oil change). Refer to the warranty and maintenance record for details of the level checking interval for this component.

## Brake pads



Brake wear depends on the style of driving, particularly in the case of vehicles used in town, over short distances. It may be necessary to have the condition of the brakes checked, even between vehicle services. Unless there is a leak in the circuit, a drop in the brake fluid level indicates that the brake pads are worn.

## Brake disc wear



For information on checking brake disc wear, contact a Peugeot Ot dealer or a qualified workshop.

## Parking brake



If excessive travel or a loss of effectiveness of this system is noticed, the parking brake must be checked, even between two services.

Checking this system must be done by a Peugeot Ot dealer or a qualified workshop.

## Electric parking brake



This system does not require any routine servicing. However, in the event of a problem, have the system checked by a Peugeot Ot dealer or a qualified workshop.

For more information, refer to the "electric parking brake - Operating faults" section.



Only use products recommended by Peugeot Ot or products of equivalent quality and specification.

In order to optimise the operation of units as important as those in the braking system, Peugeot Ot selects and offers very specific products. After washing the vehicle, dampness, or in wintry conditions, ice can form on the brake discs and pads: braking efficiency may be reduced. Make light brake applications to dry and defrost the brakes.

## AdBlue® additive and SCR system for BlueHDi Diesel engines

To assure respect for the environment and conformity with the new euro 6 emissions standard, without adversely affecting the performance or fuel consumption of Diesel engines, Peugeot has taken the decision to equip its vehicles with an effective system that associates SCR (Selective Catalytic Reduction) with a particle filter (FAP) for the treatment of exhaust gases.

### Presentation of the SCR system

Using an additive called AdBlue® containing urea, a catalytic converter turns up to 85% of nitrous oxides (NOx) into nitrogen and water, which are harmless to health and the environment.

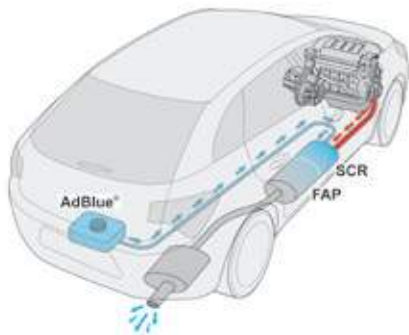

The AdBlue® additive is held in a special tank located under the boot at the rear of the vehicle. It has a capacity of 17 litres: this provides a driving range of about 12 500 miles (20 000 km), after which an alert is triggered warning you when the reserve remaining is enough for just 1 500 miles (2 400 km).

During each scheduled service of your vehicle by a Peugeot dealer or a qualified workshop, the AdBlue® additive tank is refilled in order to allow normal operation of the SCR system.

If the estimated mileage between two services is greater than 12 500 miles (20 000 km), we recommend that you go to a Peugeot dealer or a qualified workshop to have the necessary top-up carried out.

**!** Once the AdBlue® tank is empty, a system required by regulations prevents starting of the engine. If the SCR is faulty, the level of emissions from your vehicle will no longer meet the euro 6 standard: your vehicle becomes polluting. In the event of a confirmed fault with the SCR system, you must go to a Peugeot dealer or a qualified workshop as soon as possible: after a running distance of 650 miles (1 100 km), a system will be triggered automatically to prevent engine starting.

## Range indicators

When switching on the ignition, an indicator gives an estimate of the distance that can be travelled with your vehicle before engine starting is automatically prevented, once the vehicle starts using the reserve of AdBlue® or after a fault is detected with the SCR system. In the event of simultaneous system fault and low AdBlue® level, the shortest range is the one displayed.

### In the event of the risk of non-starting related to a lack of AdBlue®

**!** The engine start prevention system required by regulations is activated automatically once the AdBlue® tank is empty.

#### Range greater than 1 500 miles (2 400 km)

When the ignition is switched on, no information on range is displayed automatically in the instrument panel.



Pressing this button displays the driving range temporarily. Above 3 000 miles (5 000 km), the value is not specified.

## Remaining range between 350 and 1500 miles (600 and 2 400 km)

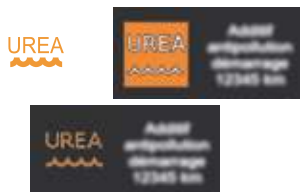

When switching on the ignition, the u Re A warning lamp comes on, accompanied by an audible signal and the display of a message (e.g.: "t op up emissions additive: Starting prevented in 900 miles") indicating the remaining range expressed in miles or kilometres.

When driving, the message is displayed every 150 miles (300 km) until the additive tank has been topped-up.

go to a Peugeot dealer or a qualified workshop to have the AdBlue® tank topped-up. You can also top-up the tank yourself.

Refer to the "t opping-up" section.

## Remaining range between 0 and 350 miles (0 and 600 km)

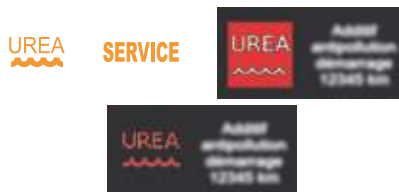

When switching on the ignition, the SeRVICe warning lamp comes on and the u Re A warning lamp flashes, accompanied by an audible signal and the display of a message (e.g. "t op up emissions additive: Starting prevented in 350 miles") indicating the remaining range expressed in miles or kilometres.

When driving, the message is displayed every 30 seconds until the additive tank has been topped-up.

go to a Peugeot dealer or a qualified workshop to have the AdBlue® tank topped-up. You can also top-up the tank yourself.

Refer to the "t opping-up" section.

If you fail to do this, there is a risk that you will not be able to start your engine.

## Breakdown related to a lack of AdBlue® additive



When switching on the ignition, the SeRVICe warning lamp comes on and the u Re A warning lamp flashes, accompanied by an audible signal and the display of the message "t op up emissions additive: Starting prevented". t he AdBlue® tank is empty: the system required by regulations prevents engine starting.

**!** t o be able to start the engine, we recommend that you call on a Peugeot dealer or a qualified workshop for the top-up required. If you carry out the top-up yourself, it is essential to add at least 3.8 litres of AdBlue® to the tank. Refer to the "t opping-up" section.

## In the event of a fault with the the SCR emissions control system

**!** A system that prevents engine starting is activated automatically from 650 miles (1 100 km) after confirmation of a fault with the SCR emissions control system. Have the system checked by a Peugeot Ot dealer or a qualified workshop as soon as possible.

### In the event of the detection of a fault

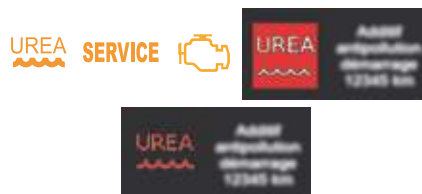

When switching on the ignition, the u Re A, SeRVICe and diagnostic warning lamps comes on, accompanied by an audible signal and the display of a message "e missions fault" to signal a fault with the emissions control system.

**i** If it is a temporary fault, the alert disappears once the exhaust gas emissions return to normal.

### During an authorised driving phase (between 650 miles and 0 miles) (1 100 km and 0 km)



If a fault with the SCR system is confirmed (after 30 miles (50 km) covered with the permanent display of the message signalling a fault), when switching on the ignition, the SeRVICe and engine diagnostic warning lamps come on and the u Re A warning lamp flashes, accompanied by an audible signal and the display of a message (e.g.: "e missions fault: Starting prevented in 150 miles") indicating the remaining range express in miles or kilometres. While driving, the message is displayed every 30 seconds while the fault with the SCR system persists.

You should go to a Peugeot Ot dealer or a qualified workshop as soon as possible. Otherwise, you will not be able to restart your engine.

## Starting prevented



every time the ignition is switched on, the SeRVICe and engine diagnostic warning lamps come on and the uReA warning lamp flashes, accompanied by an audible signal and the display of the message "e missions fault: Starting prevented".

**!** You have exceeded the authorised driving limit: the starting prevention system inhibits engine starting.

to be able to start the engine, you must call on a Peugeot dealer or a qualified workshop.

## **i** Freezing of the AdBlue® additive

the AdBlue® additive freezes at temperatures below around -11°C.

the SCR system includes a heater for the AdBlue® tank.

In exceptional circumstances (vehicle kept for a long period at temperatures that are constantly below -15°C), an emissions control system fault alert may be related to freezing of the AdBlue® in your vehicle.

Park your vehicle in a warmer area for a few hours until the additive becomes liquid again.

the emissions alert does not go off immediately, it will occur after several mile of running.



## Topping-up the AdBlue® additive

Filling the AdBlue® tank is an operation included in every routine service on your vehicle by a Peugeot dealer or a qualified workshop.

Nevertheless, given the capacity of the tank, it may be necessary to top-up the additive between services, more particularly if an alert (warning lamps and a message) signals the requirement.

You can go to a Peugeot dealer or a qualified workshop.

If you envisage topping-up yourself, please read the following warnings carefully.

### Precautions in use

The AdBlue® additive is an urea-based solution. This liquid is non-flammable, colourless and odourless (kept in a cool area).

In the event of contact with the skin, wash the affected area with soap and water. In the event of contact with the eyes, wash (irrigate) the eyes with large amounts of water or with an eye wash solution for at least 15 minutes. If a burning sensation or irritation persists, get medical attention.

If swallowed, immediately wash out the mouth with clean water and then drink plenty of water. In certain conditions (high ambient temperature, for example), the risk of release of ammonia cannot be excluded: do not inhale the product. Ammonia vapour has an irritant effect on mucous membranes (eyes, nose and throat).

**!** Keep AdBlue® out of the reach of children, in its original bottle. Never transfer AdBlue® to another container: it would lose its purity.

Use only AdBlue® additive that meets the ISO 22241 standard.

**!** Never dilute the additive with water. Never pour the additive into the Diesel fuel tank.



**AdBlue®**

The supply in a non-drip bottle simplifies topping-up. You can obtain 1.89 litre (half a US gallon) bottles from a Peugeot dealer or a qualified workshop.

**!** Never top-up from an AdBlue® dispenser reserved for heavy goods vehicles.

## Recommendations on storage

AdBlue® freezes at about -11°C and deteriorates above 25°C. It is recommended that bottles be stored in a cool area and protected from direct sunlight.

Under these conditions, the additive can be kept for at least a year.

If the additive has frozen, it can be used once it has completely thawed out.



Never store bottles of AdBlue® in your vehicle.

## Procedure

Before topping-up, ensure that the vehicle is parked on a flat and level surface.

In wintry conditions, ensure that the temperature of the vehicle is above -11°C. Otherwise, by freezing, the AdBlue® cannot be poured into its tank. Park your vehicle in a warmer area for a few hours to allow the top-up to be carried out.

- ☞ Switch off the ignition and remove the key, or if your vehicle has one, press the St ARt /St OP button to switch off the engine.

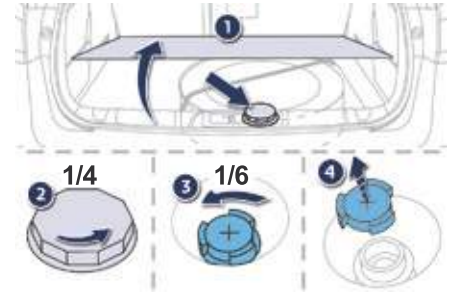

- ☞ For access to the AdBlue® tank, raise the boot carpet then, depending on equipment, lift out the spare wheel and/or the storage box.
- ☞ Without pressing, turn the black cap a quarter turn anti-clockwise and lift it off.
- ☞ Turn the blue cap a 6<sup>th</sup> of a turn anti-clockwise.
- ☞ Lift off the cap.



- ☞ Obtain a bottle of AdBlue®. After first checking the use-by date, read carefully the instructions on use on the label before pouring the contents of the bottle into your vehicle's AdBlue® tank.

**!** **Important:** if your vehicle's AdBlue® tank is completely empty - which is confirmed by the alert messages and the impossibility of starting the engine, you must add at least 3.8 litres (so two 1.89 litre bottles).

- ☞ After emptying the bottle, wipe away any spillage around the tank filler using a damp cloth.

**!** If any additive is split or splashed, wash immediately with cold water or wipe with a damp cloth.  
If the additive has crystallised, clean it off using a sponge and hot water.

- ☞ Refit the blue cap to the tank and turn it a 6<sup>th</sup> of a turn clockwise, to its stop.
- ☞ Refit the black cap and turn it a quarter of a turn clockwise without pressing. ensure that the indicator on the cap lines up with the indicator on the support.
- ☞ Depending on equipment, return the spare wheel and/or the storage box to the bottom of the boot.
- ☞ Refit the boot carpet and close the tailgate.

**!** **Important: when topping-up after running out of additive**, signalled by the message "t op up emissions additive: Starting prevented", you must wait for about 5 minutes before switching on the ignition, **without opening the driver's door, unlocking the vehicle, introducing the key into the ignition switch, or placing the key of the "Keyless Entry and Starting" system inside the vehicle.** Switch on the ignition, then wait for 10 seconds before starting the engine.

**♣** Never dispose of AdBlue® additive bottles in the household waste. Place them in a special container provided this purpose or take them to your dealer.

## Petrol engines and gearboxes

Petrol engine	1.6 litre VTI 120 hp		1.6 litre THP 155 hp	
	electronic (6-speed)		Manual (6-speed)	Automatic (6-speed)
Model code	8D5FH8/P - 8e5FH8/P 8D5FS8/P - 8e5FS8/P		8D5FV8 - 8e5FV8	8D5FNA - 8e5FNA 8D5FVA - 8e5FVA
emissions standard	euro 5		euro 5	
Cubic capacity (cc)	1 598		1 598	
Bore x stroke (mm)	77 x 85.8		77 x 85.8	
Max power: eu standard (kW)*	85 88		110 115	
Max power engine speed (rpm)	6 000		6 000	
Max torque: eu standard (Nm)	160		240	
Max torque engine speed (rpm)	4 250		1 400	
Fuel	unleaded		unleaded	
Catalytic converter	yes		yes	
<b>Oil capacities (in litres)</b>				
engine (with filter replacement)	4.25		4.25	

\* the maximum power corresponds to the value type approved on a test bed, under conditions defined by european legislation (Directive 1999/99/eC).

Petrol engine	1.6 litre e-THP 165 hp	
Gearbox	Manual (6-speed)	Automatic (6-speed)
Model code	8D5GZ-M / S - 8E5GZ-M / S	8D5GZ-T / S - 8E5GZ-T / S
emissions standard	-	-
Cubic capacity (cc)	1 598	
Bore x stroke (mm)	77 x 85.8	
Max power: eu standard (kW)*	121	
Max power engine speed (rpm)	6 000	
Max torque: eu standard (Nm)	240	
Max torque engine speed (rpm)	1 400	
Fuel	unleaded	
Catalytic converter	yes	
<b>Oil capacities (in litres)</b>		
engine (with filter replacement)	4.25	

\* t he maximum power corresponds to the value type approved on a test bed, under conditions defined by european legislation (Directive 1999/99/eC).

## Petrol weights and towed loads (in kg)

Petrol engines	1.6 litre VTi 120 hp		1.6 litre THP 155 hp			
	electronic (6-speed)		Manual (6-speed)		Automatic (6-speed)	
Model codes	8D5FH8/P - 8e5FH8/P 8D5FS8/P - 8e5FS8/P		8D5FV8 - 8e5FV8		8D5FNA - 8e5FNA 8D5FVA - 8e5FVA	
Body	Saloon	SW	Saloon	SW	Saloon	SW
- unladen weight	1 390	1 410	1 400	1 420	1 410	1 430
- Kerb weight*	1 465	1 485	1 475	1 495	1 485	1 505
- gross vehicle weight (g VW)	1 945	2 055	1 995	2 080	2 015	2 100
- gross train weight (g t W) on a 12 % gradient	3 345	3 355	3 595	3 580	3 615	3 600
- Braked trailer (within g t W limit) on a 10 % or 12 % gradient	1 400	1 300	1 600	1 500	1 600	1 500
- Braked trailer** (with load transfer within the g t W limit)	1 675	1 575	1 875	1 775	1 875	1 775
- unbraked trailer	730	740	735	745	740	750
- Recommended nose weight	75		75			

\* the kerb weight is equal to the unladen weight + driver (75 kg).

\*\* the weight of the braked trailer can be increased, within the g t W limit, if the g VW of the towing vehicle is reduced by an equal amount; warning, towing using a lightly loaded towing vehicle may have an adverse effect on its road holding.

the g t W and towed load values indicated are valid up to a maximum altitude of 1 000 metres; the towed load mentioned must be reduced by 10 % for each additional 1 000 metres of altitude.

the speed of a towing vehicle must not exceed 60 mph (100 km/h) (comply with the legislation in force in your country).

High ambient temperatures may result in a reduction in the performance of the vehicle to protect the engine; if the ambient temperature is above 37 °C, limit the towed load.

## Petrol weights and towed loads (in kg)

Petrol engine	1.6 litre e-THP 165 hp			
	Manual (6-speed)		Automatic (6-speed)	
Gearbox				
Model code	8D5GZ-M / S	8E5GZ-M / S	8D5GZ-T / S	8E5GZ-T / S
Body	Saloon	SW	Saloon	SW
- unladen weight	1 400	1 420	1 410	1 430
- Kerb weight*	1 475	1 495	1 485	1 505
- gross vehicle weight (g VW)	1 995	2 080	2 015	2 100
- gross train weight (g t W) on a 12 % gradient	3 595	3 580	3 615	3 600
- Braked trailer (within g t W limit) on a 10 % or 12 % gradient	1 600	1 500	1 600	1 500
- Braked trailer** (with load transfer within the g t W limit)	1 875	1 755	1 875	1 775
- unbraked trailer	735	745	740	750
- Recommended nose weight	75		75	

\* t he kerb weight is equal to the unladen weight + driver (75 kg).

\*\* t he weight of the braked trailer can be increased, within the g t W limit, if the g VW of the towing vehicle is reduced by an equal amount; warning, towing using a lightly loaded towing vehicle may have an adverse effect on its road holding.

t he g t W and towed load values indicated are valid up to a maximum altitude of 1 000 metres; the towed load mentioned must be reduced by 10 % for each additional 1 000 metres of altitude.

t he speed of a towing vehicle must not exceed 60 mph (100 km/h) (comply with the legislation in force in your country).

High ambient temperatures may result in a reduction in the performance of the vehicle to protect the engine; if the ambient temperature is above 37 °C, limit the towed load.

## Diesel engines and gearboxes

Diesel engine	1.6 litre HDi 115 hp			
	Manual (6-speed)		electronic (6-speed)	
Gearbox	8D9HL0 - 8e9HL0		8D9HR8/PS - 8e9HR8/PS	
Model code	8D9HL0 - 8e9HL0		8D9HR8/PS - 8e9HR8/PS	
Body	Saloon	SW	Saloon	SW
emissions standard	euro 5		euro 5	
Cubic capacity (cc)	1 560		1 560	
Bore x stroke (mm)	75 x 88.3		75 x 88,3	
Max power: eu standard (kW)*	84		84	
Max power engine speed (rpm)	3 600		3 600	
Max torque: eu standard (Nm)	240		270	
Max torque engine speed (rpm)	1 750		1 750	
Fuel	Diesel			
Catalytic converter	yes			
Particle filter	yes			
<b>Oil capacity (in litres)</b>				
engine (with filter replacement)	3.25			

\* t he maximum power corresponds to the value type approved on a test bed, under conditions defined by european legislation (Directive 1999/99/eC).



## Diesel engines and gearboxes

Diesel engine	2.0 litre HDi 140 hp		2.0 litre HDi 163 hp			
	Manual (6-speed)		Automatic (6-speed)		Manual (6-speed)	
Model code	8DRHR8 - 8eRHR8 8DRHF8 - 8eRHF8		8DRHHA - 8eRHHA 8DRHDA - 8eRHDA		8DRHH8 - 8eRHH8	
Body	Saloon	SW	Saloon	SW	Saloon	SW
emissions standard	euro 5		euro 5			
Cubic capacity (cc)	1 997		1 997			
Bore x stroke (mm)	85 x 88		85 x 88			
Max power: eu standard (kW)*	100 103		100 120			
Max power engine speed (rpm)	4 000		3 750			
Max torque: eu standard (Nm)	320		340			
Max torque engine speed (rpm)	2 000		2 000			
Fuel			Diesel			
Catalytic converter			yes			
Particle filter			yes		no	
<b>Oil capacity (in litres)</b>						
engine (with filter replacement)	5.25		5			

\* t he maximum power corresponds to the value type approved on a test bed, under conditions defined by european legislation (Directive 1999/99/eC).

## Diesel engines and gearboxes

<b>Diesel engine</b>	<b>2.2 litre HDi 204 hp</b>	
<b>Gearbox</b>	Automatic (6-speed)	
<b>Model code</b>	8D4HLA - 8e4HLA	
<b>Body</b>	Saloon	SW
emissions standard	euro 5	
Cubic capacity (cc)	2 179	
Bore x stroke (mm)	85 x 96	
Max power: eu standard (kW)*	150	
Max power engine speed (rpm)	3 500	
Max torque: eu standard (Nm)	450	
Max torque engine speed (rpm)	2 000	
Fuel	Diesel	
Catalytic converter	yes	
Particle filter	yes	
<b>Oil capacity (in litres)</b>		
engine (with filter replacement)	5.25	

\* t he maximum power corresponds to the value type approved on a test bed, under conditions defined by european legislation (Directive 1999/99/eC).

## BlueHDi Diesel engines and gearboxes

Diesel engine	2.0 litre BlueHDi 150		2.0 litre BlueHDi 180		
Gearbox	Manual (6-speed)		Automatic (6-speed)		
Model code	8DAHXM/S	8e AHXM/S	8DAHwt /S	8e AHwt /S	8u AHwt /S
Body	Saloon	SW	Saloon	SW	RXH internal combustion
emissions standard	euro 6		euro 6		
Cubic capacity (cc)	1 997		1 997		
Bore x stroke (mm)	85 x 88		85 x 88		
Max power: eu standard (kW)*	110		133		
Max power engine speed (rpm)	4 000		3 750		
Max torque: eu standard (Nm)	370		400		
Max torque engine speed (rpm)	2 000		2 000		
Fuel	Diesel		Diesel		
Catalytic converter	yes		yes		
Particle filter	yes		yes		
<b>Oil capacity (in litres)</b>					
engine (with filter replacement)	-		-		

\* t he maximum power corresponds to the value type approved on a test bed, under conditions defined by european legislation (Directive 1999/99/eC).

## Diesel weights and towed loads (in kg)

Diesel engine	1.6 litre HDi 115 hp			
	Manual (6-speed)		electronic (6-speed)	
Model code	8D9HL0 - 8e9HL0		8D9HR8/PS - 8e9HR8/PS	
Body	Saloon	SW	Saloon	SW
- unladen weight	1 405	1 425	1 410	1 430
- Kerb weight*	1 480	1 500	1 485	1 505
- gross vehicle weight (g VW)	1 975	2 080	2 005	2 100
- gross train weight (g t W) on a 12% gradient	3 175	3 180	3 205	3 200
- Braked trailer (within g t W limit) on a 10% or 12% gradient	1 200	1 100	1 200	1 100
- Braked trailer** (with load transfer with the g t W limit)	1 475	1 375	1 475	1 375
- unbraked trailer	740	745	740	750
- Recommended nose weight				75

\* the kerb weight is equal to the unladen weight + driver (75 kg).

\*\* the weight of the braked trailer can be increased, within the g t W limit, if the g VW of the towing vehicle is reduced by an equal amount; warning, towing using a lightly loaded towing vehicle may have an adverse effect on its road holding.

the g t W and towed load values indicated are valid up to a maximum altitude of 1 000 metres; the towed load mentioned must be reduced by 10 % for each additional 1 000 metres of altitude.

the speed of a towing vehicle must not exceed 60 mph (100 km/h) (comply with the legislation in force in your country).

High ambient temperatures may result in a reduction in the performance of the vehicle to protect the engine; if the ambient temperature is above 37 °C, limit the towed load.

## Diesel weights and towed loads (in kg)

Diesel engine	2.0 litre HDi 140 hp		2.0 litre HDi 163 hp			
	Manual (6-speed)		Automatic (6-speed)		Manual (6-speed)	
Model code	8DRHR8 - 8eRHR8 8DRHF8 - 8eRHF8		8DRHHA - 8eRHHA 8DRHDA - 8eRHDA		8DRHH8 - 8eRHH8	
Body	Saloon	SW	Saloon	SW	Saloon	SW
- unladen weight	1 430	1 500	1 520	1 540	1 480	1 500
- Kerb weight*	1 505	1 575	1 595	1 615	1 555	1 575
- gross vehicle weight (g VW)	2 065	2 140	2 105	2 180	2 075	2 140
- gross train weight (g t W) on a 12% gradient	3 665	3 640	3 405	3 380	3 675	3 640
- Braked trailer (within g t W limit) on a 10% or 12% gradient	1 600	1 500	1 300	1 200	1 600	1 500
- Braked trailer** (with load transfer with the g t W limit)	1 875	1 775	1 575	1 475	1 875	1 775
- unbraked trailer	750		750			
- Recommended nose weight	75		75			

\* t he kerb weight is equal to the unladen weight + driver (75 kg).

\*\* t he weight of the braked trailer can be increased, within the g t W limit, if the g VW of the towing vehicle is reduced by an equal amount; warning, towing using a lightly loaded towing vehicle may have an adverse effect on its road holding.

t he g t W and towed load values indicated are valid up to a maximum altitude of 1 000 metres; the towed load mentioned must be reduced by 10 % for each additional 1 000 metres of altitude.

t he speed of a towing vehicle must not exceed 60 mph (100 km/h) (comply with the legislation in force in your country).

High ambient temperatures may result in a reduction in the performance of the vehicle to protect the engine; if the ambient temperature is above 37 °C, limit the towed load.

## Diesel weights and towed loads (in kg)

Diesel engine	2.2 litre HDi 204 hp	
Gearbox	Automatic (6-speed)	
Model code	8D4HLA - 8e4HLA	
Body	Saloon	SW
- unladen weight	1 540	1 660
- Kerb weight*	1 615	1 735
- gross vehicle weight (g VW)	2 155	2 280
- gross train weight (g t W) on a 12% gradient	3 855	3 880
- Braked trailer (within g t W limit) on a 10% or 12% gradient	1 700	1 600
- Braked trailer** (with load transfer with the g t W limit)	1 975	1 875
- unbraked trailer		750
- Recommended nose weight		75

\* the kerb weight is equal to the unladen weight + driver (75 kg).

\*\* the weight of the braked trailer can be increased, within the g t W limit, if the g VW of the towing vehicle is reduced by an equal amount; warning, towing using a lightly loaded towing vehicle may have an adverse effect on its road holding.

the g t W and towed load values indicated are valid up to a maximum altitude of 1 000 metres; the towed load mentioned must be reduced by 10 % for each additional 1 000 metres of altitude.

the speed of a towing vehicle must not exceed 60 mph (100 km/h) (comply with the legislation in force in your country).

High ambient temperatures may result in a reduction in the performance of the vehicle to protect the engine; if the ambient temperature is above 37 °C, limit the towed load.

## BlueHDi Diesel weights and towed loads (in kg)

Diesel engine	2.0 litre BlueHDi 150		2.0 litre BlueHDi 180		
Gearbox	Manual (6-speed)		Automatic (6-speed)		
Model code	8DAHXM/S - 8e AHXM/S		8DAHt /S - 8e AHt /S		8u AHt /S
Body	Saloon	SW	Saloon	SW	RXH internal combustion
- unladen weight	1 500	1 520	1 540	1 620	1 650
- Kerb weight*	1 575	1 595	1 615	1 695	1 725
- gross vehicle weight (g VW)	2 125	2 200	2 165	2 240	2 240
- gross train weight (g t W) on a 12% gradient	3 725	3 700	3 465	3 440	3 040
- Braked trailer (within g t W limit) on a 10% or 12% gradient	1 600	1 500	1 300	1 200	800
- Braked trailer** (with load transfer with the g t W limit)	1 875	1 775	1 575	1 475	1 100
- unbraked trailer		750		750	750
- Recommended nose weight		75		75	75

\* the kerb weight is equal to the unladen weight + driver (75 kg).

\*\* the weight of the braked trailer can be increased, within the g t W limit, if the g VW of the towing vehicle is reduced by an equal amount; warning, towing using a lightly loaded towing vehicle may have an adverse effect on its road holding.

the g t W and towed load values indicated are valid up to a maximum altitude of 1 000 metres; the towed load mentioned must be reduced by 10 % for each additional 1 000 metres of altitude.

the speed of a towing vehicle must not exceed 60 mph (100 km/h) (comply with the legislation in force in your country).

High ambient temperatures may result in a reduction in the performance of the vehicle to protect the engine; if the ambient temperature is above 37 °C, limit the towed load.

## Dimensions (in mm)

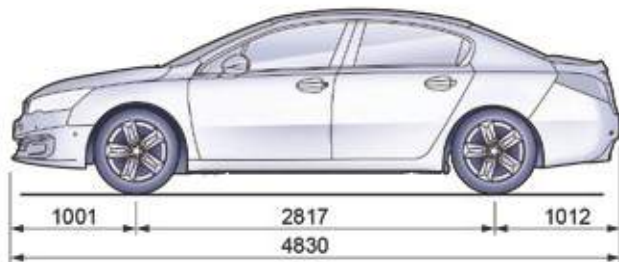
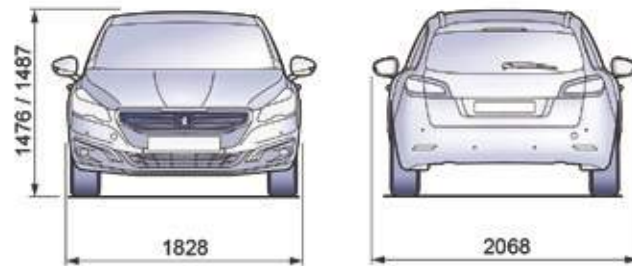
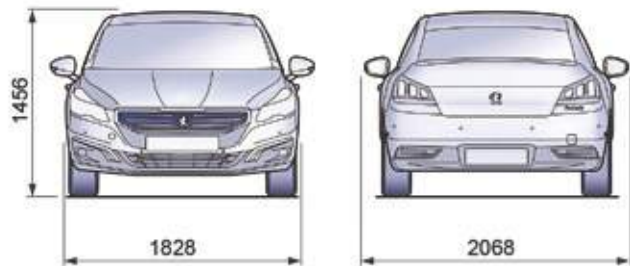

Saloon

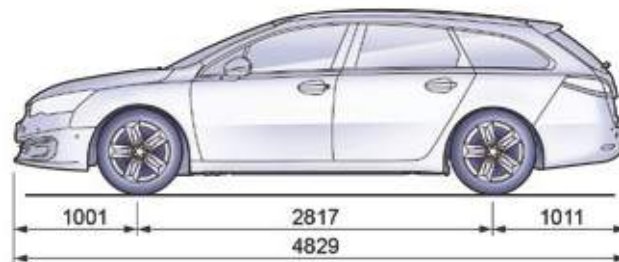

SW



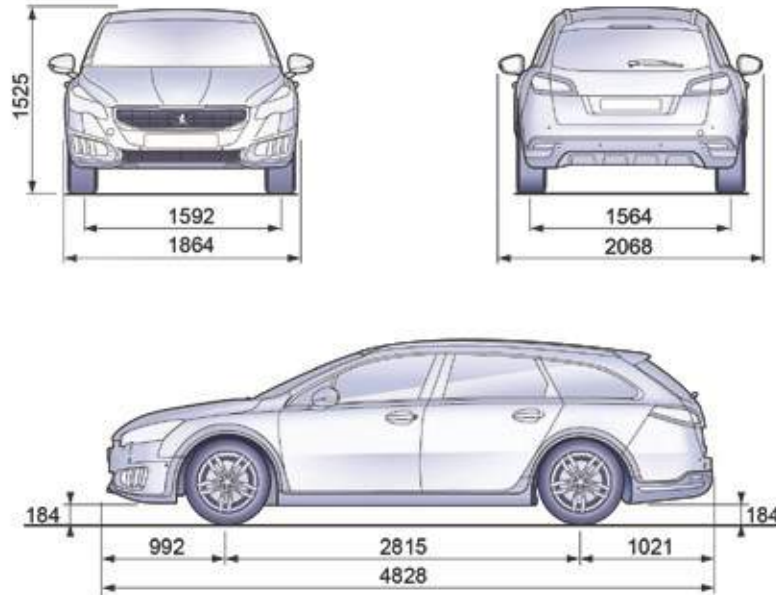

RXH internal combustion version  
(available during the 2<sup>nd</sup> half of 2014)

**!** Be aware of the ground clearance of your vehicle: around 184 mm (with the vehicle in working order: driver only and the fuel tank full) in ideal conditions.

It is important to note that this value will vary with vehicle load, the nature of the ground surface and the surroundings.

If the driver considers that the vehicle can traverse an obstacle, they assume entire responsibility for this.

## Identification markings

Various visible markings for the identification and tracing of your vehicle.

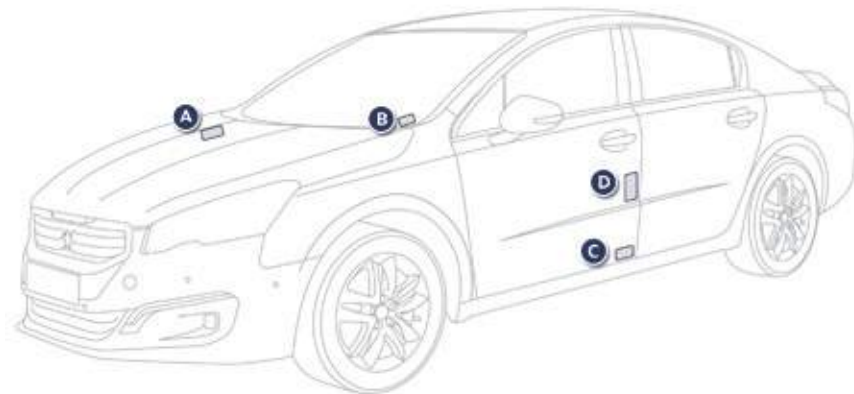

**A. Vehicle Identification Number (VIN) under the bonnet.**

This number is engraved on the bodywork near the damper support.

**B. Vehicle identification Number (VIN) on the windscreen lower crossmember.**

This number is indicated on a self-adhesive label which is visible through the windscreen.

**C. Manufacturer's label.**

This VIN is indicated on a self-destroying label affixed to the door aperture, on the driver's side.

**D. Tyre/paint label.**

This label is fitted to the middle pillar, on the driver's side.

It bears the following information:

- the tyre inflation pressures with and without load,
- the tyre sizes,
- the inflation pressure of the spare wheel,
- the paint colour code.

**i** The tyre pressures must be checked when the tyres are cold, at least once a month.

**☘** Low tyre pressures increase fuel consumption.



## EMERGENCY OR ASSISTANCE CALL

# EMERGENCY OR ASSISTANCE CALL

## PEUGEOT Connect SOS



In an emergency, press this button for more than 2 seconds. Flashing of the green LeD and a voice message confirm that the call has been made to the "Peugeot Connect SOS" centre\*.

The green LED remains on (without flashing) when communication is established. It goes off at the end of communication.

Pressing this button again immediately cancels the request. The green LED goes off. Cancellation is confirmed by a voice message. To cancel a call, tell the "Peugeot Connect SOS" call centre that the call was a mistake.

"Peugeot Connect SOS" immediately locates your vehicle, starts communication with you in your language\*\*, and where necessary sends the appropriate public emergency services\*\*. In countries where the service is not available, or when the locating service has been expressly declined, the call sent directly to the emergency services (112) without the vehicle location.



If an impact is detected by the airbag control unit, and independently of the deployment of any airbags, an emergency call is made automatically.

\* Subject to the general conditions for the service available from dealers and to technological and technical limitations.

\*\* Depending on the geographical cover of "Peugeot Connect SOS", "PEUGEOT Connect Assistance" and the official national language selected by the owner of the vehicle.

The list of countries covered and Peugeot Connect services is available from dealers or at [www.peugeot.co.uk](http://www.peugeot.co.uk).

## PEUGEOT Connect Assistance



Press this button for more than 2 seconds to request assistance if the vehicle breaks down. A voice message confirms that the call has been made\*\*.

Pressing this button again immediately cancels the request. The cancellation is confirmed by a voice message.

## Operation of the system



When the ignition is switched on, the green LeD comes on for 3 seconds indicating that the system is operating correctly.



If the orange LED flashes: there is a system fault.  
If the orange LeD is on continuously: the backup battery must be replaced.  
In either case, contact a Peugeot dealer.

If you purchased your vehicle outside the Peugeot dealer network, we invite you to have a dealer check the configuration of these services and, if desired, modified to suit your wishes. In a multi-lingual country, configuration is possible in the official national language of your choice.

For technical reasons and in particular to improve the quality of "Peugeot Connect services" services to customers, the manufacturer reserves the right to carry out updates to the vehicle's on-board telematic system.

# JBL EQUIPMENT

The Hi-Fi system is a 5.1 system developed by Peugeot in conjunction with JBL.



4 two-way speaker kits, separated by an active filter, are fitted at front and rear.

These are based on a fabric dome tweeter delivering stable and balanced treble reproduction and a 50W RMS neodymium magnet inverted motor medium-woofer possessing a very high output of bass frequencies.

The central line in the dashboard improves reproduction of the musical scene, putting the listener in a situation that realistically reproduces the original musical recording.

The bass unit located in the boot carries a 150W triple-coil true subwoofer in an optimised space, giving depth and impact to the bass ranges.

This set of speakers is controlled by a 10-way 500W RMS 2 ohm amplifier, using advanced surround sound and sound distribution handling, so as to deliver optimum performance both for the driver and for the passengers in the vehicle.



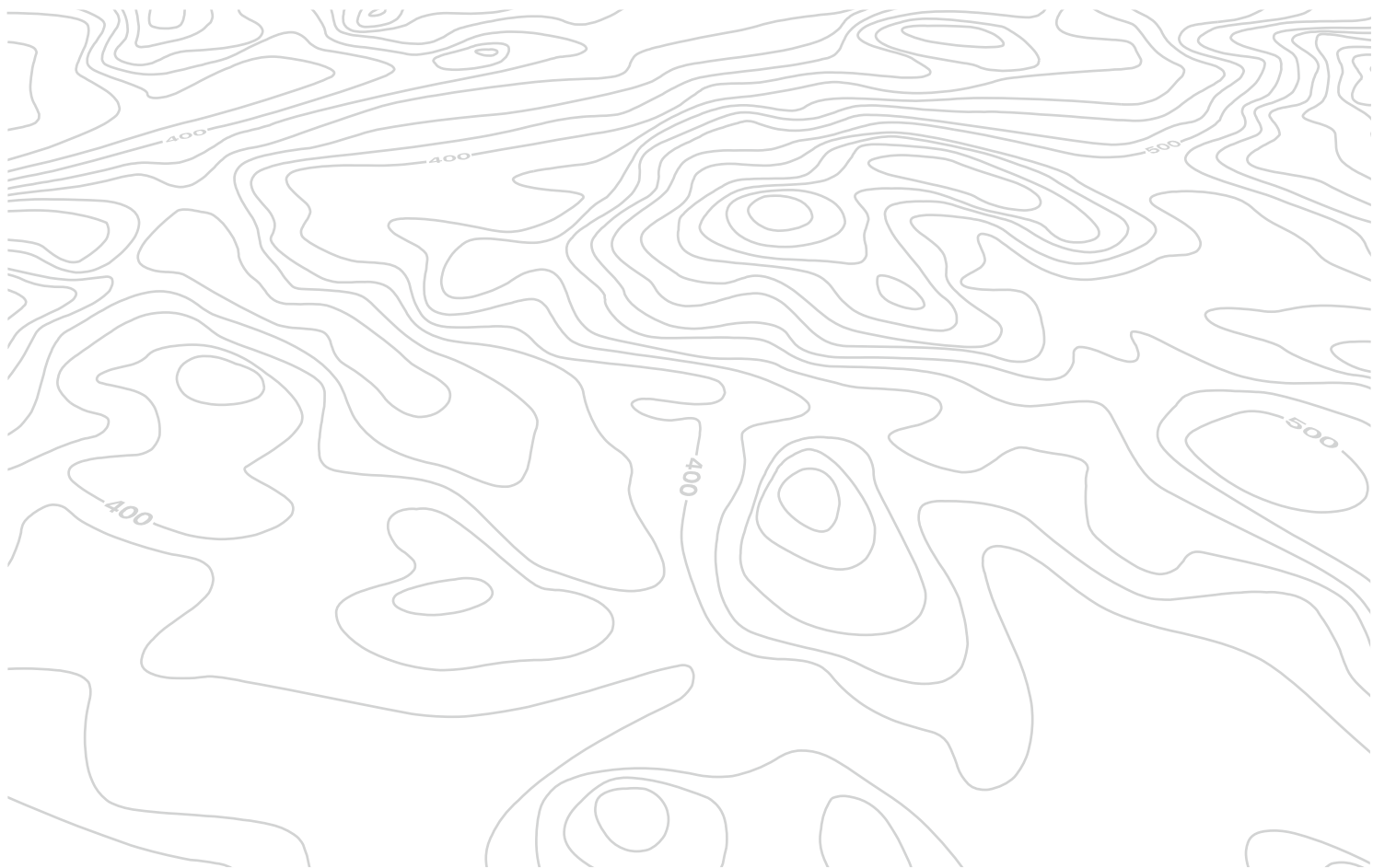



# 7-inch touch screen

GPS satellite navigation system

Multimedia audio system

Bluetooth® telephone



The system is protected in such a way that it will only operate in your vehicle.



For safety reasons, the driver must carry out operations which require prolonged attention while the vehicle is stationary.

When the engine is switched off and to prevent discharging of the battery, the system switches off following the activation of the energy economy mode.

## CONTENTS

<b>01</b>	<b>General operation</b>	<b>p. 270</b>
<b>02</b>	<b>First steps - Control panel</b>	<b>p. 272</b>
<b>03</b>	<b>Steering mounted controls</b>	<b>p. 273</b>
<b>04</b>	<b>Media</b>	<b>p. 274</b>
<b>05</b>	<b>Navigation</b>	<b>p. 292</b>
<b>06</b>	<b>Configuration</b>	<b>p. 312</b>
<b>07</b>	<b>Connected services</b>	<b>p. 322</b>
<b>08</b>	<b>Telephone</b>	<b>p. 324</b>
	<b>Frequently asked questions</b>	<b>p. 334</b>

# 01 GENERAL OPERATION



## "Navigation"

allows settings for navigation and the choice of a destination.



## "Telephone"

allows the connection of a mobile telephone via Bluetooth.



## "Configuration"

allows audio settings to be adjusted, the color scheme of the instruments and controls to be selected and the brightness of the instruments and controls to be adjusted.

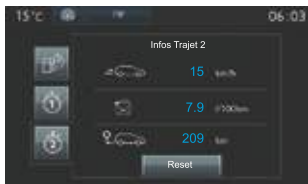

## "Driving assistance"

allows access to the trip computer and certain vehicle functions to be activated, deactivated and adjusted.



## "Media"

allows selection of a radio station, the various music sources and the display of photographs.



## "Connected services"

allows connection to an applications portal to facilitate, make safe and personalise journeys by means of a connection key available on subscription from a Peugeot Ot dealer.

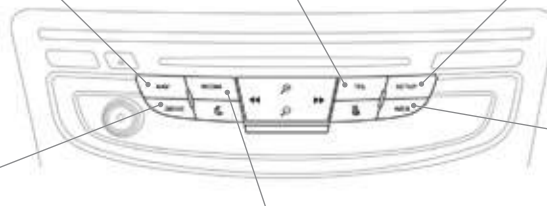

\* Depending on equipment.



# 01 GENERAL OPERATION

Use the buttons below the touch screen for access to the menus, then press the virtual buttons in the touch screen.

Each menu is displayed in one or two pages (primary page and secondary page).

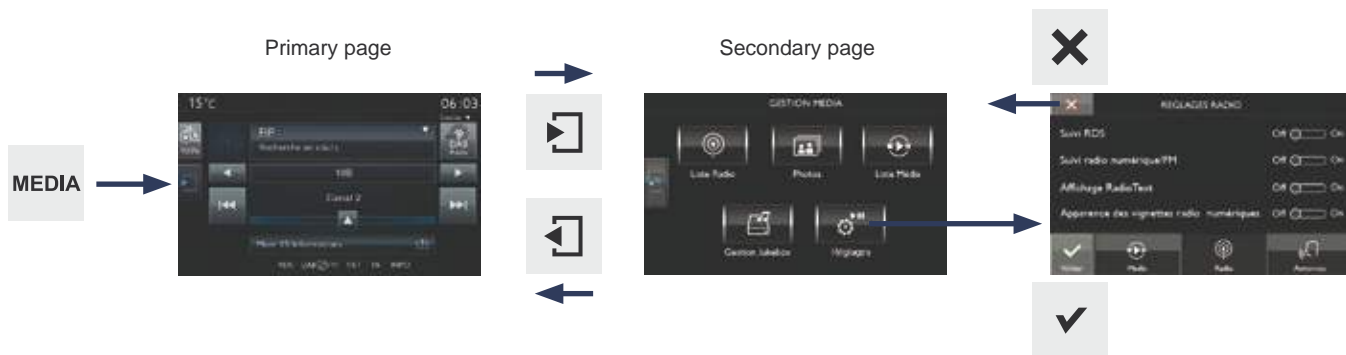
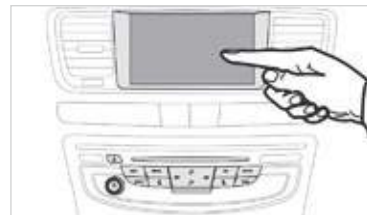

In very hot conditions, the system may go into stand-by (screen and sound completely off) for a minimum period of 5 minutes.

## 02 FIRST STEPS

With the engine running, press to mute the sound.  
With the ignition off, press to switch the system on.

Volume adjustment (each source is independent, including Traffic announcements (TA) and navigation instructions).



Short-cuts: using the touch buttons in the upper band of the touch screen, it is possible to go directly to the selection of audio source, the list of stations (or titles, depending on the source).

**i** Following prolonged operation in sunny conditions, the volume may be limited to protect the system. The return to normal takes place when the temperature in the passenger compartment drops.

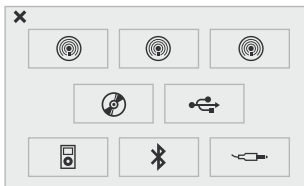

Selecting the audio source (depending on version):

- "FM" / "AM" / "DAB"\* stations.
- "u SB" memory stick.
- CD player (located in front panel).
- Jukebox\*, after first copying audio files to the internal memory of the system.
- telephone connected by Bluetooth\* and audio streaming Bluetooth\* (streaming).
- Media player connected to the auxiliary socket (jack, cable not supplied).

**i** The screen is of the "resistive" type, it is necessary to press firmly, particularly for "flick" gestures (scrolling through a list, moving the map...). A simple wipe will not be enough. Pressing with more than one finger is not recognised. The screen can be used when wearing gloves. This technology allows use at all temperatures.

**!** To clean the screen, use a soft non-abrasive cloth (spectacles cloth) without any additional product.  
Do not use pointed objects on the screen.  
Do not touch the screen with wet hands.

\* Depending on equipment.

# 03 STEERING MOUNTED CONTROLS

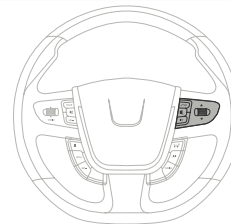
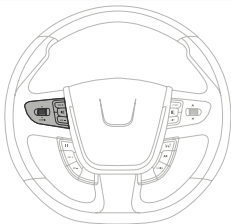

- Press: access to the instrument panel screen menu.
- Rotate: navigation in the instrument panel screen menu.



- Increase volume.



- Mute / restore sound.



- Decrease volume.



- Rotate  
Radio: automatic selection of next / previous frequency.  
Media: previous / next track.
- Short press then rotate: access to the preset stations.



- Short press: change the audio source.
- Press L/SRC button (short press): Accept an incoming call.  
Call in progress: access to telephone menu: hang up, secret mode, hands-free mode.
- Press L/SRC button (long press): Reject an incoming call or end a call in progress.  
When not making a call (long press): access to the telephone menu (Contacts, Calls log).











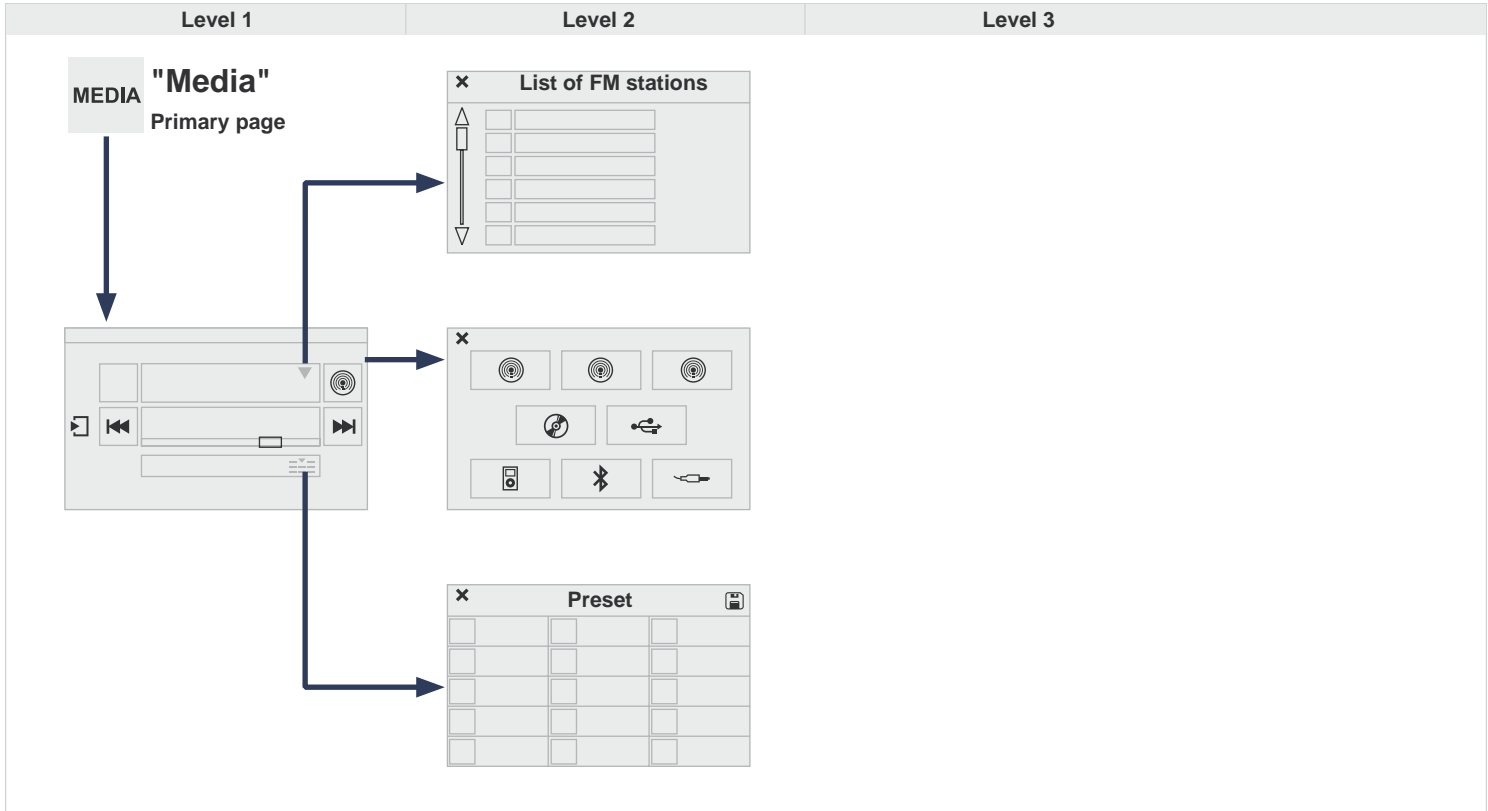









- Access to the menu carousel.



- Radio: display the list of stations.  
Media: display the list of tracks.









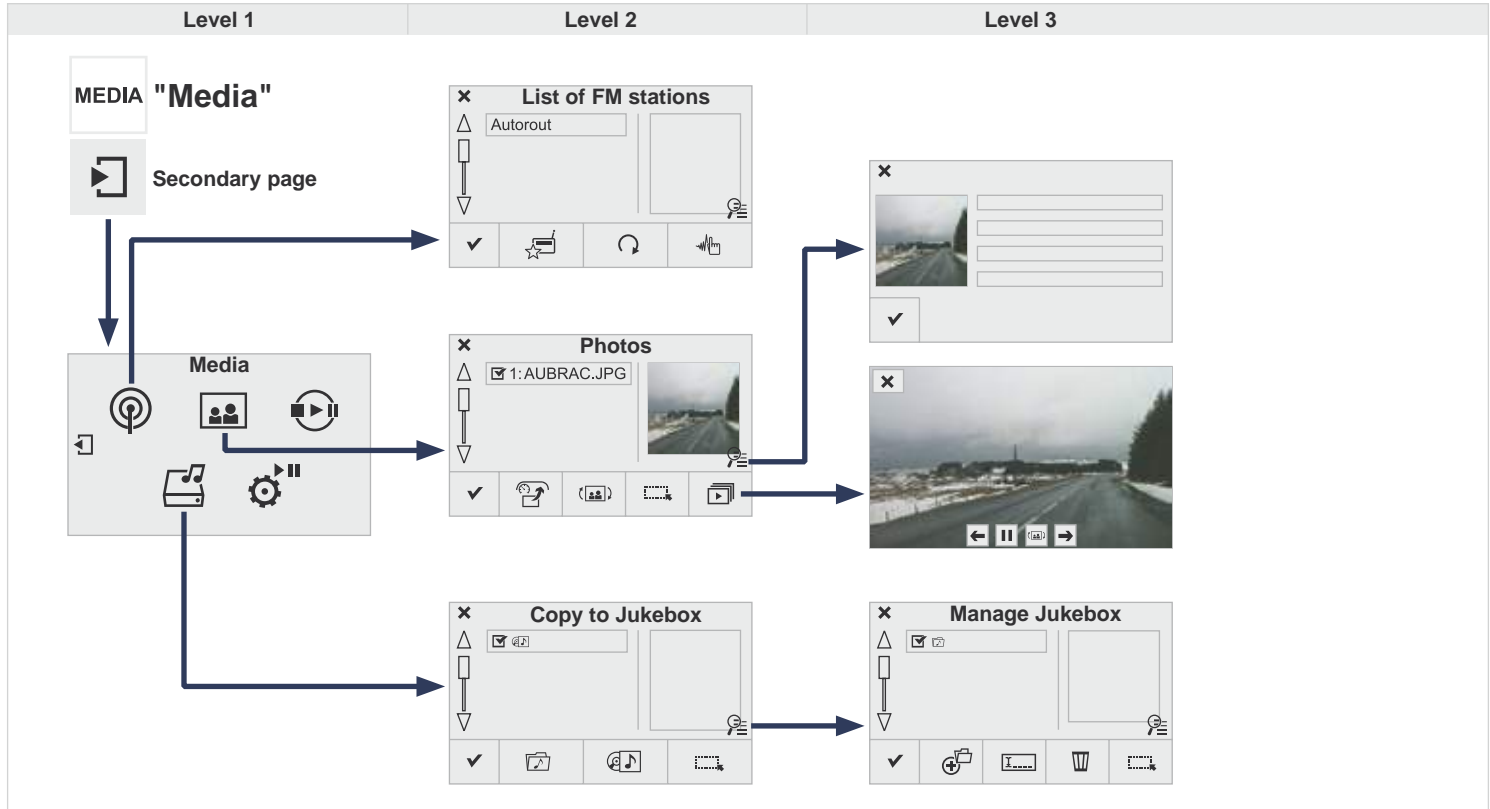

















# 04 MEDIA



Level 1		Level 2		Level 3	Comments
 	<b>Media</b> ↓ <b>List</b> →		<b>List of FM stations</b>		Press on a radio station to select it.
 	<b>Media</b> ↓ <b>Source</b> →	 <small>Radio FM</small>	<b>FM Radio</b>		Select change of source
		 <small>Radio DAB</small>	<b>DAB Radio</b>		
		 <small>Radio AM</small>	<b>AM Radio</b>		
			<b>Jukebox</b>		
			<b>CD</b>		
			<b>USB</b>		
			<b>iPod</b>		
			<b>Bluetooth</b>		
			<b>AUX</b>		
 	<b>Media</b> ↓ <b>Preset</b> →				Pres an empty location to Preset it.

# 04 MEDIA







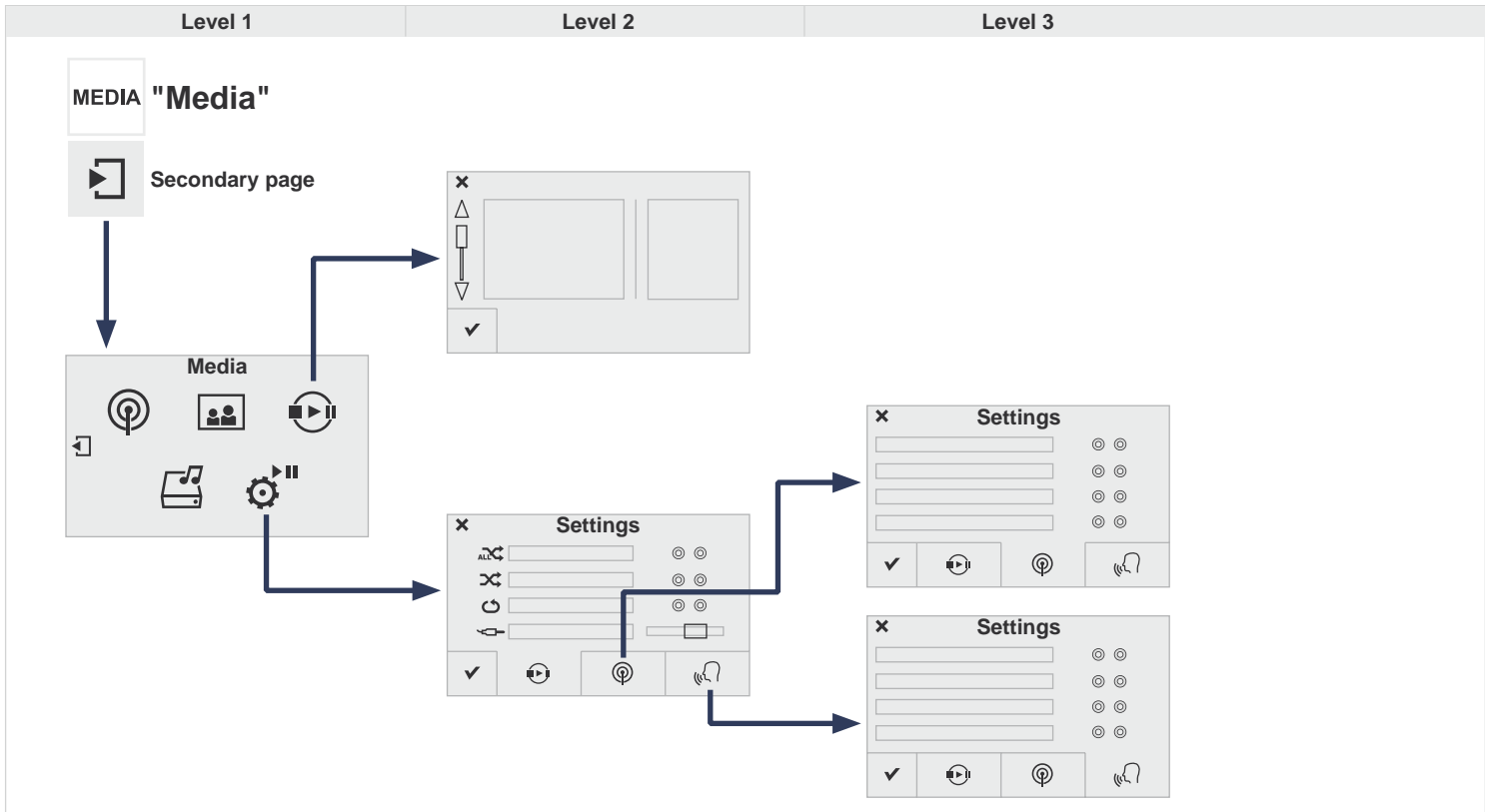









Level 1		Level 2		Level 3		Comments	
MEDIA  	<b>Media</b> ↓ <b>Secondary page</b> ↓ <b>Radio list</b> →	 <b>Preset</b>				Press a radio station to select it.	
		 <b>Update list</b>				update the list of stations received.	
		 <b>Frequency</b>				enter the desired radio frequency.	
		 <b>Confirm</b>				Save the settings.	
MEDIA  	<b>Media</b> ↓ <b>Secondary page</b> ↓ <b>Photos</b> →	 <b>Page selection</b>				Display the selected photo full screen.	
		 <b>Rotate</b>				Rotate the photo 90°.	
		 <b>Select all</b>				Select all the photos in the list. Press again to deselect.	
		 <b>Slideshow</b>	 Previous photo.  Pause / Play.  Next photo.			Display the photos in sequence, full screen.	
		 <b>Confirm</b>				Save the settings.	
		 <b>Sort by folder</b>				Choose the selection mode.	
		 <b>Sort by album</b>					
MEDIA  	<b>Media</b> ↓ <b>Secondary page</b> ↓ <b>Manage Jukebox</b> →	 <b>Select all</b>				Choose the handling mode.	
		 <b>Magnifying glass</b>	 Create folder  Rename  Delete  Select all				
		 <b>Copy</b>					Save the options.
							Save the settings

# 04 MEDIA





Level 1		Level 2		Level 3		Comments
  	<p><b>Media</b></p> <p>↓</p> <p><b>Secondary page</b></p> <p>↓</p> <p><b>Media list</b></p> <p>→</p>					Presentation of the last media used.
  	<p><b>Media</b></p> <p>↓</p> <p><b>Secondary page</b></p> <p>↓</p> <p><b>Settings</b></p> <p>→</p>		<p><b>Media</b></p> <p>↓</p> <p><b>Settings</b></p> <p>→</p>	 Random (all tracks):	Choose the play settings.	
			 Random (current album):			
			 Loop:			
			 Aux. amplification			
			<p><b>Radio</b></p> <p>↓</p> <p><b>Settings</b></p> <p>→</p>	<input type="checkbox"/> RDS options	Activate or deactivate the options.	
				<input type="checkbox"/> DAB/FM options		
				<input type="checkbox"/> Display Radio t ext		
				<input type="checkbox"/> DAB radio thumbnails		
			<p><b>Announcements</b></p> <p>↓</p> <p><b>Settings</b></p> <p>→</p>	<input type="checkbox"/> Traffic announcements (TA)	Activate or deactivate the options.	
				<input type="checkbox"/> Weather		
<input type="checkbox"/> Varied - Sport						
<input type="checkbox"/> Alert settings						
	<p><b>Confirm</b></p>		Save the settings.			

# 04 RADIO

## Selecting a station

**1a** Press on **Media** to display the primary page.  
or  
Press on **Media** to display the primary page  
then go to the secondary page.



**2a** Select "**List**" in the primary page.  
or  
Select "**Radio list**" in the secondary page.



**3a** Select a radio station from the list offered.

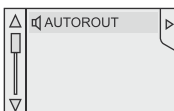

 Select "**Update list**" to refresh the list.



**1b** Press **Media** to display the primary  
page then select "**Preset**".



OR

**2b** Select a preset radio station in the list.

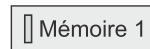

**1** If necessary, select change of source.



**2** Select "**FM Radio**" or "**AM Radio**".



**!** The exterior environment (hills, buildings, tunnel, car park, below ground...) may prevent reception, even in RDS station tracking mode.  
This phenomenon is normal in the propagation of radio waves and is in no way indicative of a fault with the audio system.

# 04 RADIO

## Changing a radio frequency

1a

Press on **Media** to display the primary page.

MEDIA



2a

**By automatic frequency search**

Press ◀ or ▶ to move the cursor for an automatic search down or up for a radio frequency.



OR

1b

Press on **Media** to display the primary page then press on the secondary page.

MEDIA



2b

Press on "**Enter frequency**" to display the primary page then press on the secondary page.



THEN

3a

Select change source.



FM



3b

Select "**FM Radio**" or "**AM Radio**".



Radio AM



Radio FM



OR

3c

enter the frequency in full (e.g.: 92.10 MHz) using the keypad then "**Confirm**".



3d

**By alphabetical list**

Press the current radio band then choose the radio station from the list offered.

FRANCE BLEU



# 04 RADIO

## Preset a station

1 Select a radio station or frequency  
(refer to the corresponding section).

2 Press on "**Preset**".



3 Select a number in the list to preset the  
previously chosen radio station.  
A long press on a number presets (memorises)  
the station.  
Or  
A press on this button presets all of the stations  
one after the other.

Mémoire 1



### Recall pre-set stations

Press on **Media** to display the primary page  
then select "**Save**".



# 04 RADIO

## Activate/ Deactivate RDS

1

Press on **Media** to display the primary page then go to the secondary page.

MEDIA



2

Select "**Settings**".



3

Select "**Radio**".



4

Activate/deactivate "**RDS options**".

Off  On

i

RDS, if activated, allows you to continue listening to the same station by automatic retuning to alternative frequencies. However, in certain conditions, coverage of an RDS station may not be assured throughout the entire country as radio stations do not cover 100 % of the territory. This explains the loss of reception of the station during a journey.

# 04 RADIO

Display of the name of the current station.

Short-cut: access to the choice of audio source and the list of stations (or titles, depending on the source).

Select the radio station.

Any thumbnail broadcast by the station.

Manage the Jukebox.  
Display current action.

Secondary page.

Previous "Multiplex".  
Previous radio station.

Display the name and number of the multiplex service being used.

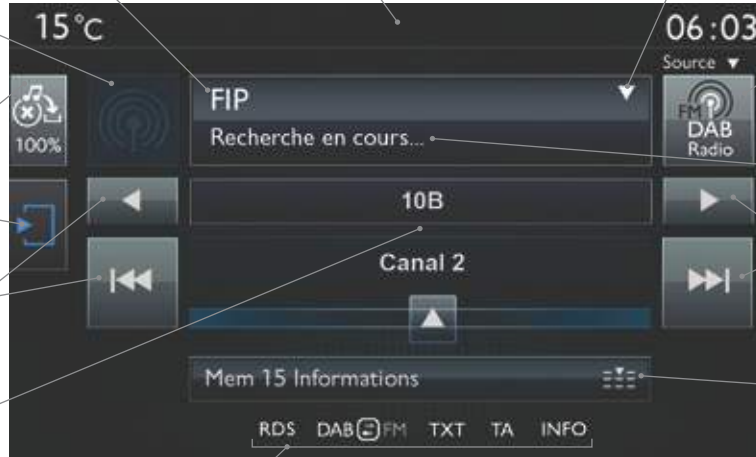

Select the audio source.  
Display the "DAB" band.

Display of "Radiotext" for the current station.

Next "Multiplex".  
Next radio station.

Preset stations, buttons 1 to 15  
Short press: select the preset radio station.  
Long press: preset a radio station.

Display of options:  
if active but not available, the display will be greyed out,  
if active and available, the display will be blank.

**i** If the "DAB" radio station being listened to is not available on "FM", the "DAB FM" option is greyed out.



**!** Journaline® is a text-based information service designed for digital radio systems. It provides up to date text-based information similar to that offered by an electronic magazine or paper. The information is structured around topics and sub-topics.

# 04 RADIO

## DAB (Digital Audio Broadcasting) Digital radio

**!** Digital radio provides higher quality reception and also the graphical display of current information on the radio station being listened to. Select "List" in the primary page.  
The range of multiplexes available is displayed in alphabetical order.

**1** Press on **Media** to display the primary page.



**2** Select change of source.



**3** Select "**DAB Radio**".



**4** Select "**List**" in the primary page.  
or  
Select "**Radio list**" in the secondary page.



**5** Select the radio station from the list offered.

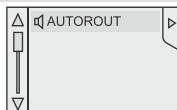

## Digital radio - DAB / FM auto tracking

**i** "DAB" does not cover 100% of the territory.  
When the digital radio signal is weak, "DAB / FM auto tracking" allows you to continue listening to the same station, by automatically switching to the corresponding "FM" analogue station (if there is one).

**1** Press **Media** to display the primary page then press on the secondary page.



**2** Select "**Settings**".



**3** Select "**RADIO**".



**4** Select "**Digital/FM auto tracking**" then "**Confirm**".



**i** If "DAB / FM auto tracking" is activated, there is a difference of a few seconds when the system switches to "FM" analogue radio with sometimes a variation in volume.  
When the digital signal is restored, the system automatically changes back to "DAB".

**!** If the "DAB" station being listened to is not available on "FM" ("**DAB/FM**" option greyed out), or "DAB / FM auto tracking" is not activated, the sound will cut out while the digital signal is too weak.

# 04 MUSIC

## CD, MP3 CD, USB player, auxiliary input



Insert the CD in the player, insert the uSB memory stick in the uSB player or connect the uSB peripheral to the uSB port using a suitable cable (not supplied).

the system builds playlists (in temporary memory), an operation which can take from a few seconds to several minutes at the first connection.

Reduce the number of non-music files and the number of folders to reduce the waiting time.

the playlists are updated every time the ignition is switched off or connection of a uSB memory stick. However, the system memorises these lists and if they are not modified, the loading time will be shorter.



### Selection of source

- 1 Press on **Media** to display the primary page.

**MEDIA**

- 2 Select change of source then choose the source.



FM

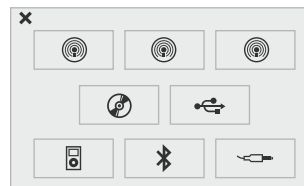

the steering mounted **SRC** (source) button can be used to go to the next media source, available if the source is active. Press **OK** to confirm the selection.

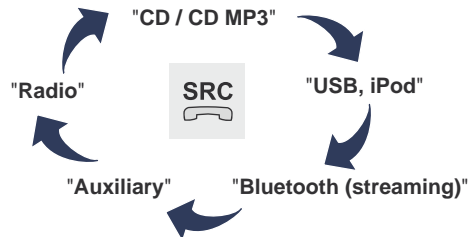



# 04 MUSIC

## CD, MP3 CD / USB player

### Information and advice



The audio equipment will only play audio files with ".wma, .aac, .flac, .ogg and .mp3" file extensions and with a bit rate of between 32 Kbps and 320 Kbps.

It also supports VBR (Variable Bit Rate) mode.

No other type of file (.mp4, ...) can be played.

WMA files must be of the standard wma 9 type.

The sampling rates supported are 11, 22, 44 and 48 KHz.



It is advisable to restrict file names to 20 characters, without using of special characters (e.g.: " " ? ; ù) to avoid any playing and displaying problems.



In order to be able to play a recorded CDR or CDRW, when recording it is preferable to select the ISO 9660 level 1, 2 or Joliet standard.

If the disc is recorded in another format it may not be played correctly.

It is recommended that the same recording standard is always used for an individual disc, with as low a speed as possible (4x maximum) for optimum sound quality.

In the particular case of a multi-session CD, the Joliet standard is recommended.



The system supports USB mass storage devices, BlackBerry® devices or Apple® players via USB ports. The adaptor cable not supplied.

Control of the peripheral device is with the audio system controls.

Other peripherals, not recognised on connection, must be connected to the auxiliary socket using a Jack cable (not supplied).



Use only USB memory sticks formatted FAT 32 (28-bit file allocation table).



The system does not support two identical devices connected at the same time (two memory sticks, two Apple® players) but it is possible to connect one memory stick and one Apple® player at the same time.



It is recommended that official Apple® USB cables are used to ensure correct operation.

# 04 MUSIC

## Selecting a track to play

Previous track.		List of u SB or CD tracks and folders.	
Next track.		up or down in the list.	
Previous folder.		Confirm, next menu level.	
Next folder.		up one menu level.	

# 04 MUSIC

## Connecting APPLE® players

- 1 Connect the Apple® player to one of the uSB ports using a suitable cable (not supplied).  
Play starts automatically.



- 2 Control is via the audio system.

**i** The classifications available are those of the portable device connected (artists / albums / genres / playlists / audiobooks / podcasts).  
The default classification used is by artist. To modify the classification used, return to the first level of the menu then select the desired classification (playlists for example) and confirm to go down through the menu to the desired track.

**i** Copies of photos and album artwork are not compatible with the audio system. These appear only with a uSB memory stick.

**!** The version of software in the audio system may not be compatible with the generation of your Apple® player.

## Audio streaming



Streaming allows audio files on your telephone to be played via the vehicle's speakers.

1

Connect the telephone: see the "**Telephone**" section, then "**Bluetooth**".  
Choose the "**Audio**" or "**All**" profile.

2

If play does not start automatically, it may be necessary to start the audio playback from the telephone.  
Control is from the peripheral device or by using the audio system buttons.

!

Once connected in streaming mode, the telephone is considered to be a media source.  
It is recommended that you activate "**Repeat**" on the Bluetooth peripheral.

## 04 MUSIC

### Using the auxiliary input (AUX) (cable not supplied)

- 1 Connect the portable device (MP3 player...) to the auxiliary JACK socket using an audio cable.



- 2 Select **Media** to display the primary page.

**MEDIA**

- 3 Select change the source.



- 4 Select the **AUXILIARY** source.



- i** First adjust the volume of your portable device (to a high level). Then adjust the volume of your audio system. Display and management of the controls are via the portable device.

# 04 MUSIC

## Managing the Jukebox

1

Connect the device (MP3 player...) to the uSB port or auxiliary socket using a suitable audio cable.

i

When no audio file is copied to the system with a capacity of 8GB, all of the Jukebox function symbols are greyed and are not available.

2

Select "**Media list**".



3

Select copy "**Copy Jukebox**".



4

Select "**Sort by folder**" or "**Sort by album**".



5

Select the magnifying glass to enter the folder or album and select audio file by audio file.



6

Select "**Confirm**" then "**Copy**".



7

Select "**New folder**" to create a folder structure in the Jukebox or select "**Keep structure**" to retain the structure from the device.











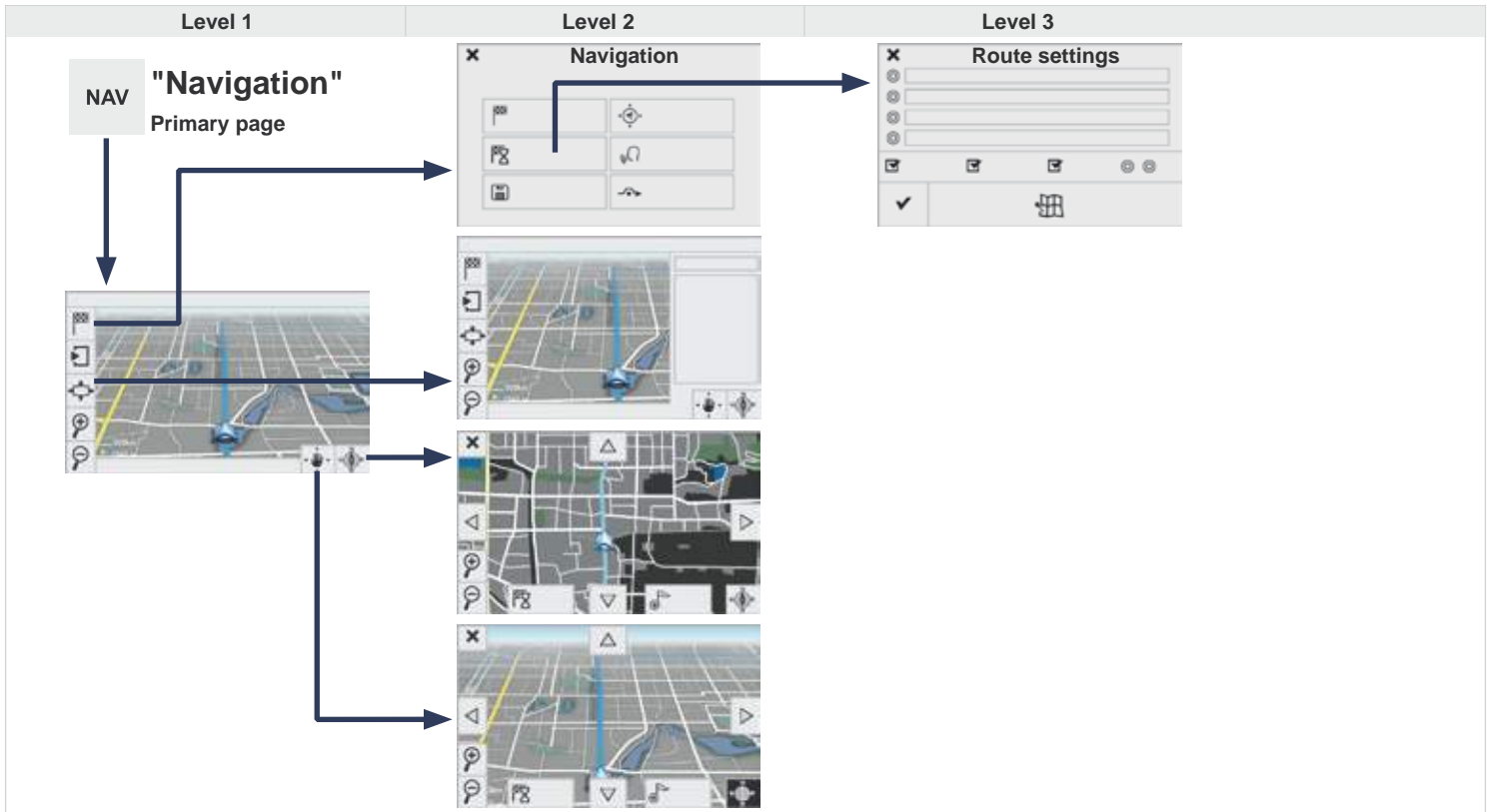





8

While copying the system returns to the primary page; you can go back to the copy view at any time by selecting this button.



# 05 NAVIGATION







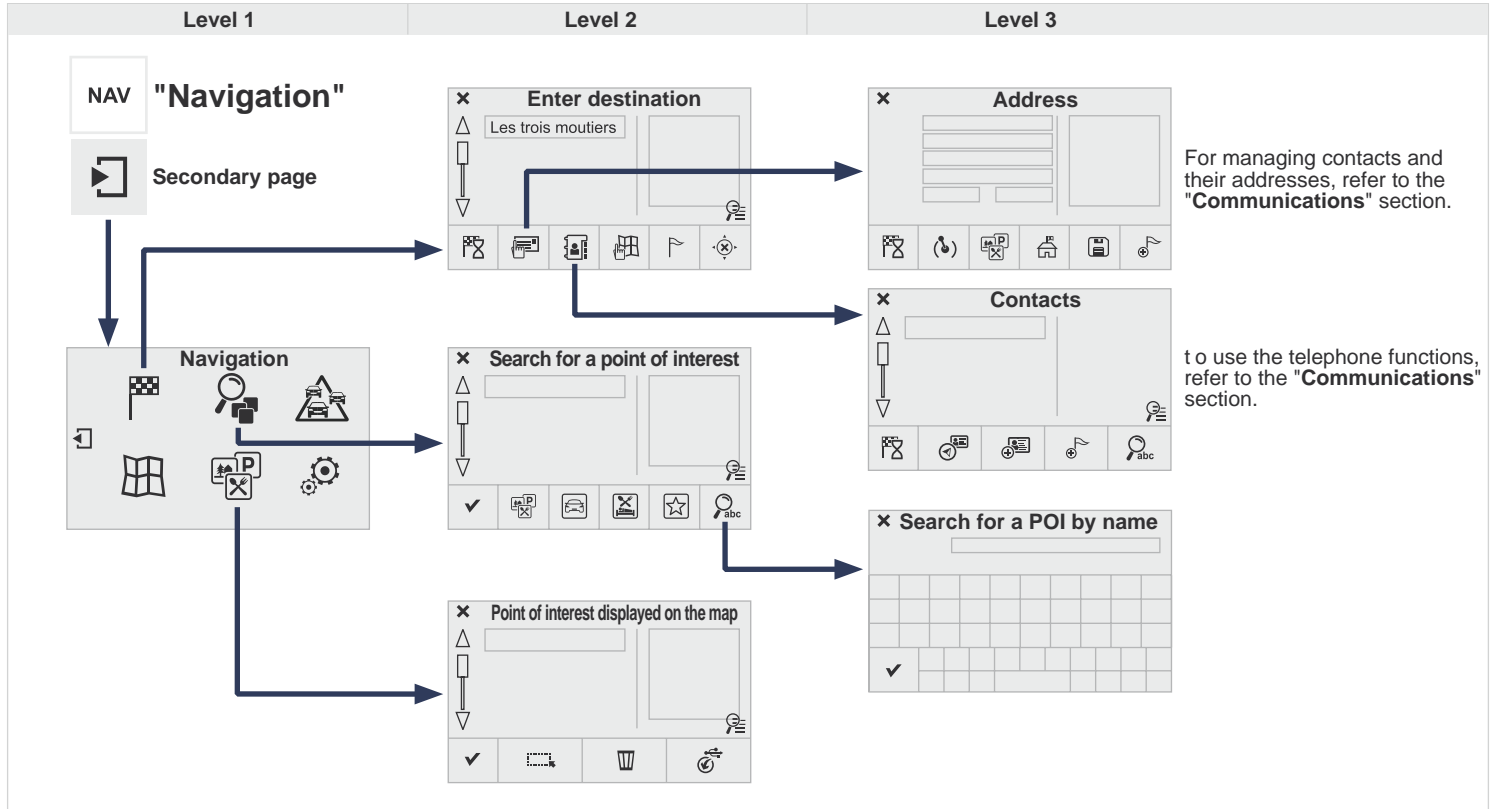































Level 1		Level 2		Level 3		Comments	
 <b>Navigation</b> ↓ <b>Settings</b> <b>Navigation</b> →	 <b>Enter destination</b>					Display recent destinations	
		 <b>Calculatory criteria</b>	<input type="radio"/>	Fastest			Choose the navigation criteria. The map displays the route chosen according to these criteria.
			<input type="radio"/>	Shortest			
			<input type="radio"/>	Time/distance			
			<input type="radio"/>	Ecological			
			<input checked="" type="checkbox"/>	Tolls			
			<input checked="" type="checkbox"/>	Ferries			
			<input type="checkbox"/>	Strict - Close			
	Show route on map				Display the map and start navigation.		
<input checked="" type="checkbox"/>	Confirm			Save the options.			
	 <b>Save</b>					Save the current address.	
	<b>Stop navigation</b>					Delete the navigation information.	
	<b>Voice</b>					Choose the volume for voice and announcement of street names.	
	<b>Diversion</b>					Detour from your initial route by a certain distance.	
 <b>Navigation</b>						Display in text mode	
						Zoom in.	
						Zoom out.	
			<input type="checkbox"/>				Display in full screen mode. Use the arrows to move the map.
							Switch to 2D map.

# 05 NAVIGATION









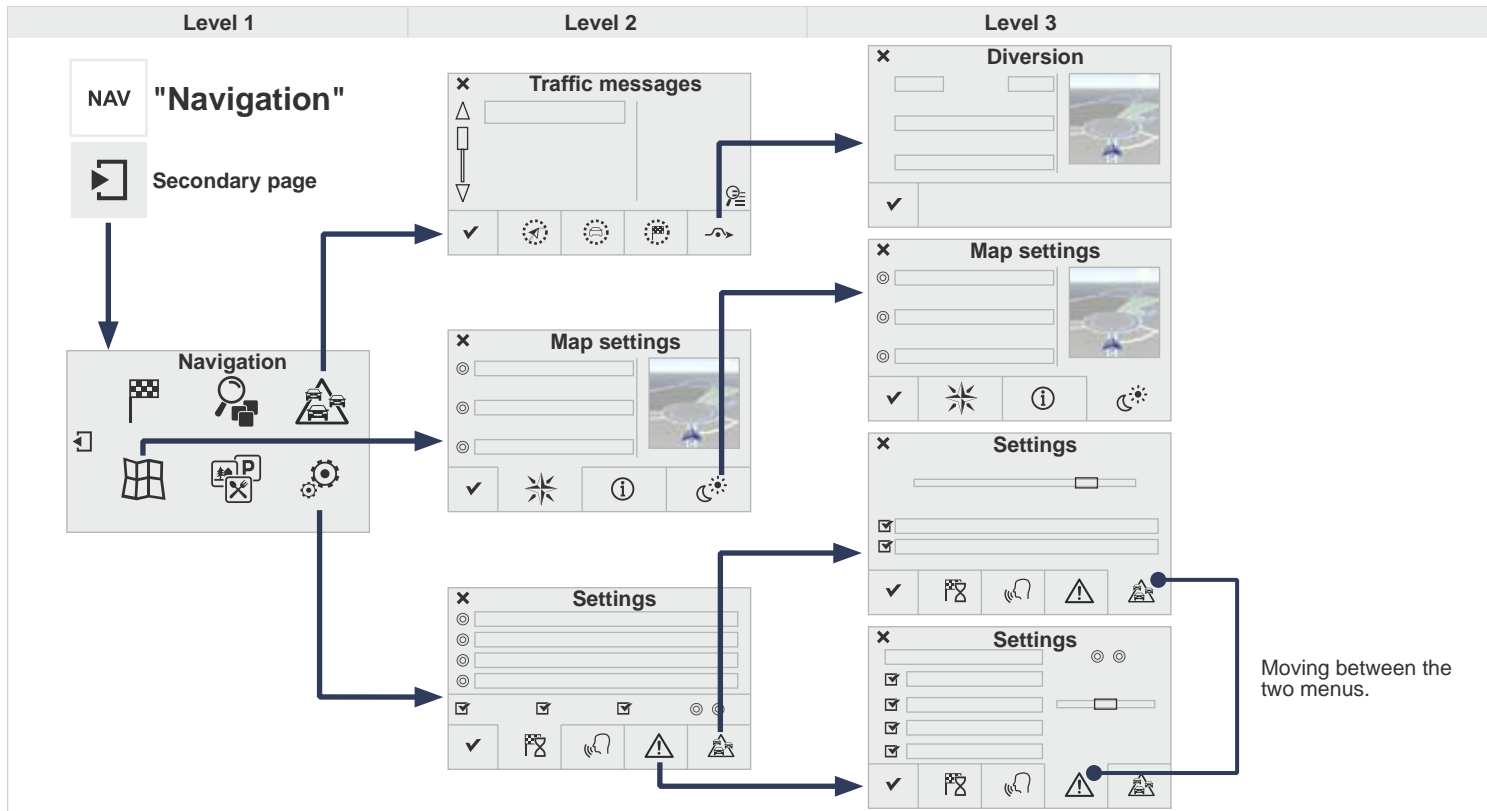















Level 1		Level 2		Level 3		Comments				
  	<p>Navigation</p> <p>↓</p> <p>Secondary page</p> <p>↓</p> <p>Enter destination</p> <p>→</p>	 <b>Address</b>			Curr. location	Address settings				
					Points of Interest					
					Town centre					
					Save		Save the current address.			
					Add waypoint		Add a waypoint to the route.			
				 <b>Contacts</b>			Navigate to	Press to calculate the route.		
							Addresses			
							Add contact			
							Add waypoint			
							Search for contact			
	Navigate to									
					<b>From map</b>	Display the map and zoom to view the roads.				
					<b>Itinerary</b>	Create, add or delete a waypoint or view the itinerary.				
					<b>Stop</b>	Delete navigation information.				
					<b>Navigate to</b>	Press to calculate the route.				
				  	<p>Navigation</p> <p>↓</p> <p>Secondary page</p> <p>↓</p> <p>Search for POI</p> <p>→</p>				<b>All POIs</b>	List of categories available. After choosing the category, select the points of interest.
									<b>Garage</b>	
	<b>Dining/hotels</b>									
	<b>Personal</b>									
	<b>By name</b>									
  	<p>Navigation</p> <p>↓</p> <p>Secondary page</p> <p>↓</p> <p>Show POIs</p> <p>→</p>				<b>Search</b>	Save the settings.				
					<b>Select all</b>					
					<b>Delete</b>					
					<b>Import POIs</b>					
					<b>Confirm</b>	Save the options.				

# 05 NAVIGATION



Level 1		Level 2		Level 3		Comments
  	Navigation ↓ Secondary page ↓ Traffic messages →	 <b>On the route</b>				Settings for the choice of messages and the filter radius.
		 <b>Around vehicle</b>				
		 <b>Near destination</b>				
		 <b>Detour</b>	<input type="radio"/> Detour over a distance <input type="radio"/> Recalculate route			
		<input checked="" type="checkbox"/> <b>Finish</b>				
  	Navigation ↓ Secondary page ↓ Map settings →	 <b>Orientation</b>	<input type="radio"/> Flat view north heading <input type="radio"/> Flat view vehicle heading <input type="radio"/> Perspective view			Choose the display and orientation of the map.
		 <b>Maps</b>				
		 <b>Aspect</b>	<input type="radio"/> "Day" map colour <input type="radio"/> "Night" map colour <input type="radio"/> Automatic day/night			
		<input checked="" type="checkbox"/> <b>Confirm</b>				
	  	Navigation ↓ Secondary page ↓ Settings →	 <b>Route settings</b>			
		 <b>Voice</b>				
		 <b>Alert!</b>				
		 <b>Traffic options</b>				
	<input checked="" type="checkbox"/> <b>Confirm</b>					Save the options.

# 05 NAVIGATION - GUIDANCE

## Choosing a new destination

### Towards a new destination

1

Press on **Navigation** to display the primary page then go to the secondary page.

NAV



2

Select **"Enter destination"**.



3

Select **"Address"**.



4

Select the **"Country:"** from the list offered then in the same way:

the **"City:"** or its post code, the **"Road:"**, the **"N°:"**. Confirm each time.

▼	FRANCE	▢
▼	PARIS	▢
▼	Blvd Hossein	▢
N°/A	20	▢



Select **"Save"** to save the address entered as a contact entry.

The system allows up to 200 entries.



5

Select **"Navigate to"**.



6

Choose the navigation criteria: **"Fastest"** or **"Shortest"** or **"Time/distance"** or **"Ecological"**.



7

Choose the restriction criteria: **"Include tollroads"**, **"Include ferries"**, **"Traffic"**, **"Strict"**, **"Close"**.



8

Select **"Confirm"** or press **"Show route on map"** to start navigation guidance.



i

To delete navigation information, press on **"Settings"** then **"Stop navigation"**.



To restore the navigation information press on **"Settings"** then **"Resume navigation"**.



# 05 NAVIGATION - GUIDANCE

## Towards a recent destination

1

Press on **Navigation** to display the primary page then go to the secondary page.

NAV



2

Select "**Enter destination**".



3

Select an address from the list offered.

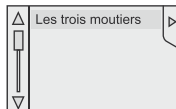

4

Select "**Navigate to**".  
Select the criteria then "**Confirm**" or press "**Show route on map**" to start guidance.



## Towards a contact

i

Navigation towards a contact imported from a telephone is only possible if the address entered is compatible with the system.

1

Press on **Navigation** to display the primary page then go to the secondary page.

NAV



2

Select "**Enter destination**".



3

Select "**Contacts**".



4

Select a destination from the contacts in the list offered.

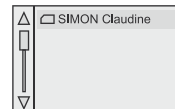

5

Select "**Navigate to**".  
Select the criteria then "**Confirm**" to start guidance.



# 05 NAVIGATION - GUIDANCE

## Towards GPS coordinates

1

Press on **Navigation** to display the primary page then go to the secondary page.

NAV



2

Select "**Enter destination**".



3

Select "**Address**".



4

enter the "**Longitude:**" then the "**Latitude:**".

6°54'689"

5

Select "**Navigate to**".  
Select the criteria then "**Confirm**" or press "**Show route on map**" to start guidance.



## Towards a point on the map

1

Press on **Navigation** to display the primary page then go to the secondary page.

NAV



2

Select "**Enter destination**".



3

Select "**From map**".



4

Zoom in on the map then select the point.





A long press displays the surrounding tourist attractions.

# 05 NAVIGATION - GUIDANCE

## Towards points of interest (POI)

Points of Interest (POI) show all of the locations of services nearby (hotels, retail outlet, airports, ...).

1

Press on **Navigation** to display the primary page then go to the secondary page.

NAV



2

Select **"Search for POI"**.



3

Select **"All POIs"** or **"Garage"** or **"Dining/hotels"** or **"Personal"** or **"By name"**.

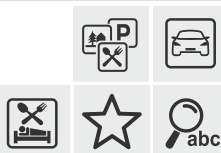

4

Select a category from the list offered.



5

Select **"Search"**.



6

Select a point of interest from the list offered.

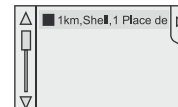

7

Select **"Navigate to"**.



i

An annual mapping update allows new points of interest to be presented to you.  
You can also update the Risk areas / Danger areas every month.  
The detailed procedure is available on:  
<http://peugeot.navigation.com>.

# 05 NAVIGATION - GUIDANCE

## Towards points of interest (POI)

1

Press on **Navigation** to display the primary page then go to the secondary page.

NAV



2

Select "**Show POIs**".



3

Select a category from the list offered then "**Confirm**".





# 05 NAVIGATION - GUIDANCE

## Risk area / Danger zone alert settings

1

Press on **Navigation** to display the primary page then go to the secondary page.

NAV



2

Select "**Settings**".



3

Select "**Alert config.**".



4

It is then possible to activate Risk Areas alerts then:

- "Audible warning"
- "Alert only when navigating"
- "Alert only for overspeed"
- "Display speed limits"
- Timing: the choice of timing allows the time before giving a Risk Area alert to be defined.

5

Select "**Confirm**".



!

These functions are only available if Risk Areas have been downloaded and installed on the system.

# 05 NAVIGATION - GUIDANCE

## Adding a waypoint

- 1 Press on **Navigation** to display the primary page then go to the secondary page.

NAV



- 2 Select **"Enter destination"**.



- 3 Select **"Itinerary"**.



- 4 Select **"Add waypoint"** then **"Address"**.



- 5 The address of the waypoint is entered in the same way as a destination, so enter the **"City:"** or post code, the **"Road:"** and the **"N°:"**. Confirm each time. Then select **"Add waypoint"**.

▼	FRANCE	
▼	PARIS	
▼	Blvd Hossein	
N°/A	20	



- 6 Select **"Navigate to"**.  
Select the criteria then **"Confirm"** to start guidance and give the general direction of the navigation route.



## Organising waypoints

- 4 To organise waypoints, carry out the previous operations 1 to 3 again (Adding a waypoint).

- 5 Select the waypoint that you want to move in the order.



- 6a Select **"Up"**.



- 6b Select **"Down"**.



- 6c Select **"Delete"**.



- Select **"Road map"** to view the changes made to the route.



# 05 NAVIGATION - GUIDANCE

## Route options

### Calculation criteria

1

Press **Navigation** to display the primary page then go to the secondary page.

NAV



2

Select "**Settings**".



3

Select "**Criteria**".



4

It is then possible to choose:

- the navigation criteria: "**Fastest**", "**Shortest**", "**Time/distance**", "**Ecological**".
- the exclusion criteria: "**Include tollroads**", "**Include ferries**", "**Traffic**", "**Strict**", "**Close**".

5

Select "**Confirm**".



!

The ecological calculation is based on mapping data but this may not always be correct.

# 05 TRAFFIC

## Traffic information

### Display of messages

- 1 Press on **Navigation** to display the primary page then go to the secondary page.



- 2 Select "**Traffic messages**".



- 3 Set the "**On the route**", "**Around**", "**Near destination**" filters to fine-tune the list. Press again to remove the filter.



- 4 Select the message from the list offered. Select the magnifying glasses to have the information spoken.

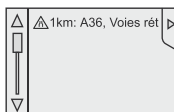

- i TMC (Traffic Message Channel) messages on GPS-Navigation contain traffic information transmitted in real time.

### Setting filters

- 1 Press on **Navigation** to display the primary page then go to the secondary page.



- 2 Select "**Settings**".



- 3 Select "**Info option**".



- 4 Select:  
- "**Warn of new messages**",  
- "**Speak messages**",  
Then enter the filter radius.



- 5 Select "**Confirm**".



- i We recommend a filter radius of:  
- 12 miles (20 km) in urban areas,  
- 30 miles (50 km) on motorways.

# 05 TRAFFIC

## Main traffic symbols

1 Red and yellow triangle: traffic information, for example:



2 Black and blue triangle: general information, for example:



## Receiving TA messages

1 Press on **Navigation** to display the primary page then go to the secondary page.

NAV



2 Select "**Settings**".



3 Select "**Voice**".



4 Activate / Deactivate "**Traffic (TA)**".

Off  On

**i** The TA (Traffic Announcement) function gives priority to TA alert messages. To operate, this function needs good reception of a radio station transmitting this type of message. When a traffic report is transmitted, the current audio source (Radio, CD, USB, ...) is interrupted automatically to play the TA message. Normal playback of the audio source resumes at the end of the transmission of the message.

# 05 TRAFFIC

## Diverting from a route

1

Press on **Navigation** to display the primary page then go to the secondary page.

NAV



2

Select "**Traffic messages**".



3

Select "**Diversion**".



4

Select the diversion distance by pressing + or -.



5

Select "**Recalculate route**". The route will be modified in time and distance.

+183 km ⌚ +00:20

6

Select "**Confirm**".



The route may be diverted following the reception of a traffic information message.

# 05 MAP

## Map settings

### Map orientation

1

Press on **Navigation** to display the primary page then go to the secondary page.

NAV



2

Select "**Map settings**".



3

Select "**Orientation**".



4

Select:

- "**Flat view north heading**" to keep the map always North up,
- "**Flat view vehicle heading**" to have the map follow the direction of travel,
- "**Perspective view**" to display a perspective view.



5

Select "**Confirm**" to save the modifications.



# 05 MAP

## Configure

1

Press on **Navigation** to display the primary page then go to the secondary page.

NAV



2

Select **"Map settings"**.



3

Select **"Aspect"**.



4

Select:

- **"Day" map colour** to have the map always in day mode.
- **"Night" map colour** to have the map always in night mode.
- **"Automatic day/night"** to have the brightness of the map adjusted automatically according to the ambient light level.

This mode makes use of the vehicle's sunshine sensor or by manual operation of the vehicle's lighting.



5

Then **"Confirm"** to save the modifications.





Street names are visible on the map from the 100 m scale.



# 05 SETTINGS

## Navigation speech synthesis

### Volume / Street names

1

Press on **Navigation** to display the primary page then go to the secondary page.

NAV



2

Select "**Settings**".



3

Select "**Voice**".



4

Select "**Voice synthesis**" and/or "**Male voice**" and/or "**Female voice**" and/or "**Speak road names**".











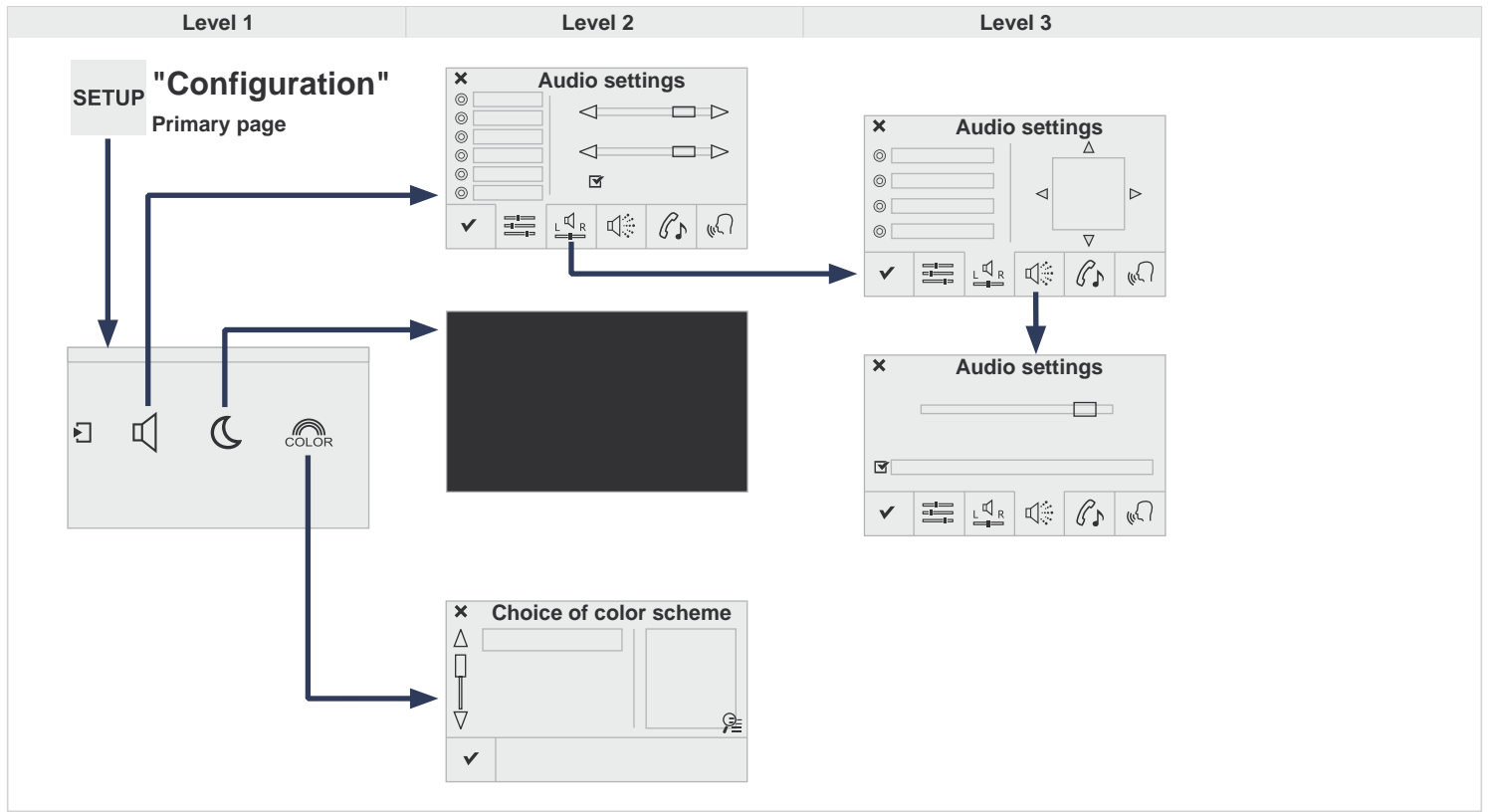



5

Select "**Confirm**" to save the modifications.











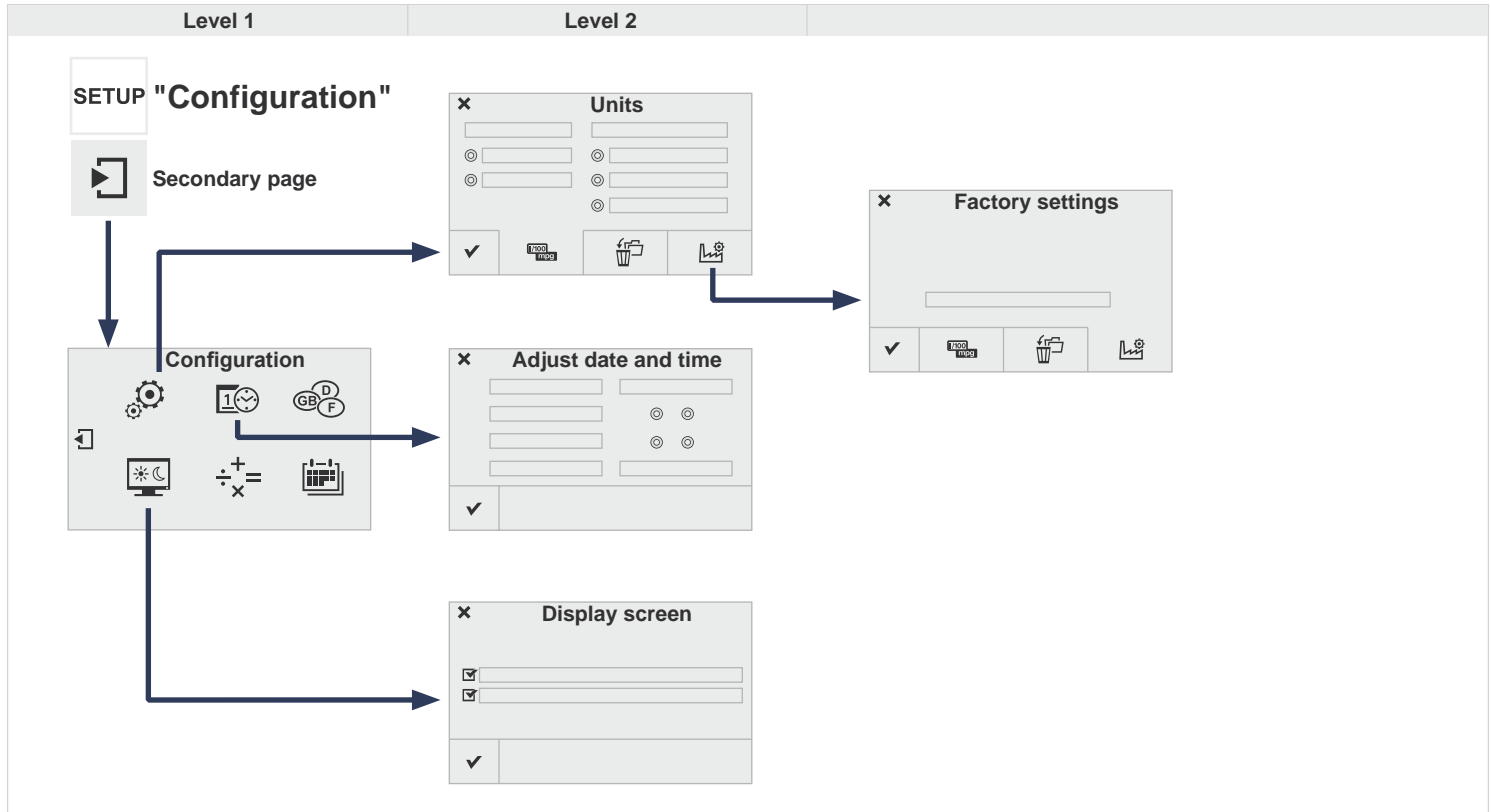



# 06 CONFIGURATION



Level 1		Level 2		Level 3	Comments
SETUP 	<b>Configuration</b> ↓ <b>Audio settings</b> →		<b>Ambience</b>		Choose the sound ambience.
			<b>Balance</b>		Set the position of the sound in the vehicle using the Arkamys® system.
			<b>Sound effects</b>		Set the volume or activate the link to vehicle speed.
			<b>Ringtones</b>		Set the telephone ringtone and volume.
			<b>Voice</b>		Set the volume and voice for speaking street names
			<b>Confirm</b>		Save the settings.
SETUP 	<b>Configuration</b> ↓ <b>Turn off screen</b> →				Turn off the display (black screen). A press on the black screen restores the display.
SETUP 	<b>Configuration</b> ↓ <b>Color schemes</b> →		<b>Confirm</b>		Having chosen the environment, save the setting.

# 06 CONFIGURATION



Level 1		Level 2		Comments
  	<b>Configuration</b> ↓ <b>Secondary page</b> ↓ <b>System Settings</b> →	 <b>Units</b>	Set the units used to display distance, fuel consumption and temperature.	
		 <b>Delete data</b>	Select the desired data in the list then press Delete.	
		 <b>Factory settings</b>	Return to factory settings.	
		<input checked="" type="checkbox"/> <b>Confirm</b>	Save the settings.	
  	<b>Configuration</b> ↓ <b>Secondary page</b> ↓ <b>Time/Date</b> →	<input checked="" type="checkbox"/> <b>Confirm</b>	Set the date and time then confirm.	
  	<b>Configuration</b> ↓ <b>Secondary page</b> ↓ <b>Screen settings</b> →	<input checked="" type="checkbox"/> <b>Automatic text scrolling</b> <input checked="" type="checkbox"/> <b>Deactivate animations</b> <input checked="" type="checkbox"/> <b>Confirm</b>	Make the setting then confirm.	







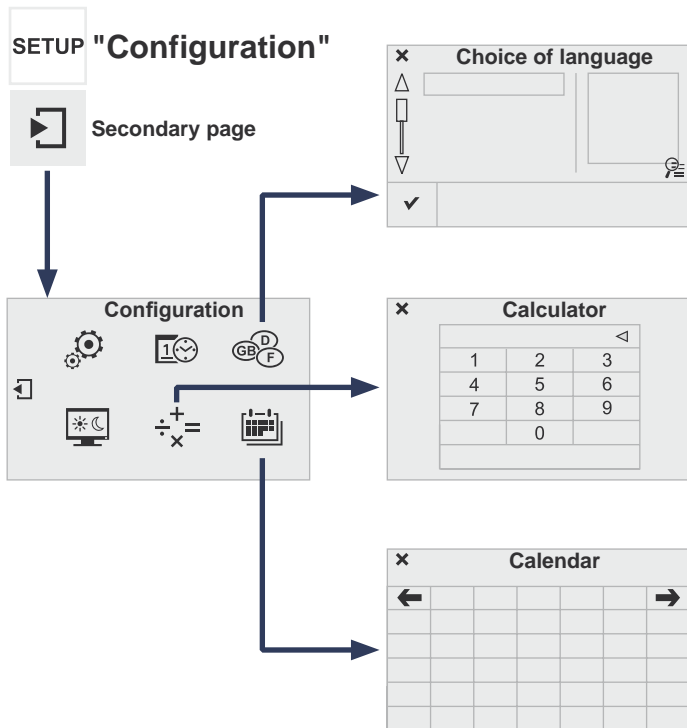

# 06 CONFIGURATION



Level 1

Level 2



Level 1		Level 2		Comments
  	<p><b>Configuration</b></p> <p>↓</p> <p><b>Secondary page</b></p> <p>↓</p> <p><b>Languages</b></p> <p>→</p>	✓	Confirm	Select the language then confirm.
  	<p><b>Configuration</b></p> <p>↓</p> <p><b>Secondary page</b></p> <p>↓</p> <p><b>Calculator</b></p> <p>→</p>			Select the calculator.
  	<p><b>Configuration</b></p> <p>↓</p> <p><b>Secondary page</b></p> <p>↓</p> <p><b>Calendar</b></p> <p>→</p>			Select the calendar.

# 06 CONFIGURATION

## Audio settings

1 Press on **Configuration** to display the primary page.

SETUP

2 Select "**Audio settings**".



3 Select "**Ambience**" or "**Balance**" or "**Sound effects**" or "**Ringtones**" or "**Voice**".

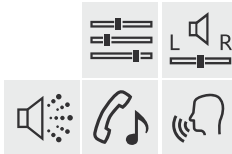

! The distribution (or spatialisation using the Arkamys® system) of sound is an audio process that allows the audio quality to be adapted to the number of listeners in the vehicle. Available only with the 6-speaker configuration.

! The audio settings (**Ambience**, **Bass**, **Treble** and **Loudness**) are different and independent for each sound source. The settings for **distribution** and **balance** are common to all sources.



- "**Ambience**" (choice of 6 musical ambiances)
- "**Bass**"
- "**Treble**"
- "**Loudness**" (Activate/Deactivate)
- "**Balance**", "**Driver**", "**All passengers**", "**Front only**"
- "**Audio setting on touch screen**"
- "**Volume linked to vehicle speed:**" (Activate/Deactivate)



On-board audio: Arkamys® Sound Staging.  
With Sound Staging, the driver and passengers are immersed in an "audio scene" recreating the natural atmosphere of an auditorium: truly a part of the scene and its surroundings.  
This new sensation is made possible by software in the audio system which processes the digital signals from the media players (radio, CD, MP3...) without changing the audio settings. This processing takes account of the characteristics of the passenger compartment to produce optimum results.  
The Arkamys® software installed in your audio system processes the digital signal from the media players (radio, CD, MP3, ...) and recreates a natural musical scene, with harmonious placement of instruments and voices in the space in front of passengers, level with the windscreen.



# 06 CONFIGURATION

## Color schemes

1

Press on **Configuration** to display the primary page.



2

Select "**Color schemes**".



3

Select the colour scheme in the list then "**Confirm**".



**i**

At each change of colour scheme the touch screen tablet's system restarts, showing a black screen for a few moments.

**!**

For safety reasons, the procedure for changing the colour scheme is only possible with the vehicle stationary.

# 06 CONFIGURATION

## System

### Modify system settings

1 Press on **Configuration** to display the primary page then go to the secondary page.



2 Select "**System Settings**".



3 Select "**Units**" to change the units of distance, fuel consumption and temperature.



4 Select "**Delete data**" to delete the list of recent destinations, personal points of interest, contacts in the list.  
Choose the item then select "**Delete**".



5 Select "**Factory settings**" to return to the original settings.



1 Press on **Configuration** to display the primary page then go to the secondary page.



2 Select "**Screen settings**".



3 Activate or deactivate "**Activate automatic text scrolling**" and "**Activate animations**".



# 06 CONFIGURATION

1

Press on **Configuration** to display the primary page then go to the secondary page.

SETUP



2

Select:

- "**Time/Date**" to change the time zone, synchronisation with g PS, time and its format and then the date.
- "**Languages**" to change the language.
- "**Calculator**" to display a calculator
- "**Calendar**" to display a calendar.



# 07 CONNECTED SERVICES



Level 1

Level 2

## WEB "Connected services"

**Primary page:**  
Driving assistance applications, see following page on "Peuge Ot CONNeCt APPS".



**Secondary page:**  
Internet navigation via Bluetooth telephone Dial-up Networking (Du N).

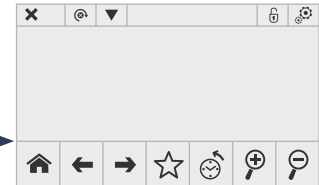
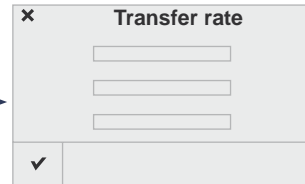
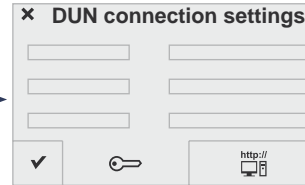
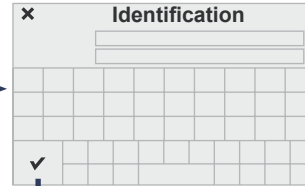
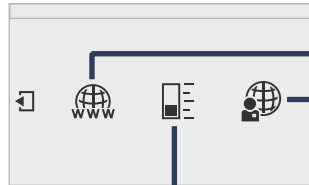

It may be that certain new generation smartphones are not compatible with this standard.

\* Depending on country.

# 07 PEUGEOT CONNECT APPS

**i** "Peugeot CONNeCt APPS" is a service providing driving aid applications in real time, that gives access to useful information such as the state of the traffic, danger zones, fuel prices, the availability of parking places, tourist sites, weather conditions, correct addresses...

It includes access to the mobile network associated with the use of these applications. "Peugeot CONNeCt APPS" is a service available under subscription contract from Peugeot dealers, depending on country and the type of touch screen, both before and after delivery of a new vehicle.

**1** Plug the "Peugeot CONNeCt APPS" connection key into one of the USB ports.

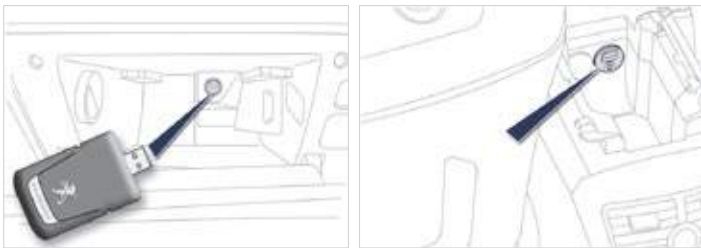

**i** For the best reception, it is recommended to connect the "Peugeot CONNeCt APPS" key to the USB port located in the glove box (available according to equipment).

**2** Press the "Connected services" menu to display the applications.

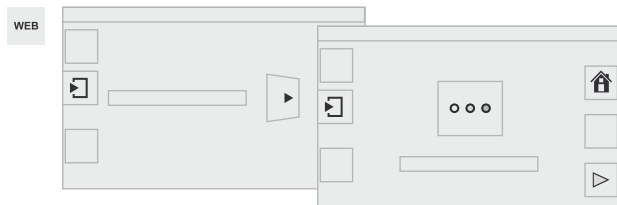

**3**



These applications use vehicle data such as the current speed, mileage, remaining fuel range or even GPS position to provide pertinent information.

**i**

For safety reasons, some functions can only be used when stationary.

**i**

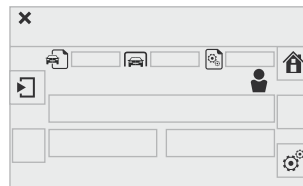

The "MyPeugeot" application is a link between the user, the manufacturer and its dealer network.

It allows the customer to know everything about their vehicle: servicing plan, accessory range, service contracts taken out, ...

It also makes possible the sending of the vehicle's mileage to the "MyPeugeot" site, or to identify a dealer.









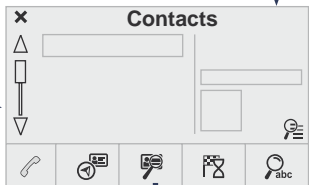
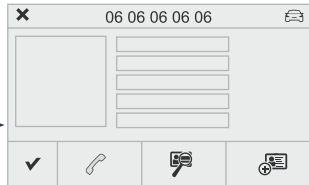
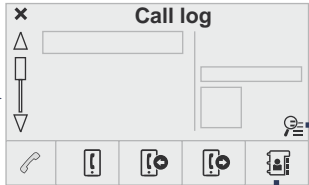
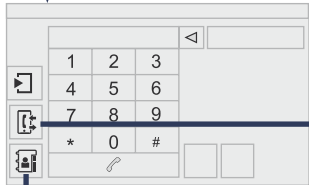











# 08 TELEPHONE



Level 1                      Level 2                      Level 3

TEL "Telephone"  
Primary page







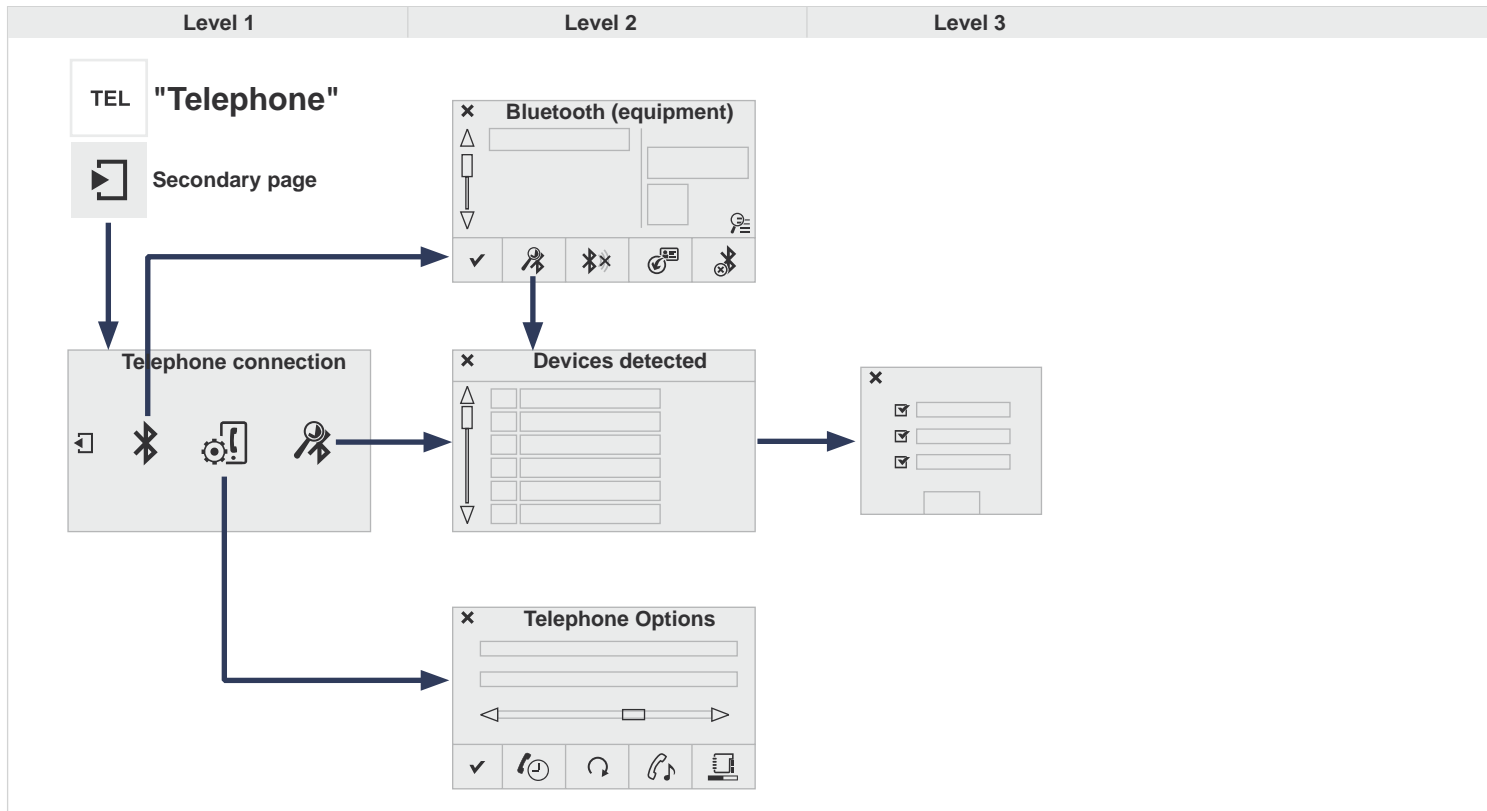











Level 1		Level 2		Level 3		Comments
TEL 	<b>Telephone</b> ↓ <b>Call log</b> →	 <b>All calls</b>				After making choices, start the call.
		 <b>Incoming calls</b>				
		 <b>Outgoing calls</b>				
		 <b>Contacts</b>				
		 <b>Magnifying glass</b>	 View			
			 Create			
	 <b>Call</b>					
TEL 	<b>Telephone</b> ↓ <b>Contacts</b> →	 <b>Addresses</b>				After making choices, start the call.
		 <b>View</b>	 New			
			 Import			
			 Delete			
			 Delete all			
			 Search for contact			
			 Confirm			
		 <b>Navigate to</b>				
		 <b>Search for contact</b>				
		 <b>Call</b>				

# 08 TELEPHONE





Level 1		Level 2		Level 3		Comments
TEL  	Telephone connection ↓ Secondary page ↓ Bluetooth Connection →	 Search				Start the search for another peripheral device to connect.
		 Disconnect				Stop the Bluetooth connection to the selected peripheral device.
		 Update				Import the contacts from the selected telephone to store them in the audio system.
		 Delete				Delete the selected telephone.
		 Confirm				Save the settings.
TEL  	Telephone connection ↓ Secondary page ↓ Search for devices →	Devices detected	<input checked="" type="checkbox"/> t elephone			Start the search for peripheral devices
			<input checked="" type="checkbox"/> Audio streaming			
			<input checked="" type="checkbox"/> Internet			
TEL  	Telephone connection ↓ Secondary page ↓ Telephone Options →	 Put on hold				Cut the microphone temporarily so that the contact cannot hear your conversation with a passenger.
		 Update				Import the contacts from the selected telephone to save then in the audio system.
		 Ringtones				Choose the telephone ringtone and volume.
		 Memory info.				Contact records used and free, percentage of storage space used by internal contacts and Bluetooth contacts.
		 Confirm				Save the settings.

# 08 BLUETOOTH

## Pairing a Bluetooth telephone First connection

### Procedure (short) from the telephone

- 1 In the Bluetooth menu of your device, select the system name in the list of devices detected.



- 2 Enter a code of at least 4 figures in the device and confirm.



- 3 enter this same code in the system, select "OK" and confirm.



### Procedure from the system

- 1 Activate the telephone's Bluetooth function and ensure that it is "visible to all" (telephone configuration).



- 2 Press on **Telephone** to display the primary page then go to the secondary page.



- 3 Select "**Bluetooth Connection**".



- ! For reasons of safety and because they require prolonged attention on the part of the driver, the operations for pairing the Bluetooth mobile telephone to the hands-free system of the audio system must be carried out with the **vehicle stationary**.

- 4 Select **Search**.  
The list of telephones detected is displayed.



- i If the telephone is not detected, it is recommended that you switch the Bluetooth function on your telephone off and then on again.

- 5 Select the name of the desired peripheral from the list and **Confirm**.

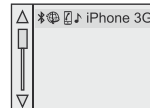

- 6 Enter a code of at least 4 figures for the connection then "**Confirm**".



- 7 enter this same code in the telephone then accept the connection.



- 8 The system offers to connect the telephone:
- in "**Telephone**" (hands-free kit, telephone only),
  - in "**Audio streaming**" (streaming: wireless playing of audio files from the telephone),
  - in "**Internet**" (internet browsing, only if your telephone is compatible with the "Du N" Dial-up Networking Bluetooth standard).
- Select one or more profiles and Confirm.

# 08 BLUETOOTH

**!** The services available depend on the network, the SIM card and the compatibility of the Bluetooth telephone used. Check the telephone manual and with your network provider for details of the services available to you.

**!** The ability of the system to connect with only one profile depends on the telephone. The two profiles may both connect by default.

**⚙** Visit [www.peugeot.co.uk](http://www.peugeot.co.uk) for more information (compatibility, additional help, ...).

**9** The telephone is added to the list.



**10** Depending on your telephone, you may be asked to accept automatic connection every time the ignition is switched on.

**!** Depending on the type of telephone, the system will ask you to accept or not the transfer of your contacts.



If not, select "**Update**".

**⚙** On return to the vehicle, the last telephone connected automatically reconnects, within around 30 seconds after switching on the ignition (Bluetooth activated).



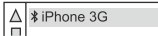

To modify the automatic connection mode, select the telephone in the list then select the desired profile.

## Connecting a Bluetooth peripheral

### Automatic reconnection

- 1** On switching on the ignition, the telephone connected when the ignition was last switched off is automatically reconnected, if this connection mode had been activated during the pairing procedure.
- 2** The connection is confirmed by the display of a message and the name of the telephone. 

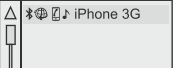
### Manual connection

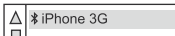
- 1** Press on **Telephone** to display the primary page then go to the secondary page. 
- 2** Select "**Bluetooth**" to display the list of paired peripherals. 
- 3** Select the peripheral to connect. 
- 4** Press on "**Search**". 
- 5** The connection is confirmed by the display of a message and the name of the telephone. 

# 08 BLUETOOTH

## Managing paired telephones

**i** This function allows the connection or disconnection of a peripheral device as well as the deletion of a pairing.

**1** Press on **Telephone** to display the primary page then go to the secondary page.



**2** Select "**Bluetooth**" to display the list of paired peripheral devices.



**3** Select the peripheral in the list.

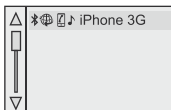

**4** Select:

- "**Search**" or "**Disconnect**" to connect or disconnect the Bluetooth connection with the peripheral selected.
- "**Delete**" to remove the pairing.



## Receiving a call

**1** An incoming call is announced by a ring and a superimposed display in the screen.

**2a** Make a short press on the steering mounted **TEL** button to accept an incoming call.



**2b** Make a long press on the steering mounted **TEL** button to reject the call.  
or  
Select "**End call**".



# 08 CONTACTS

## Making a call

### Calling a new number

- 1 Press on **Telephone** to display the primary page.



- 2 enter the phone number using the keypad then "**Call**" to start the call.



use of the telephone is not recommended while driving. We recommended that you park safely or make use of the steering mounted controls.

### Calling a contact

- 1 Press on **Telephone** to display the primary page.



Or make a long press on the steering mounted **TEL** button.



- 2 Select "**Contacts**".



- 3 Select the desired contact from the list offered.

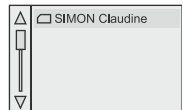

- 4 Select "**Call**".



# 08 CALL LOG

## Calling a recently used number

1

Press on **Telephone** to display the primary page.

TEL

2

Select "**Call log**".



3

Select the desired contact from the list offered.

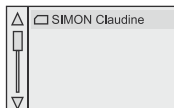

i

It is always possible to make a call directly from the telephone; park the vehicle first as a safety measure.

## Ending a call

1a

Select "**End call**".



or

1b

Make a long press on the steering mounted **TEL** button.



# 08 SETTINGS

## Ringtones

1

Press on **Telephone** to display the primary page then go to the secondary page.

TEL



2

Select "**Telephone Options**".



3

Select "**Ringtones**".



4

You can select the ringtone used and adjust its volume.

5

Select "**Confirm**".



## Managing contacts / Entries

1

Press on **Telephone** to display the primary page.

TEL

2

Select "**Contacts**".



3

Select "**Add contact**".



4

Select:

- "**New**" to add a new contact.
- "**Modify**" to edit the selected contact.
- "**Delete**" to delete the selected contact.
- "**Delete all**" to delete all of the information for the selected contact.

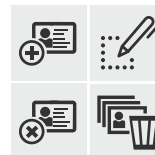

Select "**Directory information**" for the number of entries used, available, ...



# FREQUENTLY ASKED QUESTIONS

The following table groups together the answers to the most frequently asked questions concerning your audio system.

QUESTION	ANSWER	SOLUTION
<b>Navigation, guidance</b>		
The route calculation is not successful.	The guidance criteria may conflict with the current location (exclusion of toll roads on a toll motorway).	Check the guidance criteria on the Navigation Menu, "Guidance options" \ "Define calculation criteria".
I am unable to enter my post code.	The system only accepts post codes of up to 5 characters.	
The POIs do not appear.	The POIs have not been selected.	Select the POIs in the list of POIs.
The risk areas audible warning does not work.	The audible warning is not active.	Activate audible warnings in the guidance options menu, "Navigation - guidance", "Set parameters for risk areas".
The system does not suggest a detour around an incident on the route.	The guidance criteria do not take account of the MC messages.	Select the "Traffic info" function in the list of guidance criteria.
I receive a Risk area alert which is not on my route.	Other than guidance, the system announces all Risk areas positioned in a cone located in front of the vehicle. It may provide an alert for a Risk area located on nearby or parallel roads.	Zoom in on the map to view the exact position of the Risk area. Select "On the route" to no longer receive alerts other than guidance or to reduce the time for the announcement.



# FREQUENTLY ASKED QUESTIONS

QUESTION	ANSWER	SOLUTION
Certain traffic jams along the route are not indicated in real time.	On starting, it is several minutes before the system begins to receive the traffic information.	Wait until the traffic information is being received correctly (display of the traffic information icons on the map).
	The filters are too restrictive.	Modify the "Geographic filter" settings.
	In certain countries, only major routes (motorways...) are listed for the traffic information.	This phenomenon is normal. The system is dependent on the traffic information available.
The altitude is not displayed.	On starting, the initialisation of the GPS may take up to 3 minutes to receive more than 4 satellites correctly.	Wait until the system has started up completely. Check that there is a GPS coverage of at least 4 satellites (long press on the Setup button, then select "GPS coverage").
	Depending on the geographical environment (tunnel...) or the weather, the conditions of reception of the GPS signal may vary.	This phenomenon is normal. The system is dependent on the GPS signal reception conditions.
<b>Telephone, Bluetooth</b>		
I cannot connect my Bluetooth telephone.	The telephone's Bluetooth function may be switched off or the telephone may not be visible.	<ul style="list-style-type: none"> <li>- Check that your telephone's Bluetooth function is switched on.</li> <li>- Check in the telephone settings that it is "visible to all".</li> </ul>
	The Bluetooth telephone is not compatible with the system.	You can check the compatibility of your telephone at <a href="http://www.peugeot.co.uk">www.peugeot.co.uk</a> (services).
The volume of the telephone connected in Bluetooth mode is inaudible.	The volume depends both on the system and on the telephone.	Increase the volume of the audio system, to maximum if required, and increase the volume of the telephone if necessary.
	The ambient noise level has an influence on the quality of telephone communication.	Reduce the ambient noise level (close the windows, reduce the booster fan speed, slow down, ...).

# FREQUENTLY ASKED QUESTIONS

QUESTION	ANSWER	SOLUTION
Some contacts are duplicated in the list.	The options for synchronizing contacts are synchronizing the contacts on the SIM card, the contacts on the telephone, or both. When both synchronizations are selected, some contacts may be duplicated.	Select "Display SIM card contacts" or "Display telephone contacts".
Contacts are not shown in alphabetical order.	Some telephones offer display options. Depending on the settings chosen, contacts can be transferred in a specific order.	Modify the display setting in the telephone directory.
The system does not receive SMS text messages.	The Bluetooth mode does not permit sending SMS text messages to the system.	
<b>CD, MP3</b>		
The CD is ejected automatically or is not played by the player.	<p>The CD is inserted upside down, is unplayable, does not contain any audio data or contains an audio format which the player cannot play.</p> <p>The CD has been recorded in a format that is not compatible with the player (udf, ...).</p> <p>The CD is protected by an anti-pirating protection system which is not recognised by the audio system.</p>	<ul style="list-style-type: none"> <li>- Check that the CD is inserted in the player the right way up.</li> <li>- Check the condition of the CD: the CD cannot be played if it is too damaged.</li> <li>- Check the content in the case of a recorded CD: refer to the advice in the "AUDIO" section.</li> <li>- The audio system's CD player does not play DVDs.</li> <li>- Some recorded CDs will not be played by the audio system because they are not of the correct quality.</li> </ul>
There is a long waiting period following the insertion of a CD or connection of a USB memory stick.	When a new medium is inserted, the system reads a certain amount of data (directory, title, artist, etc.). This may take from a few seconds to a few minutes.	This phenomenon is normal.
The CD player sound is poor.	The CD used is scratched or of poor quality.	Insert good quality CDs and store them in suitable conditions.
	The audio equipment settings (bass, treble, ambiances) are unsuitable.	Set the treble or bass level to 0, without selecting an ambience.

# FREQUENTLY ASKED QUESTIONS

QUESTION	ANSWER	SOLUTION
Some characters in the media information are not displayed correctly while playing.	the audio system does not display some types of characters.	use standard characters to name tracks and folders.
Playing of streaming files does not start.	the peripheral device connected does not support automatic play.	Start the playback from the device.
the names of tracks and the track length are not displayed on the screen when streaming audio.	The Bluetooth profile does not allow the transfer of this information.	
<b>Radio</b>		
the quality of reception of the radio station listened to gradually deteriorates or the stored stations do not function (no sound, 87.5 Mhz is displayed...).	the vehicle is too far from the transmitter used by the station listened to or there is no transmitter in the geographical area through which the vehicle is travelling.	Activate the "RDS" function by means of the short-cut menu to enable the system to check whether there is a more powerful transmitter in the geographical area.
	the environment (hills, buildings, tunnels, basement car parks...) block reception, including in RDS mode.	this phenomenon is normal and does not indicate a fault with the audio system.
	the aerial is absent or has been damaged (for example when going through a car wash or into an underground car park).	Have the aerial checked by a Peugeot dealer.
I cannot find some radio stations in the list of stations received.	the station is not received or its name has changed in the list.	
	Some radio stations send other information in place of their name (the title of the song for example). the system interprets this information as the name of the station.	
the name of the radio station changes.		

# FREQUENTLY ASKED QUESTIONS

QUESTION	ANSWER	SOLUTION
<b>Settings, configuration</b>		
<p>In changing the setting of treble and bass the equalizer setting is deselected.</p>	<p>the selection of an equalizer setting imposes the balance settings. Modifying one without the other is not possible.</p>	<p>Modify the balance or equalizer settings to obtain the desired musical ambience.</p>
<p>In changing the equalizer setting, treble and bass return to zero.</p>		
<p>When changing the balance settings, the distribution setting is deselected.</p>	<p>the selection of a distribution setting imposes the balance settings. Modifying one without the other is not possible.</p>	<p>Modify the balance or distribution settings to obtain the desired musical ambience.</p>
<p>When changing an distribution setting, the balance setting is deselected.</p>		
<p>there is a difference in sound quality between the different audio sources (radio, CD...).</p>	<p>For optimum sound quality, the audio settings for Volume, Bass, treble, equalizer and Loudness can be adapted to the different sound sources, which may result in audible differences when changing source (radio, CD...).</p>	<p>Check that the audio settings for (Volume, Bass, treble, equalizer, Loudness) are adapted to the sources listened to. It is advisable to set the AuDIO functions (Bass, treble, Fr-Re balance, Le-Ri balance) to the middle position, select the "None", musical ambience and set the loudness correction to the "Active" position in CD mode or to the "Inactive" position in radio mode.</p>

# FREQUENTLY ASKED QUESTIONS

QUESTION	ANSWER	SOLUTION
<p>With the engine off, the system switches off after a few minutes of use.</p>	<p>When the engine is switched off, the system's operating time depends on the battery charge.</p> <p>The switch-off is normal: the system switches to economy mode and switches off to prevent discharging of the vehicle's battery.</p>	<p>Start the vehicle's engine to increase the battery charge.</p>
<p><b>USB, portable player, connection key</b></p>		
<p>Playback of my u SB memory stick starts only after a very long wait (around 2 to 3 minutes).</p>	<p>Some files supplied with the memory stick may greatly slow down access to reading the memory stick (multiplication by 10 of the catalogue time).</p>	<p>Delete the files supplied with the memory stick and limit the number of sub-folders in the file structure on the memory stick.</p>
<p>When I connect my iPhone as telephone and to the u SB port at the same time, I am unable to play the music files.</p>	<p>When the iPhone connects automatically as a telephone, it forces the streaming function. The streaming function takes the place of the u SB function which is then not useable, there is a period without sound of the track being played with Apple® players.</p>	<p>Disconnect and reconnect to the u SB port (the u SB function takes priority over streaming).</p>

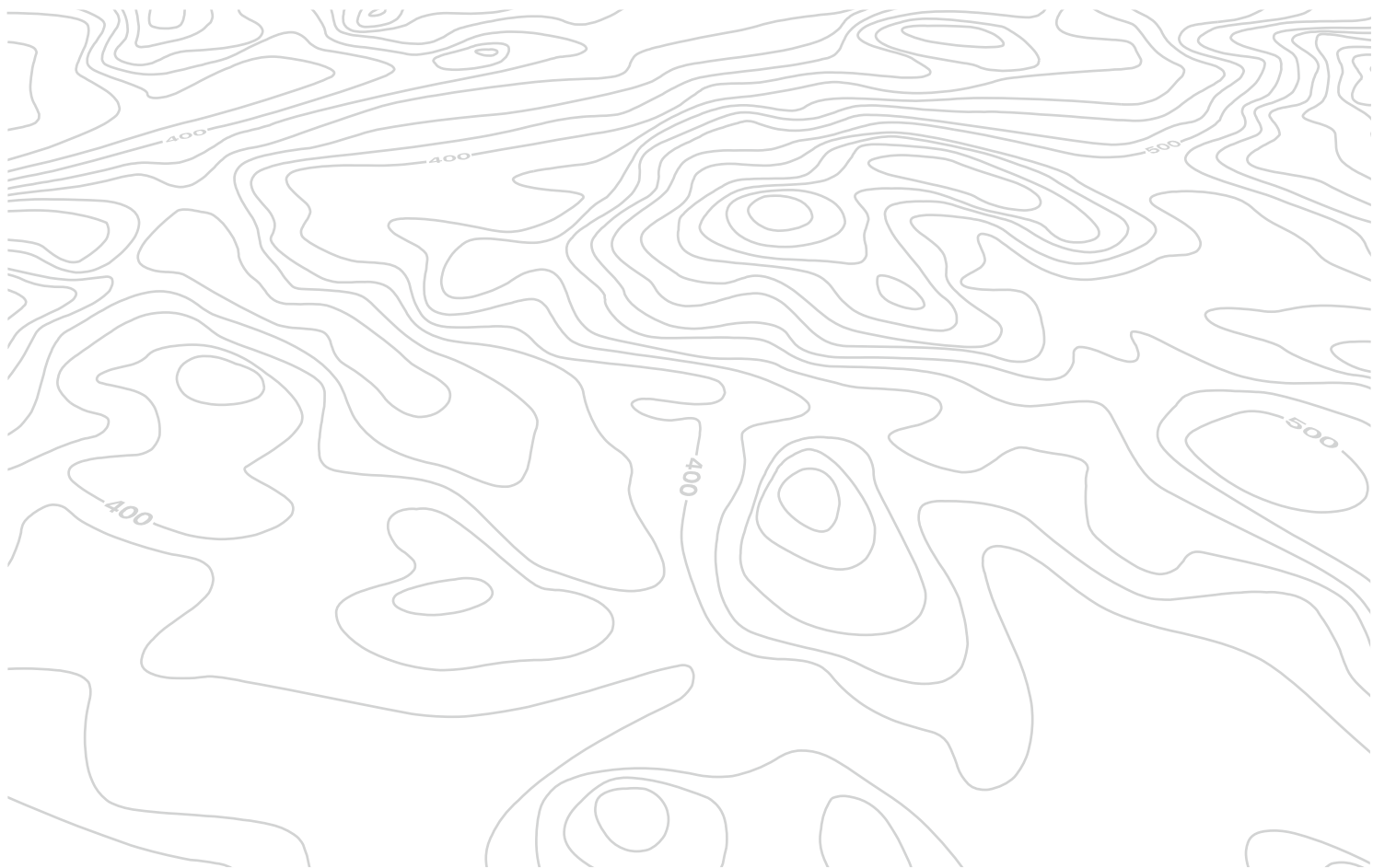



# Audio system



The system is coded in such a way that it will only operate in your vehicle.



For safety reasons, the driver must only carry out operations which require prolonged attention while the vehicle is stationary.

When the engine is switched off and to prevent discharging of the battery, the audio system may switch off after a few minutes.

## CONTENTS

<b>01</b>	<b>First steps</b>	<b>p. 342</b>
<b>02</b>	<b>Steering mounted controls</b>	<b>p. 343</b>
<b>03</b>	<b>Main menu</b>	<b>p. 344</b>
<b>04</b>	<b>Audio</b>	<b>p. 345</b>
<b>05</b>	<b>Audio settings</b>	<b>p. 355</b>
<b>06</b>	<b>Screen menu map</b>	<b>p. 356</b>
	<b>Frequently asked questions</b>	<b>p. 357</b>

# 01 FIRST STEPS

Select screen display between modes:  
Full screen: Audio  
In a window: Audio - time or track computer.  
Long press: black screen (DARK).

On / Off.  
Volume.

Selection of AM / FM wavebands.

Manual step by step search up / down for radio frequencies.  
Select previous / next MP3 folder.  
Select previous / next folder / genre / artist / playlist in the USB device.  
Navigation in a list.

Select source:  
Radio, CD, Au X, uSB.

TA (Traffic Announcement) function On / Off.  
Long press: access to type of information.

Display the list of stations received, CD/MP3 tracks or folders.  
Long press: manage the classification of MP3/WMA files / update the list of stations received.

Access to main menu.

Abandon the current operation.  
Up one level.

Confirmation or display of contextual menu.

Audio settings:  
audio ambiances, treble, bass, loudness, distribution, left/right balance, front/rear fader, automatic volume.

Select preset radio station.  
Long press: preset (store) a station.

Automatic search up / down for radio frequencies.  
Select previous / next CD, uSB track.  
Navigation in a list.





## 02 STEERING MOUNTED CONTROLS

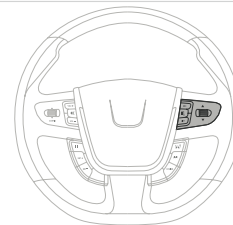
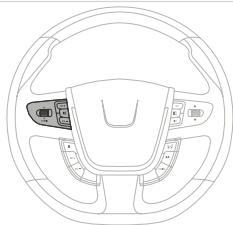

- Press: access to the instrument panel screen menu.
- Rotation: navigation in the instrument panel screen menu.



- Increase volume.



- Mute / restore sound.



- Decrease volume.



- Rotation:  
Radio: search for previous / next station.  
Media: previous / next track.  
Press: confirmation.



- Change the audio source.



- Select the type of permanent display on the screen between window and full screen modes.
- Long press: black screen (DARK).



- Radio: display the list of stations.  
Media: display the list of tracks.  
Long press: update the list of stations received.

## 03 MAIN MENU

"**Multimedia**": Media parameters,  
Radio parameters.

> Screen C

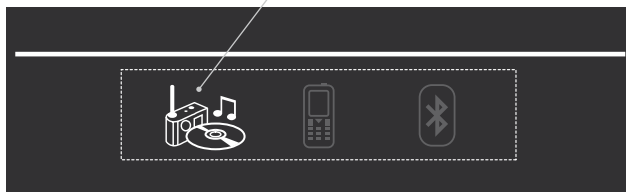

For a detailed global view of the menus available, refer to the "Screen menu map" section.

# 04 AUDIO

## Radio

### Selecting a station



the exterior environment (hills, buildings, tunnel, car park, below ground...) may prevent reception, even in RDS station tracking mode. This phenomenon is normal in the propagation of radio waves and is in no way indicative of a fault with the audio system.

1



Press **SOURCE** or **SRC** several times in succession and select radio.



2



Press **BAND** to select a waveband.

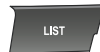
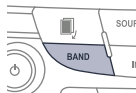

Press **LIST** to display the list of stations received in alphabetical order.



Select the desired radio station and confirm by pressing **OK**.

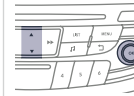

A press changes to the next or previous letter (e.g. A, B, D, F, g, J, K, ...).

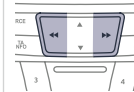

1



A long press on **LIST** builds or updates the list of stations; audio reception is cut momentarily.



# 04 AUDIO

## RDS

**i** RDS, if displayed, enables you to continue listening to the same station by automatic retuning to alternative frequencies. However, in certain conditions, coverage of an RDS station may not be assured throughout the country as radio stations do not cover 100 % of the territory. This explains the loss of reception of the station during a journey.

**1**  When the radio is displayed on the screen, press **OK** to display the contextual menu.

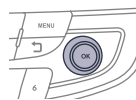

**2**   Select "**RDS**" and confirm to save. "**RDS**" is displayed in the screen.

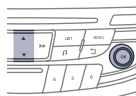

## Receiving TA messages

**i** The TA (Traffic Announcement) function gives priority to TA alert messages. To operate, this function needs good reception of a radio station transmitting this type of message. When a traffic report is transmitted, the current audio source (Radio, CD, USB, ...) is interrupted automatically to play the TA message. Normal playback of the audio source resumes at the end of the transmission of the message.

**1**  Press **TA INFO** to activate or deactivate the reception of traffic messages.

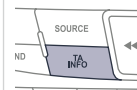

# 04 AUDIO

## Receiving INFO messages

i

The INFO function gives priority to TA alert messages. To be active, this function needs good reception of a radio station that transmits this type of message. When a message is transmitted, the current audio source (Radio, CD, USB, ...) is interrupted automatically to receive the INFO message. Normal play resumes at the end of the message transmission.

1



Make a long press on **TA INFO** to display the list of categories.

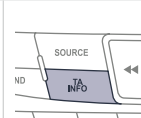

2



Select or deselect categories to activate or deactivate the reception of the corresponding messages.

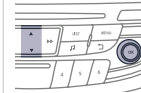

## Display RADIO TEXT

!

Radio text is information transmitted by the radio station related to the current programme or song.

### Screen C

1



With the radio displayed on the screen, press **OK** to display the contextual menu.



2



Select "**RadioText (TXT) display**" and confirm **OK** to save.

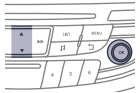

# 04 AUDIO

## Audio CD

### Playing a CD



Insert 12 cm diameter circular compact discs only.  
Some anti-pirating systems, on original discs or CDs copied using a personal recorder, may cause faults which are no reflection on the quality of the original player.  
Without pressing the **EJECT** button, insert a CD in the player, play begins automatically.

1

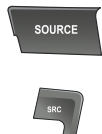

To play a disc which has already been inserted, press the **SOURCE** or **SRC** button several times in succession and select "CD".

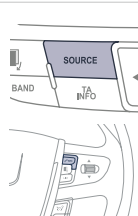

2



Press one of the buttons to select a track on the CD.

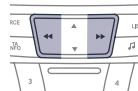

!

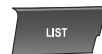

Press **LIST** to display the list of tracks on the CD.



3



Press and hold one of the buttons for fast forward or backward.

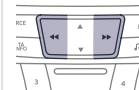

# 04 AUDIO

## CD, USB

### Information and advice



The audio system will only play files with extension ".mp3" or ".wma" and a compression rate that is constant or variable between 32 Kbps and 320 Kbps.



It is advisable to restrict file names to 20 characters without using special characters (e.g. " ? ; ù) to avoid any playing or displaying problems.



The playlists accepted are types .m3u and .pls.  
The number of files is limited to 5 000 in 500 directories on a maximum of 8 levels.



On a single disc, the CD player can read up to 255 MP3 files spread over 8 directory levels. However, it is recommended that this be kept to 2 levels so as to limit the time taken to access and play the CD. During play, the folder structure is not observed.



In order to be able to play a recorded CDR or CDRW, when recording it is preferable to select standards ISO 9660 level 1.2 or Joliet. If the disc is recorded in another format, it may not be played correctly. It is recommended that the same recording standard is always used for an individual disc, with as low a speed as possible (4x maximum) for optimum sound quality. In the particular case of a multi-session CD, the Joliet standard is recommended.



Do not connect a hard disk or USB device other than audio players to the USB port. This may cause damage to your installation.

# 04 AUDIO

## CD, USB

### Playing a compilation



Insert an MP3 compilation in the CD player or connect a memory stick to the uSB port, directly or via an extension lead.



When the system creates playlists (temporary memory) the creation time for which can take from a few seconds to several minutes.

The playlists are updated every time the ignition is switched off or a uSB memory stick is connected.

Play starts automatically after a period which depends on the capacity of the uSB memory stick.



At a first connection, the order suggested is by folder. When connecting again, the order previously chosen is retained.

1



To play a disc or memory stick which has already been inserted, press **SOURCE** or **SRC** several times in succession and select "CD" or "USB".



2



Press one of the buttons to select the next or previous track.

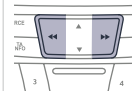

3



Press one of the buttons to select the next or previous folder in the order chosen.

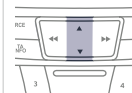

4



Press and hold one of the buttons for fast forwards or backwards.

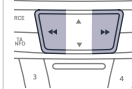

5



Press **LIST** to display the menu of folders in the compilation.





# 04 AUDIO

6



Select a line in the list.

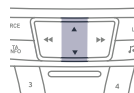

7



Select a track or a folder.

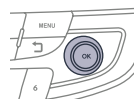

8



up a level in the menu.



9



Skip a track.

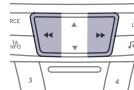

## USB memory stick - File sorting

1

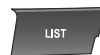

Make a long press on **LIST** or press **MENU**, select "**Multimedia**", then "**Media parameters**" and finally "**Choice of track listing**" to display the different types of sorting.



2



Having selected the desired sorting ("**By folders**", "**By artists**", "**By genres**", "**By playlists**") press **OK**.

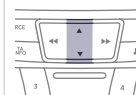

Then confirm **OK** to save the modifications.

- **By folders**: all folders containing audio files recognised on the peripheral device, in alphabetical order without following the folder structure.
- **By artists**: all of the artist names defined in the ID3 tags, in alphabetical order.
- **By genres**: all of the genres defined in the ID3 tags.
- **By playlists**: if playlists have been saved.



## 04 AUDIO

### APPLE® players or portable player



The audio files on a Mass Storage portable player\* can be heard through the vehicle's speakers by connecting it to the uSB port (cable not supplied).



Management of the device is via the audio system controls.



If the portable player is not recognised by the uSB port, connect it to the auxiliary Jack socket.



The Apple® player must be updated regularly for the best connection.



The playlists are those defined in the Apple® player.



The Apple® player must be generation 5 or later.

\* Check your player's manual.

# 04 AUDIO

## Auxiliary socket (AUX)

### Auxiliary Jack socket



The auxiliary Jack socket permits the connection of a portable non-mass storage device or an Apple® player if not recognised by the USB port.



Do not connect a device to the USB port and to the auxiliary Jack socket at the same time.

1

Connect the portable device to the auxiliary Jack socket using a suitable cable (not supplied).



2



Press the **SOURCE** or **SRC** button several times in succession and select "**AUX**".

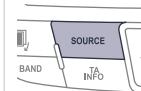

3

First adjust the volume on your portable device.



4



Then adjust the volume of the audio system.



The display and management of controls is on the portable device.



# 04 AUDIO

## Play mode



The play modes available are:

- Normal: the tracks are played in order, depending on the classification of the selected files.
- Random: the tracks in an album or folder are played in a random order.
- Random all: all of the tracks saved in the media are played in random order.
- Repeat: the tracks played are only those from the current album or folder.

1



Press **OK** for access to the contextual menu.  
or  
Press **MENU**.

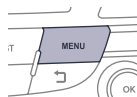

2



Select "**Multimedia**" and confirm.

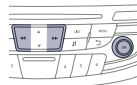

3



Select "**Media parameters**" and confirm.

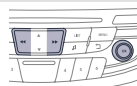

4



Select "**Read mode**" and confirm.

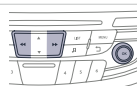

5



Select the desired play mode and confirm **OK** to save the modifications.

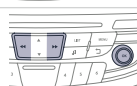

# 05 AUDIO SETTINGS

## Screen C



1



Press  to display the audio settings menu.



2

The settings available are:

- Ambience,
- Bass,
- Treble,
- Loudness,
- Distribution: Personalised or Driver,
- Left / right balance,
- Fader (front / rear balance),
- Auto. volume.

3



Select and confirm "**Other settings...**" to display the next setting in the list.

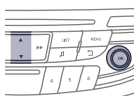

The distribution (or spatialisation using the Arkamys® system), is an audio process which allows the sound quality to be improved according to the setting chosen, corresponding to the position of the listeners in the vehicle.



The Ambience, Treble and Bass audio settings are different and independent for each sound source.



On-board audio: Arkamys® Sound Staging.

With Sound Staging, the driver and passengers are immersed in an "audio scene" recreating the natural atmosphere of an auditorium: truly a part of the scene and its surroundings.

This new sensation is made possible by software in the audio system which processes the digital signals from the media players (radio, CD, MP3...) without changing the audio settings. This processing takes account of the characteristics of the passenger compartment to produce optimum results.

The Arkamys® software installed in your audio system processes the digital signal from the media players (radio, CD, MP3, ...) and recreates a natural musical scene, with harmonious placement of instruments and voices in the space in front of passengers, level with the windshield.

# 06 SCREEN MENU MAP(S)

## Screen C



### MAIN FUNCTION

- 1 **Option A**
- 2 Option A1
- 3 Option A11
- 1 **Option B...**

### MULTIMEDIA

- 1 **Media parameters**
- 2 **Choice of playback mode**
- 3 Normal
- 3 Random
- 3 Random all
- 3 Repeat
- 2 **Choice of track listing**
- 3 By folders
- 3 By artists
- 3 By genres
- 3 By playlists
- 1 **Radio parameters**

### PERSONALISATION - CONFIGURATION

- 1 **Choice of language**
- 1 **Display configuration**
- 2 **Choice of units**
- 2 **Date and time adjustment**
- 2 **Display parameters**
- 2 **Brightness**

# FREQUENTLY ASKED QUESTIONS

The following tables contain answers to the most frequently asked questions.

QUESTION	ANSWER	SOLUTION
<p>There is a difference in sound quality between the different audio sources (radio, CD...).</p>	<p>For optimum sound quality, the audio settings (Volume, Bass, Treble, Ambience, Loudness) can be adapted to the different sound sources, which may result in audible differences when changing source (radio, CD...).</p>	<p>Check that the audio settings (Volume, Bass, Treble, Ambience, Loudness) are adapted to the sources listened to. It is advisable to set the Au DIO functions (Bass, Treble, Front-Rear Fader, Left-Right Balance) to the middle position, select the musical ambience "None" and set the loudness correction to the "Active" position in CD mode or to the "Inactive" position in radio mode.</p>
<p>When changing the settings for treble and bass, the ambience setting is deselected. When changing the ambience setting, treble and bass are reset to zero.</p>	<p>Choosing an ambience imposes settings for treble and bass. Modifying one without the other is not possible.</p>	<p>Modify the treble and bass settings or the ambience setting to obtain the desired sound quality.</p>
<p>When changing the balance setting, distribution is deselected.</p>	<p>Choosing a distribution setting imposes a balance setting. Modifying one without the other is not possible.</p>	<p>Modify the balance setting or the distribution setting to obtain the desired sound quality.</p>

# FREQUENTLY ASKED QUESTIONS

QUESTION	ANSWER	SOLUTION
<p>the quality of reception of the radio station listened to gradually deteriorates or the stored stations do not function (no sound, 87.5 MHz is displayed...).</p>	<p>the vehicle is too far from the transmitter used by the station listened to or there is no transmitter in the geographical area through which the vehicle is travelling.</p>	<p>Activate the RDS function to enable the system to check whether there is a more powerful transmitter in the geographical area.</p>
	<p>the environment (hills, buildings, tunnels, basement car parks...) block reception, including in RDS mode.</p>	<p>this phenomenon is normal and does not indicate a failure of the audio equipment.</p>
	<p>the aerial is absent or has been damaged (for example when going through a car wash or into an underground car park).</p>	<p>Have the aerial checked by a Peugeot dealer.</p>
<p>Sound cut-outs of 1 to 2 seconds in radio mode.</p>	<p>During this brief sound cut-out, the RDS searches for any frequency permitting better reception of the station.</p>	<p>Deactivate the RDS function if the phenomenon is too frequent and always on the same route.</p>
<p>The traffic announcement (T A) is displayed. I do not receive any traffic information.</p>	<p>The radio station does not broadcast traffic information.</p>	<p>Tune to a radio station which broadcasts traffic information.</p>
<p>the stored stations are not found (no sound, 87.5 MHz is displayed...).</p>	<p>An incorrect waveband is selected.</p>	<p>Press the BAND button to return to the waveband on which the stations are stored.</p>



# FREQUENTLY ASKED QUESTIONS

QUESTION	ANSWER	SOLUTION
<p>the CD is ejected automatically or is not played by the player.</p>	<p>the CD is inserted upside down, is unplayable, does not contain any audio data or contains an audio format which the player cannot play. the CD is protected by an anti-pirating protection system which is not recognised by the audio equipment.</p>	<ul style="list-style-type: none"> <li>- Check that the CD is inserted in the player the right way up.</li> <li>- Check the condition of the CD: the CD cannot be played if it is too damaged.</li> <li>- Check the content in the case of a recorded CD: consult the advice in the "Audio" section.</li> <li>- the audio equipment's CD player does not play DVDs.</li> <li>- Due to their quality level, certain writeable CDs will not be played by the audio system.</li> </ul>
<p>the CD player sound is poor.</p>	<p>the CD used is scratched or of poor quality.</p>	<p>Insert good quality CDs and store them in suitable conditions.</p>
	<p>the audio settings (bass, treble, ambience) are unsuitable.</p>	<p>Set the treble or bass level to 0, without selecting an ambience.</p>
<p>the message "USB peripheral error" or "Peripheral not recognised" is displayed in the screen.</p>	<p>the USB memory stick is not recognised. the memory stick may be corrupt.</p>	<p>Reformat the memory stick (FAT 32).</p>
<p>the Apple® player is not recognised when connecting to the USB port.</p>	<p>the Apple® player is of a generation that is not compatible with the USB.</p>	<p>Connect the Apple® player to the AuX Jack socket using a suitable cable (not supplied).</p>

# FREQUENTLY ASKED QUESTIONS

QUESTION	ANSWER	SOLUTION
<p>the hard disk or device is not recognised when connecting to the USB port.</p>	<p>Some hard disks and devices need a power supply greater than is provided by the audio system.</p>	<p>Connect the device to the 230 V socket, the 12 V socket or an external power supply.  <b>Caution:</b> ensure that the device does not transmit a voltage greater than 5 V (risk of destruction of the system).</p>
<p>In "Random all" play, not all of the tracks are played.</p>	<p>In "Random all" play, the system can only take into account up to 999 tracks.</p>	
<p>With the engine off, the audio system switches off after a few minutes of use.</p>	<p>When the engine is switched off, the audio system operating time depends on the battery charge.  the switch-off is normal: the audio system switches to economy mode and switches off to prevent discharging the vehicle's battery.</p>	<p>Start the vehicle's engine to increase the battery charge.</p>
<p>the message "the audio system is overheated" appears on the display.</p>	<p>In order to protect the installation if the surrounding temperature is too high, the audio system switches to an automatic thermal protection mode leading to a reduction of the volume or stopping of the playing of the CD.</p>	<p>Switch the audio system off for a few minutes to allow the system to cool.</p>

# exterior

## Saloon

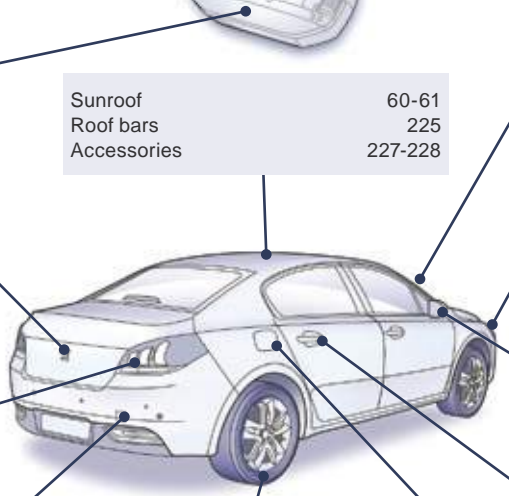
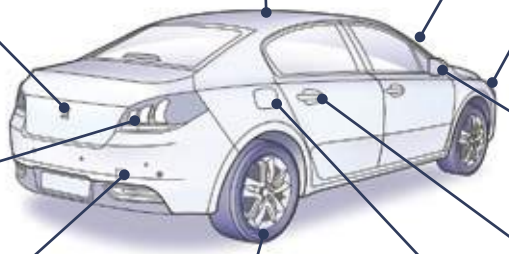
Remote control key / electronic key - opening / closing - anti-theft protection - starting - battery	41-51		Wipers Changing a wiper blade	149-152 152, 220		
Boot - opening / closing - emergency release temporary puncture repair kit	44, 56, 59 186-191		Sunroof Roof bars Accessories	60-61 225 227-228	Welcome lighting Door mirror spotlamps Additional headlamps Secondary additional headlamps Headlamp height adjustment Changing front bulbs	145 145 147 148 146 200-202
Changing bulbs - rear lamps - 3rd brake lamp - number plate lamps	203, 206		Door mirrors Blind spot monitoring	73-74 126-128		
Parking sensors towbar towing	134-136 223-224 221-222		tyre under-inflation detection eSC: ABS-eBFD, eBA, ASR, DSC Changing a wheel - tools - removing / refitting Snow chains tyre pressures	174-175 176-178 192-198 199 264	Doors - Keyless entry and Starting - opening / closing - central locking - emergency control Alarm electric windows	42-51 52-53 54-55
			Fuel tank, misfuel prevention	63-65		

# exterior

## SW

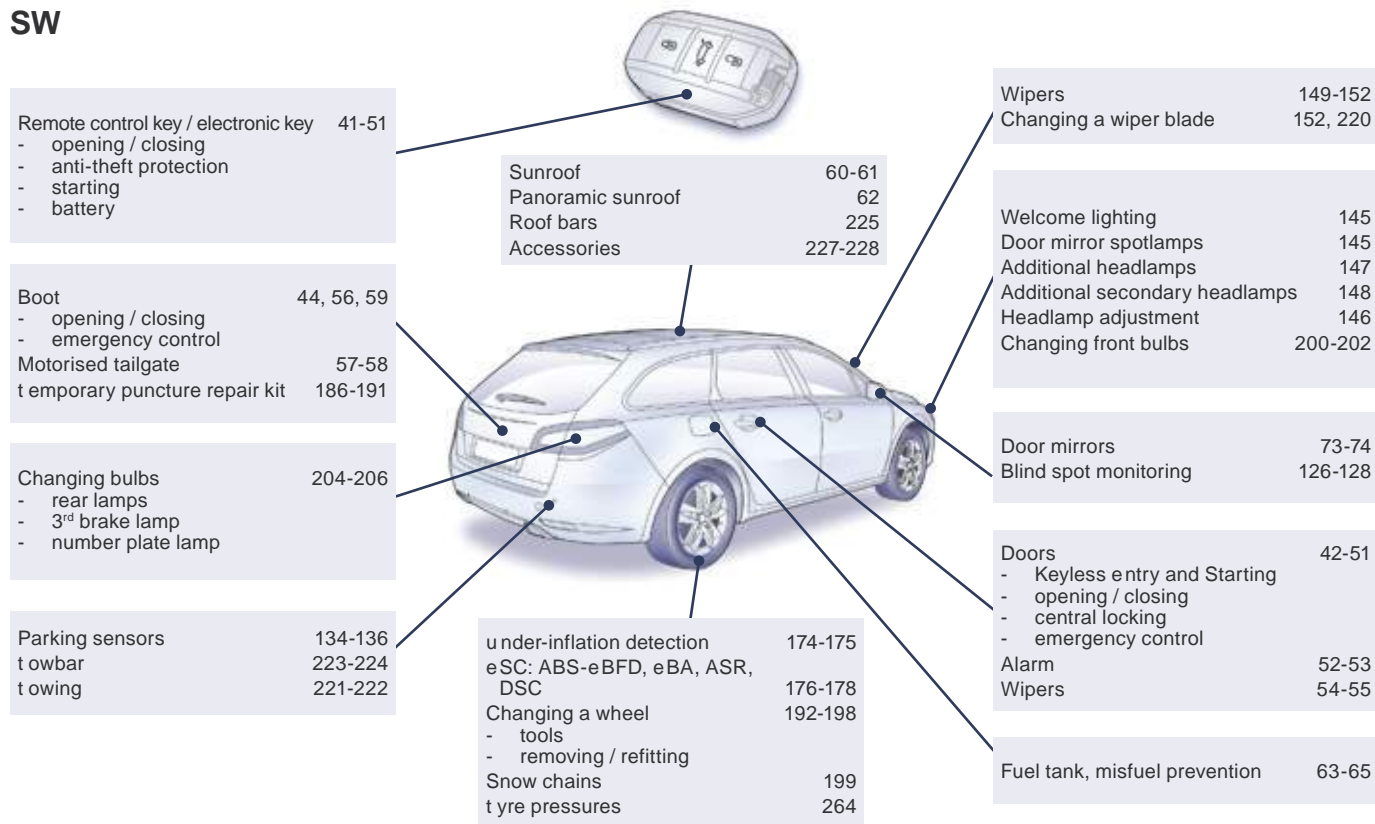

# Interior

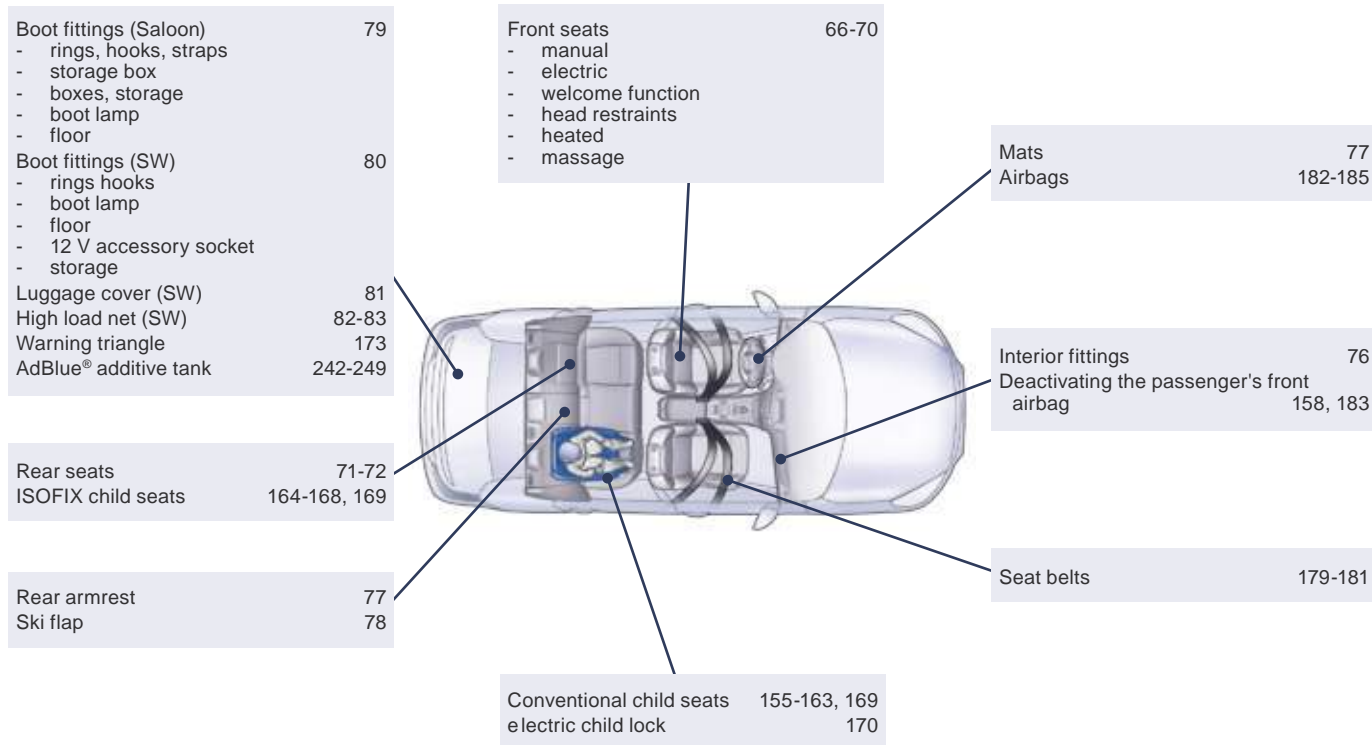

# Instruments and controls

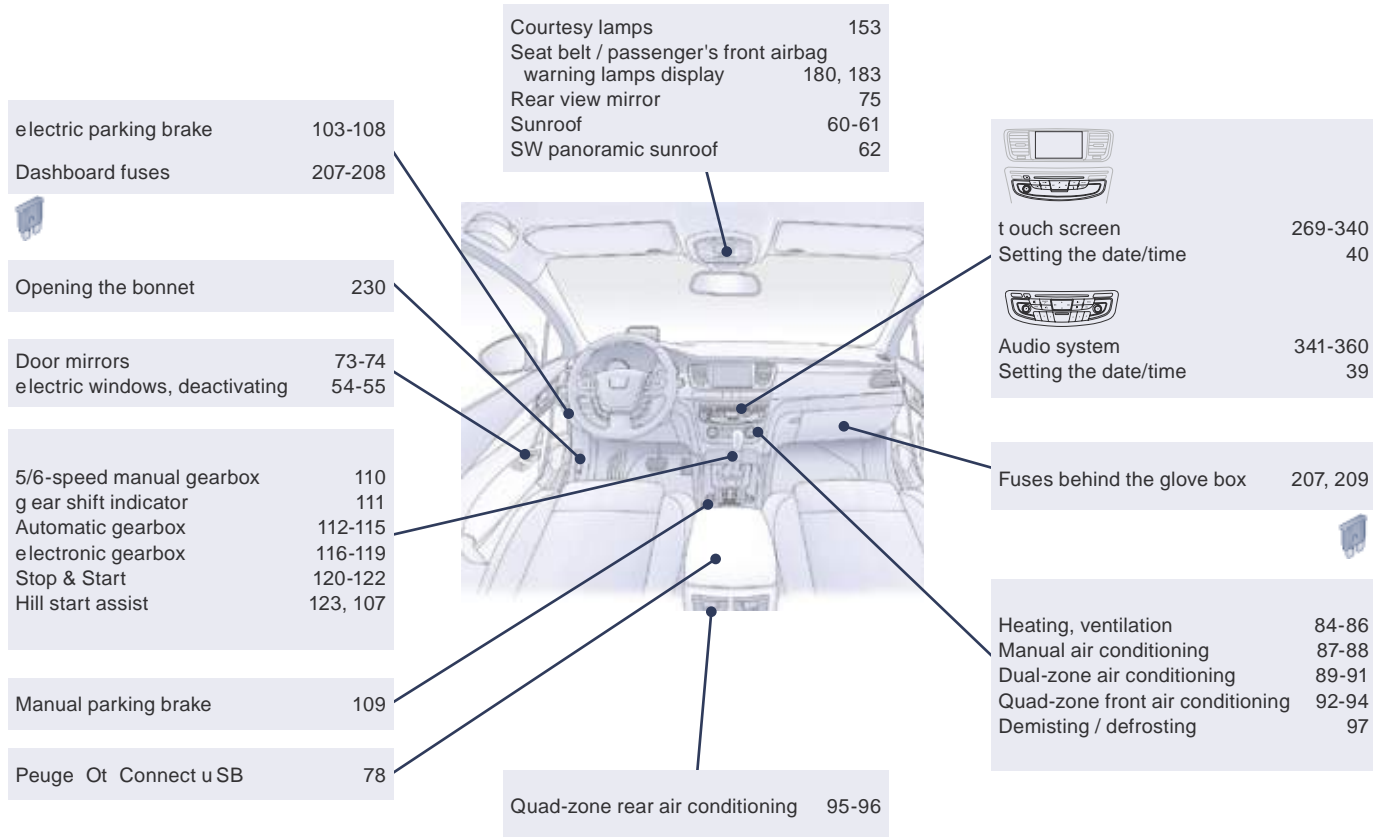

# Instruments and controls (cont.)

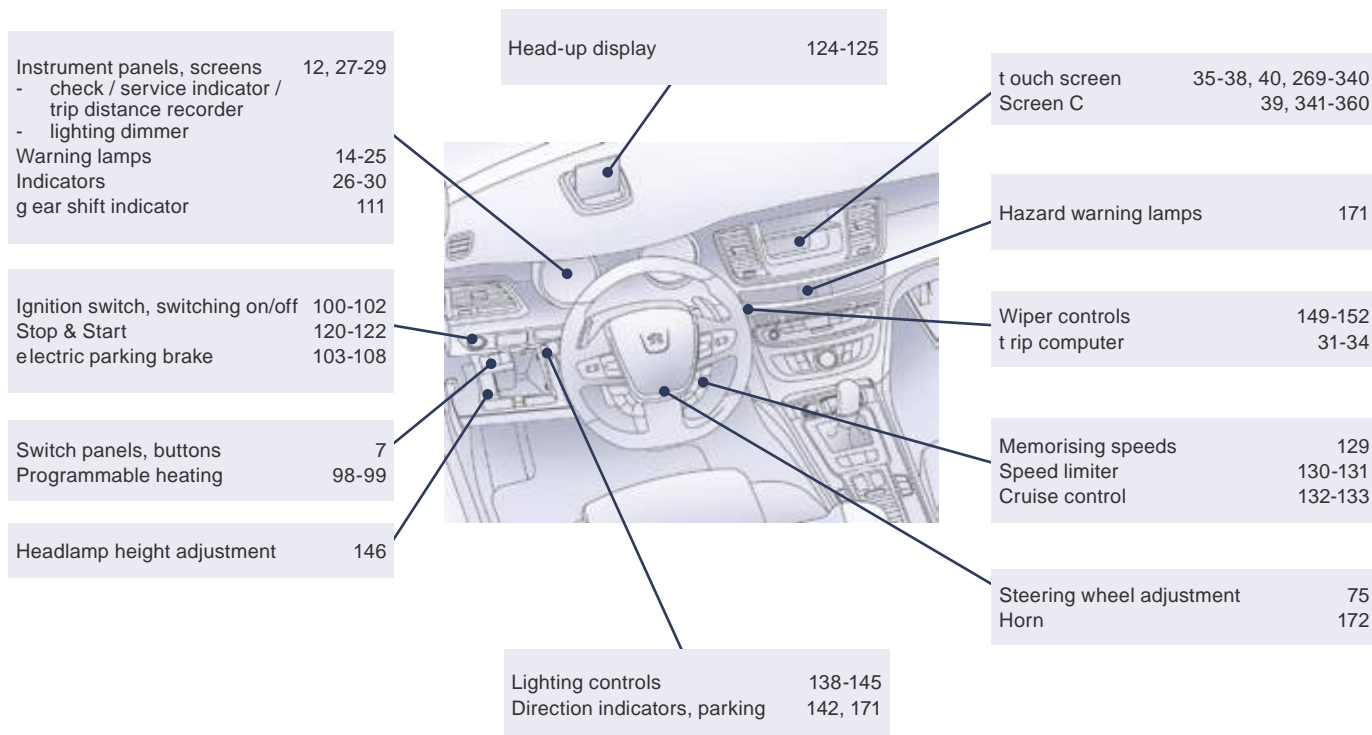

# Maintenance - technical data

<p>Checking levels 237-239</p> <ul style="list-style-type: none"> <li>- oil</li> <li>- brake fluid</li> <li>- power steering fluid</li> <li>- coolant</li> <li>- screenwash/headlamp wash fluid</li> <li>- fuel additive (Diesel)</li> </ul> <p>AdBlue® additive 242-249</p> <p>Checking components 240-241</p> <ul style="list-style-type: none"> <li>- 12 V battery</li> <li>- air filter</li> <li>- passenger compartment filter</li> <li>- oil filter</li> <li>- particle filter (Diesel)</li> <li>- gearbox</li> <li>- brake pads / discs</li> <li>- parking brake</li> <li>- electric parking brake</li> </ul>	<p>Running out of fuel (Diesel) 231</p>	<p>12V battery 211-214</p> <p>Removing/refitting the 12V battery 215-218</p> <p>Load reduction, economy mode 219</p> <p>engine compartment fuses 207, 210</p>
<p>Changing bulbs 200-206</p> <ul style="list-style-type: none"> <li>- front</li> <li>- rear</li> </ul>	<p>Opening the bonnet 230</p> <p>under the bonnet, petrol 232-233</p> <p>under the bonnet, Diesel 234-236</p> <p>Petrol engines 250-251</p> <p>Diesel engines 254-257</p>	<p>Petrol weights 252-253</p> <p>Diesel weights 258-261</p>
		<p>Identification markings 264</p> <p>Dimensions 262-263</p>



**A**

Accessories .....	227
Accessory socket, 12 volt.....	76
Adaptive lighting.....	144
AdBlue® .....	22, 27, 242
Adjusting headlamps .....	146
Adjusting head restraints.....	66, 69
Adjusting seat belt height .....	180
Adjusting the steering wheel .....	75
Airbags.....	25, 182
Airbags, curtain.....	184, 185
Airbags, front.....	182, 185
Airbags, lateral.....	184, 185
Air conditioning .....	10, 88
Air conditioning, dual-zone.....	85, 86, 89
Air conditioning, manual.....	87
Air conditioning, quad-zone.....	92
Air filter.....	240
Air flow .....	10
Air vents .....	84
Alarm .....	52
Anti-theft .....	102
Armrest.....	76
Armrest, rear.....	77
Assistance call.....	172, 265, 266
Audible warning .....	172
Audio cable .....	78, 286, 289, 290, 352, 353
Audio streaming (Bluetooth) .....	286, 289
Audio system.....	341
Automatic illumination of headlamps.....	139, 143
Automatic operation of hazard warning lamps .....	171
Automatic rain sensitive windscreen wipers.....	149, 151
Auxiliary socket.....	78, 286, 290, 352, 353

**B**

Battery.....	211-218, 240
Battery, charging.....	214
Battery, remote control .....	49-51
Blind .....	60
Blind spot sensors .....	126
Blue HDi.....	231, 242
Bluetooth (hands-free).....	328
Bluetooth (telephone).....	328
Boot .....	56-58
Boot (opening).....	44
Brake discs.....	241
Brake lamps .....	203, 204
Brake pads .....	241
Braking system warning lamp.....	20

**C**

Capacity, fuel tank .....	63
CD .....	286, 348
CD MP3.....	286, 349, 350
Central locking.....	45, 46, 48
Changing a bulb.....	200-206
Changing a fuse.....	207-210
Changing a wheel .....	185-192
Changing a wiper blade .....	152, 220
Changing the date.....	39, 40
Changing the remote control battery.....	50
Changing the time.....	39, 40
Checking levels.....	237-239
Checking the engine oil level.....	30
Checking tyre pressures (using the kit) .....	191
Checks .....	232-248
Children.....	157-170, 181, 183
Child lock .....	170
Child seats .....	155-169
Child seats, conventional.....	161-163

**D**

Child seats, ISOFIX .....	164-168
Closing the boot .....	56
Closing the doors.....	45, 48
Cold climate screen .....	226
Colour screen.....	270, 271
Connectors, audio.....	78, 286, 290, 351, 353
Coolant level .....	26, 239
Coolant temperature indicator .....	26
Cornering lamps .....	147
Courtesy lamps.....	153
Cruise control.....	129, 132
Cup holder.....	76

DAB (Digital Audio Broadcasting) .....	284, 285
Date (setting).....	39, 40
Daytime running lamps.....	141, 200-202
Deactivating eSP.....	178
Deactivating the passenger airbag.....	183
Deadlocking .....	47
Defrosting, front .....	97
Defrosting, rear .....	97
Demisting, rear.....	97
Demisting, front.....	97
Diesel .....	16
Diesel additive level.....	239
Diesel engine pre-heat warning lamp .....	16
Digital Audio Broadcasting (DAB) .....	284, 285
Dimensions .....	262
Dipped beam.....	138, 200, 202
Dipstick.....	30, 237
Direction indicators .....	171, 200, 201, 203, 204
Driving economically.....	10
Driving positions (memorising).....	68
Dynamic stability control (DSC).....	21, 176

## E

eco-driving .....	10
economy mode .....	219
electronic engine immobiliser.....	51, 102
electronic stability control (eSC).....	176
emergency boot release.....	59
emergency call .....	172, 265, 266
emergency starting.....	212
emergency starting and switching off.....	102
emergency warning lamps .....	171, 173
emissions control system, SCR .....	23
energy economy mode .....	219
engine compartment .....	232-236
engine compartment fusebox.....	210
engine, Diesel.....	65, 231, 234-236, 254, 258
engine oil .....	237
engine oil level indicator.....	30, 237
engine, petrol.....	65, 232, 233, 250, 252
engines .....	250, 254
environment.....	10, 50
equipment settings .....	13
eSC/ASR.....	176

Fuel consumption.....	10
Fuel filler cap.....	63
Fuel filler flap.....	63
Fuel gauge .....	12, 63
Fuel tank.....	63
Fusebox, dashboard .....	208
Fuses.....	207

Heating.....	85, 87, 89, 92, 95, 98
Height and reach adjustment, steering wheel .....	75
High load retaining net.....	82
Hill start assist.....	123

## G

gearbox, automatic .....	10, 112, 123, 214, 241
gearbox, electronic .....	10, 116, 120, 123, 214, 241
gearbox, manual .....	10, 110, 111, 120, 123, 241
gear lever, automatic gearbox .....	112
gear lever, manual gearbox .....	110
gear lever, electronic gearbox .....	116
gear shift indicator .....	111
ground clearance .....	263
guide-me-home.....	142, 143

Identification plates.....	264
Indicators, direction .....	171, 200, 203, 204
Inflating accessories (using the kit) .....	191
Inflating tyres .....	10, 264
Inputs for audio system .....	78, 286, 290, 352, 353
Instrument panel.....	12
Instrument panel screen .....	13, 111
Intelligent traction Control.....	177
Interior fittings .....	76
Interior mood lighting .....	154
ISOFIX mountings.....	164

## F

Filling with fuel .....	63, 65
Fitting a wheel.....	197
Fitting roof bars .....	225
Fittings, boot .....	79, 80
Flashing indicators.....	142, 171
Foglamps, front .....	140, 148, 200
Foglamps, rear.....	140, 203, 204
Folding the rear seats .....	71
Folding/unfolding the door mirrors .....	73
Frequency (radio).....	281, 345
Front seats .....	66-68
Fuel.....	10, 65

Halogen headlamps.....	200, 202
Hands-free kit .....	328, 329
Hazard warning lamps .....	171, 173
Headlamp adjustment.....	146
Headlamp wash .....	150
Headlamp wash reservoir.....	239
Head restraints, front .....	66, 69
Head restraints, rear .....	71
Head-up display.....	124, 130, 132
Heated seats.....	66, 69

## H

Jack.....	192
Jack cable .....	78, 286, 290, 352, 353
JACK socket.....	78, 286, 290, 352, 353
JBL (audio system) .....	6, 267
Jukebox (playing).....	291

## J

**K**

Keeping children safe ..... 155-170, 181, 183  
 Key ..... 41-51  
 Key, electronic ..... 41-46, 49  
 Keyless entry and  
 Starting ..... 42-47, 101, 102  
 Key with remote control ..... 102

**L**

Labels, identification ..... 264  
 Lamps, warning and indicator ..... 14-25  
 LeDs - light-emitting diodes ..... 200-206  
 Level, AdBlue® additive ..... 242  
 Level, brake fluid ..... 238  
 Level, headlamp wash ..... 151, 239  
 Level, power steering fluid ..... 238  
 Levels and checks ..... 232-239  
 Light-emitting diodes - LeDs ..... 200, 203, 204  
 Lighting bulbs  
 (replacement) ..... 200-206  
 Lighting control stalk ..... 138, 142  
 Lighting, guide-me home ..... 142, 143  
 Lighting, interior ..... 153, 154  
 Lighting on reminder ..... 141  
 Loading ..... 10, 225  
 Load reduction mode ..... 219  
 Load space cover ..... 81  
 Locating your vehicle ..... 48  
 Long objects, transporting ..... 78  
 Long fuel level ..... 21, 64  
 Luggage retaining strap ..... 79

**M**

Main beam ..... 138, 200, 202  
 Maintenance ..... 10  
 Map reading lamps ..... 153  
 Markings, identification ..... 264  
 Massage function ..... 70  
 Mat ..... 77  
 Menu ..... 274, 276, 278, 292,  
 294, 296, 312, 324, 326  
 Menu, main ..... 344  
 Menus (touch screen) ..... 270  
 Mirror, rear view ..... 75  
 Mirrors, door ..... 73, 74, 126  
 Motorised boot ..... 57, 58  
 Mountings for ISOFIX seats ..... 164  
 MP3 CD ..... 286, 349, 350

**N**

Navigation ..... 298  
 Number plate lamps ..... 206

**O**

Oil change ..... 237  
 Oil consumption ..... 237  
 Oil filter ..... 240  
 Oil level ..... 30, 237  
 Opening the boot ..... 41, 44, 56  
 Opening the doors ..... 41  
 Opening the panoramic sunroof blind ..... 62  
 Operation indicator lamps ..... 14-25

**P**

Paint colour code ..... 264  
 Panoramic glass sunroof ..... 62  
 Parking brake ..... 109, 241  
 Parking brake, electric ..... 20, 103, 241  
 Parking lamps ..... 142  
 Parking sensors, front ..... 135  
 Parking sensors, rear ..... 134  
 Particle filter ..... 239, 240  
 Passenger compartment filter ..... 240  
 Peugeot Connect APPS ..... 323  
 Peugeot Connect Assistance ..... 266  
 Peugeot Connect SOS ..... 266  
 Player, CD MP3 ..... 286, 349, 350  
 Port, USB ..... 78, 286, 290, 350, 351  
 Priming the fuel system ..... 231  
 Programmable heating (Webasto) ..... 98  
 Protecting children ..... 155-170, 181, 183  
 Puncture ..... 186

**R**

Radio ..... 280, 345  
 RDS ..... 283, 346  
 Rear foglamp ..... 140, 203, 204  
 Rear screen (demisting) ..... 97  
 Recharging the battery ..... 214  
 Reduction of electrical load ..... 219  
 Regeneration of the particle  
 filter ..... 240  
 Reinitialising the remote control ..... 49, 50  
 Remote control ..... 41-51  
 Removable screen (snow shield) ..... 226  
 Removing a wheel ..... 195  
 Removing the battery ..... 215  
 Removing the mat ..... 77  
 Repair kit, puncture ..... 186  
 Replacing bulbs ..... 200-206

Replacing fuses .....207-210  
 Replacing the air filter .....240  
 Replacing the oil filter .....240  
 Replacing the passenger  
   compartment filter .....240  
 Replacing wiper blades.....152, 220  
 Resetting the service indicator .....29  
 Reversing camera .....137  
 Reversing lamp .....203, 204  
 Risk areas (update) .....301  
 Roof bars .....225  
 Roof blind .....62  
 Routine checks .....240, 241  
 Running out of fuel (Diesel) .....231

## S

Screen, instrument panel.....13, 31  
 Screen menu.....274, 276, 278, 292,  
   294, 296, 312, 324, 326  
 Screen, monochrome .....344, 356  
 Screen, multifunction  
   (with audio equipment) .....344  
 Screenwash fluid level .....151, 239  
 Screenwash, front .....150  
 Screen-wash reservoir .....239  
 SCR (Selective Catalytic Reduction).....242  
 Seat adjustment .....66, 67  
 Seat belts .....179-181  
 Seats, rear .....71  
 Serial number, vehicle .....264  
 Service indicator .....28  
 Servicing .....10  
 Setting the clock .....39, 40  
 Sidelamps .....138, 142, 200, 202-204

Side repeater .....202  
 Ski flap .....78  
 Snow chains.....199  
 Spare wheel .....192-194  
 Speed limiter .....129, 130  
 Spotlamps, side .....145, 202  
 Starting the engine .....100-102  
 Starting the vehicle .....100, 112, 116  
 Starting using another battery .....212  
 Steering mounted controls,  
   audio .....273, 343  
 Stopping the vehicle .....100, 112, 116  
 Stop & Start.....34, 63, 90, 93, 97,  
   120, 211, 230, 240  
 Storage .....76, 77, 79, 80  
 Storage wells .....79, 80  
 Storing a speed .....129  
 Storing driving positions .....68  
 Stowing rings .....79, 80  
 Sunroof .....60  
 Switching off the engine .....100-102  
 Synchronising the remote  
   control .....49, 50  
 Synthesiser, voice .....311  
 System settings.....13, 320

t temperature control  
   for heated seats .....69  
 t temperature, coolant .....26  
 t temporary puncture repair kit .....186  
 t third brake lamp .....206  
 t three flashes function  
   (direction indicators) .....171  
 t MC (t raffic info) .....306  
 t ools .....192  
 t ouch screen.....35-38, 40, 269  
 t ouch screen (Menus) .....36, 270  
 t owbar .....223  
 t owed loads .....252, 258  
 t owing another vehicle .....222  
 t raction control (ASR) .....21, 176  
 t raffic information (t A) .....307, 346  
 t raffic information (t MC).....306, 307  
 t railer .....223  
 t rip computer .....31-34  
 t yre pressures .....264  
 t yres .....10, 264  
 t yre under-inflation detection .....25, 174, 194

## U

u nder-inflation (detection) .....25, 174, 194  
 u nlocking .....41, 42  
 u nlocking the boot .....44  
 u pdate risk areas .....301  
 u pdating the date .....39, 40  
 u pdating the time .....39, 40  
 u Re A .....242  
 u SB .....286  
 uSB  
   (Peuge Ot Connect).....78, 286, 290, 352, 353

## T

t able of weights .....252, 258  
 t ables of engines .....250, 254  
 t ables of fuses .....207  
 t ank, AdBlue® additive .....242, 247  
 t echnical data .....250-264  
 t elephone .....328

---

**V**

Vehicle configuration .....	13
Vehicle identification.....	264
Ventilation .....	84-87

---

**W**

Warning lamps .....	14-25
Warning lamp, SCR emissions control system .....	23
Warning triangle.....	173
Wash-wipe, rear.....	150
Weights .....	252, 258
Welcome function .....	68
Welcome lighting.....	145
Wiper control stalk .....	149-151
Wiper, rear.....	150
Wipers .....	17, 149, 151













**!** For any work on your vehicle, use a qualified workshop that has the technical information, competence and equipment required, which a Peugeot dealer is able to provide.

Reproduction or translation of all or part of this document is prohibited without written authorisation from Automobiles Peugeot.

Automobiles Peugeot declares, by application of the provisions of the European regulation (Directive 2000/53) relating to end of Life Vehicles, that it achieves the objectives set by this regulation and that recycled materials are used in the manufacture of the products that it sells.

Anglais

Printed in the eu

04-14



**PEUGEOT**

Automobiles PEUGEOT - Siège Social : 75, avenue de la Grande-Armée 75016 PARIS

Tél. 33 (0)1 40 66 55 11 - Fax 33 (0)1 40 66 54 14

Adresse postale : Automobiles PEUGEOT B.P. 01 75761 PARIS cedex 16 - Adresse Internet : <http://www.peugeot.com>

Société Anonyme au capital de 172 771 770 Euros - R.C.S. PARIS B 552 144 503. SIRET 552 144 503 00018. APE 341 Z

