

Handbook





On-line user guide

You can find your user guide on the PEUGEOT website, under the heading "Personal space".

Referring to the user guide on-line also gives you access to the latest information available, easily identified by the bookmarks, associated with this pictogram:



Please note the following point:

The fitting of electrical equipment or accessories which are not recommended by PEUGEOT may result in a failure of your vehicle's electronic system. Please note this specific warning. It is advisable to contact a PEUGEOT dealer to be shown the recommended equipment and accessories.

 If the heading "Personal space" is not available on the public website for your country, you can find your user guide at the following address:
<http://public.servicebox.peugeot.com>

Select:

- > the link in "Private customer access",
- > the language,
- > the model,
- > the edition date appropriate for the date of registration of your vehicle.

You will find your user guide, presented in the same way as the paper version.

WELCOME

Thank you for choosing a 107.

This handbook has been designed to enable you to make the most of your 107 in all circumstances.

On the first few pages you will find a detailed summary followed by a quick reference guide intended to help you become familiar with your vehicle.

All of the details specific to your 107, comfort, safety, driving, are then presented in this handbook, to enhance your appreciation of your vehicle and help you make the best use of it.

Your vehicle may be fitted with only some of the equipment shown in this document, depending on version, trim level and the specifications for the country of sale.

Key



Warning:

this symbol marks warnings which it is essential to observe for your own safety, for the safety of others or to avoid any risk of damaging your vehicle.



Protection of the environment:

this symbol accompanies advice relating to protection of the environment.



Information:

this symbol draws your attention to additional information for better use of your vehicle.



Page reference:

this symbol invites you to refer to the pages which provide details of the function.

Contents

Familiarisation	1	Access	2	Driving	5
Eco-driving	2	Keys / Remote control	26	2 Tronic gearbox	42
Instruments and controls	1	Doors	28		
Rev counter	19	Electric windows	28		
Instrument panel	19	Rear windows	29		
Warning lamps	20	Boot	29		
Distance recorder	23	Fuel tank	30		
Indicators	23				
Setting the time	25				
Ventilation	33	Comfort	3	Visibility	6
Heating	34			Lighting control stalk	44
Air conditioning	35			LED daytime running lamps	45
Mirrors	37			Headlamp adjustment	46
Steering wheel adjustment	37			Courtesy lamp	46
Front seats	38			Windscreen wiper stalk	47
Rear seats	39				
Interior fittings	40	Fittings	4	Safety	7
Boot fittings	41			Horn	48
				Hazard warning lamps	48
				Parking brake	48
				Emergency braking assistance	49
				ABS, EBF, CSC systems	49
				ASR and ESP systems	50
				Seat belts	51
				Airbags	54

Child safety

8

Child seats	57
ISOFIX mountings	62

Checks

10

Opening the bonnet	84
Engine	85
Checking levels	86
Checks	88

Audio equipment

Audio system / Bluetooth	93
Audio system	116

Practical information

9

Changing a wheel	65
Changing a bulb	67
Changing a fuse	71
Battery	76
Mat	79
Fitting audio equipment/speakers	79
Towing the vehicle	80
Fitting roof bars	81
Accessories	82

Technical data

11

Engine	89
Weights	90
Dimensions	91
Identification markings	92

Visual search

Alphabetical index

Opening

Remote control key

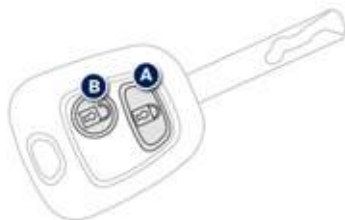

- A. Locking the vehicle.
- B. Unlocking the vehicle.

▶ 26

Central locking / unlocking of the vehicle (from inside)

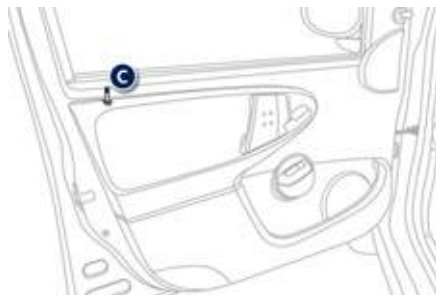

- C. Press/Pull the button on the **driver's door** to lock/unlock the doors and boot simultaneously.

▶ 28

Starting

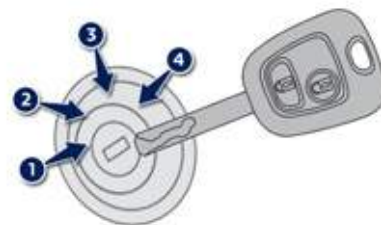

1. Stop position.
2. Accessories position (1st notch).
3. Running position (2nd notch).
4. Starting position.

Opening Fuel tank

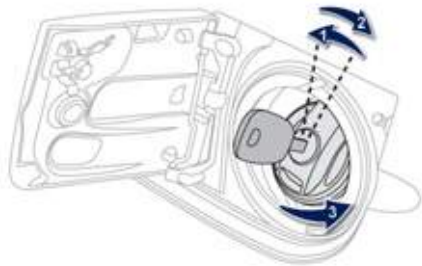

After opening the flap, insert the key in the filler cap, then turn it slightly to the left then return to the right. The key returns to its initial position and the cap is unlocked.

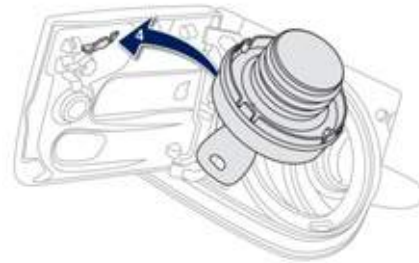

Unscrew the cap using the key. After filling the fuel tank, screw the cap back on fully to the right until it clicks and close the flap. Fuel tank capacity: approximately **35** litres.

Low fuel level



When this bar flashes, accompanied by an audible signal, you have around **5** litres of fuel remaining.



Bonnet

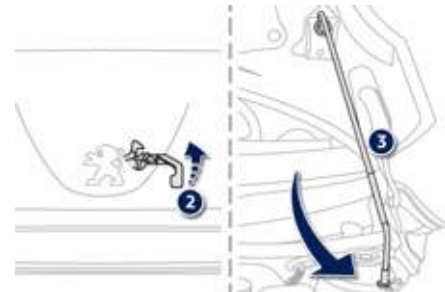

1. Interior release lever.
2. Exterior safety catch.
3. Bonnet stay.



Interior

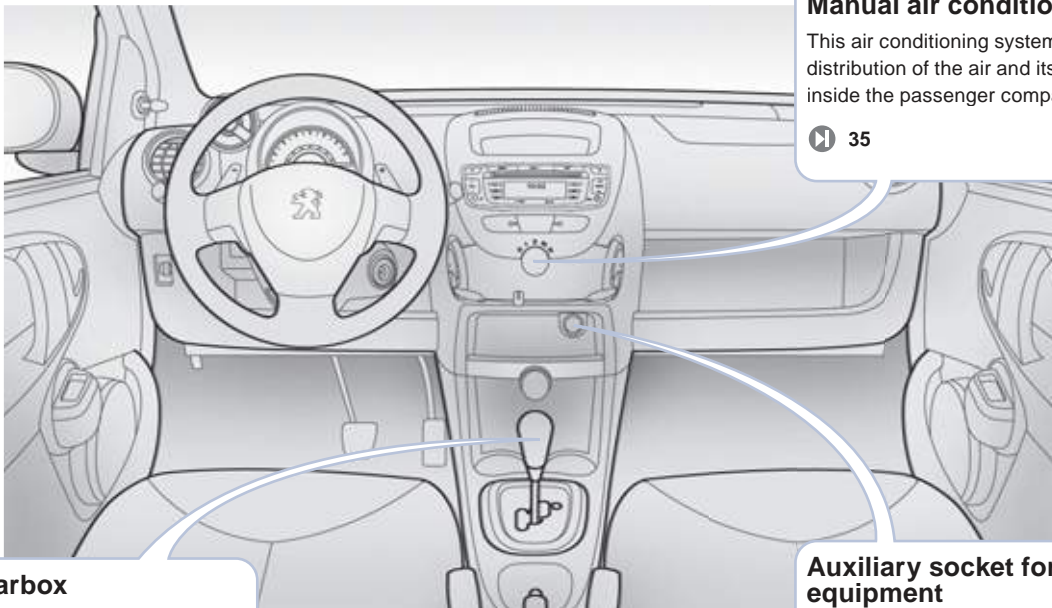

Manual air conditioning

This air conditioning system optimises the distribution of the air and its temperature inside the passenger compartment.

▶ 35

2 Tronic gearbox

This five-speed electronic gearbox offers a choice between the comfort of automated operation or the pleasure of manual gear changing.

▶ 42

Auxiliary socket for portable equipment

Compatible with many MP3 players, this socket allows you to listen to your favourite tracks while travelling. Refer to the conditions of use in the "Audio" section.

▶ 102

Instruments and controls

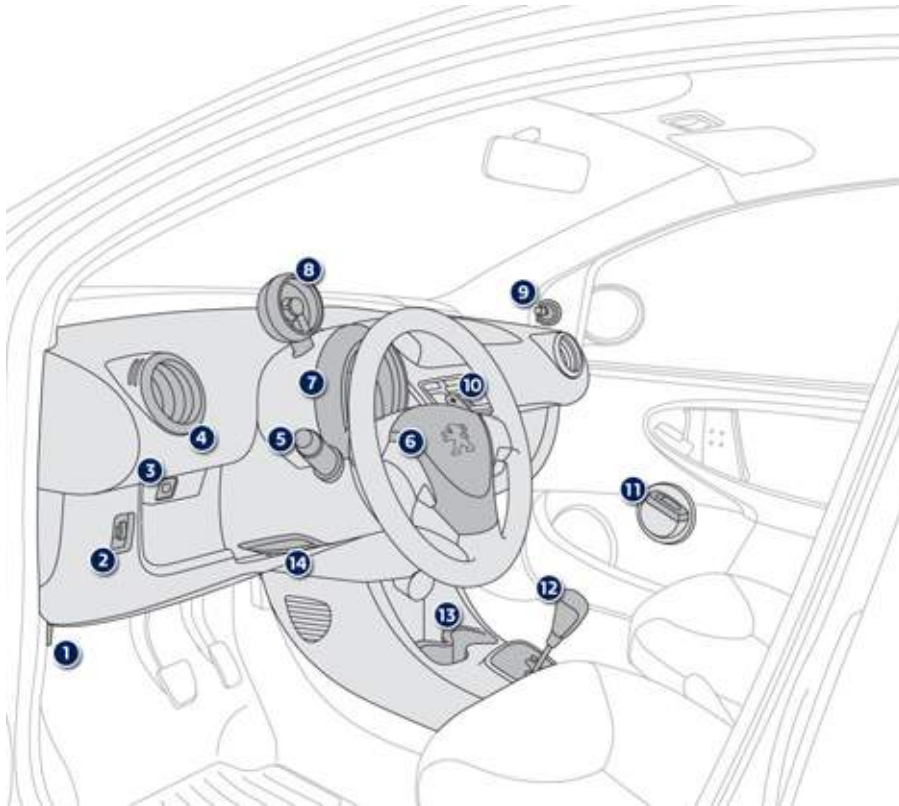

1. Bonnet release
2. Headlamp adjustment
3. Passenger's airbag deactivation
4. Adjustable side air vent
5. Lighting and direction indicator stalk
6. Driver's front airbag
Horn
7. Dashboard fusebox (under the instrument panel trim, on the right and on the left)
8. Rev counter
9. Passenger's door mirror control
10. Steering mounted controls for the 2 Tronic gearbox
11. Passenger's electric window control
12. Gear lever
13. Cup holder
14. Steering wheel height adjustment

Instruments and controls

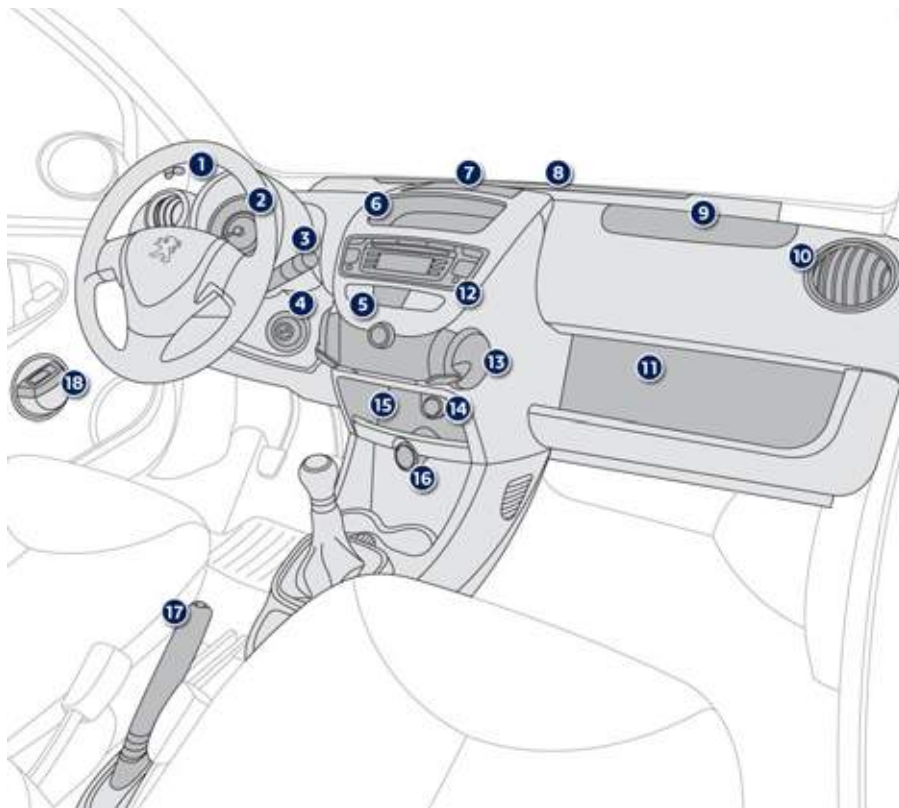

1. Driver's door mirror control
2. Instrument panel
3. Wiper stalk
4. Steering lock and ignition
5. Hazard warning lamps
6. Storage compartments
7. Diffusion grille
8. Windscreen demisting and defrosting vent
9. Passenger's front airbag
10. Adjustable side air vent
11. Storage box
12. Audio system
13. Ventilation, heating or air conditioning controls
14. Auxiliary socket for portable equipment
15. Storage compartments
16. 12 V socket (120 W max)
17. Parking brake
18. Driver's electric window control

Sitting comfortably

Front seats



1. Forwards-backwards adjustment.



2. Seat back angle adjustment.



3. Access to rear seats (3-door).

Sitting comfortably

Front electric windows



- A.** Opening and closing control.
Push or pull control **A**.

 28

Mirrors

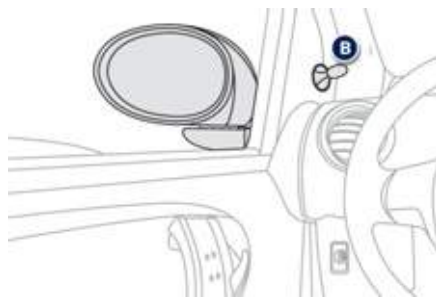

- B.** Door mirrors adjustment control.
When the vehicle is parked, the mirrors can be folded and unfolded manually.

 37

Steering wheel adjustment (with power steering)



- C.** Steering wheel height adjustment release and locking control.
1. Control released.
 2. Control locked.

 37

Seeing clearly

Lighting stalk

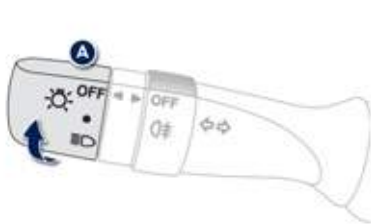

Front and rear lamps

Ring A



Lighting off.



Sidelamps.



Dipped / Main beam headlamps.

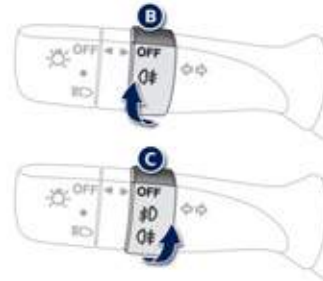

Rear foglamp

Ring B



Front foglamps and rear foglamp

Ring C



▶ 44

Wiper control stalk

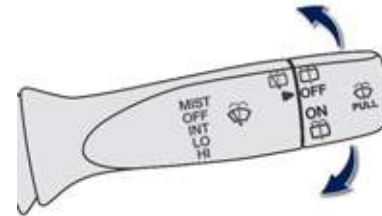

Windscreen wipers

- MIST** Single wipe.
- OFF** Off.
- INT** Intermittent wipe.
- LO** Normal wipe (moderate rain).
- HI** Rapid wipe (heavy rain).

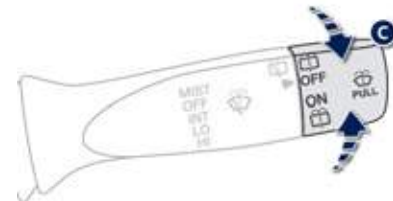

Rear wiper and rear screenwash

Ring C

▶ 47

Ventilation Heating

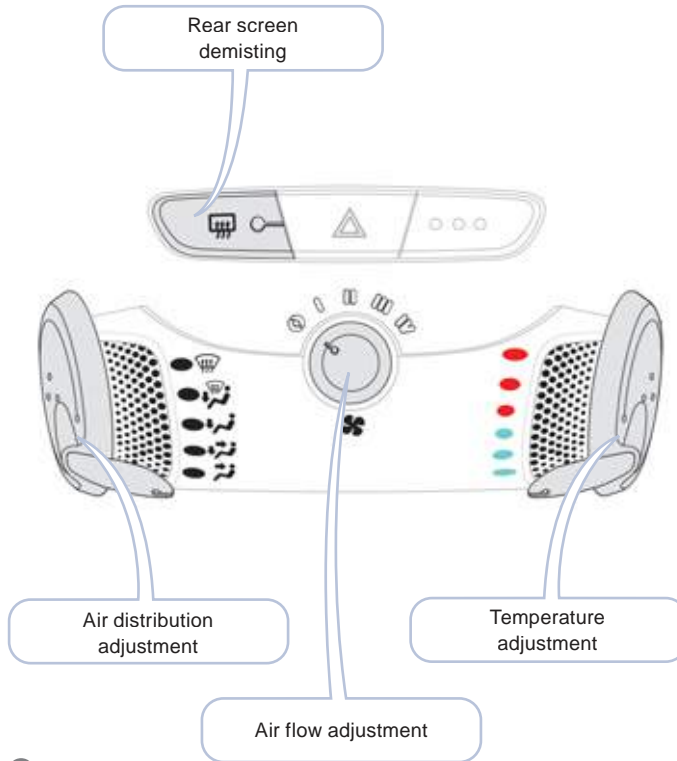



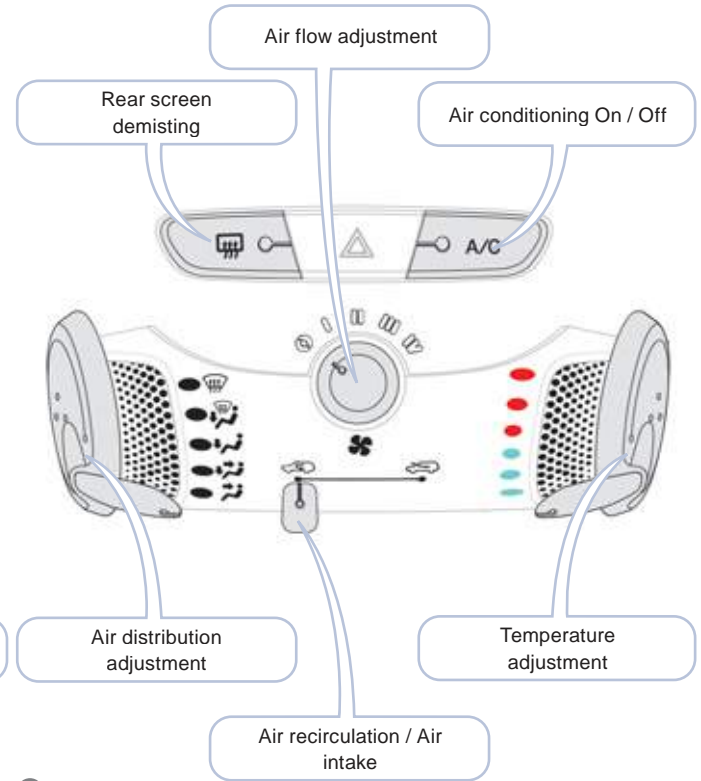







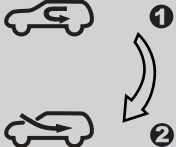

Air conditioning

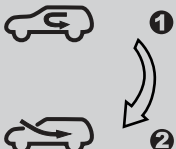

Ventilation

Recommended interior settings

I require...	Heating or Manual air conditioning				
	Air distribution	Air flow	Air recirculation/Intake of exterior air	Temperature	Manual AC
HOT					—
COLD					ON
DEMISTING DEFROSTING					ON

Monitoring Instrument panel

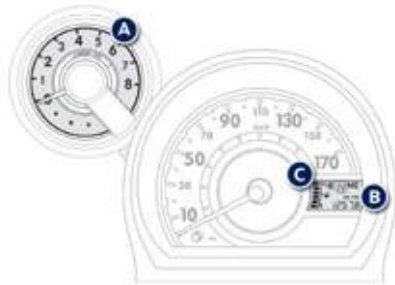

- A. Rev counter
- B. Screen
- C. Fuel gauge

▶ 19

Warning lamps



When the ignition is on, the orange and red warning lamps come on.
When the engine is running, these warning lamps should go off.
If warning lamps remain on, refer to the information on the warning lamp in question.

▶ 20

ASR/ESP option



The dynamic stability control system (ASR/ESP) optimises the vehicle's road holding.
For correct operation of the system, refer to the relevant page.

▶ 50

Safety

Passenger's airbag deactivation

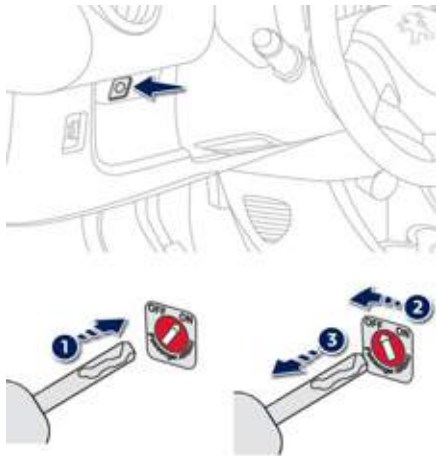

1. Insert the key.
2. Select the "OFF" position
3. Remove the key in the OFF position.

Passenger's airbag deactivated



If the passenger's airbag is deactivated, this warning lamp remains on until the passenger's airbag is reactivated.

▶ 55

"ISOFIX" mountings



Your vehicle has been approved in accordance with the new ISOFIX regulation. The rear seats are fitted with regulation ISOFIX mountings.

These are three rings for each seat:

- two lower rings **A**, located between the vehicle's seat back and cushion,
- an upper ring **B**, referred to as the TOP TETHER, located at the rear of the seat back at the bottom.

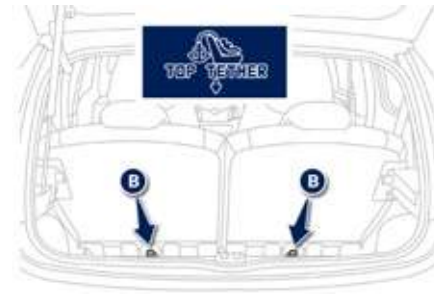

The **ISOFIX child seats** are fitted with two latches and/or a strap which are secured easily on these rings, indicated by labels or a mark on the rear seat back panel.

▶ 62

Front seat belt(s) not fastened / unfastened warning lamp



When the ignition is switched on, the warning lamp flashes if the driver and/or front passenger has not fastened their seat belt.

The warning lamp flashes when the driver and/or front passenger unfastens their seat belt with the engine running.

▶ 52

Driving safely

2 Tronic gearbox

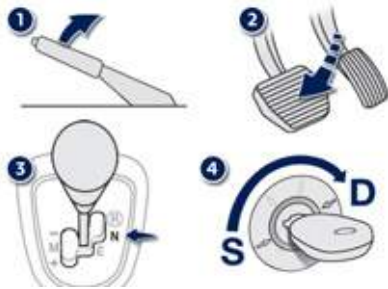

Moving off

With the parking brake applied, press the brake pedal then select position **N** to start the engine. With your foot on the brake, select position **R**, **E** or **M**. Release the parking brake, take your foot off the brake pedal, then accelerate.

▶ 42

EASY mode (automatic mode)



Select position **E** using the gear lever. The gear engaged is displayed in the instrument panel screen. The gearbox continuously selects the most suitable gear.

▶ 43

Manual mode



Place the gear lever in position **M**, then change up or down through the gears by pressing the lever:

- rearwards, "+" to change up,
- forwards, "-" to change down.

You can also use the steering mounted control paddles. The gear engaged is displayed in the instrument panel screen.

▶ 43

Manual gearbox



Press the clutch pedal fully when changing gear.

Reverse

To engage reverse gear, push the gear lever fully to the right then towards the rear. **Reverse gear can only be engaged when the vehicle is stationary, engine at idle.**



Eco-driving

Eco-driving is a range of everyday practices that allow the motorist to optimise their fuel consumption and CO₂ emissions.

Optimise the use of your gearbox

With a manual gearbox, move off gently, change up without waiting and drive by changing up quite soon.

With the 2 Tronic gearbox stay in Easy "E" without pressing the accelerator pedal heavily or suddenly.

Drive smoothly

Maintain a safe distance between vehicles, use engine braking rather than the brake pedal, and press the accelerator progressively. These practices contribute towards a reduction in fuel consumption and CO₂ emissions and also helps reduce the background traffic noise.

Control the use of your electrical equipment

Before moving off, if the passenger compartment is too warm, ventilate it by opening the windows and air vents before using the air conditioning.

Above 30 mph (50 km/h), close the windows and leave the air vents open.

Remember to make use of equipment that can help keep the temperature in the passenger compartment down (sun blinds, ...).

Switch off the air conditioning as soon as the desired temperature is attained.

Switch off the demisting and defrosting controls, if not automatic.

Switch off the headlamps and the foglamp when the level of light does not require their use.

Avoid running the engine before moving off, particularly in winter; your vehicle will warm up much faster while driving.

As a passenger, if you avoid connecting your multimedia devices (film, music, video game...), you will contribute towards limiting the consumption of electrical energy, and so of fuel.

Disconnect your portable devices before leaving the vehicle.

Limit the causes of excess consumption

Spread loads throughout the vehicle; place the heaviest items in the bottom of the boot, as close as possible to the rear seats.

Limit the loads carried in the vehicle and reduce wind resistance (roof bars, roof rack, bicycle carrier, ...). Use a roof box in preference.

Remove roof bars and roof racks after use.

At the end of winter, remove snow tyres and refit your summer tyres.

Observe the recommendations on maintenance

Check the tyre pressures regularly, when cold, referring to the label in the door aperture, driver's side.

Carry out this check in particular:

- before a long journey,
- at each change of season,
- after a long period out of use.

Don't forget the spare wheel.

Have your vehicle serviced regularly (engine oil, oil filter, air filter...) and observe the schedule of operations recommended by the manufacturer.

When refuelling, do not continue after the 3rd cut-off of the nozzle to avoid any overflow.

At the wheel of your new vehicle, it is only after the first 1 800 miles (3 000 kilometres) that you will see the fuel consumption settle down to a consistent average.

Rev counter





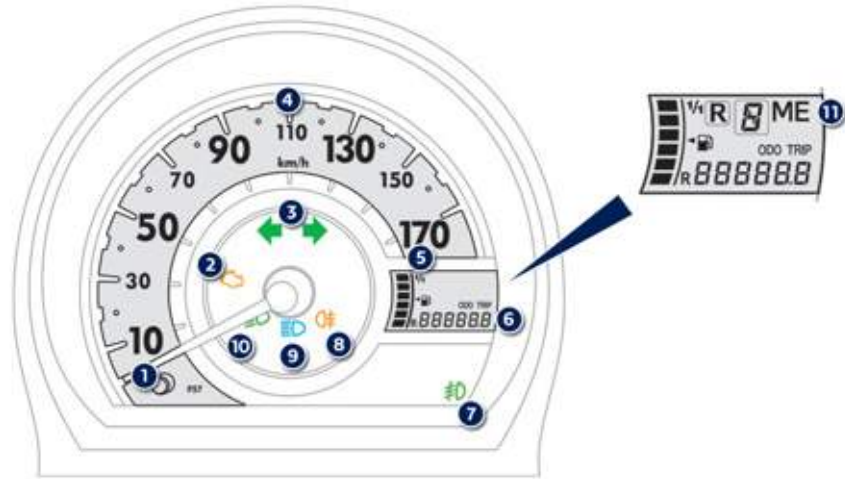

Approaching the maximum engine speed, when the rev counter needle crosses into the red zone, you must change up.





Instrument panel







- | | |
|--|--|
| <ol style="list-style-type: none"> 1. Total or trip distance recorder display button,
trip zero reset button 2. Display of warning lamps 3. Direction indicators 4. Speedometer 5. Fuel gauge | <ol style="list-style-type: none"> 6. Total / trip distance recorder 7. Front foglamp warning lamp 8. Rear foglamp warning lamp 9. Main beam headlamp warning lamp 10. Dipped beam headlamp warning lamp 11. Indicator of gear engaged or position of the gear lever for the 2 Tronic gearbox. |
|--|--|

Warning lamps

Warning lamp		is on	Cause	Action/Observations
	Parking brake	fixed.	The parking brake is applied or not properly released.	With your foot on the brake pedal, release the parking brake to switch off the warning lamp. Observe the safety recommendations. For more information, refer to the "Parking brake" section.
STOP	STOP	fixed, associated with another warning lamp.	It is associated with the engine oil pressure or the engine coolant temperature.	Stop as soon as it is safe to do so. Park, switch off the ignition and call a PEUGEOT dealer or qualified workshop.
	Engine oil pressure	fixed, associated with the STOP warning lamp.	The engine oil pressure is too low.	Stop as soon it is safe to do so. Park, switch off the ignition and contact a PEUGEOT dealer or a qualified workshop.
 + 	Braking	fixed.	The braking system fluid level has dropped significantly.	Top up with brake fluid recommended by PEUGEOT. If the problem persists, have the system checked by a PEUGEOT dealer or a qualified workshop.
		fixed, associated with the ABS warning lamp.	The braking system has a fault.	Stop as soon as it is safe to do so. Park, switch off the ignition and contact a PEUGEOT dealer or a qualified workshop.

Warning lamp		is on	Cause	Action/Observations
	Anti-lock Braking System (ABS)	fixed.	The anti-lock braking system has a fault.	The vehicle retains conventional braking. Drive carefully at reduced speed and contact a PEUGEOT dealer or a qualified workshop without delay.
	Electronic stability programme (ASR/ESP)	fixed.	The ASR/ESP system is in action.	The system optimises traction and improves the directional stability of the vehicle.
VSC		fixed.	The ASR/ESP system has a fault.	Have it checked by a PEUGEOT dealer or a qualified workshop.
	Coolant temperature	fixed.	The temperature of the engine coolant is too high.	Stop as soon as it is safe to do so. Wait until the engine has cooled down before checking up the level; top up if necessary. If the problem persists, contact a PEUGEOT dealer or qualified workshop.
	Airbags	temporarily.	This lamp comes on for a few seconds when you turn on the ignition, then goes off.	This lamp should go off when the engine is started. If it does not go off, contact a PEUGEOT dealer or a qualified workshop.
		flashing.	At least one of the airbags has a fault.	The airbags may not be deployed in the event of a serious impact. Have it checked by a PEUGEOT dealer or a qualified workshop.

Warning lamp		is on	Cause	Action/Observations
	Deactivating the passenger's airbag	fixed.	The passenger's airbag control is set to the OFF position. The passenger's front airbag is deactivated. In this case you can install a "rear facing" child seat.	Set the control to the ON position to activate the passenger's front airbag. In this case, do not fit a child seat in the rear-facing position.
	Battery charge	fixed.	The battery charging circuit has a fault (dirty or loose terminals, slack or cut alternator belt, ...).	The warning lamp should go off when the engine is started. If it does not go off, contact a PEUGEOT dealer or a qualified workshop.
P/S	Electric power steering	fixed.	The electric power steering has a fault.	Drive carefully at reduced speed. Have it checked by a PEUGEOT dealer or qualified workshop.
	Front seat belt not fastened / unfastened (depending on version)	flashing, then above 12 mph (20 km/h), accompanied by an audible signal.	The driver and/or front passenger has not fastened or has unfastened their seat belt.	Pull the strap then insert the tongue in the buckle.
	Emission control system	fixed.	The emission control system has a fault.	This lamp should go off when the engine is started. If it does not go off, contact a PEUGEOT dealer or a qualified workshop without delay.
	2 Tronic gearbox	fixed.	The 2 Tronic gearbox has a fault.	Contact a PEUGEOT dealer or a qualified workshop without delay.

Total/trip distance recorder



When the ignition is switched on, the distance recorder selected when the engine was switched off is displayed.

Press button **1** to alternate the distance display:

- total with "**ODO**" displayed,
- trip with "**TRIP**" displayed.



To reset the trip recorder to zero, when it is displayed, press and hold button **1**.

Indicators

Fuel gauge

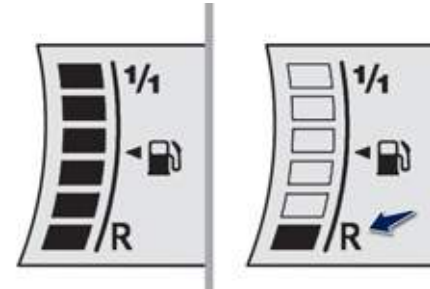

This indicates the quantity of fuel available:

- **1/1** and six bars, the fuel tank is full.
- **R** and one bar flashing, the fuel tank is on the reserve.

Low fuel level

When the minimum level in the fuel tank is reached, the last bar flashes accompanied by an audible signal.

In certain driving conditions and depending on the engine, the distance which can be travelled with the fuel remaining may be less than 30 miles (50 km).

You have approximately 5 litres remaining.

When the frequency of the flashing increases, **you have approximately 3 litres remaining.**

i At least 5 litres must be added after running out of fuel.

2 Tronic gearbox indicator

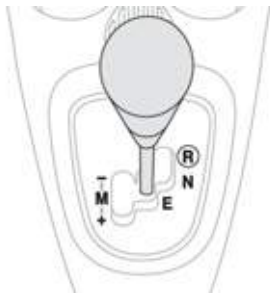

Lever on EASY mode (automatic mode)



"E" is displayed when this operating mode is selected. It goes off on switching to manual mode.

Lever in manual mode



"M" is displayed when this operating mode is selected. It is switched off on switching to EASY mode.



"Neutral"



"Reverse"



1st gear



2nd gear



3rd gear



4th gear



5th gear

"!" warning lamp



If this warning lamp comes on with the engine running, this indicates a fault with the 2 Tronic gearbox.

Contact a PEUGEOT dealer or a qualified workshop.

Setting the time

Audio system / Bluetooth



Press **MENU** then **"Config."**



Select **"Hours"** to adjust the hours.



Select:

- **"H+"** to increase the hours,
- **"H-"** to decrease the hours,
- **"M+"** to increase the minutes,
- **"M-"** to decrease the minutes,
- **"12/24"** to select the display mode.

Confirm with **"OK"**.

Radio



Press this button for more than 2 seconds, the clock display flashes.



Press this button (the value increases continuously) to adjust the hours.



Press this button (the value increases continuously) to adjust the minutes.

i You exit from this mode automatically after a few seconds without any action.

Keys / Remote control

Keys

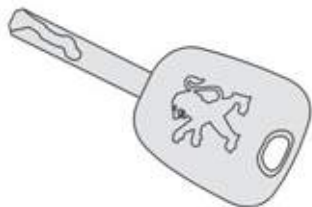

The keys allow you to switch on the ignition and operate the locks on the front doors, the boot, the fuel filler cap, the steering lock and the passenger's airbag deactivation switch.

Central locking and unlocking

From the driver's door, the keys allow you to lock and unlock the doors and boot simultaneously.

Remote control

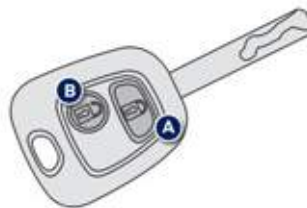

This carries out the vehicle locking - unlocking and locating functions at a distance.

Locking

Press button **A** to lock the vehicle from a distance. This is confirmed by brief lighting of the direction indicators.

Unlocking

Press button **B** to unlock the vehicle. This is confirmed by two successive flashes of the direction indicators.

i After locking, if you notice that a door is not closed properly, close it then lock the vehicle again.

! The set of keys or remote controls, supplied with your vehicle, enable you to obtain a maximum of three new keys. If all of the keys in your possession are lost, a major operation will have to be carried out on your vehicle. Contact a PEUGEOT dealer or a qualified workshop.

Locating the vehicle

To locate your vehicle in a car park, if you have locked it:

- press button **A**, the direction indicators come on briefly.

Changing the remote control battery



To change the battery, remove the screw then unclip the housing using a coin inserted at the ring.

Battery CR 2016/3 volts.

If the remote control does not work after the battery has been changed, reinitialise it.

 Do not discard the remote control batteries, they contain metals which are harmful to the environment. Take them to a PEUGEOT dealership, or to any other approved collection point.

Reinitialising the remote control

Following replacement of the remote control battery or in the event of a remote control fault, it may be necessary to reinitialise the system.

- ☞ Switch off the ignition.
- ☞ Switch the ignition on again.
- ☞ Press one of the remote control buttons immediately for a few seconds.
- ☞ Switch off the ignition and remove the key from the ignition lock.

The remote control is now working again.

If the fault persists, contact a PEUGEOT dealer or a qualified workshop.

Electronic engine immobiliser

This locks the engine management system as soon as the ignition has been switched off and therefore prevents starting of the vehicle by anyone who does not have the key.

The ignition key has an electronic chip which has a special code. When the ignition is switched on, the code must be recognised for starting to be possible.

In the event of a malfunction, your vehicle will not start.

Contact a PEUGEOT dealer or a qualified workshop.

! Driving with the doors locked may make access to the passenger compartment by the emergency services more difficult in an emergency.

As a safety measure (with children on board), remove the key from the ignition when leaving the vehicle, even for a short time.

Do not make any modifications to the electronic immobiliser system.

i The high frequency remote control is a sensitive system; do not operate it in your pockets as there is a risk that it may unlock the vehicle without you being aware of this.

Avoid pressing the buttons of your remote control out of range of your vehicle, you risk rendering it inoperative. It would then have to be reinitialised.

Doors

Locking/unlocking from the inside



To lock/unlock a door, press/pull button **A**.

i Operating the door handle does not unlock the door.

With normal locking/unlocking: the doors are locked/unlocked independently of each other.

With central locking/unlocking: the doors and boot are locked/unlocked simultaneously.

! This function operates only from the driver's door.

Driver's door open



If the driver's door is open, the courtesy lamp remains on if the button is in this position.

Child lock



This prevents the opening of either of the rear doors from the inside.

Push control **1** towards the outside of the vehicle.

! Check the status of this safety device before switching on the ignition.
This system is independent of the central locking.
Always remove the key from the ignition when leaving the vehicle.

Electric windows*

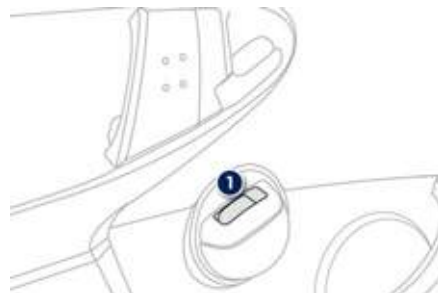

The driver and front passenger each have an electric window.

After the ignition has been switched on, press or pull control **1**. The window stops when you release the control.

! Always remove the key from the ignition when leaving the vehicle, even for a short time.
The driver must ensure that the front passenger uses their electric window correctly.
Be aware of children when operating the windows.

* Depending on version.

Rear windows (5-door)



To partially open the rear windows, pull the lever then push the window.

To close the window, pull then press the lever to lock the window.

Boot

Locking/unlocking using the key*

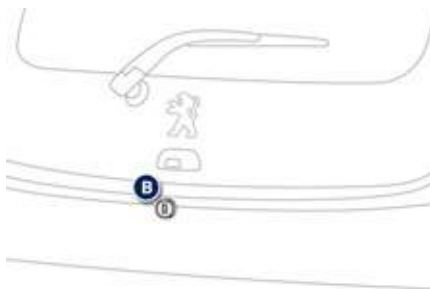

To open, operate the lock **B** using the key and raise the tailgate.

Locking / Unlocking the boot using the remote control*

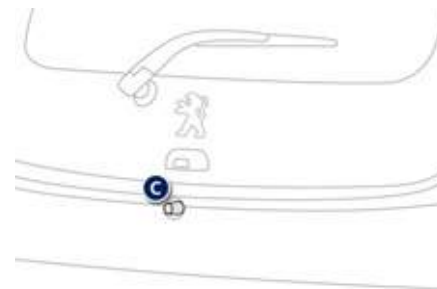

The boot is locked/unlocked using the buttons on the remote control.

Then, to open, press button **C** and raise the tailgate.

i The boot can be locked/unlocked using button **A** on the driver's door.

* According to version.

* Depending on version.

Fuel tank

Low fuel level



When the low fuel level is reached, the last bar flashes, accompanied by an audible signal.

You have approximately 5 litres remaining.

In certain driving conditions and depending on the engine, the distance which can be travelled with the fuel remaining may be less than 30 miles (50 km).

When the frequency of the flashing increases, **you have approximately 3 litres remaining.**

i If you run out of fuel, the emission control system warning lamp may come on in the instrument panel. It will go off automatically after the engine has been started a few times.

! The fuel tank must be filled **with the engine switched off.**

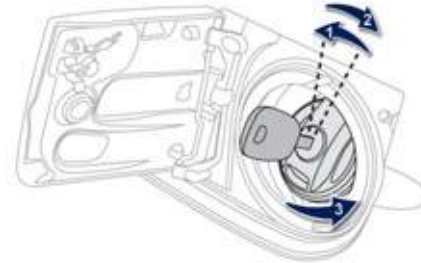

- ☞ Open the fuel filler flap.
- ☞ Insert the key in the filler cap, turn it slightly to the left and then return to the right.

The key returns to its initial position and the filler cap is then unlocked.

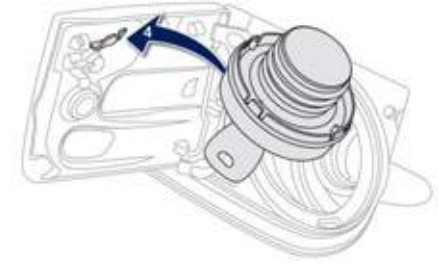

- ☞ Unscrew the cap with the key.
- ☞ Hang the filler cap on the bracket, located on the inner face of the filler flap.

A label affixed on the inside of the flap reminds you which type of fuel to use. When you fill the fuel tank, do not continue after the 3rd cut-off of the pump. This could cause malfunctions.

The capacity of the fuel tank is approximately 35 litres.

- ☞ After filling the fuel tank, screw the cap back on fully to the right until it **clicks** then close the flap.

Quality of the fuel used for petrol engines



SP95
E10

SP98

The petrol engines are perfectly compatible with E10 or E24 type petrol biofuels (containing 10 % or 24 % ethanol), conforming to European standards EN 228 and EN 15376.

E85 type fuels (containing up to 85 % ethanol) are reserved exclusively for vehicles marketed for the use of this type of fuel (BioFlex vehicles). The quality of the ethanol must comply with European standard EN 15293.

For Brazil only, special vehicles are marketed to run on fuels containing up to 100 % ethanol (E100 type).

Ventilation

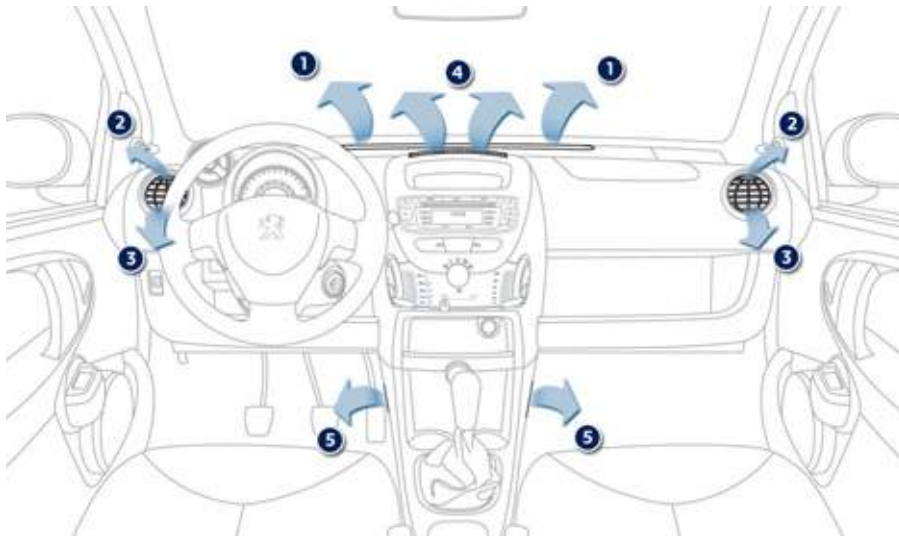

1. Windscreen demisting/defrosting vent.
2. Side window demisting/defrosting vents.
3. Side vents.
4. Diffusion grille.
5. Air outlets to the footwells.

i Recommendations for use

If the interior temperature remains very high after a prolonged period parked in the sun, first ventilate the passenger compartment for a few minutes.

For an even air distribution, make sure that you do not block the outside air inlet grille, the vents, the air passages and the air outlets to the footwells.

Ensure that the passenger compartment filter, located below the windscreen, in the engine compartment, is in good condition. Have the filter elements replaced regularly. If you drive in dusty conditions, change them twice as often. Operate the air conditioning system for 5 to 10 minutes, once or twice a month, to keep it in perfect working order.

In order to ensure that your air conditioning system continues to operate correctly, you are advised to have it checked regularly.

The condensation created by the air conditioning results in a flow of water under the vehicle when stationary which is perfectly normal.

If the system does not produce cold air, do not use it and contact a PEUGEOT dealer or a qualified workshop.



The air conditioning system does not contain chlorine and does not present any danger to the ozone layer.

Heating

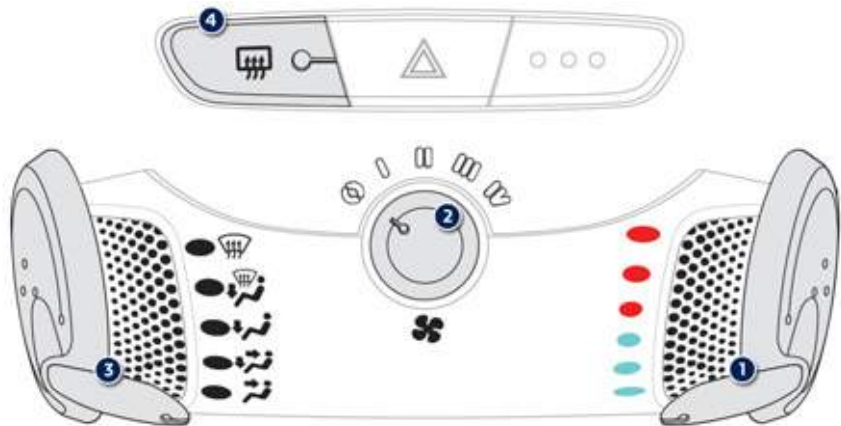

1. Temperature adjustment

Turn the control from blue (cold) to red (hot) to adjust the temperature to suit your requirements.

2. Air flow adjustment

When the ignition is switched on, turn the control to obtain a flow of air which is sufficient to ensure your comfort.

To maintain a certain level of comfort in the passenger compartment, avoid position **0** whenever possible.

In position **0**, a slight flow of air, due to the movement of the vehicle, can still be felt.

3. Air distribution adjustment



Windscreen and side windows.



Windscreen, side windows and footwells.



Footwells.



Footwells, diffusion grille and side vents.



Diffusion grille and side vents.

i The air distribution can be adjusted by placing the control in an intermediate position.

4. Rear screen demisting



With the engine running, press button **4**, the indicator lamp comes on. The system demists the rear screen. It is switched off by pressing control **4**.



Switch the system off as soon as you consider this necessary as a lower consumption of current reduces fuel consumption.

Demisting and defrosting

To quickly demist or defrost the windscreen and side windows:

- set the air distribution to "Windscreen and side windows",
- place the temperature control **1** and the air flow control **2** at maximum,
- close the side vents.

Air conditioning

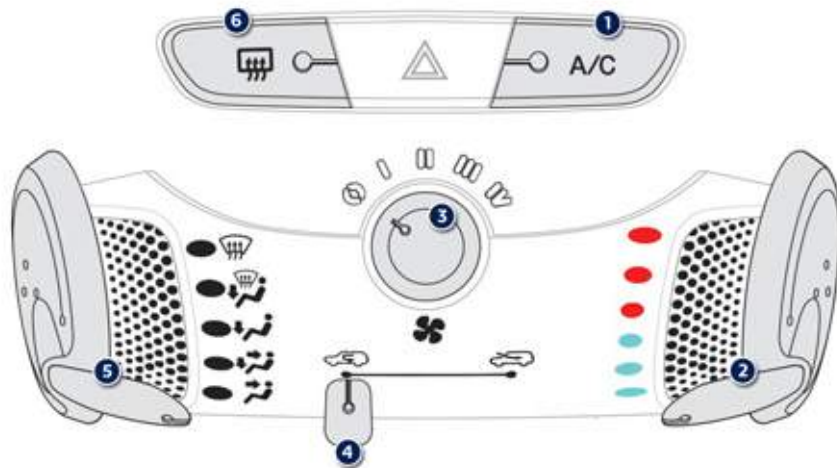

1. Air conditioning On/Off
2. Temperature adjustment
3. Air flow adjustment
4. Air recirculation / Air intake
5. Air distribution adjustment
6. Rear screen demisting

1. Air conditioning On/Off

A/C

With the engine running, press the button, the indicator lamp comes on.

The air conditioning will not operate if the air flow adjustment control 3 is in position 0.

i To quickly obtain cooled air, you can use air recirculation for a few moments. Then return to exterior air intake.

2. Temperature adjustment

Turn the control from blue (cold) to red (hot) to adjust the temperature to suit your requirements.

3. Air flow adjustment

When the ignition is switched on, turn the control to obtain a flow of air which is sufficient to ensure your comfort.

To maintain a certain level of comfort in the passenger compartment, avoid position **0** whenever possible.

In position **0**, a slight flow of air, due to the movement of the vehicle, can still be felt.

3

4. Air recirculation / Air intake



The recirculation of interior air (control **4** to the left) enables you to isolate the passenger compartment from exterior odours and smoke.



The intake of exterior air (control **4** to the right) enables you to prevent and eliminate misting of the windscreen and side windows.

! In a humid climate, use of the air recirculation may cause misting of the windows.

As soon as possible, move control **4** to the right to the "Intake of exterior air" position to avoid the risks of deterioration of the air quality and misting of the windscreen and side windows.

5. Air distribution adjustment



Windscreen and side windows.



Windscreen, side windows and footwells.



Footwells.



Footwells, diffusion grille and side vents.



Diffusion grille and side vents.

i The air distribution can be adjusted by placing the control in an intermediate position.

6. Rear screen demisting



With the engine running, press button **6**, the indicator lamp comes on.

The system demists the rear screen. It is switched off by pressing button **6** again.



Switch the system off as soon as you consider this necessary as a lower consumption of current reduces fuel consumption.

Demisting and defrosting

To quickly demist or defrost the windscreen and side windows:

- set the air distribution to "Windscreen and side windows",
- place the temperature control **2** and the air flow control **3** at maximum,
- close the side vents,
- place the air intake control **4** in the "Air intake" position,
- switch on the air conditioning by pressing button **1**.

Mirrors

Door mirrors

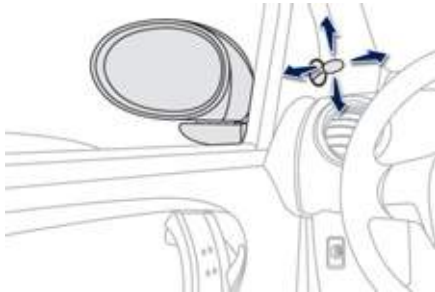

Move the lever in all four directions to adjust the mirror.

Folding/Unfolding

When the vehicle is parked, the door mirrors can be folded back and unfolded manually.

Manual rear view mirror



The rear view mirror has two positions:

- day (normal),
- night (anti-dazzle).

To change from one to the other, push or pull the lever on the lower edge of the mirror.

Steering wheel adjustment (with power steering)

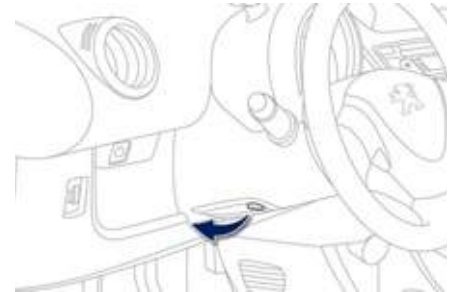

When stationary, lower the lever to release the steering wheel adjustment mechanism. Adjust to the desired **height** and lift the lever to lock the steering wheel adjustment mechanism.

! For safety reasons, these operations must not be carried out while driving.

Front seats

1. Forwards-backwards adjustment



Raise the control and slide the seat forwards or backwards.

2. Seat back angle adjustment



Push control **A** rearwards while adjusting the angle of the seat back.

3. Access to the rear seats (3-door)



Position the seat belt along the door pillar. Push control **A** rearwards to fold the seat back and move the seat forwards. To put the seat back in place, push the seat back until the seat locks. Reset the forwards-backwards adjustment of the seat and the seat back angle.

! No person or object must prevent the seat from returning to the required position.

Rear seats

Folding the backrest of the bench seat



The seat backrest is folded from the rear of the vehicle, with the boot open:

- check that the seat belt is positioned correctly on the side of the seat back to avoid damaging it,
- place the head restraints in the low position (see "rear head restraints"),
- while folding the seat backrest, pull the strap(s) **A**, located behind the seat back.

Returning the backrest of the bench seat to its initial position

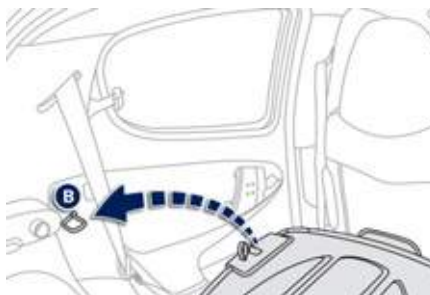

Push the backrest towards the rear and engage it on mounting **B**.

Take care not to trap the seat belts, in particular between the seat back and the mounting **B.**

Check that the backrest has engaged correctly.

Rear head restraints*

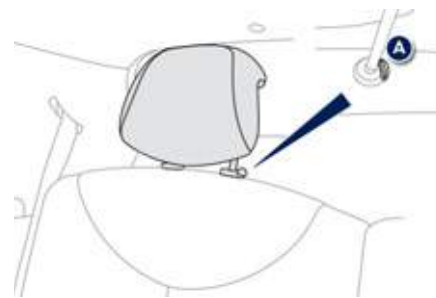

The rear head restraints can be removed and have two positions:

- high, position for use.
- low, storage position.

To raise the head restraint, pull it upwards.

To lower it, press lug **A** then the head restraint.

To remove it:

- tilt the seat back slightly,
- move the head restraint to the high position,
- press lug **A** pulling the head restraint upwards at the same time.

To refit it:

- tilt the seat back slightly,
- engage the rods of the head restraint in the openings.

To reach the low position, press lug **A**.

3

* Depending on version.

Interior fittings

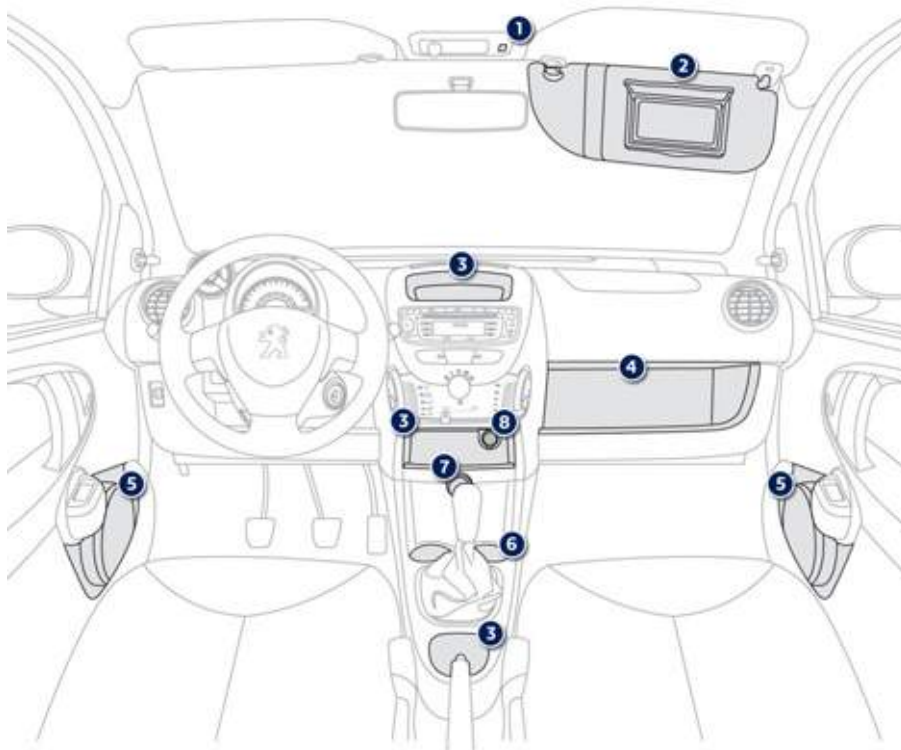

1. **Microphone for Bluetooth telephone**
2. **Sun visor**
Each sun visor has a courtesy mirror with a concealing flap and a card holder.
3. **Storage compartments**
4. **Storage box**
5. **Front door pockets and speakers**
Before opening the door, check that there are no objects protruding from the door pockets.
6. **Cup holder**
7. **12 volt accessories socket (120 W max)**
This is supplied from the accessories position (1st position of the ignition switch).
8. **Auxiliary socket (JACK and USB) for portable equipment**
9. **Storage compartments in the rear doors**

3-door



5-door



Boot fittings

1. Rear parcel shelf

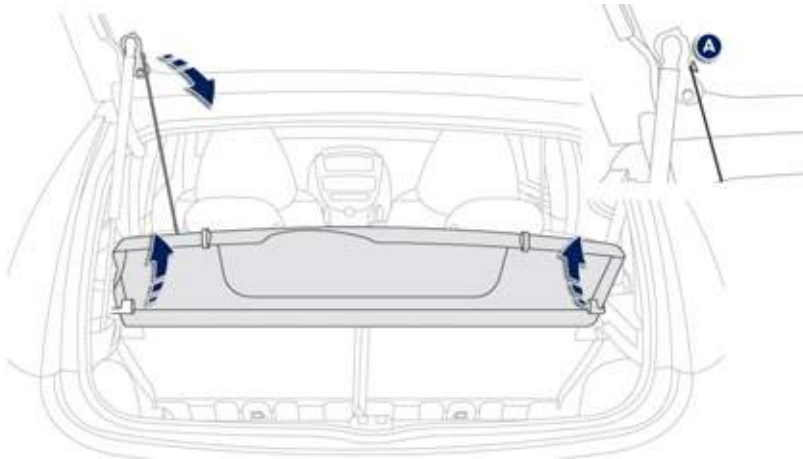

To remove the shelf:

- unhook the shelf from its fixing **A**,
- pull upwards on each side to detach it from its fixings,
- raise then tilt the shelf slightly to remove it.

There are two shelf storage options:

- either behind the rear seats,
- or flat in the boot.

2. Spare wheel / Additional storage compartments

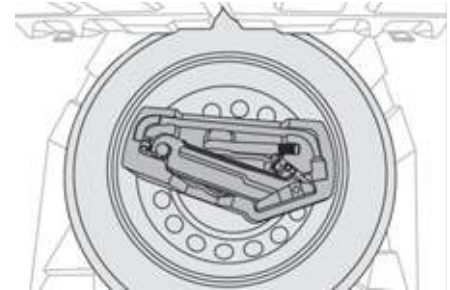

Located under the carpet and a plastic cover, this contains the tools for wheel changing and towing.

i In order to obtain additional space, the spare wheel can be removed temporarily (boot tray available as an accessory).

2 Tronic gearbox

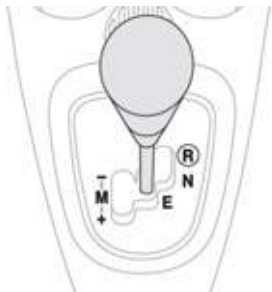

The five-speed 2 Tronic gearbox offers a choice between the ease of **automated operation** or the driving pleasure of **manual gear changing**.

Gear lever positions

Select the driving mode by moving the gear lever.



Reverse "R". This gear will be engaged when stationary or at a speed below approximately 4 mph (6 km/h).

Engagement of reverse gear is accompanied by an audible signal.



Neutral "N". Position the lever to the right in position **N**, to **start the engine**.



Easy "E": automatic gear changing.



Manual (+/-) "M": manual gear changing.

Steering mounted control paddles

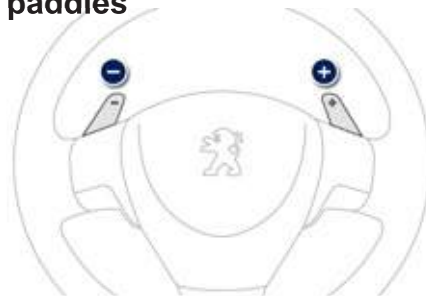

Press behind the **+** steering mounted control paddle to change up.

Press behind the **-** steering mounted control paddle to change down.

Display in the instrument panel

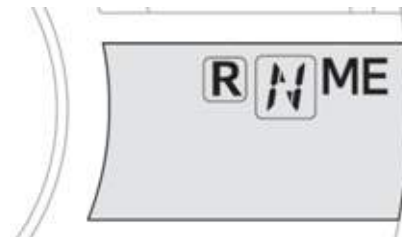

The position of the gear lever (**R**, **N**, **E** or **M**) and the gear engaged (**1** to **5**) are displayed in the instrument panel screen.

Moving off

With the parking brake applied, press the brake pedal then select position **N** to start the engine. With your foot on the brake, select position **R**, **E** or **M**.

Release the parking brake, take your foot off the brake pedal, then accelerate.

i With the engine running, in these three positions, an audible signal is heard when the driver's door is opened.

You can change from position **E** to position **M** and vice versa at any time.

Stopping - Moving off on a slope

The gearbox is an electronically controlled manual gearbox without a clutch pedal. To hold the vehicle on a slope, it is necessary to use the brake pedal or the parking brake and not the accelerator pedal. When moving off on a slope, accelerate progressively while releasing the parking brake.

EASY mode (automatic mode)

Select position **E** using the gear lever. The gear engaged is displayed in the instrument panel screen. The gearbox continuously selects the most suitable gear.

i If you press the accelerator pedal beyond the point of resistance, the 2 Tronic gearbox changes down for sharper acceleration.

Temporarily taking control of gear changes

You can temporarily take control of gear changes using the "+" and "-" steering mounted controls; if the engine speed allows, the gear change command is acted on. This function allows you to anticipate certain situations such as overtaking a vehicle or approaching a corner. After a few moments with no action on the controls, the gearbox returns to automatic control of the gears.

Manual mode

Place the gear lever in position **M**, then change up or down using:

- the gear lever, pushing:
 - rearwards, "+" to change up,
 - forwards, "-" to change down.
- or the steering mounted controls paddles.

The gear engaged is displayed on the instrument panel screen. If the engine speed is too low, the gearbox automatically changes down to prevent stalling. In the event of overheating of the clutch, position **N** is selected automatically and the symbol **N** flashes accompanied by an audible signal.

Stopping the engine

Before switching off the engine, you can change to position **N** to be in neutral. In all cases, it is essential that you apply the parking brake to immobilise the vehicle.

! On a slope, use the brake to immobilise the vehicle and place the gear lever in position **N**, **E** or **R**. Do not keep the vehicle immobilised using the accelerator.

Operating fault



With the ignition on, illumination of this warning lamp indicates a gearbox fault.

Contact a PEUGEOT dealer or a qualified workshop.



Always press the brake pedal while starting the engine.



Never select neutral **N** while the vehicle is moving. In all cases, it is essential to apply the parking brake to immobilise the vehicle.

Lighting control stalk

Front and rear lamps

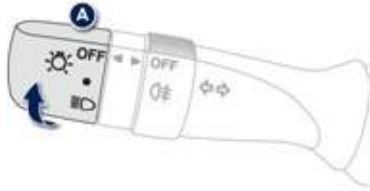

Selection is by rotation of ring A.



1. Lamps off



2. Sidelamps



3. Dipped beam / Main beam headlamps

Dipped beam / Main beam headlamps

Dipped beam headlamps: pull the stalk.

Main beam headlamps: push the stalk.

Headlamp flash

Pull the stalk fully towards you.

Lighting on audible warning

When the driver's door is opened with the ignition off, a continuous audible signal is heard if you have left your lighting on.

Front foglamps and rear foglamp

! In clear weather or in rain, both day and night, the front foglamps and the rear foglamp are dazzling and their use is prohibited.
Do not forget to switch them off when they are no longer needed.

Vehicles fitted with a rear foglamp only (ring B)

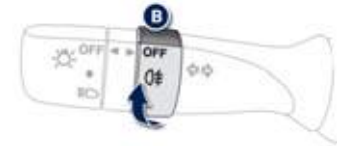

- ☞ Turn the ring B forwards to turn it on.
- ☞ Turn the ring B rearwards to switch it off.

i The rear foglamp only operates if the dipped beam / main beam headlamps are on.

Vehicles fitted with front foglamps and a rear foglamp (ring C)

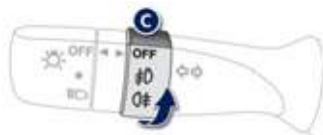

Turn the ring C :

- ☞ forwards a 1st time to switch on the front foglamps,
- ☞ forwards a 2nd time to switch on the rear foglamp,
- ☞ rearwards a 1st time to switch off the rear foglamp,
- ☞ rearwards a 2nd time to switch of the front foglamps.

- i** The front foglamps only operate if the sidelamps or dipped beam / main beam headlamps are on.
The rear foglamp only operates if the front foglamps are on.

Direction indicators



Left: stalk downwards.
Right: stalk upwards.

LED daytime running lamps*

On starting the vehicle, the LED daytime running lamps come on automatically, if the lighting stalk is in the **OFF** position.

If the sidelamps and headlamps are switched on manually or automatically, the LED lamps switch off.

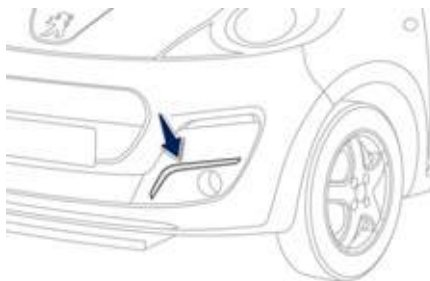

- i** To reactivate the daytime running lamps, repeat this procedure. An audible signal confirms the reactivation of the daytime running lamps.

- !** In countries where daytime running lamps are required by law, this "Daytime running lamps" function is always activated by default and must not be deactivated.

Deactivation/activation

In countries where exterior lighting by day is not a legal requirement, it is possible to deactivate the function in the following way.

- Engine stopped, lighting off and parking brake applied, switch on the ignition (key in the Running position (2nd notch)).
- Within a period of 5 seconds, turn the lighting control stalk ring **A** from the **OFF** position to the **Sidelamps** position then return to the **OFF** position three times.

An audible signal confirms the deactivation of the daytime running lamps.

* LED: light-emitting diodes.

Headlamp adjustment

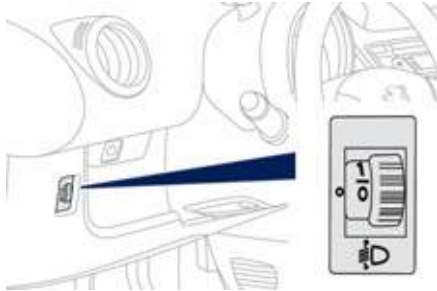

To avoid causing a nuisance to other road users, the height of the headlamps should be adjusted in relation to the load in the vehicle.

- 0.** 1 or 2 people in the front seats.
- 3 people.
- 1.** 4 people.
- 2.** 4 people + maximum authorised load.
- 3.** Driver + maximum authorised load.

The initial setting is position "0".

Courtesy lamp



In this position, it comes on on opening the driver's door.



The courtesy lamp is deactivated and is permanently off.



Permanently on.

Windscreen wiper stalk

Windscreen wiper



- MIST** Single wipe.
For a single wipe of the windscreen, push the control upwards then release it.
- OFF** Off.
- INT** Intermittent wipe.
- LO** Normal wipe (moderate rain).
- HI** Fast wipe (heavy rain).

Rear wiper and wash-wipe



Turn ring **A** to "ON" for a steady wipe.



Turn it forwards to trigger the wash during wiping.

Rear wash



Ring **A** at "OFF" (wiper off).



Turn it towards you to trigger a wash operation.

6

Windscreen wash

Pull the wipers stalk towards you.

i When using a car wash, switch off the ignition and ensure that the wiper blade is in the low position.

In winter, you are advised to wait until the windscreen has been defrosted fully before operating the windscreen wiper stalk.

Horn

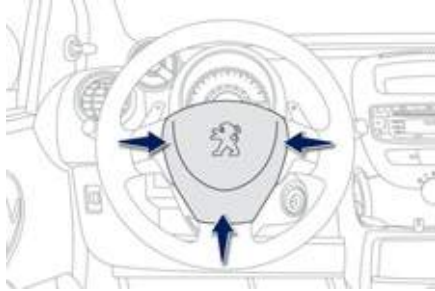

Audible warning system to alert other road users to an imminent danger.

- ☞ Press the central part of the steering wheel.

- i** Use the horn moderately and only in the following circumstances:
- immediate danger,
 -
 - approaching a location lacking visibility.

Hazard warning lamps

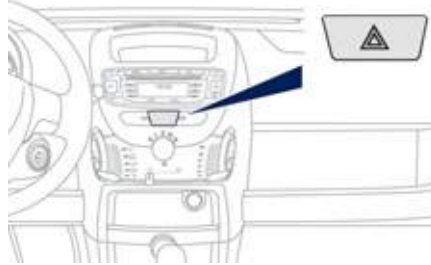

Press the button, the direction indicators flash. They can operate with the ignition off.

Parking brake

Applying

Pull the parking brake to immobilise your vehicle.

Releasing

Pull on the handle and press the button to release the parking brake.



When the vehicle is being driven, illumination of this warning lamp indicates that the parking brake is still on or has not been properly released.

! When parking on a slope, direct your wheels towards the pavement and pull the parking brake on.

Emergency braking assistance

In an emergency, this system enables you to reach the optimum braking pressure more quickly and therefore reduce the stopping distance.

It is triggered by the speed at which the brake pedal is pressed. This is felt by a reduction in the resistance of the pedal and an increase in the effectiveness of the braking.

Anti-lock braking system (ABS) and braking systems (EBFD and CSC*)

The ABS, in conjunction with the EBFD and CSC* braking systems, increases the stability and manoeuvrability of your vehicle on braking and provides improved control, in particular on poor or slippery road surfaces.

The ABS prevents wheel lock in the event of emergency braking.

The EBFD and CSC* systems provide full control of the braking pressure wheel by wheel. A distribution between:

- the front and the rear in the case of the EBFD (Electronic Brake Force Distribution),
- the left and the right in the case of the CSC* (Cornering Stability Control).

! When changing wheels (tyres), make sure that these are approved.

The anti-lock braking system comes into operation automatically when there is a risk of wheel lock.

* The CSC system is linked with the EBFD on vehicles which are not fitted with ASR/ESP systems.



When this warning lamp comes on, it indicates that there is a fault with the ABS, which could cause a loss of control of the vehicle when braking. Contact a PEUGEOT dealer or a qualified workshop.



When these warning lamps come on simultaneously, it indicates that there is a fault with the braking system or that the parking brake has not been released fully, which can cause a loss of control of the vehicle when braking.

You must stop as soon as it is safe to do so. Contact a PEUGEOT dealer or a qualified workshop.



Normal operation of the ABS may make itself felt by slight vibrations of the brake pedal.



In emergency braking, press very firmly without releasing the pressure.

Anti-slip regulation (ASR) and electronic stability programme (ESP)

These systems are linked and supplement the ABS.

The ASR system optimises drive to prevent the wheels skidding, by acting on the brakes of the driving wheels and on the engine. It also allows the directional stability of the vehicle to be improved on acceleration.

If there is a variation between the trajectory followed by the vehicle and that required by the driver, the ESP system automatically acts on the brake of one or more wheels and on the engine to put the vehicle back on course, within the limits of the laws of physics.

Operation of the ASR and ESP systems



When one of these two systems is operating, this warning lamp comes on.

Operating check



If a fault occurs with the systems, this warning lamp comes on. Contact a PEUGEOT dealer or a qualified workshop to have the systems checked.

i The ASR/ESP systems offer exceptional safety during normal driving, but this should not encourage the driver to take extra risks or drive at high speed.

Correct operation of these systems depends on observation of the manufacturer's recommendations regarding the wheels (tyres and rims), the braking components and the electronic components as well as the repair procedures use by a PEUGEOT dealer or qualified workshop. After an impact, have these systems checked by a PEUGEOT dealer or a qualified workshop.

Seat belts

Fastening/Unfastening the seat belts

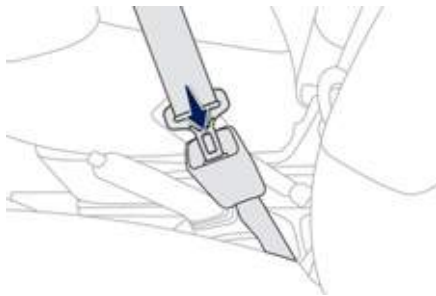

Pull the strap, then insert the buckle into the stalk.

Check that the seat belt is fastened correctly by pulling the strap.

To unfasten the seat belts, press the button on the stalk.

i Pretensioning front seat belts with force limiter

Safety in the event of front impacts has been improved by means of the introduction of pretensioning seat belts with force limiter for the front seats. Depending on the force of the impact, the pretensioning system instantly tightens the seat belts and pulls them against the body of the occupants.

The pretensioning seat belts are active when the ignition is on.

The force limiter reduces the pressure of the seat belt on the chest of the occupant, increasing their protection.

Rear seat belts

The rear seats are equipped with two three-point inertia reel seat belts.

You can store the seat belt buckles in the housing A.

3-door



5-door



Front seat belts(s) not fastened / unfastened warning lamp*

Not fastened



When the ignition is switched on, the warning lamp flashes if the driver and/or front passenger has not fastened their seat belt.

Above a speed of about 12 mph (20 km/h) and for two minutes, the warning lamp flashes accompanied by an increasing audible signal. After these two minutes, the warning lamp continues to flash but without the audible signal, if the driver and/or front passenger has not fastened their seat belt.

Unfastened



The warning lamp flashes when the driver and/or the front passenger unfastens their seat belt with the engine running.

Above a speed of about 12 mph (20 km/h) and for two minutes, the warning lamp flashes accompanied by an increasing audible signal. After these two minutes, the warning lamp continues to flash but without the audible signal, if the driver and/or front passenger has not fastened their seat belt.

* Depending on version.

! The driver must ensure that the passengers use the seat belts correctly and that they are all properly restrained before setting off.

Wherever you are seated in the vehicle, always fasten your seat belt, even for short journeys.

Do not invert the seat belt buckles as they will not fulfil their role fully.

If the seats have armrests*, the lap part of the seat belt must always pass under the armrest.

The seat belts are fitted with an inertia reel permitting automatic adjustment of the length of the strap to your size. The seat belt is stored automatically when not in use.

Before and after use, ensure that the seat belt is reeled in correctly.

The lower part of the strap must be positioned as low as possible on the pelvis.

The upper part must be positioned in the hollow of the shoulder.

The inertia reels are fitted with an automatic locking device which comes into operation in the event of a collision, on emergency braking or if the vehicle rolls over. You can release the device by pulling rapidly on the strap and releasing it.

In order to be effective, a seat belt:

- must be tightened as close to the body as possible,
- must restrain one adult only,
- must not bear any trace of cuts or fraying,
- must be pulled in front of you with a smooth movement, checking that it does not twist,
- must not be transformed or modified to avoid altering its performance.

In accordance with current safety regulations, all repairs and checks must be carried out by a PEUGEOT dealer who can guarantee that the work is carried out correctly, or qualified workshop.

Have your seat belts checked regularly by a PEUGEOT dealer or a qualified workshop and particularly if the straps show signs of damage.

Clean the seat belt straps with soapy water or a textile cleaning product, sold by PEUGEOT dealers.

After folding or moving a seat or rear bench seat, ensure that the seat belt is positioned and rolled up correctly.

Recommendations for children:

- use a suitable child seat if the passenger is less than 12 years old or shorter than one metre fifty,
- do not use the strap-guide* when a child seat is installed,
- never use the same seat belt to secure more than one person,
- never allow a child to travel on your lap.

Depending on the nature and seriousness of the impacts,

the pre-tensioning device may be triggered before and independently of the air bags. Triggering of the pre-tensioners is accompanied by a slight emission of harmless smoke and a noise, due to the activation of the pyrotechnic cartridge incorporated in the system.

In all cases, the airbag warning lamp comes on.

Following an impact, have the seat belts system checked, and if necessary replaced, by a PEUGEOT dealer or a qualified workshop.

* According to model.

Airbags

The airbags have been designed to maximise the safety of the occupants in the event of serious collisions. They work in conjunction with the force-limiting seat belts. The electronic detectors register and analyse any abrupt deceleration of the vehicle in the impact detection zones (see diagram): if the deployment threshold is reached, the airbags inflate instantly and protect the occupants of the vehicle.

Impact detection zones

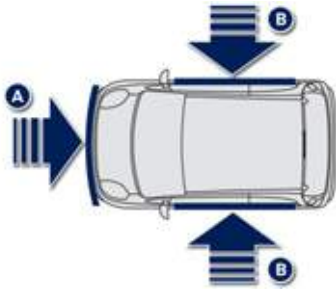

- A. Front impact zone.
- B. Side impact zone.

Immediately after the impact, the airbags deflate rapidly so that they do not hinder the visibility of the occupants nor their exit if necessary from the vehicle. The airbags are not deployed in the case of minor impacts, rear impacts or in certain roll-over conditions. The seat belt is sufficient to ensure maximum protection in these situations. The seriousness of a collision depends on the nature of the obstacle and the speed of the vehicle at the moment of the collision.

Airbags only operate when the ignition is switched on. When they are deployed, a noise is heard during inflation.

i Note: the gas escaping from the airbags can be a minor irritant.

Front airbags

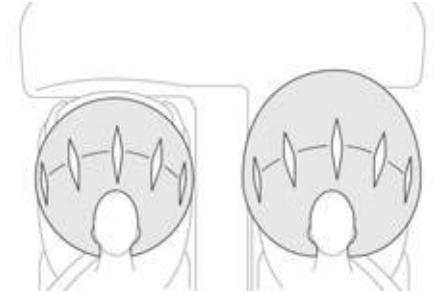

These are fitted in the centre of the steering wheel for the driver and in the dashboard for the front passenger. They are deployed simultaneously, except in cases where the passenger's airbag is deactivated, in the event of a serious front impact applied in the impact zone A in the longitudinal centreline of the vehicle, on a horizontal plane and from the front of the vehicle towards the rear. The airbag inflates between the front occupant of the vehicle and the dashboard to cushion his forward movement. The airbags therefore limit the risk of injury to the head and chest.

Front airbag fault



Flashing indicates an airbag fault, contact a PEUGEOT dealer or a qualified workshop to have the system checked. The airbags may no longer be deployed in the event of a serious impact.

Deactivating the passenger's airbag

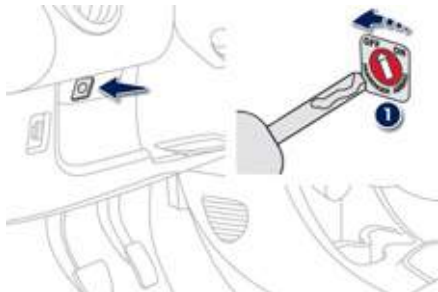

To ensure the safety of your child, it is essential to deactivate the passenger's airbag when you install a "rear-facing" child seat on the front passenger seat. Otherwise, the child would risk being seriously injured or killed if the air bag were to inflate.

☞ With the ignition switched off, insert the key into the passenger airbag deactivation switch **1**, turn it to the "OFF" position, then remove the key keeping the switch in this position.

In the "OFF" position, the passenger airbag will not be deployed in the event of an impact. As soon as the "rear-facing" child seat is removed, turn the airbag switch to the "ON" position to re-activate the airbag and thus ensure the safety of your passenger in the event of an impact.

Deactivation (check)



If the passenger airbag is deactivated, the warning lamp in the instrument panel remains on until the passenger airbag is reactivated.

Lateral airbags* and curtain airbags*

The lateral airbags are built into the front seat backs on the door side.

The deployment of these airbags requires a serious side impact applied in the side impact zone **B**, perpendicular to the longitudinal centreline of the vehicle, on a horizontal plane and from the outside of the vehicle towards the inside. The lateral airbag inflates between the front occupant of the vehicle and the door trim panel. It therefore limits the risk of injury to the chest.

The curtain airbags are built into the headlining.

The curtain airbag inflates between the front or rear occupant and the windows. It therefore limits the risk of head injuries. In the event of a minor impact or bump on the side of the vehicle or if the vehicle rolls over, the airbag may not be deployed. The airbag is not deployed in the event of a front or rear collision.

Airbag fault



Flashing indicates a fault with at least one of these airbags.

Contact a PEUGEOT dealer or a qualified workshop to have the system checked. The airbags may no longer be deployed in the event of a serious impact.

* According to version.

! For the front, lateral and curtain airbags to be fully effective, observe the following safety rules:

Wear a correctly adjusted seat belt.

Sit in a normal upright position.

Do not leave anything between the occupants and the airbags (child, animal, object...). This could hamper the operation of the airbags or injure the occupants.

All work on the airbag systems is strictly prohibited unless it is carried out by qualified personnel of the PEUGEOT dealer network or a qualified workshop.

After an accident or if the vehicle has been stolen or broken into, have the airbag systems checked.

Front airbags

Do not drive holding the steering wheel by its spokes or resting your hands on the centre part of the wheel.

Passengers must not place their feet on the dashboard.

Smoke as little as possible; deployment of the airbags can cause burns or the risk of injury from a cigarette or pipe.

Never remove or pierce the steering wheel or hit it violently.

Lateral airbags

Only put approved covers on the seats, these will not hamper the inflation of the lateral airbags. Contact a PEUGEOT dealer or a qualified workshop.

Do not fix or attach anything to the front seat backs. This could cause injury to the chest or arms when the lateral airbag inflates.

Do not sit with the upper part of the body any nearer to the door than necessary.

Curtain airbags

Do not fix or attach anything to the pillars or the roof. This could cause injury to the head when the curtain airbag inflates.

The deployment of an airbag or airbags is accompanied by a slight emission of harmless smoke and a noise due to the activation of the pyrotechnic cartridge incorporated in the system. This smoke is not harmful but sensitive individuals may experience some irritation. The detonation noise may result in a slight loss of hearing for a short time.

Even if all of the precautions mentioned are observed, injury or slight burns to the head, chest or arms when the air bag is deployed cannot be ruled out. Indeed, the bag inflates almost instantly (approximately 30 milliseconds) then deflates within the same time discharging hot gas via the openings provided for this purpose.

This equipment will only operate once. If a second impact occurs (during the same or a subsequent accident), the airbag will not inflate.

General points relating to child seats

Although one of PEUGEOT's main criteria when designing your vehicle, the safety of your children also depends on you.

- i** For maximum safety, please observe the following recommendations:
- in accordance with European regulations, **all children under the age of 12 or less than one and a half metres tall must travel in approved child seats suited to their weight**, on seats fitted with a seat belt or ISOFIX mountings*,
 - statistically, **the safest seats in your vehicle for carrying children are the rear seats**,
 - a child weighing less than 9 kg must travel in the "rearwards-facing" position both in the front and in the rear.

PEUGEOT recommends that children should travel in the **rear seats** of your vehicle:

- "rearwards-facing" up to the age of 2,
- "forwards-facing" over the age of 2.

Child seat in the front

"Rearwards-facing"

! When a "rearwards-facing" child seat is installed on the **front passenger seat**, it is essential that the passenger airbag is deactivated. Otherwise, **the child would risk being seriously injured or killed if the airbag were to inflate.**



"Forwards-facing"

When a "forwards-facing" child seat is installed on the **front passenger seat**, adjust the vehicle's seat to the intermediate longitudinal position with the seat back upright and leave the passenger airbag activated.



Intermediate longitudinal position

* The rules for carrying children are specific to each country. Refer to the current legislation in your country.

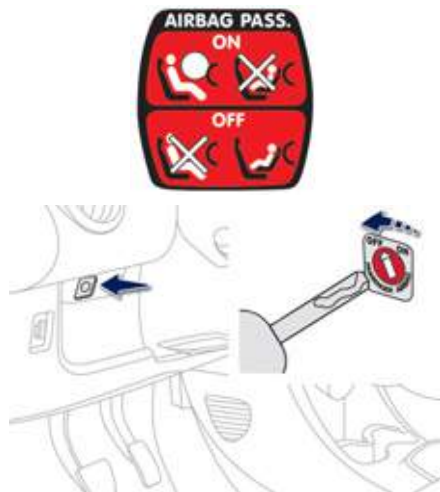

Passenger airbag OFF



Refer to the advice given on the label present on both sides of the passenger's sun visor.

! To assure the safety of your child, you must deactivate the passenger's front airbag when you install a child seat in the rearwards facing position on the front passenger's seat. Otherwise, there is a risk that the child could be seriously injured or killed if the airbag were deployed.

Child seats recommended by PEUGEOT

PEUGEOT offers a complete range of recommended child seats which are secured using a **three point seat belt**:

Group 0+: from birth to 13 kg	Groups 1, 2 and 3: from 9 to 36 kg
 <p>L1 "RÖMER Baby-Safe Plus" Installed in the rearwards-facing position.</p>	 <p>L2 "KIDDY Comfort Pro" The impact shield must be used for carrying young children (from 9 to 18 kg).</p>
Groups 2 and 3: from 15 to 36 kg	
 <p>L3 "RECARO Start".</p>	 <p>L4 "KLIPPAN Optima" From the age of 6 years (approximately 22 kg), the booster is used on its own.</p>
	<p>L5 "RÖMER KIDFIX" Can be fitted to the vehicle's ISOFIX mountings. The child is restrained by the seat belt.</p>

Locations for child seats attached using the seat belt

In accordance with European regulations, this table indicates the options for installing child seats secured using a seat belt and universally approved in accordance with the weight of the child and the seat in the vehicle.

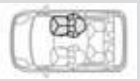
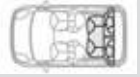
Weight of the child and indicative age					
Seat		Under 13 kg (groups 0 (a) and 0+) Up to 1 year approx	From 9 to 18 kg (group 1) 1 to 3 years approx	From 15 to 25 kg (group 2) 3 to 6 years approx	From 22 to 36 kg (group 3) 6 to 10 years approx
Front passenger seat (b)		L1	X	L3, L4	L3, L4
Rear seats		U	U	U	U

a: Group 0: from birth to 10 kg. Infant car seats and "car cots" cannot be installed on the front passenger seat.

b: consult the legislation in force in your country before installing your child on this seat.

U: seat suitable for the installation of a universally approved child seat secured using a seat belt, "rear facing" and/or "forward facing".

L_: only the child seats indicated and recommended by PEUGEOT can be installed on the seat concerned (according to country).

X: seat not suitable for fitting a child seat of the weight group indicated.

! Advice on child seats

The incorrect installation of a child seat in a vehicle compromises the child's protection in the event of an accident. Remember to fasten the seat belts or the child seat harness **keeping the slack** in relation to the child's body **to a minimum**, even for short journeys.

To install a child seat using the vehicle's seat belt, ensure that the belt is well tightened on the child seat and that it holds the child seat firmly against the vehicle's seat.

For optimum installation of the "forward facing" child seat, ensure that the back of the child seat is in contact with the back of the vehicle's seat and that the head restraint does not cause any discomfort.

If the head restraint has to be removed, ensure that it is stored or attached securely to prevent it from being thrown around the vehicle in the event of sharp braking.

Children under the age of 10 must not travel in the "forward facing" position on the front passenger seat, unless the rear seats are already occupied by other children, cannot be used or are absent.

Deactivate the passenger airbag* when a "rear facing" child seat is installed on the front seat.

Otherwise, the child would risk being seriously injured or killed if the airbag were to inflate.

Installing a booster seat

The chest part of the seat belt must be positioned on the child's shoulder without touching the neck.

Ensure that the lap part of the seat belt passes correctly over the child's thighs.

PEUGEOT recommends the use of a booster seat which has a back, fitted with a seat belt guide at shoulder level.

As a safety precaution, do not leave:

- one or more children alone and unsupervised in a vehicle,
- a child or an animal in a vehicle which is exposed to the sun, with the windows closed,
- the keys within reach of children inside the vehicle.

To protect young children from the rays of the sun, fit side blinds on the rear windows.

* According to country.

"ISOFIX" mountings

Your vehicle has been approved in accordance with the **new ISOFIX regulation**.

The seats*, represented below, are fitted with regulation ISOFIX mountings:

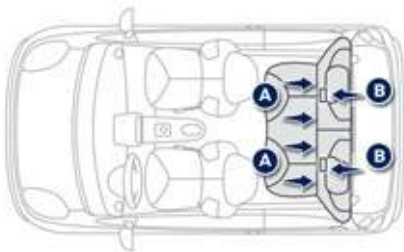

These are three rings for each seat:

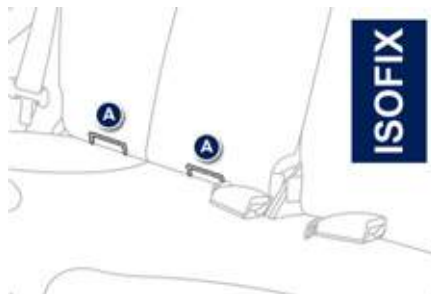

- two lower rings **A**, located between the vehicle seat back and cushion, indicated by a label,

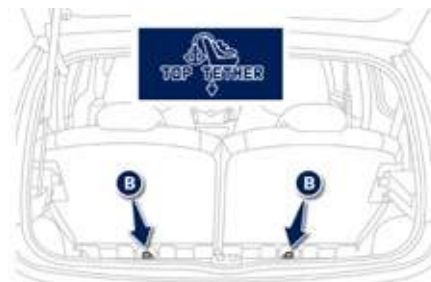

- an upper ring **B** for securing the upper strap, referred to as the **TOP TETHER**, indicated by a marking on the rear seat back panel.

This ISOFIX mounting system provides fast, reliable and safe fitting of the child seat in your vehicle.

The **ISOFIX child seats** are fitted with two latches which are secured easily on these lower rings **A**.

Some also have an **upper strap** which is attached to the upper ring **B**.

To attach this strap, raise the vehicle seat's head restraint then pass the hook between its rods. Then fix the hook on the upper ring **B** and tighten the upper strap.

! The incorrect installation of a child seat in a vehicle compromises the child's protection in the event of an accident.

i For information regarding the ISOFIX child seats which can be installed in your vehicle, refer to the table of locations for ISOFIX child seats.

* Depending on version.

ISOFIX child seats recommended by PEUGEOT and approved for your vehicle

FAIR Bimbofix ISOFIX (size category: C or A)

Group 0/1: up to 18 kg



Can be installed facing forward or rearward using an ISOFIX base which is attached to the rings **A** and includes a stay which extends down to the floor of the vehicle.

6 seat body angle positions.

Can be installed facing forward, attached to the seat using a three-point seat belt.

RÖMER Duo Plus ISOFIX (size category B1)

Group 1: from 9 to 18 kg



Is installed in the forward-facing position.

Is attached to the rings **A** and the upper ring **B**, referred to as the Top Tether, using an upper strap.

Three seat body angles: sitting, reclining, lying down.

Can be installed facing forward, attached to the seat using a three-point seat belt.

i Follow the instructions for fitting child seats contained in the seat manufacturer's installation guide.

Locations for ISOFIX child seats

Weight of the child / indicative age											
	Less than 10 kg (group 0) Up to 6 months approx		Less than 10 kg (group 0) Less than 13 kg (group 0+) Up to 1 year approx			From 9 to 18 kg (group 1) From 1-3 years approx					
Type of ISOFIX child seat	Infant carrier*		"rear facing"			"rear facing"		"forward facing"			
ISOFIX size category	F	G	C	D	E	C	D	A	B	B1	
Universal ISOFIX child seats which can be installed on the rear seats	X		X		X	X	X	IUF IL-SU			

In accordance with the European regulation, this table indicates the options for the installation of ISOFIX child seats on the vehicle seats fitted with ISOFIX mountings.

In the case of the universal and semi-universal ISOFIX child seats, the child seat's ISOFIX size category, determined by a letter **A, B, B1, C, D, E, F, G**, is indicated on the child seat next to the ISOFIX logo.

IUF: seat approved for a Universal Isofix seat, "Forward facing" with the "Top Tether" upper strap.

IL-SU: seat suitable for the installation of a semi-universal ISOFIX seat, that is:

- "rear facing" fitted with an upper strap or a support
- "forward facing" fitted with a support
- an infant carrier fitted with an upper strap or a support.

X: seat not suitable for the installation of an ISOFIX child seat of the size category indicated.

* The ISOFIX infant car seat is fixed to the lower rings of an ISOFIX seat and occupies the two rear seats.

Changing a wheel

Parking the vehicle

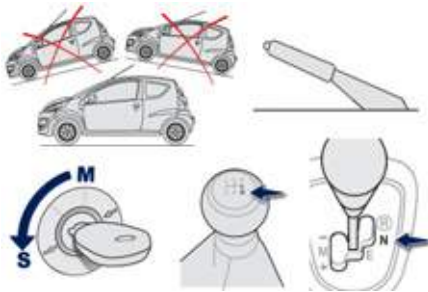

- ☞ As far as possible, immobilise the vehicle on level, stable, non-slippery ground.
- ☞ Apply the parking brake, switch off the ignition and engage first gear or reverse for the manual gearbox, position **N** for the 2 Tronic gearbox.

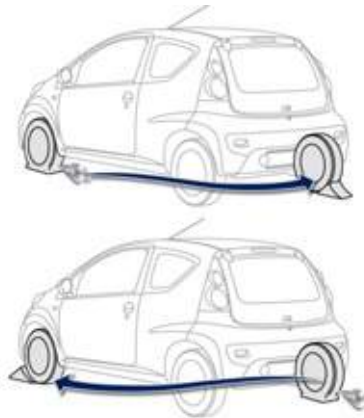

- ☞ If necessary, chock the wheel diagonally opposite the wheel to be changed.
- ☞ You must ensure that the occupants leave the vehicle and wait in a safe location.

Access to the spare wheel and the jack in the boot

- ☞ Remove the carpet then the plastic cover using the handle.

Tools

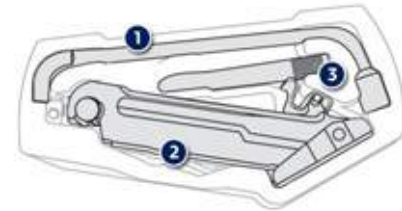

The following tools are installed in a carrier, located in the centre of the spare wheel:

1. Wheelbrace
2. Jack with handle
3. Removable towing eye

Tyre pressures

These are indicated on the label positioned on the inner pillar of the left door, see "Identification markings".

Removing the wheel

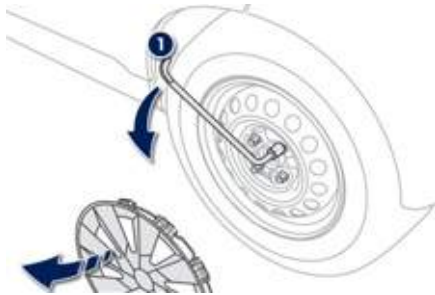

1. Remove the trim.
2. Slacken the wheel bolts using the wheelbrace 1.

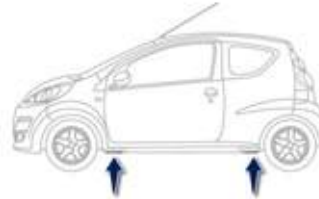

3. Place the jack 2 in contact with one of the four locations A provided on the underbody, the one closest to the wheel to be changed.
4. Extend the jack 2 until its base is in contact with the ground. Ensure that the centreline of the jack base is directly below the location A used.
5. Lift the vehicle.
6. Remove the bolts and detach the wheel.

Refitting the wheel



1. Position the wheel.
2. Screw in the bolts fully by hand.



3. Pre-tighten the bolts* using the wheelbrace 1.
4. Fold the jack 2 and detach it.

* If your vehicle is fitted with alloy wheels, when tightening the bolts it is normal to notice that the washers do not come into contact with the spare wheel. It is still fixed securely.

Changing a bulb

Front lamps

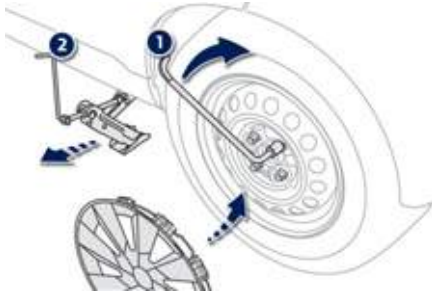

5. Tighten the wheel bolts using the wheelbrace 1.
6. Refit the trim.
7. Store the tools and the wheel in the boot.

! Never go underneath a vehicle supported only by a jack (use an axle stand). The jack and the tool kit are specific to your vehicle. Do not use them for other purposes.

i After changing a wheel:

- have the tightness of the bolts and the pressure of the spare wheel checked as soon as possible,
- have the punctured wheel repaired and refit it on the vehicle as soon as possible.

Contact a PEUGEOT dealer or a qualified workshop.

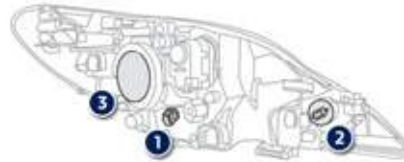
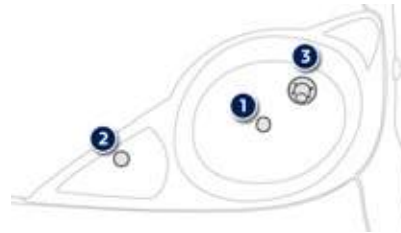

1. Sidelamps
2. Direction indicators
3. Dipped beam / Main beam headlamps

1. Sidelamps (W5 W)

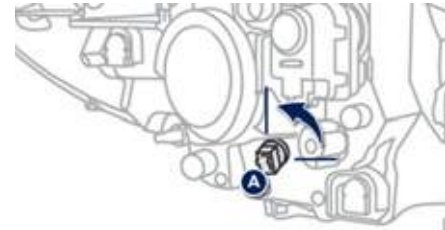

- ☞ Turn the bulb holder **A** one quarter of a turn and remove it.
- ☞ Remove the bulb and change it.

i In certain climatic conditions (low temperatures, humidity), **the presence of condensation on the internal surface of the headlamps is normal**; it disappears a few minutes after the lighting is switched on.

2. Direction indicators (PY 21 W amber)

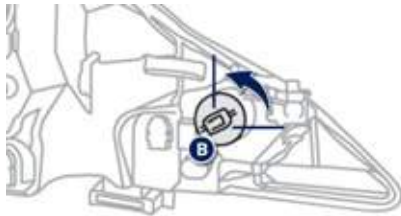

- ☞ Turn the bulb holder **B** one quarter of a turn and remove it.
- ☞ Turn the bulb one quarter of a turn.
- ☞ Remove the bulb and change it.

If you encounter any difficulties, contact a PEUGEOT dealer or a qualified workshop.

3. Dipped / Main beam headlamps (H4 - 60/55W)

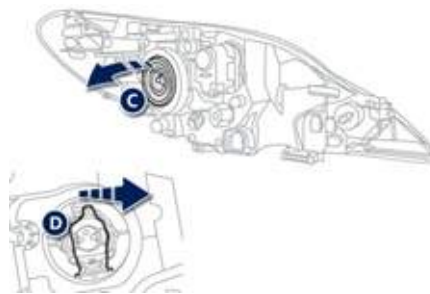

- ☞ Disconnect the connector.
- ☞ Remove the rubber cap **C**.
- ☞ Push the side of the tongue **D**.
- ☞ Remove the bulb holder and change the bulb.
- ☞ Refit the bulb holder, the tongue then the rubber cap.

If you encounter any difficulties, contact a PEUGEOT dealer or a qualified workshop.

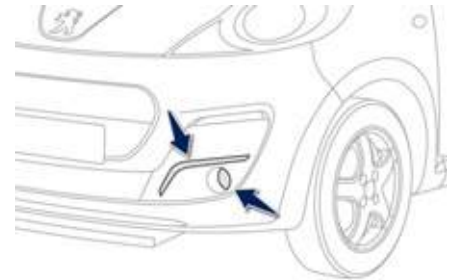

LED daytime running lamps

For the replacement of these lamps, contact a PEUGEOT dealer or qualified workshop.

Front foglamps

For replacement of these bulbs, contact a PEUGEOT dealer or a qualified workshop.

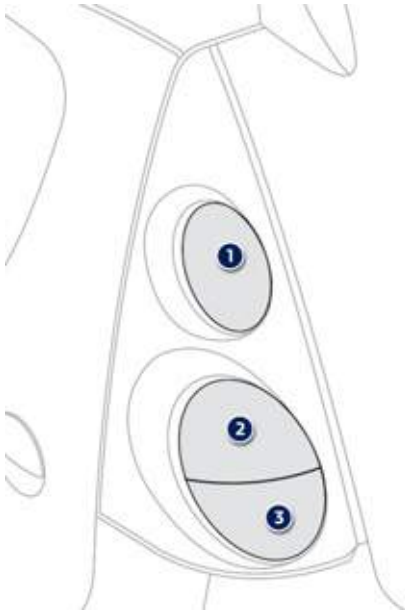

Rear lamps

1. Brake lamps / sidelamps (P 21/5 W)
2. Direction indicators (P 21 W)
3. Reversing lamp (P 21 W, near side Foglamp (P 21 W), offside

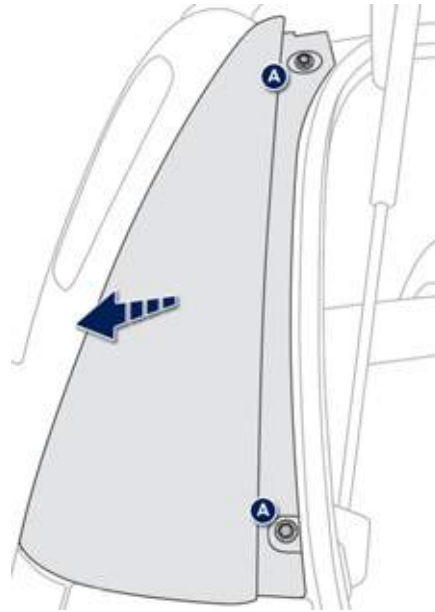

These 3 bulbs are changed by removing the lamp unit:

- ☞ open the boot,
- ☞ unscrew the two lamp fixing nuts **A**,
- ☞ remove the lamp unit by pulling outwards,
- ☞ unclip the harness,

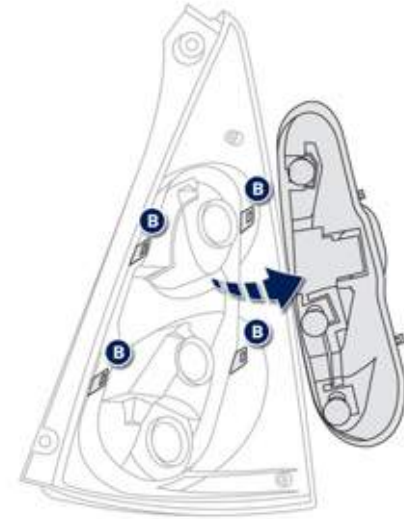

- ☞ remove the bulb holder by spreading the four tongues **B**,
- ☞ remove the bulb and change it.

When refitting, proceed in the reverse order and take care to position the bulb holder, the tongues and the lamp unit correctly.

Number plate lamps (W 5 W)

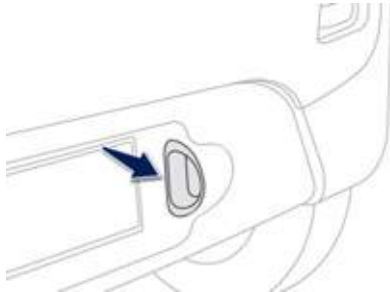

- ☞ Pass your hand under the bumper.
- ☞ Remove the bulb holder turning it one quarter of a turn.
- ☞ Remove the bulb and change it.

Third brake lamp (Four W 5 W bulbs)

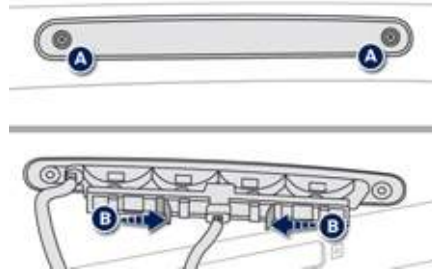

- ☞ Unscrew the 2 fixing screws **A**.
- ☞ Release the lamp unit by pushing the two tabs **B** inwards.
- ☞ Disconnect the connector and the rear screen wash pipe.
- ☞ Remove the bulb holder.
- ☞ Remove the bulb and change it.

When refitting, proceed in the reverse order and ensure that the lamp unit seal and the rear screen wash pipe have been put back in place correctly.

Direction indicator side repeaters (WY 5 W amber)

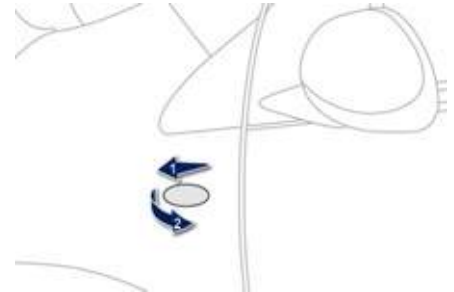

- ☞ Push the repeater forwards or rearwards and detach it by pulling towards you.
- ☞ Disconnect the bulb holder and change it.

! Do not tighten the screws more than is necessary, to avoid the risk of breaking the lamp.

Changing a fuse

The fuseboxes are located under the instrument panel trim and next to the battery in the engine compartment.

Removing and fitting a fuse

Before changing a fuse, the cause of the incident must be found and rectified.

- ☞ Use the tweezer **A** located in the fusebox under the bonnet.

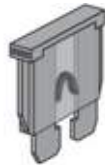

Good



Failed

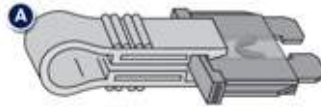

Tweezer A

- ! Always replace a failed fuse with a fuse of the same rating (same colour).

Instrument panel fuseboxes



These are located on each side of the instrument panel under the trim.

- ☞ If necessary, unlock the steering using the key.
- ☞ Turn the steering wheel to the left, remove bolt **B**.



- ☞ Turn the steering wheel to the right, remove bolt **C**.

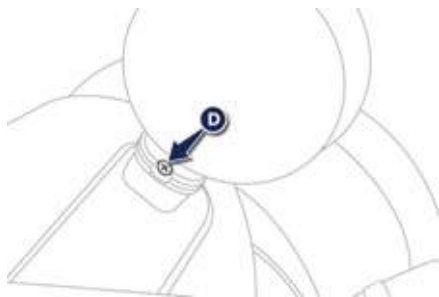

☞ For the rev counter, partially unscrew bolt **D** located behind it.

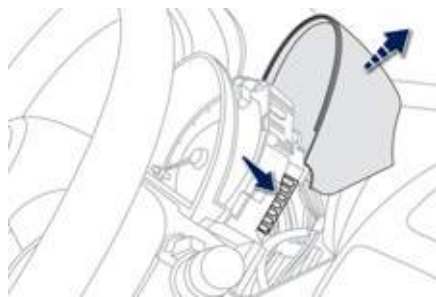

☞ Raise the instrument panel trim, and the rev counter trim if necessary, to gain access to the fuses located on the left and on the right.

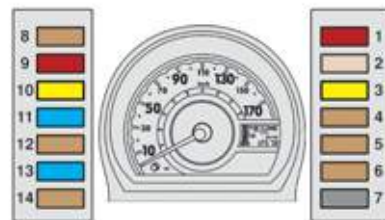

Fuse N°	Rating (A)	Functions
1	10	Brake lamps - ABS - 2 Tronic gearbox
2	25	Central locking/unlocking - Remote control
3	20	Rear screen demisting
4	7.5	Rear lamps - Number plate lamps - Instrument panel - Screen - headlamp adjustment - LED daytime running lamps - Sidelamps
5	7.5	Diagnostic socket
6	7.5	2 Tronic gearbox - Rear foglamp - ESP - LED daytime running lamps - Instrument panel - Rev counter
7	-	Not used
8	7.5	ABS/ESP - Power steering - Fan assembly
9	10	Reversing lamps - Central locking/unlocking - Electric windows - Rear screen demisting - Speedometer - Air conditioning - Heating - Rev counter - Remote control
10	20	Front and rear wipers and screenwash
11	15	Audio equipment - 12 V socket (120 W max)
12	7.5	Heated rear screen - ABS - Fan assembly - Front and rear wipers and screenwash - Power steering - Central locking/unlocking - Air conditioning - Heating - Electric windows - Speedometer - Rev counter - Remote control - Reversing lamp
13	15	Airbag - Fuel injection system - 2 Tronic gearbox - Instrument panel - Rev counter - LED daytime running lamps
14	7.5	Air conditioning - Heating
15*	40	Audio system - 12 V socket - Front and rear wipers - Power steering - ABS/ESP - Cooling fan assembly
16*	30	Electric windows
17*	40	Air conditioning - Heating

* Fuses located behind the instrument panel. To change them, contact a PEUGEOT dealer or a qualified workshop.

Engine compartment fusebox

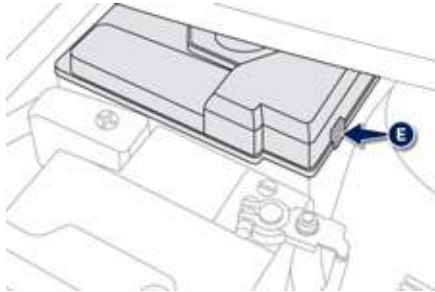

☞ Unclip the cover, pressing on the right on lug **E**, to gain access to the fuses.

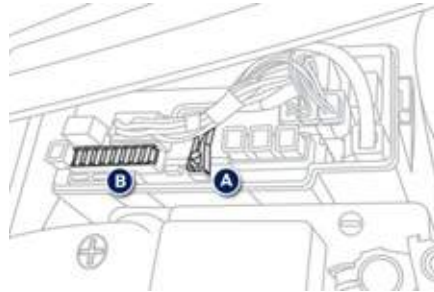

The tweezers **A** and the replacement fuses **B** are fixed at the front of the box.

i When you have finished, close the cover very carefully.



! Your vehicle's electrical system is designed to operate with standard or optional equipment. Before installing other electrical equipment or accessories on your vehicle, contact a PEUGEOT dealer or a qualified workshop.

Some electrical accessories or the way in which they are fitted may have an adverse effect on the operation of your vehicle (audio circuits, control circuit and electrical charging circuit).

PEUGEOT will not accept any responsibility for the costs incurred in repairing your vehicle or for the malfunctions resulting from the installation of auxiliary accessories which were not supplied or recommended by PEUGEOT and which were not installed in accordance with its instructions, in particular in the case of any equipment the consumption of which exceeds 10 milliamps.

Fuse N°	Rating (A)	Functions
1	5	LED daytime running lamps
2	20	Front foglamps
3	10	Left hand front lamp
4	10	Right hand front lamp
5	7.5	2 Tronic gearbox - Fuel injection system
6	7.5	2 Tronic gearbox - Fuel injection system
7	30	LED daytime running lamps - Front foglamps
8	25	ABS
	30	ABS/ESP (with VSC)
9	30	Starter motor - Heated rear screen - ABS - Cooling fan assembly - Front and rear wipers and screenwash - Power steering - Central locking/unlocking - Air conditioning - Heating - Electric windows - Speedometer - Rev counter - Remote control - Reversing lamp - Airbag - Fuel injection system - 2 Tronic gearbox - Instrument panel - LED daytime running lamps

Fuse N°	Rating (A)	Functions
10	10	Hazard warning lamps - Instrument panel - Rev counter - Direction indicators
11	20	Left hand front lamp - Right hand front lamp
12	15	Courtesy lamp - Speedometer - Audio system - Instrument panel - Rev counter
13	15	Fuel injection system - Cooling fan assembly
14	10	Horn
15	7.5	Replacement fuse
16	10	Replacement fuse
17	15	Replacement fuse
18	50	2 Tronic gearbox
19	30 /40	Cooling fan assembly
20	40	ABS
	50	ABS/ESP (with VSC)
21	50	Power steering

Battery

Procedure for charging your battery when it is flat or for starting the engine using another battery.

Access to the battery

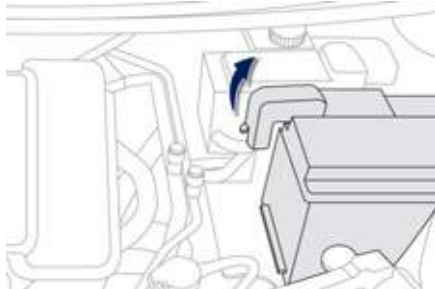

The battery is located under the bonnet.

To gain access to it:

- ☞ open the bonnet using the interior release lever, then the exterior safety catch,
- ☞ secure the bonnet stay,
- ☞ remove the plastic cover on the (+) terminal.

Starting using another battery

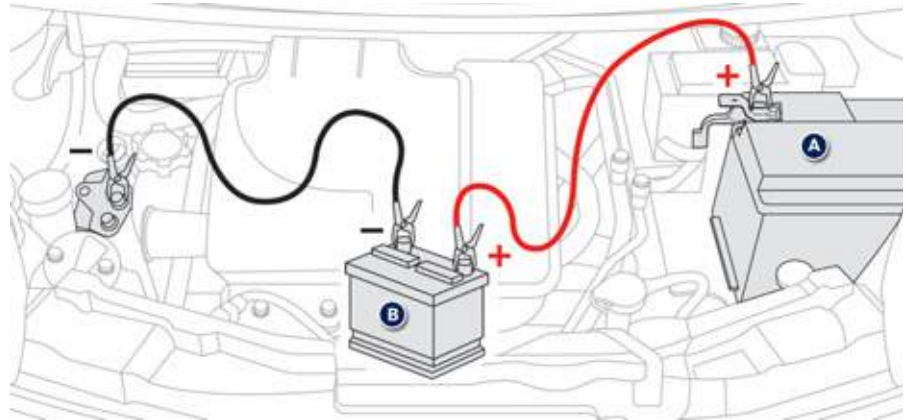

- ☞ Connect the red cable to the positive terminal (+) of the flat battery **A**, then to the positive terminal (+) of the slave battery **B**.
- ☞ Connect one end of the green or black cable to the negative terminal (-) of the slave battery **B**.
- ☞ Connect the other end of the green or black cable to the earth point **C** on your vehicle (engine mounting).
- ☞ Operate the starter, let the engine run.
- ☞ Wait until the engine returns to idle and disconnect the cables.

Charging the battery using a battery charger

- ☞ Disconnect the battery from the vehicle.
- ☞ Follow the instructions for use provided by the manufacturer of the charger.
- ☞ Connect the battery starting with the negative terminal (-).
- ☞ Check that the terminals and connectors are clean. If they are covered with sulphate (whitish or greenish deposit), remove them and clean them.



The batteries contain harmful substances such as sulphuric acid and lead. They must be disposed of in accordance with regulations and must not, in any circumstances, be discarded with household waste. Take used remote control batteries and vehicle batteries to a special collection point.



It is advisable to disconnect the battery if the vehicle is to be left unused for more than one month.



Do not reverse the polarity and use only a 12 V charger.
Do not disconnect the terminals while the engine is running.
Do not charge the batteries without disconnecting the terminals first.



Do not push the vehicle to start the engine if you have a 2 Tronic gearbox.

Before disconnecting the battery

Wait 2 minutes after switching off the ignition before disconnecting the battery.

Close the windows and the doors before disconnecting the battery.

Following reconnection of the battery

Following reconnection of the battery, switch on the ignition and wait 1 minute before starting to permit initialisation of the electronic systems. However, if problems remain following this operation, contact a PEUGEOT dealer or a qualified workshop.

Referring to the corresponding section, you must yourself reinitialise:

- the remote control key,
- the audio system.

Mat*

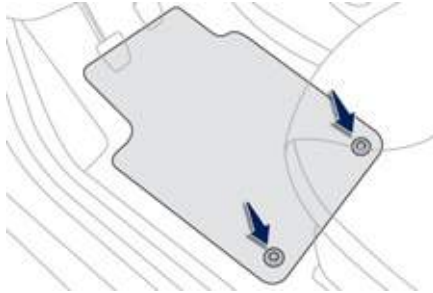

When removing the mat on the driver's side, push the seat as far back as possible and remove the two fixings.

When refitting, position the mat correctly on the pins and clip the fixings. Check that the mat is secured correctly.

To prevent the mat from becoming caught under the pedals:

- only use mats suited to the fixings already present in the vehicle. It is imperative that these fixings be used.
- never fit one mat on top of another.

* According to version.

Fitting audio equipment

Your vehicle is equipped with certain factory-fitted audio equipment:

- roof aerial,
- coaxial aerial cable,
- basic interference suppression,
- wiring for front speakers,
- two 8-way connectors.



Fitting speakers

The factory-fitted equipment allows the fitting of 100 mm diameter speakers on the dashboard.

As accessories, you can fit 165 mm diameter speakers on the rear shelf.

Making the connections

A1: -

A2: -

A3: -

A4: (+) Accessories

A5: -

A6: (+ve) Sidelamps

A7: (+ve) Permanent

A8: Earth

B1:

B2:

B3: (+) Front right speaker

B4: (-) Front right speaker

B5: (+) Front left speaker

B6: (-) Front left speaker

B7:

B8:

! Consult a PEUGEOT dealer or a qualified workshop before installing audio equipment or speakers in your vehicle.

Towing the vehicle

! Your vehicle can only be towed at the front.

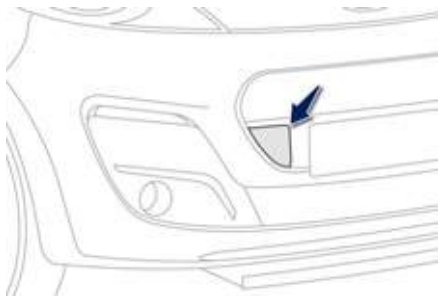

- ☞ Take the removable towing eye stowed in the spare wheel, under the boot carpet.
- ☞ Unclip the plastic cover.
- ☞ Fully screw in the towing eye.

- ☞ Install the towing bar.
- ☞ Put the gear lever into neutral (position **N** for the 2 Tronic gearbox).

! Failure to observe this instruction may lead to damage to certain components (braking, transmission, ...) and the absence of braking assistance when the engine is started.

- ☞ Unlock the steering by turning the key to the first position and release the parking brake.
- ☞ Switch on the hazard warning lamps on both vehicles.

! **Never use the radiator crossmember.**
Towing with four wheels on the road must be carried out at very low speed over a very short distance (in accordance with the legislation in force). In all other cases, your vehicle must be transported on a trailer.

i General recommendations

Observe the legislation in force in your country.

Ensure that the weight of the towing vehicle is higher than that of the towed vehicle.

The driver must stay at the wheel of the towed vehicle.

Driving on motorways and fast roads is prohibited when towing.

When towing a vehicle with all four wheels on the ground, always use an approved towing bar; rope and straps are prohibited.

When towing a vehicle with the engine off, there is no longer any power assistance for braking or steering.

In the following cases, you must always call on a professional recovery service:

- vehicle broken down on a motorway or fast road,
- when it is not possible to put the gearbox into neutral, unlock the steering, or release the parking brake,
- towing with only two wheels on the ground,
- where there is no approved towing bar available...

Fitting roof bars

When fitting transverse roof bars, use the accessories recommended by PEUGEOT and follow the manufacturer's fitting instructions. For more information, contact a PEUGEOT dealer or a qualified workshop.

Maximum weight authorised on the bars, for a loading height not exceeding 40 cm (except bicycle carrier): 50 kg.

If the height exceeds 40 cm, adapt the speed of the vehicle to the profile of the road to avoid damaging the roof bars.

i Please refer to national legislation in order to comply with the regulations concerning the transportation of objects which are longer than the vehicle.

Accessories

A wide range of accessories and genuine parts is available from the PEUGEOT dealer network. These accessories and parts have been tested and approved for reliability and safety.

They are all adapted to your vehicle and benefit from PEUGEOT's recommendation and warranty.

"Comfort": front and rear parking sensors, portable ashtray, glove box lid, insulated module, centre armrest, portable reading lamp, door deflectors, sun blinds, ...

"Transport solutions": boot liner, transverse roof bars, bicycle carrier, ski carrier, rigid and soft roof boxes, boot carpet, boot dividers, boot net, ...

You can obtain "Van" conversion kits to convert a private vehicle to a van*.

"Styling": 14 inch wheel trims, 14 and 15 inch alloy wheels, spoiler, "aluminium" interior styling kit, aluminium look and carbon fibre look mirror shells, aluminium look and carbon fibre look sill finishers, chromed exhaust tailpipe, leather steering wheel, aluminium look and carbon fibre look rear diffuser, styling stickers, door sill protectors, aluminium gear knob, "Cristal" rear lamps...

"Security and safety": anti-theft alarm, security wheel bolts, snow chains and wheel non-skid covers, high visibility vest, warning triangle, breathalyzer, child seats, first aid kit, fire extinguisher, foglamp kit, seat belt for an animal, cage for an animal...

"Protection": mats, seat covers, front and rear mudflaps, protective side rubbing strips, boot sill protector, car cover, translucent front and rear bumper protectors, rear seat cover, boot cover...

To prevent the mat from becoming caught under the pedals:

- ensure that the mat is positioned and secured correctly,
- never fit one mat on top of another.

"Multimedia": semi-integrated navigation systems, USB Box, audio systems, speakers, rear parcel shelf with speakers, Bluetooth hands-free system, hands free kit for smart phone, speed camera detector, video pack (DVD player + 2 screens) auxiliary cable for audio equipment, iPod dock, Hi-Fi module, mobile phone charger compatible with iPhone, head-up display, rear multi-media support, Wi-Fi on board, ...

* France only.

Installation of radio communication transmitters

Before installing any after-market radio communication transmitter, you can contact a PEUGEOT dealer for the specification of transmitters which can be fitted (frequency, maximum power, aerial position, specific installation requirements), in line with the Vehicle Electromagnetic Compatibility Directive (2004/104/EC).

! Depending on the legislation in force in the country, it may be compulsory to have a high visibility safety vest, warning triangle and spare bulbs and fuses available in the vehicle. The fitting of electrical equipment or accessories which are not recommended by PEUGEOT may result in a failure of your vehicle's electronic system and excessive electrical consumption. Please note this precaution. You are advised to contact a PEUGEOT representative to be shown the range of recommended equipment and accessories.

PEUGEOT & TOTAL

Partners in performance and protection of the environment

Innovation at the service of performance

The TOTAL Research and Development teams develop lubricants for PEUGEOT which satisfy the requirements of the latest technical innovations incorporated in PEUGEOT vehicles.

This ensures that you obtain the best performance and the maximum engine life.

Reduced exhaust emissions

TOTAL lubricants are formulated to optimise the efficiency of engines and the protection of the emissions post-treatment systems. It is crucial to observe the servicing recommendations made by PEUGEOT to ensure correct operation.



PEUGEOT RECOMMENDS TOTAL



PEUGEOT



TOTAL

OFFICIAL PARTNERS

10

Opening the bonnet



On the inside: pull the release lever **A**, located under the dashboard.

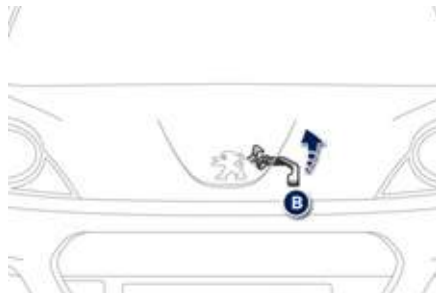

On the outside: lift the safety catch **B** and raise the bonnet.

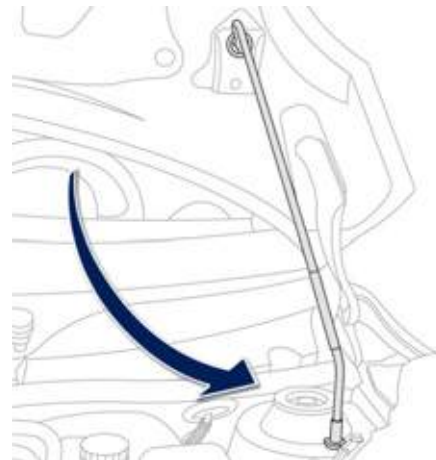

Bonnet stay

Secure the stay to hold the bonnet open.

To close

Before closing the bonnet, return the stay to its housing.
Lower the bonnet and release it at the end of its travel. Check that the bonnet is fully closed.

Engine

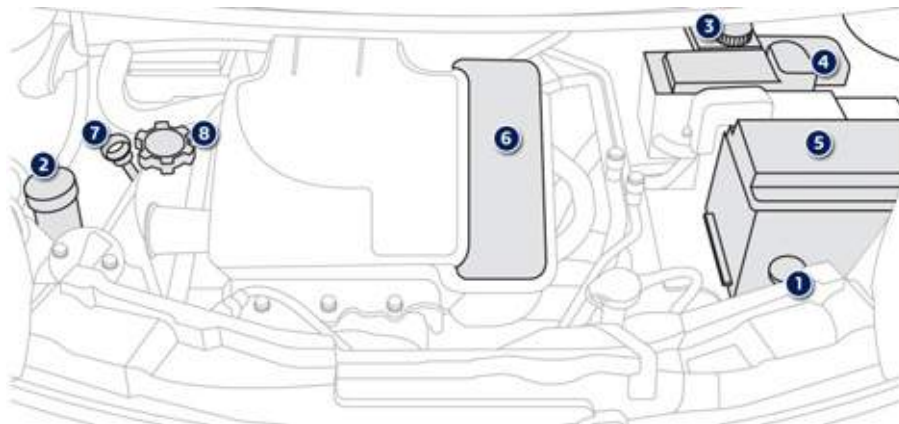

1. Coolant header tank
2. Screenwash fluid reservoir
3. Brake fluid reservoir
4. Fusebox
5. Battery
6. Air filter
7. Engine oil dipstick
8. Engine oil filler cap

Checking levels

If a level drops significantly, have the corresponding system checked by a PEUGEOT dealer or a qualified workshop.

Check all of these levels regularly and top them up if necessary, unless otherwise indicated.

! Take care when working under the bonnet, as certain areas of the engine may be extremely hot (risk of burns).

Oil level

The check is carried out either when the ignition is switched on using the oil level indicator on the instrument panel, or using the dipstick.

This manual check will only be correct if the vehicle is on level ground and the engine has been off for more than 30 minutes.

i It is normal to top up the oil level between two services (or oil changes). PEUGEOT recommends that you check the level, and top up if necessary, every 3 000 miles (5 000 kms).

After topping up the oil, the check when switching on the ignition with the oil level indicator in the instrument panel is not valid during the 30 minutes after topping up.

Engine oil change

Refer to the servicing booklet for details of the interval for this operation.

In order to maintain the reliability of the engine and emission control system, the use of additives in the engine oil is prohibited.

Oil specification

The oil must be the correct grade for your engine and conform to the manufacturer's recommendations.

Dipstick



There are two marks on the dipstick:

A = maximum

If you fill past this mark, contact a PEUGEOT dealer or a qualified workshop.

B = minimum

Never allow the level to fall below this mark.

Brake fluid level

The brake fluid level should be close to the "MAX" mark. If it is not, check the brake pad wear.

Changing the fluid

Refer to the servicing booklet for details of the interval for this operation.

Fluid specification

The brake fluid must conform to the manufacturer's recommendations and meet the DOT4 standard.

Coolant level

The coolant level should be close to the "MAX" mark but should never exceed it.

When the engine is warm, the temperature of the coolant is regulated by the fan. This can operate with the ignition off.

In addition, as the cooling system is pressurised, wait at least one hour after switching off the engine before carrying out any work.

To avoid any risk of scalding, unscrew the cap by two turns to allow the pressure to drop.

When the pressure has dropped, remove the cap and top up the level.

Changing the coolant

The coolant does not have to be changed.

Fluid specification

The coolant must conform to the manufacturer's recommendations.

Screenwash fluid level

Top up the level when necessary.

Fluid specification

For optimum cleaning and to avoid freezing, this fluid must not be topped up or replaced with plain water.

Used products

Avoid prolonged contact of used oil or fluids with the skin.

Most of these fluids are harmful to health or indeed very corrosive.



Do not discard used oil or fluids into sewers or onto the ground.

Take used oil to a PEUGEOT dealer or a qualified workshop (France) or to an authorised waste disposal site.

Checks

Unless otherwise indicated, check these components in accordance with the servicing booklet and according to your engine. Otherwise, have them checked by a PEUGEOT dealer or a qualified workshop.

12 V battery



The battery does not require any maintenance. However, check that the terminals are clean and correctly tightened, particularly in summer and winter.

When carrying out work on the battery, refer to the "Practical information" section for details of the precautions to be taken before disconnecting the battery and following its reconnection.

Air filter and passenger compartment filter



Refer to the servicing booklet for details of the replacement intervals for these components.

Depending on the environment (e.g. dusty atmosphere) and the use of the vehicle (e.g. city driving), **replace them twice as often if necessary.**

A clogged passenger compartment filter may have an adverse effect on the performance of the air conditioning system and generate undesirable odours.

Oil filter



Replace the oil filter each time the engine oil is changed. Refer to the servicing booklet for details of the replacement interval for this component.

Manual gearbox



The gearbox does not require any maintenance (no oil change). Refer to the servicing booklet for the details of the level checking interval for this component.

2 Tronic gearbox



The 2 Tronic gearbox does not require any maintenance (no oil change). Refer to the servicing booklet for details of the checking interval for this unit.

Brake pads



Brake wear depends on the style of driving, particularly in the case of vehicles used in town, over short distances. It may be necessary to have the condition of the brakes checked, even between vehicle services. Unless there is a leak in the circuit, a drop in the brake fluid level indicates that the brake pads are worn.

Brake disc wear



For information on checking brake disc wear, contact a PEUGEOT dealer or a qualified workshop.

Parking brake



If excessive travel or a loss of effectiveness of this system is noticed, the parking brake must be checked, even between two services.

Checking this system must be done by a PEUGEOT dealer or a qualified workshop.

! Only use products recommended by PEUGEOT or products of equivalent quality and specification.

In order to optimise the operation of units as important as the braking system, PEUGEOT selects and offers very specific products.

To avoid damaging the electrical units, the use of a high pressure washer in the engine compartment is strictly **prohibited.**

Engine

Engine	1.0 litre (≈ 68 hp)	
	Manual gearbox (5-speed)	2 Tronic gearbox (5-speed)
Model codes PM, PN	CFB0 / CFB4	CFB0/P
Cubic capacity (cc)	998	
Bore x stroke (mm)	71 x 84	
EU standard maximum power (kW)	50	
Max power engine speed (rpm)	6 000	
EU standard max torque (Nm)	93	
Max torque engine speed (rpm)	3 600	
Fuel	Unleaded	
Catalytic converter	Yes	
Engine oil capacity (with filter replacement)	3.2	

Weights (in kg)

Engine	1.0 litre			
	Manual gearbox (5-speed)		2 Tronic gearbox (5-speed)	
Versions	3-door	5-door	3-door	5-door
Model codes	PMCFB0 / PMCFB4	PNCFB0 / PNCFB4	PMCFB0/P	PNCFB0/P
Kerb weight	800	805	830	840
Gross vehicle weight (GVW)	1 180	1 190	1 180	1 190

The design of your vehicle does not permit the fitting of a towbar.

Dimensions (in mm)

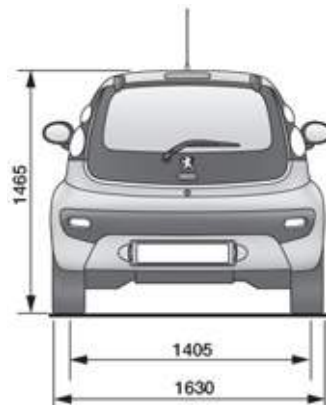
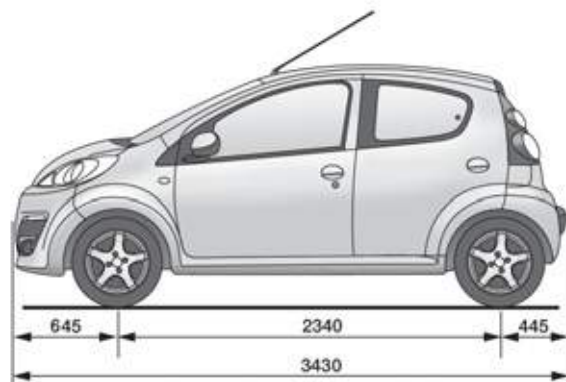
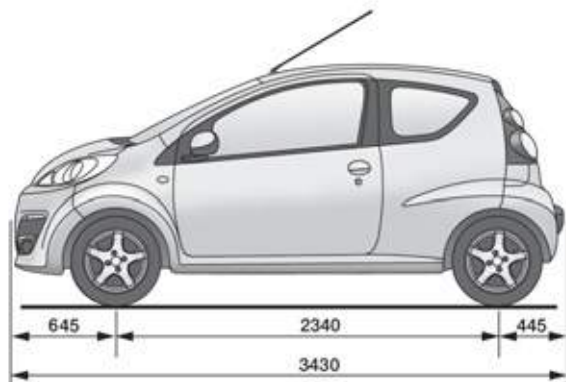

Identification markings

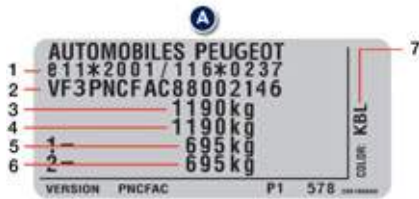

A. Manufacturer's plate.

1. EU approval number.
2. Vehicle Identification Number (VIN).
3. Gross vehicle weight.
4. Gross train weight.
5. Maximum weight on front axle.
6. Maximum weight on rear axle.
7. Paint colour reference.

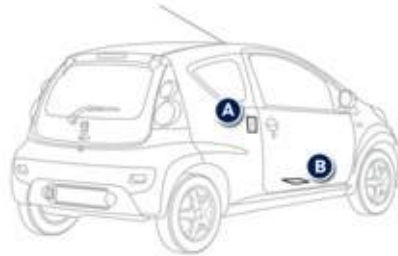

3-door

5-door

B. Vehicle Identification Number.

This is engraved on the crossmember, under the front right seat.

C. Tyres.

The label **C** affixed to the pillar, near the left door striker, indicates:

- the tyre sizes,
- the tyre pressures.

i The tyre pressures must be checked when cold, at least once a month.

🍀 If the tyre pressures are too low, this increases fuel consumption.

AUDIO SYSTEM / BLUETOOTH

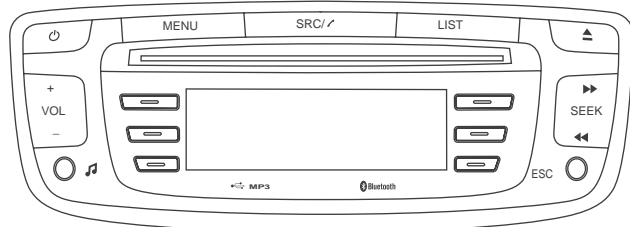

CONTENTS

01 First steps	p.	94
02 Radio	p.	95
03 Audio	p.	98
04 Using the telephone	p.	104
05 Audio settings	p.	110
06 Configuration	p.	111
07 Screen menu map	p.	112
Frequently asked questions	p.	113



For safety reasons, the driver must only carry out operations which require prolonged attention while the vehicle is stationary.

01 FIRST STEPS

Select the source:

- FM1, FM2, AM, CD, USB, AUX, Streaming.
- accept an incoming call.

Long press:

- open the calls log for the telephone connected.
- or end a call if in progress.

Display the list of stations received, the CD/USB tracks or folders.

Long press: update the list of stations received.

On / Off.

Open the main menu.

Eject CD.

Volume adjustment.



Adjust audio settings: sound ambience, treble, bass, loudness, left/right balance.

Select a preset radio station. Radio: long press: preset a radio station. Other than radio: see the corresponding sections.

Abandon the current operation. Go up one level (menu or folder).

Automatic search for a lower / higher radio frequency. Select previous / next CD, USB track. Navigation in a list. Press and hold: fast forwards or backwards.

02 RADIO

RADIO

i The exterior environment (hills, buildings, tunnel, car park, below ground...) may prevent reception, even in RDS station tracking (alternative frequencies) mode. This phenomenon is normal in the propagation of radio waves and is in no way indicative of a fault with the audio system.

PRESETTING AND SELECTING A STATION

1



Press **SRC/TEL** repeatedly and select the FM1, FM2 or AM waveband.



2



Make a long press on one of the buttons to preset the station being listened to. The name of the station is displayed and an audible signal confirms the preset.



i



Press a button to listen to the corresponding preset station.



i When recalling a preset station, if the reception of the station is poor, the radio will try to find a frequency transmitting the same programme and a message appears in the screen.

MANAGE THE LIST

i



A long press on **LIST** builds or updates the list of stations; audio reception is cut momentarily.



1



Press **LIST** to display the list of stations received in alphabetical order.



2



Select the desired radio station and confirm by pressing "**OK**".



3



A press changes to the next or previous letter (e.g. A, B, D, F, G, J, K, ...).



02 RADIO

ENTER A FREQUENCY MANUALLY

1



Press **MENU**, select "Radio", then select "Write freq."

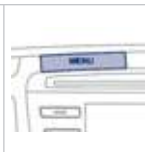

2



Press + or - to select the desired frequency and confirm with "OK".



RDS

i

RDS, if displayed, enables you to continue listening to the same station by automatic retuning to alternative frequencies. However, in certain conditions, coverage of an RDS station may not be assured throughout the country as radio stations do not cover 100 % of the territory. This explains the loss of reception of the station during a journey.

1



With source FM1 or FM2, press **MENU** then select "Radio".



2



Select or deselect "RDS" to activate or deactivate RDS then confirm with "OK" to save the setting.



02 RADIO

RECEIVING TA MESSAGES

i The TA (Traffic Announcement) function gives priority to TA alert messages. To operate, this function needs good reception of a radio station transmitting this type of message. When a traffic report is transmitted, the current audio source (Radio, CD, USB, ...) is interrupted automatically to play the TA message. Normal playback of the audio source resumes at the end of the transmission of the message.

1  Press **MENU**, select "Radio".



2  Select or deselect "**TA**" to activate or deactivate the reception of traffic messages.



DISPLAY RADIO TEXT

! Radio text is information transmitted by the radio station related to the current programme or song.

1  With the radio displayed on the screen, press **MENU** then select "**Radio**".



2  Select or deselect "**TXT**" to activate or deactivate the display of Radio Text.



03 AUDIO

AUDIO CD

PLAYING A CD



Insert 12 cm diameter circular compact discs only.

Some anti-pirating systems, on original discs or CDs copied using a personal recorder, may cause faults which are no reflection on the quality of the original player.

Without pressing the **EJECT** button, insert a CD in the player, play begins automatically.

1



To play a disc which has already been inserted, press the **SRC/TEL** button several times until CD play is displayed.



2



Press one of the buttons to select a track on the CD.
Press and hold one of the buttons for fast forward or backward.



03 AUDIO

CD, USB

INFORMATION AND ADVICE



The audio system will only play files with ".mp3", ".wma" and ".wav" on a CD and can play files with ".ogg" extension only on USB.



A high compression rate can adversely affect sound quality.



The playlists accepted on CD, MP3, iPod and USB connection are types ".m3u" and ".wpl".
The number of files recognised is limited to 5 000 in 500 folders on a maximum of 8 levels.



On a single disc, the CD player can read up to 255 MP3 files spread over 8 folder levels with a maximum of 192 folders. However, it is recommended that this be kept to 2 levels so as to limit the time taken to access and play the CD.
During play, the folder structure is not observed.



In order to be able to play a recorded CDR or CDRW, when recording it is preferable to select standards ISO 9660 level 1.2 or Joliet.
If the disc is recorded in another format, it may not be played correctly. It is recommended that the same recording standard is always used for an individual disc, with as low a speed as possible (4x maximum) for optimum sound quality.
In the particular case of a multi-session CD, the Joliet standard is recommended.



Do not connect a hard disk or USB device other than audio players to the USB port. This may cause damage to your installation.

03 AUDIO

CD, USB

PLAYING A COMPILATION



Insert an MP3 compilation in the CD player or connect a memory stick to the USB port.



The system creates playlists (temporary memory) the creation time for which can take from a few seconds to several minutes. The playlists are updated every time the ignition is switched off or a USB memory stick is connected. Play starts automatically after a period which depends on the capacity of the USB memory stick.



At a first connection, the order suggested is by folder. When connecting again, the order previously chosen is retained.

1



To play a disc or memory stick which has already been inserted, press **SRC/TEL** several times in succession and select "CD" or "USB".



2



Press one of the buttons to select the next or previous track.



3



Press one of the buttons to select the next or previous folder in the order chosen.



4



Press and hold one of the buttons for fast forwards or backwards.



03 AUDIO

5



Press **LIST** to display the structure of the folders in the compilation.



6



Select a line in the list.



7



Jump a page.



8



Up a level in the menu.



9



Press **MENU**, select "**Media**" then select or deselect "**TA**" to activate or deactivate reception of traffic messages.



10



Select the play mode: "**Normal**", "**Random**", "**Random all**" or "**Repeat**".



Return to the top level of the folder structure to select the type of tracks.

- By **Folders** (CD or USB): all folders containing audio files recognised on the peripheral device, in alphabetical order without following the folder structure.
- By **Artist** (USB only): all of the artist names defined in the ID3 Tags, in alphabetical order.
- By **Genre** (USB only): all of the genres defined in the ID3 Tags.
- By **Playlist** (CD or USB): if playlists have been saved.

03 AUDIO

APPLE® PLAYERS or MOBILE PLAYER

USB PORT OR JACK SOCKET (DEPENDING ON VERSION)



The auxiliary input, USB or JACK, allows the connection of a portable device (MP3 player...).



Do not connect a device to both the USB port and the JACK socket at the same time.

1

Connect the portable device (MP3 player...) to the USB port or the JACK socket using a suitable cable (not supplied).



The audio files on a Mass Storage portable player* can be heard through the vehicle's speakers by connecting it to the USB port or JACK socket (cable not supplied).



Management of the device is via the audio system controls; refer to the "**CD, USB**" section.



The Apple® player software must be updated regularly for the best connection.



The playlists are those defined in the Apple® player.



The Apple® player must be generation 3 or later.

* Check your player's manual.

03 AUDIO

STREAMING - PLAYING AUDIO FILES VIA BLUETOOTH



DEPENDING ON THE COMPATIBILITY OF THE PHONE



Streaming allows music files on a telephone to be heard via the vehicle's speakers.
The telephone must support the appropriate Bluetooth® profiles (profiles A2DP / AVRCP).

1



Connect the telephone: see the "USING THE TELEPHONE" section.

2



SRC/TEL

Activate the streaming source by pressing **SRC/TEL**. Control of playback is via the audio system. The contextual information can be displayed in the screen.



In certain cases, playing of the audio files must be initiated from the telephone.



The audio quality depends on the quality of the transmission from the telephone.

04 USING THE TELEPHONE

PAIRING A TELEPHONE / FIRST CONNECTION



The services offered depend on the network, the SIM card and the compatibility of the Bluetooth telephone used. Consult your telephone's manual and your operator to find out which services are available to you.



For safety reasons and because they require prolonged attention on the part of the driver, the operations for pairing of the Bluetooth mobile telephone with the Bluetooth hands-free system of your audio system must be carried out with the vehicle stationary and the ignition on.



Visit www.peugeot.co.uk for more information (compatibility, more help, ...).



It is not possible to pair more than 5 telephones. Press **MENU** and select "**Bluetooth**". Select "**BT management**". If 5 telephones are already paired, select the telephone to be deleted by pressing "**OK**" and select "**Delete**" (refer to "Managing connections").

1

Activate the telephone's Bluetooth function and ensure that it is set as visible to all (refer to the telephone instructions).



2

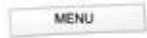

Press **MENU** then select "**Bluetooth**".



3



Select "**Search**".



4

A window is displayed with "**Searching device**".

5



Select the telephone to be paired from the list and confirm with "**OK**". Only one telephone can be paired at a time.



04 USING THE TELEPHONE



In some cases, the Bluetooth address of the telephone may appear instead of the name of the telephone.

6



A virtual keypad is displayed on the screen: choose a 4 digit code then confirm with **OK**.



7

A message is displayed on the screen of the telephone: enter the same code and confirm.



If pairing fails, try again; the number of attempts is not limited.

8

Accept the connection to the telephone.

9

A message appears in the screen to confirm the result of the connection.



Pairing can also be initiated from the telephone by searching for detected Bluetooth devices.



The directory and the calls list can be accessed after the synchronisation period (if the telephone is compatible). Automatic connection must be configured in the telephone to allow the connection each time the vehicle is started.

04 USING THE TELEPHONE

MANAGING CONNECTIONS

1



Press **MENU** then select "**Bluetooth**".



2



Select "**BT management**" and confirm. The list of paired telephones is displayed.



3



Select a telephone and confirm "**OK**".



4



Then select or deselect:

- "**Tel.**": hands-free connection
- "**Audio**": play audio files

Select "**OK**" to confirm the choice.

Select "**Delete**" to delete the pairing.



Indicates connection of the audio profile.



Indicates connection of the hands-free profile.

04 USING THE TELEPHONE

MAKING A CALL - RECENTLY CALLED NUMBERS*

1



Make a long press on **SRC/TEL** to display the calls list.



i

For access to the calls list, it is also possible to press **MENU**, select **"Telephone"**, then select **"Call"**, and finally select **"Calls list"**.

2



In the list of calls, select the number and choose **"Missed calls"**, **"Dialed calls"** or **"Answered calls"**.



3



Navigation in the calls list.



4



Previous or next page in the calls list.



5



"OK" starts the call.



i

The calls list includes the calls sent from and by from the vehicle via the connected telephone.

It is possible to make a call directly from the telephone; stop the vehicle as a safety measure.

* Depending on the compatibility of the telephone.

04 USING THE TELEPHONE

MAKING A CALL - FROM THE DIRECTORY

1



Press **MENU**, select "Telephone".



2



Select **Call** then "Directory".



3



Select the desired number and confirm. "OK" to start the call.



RECEIVING A CALL

1

An incoming call is announced by a ring and a superimposed display in the screen.

2



Press **SRC/TEL** or select "YES" to accept the call,
or
select "NO" to reject the call.



A long press on **ESC** or on **SRC/TEL** also rejects an incoming call.



04 USING THE TELEPHONE

MANAGING CALLS

1a HANG UP



In the contextual menu, select "**Hang up**" to end the call.



SRC/TEL

A long press on **SRC/TEL** also ends the call.



1b SECRET - MUTE (so that the caller cannot hear)



In the contextual menu:

- select "**Micro OFF**" to switch off the microphone.
- select "**Micro OFF**" to switch the microphone on again.



1c COMBINED MODE (to leave the vehicle without ending the call)



In the contextual menu:

- select "**Combined mode**" to transfer the call to the telephone.
- select "**Combined mode**" to transfer the call to the vehicle.





In certain cases, the combined mode has to be activated from the telephone.

The Bluetooth connection will be restored automatically if the ignition has been switched off, then on again (depending on the compatibility of the telephone).

05 AUDIO SETTINGS

1



Press  to display the audio settings menu.
Press  to go to the next setting.



!

The AMBIANCE, TREBLE and BASS audio settings are different and independent for each sound source.

2

The settings available are:

- AMBIANCE: BASS, TREBLE and LOUDNESS.
- BALANCE (left/right balance).

06 CONFIGURATION

DISPLAY AND LANGUAGE SETTINGS

1



Press **MENU** then "**Config.**".



2



Select "**Displaying**" to activate or deactivate scrolling text.



3a



Select "**Language**" to modify the display language.



3b



Select "**Version**" for information on the software.



3c



Select "**System**" when you want to install an update. Information can be obtained from a PEUGEOT dealer.



07 SCREEN MENU MAP

MENU MENU

- 1 Radio**
 - 2 TA**
 - 2 RDS**
 - 2 TXT**
 - 2 Write freq.**
- 1 Media**
 - 2 Normal**
 - 2 Random**
 - 2 Random all**
 - 2 Repeat**
 - 2 TA**

- 1 Telephone**
 - 2 Call**
 - 3 Directory**
 - 3 Calls list**
 - 4 Missed calls**
 - 4 Dialed calls**
 - 4 Answered calls**
 - 2 Phone status**
- 1 Bluetooth**
 - 2 BT management**
 - 2 Search**
- 1 Config.**
 - 2 Time**
 - 2 Displaying**
 - 3 Scrolling text**

- 2 Language**
 - 3 Deutsch**
 - 3 English**
 - 3 Español**
 - 3 Français**
 - 3 Italiano**
 - 3 Nederlands**
 - 3 Português**
 - 3 Português-Brasil**
 - 3 Русский**
 - 3 Türkçe**
 - 2 Version**
 - 2 System**

FREQUENTLY ASKED QUESTIONS

The following tables contain answers to the most frequently asked questions.

QUESTION	ANSWER	SOLUTION
There is a difference in sound quality between the different audio sources (radio, CD...).	For optimum sound quality, the audio settings (Bass, Treble, Ambience, loudness) can be adapted to the different sound sources, which may result in audible differences when changing source (radio, CD...).	Check that the audio settings (Bass, Treble, Ambience, Loudness) are adapted to the sources listened to. It is advisable to adjust audio settings (Bass, Treble, Front-Rear balance, Left-Right balance) to the middle position, select the musical ambience and set the loudness correction to the "Active" position in CD mode or to the "Inactive" position in radio mode.
When changing the settings for treble and bass, the ambience setting is deselected. When changing the ambience setting, treble and bass are reset to zero.	Choosing an ambience imposes settings for treble and bass. Modifying one without the other is only possible with a personalised ambience.	Modify the treble and bass settings or the ambience setting to obtain the desired sound quality.
The quality of reception of the radio station listened to gradually deteriorates or the stored stations do not function (no sound, 87.5 MHz is displayed...).	The vehicle is too far from the transmitter used by the station listened to or there is no transmitter in the geographical area through which the vehicle is travelling.	Activate the RDS function to enable the system to check whether there is a more powerful transmitter in the geographical area.
	The environment (hills, buildings, tunnels, basement car parks...) block reception, including in RDS mode.	This phenomenon is normal and does not indicate a failure of the audio equipment.
	The aerial is absent or has been damaged (for example when going through a car wash or into an underground car park).	Have the aerial checked by a PEUGEOT dealer.
Sound cut-outs of 1 to 2 seconds in radio mode.	During this brief sound cut-out, the RDS searches for any frequency permitting better reception of the station.	Deactivate the RDS function if the phenomenon is too frequent and always on the same route.

FREQUENTLY ASKED QUESTIONS

QUESTION	ANSWER	SOLUTION
Traffic announcement TA is displayed. I do not receive any traffic information.	The radio station does not broadcast traffic information.	Tune to a radio station which broadcasts traffic information.
The stored stations are not found (no sound, 87.5 MHz is displayed...).	An incorrect waveband is selected.	Press the SRC/TEL button to return to the waveband (FM1 or FM2) on which the stations are stored.
The CD is ejected automatically or is not played by the player.	The CD is inserted upside down, is unplayable, does not contain any audio data or contains an audio format which the player cannot play. The CD is protected by an anti-pirating protection system which is not recognised by the audio equipment.	<ul style="list-style-type: none"> - Check that the CD is inserted in the player the right way up. - Check the condition of the CD: the CD cannot be played if it is too damaged. - Check the content in the case of a recorded CD: consult the advice in the "Audio" section. - The audio equipment's CD player does not play DVDs. - Due to their quality level, certain writeable CDs will not be played by the audio system.
The CD player sound is poor.	The CD used is scratched or of poor quality.	Insert good quality CDs and store them in suitable conditions.
	The audio settings (bass, treble, ambience) are unsuitable.	Set the treble or bass level to 0, without selecting an ambience.
The Bluetooth connection is cut.	The battery of the peripheral may not be sufficiently charged.	Recharge the battery of the peripheral device.
The message "USB device error" is displayed on the screen.	The USB memory stick is not recognised. The memory stick may be corrupt.	Reformat the memory stick in FAT 16 or FAT 32.

FREQUENTLY ASKED QUESTIONS

QUESTION	ANSWER	SOLUTION
A telephone connects automatically, disconnecting another telephone.	Automatic connection overrides manual connection.	Modify the telephone settings to remove automatic connection.
An iPod is not recognised when connecting to the USB port.	The iPod is of a generation that is not compatible with the USB.	
The hard disk or device is not recognised when connecting to the USB port.	Some hard disks and devices need a power supply greater than is provided by the audio system.	Connect the device to the 230 V socket, the 12 V socket or an external power supply. Caution: ensure that the device does not transmit a voltage greater than 5 V (risk of destruction of the system).
When streaming, the sound cuts momentarily.	Some telephones prioritise connection of the "hands-free" profile.	Delete the "hands-free" connection profile to improve streaming.
In "Random all" play, not all of the tracks are played.	In "Random all" play, the system can only take into account up to 999 tracks.	
With the engine off, the audio system switches off after a few minutes of use.	When the engine is switched off, the audio system operating time depends on the battery charge. The switch-off is normal: the audio system switches to economy mode and switches off to prevent discharging the vehicle's battery.	Start the vehicle's engine to increase the battery charge.
The message "the audio system is overheated" appears on the display.	In order to protect the installation if the surrounding temperature is too high, the audio system switches to an automatic thermal protection mode leading to a reduction of the volume or stopping of the playing of the CD.	Switch the audio system off for a few minutes to allow the system to cool.

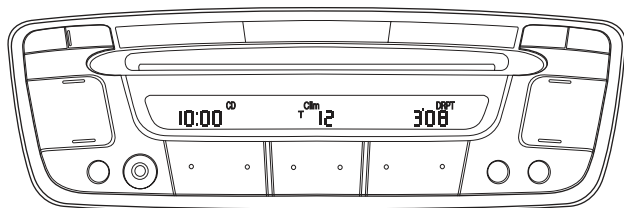

AUDIO SYSTEM



For safety reasons, the driver must only carry out operations which require prolonged attention while the vehicle is stationary.

CONTENTS

01 First steps

p. 117

02 Radio

p. 119

03 Audio system

p. 124

01 FIRST STEPS

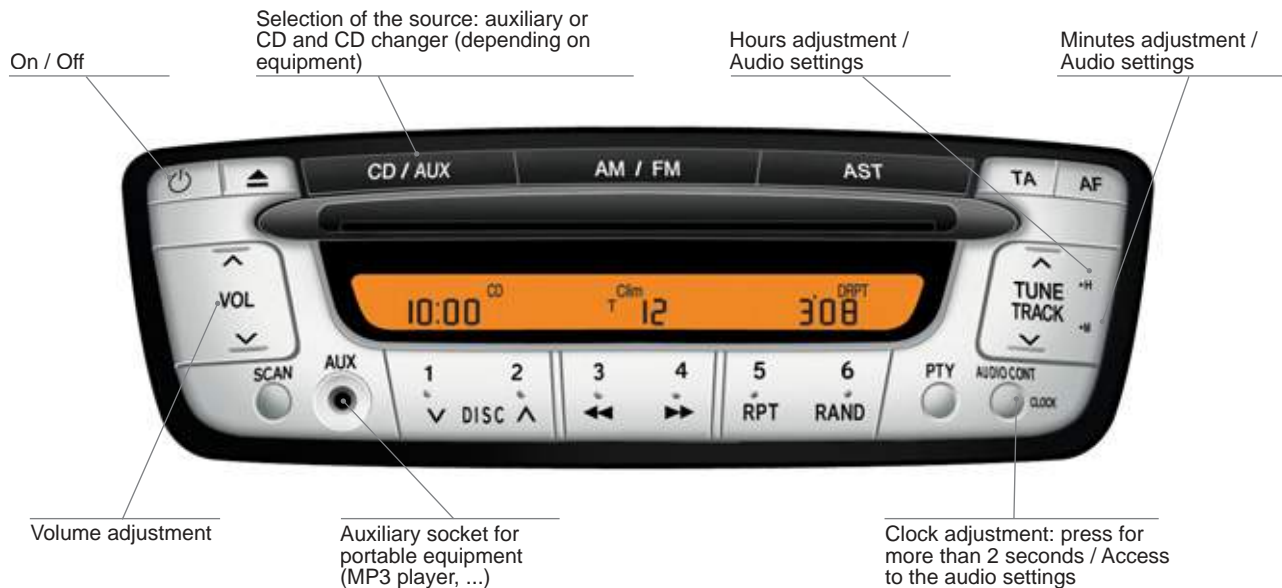

01 FIRST STEPS

GENERAL FUNCTIONS

ON / OFF

1



With the ignition key in the accessories position or with the ignition on, press this button to switch the audio equipment on or off.

i

After the engine has been switched off, the audio equipment can only operate for approximately 30 minutes, to prevent discharging of the battery.

VOLUME ADJUSTMENT

1



Press the upper part of this button several times in succession to increase the volume of the audio system or the lower part of this button to decrease it.

i

The audio system controls enable you to adjust the volume and the audio settings.

To exit from the **AUX** source, press **AM/FM**.

When using an MP3 player: increase the volume of the radio significantly (between 30 and 60) to obtain a satisfactory playing volume.

AUDIO SETTINGS

1



Press this button several times in succession to gain access to the bass (**BASS**), treble (**TREB**), front / rear balance (**FAD**) and left / right balance (**BAL**) settings.

2



When the parameter is displayed, change the setting using these two buttons.

You exit from this mode automatically after a few seconds without any action.

AUXILIARY SOCKET

1



An auxiliary socket "**AUX**" is provided for the connection of portable equipment (MP3 player, etc.).

2



In order to listen to it, connect your equipment then press this button.

02 RADIO

Selection of the AM / FM (FM1, FM2, FM3) wavebands

Autostore: automatic storing of 6 stations on AM and FM3

TA function on/off: traffic information priority

AF function on/off: alternative frequencies



Automatic search for a higher frequency: double press / Successive tuning in to the stations

Selection of the stored station / Storing of a station: press for more than 2 seconds

Selection of the type of radio programme: News, Sports, Talk, Pop, Classics

Manual search for a higher / lower frequency

02 RADIO

STATIONS

STEREO RECEPTION

i

When the radio receives a station broadcasting in stereo it automatically plays in stereo and the screen displays "ST". If the reception conditions deteriorate, the radio changes to mono and "ST" is no longer displayed.

SELECTION OF THE RADIO SOURCE

1



Press this button.

SELECTION OF A WAVEBAND

1



Press the button successively to select the wavebands FM1, FM2, FM3 and AM.

AUTOMATIC STATION SEARCH

1



Press this button twice to select the next station. Press this button briefly to listen to each station available on the FM waveband for three seconds. To stop the station scan, press this button again.

i

If the traffic information programme **TA** is selected, only stations which broadcast this type of programme are selected.

MANUAL STATION SEARCH

1



Press one of these two buttons briefly to increase or decrease the frequency displayed respectively. If you maintain the pressure on the button in the chosen direction, the frequency will be scanned continuously. The scan stops when you release the button.

02 RADIO

MANUAL STATION PRESETTING

1



Select the required station.

Press one of the buttons "1" to "6" for more than 2 seconds.
An audible signal confirms that the station has been preset.

RECALLING PRESET STATIONS

1

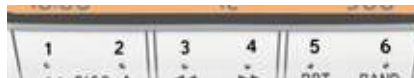

On each waveband, a brief press on one of the buttons "1" to "6" recalls the corresponding preset station.

AUTOMATIC PRESETTING OF FM STATIONS (AUTOSTORE)

1



Press this button.

Your audio equipment automatically presets the six strongest stations received on **AM** and **FM** in your current location. These stations are stored on the **AM** and **FM3** wavebands. The end of the search is signalled by two audible signals.

i

If it was not possible to find six stations the remaining memories remain empty: three dashes are displayed on the audio system screen for each empty memory.

RADIO RECEPTION

i

Your audio system will be subjected to phenomena which do not affect domestic radio sets. Both MW/LW and FM reception are subject to various forms of interference. This is no reflection on the quality of the system but is due to the nature of the signals and the way in which they are transmitted.

On MW/LW, interference may be noticed when passing under high voltage power lines or bridges, or in tunnels.

On FM, interference may be the result of increasing distance from the transmitter, deflection of the signal by obstacles (mountains, hills, buildings, etc) or of being in an area which is not covered by a transmitter.

02 RADIO

RDS SYSTEM

USING THE AF (ALTERNATIVE FREQUENCIES) FUNCTION ON THE FM WAVEBAND



The **RDS (Radio Data System)** enables you to continue listening to the same station irrespective of the frequency that it uses in your current location. The radio continuously searches for the transmitter which provides the best reception.

1

Press this button successively to activate or deactivate the function.



The screen will indicate:

- "AF" if the function is activated,
- "AF REG" if the function is activated at regional level,
- "AF" flashing if the function is not available.

REGIONAL MODE (REG)



Some stations, organised in a network, broadcast regional programmes in the various regions which they serve. The regional mode enables you to continue listening to the same programme.

SEARCH BY TYPE OF PROGRAMME (PTY)



This enables you to listen to stations which broadcast a type of programme which has a theme (NEWS, SPORTS, TALK, POP, CLASSICS).

1

When **FM** is selected, press this button:



- "no pty" is displayed,
- then press the button briefly to select a programme.

After a few seconds without any action, your selection is stored.

02 RADIO

TRAFFIC INFORMATION PROGRAMME (TA)

1



Press this button successively to activate or deactivate the function.

On FM, the multifunction display will indicate:

- "TP" or "TP EON": the radio transmits a programme while awaiting the broadcasting of traffic information.
- "TA" or "TA EON": the programme transmitted by the radio is put on standby while awaiting the broadcasting of traffic information.

i

If you wish to interrupt the transmission of a message, press this button again.

EON SYSTEM

i

This system links stations which belong to the same network. It permits the transmission of traffic information broadcast by a station which belongs to the same network as the station to which you are listening.

In order to benefit from this, select the traffic information programme **TA**.

i

The volume of the traffic information is independent of the volume of normal radio listening.

You can adjust it using the volume button, when the **TA** programme is being transmitted.

The setting will be stored and will be used during subsequent message transmissions.

03 AUDIO

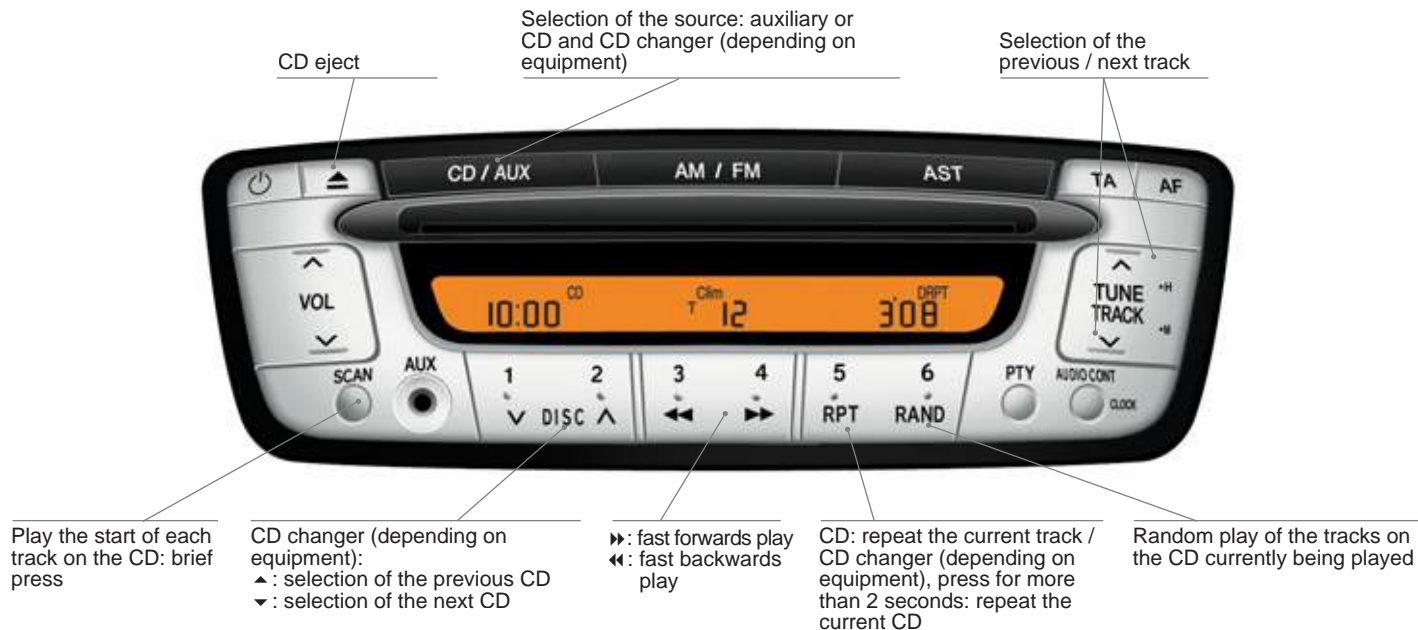

03 AUDIO

CD AND CD CHANGER (depending on equipment)

SELECTION OF A TRACK ON A CD

1



Press this button to select the next track.



Press this button to return to the start of the current track or to select the previous track.

INTROSCAN (SCAN)

1



Press this button to listen to the start of each track on the current CD.

FAST PLAY

1



Press and hold one of these buttons for fast forwards or backwards play respectively. The fast play stops when the button is released.

03 AUDIO

CD

SELECTION OF THE CD SOURCE

1



When a CD is inserted, printed face uppermost, play begins automatically.
If there is a CD in the player already, press this button.

CD EJECT

1



Press this button to eject the CD from the player.

RANDOM PLAY OF THE CD (RAND)

1



When the CD player is selected, press this button.

The tracks on the CD will be played in a random order. Press the button again to return to normal play.

The random play mode is deactivated when the audio system is switched off.

REPEAT OF A TRACK ON THE CD (RPT)

1



If you wish to listen to the current track again, press this button. To cancel the repetition, press the button again.

i

The use of copied CDs may cause faults.
Insert circular CDs only.

03 AUDIO

CD CHANGER (depending on equipment)

SELECTION OF THE CD CHANGER

1



Press this button.

RANDOM PLAY OF A CD (RAND)

1



When the CD changer is selected, press this button for 2 seconds.

The tracks of the current CD will be played in a random order.

Press the button again for 2 seconds to return to normal play.

SELECTION OF A CD

1



Press one of these buttons on the audio system to select the previous or next CD respectively.

REPEAT OF A CD (RPT)

1



If you wish to listen to the current CD again, press and hold this button.

To cancel the repetition, press the button again.

i

The use of copied CDs may cause faults.
Insert circular CDs only.

Exterior

Keys, remote control, locating the vehicle 4, 26
 Remote control battery 27
 Starting 4, 42

Opening the bonnet 84

Towing 80-81

Tyres, pressures 65, 92

Parking brake 48, 88
 ABS (EBFD-CSC) 49
 ASR/ESP 50

Fuel tank, filler cap, filling with fuel 5, 30
 Fuel gauge 23

Mirrors 37
 Roof bars 81

Opening/closing, locking/unlocking doors 28

Front lamps, foglamps 44
 Direction indicators 45
 Changing bulbs 67-68
 Adjusting the headlamps 46

LED daytime running lamps 45

Rear lamps, foglamp 44
 Changing bulbs 69
 Number plate lamps, 3rd brake lamp, side repeaters 70

Boot 29, 41
 Spare wheel, jack, changing, fitting 41, 65-67

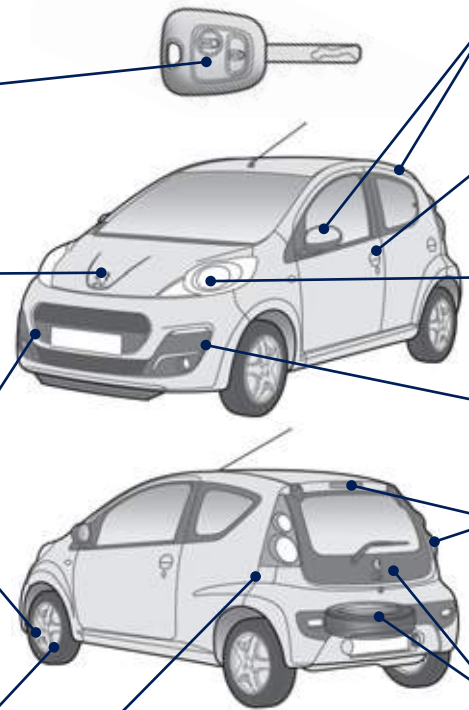

Interior

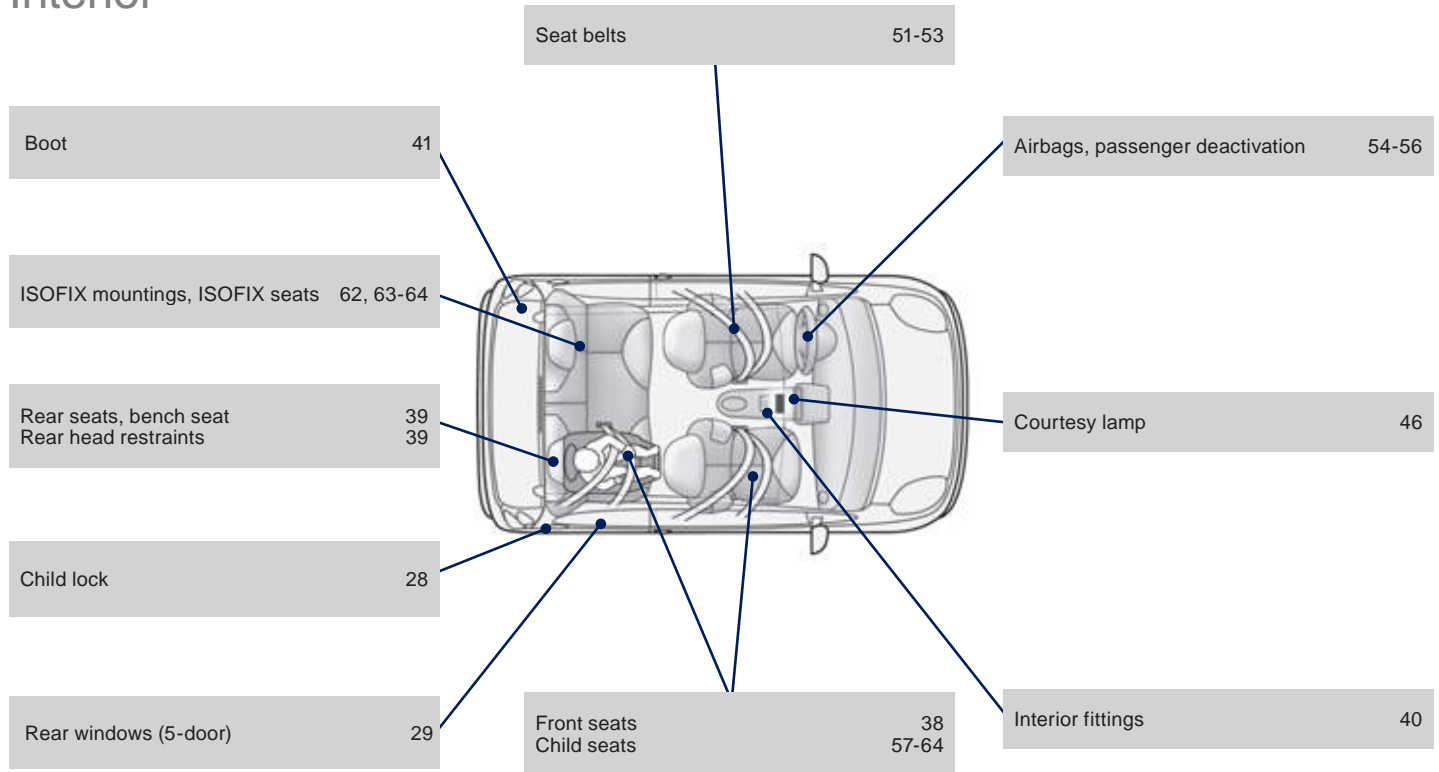

Instruments and controls

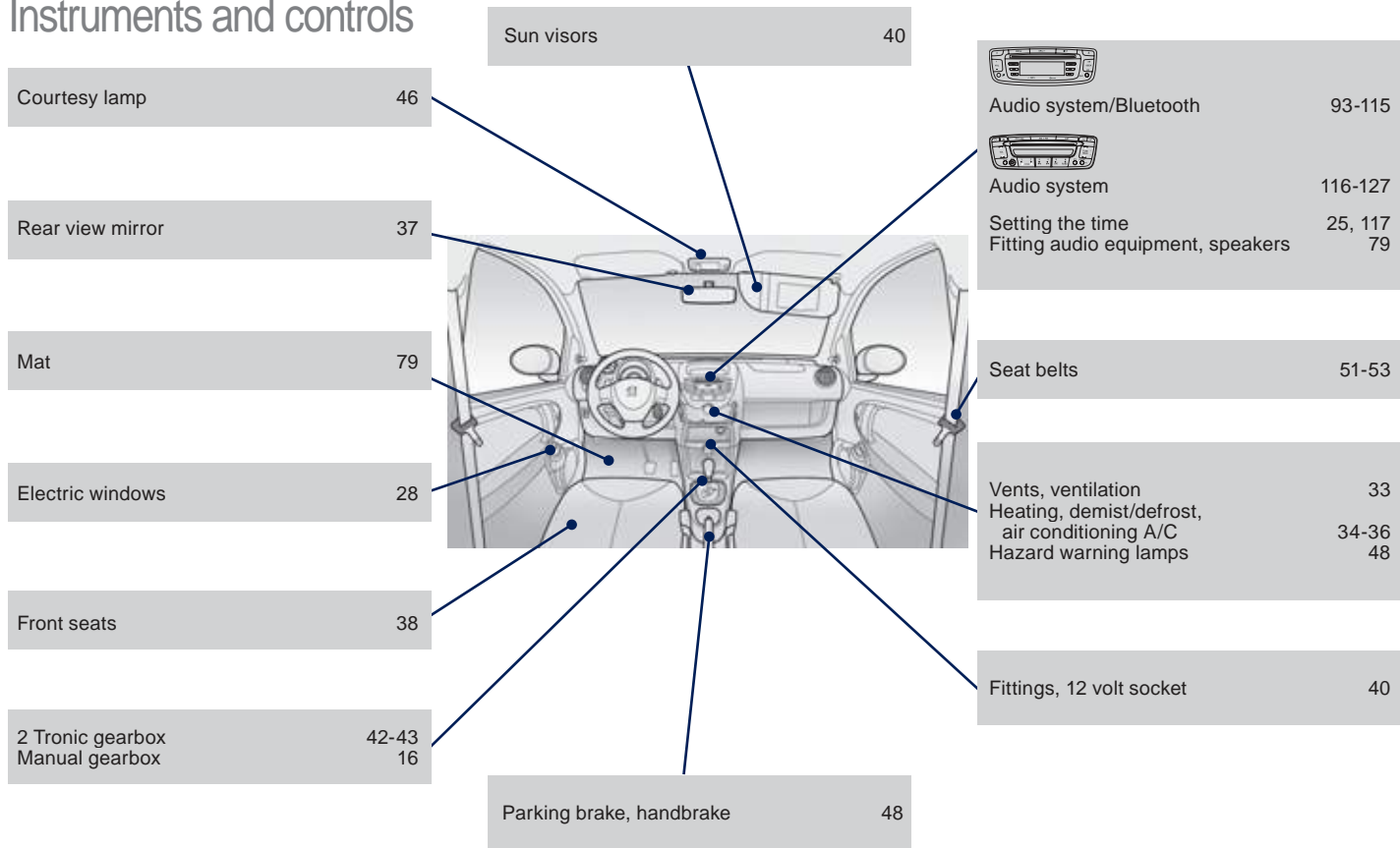

Steering mounted controls

Rev counter 19

Door mirrors 37

Lighting, sidelamps, dipped/main beam headlamps, front foglamps, direction indicators 44-45
LED daytime running lamps 45

Headlamp adjustment 46

Instrument panel 19
Warning lamps, indicator lamps 20-22
Screen, indicators, total/ trip distance recorder 19, 23-24
Fuel gauge 23
Instrument panel fuses 71-73

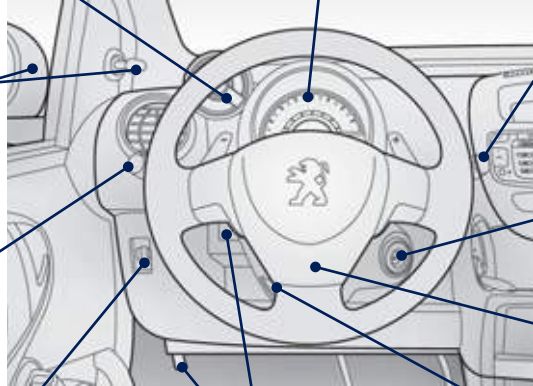

Wipers, screenwash 47

Ignition, starting, engine immobiliser 4, 16, 42

Steering wheel, height adjustment 48

Horn 37

Deactivating the passenger's airbag 55
Opening the bonnet 84

Maintenance

Technical data

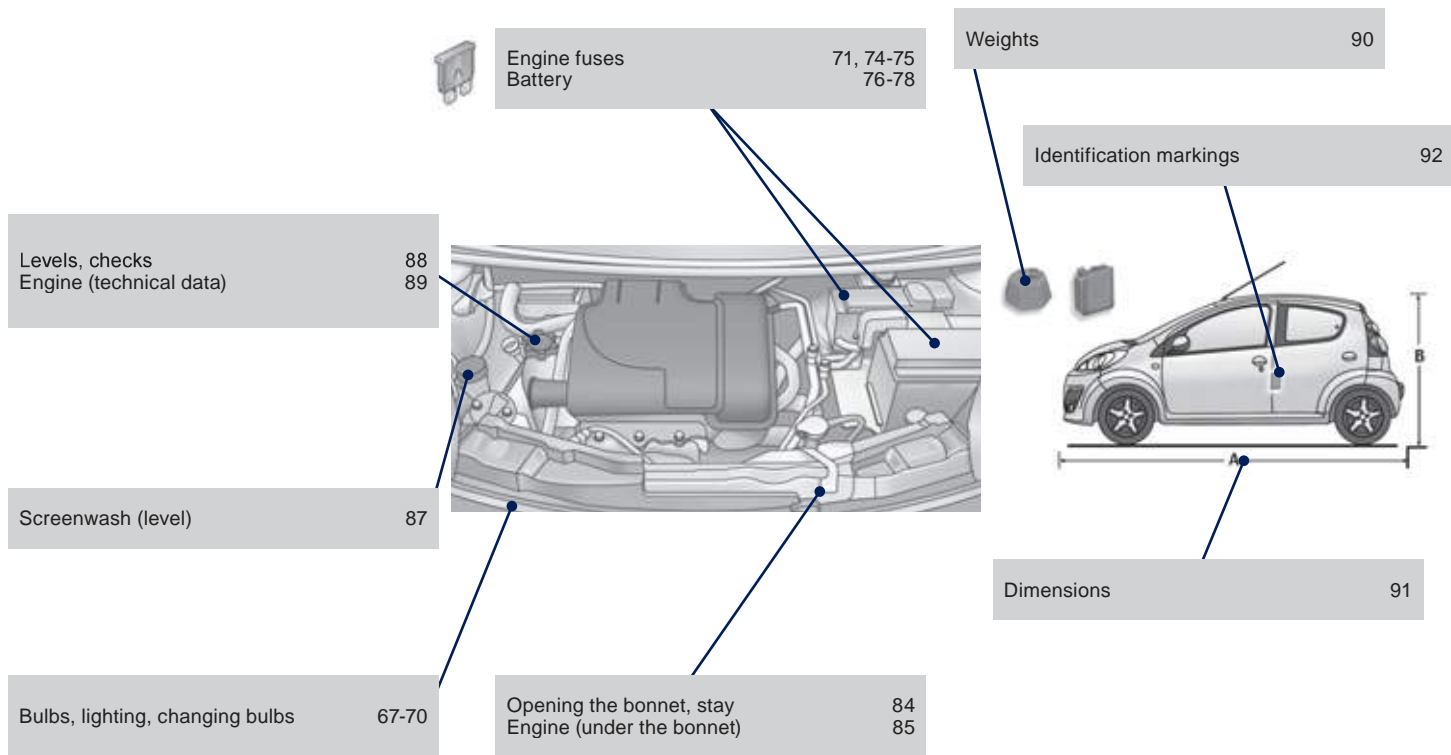

2 Tronic
gearbox..... 16, 19, 22, 24, 42, 43, 77, 88

A

ABS..... 49
Accessories 4, 82
Access to rear seats
(3-door)..... 38
Adjusting headlamps 46
Adjusting the steering wheel..... 37
Airbag fault..... 54, 55
Airbags 21, 54, 55
Airbags, curtain..... 55, 56
Airbags, front..... 56
Airbags, lateral..... 55, 56
Airbag warning lamp 54
Air conditioning 12, 17
Air conditioning, manual 13, 35
Air conditioning on/off..... 35
Air distribution adjustment 34, 35
Air filter 88
Air flow 17, 34, 35
Air flow adjustment 34, 35
Air vents 33-35
Anti-lock braking system (ABS)..... 49
Anti-theft..... 26
ASR..... 50
Assistance, emergency braking 49
Audible warning 48
Audio equipment
(general)..... 25, 117, 118
Audio streaming
(Bluetooth) 103
Audio system (CD/CD changer) 124-127
Audio system (radio) 119, 120, 122
Auxiliary socket..... 40, 117, 118

B

Backup starting..... 76
Battery..... 76-78, 88
Battery, charging..... 77
Bluetooth (hands-free) 104
Bonnet..... 84
Boot..... 41
Brake discs..... 88
Brake lamps 69
Brake pads 88
Brakes 88

C

Capacity, fuel tank 30
CD changer 124-127
CD MP3..... 98-100
Central locking 26
Changing a bulb 67, 68
Changing a fuse 71
Changing a wheel 65
Changing the remote
control battery..... 27
Changing
the time 25, 117
Checking levels..... 86, 87
Checking the engine
oil level..... 86
Checks 88
Child lock 28
Children 28, 63
Child seats 57, 59, 60
Child seats,
conventional..... 59
Coolant level 87
Courtesy mirror..... 40
Cup holder..... 40

D

Deactivating
the passenger airbag..... 55
Defrosting..... 33
Demisting..... 33
Dimensions 91
Dipped beam..... 44, 67, 68
Dipstick..... 86
Direction indicators 44, 67-69
Display screen 23
Doors..... 28
Driver's seat belt not
fastened warning lamp 22, 52
Driving mode..... 42

E

Easy mode
(automatic mode)..... 42
Eco-driving 17
Eco-driving (advice)..... 17
Economical
driving 17
Electronic engine
immobiliser..... 27
Electronic stability control
(ESP)..... 50
Engine 85, 89, 90
Engine, petrol..... 31
Engine compartment
fusebox 71
Engine oil 85, 86
Engine oil level
indicator 86
Engines 89
Environment 17
ESP 50

F

Filling with fuel 30, 31
 Fitting a wheel 65
 Flashing indicators 44, 67-70
 Folding/unfolding the door mirrors 37
 Force limiter 51
 Front foglamps 44, 68
 Front seats 38
 Fuel 17, 23, 30, 31
 Fuel consumption 17, 23, 30
 Fuel gauge 23, 30
 Fuel tank 23, 30
 Fuses 71

G

Gearbox, manual 88
 Gearbox, manual (reverse gear) 16
 Gear lever 17

H

Hands-free kit 104
 Headlamp adjustment 44
 Headlamp flash 44
 Headlamps 44, 67, 68
 Head restraints, rear 39
 Heating 12, 13, 17, 34

G

Identification 92
 Identification plates 92
 Inflating tyres 17
 Instrument panel 19

I

Instrument panel fusebox 71
 Interior fittings 40
 Interior lamp 46
 ISOFIX 62, 64
 ISOFIX child seats 63, 64
 ISOFIX mountings 62, 64

J

Jack 65
 JACK socket 40

K

Keeping children safe 28, 57, 63
 Key 26

L

Lamps, front 44, 67, 68
 Lamps, rear 44, 69, 70
 LED daytime running lamps 45
 Level, brake fluid 86
 Levels and checks 86, 87
 Lighting 44, 68
 Lighting bulbs (replacement) 67, 68
 Lighting control stalk 44
 Lighting on reminder 44
 Loading 17
 Locating your vehicle 26
 Locking/unlocking
 a door from the inside 28

M

Main beam 44, 67, 68
 Maintenance 17, 85
 Manual mode 42
 Mat 79
 Mini fuel level 23, 30
 Mirror, rear view 37
 Mirrors, door 37
 Mountings for ISOFIX seats 62
 MP3 CD 99, 100

N

Number plate lamps 70

O

Oil filter 88
 Oil level 86
 Opening the bonnet 84
 Opening the boot 29

P

Parcel shelf, rear 41
 Parking brake 20, 48, 88
 Parking the vehicle 48
 Passenger compartment filter 88
 Player, CD MP3 99, 100
 Port, USB 40, 101
 Power steering 22
 Pre-tensioning seat belts 51
 Protecting children 57, 63
 Puncture 65

R

Radio	95
Rear foglamp.....	44, 69
Rear screen (demisting).....	34, 35
Recharging the battery	77
Recirculation / exterior air intake	35
Reinitialising the remote control	27
Remote control.....	26, 27
Removing and fitting a fuse	71
Removing a wheel	65
Replacing bulbs	68
Replacing the air filter	88
Replacing the oil filter	88
Replacing the passenger compartment filter	88
Rev counter	19
Reversing lamps	69
Roof bars.....	81
Routine checks	88

S

Screen-wash reservoir.....	87
Screen menu map.....	112
Screenwash, front.....	47
Screenwash fluid level	87
Seat, rear, folding backrest	39
Seat adjustment	38, 39
Seat belts	22, 51, 53, 59
Seat belts warning lamp	22, 52
Seats, rear.....	39
Servicing	17
Setting the clock	25
Sidelamps	44, 45, 67
Side repeater.....	70
Source, CD and CD changer	124-127

Spare wheel	41, 65
Speakers (fitting).....	79
Speedometer	19, 23
Start.....	76
Starting the engine.....	4
Starting the vehicle.....	42
Steering wheel adjustment	37
Steering wheel height	37
Stopping the vehicle	42
Storage.....	40, 41
Sun visor	40
System, ABS	49
System, ASR	50
System, brakes	49

T

Tables of fuses.....	71
Temperature adjustment	34, 35
Third brake lamp	70
Time	25, 117
Tools	65
Towing another vehicle.....	80
Traffic information (TA)	97
Trip distance recorder	23
Tyre pressures	92
Tyres.....	17

U

Unlocking	26
-----------------	----

V

Ventilation	13, 33
Visibility	33

W

Warning lamp, parking brake.....	48
Warning lamps	20
Wash-wipe, rear.....	47
Weights	90
Wheel, changing	65
Window controls.....	28
Windows, rear	29
Wiper control stalk	47
Wipers	47

This handbook describes all of the equipment available in the whole range.

Your vehicle will be fitted with some of this equipment described in this document, depending on its trim level, version and the specification for the country in which it is sold.

The descriptions and illustrations are given without any obligation. Automobiles PEUGEOT reserves the right to modify the technical specifications, equipment and accessories without having to update the current handbook.

This document is an integral part of your vehicle. It should be passed on to the new user in the event of sale or transfer.

Automobiles PEUGEOT declares, by application of the provisions of the European regulation (Directive 2000/53) relating to End of Life Vehicles, that it achieves the objectives set by this regulation and that recycled materials are used in the manufacture of the products that it sells.

Reproduction or translation of all or part of this handbook is prohibited without written authorisation from Automobiles PEUGEOT.

For any work on your vehicle, use a qualified workshop that has the technical information, competence and equipment required, which a PEUGEOT dealer is able to provide.

Printed in the EU



PEUGEOT

Automobiles PEUGEOT - Siège Social : 75, avenue de la Grande-Armée 75016 PARIS

Tél. 33 (0)1 40 66 55 11 - Fax 33 (0)1 40 66 54 14

Adresse postale : Automobiles PEUGEOT B.P. 01 75761 PARIS cedex 16 - Adresse Internet : <http://www.peugeot.com>

Société Anonyme au capital de 171 284 850 Euros - R.C.S. PARIS B 552 144 503. SIRET 552 144 503 00018. APE 341 Z

Anglais

12-11

