

FAMILIARISATION

EXTERIOR

Automatic switching on of the lights

This equipment switches on the side lights and dipped headlamps automatically when a low level of light is detected or when the wipers are switched on.

» 72

Motorised boot

This equipment makes loading and unloading of the boot easier by means of its motorised opening and closing.

» 67



Tyre under-inflation detection

This equipment monitors the pressure in each tyre and warns you if a puncture or deflation is detected.

» 82

Visual and audible rear and/or front parking assistance

When parking, this equipment warns you if an obstacle is detected in front of and/or behind the vehicle.

» 95

OPENING

Remote control key



- A. Unfolding/Folding of the key.
- B. Complete or selective unlocking.
- C. Unlocking, opening and stopping of the boot.
- D. Normal locking or deadlocking.



Also...

Pressing button D for more than 2 seconds also permits automatic closing of the windows and sunroof.

Motorised boot



- A. Exterior opening.
- B. Interior closing.
- C. Unlocking, opening and stopping of the boot.



The permanent locking of the boot can be activated or deactivated via the multifunction display "Personalisation-Configuration" menu.

Fuel tank



1. Opening of the fuel filler flap.
2. Opening and hooking of the fuel tank cap.

Capacity of the fuel tank: approximately 80 litres.

FAMILIARISATION

INTERIOR

Audio and communication systems

This equipment benefits from the latest technology: audio RD4, MP3 compatible audio RT4, colour display, auxiliary sockets.

»» 123

Cruise control/speed limiter

These two functions allow you to control the speed of the vehicle in relation to the value that you have programmed.

»» 92

Dual zone automatic air conditioning

This equipment permits the setting of a different level of comfort for the driver and front passenger. It then manages this level automatically in relation to the exterior climatic conditions.

»» 44

Automatic gearbox

This equipment guarantees perfect driving by combining a fully automatic mode, associated with two special programmes, and a manual mode.

»» 89



DRIVING POSITION



1. Audio equipment steering wheel control.
2. Steering lock and ignition.
3. Wipers/wash-wipe and trip computer controls.
4. Instrument panel.

5. Driver's air bag.
Horn.
6. Gear lever.
7. Driver's footwell air outlet.

8. Fascia fuse box.
9. Manual headlamp adjustment.
Deactivation of the interior alarm.
Deactivation of the ESP/ASR system.
10. Adjustable and closing side vent.
11. Driver's side window de-icing and demisting vent.
12. Driver's seat electric controls.
13. Driver's heated seat control.
14. Bonnet release.
15. Deactivation of the parking assistance.
SPORT suspension control.
Sunroof control.
Rear blind control.
16. Armrest with storage compartment.
17. Rear ashtray.
18. Rear lighter (100 W max.).
19. Rear heated seat controls.

FAMILIARISATION

DRIVING POSITION



1. Steering wheel height and depth adjustment.
2. Cruise control/speed limiter switches.
3. Lights and direction indicators controls.
4. Adjustable and closing central vents.

5. Sunshine sensor.
6. Windscreen de-icing and demisting vent.
7. Passenger side window deicing and demisting vent.
8. Adjustable and closing side vent.

9. Disarming of the passenger air bag*.
10. Passenger air bag.
11. Glove box/Video sockets.
12. Passenger footwell air outlet.
13. Passenger heated seat control.
14. Passenger seat electric controls.
15. Front ashtray/lighter (100 W max.).
16. Handbrake.
17. Gear lever.
18. Storage compartment.
19. Audio RD4 or RT4 GPS audio/telephone.
20. Automatic air conditioning controls.
21. Central locking from the inside.
22. Multifunction display.
23. Hazard warning lights.

* According to country.

DRIVING POSITION



Colour and map screen DT

» 40



Colour screen C

» 38



JBL equipment

» 167



RT4 GPS audio/telephone

» 123



Audio RD4

» 154

FAMILIARISATION

SITTING COMFORTABLY

Electric front seat adjustment



A. Forwards-backwards adjustment.



C. Height adjustment.



F. Heated seats adjustment.



B. Seat cushion angle adjustment.



D. Seat back angle adjustment.
E. Head restraint height adjustment.



M. Adjustments memorisation.
1. Recall of the first position.
2. Recall of the second position.

SITTING COMFORTABLY

Rear bench seat

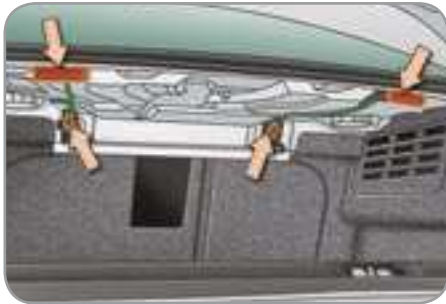

The bench seat back can be folded in two 1/3 - 2/3 sections.

The release controls are located in the boot.

Before folding the seat back:

- ☞ check that the seat belt strap is positioned correctly on the side of the seat back (1/3 or 2/3),
- ☞ release the centre seat belt strap by pressing the black button on the buckle (2/3).

When returning the seat back to the upright position, take care not to trap the seat belt.

Steering wheel adjustment



A. Steering wheel height and depth adjustment locking and release control.

1. Released position.
2. Locked position.

Electric mirror adjustment



B. Exterior mirrors selection, adjustment and folding control.

1. Selection of the driver's mirror.
2. Central position "●".
3. Selection of the passenger mirror.



Also...

4. Folding of the mirrors.

SITTING COMFORTABLY

Mirrors with automatic tilting when parking function**



Initial setting of the function (memorisation)

- ☞ With the engine running, engage reverse gear.
- ☞ Select and adjust the left and right mirrors in succession using button **B**.

Tilting the mirror to the parking position (use)

- ☞ Turn control **B** to the right or to the left, then engage reverse gear.

Returning the mirror to the normal position

- ☞ Exit reverse gear or place button **B** in the central position "●"

** According to version.

Electric window controls



1. Driver's electric window control.
2. Passenger electric window control.
3. Rear right electric window control.
4. Rear left electric window control.



Also...

5. Deactivation of the electric window controls located in the rear (child safety).

Front seat belts



1. Fastening.
2. Height adjustment.

SEEING CLEARLY

Lights



The position is indicated on the instrument panel by the corresponding indicator light.

Ring A



Lights off



Side lights



Dipped headlamps/Main beam headlamps



Your vehicle is fitted with a parking lights, automatic follow-me-home lighting and automatic switching on of the lights system.

To activate or deactivate these functions, refer to the corresponding sections.

If your lights are switched on manually, return the ring to position **0**, lights off.



Ring B



Front fog lamps

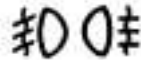

Front fog lamps and rear fog lamps

Wipers



- 2. Fast wipe.
 - 1. Normal wipe.
 - I. Intermittent wipe.
 - 0. Park.
 - AUTO.** Automatic wipe or single wipe.
 - A.** Wash-wipe.
- The windscreen wiping must be reactivated** if the ignition has been switched off for more than one minute.

FAMILIARISATION

VENTILATING

Dual zone automatic air conditioning



Use of the automatic regulation of the air conditioning is recommended.



1. Driver's automatic comfort programme.
2. Passenger automatic comfort programme.



3. Driver's temperature adjustment.
4. Passenger temperature adjustment.

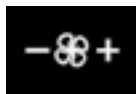

5. Air flow adjustment.



6. System off.



7. Passenger air distribution adjustment.



8. Driver's air distribution adjustment.



9. Automatic visibility programme (demisting).



10. Air intake/air recirculation.



11. Rear screen and exterior mirrors demisting.



12. Air conditioning on/off (A/C).

MONITORING

Energy Economy Mode

After the engine has been switched off, certain electrical functions can only be used for a limited combined duration, to prevent discharging of the battery.

Once this period has elapsed, the active functions are put on standby.

In order to exit the Energy Economy Mode and resume the use of these functions immediately, the engine must be started and left running for a few minutes.

If the engine has been running for at least 10 minutes, the functions are active for 30 minutes.

If the engine has been running for less than 10 minutes, this duration is 5 minutes before the return to Energy Economy Mode.

Several door or boot opening manoeuvres and triggering of the alarm may result in activation of the Energy Economy Mode.

Instrument panel and warning lights



- A. When the ignition is on, the fuel gauge needle should rise.
- B. When the engine is running, its associated low level warning light should switch off.
- C. When the ignition is on, the display should indicate "CHECK OIL", "OIL OK", "PRESSURE OK" for a few seconds.

If the messages are not correct, refer to the corresponding section.

When the ignition is on, the orange and red warning lights come on.

When the engine is running, these warning lights should be off.

If warning lights remain on, refer to the page concerned.

Controls bar



Lighting of the indicator light indicates the status of the corresponding function.

- A. Selection of the electronically controlled suspension. » 91
- B. Deactivation of the visual and audible rear and/or front parking assistance » 95
- C. Sunroof control. » 70
- D. Rear blind control. » 78

FAMILIARISATION

KEEPING YOUR PASSENGERS SAFE

Tyre under-inflation detection



Sensors check the pressure of the tyres while driving and trigger a warning if a malfunction occurs (speed above 15 mph (25 km/h)).

If one of the warning lights below appears, refer to the corresponding paragraph.



Pressure OK



Tyre under-inflated



Tyre punctured

Front passenger air bag



1. Insertion of the key.
2. Selection of the "OFF" position.
3. Removal of the key keeping the switch in this position.

Detection of seat belt not fastened/unfastened



With the vehicle stationary, when the ignition is switched on, the warning light comes on if the driver and/or the front passenger has not fastened his seat belt. From approximately 12 mph (20 km/h) the warning light flashes for two minutes accompanied by an audible signal which increases in volume. Once these two minutes have elapsed, the warning light remains on until the driver or front passenger fastens his seat belt.

When the vehicle is moving, the warning light comes on if the driver or one of the front or rear passengers unfastens his seat belt.

DRIVING SAFELY

Cruise control



This enables the vehicle to maintain a constant speed programmed by the driver.

1. Selection/Switching off of the function.
2. Storing of a speed/Decreasing of the stored speed.
3. Storing of a speed/Increasing of the stored speed.
4. Deactivation/Recalling of the stored speed.

In order for it to be stored, the vehicle speed must be above 25 mph (40 km/h), with at least fourth gear engaged on the manual gearbox (second gear on the automatic gearbox).

Speed limiter



This prevents the vehicle from exceeding the speed programmed by the driver (minimum speed 20 mph (30 km/h)).

1. Selection/Switching off of the function.
2. Decreasing of the speed.
3. Increasing of the speed.
4. Activation/Deactivation of the system.

Adjustments must be made with the engine running.

Instrument panel display



The cruise control or speed limiter mode appears on the instrument panel when it is selected.



Cruise control



Speed limiter

DRIVING SAFELY

"Porsche Tiptronic System" automatic gearbox



1. Gear lever.
2. "SPORT" button.

P: Park.
R: Reverse.
N: Neutral.
D: Drive.

M: Manual mode.
S: Sport programme.

1 2 3 4 5 6: gears engaged.

Move the lever in the gate to select one of the positions.

Once the position has been selected, the corresponding indicator light is displayed on the instrument panel display.

Indication on the instrument panel display



Switching the engine on

With the handbrake applied, select position **P** or **N**.

Switch on the ignition.

Moving off

With the engine running, from position **P** or **N**, **with your foot on the brake, release the handbrake.**

Select position **R**, **D** or **M**.

Release the brake pedal gradually; the vehicle moves off immediately.

Visual and audible rear and/or front parking assistance



A. Activation of the rear assistance.

B. Detection.

C. Deactivation/Reactivation.

During parking manoeuvres, you are guided by an audible signal and a graphic on the multifunction display.

PETROL MANUAL AND AUTOMATIC GEARBOXES INSTRUMENT PANEL



1. Engine oil temperature indicator.
2. Handbrake, low brake fluid level and electronic brake force distribution warning light.
3. Seat belt not fastened/ unfastened warning light.
4. Dipped headlamps indicator light.
5. Main beam headlamps indicator light.
6. Lighting rheostat buttons.
7. Rev counter.
8. Anti-lock braking system (ABS) warning light.
9. Emission control system warning light.
10. Left direction indicator.
11. Low fuel level warning light.
12. Fuel gauge.
13. Functions display screen:
 - Check.
 - Engine oil level gauge.
 - Warning and status indicator lights.
 - Cruise control/speed limiter.
 - Automatic gearbox.
 - Trip computer.
 - Satellite navigation system.

14. Right direction indicator.
15. Speedometer.
16. Service indicator, total and trip distance recorders.
17. Trip distance recorder zero reset button.
18. Manual check button.
19. Rear fog lamps indicator light.
20. Front fog lamps indicator light.
21. Passenger air bag disarmed warning light*.
22. Coolant temperature indicator.

* According to country.

DIESEL MANUAL AND AUTOMATIC GEARBOXES INSTRUMENT PANEL



1. Engine oil temperature indicator.
2. Handbrake, low brake fluid level and electronic brake force distribution warning light.
3. Seat belt not fastened/unfastened warning light.
4. Dipped headlamps indicator light.
5. Main beam headlamps indicator light.
6. Lighting rheostat buttons.
7. Rev counter.
8. Anti-lock braking system (ABS) warning light.
9. Diesel engine pre-heating warning light.
10. Emission control system warning light.
11. Left direction indicator.
12. Low fuel level warning light.

13. Fuel gauge.
14. Functions display screen:
 - Check.
 - Engine oil level gauge.
 - Warning and status indicator lights.
 - Cruise control/speed limiter.
 - Automatic gearbox.
 - Trip computer.
 - Satellite navigation system.
15. Right direction indicator.
16. Speedometer.
17. Service indicator, total and trip distance recorders.
18. Trip distance recorder zero reset button.
19. Manual check button.
20. Rear fog lamps indicator light.
21. Front fog lamps indicator light.
22. Passenger air bag disarmed warning light*.
23. Coolant temperature indicator.

* According to country.

OPERATION WARNING LIGHTS

With the ignition on, initially, the following warning lights illuminate on the instrument panel:



Handbrake, low brake fluid level and electronic brake force distribution warning light

This light should go out after a few seconds.

If the warning light remains on, or if it comes on when the engine is running, it indicates:

- an excessive drop in the brake fluid level, if linked with the low brake fluid level warning light on the instrument panel display,
- a malfunction of the electronic brake force distribution, if linked with the **STOP** warning light on the instrument panel display,
- an applied or incorrectly released handbrake, when the vehicle is moving, if linked with the handbrake warning light on the instrument panel display.

In the first two cases, stop immediately. Contact a PEUGEOT dealer.



Anti-lock braking system (ABS) warning light

This should go out after a few seconds.

If the warning light remains on or comes on above 8 mph (12 km/h), accompanied by an audible signal and a message on the multifunction display, this indicates a malfunction of the ABS.

However, the vehicle retains conventional servo-assisted braking.

It is linked with the corresponding warning light on the instrument panel display.

Contact a PEUGEOT dealer.



Emission control system warning light

This should go out a few seconds after the engine starts.

With the engine running, if the warning light flashes or comes on permanently, this indicates a malfunction of the emission control system.

Contact a PEUGEOT dealer as soon as possible.



Low fuel level warning light

This should go out after a few seconds.

The lighting of this warning light is accompanied by an audible signal and a message on the multifunction display.

It is linked with the corresponding warning light on the instrument panel display.

When the warning light comes on, you have enough fuel left to drive approximately 30 miles (50 km) (the capacity of the fuel tank is approximately 80 litres).



Passenger air bag disarmed warning light*

This should go out after a few seconds.

The lighting of this warning light is accompanied by a message on the multifunction display.

If the passenger air bag is disarmed, the warning light comes on when the ignition is switched on and remains on throughout the duration of disarming.

In all cases, if the warning light flashes, contact a PEUGEOT dealer.

* According to country.



Seat belt not fastened/ unfastened warning light

With the vehicle stationary, when the ignition is switched on, the warning light comes on if the driver and/or the front passenger has not fastened his seat belt. From approximately 12 mph (20 km/h) and for two minutes, the warning light flashes accompanied by an increasingly loud audible signal. Once these two minutes have elapsed, the warning light remains on until the driver or front passenger fastens his seat belt.

When the vehicle is moving, the warning light comes on if the driver or one of the front or rear passengers unfastens his seat belt.



Diesel engine pre-heating warning light

If the temperature is sufficient, the warning light does not come on and you can start without waiting.

If the warning light comes on, wait until it goes out before operating the starter.

With the ignition on, the vehicle carries out an automatic test which appears on the instrument panel display:



If no malfunction has been detected: the **CHECK OK** indicator light comes on after two seconds (following a black screen), in the absence of indicator lights showing the status of vehicle functions. If these indicator lights are present, the **CHECK OK** indicator light will come on after these.

You may start your vehicle.

If a "minor" malfunction has been detected: the warning light for the faulty function comes on. Certain indicator lights showing the status of vehicle functions may also come on, followed by the **CHECK OK** indicator light.

You can start your vehicle; however, contact a PEUGEOT dealer as soon as possible.

If a "major" malfunction has been detected: the corresponding warning light comes on. Certain indicator lights showing the status of vehicle functions may also come on. The **CHECK OK** indicator light does not come on.

Do not start your vehicle.

Contact a PEUGEOT dealer.

Following this, the following information appears on the instrument panel display:

The engine oil level appears for approximately 7 seconds; at the same time, the service indicator appears on the display located in the speedometer dial for approximately 7 seconds.

Then, the status of the tyre pressures is indicated for approximately 5 seconds.

Manual test of the vehicle



☞ Press the **"CHECK"** button on the instrument panel.

You can start a test of the vehicle manually, at any time, with the ignition on, engine running or vehicle moving.

This enables you to know:

- the warnings present,
- the status of the functions which can be activated or deactivated (automatic wipers, automatic switching on of the lights, ESP, ...).

The associated warning lights are displayed in succession on the instrument panel display.

If a warning or a change of status occurs during the **CHECK** mode, the corresponding warning light(s) are displayed during this mode and the **CHECK** will cease.

CHECK

Entering **CHECK** mode indicator light

This comes on following pressing of the **"CHECK"** button.

CHECK

Exiting **CHECK** mode indicator light

This comes on at the end of the **CHECK** mode.

With the engine running and the vehicle moving, the instrument panel display temporarily shows:

- warning lights, when a fault occurs,
- vehicle function status indicator lights, when a change occurs.

The display of certain warning lights may be accompanied by an audible signal and a message on the multi-function display.

List of warning lights

STOP**STOP warning light**

This is displayed following the **engine oil pressure, coolant temperature, punctured wheel, low brake fluid level** or **electronic brake force distribution** warning lights with which it is linked.

Stop immediately.

Contact a PEUGEOT dealer.

**Coolant temperature warning light**

This warning light is accompanied by an audible signal and a message on the multifunction display.

It is linked to the **STOP** warning light.

Stop immediately.

Wait for the engine to cool before topping up the level, if necessary.

**Low brake fluid level and electronic brake force distribution warning light**

This is linked to the warning light on the instrument panel.

Display of this warning light, accompanied by an audible signal and a message on the multifunction display, indicates an excessive drop in the brake fluid level or a malfunction of the electronic brake force distribution.

Linked with the **STOP** warning light.

Stop immediately in both cases.

Contact a PEUGEOT dealer.

**Engine oil pressure warning light**

This warning light is accompanied by an audible signal and a message on the multifunction display.

It is linked to the **STOP** warning light.

Stop immediately if this comes on when the engine is running.

Contact a PEUGEOT dealer as soon as possible.

**Puncture warning light**

This warning light comes on accompanied by an audible signal and a message on the multifunction display locating the punctured wheel.

It is linked to the **STOP** warning light.

Stop immediately.

Change the damaged wheel.

Have it repaired by a PEUGEOT dealer.

**Handbrake warning light**

Linked with the warning light on the instrument panel.

Display of this warning light, when the vehicle is moving, accompanied by an audible signal and a message on the multifunction display, indicates that the handbrake is applied or has not been released correctly.



Dynamic stability control (ESP/ASR) warning light

Display of this warning light, accompanied by an audible signal and a message on the multifunction display, indicates an ESP/ASR system malfunction. Contact a PEUGEOT dealer.



Battery charge warning light

Display of this warning light, when the engine is running, accompanied by an audible signal and a message on the multifunction display, indicates:

- faulty operation of the charging circuit,
- loose battery or starter terminals,
- a cut or slack alternator belt,
- an alternator fault.

Contact a PEUGEOT dealer.



Tyre under-inflation warning light

Display of this warning light is accompanied by an audible signal and a message on the multifunction display locating the under-inflated wheel.

Have the tyre pressure checked as soon as possible.



Engine oil level warning light

Display of this warning light is accompanied by an audible signal and a message on the multifunction display.

It indicates that the oil level is too low. Check the level using the dipstick. If the level is too low, remove the cap and top it up.



Low coolant level warning light

Display of this warning light is accompanied by an audible signal and a message on the multifunction display.

Stop immediately.

Warning: wait for the engine to cool before topping up, if necessary.

The cooling system is pressurised.

In the event of breakdown and to prevent the risk of scalding, unscrew the cap by two notches to allow the pressure to drop.

When the pressure has dropped, remove the cap and top up the level.

Contact a PEUGEOT dealer.



Electronic immobiliser warning light

Display of this warning light is accompanied by an audible signal and a message on the multifunction display.

It indicates a malfunction of the electronic immobiliser system.

Contact a PEUGEOT dealer.



Water in diesel filter warning light**

Display of this warning light is accompanied by an audible signal and a message on the multifunction display.

There is a risk of damage to the injection system.

Contact a PEUGEOT dealer as soon as possible.



Power steering warning light***

This indicates a power steering fault.

It is linked with the **STOP** warning light.

Stop immediately.

Contact a PEUGEOT dealer.

*** According to engine.

** According to country.



Front brake pad wear warning light

Display of this warning light is accompanied by an audible signal and a message on the multifunction display.

For your safety, have the pads replaced by a PEUGEOT dealer as soon as the warning light comes on.



Low fuel level warning light

This is linked with the warning light on the instrument panel.

Display of this warning light is accompanied by an audible signal and a message on the multifunction display.

When the warning light comes on, you have enough fuel to drive approximately 30 miles (50 km). The tank capacity is approximately 80 litres.



Fuel cap warning light

Display of this warning light in orange, when the engine is running, is accompanied by a diagram on the multifunction display.

Display of this warning light in red, when the vehicle is moving, is accompanied by an audible signal and a diagram on the multifunction display.

It comes on if the fuel tank cap is not correctly screwed on or is missing.



Door/boot open warning light

Display of this warning light in orange, with the engine running, is accompanied by a diagram on the multifunction display, showing which opening has not been closed correctly.

Display of this warning light in red, when the vehicle is moving, is accompanied by an audible signal and a diagram on the multifunction display showing which opening has not been closed correctly.



Air bags and pre-tensioners warning light

Display of this warning light is accompanied by an audible signal and a message on the multifunction display.

It indicates an anomaly of one of the front, side or curtain air bags or of the front pre-tensioning seat belts.

Contact your PEUGEOT dealer.



Emission control system warning light

Display of this warning light, accompanied by an audible signal and a message on the multifunction display, indicates a malfunction of the emission control system.

Contact a PEUGEOT dealer as soon as possible.



Low windscreen/headlamp wash level warning light

Display of this warning light is accompanied by an audible signal and a message on the multifunction display.

It is indicated when the ignition is switched on and when the wipers stalk is pressed.

Fill the windscreen/headlamp wash reservoir the next time you stop.



Particulate emission filter saturation warning light (Diesel)

Display of this warning light is accompanied by an audible signal and a message on the multifunction display.

When it comes on with the engine running, this indicates the start of saturation of the particulate emission filter (exceptionally long periods of town type driving conditions: reduced speed, long tailbacks...).

To regenerate the filter, you are advised to drive as soon as possible and when traffic conditions permit at a speed of 35 mph (60 km/h) or more for at least five minutes (until the warning light goes out).

If the light remains on, contact a PEUGEOT dealer.

When it comes on when the vehicle is moving, it indicates a lack of diesel additive in the reservoir for burning of the particles.

Contact a PEUGEOT dealer.

Note: after prolonged operation of the vehicle at a very low speed or at idle, you may sometimes notice steam coming from the exhaust during acceleration. This has no effect on the performance of the vehicle or on the environment.



Anti-lock braking system (ABS) warning light

This is linked to the warning light on the instrument panel.

Display of this warning light is accompanied by an audible signal and a message on the multifunction display. If the warning light remains on, or comes on at over 8 mph (12 km/h), this indicates a malfunction of the ABS.

However, the vehicle retains conventional servo-assisted braking.

Contact a PEUGEOT dealer.



Automatic headlamp adjustment warning light

Display of this warning light is accompanied by an audible signal and a message on

the multifunction display.

It comes on if there is a malfunction of the system on vehicles fitted with xenon bulbs.

Contact a PEUGEOT dealer.



Electronically controlled suspension warning light

Display of this warning light is accompanied by an audible signal and a message on the multifunction display.

It comes on when there is a malfunction of the electronically controlled suspension.

Select the automatic mode and contact a PEUGEOT dealer.



Speed control system warning light

Display of this warning light is accompanied by an audible signal and a message on the multifunction display.

It comes on if there is a malfunction of the cruise control or speed limiter.

Contact a PEUGEOT dealer.



Parking assistance system warning light

Display of this warning light is accompanied by an audible signal and a message on the multifunction display.

In reverse gear or in forward gear at a speed below 6 mph (10 km/h), it comes on if there is a malfunction of the parking assistance system.

Contact a PEUGEOT dealer.



Automatic gearbox warning light

Display of this warning light is accompanied by an audible signal and a message on the multifunction display.

It comes on if there is an abnormality in the automatic gearbox.

The gearbox will continue to operate in downgrade mode (locked in 3rd gear).

Contact a PEUGEOT dealer.



Tyre under-inflation system warning light

Display of this warning light is accompanied by an audible signal and a message

on the multifunction display indicating and locating the cause of the warning:

- a flat under-inflation sensor battery,
- a faulty under-inflation sensor,
- a missing under-inflation sensor.

Contact a PEUGEOT dealer.



Service warning light

Display of this warning light, accompanied by an audible signal and a message on the multifunction display, indicates either:

- a flat remote control battery,
- an engine management system fault. In the first case, replace the remote control battery.

In the second case, contact a PEUGEOT dealer as soon as possible.

List of status indicator lights

Dynamic stability control (ESP/ASR) system disarming indicator light

Display of this indicator light when the system is disarmed is accompanied by a message on the multifunction display.

Dynamic stability control (ESP/ASR) system activation indicator light

Display of this indicator light when the system is activated is accompanied by a message on the multifunction display.

Dynamic stability control (ESP/ASR) system operation indicator light

This comes on when the system starts to function.

Automatic headlamps disarmed indicator light

Display of this indicator light is accompanied by a message on the multifunction display.

The light comes on when the function is disarmed.

Automatic headlamps indicator light

Display of this light is accompanied by a message on the multifunction display.

The indicator light comes on when the function is activated.

Automatic windscreen wiper disarmed indicator light

Display of this light is accompanied by a message on the multifunction display.

The indicator light comes on when the function is disarmed.

Automatic windscreen wiper indicator light

Display of this light is accompanied by a message on the multifunction display.

The indicator light comes on when the function is activated.

SPORT suspension indicator light

The indicator light comes on when the **SPORT** function is activated.

AUTO suspension indicator light

The indicator light comes on when the **SPORT** function is disarmed.

Automatic gearbox lever position indicator lights

P
S
R
S
N
S
D
S

"Park" indicator light

"Reverse" indicator light

"Neutral" indicator light

"Drive" indicator light

Note: the letter **S** linked to the above indicator lights corresponds to the Sport operating programme.

"Manual" indicator lights

These indicator lights correspond to the six manually operated gears.

M 1 M 2 M 3
M 4 M 5 M 6

Coolant temperature indicator



When the needle is in **zone A**, the temperature is correct.

When the needle is in **zone B**, the temperature is too high.

In cases where the coolant temperature warning light comes on, linked to the STOP warning light, you must stop immediately.

Warning: wait for the engine to cool down before topping up the level, if necessary.

Because the cooling system is pressurised, to prevent the risk of scalding, turn the cap two notches to allow the pressure to drop.

When the pressure has dropped, remove the cap and top up the level.

Contact a PEUGEOT dealer.

Engine oil temperature indicator



When the needle is in **zone C**, the temperature is correct.

When the needle is in **zone D**, the temperature is too high.

Reduce your speed to lower the temperature.

Automatic gearbox lever position indicator lights

P
S
R
S
N
S
D
S

"Park" indicator light

"Reverse" indicator light

"Neutral" indicator light

"Drive" indicator light

Note: the letter **S** linked to the above indicator lights corresponds to the Sport operating programme.

"Manual" indicator lights

These indicator lights correspond to the six manually operated gears.

M 1 M 2 M 3
M 4 M 5 M 6

Coolant temperature indicator



When the needle is in **zone A**, the temperature is correct.

When the needle is in **zone B**, the temperature is too high.

In cases where the coolant temperature warning light comes on, linked to the STOP warning light, you must stop immediately.

Warning: wait for the engine to cool down before topping up the level, if necessary.

Because the cooling system is pressurised, to prevent the risk of scalding, turn the cap two notches to allow the pressure to drop.

When the pressure has dropped, remove the cap and top up the level.

Contact a PEUGEOT dealer.

Engine oil temperature indicator



When the needle is in **zone C**, the temperature is correct.

When the needle is in **zone D**, the temperature is too high.

Reduce your speed to lower the temperature.

Engine oil level indicator

When the ignition is switched on, the engine oil level is indicated on the instrument panel display for approximately 7 seconds.

This level is indicated at the same time as the service information which appears on the display located in the speedometer dial.

Oil level correct



Lack of oil



Flashing indicates a lack of oil which may damage the engine.

If the lack of oil is confirmed by checking using the dipstick, it is imperative that the level is topped up.

Oil level gauge fault



Check the oil level using the dipstick.

If the level is correct, the flashing indicates an engine oil level gauge

malfunction.

Contact a PEUGEOT dealer.

The level observed on the dipstick is only valid if the vehicle is parked on level ground and the engine has been off for more than 15 minutes.

Dipstick



There are 2 level marks on the dipstick:

- never exceed level A,
- in position B, top up the level via the oil filler cap, using the type of oil suited to your engine.

A = max.

B = min.

INSTRUMENT PANEL DISPLAY



After switching on the ignition, two functions are shown in succession:

- service indicator,
- total distance recorder (total and trip distances).

Note: the total and trip distances are displayed for 30 seconds when the ignition is switched off, on opening the driver's door, as well as on locking and unlocking the vehicle.

SERVICE INDICATOR

This is a visual reminder of when the next service is due. This service is to be carried out according to the manufacturer's servicing schedule.

The point at which the service is due is calculated from the last indicator zero reset. It is determined by two parameters:

- the distance travelled,
- the time elapsed since the last service.

Note: the distance remaining before the next service is due may be weighted by the time factor.

The service information appears on the display, located in the speedometer dial, at the same time as the engine oil level on the instrument panel display.

Operation

As soon as the ignition is switched on and for 7 seconds, the spanner symbolising the servicing operations is lit. The trip recorder display shows the distance remaining (in round figures) before the next service.

Example: 4,800 miles/km remain before the next service is due. When the ignition comes on and for 7 seconds the display indicates:



7 seconds after the ignition is switched on, the total distance recorder resumes normal operation and the display shows the total and trip distances.

INSTRUMENT PANEL DISPLAY



After switching on the ignition, two functions are shown in succession:

- service indicator,
- total distance recorder (total and trip distances).

Note: the total and trip distances are displayed for 30 seconds when the ignition is switched off, on opening the driver's door, as well as on locking and unlocking the vehicle.

SERVICE INDICATOR

This is a visual reminder of when the next service is due. This service is to be carried out according to the manufacturer's servicing schedule.

The point at which the service is due is calculated from the last indicator zero reset. It is determined by two parameters:

- the distance travelled,
- the time elapsed since the last service.

Note: the distance remaining before the next service is due may be weighted by the time factor.

The service information appears on the display, located in the speedometer dial, at the same time as the engine oil level on the instrument panel display.

Operation

As soon as the ignition is switched on and for 7 seconds, the spanner symbolising the servicing operations is lit. The trip recorder display shows the distance remaining (in round figures) before the next service.

Example: 4,800 miles/km remain before the next service is due. When the ignition comes on and for 7 seconds the display indicates:



7 seconds after the ignition is switched on, the total distance recorder resumes normal operation and the display shows the total and trip distances.

The distance remaining before the next service is less than 500 miles (1,000 km).

Each time the ignition is switched on and for 7 seconds, the spanner and the distance flash.

Example: 900 miles/km remain before the next service is due.

When switching on the ignition and for 7 seconds, the display shows:

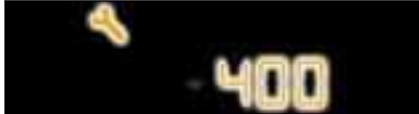

7 seconds after the ignition is switched on, the total distance recorder resumes normal operation and the spanner remains lit.

This indicates that a service should be carried out shortly. The display shows the total and trip distances.

The service is overdue..

Each time the ignition is switched on and for 7 seconds, the spanner and the excess distance flash.

Example: the service is overdue by 300 miles/km. The service should be carried out very shortly.

When the ignition is switched on and for 7 seconds, the display shows:



7 seconds after the ignition is switched on, the total distance recorder resumes normal operation and the spanner remains lit. The display shows the total and trip distances.

Note: the spanner may also be lit if the two-year interval has been exceeded.

Service indicator zero re-set



Your PEUGEOT dealer carries out this operation after each service.

However, if you carry out the service yourself, the re-set procedure is as follows:

- ☞ Switch off the ignition,
- ☞ Press and hold the trip recorder re-set button,
- ☞ Switch on the ignition.

The display begins a countdown.

When the display shows "**=0**", release the button; the spanner disappears.



After this operation, if you wish to disconnect the battery, lock the vehicle and wait for at least five minutes, otherwise the zero re-set will not be registered.

The distance remaining before the next service is less than 500 miles (1,000 km).

Each time the ignition is switched on and for 7 seconds, the spanner and the distance flash.

Example: 900 miles/km remain before the next service is due.

When switching on the ignition and for 7 seconds, the display shows:

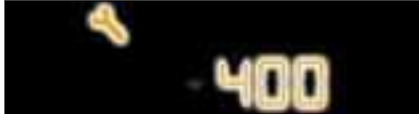

7 seconds after the ignition is switched on, the total distance recorder resumes normal operation and the spanner remains lit.

This indicates that a service should be carried out shortly. The display shows the total and trip distances.

The service is overdue..

Each time the ignition is switched on and for 7 seconds, the spanner and the excess distance flash.

Example: the service is overdue by 300 miles/km. The service should be carried out very shortly.

When the ignition is switched on and for 7 seconds, the display shows:



7 seconds after the ignition is switched on, the total distance recorder resumes normal operation and the spanner remains lit. The display shows the total and trip distances.

Note: the spanner may also be lit if the two-year interval has been exceeded.

Service indicator zero re-set



Your PEUGEOT dealer carries out this operation after each service.

However, if you carry out the service yourself, the re-set procedure is as follows:

- ☞ Switch off the ignition,
- ☞ Press and hold the trip recorder re-set button,
- ☞ Switch on the ignition.

The display begins a countdown.

When the display shows "**=0**", release the button; the spanner disappears.



After this operation, if you wish to disconnect the battery, lock the vehicle and wait for at least five minutes, otherwise the zero re-set will not be registered.

Trip recorder zero reset button



With the ignition on, press the button until the zeros appear.

Lighting rheostat button



With the headlamps on, press button **B** to increase the brightness of the lighting of the instruments and controls or button **A** to reduce it.

As soon as the lighting reaches the required level of brightness, release the button.

TRIP COMPUTER



Each press on the button, located at the end of the **wipers stalk**, displays different trip computer data in succession, depending on the multifunction display:

Colour screen C



- the **"vehicle"** tab with:
 - the range, the current consumption and the distance remaining to be travelled,
- tab **"1"** (route 1) with:
 - the average speed, the average consumption and the distance travelled calculated over route **"1"**,
- tab **"2"** (route 2) with the same characteristics for a second route.

Colour and map screen DT



- the **"Current info"** with:
 - the range, the current consumption and the distance remaining to be travelled,
- **"Route 1"** with:
 - the distance travelled, the average consumption and the average speed calculated over route **"1"**,
- **"Route 2"** with the same characteristics for a second route.

Range (km or miles)

This shows the distance that can still be covered with the fuel remaining in the tank in accordance with the average consumption over the last few miles (kilometres).

This figure may increase if there is a change in the style of driving or the road surface, producing a significant drop in current consumption.

When the range is less than 30 miles (50 km), four dashes are displayed. After filling with fuel, the range is displayed when it exceeds 62 miles (100 km).

If dashes are displayed for long periods instead of digits, contact a PEUGEOT dealer.

Current consumption (l/100 or km/l or mpg)

This is the average quantity of fuel consumed during the last few seconds.

This function is displayed only when the vehicle is travelling at a speed greater than 20 mph (30 km/h).

Average consumption (l/100 or km/l or mpg)

This is the average fuel consumption since the computer was last set to zero.

Distance travelled (km or miles)

This indicates the distance travelled since the computer was last set to zero.

Distance remaining to be travelled (km or miles)

This is the distance remaining to be travelled to the final destination. It is either calculated by the navigation system if guidance is activated or entered by the user.

If the distance is not entered, dashes are displayed in place of the digits.

Average speed (km/h or mph)

This is the average speed calculated since the computer was last set to zero (with the ignition on).

The routes

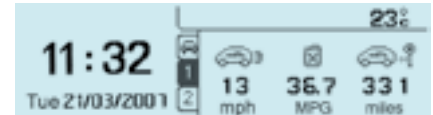

The routes "1" and "2" are independent but have identical application.

Route "1" for example allows you to make daily calculations and route "2" monthly calculations.

Zero reset

When the required route is displayed, press the end of the wipers stalk for more than two seconds.

Access via the general menu



C screen



DT screen

"TRIP" menu

Press the **"MENU"** or **"TRIP"** button to gain access to the general menu.

Select the **"Trip computer"** application using the navigator, then confirm.

The "Trip computer" menu offers various options:

- Inputting of the distance to be travelled,
- Warnings log,
- Status of the functions.

Warnings log

This summarises the active warning messages, displaying them on the multifunction display in succession.

Status of the functions

This summarises the active or inactive status of the functions present on the vehicle.

Inputting the distance remaining to be travelled

When guidance is not activated, this enables you to enter an approximate distance to the final destination.

Indication on the instrument panel display



The different trip computer data also appears on the instrument panel display at the same time.

COLOUR SCREEN C



This displays the following information, via the RD4 audio equipment control pad:

- the time,
- the date,
- the exterior temperature (the value displayed flashes if there is a risk of ice),
- the accesses check,
- the vehicle functions warning or status messages, displayed temporarily,
- the audio sources displays,
- the trip computer displays,
- the personalisation and configuration displays,
- the hands-free kit displays.

Management of the displays



The "AUDIO", "TRIP" and "TEL" buttons on the RD4 audio equipment control pad permit displaying in the main window.

Example: "TRIP"



General menu

Press the "MENU" button to gain access to the **general menu** and select one of the following functions:

- "Audio functions",
- "Trip computer",
- "Personalisation-Configuration",
- "Telephone".

Example: "Audio functions"



"Personalisation-Configuration" menu



This provides access to successive confirmation windows.

Defining the vehicle parameters

This enables you to activate or deactivate certain driving and comfort elements:

- "Automatic switching on of the lights",
- "Follow-me-home lighting" and "Duration",
- "Remote control action",
- "Permanent locking of the boot".

Example: "Automatic switching on of the lights"

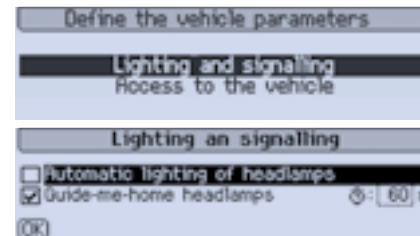

Selection of the language

German, Spanish, French, English, Italian, Dutch, Portuguese and Brazilian Portuguese.

Configuration of the display

- "Setting the brightness-video".
- "Setting the date and time".
- "Selection of the units":
 - temperature (°C or °F),
 - fuel consumption (l/100, mpg or km/l).
- "Selection of the colours".

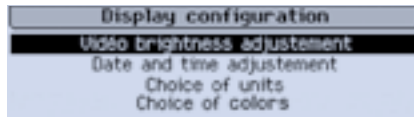

The brightness of the display and of the instrument panel may change when the lights are switched on automatically.

Changing the date and time

From the **general menu**, select the **"Personalisation-Configuration"** icon using the navigator, then confirm.



From the list displayed, select **"Configuration of the display"**, then confirm.

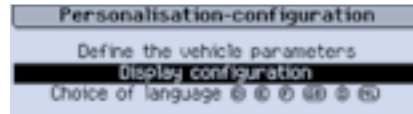

From the list displayed, select **"Setting the date and time"**, then confirm.

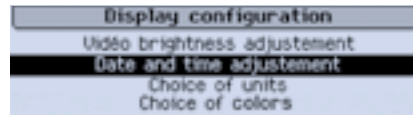

Set the parameters one by one:

- the zone selected is displayed on the screen,
- use the navigator to move from one zone to another,
- your new parameters are confirmed one by one, by pressing the navigator button,
- all of the changes are saved, if you click on **"OK"** on the screen, or cancelled, if you press the **"ESC"** button on the control pad.

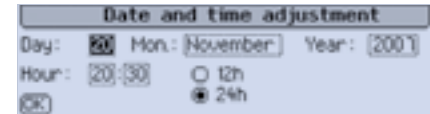

For safety reasons, configuration of the multifunction displays by the driver must be carried out while stationary.

DT COLOUR AND MAP SCREEN



This displays the following information, via the RT3 GPS audio/telephone control pad:

- the time,
- the date,
- the exterior temperature (the value displayed flashes if there is a risk of ice),
- the accesses check,
- the vehicle functions warning or status messages, displayed temporarily,
- the audio sources displays,
- the telematic systems displays (telephone, services, ...),
- the trip computer displays,
- the configuration displays,
- the satellite navigation system displays.

Management of the displays



The **"AUDIO"**, **"NAV"**, **"TRIP"** and **"TEL"** buttons on the RT3 audio/telephone control pad permit displaying in the main window.

Example: "TRIP"



General menu



Press the **"MENU"** button to gain access to the **general menu** and select one of the following functions:

- "Navigation-Guidance",
- "Audio functions",
- "Trip computer",
- "Configuration",
- "Directory",
- "Telematics",
- "Map",
- "Video".

Example: "Configuration"



"Configuration" menu



This provides access to successive confirmation windows.



The brightness of the display and of the instrument panel may change when the lights are switched on automatically.

Defining the vehicle parameters

This enables you to activate or deactivate certain driving and comfort elements:

- "Automatic switching on of the lights",
- "Follow-me-home lighting" and "Duration",
- "Remote control action",
- "Permanent locking of the boot".

Example: "Automatic switching on of the lights"

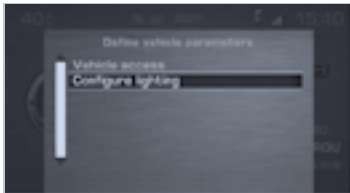

Configuration of the display

- "Selection of the colours": selection of the colours available for the display.
- "Brightness and brilliance".
- "Sound": selection of the sound ambience, setting of the voice synthesiser and of the voice commands.
- "International parameters":
 - setting of the date and time,
 - selection of the units: temperature (°C or °F) and fuel consumption (l/100, mpg or km/l).
- "Selection of the language": German, Spanish, French, English, Italian, Dutch, Portuguese and Brazilian Portuguese.



For safety reasons, configuration of the multifunction displays by the driver must be carried out while stationary.

"Video" menu



You can connect video equipment (camcorder, digital camera, DVD player, ...) to the three video sockets located in the glove box.

Video display is only possible when stationary.

Select the **"Video"** menu from the **general menu**:

- "Activate video mode" to activate/deactivate the video,
- "Video parameters" to set the display format, the brightness, the contrast and the colours.

Pressing the **"DARK"** button disconnects the video display.

Successive presses of the **"SOURCE"** button permit the selection of an audio source other than that of the video.



VENTILATION

1. Windscreen de-icing or demisting vents
2. Front window de-icing or demisting vents
3. Side vents
4. Centre vents
5. Air outlets to the front passengers' feet
6. Air outlets to the rear passengers' feet



Use of the automatic regulation of the air conditioning is recommended. It permits optimised automatic control of all of the following functions: air flow, passenger compartment temperature and air distribution, using various sensors (exterior temperature and sunshine), so there is no need to change your reference settings other than the value displayed.



Recommendations for use and notes

If the interior temperature remains very high following a prolonged period parked in the sun, do not hesitate to ventilate the passenger compartment for a few minutes.

To obtain uniform air distribution, take care not to obstruct the exterior air intake grille located at the bottom of the windscreen, the vents, the air outlets under the front seats and the air extractor in the boot.

In cold weather, in order to obtain uniform comfort, more rapid demisting or if the flow of air on your face feels uncomfortable, it is advisable to close vents 3 and 4.

When washing the vehicle using high pressure equipment, do not direct the jet towards the exterior air intake grille.

To obtain optimum demisting, we recommend that the windows are kept clean on the inside of the vehicle.

In certain cases of particularly arduous use (towing the maximum load on a steep gradient when the temperature is high), cutting off the air conditioning permits the recovery of engine power and, therefore, an increase in the towing capacity.

For the air conditioning to be fully effective, the windows must be closed.

Ensure that the passenger compartment filter is in good condition. Have the filter elements replaced regularly. If you drive in a dusty environment, replace them twice as often.

The air conditioning system does not contain chlorine and does not present any danger to the ozone layer.

Operate the air conditioning for 5 to 10 minutes, once or twice a month to keep it in perfect working order.

The water resulting from the condensation of the air conditioning system is discharged via an opening provided for this purpose. Therefore, a puddle of water may form underneath the vehicle when stationary.

If the system does not produce cold air, do not use it and contact your PEUGEOT dealer.

Flashing of the points separating the setting value digits indicates a malfunction of the air conditioning. Contact your PEUGEOT dealer.

AUTOMATIC AIR CONDITIONING (DUAL ZONE)



Dual zone: this is the differentiated regulation of the temperature and air distribution on the driver's side and the front passenger side.

The driver and his front passenger can each adjust the temperature and the distribution of the air to suit their requirements.

1 - Driver's automatic comfort programme

2 - Passenger automatic comfort programme

This is the usual air conditioning system operating mode.



Press the "AUTO" button(s).

The system is automatically set to the value required.

Depending on the level of comfort selected, the system controls the air distribution, flow, temperature and intake of air in order to guarantee comfort and an adequate circulation of air in the passenger compartment. You do not have to make any adjustments.

The "AUTO" symbol is displayed.



When the engine is cold, to prevent too great a distribution of cold air, the air flow will only reach its optimum level progressively.

Note: when the visibility programme 9 or the air intake/recirculation 10 is selected, the passenger's "AUTO" button is deactivated; the indicator light of the corresponding button flashes temporarily.

3 - Adjustment of the driver's temperature

4 - Adjustment of the passenger temperature



Press the up or down arrow to change the temperature on the driver's side 3 or passenger side 4.

The value indicated on the display corresponds to a level of comfort and not to a temperature in degrees Celsius or Fahrenheit, depending on the choice of configuration validated on the display.

A setting around the value 21 makes it possible to obtain optimum comfort. However, depending on your requirements, a setting between 18 and 24 is usual.



On entering the vehicle, the interior temperature may be much colder (or warmer) than is comfortable. There is no need to change the temperature displayed in order to obtain rapidly the level of comfort required.

The automatic regulation of the air conditioning will use its maximum performance settings to correct the temperature difference as quickly as possible.

Control via the manual controls







It is possible to adjust one or more functions manually while leaving the other functions in automatic mode.

The **"AUTO"** button indicator light is switched off.

Switching to manual mode may result in discomfort (temperature, humidity, odour, condensation) and is not advantageous for comfort.

To return to automatic mode, press the **"AUTO"** button.

To limit the discomfort resulting from use of the manual controls, we recommend the following settings:

Exterior temperatures	Air distribution	Positions of the vents (3) and (4)	Comfort in the rear seats	Blower (minimum)
Low		Vents closed.	<ul style="list-style-type: none"> - Increase the blower air flow. - Close the centre vents. 	
Average		Four vents open.		
High		Four vents open.	<ul style="list-style-type: none"> - Open the vents. - Increase the blower air flow. 	

5 - Blower and air flow

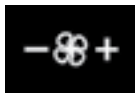

☞ Press buttons "+" and "-" respectively to increase or decrease the air flow.

The air flow symbol (fan) is filled in in relation to the value required.

To prevent condensation and deterioration of the quality of the air in the passenger compartment, ensure that an adequate flow of air is maintained.

6 - Deactivation of the air conditioning (OFF)



☞ Press the **OFF** button.

This action switches off the display and the indicator lights and deactivates all of the functions of the system, with the exception of the rear screen demisting.

The temperature-related comfort is no longer controlled (temperature, humidity, condensation).

Avoid driving for too long with the air conditioning deactivated.

☞ Pressing this button again or buttons **5**, **7** or **8** or one of the two **"AUTO"** buttons reactivates the system with the values set before it was switched off.

7 - Adjustment of the driver's air distribution

8 - Adjustment of the passenger air distribution



Successive presses of these buttons enable you to direct the flow of air on the driver's side or on the passenger side alternately towards:

- the windscreen and footwells,
- the footwells,
- the centre vent, side vent and footwells,
- the centre vent and side vent,
- the windscreen.

9 - Automatic visibility programme



In certain cases, the comfort programme may not be sufficient to demist or de-ice the windows (humidity, several passengers, ice).

☞ In this case, select the visibility programme and open the side vents in order to clear the windows quickly. It controls the air conditioning, air flow and intake and distributes the ventilation to the windscreen and side windows.

The symbols **"A/C"**, **"AUTO"** and air flow (fan) are displayed.

Once the inconvenience has been eliminated, pressing button **1** or **2** returns the system to the comfort setting.

10 - Intake of exterior air/Recirculation of interior air



This function enables you to isolate the passenger compartment from exterior fumes and odours.

- ☞ Press this button to set the air intake mode, the indicator light comes on in recirculation mode. Prolonged operation in interior air recirculation mode may result in the formation of condensation and deterioration of the quality of the interior air.

Do not drive in air recirculation mode for prolonged periods, except in truly exceptional atmospheric conditions.

The message associated with the control is displayed on the multi-function display.

- ☞ Press this button again to return to automatic control of the air intake.

For your comfort, when the ignition is switched off, the settings are stored until it is switched on again.

11 - Rear screen and mirrors demisting



- ☞ Press this button, with the engine running, to demist the rear screen and the exterior mirrors.

Demisting is switched off automatically to avoid an excessive consumption of current and in relation to the exterior temperature.

It may be stopped by pressing this button again or when the engine is switched off.

However, the demisting resumes if the engine is switched on again within one minute.

Switch off the rear screen and exterior mirrors demisting when you consider this necessary as low current consumption reduces fuel consumption.

12 - Air conditioning On/Off (A/C)



The deactivation of this function may result in temperature, humidity, odour and smoke discomfort.

- ☞ Press this button to switch off the air conditioning.

The symbol "A/C" is switched off.

- ☞ Press this button again to return to automatic operation of the air conditioning.

The symbol "A/C" is displayed.

MIRRORS



Exterior mirrors

Adjustment

- ☞ Turn knob **A** to the right or to the left to select the corresponding mirror.
- ☞ Move knob **A** in all four directions to adjust.

Folding back the mirrors electrically

- from inside:
- ☞ With the ignition on, turn knob **A** rearwards.

If the mirrors are folded back using knob **A**, they will not unfold when the vehicle is unlocked using the remote control. You must turn knob **A** again.

- from outside:
- ☞ Lock the vehicle using the remote control.

When the vehicle is parked, the exterior mirrors can be folded back manually.

Automatic day/night exterior mirrors

These darken automatically depending on the brightness from the rear.

They are linked with the automatic day/night interior mirror (see paragraph "Automatic day/night interior mirror").

To ensure maximum visibility during manoeuvres, the mirror clears automatically when reverse gear is engaged.

Automatically adjustable mirrors for parking*

These allow you to see the ground (kerb, wall...) when carrying out parking manoeuvres in reverse gear.

Initial setting of the function

- ☞ Engage reverse gear.
- ☞ Select and adjust the left and right mirrors in succession.

These settings will be stored when the vehicle is locked.

Tilting the mirror to the parking position

- ☞ Turn control **A** to the right or to the left.
- ☞ Engage reverse gear.
The exterior mirror corresponding to the side on which you are parking tilts downwards.

Returning the mirror to the normal position

- ☞ Change out of reverse gear.
After a few seconds, the glass of the corresponding mirror resumes its normal position.
You can deactivate the function by returning control **A** to the central position "●".



The end of the driver and passenger mirrors is convex in order to reduce the "blind spot" (area at edge defined by a dotted line).

As a result, objects observed in the driver and passenger mirrors are, in reality, closer than they appear.

This must be taken into account to judge correctly the distance of vehicles approaching from behind.

* According to version.

Automatic day/night interior mirror



This automatically and gradually changes between the day and night positions. To prevent dazzling, the glass of the mirror darkens automatically depending on the intensity of the light from behind. It clears as the light (headlamps of following vehicles, sunlight) decreases, ensuring maximum visibility.

Operation

Switch on the ignition and press switch 1:

- Indicator light 2 lit (switch pressed): automatic operation.
- Indicator light 2 off: automatic system off. The mirror remains at its most clear.



Special feature

To ensure maximum visibility during manoeuvres, the mirror clears automatically when reverse gear is engaged.

Manual interior mirror

The interior mirror has two positions:

- day (normal),
- night (anti-dazzle).

To change from one to the other, push or pull the lever on the lower edge of the mirror.

STEERING WHEEL HEIGHT AND DEPTH ADJUSTMENT



- ☞ When the vehicle is stationary, unlock the steering wheel by pushing handle A.
- ☞ Adjust the height and depth of the steering wheel.
- ☞ Lock by pulling handle A fully.

Automatic day/night interior mirror



This automatically and gradually changes between the day and night positions. To prevent dazzling, the glass of the mirror darkens automatically depending on the intensity of the light from behind. It clears as the light (headlamps of following vehicles, sunlight) decreases, ensuring maximum visibility.

Operation

Switch on the ignition and press switch 1:

- Indicator light 2 lit (switch pressed): automatic operation.
- Indicator light 2 off: automatic system off. The mirror remains at its most clear.



Special feature

To ensure maximum visibility during manoeuvres, the mirror clears automatically when reverse gear is engaged.

Manual interior mirror

The interior mirror has two positions:

- day (normal),
- night (anti-dazzle).

To change from one to the other, push or pull the lever on the lower edge of the mirror.

STEERING WHEEL HEIGHT AND DEPTH ADJUSTMENT



- ☞ When the vehicle is stationary, unlock the steering wheel by pushing handle A.
- ☞ Adjust the height and depth of the steering wheel.
- ☞ Lock by pulling handle A fully.

FRONT SEATS

Electric front seats



The electric functions of the driver's seat are deactivated one minute after the ignition is switched off.

A - Forwards-backwards adjustment



Push the control forwards or backwards to slide the seat.

B - Seat cushion angle adjustment



Tilt the front of the control upwards or downwards to obtain the required angle.

C - Seat height adjustment



Tilt the rear part of the control upwards or downwards to obtain the required height.



The operation of the electric seats will be deactivated temporarily if the energy economy mode is activated.

D - Seat back angle adjustment

Tilt the control to the front or the rear to obtain the correct angle.

E - Head restraint height and angle adjustment

Tilt the control upwards or push it downwards to obtain the correct height.

F - Lumbar adjustment (manual adjustment)

Raise or lower the lever to obtain the required position.



The setting is correct when the upper edge of the head restraint is level with the top of the head.

The head restraint angle can also be adjusted manually.

To remove the head restraint, tilt the seat back to 45° and place the head restraint in the high position, then pull with both hands.



Never drive with the head restraints removed; they must be in place and adjusted correctly.

G - Heated seats adjustment



With the engine running, use the corresponding adjustment dial to select the required degree of heating:

0: Off.

1: Low.

2: Medium.

3: High.

Memorising driving and mirror positions



The electrical adjustments of the seat and exterior mirrors are memorised.

Two driving positions can be memorised using buttons **M/1** and **M/2**.

Memorising using the controls on the driver's door

To memorise:

- ☞ Place the key in the ignition on position,
- ☞ Adjust your seat and mirrors,
- ☞ Press button **M**, then button **1** "first driving position" or button **2** "second driving position" within four seconds.

An audible signal confirms that a position has been memorised.

Memorising a new position cancels the previous one.

Recalling a memorised driving position

Ignition on, vehicle stationary

- ☞ Briefly press button **1** or **2** to recall the corresponding memorised position. The end of the setting is indicated by a bleep.

After recalling a memorised position a few times in succession, the function will be cancelled until the engine is started.

Vehicle moving

- ☞ Keep button **1** or **2** pressed down until the bleep indicates that setting of the corresponding memorised position is complete.

G - Heated seats adjustment



With the engine running, use the corresponding adjustment dial to select the required degree of heating:

0: Off.

1: Low.

2: Medium.

3: High.

Memorising driving and mirror positions



The electrical adjustments of the seat and exterior mirrors are memorised.

Two driving positions can be memorised using buttons **M/1** and **M/2**.

Memorising using the controls on the driver's door

To memorise:

- ☞ Place the key in the ignition on position,
- ☞ Adjust your seat and mirrors,
- ☞ Press button **M**, then button **1** "first driving position" or button **2** "second driving position" within four seconds.

An audible signal confirms that a position has been memorised.

Memorising a new position cancels the previous one.

Recalling a memorised driving position

Ignition on, vehicle stationary

- ☞ Briefly press button **1** or **2** to recall the corresponding memorised position. The end of the setting is indicated by a bleep.

After recalling a memorised position a few times in succession, the function will be cancelled until the engine is started.

Vehicle moving

- ☞ Keep button **1** or **2** pressed down until the bleep indicates that setting of the corresponding memorised position is complete.

REAR SEATS

Rear seat

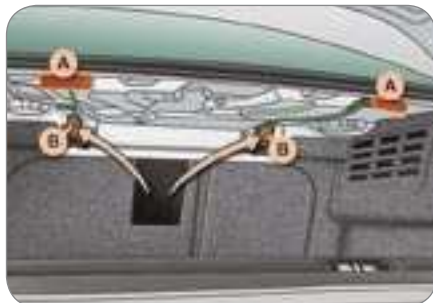

The seat back in the rear is folded down in two 1/3-2/3 parts.

Before folding down the seat back:

- ☞ check that the seat belt strap on the side of the seat back (1/3 or 2/3) is positioned correctly,
- ☞ release the lap belt strap by pressing the black button of the lock (2/3).



When returning the seat back to its original position, ensure that the seat belt is not trapped.

Folding down the seat back



The unlocking controls are located in the boot.

To unlock from the boot:

- ☞ pull the control **A** corresponding to the part of the seat back that you wish to fold down.

To unlock from inside the vehicle:

- ☞ lower the armrest and open the ski flap,
- ☞ pull the button **B** located on the unlocking housing corresponding to the part of the seat back that you wish to fold down.



When putting the seat back to its original position, for your safety make sure that it is correctly locked.

Rear heated seats controls



- ☞ Press the switch. The temperature is regulated automatically.
- ☞ Press it again to stop operation.

Note: the command to activate heating of the seat(s) remains in the memory for one minute after the ignition is switched off.

GENERAL POINTS RELATING TO CHILD SEATS

Although one of PEUGEOT's main criteria when designing your vehicle, the safety of your children also depends on you.



For maximum safety, please follow these precautions:

- in accordance with Directive 2003/20, **all children under the age of 12 or less than one metre fifty* tall must travel in approved child seats suited to their weight**, on seats fitted with a seat belt or ISOFIX mountings*,
- **statistically, the safest seats in your vehicle for the transportation of children are the rear seats**,
- **a child weighing less than 9 kg must travel in the "rearwards-facing" position both in the front and in the rear.**

PEUGEOT recommends that children should travel in the **rear seats** of your vehicle:

- **"rearwards-facing"** up to the age of 2,
- **"forwards-facing"** over the age of 2.

INSTALLING A CHILD SEAT USING A THREE POINT SEAT BELT

"Rearwards-facing"



When a "rearwards-facing" child seat is installed on the **front passenger seat**, it is essential that the passenger air bag is disarmed. Otherwise, **the child would risk being seriously injured or killed if the air bag were to inflate.**

"Forwards-facing"



When a "forwards-facing" child seat is installed on the **front passenger seat**, adjust the vehicle's seat to the intermediate longitudinal position with the seat back upright and leave the passenger air bag armed.



Intermediate longitudinal position

* The rules for transporting children are specific to each country. Consult the current legislation in your country.

CHILD SEATS RECOMMENDED BY PEUGEOT

PEUGEOT offers a complete range of recommended child seats which are secured using a three point seat belt:

Group 0: from birth to 10 kg
Group 0+: from birth to 13 kg



L1

"ROMER Baby-Safe Plus"
 Installed in the rear-facing position

Groups 1, 2 and 3: from 9 to 36 kg



L2

"KIDDY Life"
 For the safety of young children (from 9 to 18 kg), PEUGEOT recommends use of the restraining cushion.

Groups 2 and 3: from 15 to 36 kg



L3

"RECARO Start"



L4

"KLIPPAN Optima"



From the age of 6 years (approximately 22 kg), the booster is used on its own.



Passenger air bag OFF

LOCATION OF CHILD SEATS SECURED USING THE SEAT BELT

In accordance with European regulations (Directive 2000/3), this table indicates the options for the installation of child seats, secured using the seat belt and universally approved, in relation to the weight of the child and the seat in the vehicle.

Seat(s)	Weight of the child/indicative age			
	Less than 13 kg (group 0 (a) to 0+) Up to 1 year approx	From 9 to 18 kg (group 1) From 1 to 3 years approx	From 15 to 25 kg (group 2) From 3 to 6 years approx	From 22 to 36 kg (group 3) From 6 to 10 years approx
Front passenger (b) Height adjustable seat 	U (R)	U (R)	U (R)	U (R)
Rear side 	U	U	U	U
Rear centre 	X	RÖMER Duo*	L2, L3, L4	L2, L3, L4

U: seat suitable for the installation of a child seat secured using the seat belt and universally approved, "rearwards facing" and/or "forwards facing".

U (R): idem **U**, the vehicle seat must be adjusted to its highest position.

X: seat which is not suitable for the installation of a child seat of the weight group indicated.

L-: only the child seats indicated may be installed on the seat concerned (according to country).

(a) Group 0: from birth to 10 kg.

(b) Consult the current legislation in your country before installing your child on this seat.



ADVICE ON CHILD SEATS

The incorrect installation of a child seat in a vehicle compromises the child's protection in the event of an accident.

Remember to fasten the seat belts or the child seat harnesses **keeping the slack** in relation to the child's body to a minimum, even for short journeys.

For optimum installation of the "forward facing" child seat, ensure that the back of the child seat is in contact with the back of the vehicle's seat and that the head restraint does not cause any discomfort.

If the head restraint has to be removed, ensure that it is stored or attached securely to prevent it from being thrown around the vehicle in the event of sharp braking.

Children under the age of 10 must not travel in the "forward facing" position on the front passenger seat, unless the rear seats are already occupied by other children, cannot be used or are absent.

Disarm the passenger air bag when a "rear facing" child seat is installed on the front seat. Otherwise, the child would risk being seriously injured or killed if the air bag were to inflate.

Installing a booster seat

The chest part of the seat belt must be positioned on the child's shoulder without touching the neck.

Ensure that the lap part of the seat belt passes correctly over the child's thighs.

PEUGEOT recommends the use of a booster seat which has a back, fitted with a seat belt guide at shoulder level.

As a safety precaution, do not leave:

- one or more children alone and unsupervised in a vehicle,
- a child or an animal in a vehicle which is exposed to the sun, with the windows closed,
- the keys within reach of children inside the vehicle.

To prevent accidental opening of the doors, use the "Child lock".

Take care not to open the rear windows by more than one third.

To protect young children from the rays of the sun, fit side blinds on the rear windows.

"ISOFIX" MOUNTINGS

This seat is fitted with ISOFIX mountings.

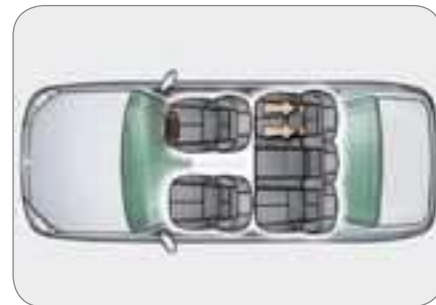

These are two rings located between the seat back and the seat cushion.

The **ISOFIX child seats** are fitted with two locks which are secured easily on these rings.

This ISOFIX mounting system guarantees reliable, safe and fast fitting of the child seat in your vehicle.



If a child is not installed in a vehicle correctly, the child's protection in the event of a collision will be compromised.



ADVICE ON CHILD SEATS

The incorrect installation of a child seat in a vehicle compromises the child's protection in the event of an accident.

Remember to fasten the seat belts or the child seat harnesses **keeping the slack** in relation to the child's body to a minimum, even for short journeys.

For optimum installation of the "forward facing" child seat, ensure that the back of the child seat is in contact with the back of the vehicle's seat and that the head restraint does not cause any discomfort.

If the head restraint has to be removed, ensure that it is stored or attached securely to prevent it from being thrown around the vehicle in the event of sharp braking.

Children under the age of 10 must not travel in the "forward facing" position on the front passenger seat, unless the rear seats are already occupied by other children, cannot be used or are absent.

Disarm the passenger air bag when a "rear facing" child seat is installed on the front seat. Otherwise, the child would risk being seriously injured or killed if the air bag were to inflate.

Installing a booster seat

The chest part of the seat belt must be positioned on the child's shoulder without touching the neck.

Ensure that the lap part of the seat belt passes correctly over the child's thighs.

PEUGEOT recommends the use of a booster seat which has a back, fitted with a seat belt guide at shoulder level.

As a safety precaution, do not leave:

- one or more children alone and unsupervised in a vehicle,
- a child or an animal in a vehicle which is exposed to the sun, with the windows closed,
- the keys within reach of children inside the vehicle.

To prevent accidental opening of the doors, use the "Child lock".

Take care not to open the rear windows by more than one third.

To protect young children from the rays of the sun, fit side blinds on the rear windows.

"ISOFIX" MOUNTINGS

This seat is fitted with ISOFIX mountings.



These are two rings located between the seat back and the seat cushion.



The **ISOFIX child seats** are fitted with two locks which are secured easily on these rings.

This ISOFIX mounting system guarantees reliable, safe and fast fitting of the child seat in your vehicle.



If a child is not installed in a vehicle correctly, the child's protection in the event of a collision will be compromised.

ISOFIX CHILD SEATS RECOMMENDED BY PEUGEOT AND APPROVED FOR YOUR VEHICLE

ISOFIX KIDDY		ISOFIX RÖMER Duo Plus
Group 0+: from birth to 13 kg	Group 1: from 9 to 18 kg	Group 1: from 9 to 18 kg
		
Installed in the rear facing position.		Installed in the forwards facing position only.
Installed in the forwards facing position.		
The body of the child seat must be in contact with the back of the vehicle's front seat.	It is essential that the vehicle's front seat is adjusted to the intermediate longitudinal position.	Secured without the top strap. Three child seat body angles: sitting, reclining and lying positions. Adjust the vehicle's front seat so that the child's feet do not touch the seat back.



These child seats can also be used on seats which are not fitted with ISOFIX mountings. In this case, it is essential that they are secured to the vehicle's seat by means of the three point seat belt.

Follow the instructions for fitting the child seat indicated in the seat manufacturer's installation guide.

REMOTE CONTROL KEY



The remote control in the key permits remote locking, deadlocking and unlocking of the doors, boot and fuel filler flap, as well as folding and unfolding of the exterior mirrors.

The key permits mechanical and independent operation of the glove box lock, of the passenger air bag disarming control and of the mechanical child lock as well as switching on of the ignition.

From the driver's door, the key permits electrical control of the locking or unlocking of the doors, boot and fuel filler flap.

If one of the doors or the boot is open, the central locking does not function.

Unfolding/Folding the key

To unfold or fold the key, press button **A** first.

Normal locking

- ☞ **Press** button **B** for complete locking of the vehicle.
- ☞ **Press** button **B** for more than **2 seconds** for **automatic closing of the windows and sunroof** in addition to locking.

Each action is confirmed by fixed lighting of the direction indicators for approximately two seconds.

The exterior mirrors fold at the same time.

Unlocking

Complete

- ☞ Press button **C** for complete unlocking of the vehicle.

This is confirmed by rapid flashing of the direction indicators for approximately two seconds.

Selective

- ☞ **Press** button **C** to unlock the driver's door and the fuel filler flap only.
- ☞ **Press the button again** to unlock the other doors and the boot.

Each action is confirmed by rapid flashing of the direction indicators for approximately two seconds.

The exterior mirrors unfold at the same time.



When the vehicle is locked, if unlocking is activated inadvertently, without a door being opened within 30 seconds, the vehicle will lock automatically.



The complete or selective unlocking can be configured by means of a parameter, via the multifunction display "**Personalisation-Configuration**" menu.

Unlocking, opening and stopping of the boot



- ☞ Press button **D** to unlock and open the boot.

This action also unlocks the doors.

- ☞ Press button **D** again to stop the movement of the boot in an intermediate position.



If the permanent locking of the boot is activated, unlocking is only possible via button **D** on the remote control.



This function can be configured by means of a parameter, via the multi-function display "**Personalisation-Configuration**" menu.

Deadlocking

This renders the external and **internal** door controls inoperative.

It also deactivates the internal central locking button.

- ☞ **Pressing** button **B** permits complete locking of the vehicle or **pressing** button **B** for more than **2 seconds** permits automatic closing of the windows and sunroof in addition to locking.
- ☞ Within five seconds, a **second press** permits deadlocking of the vehicle.



Each action is confirmed by fixed lighting of the direction indicators for approximately two seconds.

Key in ignition

A buzzer sounds on opening the driver's door, if the key has been left in the ignition.

Locating your vehicle

To locate your vehicle, if you have locked it, in a car park:

- ☞ press button **B**, the courtesy lights come on and the direction indicators flash for a few seconds.

Changing the remote control battery



Battery ref.: CR1620/3 volts.

The information "battery flat" is given by displaying of the service warning light, accompanied by an audible signal and a message on the multifunction display.

To replace the battery, unclip the casing using a coin at the notch.

If the remote control does not work after the battery has been changed, reprogramme the remote control.



Do not discard the batteries, they contain metals which are harmful to the environment.

Take them to an approved collection point.

Reprogramming the remote control

Following disconnection of the vehicle's battery, replacement of the remote control battery or in the event of a remote control malfunction, the remote control must be reinitialised.

- ☞ Switch off the ignition.
- ☞ Switch the ignition on again.
- ☞ Press the remote control locking button immediately for a few seconds.
- ☞ Switch off the ignition and remove the remote control key from the ignition lock.

The remote control is now working again.

ELECTRONIC ENGINE IMMOBILISER

This locks the engine control system a few moments after the ignition has been switched off and therefore prevents starting of the vehicle by anyone who does not have the key.

The ignition key has an electronic chip which has a special code. When the ignition is switched on, the code is recognised and starting is possible.

If the system does not function correctly, the service warning light comes on, accompanied by an audible signal and a message on the multifunction display.

In this case, your vehicle will not start. Contact a PEUGEOT dealer as soon as possible.

A heavy object attached to the key (key ring, ...), weighing down on the shaft of the key in the switch, may cause a malfunction.

CONFIDENTIAL CARD



This is given to you on delivery of your vehicle with the duplicate keys.

It contains the identification code necessary for any work carried out by a PEUGEOT dealer on the electronic immobiliser system. This code is hidden by a film, which should be removed only if necessary.

Keep your card in a safe place, never inside the vehicle.

When undertaking a long trip or journey, however, it is advisable to take it with you along with your personal papers.



Make a careful note of the number on each key. The key number is coded on the label attached to the key.

If the keys are lost, your PEUGEOT dealer can rapidly supply you with new keys.

The high frequency remote control is a sensitive system; do not operate it while it is in your pocket as there is a possibility that it may unlock your vehicle, without you being aware of it.

The remote control does not operate when the key is in the ignition, even when the ignition is switched off, except for reprogramming.

Do not operate the deadlocking function if there is anyone inside the vehicle.

Driving with the doors locked may make access to the passenger compartment by the emergency services more difficult in an emergency.

As a safety precaution (with children on board), remove the ignition key when you leave the vehicle, even for a short time.

Do not repeatedly press the button of your remote control out of range and out of sight of your vehicle. You run the risk of stopping it from working and the remote control would have to be reprogrammed.

When purchasing a second-hand vehicle:

- ensure that you are given the confidential card;
- have the key codes memorised by a PEUGEOT dealer, to ensure that the keys in your possession are the only ones which can start the vehicle.

Do not make any modifications to the electronic engine immobiliser system.

Changing the remote control battery



Battery ref.: CR1620/3 volts.

The information "battery flat" is given by displaying of the service warning light, accompanied by an audible signal and a message on the multifunction display.

To replace the battery, unclip the casing using a coin at the notch.

If the remote control does not work after the battery has been changed, reprogramme the remote control.



Do not discard the batteries, they contain metals which are harmful to the environment.

Take them to an approved collection point.

Reprogramming the remote control

Following disconnection of the vehicle's battery, replacement of the remote control battery or in the event of a remote control malfunction, the remote control must be reinitialised.

- ☞ Switch off the ignition.
- ☞ Switch the ignition on again.
- ☞ Press the remote control locking button immediately for a few seconds.
- ☞ Switch off the ignition and remove the remote control key from the ignition lock.

The remote control is now working again.

ELECTRONIC ENGINE IMMOBILISER

This locks the engine control system a few moments after the ignition has been switched off and therefore prevents starting of the vehicle by anyone who does not have the key.

The ignition key has an electronic chip which has a special code. When the ignition is switched on, the code is recognised and starting is possible.

If the system does not function correctly, the service warning light comes on, accompanied by an audible signal and a message on the multifunction display.

In this case, your vehicle will not start. Contact a PEUGEOT dealer as soon as possible.

A heavy object attached to the key (key ring, ...), weighing down on the shaft of the key in the switch, may cause a malfunction.

CONFIDENTIAL CARD



This is given to you on delivery of your vehicle with the duplicate keys.

It contains the identification code necessary for any work carried out by a PEUGEOT dealer on the electronic immobiliser system. This code is hidden by a film, which should be removed only if necessary.

Keep your card in a safe place, never inside the vehicle.

When undertaking a long trip or journey, however, it is advisable to take it with you along with your personal papers.



Make a careful note of the number on each key. The key number is coded on the label attached to the key.

If the keys are lost, your PEUGEOT dealer can rapidly supply you with new keys.

The high frequency remote control is a sensitive system; do not operate it while it is in your pocket as there is a possibility that it may unlock your vehicle, without you being aware of it.

The remote control does not operate when the key is in the ignition, even when the ignition is switched off, except for reprogramming.

Do not operate the deadlocking function if there is anyone inside the vehicle.

Driving with the doors locked may make access to the passenger compartment by the emergency services more difficult in an emergency.

As a safety precaution (with children on board), remove the ignition key when you leave the vehicle, even for a short time.

Do not repeatedly press the button of your remote control out of range and out of sight of your vehicle. You run the risk of stopping it from working and the remote control would have to be reprogrammed.

When purchasing a second-hand vehicle:

- ensure that you are given the confidential card;
- have the key codes memorised by a PEUGEOT dealer, to ensure that the keys in your possession are the only ones which can start the vehicle.

Do not make any modifications to the electronic engine immobiliser system.

CONFIDENTIAL CARD



This is given to you on delivery of your vehicle with the duplicate keys.

It contains the identification code necessary for any work carried out by a PEUGEOT dealer on the electronic immobiliser system. This code is hidden by a film, which should be removed only if necessary.

Keep your card in a safe place, never inside the vehicle.

When undertaking a long trip or journey, however, it is advisable to take it with you along with your personal papers.



Make a careful note of the number on each key. The key number is coded on the label attached to the key.

If the keys are lost, your PEUGEOT dealer can rapidly supply you with new keys.

The high frequency remote control is a sensitive system; do not operate it while it is in your pocket as there is a possibility that it may unlock your vehicle, without you being aware of it.

The remote control does not operate when the key is in the ignition, even when the ignition is switched off, except for reprogramming.

Do not operate the deadlocking function if there is anyone inside the vehicle.

Driving with the doors locked may make access to the passenger compartment by the emergency services more difficult in an emergency.

As a safety precaution (with children on board), remove the ignition key when you leave the vehicle, even for a short time.

Do not repeatedly press the button of your remote control out of range and out of sight of your vehicle. You run the risk of stopping it from working and the remote control would have to be reprogrammed.

When purchasing a second-hand vehicle:

- ensure that you are given the confidential card;
- have the key codes memorised by a PEUGEOT dealer, to ensure that the keys in your possession are the only ones which can start the vehicle.

Do not make any modifications to the electronic engine immobiliser system.

ALARM



This provides two types of protection:

- **exterior protection**, it sounds if a door, the boot or the bonnet is opened.
- **interior protection**, it sounds if the sensors detect a variation in the air movement inside the vehicle (breaking of a window or a movement inside the vehicle).

Setting the alarm

- ☞ Switch off the ignition and get out of the vehicle.
- ☞ Set the alarm by locking or dead-locking using the remote control (button **A** indicator light flashes once per second).

When the alarm is triggered, the siren sounds and the direction indicators flash for thirty seconds.

The alarm remains set following each triggering incident.



Warning: if the alarm has been triggered ten times in succession, on the eleventh time it becomes inactive.

Note: if button **A** flashes rapidly, the alarm has been triggered while you were away from your vehicle.

If you wish to lock your vehicle without setting the alarm, use the door lock.

Automatic activation*

The alarm is activated automatically two minutes after the last closing of a door or the boot.

In order to avoid accidental triggering of the alarm when a door or the boot is opened, it is essential to press the remote control opening button first.

Disarming

Unlock the vehicle with the remote control key (button **B** indicator light goes out).

Note: if the alarm has been triggered while you were away from your car, the rapid flashing of the indicator light will stop when you switch on the ignition.

* According to country.

To set the alarm with exterior protection only



If, while you are away from the vehicle, you wish to leave a window partially open or a pet inside the vehicle, you should choose exterior protection only.

- ☞ Switch off the ignition.
- ☞ In the next ten seconds, press button **B** until its indicator light is on continuously.
- ☞ Get out of the vehicle.
- ☞ Set the alarm by locking or deadlocking using the remote control (button **A** and button **B** indicator lights flash once a second).

Failure of the remote control

- ☞ Unlock the doors with the key and open the door. The alarm is triggered.
- ☞ Switch on the ignition in the next ten seconds. The alarm is disarmed.

Incorrect operation

When the ignition is switched on, if button **A** lights for ten seconds, there is a fault in the siren connection.

Contact a PEUGEOT dealer to have the system checked.

ELECTRIC WINDOWS



1. Driver's electric window switch.
2. Passenger's electric window switch.
3. Rear right electric window switch.
4. Rear left electric window switch.
5. Neutralisation of the electric controls located in the rear (child safety).



The electric windows are deactivated temporarily if the energy economy mode is activated.

To keep your children safe, press switch **5** to prevent operation of the rear windows.

To reactivate the controls, press control **5** again.

You have two options:

Manual operation:

- ☞ press or pull switch **1** gently. The window stops as soon as the switch is released.

Automatic operation:

- ☞ press or pull switch **1** fully. The window opens or closes completely when the switch is released. Pressing the switch again stops the movement of the window.



Approximately 45 seconds following removal of the ignition key, none of the windows can be opened or closed. You must switch the ignition on again to open or close the windows.

Safety auto-reverse

When the window rises and meets an obstacle, it stops and lowers again.

In the case of unwanted opening of the window on closing (for example, in the case of ice), if the window will not rise, pull the switch until the window closes completely. Continue to press the switch for one second after closing.

Following reconnection of the battery, in the event of a malfunction, you must reinitialise the safety auto-reverse function:

- open the window completely, then close it, it will rise in stages of a few centimetres with each press, repeat the operation until the window is completely closed,
- continue to press the switch for at least one second after reaching this position.

The safety auto-reverse function is not operational during these operations.



Always remove the key from the ignition when leaving the vehicle, even for a short time.

In the event of contact when operating the windows, you must reverse the movement of the window. To do this, press the switch concerned.

When the driver operates the passenger window switches, he must ensure that no one is preventing correct closing of the window.

The driver must ensure that passengers use the electric windows correctly.

Be aware of children when operating the windows.

DOORS

Opening the doors from outside



Opening the doors from inside



Locking/unlocking from the inside



- Using button **A** of the centre console: this allows the doors, the boot and the fuel filler flap to be locked or unlocked.

Note: the button **A** indicator light is lit or flashes when the vehicle is locked.

- Using button **B** on the door:
 - on the front doors this allows the doors, the boot and the fuel filler flap to be locked or unlocked.
 - on the rear doors this allows the door concerned to be locked or unlocked.



Buttons **A** and **B** and control **C** are deactivated if the vehicle is deadlocked.



Always remove the key from the ignition when leaving the vehicle, even for a short time.

In the event of contact when operating the windows, you must reverse the movement of the window. To do this, press the switch concerned.

When the driver operates the passenger window switches, he must ensure that no one is preventing correct closing of the window.

The driver must ensure that passengers use the electric windows correctly.

Be aware of children when operating the windows.

DOORS

Opening the doors from outside



Opening the doors from inside



Locking/unlocking from the inside



- Using button **A** of the centre console: this allows the doors, the boot and the fuel filler flap to be locked or unlocked.

Note: the button **A** indicator light is lit or flashes when the vehicle is locked.

- Using button **B** on the door:
 - on the front doors this allows the doors, the boot and the fuel filler flap to be locked or unlocked.
 - on the rear doors this allows the door concerned to be locked or unlocked.



Buttons **A** and **B** and control **C** are deactivated if the vehicle is deadlocked.

Automatic central locking of the doors



The doors can lock automatically while driving (speed above 6 mph [10 km/h]). You can activate or deactivate this function by pressing button **A** for more than 2 seconds.

This is indicated by a message on the multifunction display.



Driving with the doors locked may make access to the passenger compartment by the emergency services more difficult in an emergency.

"Door open" alert

With the engine running or when the vehicle is moving, the door open warning light comes on accompanied by an audible signal and/or a diagram indicating the relevant door on the multifunction display.

Child safety



This prevents either of the rear doors being opened from inside.

- ☞ Turn the switch on each rear door a quarter of a turn using the ignition key.

MOTORISED BOOT



Opening the boot

Vehicle locked/deadlocked

- ☞ Press button **A** on the remote control key.

This action will also unlock the doors and the fuel filler flap.

Automatic central locking of the doors



The doors can lock automatically while driving (speed above 6 mph [10 km/h]). You can activate or deactivate this function by pressing button **A** for more than 2 seconds.

This is indicated by a message on the multifunction display.



Driving with the doors locked may make access to the passenger compartment by the emergency services more difficult in an emergency.

"Door open" alert

With the engine running or when the vehicle is moving, the door open warning light comes on accompanied by an audible signal and/or a diagram indicating the relevant door on the multifunction display.

Child safety



This prevents either of the rear doors being opened from inside.

- ☞ Turn the switch on each rear door a quarter of a turn using the ignition key.

MOTORISED BOOT



Opening the boot

Vehicle locked/deadlocked

- ☞ Press button **A** on the remote control key.

This action will also unlock the doors and the fuel filler flap.

Automatic central locking of the doors



The doors can lock automatically while driving (speed above 6 mph [10 km/h]). You can activate or deactivate this function by pressing button **A** for more than 2 seconds.

This is indicated by a message on the multifunction display.



Driving with the doors locked may make access to the passenger compartment by the emergency services more difficult in an emergency.

"Door open" alert

With the engine running or when the vehicle is moving, the door open warning light comes on accompanied by an audible signal and/or a diagram indicating the relevant door on the multifunction display.

Child safety



This prevents either of the rear doors being opened from inside.

- ☞ Turn the switch on each rear door a quarter of a turn using the ignition key.

MOTORISED BOOT



Opening the boot

Vehicle locked/deadlocked

- ☞ Press button **A** on the remote control key.

This action will also unlock the doors and the fuel filler flap.

Vehicle unlocked



- ☞ Press button **A** on the remote control key or press the push button **B** on the boot lid.



If the automatic central locking is activated, when the vehicle reaches a speed of 6 mph (10 km/h), the boot is locked and the push button **B** is deactivated. It is reactivated when stationary by the opening of one of the doors.

Permanent locking of the boot



This function can be activated or deactivated via the multifunction display **"Personalisation-Configuration"** menu.

- ☞ When the function is active, the boot can only be opened by pressing button **A** on the remote control key.

This action will only unlock the boot.

Closing the boot lid

Press the push button **C** to start electric closing of the boot lid.

Note: do not hinder closing of the boot lid: any obstacle to closing causes the boot lid to stop and rise a few centimetres automatically.



When opening or closing the boot, ensure that no-one is close to the rear of the vehicle to avoid the risk of injury.

To close the boot lid manually, use one of the two handles inside the boot lid.

"Boot open" warning

With the engine running or when the vehicle is moving, the door open warning light comes on, accompanied by an audible signal and/or a diagram indicating the boot on the multifunction display, if the boot is not properly closed.

Stopping opening or closing of the boot lid

While electric opening or closing of the boot lid is in progress, you can stop its movement at any time:

- ☞ press the push-button **B** or **C** on the boot lid.

or

- ☞ press button **A** on the remote control key.

When it is stopped, the boot lid is held in an intermediate position electrically for approximately 10 minutes.

After this time, the system switches to standby and releases the boot lid.

To leave the intermediate position, start an electric opening or closing operation or move the boot lid manually.

Tailgate release



This enables the tailgate to be unlocked in the event of a central locking fault.

- Fold back the rear seats to gain access to the lock from inside the boot,
- Insert a small screwdriver into hole **A** of the lock to unlock the tailgate.

FILLING WITH FUEL



Low fuel level



When the minimum fuel level is reached, this warning light comes on, accompanied by an audible signal and a message on the multifunction display.

You can still drive approximately 30 miles (50 km) without filling up with fuel.

Filling with fuel

Locking and unlocking of the fuel filler flap, the doors and the boot is simultaneous.

The engine and the ignition must be switched off when filling with fuel:

- ☞ Open the fuel filler flap by pressing the front,
- ☞ Unscrew the cap and hook it over the tab located on the inside of the flap.

When filling up your tank, do not continue after the 3rd cut-off of the pump; this could cause your vehicle to malfunction.

The capacity of the tank is approximately 80 litres.

- ☞ After filling the tank, screw the cap on fully and close the fuel filler flap.

Fuel filler cap open



When this light comes on, accompanied by an audible signal and/or a message on the multifunction display, screw the cap on again and close the fuel filler flap.

Tailgate release



This enables the tailgate to be unlocked in the event of a central locking fault.

- Fold back the rear seats to gain access to the lock from inside the boot,
- Insert a small screwdriver into hole **A** of the lock to unlock the tailgate.

FILLING WITH FUEL



Low fuel level



When the minimum fuel level is reached, this warning light comes on, accompanied by an audible signal and a message on the multifunction display.

You can still drive approximately 30 miles (50 km) without filling up with fuel.

Filling with fuel

Locking and unlocking of the fuel filler flap, the doors and the boot is simultaneous.

The engine and the ignition must be switched off when filling with fuel:

- ☞ Open the fuel filler flap by pressing the front,
- ☞ Unscrew the cap and hook it over the tab located on the inside of the flap.

When filling up your tank, do not continue after the 3rd cut-off of the pump; this could cause your vehicle to malfunction.

The capacity of the tank is approximately 80 litres.

- ☞ After filling the tank, screw the cap on fully and close the fuel filler flap.

Fuel filler cap open



When this light comes on, accompanied by an audible signal and/or a message on the multifunction display, screw the cap on again and close the fuel filler flap.

SUNROOF*

You have two options:

Manual operation:

- ☞ lightly press the switch; the roof stops as soon as the switch is released.

Automatic operation:

- ☞ press the switch down fully; the roof opens or closes completely depending on where the switch is pressed.
- **to partially open the roof:** press part **A** of the switch. To close it, press part **B** of the switch.
- **to open the roof completely:** press part **B** of the switch.
- **to close it completely:** press part **A** of the switch.

Safety auto-reverse (on sliding only)

When the sunroof is closing and meets an obstacle, it stops then partially opens again.

In the event of unwanted opening of the sunroof on closing:

- press part **B** of the switch until the sunroof is fully open,
- as soon as the sunroof stops, press part **A** of the switch until the sunroof is fully closed.

The safety auto-reverse function is not operational during this operation.

Note: the sunroof shutter is manual.



The operation of the sunroof is deactivated 45 seconds after the ignition is switched off.

The operation of the sunroof will be deactivated temporarily if the energy economy mode is activated.

Always remove the key from the ignition when leaving the vehicle, even for a short time.

In the event of contact when operating the sunroof, you must reverse the movement of the sunroof. To do this, press the switch concerned.

When the driver operates the sunroof switch, he must ensure that no one is preventing correct closing of the sunroof.

The driver must ensure that passengers use the electric sunroof correctly. Be aware of children when operating the sunroof.

LIGHTS STALK



Front and rear lights (ring A)

☞ Turn ring **A** to the position required.



Lights off.



Side lights.



Dipped/main beam headlamps.

Dipped/main beam change

☞ Pull the stalk fully towards you.

Lights on

With the ignition and the automatic lights function switched off, on opening the driver's door a buzzer sounds to warn you that you have left your lights on.

Front and rear fog lamps (ring B)

☞ Turn ring **B** forwards to switch on and backwards to switch off. The position is confirmed by the light on the instrument panel.



Front fog lamps (one press)

These operate with the side lights, dipped headlamps or main beam headlamps.



Rear fog lamps (two presses)

These operate with the side lights and the front fog lamps, or with the dipped headlamps.

Direction indicators (flashers)

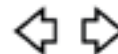

Left: downwards.

Right: upwards.



Note: if you forget to return the direction indicator to its normal position, the volume of the audible signal will increase, if you are driving at a speed greater than 50 mph (80 km/h).

Parking lights

The side lights are lit on the side the traffic is on.

With the ignition off and within the next minute, place the direction indicators stalk on the traffic side (for example: for parking on the right; switching on of the lights on the left).

This is indicated by an audible signal and lighting of the corresponding direction indicator on the instrument panel.

Automatic "follow-me-home" lighting

When you leave your vehicle with the **automatic switching on of the lights activated**, the side lights and dipped headlamps remain on for the duration selected when the ignition is switched off.

To deactivate or activate this function, pass via the multifunction display "**Personalisation-Configuration**" menu.



The timed duration must also be set, via the multifunction display "**Personalisation-Configuration**" menu.

Cancellation:

- ☞ flash the headlamps,
- ☞ get out of the vehicle and lock it.

Manual "follow-me-home" lighting

In the absence of the automatic switching on of the lights, the manual "follow-me-home" lighting can be activated.

When you leave your vehicle, the side lights and dipped headlamps remain on for approximately 1 minute.

Activation:

- ☞ switch off the engine,
- ☞ flash the headlamps,
- ☞ get out of the vehicle and lock it.

Deactivation:

- ☞ flash the headlamps again,
- ☞ get out of the vehicle and lock it.



If your lights have been switched on manually, turn the ring back to position **0**, lights off.

Automatic switching on of the lights

Side lights and dipped beam headlamps switch on automatically if the light is poor, or during operation of the windscreen wipers. They switch off as soon as the light becomes bright enough or the windscreen wipers stop.

Note: in foggy weather, the brightness sensor can detect sufficient light. As a consequence, the lights will not come on automatically.

This function is active when the vehicle is supplied to the customer.



To switch the function on or off, use the multifunction display "**Personalisation-Configuration**" menu.

Activation



When this function is activated, the indicator light on the instrument panel comes on.



The brightness of the display and of the instrument panel may change when the lights are switched on automatically.

Deactivation.



When the function is deactivated, the indicator light on the instrument panel comes on.

If the brightness sensor does not function correctly, the system activates the function and the lights come on.

Contact a PEUGEOT dealer to have the system checked.

Daytime lights*

On vehicles which are equipped with daytime lights, the dipped headlamps come on when the vehicle is started.



This indicator light comes on on the instrument panel screen.



The instruments and controls (instrument panel, multifunction display, air conditioning control panel, ...) are only lit on switching to the automatic switching on of the lights mode or when the lights are switched on manually.

* According to country.



The timed duration must also be set, via the multi-function display "**Personalisation-Configuration**" menu.

Cancellation:

- ☞ flash the headlamps,
- ☞ get out of the vehicle and lock it.

Manual "follow-me-home" lighting

In the absence of the automatic switching on of the lights, the manual "follow-me-home" lighting can be activated.

When you leave your vehicle, the side lights and dipped headlamps remain on for approximately 1 minute.

Activation:

- ☞ switch off the engine,
- ☞ flash the headlamps,
- ☞ get out of the vehicle and lock it.

Deactivation:

- ☞ flash the headlamps again,
- ☞ get out of the vehicle and lock it.



If your lights have been switched on manually, turn the ring back to position **0**, lights off.

Automatic switching on of the lights

Side lights and dipped beam headlamps switch on automatically if the light is poor, or during operation of the windscreen wipers. They switch off as soon as the light becomes bright enough or the windscreen wipers stop.

Note: in foggy weather, the brightness sensor can detect sufficient light. As a consequence, the lights will not come on automatically.

This function is active when the vehicle is supplied to the customer.



To switch the function on or off, use the multifunction display "**Personalisation-Configuration**" menu.

Activation



When this function is activated, the indicator light on the instrument panel comes on.



The brightness of the display and of the instrument panel may change when the lights are switched on automatically.

Deactivation.



When the function is deactivated, the indicator light on the instrument panel comes on.

If the brightness sensor does not function correctly, the system activates the function and the lights come on.

Contact a PEUGEOT dealer to have the system checked.

Daytime lights*

On vehicles which are equipped with daytime lights, the dipped headlamps come on when the vehicle is started.



This indicator light comes on on the instrument panel screen.



The instruments and controls (instrument panel, multifunction display, air conditioning control panel, ...) are only lit on switching to the automatic switching on of the lights mode or when the lights are switched on manually.

* According to country.

MANUAL ADJUSTMENT OF THE HEADLAMPS



For vehicles fitted with halogen bulbs, depending on the load in your vehicle, adjusting the beam of your headlamps is recommended.

- 0. 1 or 2 people in the front seats.
- . 3 people.
- 1. 5 people.
- 2. 5 people + maximum authorised loads.
- 3. Driver + maximum authorised loads.

Initial setting is position 0.

AUTOMATIC HEADLAMP ADJUSTMENT



On vehicles with xenon bulbs: **when stationary with the ignition on**, the system automatically corrects the height of the beam, whatever the load of the vehicle. The driver is then assured of having optimum lighting and not causing a nuisance to other road users.



In cases of malfunction, the warning light comes on on the instrument panel display, accompanied by an audible signal and a message on the multifunction display. The system places your headlamps to the low position.

Do not touch the xenon bulbs. Contact a PEUGEOT dealer.

WINDSCREEN WIPER STALK



Windscreen wipers

- 2 Fast wipe (heavy rain).
- 1 Normal wipe (moderate rain).
- I Intermittent wipe
- 0 Off
- AUTO** Automatic wipe or single sweep.

In the **Intermittent** position, the wiping speed is in proportion to the speed of the vehicle.

In **AUTO** mode, the wiping speed is in proportion to the intensity of the rainfall.



The wiping must be reactivated if the ignition has been switched off for more than one minute.

MANUAL ADJUSTMENT OF THE HEADLAMPS



For vehicles fitted with halogen bulbs, depending on the load in your vehicle, adjusting the beam of your headlamps is recommended.

- 0. 1 or 2 people in the front seats.
- . 3 people.
- 1. 5 people.
- 2. 5 people + maximum authorised loads.
- 3. Driver + maximum authorised loads.

Initial setting is position 0.

AUTOMATIC HEADLAMP ADJUSTMENT



On vehicles with xenon bulbs: **when stationary with the ignition on**, the system automatically corrects the height of the beam, whatever the load of the vehicle. The driver is then assured of having optimum lighting and not causing a nuisance to other road users.



In cases of malfunction, the warning light comes on on the instrument panel display, accompanied by an audible signal and a message on the multifunction display. The system places your headlamps to the low position.

Do not touch the xenon bulbs. Contact a PEUGEOT dealer.

WINDSCREEN WIPER STALK



Windscreen wipers

- 2 Fast wipe (heavy rain).
- 1 Normal wipe (moderate rain).
- I Intermittent wipe
- 0 Off
- AUTO** Automatic wipe or single sweep.

In the **Intermittent** position, the wiping speed is in proportion to the speed of the vehicle.

In **AUTO** mode, the wiping speed is in proportion to the intensity of the rainfall.



The wiping must be reactivated if the ignition has been switched off for more than one minute.

Maintenance position

This position enables the wiper blades to be removed.

In the minute following switching off of the ignition, any action on the wipers stalk positions the wipers at the top of the windscreen (parking in winter, cleaning, replacement of the blades).

To reposition the wipers after this has been done, switch on the ignition and operate the stalk.

Windscreen and headlamp wash

Pull the windscreen wiper stalk towards you. The windscreen wash then the windscreen wipers operate for a fixed period.

The headlamp wash is also activated, **if the headlamps are on.**

Screenwash/headlampwash low



When the minimum level of the reservoir is reached, this warning light comes on, accompanied by an audible signal and a message on the multi-function display.

Next time you stop, fill the screenwash/headlamp wash reservoir.

If the reservoir is empty, the warning light comes on when the ignition is switched on, or every time the stalk is operated, until the reservoir is filled.

Automatic windscreen wiper

The automatic wiping is controlled by a rain sensor, fitted on the windscreen.

In **AUTO** mode, the wipers operate automatically and **adjust their speed to the intensity of the rainfall.**

Activation



This warning light comes on on the instrument panel, accompanied by a message on the multifunction display, when the driver presses the wipers stalk down in **AUTO** mode.

Deactivation



This warning light comes on on the instrument panel when the driver moves the wipers stalk to position **1**, **1** or **2**.

In the event of a malfunction, the driver is informed of this by a message on the multifunction display.

In **AUTO** mode, the wipers will then operate in intermittent mode.

Contact a PEUGEOT dealer to have the system checked.



Do not cover the rain sensor, located on the windscreen behind the interior mirror.

When using a car wash, switch off the ignition.

In winter, it is advisable to wait until the windscreen is completely clear of ice before activating the automatic wipers.

When parking in snowy weather, position the blades at the top of the windscreen (maintenance position) to prevent the accumulation of snow.

Maintenance position

This position enables the wiper blades to be removed.

In the minute following switching off of the ignition, any action on the wipers stalk positions the wipers at the top of the windscreen (parking in winter, cleaning, replacement of the blades).

To reposition the wipers after this has been done, switch on the ignition and operate the stalk.

Windscreen and headlamp wash

Pull the windscreen wiper stalk towards you. The windscreen wash then the windscreen wipers operate for a fixed period.

The headlamp wash is also activated, **if the headlamps are on.**

Screenwash/headlampwash low



When the minimum level of the reservoir is reached, this warning light comes on, accompanied by an audible signal and a message on the multi-function display.

Next time you stop, fill the screenwash/headlamp wash reservoir.

If the reservoir is empty, the warning light comes on when the ignition is switched on, or every time the stalk is operated, until the reservoir is filled.

Automatic windscreen wiper

The automatic wiping is controlled by a rain sensor, fitted on the windscreen.

In **AUTO** mode, the wipers operate automatically and **adjust their speed to the intensity of the rainfall.**

Activation



This warning light comes on on the instrument panel, accompanied by a message on the multifunction display, when the driver presses the wipers stalk down in **AUTO** mode.

Deactivation



This warning light comes on on the instrument panel when the driver moves the wipers stalk to position **1**, **1** or **2**.

In the event of a malfunction, the driver is informed of this by a message on the multifunction display.

In **AUTO** mode, the wipers will then operate in intermittent mode.

Contact a PEUGEOT dealer to have the system checked.



Do not cover the rain sensor, located on the windscreen behind the interior mirror.

When using a car wash, switch off the ignition.

In winter, it is advisable to wait until the windscreen is completely clear of ice before activating the automatic wipers.

When parking in snowy weather, position the blades at the top of the windscreen (maintenance position) to prevent the accumulation of snow.

COURTESY LIGHTS



1. Front courtesy light

2. Front map reading lights

With the ignition on, operate the relevant switch.

3. Rear courtesy light

4. Rear map reading lights

With the ignition on, operate the relevant switch.

Pressing switch **1** switches on the front and rear courtesy lights for ten minutes.

The front and rear courtesy lights come on automatically when the ignition key is removed, on unlocking the vehicle or on opening one of the doors.

They gradually go off after the ignition has been switched on or the vehicle is locked.

Deactivation



The courtesy lights can be deactivated by pressing switch **1** for more than three seconds. Pressing switch **1** briefly switches the front and rear courtesy lights on and off.

The map reading lights are not affected by this and can still be switched on.

Activation

To re-activate the automatic lighting, press switch **1** again.

Sill illumination

The sill lighting is at the bottom of each door trim.

The lights come on automatically when a door is opened and switch off automatically when all of the doors are closed.

Boot light

The boot light is located in the left boot trim.

It comes on automatically when the boot is opened and switches off automatically when the boot is closed.

SUN VISOR WITH ILLUMINATED COURTESY MIRROR



With the ignition on, the mirror is automatically lit up when the flap is opened.

AREAS FOR TOLL CARDS/ CAR PARK TICKETS



The athermic windscreen has two non-reflective zones located either side of the base of the interior mirror. They are intended for affixing toll cards and/or car park tickets.

AIR CONDITIONED GLOVE BOX



This is fitted with a lock.

To open the glove box, lift the handle. The glove box is lit up when the cover is opened.

The glove box has a vent **A** that can be closed, which produces the same conditioned air as the vents in the passenger compartment.

It also has a pen holder **B** and three sockets* **C** for connecting video equipment.



CENTRE CONSOLE

1 - Storage compartment

2 - Front lighter (100 W max)

Press and wait for a few moments until it springs out automatically.

3 - Front ashtray

Press the cover to open the ashtray.
To release the ashtray for emptying, open it then push the cover downwards.

4 - Rear ashtray

Press the cover to open the ashtray.
To empty the ashtray, detach the receptacle by pulling it towards you.
To refit the ashtray, clip it back into its housing.

5 - Rear lighter (100 W max)

Push in and wait for a few moments until it springs out automatically.

Front armrest



To obtain a resting or driving position:

- ☞ Lift the centre handle 1 and pull the armrest forwards. To return to the initial position, push the armrest backwards.

To open the lower compartment:

- ☞ Raise the left handle 2. CDs and coins can be stored here.

To open the top compartment:

- ☞ Raise the right handle 3. This is equipped with a can holder.

REMOVING A MAT



When removing a mat on the driver's or passenger's side, push back the seat as far as possible and remove the clips.

To remove a rear mat, push the corresponding front seat forward and remove the clip.

On refitting, position the mat and tighten the securing clips fully.

Ensure that the mat is secured correctly.



To prevent the mat from becoming caught under the pedals:

- only use mats which are suited to the fixings already present in the vehicle.

It is imperative that these fixings are used.

- never fit one mat on top of another.

Rear shelf compartment



This is provided for the storage of a first aid kit.

The catch on the lid is designed to withstand a weight of 9 lbs (4 kg) on impact.

Rear armrest

This provides access to the ski flap from the passenger compartment.

It has two cup holders.

Ski flap

- ☞ Lower the armrest to access the ski flap. Open by pulling the handle downwards.

Electric rear sunblind



The blind, fitted to the rear parcel shelf, is intended to protect occupants from the glare of the sun and the lights of cars behind.

With the ignition on:

- ☞ Briefly press button **A** on the centre console to open it out.
- ☞ Briefly press button **A** again to store it away.



Do not place anything on the blind, to avoid it being damaged.

Luggage net

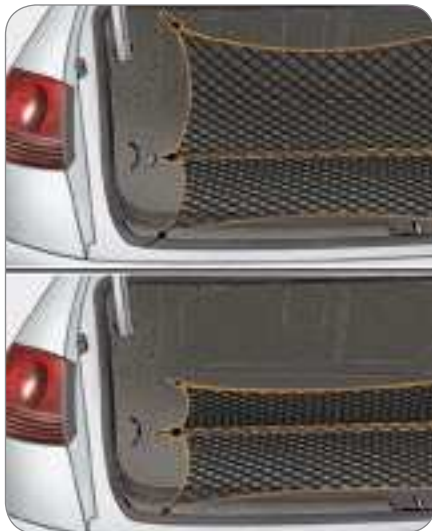

The stowing rings allow the net to be placed in different positions.

Storage compartments



There are two storage compartments located behind the side trim of the boot.

The right side storage compartment is fitted with pre-wiring for a CD changer available as an accessory. You can also store a small oil can and a high visibility jacket here.



The left side storage compartment, which houses the battery, can accommodate a box of bulbs. A warning triangle can be secured using the two external straps.

To access a storage compartment:

- ☞ Push the handle downwards and fold down the panel.



Do not place anything on the battery.

HORN



Press one of the spokes of the steering wheel.

HAZARD WARNING LIGHTS



Press the button, the direction indicators flash. They can operate with the ignition off.

Automatic lighting of hazard warning lights*

When braking in an emergency, depending on the deceleration, the hazard warning lights come on automatically. They switch off automatically the first time you accelerate.

It is also possible to switch them off by pressing the button.

ANTI-LOCK BRAKING SYSTEM (ABS) AND ELECTRONIC BRAKE FORCE DISTRIBUTION (EBFD)

The ABS, in conjunction with the electronic brake force distribution, increases the stability and manoeuvrability of your vehicle on braking, in particular on poor or slippery road surfaces.

Note: when changing wheels (tyres and rims), make sure that these are approved.

The anti-lock braking system comes into operation automatically when there is a risk of wheel lock.



When this warning light comes on, accompanied by a buzzer and a message, it indicates that there is a malfunction of the ABS, which can cause a loss of control of the vehicle when braking.



When this warning light comes on, connected to the **STOP** and **ABS** warning lights, accompanied by a buzzer and a message, it indicates that there is a malfunction of the electronic brake force distribution, which can cause a loss of control of the vehicle when braking.

Stop immediately.

In both cases, consult a PEUGEOT dealer.

Normal operation of the ABS may make itself felt by slight vibrations of the brake pedal.



In emergency braking, press very firmly without releasing the pressure.

EMERGENCY BRAKING ASSISTANCE SYSTEM

In an emergency, this system enables the optimum braking pressure to be reached more quickly, thus reducing the stopping distance.

It is triggered by the speed at which the brake pedal is activated. The effect of this is a reduction in the resistance of the pedal and an increase in braking efficiency.

* According to country.

TRACTION CONTROL (ASR) AND DYNAMIC STABILITY CONTROL (ESP)

These systems are linked and complement the ABS.

The ASR system optimises drive to prevent the wheels skidding, by acting on the brakes of the drive wheels and on the engine. It also allows the directional stability of the vehicle to be improved on acceleration.

If there is a variation between the trajectory followed by the vehicle and that required by the driver, the ESP system automatically acts on the engine and the brake of one or more wheels, in order to put the vehicle back on course, within the limits of the laws of physics.

Activation of the ASR and ESP systems



When the ignition is on, the ASR and ESP systems are always activated.

Operation of the ASR and ESP systems



The warning light flashes when the ASR or ESP is activated.

Disarming



In exceptional conditions (starting a vehicle which is bogged down, stuck in snow, on soft ground), it may be advisable to disarm the ASR and ESP systems, so that the wheels can move freely and regain grip.

- ☞ Press the **ESP OFF** switch, located under the steering wheel to the left.



The switch lights up and the warning light comes on: the ASR and ESP systems no longer have any effect on the engine operation.

Reactivation:

- ☞ Automatic if the ignition is switched off.
- ☞ Automatic from 30 mph (50 km/h).
- ☞ Manual by pressing the switch again.

Operating check



When a malfunction of the systems occurs, the switch light flashes and the warning light comes on, accompanied by an audible signal and a message on the multi-function display.

Contact a PEUGEOT dealer to have the system checked.



The ASR/ESP systems offer exceptional safety in normal driving, but this should not encourage the driver to take extra risks or drive at high speed.

The correct functioning of these systems depends on observation of the manufacturer's recommendations regarding the wheels (tyres and rims), the braking components and the electronic components, as well as the PEUGEOT assembly and operation procedures.

After an impact, have the system checked by a PEUGEOT dealer.

TYRE UNDER-INFLATION DETECTION

Sensors check the tyre pressure during driving and trigger a warning in the event of malfunction (speed greater than 15 mph [25 km/h]).

Pressure check



With the ignition on and after the engine oil level, this warning light comes on to indicate that the system is measuring the pressure of the tyres.

Pressure OK



This warning light comes on if all of the tyre pressure values measured are correct.

If one of the warning lights described below appears, refer to the corresponding paragraph.

If none of the lights appear, contact a PEUGEOT dealer to have the system checked.

Under-inflated tyre



This warning light comes on, accompanied by an audible signal and a message on the multifunction display, locating the deflated tyre.

Have the tyre pressure checked as soon as possible.

Puncture



This warning light, accompanied by an audible signal and a message on the multifunction display locating the punctured tyre, is followed by illumination of the **STOP**-warning light.

Stop immediately, avoiding any sudden movement of the steering wheel and the brakes.

Change the damaged (punctured or very deflated) tyre, and have the tyre pressure checked as soon as possible.



Note: if the damaged tyre is temporarily stored in the boot, it will again emit this message to remind you of the necessity of having it repaired. This will prevent another warning of the same type being displayed.

Sensor(s) not detected



This warning light, accompanied by an audible signal and a message on the multifunction display, indicates that under-inflation detection is absent from one (or several) tyre(s).

Contact a PEUGEOT dealer to replace the faulty sensor(s).



Note: this message is also displayed when one of the tyres is away from the vehicle (being repaired) or when a wheel without a sensor is fitted.



All repairs and changing of tyres on a wheel fitted with this system must be carried out by a PEUGEOT dealer.

The tyre under-inflation detection system is an aid to driving which does not replace the need for the driver to be vigilant or to drive responsibly.

This system does not remove the necessity for having the tyre pressure (including that of the spare wheel) checked regularly, to ensure optimum dynamic performance of the vehicle and to prevent premature wear of the tyres, particularly in the case of arduous driving conditions (heavy load, high speed).

The system may temporarily be disturbed by radio broadcasts on a frequency close to it.

SEAT BELTS



Front seat belt height adjustment

- ☞ To lower the attachment point, squeeze control 1 and slide it downwards.
- ☞ To raise the attachment point, slide control 1 upwards.

To lock the seat belts

- ☞ Pull the strap, then insert the end into the buckle.
- ☞ Check that it is fastened correctly by pulling the strap.

To unlock the seat belts

- ☞ Press the red button on the buckle, then remove the end.

Front seat belts with pre-tensioner and force limiter



Safety in the event of a frontal impact has been improved by the introduction of seat belts with pre-tensioner and force limiter connected to the front air bags. Depending on the seriousness of the impact, the pre-tensioning system instantly tightens the seat belts firmly against the bodies of the occupants.

The pre-tensioning seat belts are armed when the ignition is on.

The force limiter reduces the pressure of the seat belt on the body of the occupant in the event of an accident.

Seat belt warning light



With the vehicle stationary, when the ignition is switched on, the warning light comes on if the driver and/or the front passenger has not fastened his seat belt.



Before moving off, the driver must ensure that all passengers have fastened their seat belts.

Front seat belt not fastened/ unfastened warning



When the vehicle is stationary, ignition on, if the driver and/or the front passenger has not fastened his seat belt, the warning light on the instrument panel comes on, then

from approximately 12 mph (20 km/h) and for two minutes, this warning light flashes accompanied by an audible signal which increases in volume. Once these two minutes have elapsed, the warning light remains on until the driver or front passenger fastens his seat belt.

This warning light is always accompanied by a message on the multifunction display.

When the vehicle is moving, the warning light comes on if the driver or front passenger unfastens his seat belt.

Note: a bag or a pet placed on the front passenger seat may trigger the lighting of this warning light.

Rear seat belts

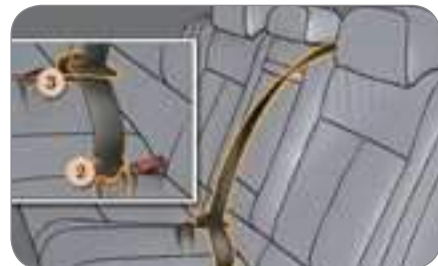

The rear seats are all fitted with a three-point inertia reel seat belt with force limiter.

Rear central seat belt

- ☞ Pull the belt located between the two head restraints at the left rear.
- ☞ Insert the fixed buckle **2** in the black clasp located on the left.
- ☞ Insert the sliding buckle **3** in the red and black movable clasp.

To release it, press the black button of the locking clasp.

Rear seat belt unfastened warning



If one of the rear passengers has unfastened his seat belt, the warning light on the instrument panel comes on if the engine is running, then from approximately

12 mph (20 km/h) and for two minutes, this warning light flashes accompanied by an audible signal which increases in volume.

Once these two minutes have elapsed, the warning light remains on until the rear passenger fastens his seat belt.

This warning light is always accompanied by a message on the multifunction display.

When the vehicle is moving, the warning light comes on if one of the rear passengers unfastens his seat belt.



The detection of the unfastening of the rear seat belts is deactivated if the ignition is switched off or if one of the vehicle's doors is opened.



Wherever you are seated in the vehicle, always fasten your seat belt, even for short journeys.

Do not invert the seat belt buckles as they will not fulfil their role fully.

To prevent this, the rear seat belt buckles are fitted with a locating tab.

The seat belts are fitted with an inertia reel permitting automatic adjustment of the length of the strap to your size. The seat belt is stored automatically when not in use.

Before and after use, ensure that the seat belt is rolled up correctly.

The lower part of the strap must be positioned as low as possible on the pelvis.

The upper part must be positioned in the hollow of the shoulder.

The inertia reels are fitted with an automatic locking device which comes into operation in the event of a collision or emergency braking. You can release the device by pulling rapidly on the strap and releasing it.

In order to be effective, a seat belt:

- must be tightened as close to the body as possible,
- must restrain one adult only,
- must not bear any trace of cuts or fraying,
- must be pulled in front of you with a smooth movement, checking that it does not twist,
- must not be transformed or modified to avoid altering its performance.

In accordance with current safety regulations, all repairs and checks must be carried out by a PEUGEOT dealer who guarantees that the work is carried out correctly.

Have your seat belts checked regularly by a PEUGEOT dealer and particularly if the straps show signs of damage.

Clean the seat belt straps with soapy water or a textile cleaning product, sold by PEUGEOT dealers.

After folding or moving a seat or rear bench seat, ensure that the seat belt is positioned and rolled up correctly.



Recommendations for children:

- use a suitable child seat if the passenger is less than 12 years old or shorter than one metre fifty,
- do not use the strap-guide* when a child seat is installed.
- never use the same seat belt to secure more than one person,
- never allow a child to travel on your lap.

Depending on the nature and seriousness of the impacts, the pre-tensioning device may be triggered before and independently of the air bags.

In all cases, the air bag warning light comes on.

Following an impact, have the seat belts system checked, and if necessary replaced, by a PEUGEOT dealer.

AIR BAGS

The air bags have been designed to maximise the safety of the occupants (with the exception of the rear centre passenger) in the event of serious collisions; they work in conjunction with the force limiting seat belts.

In the event of a serious collision, the electronic detectors record and analyse the front and side impacts suffered in the impact detection zones (see diagram): in the event of a serious impact, the air bags inflate instantly and protect the occupants of the vehicle (with the exception of the rear centre passenger).

Impact detection zones

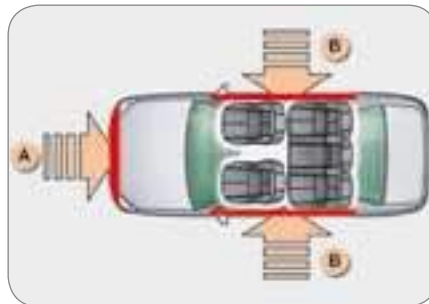

A. Front impact zone.

B. Side impact zone.

Immediately after the impact, the air bags deflate rapidly, so that they do not hinder the visibility of the occupants nor their possible exit from the vehicle.

The air bags will not be deployed in collisions which are not serious, rear impacts or in certain roll-over conditions. The seat belt is sufficient to provide maximum protection in these situations.

Air bags only operate when the ignition is switched on.



This equipment will only operate once. If a second impact occurs (during the same or a subsequent accident), the air bag will not operate.

Note: the triggering of an air bag or air bags is accompanied by a slight discharge of harmless smoke and a noise, due to the activation of the pyrotechnic cartridge incorporated in the system.

This gas may cause slight irritation.

The noise of the detonation may result in a slight loss of hearing for a short time.

FRONT AIR BAGS

These are folded in the centre of the steering wheel for the driver and in the fascia for the front passenger. They are deployed simultaneously, except in cases where the air bag is disarmed, in the event of a serious front impact applied in the impact zone **A** in the longitudinal centreline, on a horizontal plane and from the front towards the rear of the vehicle.



The air bag inflates between the front occupant of the vehicle and the fascia to cushion his forward movement. In this way, the air bags limit the risk of injury to the head and chest.

* According to model.



Recommendations for children:

- use a suitable child seat if the passenger is less than 12 years old or shorter than one metre fifty,
- do not use the strap-guide* when a child seat is installed.
- never use the same seat belt to secure more than one person,
- never allow a child to travel on your lap.

Depending on the nature and seriousness of the impacts, the pre-tensioning device may be triggered before and independently of the air bags.

In all cases, the air bag warning light comes on.

Following an impact, have the seat belts system checked, and if necessary replaced, by a PEUGEOT dealer.

AIR BAGS

The air bags have been designed to maximise the safety of the occupants (with the exception of the rear centre passenger) in the event of serious collisions; they work in conjunction with the force limiting seat belts.

In the event of a serious collision, the electronic detectors record and analyse the front and side impacts suffered in the impact detection zones (see diagram): in the event of a serious impact, the air bags inflate instantly and protect the occupants of the vehicle (with the exception of the rear centre passenger).

Impact detection zones

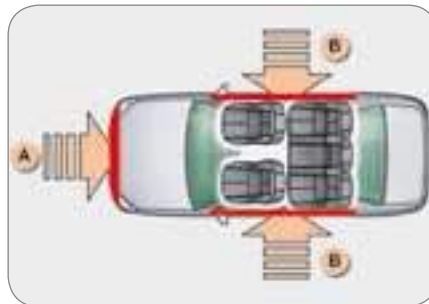

A. Front impact zone.

B. Side impact zone.

Immediately after the impact, the air bags deflate rapidly, so that they do not hinder the visibility of the occupants nor their possible exit from the vehicle.

The air bags will not be deployed in collisions which are not serious, rear impacts or in certain roll-over conditions. The seat belt is sufficient to provide maximum protection in these situations.

Air bags only operate when the ignition is switched on.



This equipment will only operate once. If a second impact occurs (during the same or a subsequent accident), the air bag will not operate.

Note: the triggering of an air bag or air bags is accompanied by a slight discharge of harmless smoke and a noise, due to the activation of the pyrotechnic cartridge incorporated in the system.

This gas may cause slight irritation.

The noise of the detonation may result in a slight loss of hearing for a short time.

FRONT AIR BAGS

These are folded in the centre of the steering wheel for the driver and in the fascia for the front passenger. They are deployed simultaneously, except in cases where the air bag is disarmed, in the event of a serious front impact applied in the impact zone **A** in the longitudinal centreline, on a horizontal plane and from the front towards the rear of the vehicle.



The air bag inflates between the front occupant of the vehicle and the fascia to cushion his forward movement. In this way, the air bags limit the risk of injury to the head and chest.

* According to model.

Front air bag malfunction



If this warning light comes on, accompanied by an audible signal and a message on the multifunction display, contact a PEUGEOT dealer to have the system checked. The air bags may no longer be triggered in the event of a serious impact.

Disarming the passenger air bag*



To ensure the safety of your child, it is essential to disarm the passenger air bag when you install a "rear-facing" child seat on the front passenger seat. Otherwise, the child would risk being killed or seriously injured if the air bag were to inflate.

☞ **With the ignition switched off**, insert the key into the passenger air bag disarming switch **1**, turn it to the **"OFF"** position, then remove the key keeping the slot in this position.

In the **"OFF"** position, the passenger air bag will not be triggered in the event of an impact.

As soon as the child seat is removed, turn the passenger air bag slot **1** to the **"ON"** position to re-activate the air bag and thus ensure the safety of your passenger in the event of an impact.

Disarming check



This is confirmed by an indicator light, accompanied by an audible signal and a message on the multifunction display.

With the ignition on, illumination of this warning light, accompanied by an audible signal and a message on the multifunction display, indicates that the passenger air bag is disarmed (switch in the **"OFF"** position). The warning light comes on on the instrument panel throughout the duration of disarming.

SIDE AIR BAGS AND CURTAIN AIR BAGS

The side air bags are incorporated in the front and rear seat backs, on the door side.

The curtain air bags are incorporated into the door pillars and the upper part of the passenger compartment.

They are deployed independently of each other depending on which side the collision occurs.

Operating check



This is confirmed by an indicator light, accompanied by an audible signal and a message on the multi-function display.

If this indicator light comes on, accompanied by an audible signal and a message, contact a PEUGEOT dealer to have the system checked.



In the rear side seats, the occupants, particularly children, must be seated correctly with the seat belt fastened and must not rest their back against the door, at the risk of exposing themselves to injury in the event of deployment of the side air bag.

* According to country.



For the front, side and curtain air bags to be fully effective, observe the following safety rules:

- Wear a correctly adjusted seat belt.
- Sit in a normal upright position.
- Do not leave anything between the occupants and the air bags (child, animal, object...). This could hamper the operation of the air bags or injure the occupants.
- All work on the air bag systems is strictly prohibited unless it is carried out by qualified personnel of the PEUGEOT network.
- After an accident or if the vehicle has been stolen or broken into, have the air bag systems checked.

Front air bags

- Do not drive holding the steering wheel by its spokes or resting your hands on the centre part of the wheel.
- Passengers must not place their feet on the fascia.
- Smoke as little as possible; deployment of the air bags can cause burns or the risk of injury from a cigarette or pipe.
- Never remove or pierce the steering wheel or hit it violently.

Side air bags

- Only put approved covers on the seats, these will not hinder the inflation of the side air bags. Contact your PEUGEOT dealer.
- Do not fix or glue anything to the seat backs. This could cause injury to the chest or arms when the side air bag is triggered.
- Do not sit with the upper part of the body any nearer to the door than necessary.

Curtain air bags

- Do not fix or glue anything to the pillars or the roof. This could cause injury to the head when the curtain air bag inflates.
- Do not remove the bolts from the grab handles installed on the roof, they play a part in securing the curtain air bags.

The triggering of an air bag or air bags is accompanied by a slight discharge of harmless smoke and a noise, due to the activation of the pyrotechnic cartridge incorporated in the system. This smoke is not harmful but sensitive individuals may experience slight irritation.

The noise of the detonation may result in a slight loss of hearing for a short time.

Even if all of the precautions mentioned are observed, a risk of injury or of slight burns to the head, chest or arms when an air bag is triggered cannot be ruled out. In fact, the bag inflates almost instantly (within approximately 30 milliseconds) then deflates within the same time discharging hot gas via the openings provided for this purpose.

This equipment will only operate once. If a second impact occurs (during the same or a subsequent accident), the air bag will not operate.

Front air bag malfunction



If this warning light comes on, accompanied by an audible signal and a message on the multifunction display, contact a PEUGEOT dealer to have the system checked. The air bags may no longer be triggered in the event of a serious impact.

Disarming the passenger air bag*



To ensure the safety of your child, it is essential to disarm the passenger air bag when you install a "rear-facing" child seat on the front passenger seat. Otherwise, the child would risk being killed or seriously injured if the air bag were to inflate.

☞ **With the ignition switched off**, insert the key into the passenger air bag disarming switch **1**, turn it to the **"OFF"** position, then remove the key keeping the slot in this position.

In the **"OFF"** position, the passenger air bag will not be triggered in the event of an impact.

As soon as the child seat is removed, turn the passenger air bag slot **1** to the **"ON"** position to re-activate the air bag and thus ensure the safety of your passenger in the event of an impact.

Disarming check



This is confirmed by an indicator light, accompanied by an audible signal and a message on the multifunction display.

With the ignition on, illumination of this warning light, accompanied by an audible signal and a message on the multifunction display, indicates that the passenger air bag is disarmed (switch in the **"OFF"** position). The warning light comes on on the instrument panel throughout the duration of disarming.

SIDE AIR BAGS AND CURTAIN AIR BAGS

The side air bags are incorporated in the front and rear seat backs, on the door side.

The curtain air bags are incorporated into the door pillars and the upper part of the passenger compartment.

They are deployed independently of each other depending on which side the collision occurs.

Operating check



This is confirmed by an indicator light, accompanied by an audible signal and a message on the multi-function display.

If this indicator light comes on, accompanied by an audible signal and a message, contact a PEUGEOT dealer to have the system checked.



In the rear side seats, the occupants, particularly children, must be seated correctly with the seat belt fastened and must not rest their back against the door, at the risk of exposing themselves to injury in the event of deployment of the side air bag.

* According to country.



For the front, side and curtain air bags to be fully effective, observe the following safety rules:

- Wear a correctly adjusted seat belt.
- Sit in a normal upright position.
- Do not leave anything between the occupants and the air bags (child, animal, object...). This could hamper the operation of the air bags or injure the occupants.
- All work on the air bag systems is strictly prohibited unless it is carried out by qualified personnel of the PEUGEOT network.
- After an accident or if the vehicle has been stolen or broken into, have the air bag systems checked.

Front air bags

- Do not drive holding the steering wheel by its spokes or resting your hands on the centre part of the wheel.
- Passengers must not place their feet on the fascia.
- Smoke as little as possible; deployment of the air bags can cause burns or the risk of injury from a cigarette or pipe.
- Never remove or pierce the steering wheel or hit it violently.

Side air bags

- Only put approved covers on the seats, these will not hinder the inflation of the side air bags. Contact your PEUGEOT dealer.
- Do not fix or glue anything to the seat backs. This could cause injury to the chest or arms when the side air bag is triggered.
- Do not sit with the upper part of the body any nearer to the door than necessary.

Curtain air bags

- Do not fix or glue anything to the pillars or the roof. This could cause injury to the head when the curtain air bag inflates.
- Do not remove the bolts from the grab handles installed on the roof, they play a part in securing the curtain air bags.

The triggering of an air bag or air bags is accompanied by a slight discharge of harmless smoke and a noise, due to the activation of the pyrotechnic cartridge incorporated in the system. This smoke is not harmful but sensitive individuals may experience slight irritation.

The noise of the detonation may result in a slight loss of hearing for a short time.

Even if all of the precautions mentioned are observed, a risk of injury or of slight burns to the head, chest or arms when an air bag is triggered cannot be ruled out. In fact, the bag inflates almost instantly (within approximately 30 milliseconds) then deflates within the same time discharging hot gas via the openings provided for this purpose.

This equipment will only operate once. If a second impact occurs (during the same or a subsequent accident), the air bag will not operate.

IGNITION SWITCH



1. **Stop** position.
2. **Running** position.
3. **Starting** position.



The RD4 audio equipment and the RT4 GPS audio/telephone can be switched on with the ignition off for a combined duration of approximately thirty minutes.

HANDBRAKE

**Applying**

Pull the handbrake to immobilise your vehicle.

Releasing

Pull on the handle and press the button to release the handbrake.



When the vehicle is being driven, the respective illumination of these warning lights on the instrument panel, accompanied by an audible signal and a message on the multifunction display, indicates that the handbrake is still on or has not been properly released.



When parking on a slope, direct your wheels towards the pavement and pull the handbrake.

6-SPEED MANUAL GEARBOX

**Reverse**

To change to reverse gear, lift the ring under the gear lever knob and push the gear lever to the left then to the front.

Reverse gear can only be engaged when the vehicle is stationary with the engine idling.

Starting the vehicle

Before starting your vehicle:

- ensure that the gear lever is in neutral,
- or
- if a gear is engaged, press the clutch pedal.



When the ignition is on with the engine off, always select neutral.

"PORSCHE TIPTRONIC SYSTEM" AUTOMATIC GEARBOX



The six speed automatic gearbox offers, as required, the comfort of the automatic program, enhanced by a manual selection suited to dynamic driving conditions: Sport program. Driving on a slippery road is detected automatically.

However, manual selection is still possible using the gear lever.

Gear selection gate

- ☞ Move the lever in the gate to select a position.

The indicator light corresponding to the position selected appears on the instrument panel screen.

Park: to immobilise the vehicle and to start the engine, with the handbrake on.

Reverse: to reverse (select this position with the vehicle stationary, engine at idle).

Neutral: to start the engine and to park, with the handbrake on.

Note: if position **N** is inadvertently engaged while driving, allow the engine to return to idle before engaging position **D** then accelerate.

Drive: to drive in automatic mode.

Manual: to drive selecting the gears.

S: Sport program.

Starting the engine

- ☞ with the handbrake on, select position **P** or **N** in the gate,
- ☞ turn the ignition key.

Moving Off

With the engine running, from position **P**:

- ☞ **to exit position P, it is essential to press the brake pedal,**
- ☞ select position **R, D** or **M**, then gradually release the pressure on the brake pedal; the vehicle moves off immediately.

To move off from position **N**:

- ☞ with your foot on the brake, release the handbrake,
- ☞ select position **R, D** or **M**, then gradually release the pressure on the brake pedal; the vehicle moves off immediately.



When the engine is at idle, brakes not applied, if position **R, D** or **M** is selected, the vehicle moves even without the accelerator being pressed.

Do not leave children unsupervised inside the vehicle, with position R, D or M selected, with the engine running, as the vehicle moves even without the accelerator being pressed.



With the ignition off, if the lever is not in position **P**, an audible signal is heard when the driver's door is opened. Move the lever to position **P**. The audible signal ceases.

When maintenance operations need to be carried out with the engine running, apply the handbrake and select position **P**.

When the engine is cold, the operation of the gearbox may differ from its operation when the engine is warm.

The Drive program

☞ Select position **D** in the gate: the gearbox operates in automatic mode.

The gearbox automatically adapts the gear in relation to the profile of the road and the vehicle load.

To obtain maximum acceleration without touching the lever (kick down), press the accelerator down fully to the end of its travel (passing the point of resistance). The program will change down automatically or will stay in the gear selected until the maximum engine speed is reached.

When travelling downhill, the program will change down automatically in order to offer efficient engine braking and good resumption of acceleration. When travelling uphill, following rapid releasing of the pedal, the gearbox maintains the gear engaged to make acceleration easier.



Never select position **N** when the vehicle is moving.

Never select positions **P** or **R** unless the vehicle is stationary.

When the ignition is on with the engine off, always select position **P** or **N**.

Sport program

The program selected is displayed on the instrument panel screen.

☞ Press button **S** once the vehicle has been started in position **D**, this program favours dynamic driving.

You can deactivate the Sport program at any time by pressing the button selected.

Operation with manual selection of the gears

- ☞ select position **M** in the gate,
- ☞ push the lever to the + sign to change up a gear and push again to change up another gear,
- ☞ pull the lever to the - sign to change down a gear and pull again to change down another gear.

You can change from position **D** (driving in automatic mode) to position **M** (driving in manual mode) at any time.



It is only possible to change from one gear to another if the vehicle speed and engine speed permit. If they do not, the vehicle will operate temporarily in automatic mode.

When the vehicle is stationary or moving very slowly, the gearbox automatically selects gear **M1**.

Program **S** (Sport) does not operate in manual gear selection mode.

Operating check



Any operating abnormality is indicated by lighting of this warning light, accompanied by an audible signal and a message on the multifunction display.

In this situation the gearbox operates in downgrade mode (locked in 3rd gear). You may feel a substantial knock when changing from **P** to **R** and from **N** to **R** (this will not cause any damage to the gearbox).

Do not exceed 60 mph (100 km/h) or keep within local speed limits.

Contact a PEUGEOT dealer as soon as possible.



If the battery is flat and the lever is in position **P**, it will be impossible to change to another position.

In particular, do not force the lever or there is a risk the gearbox may be damaged.

ELECTRONICALLY CONTROLLED SUSPENSION



The suspension adapts automatically and instantly to different driving styles and road characteristics, improving the comfort of the occupants and the vehicle's road holding capabilities.

The suspension favours a smooth shock absorption, ensuring a comfortable ride, but as soon as conditions demand a change (sporty driving, tight bends, avoidance action, etc.), it automatically selects firmer shock absorption, guaranteeing optimum road holding.

When the ignition is switched on, the electronic suspension is always active in automatic operation mode.

Selecting the SPORT position



Press switch **1**, the indicator light and the **SPORT** indicator light will come on.

In this position, the suspension is maintained in the **SPORT** position, the shock absorption and the steering assistance become firmer.

Return to automatic operation



Press switch **1** again. The indicator light will go out and the **AUTO** indicator light comes on, accompanied by an audible signal.

Operating check

This is confirmed by the switch light and the indicator lights. The switch light comes on for approximately three seconds every time the ignition is switched on.



If the switch light flashes or if the indicator light comes on, accompanied by an audible signal and a message, contact your PEUGEOT dealer.

Operating check



Any operating abnormality is indicated by lighting of this warning light, accompanied by an audible signal and a message on the multifunction display.

In this situation the gearbox operates in downgrade mode (locked in 3rd gear). You may feel a substantial knock when changing from **P** to **R** and from **N** to **R** (this will not cause any damage to the gearbox).

Do not exceed 60 mph (100 km/h) or keep within local speed limits.

Contact a PEUGEOT dealer as soon as possible.



If the battery is flat and the lever is in position **P**, it will be impossible to change to another position.

In particular, do not force the lever or there is a risk the gearbox may be damaged.

ELECTRONICALLY CONTROLLED SUSPENSION



The suspension adapts automatically and instantly to different driving styles and road characteristics, improving the comfort of the occupants and the vehicle's road holding capabilities.

The suspension favours a smooth shock absorption, ensuring a comfortable ride, but as soon as conditions demand a change (sporty driving, tight bends, avoidance action, etc.), it automatically selects firmer shock absorption, guaranteeing optimum road holding.

When the ignition is switched on, the electronic suspension is always active in automatic operation mode.

Selecting the SPORT position



Press switch **1**, the indicator light and the **SPORT** indicator light will come on.

In this position, the suspension is maintained in the **SPORT** position, the shock absorption and the steering assistance become firmer.

Return to automatic operation



Press switch **1** again. The indicator light will go out and the **AUTO** indicator light comes on, accompanied by an audible signal.

Operating check

This is confirmed by the switch light and the indicator lights. The switch light comes on for approximately three seconds every time the ignition is switched on.



If the switch light flashes or if the indicator light comes on, accompanied by an audible signal and a message, contact your PEUGEOT dealer.

CRUISE CONTROL/SPEED LIMITER



Cruise control function

This enables the vehicle to maintain a steady speed programmed by the driver.

In order for it to be memorised, the vehicle speed must be greater than 25 mph (40 km/h) with at least fourth gear engaged for vehicles fitted with a manual gearbox.

On vehicles fitted with an automatic gearbox, the lever must be in position **D** or at least second gear must be engaged in sequential driving mode.



Selecting the function

☞ Place switch **1** in the **CRUISE** position. The cruise control is not yet active and no speed has been memorised. The display indicates:



Switching the function off

☞ Place switch **1** in position **0** or **LIMIT** to switch the system off.

First activation/memorising a speed

As soon as you reach the chosen speed, press button "set-" **2** or "set+" **3**. This memorises the speed, which will be maintained automatically. The display indicates (e.g. at 70 mph (110 km/h)):



Note: It is possible to accelerate and drive momentarily at a speed greater than the memorised speed. The value memorised flashes. When the accelerator pedal is released, the vehicle will return to the memorised speed.

Cancelling the memorised speed

If you wish to cancel the memorised speed:

☞ Press button **4** or the brake or clutch pedal.

The display indicates (e.g. at 70 mph (110 km/h)):



Note: the speed memorised is cancelled automatically if the vehicle speed is less than 25 mph (40 km/h), or if the manual gearbox is in a gear lower than fourth (second gear for the automatic gearbox) or if the ESP is activated.



On a steep descent, the cruise control, which does not act on the brakes, will not be able to prevent the vehicle from exceeding the programmed speed.

The cruise control cannot, in any circumstances, replace the need to comply with speed limits or the need for vigilance and responsibility on the part of the driver.

Reactivating the memorised speed

After cancellation, press button 4. Your vehicle will return to the last memorised speed. The display indicates (e.g. at 70 mph (110 km/h)):



Changing a memorised speed

To memorise a speed higher than the previous one, there are two options:

Without using the accelerator:

☞ press button 3;

A brief press increases by 1 mph (1 km/h).

A maintained press increases in steps of 5 mph (5 km/h).

Using the accelerator:

☞ exceed the memorised speed until the required speed is reached,

☞ press button 2 or 3.

To memorise a speed lower than the previous one:

☞ press button 2;

A brief press decreases by 1 mph (1 km/h).

A maintained press decreases in steps of 5 mph (5 km/h).

Cancelling the memorised speed

☞ When the vehicle is stationary, after the ignition has been switched off, the system no longer stores any speed.

Operating check

In the event of a cruise control malfunction, the memorised speed is erased, the dashes flash for a few seconds:



Contact a PEUGEOT dealer to have the system checked.



Do not use the cruise control on slippery roads or in heavy traffic.

To prevent the mat from becoming caught under the pedals:

- ensure that the mat is positioned correctly,
- never fit one mat on top of another.

Speed limiter function



This prevents the vehicle speed exceeding the speed programmed by the driver (minimum speed of 18 mph (30 km/h)).



The operations must be carried out:

- while stationary, with the engine running,

or

- while the vehicle is moving.

Reactivating the memorised speed

After cancellation, press button 4. Your vehicle will return to the last memorised speed. The display indicates (e.g. at 70 mph (110 km/h)):



Changing a memorised speed

To memorise a speed higher than the previous one, there are two options:

Without using the accelerator:

☞ press button 3;

A brief press increases by 1 mph (1 km/h).

A maintained press increases in steps of 5 mph (5 km/h).

Using the accelerator:

☞ exceed the memorised speed until the required speed is reached,

☞ press button 2 or 3.

To memorise a speed lower than the previous one:

☞ press button 2;

A brief press decreases by 1 mph (1 km/h).

A maintained press decreases in steps of 5 mph (5 km/h).

Cancelling the memorised speed

☞ When the vehicle is stationary, after the ignition has been switched off, the system no longer stores any speed.

Operating check

In the event of a cruise control malfunction, the memorised speed is erased, the dashes flash for a few seconds:



Contact a PEUGEOT dealer to have the system checked.



Do not use the cruise control on slippery roads or in heavy traffic.

To prevent the mat from becoming caught under the pedals:

- ensure that the mat is positioned correctly,
- never fit one mat on top of another.

Speed limiter function



This prevents the vehicle speed exceeding the speed programmed by the driver (minimum speed of 18 mph (30 km/h)).



The operations must be carried out:

- while stationary, with the engine running,

or

- while the vehicle is moving.



On a steep descent or if you accelerate sharply, the speed limiter, which does not act on the brakes, will not be able to prevent the vehicle from exceeding the programmed speed.

The speed limiter cannot, in any circumstances, replace the need to comply with speed limits or the need for vigilance and responsibility on the part of the driver.

Selecting the function

Place switch **1** in the **LIMIT** position. The limiter is not yet active. By default the display indicates:



Switching the function off

Place switch **1** in position **0** or **CRUISE** or switch off the ignition to switch the system off. The last speed programmed remains in the memory.

Memorising a speed

A speed can be memorised without activation of the limiter.

A brief press on buttons **2** and **3** decreases or increases by 1 mph (1 km/h). A maintained press decreases or increases the memorised speed progressively in steps of 5 mph (5 km/h).

Activation/deactivation of the limiter

The activation is taken into account, when the vehicle is moving, when the vehicle speed is at least 5 mph (5 km/h) below the stored speed.

Pressing button **4** activates the limiter, pressing this button again deactivates it. When the limiter is active, the display indicates (e.g. at 70 mph (110 km/h)):



Exceeding the programmed speed

In exceptional situations, this method can be used to exceed the programmed speed.

Pressing the accelerator to exceed the programmed speed will have no effect unless the pedal is pressed **firmly** to the end of its travel (passing the **point of resistance**).

The limiter is deactivated temporarily and displays the speed which flashes (e.g. at 70 mph (110 km/h)):

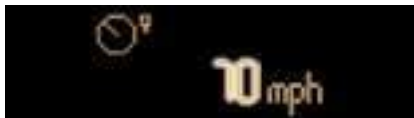

To re-activate the limiter, release the accelerator to slow down to a speed below the programmed speed.



Note: sometimes (on a steep descent), the limiter may not prevent the vehicle from exceeding the programmed speed, this speed flashes.

Operating check

In the event of a limiter malfunction, the memorised speed is erased, the dashes flash for a few seconds:



Contact a PEUGEOT dealer to have the system checked.



To prevent the mat from becoming caught under the pedals:

- ensure that the mat is positioned correctly,
- never fit one mat on top of another.

VISUAL AND AUDIBLE REAR AND/OR FRONT PARKING ASSISTANCE



This system consists of four proximity sensors, located in the rear and/or front bumper.

It detects any obstacle (person, vehicle, tree, gate, etc.) in front of or behind the vehicle. However, it cannot detect obstacles located directly under the bumper.

An object, such as a stake, cone or any other similar object may be detected at the beginning of the manoeuvre but may no longer be detected when the vehicle comes close to it.



In bad weather or in winter, ensure that the sensors are not covered with mud, frost or snow.



Detection zone

Detection

The system is activated when:

- reverse gear is engaged,
- the speed is below 6 mph (10 km/h) in forward gear.

It is accompanied by an audible signal and/or displaying of the vehicle on the multifunction display.



The system is deactivated when the vehicle has been stationary for more than 3 seconds.



The proximity of the obstacle is indicated by:

- an audible signal which becomes more rapid as the vehicle approaches the obstacle,
- a graphic on the multifunction display, with blocks which become increasingly close to the vehicle.

The obstacle is located in relation to the emission of the audible signal by the speakers; that is, front or rear and right or left.

When the distance between the vehicle and the obstacle is less than approximately twenty-five centimetres, the audible signal becomes continuous and/or the "Danger" symbol appears on the multifunction display.

The system becomes inactive again:

- when you exit reverse gear,
- when the speed is above 6 mph (10 km/h),
- at the end of the manoeuvre, when stationary, after a few seconds (front parking assistance only).

Deactivation



Press button **A** to deactivate the system (child asleep in the rear...). The indicator light on the button comes on.

Note: the rear parking assistance function only will be deactivated automatically when a trailer is being towed (vehicle fitted with a towbar recommended by PEUGEOT).

Reactivation

Press button **A** again to reactivate the system. The indicator light on the button is switched off.



If there is an operating fault, when reverse gear is engaged, the indicator light flashes, accompanied by an audible signal and a message on the multifunction display.

BONNET**Opening**

☞ Pull the lever, located on the left beneath the dashboard, downwards.

☞ Lift the catch and raise the bonnet.

Bonnet struts open the bonnet and keep it open.

Closing

☞ Lower the bonnet and release it at the end of its travel.

☞ Check that it is locked.

RUNNING OUT OF FUEL (DIESEL)

If you should run out of fuel, it is necessary to re-prime the circuit.

If the engine does not start after 15 seconds, repeat the repriming operation.

2 litre 16V HDI engine

- fill the fuel tank with at least five litres of diesel,
- unclip the style cover to gain access to the repriming pump,
- unscrew the degas screw,
- squeeze and release the manual repriming pump until diesel is seen escaping via the degas screw,
- retighten the degas screw,
- operate the starter until the engine starts.

2.2 litre 16V HDI engine

- fill the fuel tank with at least five litres of diesel,
- unclip the style cover to gain access to the repriming pump,
- operate the pump until pressure is felt,
- operate the starter until the engine starts.



3 LITRE V6 24V INJECTION PETROL ENGINE

1. Windscreen/headlamp wash reservoir.
2. Power steering reservoir.
3. Coolant reservoir.
4. Dipstick.
5. Engine oil filler cap.
6. Air filter.
7. Fuse box.
8. Brake and clutch fluid reservoir.



2 LITRE HDI 16V AND 2.2 LITRE HDI 16V TURBO DIESEL ENGINES

1. Windscreen/headlamp wash reservoir.
2. Power steering reservoir.
3. Coolant reservoir.
4. Dipstick.
5. Engine oil filler cap.
6. Air filter.
7. Fuse box.
8. Brake and clutch fluid reservoir.
9. Priming pump.
10. Degas screw*.

* On the 2 litre HDI 16V engine only.

CHECKING THE LEVELS

Oil level

- ☞ Check the level regularly and top up between changes. Maximum consumption is 0.5 l per 600 miles (1.000 km).

Carry out this check with the vehicle level, engine cold, using the oil level gauge on the instrument panel or the dipstick.

Dipstick



There are two marks on the dipstick:

A = maximum

Never fill past this mark.

B = minimum

To maintain the reliability of engines and emission control systems, the use of additives in engine oil is prohibited.

Oil change

According to the information given in the servicing booklet.

Viscosity selection

In all cases, the oil selected must meet the manufacturer's requirements.

Brake and clutch fluid level

The level must always be between the DANGER and MAXIMUM marks in the reservoir.

If the level drops substantially, contact a PEUGEOT dealer immediately.

Fluid change:

- must be carried out according to the manufacturer's servicing schedule.
- use fluids recommended by the manufacturer, which fulfil DOT4 standards.

Power steering reservoir

- ☞ Open the reservoir, with the engine cold at ambient temperature. The level should always be above the MINI mark and close to the MAXI mark.

Windscreen and headlamp wash level

For best quality cleaning and for your safety, we advise that you use products recommended by PEUGEOT (reservoir capacity 4 litres or 6.5 litres with headlamp wash).

Characteristics of the fluid

For best quality cleaning and to prevent freezing, this fluid must not be topped up or replaced with water.



Used oil

Prevent used oil from coming into prolonged contact with the skin.

Brake and clutch fluid is harmful to health and very corrosive.

Do not dispose of used oil, brake and clutch fluid or coolant into drains or onto the ground.

CHECKS

**Battery**

At the start of winter, have your battery checked by a PEUGEOT dealer.

**Air filter and passenger compartment filter**

Have the filter elements replaced regularly. **If you drive in dusty conditions, change them twice as often.**

Particulate emission filter - Additive reservoir (Diesel)

Maintenance of the particulate emission filter and filling of the additive reservoir must be carried out by a PEUGEOT dealer, according to the manufacturer's servicing schedule.

**Brake pads**

Brake pad wear depends on the style of driving, in particular for vehicles which are used in town, over short distances.



It may be necessary to check the thickness of the pads, even between services.

Handbrake

Where the handbrake travel is too great or there is a reduction in the performance of the system, the handbrake should be adjusted. Have the system checked by a PEUGEOT dealer.

Manual gearbox

This does not need an oil change. Have the level checked, according to the manufacturer's servicing schedule.

Automatic gearbox

This does not need an oil change. Have the level checked by a PEUGEOT dealer, according to the manufacturer's servicing schedule.

Oil filter

Change the filter regularly, in accordance with the servicing schedule.

Disc wear condition

For any information relating to checking of the disc wear condition, contact a PEUGEOT dealer.

In order to check the main levels and certain components, in accordance with the manufacturer's servicing schedule, refer to the pages of the servicing booklet which correspond to your vehicle's engine.



Only use products recommended by PEUGEOT or products of equivalent quality and specification.

To ensure best performance from components as important as the power steering and the braking system, PEUGEOT selects and offers specific products.

To prevent damage to the electrical units, high pressure washing of the engine compartment is strictly **prohibited**.

CHANGING A WHEEL



- ☞ Park the vehicle on level, stable and non-slippery ground.
- ☞ Apply the handbrake, switch off the ignition and engage first or reverse gear (position **P** for the automatic gearbox).

Access to the spare wheel and the jack in the boot

- ☞ Detach the luggage net.
- ☞ Lift the boot carpet using the lifting hook. Secure this hook behind the boot seal.



Tools available

The following tools are located in the polystyrene holder in the centre of the spare wheel:

1. Wheelbrace.
2. Centralising tool.
3. Wheelbrace extension.
4. Jack.
5. Removable towing eye.
6. Alloy wheel trim remover.
7. Trim cover tool.

Removal

- ☞ For vehicles with alloy wheels fitted with wheel trims, pull the centre trim by using tool **6** in one of the holes.
- ☞ Loosen the wheel bolts.
- ☞ Take the jack **4** from the tool kit.
- ☞ Place the jack in one of the four locations **A** underneath the vehicle (the nearest one to the wheel to be changed).
- ☞ Extend the jack using wheelbrace **1** and the extension **3**.
- ☞ Remove a wheel bolt at the top and fit the centralising tool **2** in its place.
- ☞ Unscrew the other bolts and remove the wheel.

Fitting a wheel



- ☞ Position the wheel using the centralising tool **2** to assist you.
- ☞ Tighten the bolts by hand and remove the centralising tool.
- ☞ Partly tighten the bolts using the wheelbrace **1**.
- ☞ Fold the jack **4** and remove it.
- ☞ Fully tighten the bolts using the wheelbrace.
- ☞ Replace the wheel trim.
- ☞ For the alloy trims, position the removal hole opposite the valve.
- ☞ Put the tool holder back in position. This helps to keep the boot floor in its correct position, to prevent any deformation of the floor when loaded.
- ☞ Tighten the spare wheel securing strap to prevent noise and for your safety in the event of impact.

For your safety, always change the wheel:

- on level, stable, non-slippery ground,
- with the handbrake applied,
- with first or reverse gear engaged (position **P** for the automatic gearbox),
- never go underneath a vehicle which is supported only by a jack (use a ramp).

After changing the wheel:

- have the tightening of the bolts and the tyre pressure checked by a PEUGEOT dealer as soon as possible,
- have the punctured wheel repaired and refit it to the vehicle as soon as possible,
- the steel spare wheel must only be

Tyres fitted with the Tyre Under-Inflation Detection System.

These wheels have a pressure sensor. Have them repaired by a PEUGEOT dealer.

Special features of alloy wheels

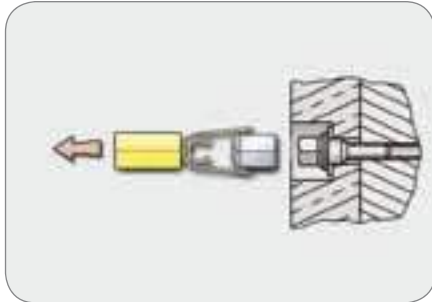

Bolt covers

Alloy wheel bolts are covered by chrome trims.

Use the yellow tool 7 to remove the trims before slackening the bolts.

Fitting the spare wheel

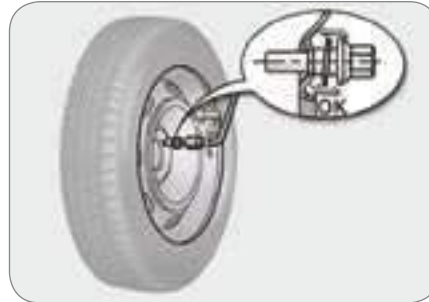

If your vehicle is fitted with a steel spare wheel, when fitting it, it is **normal** to notice when tightening the bolts that the washers do not come into contact with the rim. The spare wheel is secured by the cone-shape of each bolt.

Fitting snow tyres

If you wish to fit snow chains on your vehicle, contact a PEUGEOT dealer to find out which models are recommended for your vehicle.

Anti-theft bolts

If your wheels are fitted with an anti-theft bolt (one per wheel), the chrome trim must be removed using the yellow tool, before unscrewing the bolt using the anti-theft socket and the wheel brace.



Note: the anti-theft socket was given to you on delivery of your vehicle along with the duplicate keys and the confidential card.

Make a careful note of the code number engraved on the head of the anti-theft socket. This will enable you to obtain a duplicate socket from a PEUGEOT dealer.

CHANGING A BULB

Front lights



In the engine compartment, remove the style cover secured by one or two butterfly screws, a plastic retainer clip and two quarter turn screws.

On the left-hand side, remove the partition by lifting it to gain access to the lights.

When you have finished, do not forget to put everything back correctly.

1 - Dipped beam headlamps: H7-55 W or Xenon bulb.



WARNING: RISK OF ELECTROCUTION

Xenon bulbs must be replaced by a PEUGEOT dealer.



2 - Main beam headlamps: H1-55 W.

- ☞ Turn the protective cover of the faulty bulb a quarter of a turn and remove it.
- ☞ Disconnect the connector.
- ☞ Press the end of the securing clip to free it. Change the bulb.
- ☞ When fitting the new bulb, ensure that the direction notches are positioned correctly and the securing clip is fixed properly.
- ☞ Reconnect the connector.
- ☞ Refit the protective cover.

3 - Side lights: W 5 W.

- ☞ Pull the socket rearwards.
- ☞ Remove the bulb and change it.

4 - Direction indicators: PY 21 W (amber).

- ☞ Turn the bulb holder a quarter turn and remove it.
- ☞ Remove the bulb and change it.
- ☞ Refit the style cover.

Front foglamps: H1-55 W.



Note: in certain climatic conditions (low temperature, humidity), **condensation on the inside surface of the headlamp glass is normal**; it disappears a few minutes after the lights are switched on.

Handle the bulbs with a dry cloth.



The headlamps are fitted with polycarbonate glass with a protective coating. Do not clean them with a dry or abrasive cloth, nor with a detergent or solvent product.

Use a soft, damp cloth with soapy water.

High pressure washing

When using this type of washing on stubborn dirt, do not persist on the headlamps, the lights and their surrounds to avoid damaging their varnish and their seal.

Integrated direction indicator repeaters



- ☞ Push the repeater forwards and release it.
 - ☞ Remove the repeater and change it.
- This can be obtained from a PEUGEOT dealer.

Rear lights

Rear wing lights



1. **Direction indicators:** Hp16.
 2. **Brake lights/side lights:** Hp16.
- ☞ Detach the luggage net.
 - ☞ Lift the boot carpet with the lifting hook. Secure this hook behind the boot seal.
 - ☞ Unclip the lower part of the sill trim, then dislodge it by pulling upwards.
 - ☞ Remove the plastic retainer clip securing the side trim to the floor.
 - ☞ Unclip the side trim.



- ☞ Remove the two butterfly nuts securing the light.
- ☞ Remove the eyelet.
- ☞ Take out the lamp.
- ☞ Unclip the bulb holder.
- ☞ Change the faulty bulb.
- ☞ Clip the bulb holder.

When refitting it, ensure that the lamp is correctly positioned and secured.



Amber coloured bulbs, such as the direction indicators and side repeaters, must be replaced with bulbs of identical specification and colour.

Integrated direction indicator repeaters



- ☞ Push the repeater forwards and release it.
 - ☞ Remove the repeater and change it.
- This can be obtained from a PEUGEOT dealer.

Rear lights

Rear wing lights



1. **Direction indicators:** Hp16.
 2. **Brake lights/side lights:** Hp16.
- ☞ Detach the luggage net.
 - ☞ Lift the boot carpet with the lifting hook. Secure this hook behind the boot seal.
 - ☞ Unclip the lower part of the sill trim, then dislodge it by pulling upwards.
 - ☞ Remove the plastic retainer clip securing the side trim to the floor.
 - ☞ Unclip the side trim.



- ☞ Remove the two butterfly nuts securing the light.
- ☞ Remove the eyelet.
- ☞ Take out the lamp.
- ☞ Unclip the bulb holder.
- ☞ Change the faulty bulb.
- ☞ Clip the bulb holder.

When refitting it, ensure that the lamp is correctly positioned and secured.



Amber coloured bulbs, such as the direction indicators and side repeaters, must be replaced with bulbs of identical specification and colour.

Boot lid lights



1. **Reversing lights:** Hp16.
2. **Side lights:** Hp16.
3. **Fog lamps:** Hp16.



- ☞ Remove the three plastic retainer clips securing the cover trim (those nearest to the lamp).
 - ☞ Move aside the trim.
 - ☞ Disconnect the lamp harness.
 - ☞ Extract the lamp from its housing.
 - ☞ Remove the flat seal.
 - ☞ Unclip the bulb holder.
 - ☞ Change the faulty bulb.
 - ☞ Clip the bulb holder.
 - ☞ Put the flat seal back in place.
- When refitting it, ensure that the lamp is correctly positioned and secured.



Number plate lights: W 5 W.

- ☞ Remove the transparent cover using a screwdriver blade.
- ☞ Change the faulty bulb.



If you encounter any difficulties, contact a PEUGEOT dealer.

CHANGING A FUSE

The fuse boxes are placed in the lower part of the fascia (driver's side), in the engine compartment (left-hand side) and in the left boot trim.

Replacing a fuse

Before replacing a fuse, the cause of the incident must be found and rectified. The fuse numbers are indicated on the fuse box.



Always replace a faulty fuse with a fuse of the same rating (same colour).

Use the special pliers located on the support next to the fuse box, this support also contains the replacement fuses.

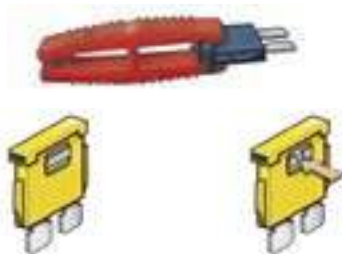

Correct

Incorrect

Fascia fuses



To access the fuses, open the cover of the storage compartment on the driver's side. Tilt the fuse box downwards.

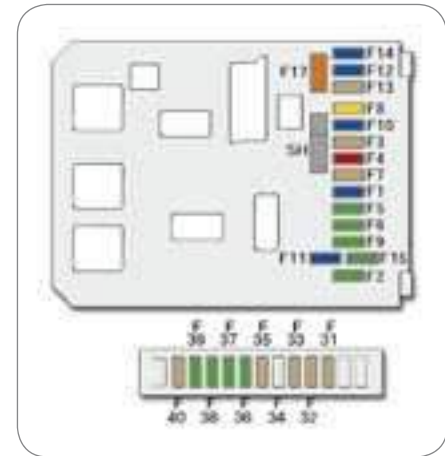

Fuse N°	Rating	Functions
F31	5 A	Right-hand brake light.
F32	5 A	Left-hand brake light.
F33	5 A	Third brake light.
F34	-	Not used.
F35	5 A	Tyre under-inflation detection control unit, CD changer.
F36	30 A	Passenger seat relay.
F37	30 A	Passenger and rear right heated seats.
F38	30 A	Driver's and rear left heated seats.
F39	30 A	Driver's seat relay.
F40	5 A	Diagnostics socket.

CHANGING A FUSE

The fuse boxes are placed in the lower part of the fascia (driver's side), in the engine compartment (left-hand side) and in the left boot trim.

Replacing a fuse

Before replacing a fuse, the cause of the incident must be found and rectified. The fuse numbers are indicated on the fuse box.



Always replace a faulty fuse with a fuse of the same rating (same colour).

Use the special pliers located on the support next to the fuse box, this support also contains the replacement fuses.

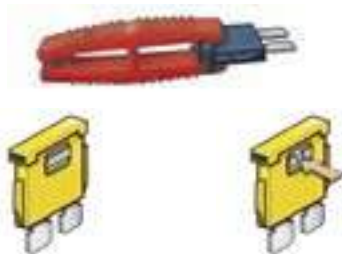

Correct

Incorrect

Fascia fuses



To access the fuses, open the cover of the storage compartment on the driver's side. Tilt the fuse box downwards.

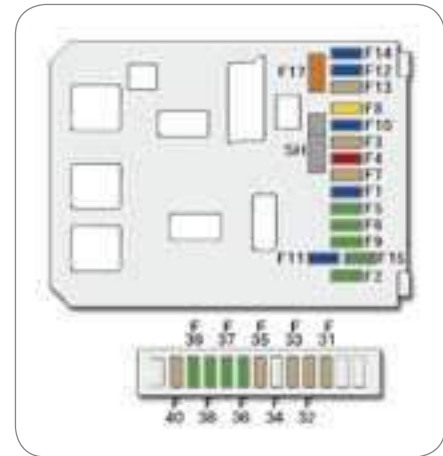

Fuse N°	Rating	Functions
F31	5 A	Right-hand brake light.
F32	5 A	Left-hand brake light.
F33	5 A	Third brake light.
F34	-	Not used.
F35	5 A	Tyre under-inflation detection control unit, CD changer.
F36	30 A	Passenger seat relay.
F37	30 A	Passenger and rear right heated seats.
F38	30 A	Driver's and rear left heated seats.
F39	30 A	Driver's seat relay.
F40	5 A	Diagnostics socket.

Fuse N°	Rating	Functions
F1	15 A	Front wash-wipe pump and wash-wipe fluid level sensor.
F2	30 A	Locking and deadlocking earth.
F3	5 A	Air bags.
F4	10 A	Clutch switch, brake dual-function switch, diagnostic connector, ESP sensor, electrochromatic mirror.
F5	30 A	Front electric windows and sunroof supply.
F6	30 A	Rear electric windows supply.
F7	5 A	Glove box switch, courtesy lights, map reading lights, courtesy mirror.
F8	20 A	Multifunction display supply, steering wheel control, alarm siren, trailer fusebox supply, audio RD4, RT4 GPS audio/telephone, electric mirror and front and rear electric window controls.
F9	30 A	Front and rear lighters (100 W max.).
F10	15 A	Additive reservoir control unit supply.
F11	15 A	Automatic gearbox control unit, automatic gearbox positions selection switch, ignition switch.
F12	15 A	Trailer fusebox supply, hands-free kit, seats relay, seat memory unit, rain and brightness sensor.
F13	5 A	Engine fusebox supply.
F14	15 A	Parking assistance control unit supply, instrument panel, air conditioning, air bags and pretensioners unit.
F15	30 A	Locking and deadlocking supply.
F17	40 A	Hi-Fi amplifier, heated mirrors.

Engine compartment fuses

To access the fuses located in the engine compartment, remove the cover and unclip the fuse box lid.

When you have finished, close the lid carefully to guarantee the sealing of the fuse box and refit the cover.

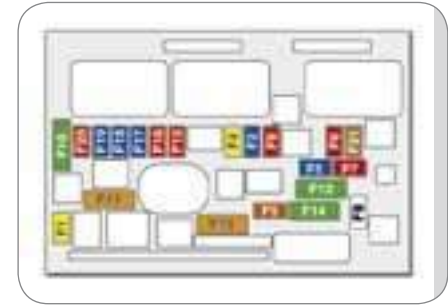

Fuse N°	Rating	Functions
F1	20 A	Engine management control unit.
F2	15 A	Horn.
F3	10 A	Rear electric blind.
F4	20 A	Headlamp wash.
F5	15 A	Fuel pump (except 2 litre HDI 16V and 2.2 litre HDI 16V), diesel heater (2 litre HDI 16V), engine management actuators (2.2 litre HDI 16V).
F6	10 A	Power steering, suspension control unit, automatic gearbox, automatic headlamp adjustment unit.
F7	10 A	Engine air flow sensor (2.2 litre HDI 16V), ESP control unit.
F8	25 A	Starter coil.
F9	10 A	Coolant level sensor, passenger compartment heating (HDI), STOP switch.
F10	30 A	Engine management actuators (injectors, ignition coil, solenoid valves, oxygen sensors).

Fuse N°	Rating	Functions
F11	40 A	Air conditioning blower relay.
F12	30 A	Wipers relay.
F13	40 A	Built-in systems interface supply (ignition positive).
F14	30 A	Air pump.
F15	10 A	Right-hand main beam headlamp.
F16	10 A	Left-hand main beam headlamp.
F17	15 A	Left-hand dipped headlamp.
F18	15 A	Right-hand dipped headlamp.
F19	15 A	Oil vapour heater (2.2 litre 16V and 2 litre HDI 16V), inlet air heating solenoid valve (2 litre HDI 16V), air flow sensor (2 litre HDI 16V), injection pump (2.2 litre HDI 16V), oxygen sensor, purge canister solenoid valve (3 litre V6 24V).
F20	10 A	Water in diesel sensor (2 litre HDI 16V and 2.2 litre HDI 16V), turbo regulation solenoid valve (2 litre HDI 16V), timing and exhaust solenoid valves (3 litre V6 24V).
F21	10 A	Fan assembly relay control.



The electrical system of your vehicle is designed to operate with standard or optional equipment.

Before installing other electrical equipment or accessories on your vehicle, consult a PEUGEOT dealer.

PEUGEOT will not accept responsibility for the cost incurred in repairing your vehicle or for rectifying malfunctions resulting from the installation of accessories not supplied or recommended by PEUGEOT and not installed in accordance with its instructions, in particular when the combined consumption of all of the additional equipment connected exceeds 10 milliamperes.

CHANGING A WINDSCREEN WIPER BLADE

Placing the wiper blades in the maintenance position

- ☞ Less than one minute after switching off the ignition, press the windscreen wiper stalk down once to position the blades at the top of the windscreen (maintenance position).

Replacing a blade

- ☞ Lift the arm, then unclip the blade and remove it.
- ☞ Fit the new blade and fold down the arm.

To reposition the blades, switch on the ignition and operate the windscreen wiper stalk.

ENERGY ECONOMY MODE

After the engine has stopped, certain functions (windscreen wiper, electric windows, sunroof, electric seats, audio equipment, telephone, dipped headlamps, video, etc.) can only be used for a limited combined duration, to prevent discharging of the battery.

Once this period has elapsed, a switching to economy mode message appears on the multifunction display and the active functions are put on standby.

These functions are reactivated automatically next time the vehicle is driven.

In order to exit the economy mode and resume the use of these functions immediately, the engine must be started and left to run for a few minutes.

If the engine has been running for at least 10 minutes, all of the functions are active for 30 minutes.

If the engine has been running for less than 10 minutes, this duration before returning to economy mode is 5 minutes.



All of these functions are available when the engine is running.

If the telephone is being used when economy mode starts, it will still be possible to finish the call.



A flat battery prevents the engine from starting.

If the doors or boot are opened several times or if the alarm is triggered, this may result in activation of the energy economy mode.

LOAD REDUCTION FUNCTION

When driving, certain functions (air conditioning, heated rear screen, heating system for passenger compartment of diesel vehicles, etc.) may be switched off temporarily, depending on the level of battery charge.

Reactivation of these functions is automatic, once the battery charge is sufficient.

Note: at the risk of discharging the battery, the functions that have been switched off may be reactivated manually.

TOWING YOUR VEHICLE



Without lifting (4 wheels on the road)

You should always use a towbar.
The towing eye is inside the spare wheel.

From the front:

- ☞ Carefully unclip the bottom of the cover, using a small screwdriver.
- ☞ Screw in the towing eye until it locks.

From the rear:

- ☞ Carefully unclip the top of the cover using a small screwdriver,
- ☞ Screw in the towing eye until it locks.



When towing with the engine switched off, there is no braking or steering assistance.



Lifting (2 wheels only on the road)

It is preferable to raise the vehicle using professional lifting equipment.

Never use the radiator crossmember.

Special features of the automatic gearbox

Towing a vehicle with an automatic gearbox in reverse gear is **prohibited (absence of lubrication)**.



When being towed with all four wheels on the ground, it is imperative that the following rules are obeyed:

- selector lever in position **N**,
- the vehicle must be towed at a speed of less than 30 mph (50 km/h) over a maximum distance of 30 miles (50 km),
- do not add oil to the gearbox.

BATTERY

The battery is located behind the left boot trim.



To disconnect the battery:

- ☞ pull the handle downwards and fold back the panel to gain access to the battery,
- ☞ disconnect the green terminal (-) of the battery.



It is advisable to disconnect the battery if the vehicle is not to be used for a period of more than one month.

TOWING YOUR VEHICLE



Without lifting (4 wheels on the road)

You should always use a towbar.
The towing eye is inside the spare wheel.

From the front:

- ☞ Carefully unclip the bottom of the cover, using a small screwdriver.
- ☞ Screw in the towing eye until it locks.

From the rear:

- ☞ Carefully unclip the top of the cover using a small screwdriver,
- ☞ Screw in the towing eye until it locks.



When towing with the engine switched off, there is no braking or steering assistance.



Lifting (2 wheels only on the road)

It is preferable to raise the vehicle using professional lifting equipment.

Never use the radiator crossmember.

Special features of the automatic gearbox

Towing a vehicle with an automatic gearbox in reverse gear is **prohibited (absence of lubrication)**.



When being towed with all four wheels on the ground, it is imperative that the following rules are obeyed:

- selector lever in position **N**,
- the vehicle must be towed at a speed of less than 30 mph (50 km/h) over a maximum distance of 30 miles (50 km),
- do not add oil to the gearbox.

BATTERY

The battery is located behind the left boot trim.



To disconnect the battery:

- ☞ pull the handle downwards and fold back the panel to gain access to the battery,
- ☞ disconnect the green terminal (-) of the battery.



It is advisable to disconnect the battery if the vehicle is not to be used for a period of more than one month.

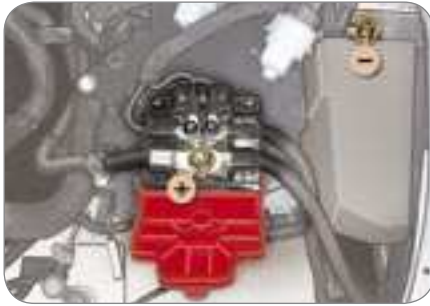

To start the vehicle from another battery, use the front additional terminal:

- ☞ open the bonnet,
- ☞ remove the left side cover,
- ☞ use the two additional (+) and (-) terminals located under the bonnet and only these,
- ☞ open the red cover of the (+) terminal,
- ☞ connect the red cable between the (+) terminal and the (+) terminal of the slave battery,
- ☞ connect the green or black cable between the (-) terminal and the negative (-) terminal of the slave battery,
- ☞ start the engine and let it run,
- ☞ wait for the engine to return to idle then disconnect the cables,
- ☞ close the red cover of the (+) terminal,
- ☞ refit the left side cover,
- ☞ close the bonnet.

To charge the battery:

- ☞ open the bonnet,
- ☞ remove the left side cover,
- ☞ use the two additional (+) and (-) terminals located under the bonnet,
- ☞ open the red cover of the (+) terminal,
- ☞ follow the instructions for use provided by the manufacturer of the charger,
- ☞ close the red cover of the (+) terminal,
- ☞ refit the left side cover,
- ☞ close the bonnet.

Do not start the vehicle while the charger is connected.



Never disconnect a terminal when the engine is running. Close the windows and sunroof fully before disconnecting the battery.

It is imperative that cables of professional quality and suitable cross-section are used; for further information, contact a PEUGEOT dealer.



After every re-connection of the battery, switch on the ignition and wait for 1 minute before starting, to allow the electronic systems to be initialised.

However, if slight difficulties are experienced after this, please contact a PEUGEOT dealer. If electrical work is carried out, disconnect the battery.

When charging or replacement of the battery is necessary, do not close the boot as, since it is only opened electrically, it would then be necessary to use the emergency control (see corresponding section).

Do not connect a slave battery to the (+) and (-) terminals located under the bonnet if there is no battery in the boot (risk of short circuit).



Batteries contain harmful substances such as sulphuric acid and lead. They must be disposed of in accordance with regulations and must not, in any circumstances, be discarded with household waste.

Take used batteries to an approved collection point.

TOWING A TRAILER, CARAVAN, BOAT, ETC...

We recommend the use of original PEUGEOT towbars and their harnesses which have been tested and approved from the design stage of your vehicle and that you entrust the fitting of the towbar to a PEUGEOT dealer.

If the towbar is not fitted by a PEUGEOT dealer, it is imperative that it is fitted using the electrical pre-equipment installed at the rear of the vehicle, in accordance with the manufacturer's instructions.

Driving advice

Distribution of loads: distribute the load in the trailer so that the heaviest loads are as close as possible to the axle and the nose weight is close to the maximum authorised without, however, exceeding it.

Cooling: towing a trailer on a slope increases the coolant temperature.

As the fan is electrically controlled, its cooling capacity is not dependent on the engine speed.

In the case of vehicles fitted with an HDI engine, it is advisable, following intensive use (towing on a motorway, prolonged driving...), to leave the engine running at idle for approximately 20 seconds before switching off the ignition. This limits any increase in the temperature of the engine after it has been switched off.

In all cases, pay attention to the coolant temperature.



Note: in certain cases of particularly arduous use (towing the maximum load in high temperatures on a steep slope), the engine automatically limits its power and selects the appropriate automatic gearbox gear in manual mode. In this case, cutting off the air conditioning allows the engine power to be recovered, and therefore the towing capacity to be increased.



If the coolant temperature warning light comes on, stop the vehicle and switch off the engine as soon as possible.

Tyres: check the tyre pressures of the towing vehicle (label on the central door pillar on the driver's side) and of the trailer towed, observing the recommended pressure.

Brakes: towing increases the braking distance. Drive at a moderate speed, change down early and brake gradually.

Side wind: sensitivity to side wind is increased. Drive smoothly and at a moderate speed.

Lighting

Manual adjustment

Adjust your headlamps so as not to dazzle other road users. Check the electrical signalling of the trailer.

Automatic adjustment

For vehicles with Xenon bulbs, and if the change in load makes it necessary, this system automatically corrects the height of the beam after approximately 2 minutes. The driver is then assured of having optimum lighting and not causing a nuisance to other road users.

ACCESSORIES FOR YOUR 607

A wide range of accessories recommended by PEUGEOT and original parts are offered by the Network.

They all benefit from PEUGEOT's recommendation.

These accessories and parts, having been tested and approved for reliability and safety, are all adapted to your PEUGEOT vehicle.

The product range offered by PEUGEOT Accessories is structured around 5 categories: PROTECTION - TOURING - IN-CAR TECHNOLOGY - STYLING - UNIVERSAL.



"Protection":

parking assistance, anti-theft alarm, stolen vehicles recovery system*, engraved windows, locking wheel nuts, first aid kit, warning triangle, high visibility safety jacket, snow chains.



Depending on the country in which the vehicle is sold, it is compulsory to have a safety jacket, warning triangle and spare bulbs available in the vehicle.

Wheels which are fitted with 235/45 R 18 tyres cannot be fitted with snow chains. For further information, contact a PEUGEOT dealer.

* According to country.



"Touring":

covers compatible with air bag components, mats, boot tray, luggage retaining net, sill protectors.

For leisure pursuits: roof bars, transportation accessories (bicycle carrier, ski carrier), roof box, child seats and booster cushions, rear screen blind, audio/telephone console, cool box.

Trailer towbar which must be fitted by the PEUGEOT Network.

Note

To prevent the mat from becoming caught under the pedals:

- ensure that the mat is positioned and secured correctly,
- never fit one mat on top of another.



"In-Car Technology":

hands-free kits, satellite navigation systems, CD changer, DVD player, video screen.

You are advised to contact a PEUGEOT dealer before installing accessory radiocommunication transmitters with external aerial on your vehicle.

Your PEUGEOT dealer will inform you of the characteristics (frequency band, maximum output power, aerial position, specific installation conditions) of the transmitters which can be fitted, in accordance with the Motor Vehicle Electromagnetic Compatibility Directive (2004/104/EC).



"Styling":

alloy wheels, wheel trims, spoiler, leather gear lever knob, styling strips, door spoilers, sport exhaust.



"Universal":

windscreen wash fluid, interior and exterior cleaning and maintenance products.



The fitting of electrical equipment or accessories which are not recommended by PEUGEOT may result in a failure of your vehicle's

electronic system.

Please note this specific warning. You are advised to contact a representative of the Marque to be shown the range of recommended equipment and accessories.

Compatible portable equipment

For the Audio RD4, the fitting of an auxiliary socket is offered specifically by the Network.

The audio cable for connection to the auxiliary socket is also offered by the Network.

Following connection of the cable and selection of the AUX mode, by means of the source button, your portable equipment is ready for use.

Set the portable equipment to half volume to avoid overloading the audio equipment sound. Then use the audio equipment volume button.

ENGINES AND GEARBOXES

MODELS: Model codes 9U...	PETROL	DIESEL			
	XFV6 - XFVJ XFVJ/D - XFVU/D	RHLH	RHRH	4HPH	4HTH
ENGINES	3 litre 24V V6 Injection	2 litre 16V HDI		2.2 litre 16V HDI	
Capacity (cm ³)	2 946	1 997		2 179	
Bore x stroke (mm)	87 x 82.6	85 x 88		85 x 96	
Number of valves	24	16		16	
Max power: EU standard (KW)	155	93	100	120	125
Max power at engine speed (rpm)	6 000	4 000		4 000	
Max torque: EU standard (Nm)	290	320		370	
Max torque at engine speed (rpm)	3 750	2 000		1 500	
Fuel	Unleaded	Diesel		Diesel	
Catalytic converter	Yes	Yes		Yes	
Particulate emission filter (PEF)	No	Yes		Yes	
Electronic injection	Yes	Yes		Yes	
GEARBOX	Automatic (6-speed)	Manual (6-speed)		Manual (6-speed)	
CAPACITIES (in litres)					
Engines (with cartridge replacement)	4.75 (1)/5.25 (2)	5.25 (1)		5.25 (1)	

CONSUMPTION

As per EC Directive 80/1268 (as amended) in MPG (litres/100 km)						
Engine	Gearbox	Model codes 9U...	Urban driving	Extra-urban driving	Mixed driving	Emission by mass of CO ₂ (g/km)
3 litre 24V V6 injection	Automatic	XFV6 - XFVJ XFVJ/D XFVU/D	19.0 (14.9)	37.6 (7.5)	27.6 (10.2)	242
2 litre 16V HDI	Manual	RHLH RHRH	34.9 (8.1)	56.5 (5.0)	46.3 (6.1)	162
2.2 litre 16V HDI	Manual	4HPH 4HTH	- 33.2 (8.5)	- 54.3 (5.2)	- 44.1 (6.4)	- 170

Fuel consumption values correct at time of printing. These consumption values were established in accordance with EC Directive 80/1268 (as amended). They may vary depending on the style of driving, traffic conditions, weather conditions, the load in the vehicle, the maintenance of the vehicle and the use of the accessories.

WEIGHTS AND TOWING LOADS (IN KG)

Engines	PETROL		DIESEL		
	3 litre 24V V6 injection		2 litre 16V HDI		2.2 litre 16V HDI
Gearboxes	Automatic		Manual		Manual
Model codes: 9U...	XFV6 - XJVJ XJVJ/D - XJVU/D		RHLH	RHRH	4HPH 4HTH
• Kerb weight	1 644		1 590		1 650
• Payload	500		493		497
• Gross vehicle weight (GVW)	2 144		2 083		2 147
• Gross train weight (GTW)*					
on 12 % gradient	3 644		3 583		3 747
on 8 % gradient	3 944		3 883		4 047
• Braked trailer (within GTW limit)					
on 12 % gradient	1 500		1 500		1 600
on 10 % gradient	1 500		1 500		1 600
on 8 % gradient	1 800		1 800		1 900
• Braked trailer**	1 800		1 760		1 850
• Unbraked trailer	750		750		750
• Recommended nose weight	72		72		74

* The speed of a towing vehicle must not exceed 60 mph (100 km/h) (comply with the legislation in force in your country).

** The weight of the braked trailer may be increased, within the GTW limit, by the same amount by which the GVW of the towing vehicle is reduced; warning, towing with a lightly loaded towing vehicle may have an adverse effect on its road holding.

The GTW values and the towing loads indicated are valid for a maximum altitude of 1 000 metres; the towing load mentioned must be reduced by 10 % for every 1 000 additional metres.

High exterior temperatures may result in lowering of the performance of the vehicle in order to protect the engine; when the exterior temperature is above 37 °C, limit the towed load.

DIMENSIONS (in mm)

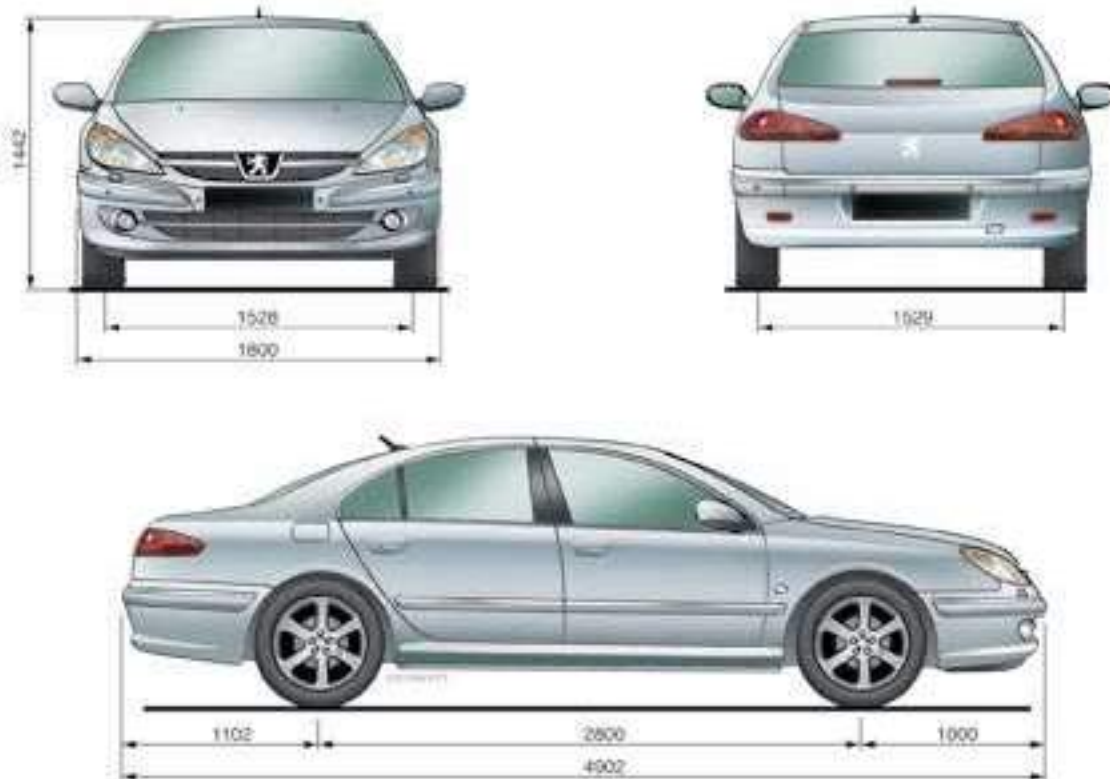
**WARNING**

Drive carefully over kerbs, speed humps, access ramps, fords and dirt tracks.

THE IDENTIFICATION FEATURES OF YOUR 607



A. Manufacturer's plate.

B. Serial number on the bodywork.

C. Serial number on the fascia.

D. Tyres.

Label **D** on the central door pillar on the driver's side indicates:

- the dimensions of the rims and tyres,
- the makes of tyre recommended by the manufacturer,

- the tyre pressures (**checking of the tyre pressure must be carried out when the tyres are cold, at least once a month**),
- the paint colour reference.

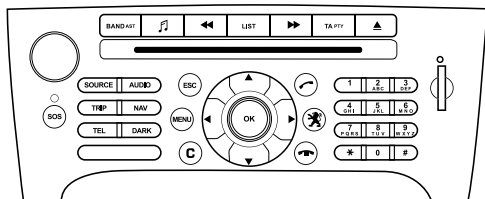

RT4

MULTIMEDIA AUDIO EQUIPMENT/TELEPHONE
JUKEBOX FUNCTION (10 GB)/GPS (EUROPE)

CONTENTS



The SERVICE BOX internet site provides additional animated information on the RT4. It can be consulted at the following address:
<http://public.servicebox.peugeot.com>
Simple registration permits access and free consultation of the handbook.



The RT4 GPS audio/telephone is coded in such a way that it will only operate in your vehicle. If it is to be installed in another vehicle, contact your PEUGEOT dealer for configuration of the system.



For safety reasons, it is imperative that the driver carries out operations which require prolonged attention while the vehicle is stationary.
When the engine is switched off and to prevent discharging of the battery, the RT4 audio/telephone may switch off after a few minutes.

- **01 First steps** pg. 124
- **02 General menu** pg. 125
- **03 GPS** pg. 126
- **04 Traffic information** pg. 135
- **05 Audio/Video** pg. 137
- **06 Telephone** pg. 144
- **07 Control short-cuts** pg. 147
- **08 Configuration** pg. 149
- **09 Display flow charts** pg. 150
- **Frequently asked questions** pg. 164
- **JBL equipment** pg. 167

FIRST STEPS 01



1. On/Off and Volume adjustment.
2. Selection of the wavebands FM1, FM2, FMast, AM.
3. Audio option adjustments: front/rear, left/right balance, loudness, sound ambiances.
4. Automatic search for a lower/higher frequency. Selection of the previous/next CD, MP3 or Jukebox track.
5. Displaying of the list of local radio stations, of the tracks on the CD or of the MP3/Jukebox folders. Long press: updating of the local radio stations.
6. TA (Traffic Announcement) function on/off. Long press: access to the PTY (radio Programme TYPes) mode.
7. Ejection of the CD.
8. SIM card slot.
9. Keypad for entering descriptions by successive presses.
10. Access to the "PEUGEOT" services menu.
11. Selection of a lower/higher frequency.
12. Selection and confirmation.
13. Selection of the previous/next CD. Selection of the previous/next MP3/Jukebox folder.
14. Cancellation of the current operation. Long press: return to the current application.
15. Displaying of the general menu.
16. Deletion of the last character entered or of the entire line.
17. Modification of the screen display. Long press: reinitialisation of the RT4 GPS audio/telephone.
18. Selection of the source: radio, Jukebox, CD, CD changer and auxiliary (AUX, if activated on the Configuration menu). Long press: CD copy to hard disc.
19. Selection of the display on the screen from the modes: TRIP, TEL, NAV and AUDIO.
20. Long press on the SOS button: emergency call.

02 GENERAL MENU

TRAFFIC INFORMATION: TMC
information, messages.

MAP: orientation, details,
display.

NAVIGATION GUIDANCE:
GPS, stages, options.

VEHICLE DIAGNOSTICS:
warnings log, status of the
functions.

VIDEO: activation, parameters.

AUDIO FUNCTIONS: radio,
CD, Jukebox, options.

TELEMATIC: telephone,
directory, SMS.

CONFIGURATION: vehicle,
display, time, languages,
voice, auxiliary socket (AUX)
parameters.



For maintenance of the display, the use of a soft, non-abrasive cloth (spectacles cloth) is recommended without any additional product.

03 GPS



SELECTING A DESTINATION

Tip: for a detailed global view of the menus available, refer to the "Display flow charts" part of this RT4 section.

1



Press the MENU button.



2



Turn the dial and select the NAVIGATION GUIDANCE function.



3



Press the dial to confirm the selection.



4



Turn the dial and select the DESTINATION CHOICE function.

DESTINATION CHOICE



5



Press the dial to confirm the selection.



6



Turn the dial and select the ENTER AN ADDRESS function.

ENTER AN ADDRESS

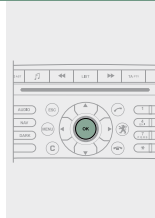

7



Press the dial to confirm the selection.



8



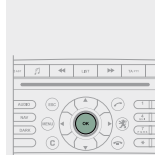

When the country has been selected, turn the dial and select the TOWN function.

TOWN







9  Press the dial to confirm the selection.



12  Press the dial to confirm the selection.



10  Turn the dial and select the letters of the town one by one confirming each time by pressing the dial.

PARIS





13 Repeat steps 8 to 12 for the ROAD and N° functions.

14  Select OK on the ENTER AN ADDRESS page.

OK



 To speed up the process, the POST CODE can be entered instead of the name of the town. Use the alphanumeric keypad to enter the letters and digits and "C" to correct.





15  Press the dial to confirm the selection.



11  Turn the dial and select OK.

OK



 Select the STORE function to record the address entered in a directory record and press the dial to confirm the selection. The points of interest (POI) indicate all of the service locations in the vicinity (hotels, various businesses, airports...).

STORE **POI**

03 GPS



GUIDANCE OPTIONS

The route chosen by the RT4 GPS audio/telephone depends directly on the guidance options. Changing these options may completely change the route.

1



Press the MENU button.



2



Turn the dial and select the NAVIGATION GUIDANCE function.



3



Press the dial to confirm the selection.



4



Turn the dial and select the GUIDANCE OPTIONS function.

GUIDANCE OPTIONS



5



Press the dial to confirm the selection.



6



Turn the dial and select the DEFINE CALCULATION CRITERIA function.

DEFINE CALCULATION CRITERIA



7



Press the dial to confirm the selection.



8



Turn the dial and select, for example, the DISTANCE/TIME function.

DISTANCE/TIME



GUIDANCE SPEECH SYNTHESIS



9



Press the dial to confirm the selection.



10



Turn the dial and select the TRAFFIC INFO function if it is not ticked.



Tick this box for optimum operation of the traffic information, diversions will be suggested.

11



Press the dial to confirm the selection.



12



Select OK and press the dial to confirm.



1



Press the MENU button.



2



Turn the dial and select the NAVIGATION GUIDANCE function.



3



Press the dial to confirm the selection.



4



Turn the dial and select the GUIDANCE OPTIONS function.



5



Press the dial to confirm the selection.



03 GPS



GUIDANCE SPEECH SYNTHESIS



ACTIONS ON THE MAP



During the announcements, the volume of each speech synthesis function (guidance, traffic information...) can be adjusted directly.



6



Select the ADJUST SPEECH SYNTHESIS function and press the dial to confirm.

ADJUST SPEECH SYNTHESIS



7



Select the DEACTIVATE function and press the dial to confirm.

DEACTIVATE



8



Select OK and press the dial to confirm.

OK



1



Press the MENU button.



2



Turn the dial and select the MAP function.



3



Press the dial to confirm the selection.



4



Turn the dial and select the MAP DETAILS function. Permits selection of the services which can be seen on the map (hotels, restaurants...).

MAP DETAILS



03 GPS



3D VIEW

For improved visibility, beyond the scale of 10 km, the map automatically switches to North Orientation.

1



Press the MENU button.



2



Turn the dial and select the MAP function.



3



Press the dial to confirm the selection.



4



Turn the dial and select the MAP ORIENTATION function.

MAP ORIENTATION



5



Press the dial to confirm the selection.



6



Turn the dial and select the 3D VIEW tab.

3D VIEW

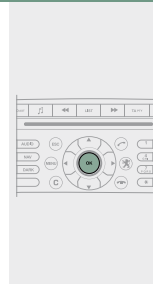

7



Select OK and press the dial to confirm.

OK

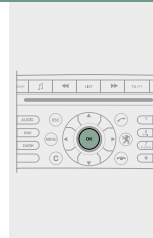

03 GPS



DISPLAYING THE MAP IN A WINDOW OR IN FULL SCREEN MODE

1



Press the MENU button.



2



Turn the dial and select the MAP function.



3



Press the dial to confirm the selection.



4



Turn the dial and select the DISPLAY MAP function.

DISPLAY MAP



5



Press the dial to confirm the selection.



6



Turn the dial and select the MAP IN WINDOW or FULL SCREEN MAP tab.

MAP IN WINDOW
FULL SCREEN MAP



7



Select OK and press the dial to confirm.

OK



03 GPS



List of POI

 Flying club

 Airport

 Lay-by

 Bowling alley

 Casino

 Business park

 Sports centre

 Town centre

 Cinema

 Sports complexes

 Culture/Museum

 Vineyard

 Garage

 Station

 Dock station

 Bus station

 Hospitals

 Hotels

 Vehicle hire

 Town halls

 Historical monuments

 Tourist information

 Theme park

 Park/Garden

 Park and ride

 Car park

 Covered parking

 Skating rink

 Ports

 Restaurant

 Shopping

 Show/Exhibition

 Winter sports centre

 Service station

 Supermarkets

 Golf course

 Tourism

 University

 Night life

03 GPS



ADDING A STAGE

1



During guidance, press the MENU button.



2



Turn the dial and select the NAVIGATION GUIDANCE function.



3



Press the dial to confirm the selection.



4



Turn the dial and select the JOURNEY LEGS AND ROUTE function.

JOURNEY LEGS AND ROUTE



5



Press the dial to confirm the selection.



6



Select the ADD A STAGE function (9 stages maximum) and press the dial to confirm.

ADD A STAGE



7



Enter for example a new address.

ENTER AN ADDRESS



8



When the new address has been entered, select OK and press the dial to confirm.



9



Select OK and press the dial to confirm the order of the stages.



The stage must be completed or deleted before the guidance can continue to the next destination. Otherwise, the RT4 GPS audio/telephone will always guide you back to the previous stage.

04 TRAFFIC INFORMATION



ACTIVATING THE FILTER ON THE ROUTE

We recommend a filter on the route and a filter around the vehicle of:

- 5 km or 10 km for a region with heavy traffic,
- 20 km for a region with a normal level of traffic,
- 100 km for long journeys (motorway).

1



Press the MENU button.



2



Turn the dial and select the TRAFFIC INFORMATION function.



3



Press the dial to confirm the selection.



4



Turn the dial and select the FILTER TRAFFIC INFORMATION function.

FILTER TRAFFIC INFORMATION



5



Press the dial to confirm the selection.



6



Select the GEOGRAPHIC FILTER function and press the dial to confirm.

GEOGRAPHIC FILTER



7



Turn the dial and select the ON THE ROUTE tab.



8



Select OK and press the dial to confirm.

OK



04 TRAFFIC INFORMATION



CONFIGURING THE TMC MESSAGE ANNOUNCEMENTS

We recommend that you do not tick the NEW MESSAGE DISPLAY tab for regions with heavy traffic.

1



Press the MENU button.



2



Turn the dial and select the TRAFFIC INFORMATION function.



3



Press the dial to confirm the selection.



4



Turn the dial and select the CONFIGURE MESSAGE ANNOUNCEMENT function.

CONFIGURE MESSAGE ANNOUNCEMENT

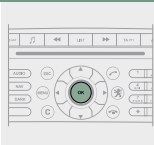

5



Press the dial to confirm the selection.



6



Select the READ MESSAGES tab.
The Traffic Information Messages will be read by the voice synthesiser.

READ MESSAGES



Select the NEW MESSAGE DISPLAY tab.
The traffic information messages are extended to the filters selected (geographic...) and can also be displayed when guidance is not active.

NEW MESSAGE DISPLAY



7



Select OK and press the dial to confirm.

OK



05 AUDIO/VIDEO



The external environment (hills, buildings, tunnels, basement car parks, ...) may block reception, including in RDS mode. This is a normal effect of the way in which radio waves are transmitted and does not indicate any failure of the audio equipment.

RADIO SELECTING A STATION

1



Press the SOURCE button several times in succession and select the RADIO.



2



Press the BAND AST button to select a waveband: FM1, FM2, FMast, AM.



3



Briefly press one of the buttons to carry out an automatic search of the radio stations.



4

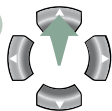

Press one of the buttons to carry out a manual search of the radio stations.







Press the LIST button to display the list of stations received locally (60 maximum). To update this list, press for more than two seconds.



RDS

1



Press the MENU button.



2



Select AUDIO FUNCTIONS then press OK.



3



Select the RADIO PREFERENCES function then press OK.

RADIO PREFERENCES



4



Select ACTIVATE FREQUENCY FOLLOWING (RDS) then press OK. RDS appears on the display.

ACTIVATE FREQUENCY FOLLOWING (RDS)





The RDS, if displayed, enables you to continue listening to the same station by means of frequency following. However, in certain conditions, this RDS station is not followed throughout the country as radio stations do not cover 100 % of the territory. This explains the loss of reception of the station during a journey.

05 AUDIO/VIDEO



MP3 CD INFORMATION AND ADVICE



The MP3 format, an abbreviation of MPEG 1.2 & 2.5 Audio Layer 3, is an audio compression standard which permits the recording of several tens of music files on a single disc.



In order to be able to play a recorded CDR or CDRW, when recording it is preferable to select standards ISO 9660 level 1.2 or Joliet. If the disc is recorded in another format, it may not be played correctly.

It is recommended that the same recording standard is always used for an individual disc, with as low a speed as possible (4x maximum) for optimum sound quality. In the particular case of a multi-session CD, the Joliet standard is recommended.



The audio equipment will only play audio files with the extension ".mp3" with a sampling rate of 22.05 KHz or 44.1 KHz. No other type of file (.wma, .mp4, m3u...) can be played.



It is advisable to restrict file names to 20 characters without using special characters (e.g.: " " ? ; ù) to avoid any playing or displaying problems.

CD PLAYING A CD OR AN MP3 COMPILATION



Insert circular compact discs only. Some anti-pirating systems, on original discs or CDs copied using a personal recorder, may generate malfunctions regardless of the quality of the original player. Insert an audio CD or an MP3 compilation in the player, play begins automatically.



1



If the player already contains a disc, press the SOURCE button several times in succession and select CD to listen to it.



2



Press one of the buttons to select a track on the CD.

Press the LIST button to display the list of tracks on the CD or of the directories of the MP3 compilation.



The playing and displaying of an MP3 compilation may depend on the recording programme and/or the parameter settings used. We recommend use of the ISO 9660 recording standard.

JUKEBOX FUNCTION COPYING A CD ONTO THE HARD DISC

1



Insert a CD or an MP3 compilation and press the MENU button.



2



Select AUDIO FUNCTIONS and press the dial to confirm.



3



Select COPY CD TO JUKEBOX and press the dial to confirm.

COPY CD TO JUKEBOX



4



Select COMPLETE CD to copy the entire CD and press the dial to confirm.

COMPLETE CD



5



Select CREATE ALBUM and press the dial to confirm.

CREATE ALBUM



The AUTO CREATION tab automatically copies the CD by default into an album of the type "album n°...".

6



Select the letters one by one and select OK to confirm.

OK



The audio or MP3 CD is copied onto the hard disc. Copying may take approximately 20 minutes depending on the duration of the CD. During this copying phase, it is not possible to listen to the albums previously recorded on the hard disc or the CDs.



If it is not an MP3 CD, the Jukebox automatically compresses the CD in MP3 format. The compression may take approximately 20 minutes depending on the duration of the CD. During this compression phase, it is possible to listen to the CD or to albums previously recorded on the hard disc.



A long press on the SOURCE button starts the copying of the CD.



When copying an MP3 CD, the Jukebox only retains the last album level. It is not possible to copy files from the Jukebox to a CD. The STOP THE CD COPY action does not delete the files which have already been transferred onto the jukebox hard disc.

JUKEBOX FUNCTION RENAMING AN ALBUM

1



Press the MENU button.

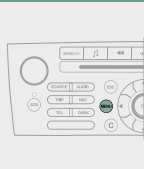

2



Select AUDIO FUNCTIONS and press the dial to confirm.



3



Select the JUKEBOX function and press the dial to confirm.

JUKEBOX



4



Select the JUKEBOX MANAGEMENT function and press the dial to confirm.

JUKEBOX MANAGEMENT



5



Select the album to be renamed and press the dial to confirm.



6



Select the RENAME tab and press the dial to confirm.

RENAME



7



Turn the dial and select the letters of the album title one by one confirming each time by pressing the dial.



Use the alphanumeric keypad to enter the letters of the album title one by one.

JUKEBOX FUNCTION LISTENING TO THE JUKEBOX

8



Select OK and press the dial to confirm.

OK



1



Press the SOURCE button several times in succession and select the JUKEBOX function.

JUKEBOX



To rename the tracks of an album, follow the same procedure, selecting the tracks to be renamed. Use the ESC button to exit from the list of tracks.

2

Press the LIST button.



Select the DELETE function to delete an album or a track from the Jukebox.

DELETE



3



Turn the dial to select the files.



Press the ESC button to return to the first file level.

USING THE AUXILIARY INPUT (AUX) JACK/RCA AUDIO CABLE NOT SUPPLIED



Press the MENU button then select the CONFIGURATION function, then SOUNDS, then ACTIVATE AUXILIARY SOURCE to activate the auxiliary input of the RT4 GPS audio/telephone.

1

Connect the portable equipment (MP3 player...) to the audio sockets (white and red, RCA type) located in the glove box using a JACK/RCA audio cable.



2



Press the SOURCE button several times in succession and select AUX.

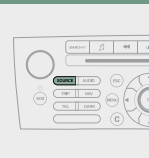

The displaying and management of the commands takes place via the portable equipment.



It is not possible to copy the files onto the hard disc from the auxiliary input.

CD CHANGER PLAYING A CD (NOT MP3 COMPATIBLE)

1



Insert one or more CDs in the changer. Press the SOURCE button several times in succession and select CD CHANGER.



2



Press one of the buttons on the alphanumeric keypad to select the corresponding CD.



3



Press one of the buttons to select a track on the CD.



It is not possible to copy the files onto the hard disc from the CD changer.

VIDEO MENU



You can connect video equipment (camcorder, digital camera, DVD player...) to the three audio/video sockets, located in the glove box.

1



After connecting the video equipment, press the MENU button.



2



Turn the dial and select the VIDEO function.



3



Press the dial to confirm the selection.



4



Turn the dial and select the **ACTIVATE VIDEO MODE** function to activate/deactivate the video.

ACTIVATE VIDEO MODE



5



Press the dial to confirm the selection.



6



Turn the dial and select the VIDEO PARAMETERS function to set the display format, the brightness, the contrast and the colours.

VIDEO PARAMETERS



7



Press the dial to confirm the selection.



Pressing the "DARK" button disconnects the displaying of the video.



Pressing the "SOURCE" button several times in succession permits the selection of an audio source other than that of the video.



Videos can only be displayed when stationary.

06 TELEPHONE



INSTALLING YOUR SIM CARD (NOT SUPPLIED)

1

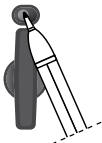

Access the slot by pressing the button using the tip of a pen.



2

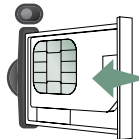
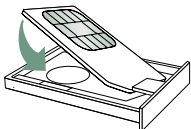

Install the SIM card in the holder and then insert it in the slot.



3

To remove the SIM card, repeat step 1.



!

Your SIM card must be installed and removed with the RT4 GPS audio/telephone switched off and the ignition off.

ENTERING THE PIN CODE

1



Enter the PIN code on the keypad.

PIN CODE



2



Confirm the PIN code by pressing button #.



When entering your PIN code, tick the STORE PIN tab to gain access to the telephone without having to enter this code when it is used subsequently.

06 TELEPHONE



CALLING A CONTACT

1



Press the PICK UP button to display the superimposed telephone menu.



2



Turn the dial and select the DIAL function.



DIAL

3



Press the dial to confirm the selection.



4



Dial the telephone number of your contact using the alphanumeric keypad.



5



Press the PICK UP button to call the number dialed.



6



Press the HANG UP button to end the call.



ACCEPTING OR REFUSING A CALL



Press the PICK UP button to accept a call.



Press the HANG UP button to refuse a call.



Press the end of the steering wheel stalk for more than 2 seconds to access the telephone menu: calls log, directory, voice mailbox.

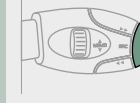

EMERGENCY CALL



In an emergency, press the SOS button until an audible signal is heard and a CONFIRMATION/ CANCELLATION screen is displayed (if valid SIM card inserted).

A call is made to the emergency services (112). In certain countries*, this emergency call is made directly by the PEUGEOT Emergency team which locates the vehicle and alerts the appropriate emergency services as quickly as possible.



* On condition that the PEUGEOT Emergency contract has been signed. This is free and of unlimited duration. Contact a PEUGEOT dealer.



When the PEUGEOT Emergency contract has been signed, it is recommended that an initial call is made to the PEUGEOT Emergency team.

CONSULTING THE SERVICES



Press the LION button to gain access to the PEUGEOT services*.



Select CUSTOMER CONTACT CENTRE to request any information about the PEUGEOT marque.



CUSTOMER CONTACT CENTRE



Select PEUGEOT ASSISTANCE to make a breakdown assistance call.



PEUGEOT ASSISTANCE

* These services and options are subject to conditions and availability.

07 CONTROL SHORT-CUTS

STEERING WHEEL CONTROLS

RADIO: selection of the previous stored station.
MP3/JUKEBOX: selection of the previous directory.
CD CHANGER: selection of the previous CD.
Selection of the previous item on a menu.

RADIO: selection of the next stored station.
MP3/JUKEBOX: selection of the next directory.
CD CHANGER: selection of the next CD.
Selection of the next item on a menu.

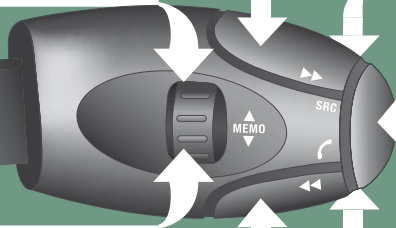

RADIO: automatic search for a higher frequency.
CD/MP3/JUKEBOX/CD CHANGER: selection of the next track.
CD/CD CHANGER: continuous press: fast forwards play.

Volume increase.

- Change of sound source.
- Confirmation of a selection.
- Pick up/Hang up the telephone.
- Press for more than 2 seconds: access to the telephone menu.

Volume decrease.

RADIO: automatic search for a lower frequency.
CD/MP3/JUKEBOX/CD CHANGER: selection of the previous track.
CD/CD CHANGER: continuous press: fast backwards play.

Mute: by pressing the volume increase and decrease buttons simultaneously.
The sound is restored by pressing one of the two volume buttons.

VOICE COMMANDS DISPLAYING THE LIST AND USING THEM



1



To display the list of available voice commands, press the end of the lights stalk to start the voice recognition, then say HELP or WHAT CAN I SAY.



For the same operation, press and hold the MENU button and select the function VOICE COMMANDS LIST.



VOICE COMMANDS LIST

2



Press the end of the lights stalk to start the voice recognition.
Say the words one by one and wait for the audible confirmation signal between each word.
The list which follows is exhaustive.

LEVEL 1	LEVEL 2	LEVEL 3
display	audio guidance navigation trip computer telephone description	
call changer	disc number previous/next disc random play list track number previous/next track repeat scan description	1 ... 20
guide to traffic info	display read	
CD player/jukebox	random play list track number previous/next track directory (MP3 CD)	1 ... 20 previous/next repeat
navigation	scan stop/resume directory show	destination description vehicle
radio	zoom out/in autostore list memory previous/next	1 ... 6
SMS/message	display read	
telephone	voice mailbox last number voice message service directory	description

08 CONFIGURATION



ADJUSTING THE DATE AND TIME

1



Press the MENU button.



2



Turn the dial and select the CONFIGURATION function.



3



Press the dial to confirm the selection.



4



Turn the dial and select the DISPLAY CONFIGURATION function.

DISPLAY CONFIGURATION



5



Press the dial to confirm the selection.



6



Turn the dial and select the ADJUST THE DATE AND TIME function.

ADJUST THE DATE AND TIME



7



Press the dial to confirm the selection.



8



Adjust the parameters one by one confirming by pressing the dial. Next select the OK tab on the display then confirm.

OK



09 DISPLAY FLOW CHARTS



1 NAVIGATION - GUIDANCE

2 SELECT DESTINATION

3 enter an address

4 country:

4 town:

4 road:

4 N°/_ :

4 curr. loc

4 Archive

4 POI

5 near

5 on the route

5 around current place

5 search by name

3 GPS coordinates

3 directory



1 MAIN FUNCTION

2 CHOICE A

3 choice A1

3 choice A2

2 CHOICE B...

3 previous destinations

2 JOURNEY LEGS AND ROUTE

3 add a stage

4 enter an address

4 directory

4 previous destinations

3 order/delete journey legs

3 divert route

3 chosen destination

2 GUIDANCE OPTIONS

3 define calculation criteria

4 fastest

4 shortest

4 distance/time

4 with tolls

4 with ferry

4 traffic info

3 set speech synthesis

3 activate/deactivate road names

3 map database description

3 delete last destinations

2 STOP/RESUME GUIDANCE



1 MAP

2 MAP ORIENTATION

3 vehicle direction

3 north direction

3 3D view

2 MAP DETAILS

3 administration and safety

4 town halls, town centre

4 universities, colleges

4 hospitals

3 hotels, restaurants and shops

4 hotels

4 restaurants

4 vineyards

4 business centres

4 supermarkets, shopping

3 **culture, tourism and shows**

4 tourism

4 culture and museums

4 casinos and nightlife

4 cinemas and theatres

4 shows and exhibitions

3 **sports and open air centres**

4 sports centres

4 golf courses

4 skating rinks, bowling alleys

4 winter sports resorts

4 parks, gardens

4 theme parks

3 **transport and automobile**

4 airports, ports

4 stations, bus stations

4 vehicle rental

4 lay-bys, car parks

4 service stations, garages

2 **DISPLAY MAP**

3 full screen map

3 map in window

2 **MOVE THE MAP**



1 **TRAFFIC INFORMATION**

2 **READ MESSAGES**

2 **FILTER TRAFFIC INFORMATION**

3 **geographic filter**

4 around the vehicle

4 around location

4 on the route

3 **road information**

4 traffic information

4 road closure

4 size limit

4 road condition

4 weather and visibility

3 **urban/city information**

4 parking

4 public transport

4 demonstrations

2 **CONFIGURE MESSAGE ANNOUNCEMENT**

3 read messages

3 new message display

2 **SELECT TMC STATION**

3 automatic TMC

3 manual TMC

3 list of TMC stations



1 **AUDIO FUNCTIONS**

2 **RADIO FAVOURITES**

3 enter a frequency

3 activate/deactivate RDS mode

3 activate/deactivate regional mode

3 display/hide radio text

2 **CD, JUKEBOX FAVOURITES**

3 activate/deactivate Introscan (SCN)

3 activate/deactivate Random mode (RDM)

3 activate/deactivate Repeat (RPT)

3 activate/deactivate display of CD info

2 **STOP THE COPY**

2 **COPY CD TO JUKEBOX**

3 copy complete cd

3 multiple selection

3 current album

3 current track

2 JUKEBOX

3 jukebox management

3 jukebox configuration

4 hi-fi (320 kbps)

4 high (192 kbps)

4 normal (128 kbps)

3 delete jukebox data

3 jukebox status

2 PLAYLIST MANAGEMENT



1 TELEMATICS

2 CALL

3 call list

3 dial

3 directory

3 mailbox

3 services

4 customer contact centre

4 PEUGEOT assistance

4 messages received

2 DIRECTORY

3 managing directory files

4 consult or modify a file

4 add a file

4 delete a file

4 delete all files

3 configure directory

4 select a directory

4 name directory

4 select starting directory

3 file transfer

4 exchange by infrared

5 send all records

5 send one record

5 receive by infrared

4 exchange with SIM card

5 send all records to SIM

5 send one record to SIM

5 receive all SIM files

5 receive a SIM file

2 TEXT MESSAGES (SMS)

3 read received text messages

3 send a text message

3 write a text message

3 delete list of text messages

2 TELEPHONE FUNCTIONS

3 network

4 network search mode

5 automatic mode

5 manual mode

4 networks available

3 length of calls

4 reset

3 manage PIN code

4 activate/deactivate

4 save PIN code

4 modify PIN code

3 call options

4 configure calls

5 display my number

5 automatic reply after x ring(s)

4 ring options

5 for voice calls

5 for text messages (SMS)

6 text message ring

3 calls diversion to mailbox n°

3 delete calls log



1 CONFIGURATION

2 DISPLAY CONFIGURATION

3 choose colour

3 adjust luminosity

3 set date and time

3 select units

2 SOUND

3 voice commands setting

3 speech synthesis setting

4 guidance instructions volume

4 other message volume

4 select female/male voice

3 activate/deactivate auxiliary source

2 SELECT LANGUAGE

2 DEFINE VEHICLE PARAMETERS*



1 VIDEO

2 ACTIVATE VIDEO MODE

2 VIDEO PARAMETERS

3 display formats

3 adjust luminosity

3 set colours

3 set contrasts



1 VEHICLE DIAGNOSTICS

2 ALERT LOG

2 STATUS OF FUNCTIONS*

2 RESET TYRE PRESS. DETEC. SYS.*



Press the MENU button for more than 2 seconds to access the following flow chart.

1 VOICE COMMANDS LIST

1 AUDIO/TELEPHONE DIAGNOSTICS

2 GPS COVERAGE

2 UNIT BACKUP POWER

2 UNIT DESCRIPTION

1 NAVIGATION DEMONSTRATION

1 SERVICES CONFIGURATION



Press the Music button several times in succession to access the following settings.

MUSICAL AMBIENCE

BASS

TREBLE

FR-RR BALANCE

LOUDNESS CORRECTION

AUTO VOLUME CORRECTION

LH-RH BALANCE



Each audio source (Radio, CD, MP3, Jukebox, CD changer) has its own separate settings.

* The parameters vary according to vehicle (refer to the "Multifunction displays" section).

FREQUENTLY ASKED QUESTIONS

The table below groups together the answers to the most frequently asked questions concerning the RD4 audio equipment and the RT4 audio/telephone.

QUESTION	RESPONSE	SOLUTION
There is a difference in sound quality between the different audio sources (radio, CD, CD changer...).	For optimum sound quality, the audio settings (Volume, Bass, Treble, Ambience, Loudness) can be adapted to the different sound sources, which may result in audible differences when changing source (radio, CD, CD changer...).	Check that the audio settings (Volume, Bass, Treble, Ambience, Loudness) are adapted to the sources listened to. It is advisable to set the AUDIO functions (Bass, Treble, Front-Rear Balance, Left-Right Balance) to the middle position, select the musical ambience "None" and set the loudness correction to the "Active" position in CD mode or to the "Inactive" position in radio mode.
The CD is ejected automatically or is not played by the player.	<p>The CD is inserted upside down, is unplayable, does not contain any audio data or contains an audio format which the player cannot play.</p> <p>The CD is protected by an anti-pirating protection system which is not recognised by the audio equipment.</p>	<ul style="list-style-type: none"> - Check that the CD is inserted in the player the right way up. - Check the condition of the CD: the CD cannot be played if it is too damaged. - Check the content in the case of a recorded CD: consult the advice in the Audio section. - The audio equipment's CD player does not play DVDs. - Due to inadequate quality, certain recorded CDs will not be played by the audio system. - The CD changer does not play MP3 CDs.
The CD player sound is poor.	The CD used is scratched or of poor quality.	Insert good quality CDs and store them in suitable conditions.
	The audio equipment settings (bass, treble, ambiences) are unsuitable.	Set the treble or bass level to 0, without selecting an ambience.

QUESTION	RESPONSE	SOLUTION
The stored stations do not function (no sound, 87.5 Mhz is displayed...)	An incorrect waveband is selected.	Press the BAND AST button to return to the waveband (AM, FM1, FM2, FMAST) on which the stations are stored.
The traffic announcement (TA) is displayed. I do not receive any traffic information.	The radio station is not part of the regional traffic information network.	Tune to a radio station which broadcasts traffic information.
The quality of reception of the radio station listened to gradually deteriorates or the stored stations do not function (no sound, 87.5 Mhz is displayed...).	The vehicle is too far from the transmitter used by the station listened to or there is no transmitter in the geographical area through which the vehicle is travelling.	Activate the RDS function to enable the system to check whether there is a more powerful transmitter in the geographical area.
	The environment (hills, buildings, tunnels, basement car parks...) block reception, including in RDS mode.	This phenomenon is normal and does not indicate a failure of the audio equipment.
	The aerial is absent or has been damaged (for example when going through a car wash or into an underground car park).	Have the aerial checked by a PEUGEOT dealer.
Sound cut-outs of 1 to 2 seconds in radio mode.	During this brief sound cut-out, the RDS searches for any frequency permitting better reception of the station.	Deactivate the RDS function if the phenomenon is too frequent and always on the same route.
With the engine off, the audio equipment switches off after a few minutes of use.	When the engine is switched off, the audio equipment operating time depends on the battery charge. The switch-off is normal: the audio equipment switches to economy mode and switches off to prevent discharging of the vehicle's battery.	Start the vehicle's engine to increase the battery charge.
The message "the audio system is overheated" appears on the display.	In order to protect the installation if the surrounding temperature is too high, the audio equipment switches to an automatic thermal protection mode leading to a reduction of the volume or stopping of the playing of the CD.	Switch the audio system off for a few minutes to allow the system to cool.

The table below groups together the answers to the most frequently asked questions concerning the RT4 audio/telephone.

QUESTION	RESPONSE	SOLUTION
The TRAFFIC INFO box is ticked. However, certain traffic jams along the route are not indicated in real time.	On starting, it is several minutes before the system begins to receive the traffic information.	Wait until the traffic information is being received correctly (displaying of the traffic information symbols on the MAP).
	In certain countries, only major routes (motorways, ...) are listed for the traffic information.	This phenomenon is normal. The system is dependent on the traffic information available.
The time taken to calculate a route sometimes seems longer than usual.	The performance of the system may slow down temporarily if a CD is being copied onto the Jukebox at the same time as a route is being calculated.	Wait until the CD has been copied or stop the copying before starting the guidance function.
Does the emergency call function work without a SIM card?	No, European regulations impose the presence of a SIM card in order to make an emergency call.	Insert a valid SIM card in the slot on the RT4 GPS audio/telephone.
My SIM card is not recognised.	The RT4 accepts 3.3 V SIM cards, the old 5 V and 1.8 V SIM cards are not recognised.	Contact your telephone operator.
After changing a wheel, the system loses its location.	The RT4 GPS audio/telephone uses the wheel rotation information to improve the GPS locating function. If a wheel is changed or deflates suddenly, the system recalculates the location. For approximately ten minutes, this recalculation may affect the quality of the locating function.	Wait until the system has completed its recalculation.
The location on the map is incorrect or inaccurate. The altitude is not displayed.	On starting, the initialisation of the GPS may take up to 3 minutes to receive more than 3 satellites correctly.	Wait until the system has started up completely. Check that there is a GPS coverage of at least 3 satellites (long press on the MENU button, then select AUDIO/TELEPHONE DIAGNOSTICS, then GPS COVERAGE).
	Depending on the geographical environment (tunnel, ...) or the weather, the conditions of reception of the GPS signal may vary.	This phenomenon is normal. The system is dependent on the conditions of reception of the GPS signal.

RD4

AUDIO EQUIPMENT/HANDS-FREE KIT

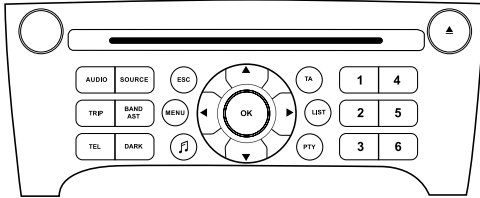

The SERVICE BOX internet site provides additional animated information on the RD4. It can be consulted at the following address:
<http://public.servicebox.peugeot.com>
Simple registration permits access and free consultation of the handbook.



The RD4 audio equipment is coded in such a way that it will only operate in your vehicle. If it is to be installed in another vehicle, contact your PEUGEOT dealer for configuration of the system.



For safety reasons, the driver must carry out operations which require prolonged attention while the vehicle is stationary.
When the engine is off, and in order to prevent discharging of the battery, the RD4 audio equipment may switch off after a few minutes.

CONTENTS

- **01 First steps** pg. 155
- **02 General menu** pg. 156
- **03 Audio** pg. 157
- **04 Hands-free kit** pg. 160
- **05 Control short-cuts** pg. 161
- **06 Configuration** pg. 162
- **07 Display flow charts** pg. 163
- **Frequently asked questions** pg. 164
- **JBL equipment** pg. 167

01 FIRST STEPS



1. On/Off and volume adjustment.
2. Selection of the display on the screen from the modes: AUDIO, trip computer (TRIP) and hands-free kit (TEL). The TEL button is not active if the hands-free kit option is not fitted.
3. Selection of the source: radio, CD and CD changer.
4. Displaying of the general menu.
5. Cancellation of the current operation/return to the previous screen.
6. Confirmation.
7. Automatic search for a lower/higher frequency. Selection of previous/next CD or MP3 track.
8. TA (Traffic Announcement) function on/off.
9. Displaying of the list of local stations, of the tracks on the CD or of the MP3 directories.
10. CD eject.
11. Buttons 1 to 6:
Selection of a stored radio station.
Selection of a CD in the CD changer.
Long press: storing of a station.
12. Access to the PTY (radio Programme TTypes) mode.
13. Selection of a lower/higher frequency. Selection of the previous/next CD. Selection of the previous/next MP3 directory.
14. Setting the audio options: front/rear balance, left/right balance, loudness, sound ambiances.
15. The DARK button changes the screen display for greater driving comfort at night.
1st press: lighting of the upper banner only.
2nd press: black screen display.
3rd press: return to the standard display.
16. Selection of the FM1, FM2, FMast and AM wavebands.

GENERAL MENU 02

> COLOUR DISPLAY C

AUDIO FUNCTIONS: radio, CD, options.

TELEPHONE: hands-free kit, matching, management of a communication.

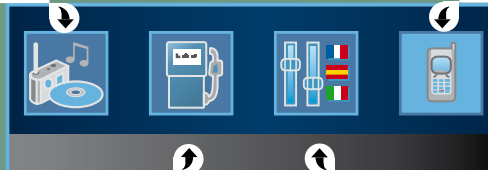

TRIP COMPUTER: distance entering, warnings, status of functions.

PERSONALISATION-CONFIGURATION: vehicle parameters, display, languages.



For a detailed global view of the menus available, refer to the "Display flow charts" section of this RD4 chapter.

03 AUDIO



The external environment (hills, buildings, tunnels, basement car parks) may block reception, including in RDS mode. This is a normal effect of the way in which radio waves are transmitted and does not indicate any failure of the audio equipment.

RADIO SELECTING A STATION

1



Press the SOURCE button several times in succession and select the radio.



2



Press the BAND AST button to select a waveband: FM1, FM2, FMast, AM.



3

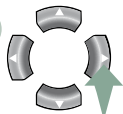

Briefly press one of the buttons to carry out an automatic search of the radio stations.

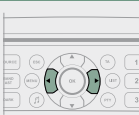

4

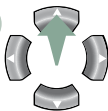

Press one of the buttons to carry out a manual search of the radio stations.



Press the LIST button to display the list of stations received locally (30 stations maximum). To update this list, press for more than two seconds.



RDS

1



Press the MENU button.



2

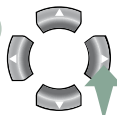

Select AUDIO FUNCTIONS then press OK.

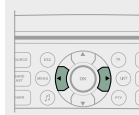

3

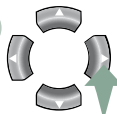

Select the FM WAVEBAND PREFERENCES function then press OK.

FM WAVEBAND PREFERENCES

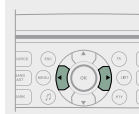

4

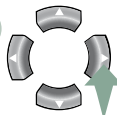

Select ACTIVATE FREQUENCY FOLLOWING (RDS) then press OK. RDS appears on the display.

ACTIVATE FREQUENCY FOLLOWING (RDS)

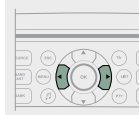

The RDS, if displayed, enables you to continue listening to the same station by means of frequency following. However, in certain conditions, this RDS station is not followed throughout the country as radio stations do not cover 100 % of the territory. This explains the loss of reception of the station during a journey.

CD CHANGER PLAYING A CD (NOT MP3 COMPATIBLE)

1



Insert the CDs in the changer one by one.

Press the SOURCE button several times in succession and select CD CHANGER.



2



Press one of the buttons on the numeric keypad to select the corresponding CD.



3

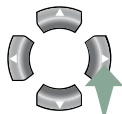

Press one of the buttons to select a track on the CD. Press and hold one of the buttons for fast forwards or backwards play.



CD PLAYING A CD



Insert circular compact discs only. Some anti-pirating systems, on original discs or CDs copied using a personal recorder, may cause faults which are no reflection on the quality of the original player.



Without pressing the EJECT button, insert a CD in the player, play begins automatically.

1



To play a disc which has already been inserted, press the SOURCE button several times in succession and select CD.



2

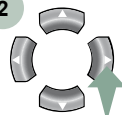

Press one of the buttons to select a track on the CD. Press the LIST button to display the list of tracks on the CD.



MP3 CD INFORMATION AND ADVICE



The MP3 format, an abbreviation of MPEG 1.2 & 2.5 Audio Layer 3, is an audio compression standard which permits the recording of several tens of music files on a single disc. The playing and displaying of an MP3 compilation may depend on the recording programme and/or the parameters used.



In order to be able to play a recorded CDR or CDRW, when recording select standards ISO 9660 level 1.2 or Joliet. If the disc is recorded in another format, it may not be played correctly. It is recommended that the same recording standard is always used for an individual disc, with as low a speed as possible for optimum sound quality. In the particular case of a multi-session CD, the Joliet standard is recommended.



The audio equipment will only play files with the extension ".mp3". No other type of file (.wma, .mp4...) can be played.



It is advisable to restrict file names to 20 characters without using special characters (e.g.: " " ? ; ù) to avoid any playing or displaying problems.

CD PLAYING AN MP3 COMPILATION



Insert an MP3 compilation in the player. The audio equipment searches for all of the music tracks, which may take anything between a few seconds and several tens of seconds, before play begins.



On a single disc, the CD player can read up to 255 MP3 files spread over 8 directory levels. However, it is advisable to keep to a limit of two levels to reduce the access time before the CD is played.

1



To play a disc which has already been inserted, press the SOURCE button several times in succession and select CD.



2

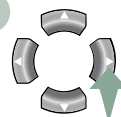

Press one of the buttons to select a track on the CD. Press the LIST button to display the list of directories of the MP3 compilation.



04 HANDS-FREE KIT



MATCHING A TELEPHONE DISPLAY C



For safety reasons and because they require prolonged attention on the part of the driver, the operations for matching of the Bluetooth mobile telephone with the RD4 hands-free kit must be carried out with the vehicle stationary and the ignition on.

- 1 Activate the telephone's Bluetooth function and carry out a search of the Bluetooth accessories present for the telephone.



- 2 Select the accessory which corresponds to the name of the vehicle, a superimposed configuration display appears on the multifunction display.



- 3 Enter the vehicle's authentication code (=1234). Depending on the telephone, you may be asked to enter this code before the superimposed configuration display appears.



- 5 Select the YES tab on the display using the buttons then confirm by pressing OK.



YES



The services offered by the hands-free kit depend on the telephone network, the SIM card and the compatibility of the Bluetooth equipment used. Consult your telephone's manual and your operator to check which services are available to you. A list of mobile telephones which offer the best range of services is available from the network. Contact a PEUGEOT dealer.

RECEIVING A CALL

- 1 An incoming call is announced by a ring and a superimposed display on the multifunction display.

2



Select the YES tab on the display using the buttons and confirm by pressing OK.

YES



Press the end of the steering wheel stalk to accept the call.



MAKING A CALL



Press the end of the steering wheel stalk for more than two seconds to access your directory.



1

If you wish to dial a number, use the keypad on your telephone.



05 CONTROL SHORT-CUTS

STEERING WHEEL CONTROLS

RADIO: selection of the previous stored station.
CD CHANGER: selection of the previous CD.
Selection of the previous item on a menu.

RADIO: selection of the next stored station.
CD CHANGER: selection of the next CD.
Selection of the next item on a menu.

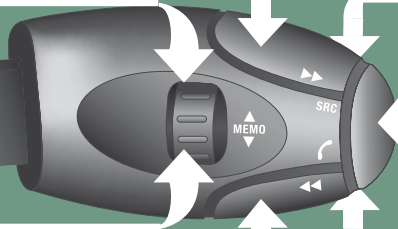

RADIO: automatic search for a higher frequency.
CD/CD CHANGER/MP3: selection of the next track.
CD/CD CHANGER: continuous press: fast forwards play.
Selection of the previous item.

Volume increase.

- Change of sound source.
- Confirmation of a selection.
- Pick up/Hang up the telephone.
- Press for more than 2 seconds: access to the telephone menu.

Volume decrease.

RADIO: automatic search for a lower frequency.
CD/CD CHANGER/MP3: selection of the previous track.
CD/CD CHANGER: continuous press: fast backwards play.
Selection of the next item.

Mute: by pressing the volume increase and decrease buttons simultaneously.

The sound is restored by pressing one of the two volume buttons.

06 CONFIGURATION



ADJUSTING THE DATE AND TIME

1



Press the MENU button.



2

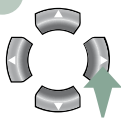

Using the arrows, select the PERSONALISATION CONFIGURATION function.



PERSONALISATION CONFIGURATION



3



Press to confirm the selection.



4

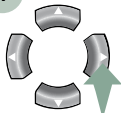

Using the arrows, select the DISPLAY CONFIGURATION function.

DISPLAY CONFIGURATION



5



Press to confirm the selection.



6

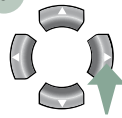

Using the arrows, select the ADJUST DATE AND TIME function.

ADJUST DATE AND TIME



7



Press to confirm the selection.



8



Adjust the parameters one by one confirming by pressing the OK button. Next select the OK tab on the display then confirm.

OK

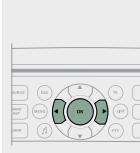

07 DISPLAY FLOW CHART monochrome C



1 AUDIO FUNCTIONS

2 FM BAND PREFERENCES

3 alternative frequencies (RDS)

4 activate/deactivate

3 regional mode (REG)

4 activate/deactivate

3 radio-text information (RDTXT)

4 activate/deactivate

2 AUDIO CD PREFERENCES

3 CD changer repeat (RPT)

4 activate/deactivate

3 track random play (RDM)

4 activate/deactivate



1 TRIP COMPUTER

2 ENTER DISTANCE TO DESTINATION

3 distance: x km

2 WARNING LOG

3 diagnostics

2 STATUS OF FUNCTIONS*

3 functions activated or deactivated



1 PERSONALISATION-CONFIGURATION

2 DEFINE THE VEHICLE PARAMETERS*

2 DISPLAY CONFIGURATION

3 video brightness adjustment

4 normal video

4 inverse video

4 brightness (- +) adjustment

3 date and time adjustment

4 day/month/year adjustment

4 hour/minute adjustment

4 choice of 12 h/24 h mode

3 choice of units

4 l/100 km-mpg-km/l

4 °Celsius/°Fahrenheit

2 CHOICE OF LANGUAGE

* The parameters vary according to vehicle (refer to the "Multifunction displays" chapter).

** According to compatibility of Bluetooth telephone and service contract.



1 TELEPHONE

2 CONSULTING DIRECTORIES**

3 telephone directory

3 call log

3 services directory

4 customer contact centre

4 breakdown call

4 emergency call

2 CONFIGURATION

3 deletion of a match

4 list of matches

3 consulting matches

4 list of matches

3 choice of a mobile to connect

4 list of mobiles

2 MANAGEMENT OF A COMMUNICATION

3 switch**

3 terminate the current call

3 secret mode

4 activate/deactivate

JBL EQUIPMENT

607: the concert hall



PRESENTATION

The JBL Hi-Fi system guarantees full respect of the musical nuances to provide high fidelity sound reproduction in your vehicle. At the heart of the system, a 240 watt multifunction amplifier (1) independently controls 12 high-definition acoustic speakers. These speakers make it possible to obtain optimum reproduction and distribution of the sound in the vehicle, both in the front and in the rear.

ADJUSTMENT IN CD MODE

The basic functions remain those of the audio equipment. No further adjustment is required. However, to benefit fully from your JBL audio system, we recommend that you set the AUDIO functions (BASS, TREB, FAD, BAL) to the central position and the Loudness to the "ON" position.

EQUIPMENT

If your 607 is fitted with a JBL Hi-Fi audio system, this is designed specifically for the passenger compartment of your vehicle.



The speakers are located:

- in the fascia panel: two Tweeters (4) incorporated in two Mid Range Speakers (5) for clear front reproduction of the sound image.
- in the front doors: two Woofers (6) for reproduction of the bass tones (low frequencies).
- in the rear doors: two Tweeters (2) and two Woofers (3) permitting a balance of the frequencies (from bass to treble) in the rear seats.
- on the rear shelf: two Subwoofers (7) designed specifically for reproduction of the extreme bass tones (very low frequencies) for true listening pleasure; you will appreciate the impact and the depth without noticing that the sound is coming from the rear of the vehicle.