

2009 Pontiac G8 Owner Manual

Seats and Restraints	1-1	Driver Information		Tire Changing	9-66
Front Seats	1-2	Center (DIC)	4-22	Jump Starting	9-84
Rear Seats	1-5	OnStar® System	4-35	Towing	9-88
Safety Belts	1-5	Lighting	5-1	Appearance Care	9-95
Airbag System	1-20	Lighting	5-1	Technical Data	10-1
Child Restraints	1-34	Infotainment	6-1	Vehicle Identification	10-1
Keys, Doors and Windows	2-1	Audio System(s)	6-1	Capacities and Specifications	10-2
Keys	2-2	Climate Controls	7-1	Service and Maintenance	11-1
Doors and Locks	2-8	Climate Controls	7-1	Service and Maintenance	11-1
Theft-Deterrent Systems	2-11	Driving and Operating	8-1	Customer Information	12-1
Windows	2-14	Starting and Operating Your Vehicle	8-2	Customer Information	12-1
Mirrors	2-16	Driving Your Vehicle	8-16	Reporting Safety Defects	12-14
Sunroof	2-18	Fuel	8-34	Vehicle Data Recording and Privacy	12-16
Storage	3-1	Vehicle Service and Care	9-1	Index	i-1
Storage	3-1	Service	9-2		
Instruments and Controls	4-1	Owner Checks	9-5		
Instrument Panel Overview	4-2	Headlamp Aiming	9-28		
Warning Lights, Gages, and Indicators	4-10	Bulb Replacement	9-31		
		Electrical System	9-36		
		Tires	9-42		



GENERAL MOTORS, GM, the GM Emblem, PONTIAC, the PONTIAC Emblem, are registered trademarks of General Motors Corporation, and the name G8 is a trademark of General Motors Corporation.

This manual includes the latest information at the time it was printed. GM reserves the right to make changes after that time without further notice. For vehicles first sold in Canada, substitute the name "General Motors of Canada Limited" for Pontiac Division wherever it appears in this manual.

This manual describes features that may or may not be on your specific vehicle.

Read this manual from beginning to end to learn about the vehicle's features and controls. Pictures, symbols, and words work together to explain vehicle operation.

Keep this manual in the vehicle for quick reference.

Canadian Owners

A French language copy of this manual can be obtained from your dealer/retailer or from:

Helm, Incorporated
P.O. Box 07130
Detroit, MI 48207

1-800-551-4123
helminc.com

Propriétaires Canadiens

On peut obtenir un exemplaire de ce guide en français auprès de concessionnaire ou à l'adresse suivante:

Helm Incorporated
P.O. Box 07130
Detroit, MI 48207

1-800-551-4123
helminc.com

Index

To quickly locate information about the vehicle use the Index in the back of the manual. It is an alphabetical list of what is in the manual and the page number where it can be found.

Cautions and Notices



A circle with a slash through it is a safety symbol which means “Do Not,” “Do not do this” or “Do not let this happen.”

A box with the word CAUTION is used to tell about things that could hurt you or others if you were to ignore the warning.



These mean there is something that could hurt you or other people.

Cautions tell what the hazard is and what to do to avoid or reduce the hazard. Read these cautions.

A notice tells about something that can damage the vehicle.

Notice: These mean there is something that could damage your vehicle.

Many times, this damage would not be covered by the vehicle’s warranty, and it could be costly. The notice tells what to do to help avoid the damage.

There are also warning labels on the vehicle which use the same words, CAUTION or Notice.

Seats and Restraints

Front Seats

Front Seats	1-2
Manual Seats	1-2
Power Seat(s)	1-2
Lumbar Seat Adjustment	1-2
Reclining Seatbacks	1-3
Head Restraints	1-4
Heated Seats	1-5

Rear Seats

Rear Seat Operation	1-5
---------------------------	-----

Safety Belts

Safety Belts	1-5
How to Wear Safety Belts Properly	1-8
Lap-Shoulder Belt	1-14
Safety Belt Use During Pregnancy	1-18
Safety Belt Extender	1-18

Safety Belt Check	1-18
Care of Safety Belts	1-19
Replacing Safety Belt System Parts After a Crash	1-19

Airbag System

Airbag System	1-20
Where Are the Airbags?	1-22
When Should an Airbag Inflate?	1-23
What Makes an Airbag Inflate?	1-25
How Does an Airbag Restrain?	1-25
What Will You See After an Airbag Inflates?	1-25
Passenger Sensing System	1-27
Servicing Your Airbag-Equipped Vehicle	1-31
Adding Equipment to Your Airbag-Equipped Vehicle	1-32
Airbag System Check	1-33
Replacing Airbag System Parts After a Crash	1-33

Child Restraints

Older Children	1-34
Infants and Young Children	1-36
Child Restraint Systems	1-39
Where to Put the Restraint	1-40
Lower Anchors and Tethers for Children (LATCH)	1-42
Replacing LATCH System Parts After a Crash	1-47
Securing Child Restraints (Rear Seat)	1-48
Securing Child Restraints (Right Front Seat)	1-50

Front Seats



- A. *Head Restraints on page 1-4.*
- B. *Lumbar Seat Adjustment on page 1-2.*
- C. *Reclining Seatbacks on page 1-3.*
- D. *Power Seat(s) on page 1-2.*
- E. *Manual Seats on page 1-2.*

Manual Seats

CAUTION

You can lose control of the vehicle if you try to adjust a manual driver's seat while the vehicle is moving. The sudden movement could startle and confuse you, or make you push a pedal when you do not want to. Adjust the driver's seat only when the vehicle is not moving.

To adjust a manual seat:

1. Lift the bar (E) to unlock the seat.
2. Slide the seat to the desired position and release the bar.

Try to move the seat to be sure it is locked in place.

Power Seat(s)

- Move the seat forward or rearward by moving the control (D) forward or rearward.
- Move the whole seat up or down by moving the control up or down.
- Tilt the seat by turning the control forward or rearward.

Lumbar Seat Adjustment

Adjust the lumbar support (B) by turning the control forward or rearward.

Reclining Seatbacks

CAUTION

You can lose control of the vehicle if you try to adjust the seat while the vehicle is moving. The sudden movement could startle and confuse you, or make you push a pedal when you do not want to. Adjust the driver's seat only when the vehicle is not moving.



CAUTION

Sitting in a reclined position when your vehicle is in motion can be dangerous. Even if you buckle up, your safety belts cannot do their job when you are reclined like this.

The shoulder belt cannot do its job because it will not be against your body. Instead, it will be in front of you. In a crash, you could go into it, receiving neck or other injuries.

(Continued)

CAUTION (Continued)

The lap belt cannot do its job either. In a crash, the belt could go up over your abdomen. The belt forces would be there, not at your pelvic bones. This could cause serious internal injuries.

For proper protection when the vehicle is in motion, have the seatback upright. Then sit well back in the seat and wear your safety belt properly.

Adjust the reclining seatback by turning the knob (C). Do not lean on the seatback while adjusting it.

1-4 Seats and Restraints

Head Restraints

The front seats have adjustable head restraints in the outboard seating positions.

The rear seats have head rests in the outboard seating positions. They are not adjustable.

CAUTION

With head restraints that are not installed and adjusted properly, there is a greater chance that occupants will suffer a neck/spinal injury in a crash. Do not drive until the head restraints for all occupants are installed and adjusted properly.



Adjust the head restraint so that the top of the restraint is at the same height as the top of the occupant's head. This position reduces the chance of a neck injury in a crash.



Pull the head restraint up to raise it. To lower the head restraint, press the button, located on the top of the seatback, and push the restraint down.

Push down on the head restraint after the button is released to make sure that it is locked in place.

The vehicle's head restraints are not designed to be removed.

Heated Seats

On vehicles with heated front seats, the controls are located on the center console. To operate the heated seats the ignition must be on.

 **(Heated Seat):** Press to turn on the heated seat.

A light indicates that the feature is working. The number of indicator lights shows the level of heat selected: one for low, two for medium, and three for high. Press the button to cycle through the temperature settings and to turn the heat off.

Rear Seats

Rear Seat Operation

The center seatback folds forward to allow access to the trunk.



Press the button at the top of the seatback to release it, then fold it forward.

Lift the seatback to return it to the sitting position. Move the safety belt out of the way, and push the seatback until it is locked in place.

Safety Belts

This section of the manual describes how to use safety belts properly. It also describes some things not to do with safety belts.

CAUTION

Do not let anyone ride where a safety belt cannot be worn properly. In a crash, if you or your passenger(s) are not wearing safety belts, the injuries can be much worse. You can hit things inside the vehicle harder or be ejected from the vehicle. You and your passenger(s) can be seriously injured or killed. In the same crash, you might not be, if you are buckled up. Always fasten your safety belt, and check that your passenger(s) are restrained properly too.

1-6 Seats and Restraints

CAUTION

It is extremely dangerous to ride in a cargo area, inside or outside of a vehicle. In a collision, people riding in these areas are more likely to be seriously injured or killed. Do not allow people to ride in any area of your vehicle that is not equipped with seats and safety belts. Be sure everyone in your vehicle is in a seat and using a safety belt properly.

This vehicle has indicators as a reminder to buckle the safety belts. See *Safety Belt Reminders on page 4-12* for additional information.

In most states and in all Canadian provinces, the law requires wearing safety belts. Here is why:

You never know if you will be in a crash. If you do have a crash, you do not know if it will be a serious one.

A few crashes are mild, and some crashes can be so serious that even buckled up, a person would not survive. But most crashes are in between. In many of them, people who buckle up can survive and sometimes walk away. Without safety belts they could have been badly hurt or killed.

After more than 40 years of safety belts in vehicles, the facts are clear. In most crashes buckling up does matter... a lot!

Why Safety Belts Work

When you ride in or on anything, you go as fast as it goes.



Take the simplest vehicle. Suppose it is just a seat on wheels.



Put someone on it.



Get it up to speed. Then stop the vehicle. The rider does not stop.



The person keeps going until stopped by something. In a real vehicle, it could be the windshield...

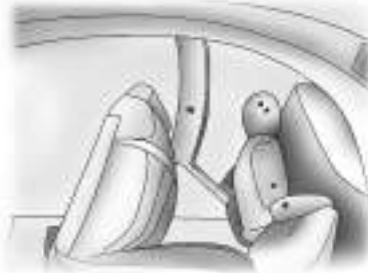

or the instrument panel...



or the safety belts!

With safety belts, you slow down as the vehicle does. You get more time to stop. You stop over more distance, and your strongest bones take the forces. That is why safety belts make such good sense.

1-8 Seats and Restraints

Questions and Answers About Safety Belts

Q: Will I be trapped in the vehicle after a crash if I am wearing a safety belt?

A: You *could* be — whether you are wearing a safety belt or not. But your chance of being conscious during and after an accident, so you *can* unbuckle and get out, is *much* greater if you are belted. And you can unbuckle a safety belt, even if you are upside down.

Q: If my vehicle has airbags, why should I have to wear safety belts?

A: Airbags are supplemental systems only; so they work *with* safety belts — not instead of them. Whether or not an airbag is provided, all occupants still have to buckle up to get the most protection. That is true not only in frontal collisions, but especially in side and other collisions.

Q: If I am a good driver, and I never drive far from home, why should I wear safety belts?

A: You may be an excellent driver, but if you are in a crash — even one that is not your fault — you and your passenger(s) can be hurt. Being a good driver does not protect you from things beyond your control, such as bad drivers.

Most accidents occur within 25 miles (40 km) of home. And the greatest number of serious injuries and deaths occur at speeds of less than 40 mph (65 km/h).

Safety belts are for everyone.

How to Wear Safety Belts Properly

This section is only for people of adult size.

Be aware that there are special things to know about safety belts and children. And there are different rules for smaller children and infants. If a child will be riding in the vehicle, see *Older Children on page 1-34* or *Infants and Young Children on page 1-36*. Follow those rules for everyone's protection.

It is very important for all occupants to buckle up. Statistics show that unbelted people are hurt more often in crashes than those who are wearing safety belts.

Occupants who are not buckled up can be thrown out of the vehicle in a crash. And they can strike others in the vehicle who are wearing safety belts.

First, before you or your passenger(s) wear a safety belt, there is important information you should know.

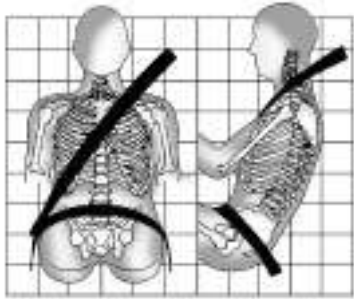

Sit up straight and always keep your feet on the floor in front of you. The lap part of the belt should be worn low and snug on the hips, just touching the thighs. In a crash, this applies force to the strong pelvic

bones and you would be less likely to slide under the lap belt. If you slid under it, the belt would apply force on your abdomen. This could cause serious or even fatal injuries. The shoulder belt should go over the shoulder and across the chest. These parts of the body are best able to take belt restraining forces.

The shoulder belt locks if there is a sudden stop or crash.

Q: What is wrong with this?

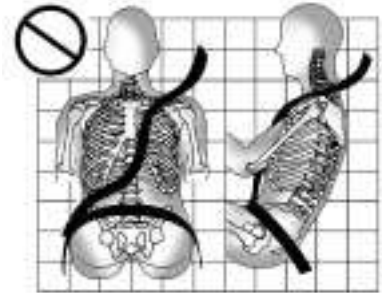

A: The shoulder belt is too loose. It will not give as much protection this way.

⚠ CAUTION

You can be seriously hurt if your shoulder belt is too loose. In a crash, you would move forward too much, which could increase injury. The shoulder belt should fit snugly against your body.

1-10 Seats and Restraints

Q: What is wrong with this?

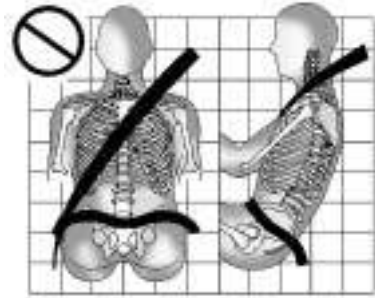

A: The lap belt is too loose. It will not give nearly as much protection this way.

CAUTION

You can be seriously hurt if your lap belt is too loose. In a crash, you could slide under the lap belt and apply force on your abdomen. This could cause serious or even fatal injuries. The lap belt should be worn low and snug on the hips, just touching the thighs.

Q: What is wrong with this?

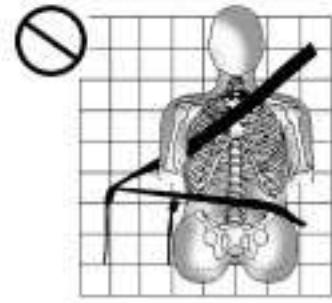

A: The belt is buckled in the wrong buckle.

⚠ CAUTION

You can be seriously injured if your belt is buckled in the wrong place like this. In a crash, the belt would go up over your abdomen. The belt forces would be there, not on the pelvic bones. This could cause serious internal injuries. Always buckle your belt into the buckle nearest you.

Q: What is wrong with this?



A: The belt is over an armrest.

⚠ CAUTION

You can be seriously injured if your belt goes over an armrest like this. The belt would be much too high. In a crash, you can slide under the belt. The belt force would then be applied on the abdomen, not on the pelvic bones, and that could cause serious or fatal injuries. Be sure the belt goes under the armrests.

1-12 Seats and Restraints

Q: What is wrong with this?

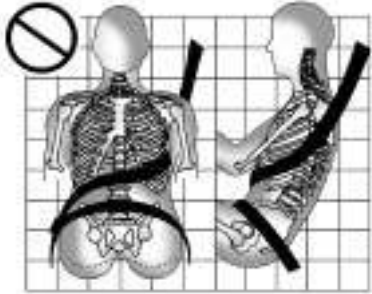

A: The shoulder belt is worn under the arm. It should be worn over the shoulder at all times.

CAUTION

You can be seriously injured if you wear the shoulder belt under your arm. In a crash, your body would move too far forward, which would increase the chance of head and neck injury. Also, the belt would apply too much force to the ribs, which are not as strong as shoulder bones. You could also severely injure internal organs like your liver or spleen. The shoulder belt should go over the shoulder and across the chest.

Q: What is wrong with this?

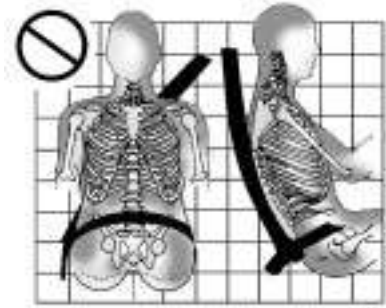

A: The belt is behind the body.

⚠ CAUTION

You can be seriously injured by not wearing the lap-shoulder belt properly. In a crash, you would not be restrained by the shoulder belt. Your body could move too far forward increasing the chance of head and neck injury. You might also slide under the lap belt. The belt force would then be applied right on the abdomen. That could cause serious or fatal injuries. The shoulder belt should go over the shoulder and across the chest.

Q: What is wrong with this?

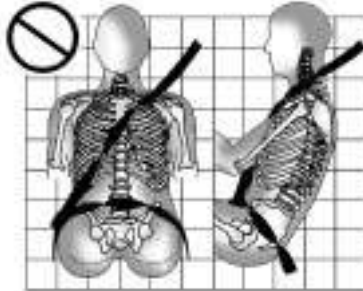

A: The belt is twisted across the body.

⚠ CAUTION

You can be seriously injured by a twisted belt. In a crash, you would not have the full width of the belt to spread impact forces. If a belt is twisted, make it straight so it can work properly, or ask your dealer/retailer to fix it.

1-14 Seats and Restraints

Lap-Shoulder Belt

All seating positions in the vehicle have a lap-shoulder belt.

The following instructions explain how to wear a lap-shoulder belt properly.

1. Adjust the seat, if the seat is adjustable, so you can sit up straight. To see how, see “Seats” in the Index.



2. Pick up the latch plate and pull the belt across you. Do not let it get twisted.

The lap-shoulder belt may lock if you pull the belt across you very quickly. If this happens, let the belt go back slightly to unlock it. Then pull the belt across you more slowly.

If the shoulder portion of a passenger belt is pulled out all the way, the child restraint locking feature may be engaged. If this happens, let the belt go back all the way and start again.



3. Push the latch plate into the buckle until it clicks.

Pull up on the latch plate to make sure it is secure. If the belt is not long enough, see *Safety Belt Extender* on page 1-18.

Position the release button on the buckle so that the safety belt could be quickly unbuckled if necessary.

4. To make the lap part tight, pull up on the shoulder belt. It may be necessary to pull stitching on the safety belt through the latch plate to fully tighten the lap belt on smaller occupants.



To unlatch the belt, push the button on the buckle. The belt should return to its stowed position.

Slide the latch plate up the safety belt webbing, when the safety belt is not in use. The latch plate should rest on the stitching on the safety belt, near the guide loop on the side wall.

Before a door is closed, be sure the safety belt is out of the way. If a door is slammed against a safety belt, damage can occur to both the safety belt and the vehicle.

Safety Belt Pretensioners

This vehicle has safety belt pretensioners for the front outboard occupants. Although the safety belt pretensioners cannot be seen, they are part of the safety belt assembly. They can help tighten the safety belts during the early stages of a moderate to severe frontal or near frontal crash if the threshold conditions for pretensioner activation are met.

And, if the vehicle has side impact airbags, safety belt pretensioners can help tighten the safety belts in a side crash.

Pretensioners work only once. If the pretensioners activate in a crash, they will need to be replaced and probably other new parts for the safety belt system. See *Replacing Safety Belt System Parts After a Crash* on page 1-19.

1-16 Seats and Restraints

Rear Safety Belt Comfort Guides

Rear shoulder belt comfort guides may provide added safety belt comfort for older children who have outgrown booster seats and for some adults. When installed on a shoulder belt, the comfort guide positions the shoulder belt away from the neck and head.

There is one guide for each outboard passenger position in the rear seat. Here is how to install a comfort guide to the safety belt:

1. Pull the elastic cord out from the side of the seatback to remove the guide from its storage pocket.



2. Place the guide over the belt and insert the two edges of the belt into the slots of the guide.

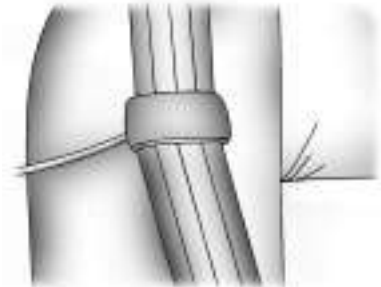

3. Be sure that the belt is not twisted and it lies flat. The elastic cord must be under the belt and the guide on top.

CAUTION

A safety belt that is not properly worn may not provide the protection needed in a crash. The person wearing the belt could be seriously injured. The shoulder belt should go over the shoulder and across the chest. These parts of the body are best able to take belt restraining forces.



4. Buckle, position, and release the safety belt as described previously in this section. Make sure that the shoulder belt crosses the shoulder.

To remove and store the comfort guide, squeeze the belt edges together so that the safety belt can be removed from the guide. Push the guide into the pocket on the side of the seatback.

Properly secure the guide loop before folding the seatback. The comfort guide and vehicle can be damaged while closing a door if it is not properly secured in its storage location.

Safety Belt Use During Pregnancy

Safety belts work for everyone, including pregnant women. Like all occupants, they are more likely to be seriously injured if they do not wear safety belts.



A pregnant woman should wear a lap-shoulder belt, and the lap portion should be worn as low as possible, below the rounding, throughout the pregnancy.

The best way to protect the fetus is to protect the mother. When a safety belt is worn properly, it is more likely that the fetus will not be hurt in a crash. For pregnant women, as for anyone, the key to making safety belts effective is wearing them properly.

Safety Belt Extender

If the safety belt will fasten around you, you should use it.

But if a safety belt is not long enough, your dealer/retailer will order you an extender. When you go in to order it, take the heaviest coat you will wear, so the extender will be long enough for you. To help avoid personal injury, do not let someone else use it, and use it only for the seat it is made to fit. The extender has been designed for adults. Never use it for securing child seats. To wear it, attach it to the regular safety belt. For more information, see the instruction sheet that comes with the extender.

Safety Belt Check

Now and then, check the safety belt reminder light, safety belts, buckles, latch plates, retractors and anchorages are working properly. Look for any other loose or damaged safety belt system parts that might keep a safety belt system from doing its job. See your dealer/retailer to have it repaired. Torn or frayed safety belts may not protect you in a crash. They can rip apart under impact forces. If a belt is torn or frayed, get a new one right away.

Make sure the safety belt reminder light is working. See *Safety Belt Reminders on page 4-12* for more information.

Keep safety belts clean and dry. See *Care of Safety Belts on page 1-19*.

Care of Safety Belts

Keep belts clean and dry.

CAUTION

Do not bleach or dye safety belts. If you do, it may severely weaken them. In a crash, they might not be able to provide adequate protection. Clean safety belts only with mild soap and lukewarm water.

Replacing Safety Belt System Parts After a Crash

CAUTION

A crash can damage the safety belt system in the vehicle. A damaged safety belt system may not properly protect the person using it, resulting in serious injury or even death in a crash. To help make sure the safety belt systems are working properly after a crash, have them inspected and any necessary replacements made as soon as possible.

After a minor crash, replacement of safety belts may not be necessary. But the safety belt assemblies that were used during any crash may have been stressed or damaged. See your dealer/retailer to have the safety belt assemblies inspected or replaced.

New parts and repairs may be necessary even if the safety belt system was not being used at the time of the crash.

Have the safety belt pretensioners checked if the vehicle has been in a crash, or if the airbag readiness light stays on after you start the vehicle or while you are driving. See *Airbag Readiness Light* on page 4-13.

Airbag System

The vehicle has the following airbags:

- A frontal airbag for the driver.
- A frontal airbag for the right front passenger.
- A seat-mounted side impact airbag for the driver.
- A seat-mounted side impact airbag for the right front passenger.
- A roof-rail airbag for the driver and the passenger seated directly behind the driver.
- A roof-rail airbag for the right front passenger and the passenger seated directly behind the right front passenger.

All of the airbags in the vehicle will have the word AIRBAG embossed in the trim or on an attached label near the deployment opening.

For frontal airbags, the word AIRBAG will appear on the middle part of the steering wheel for the driver and on the instrument panel for the right front passenger.

With seat-mounted side impact airbags, the word AIRBAG will appear on the side of the seatback closest to the door.

With roof-rail airbags, the word AIRBAG will appear along the headliner or trim.

Airbags are designed to supplement the protection provided by safety belts. Even though today's airbags are also designed to help reduce the risk of injury from the force of an inflating bag, all airbags must inflate very quickly to do their job.

Here are the most important things to know about the airbag system:

CAUTION

You can be severely injured or killed in a crash if you are not wearing your safety belt — even if you have airbags. Airbags are designed to work with safety belts, but do not replace them. Also, airbags are not designed to deploy in every crash. In some crashes safety belts are your only restraint. See *When Should an Airbag Inflate?* on page 1-23.

Wearing your safety belt during a crash helps reduce your chance of hitting things inside the vehicle or being ejected from it. Airbags are “supplemental restraints” to the safety belts. Everyone in your vehicle should wear a safety belt properly — whether or not there is an airbag for that person.

 CAUTION

Airbags inflate with great force, faster than the blink of an eye. Anyone who is up against, or very close to, any airbag when it inflates can be seriously injured or killed. Do not sit unnecessarily close to the airbag, as you would be if you were sitting on the edge of your seat or leaning forward. Safety belts help keep you in position before and during a crash. Always wear your safety belt, even with airbags. The driver should sit as far back as possible while still maintaining control of the vehicle.

Occupants should not lean on or sleep against the door or side windows in seating positions with seat-mounted side impact airbags and/or roof-rail airbags.

 CAUTION

Children who are up against, or very close to, any airbag when it inflates can be seriously injured or killed. Airbags plus lap-shoulder belts offer protection for adults and older children, but not for young children and infants. Neither the vehicle's safety belt system nor its airbag system is designed for them. Young children and infants need the protection that a child restraint system can provide. Always secure children properly in your vehicle. To read how, see *Older Children on page 1-34* or *Infants and Young Children on page 1-36*.



There is an airbag readiness light on the instrument panel cluster, which shows the airbag symbol. The system checks the airbag electrical system for malfunctions. The light tells you if there is an electrical problem. See *Airbag Readiness Light on page 4-13* for more information.

Where Are the Airbags?

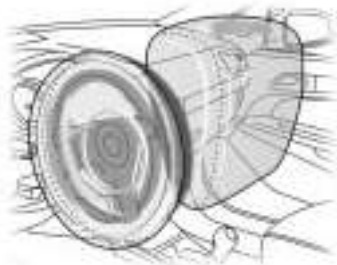

The driver frontal airbag is in the middle of the steering wheel.

The right front passenger frontal airbag is in the instrument panel on the passenger's side.



Driver Side shown, Passenger Side similar

The seat-mounted side impact airbags for the driver and right front passenger are in the side of the seatbacks closest to the door.

The roof-rail airbags for the driver, right front passenger, and second row outboard passengers are in the ceiling above the side windows.

⚠ CAUTION

If something is between an occupant and an airbag, the airbag might not inflate properly or it might force the object into that person causing severe injury or even death. The path of an inflating airbag must be kept clear. Do not put anything between an occupant and an airbag, and do not attach or put anything on the steering wheel hub or on or near any other airbag covering.

Do not use seat accessories that block the inflation path of a seat-mounted side impact airbag.

Never secure anything to the roof of a vehicle with roof-rail airbags by routing a rope or tie down through any door or window opening. If you do, the path of an inflating roof-rail airbag will be blocked.

When Should an Airbag Inflate?

Frontal airbags are designed to inflate in moderate to severe frontal or near-frontal crashes to help reduce the potential for severe injuries mainly to the driver's or right front passenger's head and chest. However, they are only designed to inflate if the impact exceeds a predetermined deployment threshold. Deployment thresholds are used to predict how severe a crash is likely to be in time for the airbags to inflate and help restrain the occupants.

Whether the frontal airbags will or should deploy is not based on how fast your vehicle is traveling. It depends largely on what you hit, the direction of the impact, and how quickly your vehicle slows down.

Frontal airbags may inflate at different crash speeds. For example:

- If the vehicle hits a stationary object, the airbags could inflate at a different crash speed than if the vehicle hits a moving object.
- If the vehicle hits an object that deforms, the airbags could inflate at a different crash speed than if the vehicle hits an object that does not deform.

- If the vehicle hits a narrow object (like a pole), the airbags could inflate at a different crash speed than if the vehicle hits a wide object (like a wall).
- If the vehicle goes into an object at an angle, the airbags could inflate at a different crash speed than if the vehicle goes straight into the object.

Thresholds can also vary with specific vehicle design.

Frontal airbags are not intended to inflate during vehicle rollovers, rear impacts, or in many side impacts.

1-24 Seats and Restraints

In addition, the vehicle has dual-stage frontal airbags. Dual-stage airbags adjust the restraint according to crash severity. The vehicle has electronic frontal sensors, which help the sensing system distinguish between a moderate frontal impact and a more severe frontal impact. For moderate frontal impacts, dual-stage airbags inflate at a level less than full deployment. For more severe frontal impacts, full deployment occurs.

The vehicle has seat-mounted side impact and roof-rail airbags. See *Airbag System on page 1-20*.

Seat-mounted side impact and roof-rail airbags are intended to inflate in moderate to severe side crashes. Seat-mounted side impact and roof-rail airbags will inflate if the crash severity is above the system's designed threshold level. The threshold level can vary with specific vehicle design.

Seat-mounted side impact and roof-rail airbags are not intended to inflate in frontal impacts, near-frontal impacts, rollovers, or rear impacts. A seat-mounted side impact airbag is intended to deploy on the side of the vehicle that is struck.

A roof-rail airbag is intended to deploy on the side of the vehicle that is struck.

In any particular crash, no one can say whether an airbag should have inflated simply because of the damage to a vehicle or because of what the repair costs were. For frontal airbags, inflation is determined by what the vehicle hits, the angle of the impact, and how quickly the vehicle slows down. For seat-mounted side impact and roof-rail airbags, deployment is determined by the location and severity of the side impact.

What Makes an Airbag Inflate?

In a deployment event, the sensing system sends an electrical signal triggering a release of gas from the inflator. Gas from the inflator fills the airbag causing the bag to break out of the cover and deploy. The inflator, the airbag, and related hardware are all part of the airbag module.

Frontal airbag modules are located inside the steering wheel and instrument panel. For vehicles with seat-mounted side impact airbags, there are airbag modules in the side of the front seatbacks closest to the door. For vehicles with roof-rail airbags, there are airbag modules in the ceiling of the vehicle, near the side windows that have occupant seating positions.

How Does an Airbag Restrain?

In moderate to severe frontal or near frontal collisions, even belted occupants can contact the steering wheel or the instrument panel.

In moderate to severe side collisions, even belted occupants can contact the inside of the vehicle.

Airbags supplement the protection provided by safety belts. Frontal airbags distribute the force of the impact more evenly over the occupant's upper body, stopping the occupant more gradually. Seat-mounted side impact and roof-rail airbags distribute the force of the impact more evenly over the occupant's upper body.

But airbags would not help in many types of collisions, primarily because the occupant's motion is not toward those airbags. See *When Should an Airbag Inflate?* on page 1-23 for more information.

Airbags should never be regarded as anything more than a supplement to safety belts.

What Will You See After an Airbag Inflates?

After the frontal airbags and seat-mounted side impact airbags inflate, they quickly deflate, so quickly that some people may not even realize an airbag inflated. Roof-rail airbags may still be at least partially inflated for some time after they deploy. Some components of the airbag module may be hot for several minutes. For location of the airbag modules, see *What Makes an Airbag Inflate?* on page 1-25.

1-26 Seats and Restraints

The parts of the airbag that come into contact with you may be warm, but not too hot to touch. There may be some smoke and dust coming from the vents in the deflated airbags. Airbag inflation does not prevent the driver from seeing out of the windshield or being able to steer the vehicle, nor does it prevent people from leaving the vehicle.

CAUTION

When an airbag inflates, there may be dust in the air. This dust could cause breathing problems for people with a history of asthma or other breathing trouble. To avoid this, everyone in the vehicle should get out as soon as it is safe to do so. If you have breathing problems but cannot get

(Continued)

CAUTION (Continued)

out of the vehicle after an airbag inflates, then get fresh air by opening a window or a door. If you experience breathing problems following an airbag deployment, you should seek medical attention.

The vehicle has a feature that may automatically unlock the doors, turn the interior lamps on, and turn the hazard warning flashers on when the airbags inflate. You can lock the doors, turn the interior lamps off, and turn the hazard warning flashers off by using the controls for those features.

In many crashes severe enough to inflate the airbag, windshields are broken by vehicle deformation.

Additional windshield breakage may also occur from the right front passenger airbag.

- Airbags are designed to inflate only once. After an airbag inflates, you will need some new parts for the airbag system. If you do not get them, the airbag system will not be there to help protect you in another crash. A new system will include airbag modules and possibly other parts. The service manual for your vehicle covers the need to replace other parts.
- The vehicle has a crash sensing and diagnostic module which records information after a crash. See *Vehicle Data Recording and Privacy on page 12-16* and *Event Data Recorders on page 12-16*.
- Let only qualified technicians work on the airbag systems. Improper service can mean that an airbag system will not work properly. See your dealer/retailer for service.

Passenger Sensing System

The vehicle has a passenger sensing system for the right front passenger position. The passenger airbag status indicator will be visible in the rearview mirror when the vehicle is started.



The words ON and OFF, or the symbol for on and off, will be visible during the system check. If you are using remote start to start the vehicle from a distance, if equipped, you may not see the system check. When the system check is complete, either the word ON or OFF, or the symbol for on or off, will be visible. See *Passenger Airbag Status Indicator* on page 4-14.

The passenger sensing system will turn off the right front passenger frontal airbag under certain conditions. The driver airbags are not affected by the passenger sensing system.

The passenger sensing system works with sensors that are part of the right front passenger seat. The sensors are designed to detect the presence of a properly-seated occupant and determine if the right front passenger frontal airbag should be enabled (may inflate) or not.

Accident statistics show that children are safer if they are restrained in the rear rather than the front seat.

We recommend that children be secured in a rear seat, including: an infant or a child riding in a rear-facing child restraint; a child riding in a forward-facing child seat; an older child riding in a booster seat; and children, who are large enough, using safety belts.

1-28 Seats and Restraints

A label on the sun visor says, "Never put a rear-facing child seat in the front." This is because the risk to the rear-facing child is so great, if the airbag deploys.

CAUTION

A child in a rear-facing child restraint can be seriously injured or killed if the right front passenger airbag inflates. This is because the back of the rear-facing child restraint would be very close to the inflating airbag. A child in a forward-facing child restraint can be seriously injured or killed if the right front passenger airbag inflates and the passenger seat is in a forward position.

Even if the passenger sensing system has turned off the right front passenger frontal airbag, no system is fail-safe. No one can

(Continued)

CAUTION (Continued)

guarantee that an airbag will not deploy under some unusual circumstance, even though it is turned off.

Secure rear-facing child restraints in a rear seat, even if the airbag is off. If you secure a forward-facing child restraint in the right front seat, always move the front passenger seat as far back as it will go. It is better to secure the child restraint in a rear seat.

The passenger sensing system is designed to turn off the right front passenger frontal airbag if:

- The right front passenger seat is unoccupied.
- The system determines that an infant is present in a rear-facing infant seat.

- The system determines that a small child is present in a child restraint.
- The system determines that a small child is present in a booster seat.
- A right front passenger takes his/her weight off of the seat for a period of time.
- The right front passenger seat is occupied by a smaller person, such as a child who has outgrown child restraints.
- Or, if there is a critical problem with the airbag system or the passenger sensing system.

When the passenger sensing system has turned off the right front passenger frontal airbag, the off indicator will light and stay lit to remind you that the airbag is off. See *Passenger Airbag Status Indicator* on page 4-14.

The passenger sensing system is designed to turn on (may inflate) the right front passenger frontal airbag anytime the system senses that a person of adult size is sitting properly in the right front passenger seat. When the passenger sensing system has allowed the airbags to be enabled, the on indicator will light and stay lit to remind you that the airbag is active.

For some children who have outgrown child restraints and for very small adults, the passenger sensing system may or may not turn off the right front passenger frontal airbag, depending upon the person's seating posture and body build. Everyone in the vehicle who has outgrown child restraints should wear a safety belt properly — whether or not there is an airbag for that person.

 **CAUTION**

If the airbag readiness light ever comes on and stays on, it means that something may be wrong with the airbag system. To help avoid injury to yourself or others, have the vehicle serviced right away. See *Airbag Readiness Light on page 4-13* for more information, including important safety information.

If the On Indicator is Lit for a Child Restraint

If a child restraint has been installed and the on indicator is lit:

1. Turn the vehicle off.
2. Remove the child restraint from the vehicle.
3. Remove any additional items from the seat such as blankets, cushions, seat covers, seat heaters, or seat massagers.

4. Reinstall the child restraint following the directions provided by the child restraint manufacturer and refer to *Securing Child Restraints (Rear Seat) on page 1-48* or *Securing Child Restraints (Right Front Seat) on page 1-50*.
5. If, after reinstalling the child restraint and restarting the vehicle, the on indicator is still lit, turn the vehicle off. Then slightly recline the vehicle seatback and adjust the seat cushion, if adjustable, to make sure that the vehicle seatback is not pushing the child restraint into the seat cushion.
6. Restart the vehicle.
If the on indicator is still lit, secure the child in the child restraint in a rear seat position in the vehicle, and check with your dealer/retailer.

If the Off Indicator is Lit for an Adult-Size Occupant



If a person of adult-size is sitting in the right front passenger seat, but the off indicator is lit, it could be because that person is not sitting properly in the seat. If this happens,

use the following steps to allow the system to detect that person and enable the right front passenger frontal airbag:

1. Turn the vehicle off.
2. Remove any additional material from the seat, such as blankets, cushions, seat covers, seat heaters, or seat massagers.
3. Place the seatback in the fully upright position.
4. Have the person sit upright in the seat, centered on the seat cushion, with legs comfortably extended.
5. Restart the vehicle and have the person remain in this position for two to three minutes after the on indicator is lit.

Additional Factors Affecting System Operation

Safety belts help keep the passenger in position on the seat during vehicle maneuvers and braking, which helps the passenger sensing system maintain the passenger airbag status. See “Safety Belts” and “Child Restraints” in the Index for additional information about the importance of proper restraint use.

A thick layer of additional material, such as a blanket or cushion, or aftermarket equipment such as seat covers, seat heaters, and seat massagers can affect how well the passenger sensing system operates. We recommend that you not use seat covers or other aftermarket equipment except when approved by GM for your specific vehicle.

See *Adding Equipment to Your Airbag-Equipped Vehicle* on page 1-32 for more information about modifications that can affect how the system operates.

The passenger sensing system may suppress the airbag deployment when liquid soaks into the seat. If this happens, the off indicator in the passenger airbag status indicator and the airbag readiness light will be lit. Have your dealer/retailer check the system.

 **CAUTION**

Stowing of articles under the passenger seat or between the passenger seat cushion and seatback may interfere with the proper operation of the passenger sensing system.

Servicing Your Airbag-Equipped Vehicle

Airbags affect how the vehicle should be serviced. There are parts of the airbag system in several places around the vehicle. Your dealer/retailer and the service manual have information about servicing the vehicle and the airbag system. To purchase a service manual, see *Service Publications Ordering Information* on page 12-15.

 **CAUTION**

For up to 10 seconds after the ignition is turned off and the battery is disconnected, an airbag can still inflate during improper service. You can be injured if you are close to an airbag when it inflates. Avoid yellow connectors. They are probably part of the airbag system. Be sure to follow proper service procedures, and make sure the person performing work for you is qualified to do so.

Adding Equipment to Your Airbag-Equipped Vehicle

Q: Is there anything I might add to or change about the vehicle that could keep the airbags from working properly?

A: Yes. If you add things that change the vehicle's frame, bumper system, height, front end or side sheet metal, they may keep the airbag system from working properly. Changing or moving any parts of the front seats, safety belts, the airbag sensing and diagnostic module, steering wheel, instrument panel, roof-rail airbag modules, the inside rearview mirror, ceiling headliner or pillar garnish trim, front sensors, or airbag wiring can affect the operation of the airbag system.

In addition, the vehicle has a passenger sensing system for the right front passenger position, which includes sensors that are part of the passenger's seat. The passenger sensing system may not operate properly if the original seat trim is replaced with non-GM covers, upholstery or trim, or with GM covers, upholstery or trim designed for a different vehicle. Any object, such as an aftermarket seat heater or a comfort enhancing pad or device, installed under or on top of the seat fabric, could also interfere with the operation of the passenger sensing system. This could either prevent proper deployment of the passenger airbag(s) or prevent the passenger sensing system from properly turning off the passenger airbag(s). See *Passenger Sensing System* on page 1-27.

If you have any questions about this, you should contact Customer Assistance before you modify your vehicle. The phone numbers and addresses for Customer Assistance are in Step Two of the Customer Satisfaction Procedure in this manual. See *Customer Satisfaction Procedure* on page 12-1.

Q: Because I have a disability, I have to get my vehicle modified. How can I find out whether this will affect my airbag system?

A: If you have questions, call Customer Assistance. The phone numbers and addresses for Customer Assistance are in Step Two of the Customer Satisfaction Procedure in this manual. See *Customer Satisfaction Procedure* on page 12-1.

In addition, your dealer/retailer and the service manual have information about the location of the airbag sensors, sensing and diagnostic module and airbag wiring.

Airbag System Check

The airbag system does not need regularly scheduled maintenance or replacement. Make sure the airbag readiness light is working. See *Airbag Readiness Light* on page 4-13 for more information.

Notice: If an airbag covering is damaged, opened, or broken, the airbag may not work properly. Do not open or break the airbag coverings. If there are any opened or broken airbag covers, have the airbag covering and/or airbag module replaced. For the location of the airbag modules, see *What Makes an Airbag Inflate?* on page 1-25. See your dealer/retailer for service.

Replacing Airbag System Parts After a Crash

CAUTION

A crash can damage the airbag systems in your vehicle. A damaged airbag system may not work properly and may not protect you and your passenger(s) in a crash, resulting in serious injury or even death. To help make sure your airbag systems are working properly after a crash, have them inspected and any necessary replacements made as soon as possible.

If an airbag inflates, you will need to replace airbag system parts. See your dealer/retailer for service.

If the airbag readiness light stays on after the vehicle is started or comes on when you are driving, the airbag system may not work properly. Have the vehicle serviced right away. See *Airbag Readiness Light* on page 4-13 for more information.

Child Restraints

Older Children



Older children who have outgrown booster seats should wear the vehicle's safety belts.

The manufacturer's instructions that come with the booster seat, state the weight and height limitations for

that booster. Use a booster seat with a lap-shoulder belt until the child passes the below fit test:

- Sit all the way back on the seat. Do the knees bend at the seat edge? If yes, continue. If no, return to the booster seat.
- Buckle the lap-shoulder belt. Does the shoulder belt rest on the shoulder? If yes, continue. If no, try using the rear safety belt comfort guide. See "Rear Safety Belt Comfort Guides" under *Lap-Shoulder Belt on page 1-14* for more information. If the shoulder belt still does not rest on the shoulder, then return to the booster seat.
- Does the lap belt fit low and snug on the hips, touching the thighs? If yes, continue. If no, return to the booster seat.
- Can proper safety belt fit be maintained for the length of the trip? If yes, continue. If no, return to the booster seat.

Q: What is the proper way to wear safety belts?

A: An older child should wear a lap-shoulder belt and get the additional restraint a shoulder belt can provide. The shoulder belt should not cross the face or neck. The lap belt should fit snugly below the hips, just touching the top of the thighs. This applies belt force to the child's pelvic bones in a crash. It should never be worn over the abdomen, which could cause severe or even fatal internal injuries in a crash.

Also see "Rear Safety Belt Comfort Guides" under *Lap-Shoulder Belt on page 1-14*.

According to accident statistics, children and infants are safer when properly restrained in a child restraint system or infant restraint system secured in a rear seating position.

In a crash, children who are not buckled up can strike other people who are buckled up, or can be thrown out of the vehicle. Older children need to use safety belts properly.

 **CAUTION**

Never do this.

Never allow two children to wear the same safety belt. The safety belt can not properly spread the impact forces. In a crash, the two children can be crushed together and seriously injured. A safety belt must be used by only one person at a time.



 **CAUTION**

Never do this.

Never allow a child to wear the safety belt with the shoulder belt behind their back. A child can be seriously injured by not wearing the lap-shoulder belt properly. In a crash, the child would not be restrained by the shoulder belt.

(Continued)

CAUTION (Continued)

The child could move too far forward increasing the chance of head and neck injury. The child might also slide under the lap belt. The belt force would then be applied right on the abdomen. That could cause serious or fatal injuries. The shoulder belt should go over the shoulder and across the chest.



Infants and Young Children

Everyone in a vehicle needs protection! This includes infants and all other children. Neither the distance traveled nor the age and size of the traveler changes the need, for everyone, to use safety restraints. In fact, the law in every state in the United States and in every Canadian province says children up to some age must be restrained while in a vehicle.

CAUTION

Children can be seriously injured or strangled if a shoulder belt is wrapped around their neck and the safety belt continues to tighten. Never leave children unattended in a vehicle and never allow children to play with the safety belts.

Airbags plus lap-shoulder belts offer protection for adults and older children, but not for young children and infants. Neither the vehicle's safety belt system nor its airbag system is designed for them.

Every time infants and young children ride in vehicles, they should have the protection provided by appropriate child restraints. Every time infants and young children ride in vehicles, they should have the protection provided by appropriate child restraints.

Children who are not restrained properly can strike other people, or can be thrown out of the vehicle.

⚠ CAUTION

Never do this.

Never hold an infant or a child while riding in a vehicle. Due to crash forces, an infant or a child will become so heavy it is not possible to hold it during a crash. For example, in a crash at only 25 mph (40 km/h), a 12 lb (5.5 kg) infant will suddenly become a 240 lb (110 kg) force on a person's arms. An infant should be secured in an appropriate restraint.



⚠ CAUTION

Never do this.

Children who are up against, or very close to, any airbag when it inflates can be seriously injured or killed. Never put a rear-facing child restraint in the right front seat.

(Continued)

CAUTION (Continued)

Secure a rear-facing child restraint in a rear seat. It is also better to secure a forward-facing child restraint in a rear seat. If you must secure a forward-facing child restraint in the right front seat, always move the front passenger seat as far back as it will go.



1-38 Seats and Restraints

Q: What are the different types of add-on child restraints?

A: Add-on child restraints, which are purchased by the vehicle's owner, are available in four basic types. Selection of a particular restraint should take into consideration not only the child's weight, height, and age but also whether or not the restraint will be compatible with the motor vehicle in which it will be used.

For most basic types of child restraints, there are many different models available. When purchasing a child restraint, be sure it is designed to be used in a motor vehicle. If it is, the restraint will have a label saying that it meets federal motor vehicle safety standards.

The restraint manufacturer's instructions that come with the restraint state the weight and height limitations for a particular child restraint. In addition, there are many kinds of restraints available for children with special needs.

CAUTION

To reduce the risk of neck and head injury during a crash, infants need complete support. This is because an infant's neck is not fully developed and its head weighs so much compared with the rest of its body. In a crash, an infant in a rear-facing child restraint settles into the restraint, so the crash forces can be distributed across the strongest part of an infant's body, the back and shoulders. Infants should always be secured in rear-facing child restraints.

CAUTION

A young child's hip bones are still so small that the vehicle's regular safety belt may not remain low on the hip bones, as it should. Instead, it may settle up around the child's abdomen. In a crash, the belt would apply force on a body area that is unprotected by any bony structure. This alone could cause serious or fatal injuries. To reduce the risk of serious or fatal injuries during a crash, young children should always be secured in appropriate child restraints.

Child Restraint Systems



(A) Rear-Facing Infant Seat

A rear-facing infant seat (A) provides restraint with the seating surface against the back of the infant.

The harness system holds the infant in place and, in a crash, acts to keep the infant positioned in the restraint.



(B) Forward-Facing Child Seat

A forward-facing child seat (B) provides restraint for the child's body with the harness.

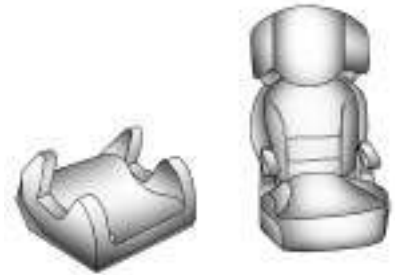

(C) Booster Seats

A booster seat (C) is a child restraint designed to improve the fit of the vehicle's safety belt system. A booster seat can also help a child to see out the window.

Securing an Add-On Child Restraint in the Vehicle

CAUTION

A child can be seriously injured or killed in a crash if the child restraint is not properly secured in the vehicle. Secure the child restraint properly in the vehicle using the vehicle's safety belt or LATCH system, following the instructions that came with that child restraint and the instructions in this manual.

To help reduce the chance of injury, the child restraint must be secured in the vehicle. Child restraint systems must be secured in vehicle seats by lap belts or the lap belt portion of a lap-shoulder belt, or by the LATCH system. See *Lower Anchors and Tethers for Children (LATCH)* on page 1-42 for more information. A child can be endangered in a crash if the child restraint is not properly secured in the vehicle.

When securing an add-on child restraint, refer to the instructions that come with the restraint which may be on the restraint itself or in a booklet, or both, and to this manual. The child restraint instructions are important, so if they are not available, obtain a replacement copy from the manufacturer.

Keep in mind that an unsecured child restraint can move around in a collision or sudden stop and injure people in the vehicle. Be sure to properly secure any child restraint in the vehicle — even when no child is in it.

Securing the Child Within the Child Restraint

CAUTION

A child can be seriously injured or killed in a crash if the child is not properly secured in the child restraint. Secure the child properly following the instructions that came with that child restraint.

Where to Put the Restraint

According to accident statistics, children and infants are safer when properly restrained in a child restraint system or infant restraint system secured in a rear seating position.

We recommend that children and child restraints be secured in a rear seat, including: an infant or a child riding in a rear-facing child restraint; a child riding in a forward-facing child seat; an older child riding in a booster seat; and children, who are large enough, using safety belts.

A label on the sun visor says, "Never put a rear-facing child restraint in the front." This is because the risk to the rear-facing child is so great, if the airbag deploys.

 **CAUTION**

A child in a rear-facing child restraint can be seriously injured or killed if the right front passenger airbag inflates. This is because the back of the rear-facing child restraint would be very close to the inflating airbag. A child in a forward-facing child restraint can be seriously injured or killed if the right front passenger airbag inflates and the passenger seat is in a forward position.

(Continued)

CAUTION (Continued)

Even if the passenger sensing system has turned off the right front passenger frontal airbag, no system is fail-safe. No one can guarantee that an airbag will not deploy under some unusual circumstance, even though it is turned off.

Secure rear-facing child restraints in a rear seat, even if the airbag is off. If you secure a forward-facing child restraint in the right front seat, always move the front passenger seat as far back as it will go. It is better to secure the child restraint in a rear seat.

See *Passenger Sensing System* on page 1-27 for additional information.

When securing a child restraint in a rear seating position, study the instructions that came with the child restraint to make sure it is compatible with this vehicle.

Wherever a child restraint is installed, be sure to secure the child restraint properly.

Keep in mind that an unsecured child restraint can move around in a collision or sudden stop and injure people in the vehicle. Be sure to properly secure any child restraint in the vehicle — even when no child is in it.

Lower Anchors and Tethers for Children (LATCH)

The LATCH system holds a child restraint during driving or in a crash. This system is designed to make installation of a child restraint easier. The LATCH system uses anchors in the vehicle and attachments on the child restraint that are made for use with the LATCH system.

Make sure that a LATCH-compatible child restraint is properly installed using the anchors, or use the vehicle's safety belts to secure the restraint, following the instructions that came with that restraint, and also the instructions in this manual. When installing a child restraint with a top tether, you must also use either the lower anchors or the safety belts to properly secure the child restraint. A child restraint must never be installed using only the top tether and anchor.

In order to use the LATCH system in your vehicle, you need a child restraint that has LATCH attachments. The child restraint manufacturer will provide you with instructions on how to use the child restraint and its attachments. The following explains how to attach a child restraint with these attachments in your vehicle.

Not all vehicle seating positions or child restraints have lower anchors and attachments or top tether anchors and attachments.

Lower Anchors

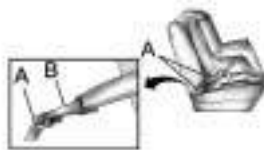

Lower anchors (A) are metal bars built into the vehicle. There are two lower anchors for each LATCH

seating position that will accommodate a child restraint with lower attachments (B).

Top Tether Anchor

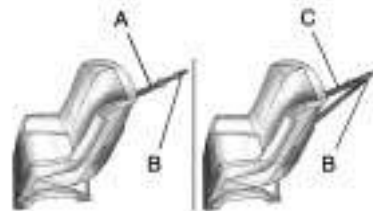

A top tether (A, C) anchors the top of the child restraint to the vehicle. A top tether anchor is built into the vehicle. The top tether attachment (B) on the child restraint connects to the top tether anchor in the vehicle in order to reduce the forward movement and rotation of the child restraint during driving or in a crash.

Your child restraint may have a single tether (A) or a dual tether (C). Either will have a single attachment (B) to secure the top tether to the anchor.

Some child restraints with top tethers are designed for use with or without the top tether being attached. Others require the top tether always to be attached. In Canada, the law requires that forward-facing child restraints have a top tether, and that the tether be attached. Be sure to read and follow the instructions for your child restraint.

If the child restraint does not have a top tether, one can be obtained, in kit form, for many child restraints. Ask the child restraint manufacturer whether or not a kit is available.

Lower Anchor and Top Tether Anchor Locations



Rear Seat

 (Top Tether Anchor): Seating positions with top tether anchors.

 (Lower Anchor): Seating positions with two lower anchors.



To assist you in locating the lower anchors, each seating position with lower anchors has two labels, near the crease between the seatback and the seat cushion.

1-44 Seats and Restraints



The top tether anchors are located on the rear seatback filler panel. Be sure to use an anchor located on the same side of the vehicle as the seating position where the child restraint will be placed.

Do not secure a child restraint in a position without a top tether anchor if a national or local law requires that the top tether be attached, or if the instructions that come with the child restraint say that the top tether must be attached. There is no place to attach the top tether in this position.

Accident statistics show that children are safer if they are restrained in the rear rather than the front seat. See *Where to Put the Restraint* on page 1-40 for additional information.

Securing a Child Restraint Designed for the LATCH System

CAUTION

If a LATCH-type child restraint is not attached to anchors, the child restraint will not be able to protect the child correctly. In a crash, the child could be seriously injured or killed. Install a LATCH-type child restraint properly using the anchors, or use the vehicle's safety belts to secure the restraint, following the instructions that came with the child restraint and the instructions in this manual.

 **CAUTION**

Do not attach more than one child restraint to a single anchor. Attaching more than one child restraint to a single anchor could cause the anchor or attachment to come loose or even break during a crash. A child or others could be injured. To reduce the risk of serious or fatal injuries during a crash, attach only one child restraint per anchor.

 **CAUTION**

Children can be seriously injured or strangled if a shoulder belt is wrapped around their neck and the safety belt continues to tighten. Buckle any unused safety belts behind the child restraint so children cannot reach them. Pull the shoulder belt all the way out of the retractor to set the lock, if your vehicle has one, after the child restraint has been installed.

Notice: Do not let the LATCH attachments rub against the vehicle's safety belts. This may damage these parts. If necessary, move buckled safety belts to avoid rubbing the LATCH attachments.

Do not fold the empty rear seat with a safety belt buckled. This could damage the safety belt or the seat. Unbuckle and return the safety belt to its stowed position.

1. Attach and tighten the lower attachments to the lower anchors. If the child restraint does not have lower attachments or the desired seating position does not have lower anchors, secure the child restraint with the top tether and the safety belts. Refer to your child restraint manufacturer instructions and the instructions in this manual.
 - 1.1. Find the lower anchors for the desired seating position.
 - 1.2. Put the child restraint on the seat.
 - 1.3. Attach and tighten the lower attachments on the child restraint to the lower anchors.

1-46 Seats and Restraints

2. If the child restraint manufacturer recommends that the top tether be attached, attach and tighten the top tether to the top tether anchor, if equipped. Refer to the child restraint instructions and the following steps:
 - 2.1. Find the top tether anchor.
 - 2.2. Route, attach, and tighten the top tether according to your child restraint instructions and the following instructions:



If the position you are using does not have a headrest or head restraint and you are using a single tether, route the tether over the seatback.



If the position you are using does not have a headrest or head restraint and you are using a dual tether, route the tether over the seatback.



If the position you are using has a fixed headrest or head restraint and you are using a dual tether, route the tether around the headrest or head restraint.



If the position you are using has a fixed headrest or head restraint and you are using a single tether, route the tether over the head restraint.

3. Push and pull the child restraint in different directions to be sure it is secure.

Replacing LATCH System Parts After a Crash

CAUTION

A crash can damage the LATCH system in the vehicle. A damaged LATCH system may not properly secure the child restraint, resulting in serious injury or even death in a crash. To help make sure the LATCH system is working properly after a crash, see your dealer/retailer to have the system inspected and any necessary replacements made as soon as possible.

If the vehicle has the LATCH system and it was being used during a crash, new LATCH system parts may be needed.

New parts and repairs may be necessary even if the LATCH system was not being used at the time of the crash.

Securing Child Restraints (Rear Seat)

When securing a child restraint in a rear seating position, study the instructions that came with your child restraint to make sure it is compatible with this vehicle.

If the child restraint has the LATCH system, see *Lower Anchors and Tethers for Children (LATCH)* on page 1-42 for how and where to install your child restraint using LATCH. If a child restraint is secured in the vehicle using a safety belt and it uses a top tether, see *Lower Anchors and Tethers for Children (LATCH)* on page 1-42 for top tether anchor locations.

Do not secure a child restraint in a position without a top tether anchor if a national or local law requires that the top tether be anchored, or if the instructions that come with the child restraint say that the top strap must be anchored.

In Canada, the law requires that forward-facing child restraints have a top tether, and that the tether be attached.

If the child restraint does not have the LATCH system, you will be using the safety belt to secure the child restraint in this position. Be sure to follow the instructions that came with the child restraint. Secure the child in the child restraint when and as the instructions say.

If more than one child restraint needs to be installed in the rear seat, be sure to read *Where to Put the Restraint* on page 1-40.

1. Put the child restraint on the seat.
2. Pick up the latch plate, and run the lap and shoulder portions of the vehicle's safety belt through or around the restraint. The child restraint instructions will show you how.



3. Push the latch plate into the buckle until it clicks.

Position the release button on the buckle so that the safety belt could be quickly unbuckled if necessary.

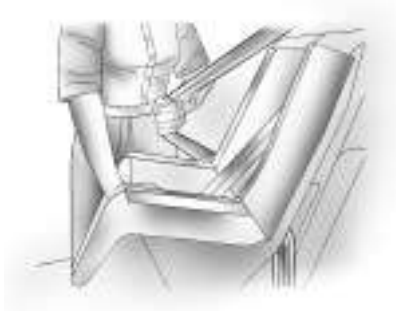

4. Pull the rest of the shoulder belt all the way out of the retractor to set the lock.



5. To tighten the belt, push down on the child restraint, pull the shoulder portion of the belt to tighten the lap portion of the belt, and feed the shoulder belt back into the retractor. When installing a forward-facing child restraint, it may be helpful to use your knee to push down on the child restraint as you tighten the belt.

6. If your child restraint has a top tether, follow the child restraint manufacturer's instructions regarding the use of the top tether. See *Lower Anchors and Tethers for Children (LATCH)* on page 1-42 for more information.
7. Push and pull the child restraint in different directions to be sure it is secure.

To remove the child restraint, unbuckle the vehicle safety belt and let it return to the stowed position. If the top tether is attached to a top tether anchor, disconnect it.

Securing Child Restraints (Right Front Seat)

This vehicle has airbags. A rear seat is a safer place to secure a forward-facing child restraint. See *Where to Put the Restraint* on page 1-40.

In addition, the vehicle has a passenger sensing system which is designed to turn off the right front passenger frontal airbag under certain conditions. See *Passenger Sensing System* on page 1-27 and *Passenger Airbag Status Indicator* on page 4-14 for more information, including important safety information.

A label on the sun visor says, "Never put a rear-facing child seat in the front." This is because the risk to the rear-facing child is so great, if the airbag deploys.

CAUTION

A child in a rear-facing child restraint can be seriously injured or killed if the right front passenger airbag inflates. This is because the back of the rear-facing child restraint would be very close to the inflating airbag. A child in a forward-facing child restraint can be seriously injured or killed if the right front passenger airbag inflates and the passenger seat is in a forward position.

(Continued)

CAUTION (Continued)

Even if the passenger sensing system has turned off the right front passenger frontal airbag, no system is fail-safe. No one can guarantee that an airbag will not deploy under some unusual circumstance, even though it is turned off.

Secure rear-facing child restraints in a rear seat, even if the airbag is off. If you secure a forward-facing child restraint in the right front seat, always move the front passenger seat as far back as it will go. It is better to secure the child restraint in a rear seat.

See *Passenger Sensing System* on page 1-27 for additional information.

If the child restraint has the LATCH system, see *Lower Anchors and Tethers for Children (LATCH)* on page 1-42 for how and where to install the child restraint using LATCH. If a child restraint is secured using a safety belt and it uses a top tether, see *Lower Anchors and Tethers for Children (LATCH)* on page 1-42 for top tether anchor locations.

Do not secure a child seat in a position without a top tether anchor if a national or local law requires that the top tether be anchored, or if the instructions that come with the child restraint say that the top strap must be anchored.

In Canada, the law requires that forward-facing child restraints have a top tether, and that the tether be attached.

You will be using the lap-shoulder belt to secure the child restraint in this position. Follow the instructions that came with the child restraint.

1. Move the seat as far back as it will go before securing the forward-facing child restraint.

When the passenger sensing system has turned off the right front passenger frontal airbag, the off indicator on the passenger airbag status indicator should light and stay lit when the vehicle is started. See *Passenger Airbag Status Indicator* on page 4-14.

2. Put the child restraint on the seat.

3. Pick up the latch plate, and run the lap and shoulder portions of the vehicle's safety belt through or around the restraint. The child restraint instructions will show you how.



4. Push the latch plate into the buckle until it clicks. Position the release button, on the buckle so that the safety belt, could be quickly unbuckled if necessary.

1-52 Seats and Restraints

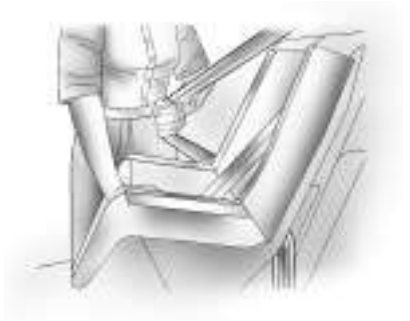

5. Pull the rest of the shoulder belt all the way out of the retractor to set the lock.



6. To tighten the belt, push down on the child restraint, pull the shoulder portion of the belt to tighten the lap portion of the belt and feed the shoulder belt back into the retractor. When installing a forward-facing child restraint, it may be helpful to use your knee to push down on the child restraint as you tighten the belt.
7. Push and pull the child restraint in different directions to be sure it is secure.

If the airbag is off, the off indicator in the passenger airbag status indicator will come on and stay on when the vehicle is started.

If a child restraint has been installed and the on indicator is lit, see "If the On Indicator is Lit for a Child Restraint" under *Passenger Sensing System* on page 1-27 for more information.

To remove the child restraint, unbuckle the vehicle safety belt and let it return to the stowed position.

Keys, Doors and Windows

Keys

Keys	2-2
Remote Keyless Entry (RKE) System	2-3
Remote Keyless Entry (RKE) System Operation	2-4
Remote Vehicle Start	2-6

Doors and Locks

Door Locks	2-8
Power Door Locks	2-9
Rear Door Security Locks	2-9
Trunk	2-10

Theft-Deterrent Systems

Theft-Deterrent Systems	2-11
Immobilizer	2-11
Immobilizer Operation	2-12
Content Theft-Deterrent	2-13

Windows

Windows	2-14
Power Windows	2-15
Sun Visors	2-15

Mirrors

Manual Rearview Mirror	2-16
Compass	2-16
Outside Power Mirror(s)	2-17
Outside Convex Mirror	2-18

Sunroof

Sunroof	2-18
---------------	------

2-2 Keys, Doors and Windows

Keys

CAUTION

Leaving children in a vehicle with the ignition key is dangerous for many reasons, children or others could be badly injured or even killed. They could operate the power windows or other controls or even make the vehicle move. The windows will function with the keys in the ignition and children could be seriously injured or killed if caught in the path of a closing window. Do not leave the keys in a vehicle with children.



One key, located inside the Remote Keyless Entry (RKE) transmitter, can be used for the ignition and all locks except the glovebox.

Press the button on the RKE transmitter to extend the key. Press the button and the key blade to retract the key.

A fixed blade key is also supplied for the glovebox.

See your dealer/retailer if a new key is needed.

Notice: If you ever lock your keys in the vehicle, you may have to damage the vehicle to get in. Be sure you have spare keys.

Contact Roadside Assistance or OnStar if you are locked out of the vehicle. See *Roadside Assistance Program* on page 12-6 or *OnStar® System* on page 4-35.

Remote Keyless Entry (RKE) System

The Remote Keyless Entry (RKE) system operates on a radio frequency subject to Federal Communications Commission (FCC) Rules and with Industry Canada.

This device complies with Part 15 of the FCC Rules. Operation is subject to the following two conditions:

1. This device may not cause interference.
2. This device must accept any interference received, including interference that may cause undesired operation of the device.

This device complies with RSS-210 of Industry Canada. Operation is subject to the following two conditions:

1. This device may not cause interference.
2. This device must accept any interference received, including interference that may cause undesired operation of the device.

Changes or modifications to this system by other than an authorized service facility could void authorization to use this equipment.

If there is a decrease in the RKE operating range, try this:

- Check the distance. The transmitter may be too far from the vehicle. Stand closer during rainy or snowy weather.
- Check the location. Other vehicles or objects may be blocking the signal. Take a few steps to the left or right, hold the transmitter higher, and try again.
- Check the transmitter's battery. See "Battery Replacement" later in this section.
- If the transmitter is still not working correctly, see your dealer/retailer or a qualified technician for service.

2-4 Keys, Doors and Windows

Remote Keyless Entry (RKE) System Operation

The Remote Keyless Entry (RKE) transmitter functions will work up to 195 feet (60 m) away from the vehicle.

There are other conditions which can affect the performance of the transmitter. See *Remote Keyless Entry (RKE) System on page 2-3*.



RKE with Remote Start Shown

The following functions may be available if the vehicle has the RKE system.

🔒 (Lock): Press to lock all doors.

If enabled through the Driver Information Center (DIC), the turn signal indicators flash or the horn sounds to indicate locking has occurred. For more information see “Flash Remote Lock” and “Beep Remote Lock” under *DIC Vehicle Customization on page 4-31*.

If any door is open when **🔒** is pressed, the horn sounds five times. All doors lock except the open door.

If the driver door is open when **🔒** is pressed, all doors lock except the driver door.

Pressing **🔒** may also arm the content theft-deterrent system. See *Content Theft-Deterrent on page 2-13*.

🔓 (Unlock): Press to unlock the driver door or all doors depending on the personalization setting. To customize remote unlocking, see “Two Stage Unlock” under *DIC Vehicle Customization on page 4-31*.



If enabled through the DIC, the turn signal indicators flash to indicate unlocking has occurred. For more information see “Flash Remote Unlock” under *DIC Vehicle Customization on page 4-31*.

Pressing **🔓** may also disarm the content theft-deterrent system. See *Content Theft-Deterrent on page 2-13*.

🚗 (Remote Trunk Release): Press and hold to unlock the trunk.

 **(Vehicle Locator/Panic Alarm):**

Press and release one time to locate the vehicle. The exterior lamps flash and the horn chirps.

Press and hold  for at least two seconds to sound the panic alarm. The horn sounds and the turn signals flash until  is pressed again or the key is placed in the ignition and turned to ON/RUN.

 **(Remote Vehicle Start):**

For vehicles with this feature, press to start the engine from outside the vehicle using the RKE transmitter. See *Remote Vehicle Start on page 2-6* for additional information.

Personal Identity Keys

This system stores electronic settings for two different keys. The settings are stored when a personal identity key is removed from the ignition and recalled when

 on the RKE transmitter is pressed. For information on storing climate control settings, radio settings and trip computer settings, see “Personal Identity Memories” under *Radio(s) on page 6-3*, “Ignition Keys” under *Climate Control System on page 7-1* and “Trip Computer” under *DIC Vehicle Customization on page 4-31*.

Programming Transmitters to the Vehicle

Only RKE transmitters programmed to this vehicle will work. If a transmitter is lost or stolen, a replacement can be purchased

and programmed through your dealer/retailer. When the replacement transmitter is programmed to this vehicle, all remaining transmitters must also be reprogrammed. Any lost or stolen transmitters will no longer work once the new transmitter is programmed.

Battery Replacement

Replace the battery if the Replace Battery in Remote Key message displays in the DIC. See “Replace Battery in Remote Key” under *DIC Warnings and Messages on page 4-26*.

The battery is not rechargeable. See your dealer/retailer to replace the battery.

2-6 Keys, Doors and Windows

Remote Vehicle Start

Your vehicle may have this feature which allows you to start the engine from outside the vehicle.

(Remote Vehicle Start):

This button will be on the RKE transmitter if you have remote start.

To enable and disable remote start, see “Remote Start” under *DIC Vehicle Customization on page 4-31*.

Vehicles with an automatic climate control system will default to a heating or cooling mode depending on the outside temperature during a remote start. When the key is turned to ON/RUN, the climate control system will turn on at the setting the vehicle was set to when the vehicle was last turned off.

Laws in some local communities may restrict the use of remote starters. For example, some laws may require a person using remote start to have the vehicle in view when doing so. Check local regulations for any requirements on remote starting of vehicles.



If your vehicle is low on fuel, do not use the remote start feature. The vehicle may run out of fuel.

If your vehicle has the remote start feature, the RKE transmitter functions will have an increased range of operation. However, the range may be less while the vehicle is running.

There are other conditions which can affect the performance of the transmitter, see *Remote Keyless Entry (RKE) System on page 2-3* for additional information.

Starting the Engine Using Remote Start

To start the engine using the remote start feature:

1. Press  on the RKE transmitter.
2. Press and hold  for about two seconds. The turn signal lamps will briefly flash to confirm the vehicle has been started. The parking lamps will turn on and remain on as long as the engine is running. The vehicle's doors will be locked.
3. After entering the vehicle during a remote start, insert and turn the key to ON/RUN to drive the vehicle.

After a remote start, the engine will automatically shut off after 10 minutes unless a time extension has been done or the vehicle's key is inserted into the ignition switch and turned to ON/RUN.

Extending Engine Run Time

To extend the engine run time by 10 minutes, repeat Steps 1 and 2 while the engine is still running. The engine run time can only be extended if it is the first remote start since the vehicle has been driven. Remote start can be extended one time.

If the remote start procedure is used again before the first 10 minute time frame has ended, the first 10 minutes will immediately expire and the second 10 minute time frame will start.

For example, if the lock button and then the remote start buttons are pressed again after the vehicle has been running for five minutes, 10 minutes are added, allowing the engine to run for a total of 15 minutes.

A maximum of two remote starts or remote start attempts are allowed between ignition cycles.

After your vehicle's engine has been started two times using the remote start button, the vehicle's ignition switch must be turned to ON/RUN and then back to LOCK/OFF using the key before the remote start procedure can be used again.

Shutting the Engine Off After a Remote Start

To manually shut off the engine after a remote start, do any of the following:

- Press  until the parking lamps turn off.
- Turn on the hazard warning flashers.
- Insert the vehicle's key into the ignition switch and turn the switch to ON/RUN and then back to LOCK/OFF.

Conditions in Which Remote Start Will Not Work

The remote vehicle start feature will not operate if any of the following occur:

- The vehicle's key is in the ignition.
- The vehicle's hood or doors are not closed.
- The hazard warning flashers are on.
- There is an emission control system malfunction.
- The engine coolant temperature is too high.
- The oil pressure is low.
- Two remote vehicle starts have already been used. The maximum number of remote starts or remote start attempts between ignition cycles with the key is two.
- The vehicle is not in P (Park).

Doors and Locks

Door Locks

 **CAUTION**

Unlocked doors can be dangerous.

- Passengers, especially children, can easily open the doors and fall out of a moving vehicle. When a door is locked, the handle will not open it. You increase the chance of being thrown out of the vehicle in a crash if the doors are not locked. So, wear safety belts properly and lock the doors whenever you drive.

(Continued)

CAUTION (Continued)

- Young children who get into unlocked vehicles may be unable to get out. A child can be overcome by extreme heat and can suffer permanent injuries or even death from heat stroke. Always lock your vehicle whenever you leave it.
- Outsiders can easily enter through an unlocked door when you slow down or stop your vehicle. Locking your doors can help prevent this from happening.

Manual Door Locks

Unlock the driver door manually from the outside using the key. Turn the key counter-clockwise once to unlock the driver door, and twice to unlock all doors.

Lock all doors manually from the outside by turning the key clockwise.

Lock and unlock the doors manually from inside the vehicle using the knob on the door. Do not use the manual door lock knob when the door is open.

The door lock cylinder turns freely when either the wrong key is used, or the correct key is not fully inserted. The free turning door lock feature prevents the lock from being forced open.

To reset the lock, turn it to the vertical position with the correct key fully inserted. Remove the key and insert it again.

If this does not reset the lock, turn the key half-way around in the cylinder and repeat the reset procedure.

Power Door Locks

The power door lock switch is located on the center console.

 **(Unlock):** Press to unlock the doors.

 **(Lock):** Remove the key from the ignition and press to lock the doors.

Rear Door Security Locks

Your vehicle has rear door security locks to prevent passengers from opening the rear doors from the inside.

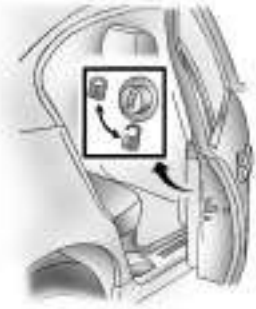

Open the rear doors to access the security locks on the inside edge of each door.

To set the locks, insert a key into the slot and turn it to the horizontal position. The door can only be opened from the outside with the door unlocked. To return the door to normal operation, turn the slot to the vertical position.

Trunk

CAUTION

It can be dangerous to drive with the trunk lid open because carbon monoxide (CO) gas can come into your vehicle. You cannot see or smell CO. It can cause unconsciousness and even death. If you must drive with the trunk lid open or if electrical wiring or other

(Continued)

CAUTION (Continued)

cable connections must pass through the seal between the body and the trunk lid:

- Make sure all other windows are shut.
- Turn the fan on your heating or cooling system to its highest speed and select the control setting that will force outside air into your vehicle. See Climate Control System.
- If you have air outlets on or under the instrument panel, open them all the way.

See *Engine Exhaust* on page 8-14.

Remote Trunk Release

To open the trunk from the outside the vehicle, press the  button on the Remote Keyless Entry (RKE) transmitter.

From inside the vehicle, press the  button located in the glove box.

The trunk can only be opened while the vehicle is in PARK (P), and when the doors are unlocked.

Emergency Trunk Release Handle

Notice: Do not use the emergency trunk release handle as a tie-down or anchor point when securing items in the trunk as it could damage the handle. The emergency trunk release handle is only intended to aid a person trapped in a latched trunk, enabling them to open the trunk from the inside.



There is an emergency trunk release handle located inside the trunk on the trunk latch. Access the release handle by folding the rear seat center seatback. See *Rear Seat Operation on page 1-5*. Pull the release handle to open the trunk from the inside.

The release can also be pulled from inside the trunk.

Theft-Deterrent Systems

Vehicle theft is big business, especially in some cities. This vehicle has theft-deterrent features, however, they do not make it impossible to steal.

Immobilizer

This device complies with Part 15 of the FCC Rules. Operation is subject to the following two conditions:

1. This device may not cause interference.
2. This device must accept any interference received, including interference that may cause undesired operation.

This device complies with RSS-210 of Industry Canada. Operation is subject to the following two conditions:

1. This device may not cause interference.
2. This device must accept any interference received, including interference that may cause undesired operation of the device.

Changes or modifications to this system by other than an authorized service facility could void authorization to use this equipment.

2-12 Keys, Doors and Windows

Immobilizer Operation

This vehicle has a passive theft-deterrent system.

The system is automatically armed when the key is removed from the ignition.

The system is disarmed when the key is turned to ON/RUN.

You do not have to manually arm or disarm the system.

The key uses a transponder that matches an immobilizer control unit in the vehicle and automatically disarms the system. Only the correct key starts the vehicle. The vehicle may not start if the key is damaged.

If the vehicle does not start:

- Make sure the fold away key is fully extended.
- Avoid attaching several keys with the ignition key.
- Avoid attaching keys from other vehicles to the ignition key.

- Do not attempt to start the vehicle with a non-approved key.
- Do not disassemble the key.

When trying to start the vehicle, if the engine does not start, the key may have a damaged transponder. Turn the ignition off and try again.

If the engine still does not start, and the key appears to be undamaged, try another ignition key.

If the engine still does not start, the vehicle needs service. See your dealer/retailer to service the theft-deterrent system and have a new key made.

The following procedure is for programming additional keys only. If all vehicle keys are lost or no longer work, see your dealer/retailer. A new key must be made prior to programming.

A maximum of four keys can be programmed for the vehicle.

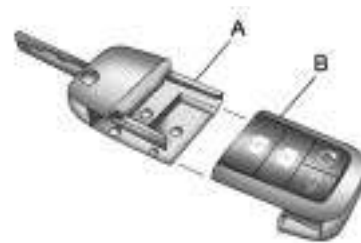

The key is purchased as two sections: the key blade and immobilizer section (A) and the remote keyless entry and remote start system section (B).



Do not join the two key sections until programming is complete.

To program a new section (A):

1. Insert the original, already programmed key into the ignition and start the engine. If the engine does not start, see your dealer/retailer.
2. Remove the key from the ignition.

3. Insert and turn the new section (A) to ON/RUN within five seconds of removing the original key.
4. Turn the new section (A) to LOCK/OFF. Section (A) is now programmed.

To program a new section (B):

1. Turn the ignition to ON/RUN with the new section (A).
The vehicle must be in P (Park).
2. Select Remote Key from the personalization menu.
3. Select Program.
4. Press  and  on the new section (B), at the same time, until you hear two beeps.
5. Repeat Step 4 for all other keys, including keys that require programming or ones previously programmed to the vehicle. Any key not reprogrammed will be erased.

6. Turn the ignition to LOCK/OFF.
7. Join sections (A) and (B) until they click.

Do not join the two key sections until programming is complete.

Do not leave the key or device that disarms or deactivates the theft deterrent system in the vehicle.

Content Theft-Deterrent

This vehicle has a content theft-deterrent alarm system.

Arming the System

To arm the system, either:

- Press  on the RKE transmitter.
- Or, lock the vehicle using the key in the driver door.

The alarm automatically arms after about 30 seconds. The security light, located on the instrument panel, flashes.

Press  on the RKE transmitter to open the trunk without setting off the alarm. The system rearms when the trunk is closed.

Disarming the System

To disarm the system, do one of the following:

- Press  on the RKE transmitter.
- Turn the ignition to ON/RUN.
- Allow the alarm to time out after about 30 seconds and reset itself.

The alarm automatically disarms.

If the system is armed and any door is unlocked without pressing  on the RKE transmitter the alarm sounds.

2-14 Keys, Doors and Windows

How to Detect a Tamper Condition

If  is pressed and the horn sounds, an attempted break-in has occurred while the system was armed.

If the alarm has been activated, the Alarm Activated message appears followed by a message showing what location set off the alarm.

If there is more than one, all will appear. Each message appears for about one second and returns to the Alarm Activated message. See *DIC Warnings and Messages on page 4-26* for additional information.

Windows

CAUTION

Leaving children, helpless adults, or pets in a vehicle with the windows closed is dangerous. They can be overcome by the extreme heat and suffer permanent injuries or even death from heat stroke. Never leave a child, a helpless adult, or a pet alone in a vehicle, especially with the windows closed in warm or hot weather.



Power Windows

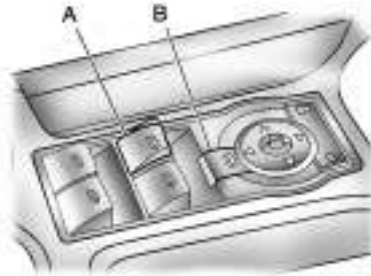

- A. Power Window Switches
- B. Rear Window Lockout Switch

The power window switches (A) for all doors are located on the center console. The switches work when the ignition is in ON/RUN, ACC/ACCESSORY, or in Retained Accessory Power (RAP). See *Retained Accessory Power (RAP)* on page 8-3.

Press down or pull up on the switch to open or close a window.

Express-Down Window

The driver and front passenger window switches have an express-down feature to allow the window to be lowered without holding the switch. Press the switch down all the way, release it, and the window goes down automatically. Stop the window while it is lowering by pressing or pulling the switch.

Rear Window Lockout

Press the lockout button  (B), to prevent rear seat passengers from operating the windows. Press the button again to turn the feature off.

Rear Power Windows

The rear doors have their own switches.

- ▼ : Press to open the window.
- ▲ : Press to close the window.

Sun Visors

Pull the visor toward you, or move it to the side to help reduce glare.

Mirrors

Manual Rearview Mirror

The vehicle has a manual rearview mirror with a compass display and OnStar[®] control buttons located at the bottom of the mirror. See your dealer/retailer for more information on the system and how to subscribe to OnStar. See *OnStar[®] System on page 4-35* for more information about the services OnStar provides.

Adjust the mirror to see clearly behind your vehicle. Hold it in the center to move it up or down and side to side.

Headlamp Glare

1. To reduce headlamp glare from vehicles following from behind, pull the lever toward you. The rear view clarity is reduced when the mirror is set to reduce headlamp glare.
2. Return the lever back to its original position as soon as the glare has disappeared to restore the rear view.

Cleaning the Mirror

Do not spray glass cleaner directly on the mirror. Use a paper towel or similar material dampened with glass cleaner.

Compass

Compass Display

 **(On/Off):** Press to turn the compass on or off. The compass display can show a maximum of two characters. For example, NE is displayed for north-east.

When the ignition and the compass feature are on, a character box displays for about two seconds. After two seconds, the mirror displays the direction the vehicle is facing.

Compass Calibration

When on, the compass automatically calibrates as the vehicle is driven. If, after two seconds, the display does not show a compass direction, (N for North, for example), there may be a strong magnetic field interfering with the compass. Interference can be caused by a magnetic antenna

mount, magnetic note pad holder, or a similar magnetic item. If CAL should ever display in the compass window, the compass might need calibration.

Press and hold  for several seconds to activate the compass calibration mode. CAL displays in the compass window on the mirror.

The mirror can be calibrated by driving the vehicle in circles at 5 mph (8 km/h) or less until the display shows a direction.



Compass Variance

The mirror is set to zone eight. If you do not live in zone eight or drive out of the area, the compass variance needs to be changed to the appropriate zone.

To adjust for compass variance:

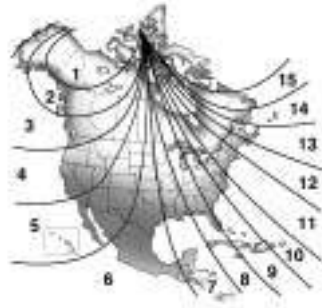
1. Find the current location and variance zone number on the following zone map.



2. Press and hold  until zone displays.
3. Once zone displays, press  repeatedly until the correct zone number displays. If CAL displays in the compass window, the compass might need calibration. See "Compass Calibration" explained previously.

Outside Power Mirror(s)



To adjust the mirrors:

1. With the ignition on, move the selector switch located on the center console to the left or right to choose either the driver's or passenger side mirror.
2. Press the arrows located on the four-way control pad to adjust the mirror. Adjust each outside mirror to see a little of your vehicle, and the area behind your vehicle.

Keep the selector switch in the center position when not adjusting either outside mirror.

2-18 Keys, Doors and Windows

Manually fold the mirrors inward to prevent damage when going through an automatic car wash. To fold, push the mirror toward the vehicle. Push the mirror outward, to return to its original position.

Outside Convex Mirror

CAUTION

A convex mirror can make things (like other vehicles) look farther away than they really are. If you cut too sharply into the right lane, you could hit a vehicle on the right. Check the inside mirror or glance over your shoulder before changing lanes.

The passenger side mirror is convex shaped. A convex mirror's surface is curved so more can be seen from the driver's seat.

Sunroof



The sunroof control is located between the sun visors. It works when the ignition is in ON/RUN. The sunroof will not operate after the engine is turned off.

From the closed position , turn the control clockwise to one of the six open positions. The sunshade opens with the sunroof.

Tilt the sunroof by turning the control counter-clockwise.

Obstruction Detection

When the sunroof encounters an obstruction while closing, it immediately returns to the fully open or tilt position. The sunroof will not move again until the control is pressed upward, or a different position is selected.

Storage

Storage

Glove Box	3-1
Cupholders	3-1
Center Console Storage	3-1
Convenience Net	3-2

Storage

Glove Box

Lift the glovebox handle up to open it. Use the key to lock and unlock the glovebox.

Cupholders

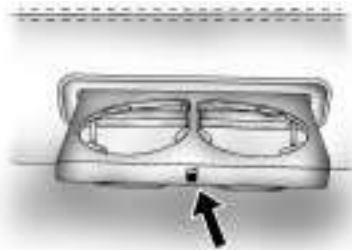

For vehicles with a rear seat cupholder, there is a cupholder on the front edge of the rear seat cushion. To open or close, press on the cupholder.

Center Console Storage

A storage area is provided under the front armrest.

To open, lift the latch on the underside of the front edge and lift the cover.

There is a coin holder towards the front of the center console storage. A rubber lining inside the storage area has slots to hold CDs.

3-2 Storage

Convenience Net

A convenience net is provided inside the trunk to secure loose items. Four hooks are provided, on each side of the trunk. The net has six loops to attach on the hooks.

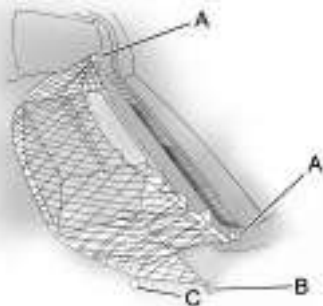

To install the net, attach each of the corner loops (A, B) to the four hooks inside the trunk, leaving the center loop (C) unhooked.

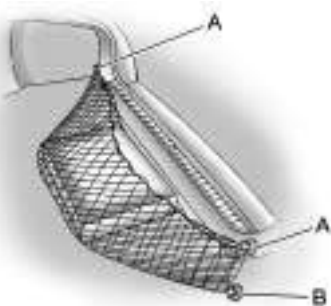

To create a pouch, attach the four corner loops (A) to each of the two top hooks. Attach the nets center loops (B) to the bottom hooks.

Instruments and Controls

Instrument Panel Overview

Instrument Panel Overview	4-2
Hazard Warning	
Flashers	4-4
Horn	4-4
Tilt Wheel	4-4
Turn Signal/Multifunction Lever	4-4
Cruise Control	4-5
Turn and Lane-Change Signals	4-7
Headlamp High/Low-Beam Changer	4-7
Windshield Wipers	4-8
Windshield Washer	4-8
Accessory Power Outlet(s)	4-9

Warning Lights, Gages, and Indicators

Warning Lights, Gages, and Indicators	4-10
Instrument Panel Cluster	4-11
Speedometer	4-12
Tachometer	4-12
Safety Belt Reminders	4-12
Airbag Readiness Light	4-13
Passenger Airbag Status Indicator	4-14
Voltmeter Gage	4-15
Charging System Light	4-15
Brake System Warning Light	4-15
Antilock Brake System (ABS) Warning Light	4-16
Engine Coolant Temperature Gage	4-17
Tire Pressure Light	4-17
Malfunction Indicator Lamp	4-18
Security Light	4-20
Fog Lamp Light	4-20

Highbeam On Light	4-20
Daytime Running Lamps (DRL) Indicator Light	4-21
Door Ajar Light	4-21
Oil Pressure Gage	4-21
Fuel Gage	4-21

Driver Information Center (DIC)

Driver Information Center (DIC)	4-22
DIC Operation and Displays	4-22
DIC Warnings and Messages	4-26
DIC Vehicle Customization	4-31

OnStar® System

OnStar® System	4-35
----------------------	------

Instrument Panel Overview

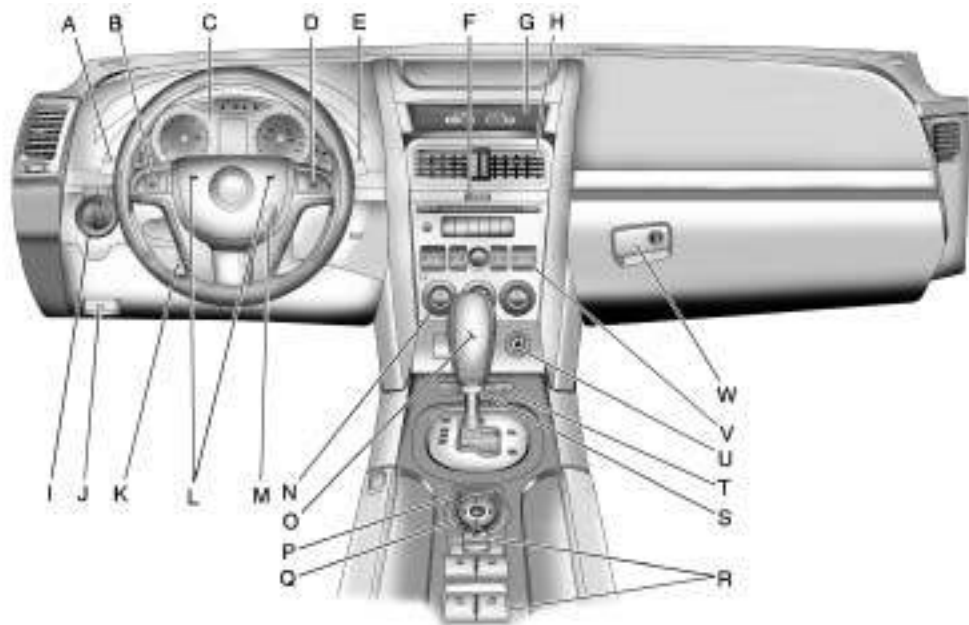

The main components of the instrument panel are the following:

- A. *Turn Signal/Multifunction Lever on page 4-4.*
- B. *Audio Steering Wheel Controls on page 6-36 and DIC Operation and Displays on page 4-22.*
- C. *Instrument Panel Cluster on page 4-11.*
- D. *Audio Steering Wheel Controls on page 6-36.*
- E. *Windshield Wipers on page 4-8.*
- F. *Hazard Warning Flashers on page 4-4.*
- G. *Voltmeter, Oil Gage. Voltmeter Gage on page 4-15.*
- H. *Outlet Adjustment on page 7-9.*
- I. *Exterior Lamps Controls on page 5-1. Instrument Panel Brightness on page 5-3. Fog Lamps on page 5-3 (If Equipped).*
- J. *Hood Release on page 9-5.*
- K. *Tilt Wheel on page 4-4.*
- L. *Horn on page 4-4.*
- M. *Ignition Positions on page 8-2.*
- N. *Climate Control System on page 7-1. Automatic Climate Control System on page 7-4 (If Equipped).*
- O. *Shift Lever. Automatic Transmission Operation on page 8-6.*
- P. *Power Door Locks on page 2-9.*
- Q. *Outside Power Mirror(s) on page 2-17.*
- R. *Power Windows on page 2-15.*
- S. *Traction Control System (TCS) Disable Button. Electronic Stability Program on page 8-19.*
- T. *Heated Seats on page 1-5 (If Equipped).*
- U. *Accessory Power Outlet(s) on page 4-9.*
- V. *Audio System(s) on page 6-1.*
- W. *Glove Box on page 3-1.*

4-4 Instruments and Controls

Hazard Warning Flashers

(Hazard Warning Flasher):

Press this button located on the instrument panel, to make the front and rear turn signal lamps flash on and off. This warns others that you are having trouble.

Press  again to turn the flashers off.

Horn

Press near or on the horn symbols on the steering wheel pad to sound the horn.

Tilt Wheel

A tilt and telescope wheel lets the steering wheel position be adjusted.

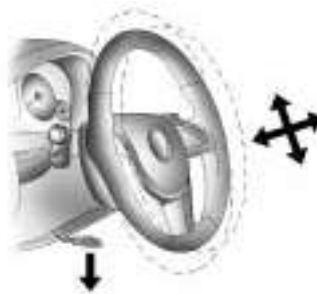

The adjustment lever is located on the left side of the steering column.

Pull the lever down to move the steering wheel up or down and in or out. Pull the lever up to lock the steering wheel in place.

Do not adjust the tilt and telescope lever while driving.

Turn Signal/Multifunction Lever



The lever on the left side of the steering column includes the following:

 : Cruise Control (If Equipped).

Turn and Lane-Change Signals.

Headlamp High/Low-Beam Changer.

Information for these features is on the pages following.

Cruise Control



For vehicles with cruise control, the lever is located on the left side of the steering wheel.

The cruise control maintains the vehicle's speed without having your foot on the accelerator pedal. The cruise control only works at speeds above 21 mph (33 km/h) (V6 engines) or above 24 mph (38 km/h) (V8 engines).

⚠ CAUTION

Cruise control can be dangerous where you cannot drive safely at a steady speed. So, do not use your cruise control on winding roads or in heavy traffic.

Cruise control can be dangerous on slippery roads. On such roads, fast changes in tire traction can cause excessive wheel slip, and you could lose control. Do not use cruise control on slippery roads.

Setting Cruise Control

⚠ CAUTION

If you leave your cruise control on when you are not using cruise, you might hit a button and go into cruise when you do not want to. You could be startled and even lose control. Keep the cruise control switch off until you want to use cruise control.

1. Press the  button at the end of the cruise control lever. The CRUISE ON light comes on in the instrument panel cluster. See *Instrument Panel Cluster* on page 4-11.
2. Get up to the desired speed.
3. Turn the band down to SET- and then release it. The CRUISE ACTIVE light comes on in the instrument panel cluster.
4. Take your foot off the accelerator pedal.

4-6 Instruments and Controls

If the vehicle is in cruise control and the Electronic Stability Program (ESP) becomes active, the cruise control automatically disengages. See *Electronic Stability Program on page 8-19*. When road conditions allow the cruise control can be used again.

Resuming a Set Speed

If the cruise control is set at a desired speed and then the brakes are applied or the  button is pressed once, the cruise control shuts off.

Once the vehicle speed is 21 mph (33 km/h) (V6 engines) or 24 mph (38 km/h) (V8 engines) or greater, turn the band briefly to RES+ position. The vehicle returns to the previously set speed and stays there.

Increasing Speed While Using Cruise Control

There are two ways to go to a higher speed:

- Turn the  band up to the RES+ position. Hold it there until the desired speed is reached, then release it.
- To increase the vehicle speed in very small amounts, turn the band to RES+ briefly and then release it. Each time this is done, the vehicle goes about 1 mph (1.6 km/h) faster.

Reducing Speed While Using Cruise Control

There are two ways to reduce the vehicle speed while using cruise control:

- Turn the  band down to the SET- position. Hold it there until the lower speed desired is reached, then release it.

- To slow down in very small amounts, turn the band to SET- briefly and then release it. Each time this is done, the vehicle will go about 1 mph (1.6 km/h) slower.

Passing Another Vehicle While Using Cruise Control

Use the accelerator pedal to increase the vehicle speed. When you take your foot off the pedal, the vehicle slows down to the cruise control speed set earlier.



Using Cruise Control on Hills

How well the cruise control works on hills depends upon the vehicle speed, load, and the steepness of the hills.

When going up steep hills, you might have to step on the accelerator pedal to maintain the vehicle speed.

When going downhill, you might have to brake or shift to a lower gear to keep the vehicle speed down. When the brakes are applied the cruise control is turned off.



Ending Cruise Control

- Step lightly on the brake pedal. When the cruise control is deactivated, the CRUISE INACTIVE message appears in the instrument panel cluster.
- Press the   button at the end of the lever two times.

Erasing Speed Memory

The cruise control set speed memory is erased when the cruise control or the ignition is turned off.

Turn and Lane-Change Signals

An arrow   on the instrument panel cluster flashes in the direction of the turn or lane change.

To signal a turn, move the lever all the way up or down.

To signal a lane change, slightly raise or lower the lever until the arrow starts to flash and release the lever. The turn signal flashes automatically three times.

The lever returns to its starting position when it is released.

To cancel the lane change, move the lever back to the starting position.

Headlamp High/Low-Beam Changer

The headlamps must be on for this feature to work.

Push the turn signal lever away from you to turn the high beams on. The fog lamps turn off automatically when high beam is selected.

This instrument panel cluster light  comes on while the high beam headlamps are on.

Pull the lever towards you to return to low beams.

To flash the high beams, pull the lever towards you. The lamps remain on high beam as long as the lever is held.

Windshield Wipers

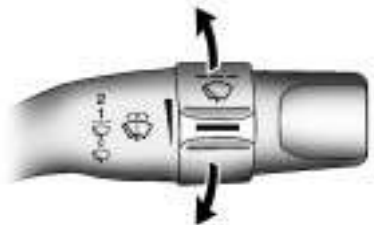



The windshield wiper/washer lever is located on the right side of the steering column.

The ignition must be turned to the ON/RUN or ACC/ACCESSORY position to use the windshield wipers.

Move the lever to the following positions:

 **(Mist):** Hold the lever in this position for continuous wiping cycles.

 **(Off):** Turns the wipers off.

 **(Intermittent):** For a delayed wiping cycle. Turn the  band forward or rearward for more frequent or less frequent wipes.

The frequency of wipes also depends on the vehicle speed. As the vehicle speed increases, so does the wiper rate.

1 (Low): For steady wiping at low speed.

2 (High): For steady wiping at high speed.

Never use the wipers on dry glass, as this could damage the wiper blade inserts and scratch the glass.

Be sure to clear ice and snow from the wiper blades before using them. If the blades are frozen to the windshield, carefully loosen or thaw them. If they become damaged, get new blades or blade inserts.

Heavy snow or ice can overload the wipers. A circuit breaker stops them until the motor cools. Clear away snow or ice to prevent an overload.

Windshield Washer

Pull the lever toward you to spray washer fluid on the windshield. The spray continues until the lever is released. The wipers will run a few times. See *Windshield Washer Fluid* on page 9-23 for information on filling the windshield washer fluid reservoir.



CAUTION

In freezing weather, do not use your washer until the windshield is warmed. Otherwise the washer fluid can form ice on the windshield, blocking your vision.

Accessory Power Outlet(s)

The accessory power outlets can be used to connect auxiliary electrical equipment, such as a cellular phone.

The vehicle has two accessory power outlets. One accessory power outlet is located under the climate controls and the other is located inside the center floor console.

To use the outlet, the ignition must be in ON/RUN or ACC/ACCESSORY. Pull down the small cover to access the outlet.

Notice: Leaving electrical equipment on for extended periods will drain the battery. Always turn off electrical equipment when not in use and do not plug in equipment that exceeds the maximum amperage rating.

This circuit is protected by a fuse and has a maximum current level. Do not use equipment exceeding the maximum amperage rating.

Certain power accessory plugs may not be compatible to the power accessory outlet and could result in blown vehicle or adapter fuses. If you experience a problem see your dealer/retailer for additional information on the power accessory plugs.

Notice: Adding any electrical equipment to the vehicle may damage it or keep other components from working as they should. The repairs would not be covered by the vehicle warranty. Do not use equipment exceeding maximum amperage rating of 10 amperes. Check with your dealer/retailer before adding electrical equipment.

When adding electrical equipment, be sure to follow the proper installation instructions included with the equipment.

Notice: Improper use of the power outlet can cause damage not covered by your warranty. Do not hang any type of accessory or accessory bracket from the plug because the power outlets are designed for accessory power plugs only.

Warning Lights, Gages, and Indicators

Warning lights and gages can signal that something is wrong before it becomes serious enough to cause an expensive repair or replacement. Paying attention to the warning lights and gages could prevent injury.

Warning lights come on when there may be or is a problem with one of the vehicle's functions. Some warning lights come on briefly when the engine is started to indicate they are working.

Gages can indicate when there may be or is a problem with one of the vehicle's functions. Often gages and warning lights work together to indicate a problem with the vehicle.

When one of the warning lights comes on and stays on while driving, or when one of the gages shows there may be a problem, check the section that explains what to do. Follow this manual's advice. Waiting to do repairs can be costly and even dangerous.

Instrument Panel Cluster

The instrument panel cluster is designed to let you know at a glance how your vehicle is running. You will know how fast you are going, how much fuel you have, and many other things you will need to drive safely and economically.

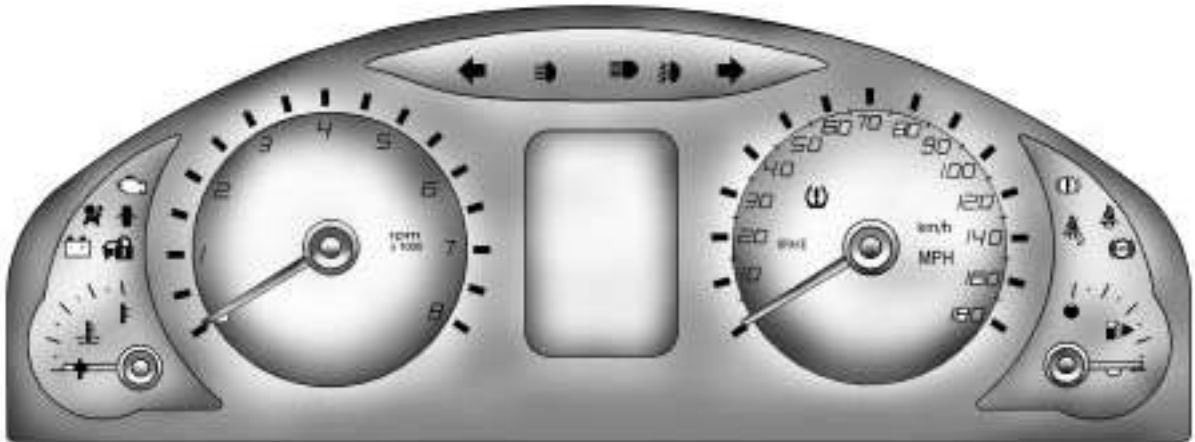

4-12 Instruments and Controls

Speedometer

The speedometer can display your speed in both miles per hour (MPH) and kilometers per hour (km/h). You can select between MPH and km/h using the UNITS display in the DIC. See *DIC Operation and Displays on page 4-22* for more information.

Tachometer

The tachometer displays the engine speed in revolutions per minute.

Safety Belt Reminders

Safety Belt Reminder Light

When the engine is started, a chime will come on for several seconds to remind people to fasten their safety belts, unless the driver's safety belt is already buckled.



The safety belt light will also come on and stay on for several seconds, then it will flash for several more.

The safety belt light will also come on and stay on for several seconds, then it will flash for several more.

This chime and light is repeated if the driver remains unbuckled and the vehicle is in motion. If the driver's belt is already buckled, neither the chime nor the light will come on.

Passenger Safety Belt Reminder Light

If your vehicle has this light, several seconds after the engine is started, a chime will sound for several seconds to remind the front passenger to buckle their safety belt. The passenger safety belt light will also come on and stay on for several seconds, then it will flash for several more.



This chime and light are repeated if the passenger remains unbuckled and the vehicle is in motion.

If the passenger's safety belt is buckled, neither the chime nor the light will come on.

Airbag Readiness Light

There is an airbag readiness light which shows the airbag symbol. The system checks the airbag's electrical system for malfunctions. The light tells you if there is an electrical problem. The system check includes the airbag sensor, the pretensioners, the airbag modules, the wiring and the crash sensing and diagnostic module. For more information on the airbag system, see *Airbag System on page 1-20*.





This light will come on when you start your vehicle, and it will flash for a few seconds. The light should go out and the system is ready.

If the airbag readiness light and the Airbag Fault message on the Driver Information Center (DIC) stays on after you start the vehicle or comes on when you are driving, your airbag system may not work properly. Have your vehicle serviced right away.

CAUTION

If the airbag readiness light stays on after the vehicle is started or comes on while driving, it means the airbag system might not be working properly. The airbags in the vehicle might not inflate in a crash, or they could even inflate without a crash. To help avoid injury, have the vehicle serviced right away.

If there is a problem with the airbag system, a message may also come on. See *DIC Warnings and Messages on page 4-26* for more information.

The message will remain until  or  are pressed, but the light will remain until the problem is fixed. See *DIC Warnings and Messages on page 4-26* for more information.

4-14 Instruments and Controls

Passenger Airbag Status Indicator

The vehicle has a passenger sensing system. See *Passenger Sensing System on page 1-27* for important safety information. The rearview mirror has a passenger airbag status indicator.

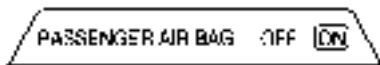

United States



Canada

When the vehicle is started, the passenger airbag status indicator will light ON and OFF, or the symbol for on and off, for several seconds

as a system check. If you are using remote start to start your vehicle from a distance, if equipped, you may not see the system check. Then, after several more seconds, the status indicator will light either ON or OFF, or either the on or off symbol to let you know the status of the right front passenger frontal airbag.

If the word ON or the on symbol is lit on the passenger airbag status indicator, it means that the right front passenger frontal airbag is enabled (may inflate).

If the word OFF or the off symbol is lit on the passenger airbag status indicator, it means that the passenger sensing system has turned off the right front passenger frontal airbag.

If, after several seconds, both status indicator lights remain on, or if there are no lights at all, there may be a problem with the lights or the passenger sensing system. See your dealer/retailer for service.

CAUTION

If the airbag readiness light ever comes on and stays on, it means that something may be wrong with the airbag system. To help avoid injury to yourself or others, have the vehicle serviced right away. See *Airbag Readiness Light on page 4-13* for more information, including important safety information.

Voltmeter Gage



The voltmeter shows the voltage output of your battery.

It is located in the center of the instrument panel.

Charging System Light





This light will come on briefly when you turn on the ignition, and the engine is not running, as a check to show it is working. Then it should go out when the engine is started.

If the light comes on and an Alternator message on the Driver Information Center (DIC) stays on, you may have a problem with the electrical charging system. Have it checked by your dealer/retailer.

Driving while this light is on could drain your battery.

If you must drive a short distance with the light on, be sure to turn off all accessories, such as the radio and air conditioner.

The Alternator message will remain until  (Trip/Fuel) or  (Enter) are pressed, but the light will remain until the problem is fixed. See *DIC Warnings and Messages on page 4-26* for more information.

Brake System Warning Light

Your vehicle's hydraulic brake system is divided into two parts. If one part is not working, the other part can still work and stop you. For good braking, though, you need both parts working well.

If the warning light comes on, there is a brake problem. Have your brake system inspected right away.

BRAKE

United States



Canada

If your vehicle has anti-lock brakes, this light should come on when you turn the key to START. If it does not come on, have it fixed so it will be ready to warn you if there is a problem.



4-16 Instruments and Controls

When the ignition is on, the brake system warning light will also come on when you set your parking brake. The light will stay on if your parking brake does not release fully. If it stays on after your parking brake is fully released, it means you have a brake problem.

If the light comes on and Brake message comes on the Driver Information Center (DIC), while you are driving, pull off the road and stop carefully. You may notice that the pedal is harder to push or the pedal may go closer to the floor. It may take longer to stop. If the light is still on, have the vehicle towed for service. See *Antilock Brake System (ABS) Warning Light* on page 4-16 and *Towing Your Vehicle* on page 9-88.

CAUTION

The brake system might not be working properly if the brake system warning light is on. Driving with the brake system warning light on can lead to a crash. If the light is still on after the vehicle has been pulled off the road and carefully stopped, have the vehicle towed for service.

The Brake message will remain until  (Trip/Fuel) or  (Enter) are pressed, but the brake light will remain until the problem is fixed. See *DIC Warnings and Messages* on page 4-26 for more information.

Antilock Brake System (ABS) Warning Light





For vehicles with the Antilock Brake System (ABS), this light will come on briefly, as a check, when you start your vehicle.

If it does not, have your vehicle serviced so that the light works properly when it needs to.

If the light and a message in the DIC stays on longer than a few seconds after you start your engine, or comes on and stays on while you are driving, try resetting the system. To reset the system:

1. If you are driving, pull over when it is safe to do so.
2. Place the vehicle in P (Park).
3. Turn off the ignition.
4. Then restart the engine.

If the light remains on after resetting the system or comes on again while driving, your vehicle needs service. If the ABS light is on, but the regular brake system warning light is not on, the antilock brakes are not working properly, but the regular brakes are still functioning. Have your vehicle serviced right away. If both brake lights are on, you do not have antilock brakes, and there's a problem with your regular brakes as well. Have your vehicle towed for service. See *Towing Your Vehicle on page 9-88*.

The ABS Fault message will remain until  (Trip/Fuel) or  (Enter) are pressed, but the warning light will remain until the problem is fixed. See *DIC Warnings and Messages on page 4-26* for more information.

Engine Coolant Temperature Gage



This gage shows the engine coolant temperature. If the gage pointer moves into the red area, the engine is too hot. It means that the engine has overheated. Pull off the road, stop the vehicle, and turn off the engine as soon as possible. See *Engine Overheating on page 9-20*.

Tire Pressure Light TPMS Light



This light comes on briefly when the engine is started and provides information about tire pressures and the Tire Pressure Monitoring System.

When the Light is On Steady

This light will also come on when one or more of your tires are significantly underinflated. A CHECK TIRE PRESSURE DIC message will accompany the light.

See *DIC Warnings and Messages on page 4-26* for more information.

Stop and check your tires as soon as it is safe to do so. If underinflated, inflate to the proper pressure. See *Tires on page 9-42* for more information.

When the Light Flashes First and Then is On Steady

This indicates that there may be a problem with the Tire Pressure Monitor System.

The light flashes for about a minute and stays on on steady for the remainder of the ignition cycle. This sequence will repeat with every ignition cycle. See *Tire Pressure Monitor System on page 9-52* and *Tire Pressure Monitor Operation on page 9-54* for more information.

Malfunction Indicator Lamp

Check Engine Light

A computer system called OBD II (On-Board Diagnostics-Second Generation) monitors operation of the fuel, ignition, and emission control systems. It ensures that emissions are at acceptable levels for the life of the vehicle, helping to produce a cleaner environment.



This light comes on when the ignition is on, but the engine is not running, as a check to show it is working. If it does not, have the vehicle serviced by your dealer/retailer.

If the check engine light comes on and stays on, while the engine is running, this indicates that there is an OBD II problem and service is required.

Malfunctions often are indicated by the system before any problem is apparent. Being aware of the light can prevent more serious damage to the vehicle. This system assists the service technician in correctly diagnosing any malfunction.

Notice: If the vehicle is continually driven with this light on, after a while, the emission controls might not work as well, the vehicle's fuel economy might not be as good, and the engine might not run as smoothly. This could lead to costly repairs that might not be covered by the vehicle warranty.

Notice: Modifications made to the engine, transmission, exhaust, intake, or fuel system of the vehicle or the replacement of the original tires with other than those of the same Tire Performance Criteria (TPC) can affect the vehicle's emission controls and can cause this light to come on. Modifications to these systems could lead to costly repairs not covered by the vehicle warranty. This could also result in a failure to pass a required Emission Inspection/Maintenance test. See *Accessories and Modifications on page 9-3*.

This light comes on during a malfunction in one of two ways:

Light Flashing: A misfire condition has been detected. A misfire increases vehicle emissions and could damage the emission control system on the vehicle. Diagnosis and service might be required.

The following can prevent more serious damage to the vehicle:

- Reduce vehicle speed.
- Avoid hard accelerations.
- Avoid steep uphill grades.
- If towing a trailer, reduce the amount of cargo being hauled as soon as it is possible.

If the light continues to flash, when it is safe to do so, stop the vehicle. Find a safe place to park the vehicle. Turn the key off, wait at least 10 seconds, and restart the engine. If the light is still flashing, follow the previous steps and see your dealer/retailer for service as soon as possible.

Light On Steady: An emission control system malfunction has been detected on the vehicle. Diagnosis and service might be required.

An emission system malfunction might be corrected by doing the following:

- Make sure the fuel cap is fully installed. See *Filling the Tank on page 8-37*. The diagnostic system can determine if the fuel cap has been left off or improperly installed. A loose or missing fuel cap allows fuel to evaporate into the atmosphere. A few driving trips with the cap properly installed should turn the light off.
- If the vehicle has been driven through a deep puddle of water, the vehicle's electrical system might be wet. The condition is usually corrected when the electrical system dries out. A few driving trips should turn the light off.

- Make sure to fuel the vehicle with quality fuel. Poor fuel quality causes the engine not to run as efficiently as designed and may cause: stalling after start-up, stalling when the vehicle is changed into gear, misfiring, hesitation on acceleration, or stumbling on acceleration. These conditions might go away once the engine is warmed up.

If one or more of these conditions occurs, change the fuel brand used. It will require at least one full tank of the proper fuel to turn the light off.

See *Gasoline Octane on page 8-35*.

If none of the above have made the light turn off, your dealer/retailer can check the vehicle. The dealer/retailer has the proper test equipment and diagnostic tools to fix any mechanical or electrical problems that might have developed.

4-20 Instruments and Controls

Emissions Inspection and Maintenance Programs

Some state/provincial and local governments have or might begin programs to inspect the emission control equipment on the vehicle. Failure to pass this inspection could prevent getting a vehicle registration.

Here are some things to know to help the vehicle pass an inspection:

- The vehicle will not pass this inspection if the check engine light is on with the engine running, or if the key is in the ON/RUN and the light is not on.
- The vehicle will not pass this inspection if the OBD II (on-board diagnostic) system determines that critical emission control systems have not been completely diagnosed by the system. The vehicle would be considered not ready for

inspection. This can happen if the battery has recently been replaced or if the battery has run down. The diagnostic system is designed to evaluate critical emission control systems during normal driving. This can take several days of routine driving. If this has been done and the vehicle still does not pass the inspection for lack of OBD II system readiness, your dealer/retailer can prepare the vehicle for inspection.

Security Light



For information regarding this light and the vehicle's security system, see *Content Theft-Deterrent* on page 2-13.

Fog Lamp Light



The fog lamp light comes on when the fog lamps are in use.

The light goes out when the fog lamps are turned off. See *Fog Lamps* on page 5-3 for more information.

Highbeam On Light



This light comes on when the high-beam headlamps are in use.

See *Headlamp High/Low-Beam Changer* on page 4-7 for more information.

Daytime Running Lamps (DRL) Indicator Light



This light turns on whenever the Daytime Running Lamps are on.

See *Daytime Running Lamps (DRL)* on page 5-2 for more information.

Door Ajar Light



When the ignition is on, this light stays on until all doors are closed and completely latched.

If a door is not closed properly, a chime sounds after the engine is started and the vehicle is not in P (Park).

Oil Pressure Gage

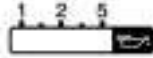

The gage shows the engine oil pressure.

It is located in the center of the instrument panel.

⚠ CAUTION

Do not keep driving if the oil pressure is low. The engine can become so hot that it catches fire. Someone could be burned. Check the oil as soon as possible and have the vehicle serviced.

Notice: Lack of proper engine oil maintenance can damage the engine. The repairs would not be covered by the vehicle warranty. Always follow the maintenance schedule in this manual for changing engine oil.

Fuel Gage



The fuel gage shows about how much fuel you have left, when the ignition is on.

When the indicator nears empty, the low fuel warning light will come on and along with a chime. There is still a little fuel left, but you should refuel soon.

Here are four things that some owners ask about. These are normal and do not indicate a problem with your fuel gage:

- At the service station, the gas pump shuts off before the gage reads full.
- It takes a little more or less fuel to fill up than the gage indicated.
- The indicator moves a little when you turn a corner or speed up.
- The gage will continue to show the remaining fuel when the ignition is turned off.

Driver Information Center (DIC)

The DIC displays information about your vehicle. It also displays warning messages if a system problem is detected. The DIC also allows some features to be customized. See *DIC Vehicle Customization on page 4-31* for more information. All messages will appear in the DIC display located in the center of the instrument panel cluster.

When the ignition is turned on, a vehicle system check is performed and the status is shown on the DIC display. If there are no warnings or service reminders, the display shows a series of welcome screens. When the ignition is turned off, the odometer appears on the display for a short period of time unless a service reminder is active.

Active service reminders are displayed for 10 seconds before the odometer appears. The odometer will reappear on the display when the driver door is opened. For more information on the warnings and messages see *DIC Warnings and Messages on page 4-26*.

DIC Operation and Displays

The DIC has different displays which can be accessed by pressing the DIC buttons located on the left side of the steering wheel. The DIC displays trip, fuel, vehicle system information, and warning messages if a system problem is detected.

DIC Buttons



 **(Trip/Fuel):** Press this button to go through the displays and the select the information.

 **(Thumbwheel):** Use the thumbwheel to scroll through the available options.

 **(ENTER to Reset/Select):** Press the thumbwheel to set or reset certain functions and to turn off or acknowledge messages on the DIC.

Trip/Fuel Menu Items

Press  to scroll through the following menu items:

- Speedometer
- UNITS
- Tire Pressure
- Customize Options
- Odometer/Trip Odometer
- Distance/Time To Go
- Range
- Avg (Average)Speed/Avg (Average) Fuel
- OverSpeed



Speedometer

Press  until the speedometer is displayed.

The speedometer shows how fast the vehicle is moving in either miles per hour (MPH) or kilometers per hour (km/h). To switch between English and metric measurements, see “UNITS” later in this section.

The digital speedometer display can be enabled or disabled. See “Digital Speedometer” under *DIC Vehicle Customization* on page 4-31 for more information.

UNITS

Move the thumbwheel up  or down  to highlight English or Metric when the UNITS display is active.

Press  to confirm the setting.

This will change the displays on the cluster, DIC, and the temperature display in the mirror to either English or metric measurements.

Tire Pressure

Press  until Tire Pressure is displayed.

The display will show a vehicle and the approximate pressures of all four tires. Tire pressure is displayed in either pounds per square inch (PSI) or in kilopascal (kPa).

This display can be customized. See *DIC Vehicle Customization* on page 4-31 for more information.



Customize Options

See *DIC Vehicle Customization* on page 4-31 for more information.

Odometer/Trip Odometer

Press  until the Odometer/Trip Odometer is displayed.

The odometer display shows the distance the vehicle has been driven in either miles (MI) or kilometers (km). To switch between English and metric measurements, see “UNITS” earlier in this section.

The Trip Odometer display shows the current distance traveled since the last reset for the trip odometer. The trip odometer can be reset to zero by pressing and holding  while the trip odometer value is highlighted. If  is only pressed briefly, the Avg Speed/Avg Fuel will be reset as well.

4-24 Instruments and Controls

Distance/Time To Go

Press  until To Go is displayed. If this item doesn't display, check that the display is turned on through the Customize Options menu. See *DIC Vehicle Customization on page 4-31* for more information.

At the start of a trip, estimate the distance to arrival (for example, from maps, road signs). Move the thumbwheel up or down until the display shows the estimated trip distance. When driving, the computer constantly updates the time to arrival, based on changing driving speeds. Use the thumbwheel to adjust the distance any time this display is shown. Time to go is shown in hours and minutes and is only shown if the distance to go is more than zero.

This display can be turned on or off and the default setting can be changed.

Range



Press  until Range is displayed. This display shows the approximate distance the vehicle can be driven without refueling. The fuel range estimate is based on an average of the vehicle's fuel economy over recent driving history and the amount of fuel remaining in the fuel tank. Fuel range cannot be reset.

Avg (Average) Speed/Avg (Average) Fuel

Press  until Avg Speed/Avg Fuel is displayed.



Avg Speed shows the average speed (while the engine is running) since the last reset.

Avg Fuel shows average fuel used since the last reset.

To reset only the Avg Speed or Avg Fuel, press and hold  while either value is highlighted. If  is only pressed briefly, the Trip Odometer will be reset as well.

OverSpeed

OverSpeed allows the driver to set a speed that they do not want to exceed. OverSpeed will illuminate in the display and a chime will sound to warn that the vehicle's speed is equal or has exceeded the preselected value. During an OverSpeed warning, the OverSpeed display is shown, allowing the driver to make adjustments.

To set the OverSpeed warning press  when OverSpeed is displayed to highlight the OverSpeed mode. Move the thumbwheel up  or down  to scroll through and highlight one of the following options:

Off: No OverSpeed warning set.

Manual: Allows you to manually set the OverSpeed warning. See "Manual OverSpeed" following.

Preset 1: Default setting 30 MPH (48 km/h)

Preset 2: Default setting 45 MPH (72 km/h)

Preset 3: Default setting 55 MPH (89 km/h)

Preset 4: Default setting 70 MPH (113 km/h)

The selection is set automatically after a few seconds.

The corresponding value of the presets will be shown on the display.

The preset OverSpeed warnings can be reprogrammed. See "Programming the OverSpeed Presets" later in this section.

Manual OverSpeed

To manually set the OverSpeed warning:

1. Use the thumbwheel to select Manual for OverSpeed.
2. Press \leftarrow to highlight the current value.
3. Use the thumbwheel to adjust the value in 5 MPH or km/h increments and press \leftarrow to confirm the setting.

To set the OverSpeed warning to the vehicle's current speed:

1. Use the thumbwheel to select Manual as described in the OverSpeed section.
2. Press \leftarrow to highlight the current value.
3. Press and hold \leftarrow for more than 3 seconds to set the value to the nearest 5 MPH or km/h above the current vehicle's speed.

Programming the OverSpeed Presets

While the vehicle's speed is 6 MPH (10 km/h) or below, each of the presets can be altered and values can be stored for future use.

To reprogram the OverSpeed presets:

1. Use the thumbwheel to select the desired preset and press \leftarrow .
2. Move the thumbwheel up \blacktriangle or down \blacktriangledown to adjust the value in 1km/h increments.
3. Press \leftarrow to confirm the setting.

Adjusting the Setting During an OverSpeed Warning

While the OverSpeed warning is displayed move the thumbwheel up ▲ or down ▼ to adjust the value when in Manual mode or to select a different preset when in Preset mode. Press and hold ← for more than 3 seconds to set the value to the nearest 5 MPH or km/h above the current vehicle's speed. If Preset mode was selected, this will change it to Manual mode.

Underspeed Chime

If an OverSpeed warning appeared and the vehicle's speed drops below the set value, you will hear a chime. The underspeed chime can be turned on or off through the vehicle customization. See *DIC Vehicle Customization on page 4-31* for more information.

DIC Warnings and Messages

Messages are displayed on the DIC to notify the driver that the status of the vehicle has changed and that some action may be needed by the driver to correct the condition. Multiple messages may appear one after another.

Some messages may not require immediate action, but you can press  or ← to acknowledge that you received the messages and to clear them from the display. Some messages cannot be cleared from the DIC display because they are more urgent. These messages require action before they can be cleared. You should take any messages that appear on the display seriously and remember that clearing the messages will only make the messages disappear, not correct the problem.

The following are the possible messages that can be displayed and some information about them.

ABS Fault

This message is displayed if there is a problem with the ABS system. The ABS light may also turn on in the instrument panel cluster. See *Antilock Brake System (ABS) Warning Light on page 4-16*. When this message is on, the brake system will still operate with the antilock operation disabled. See your dealer/retailer.

Active Select On

This message is displayed when the automatic transmission active select mode is enabled. See "Active Select Mode" under *Automatic Transmission Operation on page 8-6*.

Airbag Fault

This message is displayed if there is a problem with the airbag system or safety belt pretensioner system.

See *Airbag System on page 1-20* and “Safety Belt Pretensioners” under *Lap-Shoulder Belt on page 1-14*. The Airbag Readiness light may also come on in the instrument panel cluster. See *Airbag Readiness Light on page 4-13*. See your dealer/retailer.

Alarm Activated

This message is displayed when the content theft-deterrent system was activated by an attempted break-in. The messages may also include the location on the vehicle where the break-in was attempted. See *Content Theft-Deterrent on page 2-13* for more information.

Alternator

This message is displayed if there is a problem with the battery charging system. The charging system light may also come on in the instrument panel cluster. See *Charging System Light on page 4-15*. Driving while this message is on could drain the battery. Turn off all unnecessary accessories. Have the electrical system checked as soon as possible. See your dealer/retailer.

Battery Saver Mode On

This message is displayed when the battery voltage level is low.

Brake

This message is displayed if there is a problem with the brake system. The Brake System Warning light may also come on in the instrument panel cluster. See *Brake System Warning Light on page 4-15*. When this message is on, stop the vehicle on



the side of the road. Do not continue driving until you know that braking is possible or that the cause of the problem has been corrected, see your dealer/retailer. This message also indicates low brake fluid. Check the brake fluid level. See *Brakes on page 9-25*.

Check Engine

If this message and the Malfunction Indicator Lamp come on and stay on when driving, the system may require servicing. Although the vehicle may still be drivable and not require towing, take the vehicle to your dealer/retailer as soon as possible. If this message comes on when the Malfunction Indicator Lamp is flashing, reduce the vehicle's speed and load until the lamp stops flashing, then take the vehicle to your dealer/retailer as soon as possible. See *Malfunction Indicator Lamp on page 4-18* for more information.

Check Oil

This message is displayed if the oil pressure or oil level is low. Stop when safe, turn off the engine and check the engine oil level. See *Engine Oil on page 9-8*. Do not run the engine when this warning is illuminated. If the oil level is normal, have the system checked at your dealer/retailer.

You can press  or  to acknowledge that you received the message, but  Check Oil will continue to appear in the bottom of the DIC display until the vehicle has been serviced.

X Contact Dealer

This message is displayed when there is a fault in the instrument panel, see your dealer/retailer.

You can press  or  to acknowledge that you received the message, but **X** Service will



continue to appear in the bottom of the DIC display until the vehicle has been serviced.

Cruise On, Cruise Off, Cruise Active, and Cruise Inactive

These messages display the status of the cruise control system. See *Cruise Control on page 4-5* for more information.



Engine Immobilized Refer to Owners Manual

This message is displayed when the engine has been shutdown due to the theft-deterrent system. See *Immobilizer Operation on page 2-12* for more information.

You can press  or  to acknowledge that you received the message, but  Eng Immo will continue to appear in the bottom of the DIC display until the vehicle has been serviced.



Engine Temp (Temperature) Hot

This message is displayed when the engine coolant temperature is excessively hot. Stop the vehicle as soon as it is safe to do so. See *Engine Overheating on page 9-20*.

You can press  or  to acknowledge that you received the message, but  Temp Hot will continue to appear in the bottom of the DIC display until the vehicle has been serviced.



Low Fuel

This message is displayed when the fuel level is low.

You can press  or  to acknowledge that you received the message, but  Low Fuel will continue to appear in the bottom of the DIC display until the fuel tank has been filled above the low fuel level.

OverSpeed

This message is displayed when the vehicle's speed is greater than the set OverSpeed value. See "OverSpeed" under *DIC Operation and Displays* on page 4-22.



You can press  or move the thumbwheel up  or down  to acknowledge that you received the message, but OverSpeed will continue to appear in the bottom of the DIC display as long as the vehicle's speed exceeds the preset value.

Park Brake

This message is displayed if the parking brake is applied when you are driving. Release the parking brake. See *Parking Brake* on page 8-11.



Replace Battery in Remote Key

This message is displayed when the battery in the remote keyless entry transmitter needs to be replaced. See your dealer/retailer to replace the battery.

You can press  or  to acknowledge that you received the message, but  Key Batt will continue to appear in the bottom of the DIC display until the battery has been replaced.



Rest Reminder

This feature reminds the driver that they may have been driving for too long without a break. When the ignition is turned on, a timer starts counting. After two hours of continuous driving, the rest reminder flashes to alert the driver.

The Rest Reminder message is displayed until  or  are pressed. The rest reminder reappears after 20 minutes accompanied by a chime, unless the ignition has been turned off. For information on how to turn the rest reminder on and off, see *DIC Vehicle Customization* on page 4-31.



Safety Mode Active and Power Reduced

These messages display alternately when there is a problem with the engine control system, see your dealer/retailer.

You can press  or  to acknowledge that you received the message, but  Safety will continue to appear in the bottom of the DIC display until the vehicle has been serviced.

Service Charging System

This message is displayed when there is a fault in the battery charging system, see your dealer/retailer.



You can press  or  to acknowledge that you received the message, but  Low Batt will continue to appear in the bottom of the DIC display until the vehicle has been serviced.

Service Engine Oil

This message is displayed when the engine oil needs to be changed. When you change the engine oil, be sure to reset the Oil Life System. See *Engine Oil Life System on page 9-10* for information on how to reset the message. See *Engine Oil on page 9-8* and *Scheduled Maintenance on page 11-4* for more information.

Service Vehicle Soon

This message is displayed when there is a problem with the vehicle, see your dealer/retailer.

You can press  or  to acknowledge that you received the message, but  Service will continue to appear in the bottom of the DIC display until the vehicle has been serviced.

Sport Shift

This message is displayed when the automatic transmission is operating in sport shift mode.

See *Automatic Transmission Operation on page 8-6*.

Stability Ctrl (Control) Assistance



This message is displayed when the Electronic Stability Program (ESP[®]) is actively helping the vehicle with road grip and stability.

ESP CTRL appears at the bottom of the display and remains illuminated as long as the ESP is actively helping with road grip and stability. See *Electronic Stability Program on page 8-19*.

Stability Ctrl (Control) Off







This message is displayed when the ESP has been turned off.

See *Electronic Stability Program on page 8-19*. If this message is displayed and you have not turned off the ESP, it means there is a problem with the ESP, see your dealer/retailer.

You can press  or  to acknowledge that you received the message, but ESP OFF will continue to appear in the bottom of the DIC display until the vehicle has been serviced.



Check XX Tire Pressure

This message is displayed when the inflation pressure is low or very low in the indicated tire.

You can press  or  to acknowledge that you received the message, but  LF Tire,  RF Tire,  LR Tire, or  RR Tire will continue to appear in the bottom of the DIC display until the tire pressure is at a normal level. See *Tire Pressure Monitor System on page 9-52* for more information.



Tire Pressure System Fault

This message is displayed when there is a problem with the Tire Pressure Monitor System.

You can press  or  to acknowledge that you received the message, but  Tire Fault will continue to appear in the bottom of the DIC display until the tire pressure is at a normal level. See *Tire Pressure Monitor System on page 9-52* for more information.

Very Low Fuel



This message is displayed when the fuel level is very low.





You can press  or  to acknowledge that you received the message, but  V.Low Fuel will continue to appear in the bottom of the DIC display until enough fuel tank has been filled above the low fuel level.

DIC Vehicle Customization

Your vehicle has features that you can customize through the DIC.

Using the Customization Menu

Press  until you see Customize Options and then press . The customization options will only be available when the vehicle speed is less than 6 mph (10 km/h). If the vehicle is moving faster than that the display will show Not Available.

Move the thumbwheel up  or down  to scroll through the available options. Press  to select an item. To exit the current menu, or go back, use the thumbwheel to select  at the top of the screen and then press .

4-32 Instruments and Controls

The following items are part of the main customization menu.

- Exit
- Reset settings
- Security
- Lighting
- Trip Computer
- Language
- Remote key

See the information following for detailed descriptions of the items available under each menu item. There are also help screens available to explain the features. When selecting a menu item, wait for a few seconds and a help screen pops up with an explanation of the selected feature.

Exit

To exit the customization menu scroll to Exit and press .

You can also exit the customization menu by:

- Press  at any time to return to the trip/fuel menu.
- Drive the vehicle at more than 6 mph (10 km/h).
- Turn the ignition off.

Reset settings

This item will reset all the customization options to the factory defaults.

Security

This item will allow you to customize:

- Auto unlock
- Auto lock
- Flash remote lck (lock)
- Beep remote lck (lock)

- Flash rem (remote) unlock
- 2 Stage unlock
- Remote Start

Some of these work with your Remote Keyless Entry (RKE) transmitter. See *Remote Keyless Entry (RKE) System Operation on page 2-4* for more information.

Auto unlock

If you select Auto unlock you will be able to choose when you want the doors to unlock automatically.

Off: No automatic unlock of any doors.

Driver door key out: The driver door will unlock when the key is removed.

Driver door in park: The driver door will unlock when you put the shift lever into P (Park).

All doors at key out: All doors will unlock when the key is removed.

All doors in park: All doors will unlock when you put the shift lever into P (Park).

Auto lock

If you select Auto lock you will be able to choose when you want the doors to lock automatically.

At vehicle speed: The doors will lock when the vehicle speed is at or above 8 mph (13 km/h).

Out of Park: The doors will lock when you move the shift lever out of P (Park).

Flash remote lock

If you select Flash remote lock you will be able to choose if the parking lamps will flash when you lock the doors with the RKE transmitter.

Beep remote lock

If you select Beep remote lock you will be able to choose if the horn will sound when you lock the doors with the RKE transmitter.

Flash remote unlock

If you select Flash remote unlock you will be able to choose if the parking lamps will flash when you unlock the doors with the RKE transmitter.

2 Stage unlock

If you select 2 stage unlock you will be able to choose if you want only the driver door to unlock with the first press of the unlock button on the RKE transmitter.

Remote Start

If you select Remote start you will be able to enable or disable the remote start feature. See *Remote Vehicle Start on page 2-6* for more information.

Lighting

This item will allow you to customize:

- Approach lighting
- Egress lighting timer

Approach lighting

If you select Approach lighting you will be able to choose if you want the exterior lamps to turn on when you unlock the doors with the RKE transmitter.

Egress lighting timer

If you select Egress lighting timer you will be able to choose if, and for how long, the exterior lamps should stay on when you lock the doors.

Trip Computer

This item will allow you to customize:

- Underspeed Chime
- Distance to go
- Distance to go Default
- Digital speedo (speedometer)
- Pressure Units
- Rest reminder

4-34 Instruments and Controls

Underspeed Chime

If you select Underspeed Chime you will be able to enable or disable the underspeed chime feature. See *DIC Operation and Displays* on page 4-22 for more information.

Distance to go

If you select Distance to go you will be able to choose if you want the distance to go display to be shown on the DIC. See *DIC Operation and Displays* on page 4-22 for more information.

Distance to go Default

If you select Distance to go Default you will be able to change the distance to go default setting. The default setting is 500 km. Set the value you want it to be.

Digital speedometer

If you select Digital speedometer you will be able to choose if you want the digital speedometer to be shown on the DIC display.

Pressure Units

If you select Pressure Units you can choose how the tire pressures will be displayed. If you select PSI then all tire pressures will be displayed in PSI. If you select kPa then all tire pressures will be displayed in kPa. If you select Automatic and the Unit selection is English then all tire pressures will be displayed in PSI. If you select Automatic and the Unit selection is Metric then all tire pressures will be displayed in kPa.

Rest reminder

If you select Rest reminder you will be able to enable or disable the rest reminder feature. See *DIC Warnings and Messages* on page 4-26 for more information.

Language

This item will allow you to set the language for the displayed to English or French.

Remote Key programming

Choose Program if the vehicle's remote keys require programming. Follow the instructions on the DIC display to complete key programming. All the vehicle's keys must be programmed at the same time. If an existing key is not reprogrammed during the procedure it will no longer work.

Choose Instructions if information is required to complete programming procedure.

Choose Exit to return to the customization menu.

See *Remote Keyless Entry (RKE) System Operation* on page 2-4 for more information.

OnStar® System



OnStar uses several innovative technologies and live advisors to provide a wide range of safety, security, information, and convenience services. If the airbags deploy, the system is designed to make an automatic call to OnStar Emergency advisors who can request emergency services be sent to your location. If the keys are locked in the vehicle, call OnStar at 1-888-4-ONSTAR to have a signal sent to unlock the doors. OnStar Hands-Free Calling, including 30 trial minutes good for 60 days, is available on most vehicles.

OnStar Turn-by-Turn Navigation service, with one trial route, is available on most vehicles. Press the OnStar button to have an OnStar advisor contact Roadside Service.

OnStar service is provided subject to the OnStar Terms and Conditions included in the OnStar Subscriber glove box literature.

Some services such as Remote Door Unlock or Stolen Vehicle Location Assistance may not be available until the owner of the vehicle registers with OnStar. After the first prepaid year, contact OnStar to select a monthly or annual subscription payment plan. If a payment plan is not selected, the OnStar system and all services, including airbag notification and emergency services, may be deactivated and no longer available.

For more information visit onstar.com (U.S.) or onstar.ca (Canada), or press the OnStar button to speak with an advisor.

Not all OnStar services are available on all vehicles. To check if this vehicle is able to provide the services described below, or for a full description of OnStar services and system limitations, see the OnStar Owner's Guide in the glove box or visit onstar.com (U.S.) or onstar.ca (Canada), contact OnStar at 1-888-4-ONSTAR (1-888-466-7827) or TTY 1-877-248-2080, or press the OnStar button to speak with an OnStar advisor 24 hours a day, 7 days a week.

OnStar Services Available with the Safe & Sound Plan

- Automatic Notification of Airbag Deployment
- Advanced Automatic Crash Notification (AACN) (If equipped)
- Link to Emergency Services
- Roadside Assistance
- Stolen Vehicle Location Assistance
- Remote Door Unlock/Vehicle Alert
- OnStar Vehicle Diagnostic Email
- GM Goodwrench On Demand Diagnostics
- OnStar Hands-Free Calling with 30 trial minutes
- OnStar Virtual Advisor (U.S. Only)

OnStar Services Included with Directions & Connections Plan

- All Safe and Sound Plan Services
- OnStar Turn-by-Turn Navigation (If equipped) or Driving Directions - Advisor delivered
- RideAssist
- Information and Convenience Services

OnStar Hands-Free Calling

OnStar Hands-Free Calling allows eligible OnStar subscribers to make and receive calls using voice commands. Hands-Free Calling is fully integrated into the vehicle, and can be used with OnStar Pre-Paid Minute Packages. Most vehicles include 30 trial minutes good for 60 days. Hands-Free Calling can also be linked to a Verizon Wireless service plan in the U.S. or a Bell Mobility service

plan in Canada, depending on eligibility. To find out more, refer to the OnStar Owner's Guide in the vehicle's glove box, visit onstar.com or onstar.ca, or speak with an OnStar advisor by pressing the OnStar button or calling 1-888-4-ONSTAR (1-888-466-7827).

OnStar Turn-by-Turn Navigation

Vehicles with the OnStar Turn-by-Turn Navigation system can provide voice-guided driving directions. Press the OnStar button to have an OnStar advisor locate a business or address and download driving directions to the vehicle. Voice-guided directions to the desired destination will play through the audio system speakers. See the OnStar Owner's Guide for more information.

OnStar Virtual Advisor

OnStar Virtual Advisor is a feature of OnStar Hands-Free Calling that uses minutes to access location-based weather, local traffic reports, and stock quotes. Press the phone button and give a few simple voice commands to browse through the various topics. See the OnStar Owner's Guide for more information. This feature is only available in the continental U.S.

OnStar Steering Wheel Controls

This vehicle may have a Talk/Mute button that can be used to interact with OnStar Hands-Free Calling. See *Audio Steering Wheel Controls* on page 6-36 for more information.

On some vehicles, the mute button can be used to dial numbers into voice mail systems, or to dial phone extensions. See the OnStar Owner's Guide for more information.

How OnStar Service Works

The OnStar system can record and transmit vehicle information. This information is automatically sent to an OnStar Call Center when the OnStar button is pressed, the emergency button is pressed, or if the airbags or AACN system deploy. This information usually includes the vehicle's GPS location and, in the event of a crash, additional information regarding the crash that the vehicle was involved in (e.g. the direction from which the vehicle was hit).

When the Virtual Advisor feature of OnStar Hands-Free Calling is used, the vehicle also sends OnStar the vehicle's GPS location so they can provide services where it is located.

OnStar service cannot work unless the vehicle is in a place where OnStar has an agreement with a wireless service provider for service in that area. OnStar service also cannot work unless the vehicle is in a place where the wireless service provider OnStar has hired for that area has coverage, network capacity and reception when the service is needed, and technology that is compatible with the OnStar service. Not all services are available everywhere, particularly in remote or enclosed areas, or at all times.

4-38 Instruments and Controls

Location information about the vehicle is only available if the GPS satellite signals are unobstructed and available.

The vehicle must have a working electrical system, including adequate battery power, for the OnStar equipment to operate. There are other problems OnStar cannot control that may prevent OnStar from providing OnStar service at any particular time or place.

Some examples are damage to important parts of the vehicle in a crash, hills, tall buildings, tunnels, weather or wireless phone network congestion.

Your Responsibility

Increase the volume of the radio if the OnStar advisor cannot be heard. If the light next to the OnStar buttons is red, the system may not be functioning properly. Press the OnStar button and request a vehicle diagnostic. If the light appears clear (no light is appearing), your OnStar subscription has expired and all services have been deactivated. Press the OnStar button to confirm that the OnStar equipment is active.

Lighting

Lighting

Exterior Lamps Controls	5-1
Daytime Running Lamps (DRL)	5-2
Automatic Headlamp System	5-2
Fog Lamps	5-3
Instrument Panel Brightness	5-3
Dome Lamp(s)	5-4
Perimeter Lighting	5-4
Reading Lamps	5-4
Battery Run-Down Protection	5-4

Lighting

Exterior Lamps Controls



The exterior lamps control is located on the instrument panel to the left of the steering wheel.

It controls the following systems:

- Headlamps
- Taillamps
- Parking Lamps
- License Plate Lamps

- Instrument Panel Lights
- Sidemarker Lamps
- Fog Lamps

The exterior lamps control has four positions:

○ **(Off):** Turns the headlamps, parking lamps, and DRL off. The DRL does not turn off on vehicles first sold in Canada.

AUTO (Automatic): Turns the headlamps on and off automatically. They come on at normal brightness, together with the following:

- Parking Lamps
- Taillamps
- License Plate Lamps
- Instrument Panel Lights
- Sidemarker Lamps

5-2 Lighting

 **(Parking Lamps):** Turns on the parking lamps together with the following:

- Taillamps
- License Plate Lamps
- Instrument Panel Lights
- Sidemarker Lamps

 **(Headlamps):** Turns on the headlamps together with the following:

- Parking Lamps
- Taillamps
- License Plate Lamps
- Instrument Panel Lights
- Sidemarker Lamps

A warning chime sounds if the driver side door is opened while the ignition switch is off and the headlamps are on.

Daytime Running Lamps (DRL)

Daytime Running Lamps (DRL) can make it easier for others to see the front of your vehicle during the day. Fully functional daytime running lamps are required on all vehicles first sold in Canada.

The DRL system makes the headlamps come on at a reduced brightness when the following conditions are met:

- The ignition is on.
- The exterior lamps control is in AUTO.
- The light sensor determines it is daytime.

When the DRL are on, the taillamps, sidemarker, instrument panel and other lamps will not be on.

The headlamps automatically switch from DRL to the regular headlamps depending on the darkness of the surroundings. See “Automatic headlamp system” following.

To turn off the DRL lamps, turn the exterior lamps control to  and then release. For vehicles first sold in Canada, the DRL lamps cannot be turned off.

Automatic Headlamp System

When it is dark enough outside and the exterior lamps control is in the automatic position, the headlamps and parking lamps will turn on and off automatically. See *Exterior Lamps Controls* on page 5-1.

If the headlamps or parking lamps are left on and the ignition is turned to LOCK/OFF, the lamps automatically turn off after 10 minutes. The lamps remain off until the ignition is switched on or the lamps are turned on again using the exterior lamps control.

The vehicle has a light sensor located on top of the instrument panel. Do not cover the sensor or the headlamps will come on when they are not needed.

The system may also turn on the headlamps when driving through a parking garage or tunnel.

Fog Lamps

For vehicles with this feature, it provides better visibility in foggy or misty conditions.

The fog lamp switch is located on the exterior lamps control on the instrument panel to the left of the steering column.

☰ (Fog Lamps): To turn on the fog lamps, turn the exterior lamps control to parking lamps or headlamps and pull the fog lamps control. Push the control to turn the fog lamps off.

The fog lamp indicator in the instrument panel comes on when the fog lamps are in use.

The fog lamps control can be pulled out while the exterior lamps control is in the AUTO position. If left in this position, the fog lamps come on automatically whenever the parking lamps or low-beam headlamps turn on.

When the high-beam headlamps are turned on, the fog lamps turn off automatically. When the high-beam headlamps are turned off, the fog lamps come on again.

Some localities have laws that require the headlamps to be on along with the fog lamps.

Instrument Panel Brightness

The instrument panel lighting buttons are located above the exterior lamps control.

 : Press to brighten the instrument panel lights.

 : Press to dim the instrument panel lights.

Press both instrument panel brightness buttons at the same time to turn the night panel mode on or off.

Night panel mode lights up the speed, information displays and warning reminders while the rest of the instrument panel lights are off.

5-4 Lighting

Dome Lamp(s)

 (On/Off): Press to turn the lamp on or off.

 (Door): Press this button in and the lamps automatically turn on when a door is opened, the vehicle is unlocked, or the key is removed from the ignition.

The lamps dim to off after all the doors are closed. They turn off immediately if the ignition is turned on and all the doors are closed.



Perimeter Lighting

Press the unlock button on the Remote Keyless Entry (RKE) transmitter to turn the headlamps and back-up lamps on for 60 seconds if it is dark enough outside.

The lamps only turn on if the exterior lamp control is left in the AUTO position.

Reading Lamps

Front Reading Lamps

  (On/Off): Press to turn the lamps on or off.

Battery Run-Down Protection

This vehicle has a feature to help prevent the battery from being drained. The trunk lamp and reading lamps automatically turn off 10 minutes after the key is turned to LOCK/OFF.

The lamps are reactivated if any of the following occur:

- The ignition is turned on.
- The vehicle is unlocked.
- The trunk is opened.
- The reading lamps are turned on.

Infotainment

Audio System(s)

Audio System(s)	6-1
Setting the Clock	6-2
Radio(s)	6-3
Using an MP3	6-20
XM Radio Messages	6-24
Bluetooth®	6-25
Theft-Deterrent Feature	6-35
Audio Steering Wheel Controls	6-36
Radio Reception	6-36
Fixed Mast Antenna	6-37
XM™ Satellite Radio Antenna System	6-37

Audio System(s)

Determine which radio the vehicle has and become familiar with its features.

 **CAUTION**

This system provides you with far greater access to audio stations and song listings. Giving extended attention to entertainment tasks while driving can cause a crash and you or others can be injured or killed. Always keep your eyes on the road and your mind on the drive — avoid engaging in extended searching while driving.

Keeping your mind on the drive is important for safe driving. See *Defensive Driving on page 8-16*.

Here are some ways in which you can help avoid distraction while driving.

- Familiarize yourself with all of its controls
- Familiarize yourself with its operation.
- Set up your audio system by presetting your favorite radio stations, setting the tone, and adjusting the speakers. Then, when driving conditions permit, you can tune to your favorite radio stations using the presets and steering wheel controls if the vehicle has them.

Notice: Before adding any sound equipment to your vehicle, such as an audio system, CD player, CB radio, mobile telephone, or two-way radio, make sure that it can be added by checking with your dealer/retailer. Also, check federal rules covering mobile radio and telephone units. If sound equipment can be added, it is very important to do it properly. Added sound equipment may interfere with the operation of your vehicle's engine, radio, or other systems, and even damage them. Your vehicle's systems may interfere with the operation of sound equipment that has been added.



The vehicle has Retained Accessory Power (RAP), and the audio system can be played after the ignition is turned off. See *Retained Accessory Power (RAP)* on page 8-3 for more information.

Setting the Clock

Radio with Single CD Player

The time and date can be adjusted when the radio is either on or off, press  to display the date.



To adjust the time and date:

1. Press and hold  until the display shows the Set Clock screen and the hour display flashes.
2. Turn the volume knob to adjust the hour.
3. Press the volume knob and the minute display will flash to adjust the minutes.
4. Turn the volume knob to adjust the minutes.
5. Repeat these steps to adjust the month, date, and year.
6. Press  to save the settings. If no adjustments are made for eight seconds, the radio will automatically save the settings.

Radio with Six-Disc CD Player

The time and date can be adjusted when the radio is either on or off, press  to display the date.

To adjust the time and date:

1. Press and hold  for more than two seconds to display the Options menu.
2. Turn the MENU knob to highlight: Hour, Minute, Date, Month, and Year.
3. Highlight Hour and Press the MENU knob.
4. Turn the MENU knob to adjust the hours.
5. Press the MENU knob to return to the Options menu.
6. Repeat steps 2 through 5 to adjust the minutes, date, month, and year.
7. Press  to save the settings. If no adjustments are made for eight seconds, the radio will automatically save the settings.

Radio(s)



Radio with Single CD Player



Radio with Six-Disc CD Player

The vehicle has one of these radios as its audio system.

Playing the Radio

(Power): Press to turn the system on and off.

Radio with Single CD Player

Volume: The volume knob is located on the center of the radio. Turn to adjust the volume.

(Mute): Press to immediately stop the volume. While the volume is off, MUTED displays.

To cancel Mute, do one of the following:

- Press **(Mute)** again
- Increase the radio volume
- Turn the radio off and on

Radio with Six-Disc CD Player

◀ (Volume/Mute): Turn to adjust the volume. Press to immediately stop the volume. While the volume is off, MUTED displays.

To cancel Mute, do one of the following:

- Press **▶**.
- Increase the radio volume.
- Turn the radio off and on.

Finding a Station

BAND: Press BAND to select between FM1, FM2, AM, XM1, XM2. If the radio is in ASM (Auto Station Memory) mode ASM appears on the display and FM ASM, and AM ASM can be selected.

◀▶ (Tune): Press to tune the radio frequency down or up. When the XM Category setting is ON, only stations in the chosen category can be selected.

◀▶▶▶ (Seek): Press to seek to the previous or next station, or to select the previous or next XM Category.

The radio can seek stations with a weak or strong signal within the selected band. Limit the automatic seek from finding stations with a weak or a strong signal by using the Auto/Local/Distance feature. See Auto/Local/Distance Selection, for more information.

Auto/Local/Distant Selection:

The LO (Local) option reduces the radio's automatic seek tuning sensitivity in FM and AM modes. LO only allows the radio to seek stations with a strong signal. If a strong station cannot be found, switch the radio to DX (Distant) so that stations with weaker signals can be found. The Auto (Automatic) option will search for local stations first. If no stations can be found, the radio searches for all stations.

The Local/Distant feature has no effect when the ASM search feature is being used.

This feature does not function with the XM radio stations.

To use Local/Distant on the radio with a single CD player:

1. Press the volume knob to enter the Option Menu.
2. Turn the volume knob until SEEK SENS (seek sensitivity) highlights.
3. Press the volume knob to enter the SEEK SENS setting.
4. Turn the volume knob and highlight either LO, DX, or AUTO.
5. Press the volume knob to save and exit the setting.
6. Select the BACK option or wait eight seconds to exit the menu.

6-6 Infotainment

To use Local/Distant on the radio with a six-disc CD player:

1. Press the MENU knob to enter the Option Menu.
2. Turn the MENU knob until Seek Sens highlights.
3. Press the MENU knob to enter the Seek Sens setting.
4. Turn the MENU knob and highlight either Local, Distance, or Auto.
5. Select the BACK option or wait eight seconds to exit the menu.

Selecting an XM Category

To select an XM Category on the radio with a single CD player:

1. Press the volume knob to enter the Option Menu.
2. Turn the volume knob until XM CATEGORY highlights.

3. Press the volume knob to enter the XM CATEGORY setting.
4. Turn the volume knob and highlight the desired category.
5. Press the volume knob to save and exit the setting.
6. Select the BACK option or wait eight seconds to exit the menu.

To select an XM Category on the radio with a six-disc CD player:

1. Press the MENU knob to enter the Option Menu.
2. Turn the MENU knob until XM Category highlights.
3. Press the MENU knob to enter the XM Category setting.
4. Turn the MENU knob and highlight the desired category.
5. Select the BACK option or wait eight seconds to exit the menu.

XM Satellite Radio Service

XM is a satellite radio service that is based in the 48 contiguous United States and 10 Canadian provinces. XM Satellite Radio has a wide variety of programming and commercial-free music, coast-to-coast, and in digital-quality sound. During your trial or when you subscribe, you will get unlimited access to XM Radio Online for when you are not in the vehicle. A service fee is required to receive the XM service. For more information, contact XM at xmradio.com or call 1-800-929-2100 in the U.S. and xmradio.ca or call 1-877-438-9677 in Canada.

XM Theftlock

The XM receiver may go into theftlock mode when operating the radio in one hour logic mode. If this happens, turn the key to ACC/ACCESSORY or ON/RUN position to exit XM receiver theftlock mode.

Setting Preset Stations

Up to 42 stations (six FM1, six FM2, six AM, six FM ASM, six AM ASM, six XM1, and six XM2), can be programmed.

1. Press BAND to select FM1, FM2, AM, XM1, or XM2.
2. Tune to a station.
3. For the radio with a single CD player, press and hold one of the six numbered pushbuttons until the selected station displays and a beep sounds.
4. For the radio with a six-disc CD player, press and hold one of the six softkeys until the selected preset number displays and a beep sounds.
5. Repeat the steps to store the other presets.
6. Repeat the steps for the other radio bands.

ASM (Automatic Station Memory):

ASM searches and stores six FM and six AM stations with the strongest signal. To use ASM:

1. Press BAND to select FM or AM.
2. Press ASM for at least two seconds until a beep sounds. SEARCH displays on the radio, followed by the number of stations found.
3. The radio will automatically store the six strongest stations found as ASM presets.

Press the ASM button to alternate between the ASM radio stations and preset radio stations.

ASM displays on the radio when using the ASM presets.

ASM does not delete previously stored stations in FM1, FM2, or AM.

ASM does not function with XM radio stations.

Setting the Tone (Bass/Treble)

The tone can be set independently for each source: FM, AM, and CD. The source must be active to set the tone.

Bass and Treble can be adjusted between -6 through +6.

To adjust the bass and treble on the radio with a single CD player:

1. Press the volume knob to enter the Option Menu, AUDIO is highlighted.
2. Press the volume knob to enter the AUDIO Menu.
3. Turn the volume knob until BASS or TREBLE highlights.
4. Press the volume knob to enter the BASS or TREBLE settings.
5. Turn the volume knob to adjust the BASS or TREBLE setting.
6. Press the volume knob to save and exit the setting.
7. Select the BACK option or wait eight seconds to exit the menu.

6-8 Infotainment

To adjust the bass and treble on the radio with a six-disc CD player:

1. Press the MENU knob to enter the Option Menu, Audio is highlighted.
2. Press the MENU knob to enter the Audio menu.
3. Turn the MENU knob until Bass or Treble highlights.
4. Press the MENU knob to enter the Bass or Treble settings.
5. Turn the MENU knob to adjust the Bass or Treble setting.
6. Press the MENU knob to save and exit the setting.
7. Select the Back option or wait eight seconds to exit the menu.

The Bass and Treble cannot be adjusted while the Equalizer is being used.

Loudness Contour Circuit:

The Loudness Contour Circuit automatically boosts the bass and treble response at low volume levels.

The Loudness Contour Circuit cannot be adjusted on the base radio.

To adjust the Loudness Contour Circuit on the radio with a six-disc CD player:

1. Press the MENU knob to enter the Option Menu, Audio is highlighted.
2. Press the MENU knob to enter the Audio menu.
3. Turn the MENU knob until Loudness highlights.
4. Press the MENU knob to enter the Loudness settings.
5. Turn the MENU knob to turn the Loudness setting On or Off.
6. Press the MENU knob to save and exit the setting.
7. Select the Back option or wait eight seconds to exit the menu.

Adjusting the Speakers (Balance/Fade)

- Balance can be adjusted from L6 (left) to R6 (right)
- Fade can be adjusted from F6 (front) to R6 (rear)

To adjust the balance and fade on the radio with a single CD player:

1. Press the volume knob to enter the Option Menu, AUDIO is highlighted.
2. Press the volume knob to enter the AUDIO Menu.
3. Turn the volume knob until BALANCE or FADE highlights.
4. Press the volume knob to enter the BALANCE or FADE settings.
5. Turn the volume knob to adjust the BALANCE or FADE setting.
6. Press the volume knob to save and exit the setting.
7. Select the BACK option or wait eight seconds to exit the menu.

To adjust the balance and fade on the radio with a six-disc CD player:

1. Press the MENU knob to enter the Option Menu, Audio is highlighted.
2. Press the MENU knob to enter the Audio menu.
3. Turn the MENU knob until Balance or Fader highlights.
4. Press the MENU knob to enter the Balance or Fader settings.
5. Turn the MENU knob to adjust the Balance or Fader setting.
6. Press the MENU knob to save and exit the setting.
7. Select the Back option or wait eight seconds to exit the menu.

EQ (Equalizer): Radios with the equalizer feature have five preprogrammed equalizer curves.

Press the EQ button to select between: Rock, Classical, Pop, Vocal, Jazz and Off.

To adjust the Equalizer setting on the radio with a six-disc CD player using the menu:

1. Press the MENU knob to enter the Option Menu, Audio is highlighted.
2. Press the MENU knob to enter the Audio menu.
3. Turn the MENU knob until Equalizer highlights.
4. Press the MENU knob to enter the Equalizer settings.
5. Turn the MENU knob to adjust the Equalizer setting.
6. Press the MENU knob to save and exit the setting.
7. Select the Back option or wait eight seconds to exit the menu.

Eq Boost can be changed from -2 to +2 on the radio with a six-disc CD player only.

To adjust the amount of boost for each EQ setting on the radio with a six-disc CD player:

1. Press the MENU knob to enter the Option Menu, Audio is highlighted.
2. Press the MENU knob to enter the Audio menu.
3. Turn the MENU knob until Eq Boost highlights.
4. Press the MENU knob to enter the Eq Boost settings.
5. Turn the MENU knob to adjust the Eq Boost setting.
6. Press the MENU knob to save and exit the setting.
7. Select the Back option or wait eight seconds to exit the menu.

Radio Message

Security Lockout Active: This message displays when the coded security system has been activated. Take the vehicle to your dealer/retailer for service.

Radio Messages for XM Only

See *XM Radio Messages on page 6-24* later in this section for further detail.

Using the CD Player

The CD player plays standard sized CDs. Using CDs of a different size can damage the drive or disc, even if an adapter is used.

The CD player has a memory buffer that holds approximately seven seconds of music to prevent interruption while driving over bumpy surfaces. If the interruption lasts longer than seven seconds, the memory buffer can become empty

and playback will be interrupted until the player has time to refocus, read the disc, and fill the buffer again.

When the player reaches the end of a CD, it automatically returns to the start and plays the CD again.

- CDs can be loaded with the ignition and the radio on or off.
- CDs will stay in the player if the ignition or radio is turned off.
- If the CD was the last source selected, it resumes playing when the radio is turned on.

Loading CDs

To load a CD with the radio with a single CD player:

1. Insert a CD label side up partway into the slot.
2. The CD player will pull the CD in and begin playing if the radio is on.

To load CDs with the radio with a six-disc CD player:

 **LOAD:** Press to load CDs into the CD player. The display shows DISC and six numbers that correspond to the six CD storage locations. When a storage location has no disc loaded a dash displays.

To insert one CD:

1. Press  LOAD and Insert Disc displays.
2. The load indicator light flashes, and the radio beeps twice.
3. Insert a CD label side up partway into the slot.
4. The CD player will pull the CD in and begin playing if the radio is on.

To insert multiple CDs:

1. Press and hold  LOAD for more than two seconds, a beep sounds and Loading All Discs displays.
2. The display, the beeps, and the load indicator light prompts when to insert each CD.
3. Insert a CD label side up partway into the slot.
4. The CD player will pull the CD in and begin playing if the radio is on.

The load function is canceled when:

- A CD has not been inserted for 10 seconds.
-  EJECT is pressed.
- The radio is turned off.

Ejecting CDs

 **EJECT:** Press to stop a CD while it is playing or to eject a CD when it is not playing. Eject can be activated with the ignition and the radio off. If an ejected CD is not removed with 10 seconds, it will be automatically pulled back into the player.

To eject a single CD with the radio with a six-disc CD player:

1. Press  EJECT.
2. Press the numbered or softkey that the disc is assigned to within 3 seconds.

To eject all CDs with the radio with a six-disc CD player:

1. Press and hold  EJECT for more than two seconds, a beep sounds and Ejecting All Discs displays.
2. The display, the beeps, and the load indicator light prompts when to remove each CD.

The eject function is canceled when:

- A CD has not been removed for 10 seconds.
-  LOAD is pressed.
- The radio is turned off.

6-12 Infotainment

Playing CDs

RPT/ REPEAT: When Repeat is selected, tracks or discs can be repeated.

To use repeat with the radio with a single CD player, press RPT to replay the current track continuously. Press it again to cancel repeat.

To use repeat with the radio with a six-disc CD player, press the softkey below REPEAT to select between.

- REPEAT TRACK
- REPEAT DISC

RDM/RANDOM: When random is selected, all tracks or discs are played in random order.

To use random with the radio with a single CD player, press RDM to randomly play all tracks on the CD. Press RDM again to cancel this function.

To use random with the radio with a six-disc CD player, press the softkey below RANDOM to select between.

- RANDOM TRACK
- RANDOM DISC

DISPLAY MODE: The display modes for CD operation can be changed.

To adjust the display mode for the radio with a single CD player:

Press DISPLAY MODE to switch between Track Info Mode and CD Info Mode.

- Track Info Mode displays the track number and play time.
- CD Info Mode displays CD text information. If no data is present, No Text displays.

To adjust the display mode for the radio with a six-disc CD player:

Press the softkey under Display Mode to switch between, Normal Mode, Track Info Mode, CD Info Mode, and Disc and Track Info Mode if the CD has this information on it.

- Normal Mode displays the track number and elapsed time.
- Track Info Mode displays the track number, elapsed time, and track name. The track name is only displayed when the appropriate data is stored on the CD.
- Disc Info Mode displays the track number, elapsed time, and name of CD. The CD name is only displayed when the appropriate data is stored on the CD.
- Disc and Track Info Mode displays the track name and name of CD. Track name and CD name is only displayed when the appropriate data is stored on the CD.

BAND: Press to stop CD playback and play the radio.

⏮ (Reverse): Press to go back to the start of the current track or press multiple times until the desired track is reached.

⏮ TRACK (Reverse): Press to go back to the start of the current track or press multiple times until the desired track is reached. Press and hold **⏮ TRACK** to quickly move backward within the current track.

⏭ (Forward): Press to go to the next track of the current CD or press multiple times until the desired track is reached.

⏭ TRACK (Forward): Press to go to the next track of the current CD or press multiple times until the desired track is reached. Press and hold **⏭ TRACK** to quickly move forward within the current track.

CD: Press to start playback of a CD already in the drive if it was not the last audio source.

CD ||: Press to pause and resume playback of the CD. Press to start playback of a CD already in the player if it was not the last audio source.

|| (Pause): Press to pause and resume playback of the CD.

⏮ (Fast Reverse): Press and hold to quickly move backward within the current track.

⏭ (Fast Forward): Press and hold to quickly move forward within the current track.

⏮ DISC (Previous): Press to select the previous disc for playback.

⏭ DISC (Next): Press to select the next disc for playback.

AUX (Auxiliary): Press to stop CD playback and use the AUX input.

Playing an MP3 Disc

For more information on how to play an MP3 CD-R/RW disc, see *Using an MP3 on page 6-20*.

Care of CDs

Sound quality can be reduced because of CD quality, the method of recording, the quality of the music that has been recorded, and the way the CD has been handled.

If the surface of a CD is soiled, take a soft, lint free cloth or dampen a clean, soft cloth in a mild, neutral detergent solution mixed with water, and clean it. Make sure the wiping process starts from the center to the edge.

- Handle CDs carefully.
- Do not touch the bottom side of a CD while handling it; this could damage the surface.

6-14 Infotainment

- Pick up CDs by grasping the outer edges or the edge of the hole and the outer edge.
- Store CDs in their original cases or other protective cases and away from direct sunlight and dust.

Care of the CD Player

Notice: If a label is added to a CD, or more than one CD is inserted into the slot at a time, or an attempt is made to play scratched or damaged CDs, the CD player could be damaged. While using the CD player, use only CDs in good condition without any label, load one CD at a time, and keep the CD player and the loading slot free of foreign materials, liquids, and debris.

Do not add any label to a CD, it could get caught in the CD player. If a CD is recorded on a personal computer and a description label is needed, label the top of the recorded CD with a marking pen.

The use of CD lens cleaners for CDs is not advised, due to the risk of contaminating the lens of the CD optics with lubricants internal to the CD player mechanism.

If an error displays, see “CD Messages” later in this section.

CD Messages

If the CD ejects, or stops playing, it could be for one of the following reasons:

- The vehicle is being driven on a very rough road. The CD should play when the road becomes smoother.
- It is very hot. The CD should play when the temperature returns to normal.
- The air is very humid. Wait about an hour and try again.
- The CD is dirty, scratched, wet, or upside down.
- The label is caught in the CD player.

- The format of the CD is not compatible. See *Using an MP3 on page 6-20*.
- There was a problem while recording the CD.

If the CD is not playing correctly, for any other reason, try a known good CD.

If an error is displayed, occurs repeatedly, or cannot be corrected, write down the error and contact the dealer/retailer.

Using the Auxiliary Input Jack

Only connect portable audio players to the auxiliary input jack located on the right side of the faceplate.

Set up portable audio players while the vehicle is in P (Park). See *Defensive Driving on page 8-16* for more information on driver distraction.

Connect a 3.5 mm (1/8 inch) cable between the radio's front auxiliary input jack and a portable audio player. The radio automatically detects the device and AUX INPUT DEVICE displays. The portable audio player plays audio over the vehicle speakers. If a portable audio player has already been connected, the portable audio player does not begin playing audio until the AUX button is pressed.

The rear auxiliary input connector is located on the back of the radio. See your dealer/retailer for more information about this feature.

To disable the rear auxiliary input on the radio with a single CD player:

1. Press the volume knob to enter the Option Menu, AUDIO is highlighted.
2. Turn the volume knob until REAR AUX highlights.
3. Press the volume knob to enter the REAR AUX setting.

4. Turn the volume knob to turn the rear auxiliary input ON or OFF.
5. Press the volume knob to save and exit the setting.
6. Select the BACK option or wait eight seconds to exit the menu.

To disable the rear auxiliary input on the radio with a six-disc CD player:

1. Press the MENU knob to enter the Option Menu, Audio is highlighted.
2. Turn the MENU knob until Rear AUX highlights.
3. Press the MENU knob to enter the Rear AUX setting.
4. Turn the MENU knob to turn the rear auxiliary input On or Off.
5. Press the MENU knob to save and exit the setting.
6. Select the Back option or wait eight seconds to exit the menu.

AUX (Auxiliary): Press AUX to switch between the front and rear AUX input jack.

Press the AUX button to start audio playback from the portable audio player that is connected to the front AUX input jack, if this was the last source.

Volume: Turn to increase or decrease the volume of the portable player. Additional volume adjustments to the portable device may be needed.

BAND: Press to listen to the radio when a portable audio device is playing.

Additional Features

Help Prompts: Allows help information to be displayed for eight seconds after the request for that button or feature has been made. To enable or disable help prompts:

1. Press the MENU knob to enter the Options Menu.
2. Turn the MENU knob until Help Prompts highlights.
3. Press the MENU knob to access the Help Prompts menu.
4. Turn the MENU knob to turn change the setting to On or Off.
5. Press the MENU knob to save the setting.
6. Select the BACK option or wait eight seconds to exit the menu.

? (Help): Press to receive information about how the radio functions.

To use help for a radio button on the radio with a single CD player:

1. Press ? to enter the help menu.
2. Press the volume knob to highlight the menu item.
3. Press any of the radio buttons to display the help text.
4. Press ? again to go back one level.

To use help for a radio button on the radio with a six-disc CD player:

1. Press ? to enter the help menu.
2. Turn the MENU knob until "What does each button do?" highlights, and press the MENU knob.
3. Press any of the radio buttons to display its help text. To go back one level, press ? again.

To use help for a radio function on the radio with a single CD player:

1. Press ? to enter the help menu.
2. Press the volume knob to highlight the menu item.
3. Turn the volume knob to highlight a desired help topic to display the help text.
4. Press ? again to go back one level.

To use help for a radio function on the radio with a six-disc CD player:

1. Press ? to enter the help menu.
2. Turn the MENU knob until "Help Topics" highlights, and press the MENU knob.
3. Turn the MENU knob to highlight a desired help topic to display its help text. To go back one level, press ? again.

Startup Screen: To enable or disable the startup screen on the radio with a six-disc CD player:

1. Press the MENU knob to enter the Options Menu.
2. Turn the MENU knob until Welcome highlights.
3. Press the MENU knob to access the Welcome menu.
4. Turn the MENU knob to change the setting to On or Off.
5. Press the MENU knob to save the setting.
6. Select the BACK option or wait eight seconds to exit the menu.

Display Settings: The display brightness and illumination can only be adjusted while the radio is on. The brightness adjustment range is from -5 to +5 and the illumination adjustment range is from STD (standard) to -5.

To change the brightness and illumination settings on the radio with a single CD player:

1. Press the volume knob to enter the Options Menu.
2. Turn the volume knob until DISP SETUP (display setup) highlights.
3. Press the volume enter the DISP SETUP menu.
4. Turn the volume knob until either ILLN MODE (illumination mode) or BRIGHTNESS highlights.
5. Press the volume knob to enter either setting.
6. Turn the volume knob to change the setting.
7. Press the volume knob to save and exit the setting.
8. Select the BACK option or wait eight seconds to exit the menu.

To change the brightness and illumination settings on the radio with a six-disc CD player:

1. Press the MENU knob to enter the Options Menu.
2. Turn the MENU knob until Display highlights.
3. Press the MENU knob to access the Display setup menu and the option for Brightness highlights.
4. Turn the MENU knob to change the setting.
5. Press the MENU knob to save the setting.
6. Select the BACK option or wait eight seconds to exit the menu.

6-18 Infotainment

Speed Dependent Volume (SDV):

The SDV system automatically adjusts the radio volume to compensate for driving noise. The SDV system can only be adjusted while the radio is on. As the speed of the vehicle increases or decreases, the radio volume increases or decreases. The SDV adjustment range for the radio with a single CD player is between OFF and CUR 6, and the adjustment range for the radio with a six-disc CD player is between 0 and 5.

To adjust the SDV setting on the radio with a single CD player:

1. Press the volume knob to enter the Options Menu.
2. Turn the volume knob until AUD SETUP (audio setup) highlights.
3. Press the volume knob to enter the AUD SETUP menu.
4. Turn the volume knob until SD VOLUME (speed dependent volume) highlights.

5. Press the volume knob to enter the SD VOLUME settings.
6. Turn the volume knob to adjust the SD VOLUME setting.
7. Press the volume knob to save and exit the setting.
8. Select the BACK option or wait eight seconds to exit the menu.

To adjust the SDV setting on the radio with a six-disc CD player:

1. Press the MENU knob to enter the Options Menu.
2. Turn the MENU knob until Audio Setup highlights.
3. Press the MENU knob to enter the Audio Setup menu.
4. Turn the MENU knob until Speed Vol (speed volume) highlights.
5. Press the MENU knob to enter the Speed Vol settings.
6. Turn the MENU knob to adjust the Speed Vol setting.

7. Press the MENU knob to save and exit the setting.
8. Select the BACK option or wait eight seconds to exit the menu.

Dynamic Distortion Limiter (DDL):

The DDL system limits the amount of audio distortion that can be heard. The DDL system can only be adjusted while the radio is on. When the distortion level reaches a preset limit, the radio automatically reduces the volume until the distortion is reduced. The DDL adjustment range is between OFF and CUR 3.

To adjust the DDL setting on the radio with a single CD player:

1. Press the volume knob to enter the Options Menu and the option for AUDIO highlights.
2. Turn the volume knob until AUD SETUP highlights.
3. Press the volume knob to enter the AUD SETUP menu.
4. Turn the volume knob until DDL highlights.

5. Press the volume knob to enter the DDL setting.
6. Turn the volume knob to adjust the DDL setting.
7. Press the volume knob to save and exit the setting.
8. Select the BACK option or wait eight seconds to exit the menu.

To adjust the DDL setting on the radio with a six-disc CD player:

1. Press the MENU knob to enter the Options Menu.
2. Turn the MENU knob until Audio Setup highlights.
3. Press the MENU knob to enter the Audio Setup menu.
4. Turn the MENU knob until DDL highlights.
5. Press the MENU knob to enter the DDL setting.

6. Turn the MENU knob to change the DDL setting.
7. Press the MENU knob to save and exit the setting.
8. Select the BACK option or wait eight seconds to exit the menu.

Confirmation Beeps: Confirmation beeps are used to indicate various actions by the radio. The beeps can only be turned on or off on the radio with a six-disc CD player while it is on. The confirmation beep options are:

On: The radio beeps when storing radio a station, inserting or to removing a CD, or when the LOAD ALL or the EJECT ALL functions have started.

CD Only: The radio beeps when inserting or removing a CD.

Off: The radio does not beep.

To change the options for the beeps:

1. Press the MENU knob to enter the Options Menu.
2. Turn the MENU knob until Audio Setup highlights.
3. Press the MENU knob to enter the Audio Setup menu.
4. Turn the MENU knob until Beeps highlights.
5. Press the MENU knob to enter the Beeps setting.
6. Turn the MENU knob to change the Beeps setting.
7. Press the MENU knob to save and exit the setting.
8. Select the BACK option or wait eight seconds to exit the menu.

Personal Identity Memories (Radio with Six-Disc CD Player)

Personal Identity Memories are coded to the vehicle's keys. Only two keys can be coded. The settings are stored by the vehicle and are unique to each key.

For the audio system, the following settings are individually memorized by the key system and become unique to the particular key:

- Radio On or Off.
- Last used volume level.
- Last used source (FM, AM, or CD).
- Radio station presets.
- Bass and treble settings.
- Speaker balance and fade settings.
- Additional features such as SDV settings, Beeps, DDL settings, display priority settings, and tuner seek sensitivity.

- Equalizer and boost settings, if the radio has this feature.
- CD track and disc settings.

Radio memory presets that are stored for the first time, are automatically stored for both personal identity keys. If the presets are changed later by using a different personal identity key, they become specific for that key only.

Independent Tone Memories

The radio is equipped with Independent Tone Memories.

Bass and Treble settings are stored independently for FM, AM, and CD.

After all independent tone memories have been stored for the first ignition key, different settings can be stored for the second ignition key using the same procedure.

Using an MP3

MP3 CD-R / CD-RW Disc MP3 Format

Only the radio with a six-disc CD player can play MP3 CD's.

The MP3 player is able to read and play a maximum of:

- 50 folders.
- 11 folders in depth
- 50 playlists
- 10 sessions
- 255 files
- All items over the maximum are ignored.

To record an MP3 disc:

- Record the MP3 files onto a CD-R or CD-RW disc.
- Record playlists with an .m3u or .wpl extension.
- Do not mix standard audio and MP3 files on the same disc.
- Record the entire disc at once.
- Finalize the disc when recording an MP3 disc with multiple sessions.

Root Directory

The root directory is treated as a folder. All .mp3 files in the root directory are accessed before folders in the root directory.

Empty Directory or Folder

Empty folders and directories will not show on the display. The system will ignore empty directories and folders and advance to the next directory or folder that has .mp3 files in it.

No Folder

On a CD that contains only .mp3 files in the root directory the next and previous folder functions do not work.

On a CD that contains playlists and .mp3 files, the next and previous folder functions search playlists first and then search .mp3 files in the root folder.

Order of Play

Tracks are played in the following order for CDs that have playlists:

1. The first track in the first playlist and then continues sequentially through all tracks in each playlist.
2. When the last track of the last playlist has played, play restarts from the first track of the first playlist.

Tracks are played in the following order for CDs that do not have playlists:

1. Play starts with the first file in the root directory.
2. After all files from the root directory have played, files in the folders will play.
3. After playing the last file from the last folder, play restarts with the first file in the root directory.

File System and Naming

The radio shows track names that are shorter than 39 characters, names that are longer will be shortened. The radio will show the track name as:

- The song name that is in the ID3 tag.
- The file name without the file extension if the song name is not in the ID3 tag.

6-22 Infotainment

Preprogrammed Playlists

Playlists are accessed before files or folders in the root directory.

Preprogrammed playlists created by WinAmp™, MusicMatch™, or Real Jukebox™ software can be accessed and are treated as special folders containing compressed audio song files.

Playing an MP3

The MP3 player cannot play the smaller 3 inch (8 cm) single CDs with an adapter ring.

To play an MP3 CD:

1. Press CD if an MP3 disc is already in the player.
2. Refer to *Radio(s) on page 6-3* for information on how to load discs if the CD player is empty.

MP3 CD Display: To change the MP3 CD display, press the softkey under the label Display Mode until the desired display is shown.

The MP3 CD display modes are:

- Normal mode with folder number, track number, and elapsed time.
- Folder and song info mode with folder number, track number, folder name and song name. Folder name and song name can only be displayed when the appropriate data is stored on the CD MP3 ID tag.
- Artist and song info mode with folder number, track number, artist name, and song name. Artist name and song name can only be displayed when the appropriate data is stored on the CD MP3 ID tag.
- Song info mode with folder number, track number, and folder name.

RANDOM: Select to hear the tracks in random order. The random modes are RDM IN DISC (random in disc) or RDM IN FOLDER (random in folder).

To use RANDOM:

1. Press the softkey below the Random label to display the different random modes.
2. Press the softkey below RDM IN DISC or RDM IN FOLDER.
3. Press **▶▶** to go to the next track.
4. Press **◀◀** to go to the previous track.
5. Press the softkey below the active random mode to cancel the random mode.

REPEAT: Select to repeat tracks or folders.

To use REPEAT:

1. Press the softkey below the REPEAT label to display the different repeat modes.
2. Press the softkey below REPEAT TRACK, REPEAT DISC, or REPEAT FOLDER to choose that mode.
3. Press the softkey below the active repeat mode to cancel the repeat mode.

BROWSE MODE: Folders and tracks of an MP3 disc can be found easier by using the browse mode.

Finding a track in the current folder:

1. Press the softkey below BROWSE MODE. The files in the active folder display and the active track is highlighted.
2. Turn the MENU knob to highlight the desired track.

3. Press the MENU knob to play the highlighted track.
4. Press the softkey below EXIT to exit browse mode.

Finding a track in a different folder:

1. Press the softkey below BROWSE MODE. The files in the active folder display and the active track is highlighted.
2. Turn the MENU knob to highlight 'Folder Listing'.
3. Press the MENU knob to list all the folders on the CD.
4. Turn the MENU knob to highlight the desired folder.
5. Press the MENU knob to list the tracks in the highlighted folder.
6. Turn the MENU knob to highlight the desired track.
7. Press the MENU knob to play the highlighted track.
8. Press the softkey below EXIT to exit browse mode.

Finding a playlist:

1. Press the softkey below BROWSE MODE. The files in the active folder display and the active track is highlighted.
2. Turn the MENU knob to highlight 'Playlists'.
3. Press the MENU knob to list all the playlists on the CD.
4. Turn the MENU knob to highlight the desired playlist.
5. Press the MENU knob to play the highlighted playlist.
6. Press the softkey below EXIT to exit browse mode.

DISC ►► (Next Folder): Press and hold for more than two seconds to go to the next folder.

DISC ◀◀ (Previous Folder): Press and hold for more than two seconds to go to the previous folder.

▶▶ (Forward): Press to go to the next track or press ▶▶ multiple times until the desired track is reached.

◀◀ (Reverse): Press to go back to the start of the current track or press ◀◀ multiple times until the desired track is reached.

XM Radio Messages

XL (Explicit Language Channels): These channels, or any others, can be blocked at a customer's request, by calling 1-800-852-XXXM (9696).

XM Updating: The encryption code in the receiver is being updated, and no action is required. This process should take no longer than 30 seconds.

No XM Signal: The system is functioning correctly, but the vehicle is in a location that is blocking the XM™ signal. When the vehicle is moved into an open area, the signal should return.

Loading XM: The audio system is acquiring and processing audio and text data. No action is needed. This message should disappear shortly.

Channel Off Air: This channel is not currently in service. Tune in to another channel.

Channel Unauth: This channel is blocked or cannot be received with your XM Subscription package.

Channel Unavail: This previously assigned channel is no longer assigned. Tune to another station. If this station was one of the presets, choose another station for that preset button.

No Artist Info: No artist information is available at this time on this channel. The system is working properly.

No Title Info: No song title information is available at this time on this channel. The system is working properly.

No CAT Info: No category information is available at this time on this channel. The system is working properly.

No Information: No text or informational messages are available at this time on this channel. The system is working properly.

CAT Not Found: There are no channels available for the selected category. The system is working properly.

XM Theftlocked: The XM™ receiver in your vehicle could have previously been in another vehicle. For security purposes, XM™ receivers cannot be swapped between vehicles. If this message is received after having your vehicle serviced, check with your dealer/retailer.

XM Radio ID: If tuned to channel 0, this message alternates with the XM™ Radio 8 digit radio ID label. This label is needed to activate the service.

Unknown: If this message is received when tuned to channel 0, there could be a receiver fault. Consult with your dealer/retailer.

Check XM Receiver: If this message does not clear within a short period of time, the receiver could have a fault. Consult with your dealer/retailer.

XM Not Available: If this message does not clear within a short period of time, the receiver could have a fault. Consult with your dealer/retailer.

Bluetooth®

Vehicles with a Bluetooth system can use a Bluetooth capable cell phone with a Hands Free Profile to make and receive phone calls. The system can be used while the key is in ON/RUN or ACC/ACCESSORY position. The range of the Bluetooth system can be up to 30 ft. (9.1 m). Not all phones support all functions, and not all phones are guaranteed to work with the in-vehicle Bluetooth system. See gm.com/bluetooth for more information on compatible phones.

Voice Recognition

The Bluetooth system uses voice recognition to interpret voice commands to dial phone numbers and name tags.

Noise: Keep interior noise levels to a minimum. The system may not recognize voice commands if there is too much background noise.

When to Speak: A short tone sounds after the system responds indicating when it is waiting for a voice command. Wait until the tone and then speak.

How to Speak: Speak clearly in a calm and natural voice.

Audio System

When using the in-vehicle Bluetooth system, sound comes through the vehicle's front audio system speakers and over-rides the audio system. Use the audio system volume knob, during a call, to change the volume level. The adjusted volume level remains in memory for later calls. To prevent missed calls, a minimum volume level is used if the volume is turned down too low.

Bluetooth Controls

Use the buttons located on the steering wheel to operate the in-vehicle Bluetooth system. See *Audio Steering Wheel Controls on page 6-36* for more information.

 **(Voice In):** Press to answer incoming calls, to confirm system information, and to start speech recognition.

 **(Call End):** Press to end a call, reject a call, or to cancel an operation.

Pairing

A Bluetooth enabled cell phone must be paired to the in-vehicle Bluetooth system first and then connected to the vehicle before it can be used. See the cell phone manufacturers user guide for Bluetooth functions before pairing the cell phone. If a Bluetooth phone is not connected, calls will be

made using OnStar® Hands Free Calling, if available. Refer to the OnStar owner's guide for more information.

Pairing Information:

- Up to five cell phones can be paired to the in-vehicle Bluetooth system.
- The pairing process is disabled when the vehicle is moving.
- The in-vehicle Bluetooth system automatically links with the first available paired cell phone in the order the phone was paired.
- Only one paired cell phone can be connected to the in-vehicle Bluetooth system at a time.
- Pairing should only need to be completed once, unless changes to the pairing information have been made or the phone is deleted.

To link to a different paired phone, see *Linking to a Different Phone* later in this section.

Pairing a Phone

1. Press and hold  for two seconds. The system responds with "Ready" followed by a tone.
2. Say "Bluetooth". The system responds with "Bluetooth ready" followed by a tone.
3. Say "Pair". The system responds with instructions and a four digit PIN number. The PIN number will be used in Step 4.
4. Start the Pairing process on the cell phone that will be paired to the vehicle. Reference the cell phone manufacturers user guide for information on this process.

Locate the device named "General Motors" in the list on the cellular phone and follow the instructions on the cell phone to enter the four digit PIN number that was provided in Step 3.

5. The system prompts for a name for the phone. Use a name that best describes the phone. This name will be used to indicate which phone is connected. The system then confirms the name provided.
6. The system responds with "<Phone name> has been successfully paired" after the pairing process is complete.
7. Repeat Steps 1 through 7 for additional phones to be paired.

Listing All Paired and Connected Phones

1. Press and hold  for two seconds. The system responds with "Ready" followed by a tone.
2. Say "Bluetooth". The system responds with "Bluetooth ready" followed by a tone.

3. Say "List". The system lists all the paired Bluetooth devices. If a phone is connected to the vehicle, the system will say "Is connected" after the connected phone.

Deleting a Paired Phone

1. Press and hold  for two seconds. The system responds with "Ready" followed by a tone.
2. Say "Bluetooth". The system responds with "Bluetooth ready" followed by a tone.
3. Say "Delete". The system asks which phone to delete followed by a tone.
4. Say the name of the phone to be deleted. If the phone name is unknown, use the "List" command for a list of all paired phones. The system responds with "Would you like to delete <phone name>? Yes or No" followed by a tone.
5. Say "Yes" to delete the phone. The system responds with "OK, deleting <phone name>".

Linking to a Different Phone

1. Press and hold  for two seconds. The system responds with "Ready" followed by a tone.
2. Say "Bluetooth". The system responds with "Bluetooth ready" followed by a tone.
3. Say "Change phone". The system responds with "Please wait while I search for other phones".
 - If another phone is found, the response will be "<Phone name> is now connected".
 - If another phone is not found, the original phone remains connected.

Storing Name Tags

The system can store up to thirty phone numbers as name tags that are shared between the Bluetooth and OnStar systems.

The system uses the following commands to store and retrieve phone numbers:

- Store
- Digit Store
- Directory

Using the Store Command

The store command allows a phone number to be stored without entering the digits individually.

1. Press and hold  for two seconds. The system responds with “Ready” followed by a tone.
2. Say “Store”. The system responds with “Store, number please” followed by a tone.

3. Say the complete phone number to be stored at once with no pauses.

- If the system recognizes the number it responds with “OK, Storing” and repeats the phone number.
- If the system is unsure it recognizes the phone number, it responds with “Store” and repeats the number followed by “Please say yes or no”. If the number is correct, say “Yes”. If the number is not correct, say “No”. The system will ask for the number to be re-entered.

4. After the system stores the phone number, it responds with “Please say the name tag” followed by a tone.

5. Say a name tag for the phone number. The name tag is recorded and the system responds with “About to store <name tag>. Does that sound OK?”.

- If the name tag does not sound correct, say “No” and repeat Step 5.
- If the name tag sounds correct, say “Yes” and the name tag is stored. After the number is stored the system returns to the main menu.

Using the Digit Store Command

The digit store command allows a phone number to be stored by entering the digits individually.

1. Press and hold  for two seconds. The system responds with “Ready” followed by a tone.
2. Say “Digit Store”. The system responds with “Please say the first digit to store” followed by a tone.

3. Say the first digit to be stored. The system will repeat back the digit it heard followed by a tone. Continue entering digits until the number to be stored is complete.
 - If an unwanted number is recognized by the system, say “Clear” at any time to clear the last number.
 - To hear all of the numbers recognized by the system, say “Verify” at any time and the system will repeat them.
4. After the complete number has been entered, say “Store”. The system responds with “Please say the name tag” followed by a tone.
5. Say a name tag for the phone number. The name tag is recorded and the system responds with “About to store <name tag>. Does that sound OK?”.
 - If the name tag does not sound correct, say “No” and repeat Step 5.
 - If the name tag sounds correct, say “Yes” and the name tag is stored. After the number is stored the system returns to the main menu.

Using the Directory Command

The directory command lists all of the name tags stored by the system. To use the directory command:

1. Press and hold  for two seconds. The system responds with “Ready” followed by a tone.
2. Say “Directory”. The system responds with “Directory” and then plays back all of the stored name tags. When the list is complete, the system returns to the main menu.

Deleting Name Tags

The system uses the following commands to delete name tags:

- Delete
- Delete all name tags

Using the Delete Command

The delete command allows specific name tags to be deleted.

To use the delete command:

1. Press and hold $\hat{\text{w}}_{\Sigma}$ for two seconds. The system responds with "Ready" followed by a tone.
2. Say "Delete". The system responds with "Delete, please say the name tag" followed by a tone.
3. Say the name tag to be deleted. The system responds with "Would you like to delete, <name tag>? Please say yes or no".
 - If the name tag is correct, say "Yes" to delete the name tag. The system responds with "OK, deleting <name tag>, returning to the main menu."
 - If the name tag is incorrect, say "No". The system responds with "No. OK, let's try again, please say the name tag."

Using the Delete All Name Tags Command

The delete all name tags command deletes all stored phone book name tags and route name tags for OnStar (if present).

To use the delete all name tags command:

1. Press and hold $\hat{\text{w}}_{\Sigma}$ for two seconds. The system responds with "Ready" followed by a tone.
2. Say "Delete all name tags". The system responds with "You are about to delete all name tags stored in your phone directory and your route destination directory, are you sure you want to do this. Please say yes or no."
 - Say "Yes" to delete all name tags.
 - Say "No" to cancel the function and return to the main menu.

Making a Call

Calls can be made using the following commands:

- Dial
- Digit Dial
- Call
- Re-dial

Using the Dial Command

1. Press and hold $\hat{\text{w}}_{\Sigma}$ for two seconds. The system responds with "Ready" followed by a tone.
2. Say "Dial". The system responds with "Dial using <phone name>. "Number please" followed by a tone.

3. Say the entire number without pausing.
 - If the system recognizes the number, it responds with “OK, Dialing” and dials the number.
 - If the system does not recognize the number, it confirms the numbers followed by a tone. If the number is correct, say “Yes”. The system responds with “OK, Dialing” and dials the number. If the number is not correct, say “No”. The system will ask for the number to be re-entered.

Using the Digit Dial Command

1. Press and hold  for two seconds. The system responds with “Ready” followed by a tone.
2. Say “Digit Dial”. The system responds with “Digit dial using <phone name>, please say the first digit to dial” followed by a tone.

3. Say the digit to be dialed one at a time. Following each digit, the system will repeat back the digit it heard followed by a tone.
4. Continue entering digits until the number to be dialed is complete. After the whole number has been entered, say “Dial”. The system responds with “OK, Dialing” and dials the number.
 - If an unwanted number is recognized by the system, say “Clear” at any time to clear the last number.
 - To hear all of the numbers recognized by the system, say “Verify” at any time and the system will repeat them.

Using the Call Command

1. Press and hold  for two seconds. The system responds with “Ready” followed by a tone.

2. Say “Call”. The system responds with “Call using <phone name>. Please say the name tag” followed by a tone.
3. Say the name tag of the person to call.
 - If the system clearly recognizes the name tag it responds with “OK, calling, <phone name>” and dials the number.
 - If the system is unsure it recognizes the right name tag, it confirms the name tag followed by a tone. If the name tag is correct, say “Yes”. The system responds with “OK, calling, <name tag>” and dials the number. If the name tag is not correct, say “No”. The system will ask for the name tag to be re-entered.

Once connected, the person called will be heard through the audio speakers.



Using the Re-dial Command

1. Press and hold  for two seconds. The system responds with “Ready” followed by a tone.
2. After the tone, say “Re-dial”. The system responds with “Re-dial using <phone name>” and dials the last number called from the connected Bluetooth phone.

Once connected, the person called will be heard through the audio speakers.



Receiving a Call

When an incoming call is received, the audio system mutes and a ring tone is heard in the vehicle.

- Press  and begin speaking to answer the call.
- Press  to ignore a call.



Call Waiting

Call waiting must be supported on the Bluetooth phone and enabled by the wireless service carrier to work.

- Press  to answer an incoming call when another call is active. The original call is placed on hold.
- Press  again to return to the original call.
- To ignore the incoming call, continue with the original call with no action.
- Press  to disconnect the current call and switch to the call on hold.

Three-Way Calling

Three-Way Calling must be supported on the Bluetooth phone and enabled by the wireless service carrier to work.

1. While on a call press . The system responds with “Ready” followed by a tone.
2. Say “Three-way call”. The system responds with “Three-way call, please say dial or call”.
3. Use the dial or call command to dial the number of the third party to be called.
4. Once the call is connected, press  to link all the callers together.

Ending a Call

Press  to end a call.

Muting a Call

During a call, all sounds from inside the vehicle can be muted so that the person on the other end of the call cannot hear them.

To Mute a call

1. Press . The system responds with “Ready” followed by a tone.
2. Say “Mute Call”. The system responds with “Call muted”.

To Cancel Mute

1. Press . The system responds with “Ready” followed by a tone.
2. After the tone, say “Mute Call”. The system responds with “Resuming call”.

Transferring a Call

Audio can be transferred between the in-vehicle Bluetooth system and the cell phone.

To Transfer Audio to the Cell Phone

During a call with the audio in the vehicle:

1. Press . The system responds with “Ready” followed by a tone.
2. Say “Transfer Call.” The system responds with “Transferring call” and the audio will switch from the vehicle to the cell phone.

To Transfer Audio to the In-Vehicle Bluetooth System

The cellular phone must be paired and connected with the Bluetooth system before a call can be transferred. The connection process can take up to two minutes after the key is turned to the ON/RUN or ACC/ACCESSORY position.

During a call with the audio on the cell phone, press  for more than two seconds. The audio switches from the cell phone to the vehicle.

Voice Pass-Thru

Voice Pass-Thru allows access to the voice recognition commands on the cell phone. See the cell phone manufacturers user guide to see if the cell phone supports this feature. This feature can be used to verbally access contacts stored in the cell phone.

1. Press and hold  for two seconds. The system responds with “Ready” followed by a tone.
2. Say “Bluetooth”. The system responds with “Bluetooth ready” followed by a tone.

6-34 Infotainment

3. Say "Voice". The system responds with "OK, accessing <phone name>".
 - The cell phone's normal prompt messages will go through its cycle according to the phone's operating instructions.

Dual Tone Multi-Frequency (DTMF) Tones

The in-vehicle Bluetooth system can send numbers and numbers stored as name tags during a call. This is used when calling a menu driven phone system. Account numbers can be programmed into the phonebook for retrieval during menu driven calls.

Sending a number during a call

1. Press . The system responds with "Ready" followed by a tone.
2. Say "Dial". The system responds with "Say a number to send tones" followed by a tone.
3. Say the number to send.
 - If the system clearly recognizes the number it responds with "OK, Sending Number" and the dial tones are sent and the call continues.
 - If the system is not sure it recognized the number properly, it responds "Dial Number, Please say yes or no?" followed by a tone. If the number is correct, say "Yes". The system responds with "OK, Sending Number" and the dial tones are sent and the call continues.

Sending a Stored Name Tag During a Call

1. Press . The system responds with "Ready" followed by a tone.
2. Say "Send name tag." The system responds with "Say a name tag to send tones" followed by a tone.
3. Say the name tag to send.
 - If the system clearly recognizes the name tag it responds with "OK, Sending <name tag>" and the dial tones are sent and the call continues.
 - If the system is not sure it recognized the name tag properly, it responds "Dial <name tag>, Please say yes or no?" followed by a tone. If the name tag is correct, say "Yes". The system responds with "OK, Sending <name tag>" and the dial tones are sent and the call continues.

Clearing the System

Unless information is deleted out of the in-vehicle Bluetooth system, it will be retained indefinitely.

This includes all saved name tags in the phonebook and phone pairing information. For information on how to delete this information, see the above sections on Deleting a Paired Phone and Deleting Name Tags.

Other Information

The Bluetooth® word mark and logos are owned by the Bluetooth® SIG, Inc. and any use of such marks by General Motors is under license. Other trademarks and trade names are those of their respective owners.

This device complies with Part 15 of the FCC Rules. Operation is subject to the following two conditions:

1. This device may not cause harmful interference.
2. This device must accept any interference received, including interference that may cause undesired operation.

This device complies with RSS-210 of Industry Canada. Operation is subject to the following two conditions:

1. This device may not cause interference.
2. This device must accept any interference received, including interference that may cause undesired operation of the device.

Changes or modifications to this system by other than an authorized service facility could void authorization to use this equipment.

Theft-Deterrent Feature

The radio has an electronically coded security system that links the radio to the vehicle. When the ignition is off, a flashing red light on the upper left side of the radio indicates the security system is on. If the radio is moved to a different vehicle, it will not operate and Security Lockout Active displays. Contact your dealer/retailer to unlock the radio.

Audio Steering Wheel Controls

The vehicle has audio steering wheel controls.



Some audio controls can be adjusted at the steering wheel.

SRCE (Source): Press to select between FM1, FM2, AM, CD, Front AUX (auxiliary), or Rear AUX.

▲▼(Scroll Wheel Control):

Push to select the next disc in the changer.

Turn the scroll wheel up or down to:

- Select the next or previous preset radio station.
- Select the next or previous track.

 **(Voice Recognition):** For vehicles with OnStar[®] or Bluetooth[®] systems, press to interact with those systems. See *OnStar[®] System* on page 4-35 and *Bluetooth[®]* on page 6-25 in this manual for more information.

 **(Call End):** Press to end an OnStar or Bluetooth phone call.

+ – (Scroll Wheel Control): Turn the scroll wheel control up or down to increase or decrease the volume. Press to mute the audio system, press again to turn the sound back on.

Radio Reception

Frequency interference and static can occur during normal radio reception if items such as cell phone chargers, vehicle convenience accessories, and external electronic devices are plugged into the accessory power outlet. If there is interference or static, unplug the item from the accessory power outlet.

AM

The range for most AM stations is greater than for FM, especially at night. The longer range can cause station frequencies to interfere with each other. For better radio reception, most AM radio stations boost the power levels during the day, and then reduce these levels during the night. Static can also occur when things like storms and power lines interfere with radio reception. When this happens, try reducing the treble on the radio.

FM Stereo

FM signals only reach about 10 to 40 miles (16 to 65 km). Although the radio has a built-in electronic circuit that automatically works to reduce interference, some static can occur, especially around tall buildings or hills, causing the sound to fade in and out.

XM Satellite Radio Service

XM Satellite Radio Service gives digital radio reception from coast-to-coast in the 48 contiguous United States, and in Canada. Just as with FM, tall buildings or hills can interfere with satellite radio signals, causing the sound to fade in and out. In addition, traveling or standing under heavy foliage, bridges, garages, or tunnels may cause loss of the XM signal for a period of time.

Cellular Phone Usage

Cellular phone usage may cause interference with the vehicle's radio. This interference may occur when making or receiving phone calls, charging the phone's battery, or simply having the phone on. This interference causes an increased level of static while listening to the radio. If static is received while listening to the radio, unplug the cellular phone and turn it off.

Fixed Mast Antenna

The AM-FM antenna is located on the roof of the vehicle.

Driving through an automatic car wash without removing the antenna could damage it.

To remove the antenna, turn it counterclockwise. To replace the antenna, turn it clockwise until hand tightened.

XM™ Satellite Radio Antenna System

The XM Satellite Radio antenna is located on the roof or the rear of the vehicle. Keep the antenna clear of obstructions for clear radio reception.

Climate Controls

Climate Controls

Climate Control System	7-1
Automatic Climate Control System	7-4
Outlet Adjustment	7-9

Climate Controls

Climate Control System

The heating, cooling, and ventilation for the vehicle can be controlled with this system.



- A. Fan Control
- B. Temperature Control
- C. Air Delivery Mode Control

- D. Rear Window Defogger
- E. Air Conditioning
- F. Recirculation

7-2 Climate Controls

 **(Fan Control):** Turn clockwise or counterclockwise to increase or decrease the fan speed. Turn the knob all the way counterclockwise to turn the system off.

Temperature Control: Turn clockwise or counterclockwise to increase or decrease the temperature inside the vehicle.

Air Delivery Mode Control: Turn the knob to change the current airflow mode.

Select from the following:

 **(Vent):** Air is directed to the instrument panel outlets.

 **(Bi-Level):** Air is divided between the instrument panel outlets and the floor outlets.

 **(Floor):** Air is directed to the floor outlets with some air directed to the windshield and side window outlets.

 **(Defog):** Air is directed to the windshield, floor outlets, and side window vents. Use this mode to clear the windows of fog or moisture and warm the passengers.

 **(Defrost):** Air is directed to the windshield, with some air directed to the side window vents. Use this mode to quickly remove fog or frost from the windshield.



When defrost is selected, the air conditioning turns on automatically to improve defrosting performance. In this mode the air conditioning cannot be turned off and the recirculation mode cannot be turned on.

Air Conditioning

 **(Air Conditioning):** Press to turn on or off. An indicator comes on when the air conditioning is on. The fan must be on to use the air conditioning.

The air conditioning cannot be turned off in defrost mode. If  is pressed, the indicator light flashes three times and the air conditioning stays on.

For quick cool down on hot days, select the following settings together:

1. Press  to turn on the air conditioning.
2. Press  to turn on the recirculation.
3. Select the coolest temperature and highest fan speed.
4. Open the windows briefly to let hot air escape and then close them.
5. Once the vehicle's interior cools down, turn off the recirculation, and select . This maintains the best comfort level during extended driving.

The air conditioning system removes moisture from the air, so a small amount of water might drip under the vehicle while idling or after turning off the engine. This is normal.

The air conditioning should be turned on for at least five to ten minutes once every two weeks to lubricate the air conditioning seals, even in the winter.

Recirculation

 **(Recirculation):** Press to change the air intake between recirculated air and outside air. An indicator light comes on when the recirculation is on.

The recirculation mode recycles interior air and is not recommended for extended use. If it is used for a long period of time, the system automatically lets some fresh air into the vehicle for ventilation.

The recirculation mode cannot be turned on in defrost mode. If  is pressed, the indicator light flashes three times and recirculation stays off.

Rear Window Defogger

The rear window defogger uses a warming grid to remove fog from the rear window. It only works when the ignition is in ON/RUN.

 **(Rear Window Defogger):**

Press to turn on or off. An indicator comes on when the rear window defogger is on. The rear window defogger turns off automatically if it is left on.

Notice: Do not use anything sharp on the inside of the rear window. If you do, you could cut or damage the warming grid, and the repairs would not be covered by the vehicle warranty. Do not attach a temporary vehicle license, tape, a decal or anything similar to the defogger grid.

Passenger Compartment Air Filter

The vehicle has a passenger compartment air filter that filters the outside air entering the vehicle. The filter removes contaminants, such as pollen and dust. See your dealer/retailer for more information.

7-4 Climate Controls

Automatic Climate Control System

The heating, cooling, and ventilation for the vehicle can be controlled with this system. For vehicles with the remote start feature, the climate control system will turn on with a remote start. See *Remote Vehicle Start* on page 2-6.

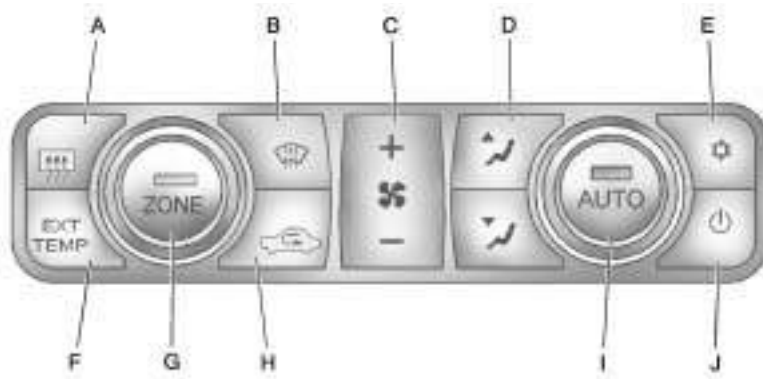

- A. Rear Window Defogger
- B. Defrost
- C. Fan Control
- D. Air Delivery Mode Control
- E. Air Conditioning

- F. EXT TEMP
- G. ZONE
- H. Recirculation
- I. AUTO
- J. Power

(OFF): Press to turn the climate control system off. Press any button to turn the system on again. While the climate control system is off the recirculation and rear window defogger can still be turned on.

Automatic Operation

AUTO (Automatic): When this button is pressed, the system automatically controls the inside temperature, the air delivery mode, the air conditioning compressor, and the fan speed. When AUTO appears in the display, the system is in full automatic operation. If any of the controls are manually adjusted, the AUTO indicator turns off in the display.

1. Press the AUTO button, if the AUTO indicator does not appear on the display.

- Adjust the temperature to a comfortable setting between 72°F (22°C) and 75°F (24°C). Choosing the coldest or warmest temperature setting will not cause the system to heat or cool any faster.
- Let the system stabilize for a few minutes.
- Adjust the air outlets or temperature.

In cold weather, the system starts in the recirculation mode with the fan off. As the engine warms up, warm air is directed to the floor outlets, before automatically changing to bi-level mode with a reduced fan speed.

Do not cover the solar sensor located in the center of the instrument panel, near the windshield. For more information on the solar sensor, see “Sensors” later in this section.

Manual Operation

+  - (Fan Control): Press + or - to increase or decrease the fan speed. The fan speed and indicator appears in the display.

The climate control system sets the fan speed automatically. When the fan speed is adjusted the system goes into semi-automatic operation. Press the AUTO button to return to automatic operation.

Temperature Control: The temperature can be adjusted separately for the driver and the passenger. Turn the temperature controls clockwise or counterclockwise to increase or decrease the temperature.

The temperature can be set between 63°F (17°C) and 176°F (30°C). A setting between 72°F (22°C) and 75°F (24°C) is recommended.

The temperature settings for each side are shown in the display. If the temperature control is past 86°F (30°C), the display shows H (hottest). Turning it past 63°F (17°C), shows C (coolest).

The EXT TEMP (Exterior Temperature) can be displayed in Fahrenheit (°F) or Celsius (°C). See *DIC Vehicle Customization on page 4-31*.

ZONE: Press to set the climate control to single-zone (SZ) mode or dual-zone (DZ) mode. SZ or DZ appears in the display when a mode is set.

Single-Zone (SZ) Mode: All zones are set to the same temperature. The temperature is shown in the display. Turn the ZONE control to set the temperature.

7-6 Climate Controls

Dual-Zone (DZ) Mode: Allows different temperatures to be set for the driver and passenger sides or to link them. When linked, the passenger side temperature uses the same temperature setting as the driver side.

Turn the AUTO control to set a different temperature for the passenger.

Press and hold the AUTO button for at least three seconds to link the passenger and driver side temperatures. Linking automatically occurs if the passenger and driver sides are set to the same temperature when the ignition is turned on.

(Air Delivery Mode Control):

Press to change the current airflow mode. The current mode selection appears in the display screen. Changing the mode cancels the automatic operation and the system goes into semi-automatic operation. Press AUTO to return to automatic operation.



Select from the following:

 (Vent): Air is directed to the instrument panel outlets.

 (Bi-Level): Air is divided between the instrument panel outlets and the floor outlets. Cooler air is directed to the upper outlets and warmer air to the floor outlets.



 (Floor): Air is directed to the floor outlets with some air directed to the outer instrument panel, windshield and side window outlets.

 (Defog): Air is directed to the windshield, floor and side window outlets. Use this mode to clear the windows of fog or moisture and warm the passengers.

 (Defrost): Press to turn the defrost on or off. The  indicator appears in the display. A portion of the air is directed to the windshield, with some air directed to the side window vents.

When defrost is selected, the air conditioning turns on automatically to improve defrosting performance. In this mode the air conditioning cannot be turned off and the recirculation mode cannot be turned on.

Air Conditioning

 **(Air Conditioning):** Press to turn the air conditioning system on or off. The  appears in the display when the air conditioning is on. When the air conditioning is turned off  OFF appears in the display.

The air conditioning cannot be turned off in defrost mode. If  is pressed, the indicator light flashes three times and the air conditioning stays on.

For quick cool down on hot days, open the windows to let the hot air to escape. After a few minutes, close the windows so the system will work more effectively.

The air conditioning system removes moisture from the air, so a small amount of water might drip under the vehicle while idling or after turning off the engine. This is normal.

The air conditioning might automatically turn off during heavy acceleration or towing with your vehicle, but the  will still display.

Recirculation

 **(Recirculation):** Press to change the air intake between recirculated air and outside air. An indicator light comes when the recirculation is activated.

The recirculation mode recycles interior air and is not recommended for extended use. If it is used for a long period of time, the system automatically lets some fresh air into the vehicle for ventilation.

Do not use the recirculation mode if occupants are smoking.

The recirculation mode cannot be turned on in defrost mode. If  is pressed, the indicator light flashes three times and recirculation stays off.

Pollution Mode: Press and hold the  button for four seconds to turn the pollution mode on or off. When it is activated, Pollution Mode Activated appears in the display. When it is turned off, Pollution Mode Inactive appears in the display.

This mode can be set when the vehicle speed is less than 9 mph (15 km/h). Recirculation will automatically turn on to help prevent exhaust fumes from entering the vehicle in slow moving traffic.

Rear Window Defogger

The rear window defogger uses a warming grid to remove fog or frost from the rear window. It only works when the ignition is in ON/RUN.

The rear window defogger will only work when the ignition is in ON/RUN.

(Rear Window Defogger):

Press to turn the rear window defogger on or off. The  indicator appears in the display. The rear window defogger turns off automatically if it is left on.

Notice: Do not use anything sharp on the inside of the rear window. If you do, you could cut or damage the warming grid, and the repairs would not be covered by the vehicle warranty. Do not attach a temporary vehicle license, tape, a decal or anything similar to the defogger grid.

EXT TEMP

EXT TEMP (Exterior Temperature):

Press EXT TEMP to show the temperature outside the vehicle or the normal display.

Pressing any other climate control button will change the display from showing the outside temperature to showing the normal display.

The units for the EXT TEMP can be displayed in °F or °C. See *DIC Vehicle Customization on page 4-31*.

Sensors

The climate control system uses three different sensors to maintain the desired temperature. The solar sensor is located on the instrument panel, near the windshield. The interior temperature sensor is located on the instrument panel near the steering wheel and the outside temperature sensor is in front of the radiator.

By monitoring the solar radiation, the air inside the vehicle and air moving across the outside sensor, the selected temperature can be maintained while using the AUTO mode by adjusting the temperature, fan speed, and air delivery system. The system may also supply cooler air to the side of the vehicle facing the sun. The recirculation mode will also be activated, as necessary. Do not cover the sensors or the automatic climate control system will not work properly.

Remote Start Climate Control Operation

For vehicles with the remote start feature and it is activated, the climate control system will automatically set the temperature to 73°F (23°C).

When the ignition is turned to ON/RUN the climate control system heats and cools the inside of the vehicle using the modes that were set before the vehicle was turned off.

Personal Identity Keys

For vehicles with the Personal Identity Key Locking System, the system remembers the last climate control settings used with different keys.

When the unlock button is pressed, the system remembers the key and sets the climate control system to the last settings used with that key. See *Remote Keyless Entry (RKE) System Operation on page 2-4*.

Passenger Compartment Air Filter

The vehicle has a passenger compartment air filter that filters the outside air entering the vehicle. The filter removes contaminants, such as pollen and dust. See your dealer/retailer for more information.

Outlet Adjustment

The air outlets have adjustable vanes to move up or down and left or right to change the direction of the airflow. Use the thumbwheels located near the air outlets on the instrument panel, to shut off the airflow.

Operation Tips

- Clear away any ice, snow or leaves from the air inlets at the base of the windshield that may block the flow of air into the vehicle.
- Use of non-GM approved hood deflectors may adversely affect performance of the system.
- Keep the path under the front seats clear of objects to help circulate the air inside of the vehicle more effectively.
- Outside air is drawn into the vehicle, unless recirculation mode is selected.

Driving and Operating

Starting and Operating Your Vehicle

New Vehicle Break-In	8-2
Ignition Positions	8-2
Retained Accessory Power (RAP)	8-3
Starting the Engine	8-4
Engine Coolant Heater	8-5
Automatic Transmission Operation	8-6
Manual Transmission Operation	8-10
Parking Brake	8-11
Shifting Into Park (Automatic Transmission)	8-12
Shifting Out of Park	8-13
Parking the Vehicle (Manual Transmission)	8-14

Parking Over Things That Burn	8-14
Engine Exhaust	8-14
Running the Vehicle While Parked	8-15

Driving Your Vehicle

Defensive Driving	8-16
Drunk Driving	8-16
Control of a Vehicle	8-17
Braking	8-17
Antilock Brake System (ABS)	8-18
Electronic Stability Program	8-19
Steering	8-22
Off-Road Recovery	8-23
Passing	8-23
Loss of Control	8-23
Driving at Night	8-24
Driving in Rain and on Wet Roads	8-25
Before Leaving on a Long Trip	8-26
Highway Hypnosis	8-26
Hill and Mountain Roads	8-26

Winter Driving	8-27
If Your Vehicle is Stuck in Sand, Mud, Ice, or Snow	8-29
Rocking Your Vehicle to Get It Out	8-30
Loading the Vehicle	8-30

Fuel

Fuel	8-34
Gasoline Octane	8-35
Gasoline Specifications	8-35
California Fuel	8-35
Additives	8-36
Fuels in Foreign Countries	8-36
Filling the Tank	8-37
Filling a Portable Fuel Container	8-38

Starting and Operating Your Vehicle

New Vehicle Break-In

Notice: Your vehicle does not need an elaborate break-in. But it will perform better in the long run if you follow these guidelines:

- Do not drive at any one constant speed, fast or slow, for the first 500 miles (805 km). Do not make full-throttle starts. Avoid downshifting to brake or slow the vehicle.
- During the first 600 miles (1 000 km), avoid using more than moderate acceleration in lower gears and avoid vehicle speeds above 68 mph (110 km/h).

- Between the first 600 miles (1 000 km) and 3,000 miles (5 000 km), heavy acceleration in lower gears can be used. Vehicle speeds above 68 mph (110 km/h) should be limited to five minutes per use.
- Avoid making hard stops for the first 200 miles (322 km) or so. During this time the new brake linings are not yet broken in. Hard stops with new linings can mean premature wear and earlier replacement. Follow this breaking-in guideline every time you get new brake linings.
- Do not tow a trailer during break-in. See *Towing a Trailer on page 9-89* for the trailer towing capabilities of your vehicle and more information.

Following break-in, engine speed and load can be gradually increased.

Ignition Positions

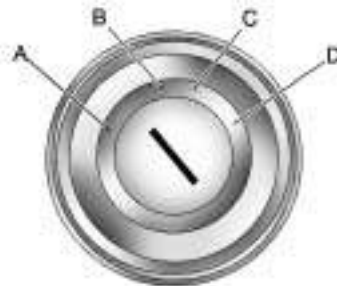

The ignition switch has four different positions.

Notice: Using a tool to force the key to turn in the ignition could cause damage to the switch or break the key. Use the correct key, make sure it is all the way in, and turn it only with your hand. If the key cannot be turned by hand, see your dealer/retailer.

To shift out of P (Park), turn the ignition to ON/RUN and apply the brake pedal.

A (LOCK/OFF): This is the only position from which you can remove the key. This locks the steering wheel, ignition and automatic transmission.

On vehicles with an automatic transmission, the shift lever must be in P (Park) to turn the ignition switch to the LOCK/OFF position.

The ignition switch can bind in the LOCK/OFF position with the wheels turned off center. If this happens, move the steering wheel from right to left while turning the key to ACC/ACCESSORY. If this doesn't work, then the vehicle needs service.

B (ACC/ACCESSORY): This position provides power to some of the electrical accessories. It unlocks the steering wheel and ignition. The transmission is also unlocked in this position on automatic transmission vehicles. To move the key from ACC/ACCESSORY to LOCK/OFF, push in the key and then turn it to LOCK/OFF.

C (ON/RUN): The ignition switch stays in this position when the engine is running. This position can be used to operate the electrical accessories, including the ventilation fan and 12 volt power outlet, as well as to display some warning and indicator lights.

The battery could be drained if you leave the key in the ACC/ACCESSORY or ON/RUN position with the engine off. You may not be able to start the vehicle if the battery is allowed to drain for an extended period of time.

D (START): This position starts the engine. When the engine starts, release the key. The ignition switch will return to ON/RUN for normal driving.

A warning tone will sound when the driver door is opened when the ignition is still in ACC/ACCESSORY and the key is in the ignition.

Retained Accessory Power (RAP)

These vehicle accessories may be used for up to 10 minutes after the engine is turned off:

- Audio System
- Power Windows

The power windows will continue to work for up to 10 minutes or until any door is opened. The radio will work when the key is in ON/RUN or ACC/ACCESSORY. Once the key is turned from ON/RUN to LOCK/OFF, the radio will continue to work for 10 minutes or until the driver door is opened.

Starting the Engine

Place the transmission in the proper gear.

Automatic Transmission

Move the shift lever to P (Park) or N (Neutral). The engine will not start in any other position. To restart the vehicle when it is already moving, use N (Neutral) only.

Notice: Do not try to shift to P (Park) if the vehicle is moving. If you do, you could damage the transmission. Shift to P (Park) only when the vehicle is stopped.

Manual Transmission

The shift lever should be in Neutral and the parking brake engaged. Hold the clutch pedal down to the floor and start the engine. The vehicle will not start if the clutch pedal is not all the way down.

Starting Procedure

1. With your foot off the accelerator pedal, turn the ignition key to START. When the engine starts, let go of the key. The idle speed will go down as the engine warms. Do not race the engine immediately after starting it.

Operate the engine and transmission gently to allow the oil to warm up and lubricate all moving parts.

The vehicle has a Computer-Controlled Cranking System. This feature assists in starting the engine and protects components. If the ignition key is turned to the START position, and then released when the engine begins cranking, the engine will continue cranking for a few seconds or until the vehicle starts. If the engine does not start and the key is held in START for many seconds, cranking will be stopped after 15 seconds

to prevent cranking motor damage. To prevent gear damage, this system also prevents cranking if the engine is already running. Engine cranking can be stopped by turning the ignition switch to ACC/ACCESSORY or LOCK/OFF.

Notice: Cranking the engine for long periods of time, by returning the key to the START position immediately after cranking has ended, can overheat and damage the cranking motor, and drain the battery. Wait at least 15 seconds between each try, to let the cranking motor cool down.

2. If the engine does not start after 5-10 seconds, especially in very cold weather (below 0°F or -18°C), it could be flooded with too much gasoline. Push the accelerator pedal all the way to the floor and holding it there as you hold the key in START for a maximum of 15 seconds.

Wait at least 15 seconds between each try, to allow the cranking motor to cool. When the engine starts, let go of the key and accelerator. If the vehicle starts briefly but then stops again, repeat the procedure. This clears the extra gasoline from the engine. Do not race the engine immediately after starting it. Operate the engine and transmission gently until the oil warms up and lubricates all moving parts.

Notice: The engine is designed to work with the electronics in the vehicle. If you add electrical parts or accessories, you could change the way the engine operates. Before adding electrical equipment, check with your dealer/retailer. If you do not, the engine might not perform properly. Any resulting damage would not be covered by the vehicle warranty.

Engine Coolant Heater

The engine coolant heater, if available, can help in cold weather conditions at or below 0°F (-18°C) for easier starting and better fuel economy during engine warm-up. Plug in the coolant heater at least four hours before starting your vehicle. An internal thermostat in the plug-end of the cord will prevent engine coolant heater operation at temperatures above 0°F (-18°C).

To Use The Engine Coolant Heater

1. Turn off the engine.
2. Open the hood and unwrap the electrical cord.

The electrical cord is located on the driver side of the engine compartment, behind the air cleaner for V8 models. The electrical cord is located on the passenger side of the engine compartment, behind the engine compartment fuse block for V6 models.

3. Plug it into a normal, grounded 110-volt AC outlet.

CAUTION

Plugging the cord into an ungrounded outlet could cause an electrical shock. Also, the wrong kind of extension cord could overheat and cause a fire. You could be seriously injured. Plug the cord into a properly grounded three-prong 110-volt AC outlet. If the cord will not reach, use a heavy-duty three-prong extension cord rated for at least 15 amps.

4. Before starting the engine, be sure to unplug and store the cord as it was before to keep it away from moving engine parts. If you do not it could be damaged.

8-6 Driving and Operating

The length of time the heater should remain plugged in depends on several factors. Ask a dealer/retailer in the area where you will be parking the vehicle for the best advice on this.

Automatic Transmission Operation

The shift lever is located on the center console between the front seats.



There are several different positions for the shift lever. When the position of the shift lever is changed,

a message is shown in the Driver Information Center (DIC). The selected gear is magnified in the DIC, and changes according to the shift lever's movement. There are also messages for Sport Shift Mode, Normal Shift Mode and Driver Shift Control.

P (Park): This position locks the rear wheels. It is the best position to use when the engine is started because the vehicle cannot move easily.

CAUTION

It is dangerous to get out of the vehicle if the shift lever is not fully in P (Park) with the parking brake firmly set. The vehicle can roll.

Do not leave the vehicle when the engine is running unless you have to. If you have left the engine

(Continued)

CAUTION (Continued)

running, the vehicle can move suddenly. You or others could be injured. To be sure the vehicle will not move, even when you are on fairly level ground, always set the parking brake and move the shift lever to P (Park). See *Shifting Into Park (Automatic Transmission)* on page 8-12. If you are pulling a trailer, see *Towing a Trailer* on page 9-89.

Make sure the shift lever is fully in P (Park) before starting the engine. The vehicle has an automatic transmission shift lock control system. Fully apply the brake pedal first and then press the shift lever button before shifting from P (Park) when the ignition key is in ON/RUN or ACC/ACCESSORY. If you cannot shift out of P (Park),

ease pressure on the shift lever and push the shift lever all the way into P (Park) while maintaining brake application. Then press the shift lever button and move the shift lever into another gear. See *Shifting Out of Park* on page 8-13.

Notice: Shifting to R (Reverse) while the vehicle is moving forward could damage the transmission. The repairs would not be covered by the vehicle warranty. Shift to R (Reverse) only after the vehicle is stopped.

R (Reverse): Use this gear to back up.

At low vehicle speeds, R (Reverse) can also be used to rock the vehicle back and forth to get out of snow, ice, or sand without damaging the transmission. See *If Your Vehicle is Stuck in Sand, Mud, Ice, or Snow* on page 8-29 for additional information.

N (Neutral): In this position, the engine does not connect with the wheels. To restart the engine when the vehicle is already moving, use N (Neutral) only.

CAUTION

Shifting into a drive gear while the engine is running at high speed is dangerous. Unless your foot is firmly on the brake pedal, the vehicle could move very rapidly. You could lose control and hit people or objects. Do not shift into a drive gear while the engine is running at high speed.

Notice: Shifting out of P (Park) or N (Neutral) with the engine running at high speed may damage the transmission. The repairs would not be covered by the vehicle warranty. Be sure the engine is not running at high speed when shifting the vehicle.

D (Drive): This position is for normal driving. It provides the best fuel economy. If more power is needed for passing, and the vehicle is:

- Going less than 35 mph (55 km/h), push the accelerator pedal about halfway down.
- Going about 35 mph (55 km/h) or more, push the accelerator all the way down.

Downshifting the transmission in slippery road conditions could result in skidding, see *Skidding* under *Loss of Control* on page 8-23

Notice: Spinning the tires or holding the vehicle in one place on a hill using only the accelerator pedal may damage the transmission. If you are stuck, do not spin the tires. When stopping on a hill, use the brakes to hold the vehicle in place.

8-8 Driving and Operating

Sport Shift Mode

The automatic transmission has a Sport Shift Mode. When you are in the Sport Shift Mode the vehicle will still shift automatically. The transmission may remain in a gear longer than it would in the normal driving mode based on braking, throttle input, and vehicle lateral acceleration. To use this feature, move the shift lever over from D (Drive) to the right quadrant. The Sport Shift message in the DIC displays. If the shift lever is not moved forward or rearward, the vehicle remains in sport mode.

Performance Mode Lift Foot Mode

Within Sport Shift Mode there is a further performance feature called Performance Mode Lift Foot (PMLF) Mode. The feature is activated automatically when sports oriented driving is detected, based on cornering and on/off throttle application. PMLF allows the transmission to hold the current gear instead of upshifting when the throttle is lifted.

Driver Shift Control (DSC)

Notice: If you drive your vehicle at high RPMs without upshifting while using Active Select Mode, you could damage the vehicle. Always upshift when necessary while using Active Select Mode.

The automatic transmission has a DSC mode that allows gear changes similar to a manual transmission.

To use this feature:

1. Move the shift lever over from D (Drive) to the right quadrant. The Sport Shift message in the DIC displays.
2. To enter the DSC mode, press the shift lever forward to upshift or rearward to downshift. The Active Select On message in the DIC will come on.

The DIC will indicate the requested gear range when moving the shift lever forward or rearward.

While using the DSC mode, the vehicle has firmer shifting and increased performance. This can be used for sport driving or when climbing or descending hills, to stay in gear longer, or to down shift for more power or engine braking.

The transmission will only allow the driver to shift into gears appropriate for the vehicle speed and engine Revolutions Per Minute (RPM). The transmission will not automatically shift to the next lower gear if the engine RPM is too high.

If shifting is prevented for any reason, the currently selected gear will flash multiple times, indicating that the transmission has not shifted gears.

While in the DSC mode, the transmission automatically downshifts when the vehicle comes to a stop.

When accelerating the vehicle from a stop in snowy and icy conditions, 1st, 2nd or 3rd gear starts can be selected from a standing start. This is useful for gentle acceleration on slippery surfaces.

To return to Normal Shift mode, slide the shift lever over from the right quadrant to the left into D (Drive). A Normal Shift message will be displayed in the DIC.

Normal Shift Mode is recommended for normal or freeway driving, as it provides optimum fuel economy.

Powertrain Braking

For vehicles with a 6 speed automatic transmission, there is an additional feature known as Powertrain Braking. When driving on steep descents where frequent braking is required, the vehicle will automatically downshift to provide engine braking assistance. This feature also reduces brake temperatures and wear.

Downshifting will only occur when the driver's foot is applied to the brake. Active Select Mode can be switched on to override the feature and gain complete control of shifts if desired.

Manual Transmission Operation

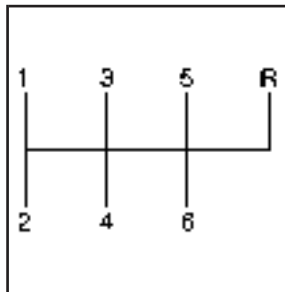

This is the shift pattern for the six-speed manual transmission.

Here is how to operate the transmission:

1 (First): Press the clutch pedal and shift into 1 (First). Then slowly let up on the clutch pedal as you press the accelerator pedal.

You can shift into 1 (First) when you are going less than 40 mph (64 km/h). If you come to a complete stop and it is hard to shift into 1 (First), put the shift lever in Neutral and let up on the clutch. Press the clutch pedal back down. Then shift into 1 (First).

2 (Second): Press the clutch pedal as you let up on the accelerator pedal and shift into 2 (Second). Then, slowly let up on the clutch pedal as you press the accelerator pedal.

3 (Third), 4 (Fourth), 5 (Fifth) and 6 (Sixth): Shift into 3 (Third), 4 (Fourth), 5 (Fifth) and 6 (Sixth) the same way you do for 2 (Second). Slowly let up on the clutch pedal as you press the accelerator pedal.

To stop, let up on the accelerator pedal and press the brake pedal. Just before the vehicle stops, press the clutch pedal and the brake pedal, and shift to Neutral.

Neutral: Use this position when you start or idle the engine. The shift lever is in Neutral when it is centered in the shift pattern, not in any gear.

R (Reverse): To back up, press down the clutch pedal and shift into R (Reverse). Apply pressure to get the lever past 5 (Fifth) and 6 (Sixth) into R (Reverse). Let up on the clutch pedal slowly while pressing the accelerator pedal.

One to Four Shift Light

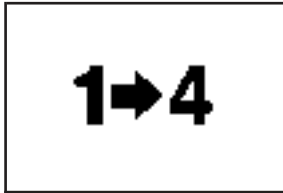

Instrument Panel
Cluster

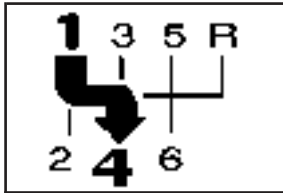

Driver Information
Center

When this light comes on, you can only shift from 1 (First) to 4 (Fourth) instead of 1 (First) to 2 (Second). The light will be displayed on the

instrument panel cluster and a message will be displayed in the Driver Information Center.

You must complete the shift into 4 (Fourth) to turn off this feature. This helps you get the best possible fuel economy.

After shifting to 4 (Fourth), you may downshift to a lower gear if you prefer.

Notice: Forcing the shift lever into any gear except FOURTH (4) when the 1 TO 4 SHIFT light comes on may damage the transmission. Shift only from FIRST (1) to FOURTH (4) when the light comes on.

This light will come on when:

- The engine coolant temperature is higher than 169°F (76°C),
- you are going 15 to 19 mph (24 to 31 km/h) and
- you are 21 percent throttle or less.

Parking Brake

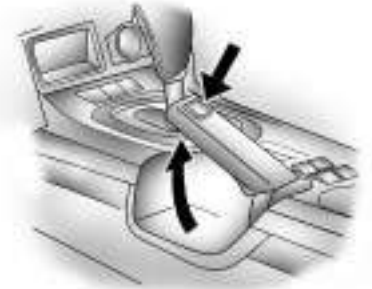

To set the parking brake, pull up on the parking brake handle. If the ignition is in the ON/RUN position, the brake system warning light will come on. See *Brake System Warning Light* on page 4-15.

8-12 Driving and Operating

To release the parking brake:

1. Hold the brake pedal down.
2. Pull the parking brake handle up until you can press the release button.
3. Hold the release button in as you move the brake handle all the way down.

Notice: Driving with the parking brake on can overheat the brake system and cause premature wear or damage to brake system parts. Make sure that the parking brake is fully released and the brake warning light is off before driving.

Driving with the park brake applied will cause a warning chime to sound and the Park Brake message to appear in the DIC. The message will remain on until:

- the park brake is released
- the vehicle comes to a stop.

If you are towing a trailer and you are parking on a hill, see *Towing a Trailer on page 9-89*.

Shifting Into Park (Automatic Transmission)

CAUTION

It can be dangerous to get out of the vehicle if the shift lever is not fully in P (Park) with the parking brake firmly set. The vehicle can roll. If you have left the engine running, the vehicle can move suddenly. You or others could be injured. To be sure the vehicle will not move, even when you are on fairly level ground, use the steps that follow. If you are pulling a trailer, see *Towing a Trailer on page 9-89*.

Use this procedure to shift into P (Park):

1. Hold the brake pedal down and set the parking brake.
See Parking Brake on page 8-11 for more information.
2. Move the shift lever into P (Park) by holding in the button on the shift lever and pushing the lever all the way toward the front of the vehicle.
3. Turn the ignition key to LOCK/OFF.
4. Remove the key and take it with you. If you can leave the vehicle with the ignition key in your hand, the vehicle is in P (Park).

Leaving Your Vehicle With the Engine Running

CAUTION

It can be dangerous to leave the vehicle with the engine running. The vehicle could move suddenly if the shift lever is not fully in P (Park) with the parking brake firmly set. And, if you leave the vehicle with the engine running, it could overheat and even catch fire. You or others could be injured. Do not leave the vehicle with the engine running.

If you have to leave the vehicle with the engine running, be sure the vehicle is in P (Park) and the parking brake is firmly set before you leave it. After you have moved the shift lever into P (Park), hold the brake pedal down. Then, see if you can move the shift lever away from P (Park) without first pushing the button.

If you can, it means that the shift lever was not fully locked into P (Park).

Torque Lock

If you are parking on a hill and you do not shift the automatic transmission into P (Park) properly, the weight of the vehicle may put too much force on the parking pawl in the transmission. You may find it difficult to pull the shift lever out of P (Park). This is called torque lock. To prevent torque lock, set the parking brake and then shift into P (Park) properly before you leave the driver seat. To find out how, see "Shifting Into Park" previously in the section.

When you are ready to drive, move the shift lever out of P (Park) before you release the parking brake.

If torque lock does occur, you may need to have another vehicle push yours a little uphill to take

some of the pressure from the parking pawl in the transmission, so you can pull the shift lever out of P (Park).

Shifting Out of Park

To shift out of P (Park):

1. Apply the brake pedal.
2. Press the shift lever button.
3. Move the shift lever to the desired position.

If you still are unable to shift out of P (Park):

1. Fully release the shift lever button.
2. Hold the brake pedal down and press the shift lever button again.
3. Move the shift lever to the desired position.

If you still cannot move the shift lever from P (Park), see *Shift Lock Manual Release on page 9-88*.

Parking the Vehicle (Manual Transmission)

If the vehicle has a manual transmission, before you get out of the vehicle, move the shift lever into R (Reverse), and firmly apply the parking brake. Once the shift lever has been placed into R (Reverse) with the clutch pedal pressed in, turn the ignition key to LOCK/OFF, remove the key and release the clutch.

If you are parking on a hill, or if the vehicle is pulling a trailer, see *Towing a Trailer on page 9-89*.

Parking Over Things That Burn

CAUTION

Things that can burn could touch hot exhaust parts under the vehicle and ignite. Do not park over papers, leaves, dry grass, or other things that can burn.

Engine Exhaust

CAUTION

Engine exhaust contains Carbon Monoxide (CO) which cannot be seen or smelled. Exposure to CO can cause unconsciousness and even death.

Exhaust may enter the vehicle if:

- The vehicle idles in areas with poor ventilation (parking garages, tunnels, deep snow that may block underbody airflow or tail pipes).
- The exhaust smells or sounds strange or different.

(Continued)

CAUTION (Continued)

- The exhaust system leaks due to corrosion or damage.
- The vehicle's exhaust system has been modified, damaged or improperly repaired.
- There are holes or openings in the vehicle body from damage or after-market modifications that are not completely sealed.

If unusual fumes are detected or if it is suspected that exhaust is coming into the vehicle:

- Drive it only with the windows completely down.
- Have the vehicle repaired immediately.

Never park the vehicle with the engine running in an enclosed area such as a garage or a building that has no fresh air ventilation.

Running the Vehicle While Parked

It is better not to park with the engine running. But if you ever have to, here are some things to know.

 CAUTION

Idling a vehicle in an enclosed area with poor ventilation is dangerous. Engine exhaust may enter the vehicle. Engine exhaust contains Carbon Monoxide (CO) which cannot be seen or smelled. It can cause unconsciousness and even death. Never run the engine in an enclosed area that has no fresh air ventilation. For more information, see *Engine Exhaust* on page 8-14.

 CAUTION

It can be dangerous to get out of the vehicle if the automatic transmission shift lever is not fully in P (Park) with the parking brake firmly set. The vehicle can roll. Do not leave the vehicle when the engine is running unless you have to. If you have left the engine running, the vehicle can move suddenly. You or others could be injured. To be sure the vehicle will not move, even when you are on fairly level ground, always set the parking brake and move the shift lever to P (Park).

Follow the proper steps to be sure the vehicle will not move. See *Shifting Into Park (Automatic Transmission)* on page 8-12.

If parking on a hill and pulling a trailer, see *Towing a Trailer* on page 9-89.

Driving Your Vehicle

Defensive Driving

Defensive driving means “always expect the unexpected.” The first step in driving defensively is to wear your safety belt, see *Safety Belts on page 1-5*.

CAUTION

Assume that other road users (pedestrians, bicyclists, and other drivers) are going to be careless and make mistakes. Anticipate what they might do and be ready. In addition:

- Allow enough following distance between you and the driver in front of you.
- Focus on the task of driving.

Driver distraction can cause collisions resulting in injury or possible death. These simple defensive driving techniques could save your life.

Drunk Driving

CAUTION

Drinking and then driving is very dangerous. Your reflexes, perceptions, attentiveness, and judgment can be affected by even a small amount of alcohol. You can have a serious — or even fatal — collision if you drive after drinking. Do not drink and drive or ride with a driver who has been drinking. Ride home in a cab; or if you are with a group, designate a driver who will not drink.

Death and injury associated with drinking and driving is a global tragedy.

Alcohol affects four things that anyone needs to drive a vehicle: judgment, muscular coordination, vision, and attentiveness.

Police records show that almost 40 percent of all motor vehicle-related deaths involve alcohol. In most cases, these deaths are the result of someone who was drinking and driving. In recent years, more than 17,000 annual motor vehicle-related deaths have been associated with the use of alcohol, with about 250,000 people injured.

For persons under 21, it is against the law in every U.S. state to drink alcohol. There are good medical, psychological, and developmental reasons for these laws.

The obvious way to eliminate the leading highway safety problem is for people never to drink alcohol and then drive.

Medical research shows that alcohol in a person's system can make crash injuries worse, especially injuries to the brain, spinal cord, or heart.

This means that when anyone who has been drinking — driver or passenger — is in a crash, that person's chance of being killed or permanently disabled is higher than if the person had not been drinking.

Control of a Vehicle

The following three systems help to control your vehicle while driving — brakes, steering, and accelerator. At times, as when driving on snow or ice, it is easy to ask more of those control systems than the tires and road can provide. Meaning, you can lose control of your vehicle.

Adding non-dealer/non-retailer accessories can affect your vehicle's performance. See *Accessories and Modifications on page 9-3*.

Braking

See *Brake System Warning Light on page 4-15*.

Braking action involves perception time and reaction time. First, you have to decide to push on the brake pedal. That is perception time. Then you have to bring up your foot and do it. That is reaction time.

Average reaction time is about three-fourths of a second. But that is only an average. It might be less with one driver and as long as two or three seconds or more with another. Age, physical condition, alertness, coordination, and eyesight all play a part. So do alcohol, drugs, and frustration. But even in three-fourths of a second, a vehicle moving at 60 mph (100 km/h) travels 66 feet (20 m). That could be a lot of distance in an emergency, so keeping enough space between your vehicle and others is important.

8-18 Driving and Operating

And, of course, actual stopping distances vary greatly with the surface of the road, whether it is pavement or gravel; the condition of the road, whether it is wet, dry, or icy; tire tread; the condition of the brakes; the weight of the vehicle; and the amount of brake force applied.

Avoid needless heavy braking. Some people drive in spurts — heavy acceleration followed by heavy braking — rather than keeping pace with traffic. This is a mistake. The brakes might not have time to cool between hard stops. The brakes will wear out much faster if you do a lot of heavy braking. If you keep pace with the traffic and allow realistic following distances, you will eliminate a lot of unnecessary braking. That means better braking and longer brake life.

If your vehicle's engine ever stops while you are driving, brake normally but do not pump the brakes. If you do, the pedal could get harder to

push down. If the engine stops, you will still have some power brake assist. But you will use it when you brake. Once the power assist is used up, it can take longer to stop and the brake pedal will be harder to push.

Adding non-dealer/non-retailer accessories can affect your vehicle's performance. See *Accessories and Modifications* on page 9-3.

Antilock Brake System (ABS)

Your vehicle has the Antilock Brake System (ABS), an advanced electronic braking system that will help prevent a braking skid.

When you start the engine and begin to drive away, ABS will check itself. You might hear a momentary motor or clicking noise while this test is going on, and you might even notice that the brake pedal moves a little. This is normal.



If there is a problem with ABS, this warning light will stay on. See *Antilock Brake System (ABS) Warning Light* on page 4-16.

Let us say the road is wet and you are driving safely. Suddenly, an animal jumps out in front of you. You slam on the brakes and continue braking. Here is what happens with ABS:

A computer senses that the wheels are slowing down. If one of the wheels is about to stop rolling, the computer will separately work the brakes at each wheel.

ABS can change the brake pressure to each wheel, as required, faster than any driver could. This can help you steer around the obstacle while braking hard.

As you brake, the computer keeps receiving updates on wheel speed and controls braking pressure accordingly.

Remember: ABS does not change the time you need to get your foot up to the brake pedal or always decrease stopping distance. If you get too close to the vehicle in front of you, you will not have time to apply the brakes if that vehicle suddenly slows or stops. Always leave enough room up ahead to stop, even though you have ABS.

Using ABS

Do not pump the brakes. Just hold the brake pedal down firmly and let antilock work for you. You might hear the antilock pump or motor operate, and feel the brake pedal pulsate, but this is normal.

Braking in Emergencies

With ABS, you can steer and brake at the same time. In many emergencies, steering can help you more than even the very best braking.

Electronic Stability Program

The vehicle has the Electronic Stability Program (ESP®) that assists with directional control of the vehicle in difficult driving conditions by reducing engine power and applying the brakes to individual wheels. This is especially useful in slippery road conditions. The system operates if it senses that the rear wheels are spinning too much, are beginning to lose traction or if it senses that the vehicle is not moving in its intended direction. It turns on automatically every time the vehicle is started.



When ESP is working, this light and the STABILITY CONTROL ASSISTANCE message will come on and the ESP CTRL message will be displayed at the bottom of the DIC.

The STABILITY CONTROL ASSISTANCE message will remain on while the system is working until the  button is pressed to display the trip computer. The ESP CTRL message stays on at the bottom of the DIC while the system is working.

8-20 Driving and Operating

The system may be heard or felt while it is working. This is normal and does not mean there is a problem with the vehicle.



When this light and the STABILITY CTRL OFF message is on and the ESP OFF message is displayed, the system will not limit wheel spin.

Adjust your driving accordingly. See *DIC Warnings and Messages* on page 4-26 for more information.

ESP is automatically enabled whenever the vehicle is started. To limit wheel spin, especially in slippery road conditions, always leave the system enabled. ESP can be turned off if needed.

It is recommended to leave the system on for normal driving conditions, but it may be necessary to turn the system off if the vehicle is stuck in sand, mud, ice or snow, and you want to rock the vehicle to attempt to free it. It may also be necessary to turn off the system when driving in extreme off-road conditions where high wheel spin is required. See *If Your Vehicle is Stuck in Sand, Mud, Ice, or Snow* on page 8-29.



The ESP button is located in front of the transmission gear selector lever.



To turn the system off or on, press and release the ESP button.

The DIC will briefly display the appropriate message and then return to the trip computer display.



When this light and the STABILITY CTRL OFF message is on briefly and the ESP OFF message is displayed at the bottom of the DIC, the system will not limit wheel spin.

If the ESP OFF message is always displayed at the bottom of the DIC when the button is pressed to turn the system on or off, the system needs repair. Contact your dealer/retailer.



The system is on when this light and the STABILITY CTRL ON message is displayed briefly on the DIC.

ESP Operation

ESP limits wheel spin by reducing engine power to the wheels and by applying brakes to each individual wheel as necessary.

The ESP system is enabled automatically when the vehicle is started, and it will activate the STABILITY CONTROL ASSISTANCE light and the ESP CTRL message on the DIC if it senses that any of the wheels are spinning or beginning to lose traction while driving.

Notice: If the wheel(s) of one axle are allowed to spin excessively while the ESC/TCS, ABS and Brake warning lights and the SERVICE ESC and/or SERVICE TRACTION messages are displayed, the differential could be damaged. The repairs would not be covered by the vehicle warranty. Reduce engine power and do not spin the wheel(s) excessively while these lights and this message are displayed.

The traction control system may activate on dry or rough roads or under conditions such as heavy acceleration while turning or abrupt upshifts/downshifts of the transmission. When this happens, a noise, vibration, or a reduction in acceleration may be noticed. This is normal.

Adding non-dealer/non-retailer accessories can affect the vehicle's performance. See *Accessories and Modifications* on page 9-3 for more information.

8-22 Driving and Operating

Steering

Power Steering

If you lose power steering assist because the engine stops or the system is not functioning, you can steer but it will take much more effort.

Steering Tips

It is important to take curves at a reasonable speed.

Traction in a curve depends on the condition of the tires and the road surface, the angle at which the curve is banked, and your speed. While in a curve, speed is the one factor you can control.

If you need to reduce speed, do it before you enter the curve, while the front wheels are straight ahead.

Try to adjust the speed so you can drive through the curve. Maintain a reasonable, steady speed. Wait to accelerate until you are out of the curve, and then accelerate gently into the straightaway.

Steering in Emergencies

There are times when steering can be more effective than braking. For example, you come over a hill and find a truck stopped in your lane, or a car suddenly pulls out from nowhere, or a child darts out from between parked cars and stops right in front of you. You can avoid these problems by braking — if you can stop in time. But sometimes you cannot; there is not room. That is the time for evasive action — steering around the problem.

Your vehicle can perform very well in emergencies like these. First apply the brakes. See *Braking on page 8-17*. It is better to remove as much speed as you can from a possible collision. Then steer around the problem, to the left or right depending on the space available.



An emergency like this requires close attention and a quick decision. If you are holding the steering wheel at the recommended 9 and 3 o'clock positions, you can turn it a full 180 degrees very quickly without removing either hand. But you have to act fast, steer quickly, and just as quickly straighten the wheel once you have avoided the object.

The fact that such emergency situations are always possible is a good reason to practice defensive driving at all times and wear safety belts properly.

Off-Road Recovery

Your vehicle's right wheels can drop off the edge of a road onto the shoulder while driving.



If the level of the shoulder is only slightly below the pavement, recovery should be fairly easy. Ease off the accelerator and then, if there is nothing in the way, steer so that your vehicle straddles the edge of the pavement. Turn the steering wheel 3 to 5 inches, 76 to 127 mm, (about one-eighth turn) until the right front tire contacts the pavement edge. Then turn the steering wheel to go straight down the roadway.

Passing

Passing another vehicle on a two-lane road can be dangerous. To reduce the risk of danger while passing:

- Look down the road, to the sides, and to crossroads for situations that might affect a successful pass. If in doubt, wait.
- Watch for traffic signs, pavement markings, and lines that could indicate a turn or an intersection. Never cross a solid or double-solid line on your side of the lane.
- Do not get too close to the vehicle you want to pass. Doing so can reduce your visibility.
- Wait your turn to pass a slow vehicle.
- When you are being passed, ease to the right.

Loss of Control

Let us review what driving experts say about what happens when the three control systems — brakes, steering, and acceleration — do not have enough friction where the tires meet the road to do what the driver has asked.

In any emergency, do not give up. Keep trying to steer and constantly seek an escape route or area of less danger.

Skidding

In a skid, a driver can lose control of the vehicle. Defensive drivers avoid most skids by taking reasonable care suited to existing conditions, and by not overdriving those conditions. But skids are always possible.

The three types of skids correspond to your vehicle's three control systems. In the braking skid, the wheels are not rolling.

8-24 Driving and Operating

In the steering or cornering skid, too much speed or steering in a curve causes tires to slip and lose cornering force. And in the acceleration skid, too much throttle causes the driving wheels to spin.

If your vehicle starts to slide, ease your foot off the accelerator pedal and quickly steer the way you want the vehicle to go. If you start steering quickly enough, your vehicle may straighten out. Always be ready for a second skid if it occurs.

Of course, traction is reduced when water, snow, ice, gravel, or other material is on the road. For safety, you want to slow down and adjust your driving to these conditions. It is important to slow down on slippery surfaces because stopping distance is longer and vehicle control more limited.

While driving on a surface with reduced traction, try your best to avoid sudden steering, acceleration, or braking, including reducing vehicle speed by shifting to a lower gear.

Any sudden changes could cause the tires to slide. You might not realize the surface is slippery until your vehicle is skidding. Learn to recognize warning clues — such as enough water, ice, or packed snow on the road to make a mirrored surface — and slow down when you have any doubt.

Remember: Any Antilock Brake System (ABS) helps avoid only the braking skid.

Driving at Night

Night driving is more dangerous than day driving because some drivers are likely to be impaired — by alcohol or drugs, with night vision problems, or by fatigue.

Night driving tips include:

- Drive defensively.
- Do not drink and drive.
- Reduce headlamp glare by adjusting the inside rearview mirror.

- Slow down and keep more space between you and other vehicles because headlamps can only light up so much road ahead.
- Watch for animals.
- When tired, pull off the road.
- Do not wear sunglasses.
- Avoid staring directly into approaching headlamps.
- Keep the windshield and all glass on your vehicle clean — inside and out.
- Keep your eyes moving, especially during turns or curves.

No one can see as well at night as in the daytime. But, as we get older, these differences increase. A 50-year-old driver might need at least twice as much light to see the same thing at night as a 20-year-old.

Driving in Rain and on Wet Roads

Rain and wet roads can reduce vehicle traction and affect your ability to stop and accelerate. Always drive slower in these types of driving conditions and avoid driving through large puddles and deep-standing or flowing water.

CAUTION

Wet brakes can cause crashes. They might not work as well in a quick stop and could cause pulling to one side. You could lose control of the vehicle.

(Continued)

CAUTION (Continued)

After driving through a large puddle of water or a car/vehicle wash, lightly apply the brake pedal until the brakes work normally.

Flowing or rushing water creates strong forces. Driving through flowing water could cause your vehicle to be carried away. If this happens, you and other vehicle occupants could drown. Do not ignore police warnings and be very cautious about trying to drive through flowing water.

Hydroplaning

Hydroplaning is dangerous. Water can build up under your vehicle's tires so they actually ride on the water. This can happen if the road is

wet enough and you are going fast enough. When your vehicle is hydroplaning, it has little or no contact with the road.

There is no hard and fast rule about hydroplaning. The best advice is to slow down when the road is wet.

Other Rainy Weather Tips

Besides slowing down, other wet weather driving tips include:

- Allow extra following distance.
- Pass with caution.
- Keep windshield wiping equipment in good shape.
- Keep the windshield washer fluid reservoir filled.
- Have good tires with proper tread depth. See *Tires on page 9-42*.
- Turn off cruise control, if equipped.

Before Leaving on a Long Trip

To prepare your vehicle for a long trip, consider having it serviced by your dealer/retailer before departing.

Things to check on your own include:

- *Windshield Washer Fluid:* Reservoir full? Windows clean — inside and outside?
- *Wiper Blades:* In good shape?
- *Fuel, Engine Oil, Other Fluids:* All levels checked?
- *Lamps:* Do they all work and are lenses clean?
- *Tires:* Are treads good? Are tires inflated to recommended pressure?
- *Weather and Maps:* Safe to travel? Have up-to-date maps?

Highway Hypnosis

Always be alert and pay attention to your surroundings while driving. If you become tired or sleepy, find a safe place to park your vehicle and rest.

Other driving tips include:

- Keep the vehicle well ventilated.
- Keep interior temperature cool.
- Keep your eyes moving — scan the road ahead and to the sides.
- Check the rearview mirror and vehicle instruments often.

Hill and Mountain Roads

Driving on steep hills or through mountains is different than driving on flat or rolling terrain. Tips for driving in these conditions include:

- Keep the vehicle serviced and in good shape.
- Check all fluid levels and brakes, tires, cooling system, and transmission.
- Going down steep or long hills, shift to a lower gear.

CAUTION

If you do not shift down, the brakes could get so hot that they would not work well. You would then have poor braking or even none going down a hill. You could crash. Shift down to let the engine assist the brakes on a steep downhill slope.

 **CAUTION**

Coasting downhill in N (Neutral) or with the ignition off is dangerous. The brakes will have to do all the work of slowing down and they could get so hot that they would not work well. You would then have poor braking or even none going down a hill. You could crash. Always have the engine running and the vehicle in gear when going downhill.

- Stay in your own lane. Do not swing wide or cut across the center of the road. Drive at speeds that let you stay in your own lane.
- Top of hills: Be alert — something could be in your lane (stalled car, accident).
- Pay attention to special road signs (falling rocks area, winding roads, long grades, passing or no-passing zones) and take appropriate action.

Winter Driving

Driving on Snow or Ice

Drive carefully when there is snow or ice between the tires and the road, creating less traction or grip. Wet ice can occur at about 32°F (0°C) when freezing rain begins to fall, resulting in even less traction. Avoid driving on wet ice or in freezing rain until roads can be treated with salt or sand.

Drive with caution, whatever the condition. Accelerate gently so traction is not lost. Accelerating too quickly causes the wheels to spin and makes the surface under the tires slick, so there is even less traction.

8-28 Driving and Operating

Try not to break the fragile traction. If you accelerate too fast, the drive wheels will spin and polish the surface under the tires even more.

The *Antilock Brake System (ABS)* on page 8-18 improves vehicle stability during hard stops on a slippery roads, but apply the brakes sooner than when on dry pavement.

Allow greater following distance on any slippery road and watch for slippery spots. Icy patches can occur on otherwise clear roads in shaded areas. The surface of a curve or an overpass can remain icy when the surrounding roads are clear. Avoid sudden steering maneuvers and braking while on ice.

Turn off cruise control, if equipped, on slippery surfaces.

Blizzard Conditions

Being stuck in snow can be in a serious situation. Stay with the vehicle unless there is help nearby. If possible, use the *Roadside Assistance Program* on page 12-6. To get help and keep everyone in the vehicle safe:

- Turn on the *Hazard Warning Flashers* on page 4-4.
- Tie a red cloth to an outside mirror.

CAUTION

Snow can trap engine exhaust under the vehicle. This may cause exhaust gases to get inside. Engine exhaust contains carbon monoxide (CO) which cannot be seen or smelled. It can cause unconsciousness and even death.

If the vehicle is stuck in the snow:

- Clear away snow from around the base of your vehicle, especially any that is blocking the exhaust pipe.
- Check again from time to time to be sure snow does not collect there.
- Open a window about two inches on the side of the vehicle that is away from the wind to bring in fresh air.

(Continued)

CAUTION (Continued)

- Fully open the air outlets on or under the instrument panel.
- Adjust the Climate Control system to a setting that circulates the air inside the vehicle and set the fan speed to the highest setting. See Climate Control System in the Index.

For more information about carbon monoxide, see *Engine Exhaust on page 8-14*.

Snow can trap exhaust gases under your vehicle. This can cause deadly CO (carbon monoxide) gas to get inside. CO could overcome you and kill you. You cannot see it or smell it, so you might not know it is in your vehicle. Clear away snow from around the base of your vehicle, especially any that is blocking the exhaust

Run the engine for short periods only as needed to keep warm, but be careful.

To save fuel, run the engine for only short periods as needed to warm the vehicle and then shut the engine off and close the window most of the way to save heat. Repeat this until help arrives but only when you feel really uncomfortable from the cold. Moving about to keep warm also helps.

If it takes some time for help to arrive, now and then when you run the engine, push the accelerator pedal slightly so the engine runs faster than the idle speed. This keeps the battery charged to restart the vehicle and to signal for help with the headlamps. Do this as little as possible to save fuel.

If Your Vehicle is Stuck in Sand, Mud, Ice, or Snow

Slowly and cautiously spin the wheels to free the vehicle when stuck in sand, mud, ice, or snow. See *Rocking Your Vehicle to Get It Out on page 8-30*.

 **CAUTION**

If you let your vehicle's tires spin at high speed, they can explode, and you or others could be injured. The vehicle can overheat, causing an engine compartment fire or other damage. Spin the wheels as little as possible and avoid going above 35 mph (55 km/h) as shown on the speedometer.

For information about using tire chains on the vehicle, see *Tire Chains on page 9-65*.

Rocking Your Vehicle to Get It Out

Turn the steering wheel left and right to clear the area around the front wheels. Turn off any stability system. Shift back and forth between R (Reverse) and a forward gear, spinning the wheels as little as possible. To prevent transmission wear, wait until the wheels stop spinning before shifting gears. Release the accelerator pedal while shifting, and press lightly on the accelerator pedal when the transmission is in gear. Slowly spinning the wheels in the forward and reverse directions causes a rocking motion that could free the vehicle. If that does not get the vehicle out after a few tries, it might need to be towed out. If the vehicle does need to be towed out, see *Towing Your Vehicle on page 9-88*.

Loading the Vehicle

It is very important to know how much weight the vehicle can carry. This weight is called the vehicle capacity weight and includes the weight of all occupants, cargo and all nonfactory-installed options. Two labels on the vehicle show how much weight it may properly carry, the Tire and Loading Information label and the Certification label.

CAUTION

Do not load the vehicle any heavier than the Gross Vehicle Weight Rating (GVWR), or either the maximum front or rear Gross Axle Weight Rating (GAWR). If you do, parts on the vehicle can break, and it can change the way your vehicle handles. These could cause you to lose control and crash. Also, overloading can shorten the life of the vehicle.

Tire and Loading Information Label

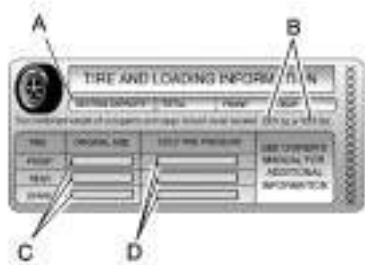

Label Example

A vehicle specific Tire and Loading Information label is attached to the vehicle's center pillar (B-pillar). With the driver's door open, you will find the label attached near the door lock post. The Tire and Loading Information label shows the number of

occupant seating positions (A), and the maximum vehicle capacity weight (B) in kilograms and pounds.

The Tire and Loading Information label also shows the tire size of the original equipment tires (C) and the recommended cold tire inflation pressures (D). For more information on tires and inflation see *Tires on page 9-42* and *Inflation - Tire Pressure on page 9-49*.

There is also important loading information on the Certification label. It tells you the Gross Vehicle Weight Rating (GVWR) and the Gross Axle Weight Rating (GAWR) for the front and rear axle. See "Certification Label" later in this section.

Steps for Determining Correct Load Limit

1. Locate the statement "The combined weight of occupants and cargo should never exceed XXX kg or XXX lbs" on your vehicle placard.
2. Determine the combined weight of the driver and passengers that will be riding in your vehicle.
3. Subtract the combined weight of the driver and passengers from XXX kg or XXX lbs.
4. The resulting figure equals the available amount of cargo and luggage load capacity. For example, if the "XXX" amount equals 1400 lbs and there will be five 150 lb passengers in your vehicle, the amount of available cargo and luggage load capacity is 650 lbs (1400 - 750 (5 x 150) = 650 lbs).

8-32 Driving and Operating

- Determine the combined weight of luggage and cargo being loaded on the vehicle. That weight may not safely exceed the available cargo and luggage load capacity calculated in Step 4.
- If your vehicle will be towing a trailer, the load from your trailer will be transferred to your vehicle. Consult this manual to determine how this reduces the available cargo and luggage load capacity of your vehicle.

See *Towing a Trailer on page 9-89* for important information on towing a trailer, towing safety rules and trailering tips.



Example 1

- Vehicle Capacity Weight for Example 1 = 1,000 lbs (453 kg).
- Subtract Occupant Weight 150 lbs (68 kg) \times 2 = 300 lbs (136 kg).
- Available Occupant and Cargo Weight = 700 lbs (317 kg).



Example 2

- Vehicle Capacity Weight for Example 2 = 1,000 lbs (453 kg).
- Subtract Occupant Weight 150 lbs (68 kg) \times 5 = 750 lbs (340 kg).
- Available Cargo Weight = 250 lbs (113 kg).



Example 3

- A. Vehicle Capacity Weight for Example 3 = 1,000 lbs (453 kg).
- B. Subtract Occupant Weight 200 lbs (91 kg) \times 5 = 1,000 lbs (453 kg).
- C. Available Cargo Weight = 0 lbs (0 kg).

Refer to the vehicle’s Tire and Loading Information label for specific information about the vehicle’s capacity weight and

seating positions. The combined weight of the driver, passengers, and cargo should never exceed the vehicle’s capacity weight.

Certification Label

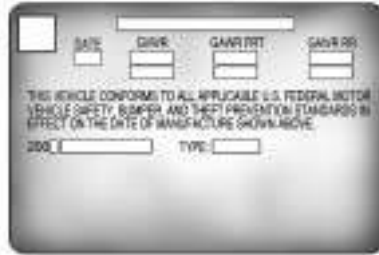

Label Example

A vehicle specific Certification label, is attached to the driver side center pillar. The label tells you the gross weight capacity of the vehicle, called the Gross Vehicle Weight Rating (GVWR). The GVWR includes

the weight of the vehicle, all occupants, fuel, and cargo. Never exceed the GVWR for the vehicle, or the Gross Axle Weight Rating (GAWR) for either the front or rear axle.

And, if you do have a heavy load, you should spread it out. See “Steps for Determining Correct Load Limit” earlier in this section.

CAUTION

Do not load the vehicle any heavier than the Gross Vehicle Weight Rating (GVWR), or either the maximum front or rear Gross Axle Weight Rating (GAWR). If you do, parts on the vehicle can break, and it can change the way your vehicle handles. These could cause you to lose control and crash. Also, overloading can shorten the life of the vehicle.

If you put things inside the vehicle — like suitcases, tools, packages, or anything else — they will go as fast as the vehicle goes. If you have to stop or turn quickly, or if there is a crash, they will keep going.

CAUTION

Things you put inside the vehicle can strike and injure people in a sudden stop or turn, or in a crash.

- Put things in the trunk of your vehicle. In a trunk, put them as far forward as you can. Try to spread the weight evenly.

(Continued)

CAUTION (Continued)

- Never stack heavier things, like suitcases, inside the vehicle so that some of them are above the tops of the seats.
- Do not leave an unsecured child restraint in the vehicle.
- When you carry something inside the vehicle, secure it whenever you can.
- Do not leave a seat folded down unless you need to.

Fuel

Use of the recommended fuel is an important part of the proper maintenance of this vehicle. To help keep the engine clean and maintain optimum vehicle performance, we recommend the use of gasoline advertised as TOP TIER Detergent Gasoline.

The 8th digit of the Vehicle Identification Number (VIN) shows the code letter or number that identifies the vehicle's engine. The VIN is at the top left of the instrument panel. See *Vehicle Identification Number (VIN)* on page 10-1.

Gasoline Octane

If the vehicle has a V8 engine, use regular unleaded gasoline with a posted octane rating of 87 or higher. If the octane rating is less than 87, you might notice an audible knocking noise when you drive, commonly referred to as spark knock. If this occurs, use a gasoline rated at 87 octane or higher as soon as possible. If you are using gasoline rated at 87 octane or higher and you hear heavy knocking, the engine needs service.

If the vehicle has the 3.6L V6 engine (VIN Code 7), use regular unleaded gasoline with a posted octane rating of 87 or higher. For best performance or trailer towing, you could choose to use middle grade 89 octane unleaded gasoline. If the octane rating is less than 87, you might notice an audible knocking noise when you drive, commonly referred

to as spark knock. If this occurs, use a gasoline rated at 87 octane or higher as soon as possible. If you are using gasoline rated at 87 octane or higher and you hear heavy knocking, the engine needs service.

Gasoline Specifications

At a minimum, gasoline should meet ASTM specification D 4814 in the United States or CAN/CGSB-3.5 or 3.511 in Canada. Some gasolines contain an octane-enhancing additive called methylcyclopentadienyl manganese tricarbonyl (MMT). We recommend against the use of gasolines containing MMT. See *Additives on page 8-36* for additional information.

California Fuel

If the vehicle is certified to meet California Emissions Standards, it is designed to operate on fuels that meet California specifications. See the underhood emission control label. If this fuel is not available in states adopting California emissions standards, the vehicle will operate satisfactorily on fuels meeting federal specifications, but emission control system performance might be affected. The malfunction indicator lamp could turn on and the vehicle might fail a smog-check test. See *Malfunction Indicator Lamp on page 4-18*. If this occurs, return to your authorized dealer/retailer for diagnosis. If it is determined that the condition is caused by the type of fuel used, repairs might not be covered by the vehicle warranty.

Additives

To provide cleaner air, all gasolines in the United States are now required to contain additives that help prevent engine and fuel system deposits from forming, allowing the emission control system to work properly. In most cases, you should not have to add anything to the fuel. However, some gasolines contain only the minimum amount of additive required to meet U.S. Environmental Protection Agency regulations. To help keep fuel injectors and intake valves clean, or if the vehicle experiences problems due to dirty injectors or valves, look for gasoline that is advertised as TOP TIER Detergent Gasoline. Also, your dealer/retailer has additives that will help correct and prevent most deposit-related problems.

Gasolines containing oxygenates, such as ethers and ethanol, and reformulated gasolines might be available in your area.

We recommend that you use these gasolines, if they comply with the specifications described earlier. However, E85 (85% ethanol) and other fuels containing more than 10% ethanol must not be used in vehicles that were not designed for those fuels.

Notice: This vehicle was not designed for fuel that contains methanol. Do not use fuel containing methanol. It can corrode metal parts in the fuel system and also damage plastic and rubber parts. That damage would not be covered under the vehicle warranty.

Some gasolines that are not reformulated for low emissions can contain an octane-enhancing additive called methylcyclopentadienyl manganese tricarbonyl (MMT); ask the attendant where you buy gasoline whether the fuel contains MMT.

We recommend against the use of such gasolines. Fuels containing MMT can reduce the life of spark plugs and the performance of the emission control system could be affected. The malfunction indicator lamp might turn on. If this occurs, return to your dealer/retailer for service.

Fuels in Foreign Countries

If you plan on driving in another country outside the United States or Canada, the proper fuel might be hard to find. Never use leaded gasoline or any other fuel not recommended in the previous text on fuel. Costly repairs caused by use of improper fuel would not be covered by the vehicle warranty.

To check the fuel availability, ask an auto club, or contact a major oil company that does business in the country where you will be driving.

Filling the Tank

⚠ CAUTION

Fuel vapor burns violently and a fuel fire can cause bad injuries. To help avoid injuries to you and others, read and follow all the instructions on the pump island. Turn off the engine when you are refueling. Do not smoke if you are near fuel or refueling the vehicle. Do not use cellular phones. Keep sparks, flames, and smoking materials away from fuel. Do not leave the fuel pump unattended when refueling the vehicle. This is against the law in some places. Do not re-enter the vehicle while pumping fuel. Keep children away from the fuel pump; never let children pump fuel.



The fuel cap is located behind a hinged fuel door on the passenger side of the vehicle.

To open the fuel door, the vehicle must be unlocked. Push on the rear edge of the door to open.

When reinstalling the cap, turn it clockwise until it clicks, otherwise the Malfunction Indicator Lamp may turn on. See *Malfunction Indicator Lamp* on page 4-18.

⚠ CAUTION

Fuel can spray out on you if you open the fuel cap too quickly. If you spill fuel and then something ignites it, you could be badly burned. This spray can happen if the tank is nearly full, and is more likely in hot weather. Open the fuel cap slowly and wait for any hiss noise to stop. Then unscrew the cap all the way.

Be careful not to spill fuel. Do not top off or overfill the tank and wait a few seconds after you have finished pumping before removing the nozzle. Clean fuel from painted surfaces as soon as possible. See *Exterior Cleaning* on page 9-98.

When replacing the fuel cap, turn it clockwise until it clicks. Make sure the cap is fully installed.

8-38 Driving and Operating

The diagnostic system can determine if the fuel cap has been left off or improperly installed. This would allow fuel to evaporate into the atmosphere. See *Malfunction Indicator Lamp on page 4-18*.

CAUTION

If a fire starts while you are refueling, do not remove the nozzle. Shut off the flow of fuel by shutting off the pump or by notifying the station attendant. Leave the area immediately.

Notice: If you need a new fuel cap, be sure to get the right type. Your dealer/retailer can get one for you. If you get the wrong type, it may not fit properly. This may cause the malfunction indicator lamp to light and may damage the fuel tank and emissions system. See *Malfunction Indicator Lamp on page 4-18*.

Filling a Portable Fuel Container

CAUTION

Never fill a portable fuel container while it is in the vehicle. Static electricity discharge from the container can ignite the fuel vapor. You can be badly burned and the vehicle damaged if this occurs. To help avoid injury to you and others:

- Dispense fuel only into approved containers.
- Do not fill a container while it is inside a vehicle, in a vehicle's trunk, pickup bed, or on any surface other than the ground.

(Continued)

CAUTION (Continued)

- Bring the fill nozzle in contact with the inside of the fill opening before operating the nozzle. Contact should be maintained until the filling is complete.
- Do not smoke while pumping fuel.
- Do not use a cellular phone while pumping fuel.

Vehicle Service and Care

Service

Service	9-2
Accessories and Modifications	9-3
California Proposition 65 Warning	9-3
California Perchlorate Materials Requirements	9-3
Doing Your Own Service Work	9-4
Adding Equipment to the Outside of the Vehicle	9-4

Owner Checks

Owner Checks	9-5
Hood Release	9-5
Engine Compartment Overview	9-6
Engine Oil	9-8
Engine Oil Life System	9-10
Engine Air Cleaner/Filter	9-11
Cooling System	9-13

Engine Coolant	9-15
Pressure Cap	9-19
Engine Overheating	9-20
Power Steering Fluid	9-21
Windshield Washer Fluid	9-23
Windshield Wiper Blade Replacement	9-24
Brakes	9-25
Battery	9-28

Headlamp Aiming

Headlamp Aiming	9-28
-----------------------	------

Bulb Replacement

Bulb Replacement	9-31
Halogen Bulbs	9-31
Headlamps and Parking Lamps	9-31
Front Turn Signal Lamps	9-33
Taillamps	9-34
License Plate Lamp	9-35
Replacement Bulbs	9-35

Electrical System

Add-On Electrical Equipment	9-36
Headlamp Wiring	9-36
Windshield Wiper Fuses	9-36

Power Windows and Other Power Options	9-36
Instrument Panel Fuse Block	9-36
Engine Compartment Fuse Block	9-38
Rear Compartment Fuse Block	9-41

Tires

Tires	9-42
Tire Sidewall Labeling	9-42
Tire Terminology and Definitions	9-46
Inflation - Tire Pressure	9-49
High-Speed Operation	9-51
Tire Pressure Monitor System	9-52
Tire Pressure Monitor Operation	9-54
Tire Inspection and Rotation	9-57
When It Is Time for New Tires	9-59
Buying New Tires	9-59
Different Size Tires and Wheels	9-61

9-2 Vehicle Service and Care

Uniform Tire Quality Grading	9-62
Wheel Alignment and Tire Balance	9-64
Wheel Replacement	9-64
Tire Chains	9-65

Tire Changing

If a Tire Goes Flat	9-66
Tire Sealant and Compressor Kit (V8 Engine)	9-67
Changing a Flat Tire	9-75
Removing the Spare Tire and Tools	9-76
Removing the Flat Tire and Installing the Spare Tire	9-77
Storing a Flat or Spare Tire and Tools	9-82
Compact Spare Tire	9-83

Jump Starting

Jump Starting	9-84
---------------------	------

Towing

Towing Your Vehicle	9-88
Shift Lock Manual Release	9-88
Recreational Vehicle Towing	9-89
Towing a Trailer	9-89

Appearance Care

Interior Cleaning	9-95
Exterior Cleaning	9-98
Sheet Metal Damage	9-102
Finish Damage	9-102
Underbody Maintenance	9-102
Chemical Paint Spotting	9-102

Service

For service and parts needs, visit your dealer/retailer. You will receive genuine GM parts and GM-trained and supported service people.

Genuine GM parts have one of these marks:



ACDelco



Parts



Goodwrench



Accessories

Accessories and Modifications

When non-dealer/non-retailer accessories are added to the vehicle, they can affect vehicle performance and safety, including such things as airbags, braking, stability, ride and handling, emissions systems, aerodynamics, durability, and electronic systems like antilock brakes, traction control, and stability control. Some of these accessories could even cause malfunction or damage not covered by the vehicle warranty.

GM Accessories are designed to complement and function with other systems on the vehicle. Your GM dealer/retailer can accessorize the vehicle using genuine GM Accessories.

When you go to your GM dealer/retailer and ask for GM Accessories, you will know that GM-trained and supported service technicians will perform the work using genuine GM Accessories.

Also, see *Adding Equipment to Your Airbag-Equipped Vehicle* on page 1-32.

California Proposition 65 Warning

Most motor vehicles, including this one, contain and/or emit chemicals known to the State of California to cause cancer and birth defects or other reproductive harm. Engine exhaust, many parts and systems (including some inside the vehicle), many fluids, and some component wear by-products contain and/or emit these chemicals.

California Perchlorate Materials Requirements

Certain types of automotive applications, such as airbag initiators, seat belt pretensioners, and lithium batteries contained in remote keyless transmitters, may contain perchlorate materials. Special handling may be necessary. For additional information, see www.dtsc.ca.gov/hazardouswaste/perchlorate.

Doing Your Own Service Work

CAUTION

You can be injured and the vehicle could be damaged if you try to do service work on a vehicle without knowing enough about it.

- Be sure you have sufficient knowledge, experience, the proper replacement parts, and tools before attempting any vehicle maintenance task.
- Be sure to use the proper nuts, bolts, and other fasteners. English and metric fasteners can be easily confused. If the wrong fasteners are used, parts can later break or fall off. You could be hurt.

If doing some of your own service work, use the proper service manual. It tells you much more about how to service the vehicle than this manual can. To order the proper service manual, see *Service Publications Ordering Information on page 12-15*.

This vehicle has an airbag system. Before attempting to do your own service work, see *Airbag System Check on page 1-33*.

Keep a record with all parts receipts and list the mileage and the date of any service work performed. See *Maintenance Record on page 11-15*.

Adding Equipment to the Outside of the Vehicle

Things added to the outside of the vehicle can affect the airflow around it. This can cause wind noise and can affect fuel economy and windshield washer performance. Check with your dealer/retailer before adding equipment to the outside of the vehicle.

Owner Checks

CAUTION

An electric fan under the hood can start up and injure you even when the engine is not running. Keep hands, clothing, and tools away from any underhood electric fan.

CAUTION

Things that burn can get on hot engine parts and start a fire. These include liquids like fuel, oil, coolant, brake fluid, windshield washer and other fluids, and plastic or rubber. You or others could be burned. Be careful not to drop or spill things that will burn onto a hot engine.

Hood Release

To open the hood:



1. Pull the release handle with the above symbol on it. It is located below the instrument panel to the left of the steering wheel.



2. Pull up on the secondary hood release. The lever is located near the middle of the hood.
3. Lift the hood.
4. Release the hood prop rod from its retainer and put it into the slot in the hood. To insert the hood prop rod into the slot.

Before closing the hood, be sure all the filler caps are on properly. Make sure to return the hood prop rod carefully back to its retainer to avoid damaging the vehicle.

9-6 Vehicle Service and Care

Engine Compartment Overview

When you open the hood, this is what you will see:

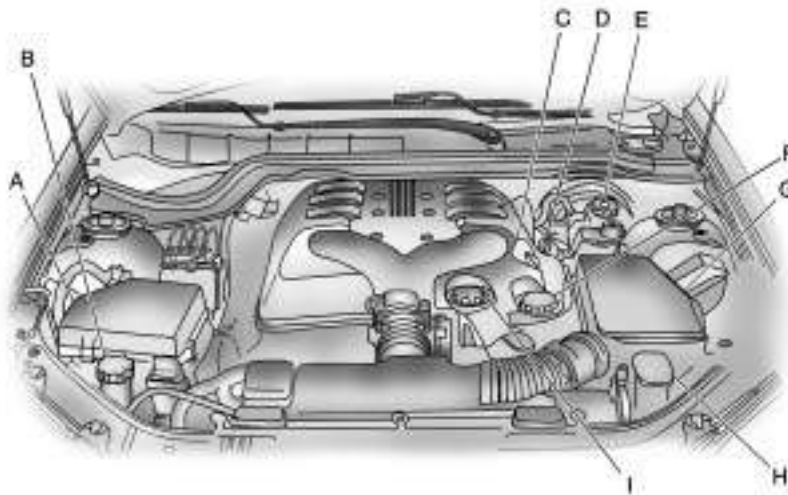

V6 Engine

- A. *Engine Compartment Fuse Block on page 9-38.*
- B. *Coolant Reservoir and Dipstick. See [Cooling System on page 9-13.](#)*
- C. *Engine Oil Fill Cap. See “When to Add Engine Oil” under [Engine Oil on page 9-8.](#)*
- D. *Engine Oil Dipstick (Out of View). See “Checking Engine Oil” under [Engine Oil on page 9-8.](#)*
- E. *Brake Master Cylinder Reservoir. See “Brake Fluid” under [Brakes on page 9-25.](#)*
- F. *Power Steering Reservoir. See [Power Steering Fluid on page 9-21.](#)*
- G. *Engine Air Cleaner/Filter on page 9-11.*
- H. *Windshield Washer Fluid Reservoir. See [Windshield Washer Fluid on page 9-23.](#)*
- I. *Radiator Pressure Cap. See [Cooling System on page 9-13.](#)*

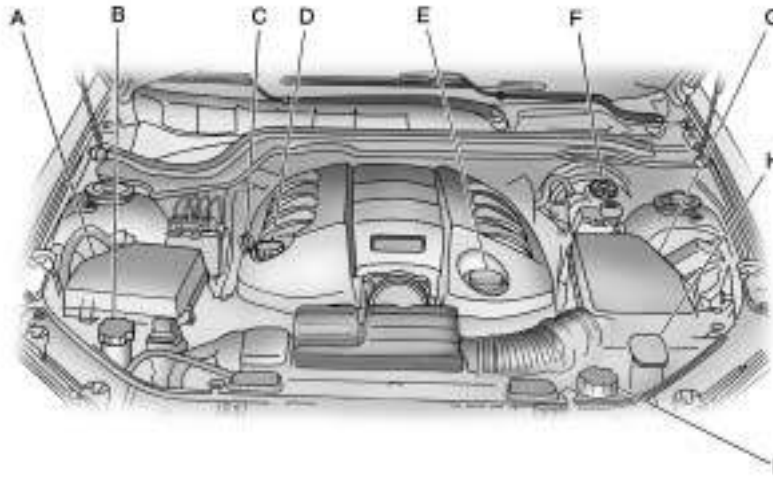

V8 Engine

- A. *Engine Compartment Fuse Block on page 9-38.*
- B. *Coolant Reservoir and Dipstick. See *Cooling System* on page 9-13.*
- C. *Engine Oil Dipstick. See "Checking Engine Oil" under *Engine Oil* on page 9-8.*
- D. *Engine Oil Fill Cap. See "When to Add Oil" under *Engine Oil* on page 9-8.*
- E. *Power Steering Reservoir. See *Power Steering Fluid* on page 9-21.*
- F. *Brake Master Cylinder Reservoir. See "Brake Fluid" under *Brakes* on page 9-25.*
- G. *Engine Air Cleaner/Filter on page 9-11.*
- H. *Windshield Washer Fluid Reservoir. See *Windshield Washer Fluid* on page 9-23.*
- I. *Radiator Pressure Cap. See *Cooling System* on page 9-13.*

9-8 Vehicle Service and Care

Engine Oil

Checking Engine Oil

It is a good idea to check the engine oil every time you get fuel. In order to get an accurate reading, the oil must be warm and the vehicle must be on level ground.

The engine oil dipstick handle is a yellow loop. See *Engine Compartment Overview on page 9-6* for the location of the engine oil dipstick.

1. Turn off the engine and give the oil several minutes to drain back into the oil pan. If you do not do this, the oil dipstick might not show the actual level.
2. Pull the dipstick and clean it with a paper towel or cloth, then push it back in all the way. Remove it again, keeping the tip down and check the level.

When to Add Engine Oil

If the oil is below the MIN (minimum) mark, add at least one quart/liter of the recommended oil. This section explains what kind of oil to use. For engine oil crankcase capacity, see *Capacities and Specifications on page 10-2*.

Notice: Do not add too much oil. If the engine has so much oil that the oil level gets above the upper mark that shows the proper operating range, the engine could be damaged.



See *Engine Compartment Overview on page 9-6* for the location of the engine oil fill cap.

Add enough oil to put the level somewhere in the proper operating range. Push the dipstick all the way back in when you are through.

What Kind of Engine Oil to Use

Look for three things:

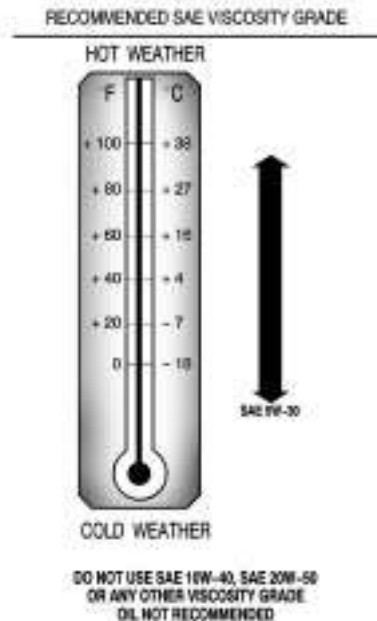

- GM6094M

Use only an oil that meets GM Standard GM6094M.

- SAE 5W-30

SAE 5W-30 is best for the vehicle. If you are in an area of extreme cold, where the temperature falls below -20°F (-29°C), use either an SAE 5W-30 synthetic oil or an SAE 0W-30 oil. Both provide easier cold starting and better protection for the engine at extremely low temperatures. These numbers on an oil container show its viscosity, or thickness. Do not use other viscosity oils such as SAE 20W-50.

- American Petroleum Institute (API) starburst symbol



Oils meeting these requirements should have the starburst symbol on the container. This symbol indicates that the oil has been certified by the American Petroleum Institute (API).

Notice: Use only engine oil identified as meeting GM Standard GM6094M and showing the American Petroleum Institute Certified For Gasoline Engines starburst symbol. Failure to use the recommended oil can result in engine damage not covered by the vehicle warranty.

Engine Oil Additives / Engine Oil Flushes

Do not add anything to the oil. The recommended oils with the starburst symbol that meet GM Standard GM6094M are all you need for good performance and engine protection.

Engine oil system flushes are not recommended and could cause engine damage not covered by the vehicle warranty.

Engine Oil Life System

When to Change Engine Oil

This vehicle has a computer system that lets you know when to change the engine oil and filter. This is based on engine revolutions and engine temperature, and not on mileage. Based on driving conditions, the mileage at which an oil change will be indicated can vary considerably. For the oil life system to work properly, you must reset the system every time the oil is changed.

When the system has calculated that oil life has been diminished, it will indicate that an oil change is necessary. The Service Engine Oil message will be displayed.

Change the oil as soon as possible within the next 600 miles (1 000 km). It is possible that, if you are driving under the best conditions, the oil life system might not indicate that an oil change is necessary for over a year. However, the engine oil and filter must be changed at least once a year and at this time the system must be reset. Your dealer/retailer has trained service people who will perform this work using genuine parts and reset the system. It is also important to check the oil regularly and keep it at the proper level.

If the system is ever reset accidentally, you must change the oil at 3,000 miles (5 000 km) since the last oil change. Remember to reset the oil life system whenever the oil is changed.

How to Reset the Engine Oil Life System

The Engine Oil Life System calculates when to change the engine oil and filter based on vehicle use. Whenever the oil is changed, reset the system so it can calculate when the next oil change is required. If a situation occurs where you change the oil prior to the Service Engine Oil message being displayed, reset the system.

After changing the engine oil, reset the system:

1. Turn the ignition key to ON/RUN with the engine off.
2. Fully press and release the accelerator pedal three times within five seconds.

If the Service Engine Oil message does not appear, the system is reset.

If the Service Engine Oil message displays, reset the system again.

What to Do with Used Oil

Used engine oil contains certain elements that can be unhealthy for your skin and could even cause cancer. Do not let used oil stay on your skin for very long. Clean your skin and nails with soap and water, or a good hand cleaner. Wash or properly dispose of clothing or rags containing used engine oil. See the manufacturer's warnings about the use and disposal of oil products.

Used oil can be a threat to the environment. If you change your own oil, be sure to drain all the oil from the filter before disposal. Never dispose of oil by putting it in the trash, pouring it on the ground, into sewers, or into streams or bodies of water. Recycle it by taking it to a place that collects used oil.

Engine Air Cleaner/Filter

See *Engine Compartment Overview on page 9-6* for the location of the engine air cleaner/filter.

When to Inspect the Engine Air Cleaner/Filter

Inspect the air cleaner/filter at the Maintenance II intervals and replace it at the first oil change after each 50,000 mile (83 000 km) interval. See "Schedule Maintenance" in Service and Maintenance for more information. If you are driving in dusty/dirty conditions, inspect the filter at each engine oil change.

How to Inspect the Engine Air Cleaner/Filter

To inspect the air cleaner/filter, remove the filter from the vehicle and lightly shake the filter to release loose dust and dirt. If the filter remains caked with dirt, a new filter is required.

To inspect or replace the engine air cleaner/filter:

1. Open the hood. See *Hood Release on page 9-5*.
2. Locate the air filter housing on the front of the driver side of the engine compartment. See *Engine Compartment Overview on page 9-6*.

9-12 Vehicle Service and Care



3. On the V8 engine, remove the airflow sensor connector by pushing in the tab and pulling straight back.

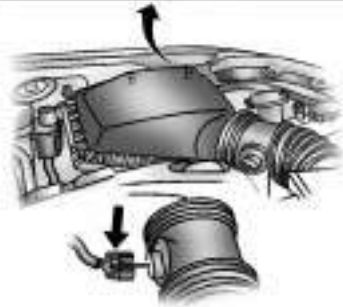

4. Remove the five retaining clips on the air filter housing.
5. Pull straight up on cover, while holding the cover remove the air filter.
6. Install the air filter.
7. Close the air filter housing cover and clip the five retaining clips.
8. On the V8 engine push in the airflow sensor connector.

CAUTION

Operating the engine with the air cleaner/filter off can cause you or others to be burned. The air cleaner not only cleans the air; it helps to stop flames if the engine backfires. If it is not there and the engine backfires, you could be burned. Do not drive with it off, and be careful working on the engine with the air cleaner/filter off.

Notice: If the air cleaner/filter is off, a backfire can cause a damaging engine fire. And, dirt can easily get into the engine, which will damage it. Always have the air cleaner/filter in place when you are driving.

Cooling System

When you decide it is safe to lift the hood, this is what you see:

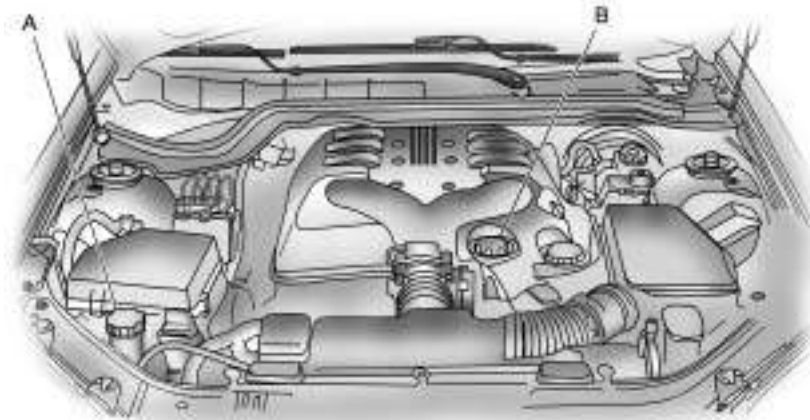

V6 Engine

- A. Engine Coolant Reservoir
- B. Radiator Cap

9-14 Vehicle Service and Care

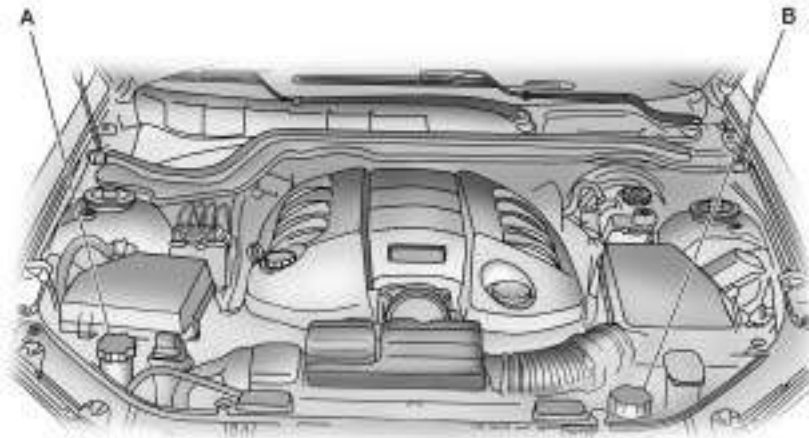

V8 Engine

- A. Engine Coolant Reservoir
- B. Radiator Cap

CAUTION

An electric engine cooling fan under the hood can start up even when the engine is not running and can cause injury. Keep hands, clothing, and tools away from any underhood electric fan.

 **CAUTION**

Heater and radiator hoses, and other engine parts, can be very hot. Do not touch them. If you do, you can be burned.

Do not run the engine if there is a leak. If you run the engine, it could lose all coolant. That could cause an engine fire, and you could be burned. Get any leak fixed before you drive the vehicle.

Notice: Using coolant other than DEX-COOL[®] can cause premature engine, heater core, or radiator corrosion. In addition, the engine coolant could require changing sooner, at 30,000 miles (50 000 km) or 24 months, whichever occurs first. Any repairs would not be covered by the vehicle warranty. Always use DEX-COOL[®] (silicate-free) coolant in the vehicle.

Engine Coolant

The cooling system in the vehicle is filled with DEX-COOL[®] engine coolant. This coolant is designed to remain in the vehicle for five years or 150,000 miles (240 000 km), whichever occurs first.

The following explains the cooling system and how to check and add coolant when it is low. If there is a problem with engine overheating, see *Engine Overheating* on page 9-20.

What to Use

CAUTION

Adding only plain water to the cooling system can be dangerous. Plain water, or some other liquid such as alcohol, can boil before the proper coolant mixture will. The vehicle's coolant warning system is set for the proper coolant mixture. With plain water or the wrong mixture, the engine could get too hot but you would not get the overheat warning. The engine could catch fire and you or others could be burned. Use a 50/50 mixture of clean, drinkable water and DEX-COOL[®] coolant.

Use a 50/50 mixture of clean, drinkable water and DEX-COOL[®] coolant. If using this mixture, nothing else needs to be added. This mixture:

- Gives freezing protection down to -34°F (-37°C), outside temperature.
- Gives boiling protection up to 265°F (129°C), engine temperature.
- Protects against rust and corrosion.
- Will not damage aluminum parts.
- Helps keep the proper engine temperature.

Notice: If an improper coolant mixture is used, the engine could overheat and be badly damaged. The repair cost would not be covered by the vehicle warranty. Too much water in the mixture can freeze and crack the engine, radiator, heater core, and other parts.

Notice: If extra inhibitors and/or additives are used in the vehicle's cooling system, the vehicle could be damaged. Use only the proper mixture of the engine coolant listed in this manual for the cooling system. See *Recommended Fluids and Lubricants* on page 11-12 for more information.

Checking Coolant

The vehicle must be on a level surface when checking the coolant level.

Check to see if coolant is visible in the coolant recovery tank. If the coolant inside the coolant recovery tank is boiling, do not do anything else until it cools down. If coolant is visible but the coolant level is not at or above the COLD mark, add a 50/50 mixture of clean, drinkable water and DEX-COOL[®] coolant at the coolant recovery tank, but be sure the cooling system is cool before this is done. See Engine Coolant Engine Coolant for more information.

The coolant reservoir is located in the engine compartment on the passenger side of the vehicle. See *Engine Compartment Overview on page 9-6* for more information on location.

The coolant level should be at or above the top mark on the coolant reservoir dipstick. If it is not, you may have a leak in the cooling system.

How to Add Coolant to the Recovery Tank



You can be burned if you spill coolant on hot engine parts. Coolant contains ethylene glycol and it will burn if the engine parts are hot enough. Do not spill coolant on a hot engine.

Notice: This vehicle has a specific coolant fill procedure. Failure to follow this procedure could cause the engine to overheat and be severely damaged.

If coolant is needed, add the proper DEX-COOL[®] coolant mixture at the coolant recovery tank.

9-18 Vehicle Service and Care

How to Add Coolant to the Radiator

CAUTION

You can be burned if you spill coolant on hot engine parts. Coolant contains ethylene glycol and it will burn if the engine parts are hot enough. Do not spill coolant on a hot engine.

Notice: This vehicle has a specific coolant fill procedure. Failure to follow this procedure could cause the engine to overheat and be severely damaged.

CAUTION

An electric engine cooling fan under the hood can start up even when the engine is not running and can cause injury. Keep hands, clothing, and tools away from any underhood electric fan.

CAUTION

Steam and scalding liquids from a hot cooling system can blow out and burn you badly. They are under pressure, and if you turn the radiator pressure cap — even a little — they can come out at high speed. Never turn the cap

(Continued)

CAUTION (Continued)

when the cooling system, including the radiator pressure cap, is hot. Wait for the cooling system and radiator pressure cap to cool if you ever have to turn the pressure cap.

If coolant is needed, add the proper mixture directly to the radiator, but be sure the cooling system is cool before this is done.

If no coolant is visible in the surge tank, add coolant as follows:

1. Check the engine coolant reservoir level and, if required, top with coolant. See *Engine Coolant* on page 9-15 Engine Coolant.



2. Locate the radiator cap.
3. Cover the cap with a thick cloth and turn it slowly counterclockwise and remove.

4. If there is no coolant or the level is low, slowly fill the system through the radiator cap opening with a 50/50 mixture of clean, drinkable water and a DEX-COOL[®] coolant until full. Wait 30 seconds for coolant to settle and top off if the level drops.

Do not spill coolant on the accessory drive belts.

If a spill occurs, rinse the belt with fresh water.

5. Start the engine.
6. With the engine idling, top off the coolant through the radiator cap opening until full.

Wait 30 seconds for the coolant to settle and top off, if the level drops.

7. Once the system is full, put the radiator cap back on by turning clockwise.

8. Turn off the ignition.
9. Check the coolant level in the reservoir and fill it until the level is at the top of the dipstick.

Notice: If the pressure cap is not tightly installed, coolant loss and possible engine damage may occur. Be sure the cap is properly and tightly secured.

Pressure Cap

Notice: If the pressure cap is not tightly installed, coolant loss and possible engine damage may occur. Be sure the cap is properly and tightly secured.

See *Engine Compartment Overview* on page 9-6 for more information on location.

Engine Overheating

The vehicle has an indicator to warn of engine overheating.

There is an engine coolant temperature warning light on your vehicle's instrument panel.

See *Engine Coolant Temperature Gage* on page 4-17.

You may decide not to lift the hood when this warning appears, but instead get service help right away. See *Roadside Assistance Program* on page 12-6.

If you do decide to lift the hood, make sure the vehicle is parked on a level surface.

Then check to see if the engine cooling fans are running. If the engine is overheating, both fans should be running. If they are not, do not continue to run the engine and have the vehicle serviced.

Notice: Engine damage from running the engine without coolant is not covered by the warranty.

Notice: If the engine catches fire because of being driven with no coolant, your vehicle can be badly damaged. The costly repairs would not be covered by the vehicle warranty.

If Steam Is Coming From The Engine Compartment



Steam from an overheated engine can burn you badly, even if you just open the hood. Stay away from the engine if you see or hear steam coming from it. Just turn it off and get everyone away from the vehicle until it cools down. Wait until there is no sign of steam or coolant before you open the hood.

If you keep driving when your engine is overheated, the liquids in it can catch fire. You or others could be badly burned. Stop your engine if it overheats, and get out of the vehicle until the engine is cool.

If No Steam Is Coming From The Engine Compartment

If an engine overheat warning is displayed but no steam can be seen or heard, the problem may not be too serious. Sometimes the engine can get a little too hot when the vehicle:

- Climbs a long hill on a hot day.
- Stops after high-speed driving.
- Idles for long periods in traffic.
- Tows a trailer.

If the overheat warning is displayed with no sign of steam:

1. Turn the air off.
2. Turn the heater on to the highest temperature and to the highest fan speed. Open the windows as necessary.
3. In heavy traffic, let the engine idle in N (Neutral) while stopped. If it is safe to do so, pull off the road, shift to P (Park) or N (Neutral) and let the engine idle.

If the temperature overheat gage is no longer in the overheat zone or an overheat warning no longer displays, the vehicle can be driven. Continue to drive the vehicle slow for about 10 minutes. Keep a safe vehicle distance from the car in front of you. If the warning does not come back on, continue to drive normally.

If the warning continues, pull over, stop, and park the vehicle right away.

If there is no sign of steam, idle the engine for three minutes while parked. If the warning is still displayed, turn off the engine until it cools down. Also, see “Overheated Engine Protection Operating Mode” later in this section.

Power Steering Fluid

Power Steering Fluid Level

Power steering fluid is used in all vehicles.

Check the level after the vehicle has been driven for at least twenty minutes so the fluid is warm.

How to Check Power Steering Fluid

To check the power steering fluid, do the following:

1. Turn the key off and let the engine compartment cool down.
2. The power steering fluid reservoir is located on the driver side toward the front of the engine compartment. See *Engine Compartment Overview* on page 9-6.



3. Wipe the cap and the top of the reservoir clean.



V6 Engine



V8 Engine

4. Turn the cap counterclockwise and pull it straight up.
5. When the engine is hot, the level should be at the hot MAX level.
When the engine is cold, the fluid level should be between MIN and MAX on the dipstick.
6. Replace the cap.

Adding Power Steering Fluid

To determine what kind of fluid to use, see *Recommended Fluids and Lubricants on page 11-12*. Always use the proper fluid. Failure to use the proper fluid can cause leaks and damage hoses and seals.

1. Turn the ignition to LOCK/OFF.
2. Top off with power steering fluid. Do not overfill the reservoir.
3. Push the cap straight down and turn clockwise to tighten.

Windshield Washer Fluid

What to Use

When you need windshield washer fluid, be sure to read the manufacturer's instructions before use. If you will be operating your vehicle in an area where the temperature may fall below freezing, use a fluid that has sufficient protection against freezing.

Adding Washer Fluid



Open the cap with the washer symbol on it. Add washer fluid until the tank is full. See *Engine Compartment Overview* on page 9-6 for reservoir location.

Notice:

- When using concentrated washer fluid, follow the manufacturer's instructions for adding water.
- Do not mix water with ready-to-use washer fluid. Water can cause the solution to freeze and damage your washer fluid tank and other parts of the washer system. Also, water does not clean as well as washer fluid.
- Fill the washer fluid tank only three-quarters full when it is very cold. This allows for fluid expansion if freezing occurs, which could damage the tank if it is completely full.
- Do not use engine coolant (antifreeze) in your windshield washer. It can damage the vehicle's windshield washer system and paint.

Windshield Wiper Blade Replacement

Front Windshield Wiper

Windshield wiper blades should be inspected for wear or cracking.

See "Maintenance Replacement Parts" in the Limited Warranty, Maintenance and owner Assistance Information manual for the proper type and length.

Raise the wiper arm, tilt the wiper blade at a 90° angle to the wiper arm, and remove to the side.

1. Turn the ignition off.
2. With the key in the ignition and key in the LOCK position, press the wiper lever down. Release the wiper lever when the wipers are in the vertical position.



3. Raise the wiper arm away from the windshield.
4. Turn the wiper blade at a 90° angle to the wiper arm and remove the blade to the side.
5. Install the new wiper blade.
6. Lower the wiper arm on to the windshield.

Rear Windshield Wiper

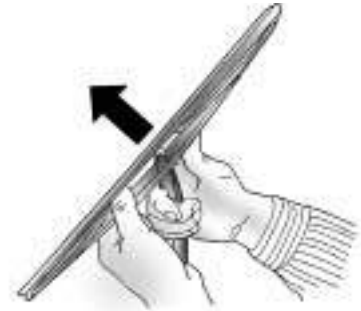

1. Lift the wiper arm straight up.
2. Push the wiper blade straight out of the wiper arm to remove.
3. Install the new wiper blade.

Brakes

Brake Fluid

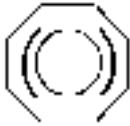

The brake master cylinder reservoir is filled with DOT-4 brake fluid.

There are only two reasons why the brake fluid level in the reservoir might go down:

- The brake fluid level goes down because of normal brake lining wear. When new linings are installed, the fluid level goes back up.

- A fluid leak in the brake hydraulic system can also cause a low fluid level. Have the brake hydraulic system fixed, since a leak means that sooner or later the brakes will not work well.

Do not top off the brake fluid. Adding fluid does not correct a leak. If fluid is added when the linings are worn, there will be too much fluid when new brake linings are installed. Add or remove brake fluid, as necessary, only when work is done on the brake hydraulic system.

CAUTION

If too much brake fluid is added, it can spill on the engine and burn, if the engine is hot enough. You or others could be burned, and the vehicle could be damaged. Add brake fluid only when work is done on the brake hydraulic system.

When the brake fluid falls to a low level, the brake warning light comes on. See *Brake System Warning Light* on page 4-15.

What to Add

Use only new DOT-4 brake fluid from a sealed container. It is recommended that the brake hydraulic system be flushed and refilled with new DOT-4 fluid at a regular maintenance service every two years. See *Additional Required Services on page 11-6* and *Recommended Fluids and Lubricants on page 11-12*.

Always clean the brake fluid reservoir cap and the area around the cap before removing it. This helps keep dirt from entering the reservoir.

CAUTION

With the wrong kind of fluid in the brake hydraulic system, the brakes might not work well. This could cause a crash. Always use the proper brake fluid.

Notice:

- **Using the wrong fluid can badly damage brake hydraulic system parts. For example, just a few drops of mineral-based oil, such as engine oil, in the brake hydraulic system can damage brake hydraulic system parts so badly that they will have to be replaced. Do not let someone put in the wrong kind of fluid.**
- **If brake fluid is spilled on the vehicle's painted surfaces, the paint finish can be damaged. Be careful not to spill brake fluid on the vehicle. If you do, wash it off immediately. See *Exterior Cleaning on page 9-98*.**

Brake Wear

This vehicle has disc brakes. Disc brake pads have built-in wear indicators that make a high-pitched warning sound when the brake pads are worn and new pads are needed. The sound can come and go or be heard all the time the vehicle is moving, except when applying the brake pedal firmly.

CAUTION

The brake wear warning sound means that soon the brakes will not work well. That could lead to an accident. When the brake wear warning sound is heard, have the vehicle serviced.

Notice: Continuing to drive with worn-out brake pads could result in costly brake repair.

Some driving conditions or climates can cause a brake squeal when the brakes are first applied or lightly applied. This does not mean something is wrong with the brakes.

Properly torqued wheel nuts are necessary to help prevent brake pulsation. When tires are rotated, inspect brake pads for wear and evenly tighten wheel nuts in the proper sequence to torque specifications in *Capacities and Specifications on page 10-2*.

Brake linings should always be replaced as complete axle sets.

Brake Pedal Travel

See your dealer/retailer if the brake pedal does not return to normal height, or if there is a rapid increase in pedal travel. This could be a sign that brake service might be required.

Brake Adjustment

Every time the brakes are applied, with or without the vehicle moving, the brakes adjust for wear.

Replacing Brake System Parts

The braking system on a vehicle is complex. Its many parts have to be of top quality and work well together if the vehicle is to have really good braking.

The vehicle was designed and tested with top-quality brake parts. When parts of the braking system are replaced — for example, when the brake linings wear down and new ones are installed — be sure to get new approved replacement parts. If this is not done, the brakes might not work properly. For example, if someone puts in brake linings that are wrong for the vehicle, the balance between the front and rear brakes can change — for the worse. The braking performance expected can change in many other ways if the wrong replacement brake parts are installed.

Battery

This vehicle has a maintenance free battery. When it is time for a new battery, see your dealer/retailer for one that has the replacement number shown on the original battery's label. The battery is located in the trunk behind a trim panel on the driver's side.

Warning: Battery posts, terminals, and related accessories contain lead and lead compounds, chemicals known to the State of California to cause cancer and reproductive harm. Wash hands after handling.

Vehicle Storage



Batteries have acid that can burn you and gas that can explode. You can be badly hurt if you are not careful. See *Jump Starting on page 9-84* for tips on working around a battery without getting hurt.

Infrequent Usage: If the vehicle is driven infrequently, remove the black, negative (-) cable from the battery. This helps keep the battery from running down.

Extended Storage: For extended storage of the vehicle, remove the black, negative (-) cable from the battery or use a battery trickle charger. This helps maintain the charge of the battery over an extended period of time.

Headlamp Aiming

The optical headlamp aiming system has been preset at the factory and should need no further adjustment

However, if the vehicle is damaged adjustment may be necessary.

If oncoming vehicles flash their high beams at you, this may also mean the vertical aim needs to be adjusted.

It is recommended that the vehicle is taken to your dealer/retailer for service if the headlamps need to be re-aimed. It is possible however, to re-aim the headlamps as described.

The vehicle should:

- Be placed so the headlamps are 25 ft. (7.6 m) from a light colored wall.
- Have all four tires on a perfectly level surface which is level all the way to the wall.
- Be placed so it is at a right angle to the wall.
- Not have any snow, ice, or mud on it.
- Be fully assembled and all other work stopped while headlamp aiming is being done.
- Have a full tank of fuel and one person or 160 lbs (75 kg) on the driver seat.
- Have all tires properly inflated.

Headlamp aiming is done with the vehicle's low-beam headlamps. The high-beam headlamps will be correctly aimed if the low-beam headlamps are aimed properly.

To adjust the vertical aim on the headlamps:

1. Open the hood. *Hood Release on page 9-5.*

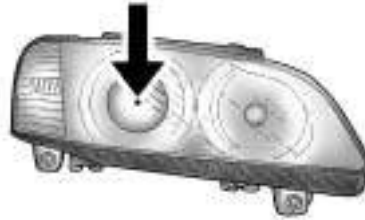

2. Locate the aim dot on the lens of the low-beam headlamp.
3. Record the distance from the ground to the aim dot on the low-beam headlamp.

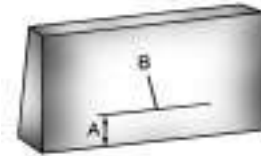

4. At the wall, measure from the ground upward (A) to the recorded distance from Step 3 and mark it.
5. Draw or tape a horizontal line (B) on the wall the width of the vehicle at the height of the mark in Step 4.

9-30 Vehicle Service and Care

Notice: Do not cover a headlamp to improve beam cut-off when aiming. Covering a headlamp may cause excessive heat build-up which may cause damage to the headlamp.

6. Turn on the low-beam headlamps and place a piece of cardboard or equivalent in front of the headlamp not being adjusted. Do not place it directly on the headlamp. This allows only the beam of light from the headlamp being adjusted to be seen on the flat surface.

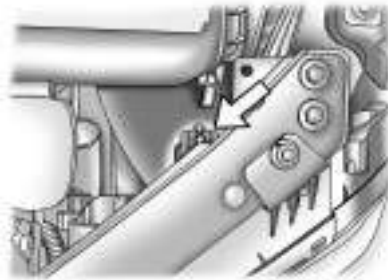

**Driver Side
(Passenger Side Similar)**

7. Locate the vertical headlamp aiming screws, which are under the hood near each headlamp assembly. The adjustment screw can be turned with a 6 mm socket wrench.
8. Turn the vertical aiming screw clockwise or counterclockwise until the headlamp beam is aimed to the horizontal tape line.

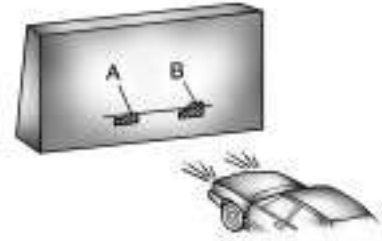

9. Make sure that the light from the headlamp is positioned at the bottom edge of the horizontal tape line. The lamp on the left (A) shows the correct headlamp aim. The lamp on the right (B) shows the incorrect headlamp aim.
10. Repeat Steps 7 through 9 for the opposite headlamp.

Bulb Replacement

For the proper type of replacement bulbs, see *Replacement Bulbs* on page 9-35.

For any bulb changing procedure not listed in this section, contact your dealer/retailer.

Halogen Bulbs

⚠ CAUTION

Halogen bulbs have pressurized gas inside and can burst if you drop or scratch the bulb. You or others could be injured. Be sure to read and follow the instructions on the bulb package.

Headlamps and Parking Lamps

To replace one of these bulbs:

If the front turn signal lamp or parking lamp needs to be changed, see your dealer/retailer.

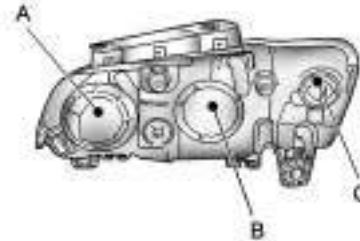

- A. Front Turn Signal Lamp/
Parking Lamp
- B. Low Beam Headlamp
- C. High Beam Headlamp

1. Open the hood. See *Hood Release* on page 9-5.

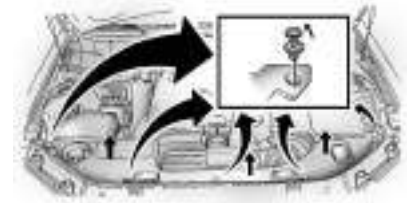

2. Remove the radiator support by turning the head screws counterclockwise and then pulling them straight out.
3. For the passenger side pull up on the coolant bottle filler neck to remove it and place it to one side.

Let the filler neck drain before pulling it all the way out. Place a clean towel over the opening of the coolant bottle after removing it.

9-32 Vehicle Service and Care

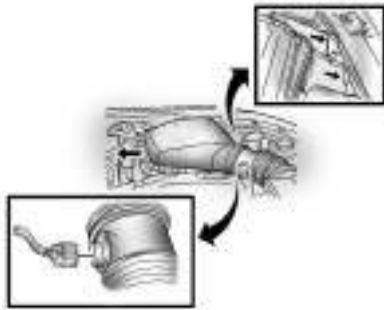

4. For the driver side remove the clip from the air cleaner/filter cover. Move the cover to the back, out of the way.

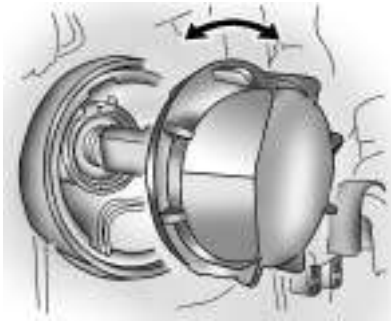

5. Turn the dust cap counterclockwise to remove.
6. Press the two prongs together on the connector to remove the wiring harness connector.

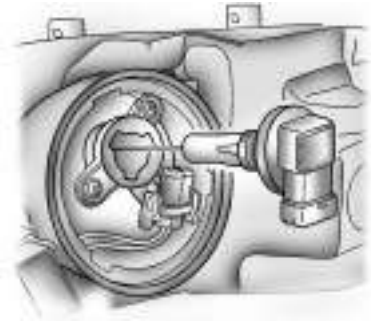

7. Turn the bulb socket counterclockwise and pull it out to remove from the lamp assembly.
8. Pull the old bulb straight out of the bulb socket.
9. Push the new bulb straight into the bulb socket until it clicks.

10. Reconnect the wiring harness to the bulb socket.
11. Push the bulb socket into the lamp assembly and turn it clockwise to lock it into place.
12. Turn the dust cap clockwise to lock it into place.
13. For the driver side reinstall the air cleaner/filter cover.
14. For the passenger side reinstall the coolant bottle filler neck.
15. Reinstall the radiator support screws.

Front Turn Signal Lamps

Front Turn Signal Lamps

1. Open the hood. See *Hood Release on page 9-5.*



2. Remove the radiator support by unscrewing and prying out the head screws.

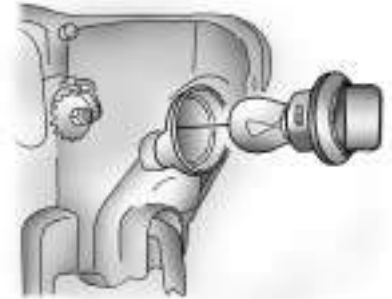

3. Turn the bulb socket counterclockwise and pull straight out.
4. Push and turn bulb counterclockwise and remove.
5. Push the bulb straight in and turn clockwise to lock into place.
6. Push the bulb socket and turn it clockwise to lock it into place.
7. Reinstall the radiator support head screws.

Taillamps



- A. Turn Signal Lamp
- B. Stoplamp/Taillamp
- C. Back-up Lamp

To replace one of these bulbs:

For any lamp not listed here, see your dealer/retailer to replace.

1. Open the trunk. See *Trunk on page 2-10*.
2. Raise the spare tire cover. See *Removing the Spare Tire and Tools on page 9-76* for more information.



3. Turn the four convenience net hooks securing the plastic trunk trim counterclockwise.
4. Pull the trunk trim straight up to remove.



5. Turn the trunk lining securing pins counterclockwise and pull down at the same time to remove.
6. Lower the spare tire cover.
7. Turn the bulb socket counterclockwise to remove it from the rear lamp housing.
8. Lightly press the bulb and turn it counterclockwise to remove it from the bulb holder.

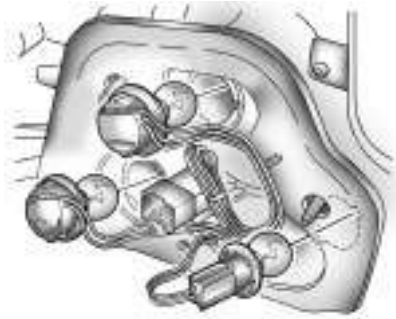

9. Push the new bulb into the socket and turn it clockwise to lock it into place.
10. Push the bulb socket straight in and turn it clockwise to lock it into place.
11. Make sure the seals are applied to the taillamp assembly and screws.
12. Raise the spare tire cover.
13. Turn the trunk lining securing pins clockwise to lock into place.

14. Return the plastic trunk trim to its original location.
15. Reinstall the plastic retaining pins.

License Plate Lamp

To replace one of these bulbs:

1. Open the trunk. See *Trunk* on page 2-10.



2. Turn the bulb socket counterclockwise and pull it straight out.

3. Pull the bulb straight out of the bulb socket.
4. Push the new bulb straight into the bulb socket until it clicks.
5. Push the bulb socket straight in and turn it clockwise to lock it into place.

Replacement Bulbs

Exterior Lamp	Bulb Number
High-Beam Headlamp	H9
Low-Beam Headlamp	H11
Stoplamp/Taillamp	P21/5W
Rear Turn Signal Lamp	PY21W
Back-up Lamp	P21W

For replacement bulbs not listed here, contact your dealer/retailer.

Electrical System

Add-On Electrical Equipment

Notice: Do not add anything electrical to the vehicle unless you check with your dealer/retailer first. Some electrical equipment can damage the vehicle and the damage would not be covered by the vehicle's warranty. Some add-on electrical equipment can keep other components from working as they should.

Add-on equipment can drain the vehicle battery, even if the vehicle is not operating.

The vehicle has an airbag system. Before attempting to add anything electrical to the vehicle, see *Servicing Your Airbag-Equipped Vehicle* on page 1-31.

Headlamp Wiring

The headlamp wiring is protected by fuses in the fuse block. An electrical overload will cause the lamps to turn off. If this happens, have the headlamp wiring checked right away.

Windshield Wiper Fuses

The windshield wiper motor is protected by a circuit breaker and a fuse. If the motor overheats due to heavy snow, etc., the wiper will stop until the motor cools. If the overload is caused by some electrical problem, have it fixed.

Power Windows and Other Power Options

Circuit breakers in the fuse block protect the power windows and other power accessories. When the current load is too heavy, the circuit breaker opens and closes, protecting the circuit until the problem is fixed or goes away.

Instrument Panel Fuse Block

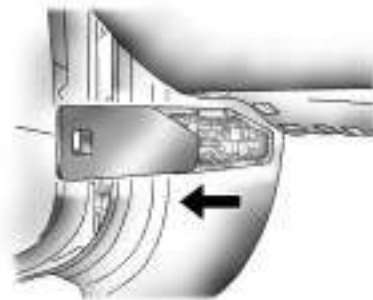

The instrument panel fuse block is located on the end of the instrument panel, on the driver side of the vehicle. To access the fuses, open the fuse panel door by pulling out.

To reinstall the door, push the door back into its original location.

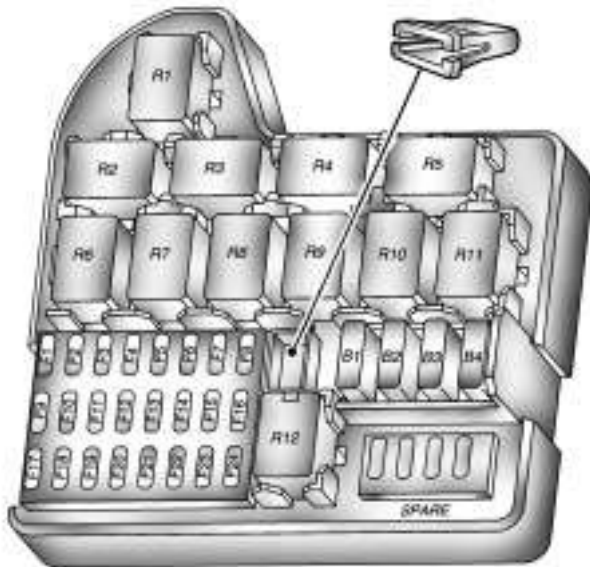

Instrument Panel Fuse Block - Fuse Puller Shown

Fuses	Usage
F1	Airbag
F2	Trunk Release
F3	Door Locks
F4	Inadvertent Power LED
F5	Courtesy/Turn Signal Lamps/Front Passenger Turn Signal
F6	Rear and Side Passenger Side Turn Signal
F7	Spare
F8	Driver Side Turn Signal
F9	Body Control Module
F10	Stoplamps
F11	Interior Lamps
F12	Discrete Logic Ignition Sensor/Theft Deterrent System
F13	Rear Cigarette Lighter

9-38 Vehicle Service and Care

Fuses	Usage
F14	Auxiliary Power
F15	Outside Rearview Mirrors
F16	Sunroof/Automatic Transmission Shift Lock
F17	Sunroof
F18	Automatic Occupant Sensor
F19	Driver Side Heated Seat
F20	Passenger Side Heated Seat
F21	Daytime Running Lamps
F22	Front Cigarette Lighter
F23	Steering Wheel Controls Backlighting
F24	Power Window
FUSE PULLER	Fuse Puller

Circuit Breakers	Usage
B1	Spare
B2	Power Windows
B3	Power Seats
B4	Spare

Relays	Usage
R1	Retain Accessory Power 1
R2	Door Locks
R3	Passenger Side Door Lock
R4	Spare
R5	Trunk Release
R6	Driver Side Lock
R7	Retain Accessory Power 2
R8	Accessory
R9	Blower
R10	Spare
R11	Daytime Running Lamps
R12	Fuel Pump

Engine Compartment Fuse Block

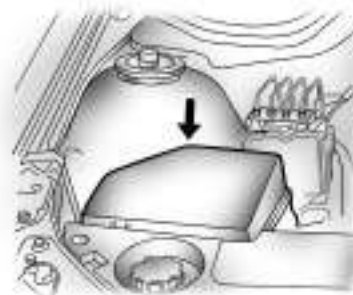

To open the fuse block cover, remove the clip on cover.

Notice: Spilling liquid on any electrical components on the vehicle may damage it. Always keep the covers on any electrical component.

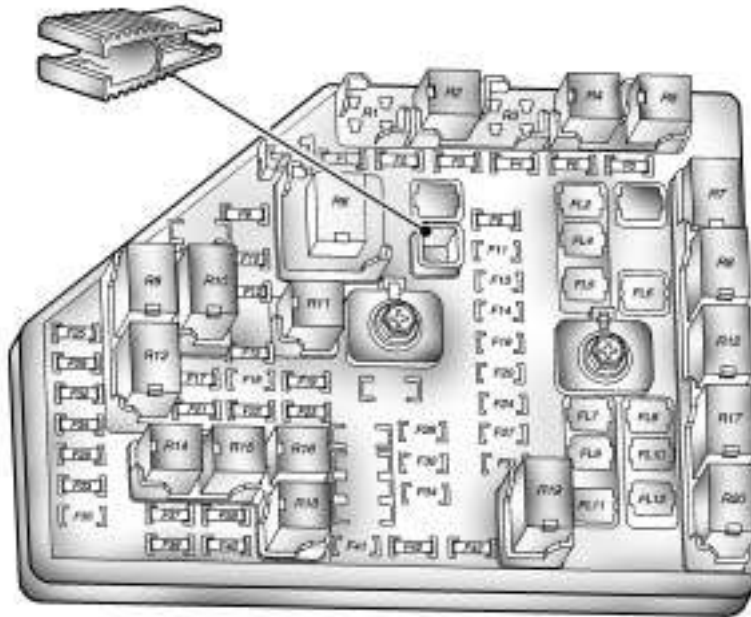

Engine Compartment Fuse Block - Fuse Puller Shown

Fuses	Usage
FL1	Spare
FL2	Rear Defog
FL3	ABS Motor
FL4	Battery Main 3
FL5	Battery Main 1
FL6	Spare
FL7	Battery Main 2
FL8	Starter
FL9	HVAC Blower Motor
FL10	Fan 1 Engine Cooling (Right)
FL11	Spare
FL12	Fan 2 Engine Cooling (Left)
F1	Comm Enable
F2	HVAC Battery
F3	Back-up Lamp
F4	Fog Lamps (Front)
F5	ABS Valves
F6	Spare
F8	Horn
F9	Transmission Control Module

9-40 Vehicle Service and Care

Fuses	Usage
F10	Driver Side Low-Beam Headlamp
F11	Spare
F12	Passenger Side Low-Beam Headlamp
F13	Spare
F14	Spare
F15	Front Wiper
F16	Spare
F17	Theft Horn
F18	Spare
F19	Passenger Side High-Beam Headlamp
F20	Spare
F21	Windshield Washer
F22	Canister Vent Solenoid
F23	Driver Side High-Beam Headlamp
F24	Spare
F25	Reverse Lockout
F26	Spare

Fuses	Usage
F27	Spare
F28	Engine Control Module 1
F29	Even Coils/Injectors
F30	Spare
F31	Spare
F32	Emission 2
F33	Emission 1
F34	Spare
F35	Odd Coils/Injectors
F36	Spare
F37	HVAC Ignition
F38	Heated Seats/ OnStar® Ignition
F39	Engine Ignition
F40	Airbags
F41	Spare
F42	Passenger Side Park Lamp
F43	Driver Side Park Lamp
FUSE PULLER	Fuse Puller

Relays	Usage
R1	Spare
R2	Comm Enable
R3	Spare
R4	Back-up Lamps
R5	Fog Lamp
R6	Low-Beam Headlamps
R7	Spare
R8	Defogger
R9	Windshield Wiper High
R10	Windshield Wiper Low
R11	High-Beam Headlamps
R12	Crank
R13	Powertrain
R14	Ignition Main
R15	Windshield Wiper
R16	Horn
R17	Fan 1 (Engine Cooling)
R18	Parking Lamps
R19	Fan 2 (Engine Cooling)
R20	Fan 3 (Engine Cooling)

Rear Compartment Fuse Block

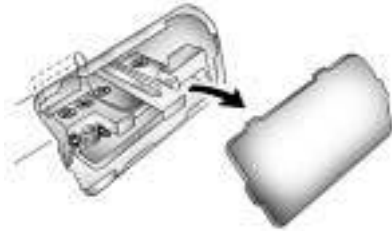

The rear compartment fuse block is located on the left side of the trunk behind a cover.

Use the fuse puller, to remove and replace fuses.



Fuses	Usage
F1	Spare
F2	Amplifier
F3	XM Radio™
F4	Radio
F5	Instrument/Display/ Remote Function Actuator/Data Link Connection

Fuses	Usage
F6	Spare
F7	Trailer
F8	OnStar™
F9	Spare
F10	ECM Battery
F11	Regulated Voltage Control Sensor
F12	Fuel Pump

Relays	Usage
R1	Spare
R2	Spare

Tires

Your new vehicle comes with high-quality tires made by a leading tire manufacturer. If you ever have questions about your tire warranty and where to obtain service, see your vehicle Warranty booklet for details.

CAUTION

Poorly maintained and improperly used tires are dangerous.

- Overloading your vehicle's tires can cause overheating as a result of too much flexing. You could have an air-out and a serious accident. See *Loading the Vehicle on page 8-30*.

(Continued)

CAUTION (Continued)

- Underinflated tires pose the same danger as overloaded tires. The resulting accident could cause serious injury. Check all tires frequently to maintain the recommended pressure. Tire pressure should be checked when your vehicle's tires are cold. See *Inflation - Tire Pressure on page 9-49*.
- Overinflated tires are more likely to be cut, punctured, or broken by a sudden impact — such as when you hit a pothole. Keep tires at the recommended pressure.

(Continued)

CAUTION (Continued)

- Worn, old tires can cause accidents. If the tire's tread is badly worn, or if your vehicle's tires have been damaged, replace them.

Tire Sidewall Labeling

Useful information about a tire is molded into its sidewall. The examples show a typical passenger vehicle tire and a compact spare tire sidewall.

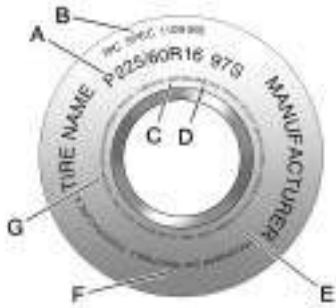

Passenger (P-Metric) Tire Example

(A) Tire Size: The tire size is a combination of letters and numbers used to define a particular tire's width, height, aspect ratio, construction type, and service description. See the "Tire Size" illustration later in this section for more detail.

(B) TPC Spec (Tire Performance Criteria Specification): Original equipment tires designed to GM's specific tire performance criteria have a TPC specification code molded onto the sidewall. GM's TPC specifications meet or exceed all federal safety guidelines.

(C) DOT (Department of Transportation): The Department of Transportation (DOT) code indicates that the tire is in compliance with the U.S. Department of Transportation Motor Vehicle Safety Standards.

(D) Tire Identification Number (TIN): The letters and numbers following DOT (Department of Transportation) code is the Tire Identification Number (TIN). The TIN shows the manufacturer and plant code, tire size, and date the tire was manufactured.

The TIN is molded onto both sides of the tire, although only one side may have the date of manufacture.

(E) Tire Ply Material: The type of cord and number of plies in the sidewall and under the tread.

(F) Uniform Tire Quality Grading (UTQG): Tire manufacturers are required to grade tires based on three performance factors: treadwear, traction, and temperature resistance. For more information see *Uniform Tire Quality Grading on page 9-62*.

(G) Maximum Cold Inflation Load Limit: Maximum load that can be carried and the maximum pressure needed to support that load.

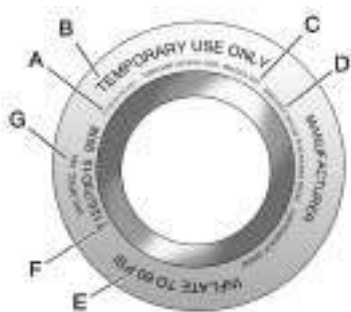

Compact Spare Tire Example

(A) Temporary Use Only: The compact spare tire or temporary use tire has a tread life of approximately 3,000 miles (5 000 km) and should not be driven at speeds over 65 mph (105 km/h). The compact spare tire is for emergency use when a regular road tire has lost air and gone flat. If your vehicle has a compact spare tire.

See *Compact Spare Tire* on page 9-83 and *If a Tire Goes Flat* on page 9-66.

(B) Tire Ply Material: The type of cord and number of plies in the sidewall and under the tread.

(C) Tire Identification Number (TIN): The letters and numbers following the DOT (Department of Transportation) code is the Tire Identification Number (TIN). The TIN shows the manufacturer and plant code, tire size, and date the tire was manufactured. The TIN is molded onto both sides of the tire, although only one side may have the date of manufacture.

(D) Maximum Cold Inflation Load Limit: Maximum load that can be carried and the maximum pressure needed to support that load.

(E) Tire Inflation: The temporary use tire or compact spare tire should be inflated to 60 psi (420 kPa). For more information on tire pressure and inflation see *Inflation - Tire Pressure* on page 9-49.

(F) Tire Size : A combination of letters and numbers define a tire's width, height, aspect ratio, construction type, and service description. The letter T as the first character in the tire size means the tire is for temporary use only.

(G) TPC Spec (Tire Performance Criteria Specification): Original equipment tires designed to GM's specific tire performance criteria have a TPC specification code molded onto the sidewall. GM's TPC specifications meet or exceed all federal safety guidelines.

Tire Size

The following illustration shows an example of a typical passenger vehicle tire size.

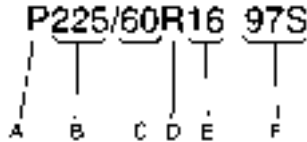

(A) Passenger (P-Metric) Tire: The United States version of a metric tire sizing system. The letter P as the first character in the tire size means a passenger vehicle tire engineered to standards set by the U.S. Tire and Rim Association.

(B) Tire Width: The three-digit number indicates the tire section width in millimeters from sidewall to sidewall.

(C) Aspect Ratio: A two-digit number that indicates the tire height-to-width measurements. For example, if the tire size aspect ratio is 60, as shown in item C of the illustration, it would mean that the tire's sidewall is 60 percent as high as it is wide.

(D) Construction Code: A letter code is used to indicate the type of ply construction in the tire. The letter R means radial ply construction; the letter D means diagonal or bias ply construction; and the letter B means belted-bias ply construction.

(E) Rim Diameter: Diameter of the wheel in inches.

(F) Service Description: These characters represent the load range and speed rating of the tire. The load index represents the load carry capacity a tire is certified to carry. The load index can range from 1 to 279. The speed rating is the maximum speed a tire is certified to carry a load. Speed ratings range from A to Z.

Tire Terminology and Definitions

Air Pressure: The amount of air inside the tire pressing outward on each square inch of the tire. Air pressure is expressed in pounds per square inch (psi) or kilopascal (kPa).

Accessory Weight: This means the combined weight of optional accessories. Some examples of optional accessories are, automatic transmission, power steering, power brakes, power windows, power seats, and air conditioning.

Aspect Ratio: The relationship of a tire's height to its width.

Belt: A rubber coated layer of cords that is located between the plies and the tread. Cords may be made from steel or other reinforcing materials.

Bead: The tire bead contains steel wires wrapped by steel cords that hold the tire onto the rim.

Bias Ply Tire: A pneumatic tire in which the plies are laid at alternate angles less than 90 degrees to the centerline of the tread.

Cold Tire Pressure: The amount of air pressure in a tire, measured in pounds per square inch (psi) or kilopascals (kPa) before a tire has built up heat from driving. See *Inflation - Tire Pressure on page 9-49*.

Curb Weight: The weight of a motor vehicle with standard and optional equipment including the maximum capacity of fuel, oil, and coolant, but without passengers and cargo.

DOT Markings: A code molded into the sidewall of a tire signifying that the tire is in compliance with the U.S. Department of Transportation (DOT) motor vehicle safety standards. The DOT code includes the Tire Identification Number (TIN), an alphanumeric designator which can also identify the tire manufacturer, production plant, brand, and date of production.

GVWR: Gross Vehicle Weight Rating. See *Loading the Vehicle on page 8-30*.

GAWR FRT: Gross Axle Weight Rating for the front axle. See *Loading the Vehicle on page 8-30*.

GAWR RR: Gross Axle Weight Rating for the rear axle. See *Loading the Vehicle on page 8-30*.

Intended Outboard Sidewall: The side of an asymmetrical tire, that must always face outward when mounted on a vehicle.

Kilopascal (kPa): The metric unit for air pressure.

Light Truck (LT-Metric) Tire: A tire used on light duty trucks and some multipurpose passenger vehicles.

Load Index: An assigned number ranging from 1 to 279 that corresponds to the load carrying capacity of a tire.

Maximum Inflation

Pressure: The maximum air pressure to which a cold tire can be inflated. The maximum air pressure is molded onto the sidewall.

Maximum Load Rating:

The load rating for a tire at the maximum permissible inflation pressure for that tire.

Maximum Loaded Vehicle

Weight: The sum of curb weight, accessory weight, vehicle capacity weight, and production options weight.

Normal Occupant Weight:

The number of occupants a vehicle is designed to seat multiplied by 150 lbs (68 kg). See *Loading the Vehicle on page 8-30*.

Occupant Distribution:

Designated seating positions.

Outward Facing Sidewall:

The side of an asymmetrical tire that has a particular side that faces outward when mounted on a vehicle. The side of the tire that contains a whitewall, bears white lettering, or bears manufacturer, brand, and/or model name molding that is higher or deeper than the same moldings on the other sidewall of the tire.

Passenger (P-Metric) Tire:

A tire used on passenger cars and some light duty trucks and multipurpose vehicles.

Recommended Inflation

Pressure: Vehicle manufacturer's recommended tire inflation pressure as shown on the tire placard. See *Inflation - Tire Pressure on page 9-49* and *Loading the Vehicle on page 8-30*.

Radial Ply Tire: A pneumatic tire in which the ply cords that extend to the beads are laid at 90 degrees to the centerline of the tread.

Rim: A metal support for a tire and upon which the tire beads are seated.

Sidewall: The portion of a tire between the tread and the bead.

Speed Rating: An alphanumeric code assigned to a tire indicating the maximum speed at which a tire can operate.

Traction: The friction between the tire and the road surface. The amount of grip provided.

Tread: The portion of a tire that comes into contact with the road.

Treadwear Indicators: Narrow bands, sometimes called wear bars, that show across the tread of a tire when only 1/16 inch (1.6 mm) of tread remains. See *When It Is Time for New Tires* on page 9-59.

UTQGS (Uniform Tire Quality Grading Standards): A tire information system that provides consumers with ratings for a tire's traction, temperature, and treadwear. Ratings are determined by tire manufacturers using government testing procedures. The ratings are molded into the sidewall of the tire. See *Uniform Tire Quality Grading* on page 9-62.

Vehicle Capacity Weight: The number of designated seating positions multiplied by 150 lbs (68 kg) plus the rated cargo load. See *Loading the Vehicle* on page 8-30.

Vehicle Maximum Load on the Tire: Load on an individual tire due to curb weight, accessory weight, occupant weight, and cargo weight.

Vehicle Placard: A label permanently attached to a vehicle showing the vehicle's capacity weight and the original equipment tire size and recommended inflation pressure. See "Tire and Loading Information Label" under *Loading the Vehicle* on page 8-30.

Inflation - Tire Pressure

Tires need the correct amount of air pressure to operate effectively.

Notice: Do not let anyone tell you that under-inflation or over-inflation is all right. It is not. If your tires do not have enough air (under-inflation), you can get the following:

- Too much flexing
- Too much heat
- Tire overloading
- Premature or irregular wear
- Poor handling
- Reduced fuel economy

If your tires have too much air (over-inflation), you can get the following:

- Unusual wear
- Poor handling
- Rough ride
- Needless damage from road hazards

A vehicle specific Tire and Loading Information label is attached to the vehicle's center pillar, below the driver's door latch. This label lists the vehicle's original equipment tires and the recommended cold tire inflation pressure for the tires when they are cold. The recommended cold tire inflation pressure, shown on the label,

is the minimum amount of air pressure needed to support your vehicle's maximum load carrying capacity. For more information regarding how much weight your vehicle can carry, see *Loading the Vehicle on page 8-30*.

How you load your vehicle affects vehicle handling and ride comfort. When driving with less than the maximum load capacity allowed for your vehicle, you can set tire inflation pressure to the recommended amounts shown in the following chart. Never load your vehicle with more weight than it was designed to carry.

9-50 Vehicle Service and Care

Tire Size	Recommended Cold Tire Inflation			
	Occupant and Cargo Weight: 573 lbs (260 kg) or Less		Occupant and Cargo Weight: Up to 917 lbs (416 kg) (Vehicle Capacity Weight)	
	Front Tires	Rear Tires	Front Tires	Rear Tires
P245/45R18 96V	33 psi (230 kPa)	33 psi (230 kPa)	36 psi (250 kPa)	39 psi (270 kPa)
245/45R18 96V	36 psi (250 kPa)	36 psi (250 kPa)	36 psi (250 kPa)	39 psi (270 kPa)
245/40R19 94W	36 psi (250 kPa)	36 psi (250 kPa)	36 psi (250 kPa)	39 psi (270 kPa)
T155/80R17 111M (Compact Spare)	60 psi (420 kPa)	60 psi (420 kPa)	60 psi (420 kPa)	60 psi (420 kPa)

When to Check

Check your tires once a month or more.

Do not forget the compact spare tire, if your vehicle has one. It should be at 60 psi (420 kPa). For more information about the vehicle's compact spare tire, see *Compact Spare Tire* on page 9-83.

How to Check

Use a good quality pocket-type gage to check tire pressure. You can't tell if your tires are properly inflated simply by looking at them. Radial tires may look properly inflated even when they're underinflated. Check the tire's inflation pressure when the tires are cold. Cold means your vehicle has been sitting for at least three hours or driven no more than 1 mile (1.6 km).

Remove the valve cap from the tire valve stem. Press the tire gage firmly onto the valve to get a pressure measurement. If the cold tire inflation pressure matches the recommended pressure on the Tire and Loading Information label, no further adjustment is necessary. If the inflation pressure is low, add air until you reach the recommended amount.

If you overfill the tire, release air by pushing on the metal stem in the center of the tire valve. Recheck the tire pressure with the tire gage.

Be sure to put the valve caps back on the valve stems. They help prevent leaks by keeping out dirt and moisture.

High-Speed Operation

CAUTION

Driving at high speeds, 100 mph (160 km/h) or higher, puts an additional strain on tires. Sustained high-speed driving causes excessive heat build up and can cause sudden tire failure. You could have a crash and you or others could be killed. Some high-speed rated tires require inflation pressure adjustment for high speed operation. When speed limits and road conditions are such that a vehicle can be driven at high speeds, make sure the tires are rated for high speed operation, in excellent condition, and set to the correct cold tire inflation pressure for the vehicle load.

Vehicles with P245/45R18 96V, 245/45R18 96V, or 245/40R19 94W size tires, require inflation pressure adjustment when driving the vehicle at speeds of 100 mph (160 km/h) or higher. Use the following chart to determine the cold tire inflation pressure when operating the vehicle under high-speed conditions.

9-52 Vehicle Service and Care

Tire Size	Recommended Cold Tire Inflation			
	Occupant and Cargo Weight: 573 lbs (260 kg) or Less		Occupant and Cargo Weight: Up to 917 lbs (416 kg) (Vehicle Capacity Weight)	
	Front Tires	Rear Tires	Front Tires	Rear Tires
P245/45R18 96V	35 psi (240 kPa)	35 psi (240 kPa)	39 psi (270 kPa)	44 psi (300 kPa)
245/45R18 96V	36 psi (250 kPa)	36 psi (250 kPa)	39 psi (270 kPa)	44 psi (300 kPa)
245/40R19 94W	36 psi (250 kPa)	36 psi (250 kPa)	39 psi (270 kPa)	44 psi (300 kPa)

When you end this high-speed driving, return the tires to the cold tire inflation pressure shown on the Tire and Loading Information label. See *Loading the Vehicle on page 8-30* and *Inflation - Tire Pressure on page 9-49*.

Tire Pressure Monitor System

The Tire Pressure Monitor System (TPMS) uses radio and sensor technology to check tire pressure levels. The TPMS sensors monitor the air pressure in your vehicle's tires and transmit tire pressure readings to a receiver located in the vehicle.

Each tire, including the spare (if provided), should be checked monthly when cold and inflated to the inflation pressure recommended by the vehicle manufacturer on the vehicle placard or tire inflation pressure label. (If your vehicle has

tires of a different size than the size indicated on the vehicle placard or tire inflation pressure label, you should determine the proper tire inflation pressure for those tires.)

As an added safety feature, your vehicle has been equipped with a tire pressure monitoring system (TPMS) that illuminates a low tire pressure telltale when one or more of your tires is significantly under-inflated.

Accordingly, when the low tire pressure telltale illuminates, you should stop and check your tires as soon as possible, and inflate them to the proper pressure. Driving on a significantly under-inflated tire causes the tire to overheat and can lead to tire failure. Under-inflation also reduces fuel efficiency and tire tread life, and may affect the vehicle's handling and stopping ability.

Please note that the TPMS is not a substitute for proper tire maintenance, and it is the driver's responsibility to maintain correct tire pressure, even if under-inflation has not reached the level to trigger illumination of the TPMS low tire pressure telltale.

Your vehicle has also been equipped with a TPMS malfunction indicator to indicate when the system is not operating properly. The TPMS malfunction indicator is combined with the low tire pressure telltale. When the system detects a malfunction, the telltale

will flash for approximately one minute and then remain continuously illuminated. This sequence will continue upon subsequent vehicle start-ups as long as the malfunction exists.

When the malfunction indicator is illuminated, the system may not be able to detect or signal low tire pressure as intended. TPMS malfunctions may occur for a variety of reasons, including the installation of replacement or alternate tires or wheels on the vehicle that prevent the TPMS from functioning properly. Always check the TPMS malfunction telltale after replacing one or more tires or wheels on your vehicle to ensure that the replacement or alternate tires and wheels allow the TPMS to continue to function properly.

See *Tire Pressure Monitor Operation* on page 9-54 for additional information.

Federal Communications Commission (FCC) and Industry and Science Canada

The Tire Pressure Monitor System (TPMS) operates on a radio frequency and complies with Part 15 of the FCC Rules. Operation is subject to the following two conditions:

1. This device may not cause harmful interference.
2. This device must accept any interference received, including interference that may cause undesired operation.

The TPMS operates on a radio frequency and complies with RSS-210 of Industry and Science Canada. Operation is subject to the following two conditions:

1. This device may not cause interference.
2. This device must accept any interference received, including interference that may cause undesired operation of the device.

Changes or modifications to this system by other than an authorized service facility could void authorization to use this equipment.

Tire Pressure Monitor Operation

The Tire Pressure Monitor System (TPMS) is designed to warn the driver when a low tire pressure condition exists. TPMS sensors are mounted onto each tire and wheel assembly, excluding the spare tire and wheel assembly. The TPMS sensors monitor the air pressure in the vehicle's tires and transmit the tire pressure readings to a receiver located in the vehicle.

When a low tire pressure condition is detected, the TPMS turns on the  low tire pressure warning light.

At the same time a message to check the pressure in a specific tire appears on the Driver Information Center (DIC) display. The low tire pressure warning light and the DIC warning message come on at each ignition cycle until the tires are inflated to the correct inflation pressure. Using the DIC, tire pressure levels can be viewed by

the driver. For additional information and details about the DIC operation and displays see *DIC Operation and Displays on page 4-22* and *DIC Warnings and Messages on page 4-26*.

The low tire pressure warning light may come on in cool weather when the vehicle is first started, and then turn off as you start to drive. This could be an early indicator that the air pressure in the tire(s) are getting low and need to be inflated to the proper pressure.

A Tire and Loading Information label shows the size of the vehicle's original equipment tires and the correct inflation pressure for the vehicle's tires when they are cold. See *Loading the Vehicle on page 8-30*, for an example of the Tire and Loading Information label and its location on the vehicle. Also see *Inflation - Tire Pressure on page 9-49*.

The vehicle's TPMS system can warn about a low tire pressure condition but it does not replace normal tire maintenance. See *Tire Inspection and Rotation on page 9-57* and *Tires on page 9-42*.

Notice: Using non-approved tire sealants could damage the Tire Pressure Monitor System (TPMS) sensors. TPMS sensor damage caused by using an incorrect tire sealant is not covered by the vehicle warranty. Always use the GM approved tire sealant available through your dealer/retailer.

TPMS Malfunction Light and Message

The TPMS will not function properly if one or more of the TPMS sensors are missing or not operating.

When the system detects a malfunction, the  low tire warning light flashes for about one minute and then stays on for the remainder

of the ignition cycle. A DIC warning message also displays. The low tire warning light and DIC warning message come on at each ignition cycle until the problem is corrected. Some of the conditions that can cause the malfunction light and DIC message to come on are:

- One of the road tires has been replaced with the spare tire. The spare tire does not have a TPMS sensor. The TPMS malfunction light and DIC message should go off once the road tire containing the TPMS sensor is re-installed.
- The TPMS sensor matching process was started but not completed or not completed successfully after installing replacement tires or rotating the vehicle's tires. The DIC message and TPMS malfunction light should go off once the TPMS sensor matching process is performed successfully.

- One or more TPMS sensors are missing or damaged. The DIC message and the TPMS malfunction light should go off when the TPMS sensors are installed and the sensor matching process is performed successfully. See the dealer/retailer for service.
- Replacement tires or wheels do not match the vehicle's original equipment tires or wheels. Tires and wheels other than those recommended for the vehicle could prevent the TPMS from functioning properly. See *Buying New Tires on page 9-59*.
- Operating electronic devices or being near facilities using radio wave frequencies similar to the TPMS could cause the TPMS sensors to malfunction.

If the TPMS is not functioning it cannot detect or signal a low tire condition. See the dealer/retailer for service if the TPMS malfunction light and DIC message comes on and stays on.

TPMS Sensor Matching Process

Each TPMS sensor has a unique identification code. Any time one or more of the TPMS sensors are replaced or the vehicle's tires are rotated, the identification codes need to be matched to the new tire/wheel location. The sensors are matched, to the tire/wheel locations, in the following order: driver side front tire, passenger side front tire, passenger side rear tire, and driver side rear tire using a TPMS diagnostic tool. See your dealer/retailer for service.

The TPMS sensors can also be matched to each tire/wheel position by increasing or decreasing the tire's air pressure. When increasing the tire's pressure, do not exceed the maximum inflation pressure indicated on the tire's sidewall. To decrease the tire's air-pressure use the pointed end of the valve cap, a pencil-style air pressure gage, or a key.

You have two minutes to match each tire and wheel position. If it takes longer than two minutes to match any tire and wheel position, the matching process stops and you need to start over.

The TPMS matching process is outlined below:

1. Set the parking brake.
2. Turn the ignition switch to ON/RUN with the engine off.
3. Press and hold the Remote Keyless Entry (RKE) transmitter's lock and unlock buttons, at the same time, for about five seconds

to start the TPMS learn mode. The horn chirps two times indicating the TPMS receiver is ready and in learn mode.

4. Start with the driver side front tire. The driver side front indicator lamp also comes on to indicate that corner's sensor is ready to be learned.
5. Remove the valve cap from the tire's valve stem. Activate the TPMS sensor by increasing or decreasing the tire's air pressure for about eight seconds. The horn chirps one time to confirm the sensor identification code has been matched to the tire/wheel position.

6. The driver side front indicator lamp turns off and the passenger side front indicator lamp comes on to indicate that corner's sensor is ready to be learned. Proceed to the passenger side front tire and repeat the procedure in Step 5.
7. The passenger side front indicator lamp turns off and the passenger side rear indicator lamp comes on to indicate that corner's sensor is ready to be learned. Proceed to the passenger side rear tire and repeat the procedure in Step 5.
8. The passenger side rear indicator lamp turns off and the driver side rear indicator lamp comes on to indicate that corner's sensor is ready to be learned. Proceed to the driver side rear tire, and repeat the procedure in Step 5.
9. After the driver side rear TPMS sensor has been learned the horn chirps two times. The driver side rear indicator lamp turns off and the TPMS sensor matching process is done. Turn the ignition switch to LOCK/OFF. If no tires are learned after entering the TPMS learn mode, or if communication with the receiver stops, or if the time limit has expired, turn the ignition switch to LOCK/OFF and start over beginning with Step 2.
10. Set all four tires to the recommended air pressure level as indicated on the Tire and Loading Information label.
11. Put the valve caps back on the valve stems.

Tire Inspection and Rotation

We recommend that you regularly inspect the vehicle's tires, including the spare tire, for signs of wear or damage. See *When It Is Time for New Tires on page 9-59* for more information.

Tires should be rotated every 5,000 to 8,000 miles (8 000 to 13 000 km). See *Scheduled Maintenance on page 11-4*.

The purpose of a regular tire rotation is to achieve a uniform wear for all tires on the vehicle. This will ensure that your vehicle continues to perform most like it did when the tires were new.

9-58 Vehicle Service and Care

Any time you notice unusual wear, rotate the tires as soon as possible and check wheel alignment. Also check for damaged tires or wheels. See *When It Is Time for New Tires on page 9-59* and *Wheel Replacement on page 9-64*.

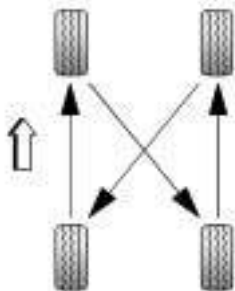

When rotating the vehicle's tires, always use the correct rotation pattern shown here.

The compact spare tire, if the vehicle has one, is not included in the tire rotation.

After the tires have been rotated, adjust the front and rear inflation pressures as shown on the Tire and Loading Information label. See *Inflation - Tire Pressure on page 9-49* and *Loading the Vehicle on page 8-30*.

Reset the Tire Pressure Monitor System. See *Tire Pressure Monitor Operation on page 9-54*.

Make certain that all wheel nuts are properly tightened. See "Wheel Nut Torque" under *Capacities and Specifications on page 10-2*.

CAUTION

Rust or dirt on a wheel, or on the parts to which it is fastened, can make wheel nuts become loose after time. The wheel could come off and cause an accident. When you change a wheel, remove any rust or dirt from places where the wheel attaches to the vehicle. In an emergency, you can use a cloth or a paper towel to do this; but be sure to use a scraper or wire brush later, if needed, to get all the rust or dirt off. See *Changing a Flat Tire on page 9-75*.

When It Is Time for New Tires

Various factors, such as maintenance, temperatures, driving speeds, vehicle loading, and road conditions influence when you need new tires.

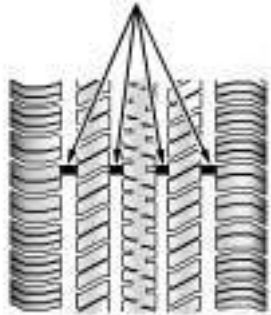

One way to tell when it is time for new tires is to check the treadwear indicators, which will appear when the tires have only 1/16 inch (1.6 mm) or less of tread remaining.

You need new tires if any of the following statements are true:

- You can see the indicators at three or more places around the tire.
- You can see cord or fabric showing through the tire's rubber.
- The tread or sidewall is cracked, cut, or snagged deep enough to show cord or fabric.
- The tire has a bump, bulge, or split.
- The tire has a puncture, cut, or other damage that cannot be repaired well because of the size or location of the damage.

The rubber in tires degrades over time, even if they are not being used. This is also true for the spare tire, if the vehicle has one. Multiple conditions affect how fast this aging takes place, including temperatures, loading conditions, and inflation pressure maintenance. With proper care and maintenance tires typically wear out before

they degrade due to age. If you are unsure about the need to replace the tires as they get older, consult the tire manufacturer for more information.

Buying New Tires

GM has developed and matched specific tires for your vehicle. The original equipment tires installed on your vehicle, when it was new, were designed to meet General Motors Tire Performance Criteria Specification (TPC Spec) system rating. If you need replacement tires, GM strongly recommends that you get tires with the same TPC Spec rating. This way, your vehicle will continue to have tires that are designed to give the same performance and vehicle safety, during normal use, as the original tires.

9-60 Vehicle Service and Care

GM's exclusive TPC Spec system considers over a dozen critical specifications that impact the overall performance of your vehicle, including brake system performance, ride and handling, traction control, and tire pressure monitoring performance. GM's TPC Spec number is molded onto the tire's sidewall near the tire size. If the tires have an all-season tread design, the TPC Spec number will be followed by an MS for mud and snow. See *Tire Sidewall Labeling on page 9-42* for additional information.

GM recommends replacing tires in sets of four. This is because uniform tread depth on all tires will help keep your vehicle performing most like it did when the tires were new. Replacing less than a full set of tires can affect the braking and handling performance of your vehicle. See *Tire Inspection and Rotation on page 9-57* for information on proper tire rotation.

CAUTION

Mixing tires could cause you to lose control while driving. If you mix tires of different sizes, brands, or types (radial and bias-belted tires), the vehicle may not handle properly, and you could have a crash. Using tires of different sizes, brands, or types may also cause damage to the vehicle. Be sure to use the correct size, brand, and type of tires on all wheels. It is all right to drive with the compact spare temporarily, as it was developed for use on the vehicle. See *Compact Spare Tire on page 9-83*.

CAUTION

If you use bias-ply tires on the vehicle, the wheel rim flanges could develop cracks after many miles of driving. A tire and/or wheel could fail suddenly, causing a crash. Use only radial-ply tires with the wheels on the vehicle.

If you must replace your vehicle's tires with those that do not have a TPC Spec number, make sure they are the same size, load range, speed rating, and construction type (radial and bias-belted tires) as your vehicle's original tires.

Vehicles that have a tire pressure monitoring system could give an inaccurate low-pressure warning if non-TPC Spec rated tires are installed on your vehicle. Non-TPC Spec rated tires may give a low-pressure warning that is higher or lower than the proper warning level you would get with TPC Spec rated tires. See *Tire Pressure Monitor System* on page 9-52.

Your vehicle's original equipment tires are listed on the Tire and Loading Information Label. See *Loading the Vehicle* on page 8-30, for more information about the Tire and Loading Information Label and its location on your vehicle.

Different Size Tires and Wheels

If you add wheels or tires that are a different size than your original equipment wheels and tires, this may affect the way your vehicle performs, including its braking, ride and handling characteristics, stability, and resistance to rollover. Additionally, if your vehicle has electronic systems such as, antilock brakes, traction control, and electronic stability control, the performance of these systems can be affected.

CAUTION

If you add different sized wheels, your vehicle may not provide an acceptable level of performance and safety if tires not recommended for those wheels are selected. You may increase the chance that you will crash and suffer serious injury. Only use GM specific wheel and tire systems developed for your vehicle, and have them properly installed by a GM certified technician.

See *Buying New Tires* on page 9-59 and *Accessories and Modifications* on page 9-3 for additional information.

Uniform Tire Quality Grading

Quality grades can be found where applicable on the tire sidewall between tread shoulder and maximum section width. For example:

Treadwear 200 Traction AA Temperature A

The following information relates to the system developed by the United States National Highway Traffic Safety Administration (NHTSA), which grades tires by treadwear, traction, and temperature performance. This applies only to vehicles sold in the United States. The grades are molded on the sidewalls of

most passenger car tires. The Uniform Tire Quality Grading (UTQG) system does not apply to deep tread, winter-type snow tires, space-saver, or temporary use spare tires, tires with nominal rim diameters of 10 to 12 inches (25 to 30 cm), or to some limited-production tires.

While the tires available on General Motors passenger cars and light trucks may vary with respect to these grades, they must also conform to federal safety requirements and additional General Motors Tire Performance Criteria (TPC) standards.

Treadwear

The treadwear grade is a comparative rating based on the wear rate of the tire when tested under controlled conditions on a specified government test course. For example, a tire graded 150 would wear one and a half (1.5) times as well on the government course as a tire graded 100. The relative performance of tires depends upon the actual conditions of their use, however, and may depart significantly from the norm due to variations in driving habits, service practices, and differences in road characteristics and climate.

Traction – AA, A, B, C

The traction grades, from highest to lowest, are AA, A, B, and C. Those grades represent the tire's ability to stop on wet pavement as measured under controlled conditions on specified government test surfaces of asphalt and concrete. A tire marked C may have poor traction performance.

 **WARNING**

The traction grade assigned to this tire is based on straight-ahead braking traction tests, and does not include acceleration, cornering, hydroplaning, or peak traction characteristics.

Temperature – A, B, C

The temperature grades are A (the highest), B, and C, representing the tire's resistance to the generation of heat and its ability to dissipate heat when tested under controlled conditions on a specified indoor laboratory test wheel. Sustained high temperature can cause the material of the tire to degenerate and reduce tire life, and excessive temperature can lead to sudden tire failure. The grade C corresponds to a level of performance which all passenger car tires must meet under the Federal Motor Vehicle Safety Standard No. 109. Grades B and A represent higher levels of performance on the laboratory test wheel than the minimum required by law.

 **WARNING**

The temperature grade for this tire is established for a tire that is properly inflated and not overloaded. Excessive speed, underinflation, or excessive loading, either separately or in combination, can cause heat buildup and possible tire failure.

Wheel Alignment and Tire Balance

The tires and wheels on your vehicle were aligned and balanced carefully at the factory to give you the longest tire life and best overall performance. Adjustments to wheel alignment and tire balancing will not be necessary on a regular basis. However, if you notice unusual tire wear or your vehicle pulling to one side or the other, the alignment might need to be checked. If you notice your vehicle vibrating when driving on a smooth road, the tires and wheels might need to be rebalanced. See your dealer/retailer for proper diagnosis.

Wheel Replacement

Replace any wheel that is bent, cracked or badly rusted or corroded. If wheel nuts keep coming loose, the wheel, wheel bolts and wheel nuts should be replaced. If the wheel leaks air, replace it (except some aluminum wheels, which can sometimes be repaired). See your dealer/retailer if any of these conditions exist.

Your dealer/retailer will know the kind of wheel you need.

Each new wheel should have the same load-carrying capacity, diameter, width, offset and be mounted the same way as the one it replaces.

If you need to replace any of the wheels, wheel bolts or wheel nuts, replace them only with new GM original equipment parts. This way, you will be sure to have the right wheel, wheel bolts and wheel nuts for the vehicle.



Using the wrong replacement wheels, wheel bolts, or wheel nuts on your vehicle can be dangerous. It could affect the braking and handling of your vehicle, make your tires lose air and make you lose control. You could have a collision in which you or others could be injured. Always use the correct wheel, wheel bolts, and wheel nuts for replacement.

Notice: The wrong wheel can also cause problems with bearing life, brake cooling, speedometer or odometer calibration, headlamp aim, bumper height, vehicle ground clearance, and tire or tire chain clearance to the body and chassis.

See *Changing a Flat Tire* on page 9-75 for more information.

Used Replacement Wheels

 **CAUTION**

Putting a used wheel on the vehicle is dangerous. You cannot know how it has been used or how far it has been driven. It could fail suddenly and cause a crash. If you have to replace a wheel, use a new GM original equipment wheel.

Tire Chains

 **CAUTION**

Do not use tire chains. There is not enough clearance. Tire chains used on a vehicle without the proper amount of clearance can cause damage to the brakes, suspension or other vehicle parts. The area damaged by the tire chains could cause you to lose control of the vehicle and you or others may be injured in a crash.

(Continued)

CAUTION (Continued)

Use another type of traction device only if its manufacturer recommends it for use on the vehicle and tire size combination and road conditions. Follow that manufacturer's instructions. To help avoid damage to the vehicle, drive slowly, readjust or remove the device if it is contacting the vehicle, and do not spin the vehicle's wheels. If you do find traction devices that will fit, install them on the front tires.

Tire Changing

If a Tire Goes Flat

It is unusual for a tire to blowout while you are driving, especially if you maintain your tires properly. See *Tires on page 9-42*. If air goes out of a tire, it is much more likely to leak out slowly. But if you should ever have a blowout, here are a few tips about what to expect and what to do:

If a front tire fails, the flat tire will create a drag that pulls the vehicle toward that side. Take your foot off the accelerator pedal and grip the steering wheel firmly. Steer to maintain lane position, and then gently brake to a stop well out of the traffic lane.

A rear blowout, particularly on a curve, acts much like a skid and may require the same correction you would use in a skid. In any rear blowout, remove your foot from the accelerator pedal. Get the vehicle under control by steering the way you want the vehicle to go. It may be very bumpy and noisy, but you can still steer. Gently brake to a stop, well off the road if possible.

If a tire goes flat, and your vehicle has a compact spare tire, see *Changing a Flat Tire on page 9-75*. This information shows you how to use the vehicle's tire changing equipment and how to change a flat tire safely.



CAUTION

Lifting a vehicle and getting under it to do maintenance or repairs is dangerous without the appropriate safety equipment and training. If a jack is provided with the vehicle, it is designed only for changing a flat tire. If it is used for anything else, you or others could be badly injured or killed if the vehicle slips off the jack. If a jack is provided with the vehicle, only use it for changing a flat tire.

Tire Sealant and Compressor Kit

If your vehicle has a factory installed Tire Sealant and Compressor kit, there is no spare tire, no tire changing equipment and no place to store a tire.

If a tire goes flat, avoid further tire and wheel damage by driving slowly to a level place and stopping.

1. Turn on the hazard warning flashers. See *Hazard Warning Flashers* on page 4-4.
2. Park your vehicle. Set the parking brake firmly and put the shift lever in P (Park). See *Shifting Into Park (Automatic Transmission)* on page 8-12.

3. Turn off the engine.
4. Inspect the flat tire.

If the tire has been separated from the wheel, has damaged sidewalls, or has a puncture larger than a ¼ inch (6 mm), the tire is too severely damaged for the tire sealant and compressor kit to be effective. See *Roadside Assistance Program* on page 12-6.

If the tire has a puncture less than a ¼ inch (6 mm) in the tread area of the tire, see *Tire Sealant and Compressor Kit (V8 Engine)* on page 9-67.

Tire Sealant and Compressor Kit (V8 Engine)

This vehicle has a tire sealant and compressor kit in place of a jack or spare tire. It is located in a foam container in the trunk. The tire sealant and compressor kit can be used to repair a flat tire by sealing small punctures in the tread of the tire. It can also be used to inflate an underinflated tire. The vehicle must be driven for five miles (8 kilometers) after the tire is sealed and inflated to the recommended pressure to ensure the sealant is distributed evenly. For detailed instructions see "Using the Tire Sealant and Compressor Kit to Temporarily Repair a Punctured Tire" later in this section.

The kit includes:

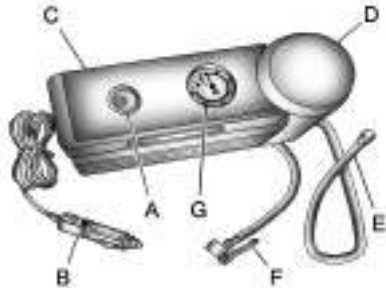

- A. On/Off Switch
- B. Air Compressor Accessory Plug
- C. Air Compressor
- D. Sealant Canister
- E. Sealant/Air Hose
- F. Air-only Hose
- G. Pressure Gage

Tire Sealant

The sealant can temporarily seal a small puncture up to 6 mm in the tread area of the tire. The sealant cannot seal sidewall damage, large punctures, or a wheel that has unseated from the wheel.

Read and follow the safe handling instructions on the label adhered to the sealant canister.

Check the tire sealant expiration date on the sealant canister. The sealant canister should be replaced before its expiration date. There is only enough sealant to seal one tire. After usage, the sealant canister and sealant/air hose assembly must be replaced. Replacement sealant canisters are available from a dealer/retailer. See "Removal and Installation of Sealant Canister" later in this section.

Using the Tire Sealant and Compressor Kit to Temporarily Seal and Inflate a Punctured Tire

Follow these directions closely for correct sealant usage.

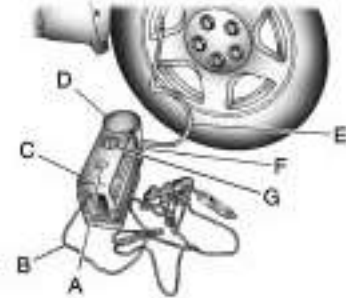

- A. On/Off Switch
- B. Air Compressor Accessory Plug
- C. Air Compressor
- D. Sealant Canister
- E. Sealant/Air Hose
- F. Air-only Hose
- G. Pressure Gage

Do a safety check before proceeding. See *If a Tire Goes Flat* on page 9-66.

Inspect the damaged tire.

The sealant cannot seal sidewall damage, large punctures, or a tire that has unseated from the wheel. See *Roadside Assistance Program* on page 12-6.

Do not remove any objects that have penetrated the tire.

1. Place the tire sealant and compressor kit on the ground and unwrap the sealant/air hose (E) from the side of the compressor.
2. Remove the air compressor accessory plug (B) from the unit. Do not plug the plug in yet.

3. Turn the tire valve stem cap counterclockwise to remove.
4. Attach the sealant/air hose (E) onto the tire valve stem. Turn it clockwise until tight.
5. Make sure the sealant and compressor kit on/off switch (A) is in the O (off) position. Plug the air compressor accessory plug (B) into an accessory power outlet in the vehicle. See *Accessory Power Outlet(s)* on page 4-9 for more information.
Do not slam door or close window on the compressor accessory plug cord.

 **CAUTION**

Idling the engine in a closed-in place or with the climate control system off can cause deadly carbon monoxide (CO). See *Engine Exhaust* on page 8-14.

6. Start the vehicle. The vehicle must be running while using the air compressor.

 **CAUTION**

Overinflation could cause the tire to rupture, and you or others could be injured. Be sure to read the inflator instructions, and inflate the tire to its recommended pressure. Do not exceed 36 psi (248 kPa).

7. Push the On/Off switch (A) to the I (on) position.
The kit will begin to inject sealant into the tire. Sealant could leak from the puncture hole until the vehicle is driven and the hole has sealed.

9-70 Vehicle Service and Care

8. Check the air pressure gage (G). If there is not a pressure reading while the compressor is running, check for leaks at the connection between the tire valve stem and the sealant/air hose (E).

9. Inflate the tire to the recommended inflation pressure, found on the Tire and Loading Information label. See *Inflation - Tire Pressure on page 9-49*.

The pressure gage (G) will initially read high while the compressor injects the sealant into the tire. Once the sealant injection is complete, the pressure will quickly drop. It will start to rise again as the tire inflates with air.

10. Turn the compressor off by pushing the On/Off button (A) to the I (off) position.

The pressure gage (G) reads slightly high while the compressor is on. Turn the compressor off to get an accurate reading. The compressor may be turned on and off until the correct pressure is reached.

Notice: If the recommended pressure cannot be reached after approximately 15 minutes, the vehicle should not be driven. The tire is too severely damaged and the tire sealant and compressor kit cannot inflate the tire. Remove the air compressor accessory plug from the accessory power outlet and unscrew the sealant/air hose from the tire valve or tire pressure monitoring sensor valve. See *Roadside Assistance Program on page 12-6*.

The tire is not sealed and will continue to leak air until the vehicle is driven and the sealant is distributed in the tire.

Steps 11 through 19 must be done right after Step 10.

Be careful while handling the tire sealant and compressor kit as they could be hot after usage.

11. Unplug the air compressor accessory plug (B) from the accessory power outlet in the vehicle.
12. Turn the sealant/air hose (E) counterclockwise to remove.
13. Replace the tire valve stem cap.
14. Stow the sealant/air hose (E) and air compressor accessory plug (B) in their original locations.



15. If the flat tire was able to be inflated to the recommended inflation pressure, remove the maximum speed label from the sealant canister and place it in a highly visible location.

The maximum speed label reminds you to drive cautiously and not to exceed 55 mph (90 km/h) until you have the damaged tire inspected and repaired.

 **CAUTION**

Storing the tire sealant and compressor kit or other equipment in the passenger compartment of the vehicle could cause injury. In a sudden stop or collision, loose equipment could strike someone. Store the tire sealant and compressor kit in its original location.

16. Return the equipment to its original storage location in the trunk.
17. Immediately drive the vehicle 5 miles (8 km) to distribute the sealant evenly in the tire.

18. Stop at a safe location and check the tire pressure, refer to Steps 1 through 9 under “Using the Tire Sealant and Compressor Kit without Sealant to Inflate an Underinflated Tire” later in this section.

If the tire pressure has fallen more than 10 psi (68 kPa), below the recommended inflation pressure, stop driving the vehicle. The tire is too severely damaged and the tire sealant and compressor cannot seal the tire. See *Roadside Assistance Program on page 12-6* if you need assistance.

If the tire pressure has not dropped more than 10 psi (68 kPa) from the recommended inflation pressure, inflate the tire back up to the recommended inflation pressure.

9-72 Vehicle Service and Care

19. Wipe off any sealant from the wheel, tire or vehicle.
20. Dispose of the used sealant canister at a local dealer/retailer or in accordance with local state codes and practices.

After using the sealant canister, replace it with a new canister available from your dealer/retailer.

This is a temporary repair. Take the vehicle to your dealer/retailer to have the tire repaired or replaced as soon as possible.

Using the Air Compressor without Sealant to Inflate an Underinflated Tire

To use the air compressor to inflate a tire with air only and not sealant:

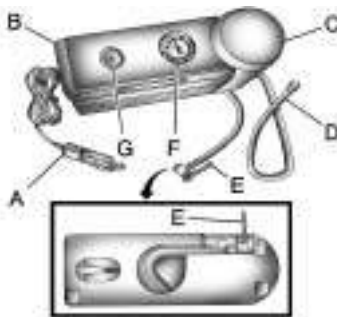

- A. Air Compressor Accessory Plug
- B. Air Compressor
- C. Sealant Canister
- D. Sealant/Air Hose
- E. Air-only Hose
- F. Pressure Gage
- G. On/Off Switch

Do a safety check before proceeding. See *If a Tire Goes Flat on page 9-66*.

To use the air compressor to inflate a tire with air only and not sealant:

1. Lift the lever and pull the air-only hose (E) from the bottom of the kit.
2. Remove the tire valve stem cap from the flat tire by turning it counterclockwise.
3. Push the air-only hose (E) onto the tire valve stem and push the lever down to secure in place.
4. Plug the air compressor accessory plug (A) into an accessory power outlet in the vehicle. See *Accessory Power Outlet(s) on page 4-9* for more information.

 **CAUTION**

Idling the engine in a closed-in place or with the climate control system off can cause deadly carbon monoxide (CO). See *Engine Exhaust on page 8-14*.

5. Start the vehicle. The vehicle must be running while using the air compressor.

 **CAUTION**

Overinflation could cause the tire to rupture, and you or others could be injured. Be sure to read the inflator instructions, and inflate the tire to its recommended pressure. Do not exceed 36 psi (248 kPa).

6. Push the On/Off switch (G) to the I (on) position.
Check the pressure gage (F). If there is not a pressure reading while the compressor is

running, check for leaks at the connection between the hose and the tire valve stem.

7. Inflate the tire up to the recommended inflation pressure using the air pressure gage (F) on the top of the unit. See *Inflation - Tire Pressure on page 9-49*.

The pressure gage (F) reads slightly high while the compressor is on. Turn the compressor off to get an accurate reading. The compressor may be turned on and off until the correct pressure is reached.

8. Push the On/Off switch (G) to the O (off) position.
Be careful while handling the tire sealant and compressor kit as they could be hot after usage.
9. Unplug the air compressor accessory plug (A) from the accessory power outlet in the vehicle and stow it in its original location.

10. Disconnect the air-only hose (E) from the tire valve stem and stow it back in its original location.
11. Replace the tire valve stem cap.

 **CAUTION**

Storing the tire sealant and compressor kit or other equipment in the passenger compartment of the vehicle could cause injury. In a sudden stop or collision, loose equipment could strike someone. Store the tire sealant and compressor kit in its original location.

12. Place the equipment in the original location in the trunk of your vehicle.

9-74 Vehicle Service and Care

Removal and Installation of the Sealant Canister

To remove the sealant canister:



1. Unlock the air-only hose from the sealant canister by pulling up on the lever.
2. Pull the air-only hose from the sealant canister.
3. Unwrap the sealant/air hose from the compressor.

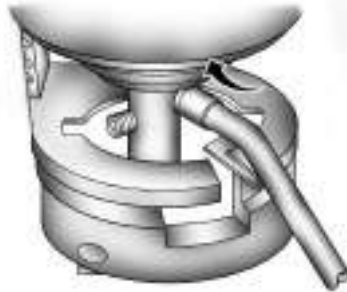

4. Turn the sealant canister so the inflator filling hose is aligned with the slot in the compressor.
5. Lift the sealant canister from the compressor and replace with a new sealant canister. Dispose of the sealant canister at a local dealer/retailer or in accordance with local state codes and practices. Replace it with a new canister, available from your dealer/retailer.

To install a new sealant canister:

1. Align the sealant/air hose with the slot in the air compressor.
2. Push the sealant canister down and turn it clockwise.
3. Wrap the sealant/air hose around the air compressor channel to stow it in its original location.
4. Push the air compressor inflator hose onto the sealant canister inlet and push the lever down.

Changing a Flat Tire

If a tire goes flat, avoid further tire and wheel damage by driving slowly to a level place. Turn on the hazard warning flashers.

CAUTION

Changing a tire can be dangerous. The vehicle can slip off the jack and roll over or fall on you or other people. You and they could be badly injured or even killed. Find a level place to change your tire. To help prevent the vehicle from moving:

1. Set the parking brake firmly.
2. Put an automatic transmission shift lever in P (Park), or shift a manual transmission to 1 (First) or R (Reverse).

(Continued)

CAUTION (Continued)

3. Turn off the engine and do not restart while the vehicle is raised.
4. Do not allow passengers to remain in the vehicle.

To be certain the vehicle will not move, put blocks at the front and rear of the tire farthest away from the one being changed. That would be the tire on the other side, at the opposite end of the vehicle.



When you have a flat tire, place the wheel block at the tire diagonally across from the flat tire.

Removing the Spare Tire and Tools

Spare Tire

The equipment you will need is located in the rear storage area.

1. Open the trunk. See *Trunk* on page 2-10.

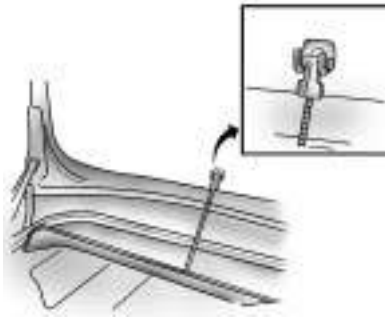

2. Pull the handle of the spare wheel cover strap straight up and secure to the trunk lid.



3. Turn the retainer nut counterclockwise and remove the spare tire.
4. Place the spare tire next to the tire being changed.
5. The jack and tools are stored below the spare tire.

Tools

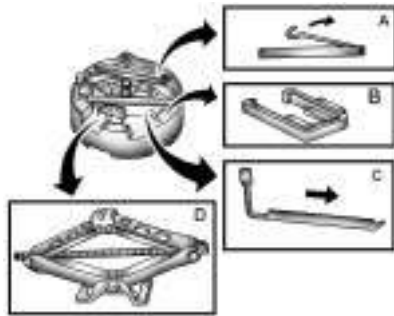

- A. Jack Handle
- B. Nut Cap Tool
- C. Wheel Wrench
- D. Jack

1. Turn the second retainer nut counterclockwise and remove the panel.
2. Remove the tools from the tool container.
3. Place the tools next to the tire being changed.

Removing the Flat Tire and Installing the Spare Tire

1. If your vehicle has wheel bolt caps, remove the caps. Store the caps with the wheel cover.

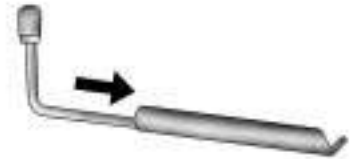

2. Use the fully extended wheel wrench to loosen all the wheel nuts one-half turn counterclockwise. Do not remove them yet.

9-78 Vehicle Service and Care

Notice: Make sure that the jack lift head is in the correct position or you may damage your vehicle. The repairs would not be covered by your warranty.

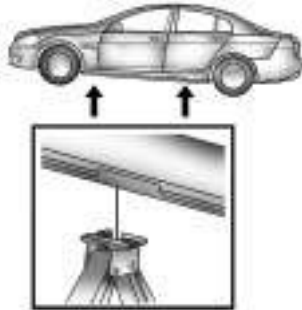

3. Position the jack lift head at the jack location nearest the flat tire. The location is indicated by a mark on the bottom edge of the vehicle. The jack must not be used in any other positions. Raise the jack until it engages with the jacking point.

4. Put the compact spare tire near you.

CAUTION

Getting under a vehicle when it is jacked up is dangerous. If the vehicle slips off the jack, you could be badly injured or killed. Never get under a vehicle when it is supported only by a jack.

CAUTION

Raising your vehicle with the jack improperly positioned can damage the vehicle and even make the vehicle fall. To help avoid personal injury and vehicle damage, be sure to fit the jack lift head into the proper location before raising the vehicle.



5. Fit the jack handle onto the jack by sliding the hook through the end of the jack.



The jack handle must be unfolded at a right angle before it is used.

6. Raise the vehicle by turning the jack handle clockwise 180°.



7. Pull the jack handle towards you.
8. Repeat Steps 7 and 8 until the vehicle is far enough off the ground so there is enough room for the compact spare tire to fit under the vehicle.

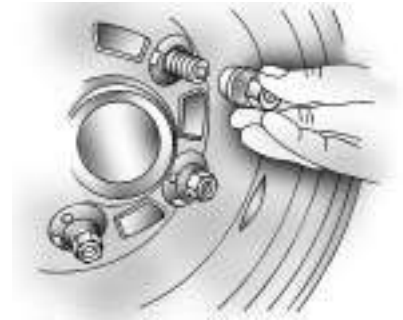

9. Remove all of the wheel nuts and place them in a dry, clean place to avoid getting dirt in the threads.

CAUTION

Rust or dirt on a wheel, or on the parts to which it is fastened, can make wheel nuts become loose after time. The wheel could come off and cause an accident. When you change a wheel, remove any rust or dirt from places where the wheel attaches to the vehicle. In an emergency, you can use a cloth or a paper towel to do this; but be sure to use a scraper or wire brush later, if needed, to get all the rust or dirt off. See *Changing a Flat Tire* on page 9-75.

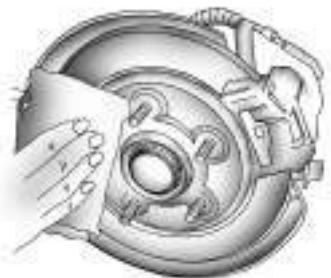

10. Remove any rust or dirt from the wheel bolts, mounting surfaces and spare wheel.
11. Place the compact spare tire on the wheel-mounting surface.

CAUTION

Never use oil or grease on bolts or nuts because the nuts might come loose. The vehicle's wheel could fall off, causing a crash.

12. Reinstall the wheel nuts with the rounded end of the nuts toward the wheel. Tighten each nut as much as possible using the wheel wrench until the wheel is held firmly against the hub. Use your free hand to prevent the wheel from turning while you are tightening.

13. Lower the vehicle by turning the jack handle counterclockwise. Lower the jack completely.
14. Tighten the wheel nuts firmly in a crisscross sequence, as shown.

**⚠ CAUTION**

Incorrect or improperly tightened wheel nuts can cause the wheel to come loose and even come off. This could lead to a crash. If you have to replace them, be sure to get new original equipment wheel nuts. Stop somewhere as soon as you can and have the nuts tightened with a torque wrench to the proper torque specification. See *Capacities and Specifications on page 10-2* for wheel nut torque specification.

Notice: Improperly tightened wheel nuts can lead to brake pulsation and rotor damage. To avoid expensive brake repairs, evenly tighten the wheel nuts in the proper sequence and to the proper torque specification. See *Capacities and Specifications on page 10-2* for the wheel nut torque specification.

Storing a Flat or Spare Tire and Tools

CAUTION

Storing a jack, a tire, or other equipment in the passenger compartment of the vehicle could cause injury. In a sudden stop or collision, loose equipment could strike someone. Store all these in the proper place.

To store a flat or spare tire and tools, do the following:

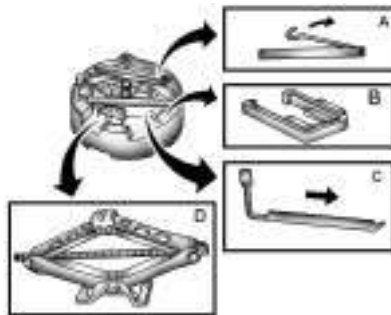

- A. Jack Handle
- B. Nut Cap Tool
- C. Wheel Wrench
- D. Jack

1. Replace the jack and tools as shown.
2. Turn the retainer nut clockwise to tighten.
3. Remove the wheel center cap by pushing it from the back.
4. Place the flat tire face up into the spare tire hub.
5. Turn the retainer nut clockwise to secure it into place.
6. Put the load floor back in place.

The compact spare tire is for temporary use only. Replace the compact spare with a full-size tire as soon as possible.

Compact Spare Tire

Although the compact spare tire was fully inflated when the vehicle was new, it can lose air after a time. Check the inflation pressure regularly. It should be 60 psi (420 kPa).

After installing the compact spare on the vehicle, stop as soon as possible and make sure the spare tire is correctly inflated. The compact spare is made to perform well at speeds up to 65 mph (105 km/h) for distances up to 3,000 miles (5 000 km), so you can finish your trip and have the full-size tire repaired or replaced at your convenience. Of course, it is best to replace the spare with a full-size tire as soon as possible. The spare tire will last longer and be in good shape in case it is needed again.

Notice: When the compact spare is installed, do not take the vehicle through an automatic car wash with guide rails. The compact spare can get caught on the rails which can damage the tire, wheel and other parts of the vehicle.

Do not use the compact spare on other vehicles.

And do not mix the compact spare tire or wheel with other wheels or tires. They will not fit. Keep the spare tire and its wheel together.

Notice: Tire chains will not fit the compact spare. Using them can damage the vehicle and can damage the chains too. Do not use tire chains on the compact spare.

Jump Starting

If the battery has run down, try to use another vehicle and some jumper cables to start your vehicle. Be sure to use the following steps to do it safely.

CAUTION

Batteries can hurt you. They can be dangerous because:

- They contain acid that can burn you.
- They contain gas that can explode or ignite.
- They contain enough electricity to burn you.

If you do not follow these steps exactly, some or all of these things can hurt you.

Notice: Ignoring these steps could result in costly damage to your vehicle that would not be covered by your warranty.

Trying to start your vehicle by pushing or pulling it will not work, and it could damage your vehicle.

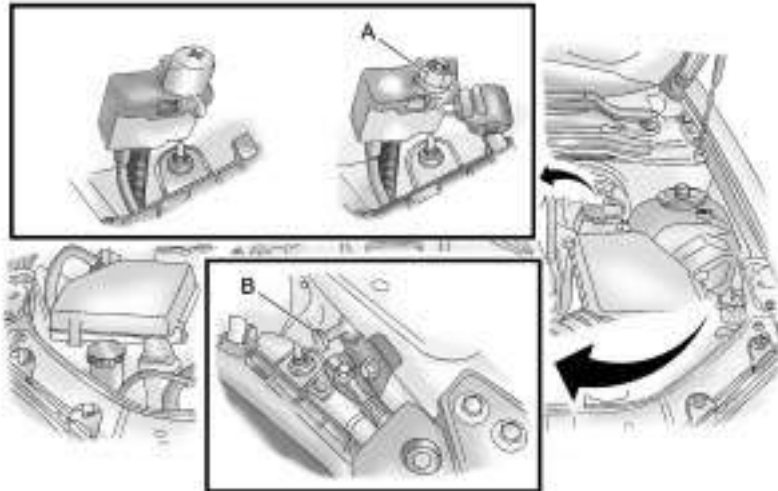

The positive jump start connection is covered by a red cap. Remove to expose the terminal.

1. Check the other vehicle. It must have a 12-volt battery with a negative ground system.

Notice: If the other vehicle's system is not a 12-volt system with a negative ground, both vehicles can be damaged. Only use vehicles with 12-volt systems with negative grounds to jump start your vehicle.

2. Position the two vehicles so that they are not touching.
3. Set the parking brake firmly and put the shift lever in P (Park). See *Shifting Into Park (Automatic Transmission)* on page 8-12.

The jump start positive (A) and negative posts (B) are located in the engine compartment on the driver side of the vehicle.

These posts are used instead of a direct connection to the battery.

Notice: If you leave the radio or other accessories on during the jump starting procedure, they could be damaged. The repairs would not be covered by the warranty. Always turn off the radio and other accessories when jump starting the vehicle.

4. Turn the ignition to LOCK/OFF and switch off all lights and accessories in both vehicles, except the hazard warning flashers if needed.

⚠ CAUTION

An electric fan can start up even when the engine is not running and can injure you. Keep hands, clothing and tools away from any underhood electric fan.

⚠ CAUTION

Using a match near a battery can cause battery gas to explode. People have been hurt doing this, and some have been blinded. Use a flashlight if you need more light.

Be sure the battery has enough water. You do not need to add water to the battery installed in your new vehicle. But if a battery has filler caps, be sure the right amount of fluid is there. If it is low, add water to take care of that first. If you don't, explosive gas could be present.

Battery fluid contains acid that can burn you. Do not get it on you. If you accidentally get it in your eyes or on your skin, flush the place with water and get medical help immediately.

⚠ CAUTION

Fans or other moving engine parts can injure you badly. Keep your hands away from moving parts once the engine is running.

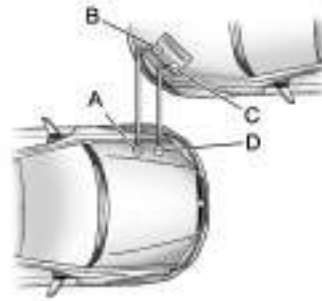

5. Connect one end of the red positive (+) cable to the jump start positive (+) post (A).

6. Connect the other end of the red positive (+) cable to the positive (+) terminal of the good battery (B).
7. Connect one end of the black negative (-) cable to the negative (-) terminal of the good battery (C).
8. Connect the other end of the black negative (-) cable to the negative (-) post (D).
9. Start the engine in the vehicle with the good battery and run the engine at idle speed for at least four minutes.
10. Try to start the vehicle that had the dead battery. If it will not start after a few tries, it probably needs service.

Notice: If the jumper cables are connected or removed in the wrong order, electrical shorting may occur and damage the vehicle. The repairs would not be covered by your warranty. Always connect and remove the

jumper cables in the correct order, making sure that the cables do not touch each other or other metal.

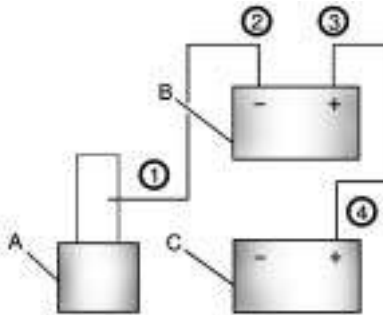

Jumper Cable Removal

- A. Heavy, Unpainted Metal Engine Part or Remote Negative (-) Terminal
- B. Good Battery or Remote Positive (+) and Remote Negative (-) Terminals
- C. Dead Battery or Remote Positive (+) Terminal

To disconnect the jumper cables from both vehicles, do the following:

1. Disconnect the black negative (-) cable from the vehicle that had the dead battery.
2. Disconnect the black negative (-) cable from the vehicle with the good battery.
3. Disconnect the red positive (+) cable from the vehicle with the good battery.
4. Disconnect the red positive (+) cable from the other vehicle.
5. Return the caps over the positive (+) and negative (-) terminals to their original positions.

Towing

Towing Your Vehicle

To avoid damage, the disabled vehicle should be towed with all four wheels off the ground. Consult your dealer/retailer or a professional towing service if the disabled vehicle must be towed. See *Roadside Assistance Program* on page 12-6.

Shift Lock Manual Release

The transmission has an electric park lock called a shift lock manual release. The key must be in the ON/RUN position, and the brake pedal pressed so the transmission gear selector can be moved from the P (Park) position. If the battery has lost power, the selector cannot be moved to neutral for towing unless the shift lock manual release is disengaged manually.

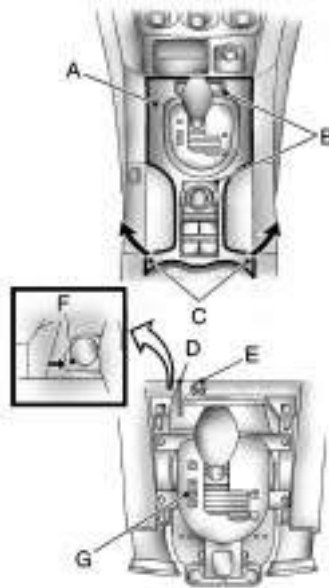

To access the shift lock manual release:

1. Apply the park brake.
2. Remove the console trim panel (A) from the console.
 - 2.1. Gently lift the back corners of the trim panel directly in front of the cupholders (C) until the two clips are released from the console.
 - 2.2. Gently lift the console trim panel from the rear until the four clips around the shift lever are released.
3. Raise the panel (A) no more than 2–3 inches (50–75 mm) to avoid disconnecting the wiring from the switches (B).
4. With the console trim panel raised, remove the retainer (E) and the shift lock manual release cover plate (D).
5. Push and hold the manual release lever (F) toward the passenger side of the vehicle.

6. Press the select button and move the transmission gear selector to the N (Neutral) position (G).
7. Release the lever (F).
8. After the vehicle has been moved, align the shift lock manual release cover plate (D) and install the retainer (E) so the automatic transmission can operate properly.
9. Place the trim panel (A) and the wires in their original position and gently press down around the outside until it clicks in place.
10. Check the operation of the switches (B) before operating the vehicle.

The transmission selector locks if it is moved back to the P (Park) position.

Recreational Vehicle Towing

Notice: Dolly towing or dinghy towing the vehicle may cause damage because of reduced ground clearance. Always put the vehicle on a flatbed truck.

The vehicle was neither designed nor intended to be towed with any of its wheels on the ground. If the vehicle must be towed, see “Towing Your Vehicle” earlier in this section.

Towing a Trailer



The driver can lose control when pulling a trailer if the correct equipment is not used or the vehicle is not driven properly. For example, if the trailer is too heavy, the brakes may not work well — or even at all. The driver and

(Continued)

CAUTION (Continued)

passengers could be seriously injured. The vehicle may also be damaged; the resulting repairs would not be covered by the vehicle warranty. Pull a trailer only if all the steps in this section have been followed. Ask your dealer/retailer for advice and information about towing a trailer with the vehicle.

Your vehicle can tow a trailer if it is equipped with the proper trailer towing equipment. To identify the trailering capacity of your vehicle, you should read the information in “Weight of the Trailer” that appears later in this section. Trailering is different than just driving your vehicle by itself. Trailering means changes in handling, acceleration, braking, durability and fuel economy.

Successful, safe trailering takes correct equipment, and it has to be used properly.

That is the reason for this part. In it are many time-tested, important trailering tips and safety rules. Many of these are important for your safety and that of your passengers. So please read this section carefully before you pull a trailer.

Load-pulling components such as the engine, transmission, wheel assemblies and tires are forced to work harder against the drag of the added weight. The engine is required to operate at relatively higher speeds and under greater loads, generating extra heat. Also, the trailer adds considerably to wind resistance, increasing the pulling requirements.

If You Do Decide To Pull A Trailer

If you do, here are some important points:

- There are many different laws, including speed limit restrictions, having to do with trailering. Make sure your rig will be legal, not only where you live but also where you will be driving. A good source for this information can be state or provincial police.
- Consider using a sway control. You can ask a hitch dealer about sway controls.
- Do not tow a trailer at all during the first 1,000 miles (1 600 km) your new vehicle is driven. Your engine, axle or other parts could be damaged.
- Then, during the first 500 miles (800 km) that you tow a trailer, do not drive over 50 mph (80 km/h) and do not make starts at full

throttle. This helps your engine and other parts of your vehicle wear in at the heavier loads.

- Use the Sport Shift mode and the cruise control when towing. The Active Select (A/S) may also be used under light load conditions.
- Obey speed limit restrictions when towing a trailer. Do not drive faster than the maximum posted speed for trailers, or no more than 55 mph (90 km/h), to save wear on your vehicle's parts.

Three important considerations have to do with weight:

- The weight of the trailer.
- The weight of the trailer tongue.
- The total weight on your vehicle's tires.

Weight of the Trailer

How heavy can a trailer safely be?

It should never weigh more than 2,000 lbs (907 kg). But even that can be too heavy.

It depends on how you plan to use your rig. For example, speed, altitude, road grades, outside temperature and how much your vehicle is used to pull a trailer are all important. It can also depend on any special equipment that you have on your vehicle, and the amount of tongue weight the vehicle can carry. See “Weight of the Trailer Tongue” later in this section for more information.

Maximum trailer weight is calculated assuming only the driver is in the tow vehicle and it has all the required trailering equipment. The weight of additional optional equipment, passengers and cargo in the tow vehicle must be subtracted from the maximum trailer weight.

You can ask your dealer/retailer for our trailering information or advice, or you can write us at our Customer Assistance Offices. See *Customer Assistance Offices on page 12-4* for more information.

Weight of the Trailer Tongue

The tongue load (A) of any trailer is an important weight to measure because it affects the total or gross weight of your vehicle. The Gross Vehicle Weight (GVW) includes the curb weight of the vehicle, any cargo you may carry in it, and the people who will be riding in the vehicle. If you have a lot of options, equipment, passengers, or cargo in your vehicle, it will reduce the tongue weight your vehicle can carry, which will also reduce the trailer weight your vehicle can tow. And if you tow a trailer, you must add the tongue load to the GVW because your vehicle will be carrying that weight, too. See

Loading the Vehicle on page 8-30 for more information about your vehicle’s maximum load capacity.

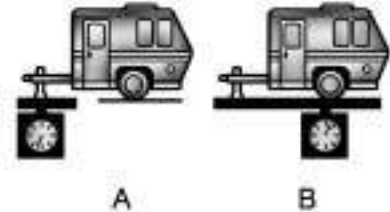

If you are using a weight-carrying hitch, the trailer tongue (A) should weigh 10 to 15 percent of the total loaded trailer weight (B).

After you have loaded your trailer, weigh the trailer and then the tongue, separately, to see if the weights are proper. If they are not, you may be able to get them right simply by moving some items around in the trailer.

Total Weight on Your Vehicle's Tires

Be sure your vehicle's tires are inflated to the upper limit for cold tires. You will find these numbers on the Tire-Loading Information label. See *Loading the Vehicle on page 8-30*. Then be sure you do not go over the GVW limit for your vehicle, including the weight of the trailer tongue.

Hitches

It is important to have the correct hitch equipment. Crosswinds, large trucks going by and rough roads are a few reasons why you will need the right hitch. Here are some rules to follow:

- The rear bumper on your vehicle is not intended for hitches. Do not attach rental hitches or other bumper-type hitches to it. Use only a frame-mounted hitch that does not attach to the bumper.

- Will you have to make any holes in the body of your vehicle when you install a trailer hitch? If you do, then be sure to seal the holes later when you remove the hitch. If you do not seal them, deadly carbon monoxide (CO) from your exhaust can get into your vehicle. See *Engine Exhaust on page 8-14*. Dirt and water can also enter the vehicle.

Safety Chains

You should always attach chains between your vehicle and your trailer. Cross the safety chains under the tongue of the trailer so that the tongue will not drop to the road if it becomes separated from the hitch. Instructions about safety chains may be provided by the hitch manufacturer or by the trailer manufacturer. Follow the manufacturer's recommendation for attaching safety chains and do not attach them to the bumper. Always

leave just enough slack so you can turn with your rig. And, never allow safety chains to drag on the ground.

Trailer Brakes

Does your trailer have its own brakes? Be sure to read and follow the instructions for the trailer brakes so you will be able to install, adjust and maintain them properly.

Because you have anti-lock brakes, do not tap into your vehicle's brake system. If you do, both brake systems will not work well, or at all.

Trailer Wiring Harness

All of the electrical circuits required for your trailer lighting system can be accessed at the driver's side rear lamp connector. This connector is located under the carpet on the rear corner of the trunk compartment.

Driving with a Trailer

Towing a trailer requires a certain amount of experience. Before setting out for the open road, you will want to get to know your rig. Acquaint yourself with the feel of handling and braking with the added weight of the trailer. And always keep in mind that the vehicle you are driving is now a good deal longer and not nearly as responsive as your vehicle is by itself.

Before you start, check all trailer hitch parts and attachments, safety chains, electrical connector, lamps, tires and mirror adjustment. If the trailer has electric brakes, start your vehicle and trailer moving and then apply the trailer brake controller by hand to be sure the brakes are working. This lets you check your electrical connection at the same time.

During your trip, check occasionally to be sure that the load is secure, and that the lamps and any trailer brakes are still working.

Towing with the Electronic Stability Program (ESP®)

When towing, the sound of the ESP modulator might be heard. The ESP is reacting to the vehicle movement caused by the trailer, which mainly occurs during cornering. This is normal when towing heavier trailers.

Following Distance

Stay at least twice as far behind the vehicle ahead as when driving your vehicle without a trailer. This can help avoid situations that require heavy braking and sudden turns.

Passing

More passing distance is needed up ahead when you are towing a trailer. And, because the vehicle is longer, it is necessary to go much farther beyond the passed vehicle before returning to the lane.

Backing Up

Hold the bottom of the steering wheel with one hand. Then, to move the trailer to the left, just move that hand to the left. To move the trailer to the right, move the hand to the right. Always back up slowly and, if possible, have someone guide you.

Making Turns

Notice: Making very sharp turns while trailering could cause the trailer to come in contact with the vehicle. The vehicle could be damaged. Avoid making very sharp turns while trailering.

When you are turning with a trailer, make wider turns than normal. Do this so your trailer will not strike soft shoulders, curbs, road signs, trees or other objects. Avoid jerky or sudden maneuvers. Signal well in advance.

Turn Signals When Towing a Trailer

When you tow a trailer, your vehicle may need a different turn signal flasher and/or extra wiring. Check with your dealer/retailer. The arrows on your instrument panel will flash whenever you signal a turn or lane change. Properly hooked up, the trailer lamps will also flash, telling other drivers you are about to turn, change lanes or stop.

When towing a trailer, the arrows on your instrument panel will flash for turns even if the bulbs on the trailer are burned out. Thus, you may think drivers behind you are seeing your signal when they are not. It is important to check occasionally to be sure the trailer bulbs are still working.

Your vehicle has bulb warning lights. When you plug a trailer lighting system into your vehicle's lighting system, its bulb warning lights may not let you know if one of your lamps goes out. So, when

you have a trailer lighting system plugged in, be sure to check your vehicle and trailer lamps from time to time to be sure they are all working. Once you disconnect the trailer lamps, the bulb warning lights again can tell you if one of your vehicle lamps is out.

Driving On Grades

Reduce speed and shift to a lower gear *before* you start down a long or steep downgrade. If you do not shift down, you might have to use your brakes so much that they would get hot and no longer work well.

On a long uphill grade, shift down to a lower gear and reduce your speed to around 45 mph (70 km/h) to reduce the possibility of engine and transmission overheating.

Parking on Hills



Parking the vehicle on a hill with the trailer attached can be dangerous. If something goes wrong, the rig could start to move. People can be injured, and both the vehicle and the trailer can be damaged. When possible, always park the rig on a flat surface.

But if you ever have to park your rig on a hill, here is how to do it:

1. Apply your regular brakes, but do not shift into P (Park) yet.
2. Have someone place chocks under the trailer wheels.
3. When the wheel chocks are in place, release the regular brakes until the chocks absorb the load.
4. Reapply the regular brakes. Then apply your parking brake, and then shift to P (Park).
5. Release the regular brakes.

When You Are Ready to Leave After Parking on a Hill

1. Apply your regular brakes and hold the pedal down while you:
 - Start your engine.
 - Shift into a gear.
 - Release the parking brake.
2. Let up on the brake pedal.
3. Drive slowly until the trailer is clear of the chocks.
4. Stop and have someone pick up and store the chocks.

Maintenance When Trailer Towing

Your vehicle will need service more often when you're pulling a trailer. See the Maintenance Schedule for more on this. Things that are especially important in trailer operation are automatic transmission fluid (don't overfill), engine oil, drive

belt, cooling system and brake system. Each of these is covered in this manual, and the Index will help you find them quickly. If you're trailering, it's a good idea to review this information before you start your trip.

Check periodically to see that all hitch nuts and bolts are tight.

Engine Cooling When Trailer Towing

Your cooling system may temporarily overheat during severe operating conditions. See *Engine Overheating* on page 9-20.

Appearance Care

Interior Cleaning

Your vehicle's interior will continue to look its best if it is cleaned often. Although not always visible, dust and dirt can accumulate on your upholstery. Dirt can damage carpet, fabric, leather, and plastic surfaces. Regular vacuuming is recommended to remove particles from the upholstery. It is important to keep your upholstery from becoming and remaining heavily soiled. Soils should be removed as quickly as possible. Your vehicle's interior may experience extremes of heat that could cause stains to set rapidly.

Lighter colored interiors may require more frequent cleaning. Use care because newspapers and garments that transfer color to your home furnishings may also transfer color to your vehicle's interior.

When cleaning your vehicle's interior, only use cleaners specifically designed for the surfaces being cleaned. Permanent damage may result from using cleaners on surfaces for which they were not intended. Use glass cleaner only on glass. Remove any accidental over-spray from other surfaces immediately. To prevent over-spray, apply cleaner directly to the cleaning cloth.

Notice: If you use abrasive cleaners when cleaning glass surfaces on your vehicle, you could scratch the glass and/or cause damage to the rear window defogger. When cleaning the glass on your vehicle, use only a soft cloth and glass cleaner.

Many cleaners contain solvents that may become concentrated in your vehicle's breathing space. Before using cleaners, read and adhere to all safety instructions on the label. While cleaning your vehicle's interior, maintain adequate ventilation by opening your vehicle's doors and windows.

Dust may be removed from small buttons and knobs using a small brush with soft bristles.

Your dealer/retailer has a product for cleaning your vehicle's glass. You can also obtain a product from your dealer/retailer to remove odors from your vehicle's upholstery.

Do not clean your vehicle using the following cleaners or techniques:

- Never use a knife or any other sharp object to remove a soil from any interior surface.
- Never use a stiff brush. It can cause damage to your vehicle's interior surfaces.

- Never apply heavy pressure or rub aggressively with a cleaning cloth. Use of heavy pressure can damage the interior and does not improve the effectiveness of soil removal.
- Use only mild, neutral-pH soaps. Avoid laundry detergents or dishwashing soaps with degreasers. Using too much soap will leave a residue that leaves streaks and attracts dirt. For liquid cleaners, about 20 drops per gallon (3.78 L) of water is a good guide.
- Do not heavily saturate the upholstery while cleaning.
- Damage to your vehicle's interior may result from the use of many organic solvents such as naphtha, alcohol, etc.

Fabric/Carpet

Use a vacuum cleaner with a soft brush attachment frequently to remove dust and loose dirt. A canister vacuum with a beater bar in the nozzle may only be used on floor carpet and carpeted floor mats. For soils, always try to remove them first with plain water or club soda. Before cleaning, gently remove as much of the soil as possible using one of the following techniques:

- For liquids: gently blot the remaining soil with a paper towel. Allow the soil to absorb into the paper towel until no more can be removed.
- For solid dry soils: remove as much as possible and then vacuum.

To clean, use the following instructions:

1. Saturate a lint-free, clean white cloth with water or club soda.
2. Wring the cloth to remove excess moisture.

3. Start on the outside edge of the soil and gently rub toward the center. Continue cleaning, using a clean area of the cloth each time it becomes soiled.
4. Continue to gently rub the soiled area until the cleaning cloth remains clean.
5. If the soil is not completely removed, use a mild soap solution and repeat the cleaning process that was used with plain water.

If any of the soil remains, a commercial fabric cleaner or spot lifter may be necessary. When a commercial upholstery cleaner or spot lifter is to be used, test a small hidden area for colorfastness first. If the locally cleaned area gives any impression that a ring formation may result, clean the entire surface.

After the cleaning process has been completed, a paper towel can be used to blot excess moisture from the fabric or carpet.

Leather

A soft cloth dampened with water can be used to remove dust. If a more thorough cleaning is necessary, a soft cloth dampened with a mild soap solution can be used. Allow the leather to dry naturally. Do not use heat to dry. Never use steam to clean leather. Never use spot lifters or spot removers on leather. Many commercial leather cleaners and coatings that are sold to preserve and protect leather may permanently change the appearance and feel of your leather and are not recommended. Do not use silicone or wax-based products, or those containing organic solvents to clean your vehicle's interior because they can alter the appearance by increasing the gloss in a non-uniform manner. Never use shoe polish on leather.

Instrument Panel, Vinyl, and Other Plastic Surfaces

A soft cloth dampened with water may be used to remove dust. If a more thorough cleaning is necessary, a clean soft cloth dampened with a mild soap solution can be used to gently remove dust and dirt. Never use spot lifters or removers on plastic surfaces. Many commercial cleaners and coatings that are sold to preserve and protect soft plastic surfaces may permanently change the appearance and feel of your interior and are not recommended. Do not use silicone or wax-based products, or those containing organic solvents to clean your vehicle's interior because they can alter the appearance by increasing the gloss in a non-uniform manner.

Some commercial products may increase gloss on your instrument panel. The increase in gloss may cause annoying reflections in the windshield and even make it difficult to see through the windshield under certain conditions.

Exterior Cleaning

Cleaning Exterior Lamps/Lenses

Use only lukewarm or cold water, a soft cloth and a car washing soap to clean exterior lamps and lenses. Follow instructions under "Washing Your Vehicle" later in this section.

Finish Care

Occasional waxing or mild polishing of the vehicle by hand may be necessary to remove residue from the paint finish. You can get approved cleaning products from your dealer/retailer.

If the vehicle has a basecoat/clearcoat paint finish, the clearcoat gives more depth and gloss to the colored basecoat. Always use waxes and polishes that are non-abrasive and made for a basecoat/clearcoat paint finish.

Notice: Machine compounding or aggressive polishing on a basecoat/clearcoat paint finish may damage it. Use only non-abrasive waxes and polishes that are made for a basecoat/clearcoat paint finish on your vehicle.

Foreign materials such as calcium chloride and other salts, ice melting agents, road oil and tar, tree sap, bird droppings, chemicals from industrial chimneys, etc., can damage the vehicle's finish if they remain on painted surfaces. Wash the vehicle as soon as possible. If necessary, use non-abrasive cleaners that are marked safe for painted surfaces to remove foreign matter.

Exterior painted surfaces are subject to aging, weather and chemical fallout that can take their toll over a period of years. You can help to keep the paint finish looking new by keeping the vehicle garaged or covered whenever possible.

Protecting Exterior Bright Metal Parts

Bright metal parts should be cleaned regularly to keep their luster. Wash with water or use chrome polish on chrome or stainless steel trim, if necessary.

Use special care with aluminum trim. To avoid damaging protective trim, never use auto or chrome polish, steam or caustic soap to clean aluminum. A coating of wax, rubbed to high polish, is recommended for all bright metal parts.

Washing Your Vehicle

The best way to preserve the vehicle's finish is to keep it clean by washing it often.

Do not wash the vehicle in direct sunlight. Use a car washing soap.

Notice: Certain cleaners contain chemicals that can damage the emblems or nameplates on your vehicle. Check the cleaning product label. If it states that it should not be used on plastic parts, do not use it on your vehicle or damage may occur and it would not be covered by the warranty.

Do not use cleaning agents that are petroleum based or that contain acid or abrasives, as they can damage the paint, metal or plastic on the vehicle. Approved cleaning products can be obtained from your dealer/retailer. Follow all manufacturers' directions regarding correct product usage, necessary safety precautions and appropriate disposal of any vehicle care product.

Rinse the vehicle well, before washing and after to remove all cleaning agents completely. If they are allowed to dry on the surface, they could stain.

Dry the finish with a soft, clean chamois or an all-cotton towel to avoid surface scratches and water spotting.

High pressure car washes may cause water to enter the vehicle. Avoid using high pressure washes closer than 12 inches (30 cm) to the surface of the vehicle. Use of power washers exceeding 1,200 psi (8 274) can result in damage or removal of paint and decals.

Notice: Conveyor systems on some automatic car washes could damage the vehicle. There may not be enough clearance for the undercarriage. Check with the car wash manager before using the automatic car wash.

Weatherstrips

Silicone grease on weatherstrips will make them last longer, seal better, and not stick or squeak. Apply silicone grease with a clean cloth. During very cold, damp weather frequent application may be required. See “Fluids and Lubricants” in the Index of the “Maintenance and Warranty and Owner assistance Information” manual.

Wheels and Trim — Aluminum or Chrome

The vehicle may have either aluminum or chrome-plated wheels. Keep the wheels clean using a soft clean cloth with mild soap and water. Rinse with clean water. After rinsing thoroughly, dry with a soft clean towel. A wax may then be applied.

Notice: Chrome wheels and other chrome trim may be damaged if you do not wash your vehicle after driving on roads that have been sprayed with magnesium, calcium or sodium chloride. These chlorides are used on roads for conditions such as ice and dust. Always wash your vehicle’s chrome with soap and water after exposure.

Notice: If you use strong soaps, chemicals, abrasive polishes, cleaners, brushes, or cleaners that contain acid on aluminum or chrome-plated wheels, you could damage the surface of the wheel(s). The repairs would not be covered by your warranty. Use only approved cleaners on aluminum or chrome-plated wheels.

The surface of these wheels is similar to the painted surface of the vehicle. Do not use strong soaps, chemicals, abrasive polishes, abrasive cleaners, cleaners with acid, or abrasive cleaning brushes on them because you could damage the surface. Do not use chrome polish on aluminum wheels.

Notice: Using chrome polish on aluminum wheels could damage the wheels. The repairs would not be covered by your warranty. Use chrome polish on chrome wheels only.

Use chrome polish only on chrome-plated wheels, but avoid any painted surface of the wheel, and buff off immediately after application.

Notice: If you drive your vehicle through an automatic car wash that has silicone carbide tire cleaning brushes, you could damage the aluminum or chrome-plated wheels. The repairs would not be covered by

your warranty. Never drive a vehicle equipped with aluminum or chrome-plated wheels through an automatic car wash that uses silicone carbide tire cleaning brushes.

Windshield and Wiper Blades

Clean the outside of the windshield with glass cleaner.

Clean the rubber blades using a lint free cloth or paper towel soaked with windshield washer fluid or a mild detergent. Wash the windshield thoroughly when cleaning the blades. Bugs, road grime, sap, and a buildup of vehicle wash/wax treatments may cause wiper streaking. Replace the wiper blades if they are worn or damaged.

Wipers can be damaged by:

- Extreme dusty conditions
- Sand and salt
- Heat and sun
- Snow and ice, without proper removal

Tires

To clean the tires, use a stiff brush with tire cleaner.

Notice: Using petroleum-based tire dressing products on your vehicle may damage the paint finish and/or tires. When applying a tire dressing, always wipe off any overspray from all painted surfaces on your vehicle.

Sheet Metal Damage

If the vehicle is damaged and requires sheet metal repair or replacement, make sure the body repair shop applies anti-corrosion material to parts repaired or replaced to restore corrosion protection.

Original manufacturer replacement parts will provide the corrosion protection while maintaining the vehicle warranty.

Finish Damage

Any stone chips, fractures or deep scratches in the finish should be repaired right away. Bare metal will corrode quickly and may develop into major repair expense.

Minor chips and scratches can be repaired with touch-up materials available from your dealer/retailer. Larger areas of finish damage can be corrected in your dealer's/retailer's body and paint shop.

Underbody Maintenance

Chemicals used for ice and snow removal and dust control can collect on the underbody. If these are not removed, corrosion and rust can develop on the underbody parts such as fuel lines, frame, floor pan, and exhaust system even though they have corrosion protection.

At least every spring, flush these materials from the underbody with plain water. Clean any areas where mud and debris can collect. Dirt packed in close areas of the frame should be loosened before being flushed. Your dealer/retailer or an underbody car washing system can do this for you.

Chemical Paint Spotting

Some weather and atmospheric conditions can create a chemical fallout. Airborne pollutants can fall upon and attack painted surfaces on the vehicle. This damage can take two forms: blotchy, ring-shaped discolorations, and small, irregular dark spots etched into the paint surface.

Although no defect in the paint job causes this, we will repair, at no charge to the owner, the surfaces of new vehicles damaged by this fallout condition within 12 months or 12,000 miles (20 000 km) of purchase, whichever occurs first.

Technical Data

Vehicle Identification

Vehicle Identification Number (VIN)	10-1
Service Parts Identification Label	10-1

Capacities and Specifications

Capacities and Specifications	10-2
-------------------------------------	------

Vehicle Identification

Vehicle Identification Number (VIN)



This is the legal identifier for your vehicle. It appears on a plate in the front corner of the instrument panel, on the driver side. It can be seen through the windshield from outside the vehicle. The VIN also appears on the Vehicle Certification and Service Parts labels and the certificates of title and registration.

Engine Identification

The eighth character in the VIN is the engine code. This code helps identify the vehicle's engine, specifications, and replacement parts. See "Engine Specifications" under *Capacities and Specifications on page 10-2* for your vehicle's engine code.

Service Parts Identification Label

This label is on the inside of the glove box. It is very helpful if you ever need to order parts. The label has the following information:

- Vehicle Identification Number (VIN)
- Model designation
- Paint information
- Production options and special equipment

Do not remove this label from the vehicle.

10-2 Technical Data

Capacities and Specifications

The following approximate capacities are given in English and metric conversions. See *Recommended Fluids and Lubricants* on page 11-12 for more information.

Application	Capacities	
	English	Metric
Air Conditioning Refrigerant R134a	For the air conditioning system refrigerant charge amount, see the refrigerant caution label located under the hood. See your dealer/retailer for more information.	
Cooling System		
3.6L V6 Engine	10.6 qt	10.0 L
6.0L V8 Engine	11.6 qt	11.0 L
Engine Oil with Filter		
3.6L V6 Engine	7.1 qt	6.7 L
6.0L V8 Engine	8.8 qt	8.3 L
Fuel Tank	19.3 gal	73.0 L

Application	Capacities	
	English	Metric
Transmission Fluid		
Automatic, 5 Speed, 3.6L V6 Engine	9.4 qt	8.9 L
Automatic, 6 Speed 6.0L V8 Engine	12.4 qt	11.7 L
Manual, 6 Speed 6.0L V8 Engine	3.7 qt	3.5 L
Wheel Nut Torque	125 lb ft	170 N•m
All capacities are approximate. When adding, be sure to fill to the approximate level, as recommended in this manual.		

Engine Specifications

Engine	VIN Code	Transmission	Spark Plug Gap
3.6L V6 Engine	7	Automatic	0.043 in (1.10 mm)
6.0L V8 Engine	Y	Automatic	0.040 in (1.02 mm)
6.0L V8 Engine	Y	Manual	0.040 in (1.02 mm)

Service and Maintenance

Service and Maintenance

- Introduction11-1
- Maintenance
 - Requirements11-2
- Your Vehicle and the Environment11-2
- Using the Maintenance Schedule11-2
- Scheduled Maintenance11-4
- Additional Required Services11-6
- Maintenance Footnotes11-7
- Owner Checks and Services11-9
- At Each Fuel Fill11-9
- At Least Once a Month11-9

- At Least Once a Year11-10
- Recommended Fluids and Lubricants11-12
- Maintenance Replacement Parts11-13
- Engine Drive Belt Routing11-14
- Maintenance Record11-15

Service and Maintenance

Introduction

Important: Keep engine oil at the proper level and change as recommended.



Have you purchased the GM Protection Plan? The Plan supplements the vehicle warranties. See the Warranty and Owner Assistance booklet or your dealer/retailer for details.

Maintenance Requirements

Notice: Maintenance intervals, checks, inspections, replacement parts, and recommended fluids and lubricants as prescribed in this manual are necessary to keep this vehicle in good working condition. Any damage caused by failure to follow scheduled maintenance might not be covered by the vehicle warranty.

Your Vehicle and the Environment

Proper vehicle maintenance not only helps to keep the vehicle in good working condition, but also helps the environment. All recommended maintenance is important. Improper vehicle maintenance can even affect the quality of the air we breathe.

Improper fluid levels or the wrong tire inflation can increase the level of emissions from the vehicle. To help protect the environment, and to keep the vehicle in good condition, be sure to maintain the vehicle properly.

Using the Maintenance Schedule

We want to help keep this vehicle in good working condition. But we do not know exactly how you will drive it. You might drive very short distances only a few times a week. Or you might drive long distances all the time in very hot, dusty weather. You might use the vehicle in making deliveries. Or you might drive it to work, to do errands, or in many other ways.

Because of all the different ways people use their vehicles, maintenance needs vary. You might need more frequent checks and replacements. So please read the following and note how you drive. If you have any questions on how to keep the vehicle in good condition, see your dealer/retailer.

This schedule is for vehicles that:

- carry passengers and cargo within recommended limits on the Tire and Loading Information label. See *Loading the Vehicle on page 8-30*.
- are driven on reasonable road surfaces within legal driving limits.
- use the recommended fuel. See *Gasoline Octane on page 8-35*.

The services in *Scheduled Maintenance on page 11-4* should be performed when indicated. See *Additional Required Services on page 11-6* and *Maintenance Footnotes on page 11-7* for further information.

 **CAUTION**

Performing maintenance work on a vehicle can be dangerous. In trying to do some jobs, you can be seriously injured. Do your own maintenance work only if you have the required know-how and the proper tools and equipment for the job. If you have any doubt, see your dealer/retailer to have a qualified technician do the work. See *Doing Your Own Service Work* on page 9-4.

Some maintenance services can be complex. So, unless you are technically qualified and have the necessary equipment, have your dealer/retailer do these jobs.

When you go to your dealer/retailer for service, trained and supported service technicians will perform the work using genuine parts.

To purchase service information, see *Service Publications Ordering Information* on page 12-15.

Owner Checks and Services on page 11-9 tells what should be checked, when to check it, and what can easily be done to help keep the vehicle in good condition.

The proper replacement parts, fluids, and lubricants to use are listed in *Recommended Fluids and Lubricants* on page 11-12 and *Maintenance Replacement Parts* on page 11-13. When the vehicle is serviced, make sure these are used. All parts should be replaced and all necessary repairs done before you or anyone else drives the vehicle. We recommend the use of genuine parts from your dealer/retailer.

11-4 Service and Maintenance

Scheduled Maintenance

When the Service Engine Oil message comes on, it means that service is required for your vehicle. Have your vehicle serviced as soon as possible within the next 600 miles (1 000 km). It is possible that, if you are driving under the best conditions, the engine oil life system may not indicate that vehicle service is necessary for over a year. However, your engine oil and filter must be changed at least once a year and at this time the system must be reset. Your dealer/retailer has trained service technicians who will perform this work using genuine parts and reset the system.

If the engine oil life system is ever reset accidentally, you must service your vehicle within 3,000 miles (5 000 km) since your last service. Remember to reset the oil life system whenever the oil is changed. See *Engine Oil Life System on page 9-10* for information on the Engine Oil Life System and resetting the system.

When the Service Engine Oil message appears, certain services, checks, and inspections are required. Required services are described in the following for "Maintenance I" and "Maintenance II." Generally, it is recommended that your first service be Maintenance I, your second service be Maintenance II, and that you alternate Maintenance I and Maintenance II thereafter. However, in some cases, Maintenance II may be required more often.

Maintenance I — Use Maintenance I if the Service Engine Oil message comes on within 10 months since the vehicle was purchased or Maintenance II was performed.

Maintenance II — Use Maintenance II if the previous service performed was Maintenance I. Always use Maintenance II whenever the Service Engine Oil message comes on 10 months or more since the last service or if the message has not come on at all for one year.

Scheduled Maintenance

Service	Maintenance I	Maintenance II
Change engine oil and filter. See <i>Engine Oil on page 9-8</i> . Reset oil life system. See <i>Engine Oil Life System on page 9-10</i> . An <i>Emission Control Service</i> .	•	•
Visually check for any leaks or damage. See <i>footnote (j)</i> .	•	•
Inspect engine air cleaner filter. If necessary, replace filter. See <i>Engine Air Cleaner/Filter on page 9-11</i> . See <i>footnote (k)</i> .		•
Rotate tires and check inflation pressures and wear. See <i>Tire Inspection and Rotation on page 9-57</i> and “Tire Wear Inspection” in <i>At Least Once a Month on page 11-9</i> .	•	•
Inspect brake system. See <i>footnote (a)</i> .	•	•
Check engine coolant and windshield washer fluid levels and add fluid as needed.	•	•
Perform any needed additional services. See “Additional Required Services” in this section.	•	•
Inspect suspension and steering components. See <i>footnote (b)</i> .		•
Inspect engine cooling system. See <i>footnote (c)</i> .		•
Inspect wiper blades. See <i>footnote (d)</i> .		•
Inspect restraint system components. See <i>footnote (e)</i> .		•
Lubricate body components. See <i>footnote (f)</i> .		•
Replace passenger compartment air filter. See <i>footnote (l)</i> .		•

11-6 Service and Maintenance

Additional Required Services

The following services should be performed at the first maintenance service (I or II) after the indicated miles (kilometers) shown for each item.

Additional Required Services

Service and Miles (Kilometers)	25,000 (40 000)	50,000 (80 000)	75,000 (120 000)	100,000 (160 000)	125,000 (200 000)	150,000 (240 000)
Inspect fuel system for damage or leaks.	•	•	•	•	•	•
Inspect exhaust system for loose or damaged components.	•	•	•	•	•	•
Replace engine air cleaner filter. See <i>Engine Air Cleaner/Filter</i> on page 9-11.		•		•		•
Change automatic transmission fluid and filter (severe service). See footnote (h).		•		•		•
Change automatic transmission fluid and filter (normal service).				•		
Replace spark plugs. <i>An Emission Control Service.</i>				•		
Engine cooling system service (or every five years, whichever occurs first). <i>An Emission Control Service.</i> See footnote (i).						•

Additional Required Services (cont'd)

Service and Miles (Kilometers)	25,000 (40 000)	50,000 (80 000)	75,000 (120 000)	100,000 (160 000)	125,000 (200 000)	150,000 (240 000)
Inspect engine accessory drive belt. <i>An Emission Control Service.</i> <i>See footnote (g).</i>						•
Change brake hydraulic fluid at a regular maintenance service every two years. <i>See footnote (m).</i>						

Maintenance Footnotes

(a) *Visually inspect brake lines and hoses for proper hook-up, binding, leaks, cracks, chafing, etc. Inspect disc brake pads for wear and rotors for surface condition. Inspect drum brake linings/shoes for wear or cracks. Inspect other brake parts, including drums, wheel cylinders, calipers, parking brake, etc.*

(b) *Visually inspect front and rear suspension and steering system for damaged, loose, or missing parts or signs of wear. Inspect power*

steering lines and hoses for proper hook-up, binding, leaks, cracks, chafing, etc.

(c) *Visually inspect hoses and have them replaced if they are cracked, swollen, or deteriorated. Inspect all pipes, fittings and clamps; replace with genuine parts as needed. To help ensure proper operation, a pressure test of the cooling system and pressure cap and cleaning the outside of the radiator and air conditioning condenser is recommended at least once a year.*

(d) *Inspect wiper blades for wear, cracking, or contamination. Clean the windshield and wiper blades, if contaminated. Replace wiper blades that are worn or damaged. See Windshield Wiper Blade Replacement on page 9-24 and “Windshield and Wiper Blades” under Exterior Cleaning on page 9-98 for more information.*

11-8 Service and Maintenance

(e) *Make sure the safety belt reminder light and safety belt assemblies are working properly. Look for any other loose or damaged safety belt system parts. If you see anything that might keep a safety belt system from doing its job, have it repaired. Have any torn or frayed safety belts replaced. Also see Airbag System Check on page 1-33.*

(f) *Lubricate all key lock cylinders, door hinges and latches, hood hinges and latches and trunk lid hinges and latches. More frequent lubrication may be required when exposed to a corrosive environment. Applying silicone grease on weatherstrips with a clean cloth will make them last longer, seal better, and not stick or squeak.*

(g) *Visually inspect belt for fraying, excessive cracks, or obvious damage. Replace belt if necessary.*

(h) *Change automatic transmission fluid and filter if the vehicle is mainly driven under one or more of these conditions:*

- In heavy city traffic where the outside temperature regularly reaches 90°F (32°C) or higher.*
- In hilly or mountainous terrain.*
- When doing frequent trailer towing.*
- Uses such as found in taxi, police, or delivery service.*

(i) *Drain, flush, and refill cooling system. This service can be complex; you should have your dealer/retailer perform this service. See Engine Coolant on page 9-15 for what to use. Inspect hoses. Clean radiator, condenser, pressure cap, and filler neck. Pressure test the cooling system and pressure cap.*

(j) *A fluid loss in any vehicle system could indicate a problem. Have the system inspected and repaired and the fluid level checked. Add fluid if needed.*

(k) *If you drive regularly under dusty conditions, inspect the filter at each engine oil change.*

(l) *If you drive regularly under dusty conditions, the filter may require replacement more often.*

(m) *Drain, flush, and refill brake hydraulic system at a regular service interval (I or II) every two years. This service can be complex; you should have your dealer/retailer perform this service. See Brakes on page 9-25.*

Owner Checks and Services

These owner checks and services should be performed at the intervals specified to help ensure vehicle safety, dependability, and emission control performance. Your dealer/retailer can assist with these checks and services.

Be sure any necessary repairs are completed at once. Whenever any fluids or lubricants are added to the vehicle, make sure they are the proper ones, as shown in *Recommended Fluids and Lubricants on page 11-12*.

At Each Fuel Fill

It is important to perform these underhood checks at each fuel fill.

Engine Oil Level Check

Notice: It is important to check the engine oil regularly and keep it at the proper level. Failure to keep the engine oil at the proper level can cause damage to the engine not covered by the vehicle warranty.

Check the engine oil level and add the proper oil if necessary. See *Engine Oil on page 9-8*.

Engine Coolant Level Check

Check the engine coolant level and add DEX-COOL[®] coolant mixture if necessary. See *Engine Coolant on page 9-15*.

Windshield Washer Fluid Level Check

Check the windshield washer fluid level in the windshield washer fluid reservoir and add the proper fluid if necessary.

At Least Once a Month

Tire Inflation Check

Inspect the vehicle's tires and make sure they are inflated to the correct pressures. Do not forget to check the spare tire, if the vehicle has one. See *Inflation - Tire Pressure on page 9-49*. If the vehicle has a spare tire, check to make sure it is stored securely. See *Changing a Flat Tire on page 9-75*.

Tire Wear Inspection

Tire rotation may be required for high mileage highway drivers prior to the Engine Oil Life System service notification. Check the tires for wear and, if necessary, rotate the tires. See *Tire Inspection and Rotation on page 9-57*.

At Least Once a Year

Starter Switch Check



CAUTION

When you are doing this inspection, the vehicle could move suddenly. If the vehicle moves, you or others could be injured.

1. Before starting this check, be sure there is enough room around the vehicle.
2. Firmly apply both the parking brake and the regular brake. See *Parking Brake on page 8-11*. Do not use the accelerator pedal, and be ready to turn off the engine immediately if it starts.
3. Try to start the engine in each gear. The vehicle should start only in P (Park) or N (Neutral). If the vehicle starts in any other position, contact your dealer/retailer for service.

Automatic Transmission Shift Lock Control System Check



CAUTION

When you are doing this inspection, the vehicle could move suddenly. If the vehicle moves, you or others could be injured.

1. Before starting this check, be sure there is enough room around the vehicle. It should be parked on a level surface.
2. Firmly apply the parking brake. See *Parking Brake on page 8-11*. Be ready to apply the regular brake immediately if the vehicle begins to move.
3. With the engine off, turn the ignition to ON/RUN, but do not start the engine. Without applying the regular brake, try to move the shift lever out of P (Park) with normal effort. If the shift lever moves out of P (Park), contact your dealer/retailer for service.

Ignition Transmission Lock Check

While parked, and with the parking brake set, try to turn the ignition to LOCK/OFF in each shift lever position.

- The ignition should turn to LOCK/OFF only when the shift lever is in P (Park).
- The ignition key should come out only in LOCK/OFF.

Contact your dealer/retailer if service is required.

Parking Brake and Automatic Transmission P (Park) Mechanism Check

CAUTION

When you are doing this check, the vehicle could begin to move. You or others could be injured and property could be damaged. Make sure there is room in front of the vehicle in case it begins to roll. Be ready to apply the regular brake at once should the vehicle begin to move.

Park on a fairly steep hill, with the vehicle facing downhill. Keeping your foot on the regular brake, set the parking brake.

- To check the parking brake's holding ability: With the engine running and the transmission in N (Neutral), slowly remove foot pressure from the regular brake pedal. Do this until the vehicle is held by the parking brake only.
- To check the P (Park) mechanism's holding ability: With the engine running, shift to P (Park). Then release the parking brake followed by the regular brake.

Contact your dealer/retailer if service is required.

Underbody Flushing Service

At least every spring, use plain water to flush any corrosive materials from the underbody. Take care to clean thoroughly any areas where mud and other debris can collect.

Tire Sealant and Compressor Kit

If the vehicle has a Tire Sealant and Compressor Kit, check the sealant expiration date printed on the instruction label of the kit at least once a year. See your dealer/retailer for a replacement canister.

11-12 Service and Maintenance

Recommended Fluids and Lubricants

Fluids and lubricants identified below by name, part number, or specification can be obtained from your dealer/retailer.

Usage	Fluid/Lubricant
Engine Oil	Engine oil which meets GM Standard GM6094M and displays the American Petroleum Institute Certified for Gasoline Engines starburst symbol. To determine the proper viscosity for your vehicle's engine, see <i>Engine Oil on page 9-8</i> .
Engine Coolant	50/50 mixture of clean, drinkable water and use only DEX-COOL [®] Coolant. See <i>Engine Coolant on page 9-15</i> .
Hydraulic Brake System	Hydraulic Brake Fluid. Use only GM Part No. U.S. 88958860, in Canada 88901244, Super DOT-4 brake fluid.
Windshield Washer	Optikleen [®] Washer Solvent.
Hydraulic Power Steering System	DEXRON [®] -VI Automatic Transmission Fluid.
Automatic Transmission	DEXRON [®] -VI Automatic Transmission Fluid.
Key Lock Cylinders	Multi-Purpose Lubricant, Superlube (GM Part No. U.S. 12346241, in Canada 10953474).
Hood Latch Assembly, Secondary Latch, Pivots, Spring Anchor, and Release Pawl	Lubriplate Lubricant Aerosol (GM Part No. U.S. 12346293, in Canada 992723) or lubricant meeting requirements of NLGI #2, Category LB or GC-LB.
Hood and Door Hinges	Multi-Purpose Lubricant, Superlube (GM Part No. U.S. 12346241, in Canada 109435474).
Weatherstrip Conditioning	Weatherstrip Lubricant (GM Part No. U.S. 3634770, in Canada 10953518) or Dielectric Silicone Grease (GM Part No. U.S. 12345579, in Canada 992887).

Maintenance Replacement Parts

Replacement parts identified below by name, part number or specification can be obtained from your dealer/retailer.

Part	GM Part Numbers	ACDelco Part Numbers
Engine Air Cleaner/Filter	92066873	—
Engine Oil Filter		
3.6L V6	25177917	PF2129
6.0L V8	89017524	PF48
Passenger Compartment Air Filter Element	92184248	—
Spark Plugs		
3.6L V6	12597464	41-990
6.0L V8	12609877	41-985
Wiper Blades		
Driver Side	92177917	—
Passenger Side	92177918	—

Engine Drive Belt Routing

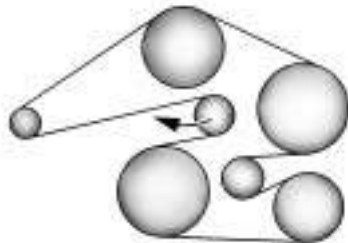

V6 Engine

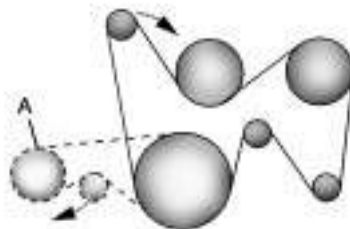

V8 Engine

(A) Air Conditioning Compressor

Customer Information

Customer Information

Customer Satisfaction Procedure	12-1
Online Owner Center	12-3
Customer Assistance for Text Telephone (TTY) Users	12-4
Customer Assistance Offices	12-4
GM Mobility Reimbursement Program	12-5
Roadside Assistance Program	12-6
Scheduling Service Appointments	12-8
Courtesy Transportation	12-9
Collision Damage Repair	12-10

Reporting Safety Defects

Reporting Safety Defects to the United States Government	12-14
Reporting Safety Defects to the Canadian Government	12-14
Reporting Safety Defects to General Motors	12-14
Service Publications Ordering Information	12-15

Vehicle Data Recording and Privacy

Vehicle Data Recording and Privacy	12-16
Event Data Recorders	12-16
OnStar®	12-17
Navigation System	12-17
Radio Frequency Identification (RFID)	12-17

Customer Information

Customer Satisfaction Procedure

Your satisfaction and goodwill are important to your dealer and to Pontiac. Normally, any concerns with the sales transaction or the operation of the vehicle will be resolved by the dealer's sales or service departments. Sometimes, however, despite the best intentions of all concerned, misunderstandings can occur. If your concern has not been resolved to your satisfaction, the following steps should be taken:

STEP ONE: Discuss your concern with a member of dealership management. Normally, concerns can be quickly resolved at that level. If the matter has already been reviewed with the sales, service, or parts manager, contact the owner of the dealership or the general manager.

12-2 Customer Information

STEP TWO: If after contacting a member of dealership management, it appears your concern cannot be resolved by the dealership without further help, in the U.S., call the Pontiac Customer Assistance Center at 1-800-762-2737. In Canada, call General Motors of Canada Customer Communication Centre at 1-800-263-3777 (English) or 1-800-263-7854 (French).

We encourage you to call the toll-free number in order to give your inquiry prompt attention. Have the following information available to give the Customer Assistance Representative:

- Vehicle Identification Number (VIN). This is available from the vehicle registration or title, or the plate at the top left of the instrument panel and visible through the windshield.
- Dealership name and location.
- Vehicle delivery date and present mileage.

When contacting Pontiac, remember that your concern will likely be resolved at a dealer's facility. That is why we suggest you follow Step One first.

STEP THREE — U.S. Owners:

Both General Motors and your dealer are committed to making sure you are completely satisfied with your new vehicle. However, if you continue to remain unsatisfied after following the procedure outlined in Steps One and Two, you can file with the BBB Auto Line Program to enforce your rights.

The BBB Auto Line Program is an out of court program administered by the Council of Better Business Bureaus to settle automotive disputes regarding vehicle repairs or the interpretation of the New Vehicle Limited Warranty. Although you may be required to resort to this informal dispute resolution program prior to filing a court action, use of the program is free of charge and your case will generally be heard

within 40 days. If you do not agree with the decision given in your case, you may reject it and proceed with any other venue for relief available to you.

You can contact the BBB Auto Line Program using the toll-free telephone number or write them at the following address:

BBB Auto Line Program
Council of Better Business
Bureaus, Inc.
4200 Wilson Boulevard
Suite 800
Arlington, VA 22203-1838

Telephone: 1-800-955-5100
www.dr.bbb.org/goauto

This program is available in all 50 states and the District of Columbia. Eligibility is limited by vehicle age, mileage and other factors. General Motors reserves the right to change eligibility limitations and/or discontinue its participation in this program.

STEP THREE — Canadian

Owners: In the event that you do not feel your concerns have been addressed after following the procedure outlined in Steps One and Two, General Motors of Canada Limited wants you to be aware of its participation in a no-charge Mediation/Arbitration Program. General Motors of Canada Limited has committed to binding arbitration of owner disputes involving factory-related vehicle service claims. The program provides for the review of the facts involved by an impartial third party arbiter, and may include an informal hearing before the arbiter. The program is designed so that the entire dispute settlement process, from the time you file your complaint to the final decision, should be completed in approximately 70 days. We believe our impartial program offers advantages over courts in most jurisdictions because it is informal, quick, and free of charge.

For further information concerning eligibility in the Canadian Motor Vehicle Arbitration Plan (CAMVAP), call toll-free 1-800-207-0685, or call the General Motors Customer Communication Centre, 1-800-263-3777 (English), 1-800-263-7854 (French), or write to:

Mediation/Arbitration Program
c/o Customer Communication Centre
General Motors of Canada Limited
Mail Code: CA1-163-005
1908 Colonel Sam Drive
Oshawa, Ontario L1H 8P7

Your inquiry should be accompanied by the Vehicle Identification Number (VIN).

**Online Owner Center
(United States only)**

The Owner Center is a resource for your GM ownership needs. Specific vehicle information can be found in one place.

The Online Owner Center allows you to:

- Get e-mail service reminders.
- Access information about your specific vehicle, including tips and videos and an electronic version of this owner manual.
- Keep track of your vehicle's service history and maintenance schedule.
- Find GM dealers/retailers for service nationwide.
- Receive special promotions and privileges only available to members.

Refer to MyGMLink.com on the web for updated information and to register your vehicle.

12-4 Customer Information

My GM Canada (Canada only)

My GM Canada is a password-protected section of gmcanada.com where you can save information on GM vehicles, get personalized offers, and use handy tools and forms with greater ease.

Here are a few of the valuable tools and services you will have access to:

- **My Showroom:** Find and save information on vehicles and current offers in your area.
- **My Dealers/Retailers:** Save details such as address and phone number for each of your preferred GM Dealers or Retailers.
- **My Driveway:** Receive service reminders and helpful advice on owning and maintaining your vehicle.
- **My Preferences:** Manage your profile, subscribe to E-News and use tools and forms with greater ease.

To sign up to My GM Canada, visit the My GM Canada section within gmcanada.com.

Customer Assistance for Text Telephone (TTY) Users

To assist customers who are deaf, hard of hearing, or speech-impaired and who use Text Telephones (TTYs), Pontiac has TTY equipment available at its Customer Assistance Center. Any TTY user in the U.S. can communicate with Pontiac by dialing: 1-800-833-PONT (7668). (TTY users in Canada can dial 1-800-263-3830.)

Customer Assistance Offices

Pontiac encourages customers to call the toll-free number for assistance. However, if a customer wishes to write or e-mail Pontiac, the letter should be addressed to:

United States — Customer Assistance

Pontiac Customer Assistance Center
P.O. Box 33172
Detroit, MI 48232-5172

www.Pontiac.com
1-800-762-2737 or
1-800-833-7668 (For Text Telephone devices (TTYs))
Roadside Assistance:
1-800-ROADSIDE (762-3743)

From Puerto Rico:
1-800-496-9992 (English)
1-800-496-9993 (Spanish)

From U.S. Virgin Islands:
1-800-496-9994

Canada — Customer Assistance

General Motors of Canada Limited
Customer Communication Centre,
CA1-163-005

1908 Colonel Sam Drive
Oshawa, Ontario L1H 8P7

www.gmcanada.com
1-800-263-3777 (English)
1-800-263-7854 (French)
1-800-263-3830 (For Text
Telephone devices (TTYs))
Roadside Assistance:
1-800-268-6800

Overseas — Customer Assistance

Please contact the local General
Motors Business Unit.

**Mexico, Central America and
Caribbean Islands/Countries
(Except Puerto Rico and U.S.
Virgin Islands) — Customer
Assistance**

General Motors de Mexico,
S. de R.L. de C.V.
Customer Assistance Center
Paseo de la Reforma #2740
Col. Lomas de Bezares
C.P. 11910, Mexico, D.F.
01-800-508-0000
Long Distance: 011-52-53 29 0 800

**GM Mobility
Reimbursement Program**



This program, available to qualified applicants, can reimburse you up to \$1,000 of the cost of eligible aftermarket adaptive equipment required for your vehicle, such as hand controls or a wheelchair/scooter lift.

The offer is available for a very limited period of time from the date of vehicle purchase/lease. For more details, or to determine your vehicle's eligibility, visit gmmobility.com or call the GM Mobility Assistance Center at 1-800-323-9935. Text telephone (TTY) users, call 1-800-833-9935.

General Motors of Canada also has a Mobility Program. Call 1-800-GM-DRIVE (463-7483) for details. TTY users call 1-800-263-3830.

12-6 Customer Information

Roadside Assistance Program

For U.S. purchased vehicles, call **1-800-ROADSIDE (762-3743)**; (Text telephone (TTY): **1-888-889-2438**).

For Canadian purchased vehicles, call **1-800-268-6800**.

Service is available 24 hours a day, 365 days a year.

Calling for Assistance

When calling Roadside Assistance, have the following information ready:

- Your name, home address, and home telephone number
- Telephone number of your location
- Location of the vehicle
- Model, year, color, and license plate number of the vehicle
- Odometer reading, Vehicle Identification Number (VIN), and delivery date of the vehicle
- Description of the problem

Coverage

Services are provided up to 5 years/100,000 miles (160 000 km), whichever comes first.

In the U.S., anyone driving the vehicle is covered. In Canada, a person driving the vehicle without permission from the owner is not covered.

Roadside Assistance is not a part of the New Vehicle Limited Warranty. Pontiac and General Motors of Canada Limited reserve the right to make any changes or discontinue the Roadside Assistance program at any time without notification.

Pontiac and General Motors of Canada Limited reserve the right to limit services or payment to an owner or driver if they decide the claims are made too often, or the same type of claim is made many times.

Services Provided

- **Emergency Fuel Delivery:** Delivery of enough fuel for the vehicle to get to the nearest service station.
- **Lock-Out Service:** Service is provided to unlock the vehicle if you are locked out. A remote unlock may be available if you have OnStar[®]. For security reasons, the driver must present identification before this service is given.
- **Emergency Tow From a Public Road or Highway:** Tow to the nearest Pontiac dealer for warranty service, or if the vehicle was in a crash and cannot be driven. Assistance is also given when the vehicle is stuck in sand, mud, or snow.

- **Flat Tire Change:** Service is provided to change a flat tire with the spare tire. The spare tire, if equipped, must be in good condition and properly inflated. It is the owner's responsibility for the repair or replacement of the tire if it is not covered by the warranty.
- **Battery Jump Start:** Service is provided to jump start a dead battery.
- **Trip Interruption Benefits and Assistance:** If your trip is interrupted due to a warranty failure, incidental expenses may be reimbursed during the 5 years/100,000 miles (160 000 km) Powertrain warranty period. Items considered are hotel, meals, and rental car.

Services Not Included in Roadside Assistance

- Impound towing caused by violation of any laws.
- Legal fines.
- Mounting, dismounting or changing of snow tires, chains, or other traction devices.
- Towing or services for vehicles driven on a non-public road or highway.

Services Specific to Canadian Purchased Vehicles

- **Fuel delivery:** Reimbursement is approximately \$5 Canadian. Diesel fuel delivery may be restricted. Propane and other fuels are not provided through this service.
- **Lock-Out Service:** Vehicle registration is required.
- **Trip Routing Service:** Detailed maps of North America are provided when requested either with the most direct route or the most scenic route. There is a limit of six requests per year. Additional travel information is also available. Allow three weeks for delivery.
- **Trip Interruption Benefits and Assistance:** Must be over 250 kilometres from where your trip was started to qualify. General Motors of

Canada Limited requires pre-authorization, original detailed receipts, and a copy of the repair orders. Once authorization has been received, the Roadside Assistance advisor will help you make arrangements and explain how to receive payment.

- **Alternative Service:** If assistance cannot be provided right away, the Roadside Assistance advisor may give you permission to get local emergency road service. You will receive payment, up to \$100, after sending the original receipt to Roadside Assistance. Mechanical failures may be covered, however any cost for parts and labor for repairs not covered by the warranty are the owner responsibility.

Scheduling Service Appointments

When your vehicle requires warranty service, contact your dealer/retailer and request an appointment. By scheduling a service appointment and advising your service consultant of your transportation needs, your dealer/retailer can help minimize your inconvenience.

If your vehicle cannot be scheduled into the service department immediately, keep driving it until it can be scheduled for service, unless, of course, the problem is safety-related. If it is, please call your dealership/retailer, let them know this, and ask for instructions.

If the dealer/retailer requests you to bring the vehicle for service, you are urged to do so as early in the work day as possible to allow for the same day repair.

Courtesy Transportation

To enhance your ownership experience, we and our participating dealers are proud to offer Courtesy Transportation, a customer support program for vehicles with the Bumper to Bumper (Base Warranty Coverage period in Canada) and extended powertrain warranty in both the U.S. and Canada.

Several courtesy transportation options are available to assist in reducing your inconvenience when warranty repairs are required.

Courtesy Transportation is not a part of the New Vehicle Limited Warranty. A separate booklet entitled "Warranty and Owner Assistance Information" furnished with each new vehicle provides detailed warranty coverage information.

Transportation Options

Warranty service can generally be completed while you wait. However, if you are unable to wait, GM helps to minimize your inconvenience by providing several transportation options. Depending on the circumstances, your dealer can offer you one of the following:

Shuttle Service

Shuttle service is the preferred means of offering Courtesy Transportation. Dealers may provide you with shuttle service to get you to your destination with minimal interruption of your daily schedule. This includes one-way or round trip shuttle service within reasonable time and distance parameters of the dealer's area.

Public Transportation or Fuel Reimbursement

If your vehicle requires overnight warranty repairs, and public transportation is used instead of the dealer's shuttle service, the expense must be supported by original receipts and can only be up to the maximum amount allowed by GM for shuttle service. In addition, for U.S. customers, should you arrange transportation through a friend or relative, limited reimbursement for reasonable fuel expenses may be available. Claim amounts should reflect actual costs and be supported by original receipts. See your dealer for information regarding the allowance amounts for reimbursement of fuel or other transportation costs.

12-10 Customer Information

Courtesy Rental Vehicle

Your dealer may arrange to provide you with a courtesy rental vehicle or reimburse you for a rental vehicle that you obtain if your vehicle is kept for an overnight warranty repair.

Rental reimbursement will be limited and must be supported by original receipts. This requires that you sign and complete a rental agreement and meet state/provincial, local, and rental vehicle provider requirements. Requirements vary and may include minimum age requirements, insurance coverage, credit card, etc. You are responsible for fuel usage charges and may also be responsible for taxes, levies, usage fees, excessive mileage, or rental usage beyond the completion of the repair.

It may not be possible to provide a like-vehicle as a courtesy rental.

Additional Program Information

All program options, such as shuttle service, may not be available at every dealer. Please contact your dealer for specific information about availability. All Courtesy Transportation arrangements will be administered by appropriate dealer personnel.

General Motors reserves the right to unilaterally modify, change or discontinue Courtesy Transportation at any time and to resolve all questions of claim eligibility pursuant to the terms and conditions described herein at its sole discretion.

Collision Damage Repair

If your vehicle is involved in a collision and it is damaged, have the damage repaired by a qualified technician using the proper equipment and quality replacement parts. Poorly performed collision repairs diminish your vehicle's resale value, and safety performance can be compromised in subsequent collisions.

Collision Parts

Genuine GM Collision parts are new parts made with the same materials and construction methods as the parts with which your vehicle was originally built. Genuine GM Collision parts are your best choice to ensure that your vehicle's designed appearance, durability, and safety are preserved. The use of Genuine GM parts can help maintain your GM New Vehicle Warranty.

Recycled original equipment parts may also be used for repair. These parts are typically removed from vehicles that were total losses in prior crashes. In most cases, the parts being recycled are from undamaged sections of the vehicle. A recycled original equipment GM part, may be an acceptable choice to maintain your vehicle's originally designed appearance and safety performance, however, the history of these parts is not known. Such parts are not covered by your GM New Vehicle Limited Warranty, and any related failures are not covered by that warranty.

Aftermarket collision parts are also available. These are made by companies other than GM and may not have been tested for your vehicle. As a result, these parts may fit poorly, exhibit premature durability/corrosion problems, and may not perform properly in subsequent collisions.

Aftermarket parts are not covered by your GM New Vehicle Limited Warranty, and any vehicle failure related to such parts are not covered by that warranty.

Repair Facility

We recommend that you choose a collision repair facility that meets your needs before you ever need collision repairs. Your dealer/retailer may have a collision repair center with GM-trained technicians and state of the art equipment, or be able to recommend a collision repair center that has GM-trained technicians and comparable equipment.

Insuring Your Vehicle

Protect your investment in your GM vehicle with comprehensive and collision insurance coverage. There are significant differences in the quality of coverage afforded by various insurance policy terms.

Many insurance policies provide reduced protection to your GM vehicle by limiting compensation for damage repairs by using aftermarket collision parts. Some insurance companies will not specify aftermarket collision parts. When purchasing insurance, we recommend that you assure your vehicle will be repaired with GM original equipment collision parts. If such insurance coverage is not available from your current insurance carrier, consider switching to another insurance carrier.

If your vehicle is leased, the leasing company may require you to have insurance that assures repairs with Genuine GM Original Equipment Manufacturer (OEM) parts or Genuine Manufacturer replacement parts. Read your lease carefully, as you may be charged at the end of your lease for poor quality repairs.

12-12 Customer Information

If a Crash Occurs

Here is what to do if you are involved in a crash.

- Check to make sure that you are all right. If you are uninjured, make sure that no one else in your vehicle, or the other vehicle, is injured.
 - If there has been an injury, call emergency services for help. Do not leave the scene of a crash until all matters have been taken care of. Move your vehicle only if its position puts you in danger or you are instructed to move it by a police officer.
 - Give only the necessary and requested information to police and other parties involved in the crash. Do not discuss your personal condition, mental frame of mind, or anything unrelated to the crash. This will help guard against post-crash legal action.
- If you need roadside assistance, call GM Roadside Assistance. See *Roadside Assistance Program* on page 12-6 for more information.
 - If your vehicle cannot be driven, know where the towing service will be taking it. Get a card from the tow truck operator or write down the driver's name, the service's name, and the phone number.
 - Remove any valuables from your vehicle before it is towed away. Make sure this includes your insurance information and registration if you keep these items in your vehicle.
 - Gather the important information you will need from the other driver. Things like name, address, phone number, driver's license number, vehicle license plate, vehicle make, model and model
- year, Vehicle Identification Number (VIN), insurance company and policy number, and a general description of the damage to the other vehicle.
 - If possible, call your insurance company from the scene of the crash. They will walk you through the information they will need. If they ask for a police report, phone or go to the police department headquarters the next day and you can get a copy of the report for a nominal fee. In some states/provinces with "no fault" insurance laws, a report may not be necessary. This is especially true if there are no injuries and both vehicles are driveable.

- Choose a reputable collision repair facility for your vehicle. Whether you select a dealer/retailer or a private collision repair facility to fix the damage, make sure you are comfortable with them. Remember, you will have to feel comfortable with their work for a long time.
- Once you have an estimate, read it carefully and make sure you understand what work will be performed on your vehicle. If you have a question, ask for an explanation. Reputable shops welcome this opportunity.

Managing the Vehicle Damage Repair Process

In the event that your vehicle requires damage repairs, GM recommends that you take an active role in its repair. If you have a pre-determined repair facility of choice, take your vehicle there, or have it towed there. Specify to the facility that any required replacement collision parts be original equipment parts, either new Genuine GM parts or recycled original GM parts. Remember, recycled parts will not be covered by your GM vehicle warranty.

Insurance pays the bill for the repair, but you must live with the repair. Depending on your policy limits, your insurance company may initially value the repair using aftermarket parts. Discuss this with your repair professional, and insist on Genuine GM parts.

Remember if your vehicle is leased you may be obligated to have the vehicle repaired with Genuine GM parts, even if your insurance coverage does not pay the full cost.

If another party's insurance company is paying for the repairs, you are not obligated to accept a repair valuation based on that insurance company's collision policy repair limits, as you have no contractual limits with that company. In such cases, you can have control of the repair and parts choices as long as cost stays within reasonable limits.

Reporting Safety Defects

Reporting Safety Defects to the United States Government

If you believe that your vehicle has a defect which could cause a crash or could cause injury or death, you should immediately inform the National Highway Traffic Safety Administration (NHTSA) in addition to notifying General Motors.

If NHTSA receives similar complaints, it may open an investigation, and if it finds that a safety defect exists in a group of vehicles, it may order a recall and remedy campaign.

However, NHTSA cannot become involved in individual problems between you, your dealer/retailer, or General Motors.

To contact NHTSA, you may call the Vehicle Safety Hotline toll-free at 1-888-327-4236 (TTY: 1-800-424-9153); go to <http://www.safercar.gov>; or write to:

Administrator, NHTSA
1200 New Jersey Avenue, S.E.
Washington D.C., 20590

You can also obtain other information about motor vehicle safety from <http://www.safercar.gov>.

Reporting Safety Defects to the Canadian Government

If you live in Canada, and you believe that your vehicle has a safety defect, notify Transport Canada immediately, in addition to notifying General Motors of Canada Limited. Call them at 1-800-333-0510 or write to:

Transport Canada
Road Safety Branch
2780 Sheffield Road
Ottawa, Ontario K1B 3V9

Reporting Safety Defects to General Motors

In addition to notifying NHTSA (or Transport Canada) in a situation like this, please notify General Motors.

Call 1-800-762-2737, or write:

Pontiac Customer Assistance Center
P.O. Box 33172
Detroit, MI 48232-5172

In Canada, call 1-800-263-3777 (English) or 1-800-263-7854 (French), or write:

General Motors of Canada Limited
Customer Communication Centre,
CA1-163-005
1908 Colonel Sam Drive
Oshawa, Ontario L1H 8P7

Service Publications Ordering Information

Service Manuals

Service Manuals have the diagnosis and repair information on engines, transmission, axle suspension, brakes, electrical, steering, body, etc.

Service Bulletins

Service Bulletins give additional technical service information needed to knowledgeable service General Motors cars and trucks. Each bulletin contains instructions to assist in the diagnosis and service of your vehicle.

Owner Information

Owner publications are written specifically for owners and intended to provide basic operational information about the vehicle. The owner manual includes the Maintenance Schedule for all models.

In-Portfolio: Includes a Portfolio, Owner Manual, and Warranty Booklet.

RETAIL SELL PRICE:
\$35.00 (U.S.) plus processing fee

Without Portfolio:
Owner Manual only.

RETAIL SELL PRICE:
\$25.00 (U.S.) plus processing fee

Current and Past Model Order Forms

Technical Service Bulletins and Manuals are available for current and past model GM vehicles. To request an order form, specify year and model name of the vehicle.

ORDER TOLL FREE:

**1-800-551-4123 Monday-Friday
8:00 AM - 6:00 PM Eastern Time**

For Credit Card Orders Only (VISA-MasterCard-Discover), visit Helm, Inc. on the World Wide Web at: helminc.com

Or you can write to:

Helm, Incorporated
P.O. Box 07130
Detroit, MI 48207

Prices are subject to change without notice and without incurring obligation. Allow ample time for delivery.

Note to Canadian Customers: All listed prices are quoted in U.S. funds. Canadian residents are to make checks payable in U.S. funds.

Vehicle Data Recording and Privacy

Your GM vehicle has a number of sophisticated computers that record information about the vehicle's performance and how it is driven. For example, your vehicle uses computer modules to monitor and control engine and transmission performance, to monitor the conditions for airbag deployment and deploy airbags in a crash and, if so equipped, to provide antilock braking to help the driver control the vehicle. These modules may store data to help your dealer/retailer technician service your vehicle. Some modules may also store data about how you operate the vehicle, such as rate of fuel consumption or average speed. These modules may also retain the owner's personal preferences, such as radio pre-sets, seat positions, and temperature settings.

Event Data Recorders

This vehicle has an Event Data Recorder (EDR). The main purpose of an EDR is to record, in certain crash or near crash-like situations, such as an airbag deployment or hitting a road obstacle, data that will assist in understanding how a vehicle's systems performed. The EDR is designed to record data related to vehicle dynamics and safety systems for a short period of time, typically 30 seconds or less. The EDR in this vehicle is designed to record such data as:

- How various systems in your vehicle were operating
- Whether or not the driver and passenger safety belts were buckled/fastened
- How far, if at all, the driver was pressing the accelerator and/or brake pedal
- How fast the vehicle was traveling

This data can help provide a better understanding of the circumstances in which crashes and injuries occur.

Important: EDR data is recorded by your vehicle only if a non-trivial crash situation occurs; no data is recorded by the EDR under normal driving conditions and no personal data (e.g., name, gender, age, and crash location) is recorded. However, other parties, such as law enforcement, could combine the EDR data with the type of personally identifying data routinely acquired during a crash investigation.

To read data recorded by an EDR, special equipment is required, and access to the vehicle or the EDR is needed. In addition to the vehicle manufacturer, other parties, such as law enforcement, that have the special equipment, can read the information if they have access to the vehicle or the EDR.

GM will not access this data or share it with others except: with the consent of the vehicle owner or, if the vehicle is leased, with the consent of the lessee; in response to an official request of police or similar government office; as part of GM's defense of litigation through the discovery process; or, as required by law. Data that GM collects or receives may also be used for GM research needs or may be made available to others for research purposes, where a need is shown and the data is not tied to a specific vehicle or vehicle owner.

OnStar®

If your vehicle has OnStar and you subscribe to the OnStar services, please refer to the OnStar Terms and Conditions for information on data collection and use. See also *OnStar® System on page 4-35* in this manual for more information.

Navigation System

If your vehicle has a navigation system, use of the system may result in the storage of destinations, addresses, telephone numbers, and other trip information. Refer to the navigation system operating manual for information on stored data and for deletion instructions.

Radio Frequency Identification (RFID)

RFID technology is used in some vehicles for functions such as tire pressure monitoring and ignition system security, as well as in connection with conveniences such as key fobs for remote door locking/unlocking and starting, and in-vehicle transmitters for garage door openers. RFID technology in GM vehicles does not use or record personal information or link with any other GM system containing personal information.

A

Accessories and
 Modifications 9-3
 Accessory Power Outlets 4-9
 Adding Equipment to Your
 Airbag-Equipped Vehicle 1-32
 Additives, Fuel 8-36
 Add-On Electrical
 Equipment 9-36
 Air Cleaner/Filter, Engine 9-11
 Air Conditioning 7-1, 7-4
 Airbag
 Passenger Status
 Indicator 4-14
 Readiness Light 4-13
 System, Replacing Parts
 After a Crash 1-33
 Airbag System 1-20
 Adding Equipment to Your
 Airbag-Equipped
 Vehicle 1-32
 Check 1-33
 How Does an Airbag
 Restrain? 1-25

Airbag System (cont.)
 Passenger Sensing
 System 1-27
 Servicing Your
 Airbag-Equipped
 Vehicle 1-31
 What Makes an Airbag
 Inflate? 1-25
 What Will You See After
 an Airbag Inflates? 1-25
 When Should an Airbag
 Inflate? 1-23
 Where Are the Airbags? 1-22
 Antenna, Fixed Mast 6-37
 Antenna, XM™ Satellite
 Radio Antenna System 6-37
 Antilock Brake
 System (ABS) 8-18
 Antilock Brake, System
 Warning Light 4-16
 Appearance Care
 Chemical Paint
 Spotting 9-102
 Exterior Cleaning 9-98

Appearance Care (cont.)
 Finish Damage 9-102
 Interior Cleaning 9-95
 Sheet Metal Damage 9-102
 Underbody Maintenance ... 9-102
 Appointments, Scheduling
 Service 12-8
 Audio System 6-1
 Audio Steering Wheel
 Controls 6-36
 Fixed Mast Antenna 6-37
 Radio Reception 6-36
 Setting the Clock 6-2
 Theft-Deterrent Feature 6-35
 XM™ Satellite Radio
 Antenna System 6-37
 Audio System(s) 6-3
 Automatic Climate Control
 System 7-4
 Automatic Headlamp
 System 5-2
 Automatic Transmission
 Operation 8-6

B

Battery	9-28
Run-Down Protection	5-4
Bluetooth®	6-25
Brake Fluid	9-25
Brakes	9-25
System Warning Light	4-15
Braking	8-17
Break-In, New Vehicle	8-2
Bulb Replacement	9-31
Front Turn Signal Lamps ...	9-33
Halogen Bulbs	9-31
Headlamp Aiming	9-28
Headlamps and Parking Lamps	9-31
License Plate Lamps	9-35
Replacement Bulbs	9-35
Taillamps	9-34
Buying New Tires	9-59

C

Calibration	2-16
California Fuel	8-35
California Perchlorate Materials Requirements	9-3

California Proposition 65 Warning	9-3
Canadian Owners	ii
Capacities and Specifications	10-2
Carbon Monoxide	2-10, 8-14, 8-27
Care, Safety Belts	1-19
Cautions and Notices	iii
CD, MP3	6-20
Center Console Storage Area	3-1
Chains, Tire	9-65
Charging System Light	4-15
Check Engine Lamp	4-18
Chemical Paint Spotting	9-102
Child Restraints Child Restraint Systems	1-39
Infants and Young Children	1-36
Lower Anchors and Tethers for Children	1-42
Older Children	1-34
Securing	1-48, 1-50
Where to Put the Restraint	1-40

Cleaning Exterior	9-98
Interior	9-95
Underbody Maintenance ...	9-102
Climate Control System	7-1
Automatic	7-4
Outlet Adjustment	7-9
Clock, Setting	6-2
Collision Damage Repair	12-10
Compact Spare Tire	9-83
Compass	2-16
Compressor Kit, Tire Sealant	9-67
Content Theft-Deterrent	2-13
Control of a Vehicle	8-17
Convenience Net	3-2
Coolant Engine	9-15
Engine Temperature Gage ...	4-17
Cooling System	9-13
Cruise Control	4-5
Cupholders	3-1

Customer Assistance
 Information
 Courtesy
 Transportation 12-4, 12-9
 Customer Assistance
 Offices 12-4
 Customer Satisfaction
 Procedure 12-1
 GM Mobility
 Reimbursement
 Program 12-5
 Reporting Safety Defects
 to General Motors 12-14
 Reporting Safety Defects
 to the Canadian
 Government 12-14
 Reporting Safety Defects
 to the United States
 Government 12-14
 Roadside Assistance
 Program 12-6
 Service Publications
 Ordering Information 12-15

D

Daytime Running Lamp 5-2
 Daytime Running Lamps
 Indicator Light 4-21
 Defensive Driving 8-16
 DIC Vehicle Customization 4-31
 Disc, MP3 6-20
 Doing Your Own Service
 Work 9-4
 Dome Lamps 5-4
 Door
 Ajar Light 4-21
 Locks 2-8
 Power Door Locks 2-9
 Rear Door Security
 Locks 2-9
 Driver Information
 Center (DIC) 4-22, 4-31
 DIC Operation and
 Displays 4-22
 DIC Warnings and
 Messages 4-26

Driving

At Night 8-24
 Before a Long Trip 8-26
 Defensive 8-16
 Drunken 8-16
 Highway Hypnosis 8-26
 Hill and Mountain Roads 8-26
 In Rain and on
 Wet Roads 8-25
 Rocking Your Vehicle to
 Get it Out 8-30
 Winter 8-27

E

EDR 12-16
 Electrical System
 Add-On Equipment 9-36
 Engine Compartment
 Fuse Block 9-38
 Headlamp Wiring 9-36
 Instrument Panel Fuse
 Block 9-36

Electrical System (cont.)	
Power Windows and	
Other Power Options	9-36
Rear Compartment	
Fuse Block	9-41
Windshield Wiper Fuses	9-36
Electronic Stability Program	8-19
Engine	
Air Cleaner/Filter	9-11
Check and Service Engine	
Soon Lamp	4-18
Coolant	9-15
Coolant Heater	8-5
Coolant	
Temperature Gage	4-17
Drive Belt Routing	11-14
Engine Compartment	
Overview	9-6
Exhaust	8-14
Oil	9-8
Oil Life System	9-10
Overheating	9-20
Starting	8-4
Event Data Recorders	12-16
Extender, Safety Belt	1-18
Exterior Lamps	5-1

F

Filter	
Engine Air Cleaner	9-11
Finish Damage	9-102
Fixed Mast Antenna	6-37
Flashers, Hazard Warning	4-4
Flat Tire	9-66
Flat Tire, Changing	9-75
Flat Tire, Storing	9-82
Fluid	
Power Steering	9-21
Windshield Washer	9-23
Fog Lamp	
Fog	5-3
Fog Lamp Light	4-20
Fuel	
Additives	8-36
California Fuel	8-35
Filling a Portable Fuel	
Container	8-38
Filling the Tank	8-37
Fuels in Foreign	
Countries	8-36
Gage	4-21
Gasoline Octane	8-35
Gasoline Specifications	8-35

Fuses

Engine Compartment	
Fuse Block	9-38
Instrument Panel Fuse	
Block	9-36
Rear Compartment Fuse	
Block	9-41
Windshield Wiper	9-36

G**Gage**

Engine Coolant	
Temperature	4-17
Fuel	4-21
Oil Pressure	4-21
Speedometer	4-12
Tachometer	4-12
Voltmeter Gage	4-15
Gasoline	
Octane	8-35
Specifications	8-35
Glove Box	3-1
GM Mobility Reimbursement	
Program	12-5

H

- Hazard Warning Flashers 4-4
- Head Restraints 1-4
- Headlamp
 - Aiming 9-28
- Headlamp Wiring 9-36
- Headlamps
 - Bulb Replacement 9-31
 - Daytime Running Lamp 5-2
 - Exterior Lamps 5-1
 - Front Turn Signal Lamps ... 9-33
 - Halogen Bulbs 9-31
 - Headlamps and Parking Lamps 9-31
 - High/Low Beam Changer 4-7
- Heater 7-1, 7-4
 - Engine Coolant 8-5
- Highbeam On Light 4-20
- High-Speed
 - Operation, Tires 9-51
- Highway Hypnosis 8-26
- Hill and Mountain Roads 8-26

Hood

- Release 9-5
- Horn 4-4
- How to Wear Safety Belts Properly 1-8

I

- Ignition Positions 8-2
- Immobilizer 2-11
- Immobilizer Operation 2-12
- Infants and Young Children, Restraints 1-36
- Inflation - Tire Pressure 9-49
- Inflator Kit, Tire 9-67
- Instrument Panel
 - Brightness 5-3
 - Cluster 4-11
 - Overview 4-2

J

- Jump Starting 9-84

K

- Keyless Entry System 2-3
- Keys 2-2

L

- Labeling, Tire Sidewall 9-42
- Lamp
 - Malfunction Indicator 4-18
- Lamps
 - Dome 5-4
 - Reading 5-4
- Lap-Shoulder Belt 1-14
- LATCH System
 - Replacing Parts After a Crash 1-47
- LATCH System for Child Restraints 1-42
- License Plate Lamps 9-35
- Light
 - Airbag Readiness 4-13
 - Antilock Brake System (ABS) Warning 4-16

Light (cont.)	
Brake System Warning	4-15
Charging System	4-15
Daytime Running Lamps	
Indicator	4-21
Door Ajar	4-21
Fog Lamp	4-20
Highbeam On	4-20
Passenger Airbag Status	
Indicator	4-14
Safety Belt Reminders	4-12
Security	4-20
Tire Pressure	4-17
Lighting	
Perimeter	5-4
Lights	
Exterior Lamps	5-1
High/Low Beam Changer	4-7
Loading Your Vehicle	8-30
Locks	
Door	2-8
Power Door	2-9
Rear Door Security Locks	2-9
Loss of Control	8-23
Lower Anchors and Tethers	
for Children	1-42
Lumbar Seat Adjustment	1-2

M

Maintenance Schedule	
Additional Required	
Services	11-6
At Each Fuel Fill	11-9
At Least Once a Month	11-9
At Least Once a Year	11-10
Introduction	11-1
Maintenance Footnotes	11-7
Maintenance Record	11-15
Maintenance	
Requirements	11-2
Normal Maintenance	
Replacement Parts	11-13
Owner Checks and	
Services	11-9
Recommended Fluids and	
Lubricants	11-12
Scheduled Maintenance	11-4
Using	11-2
Your Vehicle and the	
Environment	11-2
Malfunction Indicator Lamp	4-18
Manual Seats	1-2
Manual Transmission	
Operation	8-10

Message	
DIC Warnings and	
Messages	4-26
Mirrors	
Manual Rearview Mirror	2-16
Outside Convex Mirror	2-18
Outside Power Mirrors	2-17
MP3	6-20
MyGMLink.com	12-3

N

Navigation System,	
Privacy	12-17
New Vehicle Break-In	8-2
Normal Maintenance	
Replacement Parts	11-13
Notices and Cautions	iii

O

Off-Road Recovery	8-23
Oil	
Engine	9-8
Pressure Gage	4-21
Oil, Engine Oil Life System	9-10
Older Children, Restraints	1-34

Online Owner Center 12-3
 OnStar, Privacy 12-17
 OnStar® System, see
 OnStar® Manual 4-35
 Outlet Adjustment 7-9
 Outlets
 Accessory Power 4-9
 Outside
 Convex Mirror 2-18
 Power Mirrors 2-17
 Owner Checks and
 Services 11-9
 Owner Checks, Service 9-5
 Owners, Canadian ii

P

Paint, Damage 9-102
 Park
 Shifting Into 8-12
 Shifting Out of 8-13
 Park Brake 8-11
 Parking
 Over Things That Burn 8-14

Parking (cont.)
 Parking Your Vehicle 8-14
 Passenger Airbag Status
 Indicator 4-14
 Passenger Sensing
 System 1-27
 Passing 8-23
 Perchlorate Materials
 Requirements, California 9-3
 Perimeter Lighting 5-4
 Phone
 Bluetooth® 6-25
 Power
 Door Locks 2-9
 Electrical System 9-36
 Retained Accessory (RAP) 8-3
 Seat 1-2
 Steering Fluid 9-21
 Windows 2-15
 Pressure Cap 9-19
 Privacy 12-16
 Event Data Recorders 12-16
 Navigation System 12-17
 OnStar 12-17
 Radio Frequency
 Identification 12-17

R

Radio Frequency
 Identification
 (RFID), Privacy 12-17
 Radio(s) 6-3
 Radios
 Reception 6-36
 Setting the Clock 6-2
 Theft-Deterrent 6-35
 Reading Lamps 5-4
 Rear Door Security Locks 2-9
 Rear Heated Seats 1-5
 Rear Seat Operation 1-5
 Rearview Mirrors 2-16
 Reclining Seatbacks 1-3
 Recommended Fluids and
 Lubricants 11-12
 Recreational Vehicle Towing 9-89
 Remote Keyless Entry
 (RKE) System 2-3
 Remote Keyless Entry
 (RKE) System, Operation 2-4
 Remote Vehicle Start 2-6
 Removing the Flat Tire and
 Installing the Spare Tire 9-77

Removing the Spare Tire and Tools	9-76
Replacement Bulbs	9-35
Replacing LATCH System Parts After a Crash	1-47
Reporting Safety Defects Canadian Government	12-14
General Motors	12-14
United States Government	12-14
Restraint System Check Replacing Airbag System Parts After a Crash	1-33
Replacing Safety Belt System Parts After a Crash	1-19
Retained Accessory Power (RAP)	8-3
Roadside Assistance Program	12-6
Rocking Your Vehicle to Get it Out	8-30
Routing, Engine Drive Belt ...	11-14
Running the Vehicle While Parked	8-15

S

Safety Belt Reminders	4-12
Safety Belts	1-5
Care of	1-19
Check	1-18
How to Wear Safety Belts Properly	1-8
Lap-Shoulder Belt	1-14
Replacing Parts After a Crash	1-19
Safety Belt Extender	1-18
Safety Belt Use During Pregnancy	1-18
Scheduled Maintenance	11-4
Seats Head Restraints	1-4
Heated Seats - Rear	1-5
Lumbar Adjustment	1-2
Power Seats	1-2
Rear Seat Operation	1-5
Reclining Seatbacks	1-3
Securing Child Restraints	1-48, 1-50
Security Light	4-20

Service	9-2
Accessories and Modifications	9-3
Adding Equipment to the Outside of the Vehicle	9-4
California Perchlorate Materials Requirements	9-3
California Proposition 65 Warning	9-3
Doing Your Own Work	9-4
Engine Soon Lamp	4-18
Owner Checks	9-5
Publications Ordering Information	12-15
Service, Scheduling Appointments	12-8
Servicing Your Airbag-Equipped Vehicle	1-31
Setting the Clock	6-2
Sheet Metal Damage	9-102
Shifting Into Park	8-12
Shifting Out of Park	8-13
Signals, Turn and Lane-Change	4-7

Spare Tire
 Compact 9-83
 Installing 9-77
 Removing 9-76
 Storing 9-82
 Specifications, Capacities 10-2
 Speedometer 4-12
 Start Vehicle, Remote 2-6
 Starting the Engine 8-4
 Steering 8-22
 Steering Wheel Controls,
 Audio 6-36
 Steering Wheel, Tilt Wheel 4-4
 Storage Areas
 Center Console Storage
 Area 3-1
 Convenience Net 3-2
 Cupholders 3-1
 Glove Box 3-1
 Stuck in Sand, Mud, Ice, or
 Snow 8-29
 Sun Visors 2-15
 Sunroof 2-18

T

Tachometer 4-12
 Taillamps 9-34
 Theft-Deterrent, Radio 6-35
 Theft-Deterrent Systems 2-11
 Content Theft-Deterrent 2-13
 Immobilizer 2-11
 Immobilizer Operation 2-12
 Tilt Wheel 4-4
 Time, Setting 6-2
 Tire
 Pressure Light 4-17
 Tires 9-42
 Buying New Tires 9-59
 Chains 9-65
 Changing a Flat Tire 9-75
 Compact Spare Tire 9-83
 Different Size 9-61
 High-Speed Operation 9-51
 If a Tire Goes Flat 9-66
 Inflation - Tire Pressure 9-49
 Inspection and Rotation 9-57
 Installing the Spare Tire 9-77

Tires (cont.)

Pressure Monitor
 Operation 9-54
 Pressure Monitor
 System 9-52
 Removing the Flat Tire 9-77
 Removing the Spare
 Tire and Tools 9-76
 Storing a Flat or Spare
 Tire and Tools 9-82
 Tire Sealant and
 Compressor Kit 9-67
 Tire Sidewall Labeling 9-42
 Tire Terminology and
 Definitions 9-46
 Uniform Tire Quality
 Grading 9-62
 Wheel Alignment and
 Tire Balance 9-64
 Wheel Replacement 9-64
 When It Is Time for
 New Tires 9-59

Towing	
Recreational Vehicle	9-89
Towing a Trailer	9-89
Your Vehicle	9-88
Transmission Operation,	
Automatic	8-6
Transmission Operation,	
Manual	8-10
Trunk	2-10
Turn and Lane-Change	
Signals	4-7
Turn Signal/Multifunction	
Lever	4-4
U	
Uniform Tire Quality	
Grading	9-62
V	
Vehicle	
Control	8-17
Loading	8-30
Parking Your	8-14
Running While Parked	8-15

Vehicle Data Recording	
and Privacy	12-16
Vehicle Identification	
Number (VIN)	10-1
Service Parts Identification	
Label	10-1
Vehicle, Remote Start	2-6
Ventilation Adjustment	7-9
Visors	2-15
Voltmeter Gage	4-15

W

Warning Lights, Gages and	
Indicators	4-10
Warnings	
DIC Warnings and	
Messages	4-26
Hazard Warning Flashers	4-4
Wheels	
Alignment and Tire	
Balance	9-64
Different Size	9-61
Replacement	9-64
Where to Put the Restraint	1-40

Windows	2-14
Power	2-15
Windshield	
Washer	4-8
Washer Fluid	9-23
Wiper Blade	
Replacement	9-24
Wiper Fuses	9-36
Wipers	4-8
Winter Driving	8-27

X

XM Radio Messages	6-24
XM™ Satellite Radio	
Antenna System	6-37

Y

Your Vehicle and the	
Environment	11-2