

# ENGINE COOLING

## CONTENTS

\*106000153

GENERAL INFORMATION .....	2	THERMOSTAT .....	9
LUBRICANT .....	2	TROUBLESHOOTING .....	3
ON-VEHICLE SERVICE .....	5	WATER HOSE AND WATER PIPE	
Engine Coolant Concentration Test .....	5	<1.5L ENGINE> .....	13
Engine Coolant Leak Checking .....	5	<1.8L ENGINE> .....	15
Engine Coolant Replacement .....	5	WATER PUMP	
Radiator Cap Valve Opening Pressure Check .....	5	<1.5L ENGINE> .....	11
RADIATOR .....	6	<1.8L ENGINE> .....	12
SEALANTS .....	3		
SERVICE SPECIFICATIONS .....	2		

## GENERAL INFORMATION

14-0000000

The cooling system is designed to keep every part of the engine at appropriate temperature in whatever condition the engine may be operated. The cooling method is of the water-cooled, pressure forced circulation type in which the water pump pressurizes coolant and circulates it throughout the engine. If the coolant temperature exceeds the prescribed temperature, the thermostat opens to circulate the coolant through the radiator as well so that the heat absorbed by the coolant may be radiated into the air.

The water pump is of the centrifugal type and is driven by the timing belt or drive belt from the crankshaft.

The radiator is the corrugated fin, down flow type and is cooled by the electrical radiator fan.

The electrical radiator fan is controlled by the engine control module in accordance with the engine running condition.

## CONSTRUCTION DIAGRAM

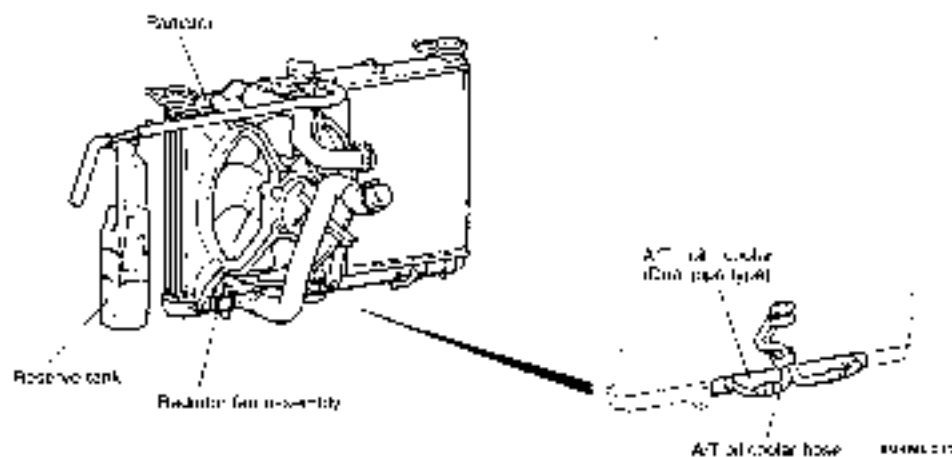

## SERVICE SPECIFICATIONS

14-0000000

Items	Standard value	Limit
High pressure valve opening pressure of radiator cap (kPa (psi))	74 - 133 (11 - 15)	64 (9.2)
Thermostat		
Valve opening temperature of thermostat (°C (°F))	82 ± 1.5 (180 ± 3)	-
Full-opening temperature of thermostat (°C (°F))	95 (203)	-
Valve lift (at 95 °C (203 °F)) (mm (in.))	8.5 (0.33) or more	-

## LUBRICANT

14-0000000

Items	Quantity (dm <sup>3</sup> (qt.))
HIGH QUALITY ETHYLENE GLYCOL ANTIFREEZE COOLANT	
1.5L Engine	5 (5.3)
1.8L Engine	6 (6.3)

## SEALANTS

14-10000-103

Items	Specified coolant
Water pump (the most cases of El. Engines)	Mitsubishi Genuine Parts No. MD970089 or equivalent

## TROUBLESHOOTING

14-10007-008

## TROUBLE SYMPTOM

Overheat		Remedy
Inoperative electric cooling fan	Faulty electrical motor	Replace
	Faulty radiator fan relay	Replace
Water leaks	Damaged radiator core joint	Replace
	Corroded or cracked hoses (radiator hose, heater hose, etc.)	Replace
	Faulty radiator cap valve or setting of spring	Replace
	Cracked intake manifold	Replace
	Cracked thermostat housing	Replace
	Loose bolts or leaking gasket in water outlet fitting	Torque bolts again or replace gasket
	Loose bolts or leaking gasket in water inlet fitting	Torque bolts again or replace gasket
	Loose water pump mounting bolts or leaking gasket	Torque bolts again or replace gasket
Faulty A/T or cooler operation	Blocked or collapsed hose and pipe	Replace
	Loose hose and band connection	Correct
Others	Insufficient engine coolant	Fill
	Too high an anti-freeze concentration	Correct anti-freeze concentration
	Loose or broken drive belt	Replace
	Damaged or blocked (insufficiently ventilated) radiator fins	Correct
	Faulty thermostat operation	Replace
	Faulty water pump operation	Replace
	Water passage clogged with slime or rust deposit or foreign substance	Clean

## No Rise in Temperature

Probable cause	Remedy
Faulty thermostat	Replace

## TROUBLESHOOTING HINTS

- Radiator fan only does not operate
  - Check fusible link No.5.
  - Check the radiator fan motor relay.
  - Check the engine control module.
  - Check the radiator fan motor.
- Condenser fan only does not operate.
  - Check fusible link No.2.
  - Check dedicated fuse No.1.
  - Check the condenser fan motor.
  - Check the condenser fan motor relay.
  - Check the engine control module.

## Fan Operating Mode

- Neither radiator fan nor condenser fan operates
  - Check fusible link No.2, 5.
  - Check dedicated fuse No.1.
  - Check the condenser fan motor or radiator fan motor.
  - Check the condenser fan motor relay or radiator fan motor relay.
  - Check the engine control module.

## Fan Operating mode

A/C switch	Engine coolant temperature [ °C ( °F) ]	Power transistor [Radiator fan]	Power transistor [Condenser fan]	Radiator fan operation	Condenser fan operation
OFF	Approx. 95 (203) or less	OFF	OFF	Stopped	Stopped
	Approx. 95 - 105 (203 - 221)	ON	OFF	Rotated	Stopped
	Approx. 106 (203) or more	ON	ON	Rotated	Rotated
ON	-	ON	ON	Rotated	Rotated

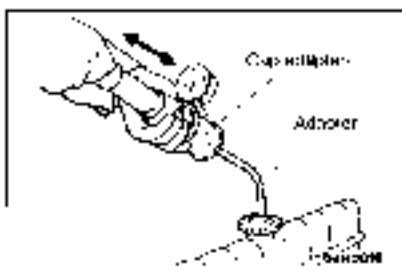

## ON-VEHICLE SERVICE

14100100020

### ENGINE COOLANT LEAK CHECK

1. Check that the coolant level is up to the filler neck. Install a radiator cap tester and apply 160 kPa (23 psig) pressure, and then check for leakage: from the radiator hose or connections.

#### Caution

1. Be sure to completely clean away any moisture from the places checked.
  2. When the tester is taken out, be careful not to spill any coolant from it.
  3. Be careful, when installing and removing the tester and when testing, not to deform the filler neck of the radiator.
2. If there is leakage, repair or replace the appropriate part.



### RADIATOR CAP VALVE OPENING PRESSURE CHECK

14100100030

1. Use a cap adapter to attach the cap to the tester.
2. Increase the pressure until the indicator of the gauge stops moving.

Limit: 64 kPa (9.2 psig)

Standard value: 74 – 103 kPa (11 – 15 psig)

3. Replace the radiator cap if the reading does not remain at or above the limit.

#### NOTE

Be sure that the cap is clean before testing, since rust or other foreign material on the cap seal will cause an improper indication.

### ENGINE COOLANT REPLACEMENT

14100100040

Refer to GROUP 00 - Maintenance Service

### ENGINE COOLANT CONCENTRATION TEST

14100100050

Refer to GROUP 00 - RECOMMENDED LUBRICANTS AND LUBRICANT CAPACITIES TABLE

## RADIATOR

## REMOVAL AND INSTALLATION

## Pre-removal operation

- 1) Fill a Cooler Drainage  
(Refer to GROUP 30 - Maintenance Service)
- 2) Air Cleaner Removal of 5 - Engine

## Post-installation Operation

- 1) Engine Coolant Supplying  
(Refer to GROUP 30 - Maintenance Service)
- 2) A/C Filter Supplying and Checking  
(Refer to GROUP 30 - Maintenance Service)
- 3) Air Cleaner Installation of 5 - Engine

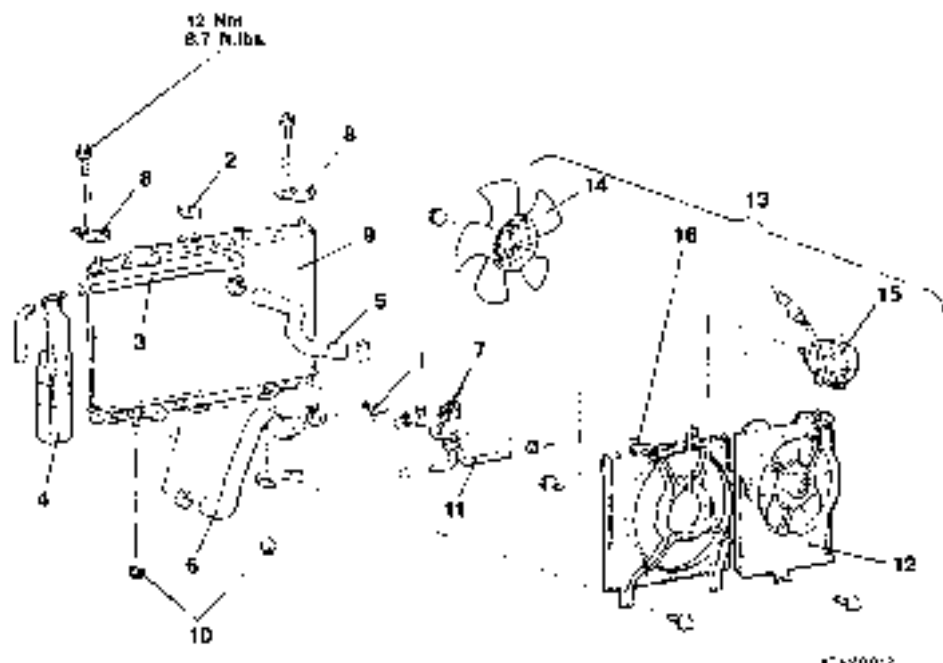

\*24700-2

## Radiator removal steps

- 1 Drain plug
- 2 Radiator cap
- 3 Overflow hose
- 4 Reserve tank
- 5 Radiator upper hose
- 6 Radiator lower hose
- 7 A/C oil cooler hose connection
- 8 Upper insulator
- 9 Radiator assembly
- 10 Lower insulator
- 11 A/C oil cooler hose assembly
- 12 Condenser fan motor assembly (vehicle with A/C)
- 13 Radiator fan motor assembly

## Radiator fan motor removal steps

- 1 Drain plug
- 2 Radiator cap
- 3 Overflow hose
- 4 Radiator upper hose
- 12 Condenser fan motor assembly (vehicle with A/C)
- 14 Fan
- 15 Radiator fan motor
- 16 Shroud

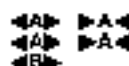

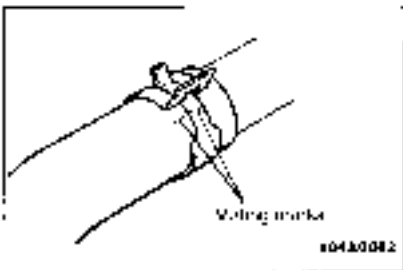
**REMOVAL SERVICE POINTS****◀▶ RADIATOR UPPER HOSE/RADIATOR LOWER HOSE DISCONNECTION**

After making mating marks on the radiator hose and the hose clamp, disconnect the radiator hose.

**◀▶ A/T OIL COOLER HOSE REMOVAL**

After removing the hose from the radiator, plug the hose and the radiator nipple to prevent dust or foreign particles from getting in.

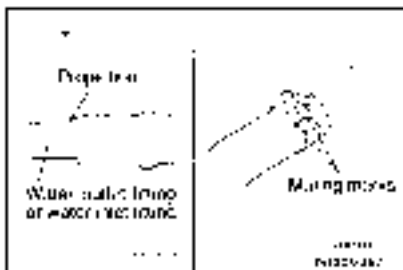
**INSTALLATION SERVICE POINT****▶▶ RADIATOR LOWER HOSE/RADIATOR UPPER HOSE CONNECTION**

1. Insert each hose as far as the projection of the water inlet fitting.
2. Align the mating marks on the radiator hose and hose clamp, and then connect the radiator hose.

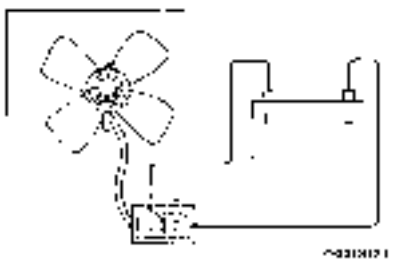
**INSPECTION**

14100180110

**RADIATOR FAN MOTOR CHECK**

1. Check to be sure that the radiator fan rotates when battery voltage is applied between terminals (as shown in the figure).
2. Check to see that abnormal noises are not produced while the motor is turning.

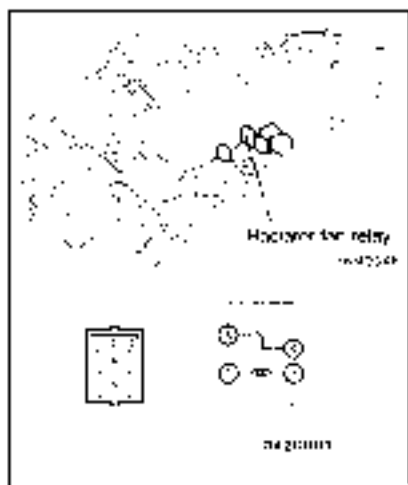

## RADIATOR FAN RELAY CONTINUITY CHECK

14 100445 (1R)

Battery voltage

Terminal No

1 2 4 5

Not supplied

.. . . .

Supplied

. . . . .



## THERMOSTAT

1.81027.00000

## REMOVAL AND INSTALLATION

## Pre-removal and Post-Installation Operation

- (1) Engine Circuit Bleeding and Supplying  
 (Refer to GROUP 03 - Maintenance Service I)
- (2) Air Circulation Removal and Installation - 1.5L Engine

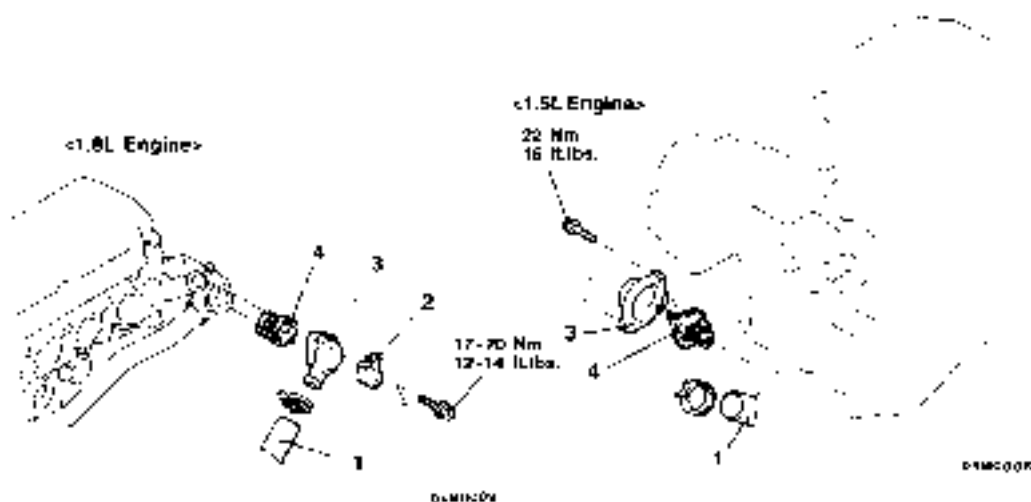

## Removal steps

- ◀A▶ ▶B▶
1. Radiator lower hose connection
  2. Connector bracket  
 (Vehicles for California)
  3. Water inlet fitting
  - ▶A▶ 4. Thermostat

## REMOVAL SERVICE POINT

## ◀A▶ RADIATOR LOWER HOSE DISCONNECTION

After making marking marks on the radiator hose and the hose clamp, disconnect the radiator hose.

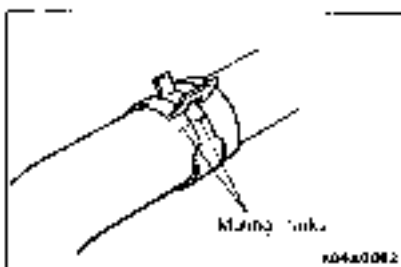

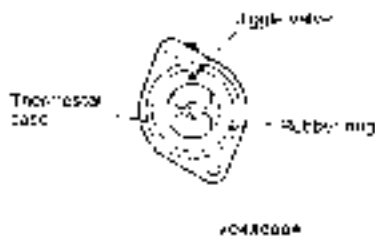

## INSTALLATION SERVICE POINTS

### ►A◄ THERMOSTAT INSTALLATION

Install the thermostat so that the jiggle valve is facing straight up.

#### Caution

Make absolutely sure that no oil adheres to the rubber ring of the thermostat. In addition, be careful not to fold over or scratch the rubber ring when inserting it the rubber ring is damaged, replace the thermostat.

### ►B◄ RADIATOR LOWER HOSE CONNECTION

1. Insert each hose as far as the projection of the water inlet fitting.
2. Align the mating marks on the radiator hose and hose clamp, and then connect the radiator hose.

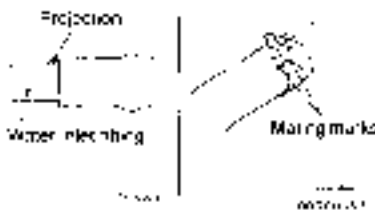

## INSPECTION

### THERMOSTAT CHECK

1. Immerse the thermostat in water, and heat the water while stirring. Check the thermostat valve opening temperature.

Standard value:

Valve opening temperature:  $82 \pm 1.5$  C ( $180 \pm 3$  F)

2. Check that the amount of valve lift is at the standard value when the water is at the full-opening temperature.

Standard value:

Full opening temperature (C   F)	Amount of valve lift (mm)
95 (203)	6.5 (.26) or more

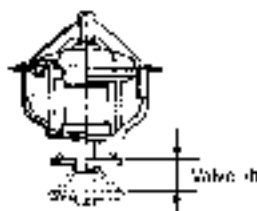

#### NOTE

Measure the valve height when the thermostat is fully closed, and use this measurement to calculate the valve height when the thermostat is fully open.

## WATER PUMP &lt;1.5L Engine&gt;

1410079439

## REMOVAL AND INSTALLATION

## Pre-removal and Post-Installation Operation

1. Engine Coolant Draining and Supplying  
(Refer to GROUP 00 - Maintenance Service)
2. Timing Belt and Tension Belt Torque: Removal and Installation  
(Refer to GROUP 11a)

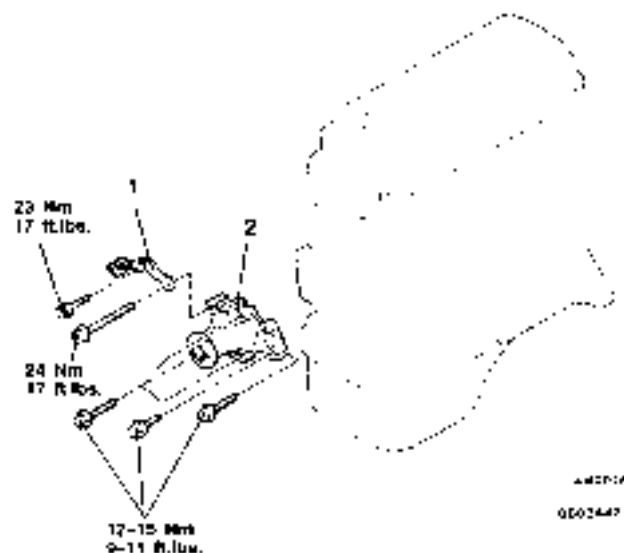

## Bolt specifications

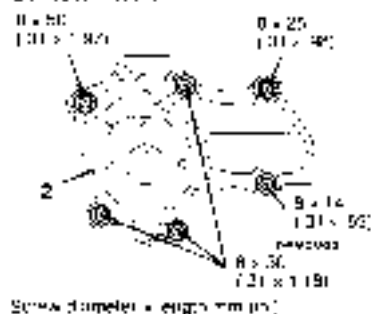

## Removal steps

1. Generator brace
  2. Water pump
- ▶A◀

## INSTALLATION SERVICE POINT

## ▶A◀ WATER PUMP INSTALLATION

Squeeze out the sealant from the tube evenly and apply it so that there is not too much sealant and no places without sealant.

## Specified Sealant:

Mitsubishi Genuine Part No. MD970389 or equivalent

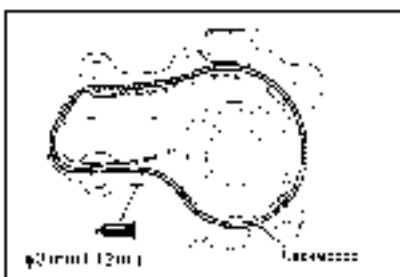

## WATER PUMP <1.8L ENGINE>

### REMOVAL AND INSTALLATION

- Pre-removal and Post-Installation Operation**
- (1) Engine Cooling Draining and Supplying  
(Refer to GROUP 09 - Maintenance Service)
  - (2) Timing Belt Removal and Installation  
(Refer to GROUP 1-B)

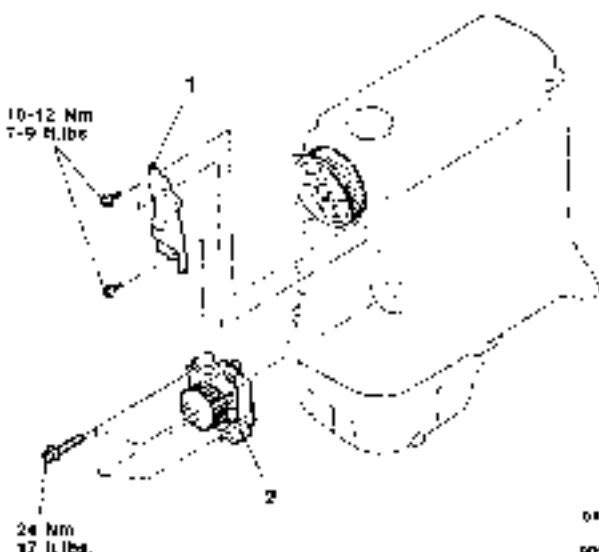

#### Removal steps

1. Timing belt rear cover
- ▶◀ 2. Water pump

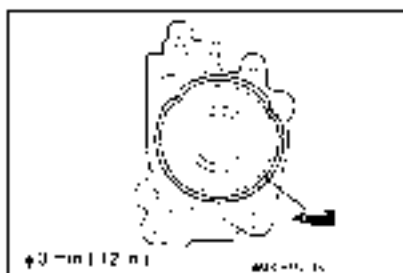
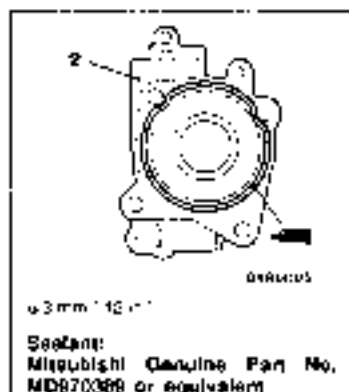

### INSTALLATION SERVICE POINT

#### ▶◀ WATER PUMP INSTALLATION

Squeeze out the sealant from the tube evenly and apply it so that there is not too much sealant and no places without sealant.

Specified Sealant:

Mitsubishi Genuine Part No. MD970389 or equivalent

## WATER HOSE AND WATER PIPE &lt;1.5L ENGINE&gt;

14-00330375

## REMOVAL AND INSTALLATION

- Pre-removal and Post-installation Operation**  
 (1) Engine Cooling System Air Bleeding  
 (Refer to GROUP 00 - Maintenance Systems)  
 (2) Air Filter Removal and Installation

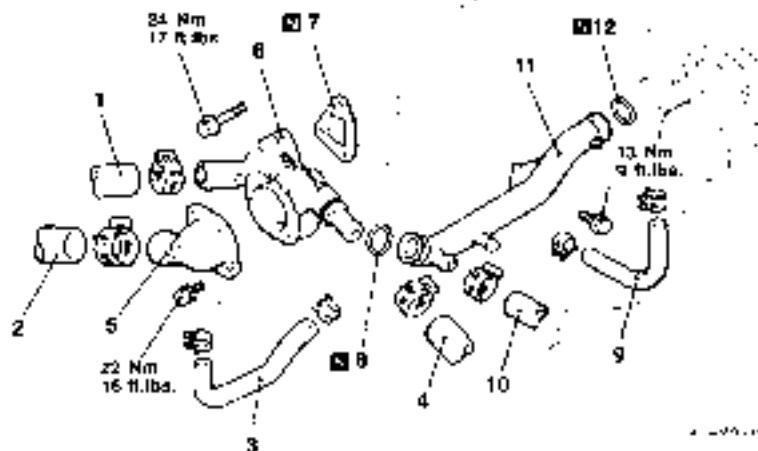

## Removal steps

- |     |     |                                   |                               |
|-----|-----|-----------------------------------|-------------------------------|
| ◀A▶ | ▶B▶ | 1. Radiator upper hose connection | 7. Gasket                     |
| ◀A▶ | ▶B▶ | 2. Radiator lower hose connection | ▶A▶ 8. O-ring                 |
|     |     | 3. Water hose                     | 9. Water hose                 |
|     |     | 4. Heater hose connection         | 10. Heater hose connector     |
|     |     | 5. Water inlet fitting            | 11. Water inlet pipe assembly |
|     |     | 6. Thermostat base assembly       | ▶A▶ 12. O-ring                |

## REMOVAL SERVICE POINT

## ◀A▶ RADIATOR UPPER HOSE/RADIATOR LOWER HOSE DISCONNECTION

After making mating marks on the radiator hose and the hose clamp, disconnect the radiator hose.

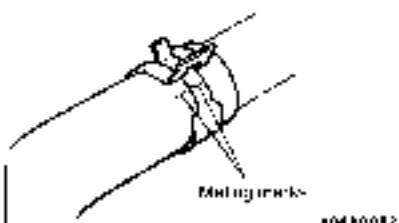

\*0430082

Thermostat cover assembly on water pump

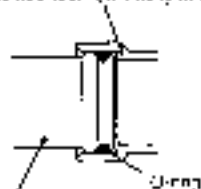

90440001

## INSTALLATION SERVICE POINTS

### ▶A◀ O-RING INSTALLATION

Insert the O-ring to the water inlet pipe assembly and coat the outer portion of the O-ring with water or engine coolant.

#### Caution

Do not allow engine oil or other grease to adhere to the O-ring.

### ▶B◀ RADIATOR UPPER HOSE/RADIATOR LOWER HOSE CONNECTION

1. Insert each hose as far as the projection of the water inlet fitting.
2. Align the mating marks on the radiator hose and hose clamp, and then connect the radiator hose.

Projection

Water inlet fitting  
or water inlet fitting

Mating mark

90440002

## INSPECTION

### WATER PIPE AND HOSE CHECK

Check the water pipe and hose for cracks, damage and clogs. Replace them if necessary.

## WATER HOSE AND WATER PIPE &lt;1.8L ENGINE&gt;

1410033030

## REMOVAL AND INSTALLATION

## Pre-removal and Post-installation Operation

- (1) Engine Coolant Draining and Supplying  
(Refer to GROUP 06 - Maintenance Service.)
- (2) Air Cleaner Removal and Installation  
(Refer to GROUP 16.)

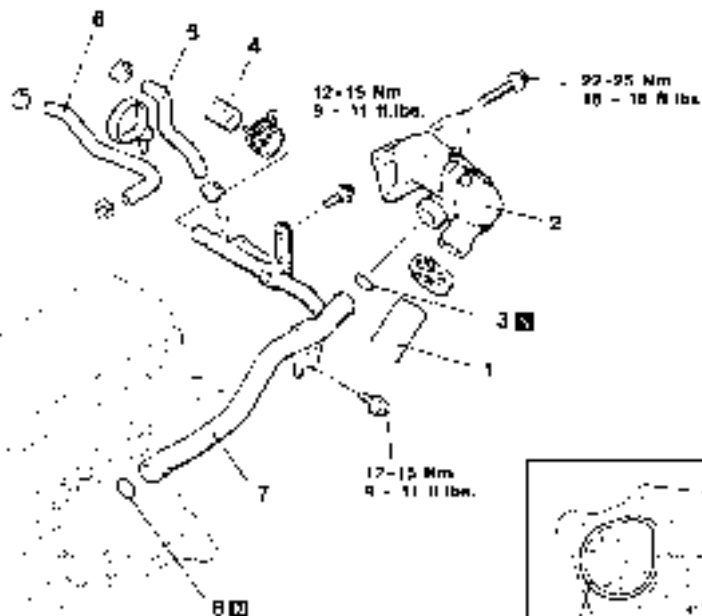

GRAPHIC

00001747

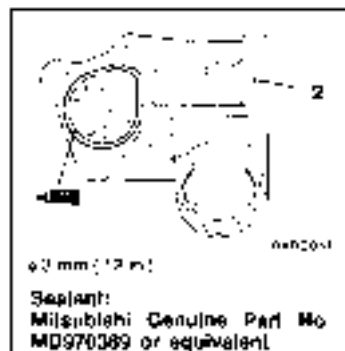

## Removal steps

- ◀A▶ ▶C▶ 1. Radiator lower hose connection
- ▶B▶ 2. Thermostat case assembly
- ▶A▶ 3. O-ring
- ▶A▶ 4. Heater hose connector
- ▶A▶ 5. Water hose
- ▶A▶ 6. Water hose
- ▶A▶ 7. Water inlet pipe assembly
- ▶A▶ 8. O-ring

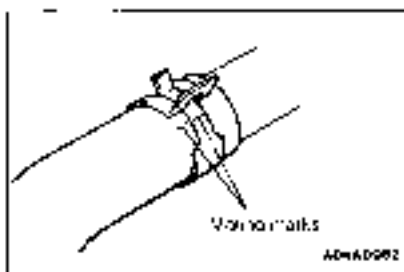

**REMOVAL SERVICE POINT**

**◀A▶ RADIATOR LOWER HOSE DISCONNECTION**

After making mating marks on the radiator hose and the hose clamp, disconnect the radiator hose.

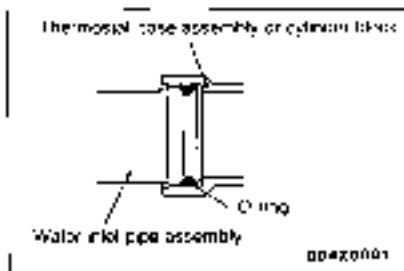

**INSTALLATION SERVICE POINTS**

**▶A◀ O-RING INSTALLATION**

Insert the O-ring to the water inlet pipe assembly, and coat the outer circumference of the O-ring with water or engine coolant.

**Caution**

Do not allow engine oil or other greases to adhere to the O-ring.

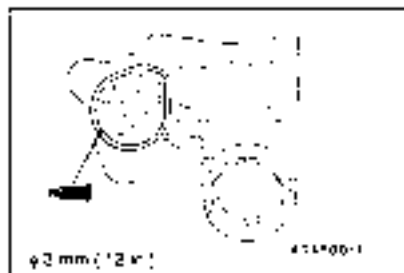

**▶B◀ THERMOSTAT CASE ASSEMBLY INSTALLATION**

Squeeze out the sealant from the tube evenly and apply it so that there is not too much sealant and no places without sealant.

**Specified Sealant:**

Mitsubishi Genuine Parts No. MD970089 or equivalent

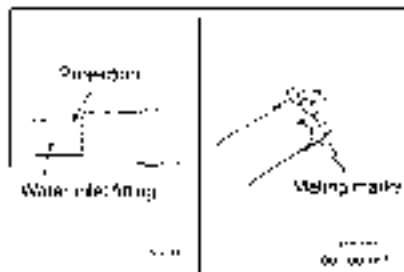

**▶C◀ RADIATOR LOWER HOSE CONNECTION**

1. Insert each hose as far as the projection of the water inlet fitting.
2. Align the mating marks on the radiator hose and hose clamp, and then connect the radiator hose.

**INSPECTION**

**WATER PIPE AND HOSE CHECK**

Check the water pipe and hose for cracks, damage and clogs. Replace them if necessary.