

FLUENCE Z.E.

DRIVER'S HANDBOOK

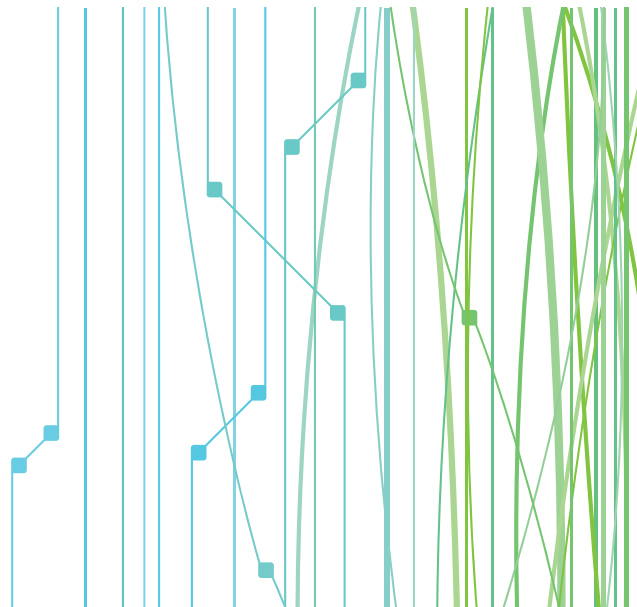

Welcome to your new electric vehicle

This driver's handbook contains the information necessary:

- for you to familiarise yourself with your vehicle, to use it to its best advantage and to benefit fully from all the functions and the technical developments it incorporates.
- to ensure that it always gives the best performance by following the simple, but comprehensive advice concerning regular maintenance.
- to enable you to deal quickly with minor faults not requiring specialist attention.

It is well worth taking a few minutes to read this handbook to familiarise yourself with the information and guidelines it contains about the vehicle and its functions and new features. If certain points are still unclear, our Network technicians will be only too pleased to provide you with any additional information.

The following symbol will help you when reading this handbook:



To indicate a hazard, danger or safety recommendation.

The descriptions of the models given in this handbook are based on the technical specifications at the time of writing. **This handbook covers all items of equipment** (both standard and optional) **available for these models but whether or not these are fitted to the vehicle depends on the version, options selected and the country where the vehicle is sold.**

This handbook may also contain information about items of equipment to be introduced later in the model year.

Throughout the manual, the “approved Dealer” is your RENAULT Dealer.

Enjoy driving your new vehicle.

Translated from French. Copying or translation, in part or in full, is forbidden unless prior written permission has been obtained from the vehicle manufacturer.



C O N T E N T S

Sections

Getting to know your vehicle

1

Driving

2

Your comfort

3

Maintenance

4

Practical advice

5

Technical specifications

6

Alphabetical index

7



Section 1: Getting to know your vehicle

Electric vehicle: introduction	1.2
Important recommendations	1.7
Electric vehicle: charging.	1.8
Traction battery quick change system.	1.14
Key, radio frequency remote control: general information, use, deadlocking	1.15
Doors.	1.17
Automatic locking when driving.	1.21
Headrests - Seats	1.22
Seat belts.	1.26
Methods of restraint in addition to the child seat belts.	1.29
in addition to the rear seat belts.	1.33
side protection	1.34
Steering wheel/Power-assisted steering.	1.36
Child safety: general information.	1.37
Choosing a child seat mounting.	1.40
fitting a child seat	1.42
deactivating, activating the front passenger airbag	1.46
Clock and exterior temperature	1.49
Driving position	1.50
Warning lights	1.54
Displays and indicators	1.57
On-board computer	1.59
Vehicle settings personalisation menu	1.68
Door mirrors.	1.69
Audible and visual signals.	1.70
Exterior lighting and signals.	1.71
Adjusting the headlight beam height.	1.74
Windscreen washers and wipers.	1.75

ELECTRIC VEHICLE: introduction (1/5)

35408

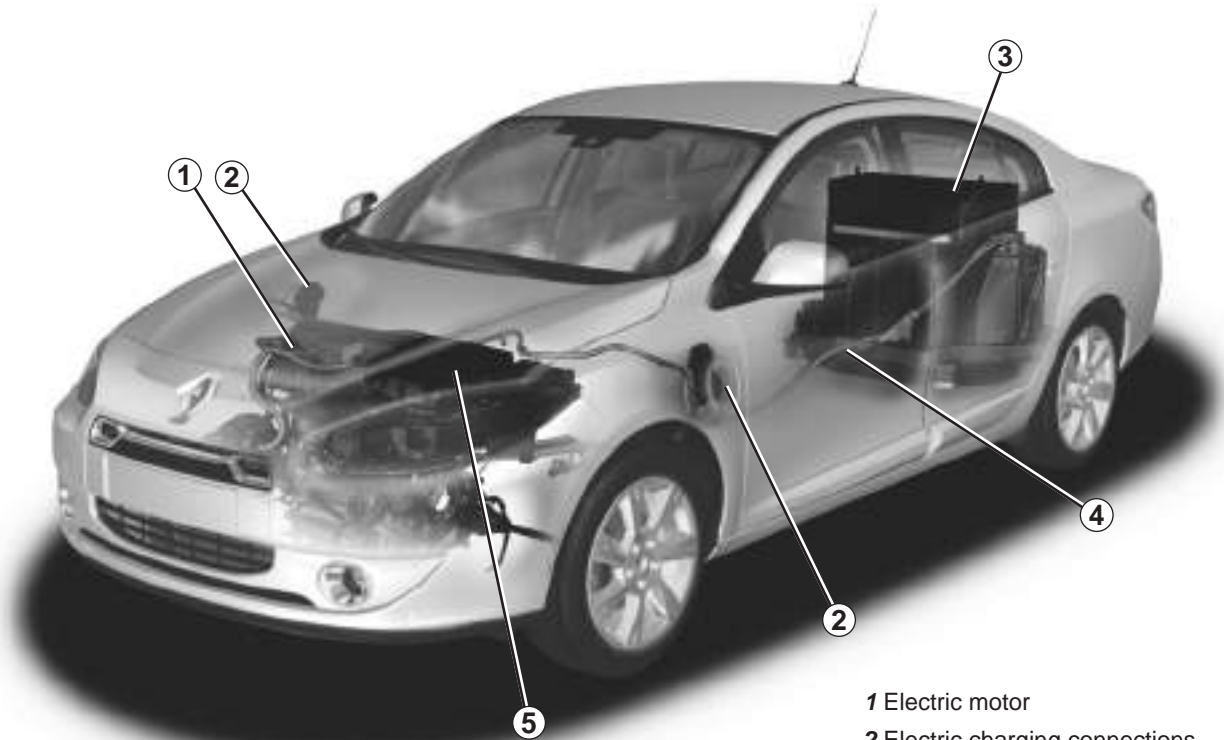

- 1 Electric motor
- 2 Electric charging connections
- 3 Traction battery
- 4 Orange electrical power cables
- 5 12 volt battery

ELECTRIC VEHICLE: introduction (2/5)

Electric vehicles have special features, but operate in a similar manner to conventional vehicles.

The main difference in electric vehicles is the exclusive use of electric energy instead of fuel, as used in convention vehicles.

We therefore recommend that you read these instructions describing your electric vehicle carefully.

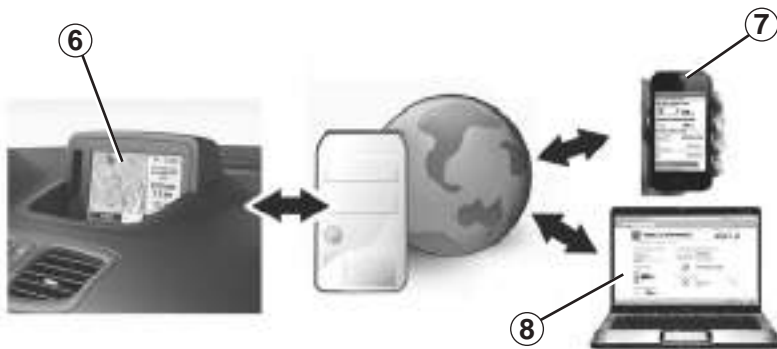

Connected services

(depending on vehicle)

Your electric vehicle has connected services which enable it to determine the charge status, among other things, using mobile phones **7** or your computer **8**. This information is also available directly on the instrument panel **6** of your vehicle.

For further information, please contact an authorised dealer.

You can subscribe to a connected service or extend it at any time by consulting an authorised dealer.

ELECTRIC VEHICLE: introduction (3/5)

Batteries

Your electric vehicle has two types of battery:

- a 400V traction battery;
- a standard 12V battery, identical to the one used in conventional vehicles.

400 V traction battery

This battery stores the energy necessary to operate the motor in your electric vehicle properly. As with any battery, it discharges after use, and must be regularly recharged.

You do not have to wait until the traction battery hits the reserve level in order to recharge it.

Charging times vary between 10 and 12 hours from a domestic power supply, or 6 to 9 hours with a special wall socket or public terminal.

Your vehicle range will depend on the charge level of the traction battery, and also on your driving style.

Please refer to information on “Vehicle range: recommendations” in Section 2.

12 volt battery

The second battery on your vehicle is a 12 V battery, similar to those used on conventional vehicles: this supplies the energy required to operate vehicle equipment (lights, washer/wipers, audio system, etc).

ELECTRIC VEHICLE: introduction (4/5)

A



The **A** symbol denotes the electrical elements of your vehicle which may present health risks.

53438



400 volt electrical circuit

The 400V electrical circuit is denoted by orange cables **4** and parts bearing the ⚠ symbol.



The vehicle drive system in an electric vehicle uses an alternating voltage of approximately 400 volts. This system can get hot during and after switching off the ignition. Respect warning messages given on the labels in the vehicle.

All interventions or modifications to the 400V electrical system (components, cables, connectors, traction battery) are strictly prohibited due to the risks they present to your safety. Please contact an authorised dealer.

The risk of serious burns or electric shocks can lead to death.

ELECTRIC VEHICLE: introduction (5/5)

Driving

As with a car with an automatic gearbox, you will have to get used to not using your left foot, and not using this foot to brake.

When driving, if you lift your foot off the accelerator pedal or depress the brake pedal, the motor generates electrical current during deceleration, and this energy is used to brake the vehicle and recharge the traction battery. Please refer to the information on the “Charge meter” in Section 2.

An electric motor generates a greater engine brake than in a petrol or diesel engine vehicle.

Special conditions

After a maximum charge of the battery and during the first few miles of using the vehicle, the engine brake will be temporarily reduced. Please adapt your driving style appropriately.



The engine brake should under no circumstances be used as a substitute for the brake pedal.

Bad weather, flooded roads:



Do not drive through floods if the depth of water is above the lower edge of the wheel rims.



Obstructions to the driver

On the driver's side, only use mats suitable for the vehicle, attached with the pre-fitted components, and check the fitting regularly. Do not lay one mat on top of another.

There is a risk of wedging the pedals

Noise

Electric vehicles are particularly quiet. You will not yet necessarily be used to it, and neither will other road users. It is difficult for them to hear the vehicle when it is moving. We recommend that you take this into account, especially when driving in urban environments and when performing manoeuvres.

As the motor is silent, you will hear noises that you are not used to hearing (aerodynamic noises, tyre noise, etc.)

When charging, the vehicle may emit noises (fan, relays, etc).



Your electric vehicle is very quiet. When getting out of the vehicle, always check that the gear selector is at **P**, engage the handbrake and switch off the ignition.

RISK OF SERIOUS INJURY

IMPORTANT RECOMMENDATIONS



Please read these instructions carefully. Failure to follow these instructions may lead to a **risk of fire, serious injury or electric shock which may present a risk to life.**

In the event of an accident or impact

In the event of an accident or an impact to the underside of the vehicle (e.g.: striking a post, raised kerb or other street furniture), this may damage the electric circuit or the traction battery.

Have the vehicle checked by an authorised dealer.

Never touch the “400 volt” components or orange cables which are exposed and visible inside or outside the vehicle.

In the event of serious damage to the traction battery, leaks may occur:

- never touch the liquids (fluids, etc.) coming from the traction battery;
- in the event of contact with the body, wash the affected area with plenty of water and consult a doctor as soon as possible.

In the event of an impact, even slight, against the charging flap and/or valve, have them checked by an authorised dealer as soon as possible.

In the event of fire

In the event of fire, make everyone evacuate the vehicle immediately and contact the emergency services, informing them that this is an electric vehicle.

Only use extinguishing agents ABC or BC that are permitted for use with electrical fires. Do not use water or other extinguishing agents.

In the event of damage to the electrical circuit, please call an authorised dealer.

All towing operations

Please refer to the information on “Towing, breakdowns” in Section 5.

Washing the vehicle

Never wash the engine compartment, the charging connection or the traction battery with a high-pressure jet.

This risks damaging the electric circuit.

Never wash the vehicle while it is charging.

Risk of electric shock and a risk to life.

ELECTRIC VEHICLE: charging (1/6)



Charging schematic diagram

- 1 Electric charging connections
- 2 Specific wall socket or recharging terminal
- 3 Charging cord

If you have any questions regarding the equipment needed for charging, please ask an authorised dealer.



Important recommendations for charging your vehicle

Please read these instructions carefully. Failure to follow these instructions may lead to **a risk of fire, serious injury or electric shocks which could result in death.**

Installation for using a standard charging cord

Have a special wall socket installed by a qualified professional.

Installation for using an occasional charging cord

Have a qualified professional check that each socket you intend to use with the occasional charging cord complies with the standards and regulations in force in your country, especially that they have:

- a Type A residual differential current of 30 mA;
- a device to protect against overvoltage (16A fuse or circuit breaker for the socket used);
- protection against overvoltage relating to lightning in exposed areas.

You are recommended to test the residual differential current device every month.

You are recommended to check regularly the domestic power supply as well as the special wall socket. In the event of deterioration (corrosion, browning, etc.), do not use it.

Please read the instructions that come with the occasional charging cord carefully to learn about usage precautions and how to use the cord.

Charging

Do not do anything to the vehicle during charging (washing, working in the engine compartment, etc.).

In the event of the presence of water, signs of corrosion or foreign bodies in the charging cord connector or in the vehicle charging socket, do not charge the vehicle. Fire hazard.

Do not attempt to touch the cord contacts, the domestic socket or the vehicle charging socket, or introduce objects into them. Never plug the charging cord into a multiple socket or an extension lead.

Do not remove or change the vehicle charging socket or the charging cord. Fire hazard.

Do not modify the installation during charging.

In the event of an impact, even slight, against the charging socket or valve, have them checked by an authorised dealer as soon as possible.

Take care of the cord: do not tread on it, immerse it in water or pull on it or let anything knock against it. Check regularly that the charging cord is in good condition. In the event of deterioration (corrosion, browning, cuts, etc.), do not use it.

ELECTRIC VEHICLE: charging (3/6)



Charging cord for standard

You are recommended to use cord **3** as a priority for charging the traction battery.

charging 3

This cord, designed specifically for wall sockets or public terminals, enables a full recharge of the traction battery in around 6 to 9 hours.

Charging cords **3** and **4** are stored in a bag in the boot of the vehicle.

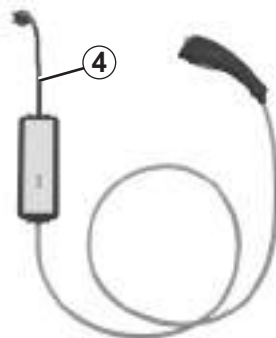

Occasional usage charging cord 4

(depending on vehicle)

This occasional charging cord **4**, for domestic sockets, enables a full recharge of the traction battery in around 10 to 12 hours.

This cord **4** should only be used for occasional charges in accordance with the installation conditions set out above.

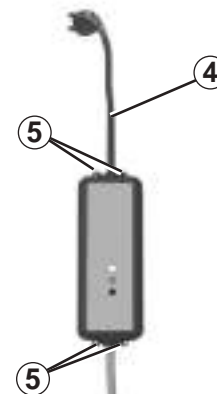

Never leave the socket hanging by the cord. Use points **5** to hold it.



Do not use an extension lead, multiple socket or adapter.
Fire hazard.

In the event of a problem, we recommend that you replace it with an identical cord. Please see an authorised dealer.

ELECTRIC VEHICLE: charging (4/6)



Charging sockets 1

The vehicle has a charging socket on each side of the vehicle.

Do not connect a cord at both vehicle charging sockets at the same time.

Avoid charging and parking your vehicle in extreme temperatures (hot or cold).

When the vehicle is parked in temperatures lower than around -25°C , the battery cannot be charged.

Favour charging the traction battery after driving and/or in mild temperatures. Otherwise, charging may take a longer period of time or even become impossible.

In the absence of any protection against overvoltage, you are recommended not to charge the vehicle in stormy weather (lightning, etc).

Recommendations

- In high temperatures, try to park and recharge the vehicle in a shaded/covered location.
- Charging can be performed in the rain or snow.

Note:

If in a snowy environment, remove snow from the vehicle charging area before plugging in or disconnecting. Snow in the socket may block the insertion of the charging cord plug.

ELECTRIC VEHICLE: charging (5/6)

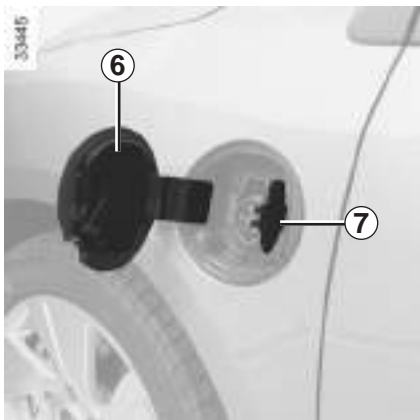

Recharging the traction battery

Switch the ignition off and unlock the opening elements:

- take the charging cord located in the boot of your vehicle;
- remove it from its storage bag;
- plug in the end of the cord to the power supply (terminal, domestic plug socket, etc);

The charging cord cannot be plugged in or removed while the opening elements are locked.

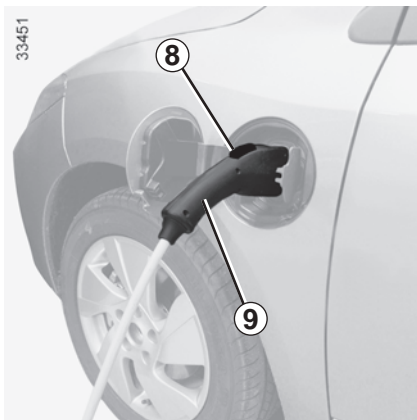

- open charging flap **6**;
- open valve **7**;
- grab handle **9**;
- plug in the vehicle cord;
- make sure you have clicked the charging cord in properly. To check the locks, pull on the handle with moderate force **9** without pressing button **8**.

Warning light  comes on the instrument panel.

If you wish, you can then lock your vehicle. This will make it impossible to unplug the cord from your vehicle.

When charging commences, the hazard warning lights will flash five times. A message on the instrument panel will tell you the remaining charging time. You do not need to wait until the charge is at reserve levels to recharge your vehicle.

Precautions to take when removing from the socket

- Check that the opening elements are unlocked;
- grab handle **9** and press button **8**;
- unplug the charging cord from the vehicle while holding down button **8**. Warning light  goes out on the instrument panel;
- close valve **7** then flap **6**;
- unplug the cord from the power supply;
- store the cord in its storage bag and put away in the boot.

NB: It does not matter about the order of plugging in/unplugging of the charging cord between the vehicle and the power supply.

ELECTRIC VEHICLE: charging (6/6)

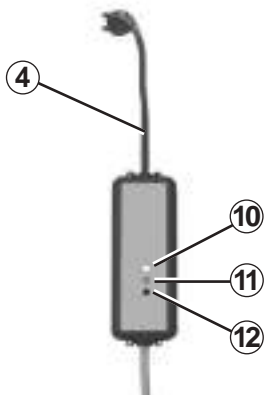

Operation notice regarding the occasional charging cord socket 4

Warning lights			Reading
READY 10 Green	CHARGE 11 Orange	FAULT 12 Red	
Switched on 0.5 seconds	Switched on 0.5 seconds	Switched on 0.5 seconds	When switching on, the warning lights go on for half a second to check that they are operating correctly.
Switched on	Switched off	Switched off	The charging cord is plugged in to the domestic plug socket and the traction battery has finished charging.
Switched on	Switched on	Switched off	The traction battery is charging.
Switched on	Switched off	Switched on or flashing	Operating fault. Unplug the cord and contact an authorised dealer.
Switched off	Switched off	Switched off	No electrical power has been detected at the domestic power socket. Check your electrical installation (circuit breaker, etc.) and start again. If the problem persists, unplug the cord and contact an authorised dealer.

TRACTION BATTERY QUICK CHANGE SYSTEM

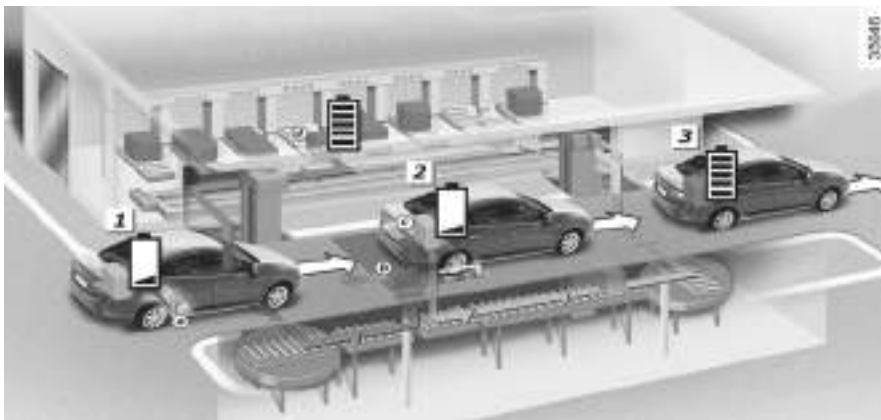

At an exchange point, it is possible to change the traction battery of the vehicle with a charged battery, as shown in the schematic diagram above.

Do not forget to switch off the ignition when replacing the traction battery.

Follow the instructions given at the exchange point. Messages will be displayed on the instrument panel if these instructions are not followed.

Risk of damage to the vehicle.

KEY/RADIO FREQUENCY REMOTE CONTROL: general information

27415

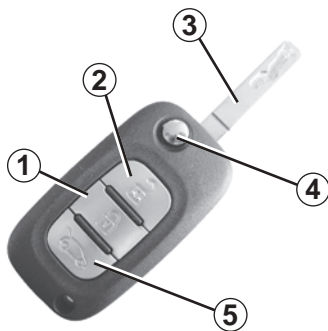

Radio frequency remote control

- 1 Locking the doors and tailgate.
- 2 Unlocking the doors and tailgate.
- 3 Driver's door and ignition key.
- 4 To release the key from its housing, press button 4. It will be released automatically.
To reinsert it in its housing, press button 4 and guide the key into the storage position.
- 5 Unlocking/Locking the boot only.

Radio frequency remote control operating range

This varies according to the surroundings: please take care not to lock or unlock the doors by inadvertently pressing the buttons on the remote control.

Interference

The presence of certain objects (metal objects, mobile telephones, or an area with strong electromagnetic radiation, etc.) close to the key may create interference and affect the operation of the system.

Advice

Avoid leaving the remote control in hot, cold or humid areas.

The key must not be used for any function other than those described in the handbook (removing the cap from a bottle, etc.).

For replacement, or if you require an additional remote control

If you lose your remote control or require another, you can obtain one from an approved Dealer.

If a remote control is replaced, it will be necessary to take the vehicle and **all of its remote controls** to an approved Dealer to initialise the system.

You may use up to four remote control units per vehicle.

Remote control unit failure

Make sure that the correct battery type is being used, and that the battery is in good condition and inserted correctly. These batteries have a service life of approximately two years.

Refer to the information on "Radio frequency remote control: Batteries" in Section 5.

KEY/RADIO FREQUENCY REMOTE CONTROL: use

27415

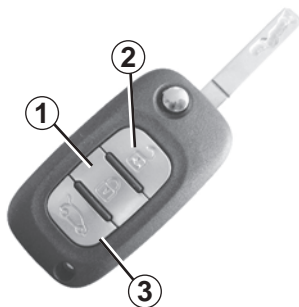

Locking the doors

Press locking button **1**.

The indicator lights and hazard warning lights **flash twice** to indicate that the doors have locked:

If an opening element (door or boot) is open or not properly closed, the opening elements quickly lock then unlock and the hazard warning lights and indicator lights do not flash.

NB: while charging the traction battery, locking the opening elements will lock the vehicle charging cord.

Unlocking the doors

Press button **2** to unlock.

The hazard warning lights and indicator lights **flash once** to indicate that the doors have unlocked.

NB: unlocking the doors will unlock the vehicle charging cord.

Unlocking/locking the boot only

(for some countries)

Press button **3** to unlock or lock the boot.

The hazard warning lights and indicator lights flash once to indicate that the tailgate is unlocked if the vehicle doors are locked.

The hazard warning lights and indicator lights flash twice to indicate that the luggage compartment lid is locked if the vehicle doors are locked.

The card buttons are deactivated when the engine is running.

The flashing status of the hazard warning lights informs you of the vehicle status:

- **one flash** indicates that the vehicle is completely unlocked;
- **two flashes** indicate that the vehicle is completely locked.



Driver's responsibility

Never leave your vehicle with the key inside and never leave a child (or a pet) unsupervised, even for a short while.

They may pose a risk to themselves or to others by starting the engine, activating equipment such as the electric windows or by locking the doors.

Risk of serious injury.

OPENING AND CLOSING THE DOORS (1/2)



Opening the doors from the outside

With the doors unlocked, hold handle **1** and pull it towards you.



Opening from the inside

Pull handle **2**.

Lights-on reminder buzzer

If you have switched off the ignition and left the lights switched on, a reminder buzzer will sound when a door is opened.



As a safety precaution, the doors should only be opened or closed when the vehicle is stationary.

Door/tailgate open buzzer

Depending on the vehicle, if a door or the luggage compartment is open or not properly closed, when the vehicle reaches approximately 12 mph (20 km/h):

- the message “Door open” or “Boot open” appears on the instrument panel accompanied by a beep lasting several seconds.
- a  warning light comes on, accompanied by a beep.

Special note

Once the engine has been switched off, the lights and accessories (radio, etc.) will continue to operate until the driver's door is opened.

OPENING AND CLOSING THE DOORS (2/2)

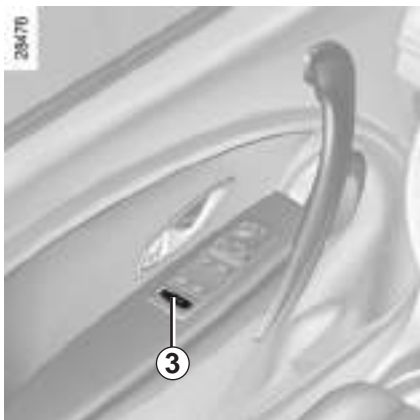

Child safety



Vehicle with switch 3

Press switch **3** to enable the rear doors to be opened. If the vehicle is equipped with electric rear windows, this action will also enable their use. The indicator light in the switch lights up to confirm that the locks have been activated.



Safety of rear occupants

The driver can enable operation of the rear doors and, depending on the vehicle, the electric windows by pressing switch **3** on the side with the illustration.

Depending on the vehicle, in the event of a fault:

- a beep sounds;
- a message is displayed on the instrument panel;
- the integrated indicator does not light up.

If the battery has been disconnected, press switch **3** on the side with the symbol to lock the rear doors.



Driver's responsibility when parking or stopping the vehicle

Never leave an animal, child or adult who is not self-sufficient alone on your vehicle, even for a short time.

They may pose a risk to themselves or to others by starting the engine, activating equipment such as the electric windows or by locking the doors.

Also, in hot and/or sunny weather, please remember that the temperature inside the passenger compartment increases very quickly.

RISK OF DEATH OR SERIOUS INJURY.

LOCKING/UNLOCKING THE DOORS (1/2)

Locking/Unlocking the doors from the outside

Please refer to the information on the “Key/Radio frequency remote control” in Section 1.

In some cases, the radio frequency remote control will not operate, or its access area will be modified:

- the remote control battery is old or the vehicle 12 V battery is discharged.
- the vehicle is located in a high electromagnetic radiation zone.

It is then possible:

- to use the key integrated in the radio frequency remote control to unlock the front left-hand door;
- to lock each of the doors manually;
- to use the interior door locking/unlocking control (refer to the following pages).

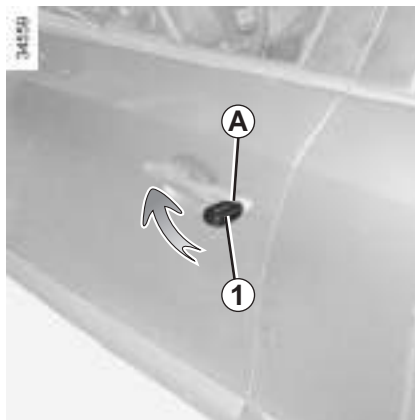

Using the key

Insert key **1** into the lock **A** of the driver's door to lock or unlock the door.



Locking the doors manually

Turn screw **2** with the door open (using the end of the key) and close the door.

This means that the doors are then locked from the outside.

The doors may then only be opened from the inside or by using the key in the driver's door.

LOCKING/UNLOCKING THE DOORS (2/2)



Interior locking/unlocking door control

Switch **3** simultaneously controls the doors and the boot.

If a door or the tailgate is open or not closed properly, the doors and tailgate lock/unlock quickly.

If you need to transport objects with the boot open, the other opening elements can still be locked: **with the engine stopped**, press switch **3** for more than five seconds to lock the other opening elements.

Locking the opening elements without the radio frequency remote control

For example, in the event of a discharged battery or the radio frequency remote control temporarily not working.

With the engine switched off and an opening element (door or boot) open, press and hold switch **3** for more than five seconds.

When the door is closed, all the doors and the tailgate will be locked. The vehicle can only be locked from the outside using the radio frequency remote control.

Door and tailgate status indicator

With the **ignition on**, the indicator light integrated in the switch **3** informs you of the status of the opening elements:

- when the light is on, the opening elements are locked;
- indicator light off, the doors and tailgate are unlocked.

When you lock the doors, the indicator light remains lit and then goes out.



Driver's responsibility

Never leave your vehicle with the key or remote control inside.

If you decide to keep the doors locked when you are driving, remember that it may be more difficult for those assisting you to gain access to the passenger compartment in the event of an emergency.

AUTOMATIC LOCKING WHEN DRIVING



Operating principle

After the vehicle is started, the system automatically locks the doors when you are driving at approximately 6 mph (10 km/h) and over.

The door can be unlocked:

- by pressing the door unlocking button **1**.
- by opening a front door (vehicle stationary).

NB: if a door is opened or closed, it will automatically lock again when the vehicle reaches a speed of 6 mph (10 km/h).

Activating/deactivating the function

Depending on the vehicle:

- Please refer to the information on the “Vehicle settings customisation menu” in Section 1; “Auto door locking while driving”:



function activated



function deactivated.

- **With the engine running**, press button **1** for approximately 5 seconds until you hear a beep.

Operating faults

If you experience an operating fault (no automatic locking, the indicator light incorporated in button **1** does not light up when trying to lock the opening elements, etc.), firstly check that the opening elements are properly closed. If they are properly closed, contact an authorised dealer.



Driver's responsibility

If you decide to keep the doors locked when you are driving, remember that it may be more difficult for those assisting you to gain access to the passenger compartment in the event of an emergency.

FRONT HEADRESTS (1/2)



Headrest A

To raise the headrest

Pull the headrest upwards to the desired height.

To lower the headrest

Press button **2** and guide the headrest down to the desired height.

To adjust the angle of the headrest

Depending on the vehicle, push back or draw the headrest **4** nearer to you until the desired position.

To remove the headrest

Raise the headrest to its highest position (tilt the seatback backwards if necessary). Press button **1** and lift the headrest to release it.

To refit the headrest

Pull out the headrest rods **3** as far as possible by pulling from the top. Take care to ensure they are clean and correctly aligned and, if there are any problems, check that the notches are facing forwards.

Insert the headrest rods into the holes (tilt the seatback backwards if necessary).

Lower the headrest until it locks, press button **1** and lower the headrest as far as possible.

Check that each headrest rod **3** is securely locked in the seatback by trying to pull them up or push them down.



The three upper positions can be manipulated without pressing button **2**. However, it is preferable to press this button to lower the headrest.



The headrest is important for safety. Ensure that it is in place and in the correct position: The top of the headrest should be as close as possible to the crown of the head and the distance between your head and the headrest should be the least possible.

FRONT HEADRESTS (2/2)

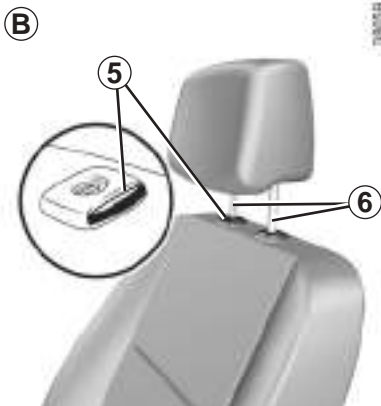

Headrest **B**

To raise the headrest

Pull the headrest upwards to the desired height.

To lower the headrest

Press button **5** and guide the headrest down to the desired height.

To remove the headrest

Raise the headrest to its highest position (tilt the seatback backwards if necessary). Press button **5** and lift the headrest to release it.

To refit the headrest

Pull the headrest rods fully out **6** by pulling from the top. Take care to ensure they are clean and correctly aligned and, if there are any problems, check that the notches are facing forwards. Insert the headrest rods into the holes (tilt the seatback backwards if necessary).

Lower the headrest until it locks, press button **5** and lower the headrest as far as it will go.

Check that each headrest rod **6** is securely locked in the seatback by trying to pull them up or push them down.



The headrest is important for safety. Ensure that it is in place and in the correct position: The top of the headrest should be as close as possible to the crown of the head and the distance between your head and the headrest should be the least possible.

REAR HEADRESTS

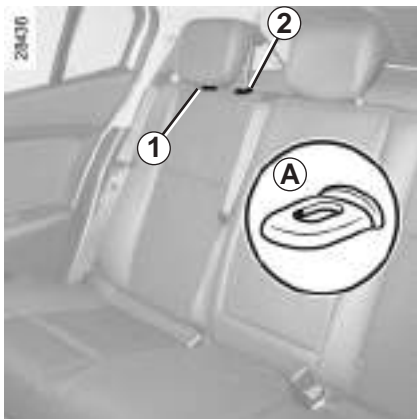

Position for use

Raise or lower the headrest while pulling it towards the front of the vehicle.

To remove the headrest

Press tabs **A** on catches **1** and **2** and remove the headrest.



To refit the headrest

Insert the headrest rods into the sleeves, and lower the headrest to the first notch.

Storage position

Lower the headrest as far as possible, then press tab **2** and lower it completely.

When the headrest is set at the lowest position (position B), this is for storage only: it should not be in this position when a seat is occupied.



The headrest is a safety component, check that it is fitted and in the correct position.

FRONT SEATS WITH MANUAL CONTROL

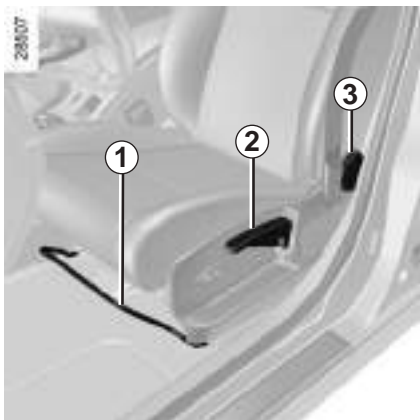

To move the seat forwards or back

Lift handle **1** to unlock. Release the handle once the seat is in the correct position and ensure that the seat is fully locked into position.

To raise or lower the seat base

Move lever **2** as many times as necessary upwards or downwards.

To tilt the seatback

Turn control knob **3** to the required position.

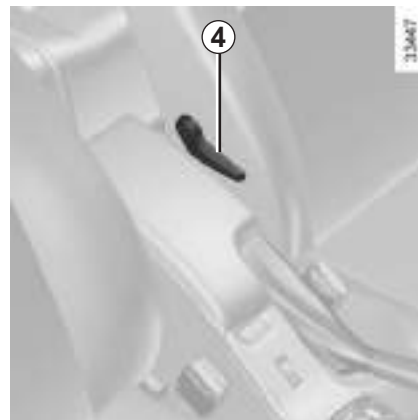

To adjust the lumbar support on the driver's seat

(depending on vehicle)

Lower handle **4** to increase the support and lift it to decrease it.



For safety reasons, carry out any adjustments when the vehicle is not being driven.

We would advise you not to recline the seatbacks too far to ensure that the effectiveness of the seat belts is not reduced.

No object should be placed on the floor (in front of the driver). Nothing should be placed around the driver's feet as such objects may slide under the pedals during sudden braking manoeuvres and obstruct their use.

SEAT BELTS (1/3)

Always wear your seat belt when travelling in your vehicle. You must also comply with the legislation of the particular country you are in.



Incorrectly adjusted or twisted seat belts may cause injuries in the event of an accident.

Use one seat belt per person, whether child or adult.

Even pregnant women should wear a seat belt. In this case, ensure that the lap belt is not exerting too much pressure on the abdomen, but do not allow any slack.

Before starting, first adjust your driving position, then ask all occupants to adjust their seat belts to ensure optimum protection.

Adjusting your driving position

- **Sit well back in your seat** (having removed your coat or jacket etc.). This is essential to ensure your back is positioned correctly;
- **adjust the distance between the seat and the pedals.** Your seat should be as far back as possible while still allowing you to fully depress the pedals. The seatback should be adjusted so that your arms are slightly bent when you hold the steering wheel;
- **adjust the position of your headrest.** For maximum safety, your head must be as close as possible to the headrest;
- **Adjust the height of the seat.** This adjustment allows you to select the seat position which offers you the best possible view.
- **adjust the position of the steering wheel.**



Adjusting the seat belts

Sit with your back firmly against the seatback.

The shoulder strap **1** should be as close as possible to the base of the neck but not on it.

Lap belt **2** should be worn flat over the thighs and against the pelvis.

The seat belt must be worn as close to the body as possible. Eg: avoid wearing heavy clothing or keeping bulky objects under the belts, etc.

SEAT BELTS (2/3)



Locking

Unwind the belt **slowly and smoothly** and ensure that buckle **3** locks into catch **5** (check that it is locked by pulling on buckle **3**). If the belt jams, allow it to return slightly before attempting to unwind it again.

If your seat belt is completely jammed, pull slowly, but firmly, so that just over 3 cm unwinds. Allow it to return slightly before attempting to unwind it again.

If there is still a problem, contact an approved dealer.

Unfastening

Press button **4** and the seat belt will be rewound by the inertia reel. Guide the belt into position.



Front seat belt reminder warning light

It lights up on the central display when the engine is started and, if the driver's seat belt is not fastened, the light flashes and a beep sounds for about two minutes when the vehicle reaches a speed of approximately 12 mph (20 km/h).

NB: an object placed on the passenger seat cushion may activate the warning light in some cases.



Adjusting the front seat belt height

Press button **6** to adjust the seat belt height so that the shoulder strap **1** is worn as shown previously:

- to lower the seat belt, press button **6** and lower the seat belt at the same time;
- to raise the seat belt, press button **6** and raise the seat belt at the same time.

Make sure that the seat belt is locked in position correctly after you have adjusted it.

SEAT BELTS (3/3)



Rear seat belt guide

Seat belt guide 7 can be used to obtain a better seat belt position.

The following information applies to the vehicle's front and rear seat belts.



- No modification may be made to the component parts of the originally fitted restraint system: belts, seats and their mountings. For special operations (e.g. fitting child seats) contact an authorised dealer.
- Do not use devices which allow any slack in the belts (e.g. clothes pegs, clips, etc.): a seat belt which is worn too loosely may cause injury in the event of an accident.
- Never wear the shoulder strap under your arm or behind your back.
- Never use the same belt for more than one person and never hold a baby or child on your lap with your seat belt around them.
- The belt should never be twisted.
- Following an accident, have the seat belts checked and replaced if necessary. Always replace your seat belts as soon as they show any signs of wear.
- Make sure that the buckle is inserted into the appropriate catch.
- Ensure that no objects are placed in the area around the seat belt catch as they could prevent it from being properly secured.
- Make sure the seat belt catch is properly positioned (it should not be hidden away, crushed or flattened by people or objects).

METHODS OF RESTRAINT IN ADDITION TO THE FRONT SEAT BELTS (1/4)

Depending on the vehicle, they are composed of:

- **seat belt inertia reel pretensioners;**
- **lap belt pretensioners;**
- **chest-level load limiters;**
- **front airbags for driver and front passenger.**

These systems are designed to act independently or together when the vehicle is subjected to a frontal impact.

Depending on the severity of the impact, the system can trigger:

- seat belt locking;
- the seat belt inertia reel pretensioner (which engages to correct seat belt slack);
- the low volume front air bag;
- the lap seat belt pretensioners to hold the occupant in his seat;
- the large volume front air bag.

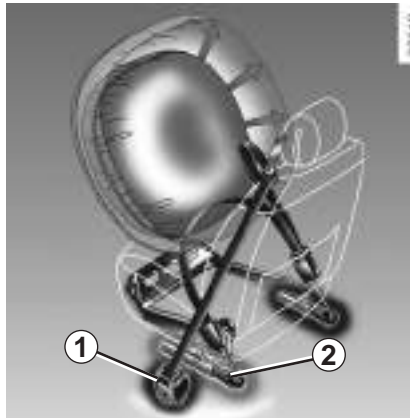

Pretensioners

The pretensioners hold the seat belt against the body, holding the occupant more securely against the seat, thus increasing the seat belt's efficiency.

In the event of a severe frontal impact and if the ignition is switched on, the system may engage the following depending on the force of the impact:

- seat belt inertia reel pretensioner **1** which instantly retracts the seat belt;
- the lap pretensioner **2** on the front seats.



– Have the entire restraint system checked following an accident.

– No operation whatsoever is permitted on any part of the system (pretensioners, air bags, computers, wiring) and the system components must not be reused on any other vehicle, even if identical.

– To avoid incorrect triggering of the system which may cause injury, only qualified personnel from an approved dealer may work on the pretensioner and air bag system.

– The electric trigger system may only be tested by a specially trained technician using special equipment.

– When the vehicle is scrapped, contact an approved dealer for disposal of the pretensioner and air bag gas generators.

METHODS OF RESTRAINT IN ADDITION TO THE FRONT SEAT BELTS (2/4)

Load limiter

Above a certain severity of impact, this mechanism is used to limit the force of the belt against the body so that it is at an acceptable level.

Air bags for driver and front passenger

Fitted to the driver and passenger side.

Depending on the vehicle, the presence of this equipment is indicated by the word "Airbag" on the steering wheel, dashboard (air bag zone **A**) and a symbol on the lower section of the windscreen.

Each air bag system consists of:

- an air bag and gas generator fitted on the steering wheel for the driver and in the dashboard for the front passenger;
- an electronic unit for system monitoring which controls the gas generator electrical trigger system;
- remote sensors;
- a single warning light  on the instrument panel.



The air bag system uses pyrotechnic principles. This explains why, when the air bag inflates, it will generate heat, produce smoke (this does not mean that a fire is about to start) and make a noise upon detonation. In a situation where an air bag is required, it will inflate immediately and this may cause some minor, superficial grazing to the skin or other problems.

METHODS OF RESTRAINT IN ADDITION TO THE FRONT SEAT BELTS (3/4)

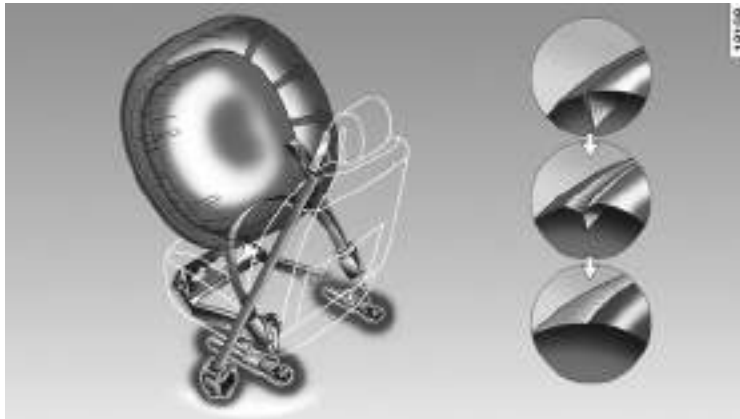

Operation

This system is only operational when the ignition is switched on.

In a severe **frontal** impact, the air bags inflate rapidly, cushioning the impact of the driver's head and chest against the steering wheel and the front passenger against the dashboard. The air bags then deflate immediately so that the passengers are not in any way hindered from leaving the vehicle.

Special feature of the front air bag

After a violent impact, it has two deployment volumes and integrates a ventilation system:

- small volume air bag, this is the first stage of operation;
- large volume air bag, the air bag seams rip so that a larger volume of gas is released into the bag (for the most severe impacts).

METHODS OF RESTRAINT IN ADDITION TO THE FRONT SEAT BELTS (4/4)

All of the warnings below are given so that the air bag is not obstructed in any way when it is inflated and also to prevent the risk of serious injuries caused by items which may be dislodged when the air bag inflates.



Warnings concerning the driver's air bag

- Do not modify the steering wheel or the steering wheel boss.
- Do not cover the steering wheel boss under any circumstances.
- Do not attach any objects (badge, logo, clock, telephone holder, etc.) to the steering wheel boss.
- The steering wheel must not be removed (except by qualified personnel from our Network).
- When driving, do not sit too close to the steering wheel. Sit with your arms slightly bent (see the information on “Adjusting your driving position” in Section 1). This will allow sufficient space for the air bag to deploy correctly and be fully effective.

Warnings concerning the passenger air bag

- Do not attach or glue any objects (badge, logo, clock, telephone holder, etc.) to the dashboard on or near the air bag.
- Do not place anything between the dashboard and the passenger (pet, umbrella, walking stick, parcels, etc.).
- The passenger must not put his or her feet on the dashboard or seat as there is a risk that serious injuries may occur. In general, parts of the body should be kept away from the dashboard (knees, hands, head, etc.).
- The devices in addition to the front passenger seat belt should be reactivated as soon as a child seat is removed, to ensure the protection of the passenger in the event of an impact.

A REAR-FACING CHILD SEAT MUST NOT BE FITTED TO THE FRONT PASSENGER SEAT UNLESS THE ADDITIONAL RESTRAINT SYSTEMS, I.E. THE PASSENGER AIR BAG, ARE DEACTIVATED.

(refer to the information on “Child safety: deactivating/activating the front passenger air bag” in Section 1)

METHODS OF RESTRAINT IN ADDITION TO THE REAR SEAT BELTS

Force limiter

Above a certain severity of impact, this mechanism is used to limit the force of the belt against the body so that it is at an acceptable level.



- Have the entire restraint system checked following an accident.
- No operation whatsoever is permitted on any part of the system (air bags, electronic control units, wiring) and the system components must not be reused on any other vehicle, even if identical.
- Only qualified personnel from our Network may work on the air bags; otherwise the system may trigger accidentally and cause injury.

SIDE PROTECTION DEVICES

Side air bags

These air bags are fitted to the front seats and are activated at the sides of the seats (door side) to protect the occupants in the event of a severe side impact.

Curtain air bags

These are air bags fitted along the sides of the vehicle in the ceiling which trigger along the front and rear side windows to protect the passengers in case of a severe side impact.

Depending on the vehicle, a marking on the windscreen informs you of the presence of additional means of restraint (airbags, pretensioners, etc.) in the passenger compartment.



Warnings concerning the side air bag

- **Fitting seat covers:** seats equipped with an air bag require covers specifically designed for your vehicle. Contact an approved Dealer to find out if these covers are available. The use of any covers other than those designed for your vehicle (and including those designed for another vehicle) may affect the operation of the air bags and reduce your protection.
- Do not place any accessories, objects or even pets between the seatback, the door and the internal fittings. Do not cover the seatback with any items such as clothes or accessories. This may prevent the air bag from operating correctly or cause injury when the air bag is deployed.
- No work or modification whatsoever may be carried out on the seat or internal fittings, except by qualified personnel from an approved dealer.
- The area between the rear bench seatback and the trim is the area of air bag operation: no objects must be placed here.

ADDITIONAL METHODS OF RESTRAINT

All of the warnings below are given so that the air bag is not obstructed in any way when it is inflated and also to prevent the risk of serious injuries caused by items which may be dislodged when the air bag inflates.



The air bag is designed to complement the action of the seat belt. Both the air bags and seat belts are integral parts of the same protection system. It is therefore essential to wear seat belts at all times. If seat belts are not worn, the occupants are exposed to the risk of serious injury in the event of an accident. It may also increase the risk of minor superficial injuries occurring when the air bag is deployed, although such minor injuries are always possible with air bags.

If the vehicle should overturn or suffer a rear impact, however severe, the pretensioners and air bags are not always triggered. Shocks to the underbody of the vehicle, e.g. from pavements, potholes or stones, can all trigger these systems.

- No work or modification **whatsoever** may be carried out on any part of the air bag system (air bags, pretensioners, computer, wiring harness, etc.), except by qualified personnel from an approved dealer.
- To ensure that the system is in good working order and to avoid accidental triggering of the system which may cause injury, only qualified Network personnel may work on the air bag system.
- As a safety precaution, have the air bag system checked if your vehicle has been involved in an accident, or is stolen or broken into.
- When selling or lending the vehicle, inform the user of these points and hand over this driver's handbook with the vehicle.
- When scrapping your vehicle, contact your approved dealer for disposal of the gas generator(s).



Operating faults

This warning light  will light up on the instrument panel when the ignition is switched on and then go out after a few seconds.

If it does not come on when the ignition is switched on, or if it comes on when the engine is running, there is a fault with the system (airbags, pretensioners, etc.) in the front and/or rear seats.

Contact your approved dealer as soon as possible. Your protection will be reduced until this fault is rectified.

STEERING WHEEL/POWER-ASSISTED STEERING

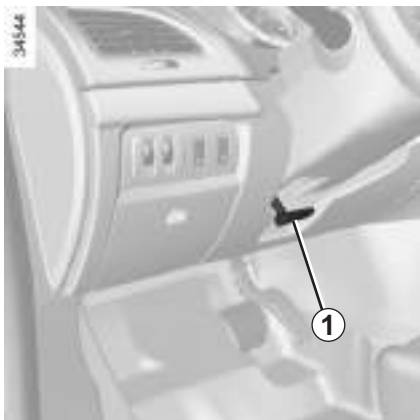

Steering wheel

Adjusting the height.

Pull lever **1** and move the steering wheel to the required position;
Then, push the lever back fully, beyond the point of resistance to lock the steering wheel.

Make sure that the steering wheel is correctly locked.



For safety reasons, only adjust the steering wheel when the vehicle is stationary.



Never switch off the ignition when travelling downhill, and avoid doing so in normal driving (assistance is not provided).

Power-assisted steering

The variable power-assisted steering system is equipped with an electronic control system which alters the level of assistance to suit the vehicle speed.

Steering is made easier during parking manoeuvres (for added comfort) whilst the force needed to steer increases progressively as the speed rises (for enhanced safety at high speeds).

Never leave the steering wheel on full lock when the vehicle is stationary.

With the engine switched off, or if there is a system fault, it is still possible to turn the steering wheel. The force required will be greater.

A noise may be heard when the steering wheel is moved quickly. This is normal.

CHILD SAFETY: General information (1/2)

Carrying children

Children, and adults, must be correctly seated and strapped in for all journeys. The children being carried in your vehicle are your responsibility.

A child is not a miniature adult. Children are at risk of specific injuries as their muscles and bones have not yet finished growing. The seat belt alone would not provide suitable protection. Use an approved child seat and ensure you use it correctly.



To prevent the doors being opened, use the “Child safety” device (refer to the information on “Opening and closing the doors” in Section 1).



A collision at 30 mph (50 km/h) is the same as falling a distance of 10 metres.

Transporting a child without a restraint is the equivalent of allowing him or her to play on a fourth-floor balcony without railings.

Never travel with a child held in your arms. In the event of an accident, you will not be able to keep hold of the child, even if you yourself are wearing a seat belt.

If your vehicle has been involved in a road accident, replace the child seat and have the seat belts and ISOFIX anchorage points checked.



Driver’s responsibility when parking or stopping the vehicle

Never leave an animal, child or adult who is not self-sufficient alone on your vehicle, even for a short time.

They may pose a risk to themselves or to others by starting the engine, activating equipment such as the electric windows or by locking the doors.

Also, in hot and/or sunny weather, please remember that the temperature inside the passenger compartment increases very quickly.

RISK OF DEATH OR SERIOUS INJURY.

CHILD SAFETY: General information (2/2)

Using a child seat

The level of protection offered by the child seat depends on its ability to restrain your child and on its installation. Incorrect installation compromises the protection it offers the child in the event of harsh braking or an impact.

Before purchasing a child seat, check that it complies with the regulations for the country you are in and that it can be fitted in your vehicle. Consult an approved dealer to find out which seats are recommended for your vehicle.

Before fitting a child seat, read the manual and respect its instructions. If you experience any difficulties during installation, contact the manufacturer of the equipment. Keep the instructions with the seat.

Set a good example by always fastening your seat belt and teaching your child:

- to strap themselves in correctly;
- to always get in and out of the car at the kerb, away from busy traffic.

Do not use a second-hand child seat or one without an instruction manual.

Check that there are no objects in the vicinity of the child seat which could impede its operation.



Never leave a child unattended in the vehicle.

Check that your child is always strapped in and that the belt or safety harness used is correctly set and adjusted. Avoid wearing bulky clothing which could cause the belts to slacken.

Never let your child put their head or arms out of the window.

Check that the child is in the correct position for the entire journey, especially if asleep.

CHILD SAFETY: choosing a child seat



31235

Rear-facing child seats

A baby's head is, proportionally, heavier than that of an adult and its neck is very fragile. Transport the child in this position for as long as possible (until the age of 2 at the very least). It supports both the head and the neck.

Choose a bucket type seat for best side protection and change it as soon as the child's head is higher than the shell.



31233

Forward-facing child seats

The child's head and abdomen need to be protected as a priority. A forward-facing child seat which is firmly attached to the vehicle will reduce the risk of impact to the head. Ensure your child travels in a forward-facing seat with a harness or buckle for as long as their size permits. Choose a bucket type seat for optimum side protection.



31234

Booster cushions

From 15 kg or 4 years, the child can travel using a booster seat, which will enable the seat belt to be adapted to suit his/her size and shape. The booster seat cushion must be fitted with guides to position the seat belt on the child's thighs rather than the stomach. It is recommended that you use a seat-back fitted with a belt strap guide which can be adjusted in terms of height to position the seat belt in the centre of the shoulder. It must never rest on the neck or on the arm.

Choose a bucket type seat for optimum side protection.

CHILD SAFETY: choosing a child/baby seat mounting (1/2)

There are two ways of attaching child seats: via the seat belt or using the ISOFIX system.

Attachment via the seat belt

The seat belt must be adjusted to ensure that it is effective in the event of harsh braking or an impact.

Ensure that the strap paths indicated by the child seat manufacturer are respected.

Always check that the seat belt is correctly fastened by pulling it up, then pulling it out fully whilst pressing on the child seat.

Check that the seat is correctly held by moving it from side to side and back to front: the seat should remain firmly fixed.

Check that the child seat has not been installed at an angle and that it is not resting against a window.



No modifications may be made to the component parts of the restraint system (ISOFIX seat belts, seats and their mountings) originally fitted.



Do not use the child seat if it may unfasten the seat belt restraining it: the base of the seat must not rest on the buckle and/or catch of the seat belt.



The seat belt must never be twisted or the tension relieved. Never pass the shoulder strap under the arm or behind the back. Check that the seat belt has not been damaged by sharp edges. If the seat belt does not operate normally, it will not protect the child. Consult an approved dealer. Do not use this seat until the seat belt has been repaired.

Attachment using the ISOFIX system

Authorised ISOFIX child seats are approved in accordance with regulation ECE-R44 in one of the three following scenarios:

- ISOFIX universal 3-point forward-facing seat
- ISOFIX semi-universal 2-point seat
- specific

For the latter two, check that your child seat can be installed by consulting the list of compatible vehicles.

Attach the child seat with the ISOFIX locks, if these are provided. The ISOFIX system allows quick, easy, safe fitting. The ISOFIX system consists of 2 rings and, in some cases, a third ring.



Before using an ISOFIX child seat that you purchased for another vehicle, check that its installation is authorised. Consult the list of vehicles which can be fitted with the seat from the equipment manufacturer.

CHILD SAFETY: choosing a child/baby seat mounting (2/2)

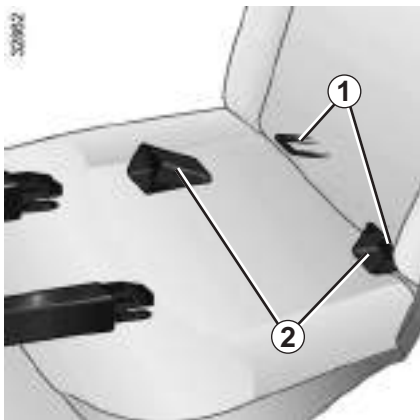

The two rings **1** are located between the seatback and the seat base of the seat and are identified by a marking.

To ensure your child seat can be easily fitted and locked on rings **1**, use access guides **2** on the child seat.

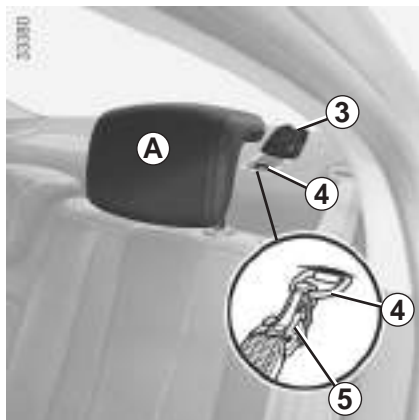

The third ring is used to attach the upper strap on some child seats.

Raise headrest **A** and pass the belt between the headrest guides.

Raise cover **3** on the rear parcel shelf. Fix hook **5** to ring **4**.

Pull the belt so that the back of the child seat comes into contact with the vehicle seatback.



The ISOFIX anchorage points have been exclusively designed for child seats with the ISOFIX system. Never fit a different type of child seat, seat belt or other objects to these anchorage points.

Check that nothing is obstructing the anchorage points.

If your vehicle has been involved in a road accident, have the ISOFIX anchorage points checked and replace your child seat.

CHILD SAFETY: fitting a child seat (1/4)

Some seats are not suitable for fitting child seats. The diagram on the following page shows you how to attach a child seat.

The types of child seats indicated may not be available. Before using a different child seat, check with the manufacturer that it can be fitted.



Fit the child seat in a rear seat wherever possible.

Check that when installing the child seat in the vehicle it is not at risk of coming loose from its base.

If you have to remove the headrest, check that it is correctly stored so that it does not come loose under harsh braking or impact.

Always attach the child seat to the vehicle even if it is not in use so that it does not come loose under harsh braking or impact.

In the front seat

The laws concerning children travelling in the front passenger seat differ in every country. Consult the legislation in force and follow the indications on the diagram on the following page.

Before fitting a child seat in this seat (if authorised):

- lower the seat belt as far as possible;
- move the seat as far back as possible;
- gently tilt the seatback away from vertical (approximately 25°);
- on equipped vehicles, raise the seat base as far as possible.

Do not change these settings after the child seat is installed.



RISK OF DEATH OR SERIOUS INJURY:

before installing a rear-facing child seat in this seat, check that the airbag has been deactivated (refer to “Child safety: front passenger airbag deactivation/activation” Section 1).

In the rear side seat

A carrycot can be installed across the vehicle and will take up at least two seats. Position the child with his or her feet nearest the door.

Move the front seat as far forward as possible to install a rear-facing child seat, then move back the seat in front as far as it will go, although without allowing it to come into contact with the child seat.

For the safety of the child in the forward-facing seat, do not move the seat in front back past the middle of the runner, do not tilt the seatback too far (maximum of 25°) and raise the seat as much as possible.

Check that the forward-facing child seat is resting against the back of the vehicle seat and that the headrest of the vehicle is not obstructing its use.



Make sure that the child seat or the child's feet do not prevent the front seat from locking correctly. Refer to the information on the “Front seat” in Section 1.

CHILD SAFETY: fitting a child seat (2/4)

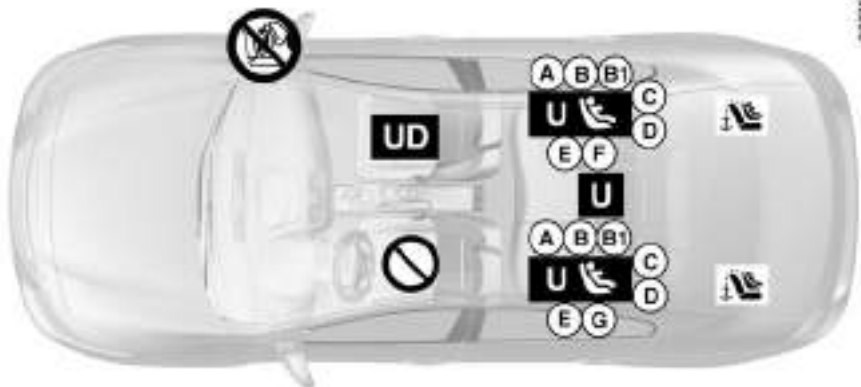

 Check the status of the air bag before fitting a child seat or allowing a passenger to use the seat.



RISK OF DEATH OR SERIOUS INJURY:

Before fitting a rear-facing child seat on the front passenger seat, check that the airbag has been deactivated (refer to the information on “Child safety: deactivating/activating the front passenger airbag” at the end of the section).



Seat not suitable for fitting child seats.

Child seat attached using the belt



Seat which allows a child seat with “Universal” approval to be attached by a seat belt.



Seat which **only** allows a **rear-facing** standardised “Universal” seat to be installed using a seat belt.



Using a child safety system which is not approved for this vehicle will not correctly protect the baby or child. They risk serious or even fatal injury.

Child seat attached using the ISOFIX mounting



Seat which allows an ISOFIX child seat to be fitted.



The rear seats are fitted with an anchorage point which allows a forward-facing ISOFIX child seat with universal approval to be fitted. The anchorage points are located in the luggage compartment and are visible.

The size of the ISOFIX child seat is indicated by a letter:

- A, B and B1: for forward-facing seats in group 1 (9 to 18 kg);
- C: rear-facing seats in group 1 (9 to 18 kg);
- D and E: shell seat or rear-facing seats in group 0 or 0+ (less than 13 kg);
- F and G: carrycots in group 0 (less than 10 kg).

CHILD SAFETY: fitting a child seat (3/4)

The table below summarises the information already shown on the diagram on the previous page, to ensure the regulations in force are respected.

Type of child seat	Weight of the child	Seat size	Front passenger seat (1) (2)	Rear side seats	Rear centre seat
Carrycot fitted across the vehicle Group 0	< 10 kg	F, G	X	U - IL (3)	U (3)
Rear-facing shell seat Group 0 or 0+	< 13 kg and 9 to 18 kg	E, D	U	U - IL (4)	U (4)
rear-facing seat Group 0+ and 1	9 to 18 kg	C	U	U - IL (4)	U (4)
Forward-facing seat Group 1	9 to 18 kg	A, B, B1	X	U - IUF - IL (5)	U (5)
Booster seat Group 2 and 3	15 to 25 kg and 22 to 36 kg	-	X	U (5)	U (5)



(1) RISK OF DEATH OR SERIOUS INJURY: before installing a child seat on the front passenger seat, check that the airbag has been deactivated (refer to “Child safety: front passenger airbag deactivation/activation” Section 1).

CHILD SAFETY: fitting a child seat (4/4)

X = Seat not suitable for fitting child seats.

U = Seat which allows a child seat with "Universal" approval to be installed using a seat belt; check that it can be fitted.

IUF/IL = On equipped vehicles, seat which allows an approved "Universal/semi-universal or vehicle specific" child seat to be attached using the ISOFIX system; check that it can be fitted.

- (2) Only a rear-facing child seat can be fitted in this seat: raise the seat to the maximum and position it as far back as possible, tilting the seatback slightly (approximately 25°).
- (3) A carrycot can be installed across the vehicle and will take up at least two seats. Position the child with his or her feet nearest the door.
- (4) Move the front seat as far forward as possible to install a rear-facing child seat, then move back the seat in front as far as it will go, although without allowing it to come into contact with the child seat.
- (5) Forward-facing child seat; position the seatback of the child seat in contact with the seatback of the vehicle seat. Adjust the headrest, or remove it if necessary. Do not push the front seat more than halfway back on its runners and do not recline the seatback more than 25°.

CHILD SAFETY: deactivating, activating the front passenger airbag (1/3)

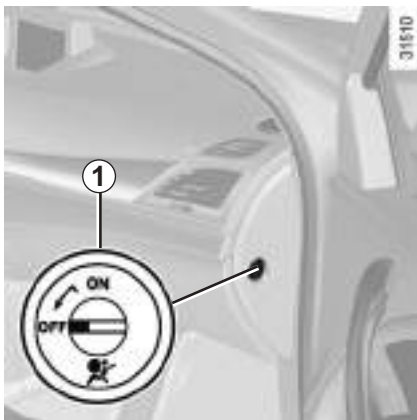

Deactivating the front passenger air bags (on equipped vehicles)

You **must** deactivate certain devices in addition to the front passenger seat belt before fitting a child seat in the front passenger seat.

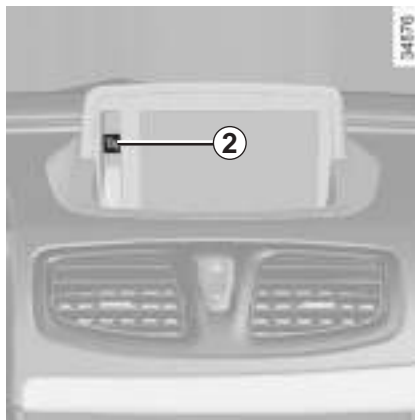

To deactivate the airbags: when the vehicle is stationary, push and turn lock 1 to position OFF.

With the ignition on, you **must** check that warning light 2  is lit on the central display and, depending on the vehicle, that the message "Passenger airbag off" is displayed.

This light remains permanently lit to let you know that you can fit a child seat.



The passenger air bag must only be deactivated or activated **with the ignition off.**

If it is interfered with when the vehicle is being driven, indicator

lights  and  will come on.

Switch the ignition off then on again to reset the air bag in accordance with the lock.

CHILD SAFETY: deactivating, activating the front passenger airbag (2/3)

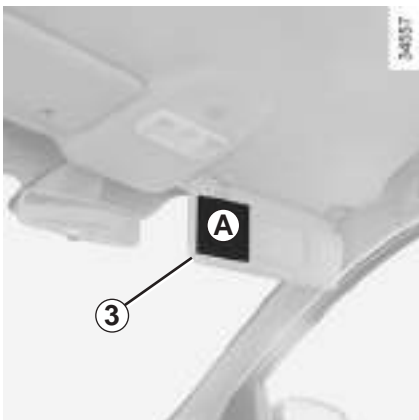

DANGER

Since front passenger airbag triggering and the position of a rear-facing child seat are incompatible, **NEVER** use a restraining device for rear-facing children on a seat with an **ACTIVATED AIRBAG** in front of it. This provides a risk of **DEATH** or **SERIOUS INJURY** to the **CHILD**.

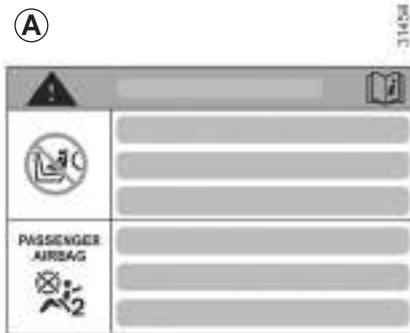

The markings on the dashboard and labels **A** on each side of the passenger sun visor **3** (for example, the labels shown above) will remind you of these instructions.

CHILD SAFETY: deactivating, activating the front passenger airbag (3/3)

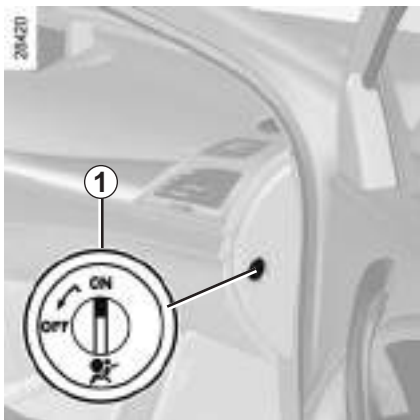

Activating the front passenger air bags

You should reactivate the air bag as soon as you remove the child seat from the front passenger seat to ensure the protection of the front passenger in the event of an impact.

Reactivating the airbags: when the vehicle is stationary, push and turn lock **1** to position **ON**.

With the ignition on, you **must** check that the warning light **2**  is off.

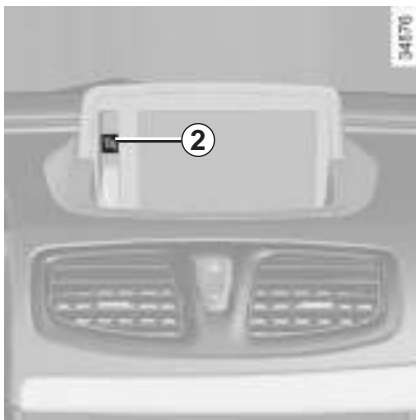

Operating faults

It is forbidden to fit a rear-facing child seat to the front passenger seat if the air bag activation/deactivation system is faulty.

Allowing any other passenger to sit in that seat is not recommended.

Contact your approved dealer as soon as possible.



DANGER

Since front passenger airbag triggering and the position of a rear-facing child seat are incompatible, **NEVER** use a restraining device for rear-facing children on a seat with an **ACTIVATED AIRBAG** in front of it. This provides a risk of **DEATH** or **SERIOUS INJURY** to the **CHILD**.



The passenger air bag must only be deactivated or activated **with the ignition off**.

If it is interfered with when the vehicle is being driven, indicator

lights



and



will come on.

Switch the ignition off then on again to reset the air bag in accordance with the lock.

CLOCK AND EXTERIOR TEMPERATURE



With the ignition on, the time and, depending on the vehicle, the exterior temperature are displayed.

Resetting the clock 1

Vehicles equipped with a navigation system, radio, etc.

Refer to the equipment instructions for the special features.

External temperature indicator

Special note:

When the outside temperature is -3°C to $+3^{\circ}\text{C}$, the $^{\circ}\text{C}$ characters flash (signalling a risk of ice on the road).



External temperature indicator

As ice formation is related to climatic exposure, local air humidity and temperature, the external temperature alone is not sufficient to detect ice.

DRIVING POSITION: LEFT-HAND DRIVE (1/2)

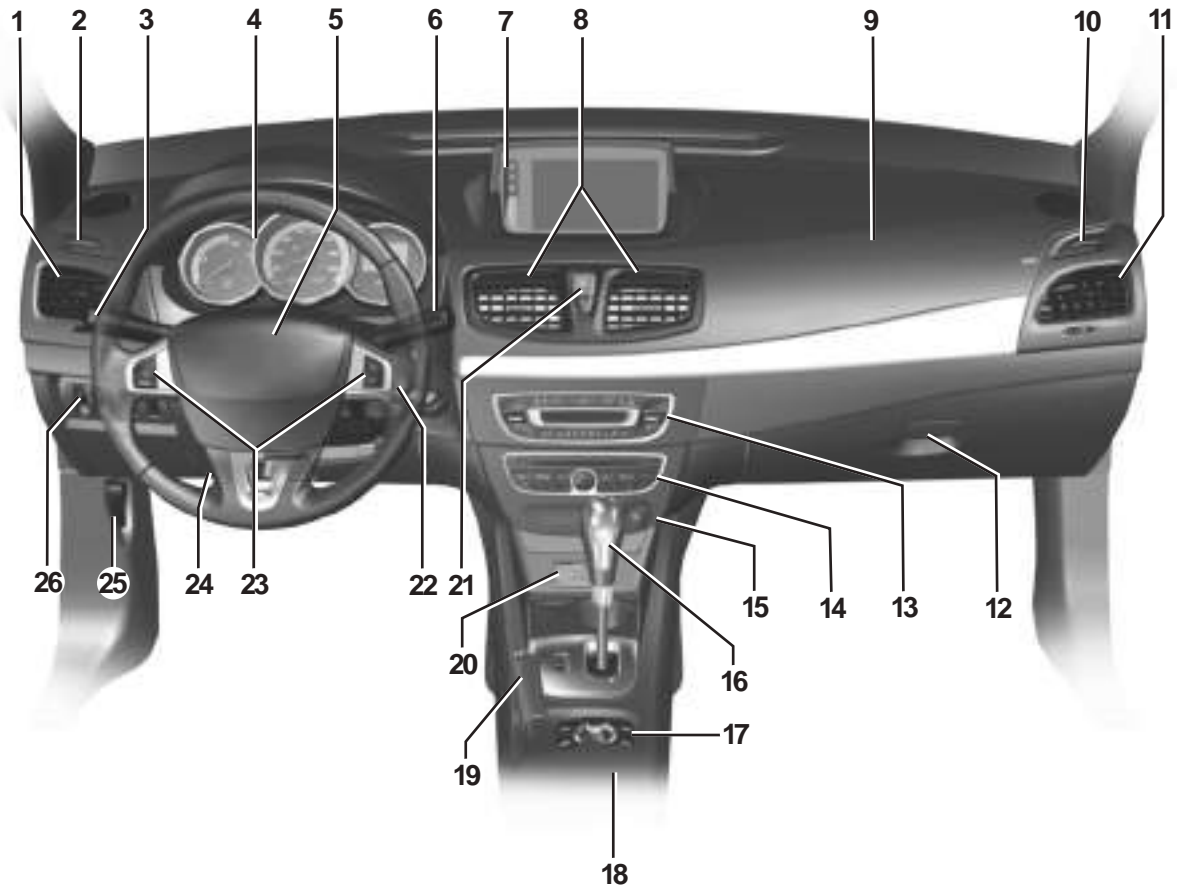

DRIVING POSITION: LEFT-HAND DRIVE (2/2)

The equipment fitted, described below, **DEPENDS ON THE VERSION AND COUNTRY.**

- 1** Side air vent.
- 2** Side window demister outlet.
- 3** Stalk for:
 - direction indicator lights,
 - exterior lights,
 - front fog lights,
 - rear fog light.
- 4** Instrument panel.
- 5** Driver's air bag and horn location.
- 6** – Windscreen wiper/washer stalk,
 - Trip computer information read-out control and vehicle settings personalisation menu.
- 7** – Display (depending on the vehicle) of time, temperature, radio information, navigation system information, etc.
 - Driver and front passenger seat belt unfastened and passenger airbag deactivated warning lights.
- 8** Centre air vents.
- 9** Location for passenger air bag.
- 10** Side window demister outlet.
- 11** Side air vent.
- 12** Glove box.
- 13** Air-conditioning control.
- 14** Location for radio, navigation system, etc.
- 15** Cigarette lighter.
- 16** Gearstick.
- 17** Multimedia control.
- 18** Cruise control/speed limiter control.
- 19** Handbrake.
- 20** Audio connection socket.
- 21** Central door locking/unlocking controls and hazard warning lights switch.
- 22** Key ignition switch
- 23** Cruise control/speed limiter controls
- 24** Control for adjusting steering wheel height.
- 25** Bonnet release control.
- 26** Controls for:
 - headlight beam height remote adjustment;
 - lighting dimmer for control instruments;
 - activation/deactivation of the traction control system.

DRIVING POSITION: RIGHT-HAND DRIVE (1/2)

11 R

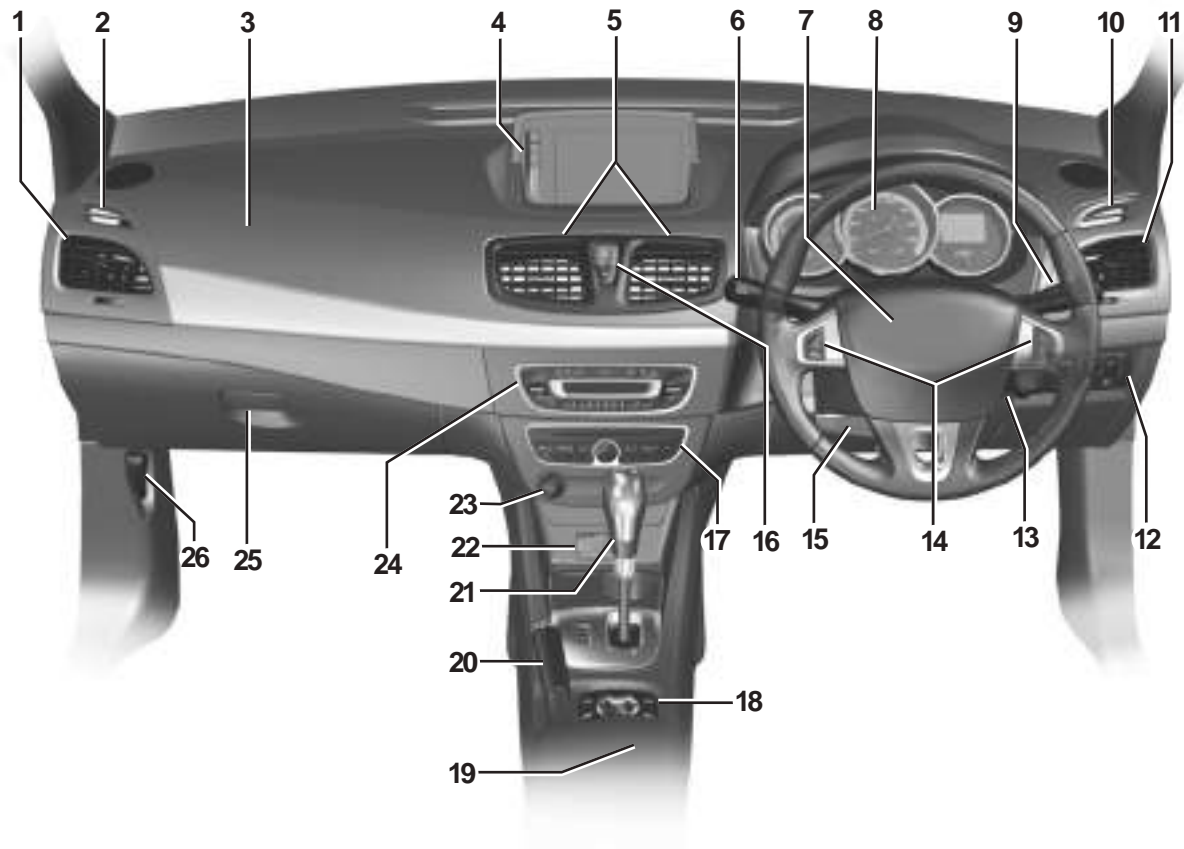

DRIVING POSITION: RIGHT-HAND DRIVE (2/2)

The equipment fitted, described below, **DEPENDS ON THE VERSION AND COUNTRY.**

- 1 Side air vent.
- 2 Side window demister outlet.
- 3 Location for passenger air bag.
- 4 – Display (depending on the vehicle) of time, temperature, radio information, navigation system information, etc.
 - Driver and front passenger seat belt unfastened and passenger airbag deactivated warning lights.
- 5 Centre air vents.
- 6 Stalk:
 - direction indicator lights,
 - exterior lights,
 - front fog lights,
 - rear fog light.
- 7 Location for driver's air bag and horn.
- 8 Instrument panel.
- 9 – Windscreen wiper/washer stalk,
 - Trip computer information read-out control and vehicle settings personalisation menu.
- 10 Side window demister outlet.
- 11 Side air vent.
- 12 Controls for:
 - headlight beam height remote adjustment;
 - lighting dimmer for control instruments;
 - activation/deactivation of the traction control system.
- 13 Key ignition switch.
- 14 Cruise control/speed limiter controls.
- 15 Control for adjusting steering wheel height.
- 16 Central door locking/unlocking controls and hazard warning lights switch.
- 17 Location for radio, navigation system, etc.
- 18 Multimedia control.
- 19 Cruise control/speed limiter control.
- 20 Handbrake.
- 21 Gearstick.
- 22 Audio connection socket.
- 23 Cigarette lighter.
- 24 Air-conditioning control.
- 25 Glove box.
- 26 Bonnet release control.

WARNING LIGHTS (1/3)

The presence and operation of the warning lights **DEPEND ON THE EQUIPMENT AND COUNTRY.**



Instrument panel A: lights up when the headlamps are switched on. The brightness can be adjusted by turning the control knob **1**.
In some cases, the appearance of a warning light is accompanied by a message.

The  warning light means you should **drive very carefully** to an approved dealer as soon as possible. If you fail to follow this recommendation, you risk damaging your vehicle.



Side light tell-tale light



Main beam headlight tell-tale light



Dipped beam headlight tell-tale light



Front fog light tell-tale light



Rear fog light tell-tale light



Left-hand direction indicator tell-tale light



Right-hand direction indicator tell-tale light



Door status warning light

If it lights up with the ignition on, a door or the tailgate is open or not properly closed.



Warning light **STOP** requires you to stop immediately, for your own safety, as soon as traffic conditions allow. Switch off the engine and do not restart it. Contact an approved Dealer.



Air bag warning light

This comes on when the ignition is switched on and goes out after a few seconds.

If it does not light up when the ignition is switched on, or if it lights up when the engine is running, it indicates a fault in the system.

Contact your approved Dealer as soon as possible.



Vehicle ready for driving warning light

This comes on when the engine is started.



Not used



If no lights or sounds are apparent, this indicates a fault in the instrument panel. This indicates that it is essential to stop immediately (as soon as traffic conditions allow). Ensure that the vehicle is correctly immobilised and contact an approved Dealer.

WARNING LIGHTS (2/3)

The presence and operation of the warning lights **DEPEND ON THE EQUIPMENT AND COUNTRY.**



STOP **STOP light**
This lights up when the ignition is switched on and goes out as soon as the engine is started. It comes on with other warning lights and/or messages, and is accompanied by a beep.

It requires you to stop immediately, for your own safety, as soon as traffic conditions allow. Switch off the engine and do not restart it.

Contact an approved Dealer.

Brake circuit fault warning light

If it comes on during braking and is accompanied by the **STOP** warning light and a beep, it indicates that the fluid level in the circuit is low or that there is a braking system fault. Stop as soon as traffic conditions allow and contact an approved Dealer.

12 V battery charge warning light

If it comes on together with the **STOP** warning light and a beep, it indicates that the electrical circuit is overcharged or undercharged.

Warning light

This lights up when the ignition is switched on and goes out as soon as the engine is started. It can light up in conjunction with other warning lights and/or messages on the instrument panel.

It means you should **drive very carefully** to an approved dealer as soon as possible. If you fail to follow this recommendation, you risk damaging your vehicle.

Front seat belt reminder warning light

It lights up on the central display when the engine is started and, if the driver's seat belt is not fastened, the light flashes and a beep sounds for about two minutes when the vehicle reaches a speed of approximately 12 mph (20 km/h).

Cruise control and speed limiter indicator lights

Refer to the information on "Cruise control/speed limiter" in Section 2.

Charging cord plugged in warning light

This comes on when the charging cord is plugged into the vehicle.

WARNING LIGHTS (3/3)

The presence and operation of the warning lights **DEPEND ON THE EQUIPMENT AND COUNTRY.**



Anti-lock braking warning light

This lights up when the ignition is switched on and goes out after a few seconds.

If it does not go out after the ignition is switched on, or lights up when driving, there is a fault with the ABS. Braking will then be as normal, without the ABS. Contact an approved Dealer as soon as possible.

Electrotechnical system warning light

When the blue warning light comes on, this means that the traction battery temperature is too low.

When the orange warning light comes on, this means the traction battery or the motor temperature is too high. Opt for a calmer driving style.

If either of these warning lights come on, this may lead to reduced vehicle performance.

Low traction battery level warning light

This comes on when the traction battery charge level has reached the reserve threshold. Please see the information on “Displays and indicators” in Section 1.

Electrotechnical system warning light

If it lights up while driving, this means there is an electrotechnical fault in the “400 Volt” electrical circuit. Please see an authorised dealer as soon as possible.

Electronic Stability Program and traction control system warning light

There are several reasons for the warning light coming on: please refer to the information on “Driver correction devices and aids” in Section 2.

DISPLAYS AND INDICATORS (1/2)

The presence and operation of the display and indicators **DEPENDS ON THE LEVEL OF EQUIPMENT AND THE COUNTRY.**

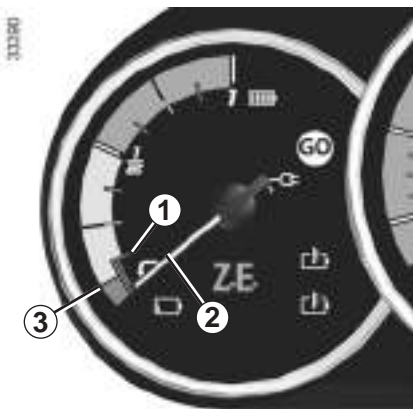

Charge level 2

The gauge indicates the level of energy remaining.

Reserve level 1

This indicates that the battery is at approximately 12% charge. Warning light  comes on, along with a beep.

To optimise your range, please see the information on “Recommendations: saving energy” in Section 2.

Imminent immobilisation level 3

This indicates that the battery is at less than 6% charge. A beep is repeated every 20 seconds and warning light  flashes. The message “Limited performance” is displayed on the instrument panel.

Motor performance gradually decreases until the vehicle comes to a stop.

Please see the information on “Towing: in the event of energy loss” in Section 5.



Speedometer 4

Vehicle speed is limited to approximately 80 mph (135 km/h).

DISPLAYS AND INDICATORS (2/2)

The presence and operation of the display and indicators **DEPENDS ON THE LEVEL OF EQUIPMENT AND THE COUNTRY.**

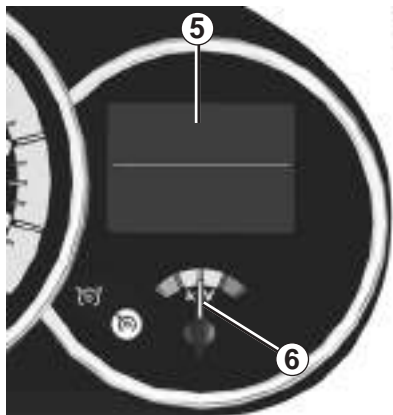

Multifunction display 5

Please refer to the information on the “Trip computer: general information” in Section 1.

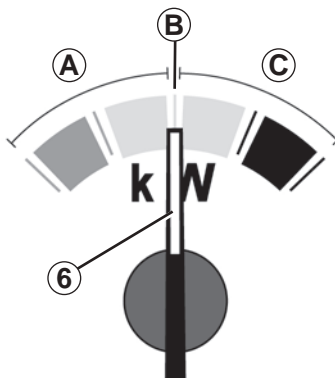

Charge meter 6

Please refer to the information on the “Charge meter” in Section 2.

“Energy recovery” usage zone A

The needle tells you that the vehicle is generating energy and the traction battery is being recharged (under braking or going downhill).

Position B “neutral”

The needle tells you that you are at nil consumption (the vehicle is at a standstill without consuming energy).

“Consumption” usage range C

The needle tells you the energy consumption (vehicle moving on a flat surface, for example).

TRIP COMPUTER: general information (1/2)

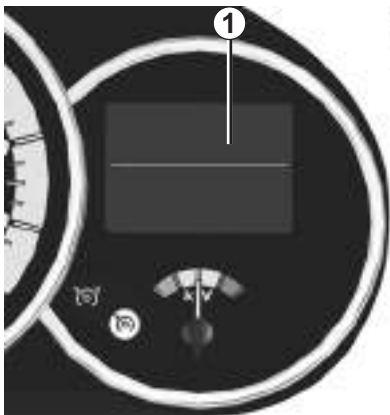

Trip computer 1

Depending on the vehicle, this includes the following functions:

- distance travelled;
- journey parameters;
- information messages;
- operating fault messages (connected to the warning light );
- warning messages (connected to the **STOP** warning light);
- vehicle settings customisation menu.

All these functions are described on the following pages.



Display selection keys 2 and 3

Scroll through the following information upwards (key **2**) or downwards (key **3**) by pressing briefly and successively (the display depends on the vehicle equipment and country).

a) total mileage and trip mileage recorder;

- b) journey parameters:
- total energy consumption since the last reset;
 - average energy consumption;
 - current energy consumption;
 - total energy consumption since the vehicle first entered into service;
 - estimated range;
 - distance travelled;
 - average speed.

c) mileage before service;

e) vehicle settings customisation menu;

f) trip log, operating faults and information message readout.

TRIP COMPUTER: general information (2/2)



Trip mileage resetting

With “trip mileage recorder” selected on the display, press button **2** or **3** until the mileage recorder resets to zero.

Resetting the journey parameters (reset button)

with the display showing one of the journey parameters, press button **2** or **3** until the display is reset.

Reading energy consumption values

Some vehicle equipment items consume energy: the energy consumed by the vehicle may therefore differ from the energy consumed on the electric counter.

Interpreting some of the values displayed after resetting







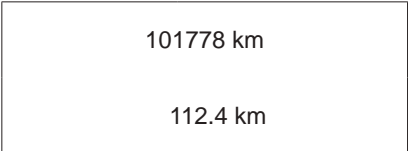

The values showing average energy consumption and average speed will become more stable and reliable the further you have travelled since the last time the Reset button was pressed.

Automatic resetting of the journey parameters

Resetting occurs automatically when the maximum value of any of the parameters is exceeded.

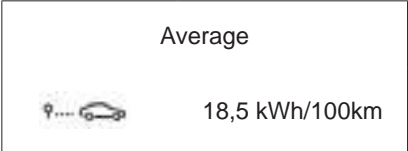

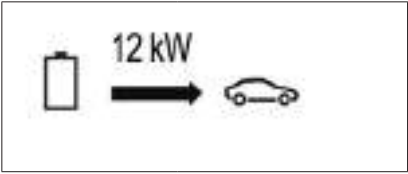
TRIP COMPUTER AND WARNING SYSTEM: journey parameters (1/4)

The display of information shown below **DEPENDS ON THE VEHICLE EQUIPMENT AND COUNTRY.**

Examples of selections	Interpreting the display selected
 <p>101778 km 112.4 km</p>	 a) Total mileage and trip mileage recorder.
 <p>Consumption 20 kWh</p>	 b) Journey parameters. Energy consumed since the last reset.
 <p>Average 18,5 kWh/100km</p>	 Average energy consumption since the last reset. The value is displayed after having travelled at least 400 metres since the last reset.
 <p>12 kW</p>	 Current energy consumption.



TRIP COMPUTER AND WARNING SYSTEM: journey parameters (2/4)

The display of information shown below **DEPENDS ON THE VEHICLE EQUIPMENT AND COUNTRY.**

Examples of selections	Interpreting the display selected
<p data-bbox="269 300 344 325">Range</p>  <p data-bbox="367 378 447 400">118 km</p>	<p data-bbox="563 333 636 370">➔</p> <p data-bbox="662 311 1120 337">Estimated range with remaining energy.</p> <p data-bbox="662 348 1428 400">Value estimated based on average energy usage over the last 125 miles (200 km).</p>
<p data-bbox="261 468 352 493">Distance</p>  <p data-bbox="367 542 447 564">522 km</p>	<p data-bbox="563 501 636 538">➔</p> <p data-bbox="662 507 1085 533">Distance travelled since the last reset.</p>
<p data-bbox="261 647 352 673">Average</p>  <p data-bbox="367 721 447 743">48 km/h</p>	<p data-bbox="563 680 636 717">➔</p> <p data-bbox="662 675 1170 728">Average speed since the last reset. The value is displayed after driving 400 metres.</p>
<p data-bbox="238 826 374 852">Consumption</p> <p data-bbox="359 902 450 925">487 kWh</p>	<p data-bbox="563 860 636 897">➔</p> <p data-bbox="662 865 1251 891">Total energy usage since vehicle first entered service.</p>



TRIP COMPUTER AND WARNING SYSTEM: journey parameters (3/4)

The display of information shown below **DEPENDS ON THE VEHICLE EQUIPMENT AND COUNTRY.**

Examples of selections	Interpreting the display selected
<div data-bbox="107 273 508 426" style="border: 1px solid black; padding: 10px; text-align: center;">Service due in 1936 km</div>	<p data-bbox="662 277 873 303">c) Service interval.</p> <p data-bbox="560 331 628 367"></p> <p data-bbox="689 318 1427 367">Distance remaining until the next service (displayed in miles/kilometres), then when the service nears, several scenarios are possible:</p> <ul data-bbox="689 370 1427 544" style="list-style-type: none"><li data-bbox="689 370 1427 449">– distance/time remaining less than 900 miles (1,500 km) or one month: the message “Service due in” is displayed accompanied by the nearest term (distance or time);<li data-bbox="689 463 1427 544">– distance/time remaining 0 km/miles or service date reached: the message “Service vehicle” is displayed accompanied by the  warning light. <p data-bbox="689 557 1230 583">The vehicle requires a service as soon as possible.</p>
<p data-bbox="84 654 1052 675">Resetting the display after the service in accordance with the maintenance schedule.</p> <p data-bbox="84 678 1427 700">The service interval must only be reset after a service which complies with the recommendations in the maintenance schedule.</p> <p data-bbox="84 714 1427 766">Special note: To reset the service interval, press and hold one of the display reset buttons for approximately 10 seconds until the display shows the mileage permanently.</p>	

TRIP COMPUTER AND WARNING SYSTEM: journey parameters (4/4)

The display of information shown below **DEPENDS ON THE VEHICLE EQUIPMENT AND COUNTRY.**

Examples of selections	Interpreting the display selected
<p data-bbox="107 286 508 426">SETTINGS MENU press and hold</p>	<p data-bbox="556 286 1425 400"> d) Vehicle settings customisation menu. Enables certain vehicle functions to be set (instrument panel language, parking distance control, etc.). Refer to the information on “Vehicle settings customisation menu” in Section 1.</p>
<p data-bbox="107 454 508 594">Speed limiter 90 km/h</p>	<p data-bbox="556 454 1425 589"> e) Cruise control/speed limiter programmed speed. Refer to the information on the “Speed limiter” and “Cruise control” in Section 2.</p>
<p data-bbox="107 622 508 762">Cruise control 90 km/h</p>	
<p data-bbox="107 801 508 953">No message available</p>	<p data-bbox="556 801 1425 947"> f) Trip log. Successive display: – information messages (passenger airbag OFF etc); – operating fault messages.</p>

TRIP COMPUTER AND WARNING SYSTEM: information messages

These can help in the vehicle starting phase, or give information about a selection or a driving status. Examples of information messages are given in the following pages.

Examples of messages	Interpreting the display selected
"Charge remain. 02:10"	Indicates the time remaining before a full charge.
"Checking control functions"	Displayed with the ignition on when the vehicle is running self-diagnostics.
"Traction control off"	Indicates that you have deactivated the ASR function.
"No message available"	No warning is stored.
"Steering wheel not locked"	Indicates that the steering column has not been locked.
"Performance limited"	Indicates deterioration of vehicle performance.
"Brake the vehicle"	Follow these instructions: risk of damage to the motor.

TRIP COMPUTER AND WARNING SYSTEM: operating fault messages

These appear with the  warning light and mean that you should drive very carefully to an authorised dealer as soon as possible. If you fail to follow this recommendation, you risk damaging your vehicle.

They disappear when the display selection key is pressed or after several seconds and are stored in the computer log. The  warning light stays on. Examples of operating fault messages are given in the following pages.

Examples of messages	Interpreting the display selected
« Check airbag »	Indicates a fault in the restraint system in addition to the seat belts. In the event of an accident, it is possible that they may not be triggered.
« Elec. System to check »	Indicates a fault on one of the pedal sensors or in the 12 V battery management system.
« Check braking system »	Indicates wear or the need to check the braking system.
« Service required »	Indicates that the system linked to the fast traction battery replacement should be checked.
« Elec. System to check »	Indicates a fault in the traction system.
« Battery charge impossible »	Indicates a fault on the traction battery recharge system.

TRIP COMPUTER AND WARNING SYSTEM: warning message

These appear with the **STOP** warning light and require you to stop immediately, for your own safety, as soon as traffic conditions allow. Stop your engine and do not restart it. Contact an approved Dealer.

Examples of warning messages are given in the following pages. **Note:** the messages appear on the display either individually or alternately (when there are several messages to be displayed), and may be accompanied by a warning light and/or a beep.

Examples of messages	Interpreting the display selected
"Braking system fault"	Indicates a fault in the braking system.
« Power steering fault »	Indicates a fault in the steering.
« Electrical motor fault »	Indicates that the vehicle is losing power.
« Electrical fault danger »	Indicates a fault in the electric system.

VEHICLE SETTINGS CUSTOMISATION MENU

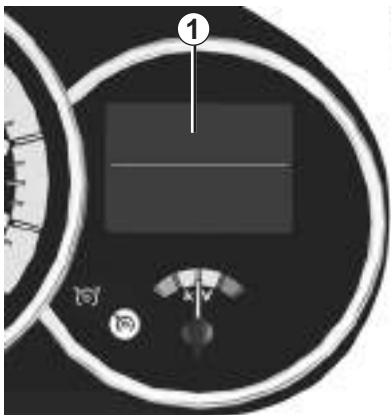

On equipped vehicles, this function, which is integrated in the trip computer **1**, allows you to activate/deactivate some of the vehicle's functions.

Accessing the settings customisation menu

With the vehicle stopped, press button **2** or **3** several times until the message "Settings menu: press and hold" is shown on display **1**. Press either button **2** or **3** for longer than 2 seconds to enter the menu.



Adjusting the settings

Press button **2** or **3** to select a function to change:

- a) Auto door locking while driving ;
- b) Auto dipped-beam headlights ;
- c) Rear parking sensor ;
- d) Parking sensor volume ;
- e) LANGUAGE.



function activated

function deactivated

Once a line has been selected, keep pressing button **2** or **3** to change the function: If you select either "Parking sensor volume" or "LANGUAGE", you will have to make a further selection (sound volume of the parking distance control or instrument panel language). In this case, make your selection and confirm it by holding either button **2** or **3**, the value selected is shown by a



in front of the line.

To exit the menu, select "EXIT" or "BACK" then confirm by keeping either button **2** or **3** pressed. It may be necessary to carry out this operation more than once.

The vehicle settings personalisation menu cannot be used when driving. The display automatically switches back to trip computer mode.

REAR-VIEW MIRRORS

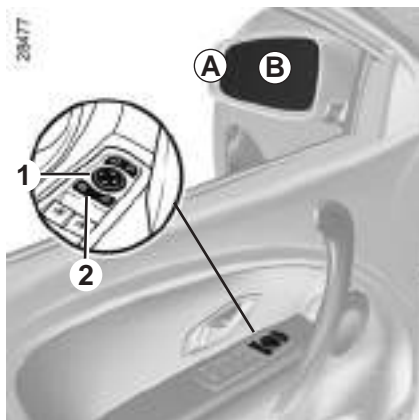

Door mirrors

Adjustment

Select the door mirror using switch **2**, then use button **1** to adjust it to the desired position.

Heated door mirrors

(depending on the vehicle)

Mirror de-icing is carried out at the same time as rear screen de-icing.



The driver's door mirror may have two clearly defined zones. Zone **B** shows what can normally be seen in an ordinary rear-view mirror. Zone **A** increases rear side visibility.

The objects in zone A look much further away than they really are.

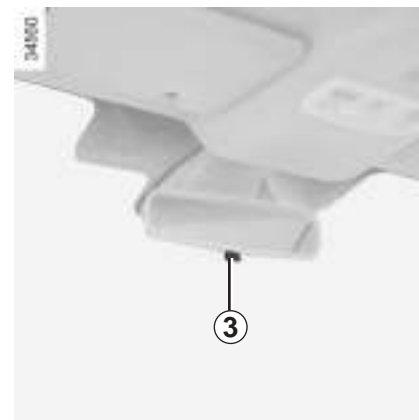

Interior rear view mirror

Its position can be adjusted.

Rear view mirror with lever 3

For night driving, to avoid being dazzled by the headlights of the car behind you, flip the small lever **3** located behind the rear view mirror.

Rear view mirror without lever 3

The rear view mirror darkens automatically at night if you are being followed by a vehicle with its lights on.

AUDIBLE AND VISUAL SIGNALS



Horn

Press on the sides of the steering wheel boss **A**.

Headlight flasher

Pull stalk **1** towards you to flash the headlights.

Direction indicators

Move stalk **1** parallel to the steering wheel and in the direction you are going to turn it.

When driving on the motorway, the steering wheel is not often turned enough to return the stalk automatically to **0**. There is an intermediate position in which the switch may be held when changing lanes.

When the stalk is released, it automatically returns to **0**.



Hazard warning lights

Press switch **2**. This switch illuminates all four direction indicators and the side-mounted indicator lights simultaneously. It must only be used in an emergency to warn drivers of other vehicles that you have had to stop in an area where stopping is prohibited or unexpected or that you are obliged to drive under special conditions.

Depending on the vehicle, the hazard warning lights may come on automatically under heavy deceleration. You can switch them off by pressing switch **2**.

EXTERIOR LIGHTING AND SIGNALS (1/3)



30942



Side lights

Turn the ring **2** until the symbol is opposite mark **3**.



Dipped beam headlights

Manual operation

Turn the ring **2** until the symbol is opposite mark **3**. This indicator light on the instrument panel comes on.

Automatic operation

Turn ring **2** until the AUTO symbol is opposite mark **3**: with the engine running, the dipped beam headlights switch on or off automatically depending on the brightness of the light outside, without any action on stalk **1**.



Main beam headlights

With the dipped beam headlights lit, pull stalk **1** towards you. This indicator light on the instrument panel comes on.

To return to the dipped headlight position, pull the stalk **1** towards you again.



Before driving at night: check the electrical equipment is operating correctly and adjust your headlights (if your vehicle is not carrying its normal load). As a general precaution, check that the lights are not obscured (by dirt, mud, snow or objects being transported).

EXTERIOR LIGHTING AND SIGNALS (2/3)



Switching off the lights

There are two possibilities:

- manually, move ring **2** to position **0**;
- the lights will go out automatically when the engine is switched off, the driver's door is opened or the vehicle is locked. In this case, the next time the engine is started the lights will be switched back on according to the position of the ring **2**.

NB: if the fog lights are lit, the lights are not switched off automatically.

“See-me-home lighting” function

Depending on the vehicle, this function allows you to briefly switch on the dipped beam headlights (to provide light when opening a gate, etc.).

With the engine and lights off and ring **2** in the **0** position, pull stalk **1** towards you: the dipped beam headlights light up for approximately thirty seconds. To increase this duration, you may pull the stalk up to four times (total time restricted to two minutes). Depending on the vehicle, the message “See-me-home _ _ _” accompanied by the lighting time is displayed on the instrument panel to confirm the action.

To switch off the lights before they go out automatically, turn ring **2** to any position, then return it to position **0**.

Lights-on reminder buzzer

If the lights are on after the engine is switched off, a warning beep sounds when the driver's door is opened to warn you that the lights are still on.

EXTERIOR LIGHTING AND SIGNALS (3/3)

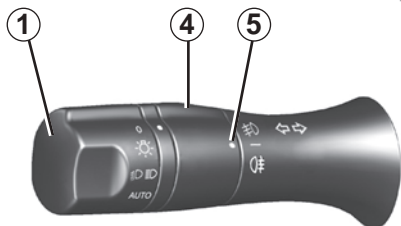

Front fog lights

Turn centre ring **4** on the stalk **1** until the symbol faces mark **5**, then release it.

Operation of the fog lights depends on the exterior lighting position selected, and an indicator light will light up on the instrument panel.

Rear fog light

Turn centre ring **4** on the stalk until the symbol faces mark **5**, then release it.

Operation of the fog lights depends on the exterior lighting selected, and an indicator light will light up on the instrument panel.

To avoid inconveniencing other road users, remember to switch off the rear fog light when it is no longer needed.

Turning off the fog lights

Turn ring **4** again until mark **5** is opposite the symbol for the fog light you wish to switch off. The corresponding indicator light goes out on the instrument panel.

The front and rear fog lights switch off when the exterior lights are switched off.

When driving in fog or snow, or when transporting objects which are higher than the roof, the headlights do not come on automatically.

The driver remains in full control of switching on the fog lights: the indicator lights on the instrument panel inform you whether the fog lights are lit (indicator light on) or not (indicator light off).

ELECTRICAL ADJUSTMENT OF THE DIPPED BEAM HEADLIGHTS



On vehicles fitted with this function, control **A** allows you to adjust the height of the beams according to the load.

Turn control **A** downwards to lower the headlights and upwards to raise them.

For vehicles not fitted with control **A**, adjustment is automatic.

	For manual setting Examples of positions for adjusting control A according to the load.
Driver alone or with front passenger	0
Driver with one front passenger and one rear passenger	0
Driver with one front passenger and two or three rear passengers	1
Driver with one front passenger, three rear passengers and luggage	3

WINDSCREEN WASH/WIPE (1/2)

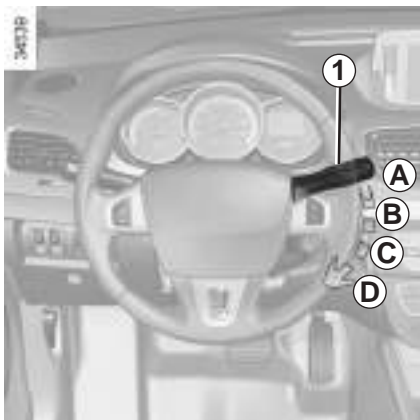

Vehicle fitted with intermittent windscreen wipers

A park

B intermittent wiping

The wipers will pause for several seconds between sweeps. It is possible to change the time between sweeps by turning ring 2.

C normal wiping speed

D fast wiping speed

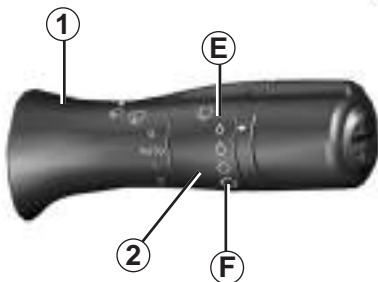

Special note

When driving the vehicle, the wiping speed slows down whenever the vehicle stops. For example, fast wiping speed will slow to normal wiping speed. As soon as the vehicle moves off, wiping will return to the speed originally selected.

If stalk 1 is operated, it overrides and cancels the automatic function.

For all vehicles, position **C** can be accessed with the ignition on and positions **B** and **D** can only be accessed with the engine running.

Vehicle fitted with front windscreen wiper rain sensor

A park

B automatic wiper function.

When this position is selected, the system detects water on the windscreen and triggers the wipers at a suitable wiping speed. It is possible to change the triggering threshold and the time sweeps by turning ring 2:

- **E**: minimum sensitivity
- **F**: maximum sensitivity

NB: in foggy weather or during snowfalls, the wiping is not automatically triggered and remains under the driver's control.

C normal wiping speed

D fast wiping speed

WINDSCREEN WASH/WIPE (2/2)



Windscreen washer

With the **ignition on**, pull stalk **1** then release.

A brief pull will trigger a single sweep of the wipers, in addition to the windscreen washer.

A longer pull will trigger three sweeps of the wipers followed, a few seconds later, by a fourth, in addition to the windscreen washer.

In freezing or snowy weather, ensure they are not stuck to the windscreen (including the central area located behind the interior rear-view mirror) and the rear screen before starting the wipers (risk of motor overheating).



When working in the engine compartment, ensure that the windscreen wiper stalk is in position **A** (off).

Risk of injury.



Before any action on the windscreen (washing the vehicle, de-icing, cleaning the windscreen, etc.) return stalk **1** to position **A** (off).

Risk of injury and/or damage.

Section 2: Driving

(Advice on use relating to fuel economy and the environment)

Starting, stopping the engine	2.2
Gear control	2.3
Handbrake	2.4
Vehicle range: recommendations	2.5
Environment	2.7
Charge meter	2.8
Driving correction devices	2.9
Speed limiter	2.13
Cruise control	2.16
Parking distance control	2.20

STARTING, STOPPING THE ENGINE



“Stop and steering lock” position St

To unlock: turn the key and the steering wheel slightly.

To lock: remove the key and turn the steering wheel until the steering column locks.

“Accessories” position A

When the ignition is switched off, any accessories (radio, etc.) will continue to function.



“On” position M

The ignition is switched on:

Start position D

Starting the engine

- Move the gear lever to position **P** only ;
- turn the key to position **D** and release it.

Warning light  may flash on the instrument panel, along with a beep. As soon as light  stops flashing and the beep stops, the vehicle is ready to drive.

The vehicle can only be started if the charging cord is unplugged from the vehicle.

The vehicle can only be started if the selection lever is at **P**. Please see the information on “Gear control” in Section 2.

Stopping the engine

Bring the key to “Stop” position. Warning light  goes out.



Driver’s responsibility

Never leave your vehicle with the key inside and never leave a child (or a pet) unsupervised, even for a short while.

There is a risk that they could start the engine or operate electrical equipment (electric windows etc.) and trap part of their body (neck, arms, hands, etc.).

Risk of serious injury.

Never switch off the ignition before the vehicle has stopped completely. Once the engine has stopped, the brake servo, power-assisted steering, etc., and the passive safety devices such as the airbags and pre-tensioners will no longer operate.

GEAR CONTROL (1/2)



Operates similar to an automatic gearbox.

Selector lever 1

The display 3 on the instrument panel indicates the gear lever position.

- 4: P: park
- 5: R: reverse gear
- 6: N: neutral
- 7: D: forward
- 8: display of gear lever position

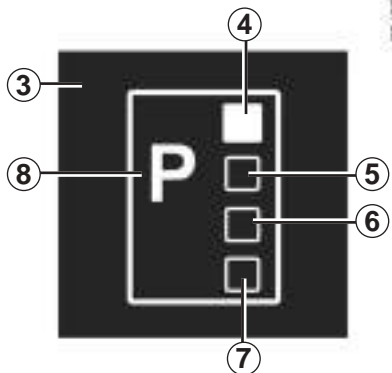

Operation

With your foot on the brake pedal, the selection lever 1 in P, switch on the ignition.

Start the motor.

To move out of position P, you must depress the brake pedal before pressing unlocking button 2.

With the foot on the brake pedal (warning light  on the display 3 goes out), move the lever out of position P.

Only engage D or R when the vehicle is stopped, with your foot on the brake and the accelerator pedal released.

Driving

Put lever 1 in position D.

The vehicle moves forward once you release the brake pedal (without pressing on the accelerator pedal).

While driving, press the accelerator pedal to achieve the desired speed.

Reverse

Put lever 1 in position R.

The reversing lights will come on as soon as reverse gear is selected (with the ignition on).

The vehicle can only start if the gear selector is in position P.

The vehicle can only be started if the charging cord is unplugged from the vehicle.

GEAR CONTROL (2/2)/HANDBRAKE

Parking the vehicle

When the vehicle is at a standstill, place the lever in position **P**: the drive wheels are mechanically locked by the transmission.

Apply the handbrake.



In the event an impact to the underside of the vehicle (e.g.: striking a post, raised kerb or other street furniture) this may result in damage to the vehicle (e.g.: twisted axle), the electrical circuit or the traction battery.

Do not touch the circuit elements or any fluids or liquids.

To prevent any risk of accident, have your vehicle checked by an authorised dealer.

Risk of serious injury or electric shock and risk to life.

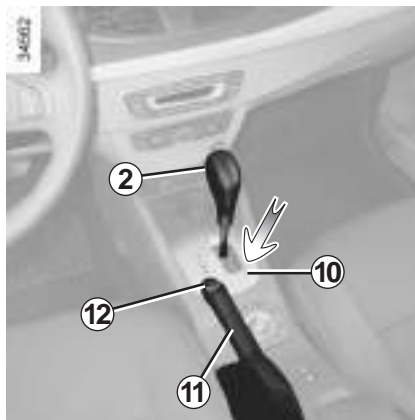

When setting off, if the lever is locked in position **P** even though you are depressing the brake pedal and pressing unlocking button **2**, the lever can be released manually. To do this, press the button by inserting an object into the hole **10** and simultaneously press unlocking button **2** located on the lever.

Handbrake

To release:

Pull the lever **11** up slightly, press button **12** and then lower the lever to the floor.

To apply:

Pull lever **11** upwards and make sure the vehicle is immobilised.



Make sure that the handbrake is properly released when driving (red indicator light off), otherwise overheating may occur.



When stationary and depending on the slope and/or vehicle load, it may be necessary to pull up the handbrake at least two extra notches and engage position **P**.

VEHICLE RANGE: recommendations (1/2)

The vehicle range is approved for a mixed NEDC cycle (New European Driving Cycle).

In real usage, the range of an electric vehicle may vary depending on several factors over which you have partial control, which may make a considerable difference to the vehicle range. These factors are:

- speed and driving style;
- type of road;
- heating level;
- tyres;
- vehicle loading.

Speed and driving style

High speeds will reduce your vehicle's range.

A “sporty” driving style reduces your vehicle range: opt for a “lighter” driving style.

Drive at a constant speed.

Adapt your driving to avoid excessive energy consumption. Please refer to the “Charge meter” information in Section 2.

3-4620



Anticipate traffic changes by lifting your foot off the accelerator pedal in order to recover energy. Please refer to the “Charge meter” information in Section 2.

3-4620



Road type

Do not try to maintain the same speed up a hill, accelerate no more than you would on the level. Keep your foot in the same position on the accelerator pedal.

VEHICLE RANGE: recommendations (2/2)

34025



Heating levels

The use of heating or air-conditioning reduces vehicle range.

Before using the vehicle, you are recommended to favour “programmable heating” mode to help maintain the vehicle’s optimum range (please refer to the information on “Air-conditioning: programming” in Section 3).

Keep your usage of heating or air-conditioning down to a minimum while driving. Favour ECO mode - please see the information on “Automatic air-conditioning” in Section 3.

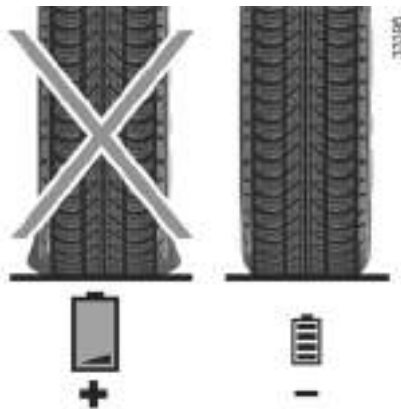

Tyres

An under-inflated tyre increases energy consumption. Comply with the specified tyre pressures for your vehicle.

When driving, use tyres made by the same manufacturer, with the same dimensions, type and structure as the original tyres. The use of non-regulation tyres significantly reduces vehicle range.

Please see the information on “Tyre pressure” in Section 4.

Vehicle loading

Avoid pointlessly overloading your vehicle.

ENVIRONMENT

Your vehicle has been designed with respect for the **environment** in mind for its entire service life: during production, use and at the end of its life. This commitment is illustrated by the of the manufacturer eco² signature.

Manufacture

Your vehicle has been manufactured at a factory which complies with a policy to reduce the environmental impact on the surrounding areas (reduction of water and energy consumption, visual and noise pollution, atmospheric emissions and waste water; sorting and re-using waste).

Emissions

Your vehicle has been designed to emit fewer greenhouse gases (CO₂) while in use, and therefore to consume less fuel (eg. 140 g/km, equivalent to 5.3 l/100 km for a diesel vehicle).

Our vehicles are also equipped with a particle filter system including a catalytic converter, an oxygen sensor and an active carbon filter (the latter prevents vapour from the fuel tank being released into the open air).

For certain diesel vehicles, this system also has a particle filter to reduce the volume of soot particles emitted.

Please make your own contribution towards protecting the environment too

- Worn parts replaced in the course of routine vehicle maintenance (vehicle battery, oil filter, air filter, batteries, etc.) and oil containers (empty or filled with used oil) must be disposed of through specialist organisations.

- At the end of the vehicle's service life, it should be sent to approved centres to ensure that it is recycled.
- In all cases, comply with local legislation.

Recycling

Your vehicle is 85% recyclable and 95% recoverable.

To achieve these objectives, many of the vehicle components have been designed to enable them to be recycled. The materials and structures have been carefully designed to allow these components to be easily removed and reprocessed by specialist companies.

In order to preserve raw material resources, this vehicle incorporates numerous parts made from recycled plastics or renewable materials (vegetable or animal-derived materials such as cotton or wool).

CHARGE METER

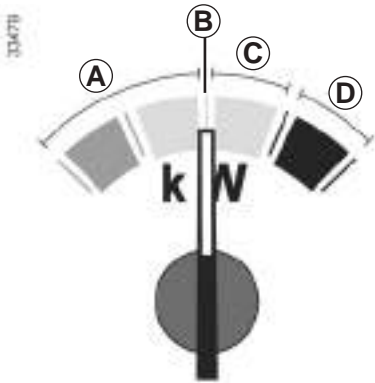

The traction battery supplies the electrical energy required for the motor to move the vehicle.

When you lift your foot off the accelerator pedal, the motor generates electrical current during deceleration, and this energy is used to recharge the traction battery.

“Energy recovery” usage zone A

Indicates that the vehicle is generating energy and recharging the battery.

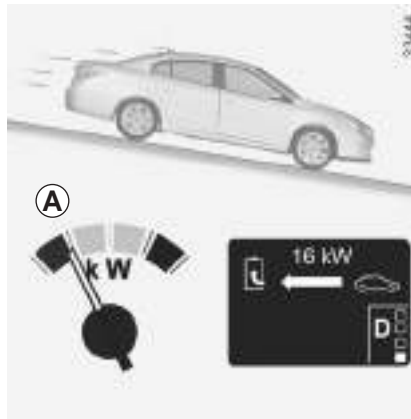

Energy recovery features

The motor generates a more significant engine brake than a conventional vehicle.

After a maximum charge for the traction battery and during the first few miles when driving the vehicle, the engine brake is temporarily reduced. Please adapt your driving style appropriately.

Position B “neutral”

Indicates nil consumption.

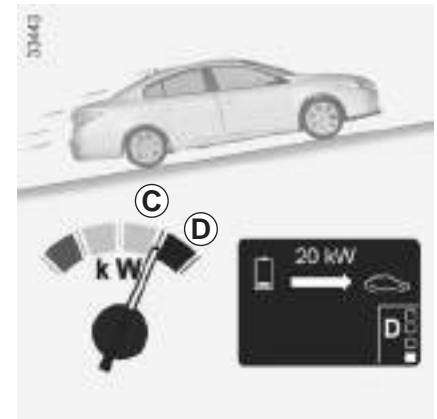

“Recommended consumption” usage zone C

Indicates “economical” energy consumption.

“Consumption not recommended” usage zone D

Indicates high energy consumption.

DRIVER CORRECTION DEVICES/AIDS (1/4)

These include:

- the **ABS (anti-lock braking system)**;
- the **electronic stability program ESP with understeer control and traction control ASR**;
- **emergency brake assist with, depending on the vehicle, braking anticipation.**



These functions are an additional aid in the event of critical driving conditions, enabling the vehicle behaviour to be adapted to suit the driving conditions.

However, the functions do not take the place of the driver. **They do not increase the vehicle's limits and should not encourage you to drive more quickly.** Therefore, they can under no circumstances replace the vigilance or responsibility of the driver when manoeuvring the vehicle (the driver must always be ready for sudden incidents which may occur when driving).

ABS (anti-lock braking system)



Under heavy braking, the ABS prevents the wheels from locking, allowing the stopping distance to be managed and keeping control of the vehicle.



Under these circumstances, the vehicle can be steered to avoid an obstacle whilst braking. In addition, this system can increase stopping distances, particularly on roads with low surface grip (wet ground etc.).

You will feel a pulsation through the brake pedal each time the system is activated. The ABS does not in any way improve the vehicle's physical performance relating to the road surface and roadholding. It is still **essential** to follow the rules of good driving practice (such as driving at a safe distance from the vehicle in front etc.).

In an emergency, apply **firm and continuous pressure** to the brake pedal. There is no need to pump it repeatedly. The ABS will modulate the force applied in the braking system.

Operating faults:

-  and  lit up on the instrument panel alongside, depending on the vehicle, messages "Check ABS", "Check braking system" and "Check ESP": ABS, ESP and emergency brake assist are deactivated. **Braking is always enabled;**

- , ,  and **STOP** lit up on the instrument panel alongside the message "Braking system fault": **this indicates a fault in the braking system.**

In both cases, consult an approved Dealer.



Your braking systems are partially operational. However, it is **dangerous to brake suddenly** and it is essential to stop immediately, as soon as traffic conditions allow. Contact an approved dealer.

DRIVER CORRECTION DEVICES/AIDS (2/4)

Electronic stability program ESP with understeer control and traction control ASR

Electronic stability program ESP

This system helps you to keep control of the vehicle in critical driving conditions (avoiding an obstacle, loss of grip on a bend, etc.).

Operating principle

A sensor in the steering wheel detects the direction selected by the driver.

Other sensors throughout the vehicle measure the actual direction.

The system compares driver input to the actual trajectory of the vehicle and corrects the trajectory if necessary by controlling the braking of certain wheels and/or engine power. In the event that the system is engaged, indicator light



flashes on the instrument panel.

Understeer control

This system optimises the action of the ESP in the case of pronounced understeering (loss of front axle road holding).

Traction control ASR

This system helps to limit wheelspin of the drive wheels and to control the vehicle when pulling away accelerating or decelerating.

Operating principle

Using the wheel sensors, the system measures and compares the speed of the drive wheels at all times and slows down their over-rotation. If a wheel is starting to slip, the system brakes automatically until the drive supplied becomes compatible with the level of grip under the wheel again.

Operating faults

When the system detects an operating fault the message “Check ESP” and warning light  appear on the instrument panel. In this case, the ESP and ASR are deactivated.

Consult an approved dealer.

DRIVER CORRECTION DEVICES/AIDS (3/4)



Disabling the ASR function

In some situations (driving on very wet ground: snow, mud, etc. or driving with snow chains fitted), the system may reduce the engine output to limit wheel-spin. If this is not required, it is possible to deactivate the function by pressing switch **1**.

The message “Traction control off” is displayed on the instrument panel to inform you.

The traction control ASR offers additional safety, it is recommended that you do not drive with the function disabled. Correct this as soon as possible by pressing switch **1** again.

NB: the function is reactivated automatically when the ignition is switched on or when a speed of approximately 24 mph (40 km/h) is exceeded.

Emergency brake assist

This system supplements the ABS and helps reduce vehicle stopping distances.

Operating principle

The system is for detecting an emergency braking situation. In this case, the braking assistance immediately develops maximum power and may trigger ABS regulation.

ABS braking is maintained as long as the brake pedal is applied.

Hazard warning lights switching on
These may light up in the event of rapid deceleration.

Operating faults

When the system detects an operating fault the message “Check braking system” appears on the instrument panel along with the  warning light.

Consult an approved dealer.

Braking anticipation

Depending on the vehicle, when you rapidly release the accelerator, the system anticipates the braking manoeuvre in order to reduce stopping distances.

Special cases

When using the cruise control:

- if you use the accelerator, when you release it, the system may be triggered;
- if you do not use the accelerator, the system will not be triggered.

DRIVER CORRECTION DEVICES/AIDS (4/4)

Hill start assistance

This function assists the driver when starting on hills. It prevents the vehicle from rolling backwards, depending on the slope, by automatically applying the brakes when the driver lifts his/her foot off the brake pedal to depress the accelerator pedal.

System operation

It only operates when the gear lever is in a position other than neutral (other than **N** or **P**) and the vehicle is completely stationary (brake pedal depressed).

The system holds the vehicle for approximately **2 seconds**. The brakes are then gradually released (the vehicle will move according to the slope).



The hill start assistance system cannot completely prevent the vehicle from rolling backwards in all situations (extremely steep gradients, etc.).

In all cases, the driver may depress the brake pedal to prevent the vehicle from rolling backwards.

The hill start assistance function should not be used for prolonged stops: use the brake pedal.

This function is not designed to immobilise the vehicle permanently.

If necessary, use the brake pedal to stop the vehicle.

The driver must remain particularly vigilant when driving on slippery or low-grip surfaces and/or on hills.

Risk of serious injury.

CRUISE CONTROL, SPEED LIMITER: speed limiter (1/3)



The speed limiter function helps you stay within the driving speed limit that you choose, known as the **limit speed**.

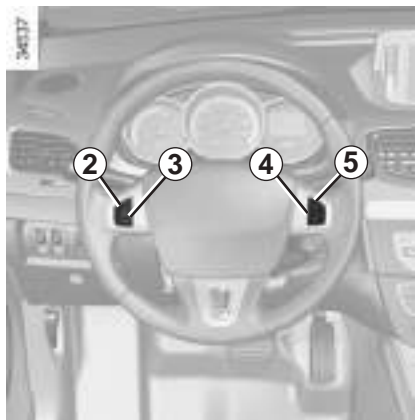

Controls

- 1 Main “On/Off” switch.
- 2 Limit speed activation, storage and increase switch (+).
- 3 Decrease limit speed (-).
- 4 Speed limiter function standby (with limited speed memory) (O).
- 5 Activation and recall of stored limit speed (R).



Switching on

Press switch **1** on side . Indicator light **6** comes on, lit orange, and the message “Speed limiter” appears on the instrument panel, accompanied by dashes to indicate that the speed limiter function is activated and waiting to store a limit speed.

To store the current speed, press switch **2** (+): the limit speed will replace the dashes.

The minimum stored speed is 20 mph (30 km/h).

CRUISE CONTROL, SPEED LIMITER: speed limiter (2/3)



Driving

When a limited speed has been stored and this speed is not reached, driving is similar to driving a vehicle without the speed limiter function.

Once you have reached the stored speed, no effort on the accelerator pedal will allow you to exceed the programmed speed except in an emergency (refer to information on “Exceeding the limit speed”).

Varying the limit speed

The limit speed may be changed by repeatedly pressing:

- switch **2** (+) to increase speed;
- switch **3** (-) to reduce speed.

Exceeding the limit speed

It is possible to exceed the limit speed at any time. To do this: press the accelerator pedal **firmly and fully** (beyond the resistance point).

While the speed is being exceeded, the programmed speed displayed on the instrument panel flashes.

Then, release the accelerator: the speed limiter function will return as soon as you reach a speed lower than the stored speed.

Limited speed cannot be maintained

If driving up or down a steep gradient, the system is unable to maintain the limit speed: the stored speed will flash on the instrument panel information display to inform you of this situation.



The speed limiter function is in no way linked to the braking system.

CRUISE CONTROL, SPEED LIMITER: speed limiter (3/3)

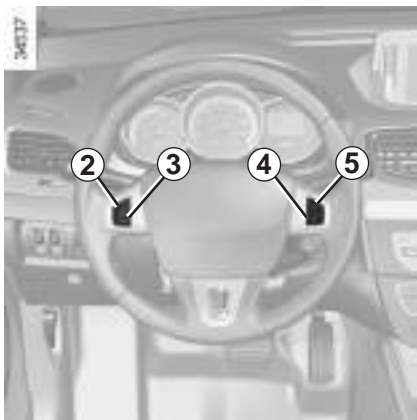

Putting the function on standby

The speed limiter function is suspended when you press switch **4** (O). In this case, the limit speed remains stored and the message “Memorised” accompanied by this speed appears on the instrument panel.

Recalling the limit speed

If a speed has been saved, it can be recalled by pressing switch **5** ((R)).

When the speed limiter is put on standby, pressing switch **2** (+) reactivates the function without taking into account the stored speed: it is the speed at which the vehicle is moving that is taken into account.

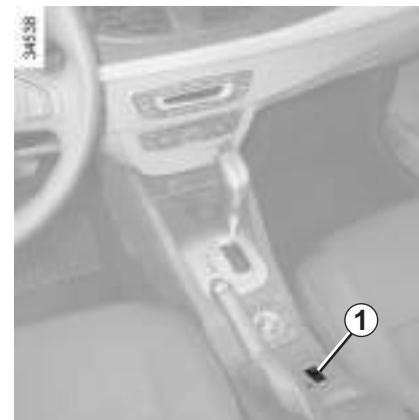

Switching off the function

The speed limiter function is deactivated if you press switch **1**: in this case a speed is no longer stored. The orange instrument panel warning light  goes out, confirming that the function is stopped.

CRUISE CONTROL, SPEED LIMITER: cruise control function (1/4)



The cruise control function helps you to maintain your driving speed at a speed that you choose, called the **cruising speed**.

This cruising speed may be set at any speed above 20 mph (30 km/h).



The cruise control function is in no way linked to the braking system.



This function is an additional driving aid. However, the function does not take the place of the driver.

Therefore, it can under no circumstances replace the driver's responsibility to respect speed limits and to be vigilant (the driver must always be ready to brake). Cruise control must not be used in heavy traffic, on undulating or slippery roads (black ice, aquaplaning, gravel) and during bad weather (fog, rain, side winds etc.).

There is a risk of accidents.

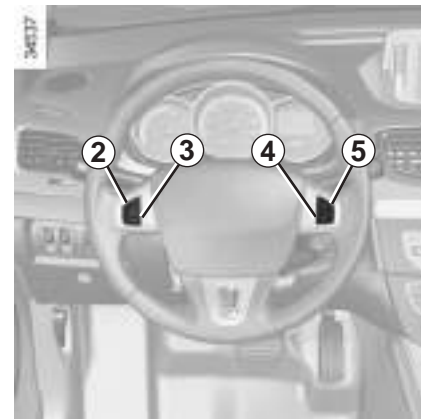

Controls

- 1 Main "On/Off" switch.
- 2 Limit speed activation, storage and increase switch (+).
- 3 Decrease cruising speed (-).
- 4 Switch the function to standby (with cruising speed saved) (O).
- 5 Activation with recall of stored governed cruising speed (R).

CRUISE CONTROL, SPEED LIMITER: cruise control function (2/4)



Switching on

Press switch **1** side .

Indicator light **6** comes on, lit green, and the message “Cruise control” appears on the instrument panel, accompanied by dashes to indicate that the cruise control function is activated and waiting to store a cruising speed.



Activating cruise control

At a steady speed (above 18 mph (30 km/h approximately)) press switch **2** or (+): the function is activated and the current speed is saved.

The cruising speed replaces the dashes and the cruise control is confirmed by the appearance of warning light **7** lit green, as well as warning light **6**.



Driving

Once a cruising speed is stored and the cruise control function is active, you may lift your foot off the accelerator pedal.



Important: you are nevertheless advised to keep your feet close to the pedals in order to react if necessary.

CRUISE CONTROL, SPEED LIMITER: cruise control function (3/4)

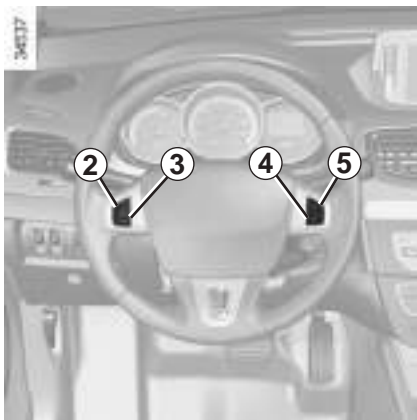

Adjusting the cruising speed

The cruising speed may be changed by pressing the following repeatedly:

- switch **2** (+) to increase the speed,
- switch **3** (-) to decrease the speed.



The cruise control function is in no way linked to the braking system.

Exceeding the cruising speed

The cruising speed may be exceeded at any time by depressing the accelerator pedal. While it is being exceeded, the cruising speed flashes on the instrument panel.

Then, release the accelerator: after a few seconds, the vehicle will automatically return to its set cruising speed.

Cruising speed cannot be maintained

When driving down a steep gradient, the system is unable to maintain the cruising speed: the stored speed will flash on the instrument panel information display to inform you of this situation.

CRUISE CONTROL, SPEED LIMITER: cruise control function (4/4)

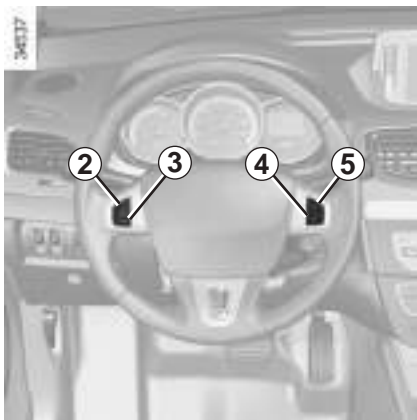

Putting the function on standby

The function is set to standby if you:

- use the switch 4 (O);
- the brake pedal;
- move to neutral position.

In all three cases, the cruising speed remains stored and the message “Memorised” appears on the instrument panel.

Standby is confirmed when indicator light  goes out.

Returning to the cruising speed



If a speed is stored, it can be recalled, once you are sure that the road conditions are suitable (traffic, road surface, weather conditions, etc.). Press switch 5 (R) if the vehicle speed is above 20 mph (30 km/h).

When the stored speed is recalled, activation of the cruise control is confirmed by the illumination of the  warning light.

NB: if the speed previously stored is much higher than the current speed, the vehicle will accelerate more rapidly to reach this threshold.



Switching off the function

The cruise control function is deactivated if you press switch 1: in this case a speed is no longer stored. The two instrument panel warning lights  and  go out to confirm that the function is deactivated.

When the cruise control function is put on standby, pressing switch 2 (+) reactivates the cruise control function without taking into account the stored speed: it is the speed at which the vehicle is moving that is taken into account.



Putting the cruise control on standby or switching it off does not cause a rapid reduction in speed: you must brake by depressing the brake pedal.

PARKING DISTANCE CONTROL (1/2)

Operating principle

Ultrasonic detectors fitted in the vehicle's rear bumper measure the distance between the vehicle and an obstacle whilst reversing.

When reversing, most objects located less than approximately 1.5 metres away from the rear of the vehicle are detected and a beep is emitted.

This measurement is indicated by beeps which become more frequent the closer you come to the obstacle, until they become a continuous beep when the vehicle is approximately 25 centimetres from the obstacle.



This function is an additional aid that indicates the distance between the vehicle and an obstacle whilst reversing, using sound signals.

Under no circumstances should it replace the driver's care or responsibility whilst reversing.

The driver should always look out for sudden hazards during driving: always ensure that there are no moving obstacles (such as a child, animal, pram or bicycle, etc.) or small, narrow objects such as stones or posts in your path when manoeuvring.

Automatic activation/deactivation of the rear parking distance control

The system deactivates:

- when the handbrake is engaged;
- when the vehicle speed is above approximately 4 mph (7 km/h);
- when the vehicle is stationary for more than approximately five seconds and an obstacle is detected (such as when in a traffic jam etc.);
- when you are in positions **N** and **P**.



In the event an impact to the underside of the vehicle (e.g.: striking a post, raised kerb or other street furniture) this may result in damage to the vehicle (e.g.: twisted axle), the electrical circuit or the traction battery.

To avoid any risk of accident, have your vehicle checked by an approved dealer.

PARKING DISTANCE CONTROL (2/2)



Adjusting the parking distance control volume

From the vehicle settings customisation menu (refer to the information on “Vehicle customisation menu” in Section 1), select the line “Parking sensor volume” to adjust the parking distance control volume and confirm by pressing key **1** or **2**.

When the vehicle is being driven at a speed below approximately 4 mph (7 km/h), certain noises (motorcycle, lorry, pneumatic drill, etc.) may trigger the beeping sound.

Prolonged deactivation of the system

From the vehicle settings personalisation menu (refer to the information on the “Vehicle settings personalisation menu” in Section 1), select the line “Rear parking sensor” then activate or deactivate the system:



function deactivated;



function activated.

Operating faults

Depending on the vehicle, when the system detects an operating fault, the message “check parking distance control” appears on the instrument panel, accompanied by the  warning light and a beep lasting approximately 5 seconds. Please see an authorised dealer.

Special features

Make sure that the ultrasonic sensors are not obscured (by dirt, mud, snow, etc.).

Section 3: Your comfort

Air vents	3.2
Automatic climate control	3.4
Air conditioning: programming	3.9
Air conditioning: information and advice on use	3.11
Electric windows	3.12
Interior lighting	3.14
Sun visor	3.15
Passenger compartment storage space and fittings	3.16
Accessories socket	3.19
Ashtray – Cigarette lighter	3.19
Luggage compartment	3.20
Roof bars	3.21
Multimedia equipment	3.22

AIR VENTS: air outlets (1/2)

15045

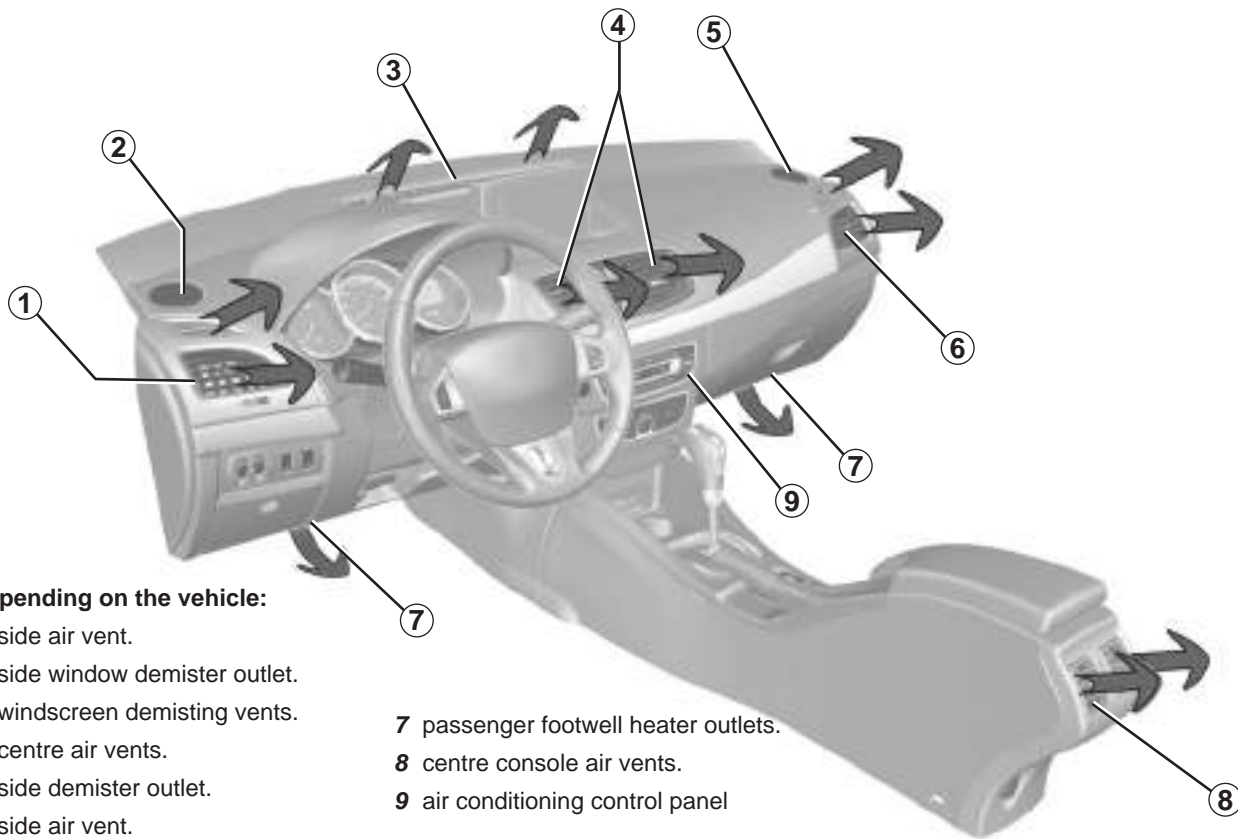

Depending on the vehicle:

- 1 side air vent.
- 2 side window demister outlet.
- 3 windscreen demisting vents.
- 4 centre air vents.
- 5 side demister outlet.
- 6 side air vent.
- 7 passenger footwell heater outlets.
- 8 centre console air vents.
- 9 air conditioning control panel

AIR VENTS: air outlets (2/2)

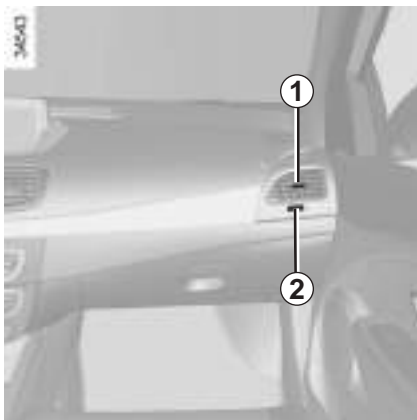

Direction

Right/left: move tabs **1** to the right or left.

Up/down: lower or raise tabs **1**.

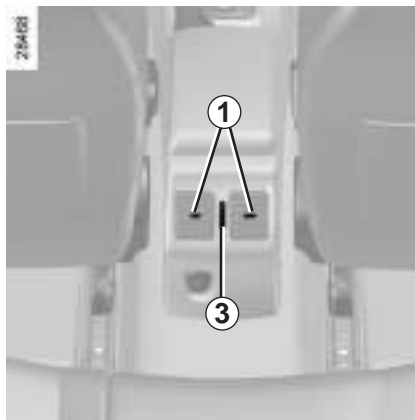

Air flow

Turn control knob **2** (beyond the point of resistance).

To the right: opened to maximum.

To the left: closed.

Turn control knob **3** (beyond the point of resistance).

Upwards: opened to maximum.

Down: closed.

To remove bad odours from your vehicles, only use the systems designed for this purpose. Consult an approved Dealer.



Do not add anything to the vehicle's ventilation circuit (for example, to remove bad odours).

There is a risk of damage or of fire.

AUTOMATIC CLIMATE CONTROL (1/5)



The controls

1 and **6** Air temperature.

2, **3** and **4** Automatic programmes.

5 Distribution of air in the passenger compartment.

7 Activating, deactivating the air-conditioning programming.

8 Air conditioning.

9 De-icing/demisting of the rear screen and, depending on the vehicle, the door mirrors.

10 "Clear View" function.

11 Air recirculation.

12 Adjusting the fan speed until the system switches off.

13 Display.

Automatic mode

The automatic climate control system guarantees comfort in the passenger compartment and good visibility (except in the event of extreme conditions), whilst optimising consumption. The system controls the ventilation speed, air distribution, air recirculation, and starting and stopping the air conditioning and air temperature. This mode consists of a choice of three programmes:

ECO : Limits the electricity consumption of the air-conditioning system to optimise vehicle range. The temperature is too low - Press button **2**. This mode sets the passenger temperature control as the driver's temperature control.

AUTO: allows the selected comfort level to be best attained, depending on the exterior conditions. Press button **3**.

FAST : emphasises the actions of the system to reach the desired comfort level more quickly. Press button **4**.

AUTOMATIC CLIMATE CONTROL (2/5)

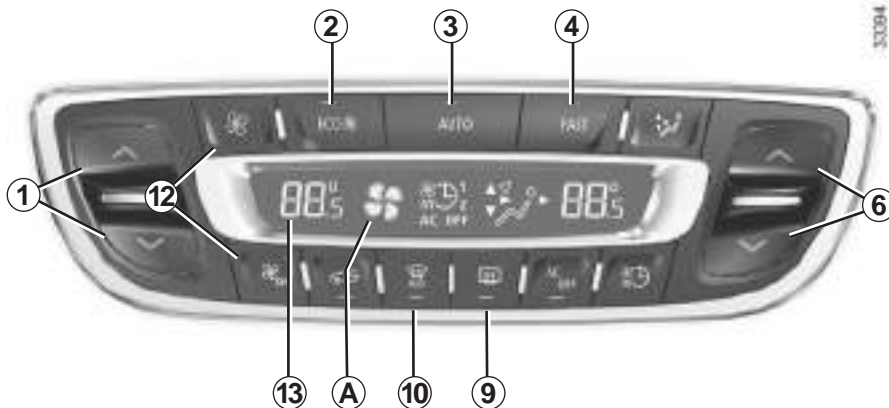

Varying the ventilation speed

In automatic mode, the system uses the most suitable amount of air to reach and maintain the desired comfort level.

You can still adjust the ventilation speed by pressing buttons **12** to increase or reduce the ventilation speed.

In this case, the ventilation speed, which is no longer controlled automatically, appears in zone **A** on the display **13**.

Temperature adjustment

Press button **1** or **6** to raise or lower the left-hand **1** or right-hand **6** temperature. Pressing button **3** for more than 2 seconds sets the passenger temperature to the driver's temperature.

Special note: the highest and lowest settings allow the system to produce maximum hot or cold temperature levels ("LO" and "HI" on display **13**).

Clear View function

Press button **10**: the integrated indicator light comes on.

This function quickly demists and de-ices the windscreen, the rear screen, the front side windows, and the door mirrors (depending on the vehicle). The air conditioning and rear screen de-icing functions must be activated.

Press button **9** to stop the heated rear screen operating; the integrated indicator goes out.

You can change the fan speed: press buttons **12**.

To exit this function, press:

- button **10** again,
- one of either button **2**, **3** or **4**.

Some buttons have an operating tell-tale which indicates the operating status.

AUTOMATIC CLIMATE CONTROL (3/5)



Switching air conditioning on or off

In automatic mode, the system switches the air conditioning system on or off, depending on the climate conditions.

Press button **8** to switch off the air conditioning; the integrated indicator comes on and "AC OFF" is shown on display **13**.

The displayed temperature values show a comfort level.

When starting the engine, increasing or decreasing the value displayed will not allow the comfort level to be reached any more quickly. The system will always optimise the temperature increase or decrease (the ventilation system does not start instantly at maximum speed: it gradually increases). This may take several minutes.

Generally speaking, unless there is a particular reason not to, the dashboard air vents should remain open.

Favour the use of automatic mode, selecting one of the automatic programmes ECO, AUTO or FAST.

In automatic mode (indicator light for button **3** on), all heating and air conditioning functions are controlled by the system.

You can also change the system selection, in this case, indicator light for button **3** will go out and the changed function, which is no longer controlled by the system, is shown on display **13**.

To return to automatic mode, press one of programmes: **ECO**, **AUTO** or **FAST**.

AUTOMATIC CLIMATE CONTROL (4/5)

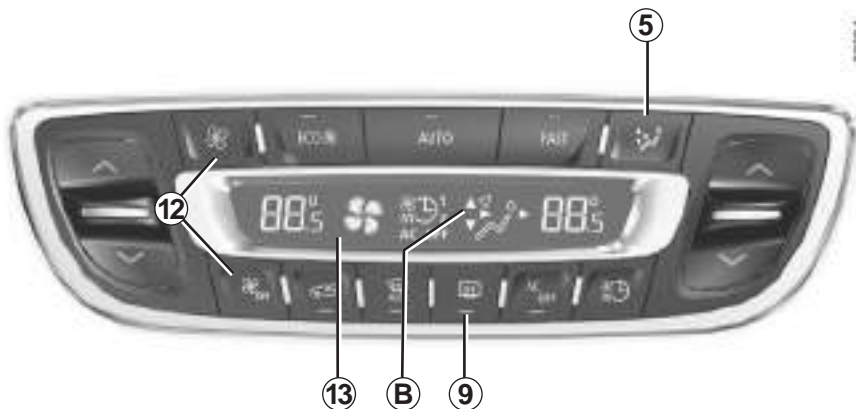

Rear screen de-icing/ demisting

Press button **9**: the integrated indicator light comes on. This function permits rapid demisting/de-icing of the rear screen and de-icing of the door mirrors (on equipped vehicles).

To exit this function, press button **9** again. Demisting automatically stops by default.

Adjusting the distribution of air in the passenger compartment

There are five air distribution options. Press switch **5** to scroll through them. The arrows located in area **B** on the display **13** combine to show you the distribution selected:



The air flow is directed to the windshield and the front side window demisting vents.



The air flow is distributed between all the air vents, the front side window demisting vents, the windshield demisting vents and the footwells.



The air flow is directed mainly towards the footwells.



The air flow is directed towards the dashboard vents and the footwells.



All the air flow is directed to the dashboard vents.

In this situation, the distribution of air in the passenger compartment, which is no longer automatically controlled, appears on the display.

AUTOMATIC CLIMATE CONTROL (5/5)

Recycling

This function is controlled automatically, but it can also be activated manually.

NB:

- during recirculation, air is taken from the passenger compartment and is recycled, with no air being taken from outside the vehicle;
- air recirculation allows the external atmosphere to be cut off (when driving in polluted areas, etc.);
- lowering the passenger compartment temperature as quickly as possible.



Manual use

Pressing button **11** allows air recirculation to be forced, **in this case, the integrated indicator comes on.**

Prolonged use of this position may lead to odours, caused by non-renewal of air, and the formation of condensation on the windows.

We therefore advise you to return to automatic mode as soon as the air recirculation function is no longer required, by pressing button **11** again.

Stopping the system

Press button **12** to switch off the system; in this case "OFF" is shown on display **13**. To switch the system on, press one of switches **2, 3 or 4**.

The demisting/de-icing will still take priority over the air recirculation.

AIR CONDITIONING: programming (1/2)



Adjusting the programming

This function enables the electric network (and not the traction battery) to be used under certain conditions, in order to obtain a comfortable temperature prior to using the vehicle.

The programmable air-conditioning is triggered the hour before the programmed hour in order to reach a comfortable temperature.

The $\frac{88.5}{D_2}$ symbol and the AUTO button warning light are displayed on the air-conditioning control panel.

Operating conditions

- the ignition must be switched off;
- the traction battery charging must have finished for the function to be triggered;
- programming must be done at least 1 hour prior to triggering the function; and
- the vehicle must be connected to a power supply.

AIR CONDITIONING: programming (2/2)



Programming the function start time

Two different times can be programmed.

- to programme the start time, hold down button **A** or **B** on stalk **4** until the message “Settings menu” appears on display **3**;
- scroll down the menu using buttons **A** and **B** until the ⌚^1 or ⌚_2 symbol appears;

- hold down button **A** or **B** - the hours flash;
- press buttons **A** and **B** to set the hour;
- hold down button **A** or **B** to confirm the hour setting;
- the minutes flash - press buttons **A** and **B** to set the minutes;
- hold down button **A** or **B** to confirm the minutes setting. Your settings are now saved.

Activating the function

- With the ignition switched on and the air-conditioning operating (please refer to the information on “Automatic air-conditioning” in Section 3);
- press button **2** ⌚^1 until the ⌚^1 or ⌚_2 symbol is displayed on display **1**;
- switch off the ignition;
- put your vehicle on charge.

The function is triggered one hour prior to the programmed time to reach a comfortable temperature.

Automatically switching off the function

- about 30 minutes after the programmed time;
- if the charging socket is disconnected;
- if the ⌚^1 or ⌚_2 no longer appear on display **1** when you press button **2** ⌚ .

The two programmed times cannot be activated simultaneously.

AIR CONDITIONING: information and advice on use.

Advice on use

In some situations, (air conditioning off, air recirculation activated, ventilation speed at zero or low, etc.) you may notice that condensation starts to form on the windows and windscreen.

If there is condensation, use the “**Clear View**” function to remove it, then use the air conditioning in automatic mode to stop it forming again. If the condensation does not clear, use the **FAST** programme.

Range

It is normal to notice an increase in energy usage when the air conditioning is operating.

Recommendations for reducing consumption and therefore helping to preserve the environment:

Drive with the air vents open and the windows closed.

If the vehicle has been parked in the sun, open the doors for a few moments to let the hot air escape before starting the engine.

Maintenance

Refer to the Maintenance Document for your vehicle for the inspection frequency.

Operating faults

As a general rule, contact your approved dealer in the event of an operating fault.

- **Reduction in de-icing, demisting or air conditioning performance.**
This may be caused by the passenger compartment filter cartridge becoming clogged.
- **No cold air is being produced.**
Check that the controls are set correctly and that the fuses are sound. Otherwise, switch off the system.

Presence of water under the vehicle.

After prolonged use of the air conditioning system, it is normal for water to be present under the vehicle. This is caused by condensation.



Do not open the refrigerant fluid circuit. The fluid may damage eyes or skin.

ELECTRIC WINDOWS (1/2)

These systems operate with the ignition on or off, until one of the front doors is opened (limited to about 3 minutes).



Safety of rear occupants

The driver can disable operation of the electric windows and, depending on the vehicle, the rear doors, by pressing switch **4**. The indicator light integrated in the switch lights up to confirm that the locks have been activated.

Driver's responsibility

Never leave your vehicle with the key inside and never leave a child (or a pet) unsupervised, even for a short while. They may pose a risk to themselves or to others by starting the engine, activating equipment such as the electric windows or by locking the doors. If a body part gets trapped, reverse the direction of travel of the window as soon as possible by pressing the relevant switch.

Risk of serious injury.

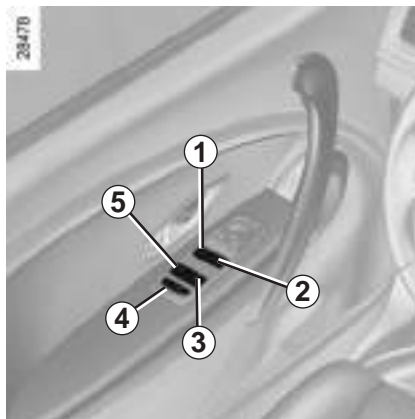

Electric windows

Press the window switch down or pull it up to lower or raise the window to the desired height: the rear windows do not open fully.

One-touch mode

This mode works in addition to the operation of the electric windows described previously. It either operates on the front windows only, or on all the windows.

Briefly press or pull the window switch fully: the window is fully lowered or raised. Pressing the switch again stops the window moving.

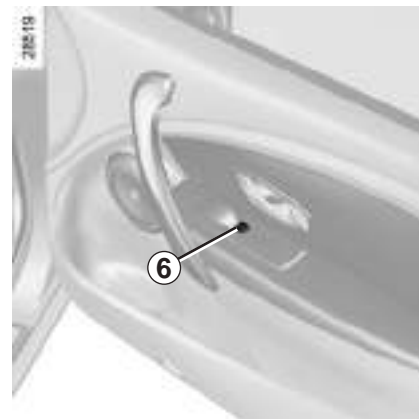

From the driver's seat, use switch:

- 1** for the driver's side;
- 2** for the front passenger side;
- 3** and **5** for the rear passengers.

From the passenger seats, use switch **6**.

Front window features: If the window detects resistance when closing (e.g. fingers, etc.) it stops and then lowers again by a few centimetres.

Avoid resting any objects against a half-open window: there is a risk that the electric window could be damaged.

ELECTRIC WINDOWS (2/2)

Operating faults

In case of a fault when closing a window, the system reverts to normal mode: pull the switch concerned up as often as necessary to fully close the window (the window will close gradually), hold the switch (still on the closure side) for three seconds then lower and raise the window fully to reinitialise the system.

If necessary, contact your approved Dealer.

Usage precautions

Clean the seal every three months with products selected by our Technical Department.



Closing windows can cause serious injury.

INTERIOR LIGHTING (1/2)

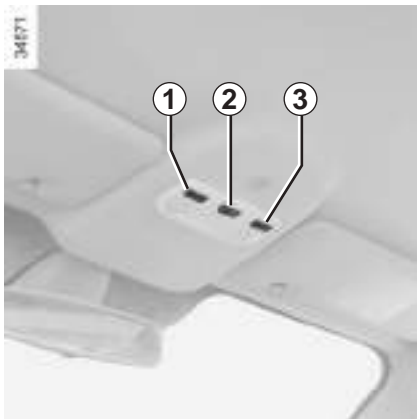

Courtesy light

Tilt switch **2** to move it to the position for:

- permanent lighting;
- lighting controlled by opening one of the doors. This switches off after a time delay, once the doors concerned have been closed correctly;
- immediate switching off.

Map reading lights

Move switches **1** or **3**.

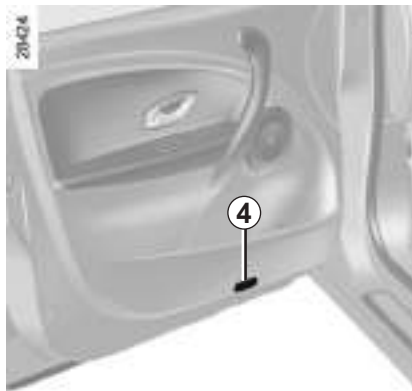

Front door lights

Light **4** comes on when the door is opened.

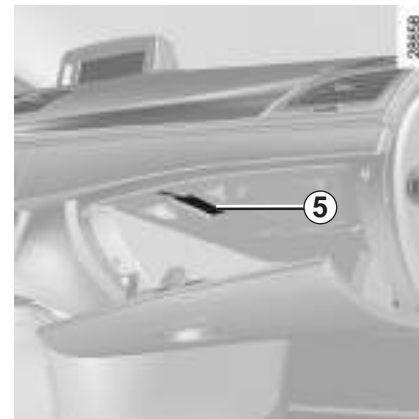

Glove box light

Light **5** comes on when the cover is opened.

When the doors or luggage compartment are unlocked and opened the courtesy and footwell lights come on temporarily.

INTERIOR LIGHTING (2/2)/SUN VISOR

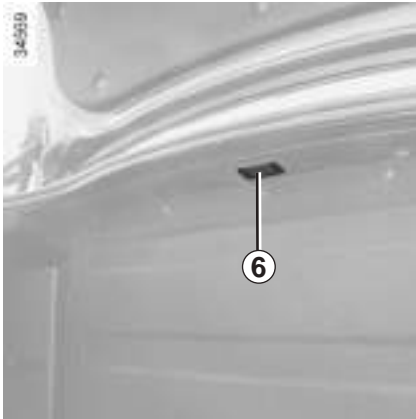

Luggage compartment light

Light **6** comes on when the boot is opened.

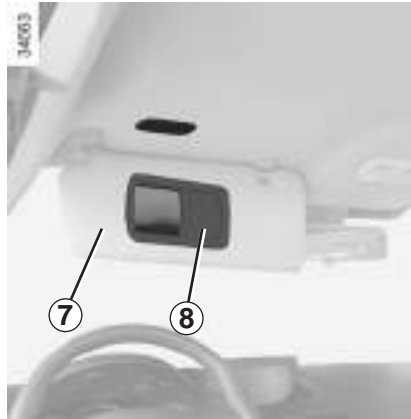

Sun visor

Lower the sun visor **7** over the wind-screen or unclip it and turn it over the side window.

Courtesy mirrors

Slide cover **8**, depending on the vehicle, and the mirror is lit.

PASSENGER COMPARTMENT STORAGE, FITTINGS (1/3)



Front door storage compartments 1



Ensure that no hard, heavy or pointed objects are placed in the “open” storage compartments in such a way that they may fall onto passengers during sudden turning, braking or in the event of an accident.



Cup holder 2



When turning corners, accelerating or braking, ensure that the receptacle being held by the cup holder is not dislodged.

There is a risk of burning if hot liquid escapes.



No object should be placed on the floor (in front of the driver). Such objects may slide under the pedals during sudden braking manoeuvres and obstruct their use.

PASSENGER COMPARTMENT STORAGE, FITTINGS (2/3)

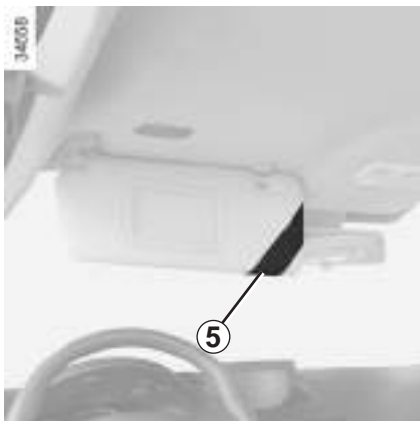

Sun visor storage 5

This can be used for storing motorway tickets, cards, etc.

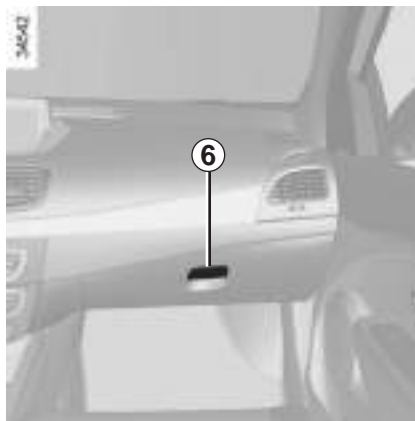

Glove box

Pull handle 6 to open it.

It can hold A4 size documents, a large bottle of water, etc.



Rear door storage compartment 7



Ensure that no hard, heavy or pointed objects are placed in the "open" storage compartments in such a way that they may fall onto passengers during sudden turning, braking or in the event of an accident.

PASSENGER COMPARTMENT STORAGE, FITTINGS (3/3)



Rear armrest storage

Pull down the armrest **8**.



Grab handle **9**

This offers support and can be held when the vehicle is being driven.

Do not use it for getting into or out of the vehicle.

Clothes hooks **10**

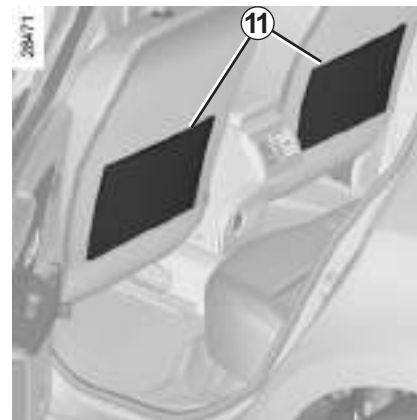

Front seat storage pockets **11**



When turning corners, accelerating or braking, ensure that the receptacle being held by the cup holder is not dislodged.

There is a risk of burning if hot liquid escapes.

ASHTRAY, CIGAR LIGHTER, ACCESSORIES SOCKET

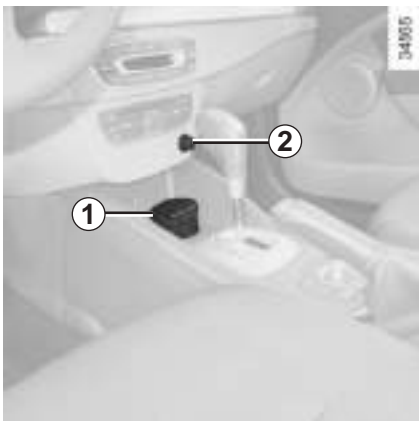

Ashtray 1

To open, lift the cover. To empty, pull the ashtray towards you and it will be released from its housing.

Cigarette lighter 2

With the ignition on, push in cigarette lighter **2** - it will spring back with a click when it is ready. Pull it out to use. After use, replace it without pushing it all the way in.



Accessories sockets

You may use cigarette lighter recess **2** or socket **3** (depending on the vehicle). They are designed for connecting accessories with a maximum power rating of 120 Watts (voltage: 12V) which have been approved by our Technical Department.

If your vehicle is not fitted with a cigar lighter and an ashtray, these can be obtained from an approved Dealer.



Connect accessories with a maximum power of 120 Watts only.

Fire hazard.

TAILGATE



Opening

Press button **1** and lift the boot lid

Closing

Lower the boot lid using handle **3** inside the boot (depending on the vehicle) to assist you.

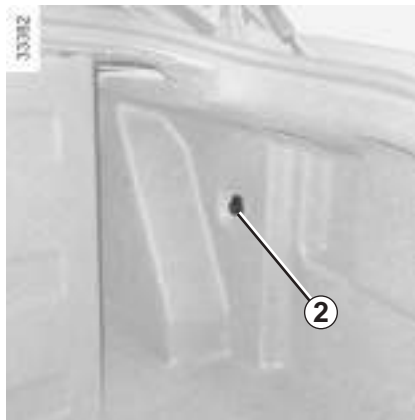

Transporting objects

Lashing hook

Hook **2** enables loads to be secured.

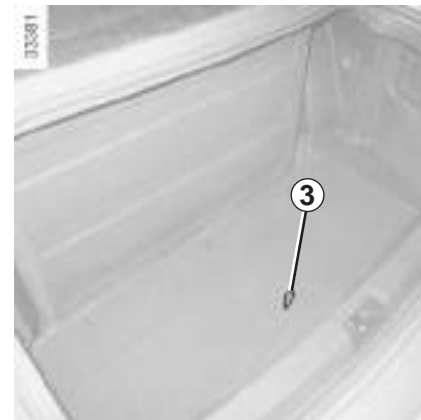

Storage tray

Situated under the luggage compartment carpet - "lift the carpet using strap **3**"



Always position the heaviest items directly on the floor. The luggage should be loaded in such a way that no items will be thrown forward and strike the occupants if the driver has to brake suddenly.

ROOF BARS: access to fixing points

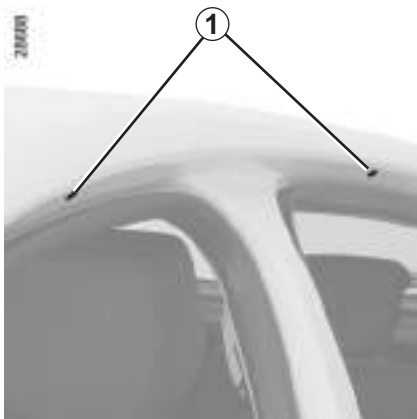

Open the doors to access the fixing points 1.



If original roof bars, approved by our Technical Department, are supplied with screws, only use these screws for attaching the roof bars to the vehicle.

For information on the range of equipment adapted to your vehicle, we advise you to consult an approved Dealer.

Refer to the fitting instructions for information on how to fit roof bars and conditions of use.

Please keep these instructions with the rest of the vehicle documentation.

Maximum permissible load on roof rack: refer to Section 6 "Weights".

MULTIMEDIA EQUIPMENT

The presence and location of this equipment depends on the vehicle's multimedia equipment.

- 1 Radio;
- 2 Display;
- 3 Multimedia control;
- 4 Steering column control;
- 5 Microphone.

Hands-free telephone integrated control

On equipped vehicles, use microphone **5** and steering column control **4**.

To operate this equipment: please refer to the instructions for the equipment which should be kept with the other vehicle documentation.



Using the telephone

We remind you of the need to conform to the legislation in force concerning the use of such equipment.

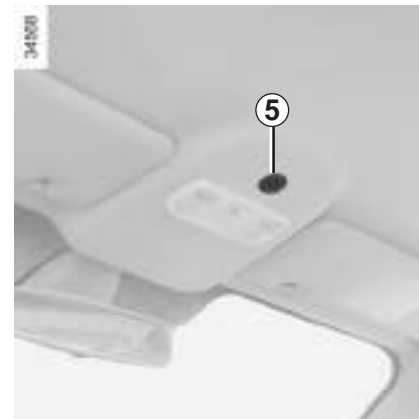
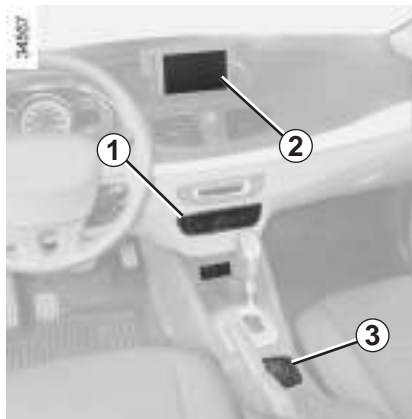

Section 4: Maintenance

Bonnet	4.2
Levels	4.4
coolant	4.4
brake fluid.	4.5
windscreen washer reservoir	4.5
12 volt battery	4.6
Tyre pressure.	4.8
Bodywork maintenance	4.9
Interior trim maintenance.	4.11
	4.1

BONNET (1/2)



To open, pull handle **1**, located on the left-hand side of the dashboard.



The engine may be hot when carrying out operations in close proximity. In addition, the engine cooling fan can come on at any moment.

Risk of injury.

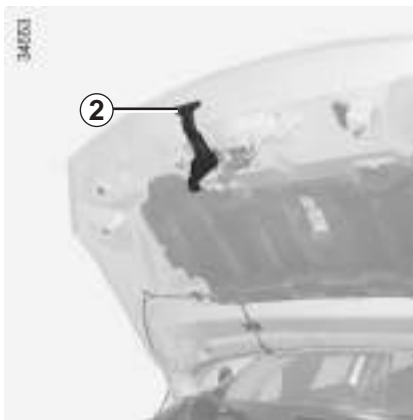

Unlocking the bonnet catch

To release it, lift tab **2**.



In the event of even a slight impact involving the radiator grille or bonnet, have the bonnet lock checked by an authorised dealer as soon as possible.

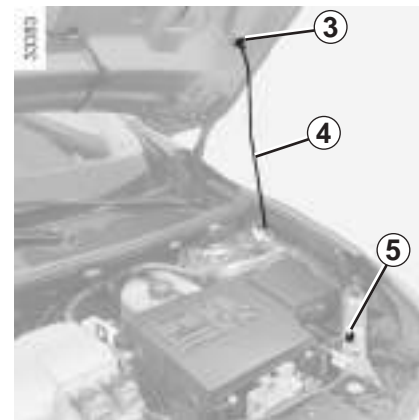

Opening the bonnet

Lift the bonnet, release stay **4** from its holder **5**. For your safety, **always** fix it in location **3** on the bonnet.



Do not do any work under the bonnet when the vehicle is charging or when the ignition is switched on.

BONNET (2/2)

Closing the bonnet

Check that nothing has been left in the engine compartment.

To close the bonnet, replace stay **4** back into its holder **5**, hold the bonnet in the middle and lower it to 30cm above the closed position, then release it. It will latch automatically under its own weight.



After carrying out any work in the engine compartment, check that nothing has been left behind (cloth, tools, etc.). Otherwise, this may lead to engine damage.



Ensure that the bonnet is properly locked. Ensure that nothing is preventing locking (grit, cloths, etc.).

LEVELS (1/2)

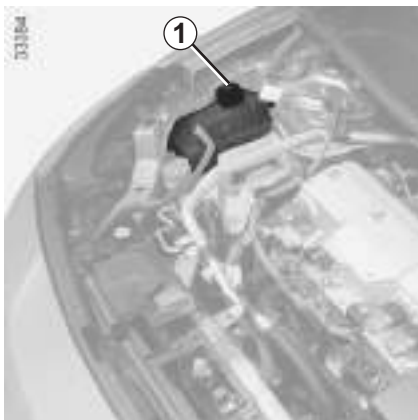

Coolant

The level is checked with the engine switched off and on flat ground. The level when cold must be between the “MIN” and “MAX” marks on coolant reservoirs **1** and **2**.

Top this level up when **cold** before the “MINIMUM” mark is reached.



Do not do any work under the bonnet when the vehicle is charging or when the ignition is switched on.

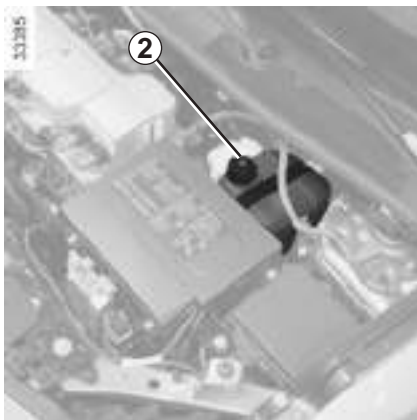

Checking intervals

Check the coolant level regularly (very severe damage is likely to be caused to the engine if it runs out of coolant).

If the level needs to be topped up, only use products approved by our Technical Department which ensure:

- protection against freezing;
- anticorrosion protection of the cooling system.

Replacement intervals

Refer to the Maintenance Document for your vehicle.



No operations should be carried out on the cooling circuit when the engine is hot.

Risk of burns.

Consult your approved dealer at once if you notice an abnormal or repeated drop in any of the fluid levels.

LEVELS (2/2)



Brake fluid level

The level should be read with the engine switched off and on level ground. This should be checked frequently, and immediately if you notice even the slightest loss in braking efficiency.



The engine may be hot when carrying out operations in close proximity. In addition, the engine cooling fan can come on at any moment.

Risk of injury.

Topping up

After any operation on the hydraulic circuit, a specialist must replace the fluid. Only use fluids approved by our Technical Department (and taken from a sealed container).

Replacement intervals

Refer to the Maintenance Document for your vehicle.

Level 3

It is normal for the level to drop as the linings become worn, but it should never drop below the **MIN** line.

If you wish to check the disc wear yourself, you should obtain the document explaining the checking procedure from our network or from the manufacturer's website.

Consult your approved dealer at once if you notice an abnormal or repeated drop in any of the fluid levels.



Windscreen washer reservoir

Topping up

Open cap **4**, fill until you can see the fluid, then refit the cap.

Liquid

Screen wash product (product with antifreeze in winter).

Jets

Use a tool such as a needle to adjust the height of the windscreen washer jets.

12 VOLT BATTERY (1/2)

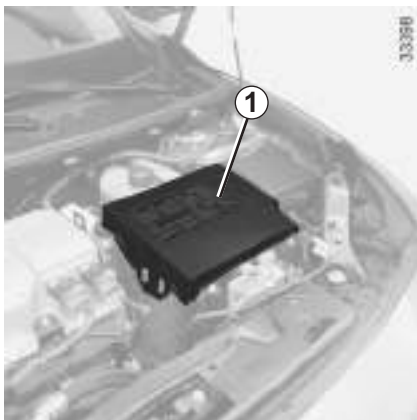

Maintenance

Refer to the Maintenance Document for your vehicle.



Handle the battery with care as it contains sulphuric acid, which must not come into contact with eyes or skin. If it does, wash the affected area with plenty of cold water. If necessary, consult a doctor.

Ensure that naked flames, red hot objects and sparks do not come into contact with the battery as there is a risk of explosion.

The charge status of the 12 volt battery **1** can decrease, especially if you use your vehicle:

- when the outside temperature drops;
- after extended use of energy-consuming devices (radio etc.) with the engine switched off.

Replacement

As this operation is complex, we advise you to contact an approved Dealer.



Do not work on the 12 volt battery (charging, replacing, etc.):

- without switching off the ignition;
- if your traction battery is charging

Please refer to the information on “Electric vehicle: charging” in Section 1.

Risk of serious injury.

2018



The battery is a **specific type**, please ensure it is replaced with the same type. Consult an approved dealer.



Replacing the 12 volt battery:
For your own safety, you **must** respect the replacement intervals (without exceeding them) as stated in the maintenance document.

12 VOLT BATTERY (2/2)

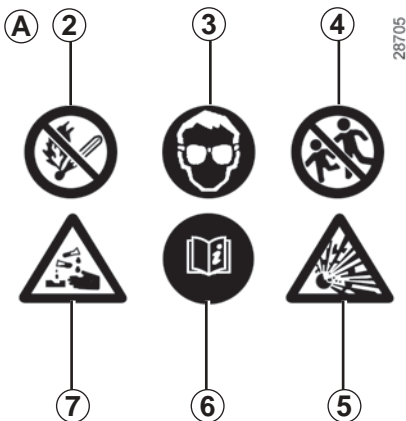

Label A

Observe the indications on the battery:

- **2** naked flames and smoking are forbidden;
- **3** eye protection required;
- **4** keep away from children;
- **5** explosive materials;
- **6** refer to the handbook;
- **7** corrosive materials.



The engine may be hot during operations in close proximity. In addition, the engine cooling fan may start at any moment.

Risk of injury.

TYRE PRESSURE

27192

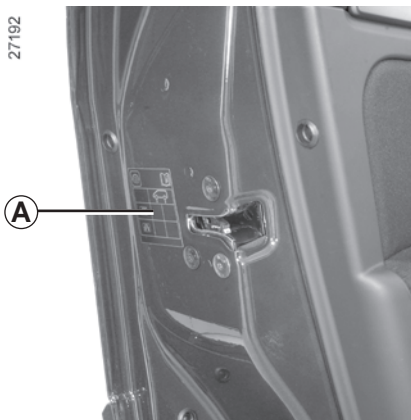

Label A

Open the driver's door to read it.

Tyre pressures should be checked when the tyres are cold.

If the tyre pressures cannot be checked when the tyres are **cold**, increase the pressures from **0.2 to 0.3 bar (or 3 PSI)**.
Never deflate a hot tyre.

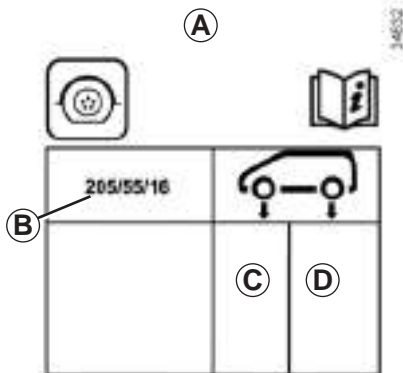

B : dimension of the tyres fitted to the vehicle.

C : tyre pressures for the front wheels.

D : tyre pressures for the rear wheels.

Tyre safety and use of snow chains:

Refer to the information on "Tyres" in Section 5 for the servicing conditions and, depending on the version, the use of chains.



When they need to be replaced, only tyres of the same make, size, type and profile should be used.

They must: either be identical to those fitted originally or conform to those recommended by your authorised dealer.

BODYWORK MAINTENANCE (1/2)

A well-maintained vehicle will last longer. It is therefore recommended to maintain the exterior of the vehicle regularly.

Your vehicle has been treated with very effective anti-corrosion products. It is nevertheless subject to various outside influences.

Corrosive agents in the atmosphere

- atmospheric pollution (built-up and industrial areas),
- saline atmospheres (near the sea, particularly in hot weather),
- seasonal and damp weather conditions (e.g. road salt in winter, water from road cleaners, etc.).

Minor impacts

Abrasive action

Dust and sand in the air, mud, road grit thrown up by other vehicles, etc.

You should take a number of minor precautions in order to safeguard your vehicle against such risks.

What you should not do

Do not degrease or clean mechanical components (e.g. the engine compartment), underneath the body, parts with hinges (e.g. inside the doors) and painted plastic external fittings (e.g. bumpers) using high-pressure cleaning equipment or by spraying on products not approved by our Technical Department. Doing this could give rise to corrosion or operational faults.

Wash the vehicle in bright sunlight or freezing temperatures.

Do not scrape off mud or dirt without pre-wetting.

Allow dirt to accumulate on the exterior.

Allow rust to form following minor impacts.

Do not use solvents not approved by our Technical Department to remove stains as this could damage the paintwork.

Do not drive in snow or muddy conditions without washing the vehicle, particularly under the wheel arches and body.

You should

Wash your car frequently, **with the engine off**, with cleaning products recommended by the manufacturer (never use abrasive products). Rinse thoroughly beforehand with a jet:

- spots of tree resin and industrial grime;
- mud in the wheel arches and underneath the body which forms damp patches;
- **bird droppings**, which cause a chemical reaction with the paint that **rapidly discolours paintwork and may even cause the paint to peel off**;
- wash the vehicle **immediately** to remove these marks since it is impossible to remove them by polishing;
- salt, particularly in the wheel arches and underneath the body after driving in areas where the roads have been gritted.

Withdraw the vegetable falls (resin, film etc.) from the vehicle regularly.

BODYWORK MAINTENANCE (2/2)

Observe the vehicle stopping distances when driving on gravelled surfaces to prevent paint damage.

Repair, or have repaired quickly, areas where the paint has been damaged, to prevent corrosion spreading.

Remember to visit the body shop periodically in order to maintain your anti-corrosion warranty. Refer to the Maintenance Document.

Respect local regulations about washing vehicles (e.g. do not wash your vehicle on a public highway).

If it is necessary to clean mechanical components, hinges, etc., spray them with products approved by our Technical Department to protect them after they have been cleaned.

We have selected special products to care for your vehicle and you can obtain these from the manufacturer's accessory outlets.

Using a roller type car wash

Return the windscreen wiper stalk to the Park position (refer to the information on the "Windscreen washer, wiper" in Section 1). Check the mounting of external accessories, additional lights and mirrors, and ensure that the wiper blades are secured with adhesive tape. Remove the radio aerial mast if your vehicle is fitted with this equipment. Remember to remove the tape and refit the antenna after washing.



Washing the vehicle

Never wash the engine compartment, the charging connection or the traction battery with a high-pressure jet.

This risks damaging the electric circuit.

Never wash the vehicle while it is charging.

Risk of electric shock and a risk to life.

Cleaning the headlights

As the headlights are made of plastic "glass", use a soft cloth or cotton wool to clean them. If this does not clean them properly, moisten the cloth with soapy water, then wipe clean with a soft damp cloth or cotton wool. Finally, carefully dry off with a soft dry cloth.

Cleaning products containing alcohol must not be used.

Vehicles with a matte paint finish

This type of paint requires certain precautions.

Do not do the following

- use wax-based products (polishing);
- rub too hard;
- wash the vehicle in a roller-type car wash;
- wash the vehicle using a high-pressure device;
- attach stickers to the paintwork (risk of leaving marks).

You should do the following

Wash the vehicle by hand using plenty of water, using a soft cloth or a gentle sponge.

INTERIOR TRIM MAINTENANCE (1/2)

A well-maintained vehicle will last longer. It is therefore recommended to maintain the interior of the vehicle regularly.

A stain should always be dealt with swiftly.

Whatever type of stain is on the trim, use **cold** (or warm) **soapy water with natural soap**.

Detergents (washing-up liquid, powdered products, alcohol-based products) should not be used.

Use a soft cloth.

Rinse and soak up the excess.

Glass instrument panel

(e.g. instrument panel, clock, exterior temperature display, radio display, etc.)

Use a soft cloth (or cotton wool).

If this does not clean it properly, use a soft cloth (or cotton wool) slightly moistened with soapy water and then wipe clean with a soft damp cloth or cotton wool.

Finally, **carefully** dry off with a soft dry cloth.

Cleaning products containing alcohol must not be used under any circumstances.

Seat belts

These must be kept clean.

Use products selected by our Technical Department (Approved outlets) or warm, soapy water and a sponge and wipe with a dry cloth.

Detergents or dyes must not be used under any circumstances.

Textiles (seats, door trim, etc)

Vacuum-clean the textiles **regularly**.

Liquid stain

Use soapy water.

Dab lightly (never rub) with a soft cloth, rinse and remove the excess.

Solid or pasty stain

Carefully remove the excess solid or pasty material **immediately** with a spatula (working from the edges to the centre to avoid spreading the stain).

Clean as for a liquid stain.

Special instructions for sweets or chewing gum

Put an ice cube on the stain to solidify it, then proceed as for a solid stain.

For further recommendations for maintaining the interior, and/or for any unsatisfactory results, please see an authorised dealer.

INTERIOR TRIM MAINTENANCE (2/2)

Removal/replacing removable equipment originally fitted in the vehicle

If you need to remove equipment in order to clean the passenger compartment (for example, mats), always ensure that they are correctly refitted and are the right way around (the driver's mat should be fitted on the driver's side, etc.) and fit them with the components supplied with the equipment (for example, the driver mat should always be fixed using the pre-fitted mounting components).

With the vehicle stationary, ensure that nothing will impede driving (anything obstructing the pedals, heel wedged by the mat, etc.).

You should not:

You are strongly advised not to position objects such as deodorants, scents, etc. near air vents, as this could damage your dashboard trim.



You are strongly recommended not to use high-pressure or spray cleaning equipment inside the passenger compartment: use of such equipment could impair the correct functioning of the electrical or electronic components in the vehicle, or have other detrimental effects.

Section 5: Practical advice

Tool kit	5.2
Wheel trim	5.3
Tyre inflation kit	5.4
Changing a wheel	5.9
Tyres (tyre and wheel safety, use in winter)	5.11
Headlights (changing bulbs)	5.14
Rear lights (changing bulbs)	5.17
Indicator lights (changing bulbs)	5.18
Interior lights (changing bulbs)	5.19
Fuses.	5.21
12 volt battery: breakdowns.	5.23
Radio frequency remote control unit: battery.	5.25
Accessories	5.26
Wipers (replacing blades)	5.27
Towing/breakdown.	5.28
Operating faults	5.31

TOOL KIT (1/2)

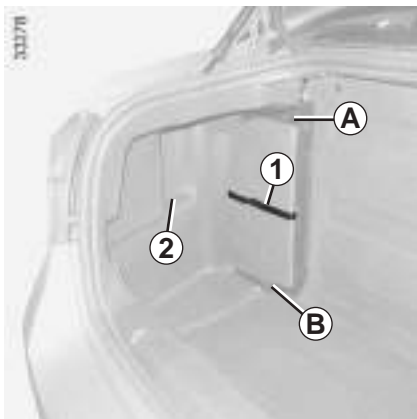

the tool kit contains tools and the tyre inflation kit. It is located in the boot.

To get to it:

- remove strap **1** and attach it **2**.
- position your hands at **A** and **B**;
- pull the kit **3** towards you.

To use the tyre inflation kit, please refer to “Tyre inflation kit” in Section 5.



Inflation kit

To use the tyre inflation kit, please refer to “Tyre inflation kit” in Section 5.



Do not leave the tools unsecured inside the vehicle as they may come loose under braking. After use, check that all the tools are correctly clipped into the tool kit, then position it correctly in its housing: there is a risk of injury.

TOOL KIT (2/2)/TRIM



Tools

The composition of the tool kit varies according to the vehicle.

Rear lights key 4

Used to unscrew the rear lights.

Front headlight key 5

Used to unscrew the headlights.

Wheelbrace 6

Jack 7

When replacing the jack, fold it correctly and position the wheelbrace correctly before replacing it in its position.



The jack is designed for wheel changing purposes only. Under no circumstances should it be used for carrying out repairs underneath the vehicle or to gain access to the underside of the vehicle.

Hubcap tool 8

This tool is used to remove the wheel trims.

Wheel bolt guide 9

To finish loosening or starting to tighten the wheel bolts.

Tow eye 10

Refer to the information on “Towing” in Section 5.

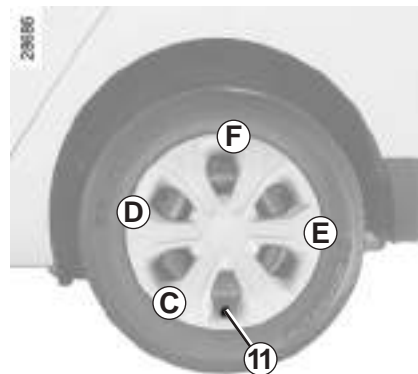

Wheel trim

Remove it using the hubcap tool **8** by connecting the hook in the recess provided next to the valve **11** (to attach the metal clip).

To refit the wheel trim, align it with valve **11**. Push the retaining hooks in fully, starting with side **C** near the valve, followed by **D** and **E**, finishing at **F** opposite the valve.

NB: if you are using anti-theft bolts, refer to the information on “Changing a wheel”.



Never leave tools unsecured in the vehicle: there is a risk that they may be thrown about during braking. After use, check that all the tools are correctly clipped into the tool kit, then position it correctly in its housing: there is a risk of injury.

TYRE INFLATION KIT (1/5)

82079



The kit repairs tyres when tread **A** has been damaged by objects smaller than 4 mm. It cannot repair all types of puncture, such as cuts larger than 4 mm, or cuts in tyre sidewall **B**.

Ensure also that the wheel rim is in good condition.

Do not pull out the foreign body causing the puncture if it is still in the tyre.



Do not attempt to use the inflation kit if the tyre has been damaged as a result of driving with a puncture.

You should therefore carefully check the condition of the tyre sidewalls before any operation.

Driving with underinflated, flat or punctured tyres can be dangerous and may make the tyre impossible to repair.

This repair is temporary

A tyre which has been punctured should always be inspected (and repaired, where possible) as soon as possible by a specialist.

When taking a tyre which has been repaired using this kit to be replaced, you must inform the specialist.

When driving, vibration may be felt due to the presence of the repair product injected into the tyre.



The kit is only approved for inflating the tyres of the vehicle originally equipped with the kit.

It must never be used to inflate the tyres of another vehicle, or any other inflatable object (rubber ring, rubber boat, etc.).

Avoid spillage on skin when handling the repair liquid bottle. If droplets do leak out, rinse them off with plenty of water.

Keep the repair kit away from children.

Do not dispose of the empty bottle in the countryside. Return it to your approved dealer or to a recycling organisation.

The bottle has a limited service life which is indicated on its label. Check the expiry date.

Contact an approved dealer to replace the inflation tube and repair product bottle.

TYRE INFLATION KIT (2/5)



Inflation kit C

Depending on the vehicle, in the event of a puncture, use the kit located in the boot.



Before using this kit, park the vehicle at a sufficient distance from traffic, switch on the hazard warning lights, apply the handbrake, ask all passengers to leave the vehicle and keep them away from traffic.

Depending on the vehicle, remove the central partition in the storage compartment to access the inflation kit.

Open the kit, remove caps **1** and **3** (the cap **must not** be removed from the bottle) then screw bottle **2** to its base **3**.

Key in “Accessories” position, hand-brake engaged

- unscrew the valve cap on the wheel concerned and screw inflation adapter **6** onto the valve;
- connect adapter **8** to the accessories socket on the dashboard of the vehicle;
- press switch **5** to inflate the tyre to the recommended pressure (check the label affixed to the edge of the driver’s door);
- after a maximum of 5 minutes, stop inflating and read the pressure (on pressure gauge **4**);

Note: while the bottle is emptying (approximately 30 seconds), pressure gauge **4** will briefly indicate a pressure of 6 bar, then the pressure will drop.

- adjust the pressure: to increase it, continue inflating with the kit, to reduce it, turn button **7** located on the inflation adapter.

If a minimum pressure of 1.8 bar is not reached after 15 minutes, repair is not possible; do not drive the vehicle but contact an approved dealer.



If the vehicle is parked on the hard shoulder, you must warn other road users of your vehicle’s presence with a warning triangle or with other devices as per the legislation applying to the country you are in.

TYRE INFLATION KIT (3/5)



Once the tyre is inflated correctly:

- stop using the kit;
- close the integrated cap on the bottle again;
- disconnect adapter **8**;



Nothing should be placed around the driver's feet as such objects may slide under the pedals during sudden braking manoeuvres and obstruct their use.

- affix driving recommendation label **9** to the dashboard where it can easily be seen by the driver;
- store the kit;
- after the first inflation procedure the tyre will still be leaking; it is vital to drive in order to plug the hole;
- start immediately and drive at between 12 and 40 mph (20 and 60 km/h) in order to distribute the product evenly in the tyre and, after driving for 2 miles, stop and check the pressure;
- If the pressure is greater than 1.3 bar but less than the recommended pressure, readjust it (please refer to the label affixed to the edge of the driver's door). Otherwise, please contact an authorised dealer: the tyre cannot be repaired.

Note: after using the inflation kit, you should visit an approved Dealer to replace the inflation hose and the bottle of repair product.

Precautions when using the kit

The kit should not be operated for more than 15 consecutive minutes.



Please be aware that a poorly tightened or missing valve cap can make the tyres less airtight and lead to pressure loss.

Always use valve caps identical to those fitted originally and tighten them fully.



Following repair with the kit, do not travel further than 120 miles (200 km). In addition, reduce your speed and under no circumstances exceed 48 mph (80 km/h). The sticker, which you must affix in a prominent position on the dashboard, reminds you of this.

Depending on the country or local legislation, a tyre repaired with the inflation kit may need to be replaced.

TYRE INFLATION KIT (4/5)

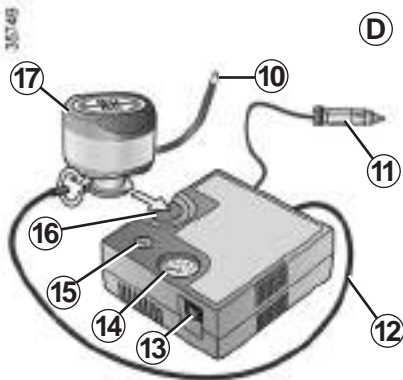

Inflation kit D

Depending on the vehicle, in the event of a puncture, use the kit located in the boot.



Before using this kit, park the vehicle at a sufficient distance from traffic, switch on the hazard warning lights, apply the handbrake, ask all passengers to leave the vehicle and keep them away from traffic.

With the engine running and the parking brake applied,

- unroll the hose from the container;
- connect the compressor hose **12** to the container's inlet **17**;
- depending on the vehicle, connect the container **17** to the compressor from the container recess **16**;
- unscrew the valve cap on the relevant wheel and screw on the container's inflation adapter **10**;
- adapter **11** must be connected to the vehicle accessories socket;
- press switch **13** to inflate the tyre to the recommended pressure (please refer to the information in the section on "Tyre pressure");

- after a maximum of **15** minutes, stop inflating and read the pressure (on pressure gauge **14**).

Note: while the container is emptying (approximately 30 seconds), the pressure gauge **14** will briefly indicate a pressure of up to **6** bar. The pressure will then drop.

- adjust the pressure: to increase it, continue inflation with the kit; to reduce it, press button **15**.

If a minimum pressure of 1.8 bar is not reached after 15 minutes, repair is not possible; do not drive the vehicle but contact an approved dealer.



If the vehicle is parked on the hard shoulder, you must warn other road users of your vehicle's presence with a warning triangle or with other devices as per the legislation applying to the country you are in.

TYRE INFLATION KIT (5/5)

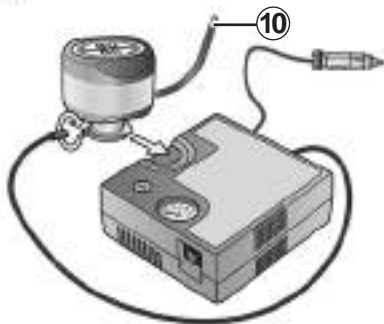

Once the tyre is correctly inflated, remove the kit: slowly unscrew the inflation adapter **10** to prevent any repair product from escaping and store the container in plastic packaging to prevent the product from escaping.



Nothing should be placed around the driver's feet as such objects may slide under the pedals during sudden braking manoeuvres and obstruct their use.

- Affix the driving recommendation label to the dashboard where it can easily be seen by the driver;
- Put the kit away.
- At the end of this initial inflation operation, air will still escape from the tyre. You must drive a short distance in order to seal the hole.
- Start immediately and drive at between 12 and 40 mph (20 and 60 km/h) in order to distribute the product evenly in the tyre and, after driving for 2 miles (3 km), stop and check the pressure.
- If the pressure is greater than 1.3 bar but less than the recommended pressure (refer to the label affixed to the edge of the driver's door), readjust it. Otherwise, please contact an authorised dealer: the tyre cannot be repaired.

Precautions when using the kit

The kit should not be operated for more than 15 consecutive minutes.



Please be aware that a poorly tightened or missing valve cap can make the tyres less airtight and may lead to pressure loss.

Always use valve caps identical to those fitted originally and tighten them fully.



Following repair with the kit, do not travel further than 120 miles (200 km). In addition, reduce your speed and under no circumstances exceed 48 mph (80 km/h). The sticker, which you must affix in a prominent position on the dashboard, reminds you of this.

Depending on the country or local legislation, a tyre repaired with the inflation kit may need to be replaced.

CHANGING A WHEEL (1/2)

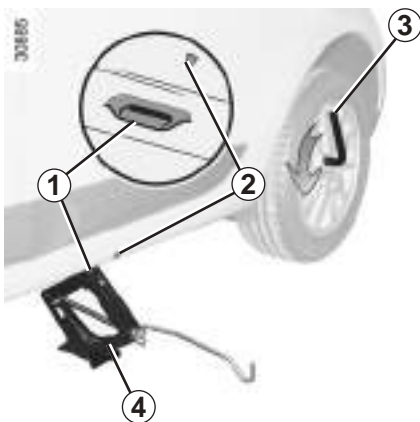

Switch on the hazard warning lights.

Keep the vehicle away from traffic and on a level surface where it will not slip (if necessary, place a solid support under the jack base).

Engage the handbrake and put the gearstick in position **P**.

Ask all the passengers to leave the vehicle and keep them away from traffic.

Vehicles equipped with a jack and wheelbrace

If necessary, remove the wheel trim.

- Use the wheelbrace **3** to slacken off the wheel bolts. Position it so as to be able to push from above;
- place the jack **4** horizontally; the jack head **must** be lined up with the sill **1** closest to the wheel concerned, as shown by arrow **2**.



If the vehicle is parked on the hard shoulder, you must warn other road users of your vehicle's presence with a warning triangle or with other devices as per the legislation applying to the country you are in.

- start cranking the jack up by hand to align the base plate (which should be pushed slightly under the vehicle);
- turn the wheelbrace until the wheel lifts off the ground;
- undo the bolts and take off the wheel;
- fit the emergency spare wheel on the central hub and turn it to locate the mounting holes in the wheel and the hub.

If the vehicle is not equipped with a jack or wheelbrace, you can obtain these from your authorised dealer.



To prevent any risk of injury or damage to the vehicle, raise the jack until the wheel you are replacing is a maximum of 3 centimetres off the ground.

CHANGING A WHEEL (2/2)

With the wheel on the ground, tighten the bolts fully and have the tightness of the bolts checked (tightening torque: 110 N.m) and the emergency spare wheel pressure checked as soon as possible.

Anti-theft bolt

If you use anti-theft bolts, fit these nearest the valve (wheel embelisher may not be able to fit).



If you have a puncture, replace the wheel as soon as possible.

A tyre which has been punctured should always be inspected (and repaired, where possible) by a specialist.

TYRES (1/3)

Tyre and wheel safety

The tyres are the only contact between the vehicle and the road, so it is essential to keep them in good condition.

You must make sure that your tyres conform to local road traffic regulations.



When they need to be replaced, only tyres of the same make, size, type and profile should be used.

Tyres fitted to the vehicle should either be identical to those fitted originally or conform to those recommended by your approved dealer.



Maintaining the tyres

The tyres must be in good condition and the tread form must have sufficient depth; tyres approved by our Technical Department have wear warning strips **1** that are **indicators moulded into the tread at several points.**

When the tyre tread has been worn to the level of the wear indicators, **they become visible 2:** it is **then** necessary to replace your tyres because the tread rubber is **no more than 1.6 mm deep, resulting in poor roadholding on wet roads.**

An overloaded vehicle, long journeys by motorway, particularly in very hot weather, or continual driving on poorly surfaced minor roads will lead to more rapid tyre wear and affect safety.



Incidents which occur when driving, such as striking the kerb, may damage the tyres and wheel rims, and could also lead to misalignment of the front or rear axle geometry. In this case, have the condition of these checked by an approved dealer.

TYRES (2/3)

Tyre pressures

Adhere to the tyre pressures. The tyre pressures should be checked at least once a month and additionally before any long journey (refer to the label affixed to the edge of the driver's door). Please refer to the information on "Tyre pressures" in Section 4.



Incorrect tyre pressures

lead to abnormal tyre wear and unusually hot running. These are factors which may seriously affect safety and lead to:

- poor road holding,
- risk of bursting or tread separation.

The pressure depends on the load and the speed of use. Adjust the pressure according to the conditions of use (refer to the label affixed to the edge of the driver's door).

Pressures should be checked when the tyres are cold; ignore higher pressures which may be reached in hot weather or following a fast journey.

If tyre pressures cannot be checked when the tyres are **cold**, the normal pressures must be increased by **0.2** to **0.3** bar (or **3 PSI**).

Never deflate a hot tyre.

Special note

Depending on the vehicle, there may be an adapter which needs to be positioned on the valve before air is added.



Please be aware that a poorly tightened or missing valve cap can make the tyres less airtight and lead to pressure loss.

Always use valve caps identical to those fitted originally and tighten them fully.

Fitting new tyres



For safety reasons, this operation must be carried out by a specialist.

Fitting different tyres may change your vehicle as follows:

- It may mean that your vehicle no longer conforms to current regulations;
- It may change the way it handles when cornering;
- It may cause the steering to be heavy;
- It may affect the use of snow chains.

TYRES (3/3)

Use in winter

Chains

For safety reasons, fitting snow chains to the rear axle is strictly forbidden.

Chains cannot be fitted to tyres which are larger than those originally fitted to the vehicle.

Snow or Winter tyres

We would recommend that these be fitted to all **four wheels** to ensure that your vehicle retains maximum adhesion.

Warning: These tyres sometimes have a specific direction of rotation and a maximum speed index which may be lower than the maximum speed of your vehicle.

Studded tyres

This type of equipment may only be used for a limited period and as laid down by local legislation. It is necessary to observe the speed specified by current legislation.

These tyres must, at a minimum, be fitted to the two front wheels.

NB:

The use of snow tyres, winter tyres or studded tyres significantly reduces the vehicle range.



Chains may only be fitted to tyres of the same size as those originally fitted to **your vehicle**.

Chains may be fitted, provided that they are specific chains. We would advise you to consult an approved Dealer.

In all cases, we would recommend that you contact an approved dealer who will be able to advise you on the choice of equipment which is most suitable for your vehicle.

FRONT HEADLIGHTS: changing bulbs (1/2)

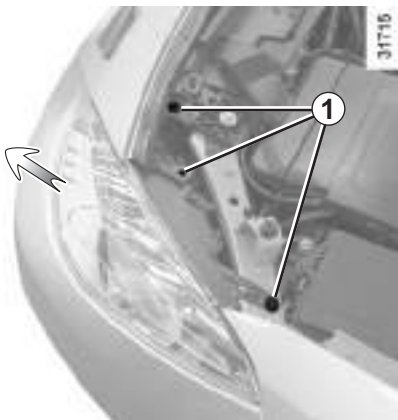

The bulbs detailed below can be replaced. However, we recommend that these be replaced by an approved dealer if this proves difficult. After opening the bonnet, unscrew the screws **1** using standard tools or, depending on the vehicle, using the spanners provided in the tool kit.

Pull the headlight as far as possible in the direction shown by the arrow.

Note: the headlight cannot be pulled out completely. Avoid pulling too hard, as this could damage the connections.

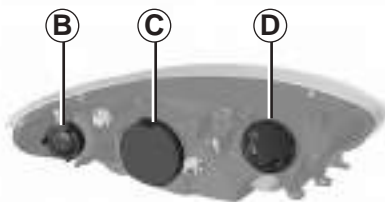

Obtain an emergency kit containing a set of spare bulbs and fuses from an approved Dealer.



Do not do any work under the bonnet when the vehicle is charging or when the ignition is switched on.

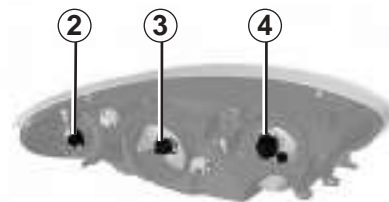

Direction indicators

Remove cover **B**, unscrew bulb holder **2** a quarter of a turn and unscrew the bulb a quarter of a turn.

Bulb type: PY21W.

FRONT HEADLIGHTS: replacing bulbs (2/2)

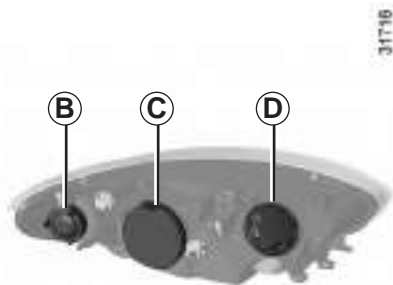

Dipped beam headlights C

Remove cover **C**, then unclip bulb connector **3**.

Press the top of clip **6**, remove the assembly from its housing and take out the bulb.

Bulb type: H7.

It is **essential** to use anti U.V. 55W bulbs so as not to damage the plastic on the headlights.

Do not touch the bulb glass.

When the bulb has been changed, make sure you refit the cover correctly.

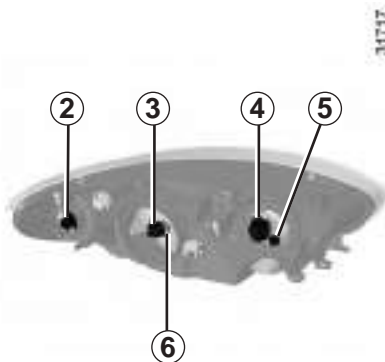

Main beam headlights

Unscrew cover **D** a quarter of a turn and remove connector **4** with the bulb.

Remove the lamp from the connector.

Bulb type: H7.

Side lights

Unscrew cover **D** a quarter of a turn, pull bulb holder **5** and take out the bulb.

Bulb type: W5W.



The bulbs are under pressure and can break when replaced.

Risk of injury.



The engine may be hot when carrying out operations in close proximity. In addition, the engine cooling fan can come on at any moment.

Risk of injury.

FRONT HEADLIGHTS: front fog lights, additional lights



Front fog lights 1

However, because the front bumper needs to be removed, **you are advised to have your bulbs replaced by an approved dealer.**



The bulbs are under pressure and can break when replaced.

Risk of injury.

Additional lights

If you wish to fit fog lights or long range headlights to your vehicle, consult an authorised dealer.



Any operation on (or modification to) the electrical system must be performed by an approved dealer since an incorrect connection might damage the electrical equipment (harness, components and in particular the alternator). In addition, your Dealer has all the parts required for fitting these units.

REAR LIGHTS AND SIDE LIGHTS: changing bulbs (1/2)

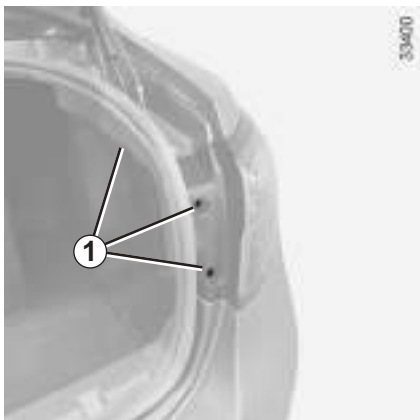

Direction indicator lights/ brake and side lights

- Open the boot and unscrew bolts **1** using the rear lights key (refer to the information on the “Tool kit” in Section 5), then take out the light unit by pulling it back.
- Release clips **3** to remove bulb holder **2**.
- Unscrew bulb holder **4** or **5** and replace the bulb.

Note: ensure that the cable is in place before inserting the light unit.

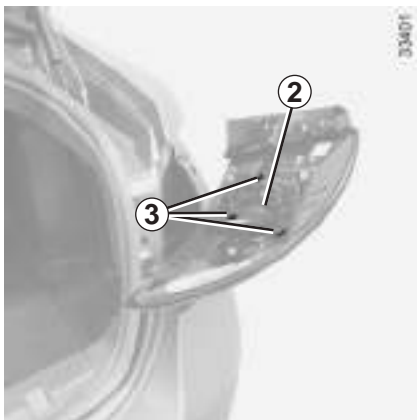

Direction indicator lights **4**

Bulb type: PY21W.

Side light and brake light **5**

Bulb type: P21/5W.

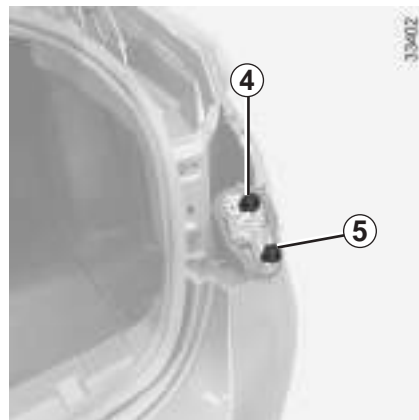

Refitting

To refit, proceed in the reverse order, taking care not to damage the wiring.



The bulbs are under pressure and can break when replaced.

Risk of injury.

REAR LIGHTS AND SIDE LIGHTS: changing bulbs (2/2)



Reversing light or rear fog light **7** or **8**

Please see an authorised dealer.

High-level brake light **6**

Consult an approved Dealer.



Number plate lights **10**

- Unclip light **10** by pressing tab **9**;
- remove the light cover to gain access to the bulb.

Bulb type: W5W.

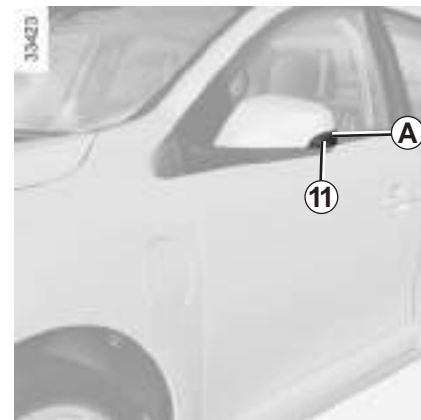

Side indicator lights **11**

- Unclip indicator light **11** (using a flat-blade screwdriver type tool positioned at **A** to move the indicator light towards the front of the vehicle);
- Turn the bulb holder a quarter of a turn and take out the bulb.

Bulb type: W5W.



The bulbs are under pressure and can break when replaced.

Risk of injury.

INTERIOR LIGHTING: changing bulbs (1/2)

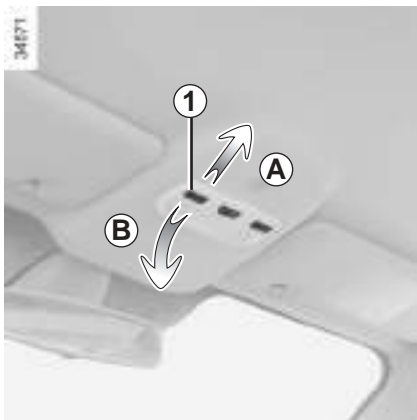

Courtesy light

- Position the 3 switches in the central position;
- move the courtesy light backwards (movement **A**) then tilt the front downwards (movement **B**);
- when removing the courtesy light, ensure that you do not pull the electrical wires;
- unclip the lens **1**;

Note: to remove the defective bulb, you can use a flat-blade screwdriver or similar.

Bulb type: W5W.

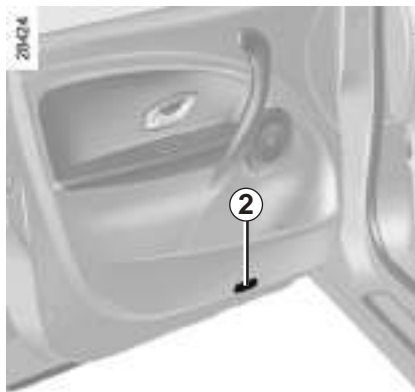

Door lights

Unclip light **2** (using a flat-blade screwdriver or similar).

Turn the bulb holder a quarter of a turn and take out the bulb.

Bulb type: W5W.



The bulbs are under pressure and can break when replaced.

Risk of injury.

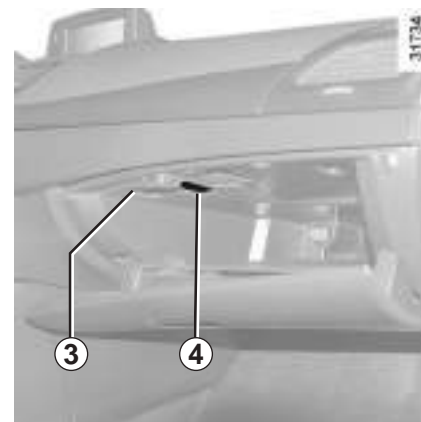

Glove box light

Open the access cover **3**, you can then unclip the bulb holder more easily **4**.

Bulb type: C5W.

INTERIOR LIGHTING: replacing bulbs (2/2)

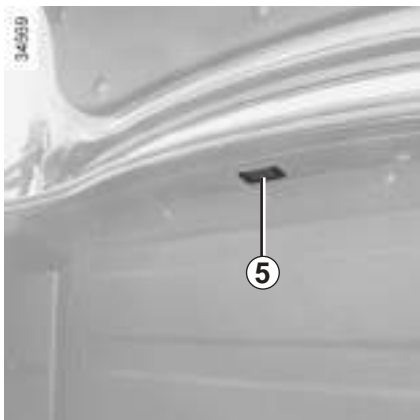

Luggage compartment light

Unclip the light **5** (using a tool such as a flat-blade screwdriver).

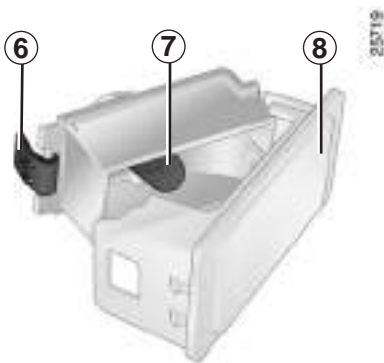

Disconnect the light.

Press tab **6** to release the lens **8** and access bulb **7**.

Bulb type: W5W.



The bulbs are under pressure and can break when replaced.

Risk of injury.

FUSES (1/2)



Fuse box

If any electrical component does not work, check the condition of the fuses.

Unclip flap **A** for left-hand drive vehicles or **B** for right-hand drive vehicles.

In accordance with local legislation or as a precautionary measure:

Obtain an emergency kit containing a set of spare bulbs and fuses from an approved Dealer.



Check the fuse in question and **replace it**, if necessary, **by a fuse of the same rating**.

If a fuse is fitted where the rating is too high, it may cause the electrical circuit to overheat (risk of fire) in the event of an item of equipment using an excessive amount of current.

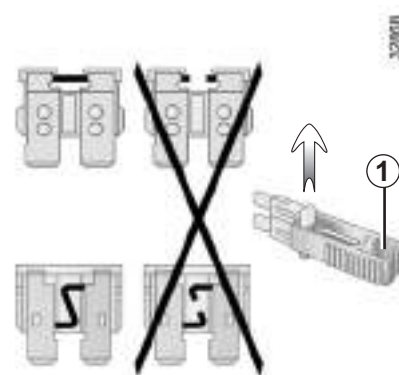

Tweezers 1

Remove the fuse using tweezers **1**, located at the back of cover **A** or **B**.

To remove the fuse from the tweezers, slide the fuse to the side.

It is not advisable to use the free fuse locations.

FUSES (2/2)

②	25 A	⑥	10 A	⑩	10 A
③	30 A			⑪	5 A
④	10 A	⑦	15 A	⑫	10 A
①	10 A	⑧	5 A	⑬	5 A
⑤	15 A	⑨	25 A	⑭	10 A
				⑮	10 A

Allocation of fuses

(the presence of certain fuses depends on the vehicle equipment level)

- 1 Brake lights;
- 2 Automatic door locking;
- 3 Driver's electric window;
- 4 Passenger compartment unit;
- 5 Direction indicator lights;
- 6 Navigation system;
- 7 Rear screen wiper;
- 8 ABS/ESP;
- 9 Passenger electric window;
- 10 Windscreen washer;
- 11 Heated door mirrors;
- 12 Radio;
- 13 Traction battery;
- 14 Rear seat accessories socket;
- 15 Cigarette lighter.

34541

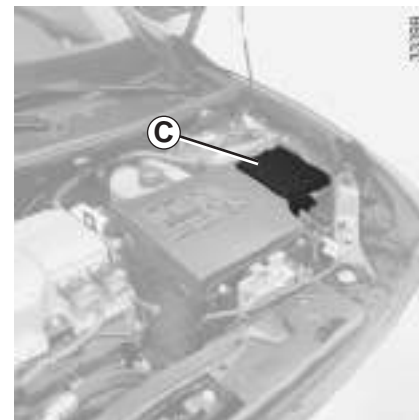

Some accessories are protected by fuses located in the engine compartment in fuse box **C**.

However, because of their reduced accessibility, we advise you to have your fuses replaced by an approved Dealer.



Do not do any work under the bonnet when the vehicle is charging or when the ignition is switched on.

12 VOLT BATTERY: breakdown recovery (1/2)

To avoid all risk of sparks:

- Switch off the vehicle ignition.
- Ensure that any electrical consumers (courtesy lights, etc.) are switched off before disconnecting or reconnecting the battery.
- When charging, stop the charger before connecting or disconnecting the battery.
- Do not place metal objects on the battery to avoid creating a short circuit between the terminals.
- Make sure that you reconnect the battery terminals after refitting.



Special procedures may be required to charge some batteries. Contact your approved dealer.

Avoid all risk of sparks which may cause an immediate explosion, and charge the battery in a well-ventilated area. Risk of serious injury.

Connecting a battery charger

The battery charger must be compatible with a battery with nominal voltage of 12 volts.

Before disconnecting the battery, check that:

- the ignition is switched off;
- the gear control should be in position **P** (please refer to the information on the “Gear control” in Section 2;
- the charging cable is disconnected.



Do not work on the 12 volt battery (charging, replacing, etc.):

- without switching off the ignition;
- if your traction battery is charging.

Please refer to the information on “Electric vehicle: charging” in Section 1.

Risk of serious injury.

Disconnect the leads connected to both battery terminals, **starting with the negative terminal.**

Follow the instructions given by the manufacturer of the battery charger you are using.



Handle the battery with care as it contains sulphuric acid, which must not come into contact with eyes or skin. If it does, wash the affected area with plenty of cold water. If necessary, consult a doctor.

Ensure that naked flames, red hot objects and sparks do not come into contact with the battery as there is a risk of explosion.

The engine may be hot when carrying out operations in close proximity. In addition, the engine cooling fan can come on at any moment.

Risk of injury.

12 VOLT BATTERY: breakdown recovery (2/2)

Starting the vehicle using the battery from another vehicle

If you have to use the battery from another vehicle to start, obtain suitable jump leads (with a large cross section) from an approved dealer or, if you already have jump leads, ensure that they are in perfect condition.

The two batteries must have an identical nominal voltage of 12 volts. The battery supplying the current should have a capacity (amp-hours, Ah) which is at least the same as that of the discharged battery.

Switch off your vehicle ignition. Ensure that there is no risk of contact between the two vehicles (risk of short circuiting when the positive terminals are connected) and that the discharged battery is properly connected.

Start the engine of the vehicle supplying the current and run it at an intermediate engine speed.

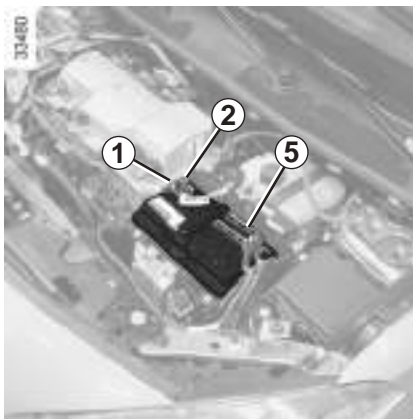

Attach positive lead **A** to **mounting 1** attached to (+) terminal **2** then to (+) **terminal 3** of the battery supplying the current.

Attach the negative lead **B** to the (-) **terminal 4** of the battery supplying the current, then to the (-) **terminal 5** of the discharged battery.

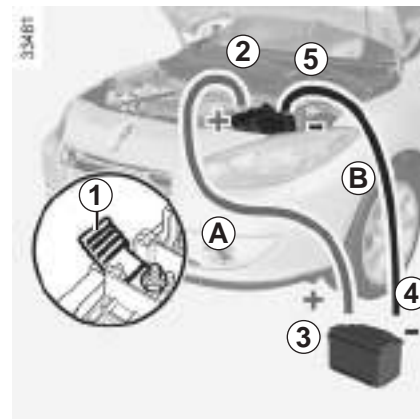

As soon as it starts, disconnect cables **A** and **B** in reverse order (**5 - 4 - 3 - 2**).



Check that there is no contact between leads **A** and **B** and that the positive lead **A** is not touching any metal parts on the vehicle supplying the current.

Risk of injury and/or damage to the vehicle.

Do not use your electric vehicle to restart the 12 volt battery in a conventional vehicle. The 12 volt electric power of an electric vehicle is not enough to perform such an operation.

Risk of damage to vehicle

RADIO FREQUENCY REMOTE CONTROL: battery



Replacing the battery

Open the case at slot **1** using a coin, and replace battery **2**, observing the polarity shown on the back of the cover.

When refitting, ensure that the cover is correctly clipped into place.



Note: It is not advisable to touch the electrical circuit in the key cover when replacing the battery.

Do not touch the battery or the contact strips with your fingers. Use a soft cloth.



Do not dispose of your used batteries in the countryside. Give them to an organisation that collects and recycles used batteries.



Batteries can be obtained from your approved Dealer.

These batteries should have a service life of approximately two years.

ACCESSORIES



Electrical and electronic accessories

Before installing this type of accessory, make sure it is compatible with your vehicle. You can get advice from an authorised dealer.

To install an accessory requiring intervention with the vehicle's 12 V electrical circuit, please follow these instructions:

- disconnect the charging cord from the traction battery;
- switch off the ignition;
- disconnect the 12 V battery.

Risk of serious injury.

Connect accessories with a maximum power of 120 watts only. **Fire hazard.**

No work may be carried out on the vehicle's electrical or radio circuits, except by authorised dealers: an incorrectly connected system may result in damage being caused to the electrical equipment and/or the components connected to it.

If the vehicle is fitted with any aftermarket electrical equipment, make sure that the installation is correctly protected by a fuse. Establish the rating and position of this fuse.

Use of transmission/receiving devices (telephones, CB equipment etc.).

Telephones and CB equipment with integrated aerials may cause interference to the electronic systems originally fitted to the vehicle: it is advisable only to use equipment with an external aerial. **Furthermore, we remind you of the need to conform to the legislation in force concerning the use of such equipment.**

Fitting after-market accessories

If you wish to install accessories on the vehicle: please contact an authorised dealer. Also, to ensure the correct operation of your vehicle, and to avoid any risk to your safety, we recommend that you use only accessories specifically designed for your vehicle, which are the only accessories for which the manufacturer will provide a warranty.

If you are using an anti-theft device, only attach it to the brake pedal.

Obstructions to the driver

On the driver's side, only use mats suitable for the vehicle, attached with the pre-fitted components, and check the fitting regularly. Do not lay one mat on top of another. **There is a risk of wedging the pedals**

WINDSCREEN WIPER BLADES

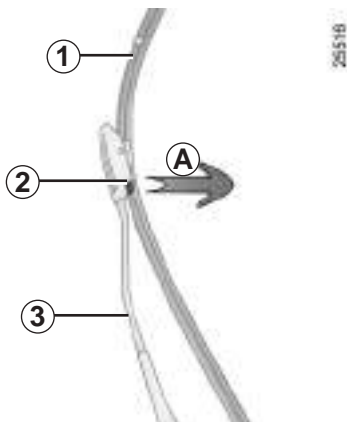

Replacing wiper blades 1

With the ignition on and the engine switched off, lower the windscreen wiper stalk completely: they stop slightly away from the bonnet. Lift wiper arm **3**, pull tab **2** (movement **A**) and push the blade upwards.

To refit

Slide the blade along the arm until it clips on. Make sure that the blade is correctly locked in position. Return the windscreen wiper stalk to the park position.

Keep monitoring the condition of the wiper blades. How long they last depends on you:

- clean the blades and the windscreen regularly with soapy water;
- do not use them when the windscreen is dry;
- free them from the windscreen when they have not been used for a long time.



- In frosty weather, make sure that the wiper blades are not stuck by ice (to avoid the risk of the motor overheating).
- Check the condition of the wiper blades. They should be replaced as soon as they become less efficient: approximately once a year.

When changing the blade, when it has been removed, do not let the wiper arm fall against the window: risk of breaking the window.

TOWING, BREAKDOWN (1/3)

Choice of breakdown service

In the event of an energy fault

In the event of a fully discharged traction battery, any type of towing is permitted: **towing on a flatbed truck** or **towing on the road** using the tow eye (please see following pages).

All other cases

Only towing on a flatbed truck is permitted.

30442

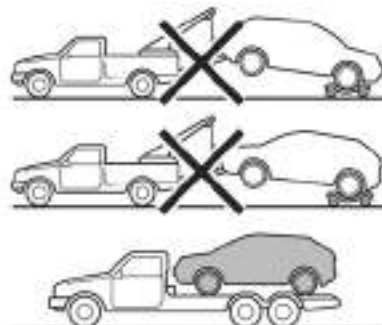
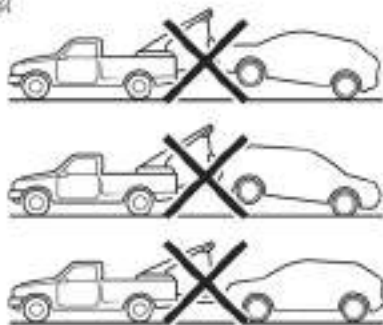

Towing on a flatbed truck

Breakdown recovery **must** be performed on a flat surface under all circumstances except where the vehicle is immobilised following a full discharge of the traction battery. In the event of a total energy loss, please see the following pages.

Before repairs, insert the key in the ignition to unlock the steering column. Turn it to position **M**.

The regulations in force for breakdown recovery must always be observed.

TOWING, BREAKDOWN (2/3)



In the event of an energy fault: towing

In the event of a fully discharged traction battery:

- the warning light  flashes;
- needle **1** is in the lower section of the reserve zone.

It is possible to recover on a flatbed truck or tow the vehicle using the tow eye, following the instructions below.



When the engine is stopped, steering and braking assistance are not operational.



Before towing, insert the key in the switch to unlock the steering column. Turn it to position **M**.

The column is unlocked, the accessory functions are supplied: the vehicle lights can be used (hazard warning lights, brake lights etc.). The towed vehicle's lights must be switched on at night.

The speed specified by current legislation for towing must always be observed.

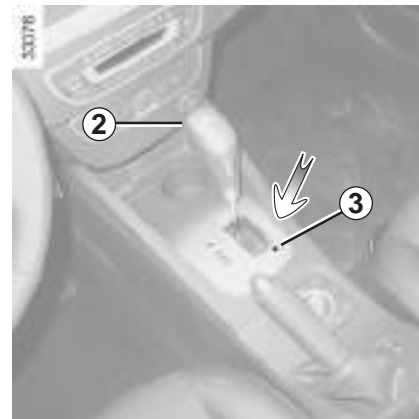

Bring lever to position **N**.



If the lever is stuck in **P**, even though you are depressing the brake pedal, the lever can be released manually. To do this, insert a rigid rod in the hole **3**, press the rod and unlocking button **2** located on the lever simultaneously.

TOWING, BREAKDOWN (3/3)

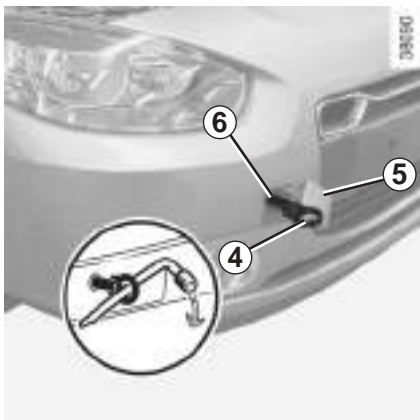

Access to towing points

Only use the front 6 and rear 7 towing points.

These towing points may only be used for towing: never use them for lifting the vehicle directly or indirectly.



Do not remove the key from the ignition when the vehicle is being towed.

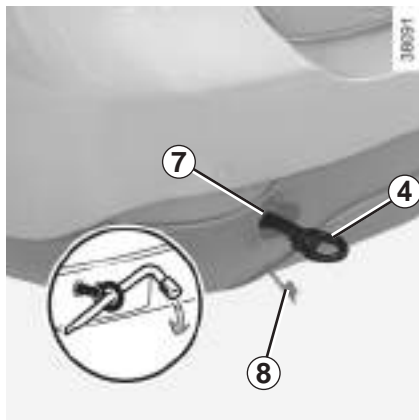

Unclip cover **5** or **8** by inserting a flat-blade screwdriver or similar under the cover.

Tighten towing hitch 4 fully: as much as possible by hand at first, then finish tightening it using the wheelbrace.

Only use the tow hitch **4** and the wheelbrace located under the boot carpet in the tool kit (please refer to the paragraph entitled "Tool kit").



Do not leave the tools unsecured inside the vehicle as they may come loose under braking.

After use, check that all the tools are correctly clipped into the tool kit, then, depending on the vehicle, position it correctly in its housing. Risk of injury.

OPERATING FAULTS (1/4)

The following advice will enable you to carry out quick, temporary repairs. For safety reasons you should always contact an approved dealer as soon as possible.

FAULTS	POSSIBLE CAUSES	WHAT TO DO
Impossible to charge the traction battery.	No electrical current in domestic sockets or poor connection of cable to domestic socket.	Check your installation (circuit breaker, programmer, etc.). Check the connections (socket, etc.). Please refer to the information on "Electric vehicle: charging" in Section 1.
	The outdoor temperature is lower than -26°C.	Recharge your vehicle in a more suitable environment. If necessary, refer to the paragraph on "Towing, breakdown" in Section 5.
	The cord is defective.	Please see an authorised dealer to replace it.
The programmable air conditioning fails to work.	One of the usage conditions is not complied with (the traction battery is not charged, etc).	Please refer to the information on "Air-conditioning: programming" in Section 3.

OPERATING FAULTS (2/4)

FAULTS	POSSIBLE CAUSES	WHAT TO DO
The remote control does not lock or unlock the doors.	The remote control battery is flat.	Use the emergency key.
	Use of appliances operating on the same frequency as the remote control (mobile phone, etc.).	Stop using the devices or use the key.
	Vehicle located in a high electromagnetic radiation zone. Discharged battery.	Replace the battery. You can still lock/unlock and start your vehicle (refer to the information on “Locking, unlocking the opening elements” in Section 1 and “Starting, stopping the engine” in Section 2).
The steering column remains locked.	Steering wheel locked.	To unlock, move the key and the steering wheel (please refer to the information on “Starting, stopping the engine” in Section 2).
Vibrations.	Tyres not inflated to correct pressures, incorrectly balanced or damaged.	Check the tyre pressures. If this is not the problem, have them checked by an approved Dealer.

OPERATING FAULTS (3/4)

Electrical equipment	POSSIBLE CAUSES	ACTION REQUIRED
The wipers do not work.	Wiper blades stuck.	Free the blades before using the wipers.
	Broken windscreen wiper fuse.	Consult an approved dealer.
	Motor fault.	Consult an approved dealer.
The wiper does not stop.	Faulty electrical controls.	Consult an approved dealer.
Direction indicators flashing more quickly.	Blown bulb.	Replace the bulb.
The indicators are not working.	On one side only: – blown bulb,	Replace the bulb. Consult an approved dealer.
	On both sides: – fuse blown, – faulty flasher unit.	Replace it. Needs replacing: please see an authorised dealer.

OPERATING FAULTS (4/4)

Electrical equipment		POSSIBLE CAUSES	ACTION REQUIRED
The headlights are not working.	Only one:	– blown bulb,	Replace the bulb.
		– disconnected wire or incorrectly-positioned connector,	Check and reconnect the wire or the connector.
		– faulty earth connection.	See above.
	Both:	– if the circuit is fused.	Check and replace if necessary.
The headlights do not switch off.		Faulty electrical controls.	Consult an approved dealer.
Traces of condensation in the lights.		This is not a fault. The presence of traces of condensation in lights is a natural phenomenon linked to variations in temperature. These traces soon disappear when the lights are switched on.	

Section 6: Technical specifications

Vehicle identification plates	6.2
Engine identification plate	6.3
Engine specification.	6.3
Weights	6.4
Dimensions	6.5
Replacement parts and repairs	6.6
Service sheets	6.7
Anti-corrosion check	6.13
	6.1

VEHICLE IDENTIFICATION PLATES

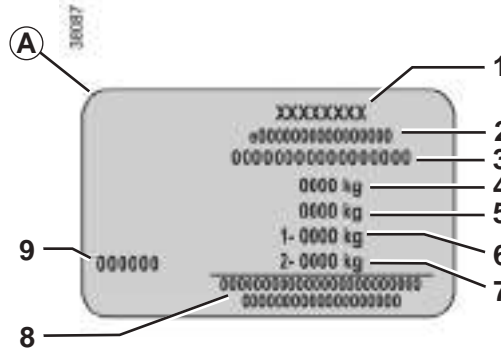
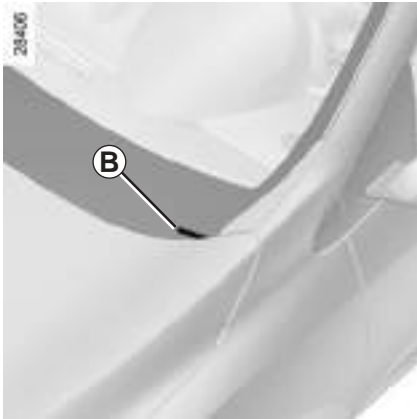
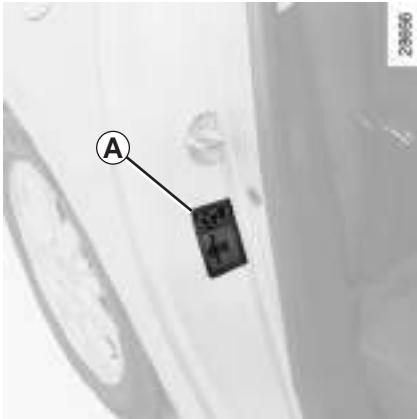

The information shown on the vehicle identification plate should be quoted on all correspondence or orders.

Vehicle identification plate A

- 1 Manufacturer name.
 - 2 EC design number or approval number.
 - 3 Identification number.
 - 4 MAM (Maximum Authorised Mass) for front axle.
- Depending on the vehicle, this information is also given on marking B.**

- 5 GTW (Gross train weight: vehicle fully loaded, with trailer).
- 6 MPAW (Maximum Permissible Weight) for front axle.
- 7 MPAW on rear axle.
- 8 Reserved for related or additional entries.
- 9 Paint reference (colour code).

ENGINE IDENTIFICATION PLATE/ENGINE SPECIFICATION

33293

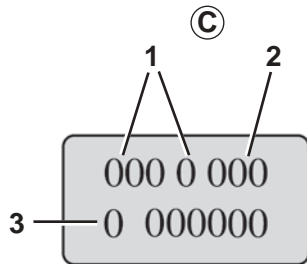

Engine identification plate

The information on the engine plate (or label) **C** should be quoted on all your correspondence or orders.

(Location varies depending on engine)

- 1 Engine type.
- 2 Engine suffix.
- 3 Engine number.

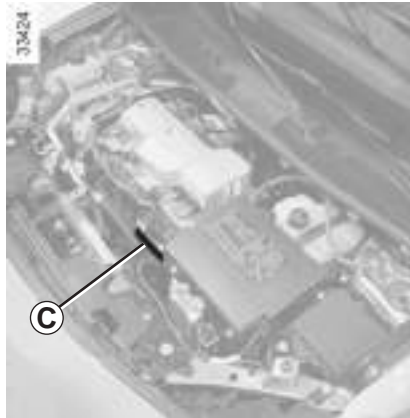

Engine specification

Engine type 1: 5AM

WEIGHTS (in kg)

The weights indicated for a basic vehicle without options: they vary depending on the your vehicle's equipment. Consult your approved Dealer.

Maximum permissible all-up weight (MMAC) Total train weight (MTR)	Weights are indicated on the vehicle identification plate (refer to the information on "Vehicle identification plates" in Section 6)
Braked Trailer Weight	Prohibited
Unbraked Trailer Weight	Prohibited
Permissible nose weight	Prohibited
Permissible load on the roof with the carrying device	80 kg (including the carrying device)

DIMENSIONS (in metres)

33402

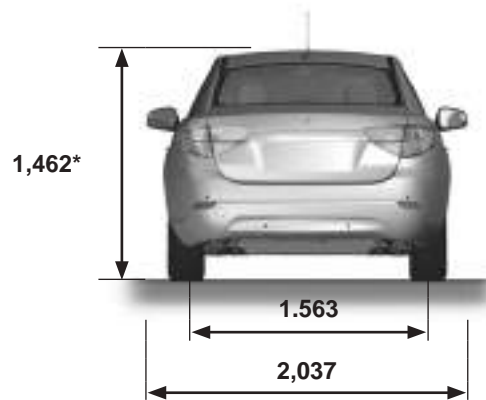
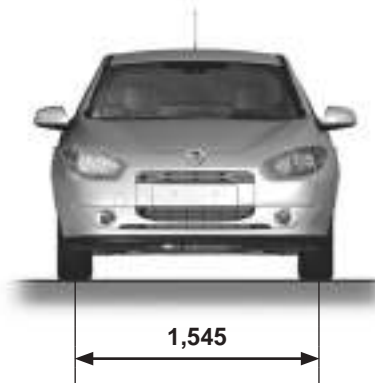
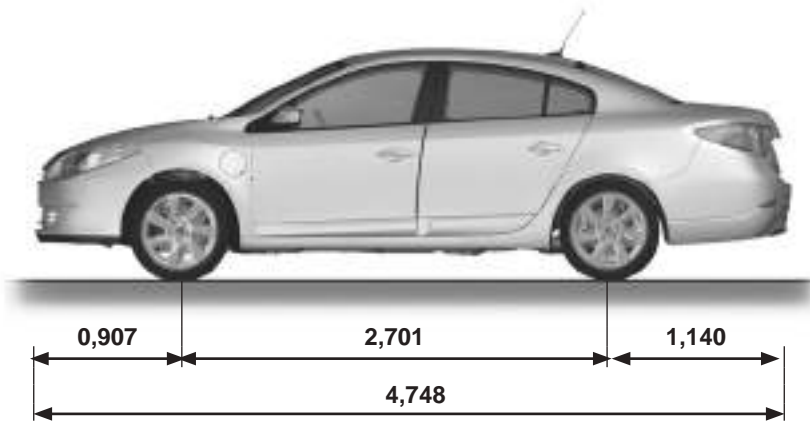

* Unladen

REPLACEMENT PARTS AND REPAIRS

Original parts are based on strict specifications and are subject to highly-specialised tests. Therefore, they are of at least the same level of quality as the parts fitted originally.

If you always fit genuine replacement parts to your vehicle, you will ensure that it performs well. Furthermore, repairs carried out within the manufacturer's Network using original parts are guaranteed according to the conditions set out on the reverse of the repair order.

SERVICE SHEETS (1/6)

VIN:

Date: _____ Miles (Km): _____		Invoice number: _____		Comments/miscellaneous	
Type of operation:		Stamp			
Service <input type="checkbox"/>					
..... <input type="checkbox"/>					
Anti-corrosion check:					
OK <input type="checkbox"/> Not OK* <input type="checkbox"/>					
*See specific page					
Date: _____ Miles (Km): _____		Invoice number: _____		Comments/miscellaneous	
Type of operation:		Stamp			
Service <input type="checkbox"/>					
..... <input type="checkbox"/>					
Anti-corrosion check:					
OK <input type="checkbox"/> Not OK* <input type="checkbox"/>					
*See specific page					
Date: _____ Miles (Km): _____		Invoice number: _____		Comments/miscellaneous	
Type of operation:		Stamp			
Service <input type="checkbox"/>					
..... <input type="checkbox"/>					
Anti-corrosion check:					
OK <input type="checkbox"/> Not OK* <input type="checkbox"/>					
*See specific page					

SERVICE SHEETS (2/6)

VIN:

Date: _____ Miles (Km): _____		Invoice number: _____		Comments/miscellaneous	
Type of operation:		Stamp			
Service <input type="checkbox"/>					
..... <input type="checkbox"/>					
Anti-corrosion check:					
OK <input type="checkbox"/> Not OK* <input type="checkbox"/>					
*See specific page					

Date: _____ Miles (Km): _____		Invoice number: _____		Comments/miscellaneous	
Type of operation:		Stamp			
Service <input type="checkbox"/>					
..... <input type="checkbox"/>					
Anti-corrosion check:					
OK <input type="checkbox"/> Not OK* <input type="checkbox"/>					
*See specific page					

Date: _____ Miles (Km): _____		Invoice number: _____		Comments/miscellaneous	
Type of operation:		Stamp			
Service <input type="checkbox"/>					
..... <input type="checkbox"/>					
Anti-corrosion check:					
OK <input type="checkbox"/> Not OK* <input type="checkbox"/>					
*See specific page					

SERVICE SHEETS (3/6)

VIN:

Date: _____ Miles (Km): _____		Invoice number: _____		Comments/miscellaneous	
Type of operation:		Stamp			
Service <input type="checkbox"/>					
..... <input type="checkbox"/>					
Anti-corrosion check:					
OK <input type="checkbox"/> Not OK* <input type="checkbox"/>					
*See specific page					
Date: _____ Miles (Km): _____		Invoice number: _____		Comments/miscellaneous	
Type of operation:		Stamp			
Service <input type="checkbox"/>					
..... <input type="checkbox"/>					
Anti-corrosion check:					
OK <input type="checkbox"/> Not OK* <input type="checkbox"/>					
*See specific page					
Date: _____ Miles (Km): _____		Invoice number: _____		Comments/miscellaneous	
Type of operation:		Stamp			
Service <input type="checkbox"/>					
..... <input type="checkbox"/>					
Anti-corrosion check:					
OK <input type="checkbox"/> Not OK* <input type="checkbox"/>					
*See specific page					

SERVICE SHEETS (4/6)

VIN:

Date: _____ Miles (Km): _____		Invoice number: _____		Comments/miscellaneous	
Type of operation:		Stamp			
Service <input type="checkbox"/>					
..... <input type="checkbox"/>					
Anti-corrosion check:					
OK <input type="checkbox"/> Not OK* <input type="checkbox"/>					
*See specific page					
Date: _____ Miles (Km): _____		Invoice number: _____		Comments/miscellaneous	
Type of operation:		Stamp			
Service <input type="checkbox"/>					
..... <input type="checkbox"/>					
Anti-corrosion check:					
OK <input type="checkbox"/> Not OK* <input type="checkbox"/>					
*See specific page					
Date: _____ Miles (Km): _____		Invoice number: _____		Comments/miscellaneous	
Type of operation:		Stamp			
Service <input type="checkbox"/>					
..... <input type="checkbox"/>					
Anti-corrosion check:					
OK <input type="checkbox"/> Not OK* <input type="checkbox"/>					
*See specific page					

SERVICE SHEETS (5/6)

VIN:

Date:	Miles (Km):	Invoice number:	Comments/miscellaneous
Type of operation:		Stamp	
Service	<input type="checkbox"/>		
.....	<input type="checkbox"/>		
Anti-corrosion check:			
OK	<input type="checkbox"/>	Not OK*	<input type="checkbox"/>
*See specific page			

Date:	Miles (Km):	Invoice number:	Comments/miscellaneous
Type of operation:		Stamp	
Service	<input type="checkbox"/>		
.....	<input type="checkbox"/>		
Anti-corrosion check:			
OK	<input type="checkbox"/>	Not OK*	<input type="checkbox"/>
*See specific page			

Date:	Miles (Km):	Invoice number:	Comments/miscellaneous
Type of operation:		Stamp	
Service	<input type="checkbox"/>		
.....	<input type="checkbox"/>		
Anti-corrosion check:			
OK	<input type="checkbox"/>	Not OK*	<input type="checkbox"/>
*See specific page			

SERVICE SHEETS (6/6)

VIN:

Date: _____ Miles (Km): _____		Invoice number: _____		Comments/miscellaneous	
Type of operation:		Stamp			
Service <input type="checkbox"/>					
..... <input type="checkbox"/>					
Anti-corrosion check:					
OK <input type="checkbox"/> Not OK* <input type="checkbox"/>					
*See specific page					

Date: _____ Miles (Km): _____		Invoice number: _____		Comments/miscellaneous	
Type of operation:		Stamp			
Service <input type="checkbox"/>					
..... <input type="checkbox"/>					
Anti-corrosion check:					
OK <input type="checkbox"/> Not OK* <input type="checkbox"/>					
*See specific page					

Date: _____ Miles (Km): _____		Invoice number: _____		Comments/miscellaneous	
Type of operation:		Stamp			
Service <input type="checkbox"/>					
..... <input type="checkbox"/>					
Anti-corrosion check:					
OK <input type="checkbox"/> Not OK* <input type="checkbox"/>					
*See specific page					

ANTICORROSION CHECK (1/6)

If the continuation of the warranty is subject to repair, it is indicated below.

VIN:

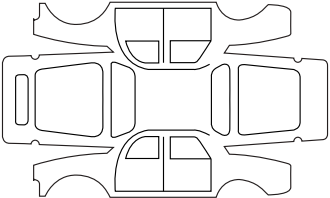
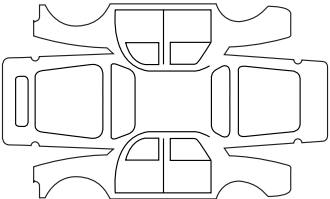
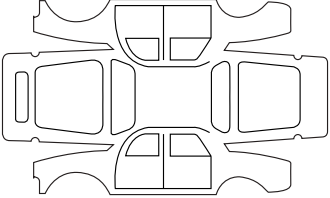
Corrosion repair operation to be carried out:		Stamp
Date of repair:		
Repair to be carried out:		Stamp
Date of repair:		
Repair to be carried out:		Stamp
Date of repair:		

ANTICORROSION CHECK (2/6)

If the continuation of the warranty is subject to repair, it is indicated below.

VIN:

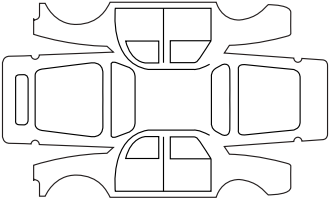
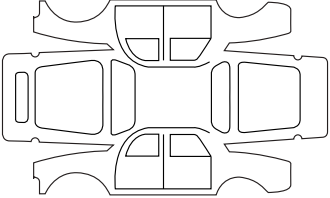
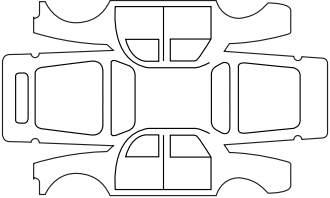
Corrosion repair operation to be carried out:		
Corrosion repair operation to be carried out:		Stamp
Date of repair:		
Repair to be carried out:		
Repair to be carried out:		Stamp
Date of repair:		
Repair to be carried out:		
Repair to be carried out:		Stamp
Date of repair:		

ANTICORROSION CHECK (3/6)

If the continuation of the warranty is subject to repair, it is indicated below.

VIN:

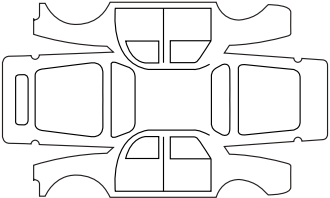
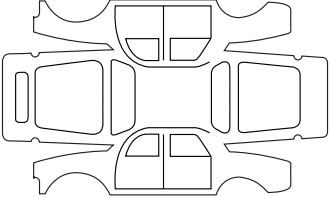
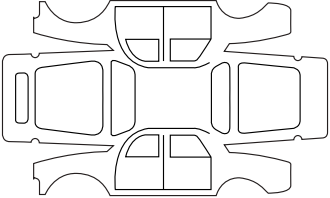
Corrosion repair operation to be carried out:		
Corrosion repair operation to be carried out:		Stamp
Date of repair:		
Repair to be carried out:		
Repair to be carried out:		Stamp
Date of repair:		
Repair to be carried out:		
Repair to be carried out:		Stamp
Date of repair:		

ANTICORROSION CHECK (4/6)

If the continuation of the warranty is subject to repair, it is indicated below.

VIN:

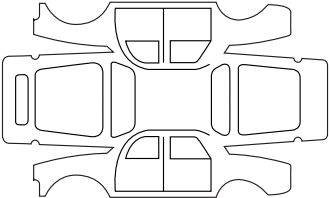
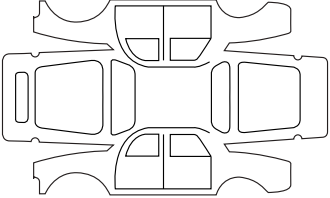
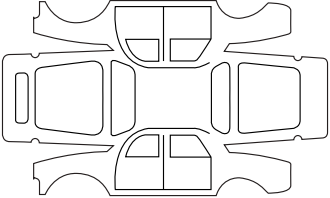
Corrosion repair operation to be carried out:		
Corrosion repair operation to be carried out:		Stamp
Date of repair:		
Repair to be carried out:		
Repair to be carried out:		Stamp
Date of repair:		
Repair to be carried out:		
Repair to be carried out:		Stamp
Date of repair:		

ANTICORROSION CHECK (5/6)

If the continuation of the warranty is subject to repair, it is indicated below.

VIN:

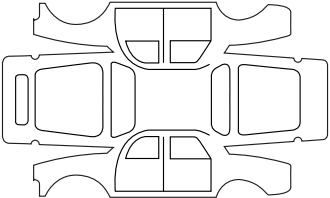
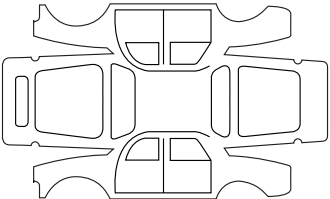
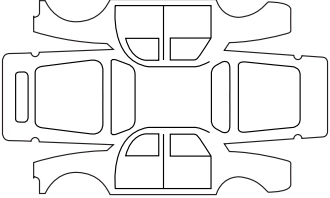
Corrosion repair operation to be carried out:		
Corrosion repair operation to be carried out:		Stamp
Date of repair:		
Repair to be carried out:		
Repair to be carried out:		Stamp
Date of repair:		
Repair to be carried out:		
Repair to be carried out:		Stamp
Date of repair:		

ANTICORROSION CHECK (6/6)

If the continuation of the warranty is subject to repair, it is indicated below.

VIN:

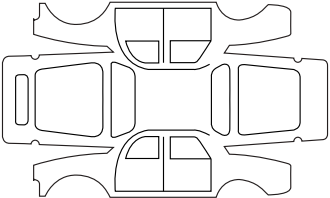
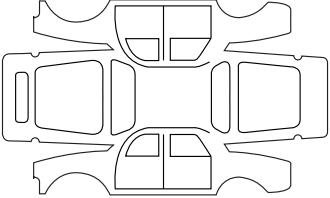
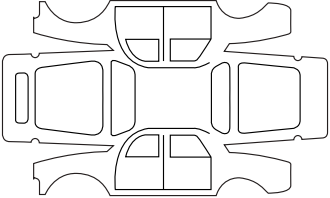
Corrosion repair operation to be carried out:		
Corrosion repair operation to be carried out:		Stamp
Date of repair:		
Repair to be carried out:		
Repair to be carried out:		Stamp
Date of repair:		
Repair to be carried out:		
Repair to be carried out:		Stamp
Date of repair:		

ALPHABETICAL INDEX (1/5)

A

ABS	2.9 → 2.12
accessories.....	5.26
accessories socket	3.19
additional methods of restraint	1.29 → 1.32, 1.35
side protection	1.34
to the front seat belts	1.29 → 1.32
to the rear seat belts	1.29 → 1.33
adjusting your driving position	1.22 – 1.23, 1.26
air bag.....	1.29 → 1.35
activating the front passenger air bags.....	1.48
deactivating the front passenger air bags.....	1.46
air conditioning	3.4 → 3.8, 3.11
air vents.....	3.2 – 3.3
anti-corrosion check	6.13 → 6.18
anti-corrosion protection.....	4.9
anti-lock braking system: ABS.....	2.9 → 2.12
armrest:	
front.....	3.17
ashtray.....	3.19
ASR (traction control)	2.9 → 2.12
audible and visual signals.....	1.70

B

battery.....	1.55
12 volt battery	
breakdown recovery	5.23 – 5.24
maintenance	4.6 – 4.7
12 volt battery	1.2 → 1.6, 4.6 – 4.7, 5.23 – 5.24
battery (remote control)	5.25
bonnet.....	4.2 – 4.3
brake fluid.....	4.5
bulbs	
changing	5.14 → 5.18

C

central door locking	1.19 → 1.21
changing a bulb	5.14 → 5.18
changing a wheel.....	5.9 – 5.10
changing gear.....	2.3 – 2.4
charge meter	1.58, 2.8
charging cord.....	1.8 → 1.13
charging flap.....	1.7 → 1.13
charging socket	1.2 → 1.6, 1.8 → 1.13
child restraint/seat	1.37 – 1.38, 1.40 → 1.48
child safety.....	1.15, 1.37 – 1.38, 1.40 → 1.48, 3.12
child seats.....	1.37 – 1.38, 1.40 → 1.45
children.....	1.15, 1.17 – 1.18, 1.37 – 1.38
children (safety).....	3.12
cigar lighter	3.19
cleaning:	
inside the vehicle	4.11 – 4.12
clock	1.49
closing the doors	1.17 → 1.20
connected services.....	1.3
control instruments	1.54 → 1.60
controls.....	1.50 → 1.53
coolant.....	4.4
courtesy light	3.14 – 3.15, 5.19 – 5.20
courtesy mirrors.....	3.15
cruise control	1.55, 2.13 → 2.19
cruise control-speed limiter.....	2.13 → 2.19
customised vehicle settings	1.68
customising the vehicle settings	1.68

D

dashboard.....	1.50 → 1.53
daytime running lights.....	1.71
display	1.54 → 1.58
doors.....	1.17 – 1.18, 1.21
doors/tailgate	1.17 – 1.18, 1.21

ALPHABETICAL INDEX (2/5)

driver's position	1.50 → 1.56
driving	2.2 → 2.6, 2.9 → 2.21
driving position	
settings	1.26 → 1.28

E

electric beam height adjustment.....	1.74
»400 volt« electrical circuit.....	1.2 → 1.7
electric vehicle	
vehicle range	2.5 – 2.6
noise	1.6
charge.....	1.8 → 1.13
driving.....	1.6, 2.5 – 2.6
quick change of traction battery.....	1.14
presentation	1.2 → 1.6
important recommendations	1.7, 1.9
electric windows	3.12 – 3.13
electrical installation	1.9
Electronic Stability Program: ESP	2.9 → 2.12
emergency brake assist.....	2.9 → 2.12
emergency braking.....	2.9 → 2.12
energy	
recovery	2.8
saving	2.5
charge meter (function).....	2.8
consumption	2.8
energy saving	2.5 – 2.6
energy consumption	1.57 – 1.58, 2.5 – 2.6
energy recovery.....	2.5
engine specifications	6.3
environment.....	2.7
ESP: Electronic Stability Program	2.9 → 2.12
external temperature	1.49

F

faults	
operating faults	5.31 → 5.34
fittings	3.16 → 3.18
fog lights	5.16
front passenger air bag deactivation	1.46
front seat adjustment.....	1.25
front seats	
adjustment	1.22 – 1.23, 1.25 → 1.28
with manual controls	1.25
fuses.....	5.21 – 5.22

G

gear lever.....	2.3 – 2.4
glove box	3.18

H

handbrake.....	2.4
hands-free telephone integrated control.....	3.22
hazard warning lights signal	1.70 – 1.71
headlight beam adjustment	1.74
headlight flashers	1.70
headlight washer	1.76
headrest.....	1.22 → 1.24
heating and air conditioning system	3.11
heating, air conditioning: programming	2.6, 3.9 – 3.10
heating system	3.4 → 3.10
heating/air conditioning programming	3.9 – 3.10
horn	1.70
horn:	
flash	1.70
sounding the horn	1.70
hubcap tool.....	5.3

I

indicators	1.70, 5.14
------------------	------------

ALPHABETICAL INDEX (3/5)

indicators:

direction indicators.....	1.70
exterior temperature indicator.....	1.49
instrument panel.....	1.54 → 1.60
instrument panel.....	1.54 → 1.67, 1.71
instrument panel messages.....	1.59 → 1.67
interior trim	
maintenance.....	4.11 – 4.12

J

jack.....	5.3
-----------	-----

K

keys.....	1.15 – 1.16
-----------	-------------

L

levels:

brake fluid.....	4.5
coolant.....	4.4
windscreen washer reservoir.....	4.5

lifting the vehicle

changing a wheel.....	5.9 – 5.10
-----------------------	------------

lighting:

exterior.....	1.71 → 1.73
instrument panel.....	1.71
interior.....	3.14 – 3.15, 5.19 – 5.20

lights

additional.....	5.16
adjustment.....	1.74
changing bulbs.....	5.14 – 5.15
fog lights.....	5.16
front.....	5.14 – 5.15

lights:

adjusting.....	1.74
brake lights.....	5.17 – 5.18
dipped beam headlights.....	1.54, 1.71, 5.15

direction indicators.....	1.54, 1.70, 5.14, 5.17
fog lights.....	1.54, 1.73, 5.16, 5.18
hazard warning.....	1.70
indicator lights.....	5.18
main beam headlights.....	1.54, 1.72, 5.15
number plate lights.....	5.18
reversing lights.....	5.18
side lights.....	1.71, 5.15, 5.17
locking the doors.....	1.15 → 1.18, 1.21

M

maintenance:

bodywork.....	4.9 – 4.10
interior trim.....	4.11 – 4.12
mechanical.....	4.2 – 4.3, 6.7 → 6.12
map reading lights.....	3.14 – 3.15
menu for customising the vehicle settings.....	1.68
methods of restraint in addition to the seat belts...1.29 → 1.35	
multimedia equipment.....	3.22

N

navigation.....	3.22
navigation system.....	3.22

O

opening the doors.....	1.17 → 1.20
operating faults.....	1.66, 5.31 → 5.34

P

paintwork

maintenance.....	4.9 – 4.10
parking distance control.....	2.20 – 2.21
power-assisted steering.....	1.36
practical advice.....	2.5 – 2.6
pretensioners.....	1.29 → 1.32
puncture.....	5.9 – 5.10

ALPHABETICAL INDEX (4/5)

Q

Quickdrop (system) 1.14

R

radio 3.22

rear view mirrors 1.69

RENAULT ANTI-INTRUDER DEVICE (RAID) 1.21

replacement parts 6.6

reverse gear

 selecting 2.3 – 2.4

reversing sensor 2.20 – 2.21

roof bars 3.21

roof rack

 roof bars 3.21

S

seat belt pretensioners 1.29 → 1.32

 front seat belt 1.29 → 1.32

seat belts 1.26 → 1.32, 1.34 – 1.35, 1.55

see-me-home lighting 1.72, 1.74

service sheets 6.7 → 6.12

side protection devices 1.34

signals and lights 1.71 → 1.74

speed control 2.3 – 2.4

speed limiter 1.55, 2.13 → 2.15

starting 2.2

starting the engine 2.2

steering wheel

 adjustment 1.36

stopping the engine 2.2

storage compartment 3.16 → 3.18

storage compartments 3.16 → 3.18

sun visor 3.15

T

tailgate 3.20

tanks and reservoirs

 brake fluid 4.5

 coolant 4.4

tanks and reservoirs:

 windscreen washer 4.5

technical specifications 6.6

telephone 3.22

temperature regulation 3.4 → 3.8

tool kit 5.2 – 5.3

towing

 in the event of energy failure 5.28 → 5.30

 breakdown 5.28 → 5.30

towing hitch 5.3, 5.29 – 5.30

towing rings 1.40 – 1.41

traction battery 1.2 → 1.7

traction battery charge 1.8 → 1.13

traction control: ASR 2.9 → 2.12

transporting children 1.37 – 1.38, 1.40 → 1.48

transporting objects

 in the luggage compartment 3.20

trims 5.3

trip computer and warning system 1.59 → 1.67

tyre inflation kit 5.2, 5.4 → 5.8

tyre pressure 4.8, 5.12

tyre pressures 4.8

tyres 4.8, 5.11 → 5.13

U

unlocking the doors 1.19 – 1.20

V

vehicle range 2.5 – 2.6

ventilation 3.4 → 3.8

W

warning buzzer 1.17, 1.70, 1.72

ALPHABETICAL INDEX (5/5)

warning lights.....	1.54 → 1.56, 1.59 – 1.60
washing	4.9 – 4.10
weights	6.4
wheelbrace	5.3
wheels (safety)	5.11 → 5.13
windscreen washer.....	1.75 – 1.76, 4.5
windscreen washer/wiper	1.75 – 1.76
wiper blades	5.27
wipers	1.75 – 1.76
blades	5.27

FLUENCE Z.E.



(www.e-guide.renault.com)

RENAULT S.A.S. SOCIÉTÉ PAR ACTIONS SIMPLIFIÉE AU CAPITAL DE 533 941 113 € / 13-15, QUAI LE GALLO
92100 BOULOGNE-BILLANCOURT R.C.S. NANTERRE 780 129 987 — SIRET 780 129 987 03591 / TÉL. : 0810 40 50 60

NU 914-4 – 99 91 064 90R – 08/2012 – Edition anglaise



9 9 9 1 0 6 4 9 0 R

TO