

Your Owner's Manual



Electronic version available on the Internet

<http://go.skoda.eu/owners-manuals>



ŠKODA SUPERB iV 09.2019
Angličtina/English



3V1012720AA

OWNER'S MANUAL

ŠKODA SUPERB iV



ŠKODA
SIMPLY CLEVER

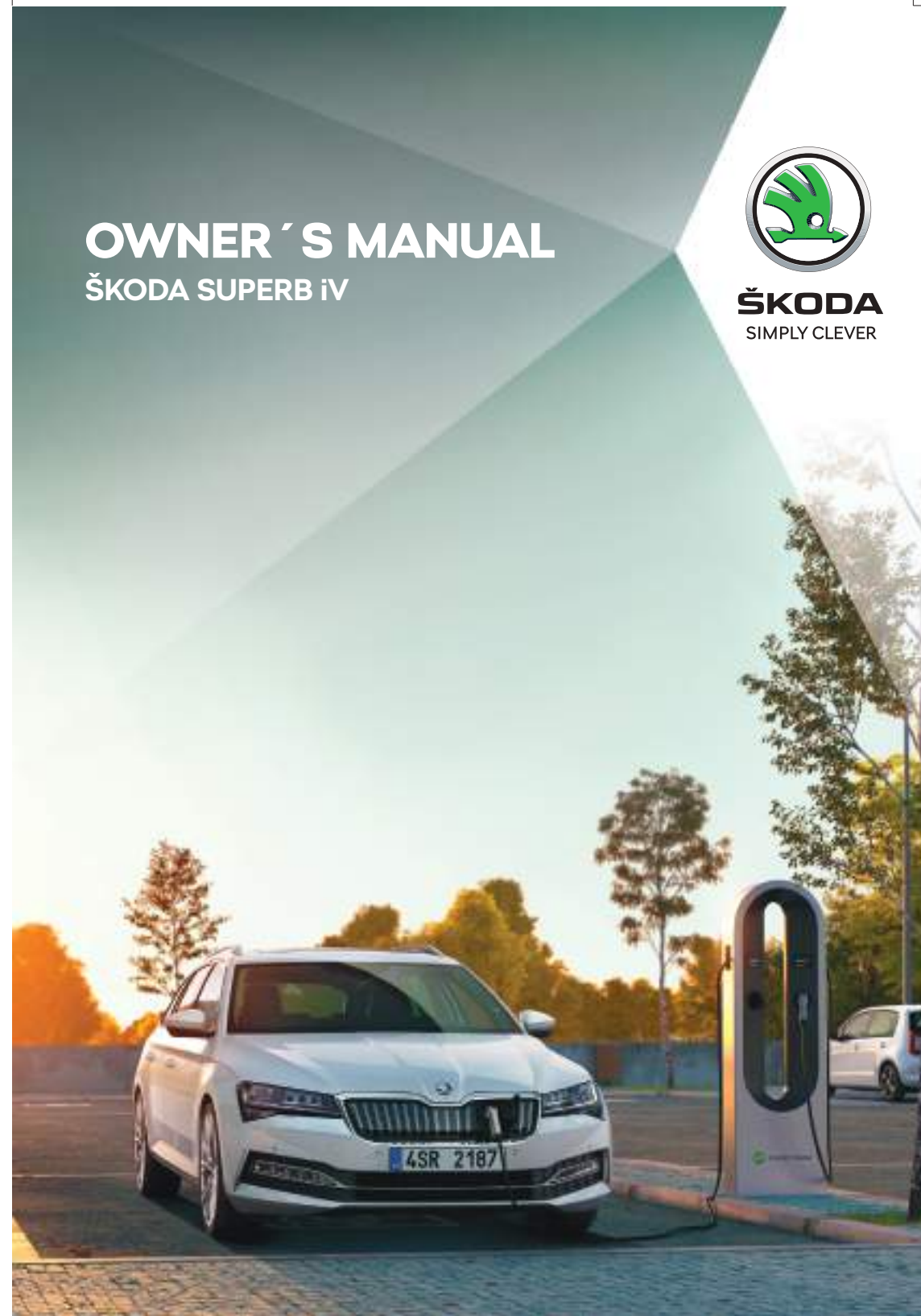

Documentation of vehicle delivery

Vehicle Identification Number (VIN)

| | | | | | | | | | | | | | | | | | | | |
|--|--|--|--|--|--|--|--|--|--|--|--|--|--|--|--|--|--|--|--|
| | | | | | | | | | | | | | | | | | | | |
|--|--|--|--|--|--|--|--|--|--|--|--|--|--|--|--|--|--|--|--|

Date of vehicle delivery ____ / ____ / _____

| |
|-----------------------------------|
| ŠKODA Partner |
| Stamp and signature of the vendor |

I confirm that I have taken delivery of the vehicle in good condition, have received information on how to operate it correctly, and have had the terms of the warranty explained to me.

| |
|---------------------------|
| Signature of the customer |
|---------------------------|

Does the vehicle have an extended warranty?

YES

NO

Limitations of the ŠKODA extended warranty^{a)}

Years: _____

or

km/mileage: _____

or

Miles: _____

^{a)} Depending on which comes first.



Reprinting, duplicating, translating and any other use, either in whole or in part, is not permitted without the written consent of ŠKODA AUTO a.s.

ŠKODA AUTO a.s. expressly reserves all rights relating to copyright laws.

Subject to change.

Issued by: ŠKODA AUTO a.s.

© ŠKODA AUTO a.s. 2019

Vehicle owner

First Vehicle owner

This vehicle with the registration plate

belongs to:

Title, name/company:

Address:

Telephone:

ŠKODA Partner:

Second Vehicle owner

This vehicle with the registration plate

belongs to:

Title, name/company:

Address:

Telephone:

ŠKODA Partner:

Service consultant:

Telephone:

Service consultant:

Telephone:



3V1012720AA

Table of Contents

| | | | |
|-----------|--|-----------|--|
| 1 | Vehicle owner | 33 | Seats, steering wheel and mirror |
| 5 | About the Owner's Manual | 33 | Front seat - with manual operation |
| 5 | About the Owner's Manual | 33 | Front seat - with electrical operation |
| 6 | Explanations | 34 | Memory function of the seat |
| 7 | Vehicle overviews | 34 | Massage function in the driver's seat |
| 7 | Front vehicle area | 35 | Rear seats |
| 9 | Rear vehicle area | 35 | Headrests |
| 10 | Driver's seat | 36 | Front armrest |
| 10 | Centre console and passenger seat | 36 | Rear armrest |
| 11 | Engine compartment | 36 | Load-through device |
| 11 | Indicator lights | 36 | Seat heating and ventilation |
| 11 | Functionality | 37 | Steering wheel |
| 11 | Indicator light overview | 38 | Heated steering wheel |
| 15 | Correct and safe | 38 | Interior rear-view mirror |
| 15 | Introductory notes for correct use | 38 | Exterior mirror |
| 15 | New vehicle or new parts | 40 | Restraint systems and airbags |
| 15 | Regular checks | 40 | Seat belts |
| 15 | No improper vehicle adjustments | 41 | Child seat |
| 15 | Keeping sensors and cameras in working order | 42 | Fasteners for child seats |
| 16 | Engine compartment | 44 | Airbags |
| 16 | Vehicle battery | 45 | Key switch for the front passenger airbag |
| 16 | Notes on the high-voltage system | 46 | Lighting, windscreen wipers and washers |
| 17 | Using electrical sockets in the vehicle | 46 | Exterior lighting |
| 17 | Before your journey | 49 | COMING HOME, LEAVING HOME exterior lighting |
| 19 | Safe driving | 49 | Light Assist high-beam assist system |
| 20 | Emergency call | 49 | Dynamic Light Assist headlight assist system |
| 20 | After an accident | 50 | Replace light bulbs |
| 22 | Keys, locks and alarm system | 51 | Interior lighting |
| 22 | Key | 51 | Interior ambient light |
| 23 | Central locking | 52 | Windscreen wipers and washers |
| 24 | Keyless locking (KESSY) | 54 | Heating and air conditioning system |
| 25 | Alarm system | 54 | Climatronic automatic air conditioning system |
| 26 | Doors, windows and boot lid | 55 | Auxiliary heating and ventilation |
| 26 | Doors | 57 | Driver information system |
| 26 | Child safety lock on the rear doors | 57 | Analogue instrument panel |
| 26 | Window - with electrical operation | 58 | Digital instrument cluster |
| 28 | Sliding/tilting roof | 59 | Instrument cluster display |
| 29 | Sunblind - with manual operation | 59 | Driving data |
| 29 | Sunblind - with electrical operation | 61 | E-Manager |
| 29 | Sunblind for the rear window | 62 | e-Displays |
| 29 | Sun protection roller blinds for the rear door panes | 62 | Speed limit warning |
| 29 | Sun visors | 63 | Vehicle condition |
| 29 | Heated windscreen | 63 | Infotainment Amundsen |
| 30 | Boot lid - with manual operation | 63 | Infotainment overview |
| 30 | Boot lid - with electrical control | 63 | System |
| 31 | Electrically operated contactless boot lid | 65 | Screen |
| 32 | Unlocking the boot lid | 66 | Infotainment keyboard |
| | | 67 | Voice control |
| | | 68 | Radio |
| | | 71 | Media |
| | | 75 | Images |
| | | 76 | User management |
| | | 77 | Mobile device management |

| | | | |
|------------|---|------------|--|
| 79 | Telephone | 146 | High-voltage system |
| 82 | Wi-Fi | 146 | High-voltage system and high-voltage battery |
| 83 | SmartLink | 148 | Charging of high-voltage battery |
| 85 | ŠKODA Connect online services | 151 | Charging cable |
| 87 | Navigation | | |
| 92 | Infotainment Columbus | 153 | Engine, exhaust system and fuel |
| 92 | Infotainment overview | 153 | Bonnet |
| 92 | System | 153 | Engine oil |
| 93 | Screen | 154 | Coolant |
| 94 | Keypad | 155 | Engine electronics |
| 95 | Voice control | 155 | Particle filter |
| 96 | Radio | 155 | Exhaust control system |
| 99 | Media | 155 | Fuel filler flap |
| 103 | Images | 156 | Petrol |
| 104 | User management | 157 | Vehicle battery and fuses |
| 106 | Mobile device management | 157 | Vehicle battery |
| 107 | Telephone | 158 | Using the jump-starting cable |
| 110 | Wi-Fi | 159 | Fuses |
| 111 | SmartLink | 159 | Fuses in the dash panel |
| 114 | ŠKODA Connect online services | 161 | Fuses in the engine compartment |
| 115 | Navigation | 162 | Wheels |
| 120 | Starting and driving | 162 | Tyres and rims |
| 120 | Start | 163 | All-season or winter tires |
| 121 | Starting issues | 163 | Snow chains |
| 121 | Automatic gearbox | 163 | SEAL tyres |
| 123 | Vehicle driving mode | 164 | Changing the wheel and raising the vehicle |
| 123 | Select Drive | 165 | Breakdown kit |
| 124 | Economical driving style | 166 | Tyre pressure |
| 125 | Towing a trailer | 167 | Tyre pressure monitor |
| 126 | Towing eye and towing procedure | 167 | Tyre pressure monitoring system |
| 126 | Brakes | 168 | Wheel bolt cover caps |
| 127 | Electric parking brake | 168 | Full wheel frame |
| 128 | Auto Hold automatic holding function | 169 | Storage space and interior equipment |
| 129 | Driver assist systems | 169 | Equipment in the boot |
| 129 | Braking and stabilising systems | 169 | Emergency equipment |
| 130 | Front Assist | 169 | Fasteners in the boot |
| 131 | Pedestrian detection system | 170 | Fastening nets |
| 131 | Speed limiter | 170 | Multifunctional pocket |
| 132 | Cruise control system | 170 | Net partition |
| 132 | Adaptive Cruise Control (ACC) | 171 | Removable light |
| 135 | Lane Assist | 172 | Rigid boot cover |
| 136 | Traffic jam assistant | 172 | Roll-up luggage compartment cover |
| 136 | Lane change assist system Side Assist | 173 | Through-loading bag |
| 137 | Traffic sign recognition | 173 | Overview of passenger compartment |
| 138 | Crew Protect Assist proactive occupant protection | 174 | Storage compartment under the front seat |
| 138 | Driver Alert fatigue detection assistant | 174 | Storage compartment for an umbrella |
| 138 | Emergency situation assist systemEmergency Assist | 174 | Phonebox |
| 139 | Park Assist systems | 175 | Cup holder |
| 139 | Park Pilot parking aid | 176 | Waste container |
| 140 | Rear view camera | 176 | Ashtray and cigarette lighter |
| 142 | Area View environment overview | 176 | Ceiling |
| 143 | Rear Traffic Alert | 176 | Display in rear centre console |
| 143 | Park steering assistant | 177 | Tablet holder |
| 145 | Trailer assist trailer manoeuvring aid | 178 | Storage compartment for the tablet |
| | | 178 | 12-Volt power socket |
| | | 178 | 230-Volt power socket |

4 Table of Contents

179 Roof rack and hitch

- 179 Roof rack
- 179 Swivelling hitch

181 Maintaining and cleaning

- 181 Service events
- 181 Service work, adjustments and technical changes
- 182 Interior
- 182 Exterior

184 Technical data and specifications

- 184 Requirements for the technical data
- 184 Vehicle identification data
- 185 Maximum permissible weights
- 185 Operating weight
- 186 Vehicle dimensions
- 186 Engine specifications
- 186 Event Data Recorder
- 187 Information about the radio systems in the vehicle
- 187 Rights arising from defective performance, ŠKODA warranties

190 Index

About the Owner's Manual

General

This Owner's Manual applies to all **chassis variants** of the vehicle, including all **models** and **trim levels**.

All possible **trim levels** are described here without identifying them as special trims, model variants or market-dependent equipment. This means that **not all the trim components** described in this Owner's Manual are available in your vehicle.

The **images** in this Owner's Manual are for illustrative purposes only. The images may differ from your vehicle; these are for general information purposes only.

ŠKODA AUTO is constantly working on the further development of all vehicles. It is therefore possible for changes to be made at any time to the scope of delivery in terms of shape, equipment and technology. The information contained in this Owner's Manual corresponds to the information available at the time of going to press.

No legal claims can therefore be derived from the technical data, illustrations and information in this Owner's Manual.

Electronic version of the Owner's Manual

The printed Owner's Manual contains the most important information regarding vehicle operation and vehicle maintenance.

Complete information is included in the electronic version of the Owner's Manual. This is available on the ŠKODAweb pages as well as in the mobile application MyŠKODA, which can be downloaded.



► <http://go.skoda.eu/owners-manuals>

About the Owner's Manual

General

This Owner's Manual applies to all **chassis variants** of the vehicle, including all **models** and **trim levels**.

All possible **trim levels** are described here without identifying them as special trims, model variants or market-dependent equipment. This means that **not all the trim components** described in this Owner's Manual are available in your vehicle.

The **images** in this Owner's Manual are for illustrative purposes only. The images may differ from your vehicle; these are for general information purposes only.

ŠKODA AUTO is constantly working on the further development of all vehicles. It is therefore possible for changes to be made at any time to the scope of delivery in terms of shape, equipment and technology. The information contained in this Owner's Manual corresponds to the information available at the time of going to press.

No legal claims can therefore be derived from the technical data, illustrations and information in this Owner's Manual.

Explanations

Terms used

“Specialist garage” - A workshop that carries out specialist service tasks for ŠKODA vehicles. A specialist can be a ŠKODA Partner, a ŠKODA Service Partner, or an independent workshop.

“ŠKODA Service Partner” - A workshop that has been contractually authorised by ŠKODA AUTO or its distribution partner to perform service work on ŠKODA vehicles and to sell ŠKODA Genuine Parts.

“ŠKODA Partner” - A company that has been contractually authorised by ŠKODA AUTO or its distribution partner to sell new ŠKODA vehicles and, when applicable, to service them using ŠKODA Genuine Parts and sell ŠKODA Genuine Parts.

Text notes

“Press” - short press (e.g. a button) within 1 second

“Hold” - long press (e.g. a button) for more than 1 second

Direction indications

All direction indications, such as “left”, “right”, “front”, “rear”, relate to the forwards direction of travel of the vehicle.

DANGER

Texts with this symbol indicate dangerous situations which, if the safety instructions are not observed, will result in death or serious injury.

WARNING

Texts with this symbol indicate dangerous situations which, if the safety instructions are not observed, could result in death or serious injury.

CAUTION

Texts marked with this symbol indicate dangerous situations which, if the safety instructions are not observed, could result in minor or moderate injury.

NOTICE

Texts with this symbol indicate situations which, if the corresponding instructions are not observed, will result in damage to the vehicle.

 Texts with this symbol contain additional information.

Vehicle overviews

Front vehicle area

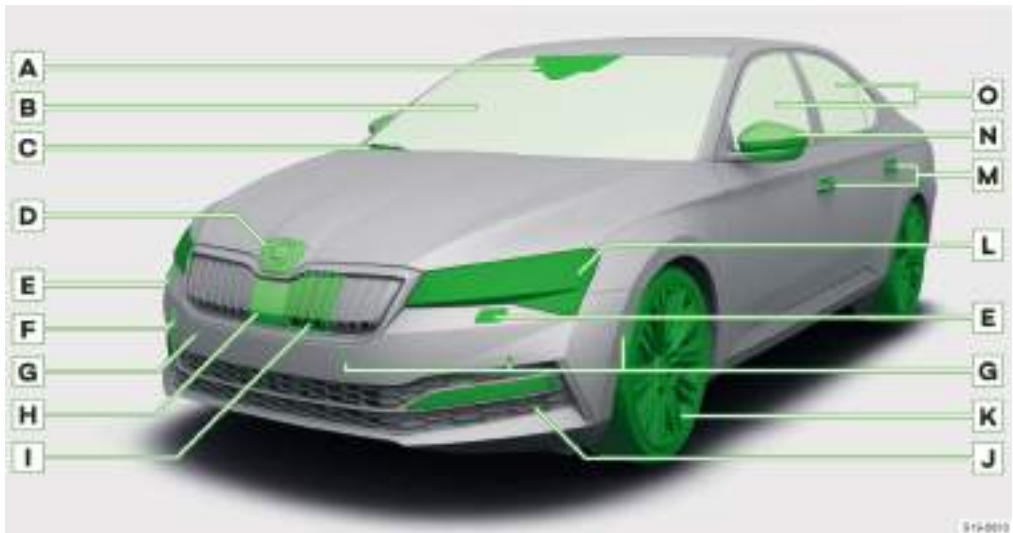

- A** Under the windscreen
 - ▶ Camera for assist systems
 - ▶ Light sensor for automatic driving light circuit » [page 46](#)
 - ▶ Rain sensor for automatic wiping » [page 52](#)
- B** Windscreen - heating » [page 30](#)
- C** Windscreen wiper – operation » [page 52](#)
- D** Bonnet release lever (under the flap) » [page 153](#)
- E** Headlight washers » [page 52](#)
- F** Cover for screw-in towing eye socket » [page 126](#)
- G** Ultrasonic sensors for assist systems
- H** Cover in the radiator grille
 - ▶ Front radar sensor for assist systems
 - ▶ Camera for assist systems
- I** Battery charging flap » [page 148](#)
- J** Fog lights - operation » [page 47](#)
- K** Wheels
 - ▶ Tyres and rims » [page 162](#)
 - ▶ Changing the wheel and raising the vehicle » [page 164](#)
 - ▶ Breakdown kit » [page 165](#)
 - ▶ Tyre pressure » [page 166](#)
 - ▶ Tyre pressure monitor » [page 167](#)
 - ▶ Tyre pressure monitoring system » [page 167](#)
- L** Headlight
 - ▶ Operation » [page 47](#)
 - ▶ Light Assist high-beam assist system » [page 49](#)
 - ▶ Dynamic Light Assist headlight assist system » [page 49](#)

8 Vehicle overviews › Front vehicle area

- ▶ Replace light bulbs » [page 50](#), » [page 50](#)

M Door handles

- ▶ Open the door » [page 26](#)
- ▶ Keyless locking (KESSY) » [page 24](#)

N Exterior mirror

- ▶ Operation » [page 38](#)
- ▶ Camera for assist systems

O Side door windows - operation » [page 27](#)

- › Keep the sensors and cameras for the assist systems clean » [page 15](#).

Rear vehicle area

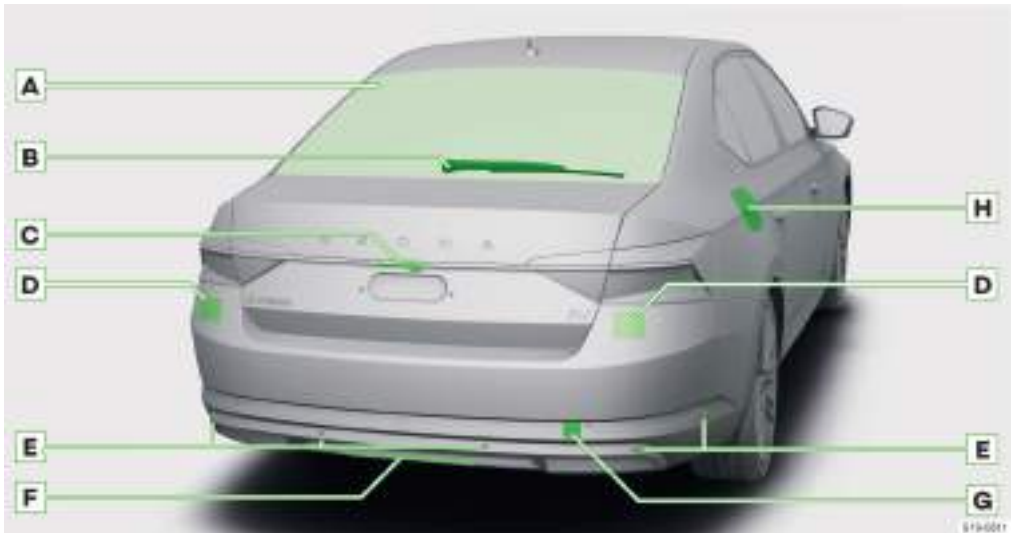

- A** Rear window - heating » [page 30](#)
 - B** Rear window wiper and washer - Operation » [page 52](#)
 - C** Handle of the boot lid
 - ▶ Manually operated boot lid » [page 30](#)
 - ▶ Electrically operated boot lid » [page 30](#)
 - ▶ Camera for assist systems
 - D** Radar sensors for assist systems (in the bumper)
 - E** Ultrasonic sensors for assist systems
 - F** Swivelling hitch » [page 179](#)
 - G** Cover for screw-in towing eye socket » [page 126](#)
 - H** Fuel filler flap » [page 155](#)
 - ▶ Sticker with tyre pressures » [page 166](#)
 - ▶ Sticker with prescribed fuel
 - ▶ Ice scraper
- › Keep the sensors and cameras for the assist systems clean » [page 15](#).

Driver's seat



- A** Side Assist lane change assist system indicator light » page 136
- B** Door opening lever » page 26
- C** Light switch » page 47
- D** Air outlet nozzle
- E** Operating lever (depending on equipment):
 - ▶ Flashing and high beam » page 47
 - ▶ Cruise control » page 132
 - ▶ Speed limiter » page 131
 - ▶ High-beam assist system » page 49
 - ▶ Headlight Assist System » page 50
- F** Buttons/dials on the multifunction steering wheel » page 59
- G** Depending on the equipment:
 - ▶ Analogue instrument cluster » page 57
 - ▶ Digital instrument cluster » page 58
- H** Control lever:
 - ▶ Windscreen wipers and washers » page 52
 - ▶ Information system » page 59
- I** Starter button » page 120
- J** Steering wheel with horn/with driver's front airbag » page 44
- K** Safety lever for steering wheel adjustment » page 37
- L** Operation of the automatic distance control » page 133
- M** Bonnet release lever » page 153
- N** Exterior mirror operation » page 38
- O** Window operation » page 27

Centre console and passenger seat

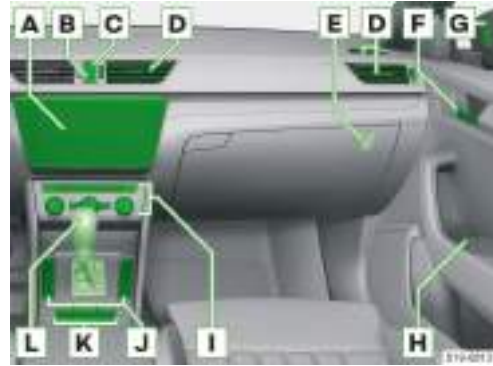

- A** Infotainment (depending on trim level):
 - ▶ Columbus » page 92
 - ▶ Amundsen » page 63
- B** Hazard warning system button » page 47
- C** Pilot light for front passenger airbag » page 45
- D** Air outlet nozzle
- E** Key switch for passenger front airbag (in front passenger storage compartment) » page 45
- F** Door opening lever » page 26
- G** Side Assist lane change assist system indicator light » page 136
- H** Window operation in the passenger door » page 27
- I** Operation of air conditioning system » page 54
- J** Buttons (depending on the equipment):
 - ▶ Sport driving mode » page 123
 - ▶ Choice between electric and hybrid drive
 - ▶ Driving mode selection » page 123
 - ▶ Unlocking the fuel filler flap » page 155
 - ▶ Park Assist » page 143
 - ▶ Area View environment overview » page 142
 - ▶ Button for the electric boot lid » page 30
- K** Buttons:
 - ▶ Auto Hold » page 128
 - ▶ Parking brake » page 127
 - ▶ Central locking » page 23
- L** Selector lever for gearbox » page 121

Engine compartment



- A** Coolant expansion tank for combustion engine » [page 154](#)
- B** Engine oil dipstick » [page 153](#)
- C** Engine oil filler opening » [page 153](#)
- D** Coolant expansion tank for high-voltage system » [page 154](#)
- E** Brake fluid reservoir » [page 127](#)
- F** Fuse box » [page 161](#)
- G** Windscreen washer fluid reservoir » [page 52](#)

Indicator lights

Functionality

⚠ WARNING

Ignoring the illuminated indicator lights and associated messages on the instrument cluster display may result in accidents, serious injury or damage to the vehicle.

The indicator lights in the instrument cluster indicate the current status of certain functions or faults.

The illumination of some of the indicator lights may be accompanied by acoustic signals and messages in the instrument cluster display.

Colour display of the indicator lights

Depending on the vehicle equipment, the colour scheme of the indicator lights may vary. The coolant indicator light can, e.g. be shown in colour as follows.

 - colour display

 - black and white display

Additional indicator lights







Depending on the meaning, the additional indicator light will also light up in the display along with some of the indicator lights.

 - Danger

























 - Warning























Indicator light overview























After switching on the ignition, some indicator lights for the functional test of the vehicle systems light up briefly. If the tested systems are in order, the respective indicator lights go out a few seconds after the ignition is switched on or after the engine has been started.























| Symbol | Meaning |
|---|---|
|  | Indicates a warning together with another warning light » page 11 . |
|  | Front seat belt not fastened » page 40 . |
|  | Vehicle battery is not charging » page 158 . |
|  | Along with  - Engine fault » page 155 , » page 158 . |
|  | Engine oil pressure too low » page 153 . |
|  | Engine oil level too low » page 153 . |

12 Indicator lights › Indicator light overview





| Symbol | Meaning |
|---|---|
|  | Coolant level is too low » page 154. |
|  | Coolant temperature too high » page 155. |
|  | Brake fluid level is too low » page 127. |
|  | Electromechanical brake booster faulty » page 130. |
|  | Together with  - Brake system and ABS faulty » page 130. |
|  | Parking on a slope with too much inclination » page 128. |
|  | Parking brake on » page 127. |
|  | Illuminates - Power assisted steering faulty » page 37. |
|  | Flashing - Steering lock faulty » page 37. |
|  | Automatic gearbox impaired » page 122. |
|  | Automatic gearbox overheated » page 122. |
|  | hybrid drive system faulty » page 155. |
|  | Along with  faulty high-voltage system cooling circuit » page 155. |
|  | Warning if there is a risk of a collision » page 130. |
|  | ACC does not decelerate sufficiently » page 133. |
|  | Indicates a warning along with another warning light » page 11. |
|  | The fuel supply has reached the reserve area. » page 157. |
|  | flashes - the high-voltage battery is charged » page 149. |
|  | Windscreen washer fluid level too low » page 53. |
|  | Bulb faulty » page 48. |
|  | Rear fog light switched on » page 47. |
|  | Engine oil level too high or engine oil level sensor impaired » page 154. |
|  | Clogged particle filter » page 155. |

| Symbol | Meaning |
|--|--|
|  | Parking brake error » page 128. |
|  | Hybrid drive system faulty » page 155. |
|  | Recuperation error » page 122. |
|  | ABS faulty » page 130. |
|  | Worn brake pads » page 127. |
|  | Automatic gearbox overheated » page 122. |
|  | Automatic gearbox impaired » page 122. |
|  | Tyre pressure control system faulty » page 167. |
|  | Tyre pressure change » page 163, » page 167, » page 167, » page 168. |
|  | Illuminates - Power assisted steering faulty » page 37. |
|  | Flashing - Steering lock not unlocked » page 37. |
|  | Flashing - Steering lock faulty » page 37. |
|  | Adaptive suspension faulty » page 123. |
| EPC | Petrol engine control faulty » page 155. |
|  | Emission control system faulty » page 155. |
| ON  | Flashes together with OFF  - Key switch for airbag deactivation faulty » page 46. |
| OFF  | Front passenger airbag switched off » page 46. |
| ON  | Front passenger airbag switched on » page 46. |
|  | Airbag system faulty » page 45. |
|  | Crew Protect Assist faulty » page 138. |
|  | Illuminates for 4 seconds and then flashes - Airbag or belt tensioner deactivated with diagnostic device » page 45. |
|  | Illuminates 4 s - Front passenger airbag deactivated with key switch » page 46. |

| Symbol | Meaning |
|---|--|
|  | Ball rod not locked » page 180. |
|  | ASR deactivated » page 130. |
|  | Illuminates - ESC or ASR faulty » page 130. |
|  | Flashing - ESC or ASR is engaged » page 129. |
|  | Front Assist deactivated » page 130. |
|  | ACC not available » page 135. |
|  | Lane Assist intervenes » page 135. |
|  | Lane Assist intervenes » page 135. |
|  | Turn signal light, left » page 48. |
|  | Turn signal light, right » page 48. |
|  | Trailer turn signal light » page 48. |
|  | Front fog lights switched on » page 47. |
|  | The selector lever is locked » page 121. |
|  | Vehicle is secured by Auto Hold » page 128. |
|  | The high-voltage battery is charged » page 149. |
|  | Lane Assist is activated and ready to intervene » page 135. |
|  | Lane Assist is activated and ready to intervene » page 135. |
|  | ACC controls the driving speed » page 133. |
|  | The cruise control system controls the driving speed » page 132. |
|  | Speed limiter controls the driving speed » page 131. |
|  | Low outside temperature » page 59. |
|  | High beam or flasher activated » page 47. |
|  | Rear seat belt not fastened » page 40. |

| Symbol | Meaning |
|---|---|
|  | A rear seat belt is fastened » page 40. |
|  | High beam Assist System switched on » page 49, » page 50. |
|  | No light is switched on » page 47. |
|  | The charging plug is connected to the charging socket » page 149. |
|  | Driving with electric drive » page 123. |
|  | Driving with electric drive is not available » page 124. |
|  | Driving with hybrid drive - automatic mode » page 124. |
|  | Driving with hybrid drive - charging the high-voltage battery » page 124. |
|  | Driving with hybrid drive - Maintaining the state of charge of the high-voltage battery » page 124. |
|  | Driving with hybrid drive - discharging the high-voltage battery » page 124. |
|  | Maximum Performance » page 122, » page 123. |
|  | Speed limiter faulty » page 132. |
|  | Speed limiter activated » page 131. |
|  | ACC activated » page 133. |
|  | ACC controls the driving speed according to the road » page 133. |
|  | ACC controls the driving speed according to the permissible speed » page 133. |
|  | Cruise control system faulty » page 132. |
|  | Cruise control activated » page 132. |
|  | Safety distance too small » page 130. |
|  | Consumption-friendly driving » page 125. |
|  | Break recommendation » page 138. |
|  | Driving mode Normal » page 123. |

14 Indicator lights › Indicator light overview

| Symbol | Meaning |
|---|--|
|  | Driving mode Eco » page 123 . |
|  | Comfort Driving Mode » page 123 . |
|  | Driving mode Individual » page 123 . |
|  | Driving mode Sport » page 123 . |

Correct and safe

Introductory notes for correct use

- ▶ Read this Owner's Manual carefully, as proceeding in accordance with this manual is a prerequisite for the correct use of the vehicle. This Owner's Manual should therefore always be in the vehicle.
- ▶ When using the vehicle, the generally binding legal provisions that are specific to the country must be observed. Such as those for transporting children, switching off airbags, using tyres, road traffic and the like.
- ▶ Do not exceed the maximum permissible weights and loads.
- ▶ Do not exceed the maximum permissible roof load.
- ▶ Use the specified fuel and operating fluids.
- ▶ Drive on roads that meet the technical vehicle parameters. Obstacles that exceed the ground clearance of the vehicle can damage the vehicle when driving over them.
- ▶ Care must be taken during operations related to operation, maintenance and self-help to avoid damage to the vehicle or injury. If required, seek the help of a specialised garage.
- ▶ All work on the vehicles and safety systems e.g. on the seatbelts or the airbag system, may only be carried out by a specialist garage.
- ▶ When using accessories, please note the instructions in the accessory manufacturer's instruction manual. These include child seats, roof racks, compressors etc.
- ▶ Please note the service intervals.

New vehicle or new parts

New vehicle - Running in the engine

Driving style during the first 1500 km determines the quality of the engine run-in process.

- ▶ During the first 1000 km, rev the engine to max. 3/4 of the highest permissible engine speed and avoid using a trailer.
- ▶ Over the next 500 km, the engine speed can be slowly increased.

Depending on driving style and operating conditions, the engine consumes some oil, up to 0.5 l/1000 km. Consumption may be higher over the next 5000 km.

New brake pads

New brake pads do not provide the optimum braking effect during the first 200 km, they have to be worn in first. Therefore, drive very carefully.

New tyres

New tyres do not have optimum grip for the first 500 km. Therefore, drive very carefully.

Regular checks

What should be taken into account before driving?

A vehicle with technical defects can increase the risk of accidents and injuries.

Eliminate any defects before driving. If required, seek the help of a specialised garage.

Pay special attention to the following points.

- ▶ Is the tyre undamaged?
- ▶ Is the tyre tread sufficient?
- ▶ Is the tyre pressure sufficient?
- ▶ Do the headlamps, brake and turn signals work?
- ▶ Is the windscreen in good condition?
- ▶ Is the engine oil, brake fluid and coolant level OK?
- ▶ Is the air intake in the engine compartment free from obstruction?
- ▶ Are the air outlet nozzles or air intake in front of the windscreen free from obstruction?
- ▶ Are the windscreen wiper and washer system and windscreen wiper blades functional?
- ▶ Is the windscreen washer fluid level sufficient?
- ▶ Are the windscreen wiper blades in good condition?
- ▶ Are all seatbelt system components in good working order? Are the seatbelts clean and have the buckles been unclogged?
- ▶ Is the spoiler working properly?
- ▶ Are parts and components of the vehicle still visibly attached?
- ▶ Are there no oil stains or other operating fluids under the vehicle?

No improper vehicle adjustments

Improper modifications can cause interference and affect safety-related functions and other functions of the vehicle.

- ▶ Adjustments and technical modifications to the vehicle should only be carried out by a specialist garage.
- ▶ Do not cover the engine with additional insulation materials, e.g. a blanket.

Keeping sensors and cameras in working order

Some functions of your vehicle are supported by sensors and cameras inside and outside the vehicle.

The rear-mounted accessories, e.g. bike rack, may affect system and camera functionality.

- ▶ Do not cover or put a sticker over the sensors and cameras and keep them clean.

- ▶ If there is damage suspected to the sensors or cameras, seek the help of a specialist garage.

Engine compartment

Before opening the engine compartment flap

Risk of scalding! Do not open the engine compartment flap if steam or coolant comes out of the engine compartment.

- ▶ Stop the engine and allow it to cool.
- ▶ Open the driver door.

When working in the engine compartment

- ▶ Keep children away from the engine compartment.
- ▶ Do not touch the radiator fan. The radiator fan can turn itself on, even when the ignition is off.
- ▶ Do not touch electrical cables. Avoid short circuits in the electrical system, especially on the vehicle battery.
- ▶ Do not smoke near the vicinity of the engine and refrain from handling open flames or sparks.
- ▶ If you need to work in the engine compartment with the engine running, be mindful of rotating engine parts and electrical equipment.
- ▶ Do not leave any objects in the engine compartment.

Handling operating fluids

Your vehicle needs various fuels to operate that can affect health or the environment when they are emitted. These include fuel, oils, battery acid, coolant and brake fluid.

- ▶ Only use operating fluids outdoors or in well-ventilated areas. If required, wear protective equipment.
- ▶ Do not use or check operating fluids with the engine running.
- ▶ In the event of contact with operating fluids, wash affected areas with warm water. If required, seek medical help.
- ▶ The leaked engine oil in the engine compartment can cause a fire, so wipe it off with a cloth.
- ▶ Store cloths soiled by brake fluids in a well-ventilated place until disposal. Cloths with residues of engine oil can ignite and cause a fire.

Vehicle battery

Handling the vehicle battery

Battery acid is highly corrosive. Improper handling of the vehicle battery can cause an explosion, fire, chemical burns or poisoning!

- ▶ When handling the vehicle battery, eye and skin protection must be worn.
- ▶ Do not tilt the vehicle battery, as it may leak battery acid.

- ▶ If battery acid comes into contact with skin, wash the affected areas with water for a few minutes. Get medical help without delay.
- ▶ Do not charge a frozen or thawed vehicle battery. Replace a frozen vehicle battery.
- ▶ Do not use a damaged vehicle battery.
- ▶ Short circuit! Do not connect the battery terminals.

Notes on the high-voltage system

⚠ DANGER

Improper handling of the high-voltage system and battery can result in burns, injuries or fatal electric shock.

- ▶ It must always be assumed that the high-voltage battery is charged and that the high-voltage system is live. This also applies when the electric drive is switched off and the ignition is switched off.
- ▶ Do not touch the high-voltage cables or the high-voltage battery, even with the aid of other objects.
- ▶ Do not carry out any work on the high-voltage system or the high-voltage battery.
- ▶ Do not open or repair the components of the high-voltage system.
- ▶ Do not replace, remove or disconnect the orange high-voltage cables.
- ▶ Do not open, replace, or remove the cover of the high-voltage battery.
- ▶ Work on the high-voltage system and the systems influenced by it may only be carried out by qualified service technicians.
- ▶ When working on the high-voltage system and the high-voltage battery, the specifications and guidelines of the ŠKODA AUTO company must be adhered to.
- ▶ Before carrying out any work on the vehicle, where there is a risk of damaging the components of the high-voltage system, the vehicle must be free from any voltage. This work may only be carried out by qualified service technicians.
- ▶ Damage to the vehicle or the high-voltage battery can result in the escape of toxic and flammable gases. Open the windows so that any escaping gases can escape from the vehicle. Do not inhale the gases.
- ▶ Avoid contact with liquids and gases leaking from the high-voltage battery.
- ▶ In the event of fire, leave the vehicle and stay at a safe distance. Inform rescuers about the fact that it is a vehicle with a high-voltage battery.» [page 20, After an accident](#)

⚠ WARNING

- ▶ The air supply to the electric drive must not be restricted and the electric drive must not be covered by any additional insulating materials (e.g. by a cover).

⚠ WARNING

Risk of an accident!

An vehicle with an electric drive does not make any noise when driving or decelerating. It may not be noticed by other road users.

Using electrical sockets in the vehicle

Improper handling of sockets can lead to life-threatening electric shock or fire.

- ▶ The sockets may get hot during operation. Do not touch hot sockets.
- ▶ Protect sockets from liquids.
- ▶ If moisture gets into the socket, let the socket dry before reusing it.
- ▶ Do not insert any objects into the socket contacts.

Before your journey

Adults and children, cargo and objects - everything has its place in the vehicle. Observe the following instructions so that all occupants are protected in the best possible way in the event of an accident.

Before you go

- ▶ Ensure that you have a good view of outside the vehicle.
- ▶ Adjust the rearview mirrors.
- ▶ Close all doors and the engine compartment and boot flap.
- ▶ Take up the correct sitting position, adjust the seats correctly and fasten the seat belt properly. Ensure that passengers do likewise. Always leave the seat belt on while driving.
- ▶ Only one person can be secured with a seat belt.
- ▶ Make sure that the seat belts are not trapped, e.g. in the door or in the seat.
- ▶ Check seat belts, their locks and attachment points for damage.

Sitting safely

For the safety of the occupants and to reduce the risk of injury in the event of an accident, the following instructions must be observed.

- ▶ Stand the backrests upright. If the front passenger seat backrest has been folded forward, only the seat behind the driver's seat may be used for transporting passengers.
- ▶ Engage the rear seat backrests correctly.

- ▶ Adjust the height-adjustable headrest so that the top of the headrest is as close as possible to the top of the head.
- ▶ Keep your feet in the footwell.
- ▶ Use the entire seat.
- ▶ Do not lean forward or sit to the side.
- ▶ Do not hold your limbs out the window.

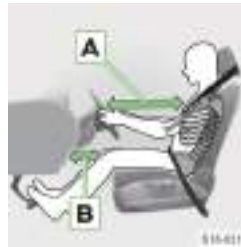

- ▶ Adjust the driver's seat in the longitudinal direction so that the pedals can be fully pushed through with slightly bent legs.

- ▶ Adjust the steering wheel so that the distance **A** between the steering wheel and sternum is at least 25

cm.

- ▶ For vehicles with driver's knee airbag, adjust the driver's seat longitudinally so that the distance **B** from the legs to the dash panel in the area of the knee airbag is at least 6 cm.
- ▶ Adjust the angle of the backrest so that the steering wheel can be reached at the top with your arms slightly bent.
- ▶ Move the passenger seat back as far as possible. The front passenger must maintain a minimum distance of 25 cm from the dash panel.

Correct belt webbing arrangement



The webbing arrangement is extremely important for the seat belts to offer the best possible protection.

- ▶ The shoulder strap must run over the middle of the shoulder, must never run over the neck, and must lie firmly against the body

(it must not run over loose layers of clothing).

- ▶ The lap belt part must be placed in front of the pelvis and fit tightly.
- ▶ In pregnant women, the lap belt part must be as low as possible on the pelvis, so that no pressure is exercised on the abdomen.
- ▶ The webbing must not be pinched or twisted and rub against sharp edges.
- ▶ The webbing must not pass over solid or fragile objects in clothing, such as a key ring, etc.
- ▶ The tongue may only be inserted into the buckle of the associated seat.

- ▶ The webbing must be tight. Therefore, do not attach clamps or similar items to the webbing for adjusting the seat belt according to body size.

Correct steering wheel position



- ▶ Hold the steering wheel with both hands on the outer edge in the "9 o'clock" and "3 o'clock" position. Otherwise, you may experience serious injury to the arms, hands and head when deploying the airbag.

Be mindful of the effect of the airbag system

Airbag systems can only properly protect if all occupants have been secured and they are in the correct seating position.

No persons, animals or objects such as cup holders or hangers for clothes may be in the deployment area of the airbags » [page 45](#).

- ▶ Do not cover or stick anything over the steering wheel or the dash panel. The front airbags were not able to deploy.

The front passenger airbag should be switched off in some situations » [page 45](#).

Securing children properly

- ▶ Do not carry a child on your lap, and secure the child and yourself with a seat belt.
- ▶ Only transport children in a suitable child seat » [page 42](#).

Children under 150 cm tall will not be properly protected without a child seat. Children that have been inadequately secured can be thrown through the vehicle in the event of an accident or a sudden manoeuvre. You can cause life-threatening injuries to yourself and other occupants.

If children lean forward or assume a wrong sitting position while driving, they are more likely to be injured in the event of an accident. This is especially true for children who are carried in the passenger seat - when the airbag system triggers, they can be seriously injured or killed!

A child that has been incorrectly secured in the wrong sitting position - endangered by the side airbag



The child should not be in the deployment area of the side airbag.

A child that has been properly secured in a child seat



There must be enough room between the child and the exit area of the side airbag to offer the best possible protection.

Transporting objects safely

When moving heavy objects, there is a shift in emphasis. Thus, the driving behaviour of the vehicle changes.

- ▶ Adjust driving speed and driving style to this changed driving behaviour.

Unsecured or misplaced items may be thrown around in the event of an accident or sudden manoeuvre. There is a risk of serious injury and loss of control of the vehicle!

In a rear-end collision at 50 km/h unsecured objects are thrown forward with up to 50 times their weight. A 1.5 litre water bottle is thrown up to 75 kg.

- ▶ Transport objects securely.
- ▶ Stow objects so they do not hinder the driver. Keep the driver footwell clear.
- ▶ Stow small items in the storage compartments.
- ▶ Do not leave lockable storage compartments open.
- ▶ Do not let items protrude out of the slots. This note does not apply to bottles in bottle trays.
- ▶ Do not place any objects on the dash panel or on the luggage compartment cover.
- ▶ Do not exceed the maximum permissible load of fasteners and shelves.
- ▶ Distribute the load evenly in the luggage compartment and fasten it so it cannot slip.
- ▶ Place heavy objects in the luggage compartment as far forward as possible.

Safe driving

Introductory notes

- ▶ Pay attention when you are driving! As a driver, you are fully responsible for road safety.
- ▶ Always adjust driving speed to the road conditions as well as the traffic and weather conditions.

Paying attention to warning signals

The driver information system warns you with indicator lights and messages in the event of any faults.

Failure to follow the warnings may increase the risk of accidents and injuries.

- ▶ If the vehicle issues a warning signal, then park the vehicle safely and follow the information in the instrument cluster, and in this manual.

Using assistance systems in a clever way

The assistance systems are only for support and do not absolve you from your responsibility for driving the vehicle.

The assistance systems are subject to physical and technical limitations. Therefore, in certain situations, system reactions may be perceived as undesirable or delayed.

- ▶ Stay alert and be ready to intervene.
- ▶ Familiarise yourself with the assistance systems, their limitations and operating conditions.
- ▶ Activate, deactivate and adjust the assistance systems so that you have full control of the vehicle in any traffic situation.

Driving with a loaded roof rack

When transporting objects on the roof rack, the vehicle's driving behaviour changes.

- ▶ Adapt your speed and driving style to this.

Towing a trailer

The vehicles handling characteristics change with a trailer. The assistance systems may behave differently.

- ▶ Drive more slowly, excessive speed can lead to loss of control of the vehicle.
- ▶ Keep a larger distance from the vehicle in front.
- ▶ Do not exceed the max. vertical load and the permissible trailer load.

Driving through water

There must be no water ingress into the vehicle systems e.g. into the engine's air intake system!

- ▶ Therefore, determine the water depth before driving through water. The water level must not exceed the lower edge of the lower beam.
- ▶ Drive at max. walking speed. Otherwise, a wave may form in front of the vehicle, increasing the water level.

- ▶ Never stop in the water, do not drive backwards and never stop the engine.

Vehicle operation in different weather conditions

If you wish to operate your vehicle in countries with different weather conditions from those specified, please contact a ŠKODA Partner. They will advise you if certain precautions need to be taken to ensure the full functioning of the vehicle or to prevent damage (e.g. coolant, battery replacement, etc.).

Is something wrong?

- ▶ Pay attention to changes in vehicle handling.
- ▶ If in doubt about safety, stop driving and seek the help of a specialist garage.
- ▶ Unusual vibrations or the vehicle 'pulling' to the side may indicate a puncture.
- ▶ If tyre pressure loss is very quick, try to stop the vehicle carefully without heavy steering or heavy braking.
- ▶ Immediately remove foreign bodies stuck in the tyre tread.
- ▶ Do not remove foreign objects that have penetrated into the tyre. Check the tyre pressure and seek the help of a specialised garage.
- ▶ Immediately remove any objects jammed under the floor of the vehicle. These can damage the vehicle or ignite and cause a fire.

Parking the vehicle safely

A vehicle that has not been secured may roll away and cause accidents.

- ▶ For parking, look for a place with suitable ground. Do not park the vehicle on flammable materials such as dried leaves, spilt fuel. Hot vehicle parts can cause a fire.

Carry out the following activities in the specified order when parking.

- › Stop the vehicle and keep the brake pedal depressed.
- › Secure the vehicle with the parking brake.
- › For vehicles with an automatic gearbox, put the selector lever in the **P** position.
- › Turn off the engine.
- › For vehicles with manual transmission, engage 1st gear or reverse gear.
- › Release the brake pedal.

Exiting the vehicle

Do not leave children unattended in the vehicle!

- ▶ Children may injure themselves when handling the seats, releasing the parking brake etc.
- ▶ In emergency situations, children are not able to leave the vehicle on their own or help themselves.
- ▶ At very high or very low temperatures, there is danger to life!

- ▶ When locking the vehicle, the SAFE function switches on. As a result, no doors or windows can be opened from the inside. Turn off the SAFE function if people are left behind in the locked vehicle » page 23.

Emergency call

⚠ WARNING

Availability of a mobile network is indispensable for establishing a connection to the emergency number.

⚠ WARNING

This emergency service is only available in some countries.

⚠ WARNING

If the vehicle is located in an area without a functioning emergency call system infrastructure, no vehicle data shall be transmitted to the emergency call centre.

After the start of the conversation, the emergency call centre also contains information as to the accident location and the severity of the accident, the number of occupants with seatbelts on and the vehicle identification number (VIN).

Once the connection has been established, communication with the emergency call centre takes place via the loudspeaker and microphone installed in the vehicle.

Personal data

Personal customer data is collected, processed and used by ŠKODA AUTO in accordance with the provisions of the generally binding legal provisions in the area of personal data protection.

The current declaration on the protection of personal data can be found on the following website: <https://www.skoda-auto.com/other/personal-data>.

Serious accident - automatic call

In the event of an accident where the airbag or belt tensioner activates, a call is automatically started with the emergency call centre.

Minor accident - call option

The Infotainment screen displays the option to set up a connection to the emergency call centre or breakdown service.

Manual call



- ▶ Keep the SOS key pressed down.
- ▶ Confirm the connection to the emergency call centre in the Infotainment screen.
- ▶ To cancel the connection to the emergency call centre before starting the call, press the SOS button again or

confirm the cancellation of the connection in the Infotainment screen.

Starting a manual conversation can then be used, for example, if you also report an accident in which you are not directly involved.

Indicator light



The system state is displayed after the ignition is switched on by the warning light **A** illuminating.

- ▶ Green - lit up - the system is functional.
- ▶ Green - flashing - a call is being made to the emergency call centre.
- ▶ Red - lit up - there is a system failure, immediately seek the help of a specialist garage.
- ▶ Not lit up - the system is out of order due to a long term unavailable mobile network, if this circumstance persists, the system will require the assistance of a specialist garage.

⚠ WARNING

If there is a system fault, no emergency call is possible.

After an accident

What to do after an accident

Where possible, please observe the following instructions.

- ▶ Switch off the ignition.
- ▶ Turn on the hazard warning lights.
- ▶ Set up the warning triangle to warn other road users.
- ▶ Stay at a safe distance from the vehicle.
- ▶ Report the accident to the emergency services. If the vehicle has a high-voltage battery, inform the emergency services.
- ▶ Wait for the emergency services to arrive.

i If the airbags or the belt tensioners trigger in the event of an accident, the high-voltage system is automatically deactivated at the same time.

Safety systems

After an accident, the safety systems of the vehicle, e.g. seatbelts and airbag system, may be out of action.

- ▶ Have the vehicle's safety systems checked by a specialist garage, even if no load or trip has occurred.
- ▶ Have damaged, loaded or triggered components of the safety systems replaced by a specialist garage.

What to do in the event of a fire

Where possible, please observe the following instructions.

- › Switch off the ignition.
- › Turn on the hazard warning lights.
- › Set up the warning triangle to warn other road users.
- › Stay at a safe distance from the vehicle.
- › Report the fire to the emergency services. If the vehicle has a high-voltage battery, inform the emergency services.
- › Wait for the emergency services to arrive.

⚠ WARNING

- ▶ Do not try to extinguish the fire yourself.
- ▶ Do not stand close to the burning vehicle.

Keys, locks and alarm system

Key

Key Overview



- 🔒 Locking the vehicle
- 🔓 Operate the boot lid
- 🔓 Unlocking the vehicle
- A** Battery status warning lamp
- B** Locking tab for removal of the key bit

ⓘ NOTICE

- ▶ Protect the key from moisture and strong vibrations.
- ▶ Keep the grooves in the key clean.

ⓘ The effective range of the key is about 30m. The effective range of the key can be reduced, e.g. due to signal interference from other transmitters.

Remove the key bit



- ▶ Unlock the securing tab **A**.
- ▶ Remove the key bit **B**.



Troubleshooting

The battery in the key is almost empty

- ▶ After pressing a button on the key, the warning light does not flash.

Or:

- ▶ A message stating it is necessary to change the battery will be displayed.

- ▶ Replace the battery » page 22.

The vehicle cannot be unlocked or locked with the remote control

There may be the following reasons.

- ▶ The battery in the key is empty.
- ▶ Replace the battery » page 22.
- ▶ The key is not synchronized.

Synchronize the key as follows.

- ▶ Press one of the buttons on the key.
- ▶ Unlock the door within 1 minute with the key via the locking cylinder » page 24.

ⓘ If necessary, the key must be synchronized if one of the buttons on the key has been repeatedly pressed outside of the effective range of the remote control.

Changing the key battery

The new battery must comply with the specification of the original battery.



- ▶ Remove the key bit.
- ▶ Insert a small flat-head screwdriver into the resulting opening.
- ▶ Loosen the battery cover by turning the screwdriver.



- ▶ Slide on the battery cover.



- ▶ Remove the battery.
- ▶ Press any button on the remote key to reset the key.
- ▶ Insert the new battery.
- ▶ Fit the battery cover and press until it clicks into place.

Central locking

Functionality

Central locking system

The system simultaneously unlocks and locks all doors, the charging socket cover and the luggage compartment door.

Unlock indicator: double flashing of the indicator lights.

Lock indicator: single flashing of the indicator lights.

The warning light in the driver's door will flash for about 2 seconds in quick succession after the vehicle is locked, then it will start flashing regularly at longer intervals.

I If none of the doors or the boot lid is opened within 45 seconds of unlocking, the vehicle automatically locks again.

SAFE function

Depending on the equipment, the SAFE function can be integrated into the central locking system.

The SAFE function prevents the doors from opening from the inside once the vehicle is locked.

The SAFE function switches on when the vehicle is locked.

In the display of the instrument cluster after the ignition is switched off, a message regarding the SAFE function is displayed.

⚠ DANGER

Risk of death!

▶ When the vehicle is locked and the SAFE function is switched on, nobody is allowed to remain in the vehicle.

Turn off the SAFE function

▶ By double locking within 2 seconds.

Or:

▶ Together with the deactivation of the interior monitoring » [page 25, Settings](#).

The warning light in the driver's door will flash for about 2 seconds in quick succession after the vehicle is locked, then goes out and starts flashing regularly at longer intervals after about 30 secs.

When the SAFE function is switched off, the door can be opened from the inside by pulling once on the opening lever.

The SAFE function is switched on again after unlocking and locking the vehicle.

Operation

Ways in which central locking operates

Depending on the equipment:

- ▶ Key. » [page 22](#)
- ▶ Keyless locking (KESSEY). » [page 24](#)
- ▶ Central locking button.

Lock/unlock using the central locking button

▶ Press the  button in the centre console.

The  symbol in the button comes on when locked.

The button locks all of the doors and the boot lid.

The vehicle is also unlocked when a door is opened from the inside.

⚠ WARNING

A locked vehicle with a central locking button makes it difficult for responders to enter the vehicle in an emergency.

Setting the unlocking and locking function

The lock and unlock functions are set in the following menu in the Infotainment system.

CAR >  > 

Or:

MENU >  >  > 

All doors

Unlocking of all doors, the boot lid and the battery charging flap.

Single door

Using the  button on the key, the driver's door and the battery charging flap are unlocked.

In vehicles equipped with a keyless locking system, the door near to which the key is located and the battery charging flap are unlocked by touching the door handle.

When unlocked again, the other doors and the boot lid are unlocked.

Doors on one side of the vehicle

Using the  button on the key, the doors on the driver's side and the battery charging flap are unlocked.

In vehicles equipped with a keyless locking system, the doors on the passenger's side near to which the key is located and the fuel filler flap are unlocked by touching the door handle.

When unlocked again, the other doors and the boot lid are unlocked.

Automatic locking after starting

After starting, all doors and the boot lid are locked when a speed of 15 km/h is reached.

The vehicle is unlocked when a door is opened from the inside.

⚠ WARNING

An automatically locked vehicle makes it difficult for responders to enter the vehicle in an emergency.

Troubleshooting

Central locking fault

- › The warning light in the driver's door first flashes for 2 secs in quick succession.
- › Then it lights up continuously.
- › After 30 secs, it flashes slowly.
- › Seek the help of a specialist garage.

Mechanically unlocking and locking the door

Unlocking and locking the door with the lock cylinder



- Remove the cover
- › Pull on the door handle of the vehicle and hold it.
 - › Insert the key bit into the recess on the underside of the cover.
 - › Lift the cover in the direction of the arrow.
 - › Release the door handle.



- Locking and unlocking
- › Insert the removed key bit with the handle facing **downwards** into the lock cylinder and unlock or lock it.

- Install cover
- › Pull on the door handle and hold it.
 - › Replace the cover.

- › Release the door handle.

Locking the door without the lock cylinder



- › Open the door.

- › For vehicles with a panel over the opening, remove the panel.
- › Insert the key or a flat-head screwdriver into the slot.
- › Turn the key or flat-head screwdriver towards the outside of the vehicle (spring-loaded position).

After closing, the door is locked.

Keyless locking (KESSY)

Usage

The keyless locking system, KESSY, enables unlocking and locking of the vehicle without actively using the remote control key.

Operation

Keep the key with you when unlocking and locking.

The sensors on the handle are intended to be operated with bare hands, e.g. wearing gloves may affect the function of the sensors.

Unlocking



- › Grab the door handle.
- › Open the door.

Lock



- › Touch the sensor.
- After locking, it is not possible to unlock within 2 seconds by touching the door handle. This can be used to check whether the vehicle is locked.

Unlocking the boot lid

- › Press the handle of the boot lid.

Protection against inadvertently locking the key in the vehicle

If the key is locked inside the vehicle, the vehicle will unlock itself automatically. If no door is opened within 45 seconds, the vehicle automatically locks again.

If the key is locked in the luggage compartment, the luggage compartment lid will automatically unlock itself.

Deactivate keyless locking

- › Lock the vehicle with the button  on the key.
 - › Within 5 s, touch the sensor on the door handle with your finger.
- Deactivation is confirmed by a single flash of the direction indicators.
- › To check the deactivation, wait at least 10 seconds and then pull the door handle.

The door must remain locked.

Keyless locking is automatically activated once again after the vehicle is unlocked.

Troubleshooting

The vehicle cannot be unlocked or locked using the sensors on the handle

- › Lock or unlock the vehicle with the button on the key.
- › Then try to unlock or lock the vehicle using the sensors on the handle.
- › If keyless locking does not work, seek the help of a specialist garage.

Alarm system

Functionality

The alarm system triggers audible and visual signals during a break-in or towing attempt.

The alarm system is activated automatically approximately 30 seconds after the vehicle is locked.

The alarm system is automatically deactivated after the vehicle is unlocked.

Alarm triggering

The activated alarm system triggers an alarm when one of the following events occurs.

- ▶ Opening the bonnet.
- ▶ Opening the boot lid.
- ▶ Opening the door.
- ▶ Manipulation of the ignition lock.
- ▶ Towing the vehicle.
- ▶ Movement in the vehicle.
- ▶ Sudden and significant voltage drop of the electrical system.
- ▶ Uncoupling the trailer.
- ▶ Opening the door unlocked via the lock cylinder.

Switching off the triggered alarm

- › Unlock the vehicle.

Or:

- › Turn on the ignition.

Operating conditions

For the correct functioning of the alarm system, all windows must be closed.

A trailer is integrated into the alarm system under the following conditions.

- ✓ The vehicle is factory-fitted with a towing device.
- ✓ The trailer is electrically connected to the vehicle via the trailer socket.
- ✓ The trailer is not equipped with LED taillights.

If the electrical connection to the trailer is interrupted on a vehicle with an activated alarm system, warning signals are triggered.

-  Disable the alarm before connecting or disconnecting a trailer.

Settings

The following functions of the alarm system can be deactivated at the same time.

- ▶ Interior monitoring.
- ▶ Towing protection.

Deactivation will also switch off the SAFE function » [page 23, Functionality](#).

Deactivation

- ▶ By double locking within 2 seconds.

Or:

- ▶ In Infotainment, in the **CAR** >  >  > menu item for interior monitoring.

Or:

- ▶ In Infotainment, in the **MENU** >  >  > menu item for interior monitoring.

The deactivated functions are reactivated after the vehicle is unlocked and locked again.

-  Deactivation is to be carried out if the vehicle is, for example, towed or transported.

Doors, windows and boot lid

Doors

Opening/closing the door

Opening from the outside



- › Unlock the vehicle and pull on the door handle.

Opening from the inside



- › Pull the door opening lever and push the door away from you.

Closing from the inside

- › Grasp the pull handle and close the door.

Child safety lock on the rear doors

Operation

The child lock prevents the rear doors from being opened from the inside.

Switching on and off



- › Turn the fuse with the vehicle key or a flat-head screwdriver.

A Child lock switched off

B Child lock switched on

Electrically operated fuse



- › Press the **left** button to switch on/off the fuse in the **left** rear door.
- › Press the **right** button to switch on/off the fuse in the **right** rear door.

The fact that the fuse is switched on can be seen by the illuminated  displayed in the button.

The fact that the fuse is switched on can be seen by the illuminated  displayed in the button.

Window - with electrical operation

What you should be mindful of

Force limiter

To reduce the risk of pinch injuries when closing the windows, the vehicle has a force limiter.

If there is an obstacle, the window closing process is stopped and the pane retracts by several centimetres.

If the obstacle prevents it from being closed for the next 10 seconds, the closing process is interrupted once again and the window goes down by several centimetres.

If you attempt to close the window again within 10 seconds of the window being moved down for the second time, even though the obstacle was not yet removed, the closing process is only stopped. During this time, it is not possible to automatically close the windows by pulling the button all the way. The force limiter is, however, switched on.

The force limiter is only not operational if you attempt to close the window again within the next 10 seconds – the window will now close with full force! If you wait longer than 10 seconds, the force limiter is switched on again.

⚠ CAUTION

Risk of injury!

- › Close the windows carefully, even though they have a force limiter.

Overview of the operating buttons on the driver's door



Depending on the equipment:

- A** Window on the front left
- B** Window on the front right
- C** Rear left window
- D** Rear right window
- E** Deactivation/activation of the buttons in the rear doors
- F** Deactivation/activation of the key in the left rear door (part of the child safety lock with electric operation)
- G** Deactivation/activation of the key in the right back door (part of the child safety lock with electric operation)

Operation

To open

- › Press the corresponding button slightly downwards and hold it until the window has reached the desired position.

Or:

- › Press the corresponding button until it stops; the window opens automatically. Pressing the button again will stop the opening process.

Closing

- › To close, pull gently upwards on the top edge of the corresponding button and hold until the window has reached the desired position.

Or:

- › Pull the corresponding button until it stops; the window closes automatically. By pressing the button again, the closing process is stopped.

I After switching off the ignition, the windows can still open and close for about 10 minutes so long as none of the doors are opened.

Open all of the windows at the same time

- › Press and hold the button on the key.

Or:

- › Turn off the ignition, open the driver's door, and hold down the driver's window button until it stops.

I Depending on the setting, only the driver's window can be opened in this way.

Close all of the windows at the same time

- › Press and hold the button on the key.

Or:

- › Turn off the ignition, open the driver's door, and pull upwards on the driver's window button until it stops.

Or:

- › For vehicles with a keyless locking system, hold one finger on the sensor on the outside of the handle on the front door.

I Depending on the setting, only the driver's window can be closed in this way.

Settings

The window operation is set in the following menu in the Infotainment system.

CAR > > > Menu item for window operation

Or:

MENU > > > > Menu item for window operation

Troubleshooting

The window regulator has stopped working after repeated opening and closing

The window regulator mechanism could have overheated.

- › Allow the window regulator mechanism to cool down.

The automatic window operation does not work after disconnecting the vehicle battery

- › Enable automatic window operation » [page 27](#).

Activation after disconnecting the vehicle battery

Activate automatic window operation

- › Turn on the ignition.
- › Pull the corresponding button upwards and the window closes.
- › Release the button.
- › Pull up the respective button and hold for 1 second.

Sliding/tilting roof

What you should be mindful of

Force limiter

To reduce the risk of pinch injuries when closing the tilt/slide sunroof, the vehicle has a force limiter.

If there is an obstacle, the glass panel closing process is stopped and the pane retracts by several centimetres.

If the obstacle is not removed, the force limiter will be disabled during the third closing attempt. The sliding/tilting roof will then close with full force.

⚠ CAUTION

Risk of injury!

- ▶ Close the sliding/tilting roof carefully, even though there is a force limiter.

📌 NOTICE

- ▶ During winter time, if necessary, remove any ice and snow around the area of the sliding/tilting roof before opening.
- ▶ Always close the sliding/tilting roof before disconnecting the battery.

Operating conditions

- ✓ The ignition is switched on.
- ✓ The temperature is higher than -20 °C.

Operation



- A** Gradual opening
- B** Complete opening
- C** Gradually reset
- D** Fully reset



- A** Gradual opening
- B** Full opening
- C** Gradual closing
- D** Complete closing

📌 After moving the switch to the position **B** the sliding/tilting roof is in the low-noise position (at a speed of about 80 km/h).

After another movement to position **B** the sliding/tilting roof opens completely.

📌 After switching off the ignition, the sliding/tilting roof can still open and close for about 10 minutes so long as none of the doors are opened.

Comfort operation of the tilting/sliding sunroof

The comfort operation makes it possible to lock the sliding/tilting roof with the key if necessary.

- › Press and hold the button to **turn it off**.
- › Press and hold the button to **close it**.

On vehicles with a keyless locking system, it is possible to **close** the sliding/tilting roof via the sensor in the door handle of the front door.

- › Hold one finger on the sensor on the outside of the handle on the front door.

Troubleshooting

Operation of the sliding/tilting sunroof does not work after disconnecting the vehicle battery

- › Activating operation of the sliding/tilting sunroof » [page 28](#).

Activation after disconnecting the vehicle battery

Activating operation of the sliding/tilting sunroof



- › Turn on the ignition.
- › Pull the switch all the way down and hold it down.

After about 10 secs, the sliding/tilting roof opens and closes again.

- › Release the switch.

Sunblind - with manual operation

Operation



- › Pull the handle in the appropriate direction.

Sunblind - with electrical operation

Operation



- To open
- To close

- › Press or hold the button to **move** the roller blind.
- › Press or release the button to **stop** the roller blind from moving.

Activation after disconnecting the vehicle battery

- › Turn on the ignition.
- › Keep the key pressed down. The sunblind opens and closes again.
- › Release the button.

Sunblind for the rear window

Operation



Brightness protection

- › Pull out the sun protection blind by the handle and hang it into the holders **A**.

Rolling up

- › Remove the sun protection blind from the holders at the handle and let it roll in slowly.

Sun protection roller blinds for the rear door panes

Operation



Brightness protection

- › Pull out the sun protection blind by the handle and hang it into the holder **A**.

Rolling up

- › Remove the sun protection blind from the holder at the handle and let it roll in slowly.

Sun visors

Folding up and folding down



- 1 Swivel the front visor towards the windscreen
- 2 Swivel the visor towards the door

Heated windscreen

Usage

Windscreen heating is used for defrosting or ventilating the windscreen.

Conditions

- ✓ The engine is running.

Operation

Heated rear window

- › Press the  key to turn on the heated rear window.

Heated windscreen

- › Press the  key to turn on the heated windscreen.

Windscreen heating switches off automatically after 10 minutes.

Settings



Automatic heated windscreen

The heated windscreen switches on automatically if the windscreen mists up.

This function is set in the following menu in the Infotainment system.

- › Press the key **MENU** on the Climatronic control panel ›, tap  in the Infotainment screen.

Or:

- › Tap on **MENU** ›  ›  in the Infotainment screen.

Troubleshooting

The indicator light in the button or below the button flashes

The heating does not work as the battery charging level is low.

Boot lid - with manual operation

Operation

To open



- › Press the handle and lift the lid.

The option to open by pressing the handle is deactivated once a speed of 5 km/h is reached. This is activated again after the vehicle has stopped and a door is opened.

Closing



- › Grasp the fixture **A** and pull the lid down.

⚠ CAUTION

Danger of opening the lid while driving!

- › Ensure that the lock is properly engaged after closing the lid.

Set a delayed lid lock

If the lid is unlocked with the  button on the key, the lid is automatically locked again after closing.

The period after which the lid is locked automatically can be extended by a specialist garage.

Boot lid - with electrical control

Operation

⚠ CAUTION

Risk of injury!

- › Only operate the flap when there is nobody or no objects in the swivel area.

⚠ CAUTION

Danger of opening the lid while driving!

- › Ensure that the lock is properly engaged after closing the lid.

ⓘ NOTICE

- › Do not manually close the tailgate when moving.
- › Before operating the tailgate, check that there are no objects in the swivel area that could damage the tailgate. Also check that there are no objects within the immediate vicinity of the vehicle that could damage the vehicle interior and the transported objects.

I If the tailgate hits an obstacle when closing, it stops and an audible signal sounds.

I When automatically closing the tailgate, e.g. under the weight of snow, a broken beep sounds.

Handle in the tailgate

- › Press the handle to open, close or stop the movement of the tailgate.

The option to open by pressing the handle is deactivated once a speed of 5 km/h is reached. This is activated again after the vehicle has stopped and a door

is opened.

Button in the tailgate

- › Press the button to open, close or stop the movement of the tailgate.

Button in the centre console

- › To open the tailgate, hold the button until the tailgate starts to open.
- › Press the button to stop the tailgate from moving.

Button on the key

- › Press the  button to open, close or stop the movement of the tailgate.

The option to lock exists only on vehicles with a keyless locking system. The key must not be in the vehicle and must be at a distance of max. 2 m from the tailgate.

I The tailgate can also be closed by pulling it briefly downwards.

Settings**Set the uppermost position of the tailgate and store it**

It makes sense to set the top position of the tailgate, e.g. setting for the opening of the tailgate in a limited space due to the garage height.

- › Stop the lid in the desired position.
- › Press the  button and hold down on the lower edge of the tailgate until an audible signal sounds.

Re-adjusting the top starting position of the lid

- › Carefully raise the flap manually to the limit.
- › Press the  button and hold down on the lower edge of the tailgate until an audible signal sounds.

Troubleshooting**The tailgate does not react to the opening signal**

- › There is a possible obstacle, e.g. snow; remove it.

Or:

- › Press the handle in the tailgate and lift the lid.

Or:

- › Mechanically unlock the flap » page 32.

The tailgate does not react to the closing signal

- › Close the tailgate manually.

! NOTICE

- ▶ Close the tailgate slowly, push down the tailgate and push in the lock on the centre of the rear edge of the tailgate.

Electrically operated contactless boot lid**Operating conditions**

- ✓ Ignition switched off.
- ✓ You have the vehicle key with you.
- ✓ No trailer or other accessory is connected to the trailer socket.

Operation

Opening/closing the lid



- › Quickly swing a foot under the rear bumper in the sensor area.

If the lid doesn't move, wait a few seconds and repeat the swing motion.

Closing display

When you close the lid, audible signals are sounded.

Stopping/ restoring lid movement

The lid movement can be stopped by a rapid swinging motion with your foot. Lid movement is restored by a subsequent swinging motion with your foot.

Restriction

The system function may be restricted in the following cases.

- ▶ Downpour.
- ▶ Dirty rear bumper.

Settings

Activating and deactivating

The function is activated and deactivated in the following menu in the Infotainment.

CAR >  > 

Or:

MENU >  >  > 

We recommend that the function is deactivated in the following cases:

- ▶ Installation of a roof rack.
- ▶ Coupling a trailer or another accessory to the hitch.
- ▶ Car wash.
- ▶ Maintenance and repair work in the back of the vehicle.

Unlocking the boot lid

Unlocking

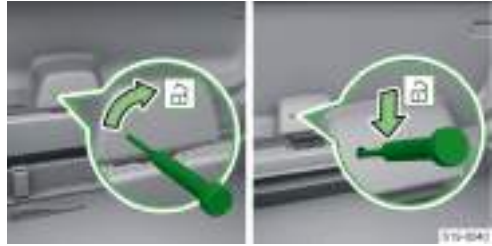

- › Insert a screwdriver into the opening in the panel.
- › Release the flap by moving it in the direction of the arrow.

Seats, steering wheel and mirror

Front seat - with manual operation

Controls on the seat



- A** Adjusting the seat in the longitudinal direction - after releasing the operating lever, the lock must audibly click into place
- B** Adjusting the height
- C** Adjusting the angle of the backrest - do not lean against the backrest during adjustment
- D** Adjusting the extent of the curvature of the lumbar support

After a certain time, play can develop within the adjustment mechanism of the backrest angle.

Folding passenger seat backrest

Folding down



- › Pull on the operating lever.
- › Fold the backrest forwards until it clicks into place.

Folding back up

- › Pull on the operating lever.
- › Press the backrest backwards until it audibly clicks into place.

Front seat - with electrical operation

Controls on the seat

Adjusting the seat

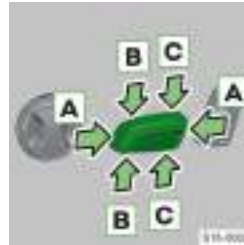

- A** Adjust in a longitudinal direction
- B** Adjust the inclination
- C** Adjusting the height

Adjusting the seat back

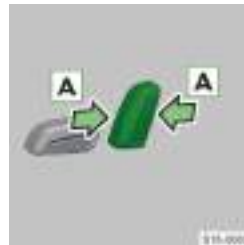

- A** Adjust the inclination

Adjusting the lumbar support

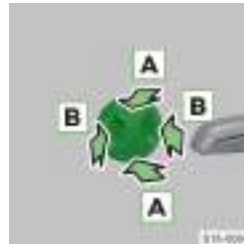

- A** Set the position of the curvature
- B** Set the extent of the curvature

Adjusting the passenger seat from the rear seats



- A** Adjusting the angle of the seat backrest
- B** Adjusting a seat in a forward/back direction

Set the length of the seat manually



- › Press the release handle.
- › Push the front part of the seat forwards or backwards.

Memory function of the seat

Functionality

Valid for vehicles with electrically adjustable driver's seat.

Each of the memory buttons on the driver's seat can be used to store and recall the set driver's seat and exterior mirror position.

Depending on the equipment, the front passenger seat may also have a memory function.

Operation

Retrieve stored position

- › With the ignition off and the driver's door open, **press** the desired memory button.
- › In other instances, **hold** the key for example with the ignition switched on or the driver's door closed.

The passenger seat position can be retrieved in the same way.

Stop position change

- › With the ignition off and the driver's door open, **press** any button on the seat to be adjusted.

Or:

- › Press the  button on the key.
- › In other cases, **release** the held memory button.

Settings

Storing driver's seat and exterior mirror position for driving forwards



- › Turn on the ignition.
- › Adjust the seat and the exterior mirrors.
- › Press the button **A** and within 10 seconds one of the memory buttons **B**.

Storing is confirmed by an acoustic signal.

i The seat position can be stored if the angle of inclination of the seat back relative to the seat surface is less than approximately 110° and the seat is not in any of the end positions.

Save front passenger seat position

Storing the passenger seat position is analogous to storing the driver's seat position.

Storing front passenger's exterior mirror position for reversing

- › Turn on the ignition.
- › Activate the folding function of the mirror in the Infotainment in the following menu.

CAR >  >  > 

Or:

MENU >  >  > 

- › Turn the exterior mirror knob to the position **R**.
- › Engage reverse gear.
- › Adjust the mirror to the desired position.
- › Disengage reverse gear.

The set mirror position is saved.

i When changing the stored seat and exterior mirror position for forward driving, the passenger exterior mirror position for reverse driving must be restored.

Massage function in the driver's seat

Turn on/turn off



- › Press the  button.

Function switches off automatically after 10 minutes.

⚠ CAUTION

- ▶ Only switch the function on and off when the vehicle is stationary.

Rear seats

Folding down the seat backs

Before folding down

- ▶ Insert the rear headrests as far as they will go or remove them.
- ▶ Adjust the position of the front seats in such a way that they are not damaged by the folded-down seat backrests.
- ▶ For vehicles with a mesh partition, roll it into the housing, then unlock the left seat backrest followed by the right seat backrest.
- ▶ Pull the outer seat belt to the side trim.

Folding forwards from the passenger compartment



- ▶ Press the release handle and fold the seat forwards.

Folding forwards from the luggage compartment



- ▶ Pull on the lever.
The seat back is unlocked and partly folded forwards.

Folding back up

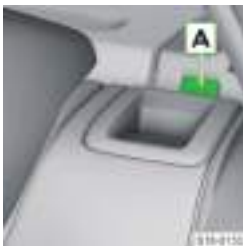

- ▶ Pull the outer seat belt to the side trim.
- ▶ Fold the seat backrest back up.
The release handle must audibly click into place.
- ▶ Check that the seat backrest has locked in place. The pin **A** must not be visible.

Headrests

Adjusting the height of the headrests

Front headrests

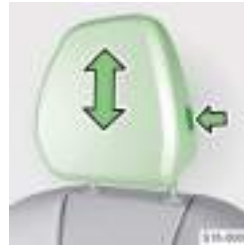

- ▶ Hold the safety button and move the headrest in the desired direction.

Rear headrests



- ▶ Move the headrest in the desired direction.
When pushing down, press and hold the safety button.

Folding side bolsters on the rear headrest



- The folded down side bolsters reduce uncontrolled sideways head movement, e.g. when sleeping.
- ▶ Adjust the headrest to the initial pulled out position.
 - ▶ Fold down the side bolsters on the headrest.

Removing and inserting the rear headrests

Removing



- ▶ Partially fold the respective seat back forwards.
- ▶ Move the headrest up to the stop.
- ▶ Hold safety button **A** and, at the same time, push safety button **B** into the opening with a flat-head screwdriver

and remove the headrest.

Inserting

- ▶ Insert the headrest into the seat backrest.

The safety button must click into place.

Front armrest

Settings



- Adjusting the height
- › Raise the backrest to one of the locked positions.
- Folding down
- › Raise the backrest beyond the highest locked position and fold it down again.

Rear armrest

Settings



- › Fold down the armrest.
- The folded-down armrest can be used as a storage table.

Load-through device

Open and close

Open from the passenger compartment



- › Fold down the armrest.
- › Press the lid in the upper area and pull on the handle.
- › Open the lid.

Open from the luggage compartment



- › Press the store button.
- › Open the lid.

To close

- › Fold back the lid from the passenger compartment until it clicks into place.

After closing, the red mark on the back of the cover above the safety button must not be visible.

⚠ WARNING

- ▶ The through-loading channel is only intended for transporting skis in a secured through-loading bag.

Seat heating and ventilation

What you should be mindful of

⚠ WARNING

Risk of burns!

- ▶ Do not switch on the seat heater for persons with limited perception of pain or temperature.

① NOTICE

Risk of seat damage!

- ▶ Do not kneel on the seats or otherwise puncture them.
- ▶ Do not turn on the heater in the following situations.
 - ▶ The seat is not occupied.
 - ▶ There are objects on the seat, such as a child seat.
 - ▶ There are additional seat covers or protective covers on the seat.

Conditions

- ✓ The engine is running.

Operation

Depending on the equipment, the front seats can be heated or heated and ventilated. The outer rear seats can only be heated.

Models without seat ventilation

- › Press the or key to switch on the seat heating.

The seat heating is switched on with maximum heating output. By repeatedly pressing the button, the heating output is reduced until it is switched off.

The heat output is determined by the number of illuminated indicator lights that are shown in the key or in the Climatronic display.

Models with seat ventilation

- › Press the  or  button.

The Infotainment screen displays a menu for operating the front seat heater and ventilation.

- › Adjust the heating output/ventilation level.



i If the seat heating and ventilation functions are both switched on at the same time, the heating output/ventilation level can only be adjusted in the Infotainment screen.

Display heating output/ventilation level from the button



- - - Seat heating switched on
- - - Seat ventilation switched on
- - - Seat heating and ventilation switched on

Settings

Lock increases in heat output for the rear seat heater

- › To turn the function on or off, press the **MENU** button on the Climatronic \rightarrow /  in the Infotainment screen.

Or:

- › Tap on **MENU** \rightarrow  \rightarrow /  in the Infotainment screen.

When the function is switched on, the heating output can only be turned down.

Steering wheel

Adjust the steering wheel

⚠ WARNING

Risk of an accident!

- ▶ Do not adjust the steering wheel while driving.



- › Swing the safety lever downwards.



- › Adjust the steering wheel to the desired position.





- › Press the safety lever as far as it will go.

Troubleshooting

Power assisted steering faulty

 illuminates - total failure of the power assisted steering, failure of steering assistance

- › Turn off the ignition, start the engine and drive a few meters.
- › If the  indicator light does not go out, stop driving. Seek the help of a specialist garage.

 illuminates - partial failure of the power assisted steering, possible reduction in power steering

- › Turn off the ignition, start the engine and drive a few meters.
- › If the  indicator light does not go out, continue driving, exercising appropriate caution. Seek the help of a specialist garage.

Steering column lock faulty

 flashing
Message regarding a fault in the steering column lock

- › Stop the vehicle.
- › Seek the help of a specialist garage.

After switching off the ignition, it is then no longer possible to switch on the ignition, to lock the steering and to switch on the electrical components.

 flashing
Message regarding a fault in the steering lock

- › You may continue driving, exercising appropriate caution. Seek the help of a specialist garage.

Steering column lock not unlocked

 flashing
Message concerning the required steering wheel movement

- › Move the steering wheel slightly back and forth.
- › If the steering does not unlock, stop the vehicle and seek the help of a specialist garage.

Heated steering wheel

Conditions



- ✓ The engine is running.

Operation

Applies to Climatronic.

- › Press the **MENU** button on the Climatronic ›, tap the  Infotainment screen to turn on steering wheel heating.

Or:

- › tap **MENU** ›  ›  in the Infotainment screen to turn on steering wheel heating.

Adjust the heating output of the heated steering wheel

- › Tap  › Heated steering wheel on the Infotainment screen to adjust the heating level.

The output level of the heating is indicated by the number of illuminated warning lights in the  switch.

Settings



Steering wheel heating together with driver's seat heating

Applies to Climatronic.

When the function is switched on, pressing the button for the driver's seat heating also turns steering wheel heating on or off.

- › Press the **MENU** button on the Climatronic in the ›  Infotainment screen and select the menu item for coupling the seat and steering wheel heating.

Or:

- › Tap on **MENU** ›  ›  in the Infotainment screen and select the option for the coupling of the seat and steering wheel heating.

When the function is switched on, the function surface  is displayed in the Infotainment screen. This can be used to switch steering wheel heating on or off.

Interior rear-view mirror

Operation

Interior mirror with manual darkening



- A** Mirror is not darkened
- B** Mirror darkens

Interior mirror with automatic darkening

Darkening of the mirror is automatically controlled through the sensors in the mirror once the engine is started.

⚠ CAUTION

Risk of an accident!

A glowing display e.g. a mobile phone or navigation device may affect the function of the automatic mirror darkening.

- ▶ Do not attach these devices close to the mirror.



Exterior mirror

Operation

Positions of the rotary knob

The mirrors can be folded manually or electrically, depending on the equipment.



- L** Adjust the left mirror
- 0** Switch off operation
- R** Adjust the right mirror
-  Fold mirror in electrically (to fold back out, select a different position)
-  Heat the mirror

when the engine is running

Adjusting the mirror surface

- › Select position **L** or **R**.
- › Turn the rotary knob in the direction of the arrows.

Folding electrically folding mirrors automatically

The mirrors fold in when the vehicle is locked and fold back out when the vehicle is unlocked, if this feature is activated.

[!] Locking of the vehicle is not indicated by the fact that the mirrors fold in. Locking of the vehicle is indicated by the turn signal lights flashing.

Manually foldable mirrors

- › Fold the mirror towards the side window by applying pressure with your hand.

Setting the mirror surfaces synchronously

When adjusting the mirror surface of the driver's mirror, the mirror surface of the front passenger's mirror is adjusted at the same time if this function is activated.

Mirror with memory function

Valid for vehicles with electrically adjustable driver's seat.

The current setting for the exterior mirror surfaces can be stored in the memory of the driver's seat » [page 34](#).

Lower the passenger mirror surface when reversing

Valid for vehicles with electrically adjustable driver's seat.

The mirror surface of the passenger mirror takes in the memory of the driver's seat » [page 34](#) stored position to improve visibility when reversing.

Conditions

- ✓ The function can be activated in Infotainment.
- ✓ The mirror position is saved.
- ✓ The reverse gear is engaged.
- ✓ The adjustment knob is in the **R** position.

The mirror automatically resumes the home position when driving forward at speeds above 15 km/h or after the ignition is switched off.

⚠ WARNING

Risk of an accident!

The exterior mirrors make objects appear farther away.

- ▶ Use the rear-view mirror to determine the distance from vehicles behind.

ⓘ NOTICE

Danger of mirror damage!

- ▶ If the electrically foldable mirror is swung out by external influences (e.g. due to an impact during manoeuvring), fold the mirror in using the rotary knob and wait for an audible folding sound.

Settings

Activation or deactivation of the automatic folding of the exterior mirrors, the synchronous adjustment of the mirror surfaces as well as the lowering of the passenger-side mirror surface when reversing are carried out in the Infotainment in the following menu.

CAR >  > 

Or:

MENU >  >  > 

Troubleshooting**Electric mirror operation impaired**

- ▶ Adjust the mirror surface by pressing it lightly with your finger.

⚠ CAUTION

Risk of burns!

- ▶ Do not touch heated exterior mirror surfaces.

Restraint systems and airbags

Seat belts

Functionality

Seat belts that are fastened correctly offer very good protection in the event of an accident. They reduce the risk of an injury and increase the chance of survival in the event of a major accident.

⚠ WARNING

- ▶ The seat belts must not be removed or altered in any other way.
- ▶ Do not attempt to repair the seat belts yourself. Have a damaged seat belt replaced immediately by a specialist garage.

Automatic belt retractor

The automatic belt retractor locks the belt when the belt is pulled jerkily or when the belt is being rolled up violently.

⚠ WARNING

If the seat belt does not lock when pulled jerkily, have the retractor checked by a specialist garage.

Belt tensioners

The safety of the driver, front passenger and passengers on the outer rear seats **who are wearing their seat belts** is enhanced by the belt tensioners fitted to the inertia reels on the front and rear external seat belts.

If there is a collision with a certain severity, the seat belt is tightened by the belt tensioner so that unwanted body movement is prevented.

The belt tensioner can also be deployed when the seat belt is not fastened.

Belt tensioners are **not activated** in the event of a roll-over, **minor** collisions or in accidents in which no major forces are produced.

☐ Smoke is released when the belt tensioner is deployed. This does not indicate a vehicle.

Reversible belt tensioner

Vehicles with a proactive occupant protection system include reversible belt tensioners › [page 138](#).

The reversible belt pretensioners increase safety for the belted driver and front passenger by automatically tightening the seat belt tightly over the body in critical driving situations and then releasing it again.

Status display in the instrument cluster display



illuminated – a front seat belt is not fastened



illuminated – a rear seat belt is not fastened



illuminated – a rear seat belt is fastened.

Operation

Fastening the seat belt



- ▶ Grasp the buckle latch and slowly pull the belt over the chest and pelvis towards the buckle.
- ▶ Insert the buckle latch into the buckle until there is an audible click.
- ▶ Pull on the belt to ensure that the buckle is securely fastened.

Unfastening the seat belt



- ▶ Grasp the buckle latch and release it by pressing the red button.
- ▶ Hold the belt so it does not twist when rolling up.

Setting



- ▶ Move the seat belt height adjuster upwards to increase the height.



- ▶ Press the safety button and move the seat belt height adjuster down to reduce the height.
- ▶ After adjustment, firmly pull on the belt to ensure that the seat belt height adjuster has correctly locked in place and that the belt is locked securely.

Troubleshooting

Blocked belt retractor



- › Grasp the strap in the middle and pull quickly in the direction of the arrow.
- › Hold the strap and let it roll up slowly.
- › Pull on the strap to see if the retractor is working properly.
- › If the strap is still blocked, repeat the unblocking procedure once or twice.

- › If the strap is still blocked, seek the help of a specialist garage.

Child seat

What you should be mindful of

For how to install and use the child seat, please note the instructions in this Owner's Manual as well as the instructions of the child seat manufacturer.

For safety reasons, we always recommend that children are transported on the back seats. Carry children on the front passenger seat only in exceptional cases.

Child seats according to standard ECE-R 44 the European Economic Commission.

Child seats according to standard ECE-R 44 are marked with the test symbol: large E in a circle, with the test number below.

We recommend using child seats from the ŠKODA Genuine Accessories range. These child seats have been developed and tested for use in ŠKODA vehicles. They meet the standard ECE-R 44.

⚠ WARNING

- ▶ When installing the child seat on the rear seat, adjust the front seat so that there is no contact between the front seat and the child seat or the child carried in the child seat.
- ▶ Before installing a forward-facing child seat, adjust the headrest so that it is as low as possible.
- ▶ If the headrest prevents the child seat from being fitted, adjust the headrest to the highest position.
- ▶ If using a separate child seat cushion, adjust the headrest so that the child's head is flush with, but not protruding above the height of the top edge of the headrest.

Using a child seat on the front passenger seat

Never use a child seat in which the child is carried with his or her back to the direction of travel on a seat protected by an active airbag placed in front of the seat. This could cause serious injury to the child, even death.

This is also indicated by the following stickers.



Sticker on the passenger sun visor.



Sticker on the central body pillar on the passenger side.

The following instructions must be followed when using a child seat on the front passenger seat.

- ▶ When using a rear-facing child seat, the front passenger airbag must be deactivated.
- ▶ If possible, adjust the front passenger seat backrest so that it is vertical, to ensure that there is secure contact between the backrest and the child seat.
- ▶ If possible, move the front passenger seat backwards so that there is no contact between the front passenger seat and the child seat behind it.
- ▶ Adjust the height-adjustable front passenger seat as much as possible.
- ▶ Set the front passenger seat belt as high up as possible.

⚠ WARNING

Risk of the seat belt causing a neck injury to the transported child!

- ▶ For child seats in groups 2 and 3, ensure that the guide fitting attached to the child seat headrest is positioned in front of or at the same height as the seat belt height adjuster on the central body pillar.
- ▶ Adjust the height of the front passenger seat belt so that the belt passes through the guide fitting without kinking and is not bent over the edge of the guide fitting.

42 Restraint systems and airbags › Fasteners for child seats

⚠ WARNING

As soon as the rear-facing child seat is no longer being used on the front passenger seat, activate the front passenger airbag again.

Recommended child seats

Grouping of child seats according to standard ECE-R 44.

| Group | Weight of the child |
|-------|---------------------|
| 0 | up to 10 kg |
| 0+ | up to 13 kg |
| 1 | 9-18 kg |
| 2 | 15-25 kg |
| 3 | 22-36 kg |

Recommended child seats

| Group | Manufacturer | Type | Attachment | Order number | Approval number (E1 ...) |
|-------------------|--------------|-------------------------|-----------------------|--------------|--------------------------|
| 0+ up to 13 kg | Britax Römer | Baby Safe Plus | Isofix base frame | 1ST019907 | 04 301146 |
| 1 9-18 kg | Britax Römer | Duo Plus TT | ISOFIX and TOP TETHER | DDA000006 | 04 301133 |
| 2-3 15-36 kg | Britax Römer | Kidfix XP ^{a)} | ISOFIX | 000019906K | 04 301198 |
| | Britax Römer | Kidfix II XP | ISOFIX | 000019906L | 04 301323 |

^{a)} For optimum protection, especially in the event of a side impact, it is recommended that you use this child seat complete with the backrest.

Fasteners for child seats

Use of child seats

Overview of usability of child seats according to standard ECE-R 16.

Child seats that use the ISOFIX System

| Group | Size category of child seat ^{a)} | Passenger seat with activated front airbag ^{b)} | Passenger seat with deactivated front airbag ^{b)} | Outer rear seats ^{c)} | Middle rear seat |
|-------------------|---|--|--|--------------------------------|------------------|
| 0 up to 10 kg | E | X | X | IL | X |
| 0+ up to 13 kg | E | X | X | IL | X |
| | D | | | | |
| | C | | | | |
| 1 9-18 kg | D | X | X | IL | X |
| | C | | | | |
| | B | | | | |
| | B1 | | | | |
| | A | | | | |
| 2 15-25 kg | - | X | X | IL | X |
| 3 22-36 kg | - | X | X | IL | X |

^{a)} The size category of the child seat is indicated on the child seat plate.

^{b)} If the passenger seat is equipped with ISOFIX system retaining eyes, it is suitable for the installation of an ISOFIX child seat with "Semi-Universal" approval.

^{c)} The seat is suitable for an ISO / R3 fixing.

IL The seat is suitable for the ISOFIX child seats with "Semi-Universal" approval.

X The seat is not equipped with eyelets for the ISOFIX System.

i-Size

| Passenger seat with activated front airbag | Passenger seat with deactivated front airbag | Outer rear seats | Middle rear seat |
|--|--|------------------|------------------|
| X | X | i-U | X |

i-U The seat is suitable for forward- and backward-facing i-Size child seats of the "Universal" category.

X The seat is not suitable for i-Size child seats of the "Universal" category.

Child seat fastened with a safety belt

| Group | Passenger seat with activated front airbag | Passenger seat with deactivated front airbag | Outer rear seats | Middle rear seat ^{a)} |
|-------------------|--|--|------------------|--------------------------------|
| 0 up to 10 kg | X | U ^{b)} | U | U |
| 0+ up to 13 kg | X | U ^{b)} | U | U |
| 1 9-18 kg | UF | U | U | U |
| 2 15-25 kg | UF | U | U | U |
| 3 22-36 kg | UF | U | U | U |

^{a)} It is forbidden to install a child seat with a support foot in the middle rear seat.

^{b)} Adjust the height-adjustable front passenger seat as much as possible.

U The seat is suitable for the child seat category "Universal" and is permitted for use in this weight group.

UF The seat is suitable for forward-facing child seats in the "Universal" category and is permitted for use in this weight group.

X The seat is not suitable for children in this weight group.

Overview

ISOFIX

⚠ WARNING

- ▶ Do not attach any other child seats, straps or objects to the holding eyelets provided for the installation of a child seat using the ISOFIX system.

The ISOFIX system allows for the fast and secure installation of the child seat. The eyelets for installing the child seat using the ISOFIX system are located on the outer rear seats and possibly on the front passenger seat.

A child seat that uses the ISOFIX system can only be installed in the vehicle if it is approved for this vehicle type. Further information can be obtained from a ŠKODA partner or from a list of vehicles enclosed with the child seat.



- ▶ Remove the covers before installing the child seat.

TOP TETHER

⚠ WARNING

- ▶ Child seats that use the TOP TETHER system should only be used on those seats that are fitted with holding eyes bearing the TOP TETHER symbol.
- ▶ Only attach one fastening strap on the child seat to the holding eyelet in the TOP TETHER system.
- ▶ When attaching the child seat with the TOP TETHER system, no other object must be attached to the TOP TETHER system holding eyelet.



Holding eyelets on the rear seats

The belt fastened into the TOP TETHER system restricts the movement of the upper part of the child seat. The holding eyelets for attaching the belt are

located on the outer rear seats **A**, as well as on the middle rear seat **B** when necessary.

Airbags

Usage

The airbag system offers additional occupant protection in the event of severe frontal and side collisions, as a supplement to the seat belts.

The best possible protective effect of the airbag is achieved only when the seat belt is also worn. The airbag system is no substitute for the seat belts.

Functionality

When sinking into the inflated airbag, the forward movement of the body is damped and the risk of injury is reduced.

I As the airbags inflate, smoke is released. This does not indicate a vehicle.

Function condition

- ✓ Ignition is switched on.

Airbag deployment in the event of an accident

Airbag deployment is influenced by many factors. The deceleration rate at the time of impact is crucial.

⚠ WARNING

Danger of serious or fatal injuries!

- ▶ Maintain the correct seating position.
- ▶ Do not keep your limbs in the deployment area of the airbags.

In the following situations, **no** airbags are deployed.

- ▶ Minor frontal and side collisions.
- ▶ Rear-end collision.
- ▶ Vehicle rollover.

If the measured deceleration rate is below the reference values programmed into the control unit, the airbags will not be deployed despite possible serious vehicle damage.

Airbag overview

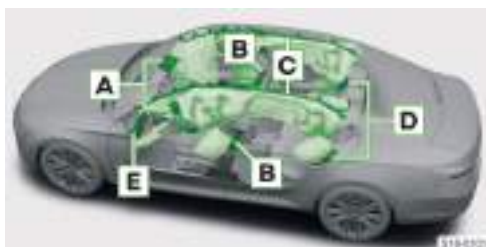

- A** Front airbags
- B** Side airbags - front
- C** Head airbags
- D** Side airbags - rear
- E** Driver's knee airbag

The installation location of the airbags is marked with the lettering **AIRBAG**.

⚠ WARNING

Danger of a functional restriction of the side airbags!

- ▶ Do not exert excessive forces, e.g. impacts, on the seat backs.
- ▶ Do not use seat covers that have not been made by ŠKODA.
- ▶ Have damaged seat covers at the installation location of the side airbags repaired by a specialist garage.

Deactivating the airbags

We recommend having airbags other than the front passenger airbag deactivated » [page 45, Operation](#) by a ŠKODA service partner.

Deactivation of the airbags is provided for the following cases, for example.

- ▶ If the driver's seat adjustment is correct, the distance of at least 25 cm between the centre of the steering wheel and the sternum can not be maintained.
- ▶ Additional operating controls for a physically disadvantaged driver are installed in the vehicle.
- ▶ The vehicle has special seats, e.g. orthopaedic seats without side airbags.

 illuminates for 4 seconds after the ignition is switched on and then flashes for 12 seconds - Airbag or belt tensioner deactivated with the diagnostic device

Message regarding the deactivated airbag or belt tensioner

⚠ WARNING

If an airbag is deactivated during the sale of the vehicle, inform the buyer!

Troubleshooting

Airbag system faulty

 illuminates
Message regarding an airbag fault

- › Seek the help of a specialist garage.

Key switch for the front passenger airbag

Usage

Deactivation of the front passenger airbag is provided for the following cases, for example.

- ▶ A rear-facing child seat is mounted on the front passenger seat.
- ▶ The vehicle has special seats, e.g. orthopaedic seats without side airbags.

What you should be mindful of

⚠ WARNING

Danger of fault in the passenger airbag deactivation system!

- ▶ Only deactivate the airbag when the ignition is switched off!

⚠ WARNING

Danger of unexpected deployment of the passenger airbags in an accident!

- ▶ If the front passenger airbag has been deactivated with the key, do not leave the key in the key switch while driving. Vibrations can cause the key to turn in the slot and activate the airbag!

Operation

Before switching off/switching on the front passenger airbag

- › Remove the key bit.

Switch front passenger front airbag on/off



- › Switch off the ignition.
- › Open the storage compartment on the passenger's side.
- › Insert the key bit into the slot in the key switch as far as it will go.
- › To **Switch off**, carefully rotate the key switch into the position **OFF**.

- › To **Switch on**, carefully rotate the key switch into the position **ON**.
- › Remove the key bit from the slot.

- › Close the storage compartment on the passenger's side.
- › Turn on the ignition and check that the front passenger airbag indicator lights are lit up.

Status display in the instrument cluster display

 lights up 4 secs after the ignition is switched on – passenger front airbag switched off

Indicator lights



- ▶ After switching on the ignition, the two indicator lights light up briefly.
- ▶ If the system is OK, both of the indicator lights go out.



- ▶ One of the indicator lights then lights up again depending on the position of the key switch.

OFF  Lights up - front passenger airbag switched off

ON  Lights up 65 secs after the ignition is switched on – passenger front airbag switched on

Troubleshooting

Key switch for airbag deactivation is faulty

ON  flashes together with **OFF** . The front passenger airbag will not be deployed in the event of an accident!

- › Have the airbag system checked by a specialist garage immediately.

Lighting, windscreen wipers and washers

Exterior lighting

Functionality

Unless otherwise stated, the light works when the ignition is switched on.

Daylight running lights

The daytime running lights illuminate the area in front of the vehicle.

 For vehicles for certain markets, they also illuminate the rear vehicle area.

Operating conditions

- ✓ The lights switch is in position **0**, **AUTO** or .

Switching the low beam on/off automatically

The low beam is automatically switched on or off depending on the lighting conditions.

Operating conditions

- ✓ The light switch is in the **AUTO** position.

The automatic headlight circuit is indicated by the illumination of the  symbol in the light switch.

Switching low beam on/off automatically in rain

Operating conditions

- ✓ The light switch is in the **AUTO** position.
- ✓ The function is activated.
- ✓ The windscreen wipers are switched on for longer than 30 seconds.

The automatic headlight circuit is indicated by the illumination of the  symbol in the light switch.

Full LED headlights

When the light switch is in position **AUTO**, the headlights provide the best possible beam of light in front of the vehicle.

The **Dynamic cornering light** function ensures the best possible illumination of the curve area.

CORNER function

The CORNER function is intended for turning or manoeuvring (e.g. when parking).

The function illuminates the vicinity of the vehicle front in the direction of travel.

Operating conditions

- ✓ The turn signal is switched on or the front wheels are steered sharply.
- ✓ The low beam is switched on.
- ✓ The fog lights are not switched on.
- ✓ The driving speed is lower than 40 km/h.

When no light is switched on

The symbol ☼ in the light switch may also light up in the instrument cluster, indicating that it is necessary to switch on the light.



illuminates

› Switch on the light.

Operation



- 0 Switching off the lights except the daytime running lights
- AUTO Switching the low beam on/off automatically
- ☼ Switching on the parking lights
- ☾ Switching on the low beam

[i] As the basic position of the light switch, use position **AUTO**.

Main beam

The high beam works when the low beam is on.

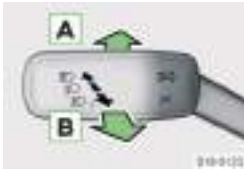

- A** Switch on the high beam - the warning light in the instrument cluster illuminates ☾
- B** Switch off the high beam - in the instrument cluster, the indicator light goes out. ☾ Switch on the headlight flasher - the warning light is illuminated ☾

⚠ CAUTION

Risk of an accident!

▶ Do not dazzle other road users with the high beam.

Turn signal

Turn signal - convenience signalling

Convenience signalling enables three flashes of the turn signal lights without having to move the lever up or down.

› Tap the control lever up or down.

The corresponding turn signal lights flash three times.

Tap the lever in the opposite direction ahead of time to stop signalling.

Fog light



Positions for pulling out the light switch

- 1** Fog lights - the warning light in the instrument cluster illuminates ☾
- 2** Rear fog light - the warning light in the instrument cluster illuminates ☾

- › Turn the light switch to position **AUTO**. ☼ or ☾.
- › Pull the light switch to the appropriate position.

[i] The rear fog light does not illuminate when an accessory is connected to the trailer socket.

[i] The rear fog lamp automatically shuts off when the boot lid is opened. The indicator light ☾ stays on.

Hazard warning light system

› To switch on or off, press the button ▲ in the central part of the dash panel.

When the hazard warning system is on and the turn signal is switched on, the hazard warning lights will be switched off temporarily and only the turn signal will flash on the relevant side of the vehicle.

The hazard warning lights can be switched on automatically during hard braking. The hazard warning lights are then switched off again automatically when starting off or accelerating.

One-sided parking light P<

The one-sided parking light allows one side of the parked vehicle to be illuminated through activation of the corresponding sidelights.

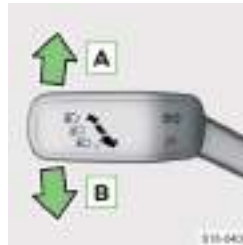

- A** Switch on the side-lights on the right
- B** Switch on the side-lights on the left

- › Switch off the ignition.
- › Move the lever to the appropriate position.
- › Lock the vehicle.

When the parking light is switched on, an acoustic

warning signal sounds and the driver's door is opened. After a few seconds or after the driver's door is closed, the warning signal will stop.

Double-sided parking light >><

The two-sided parking light allows the parked vehicle to be illuminated through activation of the side-lights.

› Turn on the ignition.

- › Turn the light switch to position .
- › Switch off the ignition.
- › Lock the vehicle.

The light may switch off automatically if the battery is low. If the two-sided parking light is switched on when the ignition is switched off, the light will not switch off automatically.

When the parking light is switched on, an acoustic warning signal sounds after the ignition is switched off and the driver's door is opened. After a few seconds or after the driver's door is closed, the warning signal will stop.

Settings

Activating/deactivating the automatic headlights system in rain

The function is activated or deactivated in the following menu in the Infotainment system.

CAR >  > 

Or:



MENU >  >  > 

Activating/deactivating convenience signalling

The function is activated or deactivated in the following menu in the Infotainment system.

CAR >  > 

Or:

MENU >  >  > 

Headlight range control of the LED headlights

The headlight range control is carried out in the Infotainment system in the following menu.

CAR >  > 

Or:

MENU >  >  > 

- › Select the position of the control according to the vehicle's current load status.

- 0 Front seats occupied, luggage compartment empty
- 2 All seats occupied, luggage compartment empty
- 4 All seats occupied, luggage compartment loaded
- 6 Driver's seat occupied, luggage compartment loaded

In the event of another vehicle loading condition, the positions **1**, **3**, **5** can be used.

 For the Full LED headlights, the headlight range control is adjusted automatically.

WARNING

Risk of an accident!

An incorrectly adjusted headlight range can cause insufficient vehicle lighting or can dazzle other road users.

- › Adjust the headlight range correctly.

Converting the Full LED headlights for the opposite direction of traffic - driving abroad

- › Switch on travel mode in the Infotainment in the following menu.

CAR >  > 

Or:

MENU >  >  > 

Adapt LED headlights for the opposite direction of traffic - driving abroad

- › Seek the help of a specialist garage.

Activate/deactivate dynamic cornering light function for Full LED headlamps

The function is activated or deactivated in the following menu in the Infotainment system.

CAR >  > 

Or:

MENU >  >  > 

Troubleshooting

Turn signal light defective

-  flashes faster - turn signal light on the right defective

- › Check the turn signal light on the right.



-  flashes faster - turn signal light on the left defective

- › Check the turn signal light on the left.

-  does not flash when the trailer is hitched - trailer turn signal light defective

- › Check the trailer lighting.

Light bulb or LED bulb is defective

-  illuminates together with  Information appears in the display regarding the affected lights.

- › Replace the defective bulb.

- › In case of a defective LED bulb, contact a specialist garage for help.

The headlights are misted up on the inside

Inside the headlights, moisture may occur. This is not a defect.

Malfunction of the automatic headlight circuit

- › Clean the windscreen in the area of the rain/light sensor.

Beam of light in front of the vehicle has shortened
Headlight defective.

› Seek the help of a specialist garage.

Driving lights defective

If a message regarding the failed driving lights is displayed, the light will work in emergency mode.

- › Drive on, exercising appropriate caution.
- › Seek the help of a specialist garage.

COMING HOME, LEAVING HOME exterior lighting

Functionality

The COMING HOME function turns on the light after turning off the ignition and opening the driver's door. The light switches off automatically after the set lighting time has elapsed.

The LEAVING HOME function switches on the light when unlocking the vehicle with the wireless remote control.

Operating conditions

- ✓ Visibility has worsened.
- ✓ The light switch is in the **AUTO** position.

Settings

This function is set in the following menu in the Infotainment system.

CAR >  > 

Or:

MENU >  >  > 

Light Assist high-beam assist system

Functionality

The high beam assist system automatically switches the high beam on and off.

⚠ WARNING

Risk of an accident!

- ▶ If necessary, manually switch the high beam on or off.

Operating conditions

- ✓ The system is activated.
- ✓ The light switch is in the **AUTO** position.
- ✓ The driving speed is higher than 30 km/h (for some countries, higher than 60 km/h).

- ✓ The low beam is switched on.

Operation

Switching on



- › Push the lever in the direction of the arrow.
- ☰ in the instrument cluster lights up.

Switching off

- › Manually switch the high beam on or off.

Settings

Activation/deactivation

The function is activated or deactivated in the following menu in the Infotainment system.

CAR >  > 

Or:

MENU >  >  > 

Dynamic Light Assist headlight assist system

Functionality

The headlight assist system automatically switches the high beam on and off.

When the high beam is switched on, it adjusts the light cone so that the drivers of oncoming and preceding vehicles are not dazzled.

⚠ WARNING

Risk of an accident!

- ▶ If necessary, manually switch the high beam on or off.

Operating conditions

- ✓ The system is activated.
- ✓ The light switch is in the **AUTO** position.
- ✓ The low beam is switched on.
- ✓ The system has detected that the vehicle is not in an urban area.

Operation

Switching on



› Push the lever in the direction of the arrow.

☰ in the instrument cluster lights up.

Switching off

› Manually switch the high beam on or off.

Function restriction

The system may dazzle other road users if their headlights/lights are not detected for the following reasons, for example.

- ▶ The headlights/lights of oncoming vehicles are covered by crash barriers, for example.
- ▶ The headlamps/lights of the oncoming or preceding vehicle are dirty or not functioning. The system can also recognize a vehicle as a single-lane means of transport.

Settings

Activation/deactivation

The Dynamic Light Assist system is activated or deactivated in the following menu in the Infotainment system.

CAR › ›

Or:

MENU › › ›

Replace light bulbs

What you should be mindful of

DIY replacement of the following bulbs is possible. Have the remaining light sources replaced by a specialist garage.

The new bulb must conform to the specification of the original light bulb. The name of the bulb is marked on the bulb socket.

① NOTICE

Danger of headlight damage due to the ingress of water and dirt!

- ▶ Always fit the protective cap on the headlight correctly after changing a bulb.

Conditions for changing a bulb

- ✓ Ignition switched off.
- ✓ Light switched off.

Front turn signal

- › Remove the protective cap from the headlight.
- › Remove the base with the bulb.



› Change the bulb in the socket.

› Insert the socket with the light bulb into the light so that the fixing lugs **A** fit into the recesses on the headlight.

› Fit the protective cap on the headlight again.

Rear turn signal and reversing lights

Loosen and remove the light



› Remove the cover with the bracket from the tool kit.



› Unscrew the screws **A** and remove the light.



› Press the lock mechanisms on the connector and remove the connector.

Replacing the light bulb



- › Turn the corresponding socket with the bulb and remove it.



- › Turn the defective bulb in the socket and remove it.
- › Insert a new light bulb into the socket and secure the light bulb by turning it in the direction of ↻.
- › Insert the socket with the new bulb into the light so that the guide

lugs on the socket are aligned with the corresponding openings in the light.

- › Turn the socket clockwise ↻ to secure.

Insert and fix the light

- › Insert the connector into the light until it clicks into place.



- › Insert the lamp with the holes **A** onto the pins **B** in the body.

ⓘ NOTICE

Risk of damage to the electrical system due to water ingress!

- ▶ Make sure that the seal is inserted correctly when installing the light **C**.

ⓘ NOTICE

Risk of damage to the electrical system!

- ▶ Make sure that the cables between the light and the body are not pinched when the light is inserted.
- › Screw the light into place.
- › Fit the cover of the light, ensuring it clicks into place.

Interior lighting

Operation

Operation of the lighting

- ☞ Lighting in front and rear
- ☞ **REAR** Rear lighting
- ☞ Reading lights
- ☞ Automatic switch on and switch off
 - When the front light is set to ☞, the rear light is automatically switched on or off.

Switching on automatically

The light switches on when one of the following events occurs.

- ▶ The vehicle is unlocked.
- ▶ One of the doors is opened.
- ▶ The ignition is switched off.

Automatic switch off

The light switches off when one of the following events occurs.

- ▶ The vehicle is locked.
- ▶ The ignition is switched on.
- ▶ About 30 seconds after all the doors have been closed.

Automatic switching on/off of the footwell lighting

The lighting only works when the dipped or parking lights are on.

The lighting is also switched on automatically after opening the door (e.g. when getting in or out).

Turn on the lighting for the make-up mirror in the sun visors on the windscreen

- › Slide on the cover of the make-up mirror.

Settings

The footwell lighting is set in the following menu in the Infotainment system.

CAR > ☞ > menu item for interior lighting.

Or:

MENU > ☞ > ☞ > menu item for interior lighting.

Interior ambient light

Usage

The ambient lighting ensures a comfortable atmosphere in the vehicle interior.

The lighting only works when the dipped or parking lights are on.

The lighting is also switched on automatically after opening the door (e.g. when getting in or out).

Settings

The ambient lighting is set in the Infotainment system, in the following menu.

CAR > >

Or:

MENU > > >

Windscreen wipers and washers

Operating conditions

- ✓ Engine compartment flap closed.
- ✓ Boot door closed.
- ✓ Ignition is switched on.

Operation

⚠ WARNING

Risk of an accident!

At low temperatures, windscreen washer fluid can freeze on the windscreen and restrict visibility.

- ▶ Only use the windscreen washer when the windscreen is warm.

Wipe and wash the windscreen



HIGH Fast wiping

LOW Slow wiping

INT Depending on the equipment:

- ▶ Intermittent wiping
- ▶ Automatic wiping controlled by the rain sensor

OFF Switching off

1x Tip-wiping (spring-loaded position)

A ... Setting the wiping speed for the position **INT**

Washing and wiping (spring-loaded position)

Depending on the vehicle equipment, the windscreen washer nozzles of the windscreen can be heated automatically after starting the engine.

Clean headlights

When the headlights are switched on, they are cleaned the first time and after every tenth wash of

the windscreen. The cleaning interval can be set by a specialist company.

Wipe and wash the rear window



Washing and wiping the window (spring-loaded position)

Washing the reversing camera (spring-loaded position)

Wiping

OFF Switching off

Automatic rear window wiping

When the windscreen wipers are switched on, the rear window is automatically wiped when the reverse gear is engaged.

Settings

Activating/deactivating automatic wiping

The functions for automatic rear window wiping and automatic wiping in the rain can be activated and deactivated in the following menu in the Infotainment system.

CAR > >

Or:

MENU > > >

Refilling windscreen washer fluid

⚠ WARNING

Risk of an accident!

- ▶ Use windscreen washer fluid that is suitable for the weather conditions.

ⓘ NOTICE

Risk of damage to the windscreen washer system!

- ▶ When refilling the washer fluid, do not remove the strainer from the neck of the container.

ⓘ NOTICE

Risk of damage to the headlights!

- ▶ Only use washer fluid that does not attack polycarbonates.

ⓘ NOTICE

Risk of damage to engine compartment components!

- ▶ Close the container after refilling the windscreen washer fluid.

The windscreen washer tank is located in the engine compartment » [page 11](#).

The container can hold a volume of 3 litres and 6 litres for vehicles with a headlight cleaning system. When the container is in the left-hand area of the engine compartment, the volume of the container is 3.5 litres.

- › Open the engine compartment lid » [page 153](#).
- › Gently open the top of the lid.
- › Top up the windscreen washer fluid.

Troubleshooting**Windscreen washer fluid level too low**

illuminates together with ⚠

- › Top up the windscreen washer fluid.

Frozen windscreen wipers

- › Carefully remove frozen windscreen wipers from the windscreen before switching on the ignition and free them from snow and ice.

Folding down windscreen wiper arms and replacing windscreen wiper blades**Fold the windscreen wiper arms away from the windscreen****ⓘ NOTICE**

Risk of damage to the windscreen wipers and the engine compartment flap!

- ▶ Close the engine compartment flap before the windscreen wiper arms are folded away from the windscreen.
- ▶ Do not turn on the ignition when the windscreen wiper arms are folded away.
- › Switch the ignition on and off again.



- › Within 10 seconds, press the control lever down and hold for about 2 seconds.

The windscreen wiper arms are in the folded position.

- › Fold the windscreen wiper arms away from the windscreen.

Replace the windscreen wiper blade**⚠ CAUTION**

Risk of an accident!

- ▶ Change the windscreen wiper blades once or twice a year.
- › Fold the windscreen wiper arm away from the windscreen.



- › Press the catch and remove the wiper blade.
- › Insert the new wiper blade until it clicks into place.
- › Fold the windscreen wiper arm back onto the windscreen.
- › Turn on the ignition and push the control lever down.

Heating and air conditioning system

Climatronic automatic air conditioning system

What you should be mindful of

- ▶ We recommend a difference of max. 5°C between the outside temperature and the interior temperature.
- ▶ We recommend switching the cooling system off about 10 minutes before the end of the journey to prevent odour formation.
- ▶ Annual disinfection of the air conditioning is recommended.

⚠ WARNING

Danger of misting!

- ▶ Always keep the fan on.

Operating conditions for the cooling system

- ✓ The outside temperature is below 2 °C.
- ✓ The engine is running.
- ✓ The blower is switched on.

Operation



- A** Set the temperature for the left side
- B** Set the temperature for the right side
- C** Set the direction of the air outlet
- D** Set the blower speed
- E** Set the temperature for the left side
- F** Set the temperature for the right side
- G** Depending on the equipment:
 - ▶ Switch auxiliary heating and ventilation on/off
 - ▶ **REST** Use of residual engine heat for maintaining heat in the vehicle interior

It is possible to switch on within 30 minutes of switching off the ignition.

Switching off the function takes about 30 minutes.
- H** Interior temperature sensor

- Switch recirculated air mode on/off
- MAX** Switch the windscreen ventilation/defrosting mode on/off

MENU Operate Climatronic in the Infotainment system

SYNC Switch maintenance of the interior temperature on/off according to the temperature setting for the driver's side

AUTO Press - Switch on automatic mode
 This function keeps the temperature constant and prevents the windows from misting.
 Hold - Maintain the interior temperature in accordance with the temperature setting for the driver side (SYNC function)

A/C Switch the cooling system on/off

With a temperature setting outside of the number range, one of the following icons will be displayed in the Climatronic display.

- LO** Maximum cooling power
- HI** Maximum heating power

Consumption-friendly operation of the Climatronic

If one of the seats is not occupied, the Climatronic adjusts the air temperature accordingly to reduce energy consumption.

In the Climatronic display, Eco is displayed.

i During operation of the air conditioning system, there may be an automatic increase in the engine idle speed.

Recirculated air mode

The recirculation mode prevents contaminated outside air getting into the interior of the vehicle.

Briefly switching on recirculation mode can increase the cooling effect.

⚠ WARNING

Risk of an accident!

In recirculation mode, there is no fresh air supply from the outside. This can result in loss of driver attention and fogging up of windows.

- ▶ Keep the recirculation mode switched on for a short time only.

Settings

Displaying the settings menu

- › Tap the **MENU** button on the Climatronic.

Or:

- › Tap on **MENU** > in the Infotainment screen.



- A** Select Climatronic mode
 - B** Set the direction of the air outlet in manual mode
 - C** Set the temperature for the left side
 - D** Set the temperature for the right side
 - E** Show the front settings menu
 - F** Show the back settings menu
- A/C** Switch the cooling system on/off
- ⌘ According to the selected Climatronic mode:
 - ▶ Manual mode - Set the blower speed
 - ▶ Automatic mode - Set the operating power
- SYNC** Switch maintenance of the interior temperature on/off according to the temperature setting for the driver's side

Further Climatronic settings

- › To make further settings, press the **MENU** button on the Climatronic >, tap on ⌘ in the Infotainment screen.
 - ▶ *Automatic air recirculation* - Automatic re-circulated air mode on/off.
 - ▶ *Automatic supplementary heater* - Switch fast interior heating on/off.
 - ▶ *Automatic windscreen heating* - Switch automatic windscreen heating on/off.

Troubleshooting

Water under the vehicle

When the cooling system is switched on, water can drip off the air conditioning system. This is not a leak.

Fogging

- › Increase the blower speed and switch on the cooling system.

Automatic switch-off of the cooling system

If the coolant temperature is too high, the cooling system may switch off automatically. This ensures sufficient engine cooling.

Auxiliary heating and ventilation

Usage

The auxiliary heater heats the vehicle interior and the engine.

The auxiliary ventilation makes it possible to supply fresh air to the vehicle interior when the engine is switched off. As a result, the interior temperature is lowered, e.g. when the vehicle is parked in the sun.

What you should be mindful of

⚠ DANGER

Risk of poisoning!

- ▶ The auxiliary heater must not be operated in enclosed spaces.

⚠ DANGER

Risk of fire!

- ▶ Switch off the auxiliary heater before refuelling.
- ▶ The exhaust pipe for the auxiliary heater is located on the underside of the vehicle. Therefore, do not stop the vehicle in places where the exhaust gases could come into contact with easily flammable materials, e.g. dry grass, spilled fuel etc.

Functionality

The system heats or ventilates the vehicle interior depending on the settings of the air conditioning system and the air outlet nozzles before the ignition is switched off.

The system consumes fuel from the fuel tank when operating the heating.

Operating conditions

- ✓ The battery charge is sufficient.
- ✓ The fuel supply is sufficient, the instrument cluster does not light up ⚠.

Operation

Switching on/off via the control panel of the air conditioning system

- › Press the **⏻** button.

Switch on/off with the radio remote control

- › Hold down the corresponding key.



- A** Indicator light
- B** Antenna
- OFF** Switching off
- ⏻** Switching on

1 Hold the radio remote control with the antenna facing upwards.
Keep a distance of at least 2 m from the vehicle.

NOTICE

► Protect the remote control from moisture, strong vibrations and direct sunlight.

Display of the radio remote control indicator light

- Lit up green for 2 seconds - switch on.
- Lit up red for 2 seconds - switch off.

Range of the radio remote control

The range of the wireless remote control is a few hundred meters when the battery is full. For example, obstacles or weather conditions can reduce the range.

Set automatic switch on

Display menu

► Press the key **MENU** on the Climatronic control panel ►, tap **⏻** in the Infotainment screen.

Settings and information in the Infotainment screen

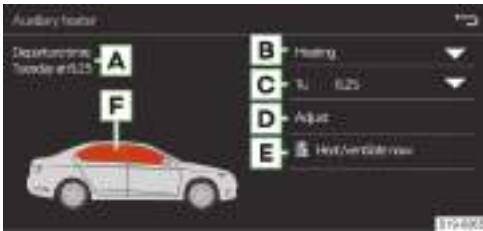

- A** Day and time when the vehicle is to be ready for use
- B** Setting the heating/ventilation
- C** List of pre-selected times, activation / deactivation of the preset time
- D** Set the selected choice of time and the duration (10-60 minutes)
- E** Immediate activation
- F** When the heating is running, the windows are displayed in red

When ventilation is running, the windows are displayed in blue



- A** Currently displayed preset time
- B** Activation of the currently displayed preset time
- C** Setting the departure time

When automatic switching on is activated, the warning light in the **⏻** symbol button lights up after the ignition is turned off.

Only one preset time can be active. The activated preset time will be deactivated again after it has started automatically. To start the next pre-set time, this pre-set time must be activated.

1 When selecting the day in the preset time, there is an option between Sunday and Monday without the specified day. When this position is selected, the system is switched on every day without the need to select a day.

Troubleshooting

Steam in the engine compartment

In the engine compartment, steam may form during the operation of the heater. This is not a defect.

Running the auxiliary heater after stopping the engine

After switching off the system, the coolant pump and the auxiliary heating will continue running a little while longer in order to burn the remaining fuel in the heating.

Indicator light in the radio remote control

- Flashes green in a slow sequence - the switch-on signal was not received.
- Flashes red in a slow sequence - the switch-off signal was not received.
- Flashing green in rapid succession - the parking heater is locked, e.g. because the fuel tank is almost empty or there is an error.
- Check the level of fuel.
- If the fuel quantity is OK, seek the help of a specialist company.
- If the indicator is orange or flashing - the battery is almost discharged.

Change the battery in the remote control



- › Use a thin screwdriver to remove the cover in the marked area.
- › Open the cover and push it out.



- › Use a screwdriver to loosen the battery in the marked area.
- › Replace the battery.
- › Insert the guard and push it until it audibly locks into place.

Driver information system

Analogue instrument panel

Overview

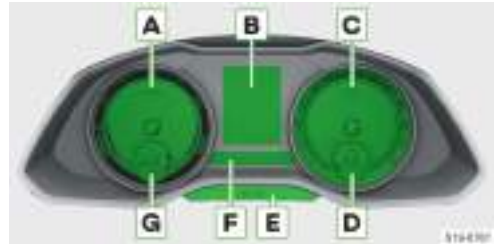

- A** Power display
- B** Display
- C** Speedometer
- D** Fuel gauge
- E** Time adjust button
- F** Bar with indicator lights
- G** Rev. counter

I In poor visibility and with dipped headlights off, the brightness of the instrument cluster lighting is reduced to remind the driver to turn on the light.

Settings

Setting the language

The language is set in the following menu in the Infotainment system.

MENU >

Set time



- › Press and hold the button in the instrument cluster until the **Time** menu item is shown in the display.
- › Release the button, the display shows the hour setting.
- › Press the button repeatedly to set the hours.
- › Wait 4 seconds, the display shows the minute setting.
- › Press the key repeatedly to set the minutes.
- › Wait 4 seconds, the display shows the initial setting.

The time is set in the Infotainment system in the following menu.

MENU >

Setting the brightness of the instrument cluster lighting

The brightness of the instrument lighting is adjusted automatically according to the given lighting conditions.

When low beam is switched on, the brightness of the instruments lighting can be adjusted in the following menu in the Infotainment system.

CAR > ☞ > ☼

Or:

MENU > ☞ > ☞ > ☼

Digital instrument cluster

Overview



- A** Bar with indicator lights
- B** Charge level indicator for high-voltage battery
- C** Fuel gauge
- D** Display - 5 possible display variants
- E** Additional Information
- F** Central display area

Settings

Setting the language

The language is set in the following menu in the Infotainment system.

MENU > ☞

Set time

The time is set in the following menu in the Infotainment system.

MENU > ☞

Setting the brightness of the instrument cluster lighting

The brightness is adjusted automatically according to the given lighting conditions.

The brightness is adjusted with the dipped beam switched on in the infotainment in the following menu.

CAR > ☞ > ☼

Or:

MENU > ☞ > ☞ > ☼

Set the variant of the display

> Press the **VIEW** button on the multifunction steering wheel to change the variant of the display presentation.

Select displayed variants

- > Press and hold the **VIEW** button on the multifunction steering wheel.
- > Select and confirm the menu item for the display variants.
- > Select one of the following variants of the display and confirm.



- A** Classic display
- B** Advanced display
- C** Modern display
- D** Basic display
- E** Sporty display

Choose display of additional information

- > Press and hold the **VIEW** button on the multifunction steering wheel.
- > Select and confirm one of the following prefix options (the scope of the prefix options depends on the type of Infotainment).
 - ▶ **Auto** - Information depending on the selected driving mode
 - ▶ **Classic** - Information about the selected gear and the current speed
 - ▶ adjustable pre-selection options

Setting the pre-selection option for the display of additional information

The pre-selection option for displaying additional information is set in the Infotainment system in the following menu.

CAR > ☞ > Menu item for the virtual cockpit

Or:

MENU > ☞ > ☞ > Menu item for the virtual cockpit

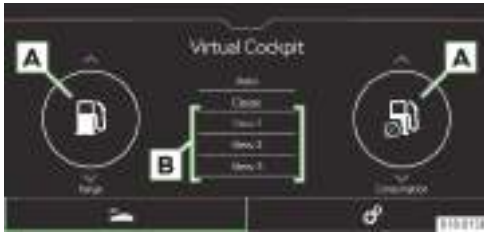

- › Select the desired additional information in the **A** areas.
- › The desired function area for the preselection option in the area **B** hold to save the selection (the scope of the preset options depends on the type of Infotainment).

Instrument cluster display

Display overview and overview of the menu items in the main menu

Depending on the equipment, the following information is shown in the display.



- A** Time
- B** Compass direction display
Selected gear/gear recommendation
Automatic gearbox selector lever positions
Detected traffic signs
- C** Menu, indicator lights and information
- D** Outside temperature
❄ or ❄ - low outside temperature
- E** Total distance travelled
- F** Trip - Distance travelled after resetting the memory

Main menu items

- ▶ Driving data » page 59
- ▶ Assist systems - Activate/deactivate assist systems
- ▶ Navigation - e.g. Display driving recommendations, compass, list of destination
- ▶ Audio - Using radio and media
- ▶ Telephone - Call list, accept or reject an incoming call
- ▶ Vehicle - Vehicle condition » page 63

Operation

Operation via the control lever



- A** Press - Switch between menu items/set values
Hold - Show main menu
- B** Press - Confirm the

menu item

Operation via the multifunction steering wheel



- 🔊 Switch voice control on/off
- A** Rotate - Adjust the volume
Press - Switch the sound off/on
- ▶ Switch to the next track/station
- ◀ Switch to the previous track/station
- ⚙ Show menu of assist systems
- VIEW** Depending on the equipment:
 - ▶ **Press** - Show previous menu (if one has been selected) / Show telephone menu
 - Or:
 - ▶ **Press** - Change the display
 - ▶ **Hold** - Display the menu of preset options with additional information
- B** Rotate - Switch between menu items/Set values/Manually change map scale
Press - Confirm the menu item
Turn and press - Activate automatic map scale changing
- 🏠 **Press** - Return to the menu one level higher
Hold - Show main menu

Driving data

Overview

The driving data display works with the ignition switched on.

In the instrument cluster display

Depending on the equipment, the display of the instrument cluster shows information such as speed, fuel consumption, range, etc.

In infotainment

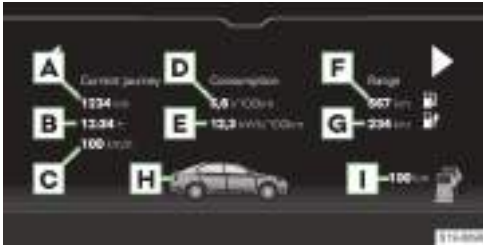

- A** Distance travelled
- B** Driving time
- C** Average speed
- D** Average fuel consumption
- E** Average power consumption
- F** Fuel range
- G** Electric range
- H** Graphical fuel and power supply gauge - If the expected range is less than 300 km, the vehicle slowly approaches the symbol
- I** Total range

Memory

The system saves the driving data in the following memories.

Since start

- ▶ Driving data from the time of switching on the ignition until the ignition is switched off again is stored in the memory. If the journey is interrupted for more than 2 hours, the memory will be reset.

Long-term

- ▶ The driving data of all trips up to a total of 99 hours and 59 minutes driving time or 9999 km driving distance is stored in the memory. If one of the listed values is exceeded, the memory is reset.

Since refuel

- ▶ Driving data from the time the fuel tank was last filled is stored in the memory. The memory is reset the next time the tank is filled.

Operation

Display driving data in the display of the instrument cluster via the operating lever

- ▶ The menu item for the driving data in the main menu in the display of the instrument cluster.



- A** Press - Select information/Set values
- B** Press - Confirm information

Display driving data in the display of the instrument cluster via the multi-functional steering wheel

- ▶ The menu item for the driving data in the main menu in the display of the instrument cluster.



- A** Rotate - Select information/Set values
- Press - Confirm information

Displaying driving data in the infotainment system

The driving data is displayed in the menu in the infotainment system.

CAR > > Menu item for drive data

Or:

MENU > > > Menu item for the driving data

Select and reset the memory for driving data in the display of the instrument cluster using the control lever



- ▶ To **set** the memory for the displayed driving data, press button **A** repeatedly.
- ▶ To **reset** the memory, press and hold button **A**.

A.

Select memory for driving data in the display of the instrument cluster via the multifunction steering wheel and reset it



- ▶ To **set** the memory for the displayed driving data, press selection wheel **A** repeatedly.
- ▶ To **reset** the memory, hold the dial **A**.

Selecting the memory in the infotainment system

To select the memory, use the functional areas ◀ ▶ in the following menu in the infotainment system.

CAR > > Menu item for drive data

Or:



MENU > > > Menu item for the driving data

Resetting the memory in the infotainment system

The memory is reset in the following menu in the infotainment system.

CAR >  > 

Or:



MENU >  >  > 

Settings**Select driving data to be displayed**

The driving data to be displayed is selected in the following Infotainment menu.

CAR >  > 

Or:



MENU >  >  > 

Setting units

The units are set in the following Infotainment menu.

CAR >  > 

Or:



MENU >  >  > 

E-Manager**Settings****Display main menu**

> Turn on the ignition.

> In the Infotainment, tap MENU > .

In the left area of the main menu there are three menu items for setting the departure time with the following functions and information.

- ▶ Activation/deactivation of the set departure time.
- ▶ Set the departure time and day of the weekday(s).
- ▶  Activated repetition of the set departure time.
- ▶  Activated charging.
- ▶  Activated interior cooling.

The right part of the main menu contains the following functions and information.

- ▶ Next set departure time.
- ▶ Information about set functions.
- ▶ Activate/deactivate the stand-by heating
- ▶  More settings.

Setting the departure time

> In the main menu, select one of the menu items for setting the departure time.

In the menu that is displayed, the following menu items can be set or switched on.

- ▶ Departure time.
- ▶ Weekday(s)

- ▶ Repeat for the selected weekday(s).
- ▶ Interior cooling.
- ▶ Charge.
- ▶ Low tariff.
- ▶ Time lapse for low tariff.

More settings

> Tap on the main menu function area .

In the menu that is displayed, the following menu items can be set or switched on.

- ▶ Desired interior temperature.
- ▶ Use of the energy from the high-voltage battery for interior cooling. If the function is not switched on, the interior cooling is started only when charging.
- ▶ Value for charging current.
- ▶ Lower battery charging limit.

e-Displays

Overview

Energy flow display

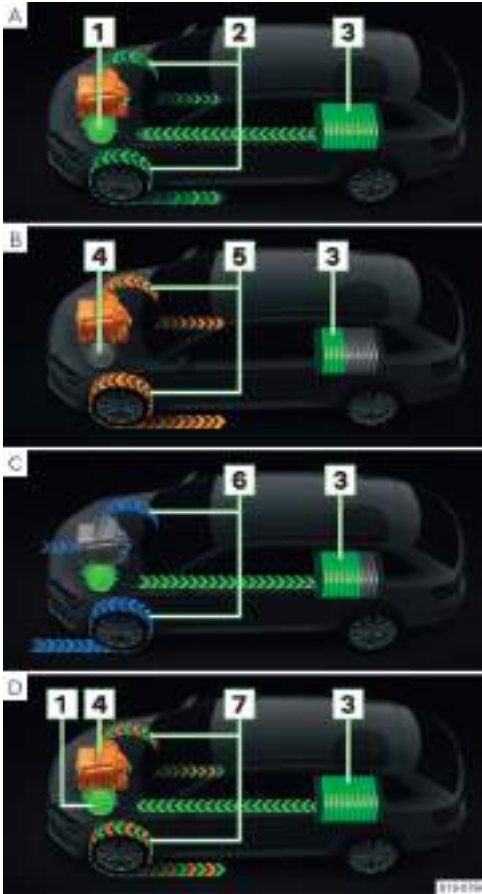

- A Electric motor active
- B Combustion engine active
- C Energy recovery (recuperation)
- D Electric motor and combustion engine active

- 1 The electric motor is active.
- 2 The vehicle is driven by the electric motor, the high-voltage battery discharges.
- 3 High-voltage battery
- 4 The combustion engine is active.
- 5 The vehicle is driven by the combustion engine, and the state of charge of the high-voltage battery is maintained.

6 The high-voltage battery is charged by energy recuperation.

7 At full acceleration, the electric motor and the combustion engine are active, and the high-voltage battery discharges.

The energy flow is displayed using coloured representations.

- ▶ Green - energy flow **from** the high-voltage battery (operated by electric motor) or **to** the high voltage battery (battery charging).
- ▶ Orange - energy flow from the combustion engine to the driven axle (operated by combustion engine).
- ▶ Blue - energy recovery through idling thrust or recuperation.

Range monitor

The range monitor displays the electrical range as well as the effect of switched-on consumers of the energy consumption. Tap on the *Potential*: function surface to open a list of consumers.

Zero Emissions

The Zero emissions view shows the total distance covered from the start of the journey as well as the proportion of the distance travelled using electric drive.

Operation

Display in Infotainment

- › Turn on the ignition.
- › In the Infotainment, tap **MENU** > > .
- › Select the desired e-Display.

Speed limit warning

Usage

The system offers the possibility to set a speed limit beyond which an acoustic warning signal will sound and the following warning message appears in the display of the instrument cluster.

Settings

Setting the speed limit

- › Select and confirm the *Warning* menu item at or (depending on display type).
- › **When the vehicle is stationary**, set the desired speed limit and confirm.
- › **While driving**, drive at the desired speed and confirm it as the speed limit.

Resetting the speed limit

- › Select and confirm the *Warning* menu item at or ☹ (depending on display type).
- › To reset the speed limit, confirm the stored value.

If the journey is interrupted for more than 2 hours, the set limit is deactivated, but the set value remains stored.

Vehicle condition

Display

The vehicle status is displayed in the following menu in the infotainment system.

CAR › › Menu item for the vehicle status

Or:

MENU › › › Menu item for the vehicle status

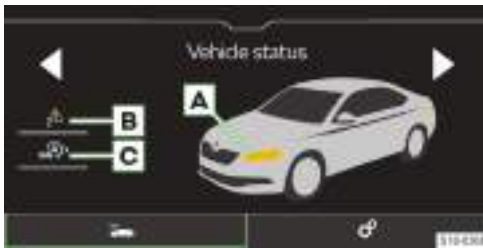

- A** Vehicle areas displayed in colour indicate associated warnings.
- B** ✓ No notification
 Warning messages regarding the vehicle condition and their quantity
- C** Display of information about the condition of the START-STOP system
 ▶ Activation/deactivation of information regarding the messages of the START-STOP system in another screen display

Functionality

In the event of a system fault, messages regarding the fault in question are displayed on the instrument cluster display when the ignition is switched on.

Messages in relation to faults can also be displayed in the Infotainment.

I The warning messages will continue to be displayed until the malfunctions have been remedied. After the message is displayed for the first time, only the indicator lights (Hazard) or (Warning) remain displayed.

Infotainment Amundsen

Infotainment overview



- A** Touchscreen
- B** Rotary control on the left
 - ▶ **Press:** Switch Infotainment on/off
 - ▶ **Turn:** Adjust Volume
- C** Rotary control on the right
 - ▶ **Press:** Confirm menu item
 - ▶ **Turn:** select menu item/set value

RADIO Radio menu

MEDIA Media menu

PHONE Phone menu

VOICE Voice control

NAV Navigation menu

APP SmartLink menu

CAR Information about vehicle settings

MENU Overview of Infotainment menus

System

Control centre

Usage

The Infotainment control centre provides quick access to the following functions.

- ▶ Setting the instrument and key illumination.
- ▶ User account management.
- ▶ Setting the personal data protection level.
- ▶ Functional surfaces of preferred features.
- ▶ List of information messages.

Opening the control centre

- › Press the bar at the top of the screen and drag down.

Closing the control centre

- › Tap on ▲.

Or:

- › Press the bar at the bottom of the screen and drag up.

Or:

- › Wait 5 seconds.

Settings

- › To **open edit mode**, press any functional surface of the preferred feature.
- › To **add the preferred feature**, move the desired function from the top of the screen to the functional surface at the bottom of the screen.
- › To **close edit mode**, tap on ×.

Restriction

For safety reasons, operation of some Infotainment functions while driving is not possible or is restricted.

The Infotainment system indicates this by means of a message in the screen.

Basic settings**Setting basic functions**

The following Infotainment functions are set in the **MENU** › ⚙ menu.

- ▶ Time and date.
- ▶ Language.
- ▶ Units.
- ▶ Restore factory settings.

Sound settings

The Infotainment sound is set in the menu **MENU** › ⏪.

The following menu items can be set.

- ▶ Setting the equalizer.
- ▶ Adjusting the volume ratio.
- ▶ Volume adjustment of individual Infotainment functions.

Some are adjustable, for example the following menu items.

- ▶ Volume adjustment of voice commands.
- ▶ Setting the maximum volume when Infotainment is turned on.

- ▶ Speed-dependent volume setting.
- ▶ Setting the Infotainment to mute with the parking aid switched on.

Depending on the equipment, the following advanced sound settings can be set.

- ▶ Setting space optimisation.
- ▶ Setting the audio profiles according to genre.
- ▶ Adjusting the subwoofer volume.

Configuration wizard

The configuration wizard helps to set certain Infotainment functions.

The configuration wizard is automatically displayed if there are at least two non-selected menu items after turning on the Infotainment.

- › To **switch off the automatic display**, tap on *Don't show again* when the configuration wizard is displayed.
- › For **manual display**, tap on **MENU** › ⚙ › *Configuration wizard*.

Setting the HOME menu

- › To **display another page** of the HOME menu, press the screen with two fingers and drag it to the left or right.

To **add the preferred menu**, proceed as follows.

- › Tap on an empty functional surface.

Or:

- › Press and hold an occupied functional surface and then tap on an empty functional area.
- › Select a menu with the desired dimension of the functional surface.
- › Tap on × to exit edit mode.

To **remove the preferred menu**, proceed as follows.

- › Press an occupied functional surface.
- › Tap on ⏏.
- › Tap on × to exit edit mode.

Setting the MENU

The position of the functional surfaces in the MENU menu can be customized as follows.

- › Press and hold the desired functional surface until it is free.
- › Move the functional surface to a different position.

Troubleshooting**Infotainment not responding**

The Infotainment system must be restarted.

- › Press ⏻ for more than 10 s.
- › Wait for the restart to complete.

System update

We recommend having the system update carried out by a specialist company.

The system update ensures optimal function of the Infotainment system, e.g. compatibility with new phones.

Determine system version

> Tap MENU >  > System information.

Screen

Overview



- A** Status bar
- B** Bar with the functional surfaces of the displayed menu
- C** Display of the control centre
- D** Other pages of the menu

Operation

ⓘ NOTICE

Danger of screen damage!

▶ The Infotainment screen is operated by **touching it lightly with your finger**.

In principle, operation by touch is identical to the operation of a mobile phone.

The following operating modes are specific to the Infotainment system.

Dragging up or down with two fingers



- ▶ Quickly review the list of phone contacts.
- ▶ Change 2D/3D map display.

Dragging left or right with two fingers



- ▶ Display next page of the HOME menu.

Pulling apart with two fingers



- ▶ Enlarge image.
- ▶ Zoom in to the map.

Pulling together with two fingers



- ▶ Minimize image.
- ▶ Zoom out of the map.

Turn two fingers



- ▶ Rotate image.
- ▶ Rotate the map.

Contactless gesture control

The Infotainment menus marked with the  symbol can be controlled by hand gestures.



- ▶ Gesture control is achieved by slowly moving the hand back and forth approximately 8 cm above the lower edge of the screen.

Depending on the setting, a recognized gesture can be confirmed acoustically and animated.

Displaying operation help

> Tap on MENU >  > .

Settings

The following basic screen functions are set in the MENU >  > Screen menu.

- ▶ Brightness level of the screen.
- ▶ Switch off the screen.

- ▶ Display the time.
- ▶ Confirmation sounds and animations.

Infotainment keyboard

Keypad overview

The arrangement of the keypad characters depends on the Infotainment language that has been set.

In Infotainment, the following types are used, depending on the context.

- ▶ Alphanumeric.
- ▶ Numeric.
- ▶ Keypad for input.
- ▶ Keypad for search.



Keypad example

- A** Input line
- ▶ ⌫ Delete characters before the cursor
 - ▶ **Tap:** delete the last character
 - ▶ **Hold:** delete all characters in sequence
 - ▶ ∨ Display functional surfaces for moving the cursor in the input line
 - ▶ < Move cursor to the left
 - ▶ > Move cursor to the right
- B** Entries searched for
- ▶ ∨ Show list
- C** Keypad functional surfaces
- ▶ ↵ Change to lowercase
 - ▶ ⤴ Switch to the first capital letter, followed by lowercase letters
 - ▶ ⤴ Switch to uppercase
 - ▶ ABC/ABB Switch to the language keypad
 - ▶ 12# Switch to the numeric and character keypad
 - ▶ 1/2/2/2 Switch to other character variants
 - ▶ 🇩🇪 Show additional keypad languages
 - ▶ ␣ Insert a space
 - ▶ ↵ The next line
 - ▶ ⌨ **Hold:** Show additional character variants
 - ▶ 🔒 Display the entered password

- ▶ OK Confirm the characters that have been entered

Numeric keypad



Keypad example

- A** Input line
- ▶ ⌫ Delete characters before the cursor
 - ▶ **Tap:** delete the last character
 - ▶ **Hold:** delete all characters
- B** Keypad functional surfaces
- ▶ OK Confirm the characters that have been entered
 - ▶ ⓘ If context-sensitive, alphanumeric characters can be entered by holding a functional surface with a digit.

Operation

The Infotainment keypad is used to enter characters, letters and numbers.

The keypad will be **automatically displayed** when Infotainment prompts for characters.

Find

When entering characters, corresponding entries are searched for.

The entry to be searched for can be entered including diacritics.

The keyboard will only provide characters that match the stored entries.

- › To **display searched entries** tap ∨.

Show additional keypad languages

To use the additional keypad languages, the desired languages must be set first.

- › Tap 🇩🇪 or repeatedly tap the flag symbol until the desired language keypad is displayed.

Further character variants

- › Press and hold the sign with the symbol ⌨.
- › Select the desired symbol.

Setting additional keypad languages

- › Tap **MENU** >  > *Additional keypad languages*.

Voice control

Functionality

Voice control principle

Voice control works according to the principle of dialogue between the user and the Infotainment system.

The user says a voice command. The Infotainment system responds or executes the voice command.

Operating conditions

- ✓ Ignition is switched on.
- ✓ Infotainment is switched on.

Operation

Voice control process

- › To **switch on** voice control on the multifunction steering wheel, press the  button.

Or:

- › Say the “OK *Laura*” activation command.

I The prerequisite for recognising the activation command is the switched on menu item **MENU** >  > *voice control* > *active*.

After switching on, the  icon is displayed.

- › Say a voice command.

During recognition of the voice command, the  icon is displayed.

The Infotainment system then executes the voice command or plays the message. During the message, the  icon is displayed.

After the execution of the voice command, voice control is switched off.

Correcting a voice command

- › During voice command input, press the  button on the multifunction steering wheel and say a new voice command.

Stopping voice control

Stopping leaves more time for voice command input, e.g. for searching for a phone contact.

- › Move your finger up or down over the Infotainment screen.

Or:

- › Say the “*pause*” voice command.

Resuming stopped voice control

- › Press the  button on the multifunction steering wheel.

Or:

- › Tap on  in the Infotainment screen.

Stopping the played back message

- › Press the  button on the multifunction steering wheel.

Ending voice control

- › Press and hold the  button on the multifunction steering wheel.

Or:

- › Say the voice command “*cancel*” during voice command input.

Restriction

For some Infotainment languages, no voice control is available. The Infotainment system will indicate this.

The messages are generated by the Infotainment system. Flawless clarity (e.g. road or city name) cannot always be guaranteed.

You cannot use voice control while a phone call is in progress.

Settings

The following voice control functions are set in the menu **MENU** >  > *Voice control*.

- ▶ Confirmation tones.
- ▶ Enable/disable use of the activation word.

Self-help

Starting acoustic help

- › If the Infotainment system is expecting a voice command, say “*Help*”.

The “*Help*” voice command can be issued repeatedly for further tips on voice control.

Displaying the help

- › Tap on **MENU** >  > .

Or:

- › If Infotainment is expecting a voice command, say “*Overview*”.

Switch example voice commands display on / off

The system offers the option of displaying example voice commands after switching on the voice control in the Infotainment screen.

- › To **turn MENU** >  > *voice control on/off*, tap > *Show in Infotainment system*.

Radio

Overview

Display main menu

› Tap on RADIO.

Or:

› Tap on MENU ›

Analogue and digital radio player

› **A** Tap and select the desired frequency range.

› Tap and search for or select the desired station.

› Tap on .



A Select source

B Station name

C Information about the broadcast content

D Station logos

List of available stations

★ Show favourites

Information about the station

Search stations manually (valid for AM and FM)

Settings

List of available analogue and digital radio stations

› Tap on .

Played station

★ Station stored on the presets

TP A traffic radio station is set

The DAB transmitter emits images which are displayed in the information to the station

Manual update of the station list

In the station list, information about the programme type and the channel identification of the regional channel can be displayed.

Web radio player

› **A** tap and select a web radio station.

› Tap and search or select web radio.

› Tap on .



A Select source

B Station name

C Information about the broadcast content

D Station logos

List of web radio and podcasts

★ Show favourites

Information about the programme as well as the broadcast content of the web radio

Settings

Podcast player

› **A** tap and select an online radio station.

› Tap and search for or select the desired pocast.

› Tap on .



A Select source

B Podcast name

C Information about the broadcast content

D Podcast logo with the symbol

▷ **Tap:** start playback

⏏ **Tap:** pause

◀◀ **Tap:** Go back 15 secs

▶▶ **Tap:** Go forward 15 secs

View episodes of the podcast being played

List of online radio stations and podcasts

★ Show favourites

Show information about the podcast

Settings

List of online radio stations and podcasts

› Tap on .



- 🔍 Search for online radio stations and podcasts
- 📁 Recently heard web radio and podcasts
- 📊 100 most popular web radio stations depending on the Infotainment language that has been set
- 📍 Go to podcasts and select
- 📁 Search and select web radio stations and podcasts for the selected country
- 🌐 Search for and select web radio stations and podcasts according to the selected language
- ✓ Search and select web radio stations and podcasts by genre of choice
- 📁 See list of related podcasts based on content listened to
- 📁 See list of related web radio stations based on content listened to

I The podcasts are shown in the displayed lists with the icon 📁.

List of favourite channels and podcasts

- In the Radio main menu, tap ★.



- A** Select source
- B** Radio text
- C** Preset buttons for favourite stations and podcasts

Operation

Select station



- Tap ◀ or ▶ at the top of the screen.

SCAN function

The function plays receivable stations of the selected frequency range in succession for a few seconds each.

- To **start automatic play** ⏮, tap Scan.
- To **stop automatic play**, tap *scan*.

Find stations manually

Manual search is available for AM and FM stations.

- To display the for the FM station, turn on the > *Advanced settings* > *Show stations*: turn on > *FM*.
- In the Radio main menu, tap .
- To **search in sequence**, tap ◀ or ▶ next to the displayed frequency range scale.

Or:

- Hold down the scroll mark on the frequency range scale and move it to the desired value.

Restriction

- ▶ Infotainment supports digital radio reception in DAB and DAB+ formats.
- ▶ Car parks, tunnels, tall buildings or mountains can restrict radio reception.
- ▶ In the rear side windows, there are antennas for receiving the radio signal.
Covering the panes with foils or metal-coated labels may affect the reception of the radio signal.
- ▶ The ŠKODA AUTO company assumes no responsibility for the availability, correct functioning and broadcast information of the RDS service.

Settings

Save the station currently being listened to as a favourite from the Radio main menu

- Hold the desired station key for preferred stations until the station is stored.

Save station to favourites from the list of available stations

Applies to AM, FM and DAB frequency ranges.

- › Hold the line with the name of the desired station.
- › Tap the desired preset button.

Save channels from the list of web radio stations and podcasts

Valid for web radio stations and podcasts

- › Select a web radio station as the playback source.
- › Tap on .
- › Go to the desired web radio station or podcast and select it.
- › Hold the line with the name of the desired station or podcast.
- › Tap the desired preset button.



 With podcasts, it is not possible to save the individual episodes.

Deleting favourites

- › In the **Radio** main menu, tap  › *Delete presets.*
- › To delete a station button for preferred stations, tap the desired station button and confirm the deletion.
- › To delete all presets for preferred stations, tap *Delete all* and confirm the deletion.

Functional surfaces   for analogue and digital radios



Applies to AM, FM and DAB frequency ranges.

The variant for **changing stations** using the function surface   in the **Radio** main menu is set as follows.

- › In the **Radio** main menu, tap  › *Arrow buttons.*
- › Select the variant for switching between the stations stored on the station buttons or the stations stored in the list of available stations.

Function surfaces   for web radio stations and podcasts

Valid for web radio stations and podcasts

The variant for **changing stations** using the function surface   in the **Radio** main menu is set as follows.

- › In the **Radio** main menu, tap  › *Arrow buttons.*
- › Select the variant for switching between the stations stored on the station keys or the last web stations and podcasts listened to.

Switch traffic reception (TP) for stations on/off
Applies to FM and DAB frequency range.

- › In the **Radio** main menu, tap  › *Traffic program (TP).*

Assign station logo from the Infotainment memory
Applies to the FM and DAB frequency ranges.

Infotainment offers the option of assigning logos, which are stored in the Infotainment memory, to the stations.

- › In the **Radio** main menu, tap  › *Station logos.*
- › Select the desired station and logo.

Switching off the station logo display

Applies to the FM and DAB frequency ranges.

- › In the **Radio** main menu, tap  › *Station logos.*
- › Select the desired station and *No station logo.*

Activating / deactivating automatic station logo assignment

Applies to the FM and DAB frequency ranges.

When the function is switched on, a station logo from the Infotainment memory is assigned when the station is stored on a preset.

- › In the **Radio** main menu, tap  › *Advanced settings* › *Auto-select station logos.*

Turn on/off radio text reception

Applies to the FM and DAB frequency ranges.

When the function is switched on and the station buttons are displayed, you can see more information about the content broadcast from the station to which you are listening.

- › In the **Radio** main menu, tap  › *Radio text.*

Regional FM station logo

Applies to the FM frequency range.

Infotainment provides the option of using country-specific FM station logos.

- › In the **Radio** main menu, tap on  › *Advanced settings* › *Region for station logo.*
- › Choose the country.

Switching additional announcements of the DAB transmitter on / off

Applies to the DAB frequency range.

When the function is switched on, other announcements are received as traffic announcements. E.g. weather news, sports reports, financial news etc.

- › In the **Radio** main menu, tap  › *Advanced settings* › *Additional DAB announcements.*

Switch RDS on/off

Applies to the FM frequency range.

The menu item is only available for some countries.

- › In the **Radio** main menu, tap  › *Advanced settings* › *Radio Data System (RDS).*

If the **RDS function is disabled**, the following menu items in **FM station** settings are not available.

- ▶ Traffic programme (TP).
- ▶ Radio text.
- ▶ RDS Regional.
- ▶ Automatic frequency change (AF).
- ▶ Regional station logo.

Switch automatic switching to a similar DAB transmitter on / off

Applies to the DAB frequency range.

When the function is switched on and there is signal loss from the DAB station being listened to, Infotainment automatically sets another DAB station with similar content.

- › In the **Radio** main menu, tap  › *Advanced settings* › *Switch to a similar station if reception is poor.*

Displaying FM / DAB stations or FM stations in the list of available stations

Applies to the FM and DAB frequency ranges.

Depending on the following setting, the stations of the selected frequency range are displayed in the list of available stations.

- › In the **Radio** main menu, tap  › *Advanced settings* › *Show stations.*
- › Select one of the following menu items.
 - ▶ *FM/DAB* - the list shows available FM and DAB stations.
 - ▶ *FM* - the list shows available FM stations.

Sound quality of web radio stations and podcasts

Valid for web radio stations and podcasts.

- › To adjust the sound quality in the main menu, tap **Radio**  › *Audio Quality.*
- › Choose low or high quality.

The quality you set affects the amount of data used in the data connection.

Quality also depends on the speed and availability of the data connection.

 If playback failure occur, reduce the sound quality.

Media

What you should be mindful of

- ▶ Do not save any important data or that which has not been backed up on the connected audio sources. ŠKODA assumes no responsibility for lost or damaged files or connected audio sources.
- ▶ When changing or connecting an audio source, this may cause sudden changes in volume. Reduce the volume before changing or connecting an audio source.
- ▶ When connecting an audio source, the source information messages can be displayed. These messages must be observed and, if necessary, confirmed.
- ▶ The national copyright laws that apply in your country must be observed.

Overview

Display main menu

- › Tap on **MEDIA**.

Or:

- › Tap on **MENU** › .

Music player



 Select source

 Manage files / multimedia database

 Show favourites

 Details about the track being played

 Settings

Video player

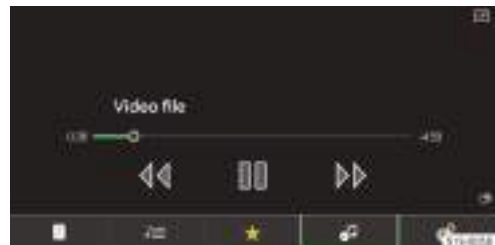

 Manage files / multimedia database

 Show favourites

 Show video

 Shrink image display

 Enlarge the image display

 Settings

Player controls

Operation - Basics



- A** Album image / symbol of the connected source
- ▶ **Tap:** list available albums
 - ▷ **Tap:** start playback
 - ⏸ **Tap:** pause
 - ◀◀ **Within 3 seconds of starting playback, tap:** play the previous song
 - ◀◀ **After 3 seconds, tap from the start of playback:** to play the current title from the beginning
 - ◀◀ **Hold:** fast rewind within the title
 - ▶▶ **Tap:** play the next song
 - ▶▶ **Hold:** fast forward within the title

Movement within the title is also possible by dragging the finger over the timeline.

Advanced operation

- 🔁 Turn on / off repeat playback of the current track
- 🔁 Turn on / off repeat playback of the current album / folder
- 🔁 Turn on / off random playback of the current album / folder
- 📌 Save the played track in the "My playlist" playlist

"My playlist" management

- ▶ To **display the playlist**, tap \mathbb{E} > \mathbb{E} > \mathbb{E} > \mathbb{E} .

- ▶ To **manage the playlist** tap \mathbb{E} in the displayed playlist.

The following activities can be carried out in playlist management.

- ▶ Control playback.
- ▶ Change the order of a title in the list by holding and moving \mathbb{E} to the desired position.
- ▶ Delete title.

Settings

Manage favourites

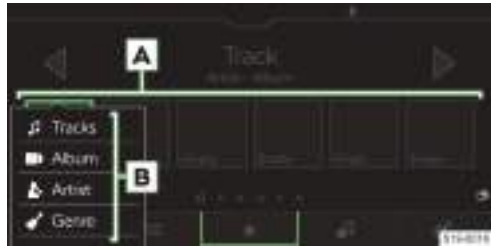

- › To **save**, hold the desired functional area for favourites **A**.
- › Choose one of the available list entries **B**.
- › To **delete**, in the **media** main menu, tap on \mathbb{E} > *manage favourites*.
- › To delete a **favourite**, tap on the list entry and confirm the deletion.

Or:

- › To delete **all favourites**, tap on *Delete all* and confirm the deletion.

Traffic

- › To **turn on/off** the traffic monitoring during the playback of media files, go to the **Media** main menu and tap on \mathbb{E} > **Traffic programme (TP)**.

Supported sources and files

Supported sources

| Source | Interface | Type | Specification | File system |
|-------------------|---|-------|--|---|
| USB | USB 1.x; 2.x 3.x or higher with USB 2.x support | MSC | USB stick | VFAT FAT16 FAT32 exFAT NTFS |
| | | | HDD (without special software) | |
| | | | USB devices that use the USB mass storage support protocol | |
| | | MTP | Devices running the Android or Windows Phone operating system that support the Media Transfer Protocol | |
| | | Apple | Devices with the iOS operating system and the iAP2 protocol | HFS+ |
| Bluetooth® player | Bluetooth® | - | Bluetooth® protocols A2DP and AVRCP (1.0 - 1.6) | - |

Compatibility of mobile devices

It is possible to check the ŠKODA web pages to see if Infotainment is compatible with the selected mobile device being tested. This check is carried out by using the following reference or by reading the QR code.

► <http://go.skoda.eu/compatibility>



All information given is incidental and is for information purposes.

The company, ŠKODA AUTO, cannot guarantee full functionality and compatibility, e.g. due to software update of infotainment and mobile devices.

Supported audio files

| Compression format | Codec type | File extension | Max. bit rate [kbps] | Max. sampling rate [kHz] | Multi channels |
|--------------------|------------------|----------------|----------------------|--------------------------|---|
| MPEG | MPEG 1 Layer 2 | mp2 | 32 - 384 | 32, 44, 48 | Mono, stereo, Joint stereo |
| | MPEG 2 Layer 2 | | 8 - 160 | 16, 22, 24 | |
| | MPEG 1 Layer 3 | mp3 | 32 - 320 | 32, 44, 48 | Mono, dual mono, Stereo, Joint Stereo |
| | MPEG 2 Layer 3 | | 8 - 160 | 16, 22, 24 | |
| | MPEG 2.5 Layer 3 | | | 8, 11, 12 | |

| Compression format | Codec type | File extension | Max. bit rate [kbps] | Max. sampling rate [kHz] | Multi channels |
|--------------------|-------------------------------|----------------|----------------------|--|----------------------------|
| WMA | Windows Media Audio 7 | wma | 6 - 192 | 8, 16, 22, 32, 44, 48, 96 | Mono, stereo, Joint stereo |
| | Windows Media Audio 8 | | 8 - 384 | 8, 11, 16, 22, 32, 44, 48, 96 | |
| | Windows Media Audio 9 and 9.1 | | 8 - 768 | | |
| | Windows Media Audio 9.2 | | 8 - 320 | | |
| | Windows Media Audio 10 | | 32 - 768 | 32, 44, 48, 96 | |
| ADTS | AAC LC | aac | 16 - 2048 | 22, 24, 32, 44, 48 | Stereo |
| | AAC HE | | | 16, 22, 24, 32, 44, 48 | |
| | AAC HEv2 | | | 22, 24, 32, 44, 48 | |
| MP4 | M4A LC | m4a | 16 - 400 | 22, 24, 32, 44, 48 | Stereo |
| | M4A HE | | | 16, 22, 24, 32, 44, 48 | |
| | M4A HEv2 | | 16 - 64 | 22, 24, 32, 44, 48 | |
| OGG | OGG-Vorbis | ogg | 8 - 576 | 8, 11, 12, 16, 22, 24, 32, 44, 48, 96 | Mono, Stereo |
| FLAC | FLAC | flac | - | 8, 11, 12, 16, 22, 24, 32, 44, 48, 64, 88, 96, 192 | Mono, stereo, Joint stereo |
| RIFF | WAV | wav | 64 - 3072 | 8, 11, 12, 16, 22, 24, 32, 44, 48, 96 | Mono, Stereo |
| Monkey's | Monkey's | ape | 8 - 192 | | |
| SBC | Bluetooth A2DP | - | 8 - 345 | 8, 11, 12, 16, 22, 24, 32, 44, 48 | Mono, stereo, Joint stereo |
| OPUS | OPUS | opus | 6 - 2000 | 8 - 48 | Mono, stereo, Multichannel |

Files that are protected by **DRM**- and **iTunes®** methods are not supported by Infotainment.

Supported video files

| Codec type | File extension | Max. recordings per second bit rate [Mbit/s] |
|----------------|----------------------------------|--|
| MPEG 1 | mpg mpeg m1v mPV | 1.5 |
| MPEG 2 | mpg mpeg ps m2v | 15 |
| MPEG 4 (H.264) | m4p mp4 m4v mp4v mov | 50 |
| MPJEG | | |
| MPEG 4 (ISO) | | |
| Xvid | Xvid | 20 |

| Codec type | File extension | Max. recordings per second bit rate [Mbit/s] |
|------------|----------------|--|
| WMV9 | wmv asf | 50 |

Supported playlists

| Codec type | File extension |
|------------|----------------|
| M3U | m3u |
| M3U8 | m3u8 |
| PLS | pls |
| WPL | wpl |
| ASX | asx |

Images

Overview

Display main menu

> Tap on MENU >

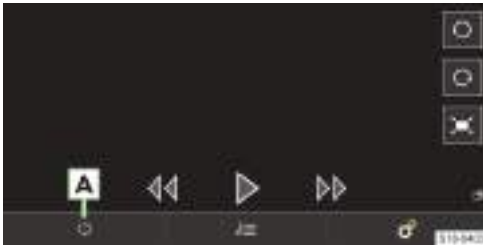

A Select source

Manage files

Settings

Operation

Operation using the functional surfaces

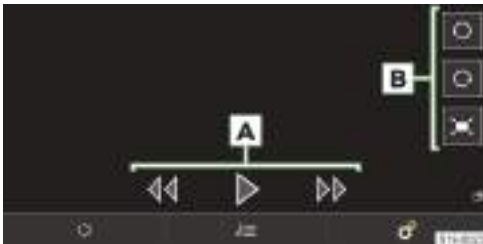

A Look at images

- > >> Show the next image
- > << Show the previous image
- > > Start slideshow
- > << Stop slideshow

B View image

- > ○ Turn to the left
- > ○ Turn to the right
- > Display in initial size

Gesture control



> Show the next image.



> Show the previous image.



> Enlarge view.





> Zoom out.



> Turn 90 °.

Settings

The following Infotainment functions are set in the MENU ›  ›  menu.

- ▶ Display image size.
- ▶ Display image duration during the slideshow.
- ▶ Slideshow repeat.

Supported sources and files

Supported sources

| Source | Interface | Specifica- tion | File system |
|--------|---|---|---------------------------------|
| USB | USB 1.x; 2.x 3.x or higher with USB 2.x support | USB stick | VFAT |
| | | HDD (without special software) | FAT16 FAT32 exFAT NTFS |

Supported files

| Codec type | File extension | Max. resolution [Mpx] |
|------------|----------------|-------------------------------|
| BMP | bmp | 4 |
| JPG; JPEG | jpg; jpeg | 4 (Progressive Mode) 64 |
| GIF | gif | 4 |
| PNG | png | 4 |

The maximum supported image size is 20 MB.

User management

Functionality

User accounts

User Management displays the accounts of the last active users.

The following activities can be carried out in user management.

- ▶ Selection of user account.
- ▶ User registration.
- ▶ Adding and removing a user account.
- ▶ Account security settings.

Personalisation

Personalisation allows multiple drivers to use a vehicle with an individual setting.

After unlocking the vehicle and opening the driver's door, all personalised functions are set according to the user account assigned to the key used to unlock the vehicle.

Any change to the set personalised functions is automatically stored in the active user account.

If the vehicle is within range of a contractual mobile phone network, the settings are automatically saved in the ŠKODA Connect online user account and the key used when the ignition is switched off.

 Does not apply to the guest user account.

ŠKODA Connect online services

ŠKODA Connect online service offer the option of connecting the vehicle to the online world. They thus represent an extension of the vehicle and Infotainment functions.

The availability of ŠKODA Connect online services for the respective user accounts depends on the following conditions.

- ▶ Vehicle type and trim.
- ▶ Infotainment type.
- ▶ Availability of services in the respective country.
Availability in each country can be checked on the ŠKODA Connect website.
- ▶ Activation of respective services.

Use of the ŠKODA Connect online services requires prior registration of the main user and subsequent activation of the online services.

- ▶ Protection level is set in Infotainment for the transmission of personal data.

User Account Types

Main Users

The main user is a registered user with activated ŠKODA Connect online services and a vehicle assigned to his account.

The main user has full control over the settings and operation of the vehicle.

The main user can choose up to five co-users on the ŠKODA Connect Portal website or in the ŠKODA Connect application.

All settings are stored in the main user's personal online account.

Shared user

The shared user is a user who has been chosen by the main user.

The shared user, like the main user, can take full advantage of the personalisation features and certain online functionalities of the vehicle.

All settings are stored in the shared user's personal online account, which is linked to the main user account.

User with a ŠKODA Connect online account

The user was not selected by the main user, but has his own ŠKODA Connect online account.

The user can take full advantage of the personalisation features.

All settings are stored in the personal online account of the user who is logged in.

Guest

A guest account is anonymous and will in no way synchronise with **ŠKODA Connect** online services.

All changes to settings related to this account are stored exclusively in the vehicle.

Conditions

The following conditions must be met for unlimited use of the personalization function, management of user accounts and their synchronization with online accounts.

- ✓ A main user with active ŠKODA Connect online services is registered in Infotainment.
 - ✓ The vehicle is within range of a contractual mobile network.
- In areas where this is insufficient signal, e.g. in underground garages, functionality may be limited.

Operation

Introductory log on screen

When the ignition and the Infotainment are switched on, the log on screen for logging in to the user account is displayed.

i The log on screen cannot be skipped. It is necessary to log in to one of the user accounts, otherwise the Infotainment will be disabled.

Some user accounts can be protected. Protected accounts are in the user list showing the icon **Ⓜ**.

To **log in** to the protected user account you need the S-PIN created when creating the user account on the ŠKODA Connect Portal website, in the ŠKODA Connect application or when registering the user in infotainment.



- › If you do not want to enter the S PIN next time, please select the *Remember S-PIN* option.

i Verification of the user by entering the S-PIN can be switched off/on in the **MENU** > **Ⓜ** > **⚙** > *Protect user profile* > *Protect user profile* menu item.

- › To register another user, tap on *Change user*.

A menu with available users and the option to enter a new user will be displayed.

Final logout screen

When the ignition is switched off, the logout screen is displayed. If the user account currently in use is not protected by the S-PIN, the user is automatically logged out.

If the user account is protected by the S-PIN, the following menu is displayed.

- ▶ *OK* - after switching on the ignition again within 30 minutes, no registration for the protected user account using the S-PIN is necessary.
- ▶ *Log out* - after switching on the ignition, the S-PIN is required to log in to the protected user account.

Settings

Delete user

- › To display the user accounts **MENU** > **Ⓜ** > **⚙**, tap *Delete users*.
- › To delete the user, select the user and confirm the deletion.

i Deleting the main user account will delete the shared user accounts.

Delete the current user account

- › **MENU** > **Ⓜ** > **⚙** > Tap *Delete user profile* and confirm the deletion.

User management

- › Tap on **MENU** > **Ⓜ**.



Ⓜ Details of the currently selected user

- ▶ **Ⓜ** - A user account protected by the S-PIN

Ⓜ Change to another user / input data for a new user
⚙ Settings

Mobile device management

Cybernetic security

Your vehicle contains components that are used to exchange information and data between the vehicle and the connected mobile devices or the Internet.

These components have security mechanisms that minimise the risk of unauthorised access to the vehicle systems.

Regular software updates help reduce the risk of unauthorised access to vehicle systems and vehicle functions. The following guidelines must therefore be observed.

- › Use only media carriers, Bluetooth® devices, and mobile devices that contain no harmful data or malware.
- › Regularly update the software provided by ŠKODA AUTO.

We recommend having the system software and components updated by a specialist company.

⚠ WARNING

Risk of an accident!

Malware in the vehicle can influence certain vehicle functions or deactivate them if necessary.

- › If the vehicle reacts in an unusual way, immediately reduce speed or stop the vehicle.
- › Seek the help of a specialist garage.

⚠ WARNING

Malware in the vehicle may gain unauthorised access to the information and data of the vehicle, and on occasion, to connected mobile devices.

Overview

Using mobile device management, devices can be connected, disconnected, and interchanged.

Display mobile device management

- › Tap on **MENU** >  > *Manage mobile devices*.



- ✔ The device enables a connection via the Bluetooth® "hands-free profile"
- ✔ The device is connected via the Bluetooth® "hands-free profile"
- ⊙ The device enables a connection via the Bluetooth® audio profile
- ⊙ The device is connected via the Bluetooth® audio profile
- ⊞ Remove the device from the list **previously connected devices**
- ▲ The device enables a SmartLink connection to be made via Android Auto

- ⊞ The device enables a SmartLink connection to be made via Apple CarPlay
- ⊞ The device enables a SmartLink connection to be made via MirrorLink
- A Connected / Previously connected devices
- B Available devices

Limitations of mobile devices and applications

Availability of features

The availability of certain features depends on the type of mobile device, as well as that of the applications installed.

Compatibility of mobile devices

It is possible to check the ŠKODA web pages to see if Infotainment is compatible with the selected mobile device being tested. This check is carried out by using the following reference or by reading the QR code.

- ▶ <http://go.skoda.eu/compatibility>



All information given is incidental and is for information purposes.

The company, ŠKODA AUTO, cannot guarantee full functionality and compatibility, e.g. due to software update of infotainment and mobile devices.

Bluetooth® compatibility of mobile devices

Due to the large number of mobile devices, it is not possible to guarantee total Bluetooth® compatibility with Infotainment. Bluetooth® compatibility depends on the Bluetooth® version as well as the implementation of Bluetooth® protocols by the manufacturer of the mobile device.

Applications in mobile devices

Mobile devices can be used to install applications that allow you to view additional information on the Infotainment screen, or to operate the Infotainment system.

Due to the variety of applications, as well as their ongoing development, the available applications may not function on all mobile devices. ŠKODA AUTO assumes no liability for their proper functioning.

The scope of available applications and their functionality is dependent on the type of Infotainment, as well as the vehicle and country.

Connection set-up

Connect a mobile device to Infotainment

- › Find available Bluetooth® devices in the mobile device.
- › Select the Infotainment Bluetooth® unit.

The unit name can be determined by tapping **MENU** ›  › *Manage mobile devices* ›  › *device name*.

- › Confirm the PIN; enter it if necessary and then confirm.

Connect Infotainment to a non-paired mobile device

- › Tap on **MENU** ›  › *Manage mobile devices*.
- › Select the desired device from the list of **available devices**.
- › Select the desired Bluetooth® profile.
- › Confirm the PIN; enter it if necessary and then confirm.
- › If two devices are connected to the Infotainment, select the device to be replaced.

Connect Infotainment to a previously connected mobile device

- › Tap on **MENU** ›  › *Manage mobile devices*.
- › Select the desired device from the list of **previously connected devices**.
- › Select the desired Bluetooth® profile.
- › If two devices are connected to the Infotainment, select the device to be replaced.

SmartLink Connection

Infotainment provides the ability to connect SmartLink to compatible mobile devices using the following connection types.

- ▲ Android Auto
- Apple CarPlay
- MirrorLink

Mobile devices can be connected to the Infotainment via USB cable or Wi-Fi, as long as the mobile device supports it.

- › Connect the mobile device to the Infotainment.
- › Tap the icon of the supported connection.

Telephone

Telephone main menu

Display main menu

- › Tap on **PHONE**.

Or:



- › Tap on **MENU** › .





- A** Name of the connected telephone
 - ▶ **Tap:** Show list of previously connected phones
- B** Name of telephone service providers
 - ▶ If the symbol ▶ is displayed in front of the name, roaming is active.
- C** Preset buttons for preferred contacts
 - Change the main telephone with the additional telephone
 - Enter telephone number
 - Contact list
 - ✉ Text messages / emails
 - ☎ Call lists
 - ⚙ Settings

Conditions for connecting a telephone with Infotainment

- ✓ The Bluetooth® function of the Infotainment and the telephone needs to be switched on.

The Bluetooth® function of the Infotainment is switched on in the menu item **MENU** ›  › *Manage mobile devices* ›  › *Bluetooth*.
- ✓ Visibility of the Infotainment is switched on.

The visibility of the Infotainment is switched on in the menu item **MENU** ›  › *Manage mobile devices* ›  › *Visibility*.
- ✓ The telephone is within signal range of the Infotainment's Bluetooth® unit.
- ✓ The telephone is compatible with Infotainment.

Telephone operation

Enter telephone number

- › In the **Telephone** main menu, tap .
- › Enter the telephone number using the numeric keypad that is displayed.

i The displayed numeric keypad can also be used for searching for contacts.

If, for example, the digits 32 are entered, contacts with the letter sequence DA, FA, EB etc. are displayed next to the numeric keypad.

List of telephone contacts

The list of telephone contacts is imported from the connected main telephone.

- › To **display** the contact list in the **telephone** main menu, tap .
- › To **search** within the list, tap *Enter contact*.
- › Enter the details you wish to find.
- › To **establish a connection** with a contact, tap the functional area showing the desired contact.

If a contact has multiple telephone numbers, select the telephone number from the displayed list.









- › To display the **details** for a contact, tap >.

Establish a connection to the voice mailbox number

- › In the **Telephone** main menu, tap  > *o.o.*

Telephone conversation

Depending on the context of the telephone conversation, the following functions can be selected.



-  End connection / reject incoming call / end call
-  Answer an incoming call / return to the held call
-  Switch the ringer off / on
-  Hold a call
-  Switch the microphone off / on
-  Show details of the caller
-  Answer a call from the second telephone during a call on the first telephone
The ongoing call on the first telephone is terminated by accepting the call.
- › To **switch the call tone from the speakers to the telephone**, go to the **telephone** main menu and tap on  > *hands-free*.
- › To **switch the call tone from the telephone to the speakers**, tap .

Conference call





A conference call is a joint telephone conversation with a minimum of three and a maximum of six participants.

- › Make the next call during an ongoing conversation/conference.



Or:

- › Accept a new incoming call by tapping the function area .
- › To **start** a conference call, tap on the functional area .



During an ongoing conference call, the following functions can be selected depending on the context.

-  Hold the conference call and leave temporarily (the conference will continue in the background)
-  Return to the conference being held
-  Switch the microphone off / on
-  End the conference
-  Show details of the conference call

In the details of the conference call, depending on the connected telephone, the following functions can be selected.

-  Show details of the conference call participants
-  End conversation with the conference call participant
-  Conversation with a participant outside of the conference call





Send a text message

- › In the **Telephone** main menu, tap  >  *Messages* > 
New text message.
- › Write a text message and confirm; a view of the message is displayed.

The message can be edited when the text area within the view is tapped.

- › Search for or select the recipient of the message.
- › Add more recipients or confirm selected recipients.
- › Tap *Send*.



Display received text messages

- › In the **Telephone** main menu, tap  >  *Messages* >  or .



- › Messages that are received are displayed as individual messages or as messages in a conversation, depending on the following setting.

In order to **switch the display of messages in a conversation on or off**, go to the **Telephone** main menu and tap  > *Show messages as a conversation*.

- › To **switch on or off a graphic notification** regarding the receipt of a new message, go to the **Telephone** main menu and tap  > *New message notifications*.

 Infotainment offers the possibility to read the text message (context-dependent) by means of the generated Infotainment voice if  is tapped.

Send E-mails



- › In the **Telephone** main menu, tap on  >  *E-mails* > 
New e-mail.

- › Write an e-mail and confirm that an e-mail is displayed.

The text can be edited when the text area within the view is tapped.

- › Search for or select the recipient of the email.
- › Add more recipients or confirm selected recipients.
- › Enter the subject of the e-mail.
- › Tap *Send*.

Show received e-mails

- › In the **Telephone** main menu, tap  >  *E-mails* > .
- › Select the desired e-mail.

- › To **switch on or off a graphic notification** regarding the receipt of a new e-mail, go to the **Telephone** main menu and tap  > *New message notifications*.

Settings for Infotainment telephone functions



Telephone-Infotainment-Connection types

The way in which the telephone is connected depends on the number of phones currently connected to the Infotainment.

- ▶ **No telephone** - The telephone is connected as a main telephone.
- ▶ **One telephone** - The telephone is connected as an additional telephone.
- ▶ **Two telephones** - Select the telephone to be replaced.
- ▶ To **switch between the main telephone and the supplementary telephone** in the main menu, tap **telephone #1**.

Connect the telephone to Infotainment

- ▶ Find available Bluetooth® devices on the phone.
- ▶ Select the Infotainment Bluetooth® unit.

The unit name can be determined by the menu item **MENU** >  > *Manage mobile devices* >  > *Device name*.

- ▶ Confirm the PIN; enter it if necessary and then confirm.

Connect Infotainment to a non-paired telephone - no telephone is connected

- ▶ Tap on **PHONE**.

Or:

- ▶ Tap on **MENU** > .
- ▶ Follow the instructions in the Infotainment screen.

Connecting Infotainment to a non-paired telephone - another telephone is connected

- ▶ Tap on **MENU** >  > *Manage mobile devices*.
- ▶ Select the desired device from the list of **available devices**.
- ▶ Select the desired Bluetooth® profile.
- ▶ Confirm the PIN; enter it if necessary and then confirm.

The telephone is connected as an additional telephone.

Or:

- ▶ If two telephones are connected to the Infotainment, select the telephone to be replaced.

Connect Infotainment to a previously paired telephone

- ▶ Tap on **MENU** >  > *Manage mobile devices*.

Or:

Tap on **PHONE** >  > *Select mobile phone*.

- ▶ Select the desired device from the list of **previously connected devices**.

The telephone is connected as an additional telephone.

Or:

- ▶ If two telephones are connected to the Infotainment, select the telephone to be replaced.

Manage preset buttons for preferred contacts



- ▶ To **save** the desired preset button, press and hold **A**.
- ▶ Select a contact from the displayed list.
- ▶ If the contact contains multiple telephone numbers, choose the desired telephone number.
- ▶ To **display the menu for deleting** go to the **Telephone** main menu and tap  > *Manage favourites*.
- ▶ To delete **one** preset, tap on the list entry and confirm the deletion.

Or:

- ▶ To delete **all** presets, tap on *Delete all* and confirm the deletion.

Import telephone contacts

After first connecting the main telephone with Infotainment, telephone contacts will start to be imported into the Infotainment memory.

Infotainment can import up to 5000 telephone contacts together with contact pictures. Each contact can include max. 5 telephone numbers.

Depending on the type of telephone, import confirmation may be required.

Update telephone contacts

When re-connecting the telephone with Infotainment, an **automatic** update of the list is carried out.

- ▶ For a **manual** update of the list in the **telephone** main menu, tap on  > *Import contacts*.

Sort contacts in the phone book

- ▶ In the **telephone** main menu, tap on  > *Sort by*: and select the sort type.

Ringer

Some phones do not allow the use of the telephone ringtone; instead, the Infotainment ringtone is used.

- ▶ To **set the Infotainment ring** go to the **Telephone** main menu and tap  > *Select ringtone*.
- ▶ Select the ringtone.

Number for the voice mailbox

- ▶ To **set the voice mailbox number** go to the **Telephone** main menu and tap on  > *Mailbox number*.

- › Enter the number of the voice mailbox.

Turn the graphic notice regarding receiving a new message/email on or off

When the feature is on, the new message icon appears on the status bar and in the feature area for the messages when a new message/e-mail is received.

- › In the **Telephone** main menu, tap  › *New message notifications*.

Simultaneous calls

This applies to some countries.

Depending on the connected telephone, it is possible to answer the next incoming call and hold the previous call.

- › To switch on simultaneous calls, tap on **telephone**  › *Parallel talks*.

Wi-Fi

Functionality

The Wi-Fi can be used for the internet connection or for the SmartLinkConnection.

The Infotainment hotspot can connect up to 8 mobile devices. At the same time, the Infotainment can be connected to another hotspot.





- › To display the list of connected mobile devices, tap **MENU** ›  › *Wi-Fi* › *Infotainment system as hotspot* › *Connected devices*.

Overview of available hotspots

Display available hotspots

- › Tap **MENU** ›  › *Wi-Fi* › *Wi-Fi*.



- A** Previously connected hotspots
- B** Available hotspots
- C** The hotspot supports the WPS connection
-  Currently connected hotspot
-  Delete information about the hotspot connection
-  Wi-Fi signal strength of the hotspot
-  The Wi-Fi signal from the hotspot is not available

Function restriction

The Infotainment system can only be connected to a hotspot with WPA2 access protection.

Settings

Connect a mobile device to the Infotainment hotspot

- › Turn on the Infotainment's Wi-Fi hotspot in the menu item **MENU** ›  › *Wi-Fi* › *Infotainment system as a hotspot* › *Use as a hotspot*.
- › Turn on the Wi-Fi on the mobile device.
- › In the list of available Wi-Fi devices, look for Infotainment Wi-Fi.

The name of the Infotainment is taken from the menu item **MENU** ›  › *Wi-Fi* › *Infotainment system as a hotspot* › *Network name*.

- › Select the Infotainment hotspot and enter the required password.

The password for connecting to the Infotainment hotspot is taken from the menu item **MENU** ›  › *Wi-Fi* › *Infotainment system as hotspot* › *Network key*.

- › Confirm the connection.

Connect Infotainment to the mobile device hotspot



- › Turn on the Infotainment's Wi-Fi unit in the menu item **MENU** ›  › *Wi-Fi* › *Wi-Fi* › *Wi-Fi on*.
- › Select the desired hotspot in the list of available hotspots.
- › Enter the password for connecting to mobile devices.

-  Infotainment stores passwords for previously connected hotspots.

Security level of the Infotainment hotspot

The security level is factory-set at WPA2 and cannot be changed.

Data transmission with the connected device

- › To turn data transmission with the connected device on or off, tap **MENU** ›  › *Wi-Fi* › *Infotainment system as hotspot* › *Connected devices* › .

Change the name of the Infotainment hotspot

- › Tap **MENU** ›  › *Wi-Fi* › *Infotainment system as hotspot* › *Network name*.
- › Enter the name and confirm.

Change password for connection to Infotainment hotspot

The password must be a minimum of 8 and a maximum of 63 characters.

- › Tap **MENU** ›  › *Wi-Fi* › *Infotainment system as a hotspot* › *Network key*.
- › Enter the password and confirm.

Quick connection of Infotainment with the mobile device hotspot

- › On the mobile device, turn on the hotspot, its visibility, and the option for WPS connection.
- › Tap **MENU** > > Wi-Fi > Wi-Fi: > WPS quick connection (WPS button).

Automatic WPS connection

- › Tap **MENU** > > Wi-Fi > Quick connection to Infotainment system.
- › In the mobile device, switch on the option for connection via WPS.
- › Wait for the connection to be established and, if necessary, confirm the respective messages.

Manual WPS connection

- › In the mobile device, switch on the option for connection via WPS PIN.

The mobile device display will show the WPS PIN for connecting to the Infotainment.

- › Tap **MENU** > > Wi-Fi > Quick connection to Infotainment system > > WPS PIN.
- › Enter the WPS PIN in the Infotainment and confirm.
- › Wait for the connection to be established and, if necessary, confirm the respective messages.

Automatic connection using the QR code

- › Tap **MENU** > > Wi-Fi > Quick connection to Infotainment system.
- › In the mobile device, switch on the option for connection via QR Code.
- › With the mobile device, read the QR code displayed on the Infotainment screen.
- › Wait for the connection to be established and, if necessary, confirm the respective messages.

Tips for a perfect connection

- Keep only the hotspot to be connected switched on and switch off the other hotspots.
- › Delete unused hotspots. This shortens the time required to establish a connection.
- › For some hotspots, the connection takes longer, so wait for the connection to finish.
- › If the connection is interrupted, recheck the available hotspots and repeat the connection.

SmartLink

Functionality

SmartLink offers the ability to display and operate certified applications from a connected mobile device in the Infotainment screen.

Certification may be conditional upon the use of the latest update to the particular SmartLink application.

Applications include, for example, apps for route guidance, telephoning, listening to music, etc.

Mobile devices can be connected via a USB cable or Wi-Fi.

Supported connection types

SmartLink supports the following connection types.

- ▶ Android Auto.
- ▶ Apple CarPlay.
- ▶ MirrorLink.

Overview of the SmartLink connection

Main menu SmartLink

- › Tap on **MENU** > .



- A** Previously connected device
- B** Currently connected device
- Display information about SmartLink
- Separation of the active connection
- Settings for the SmartLink menu

Android Auto

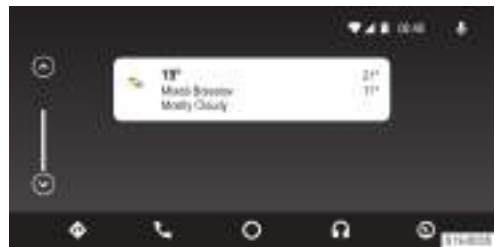

- Navigation applications
- Telephone applications
- Overview of running applications, phone calls, incoming text messages, and more.
- Music applications
- Display of other available applications as well as the option to return to the SmartLink main menu
- Turn on voice control (Google Voice)

Apple CarPlay

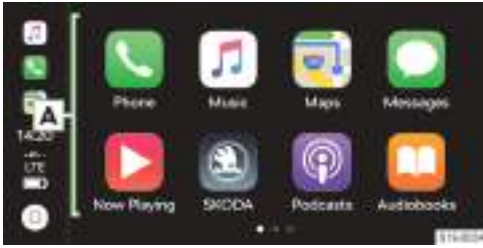

- A** List of available applications
- Depending on the duration of operation:
 - ▶ **Tap:** Return to the Apple CarPlay main menu
 - ▶ **Hold:** Turn on voice control (Siri)

MirrorLink



- ⊖ It is not possible to operate the application while driving
- Return to the SmartLink main menu
- ☰ List of running applications
- ☞ Display of the last running application in connected mobile devices
- ⚙ Settings

Connection conditions

General connection conditions

- ✓ The mobile device supports the following SmartLink connection types: Android Auto, Apple CarPlay and MirrorLink.
- ✓ Mobile devices, as well as the type of SmartLinkconnection, are supported in the respective market.
- ✓ Some connected mobile devices require the mobile device to be “unlocked”.

Conditions for Android Auto

- ✓ The device to be connected must have Android AutoSupport.
- A list of devices, supported regions and applications that the Android Auto connection supports can be found on the websites of Google Inc..

- ✓ The Android Auto application needs to be installed on the mobile device.
- ✓ Some applications require the data connection in the mobile device to be turned on.

Conditions for Apple CarPlay

- ✓ The device to be connected must have Apple CarPlaySupport.
- A list of devices, supported regions and applications that the Apple CarPlay connection supports can be found on the websites of Apple Inc..
- ✓ Siri voice control is on.
 - ✓ The data connection is switched on in the mobile device.

Conditions for MirrorLink

- ✓ The device to be connected must have MirrorLinkSupport.
- A list of devices and applications that the MirrorLink connection supports can be found on the websites of Car Connectivity Consortium®.
- ✓ The MirrorLink application needs to be installed on the mobile device.
 - ✓ Some applications require the data connection in the connected mobile device to be turned on.

Operation

Operation of the running MirrorLink application

- Display of control surfaces at the bottom
- Display of control surfaces at the top
- ⌂ Return to the MirrorLink main menu

Restriction

Restriction of the navigation function

If route guidance is currently being carried out through Infotainment, this is ended when you start route guidance in the Apple CarPlay application.

If there is route guidance in the Apple CarPlay application, it is ended by starting the destination guidance using Infotainment.

Restriction of SmartLink applications while driving



For safety reasons, operation of some SmartLinkapplications while driving is not possible or is restricted.

SmartLink settings

Apple CarPlay - Connection via USB

- › Turn on the Infotainment.
- › Turn on the mobile device.
- › Connect the mobile device to the front USB input using a cable.
- › Choose to connect via Apple CarPlay.

Apple CarPlay - Connection via Wi-Fi from Infotainment

- › Turn on Bluetooth® and Bluetooth® visibility in the Apple mobile device.
- › Tap on MENU >  > *Manage mobile devices*.
- › In the displayed list, look for and select the desired device with the symbol .
- › Follow the instructions on the Infotainment screen and confirm the Bluetooth® pairing.
- › If another device is connected to the Infotainment, select the device to be replaced.

Apple CarPlay - Connection via Wi-Fi from mobile devices

To establish a connection, the following conditions must be met.

- ✓ The minimum iOS version is 9.
- ✓ No other mobile device can be connected via SmartLink.
- ✓ Wi-Fi and Bluetooth® functionality is switched on in the Infotainment system.
- › In the mobile device, turn on the CarPlay function.
- › Press and hold the  button on the multifunction steering wheel.

The Infotainment screen displays a connection message with the name of the Bluetooth® unit of the Infotainment.

- › Find available Bluetooth® devices on the phone.
- › Select the Infotainment Bluetooth® unit.
- › If necessary, confirm the PIN.
- › In the Infotainment screen, select the connection type Apple CarPlay.

Apple CarPlay – Disconnection

- › In the Apple CarPlay main menu, tap on the “ŠKODA” functional area.
- › Tap on .

Android Auto - Connection via USB

- › Turn on the Infotainment.
- › Turn on the mobile device.
- › Connect the mobile device to the front USB input using a cable.
- › Choose to connect via Android Auto.



Android Auto - Disconnection

- › In the main menu of Android Auto  > tap on “Return to ŠKODA”.
- › Tap on .

MirrorLink - Connection via USB

- › Turn on the Infotainment.
- › Turn on the mobile device.
- › Connect the mobile device to the front USB input using a cable.
- › Choose to connect through MirrorLink.

MirrorLink - Disconnection

- › In the MirrorLink main menu, tap .
- › Tap on .

Change to another device / connection type

Infotainment allows you to switch between currently connected devices and the connection type.

- › Tap on MENU > .
- › Select the desired device or connection type.

ŠKODA Connect online services

Functionality

ŠKODA Connect online service offer the option of connecting the vehicle to the online world. They thus represent an extension of the vehicle and Infotainment functions.

For ŠKODA Connect Services functionality, the vehicle must be within range of a mobile network through which the ŠKODA Connect Services are provided. The availability, functioning, connection speed and technology used in the mobile network can be different in the respective countries and are dependent on the mobile network operator.

The ŠKODA Connect online services are not included in the equipment of the vehicle. These will be published separately on the ŠKODA Connect Portal website, in the ŠKODA Connect application or ordered in Infotainment.

The offer of ŠKODA Connect online services depends on the type of vehicle and its trim level, Infotainment and country. Availability in each country can be checked on the ŠKODA Connect website.

The rights and obligations of the Parties with respect to the provision of these services are governed by a separate agreement. Current legal documents regarding the online services can be found on the ŠKODA Connect Portal as well as the ŠKODA Connect application.

ŠKODA Connect website

▶ <http://go.skoda.eu/skoda-connect>



For example, the ŠKODA Connect website contains the latest information about the online services, a link to the ŠKODA Connect Portal as well as the option of downloading the ŠKODA Connect application.

ŠKODA Connect Portal website

▶ <http://go.skoda.eu/connect-portal>



The ŠKODA Connect Portal website is used, for example, for registration, activation and ordering of online services. It

also provides the option of remote access to the vehicle.

Information call

The information call may be used in the case of problems with the online services or for information regarding the products and services of the ŠKODA brand.

- ✓ The functional condition represents the active online ŠKODA Connect services.



› Press the **i** button.

Breakdown call

The breakdown call can be used in the event of a breakdown.

- ✓ The functional condition represents the active online ŠKODA Connect services.



› Press the **🚑** button.

ŠKODA Connect Application

The ŠKODA Connect application enables remote access to the vehicle using a mobile device. It can also be used for user registration and to activate and configure the online services.

The application can be downloaded to the mobile device after scanning the following QR code or link.

- ▶ <http://go.skoda.eu/skodaconnectapp>



Settings

Use of the ŠKODA Connect online services requires **prior registration of the main user** and subsequent **activation of the online services**.

Registration and activation of online services

User registration and activating ŠKODA Connect online services is carried out on the ŠKODA Connect Portal website, in the ŠKODA Connect application, or in Infotainment.

In order to complete user registration, you will need to access your e-mails.

To activate ŠKODA Connect online services in the vehicle, two original keys from your vehicle are required.

Registering and activating online services in infotainment - no user

- › Turn on the Infotainment.
- › In the welcome window that appears, tap *Register*.
- › Enter the required information and confirm.
- › Follow the instructions on the screen.

Registration and activation of online services in Infotainment - new user

- › Turn on the Infotainment.
- › Tap **MENU** › **👤** › **🔗** › *New user*.
- › Enter the required information and confirm.
- › Follow the instructions on the screen.

Delete user

- › Tap **MENU** › **👤** › **🔗** › *Delete user*.
- › Select the user and confirm the deletion.

Connection status of the online services

The status of the connection to the ŠKODA Connect online services is displayed by the discolouration of the **📶** symbol shown in the status bar on the Infotainment screen.

- ▶ **White** - online services are available.
- ▶ **Grey** - online services are not available.

Setting the personal data protection level

The level of protection of personal data in ŠKODA Connect online services is indicated by an icon in the status bar on the Infotainment screen.



- › Open the Infotainment control enter by holding down the bar at the top of the screen and pulling it down.
- › To **Display information**, tap **📄** for the respective protection levels.



- › To display the menu for **Setting the protection level**, tap the **A** symbol.
- › Select one of the following options for sending vehicle and user data.
 - 👤 Send only the legally required data.
 - 👤 Send the vehicle and user data.
 - 👤 Send the vehicle and user data as well as the data regarding the vehicle position.
 - 👤 Division of vehicle position data on the website ŠKODA Connect Portal and in the ŠKODA Connect application .

Switching the online service data connection on / off

For ŠKODA Connect online services, the prepaid data connection for online services can be used.

- › Tap **MENU** > ⚙️ > *Data connection* > *Integrated data connection (eSIM)*.

Overview of online service data connection usage

- › To display, tap **MENU** > ⚙️ > *Data connection* > *Data plans*.

Navigation

Navigation announcements

Infotainment route guidance takes place using graphic driving recommendations and navigation announcements.

The navigation announcements are generated by the Infotainment system. Navigation announcement clarity (e.g. road or city name) cannot always be guaranteed.

Repeat the last navigation announcement

- › Tap on ... > ↺.

Turn off navigation announcements

- › Tap on ... > 🔊.

Navigation overviews

Display main menu

- › Tap on **MENU** > ⏪.

Map overview



- A** Vehicle position
- B** Route
- C** Route view
- 📍 End route guidance
- D** Display the destination input and route view menu
- E** Traffic obstruction
- F** Following driving recommendation
- G** POI
- H** Change map orientation
 - ▶ North-facing 2D map
 - ▶ 2D map facing the direction of travel
 - ▶ 3D map facing the direction of travel
- I** Road sign for the affected route section
- 📍 Find destination
- 📍 Centre the map on the vehicle position
- ⋮ **Displaying the settings menu**
 - 🔊 Turn off navigation announcements
 - ↺ Repeat the last navigation announcement
 - 🗺 Show the default map
 - 📶 Show map with information about range using electric drive
 - J** Display map in accordance with the following setting
 - ▶ *Auto* - Map in day / night mode depending on the vehicle lighting currently switched on
 - ▶ *Day* - Map in day mode
 - ▶ *Night* - Map in night mode
 - 📍 Show the entire route
 - K** End route guidance
 - ⚙️ Settings

Map with information about range using electric drive

The map shows the estimated range achievable using the electric drive if using highlighted sections.

- › Tap on ... > 📶.



Find destination

› Tap on ▶ ▶ 📍.



- A** Input line
- B** List of destinations that have recently been searched for
- C** POI categories
 - › Tap: search for the selected category
 - √ Show destination list
 - ☑ Enter destination via address / find destination

Select the destination you are looking for

- › Enter the details for the destination search.
- › Select the desired destination.

Destination details are displayed with the option of starting route guidance.

Selecting the destination entered via the address

› Tap on 📍.

A menu for entering the destination via the address is displayed.

› Enter the required information.

Destination details are displayed with the option of starting route guidance.

List of stored destinations

› Tap on ▶ ▶ 📍.



- A** List of stored destinations
- B** Select category of stored destinations
 - ▶ 📍 - Favourites
 - ▶ 📍 - Last destinations
 - ▶ 📞 - Telephone contact destinations

Selecting the stored destination

- › Select the category of stored destinations.
- › Select the desired destination.

Destination details are displayed with the option of starting route guidance.

Recommended destinations

› Tap on ▶ ▶ 📍.

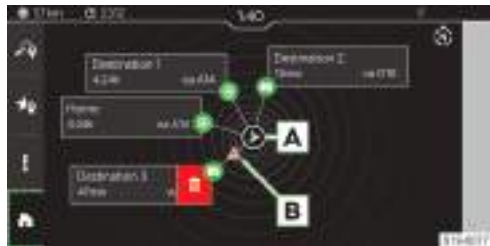

- A** North-facing vehicle position
- B** Traffic obstruction
- ☒ Delete the recommended destination

The view can display up to 5 recommended destinations in the following categories.

- ▶ Home address destination.
- ▶ Business address destination.
- ▶ Favourites.
- ▶ Last destinations.

Destination alignment depends on the direction in relation to the current vehicle position. The functional surface with the destination displays information about the estimated travel time to the destination.

If the vehicle has active online services and there is a traffic obstruction on the route to the destination, the traffic obstruction icon will be displayed.

Delete the recommended destination

- › Touch the functional surface for the recommended destination and swipe left.
- › Tap on .

Selecting destination by tapping the map point



- › Tap the desired item or the POI icon in the map.





- A** Show destination details with the following possible settings
 - ▶ ☆ - Save destination as a favourite
 - ▶ ★ - Delete favourites
 - ▶  - Set destination as a starting point for route guidance in demo mode
- B** Start direct route guidance
- C** Route calculation

Route calculation



- A** Current vehicle position
- B** Proposed fastest route
- C** Alternative routes
- D** Destination position
- E** 15 s time countdown before automatic start of the route guidance
 - › **Tap:** Interrupt time countdown
- F** Start route guidance
 -  Show information on the selected route
 -  Set parameters for route calculation

Route overview

- › Tap on  > .



- A** Information on current vehicle position
- B** Final route destination
 - Tap:** the following menu items can be selected.
 - › Show on map
 - › Stop route guidance
- C** Destination provided by Infotainment on the route
 - Tap:** the following menu items can be selected.
 - › Show on map
 - › Add stopover destination
- D** Route stopover
 - Tap:** the following menu items can be selected.
 - › Show on map
 - › Delete
- E** Traffic obstruction on the route
 - Tap:** the following menu items can be selected.
 - › Show on map
 - › Avoid
- F** Route view

Changing route destinations

In the route overview, it is possible to exchange the destination and the intermediate destinations with each other and thus change their order.

- › Hold the line with the desired destination until the functional surface for the destination becomes free.
- › Move the destination to the desired position and release the functional surface.

The route is re-calculated.

Overview of traffic density

When ŠKODA online services are activated, traffic density information can be displayed in the form of the following colour scale in the route view **F**.

Low density — — — — **High density**

— Traffic density information is not available

Touch operation

Gesture control



▶ Move the map.



▶ Enter destination by tapping the map item.



▶ Switch 2D/3D map display.



▶ Zoom in to the map.



▶ Zoom out of the map.



▶ Rotate the map.

Restriction

Infotainment may give incorrect driving recommendations if the road conditions or the traffic do not match the navigation data. This can lead to the route guidance being carried out using a different route or proposing a change of direction in a one-way street.

Information for updating the navigation data must be requested from a ŠKODA partner.

Settings

Avoiding traffic obstructions

If the function is switched on and the Infotainment receives information about a traffic obstruction on the route from online traffic information, the route is recalculated.

Infotainment may suggest a detour to avoid traffic obstructions, depending on the following settings.

- › Tap ... › › Route guidance › Avoid traffic congestion.
- › Select the desired menu item.

Showing information on the destination / waypoint

The status line displays information on the distance and travel time to the destination, depending on the following setting.

- › Tap ... › › Route guidance › Show information for..
- › Select the desired menu item for the destination type.

Showing arrival time information in the destination / driving time

The status line displays information on the travel time depending on the following setting.

- › Tap ... › › Route guidance › Time display..
- › Select the desired menu item.

Switching display of country-specific speed limits on / off

When the function is switched on, the country-specific speed limits are displayed when crossing national borders.

- › Tap ... › › Route guidance › Country information at border crossings.

Switching the display of road signs on motorways and expressways on / off

When the function is switched on, Infotainment displays traffic and information signs on motorways and expressways.

- › Tap ... › › Route guidance › Information signs on motorways and dual carriageways.

Switching the fuel warning on / off

When the function is switched on and the fuel supply reaches the reserve area, a warning message appears with the option of going to the nearest petrol station.

- › Tap ... › › Route guidance › Fuel warning.

Switching the speed limit warning on / off

- › Tap ... › › Route guidance › Road signs.
- › Set the note type and the value for exceeding the permissible speed.

Settings for trailer operation

To calculate the correct route for trailer operation, switch on trailer inclusion.

- › Tap ... › › Route guidance › Trailer › Include trailer.

Set the maximum speed for trailer operation to correctly calculate the route time.

- › Tap ... ›  › *Route guidance* › *Trailer* › *Maximum speed for trailers*.
- › Set the maximum speed for the trailer.

Setting navigation announcements

- › Tap ... ›  › *navigation announcements*.
- › Select and set the desired menu item.



Show preferred POI categories

Favourite POI categories are displayed on the map and provided in the destination search.

- › Tap ... ›  › *Basic functions* › *Define preferred POI categories*.
- › Set favourite categories.

Show charging stations

The charging stations can be displayed on the map.

- › Tap ... ›  › *Basic functions* › *Define preferred POI categories*.
- › Choose category .

Setting home address

The defined destination of the home address is displayed in the overview of recommended destinations.

- › Tap ... ›  › *Basic functions* › *Enter home address*.

Setting business address

The defined destination of the business address is displayed in the overview of recommended destinations.

- › Tap ... ›  › *Basic functions* › *Enter business address*.

Switching demo mode on / off

In demo mode, the route guidance from the starting point of the demo mode to the selected destination is simulated.

When the function is switched on, Infotainment issues a query before the start of route guidance as to where whether the route guidance should be carried out in the normal way or in demo mode.

- › Tap ... ›  › *Basic functions* › *Demo mode*.

Defining the starting point of the demo mode

- › Select or locate the desired destination to be the starting point of demo mode.
- › In the displayed destination details, tap *More* › .

Updating the navigation database

Information on updating the navigation database must be requested from a ŠKODA partner, or refer to the following ŠKODA websites.

- ▶ <http://go.skoda.eu/updateportal>

Automatic update

Infotainment automatically offers an update option if the following conditions are met.

- ✓ The “Infotainment Online” online services are activated.
- ✓ An update of the navigation database for the current vehicle position or route destination is available.

Determining the navigation database version

- › Tap **MENU** ›  › *System information*.

Infotainment Columbus

Infotainment overview



A Touchscreen

MENU All menus

HOME Favourite menus

⏮ Increase the volume

⏭ Decrease the volume

⏻ Condition-based:

▶ **Infotainment switched off**

▶ **Tap:** Turn on Infotainment

▶ **Infotainment switched on**

▶ **Tap:** Switch sound off/on

▶ **Hold:** Switch off Infotainment

System

Control centre

Usage

The Infotainment control centre provides quick access to the following functions.

- ▶ Setting the instrument and key illumination.
- ▶ User account management.
- ▶ Setting the personal data protection level.
- ▶ Functional surfaces of preferred features.
- ▶ List of information messages.

Opening the control centre



▶ Press the bar at the top of the screen and drag down.

Closing the control centre

▶ Tap on ▲.

Or:

▶ Press the bar at the bottom of the screen and drag up.

Or:

▶ Wait 5 seconds.

Settings

▶ To **open edit mode**, press any functional surface of the preferred feature.

▶ To **add the preferred feature**, move the desired function from the top of the screen to the functional surface at the bottom of the screen.

▶ To **close edit mode**, tap on ×.

Restriction

For safety reasons, operation of some Infotainment functions while driving is not possible or is restricted.

The Infotainment system indicates this by means of a message in the screen.

Basic settings

Setting basic functions

The following Infotainment functions are set in the **MENU** > ⚙️ menu.

- ▶ Time and date.
- ▶ Language.
- ▶ Units.
- ▶ Restore factory settings.

Sound settings

The Infotainment sound is set in the menu **MENU** > 🔊.

The following menu items can be set.

- ▶ Setting the equalizer.
 - ▶ Adjusting the volume ratio.
 - ▶ Volume adjustment of individual Infotainment functions.
- Some are adjustable, for example the following menu items.
- ▶ Volume adjustment of voice commands.
 - ▶ Setting the maximum volume when Infotainment is turned on.
 - ▶ Speed-dependent volume setting.
 - ▶ Setting the Infotainment to mute with the parking aid switched on.

Depending on the equipment, the following advanced sound settings can be set.

- ▶ Setting space optimisation.
- ▶ Setting the audio profiles according to genre.
- ▶ Adjusting the subwoofer volume.

Configuration wizard

The configuration wizard helps to set certain Infotainment functions.

The configuration wizard is automatically displayed if there are at least two non-selected menu items after turning on the Infotainment.

- > To **switch off the automatic display**, tap on *Don't show again* when the configuration wizard is displayed.
- > For **manual display**, tap on **MENU** > > *Configuration wizard*.

Setting the HOME menu

- > To **display another page** of the HOME menu, press the screen with two fingers and drag it to the left or right.

To **add the preferred menu**, proceed as follows.

- > Tap on an empty functional surface.

Or:

- > Press and hold an occupied functional surface and then tap on an empty functional area.
- > Select a menu with the desired dimension of the functional surface.
- > Tap on \times to exit edit mode.

To **remove the preferred menu**, proceed as follows.

- > Press an occupied functional surface.
- > Tap on .
- > Tap on \times to exit edit mode.

Setting the MENU

The position of the functional surfaces in the MENU menu can be customized as follows.

- > Press and hold the desired functional surface until it is free.
- > Move the functional surface to a different position.

Troubleshooting

Infotainment not responding

The Infotainment system must be restarted.

- > Press for more than 10 s.
- > Wait for the restart to complete.

System update

We recommend having the system update carried out by a specialist company.

The system update ensures optimal function of the Infotainment system, e.g. compatibility with new phones.

Determine system version

- > Tap **MENU** > > *System information*.

Screen

Overview



- A** Status bar
- B** Bar with the functional surfaces of the displayed menu
- C** Display of the control centre
- D** Other pages of the menu

Operation

NOTICE

Danger of screen damage!

- > The Infotainment screen is operated by **touching it lightly with your finger**.

In principle, operation by touch is identical to the operation of a mobile phone.

The following operating modes are specific to the Infotainment system.

Dragging up or down with two fingers



- > Quickly review the list of phone contacts.
- > Change 2D/3D map display.

Dragging left or right with two fingers



- > Display next page of the HOME menu.

Pulling apart with two fingers



- ▶ Enlarge image.
- ▶ Zoom in to the map.

Pulling together with two fingers



- ▶ Minimize image.
- ▶ Zoom out of the map.

Turn two fingers



- ▶ Rotate image.
- ▶ Rotate the map.

Contactless gesture control

The Infotainment menus marked with the  symbol can be controlled by hand gestures.



- ▶ Gesture control is achieved by slowly moving the hand back and forth approximately 8 cm above the lower edge of the screen.

Depending on the setting, a recognized gesture can be confirmed acoustically and animated.

Displaying operation help

- ▶ Tap on MENU >  > .

Settings

The following basic screen functions are set in the MENU >  > Screen menu.

- ▶ Brightness level of the screen.
- ▶ Switch off the screen.
- ▶ Display the time.
- ▶ Confirmation sounds and animations.

Keypad

Keypad overview













The arrangement of the keypad characters depends on the Infotainment language that has been set.

In Infotainment, the following types are used, depending on the context.

- ▶ Alphanumeric.
- ▶ Numeric.
- ▶ Keypad for input.
- ▶ Keypad for search.



Keypad example

- A** Input line
 - ▶  Delete characters before the cursor
 - ▶ **Tap:** delete the last character
 - ▶ **Hold:** delete all characters in sequence
 - ▶  Display functional surfaces for moving the cursor in the input line
 - ▶  Move cursor to the left
 - ▶  Move cursor to the right
- B** Entries searched for
 - ▶  Show list
- C** Keypad functional surfaces
 - ▶  Change to lowercase
 - ▶  Switch to the first capital letter, followed by lowercase letters
 - ▶  Switch to uppercase
 - ▶ **ABC/ABB** Switch to the language keypad
 - ▶ **12#** Switch to the numeric and character keypad
 - ▶ **1/2/2/2** Switch to other character variants
 - ▶  Show additional keypad languages
 - ▶  Insert a space
 - ▶  The next line
 - ▶  **Hold:** Show additional character variants
 - ▶  Display the entered password
 - ▶ **OK** Confirm the characters that have been entered

Numeric keypad



Keypad example

- A** Input line
 - ▶ Delete characters before the cursor
 - ▶ **Tap:** delete the last character
 - ▶ **Hold:** delete all characters
 - B** Keypad functional surfaces
 - ▶ Confirm the characters that have been entered
- I** If context-sensitive, alphanumeric characters can be entered by holding a functional surface with a digit.

Operation

The Infotainment keypad is used to enter characters, letters and numbers.

The keypad will be **automatically displayed** when Infotainment prompts for characters.

Find

When entering characters, corresponding entries are searched for.

The entry to be searched for can be entered including diacritics.

The keyboard will only provide characters that match the stored entries.

- › To **display searched entries** tap .

Show additional keypad languages

To use the additional keypad languages, the desired languages must be set first.

- › Tap or repeatedly tap the flag symbol until the desired language keypad is displayed.

Further character variants

- › Press and hold the sign with the symbol .
- › Select the desired symbol.

Setting additional keypad languages

- › Tap **MENU** > > *Additional keypad languages*.

Voice control

Functionality

Voice control principle

Voice control works according to the principle of dialogue between the user and the Infotainment system.

The user says a voice command. The Infotainment system responds or executes the voice command.

Operating conditions

- ✓ Ignition is switched on.
- ✓ Infotainment is switched on.

Operation

Voice control process

- › To **switch on** voice control on the multifunction steering wheel, press the button.

Or:

- › Say the “OK *Laura*” activation command.

I The prerequisite for recognising the activation command is the switched on menu item **MENU** > > *voice control* > *active*.

After switching on, the icon is displayed.

- › Say a voice command.

During recognition of the voice command, the icon is displayed.

The Infotainment system then executes the voice command or plays the message. During the message, the icon is displayed.

After the execution of the voice command, voice control is switched off.

Correcting a voice command

- › During voice command input, press the button on the multifunction steering wheel and say a new voice command.

Stopping voice control

Stopping leaves more time for voice command input, e.g. for searching for a phone contact.

- › Move your finger up or down over the Infotainment screen.

Or:

- › Say the “*pause*” voice command.

Resuming stopped voice control

- › Press the button on the multifunction steering wheel.

Or:

- › Tap on in the Infotainment screen.

Stopping the played back message

- > Press the button on the multifunction steering wheel.

Ending voice control

- > Press and hold the button on the multifunction steering wheel.

Or:

- > Say the voice command “cancel” during voice command input.

Restriction

For some Infotainment languages, no voice control is available. The Infotainment system will indicate this.

The messages are generated by the Infotainment system. Flawless clarity (e.g. road or city name) cannot always be guaranteed.

You cannot use voice control while a phone call is in progress.

Settings

The following voice control functions are set in the menu **MENU** > > *Voice control*.

- ▶ Confirmation tones.
- ▶ Enable/disable use of the activation word.

Self-help

Starting acoustic help

- > If the Infotainment system is expecting a voice command, say “Help”.

The “Help” voice command can be issued repeatedly for further tips on voice control.

Displaying the help

- > Tap on **MENU** > > .

Or:

- > If Infotainment is expecting a voice command, say “Overview”.

Switch example voice commands display on / off

The system offers the option of displaying example voice commands after switching on the voice control in the Infotainment screen.

- > To turn **MENU** > > *voice control on/off*, tap > *Show in Infotainment system*.

Radio

Overview

Display main menu

- > Tap on **MENU** > .

Analogue and digital radio player

- > Tap and select the desired frequency range.
- > Tap and search for or select the desired station.
- > Tap on .



- Select source
- Station name
- Information about the broadcast content
- Station logos

List of available stations

★ Show favourites

Information about the station

Search stations manually (valid for AM and FM)

Settings

List of available analogue and digital radio stations

- > Tap on .
- Played station
- ★ Station stored on the presets
- TP A traffic radio station is set
- The DAB transmitter emits images which are displayed in the information to the station
- Manual update of the station list

In the station list, information about the programme type and the channel identification of the regional channel can be displayed.

Web radio player

- > tap and select a web radio station.
- > Tap and search or select web radio.
- > Tap on .



- A** Select source
- B** Station name
- C** Information about the broadcast content
- D** Station logos
- 🔍 List of web radio and podcasts
- ★ Show favourites
- ℹ️ Information about the programme as well as the broadcast content of the web radio
- ⚙️ Settings

Podcast player

- **A** tap and select an online radio station.
- Tap 🔍 and search for or select the desired podcast.
- Tap on ℹ️.



- A** Select source
- B** Podcast name
- C** Information about the broadcast content
- D** Podcast logo with the ℹ️ symbol
- ▶ **Tap:** start playback
- ⏸ **Tap:** pause
- ⏮ **Tap:** Go back 15 secs
- ⏭ **Tap:** Go forward 15 secs
- 📄 **Tap:** View episodes of the podcast being played
- 🔍 List of online radio stations and podcasts
- ★ Show favourites
- ℹ️ Show information about the podcast
- ⚙️ Settings

List of online radio stations and podcasts

- Tap on 🔍.



- 🔍 Search for online radio stations and podcasts
- 📁 Recently heard web radio and podcasts
- 📊 100 most popular web radio stations depending on the Infotainment language that has been set
- 📍 Go to podcasts and select
- 🌐 Search and select web radio stations and podcasts for the selected country
- 🌐 Search for and select web radio stations and podcasts according to the selected language
- ✔ Search and select web radio stations and podcasts by genre of choice
- 📁 See list of related podcasts based on content listened to
- 📁 See list of related web radio stations based on content listened to

I The podcasts are shown in the displayed lists with the icon 📁.

List of favourite channels and podcasts

- In the Radio main menu, tap ★.



- A** Select source
- B** Radio text
- C** Preset buttons for favourite stations and podcasts

Operation

Select station



- › Tap ◀ or ▶ at the top of the screen.



SCAN function

The function plays receivable stations of the selected frequency range in succession for a few seconds each.

- › To **start automatic play** , tap Scan.
- › To **stop automatic play**, tap .

Find stations manually

Manual search is available for AM and FM stations.

- › To display the  functional surface for the FM station, turn on the  > *Advanced settings* > *Show stations*: turn on > FM.
- › In the Radio main menu, tap .
- › To **search in sequence**, tap ◀ or ▶ next to the displayed frequency range scale.

Or:

- › Hold down the scroll mark on the frequency range scale and move it to the desired value.

Restriction

- ▶ Infotainment supports digital radio reception in DAB and DAB+ formats.
- ▶ Car parks, tunnels, tall buildings or mountains can restrict radio reception.
- ▶ In the rear side windows, there are antennas for receiving the radio signal.
Covering the panes with foils or metal-coated labels may affect the reception of the radio signal.
- ▶ The ŠKODA AUTO company assumes no responsibility for the availability, correct functioning and broadcast information of the RDS service.

Settings

Save the station currently being listened to as a favourite from the Radio main menu

- › Hold the desired station key for preferred stations until the station is stored.

Save station to favourites from the list of available stations

Applies to AM, FM and DAB frequency ranges.

- › Hold the line with the name of the desired station.
- › Tap the desired preset button.

Save channels from the list of web radio stations and podcasts

Valid for web radio stations and podcasts

- › Select a web radio station as the playback source.
- › Tap on .
- › Go to the desired web radio station or podcast and select it.
- › Hold the line with the name of the desired station or podcast.
- › Tap the desired preset button.

 With podcasts, it is not possible to save the individual episodes.

Deleting favourites

- › In the **Radio** main menu, tap  > *Delete presets*.
- › To delete a station button for preferred stations, tap the desired station button and confirm the deletion.
- › To delete all presets for preferred stations, tap *Delete all* and confirm the deletion.

Functional surfaces ◀ ▶ for analogue and digital radios

Applies to AM, FM and DAB frequency ranges.

The variant for **changing stations** using the function surface ◀ ▶ in the **Radio** main menu is set as follows.

- › In the **Radio** main menu, tap  > *Arrow buttons*.
- › Select the variant for switching between the stations stored on the station buttons or the stations stored in the list of available stations.

Function surfaces ◀ ▶ for web radio stations and podcasts

Valid for web radio stations and podcasts

The variant for **changing stations** using the function surface ◀ ▶ in the **Radio** main menu is set as follows.

- › In the **Radio** main menu, tap  > *Arrow buttons*.
- › Select the variant for switching between the stations stored on the station keys or the last web stations and podcasts listened to.

Switch traffic reception (TP) for stations on/off

Applies to FM and DAB frequency range.

- › In the **Radio** main menu, tap  > *Traffic program (TP)*.

Assign station logo from the Infotainment memory

Applies to the FM and DAB frequency ranges.

Infotainment offers the option of assigning logos, which are stored in the Infotainment memory, to the stations.

- › In the **Radio** main menu, tap  › Station logos.
- › Select the desired station and logo.

Switching off the station logo display

Applies to the FM and DAB frequency ranges.

- › In the **Radio** main menu, tap  › Station logos.
- › Select the desired station and No station logo.

Activating / deactivating automatic station logo assignment

Applies to the FM and DAB frequency ranges.

When the function is switched on, a station logo from the Infotainment memory is assigned when the station is stored on a preset.

- › In the **Radio** main menu, tap  › Advanced settings › Auto-select station logos.

Turn on/off radio text reception

Applies to the FM and DAB frequency ranges.

When the function is switched on and the station buttons are displayed, you can see more information about the content broadcast from the station to which you are listening.

- › In the **Radio** main menu, tap  › Radio text.

Regional FM station logo

Applies to the FM frequency range.

Infotainment provides the option of using country-specific FM station logos.

- › In the **Radio** main menu, tap on  › Advanced settings › Region for station logo.
- › Choose the country.

Switching additional announcements of the DAB transmitter on / off

Applies to the DAB frequency range.

When the function is switched on, other announcements are received as traffic announcements. E.g. weather news, sports reports, financial news etc.

- › In the **Radio** main menu, tap  › Advanced settings › Additional DAB announcements.

Switch RDS on/off

Applies to the FM frequency range.

The menu item is only available for some countries.

- › In the **Radio** main menu, tap  › Advanced settings › Radio Data System (RDS).

If the **RDS function is disabled**, the following menu items in **FM station** settings are not available.

- ▶ Traffic programme (TP).
- ▶ Radio text.
- ▶ RDS Regional.
- ▶ Automatic frequency change (AF).
- ▶ Regional station logo.

Switch automatic switching to a similar DAB transmitter on / off

Applies to the DAB frequency range.

When the function is switched on and there is signal loss from the DAB station being listened to, Infotainment automatically sets another DAB station with similar content.

- › In the **Radio** main menu, tap  › Advanced settings › Switch to a similar station if reception is poor.

Displaying FM / DAB stations or FM stations in the list of available stations

Applies to the FM and DAB frequency ranges.

Depending on the following setting, the stations of the selected frequency range are displayed in the list of available stations.

- › In the **Radio** main menu, tap  › Advanced settings › Show stations.
- › Select one of the following menu items.
 - ▶ FM / DAB - the list shows available FM and DAB stations.
 - ▶ FM - the list shows available FM stations.

Sound quality of web radio stations and podcasts

Valid for web radio stations and podcasts.

- › To adjust the sound quality in the main menu, tap **Radio**  › Audio Quality.
- › Choose low or high quality.

The quality you set affects the amount of data used in the data connection.

Quality also depends on the speed and availability of the data connection.

 If playback failure occur, reduce the sound quality.

Media

What you should be mindful of

- ▶ Do not save any important data or that which has not been backed up on the connected audio sources. ŠKODA assumes no responsibility for lost or damaged files or connected audio sources.
- ▶ When changing or connecting an audio source, this may cause sudden changes in volume. Reduce the volume before changing or connecting an audio source.
- ▶ When connecting an audio source, the source information messages can be displayed. These messages must be observed and, if necessary, confirmed.
- ▶ The national copyright laws that apply in your country must be observed.

Overview

Display main menu

- ▶ Tap on MENU > 1.

Music player



A Select source

- ☰ Manage files / multimedia database
- ★ Show favourites
- 🎵 Details about the track being played
- ⚙️ Settings

Video player

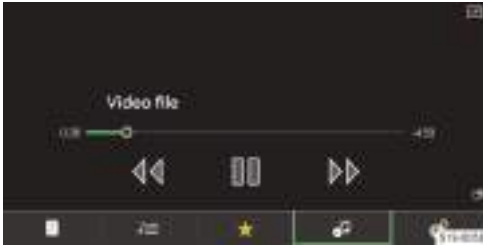

- ☰ Manage files / multimedia database
- ★ Show favourites
- 🎵 Show video
- 📐 Shrink image display
- 📐 Enlarge the image display
- ⚙️ Settings

Player controls

Operation - Basics



A Album image / symbol of the connected source

- ▶ **Tap:** list available albums
- ▶ **Tap:** start playback
- ⏸ **Tap:** pause
- ◀◀ **Within 3 seconds of starting playback, tap:** play the previous song
- ◀◀ **After 3 seconds, tap from the start of playback:** to play the current title from the beginning
- ◀◀ **Hold:** fast rewind within the title
- ▶▶ **Tap:** play the next song
- ▶▶ **Hold:** fast forward within the title

Movement within the title is also possible by dragging the finger over the timeline.

Advanced operation

- 🔁 Turn on / off repeat playback of the current track
- 🔄 Turn on / off repeat playback of the current album / folder
- 🎲 Turn on / off random playback of the current album / folder
- 📌 Save the played track in the "My playlist" playlist

"My playlist" management

- ▶ To **display the playlist**, tap ☰ > 📁 > 🎵 > 📌.
- ▶ To **manage the playlist** tap / in the displayed playlist.

The following activities can be carried out in playlist management.

- ▶ Control playback.
- ▶ Change the order of a title in the list by holding and moving ☰ to the desired position.
- ▶ Delete title.

Settings

Manage favourites

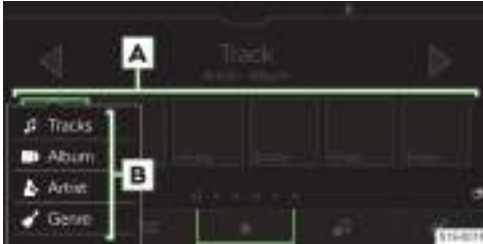

> To **save**, hold the desired functional area for favourites **A**.

- > Choose one of the available list entries **B**.
- > To **delete**, in the **media** main menu, tap on > **manage favourites**.
- > To delete **a favourite**, tap on the list entry and confirm the deletion.

Or:

- > To delete **all favourites**, tap on *Delete all* and confirm the deletion.

Traffic

- > To **turn on/off** the traffic monitoring during the playback of media files, go to the **Media** main menu and tap on > **Traffic programme (TP)**.

Supported sources and files

Supported sources

| Source | Interface | Type | Specification | File system |
|-------------------|---|--|--|---|
| USB | USB 1.x; 2.x 3.x or higher with USB 2.x support | MSC | USB stick | VFAT FAT16 FAT32 exFAT NTFS |
| | | | HDD (without special software) | |
| | | USB devices that use the USB mass storage support protocol | | |
| | | MTP | Devices running the Android or Windows Phone operating system that support the Media Transfer Protocol | |
| | | Apple | Devices with the iOS operating system and the iAP2 protocol | HFS+ |
| Bluetooth® player | Bluetooth® | - | Bluetooth® protocols A2DP and AVRCP (1.0 - 1.6) | - |

Compatibility of mobile devices

It is possible to check the ŠKODA web pages to see if Infotainment is compatible with the selected mobile device being tested. This check is carried out by using the following reference or by reading the QR code.

> <http://go.skoda.eu/compatibility>



All information given is incidental and is for information purposes.

The company, ŠKODA AUTO, cannot guarantee full functionality and compatibility, e.g. due to software update of infotainment and mobile devices.

Supported audio files

| Compression format | Codec type | File extension | Max. bit rate [kbps] | Max. sampling rate [kHz] | Multi channels |
|--------------------|-------------------------------|----------------|----------------------|--|---------------------------------------|
| MPEG | MPEG 1 Layer 2 | mp2 | 32 - 384 | 32, 44, 48 | Mono, stereo, Joint stereo |
| | MPEG 2 Layer 2 | | 8 - 160 | 16, 22, 24 | |
| | MPEG 1 Layer 3 | mp3 | 32 - 320 | 32, 44, 48 | Mono, dual mono, Stereo, Joint Stereo |
| | MPEG 2 Layer 3 | | 8 - 160 | 16, 22, 24 | |
| | MPEG 2.5 Layer 3 | | | 8, 11, 12 | |
| WMA | Windows Media Audio 7 | wma | 6 - 192 | 8, 16, 22, 32, 44, 48, 96 | Mono, stereo, Joint stereo |
| | Windows Media Audio 8 | | 8 - 384 | 8, 11, 16, 22, 32, 44, 48, 96 | |
| | Windows Media Audio 9 and 9.1 | | 8 - 768 | | |
| | Windows Media Audio 9.2 | | 8 - 320 | | |
| | Windows Media Audio 10 | | 32 - 768 | 32, 44, 48, 96 | |
| ADTS | AAC LC | aac | 16 - 2048 | 22, 24, 32, 44, 48 | Stereo |
| | AAC HE | | | 16, 22, 24, 32, 44, 48 | |
| | AAC HEv2 | | | | |
| MP4 | M4A LC | m4a | 16 - 400 | 22, 24, 32, 44, 48 | Stereo |
| | M4A HE | | | 16, 22, 24, 32, 44, 48 | |
| | M4A HEv2 | | 16 - 64 | | |
| OGG | OGG-Vorbis | ogg | 8 - 576 | 8, 11, 12, 16, 22, 24, 32, 44, 48, 96 | Mono, Stereo |
| FLAC | FLAC | flac | - | 8, 11, 12, 16, 22, 24, 32, 44, 48, 64, 88, 96, 192 | Mono, stereo, Joint stereo |
| RIFF | WAV | wav | 64 - 3072 | 8, 11, 12, 16, 22, 24, 32, 44, 48, 96 | Mono, Stereo |
| Monkey's | Monkey's | ape | 8 - 192 | | |
| SBC | Bluetooth A2DP | - | 8 - 345 | 8, 11, 12, 16, 22, 24, 32, 44, 48 | Mono, stereo, Joint stereo |
| OPUS | OPUS | opus | 6 - 2000 | 8 - 48 | Mono, stereo, Multichannel |

Files that are protected by **DRM-** and **iTunes®** methods are not supported by Infotainment.

Supported video files

| Codec type | File extension | Max. recordings per second bit rate [Mbit/s] |
|------------|---------------------------|--|
| MPEG 1 | mpg mpeg m1v mPV | 1.5 |

| Codec type | File extension | Max. recordings per second bit rate [Mbit/s] |
|----------------|----------------------------------|--|
| MPEG 2 | mpg mpeg ps m2v | 15 |
| MPEG 4 (H.264) | m4p mp4 m4v mp4v mov | 50 |
| MPJEG | | |
| MPEG 4 (ISO) | | |
| Xvid | Xvid | 20 |
| WMV9 | wmv asf | 50 |

Supported playlists

| Codec type | File extension |
|------------|----------------|
| M3U | m3u |
| M3U8 | m3u8 |
| PLS | pls |
| WPL | wpl |
| ASX | asx |

Images

Overview

Display main menu

- › Tap on MENU > 

Image viewer



A Select source

 Manage files

 Settings

Operation

Operation using the functional surfaces

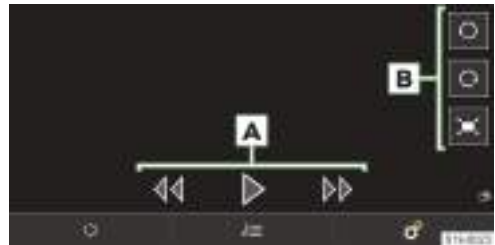

A Look at images

- ▶▶ Show the next image
- ▶◀◀ Show the previous image
- ▶▶ Start slideshow
- ▶◻◻ Stop slideshow

B View image

- ▶◻ Turn to the left
- ▶◻ Turn to the right
- ▶◻ Display in initial size

Gesture control



▶ Show the next image.



▶ Show the previous image.



▶ Enlarge view.



▶ Zoom out.



▶ Turn 90°.

Settings

The following Infotainment functions are set in the **MENU** > > menu.

- ▶ Display image size.
- ▶ Display image duration during the slideshow.
- ▶ Slideshow repeat.

Supported sources and files

Supported sources

| Source | Interface | Specification | File system |
|--------|---------------------|---------------|---------------------------------|
| USB | USB 1.x; 2.x 3.x | USB stick | VFAT FAT16 FAT32 exFAT |
| | | HDD | |

| Source | Interface | Specification | File system |
|--------|--------------------------------|----------------------------|-------------|
| | or higher with USB 2.x support | (without special software) | NTFS |

Supported files

| Codec type | File extension | Max. resolution [Mpx] |
|------------|----------------|----------------------------|
| BMP | bmp | 4 |
| JPG; JPEG | jpg; jpeg | 4 (Progressive Mode) 64 |
| GIF | gif | 4 |
| PNG | png | 4 |

The maximum supported image size is 20 MB.

User management

Functionality

User accounts

User Management displays the accounts of the last active users.

The following activities can be carried out in user management.

- ▶ Selection of user account.
- ▶ User registration.
- ▶ Adding and removing a user account.
- ▶ Account security settings.

Personalisation

Personalisation allows multiple drivers to use a vehicle with an individual setting.

After unlocking the vehicle and opening the driver's door, all personalised functions are set according to the user account assigned to the key used to unlock the vehicle.

Any change to the set personalised functions is automatically stored in the active user account.

If the vehicle is within range of a contractual mobile phone network, the settings are automatically saved in the ŠKODA Connect online user account and the key used when the ignition is switched off.

Does not apply to the guest user account.

ŠKODA Connect online services

ŠKODA Connect online service offer the option of connecting the vehicle to the online world. They thus represent an extension of the vehicle and Infotainment functions.

The availability of ŠKODA Connect online services for the respective user accounts depends on the following conditions.

- ▶ Vehicle type and trim.
- ▶ Infotainment type.
- ▶ Availability of services in the respective country.
Availability in each country can be checked on the ŠKODA Connect website.
- ▶ Activation of respective services.
Use of the ŠKODA Connect online services requires prior registration of the main user and subsequent activation of the online services.
- ▶ Protection level is set in Infotainment for the transmission of personal data.

User Account Types

Main Users

The main user is a registered user with activated ŠKODA Connect online services and a vehicle assigned to his account.

The main user has full control over the settings and operation of the vehicle.

The main user can choose up to five co-users on the ŠKODA Connect Portal website or in the ŠKODA Connect application.

All settings are stored in the main user's personal online account.

Shared user

The shared user is a user who has been chosen by the main user.

The shared user, like the main user, can take full advantage of the personalisation features and certain online functionalities of the vehicle.

All settings are stored in the shared user's personal online account, which is linked to the main user account.

User with a ŠKODA Connect online account

The user was not selected by the main user, but has his own ŠKODA Connect online account.

The user can take full advantage of the personalisation features.

All settings are stored in the personal online account of the user who is logged in.

Guest

A guest account is anonymous and will in no way synchronise with ŠKODA Connect online services.

All changes to settings related to this account are stored exclusively in the vehicle.

Conditions

The following conditions must be met for unlimited use of the personalization function, management of

user accounts and their synchronization with online accounts.

- ✓ A main user with active ŠKODA Connect online services is registered in Infotainment.
- ✓ The vehicle is within range of a contractual mobile network.

In areas where this is insufficient signal, e.g. in underground garages, functionality may be limited.

Operation

Introductory log on screen

When the ignition and the Infotainment are switched on, the log on screen for logging in to the user account is displayed.

[i] The log on screen cannot be skipped. It is necessary to log in to one of the user accounts, otherwise the Infotainment will be disabled.

Some user accounts can be protected. Protected accounts are in the user list showing the icon **u**.

To **log in** to the protected user account you need the S-PIN created when creating the user account on the ŠKODA Connect Portal website, in the ŠKODA Connect application or when registering the user in infotainment.



- ▶ If you do not want to enter the S PIN next time, please select the *Remember S-PIN* option.

[i] Verification of the user by entering the S-PIN can be switched off/on in the **MENU** > **u** > **Protect user profile** > *Protect user profile* menu item.

- ▶ To register another user, tap on *Change user*.

A menu with available users and the option to enter a new user will be displayed.

Final logout screen

When the ignition is switched off, the logout screen is displayed. If the user account currently in use is not protected by the S-PIN, the user is automatically logged out.

If the user account is protected by the S-PIN, the following menu is displayed.

- ▶ **OK** - after switching on the ignition again within 30 minutes, no registration for the protected user account using the S-PIN is necessary.

- ▶ Log out - after switching on the ignition, the S-PIN is required to log in to the protected user account.

Settings

Delete user

- › To display the user accounts MENU › 👤 › ⚙️, tap Delete users .
- › To delete the user, select the user and confirm the deletion.

ⓘ Deleting the main user account will delete the shared user accounts.

Delete the current user account

- › MENU › 👤 › ⚙️ › Tap Delete user profile and confirm the deletion.

User management

- › Tap on MENU › 👤.



- 👤 Details of the currently selected user
 - ▶ 👤 - A user account protected by the S-PIN
- 👤 Change to another user / input data for a new user
- ⚙️ Settings

Mobile device management

Cybernetic security

Your vehicle contains components that are used to exchange information and data between the vehicle and the connected mobile devices or the Internet.

These components have security mechanisms that minimise the risk of unauthorised access to the vehicle systems.

Regular software updates help reduce the risk of unauthorised access to vehicle systems and vehicle functions. The following guidelines must therefore be observed.

- › Use only media carriers, Bluetooth® devices, and mobile devices that contain no harmful data or malware.
- › Regularly update the software provided by ŠKODA AUTO.

We recommend having the system software and components updated by a specialist company.

⚠️ WARNING

Risk of an accident!

Malware in the vehicle can influence certain vehicle functions or deactivate them if necessary.

- › If the vehicle reacts in an unusual way, immediately reduce speed or stop the vehicle.
- › Seek the help of a specialist garage.

⚠️ WARNING

Malware in the vehicle may gain unauthorised access to the information and data of the vehicle, and on occasion, to connected mobile devices.

Overview

Using mobile device management, devices can be connected, disconnected, and interchanged.

Display mobile device management

- › Tap on MENU › ⚙️ › Manage mobile devices.



- 🔗 The device enables a connection via the Bluetooth®“hands-free profile”
- 🔗 The device is connected via the Bluetooth®“hands-free profile”
- 🔗 The device enables a connection via the Bluetooth® audio profile
- 🔗 The device is connected via the Bluetooth® audio profile
- 🗑️ Remove the device from the list **previously connected devices**
- 🔗 The device enables a SmartLink connection to be made via Android Auto
- 🔗 The device enables a SmartLink connection to be made via Apple CarPlay
- 🔗 The device enables a SmartLink connection to be made via MirrorLink

A Connected / Previously connected devices

B Available devices

Limitations of mobile devices and applications

Availability of features

The availability of certain features depends on the type of mobile device, as well as that of the applications installed.

Compatibility of mobile devices

It is possible to check the ŠKODA web pages to see if Infotainment is compatible with the selected mobile device being tested. This check is carried out by using the following reference or by reading the QR code.

▶ <http://go.skoda.eu/compatibility>



All information given is incidental and is for informational purposes.

The company, ŠKODA AUTO, cannot guarantee full functionality and compatibility, e.g. due to software update of infotainment and mobile devices.

Bluetooth® compatibility of mobile devices

Due to the large number of mobile devices, it is not possible to guarantee total Bluetooth® compatibility with Infotainment. Bluetooth® compatibility depends on the Bluetooth® version as well as the implementation of Bluetooth® protocols by the manufacturer of the mobile device.

Applications in mobile devices

Mobile devices can be used to install applications that allow you to view additional information on the Infotainment screen, or to operate the Infotainment system.

Due to the variety of applications, as well as their ongoing development, the available applications may not function on all mobile devices. ŠKODA AUTO assumes no liability for their proper functioning.

The scope of available applications and their functionality is dependent on the type of Infotainment, as well as the vehicle and country.

Connection set-up

Connect a mobile device to Infotainment

- ▶ Find available Bluetooth® devices in the mobile device.
- ▶ Select the Infotainment Bluetooth® unit.

The unit name can be determined by tapping **MENU** > > *Manage mobile devices* > > *device name*.

- ▶ Confirm the PIN; enter it if necessary and then confirm.

Connect Infotainment to a non-paired mobile device

- ▶ Tap on **MENU** > > *Manage mobile devices*.
- ▶ Select the desired device from the list of **available devices**.
- ▶ Select the desired Bluetooth® profile.
- ▶ Confirm the PIN; enter it if necessary and then confirm.
- ▶ If two devices are connected to the Infotainment, select the device to be replaced.

Connect Infotainment to a previously connected mobile device

- ▶ Tap on **MENU** > > *Manage mobile devices*.
- ▶ Select the desired device from the list of **previously connected devices**.
- ▶ Select the desired Bluetooth® profile.
- ▶ If two devices are connected to the Infotainment, select the device to be replaced.

SmartLink Connection

Infotainment provides the ability to connect SmartLink to compatible mobile devices using the following connection types.

- ▲ Android Auto
- Apple CarPlay
- MirrorLink

Mobile devices can be connected to the Infotainment via USB cable or Wi-Fi, as long as the mobile device supports it.

- ▶ Connect the mobile device to the Infotainment.
- ▶ Tap the icon of the supported connection.

Telephone

Telephone main menu

Display main menu

- ▶ Tap on **MENU** > .



- A** Name of the connected telephone
 - ▶ **Tap:** Show list of previously connected phones
- B** Name of telephone service providers
 - ▶ If the symbol is displayed in front of the name, roaming is active.

- C** Preset buttons for preferred contacts
- Change the main telephone with the additional telephone
- Enter telephone number
- Contact list
- Text messages / emails
- Call lists
- Settings

Conditions for connecting a telephone with Infotainment

- ✓ The Bluetooth® function of the Infotainment and the telephone needs to be switched on.
The Bluetooth® function of the Infotainment is switched on in the menu item **MENU** > > *Manage mobile devices* > > *Bluetooth*.
- ✓ Visibility of the Infotainment is switched on.
The visibility of the Infotainment is switched on in the menu item **MENU** > > *Manage mobile devices* > > *Visibility*.
- ✓ The telephone is within signal range of the Infotainment's Bluetooth® unit.
- ✓ The telephone is compatible with Infotainment.

Telephone operation

Enter telephone number

- › In the **Telephone** main menu, tap .
 - › Enter the telephone number using the numeric keypad that is displayed.
- The displayed numeric keypad can also be used for searching for contacts. If, for example, the digits 32 are entered, contacts with the letter sequence DA, FA, EB etc. are displayed next to the numeric keypad.

List of telephone contacts

The list of telephone contacts is imported from the connected main telephone.

- › To **display** the contact list in the **telephone** main menu, tap .
- › To **search** within the list, tap *Enter contact*.
- › Enter the details you wish to find.
- › To **establish a connection** with a contact, tap the functional area showing the desired contact.

If a contact has multiple telephone numbers, select the telephone number from the displayed list.

- › To display the **details** for a contact, tap >.

Establish a connection to the voice mailbox number

- › In the **Telephone** main menu, tap > *o.o.*

Telephone conversation

Depending on the context of the telephone conversation, the following functions can be selected.

- End connection / reject incoming call / end call
- Answer an incoming call / return to the held call
- Switch the ringer off / on
- Hold a call
- Switch the microphone off / on
- Show details of the caller
- Answer a call from the second telephone during a call on the first telephone
The ongoing call on the first telephone is terminated by accepting the call.
- › To **switch the call tone from the speakers to the telephone**, go to the **telephone** main menu and tap on > *hands-free*.
- › To **switch the call tone from the telephone to the speakers**, tap .

Conference call

A conference call is a joint telephone conversation with a minimum of three and a maximum of six participants.

- › Make the next call during an ongoing conversation / conference.

Or:

- › Accept a new incoming call by tapping the function area .
- › To **start** a conference call, tap on the functional area .

During an ongoing conference call, the following functions can be selected depending on the context.

- Hold the conference call and leave temporarily (the conference will continue in the background)
- Return to the conference being held
- Switch the microphone off / on
- End the conference
- Show details of the conference call

In the details of the conference call, depending on the connected telephone, the following functions can be selected.

- Show details of the conference call participants
- End conversation with the conference call participant
- Conversation with a participant outside of the conference call

Send a text message

- › In the **Telephone** main menu, tap > *Messages* > *New text message*.
- › Write a text message and confirm; a view of the message is displayed.

The message can be edited when the text area within the view is tapped.

- › Search for or select the recipient of the message.
- › Add more recipients or confirm selected recipients.
- › Tap *Send*.

Display received text messages

- › In the **Telephone** main menu, tap › *Messages* › or .

- › Messages that are received are displayed as individual messages or as messages in a conversation, depending on the following setting.

In order to **switch the display of messages in a conversation on or off**, go to the **Telephone** main menu and tap › *Show messages as a conversation*.

- › To **switch on or off a graphic notification** regarding the receipt of a new message, go to the **Telephone** main menu and tap › *New message notifications*.

Infotainment offers the possibility to read the text message (context-dependent) by means of the generated Infotainment voice if is tapped.

Send E-mails

- › In the **Telephone** main menu, tap on › *E-mails* › *New e-mail*.

- › Write an e-mail and confirm that an e-mail is displayed.

The text can be edited when the text area within the view is tapped.

- › Search for or select the recipient of the email.
- › Add more recipients or confirm selected recipients.
- › Enter the subject of the e-mail.
- › Tap *Send*.

Show received e-mails

- › In the **Telephone** main menu, tap › *E-mails* › .
- › Select the desired e-mail.

- › To **switch on or off a graphic notification** regarding the receipt of a new e-mail, go to the **Telephone** main menu and tap › *New message notifications*.

Settings for Infotainment telephone functions

Telephone-Infotainment-Connection types

The way in which the telephone is connected depends on the number of phones currently connected to the Infotainment.

- ▶ **No telephone** - The telephone is connected as a main telephone.
- ▶ **One telephone** - The telephone is connected as an additional telephone.
- ▶ **Two telephones** - Select the telephone to be replaced.

- › To **switch between the main telephone and the supplementary telephone** in the main menu, tap **telephone** .

Connect the telephone to Infotainment

- › Find available Bluetooth® devices on the phone.
- › Select the Infotainment Bluetooth® unit.

The unit name can be determined by the menu item **MENU** › › *Manage mobile devices* › › *Device name*.

- › Confirm the PIN; enter it if necessary and then confirm.

Connect Infotainment to a non-paired telephone - no telephone is connected

- › Tap on **PHONE**.

Or:

- › Tap on **MENU** › .
- › Follow the instructions in the Infotainment screen.

Connecting Infotainment to a non-paired telephone - another telephone is connected

- › Tap on **MENU** › › *Manage mobile devices*.
- › Select the desired device from the list of **available devices**.

- › Select the desired Bluetooth® profile.
- › Confirm the PIN; enter it if necessary and then confirm.

The telephone is connected as an additional telephone.

Or:

- › If two telephones are connected to the Infotainment, select the telephone to be replaced.

Connect Infotainment to a previously paired telephone

- › Tap on **MENU** › › *Manage mobile devices*.

Or:

Tap on **PHONE** › › *Select mobile phone*.

- › Select the desired device from the list of **previously connected devices**.

The telephone is connected as an additional telephone.

Or:

- › If two telephones are connected to the Infotainment, select the telephone to be replaced.

Manage preset buttons for preferred contacts



- > To **save** the desired preset button, press and hold **A**.
- > Select a contact from the displayed list.
- > If the contact contains multiple telephone numbers, choose the desired telephone number.
- > To **display the menu for deleting** go to the **Telephone** main menu and tap > *Manage favourites*.
- > To delete **one** preset, tap on the list entry and confirm the deletion.

Or:

- > To delete **all** presets, tap on *Delete all* and confirm the deletion.

Import telephone contacts

After first connecting the main telephone with Infotainment, telephone contacts will start to be imported into the Infotainment memory.

Infotainment can import up to 5000 telephone contacts together with contact pictures. Each contact can include max. 5 telephone numbers.

Depending on the type of telephone, import confirmation may be required.

Update telephone contacts

When re-connecting the telephone with Infotainment, an **automatic** update of the list is carried out.

- > For a **manual** update of the list in the **telephone** main menu, tap on > *Import contacts*.

Sort contacts in the phone book

- > In the **telephone** main menu, tap on > *Sort by:* and select the sort type.

Ringer

Some phones do not allow the use of the telephone ringtone; instead, the Infotainment ringtone is used.

- > To **set the Infotainment ring** go to the **Telephone** main menu and tap > *Select ringtone*.
- > Select the ringtone.

Number for the voice mailbox

- > To **set the voice mailbox number** go to the **Telephone** main menu and tap on > *Mailbox number*.
- > Enter the number of the voice mailbox.

Turn the graphic notice regarding receiving a new message/email on or off

When the feature is on, the new message icon appears on the status bar and in the feature area for the messages when a new message/e-mail is received.

- > In the **Telephone** main menu, tap > *New message notifications*.

Simultaneous calls

This applies to some countries.

Depending on the connected telephone, it is possible to answer the next incoming call and hold the previous call.

- > To switch on simultaneous calls, tap on **telephone** > *Parallel talks*.

Wi-Fi

Functionality

The Wi-Fi can be used for the internet connection or for the SmartLinkConnection.

The Infotainment hotspot can connect up to 8 mobile devices. At the same time, the Infotainment can be connected to another hotspot.

- > To display the list of connected mobile devices, tap **MENU** > > *Wi-Fi* > *Infotainment system as hotspot* > *Connected devices*.

Overview of available hotspots

Display available hotspots

- > Tap **MENU** > > *Wi-Fi* > *Wi-Fi*.



A Previously connected hotspots

B Available hotspots

C The hotspot supports the WPS connection

Currently connected hotspot

Delete information about the hotspot connection

Wi-Fi signal strength of the hotspot

The Wi-Fi signal from the hotspot is not available

Function restriction

The Infotainment system can only be connected to a hotspot with WPA2 access protection.

Settings

Connect a mobile device to the Infotainment hotspot

- ▶ Turn on the Infotainment's Wi-Fi hotspot in the menu item **MENU** >  > Wi-Fi > Infotainment system as hotspot > Use as hotspot.
- ▶ Turn on the Wi-Fi on the mobile device.
- ▶ In the list of available Wi-Fi devices, look for Infotainment Wi-Fi.

The name of the Infotainment is taken from the menu item **MENU** >  > Wi-Fi > Infotainment system as hotspot > Network name.

- ▶ Select the Infotainment hotspot and enter the required password.

The password for connecting to the Infotainment hotspot is taken from the menu item **MENU** >  > Wi-Fi > Infotainment system as hotspot > Network key.

- ▶ Confirm the connection.

Connect Infotainment to the mobile device hotspot

- ▶ Turn on the Infotainment's Wi-Fi unit in the menu item **MENU** >  > Wi-Fi > Wi-Fi: Turn on > Wi-Fi on.
- ▶ Select the desired hotspot in the list of available hotspots.
- ▶ Enter the password for connecting to mobile devices.

I Infotainment stores passwords for previously connected hotspots.

Security level of the Infotainment hotspot

The security level is factory-set at WPA2 and cannot be changed.

Activate/deactivate data transfer between the Infotainment and the connected device

- ▶ To turn data transmission on or off, tap **MENU** >  > Wi-Fi > Infotainment system as hotspot > Connected devices > .

Change the name of the Infotainment hotspot

- ▶ Tap **MENU** >  > Wi-Fi > Infotainment system as hotspot > Network name.

- ▶ Enter the name and confirm.

Change password for connection to Infotainment hotspot

The password must be a minimum of 8 and a maximum of 63 characters.

- ▶ Tap **MENU** >  > Wi-Fi > Infotainment system as hotspot > Network key.
- ▶ Enter the password and confirm.

Quick connection of Infotainment to the mobile device hotspot

- ▶ On the mobile device, turn on the hotspot, its visibility, and the option for WPS connection.
- ▶ **MENU** >  > Wi-Fi > Wi-Fi: Tap > WPS quick connection (WPS button).



Automatic WPS connection

- ▶ Tap **MENU** >  > Wi-Fi > Quick connection to Infotainment system.
- ▶ In the mobile device, switch on the option for connection via WPS.
- ▶ Wait for the connection to be established and, if necessary, confirm the respective messages.

Manual WPS connection

- ▶ In the mobile device, switch on the option for connection via WPS PIN.

The mobile device display will show the WPS PIN for connecting to the Infotainment.

- ▶ Tap **MENU** >  > Wi-Fi > Quick connection to Infotainment system >  > WPS PIN.
- ▶ Enter the WPS PIN in the Infotainment and confirm.
- ▶ Wait for the connection to be established and, if necessary, confirm the respective messages.

Automatic connection using the QR code

- ▶ Tap **MENU** >  > Wi-Fi > Quick connection to Infotainment system.
- ▶ In the mobile device, switch on the option for connection via QR Code.
- ▶ With the mobile device, read the QR code displayed on the Infotainment screen.
- ▶ Wait for the connection to be established and, if necessary, confirm the respective messages.

Tips for a perfect connection

- I**
- ▶ Keep only the hotspot to be connected switched on and switch off the other hotspots.
- ▶ Delete unused hotspots. This shortens the time required to establish a connection.
- ▶ For some hotspots, the connection takes longer, so wait for the connection to finish.
- ▶ If the connection is interrupted, recheck the available hotspots and repeat the connection.

SmartLink

Functionality

SmartLink offers the ability to display and operate certified applications from a connected mobile device in the Infotainment screen.

Certification may be conditional upon the use of the latest update to the particular SmartLink application.

Applications include, for example, apps for route guidance, telephoning, listening to music, etc.

Mobile devices can be connected via a USB cable or Wi-Fi.

Supported connection types

SmartLink supports the following connection types.

- ▶ Android Auto.
- ▶ Apple CarPlay.
- ▶ MirrorLink.

Overview of the SmartLink connection

Main menu SmartLink

▶ Tap on MENU > .



- A** Previously connected device
- B** Currently connected device
- ⓘ Display information about SmartLink
- 🔌 Separation of the active connection
- ⚙️ Settings for the SmartLink menu

Android Auto

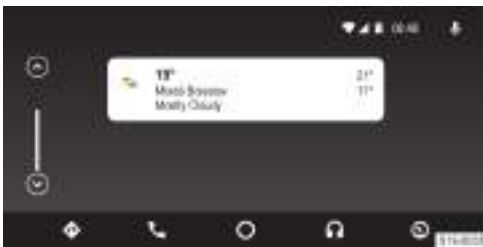

- 📍 Navigation applications
- ☎️ Telephone applications
- Overview of running applications, phone calls, incoming text messages, and more.
- 🎵 Music applications
- ⓘ Display of other available applications as well as the option to return to the SmartLink main menu
- 🗣️ Turn on voice control (Google Voice)

Apple CarPlay



- A** List of available applications
- Depending on the duration of operation:
 - ▶ **Tap:** Return to the Apple CarPlay main menu
 - ▶ **Hold:** Turn on voice control (Siri)

MirrorLink



- ⊖ It is not possible to operate the application while driving
- 🏠 Return to the SmartLink main menu
- 📺 List of running applications
- 📄 Display of the last running application in connected mobile devices
- ⚙️ Settings

Connection conditions

General connection conditions

- ✓ The mobile device supports the following SmartLink connection types: Android Auto, Apple CarPlay and MirrorLink.
- ✓ Mobile devices, as well as the type of SmartLinkconnection, are supported in the respective market.
- ✓ Some connected mobile devices require the mobile device to be "unlocked".

Conditions for Android Auto

- ✓ The device to be connected must have Android AutoSupport.

A list of devices, supported regions and applications that the Android Auto connection supports can be found on the websites of Google Inc..

- ✓ The Android Auto application needs to be installed on the mobile device.
- ✓ Some applications require the data connection in the mobile device to be turned on.

Conditions for Apple CarPlay

- ✓ The device to be connected must have Apple CarPlaySupport.
- A list of devices, supported regions and applications that the Apple CarPlay connection supports can be found on the websites of Apple Inc..
- ✓ Siri voice control is on.
 - ✓ The data connection is switched on in the mobile device.

Conditions for MirrorLink

- ✓ The device to be connected must have Mirror-LinkSupport.
- A list of devices and applications that the Mirror-Link connection supports can be found on the websites of Car Connectivity Consortium®.
- ✓ The MirrorLink application needs to be installed on the mobile device.
 - ✓ Some applications require the data connection in the connected mobile device to be turned on.

Operation

Operation of the running MirrorLink application

- Display of control surfaces at the bottom
- Display of control surfaces at the top
- ☰ Return to the MirrorLink main menu

Restriction

Restriction of the navigation function

If route guidance is currently being carried out through Infotainment, this is ended when you start route guidance in the Apple CarPlay application.

If there is route guidance in the Apple CarPlay application, it is ended by starting the destination guidance using Infotainment.

Restriction of SmartLink applications while driving

For safety reasons, operation of some SmartLinkapplications while driving is not possible or is restricted.

SmartLink settings

Apple CarPlay - Connection via USB

- › Turn on the Infotainment.
- › Turn on the mobile device.
- › Connect the mobile device to the front USB input using a cable.
- › Choose to connect via Apple CarPlay.

Apple CarPlay - Connection via Wi-Fi from Infotainment

- › Turn on Bluetooth® and Bluetooth® visibility in the Apple mobile device.
- › Tap on **MENU** > > *Manage mobile devices*.
- › In the displayed list, look for and select the desired device with the symbol .
- › Follow the instructions on the Infotainment screen and confirm the Bluetooth® pairing.
- › If another device is connected to the Infotainment, select the device to be replaced.

Apple CarPlay - Connection via Wi-Fi from mobile devices

To establish a connection, the following conditions must be met.

- ✓ The minimum iOS version is 9.
- ✓ No other mobile device can be connected via SmartLink.
- ✓ Wi-Fi and Bluetooth® functionality is switched on in the Infotainment system.
- › In the mobile device, turn on the CarPlay function.
- › Press and hold the button on the multifunction steering wheel.

The Infotainment screen displays a connection message with the name of the Bluetooth® unit of the Infotainment.

- › Find available Bluetooth® devices on the phone.
- › Select the Infotainment Bluetooth® unit.
- › If necessary, confirm the PIN.
- › In the Infotainment screen, select the connection type Apple CarPlay.

Apple CarPlay – Disconnection

- › In the Apple CarPlay main menu, tap on the “ŠKODA” functional area.
- › Tap on .

Android Auto - Connection via USB

- › Turn on the Infotainment.
- › Turn on the mobile device.
- › Connect the mobile device to the front USB input using a cable.
- › Choose to connect via Android Auto.



Android Auto - Disconnection

- › In the main menu of Android Auto > tap on “Return to ŠKODA”.
- › Tap on .

MirrorLink - Connection via USB

- › Turn on the Infotainment.
- › Turn on the mobile device.
- › Connect the mobile device to the front USB input using a cable.
- › Choose to connect through MirrorLink.

MirrorLink - Disconnection

- › In the MirrorLink main menu, tap .
- › Tap on .

Change to another device / connection type

Infotainment allows you to switch between currently connected devices and the connection type.

- › Tap on **MENU** › .
- › Select the desired device or connection type.

ŠKODA Connect online services**Functionality**

ŠKODA Connect online service offer the option of connecting the vehicle to the online world. They thus represent an extension of the vehicle and Infotainment functions.

For ŠKODA Connect Services functionality, the vehicle must be within range of a mobile network through which the ŠKODA Connect Services are provided. The availability, functioning, connection speed and technology used in the mobile network can be different in the respective countries and are dependent on the mobile network operator.

The ŠKODA Connect online services are not included in the equipment of the vehicle. These will be published separately on the ŠKODA Connect Portal website, in the ŠKODA Connect application or ordered in Infotainment.

The offer of ŠKODA Connect online services depends on the type of vehicle and its trim level, Infotainment and country. Availability in each country can be checked on the ŠKODA Connect website.

The rights and obligations of the Parties with respect to the provision of these services are governed by a separate agreement. Current legal documents regarding the online services can be found on the ŠKODA Connect Portal as well as the ŠKODA Connect application.

ŠKODA Connect website

- ▶ <http://go.skoda.eu/skoda-connect>



For example, the ŠKODA Connect website contains the latest information about the online services, a link to the ŠKODA Connect Portal as well as the option of downloading the ŠKODA Connect application.

ŠKODA Connect Portal website

- ▶ <http://go.skoda.eu/connect-portal>



The ŠKODA Connect Portal website is used, for example, for registration, activation and ordering of online services. It

also provides the option of remote access to the vehicle.

Information call

The information call may be used in the case of problems with the online services or for information regarding the products and services of the ŠKODA brand.

- ✓ The functional condition represents the active online ŠKODA Connect services.



- › Press the **i** button.

Breakdown call

The breakdown call can be used in the event of a breakdown.

- ✓ The functional condition represents the active online ŠKODA Connect services.



- › Press the **A** button.

ŠKODA Connect Application

The ŠKODA Connect application enables remote access to the vehicle using a mobile device. It can also be used for user registration and to activate and configure the online services.

The application can be downloaded to the mobile device after scanning the following QR code or link.

- ▶ <http://go.skoda.eu/skodaconnectapp>

**Settings**

Use of the ŠKODA Connect online services requires **prior registration of the main user** and subsequent **activation of the online services**.

Registration and activation of online services

User registration and activating ŠKODA Connect online services is carried out on the ŠKODA Connect Portal website, in the ŠKODA Connect application, or in Infotainment.

In order to complete user registration, you will need to access your e-mails.

To activate ŠKODA Connect online services in the vehicle, two original keys from your vehicle are required.

Registering and activating online services in infotainment - no user

- › Turn on the Infotainment.
- › In the welcome window that appears, tap *Register*.
- › Enter the required information and confirm.
- › Follow the instructions on the screen.

Registration and activation of online services in Infotainment - new user

- › Turn on the Infotainment.
- › Tap **MENU** > > > *New user*.
- › Enter the required information and confirm.
- › Follow the instructions on the screen.

Delete user

- › Tap **MENU** > > > *Delete user*.
- › Select the user and confirm the deletion.

Connection status of the online services

The status of the connection to the ŠKODA Connect online services is displayed by the discolouration of the symbol shown in the status bar on the Infotainment screen.

- ▶ **White** - online services are available.
- ▶ **Grey** - online services are not available.

Setting the personal data protection level

The level of protection of personal data in ŠKODA Connect online services is indicated by an icon in the status bar on the Infotainment screen.



- › Open the Infotainment control enter by holding down the bar at the top of the screen and pulling it down.

› To **Display information**, tap for the respective protection levels.



- › To display the menu for **Setting the protection level**, tap the symbol.
- › Select one of the following options for sending vehicle and user data.
 - Send only the legally required data.
 - Send the vehicle and user data.
 - Send the vehicle and user data as well as the data regarding the vehicle position.
 - Division of vehicle position data on the website ŠKODA Connect Portal and in the ŠKODA Connect application .

Switching the online service data connection on / off

For ŠKODA Connect online services, the prepaid data connection for online services can be used.

- › Tap **MENU** > > *Data connection* > *Integrated data connection (eSIM)*.

Overview of online service data connection usage

- › To display, tap **MENU** > > *Data connection* > *Data plans*.

Navigation

Navigation announcements

Infotainment route guidance takes place using graphic driving recommendations and navigation announcements.

The navigation announcements are generated by the Infotainment system. Navigation announcement clarity (e.g. road or city name) cannot always be guaranteed.

Repeat the last navigation announcement

- › Tap on ... > .

Turn off navigation announcements

- › Tap on ... > .

Navigation overviews

Display main menu

- › Tap on **MENU** > .

Map overview



- A** Vehicle position
- B** Route
- C** Route view
- 📍 End route guidance
- D** Display the destination input and route view menu
- E** Traffic obstruction
- F** Following driving recommendation
- G** POI
- H** Change map orientation
 - ▶ North-facing 2D map
 - ▶ 2D map facing the direction of travel
 - ▶ 3D map facing the direction of travel
- I** Road sign for the affected route section
- 🔍 Find destination
- 📍 Centre the map on the vehicle position
- ⋮ **Displaying the settings menu**
 - 🔊 Turn off navigation announcements
 - 🔁 Repeat the last navigation announcement
 - 📍 Show the default map
 - 🔋 Show map with information about range using electric drive
- J** Display map in accordance with the following setting
 - ▶ Auto - Map in day / night mode depending on the vehicle lighting currently switched on
 - ▶ Day - Map in day mode
 - ▶ Night - Map in night mode
- 📏 Show the entire route
- K** End route guidance
- ⚙️ Settings

Map with information about range using electric drive

The map shows the estimated range achievable using the electric drive if using highlighted sections.

- ▶ Tap on ⋮ > 🔋.



Find destination

- ▶ Tap on ▶ > 🔍.



- A** Input line
- B** List of destinations that have recently been searched for
- C** POI categories
 - ▶ **Tap:** search for the selected category
 - √ Show destination list
 - 📍 Enter destination via address / find destination

Select the destination you are looking for

- ▶ Enter the details for the destination search.
- ▶ Select the desired destination.

Destination details are displayed with the option of starting route guidance.

Selecting the destination entered via the address

- ▶ Tap on 📍.

A menu for entering the destination via the address is displayed.

- ▶ Enter the required information.

Destination details are displayed with the option of starting route guidance.

List of stored destinations

- ▶ Tap on ▶ > 📍.



- A** List of stored destinations
- B** Select category of stored destinations
 - ▶ ☆ - Favourites
 - ▶ 📍 - Last destinations
 - ▶ 📞 - Telephone contact destinations

Selecting the stored destination

- ▶ Select the category of stored destinations.
- ▶ Select the desired destination.

Destination details are displayed with the option of starting route guidance.

Recommended destinations

- ▶ Tap on ▶ > 🏠.

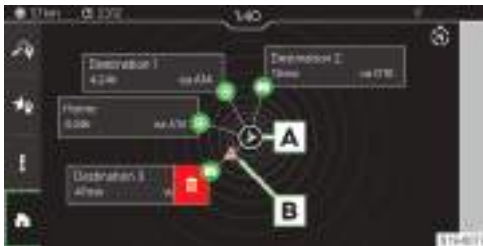

- A** North-facing vehicle position
- B** Traffic obstruction
- ☰ Delete the recommended destination

The view can display up to 5 recommended destinations in the following categories.

- ▶ Home address destination.
- ▶ Business address destination.
- ▶ Favourites.
- ▶ Last destinations.

Destination alignment depends on the direction in relation to the current vehicle position. The functional surface with the destination displays information about the estimated travel time to the destination.

If the vehicle has active online services and there is a traffic obstruction on the route to the destination, the traffic obstruction icon will be displayed.

Delete the recommended destination

- ▶ Touch the functional surface for the recommended destination and swipe left.
- ▶ Tap on ☰.

Selecting destination by tapping the map point

- ▶ Tap the desired item or the POI icon in the map.



- A** Show destination details with the following possible settings
 - ▶ ☆ - Save destination as a favourite
 - ▶ ★ - Delete favourites
 - ▶ 📍 - Set destination as a starting point for route guidance in demo mode
- B** Start direct route guidance
- C** Route calculation

Route calculation



- A** Current vehicle position
- B** Proposed fastest route
- C** Alternative routes
- D** Destination position
- E** 15 s time countdown before automatic start of the route guidance
 - ▶ Tap: Interrupt time countdown
- F** Start route guidance
 - ☰ Show information on the selected route
 - ⌘ Set parameters for route calculation

Route overview

- ▶ Tap on ▶ > i.

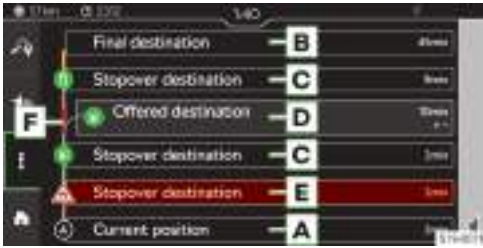

- A** Information on current vehicle position
- B** Final route destination
Tap: the following menu items can be selected.
 - › Show on map
 - › Stop route guidance
- C** Destination provided by Infotainment on the route
Tap: the following menu items can be selected.
 - › Show on map
 - › Add stopover destination
- D** Route stopover
Tap: the following menu items can be selected.
 - › Show on map
 - › Delete
- E** Traffic obstruction on the route
Tap: the following menu items can be selected.
 - › Show on map
 - › Avoid
- F** Route view

Changing route destinations

In the route overview, it is possible to exchange the destination and the intermediate destinations with each other and thus change their order.

- › Hold the line with the desired destination until the functional surface for the destination becomes free.
- › Move the destination to the desired position and release the functional surface.

The route is re-calculated.

Overview of traffic density

When ŠKODA online services are activated, traffic density information can be displayed in the form of the following colour scale in the route view **F**.

Low density — — — — **High density**

— Traffic density information is not available

Touch operation

Gesture control



▶ Move the map.



▶ Enter destination by tapping the map item.



▶ Switch 2D/3D map display.



▶ Zoom in to the map.



▶ Zoom out of the map.



▶ Rotate the map.

Restriction

Infotainment may give incorrect driving recommendations if the road conditions or the traffic do not match the navigation data. This can lead to the route guidance being carried out using a different route or proposing a change of direction in a one-way street.

Information for updating the navigation data must be requested from a ŠKODA partner.

Settings

Avoiding traffic obstructions

If the function is switched on and the Infotainment receives information about a traffic obstruction on the route from online traffic information, the route is recalculated.

Infotainment may suggest a detour to avoid traffic obstructions, depending on the following settings.

- › Tap ... ›  › *Route guidance* › *Avoid traffic congestion*.
- › Select the desired menu item.

Showing information on the destination / waypoint

The status line displays information on the distance and travel time to the destination, depending on the following setting.

- › Tap ... ›  › *Route guidance* › *Show information for...*
- › Select the desired menu item for the destination type.

Showing arrival time information in the destination / driving time

The status line displays information on the travel time depending on the following setting.

- › Tap ... ›  › *Route guidance* › *Time display...*
- › Select the desired menu item.

Switching display of country-specific speed limits on / off

When the function is switched on, the country-specific speed limits are displayed when crossing national borders.

- › Tap ... ›  › *Route guidance* › *Country information at border crossings*.

Switching the display of road signs on motorways and expressways on / off

When the function is switched on, Infotainment displays traffic and information signs on motorways and expressways.

- › Tap ... ›  › *Route guidance* › *Information signs on motorways and dual carriageways*.

Switching the fuel warning on / off

When the function is switched on and the fuel supply reaches the reserve area, a warning message appears with the option of going to the nearest petrol station.

- › Tap ... ›  › *Route guidance* › *Fuel warning*.

Switching the speed limit warning on / off

- › Tap ... ›  › *Route guidance* › *Road signs*.

- › Set the note type and the value for exceeding the permissible speed.

Settings for trailer operation

To calculate the correct route for trailer operation, switch on trailer inclusion.

- › Tap ... ›  › *Route guidance* › *Trailer* › *Include trailer*.

Set the maximum speed for trailer operation to correctly calculate the route time.

- › Tap ... ›  › *Route guidance* › *Trailer* › *Maximum speed for trailers*.
- › Set the maximum speed for the trailer.

Setting navigation announcements

- › Tap ... ›  › *navigation announcements*.
- › Select and set the desired menu item.



Show preferred POI categories

Favourite POI categories are displayed on the map and provided in the destination search.

- › Tap ... ›  › *Basic functions* › *Define preferred POI categories*.
- › Set favourite categories.

Show charging stations

The charging stations can be displayed on the map.

- › Tap ... ›  › *Basic functions* › *Define preferred POI categories*.
- › Choose category .

Setting home address

The defined destination of the home address is displayed in the overview of recommended destinations.

- › Tap ... ›  › *Basic functions* › *Enter home address*.

Setting business address

The defined destination of the business address is displayed in the overview of recommended destinations.

- › Tap ... ›  › *Basic functions* › *Enter business address*.

Switching demo mode on / off

In demo mode, the route guidance from the starting point of the demo mode to the selected destination is simulated.

When the function is switched on, Infotainment issues a query before the start of route guidance as to where whether the route guidance should be carried out in the normal way or in demo mode.

- › Tap ... ›  › *Basic functions* › *Demo mode*.

Defining the starting point of the demo mode

- › Select or locate the desired destination to be the starting point of demo mode.
- › In the displayed destination details, tap *More* › .

Updating the navigation database

Information on updating the navigation database must be requested from a ŠKODA partner, or refer to the following ŠKODA websites.

- ▶ <http://go.skoda.eu/updateportal>

Automatic update

Infotainment automatically offers an update option if the following conditions are met.

- ✓ The “Infotainment Online” online services are activated.
- ✓ An update of the navigation database for the current vehicle position or route destination is available.

Determining the navigation database version

- › Tap **MENU** ›  › System information.

Starting and driving

Start

Notes on starting

⚠ DANGER

Danger of poisoning by exhaust gases!

- ▶ Do not run the combustion engine in an enclosed space.

Operating conditions

- ✓ The vehicle key is located in the vehicle interior.

① NOTICE

Risk of key loss, possibly of key damage!

The system can detect the key even if it has been forgotten on the vehicle roof.

- ▶ Always keep the key with you.

Switching the ignition on and off



- › Press the starter button.

Start

- › Secure the vehicle with the parking brake.
- › Keep the brake pedal depressed.
- › Move the selector lever to position **P** or **N**.
- › Press the starter button.

ⓘ At temperatures above approx. -10°C and with a sufficient state of charge of the high-voltage battery, only the electric motor will start up after starting. The start of the electric motor is displayed as follows.

- ▶ At the same time, an audible signal is emitted.
- ▶ The pointer of the power indicator moves to **0**.
- ▶ The **READY** menu is shown on the instrument cluster display.

① NOTICE

With very low outdoor temperatures, the temperature of the high-voltage battery may drop so low that it may no longer be possible to start the engine. Starting the engine again is only possible when the temperature of the high-voltage battery has risen sufficiently.

⚠ CAUTION

Danger of unexpected vehicle movement!

- ▶ At temperatures below -10°C , start the vehicle with the selector lever in the **P** position.

Stopping the engine

- › Secure the vehicle with the parking brake.
- › Press the starter button.

⚠ WARNING

Steering lock hazard!

- ▶ During a journey with the engine stopped, the ignition must always be switched on.

Starting issues

Troubleshooting

ⓘ NOTICE

Danger of engine damage!

- ▶ Do not start the vehicle by towing.

The engine does not start

- ▶ Switch off the ignition.
- ▶ Wait 30 seconds and repeat the starting procedure.
- ▶ If the engine does not start, use the jump start cables with the battery of another vehicle » [page 158](#) or seek the help of a specialist garage.

The engine does not start, the display shows a message regarding the immobilizer

- ▶ Use the other vehicle key.
- ▶ If the engine does not start, seek the help of a specialist garage.

Starting is not possible with the starter button, the system did not detect the key



- ▶ Press the starter button with the key.
- ▶ If the engine does not start, seek the help of a specialist garage.

i The key might not be detected if the battery in the key is nearly discharged or the signal is faulty.

The engine cannot be turned off with the starter button

- ▶ Hold the starter button or press twice.

The radiator fan keeps running even after the engine has stopped

The radiator fan can continue to run for approximately 10 minutes after the engine is stopped. This is not a defect.

The combustion engine makes noises after the cold start

The increased running noise is due to the briefly increased engine speed. This is not a defect.

Automatic gearbox

Lever positions

**P Parked vehicle**

The drive wheels are locked.

P Only set the position when the vehicle is stationary.

R Reverse gear

R Only set the position when the vehicle is stationary.

N Neutral

There is no transmission of engine power to the wheels.

D/B Forward drive/forward drive with recuperation

The gear is changed automatically.

In **B** mode, recuperation braking occurs when driving downhill and when rolling to a stop. This will re-charge the high-voltage battery.

The recuperation braking can also be done when pressing the brake pedal.

▽ Choose between **D** and **B** (spring-loaded position)

Moving the selector lever out of the **P** or **N** position



lights up - the selector lever is locked



- ▶ Press the brake pedal, and at the same time, press the button in the selector lever.

⚠ WARNING

Risk of the stationary vehicle rolling away automatically!

- ▶ When the selector lever is in the **D/B** position, **R** position or in manual shift mode, secure the vehicle with the brake.

Operation

Starting up

- ▶ Keep the brake pedal depressed.
- ▶ Start the engine.
- ▶ Press the button in the selector lever and set it to the desired position.
- ▶ Release the brake pedal and press the accelerator pedal lightly.

Speeding up while driving (kick-down)

- › Fully depress the accelerator.

In the instrument cluster display,  is shown.

Stopping temporarily (e.g. at a junction)

- › Leave the selector lever in the **D/B** position and secure the vehicle with the brake pedal.

Stopping

- › Keep the brake pedal depressed.
- › Secure the vehicle with the parking brake.
- › Press the button in the selector lever and set it to the **P** position.
- › Turn off the engine.

Driving in neutral

If the system detects that no gear is engaged while driving, it automatically switches to neutral position.



Requirements for driving in neutral position

- ✓ **D** mode is chosen.
- ✓ Neither the accelerator nor the brake pedal is pressed.
- ✓ The vehicle speed is 20-130 km/h.
- ✓ There is no device connected to the trailer socket.

Manually switching gear with the selector lever





- › To **turn on**, put the selector lever in the **D/B** position to the right (to the left for right-hand drive vehicles).
- › To **turn off**, put the selector lever back in the **D/B** position.



-  Changing up a gear
-  Changing down a gear

Manually changing gear with the shift paddles on the steering wheel



-  Changing down a gear
-  Changing up a gear
- › To switch on the **rock-er switch**, press  or .
- › To **Turn off** the rocker switch, hold .

If none of the shift paddles are pressed for a certain time, manual shift mode turns off automatically.

If the engine threatens to over-rev



- ▶ The gearbox automatically changes to the next higher gear.
- ▶ The transmission prevents changing to the next lower gear.



Troubleshooting

The selector lever cannot be moved out of position P in the normal way

- › Mechanically unlock the selector lever » [page 122](#).



Gearbox overheated

-  illuminates together with  Message regarding the gearbox overheating
- › You may continue driving, exercising appropriate caution.



-  illuminates together with  Message regarding the gearbox overheating

- › Stop driving! Stop the vehicle and stop the engine.
- › After the indicator light goes out, your journey can continue.
- › If the warning light does not go out, stop driving! Seek the help of a specialist garage.

Gearbox impaired

-  illuminates together with  Message regarding the gearbox in emergency mode

- › You may continue driving, exercising appropriate caution.
- › Immediately seek the help of a specialist garage.

-  illuminates together with  Message regarding a gearbox fault

- › Stop driving! Seek the help of a specialist garage.

Recuperation error

-  illuminates Message regarding a recuperation fault

- › Seek the help of a specialist garage.

Starting up a vehicle that is stuck

- › Adjust the selector lever between **D/B** and **R**. The vehicle will then start to rock and be easier to free.

Mechanical selector lever release

- › Secure the vehicle with the parking brake.
- › Open the stowage compartment in the front centre console.



- › Insert a flat-head screwdriver or push a similar tool into the gap in the area of arrow **A**.
- › Carefully loosen and lift the quadrant cover.



- › Press on the plastic part in the direction of the arrow and at the same time press the button on the selector lever.
- › Put the selector lever in **N** position.

Vehicle driving mode

Usage

The driving mode offers the possibility of adapting the driving behaviour to the desired driving style.

Overview

Information about the selected driving mode is displayed in the status bar in the Infotainment screen as well as in the digital instrument cluster.

Eco mode

Eco mode is suitable for a relaxed driving style and helps to save fuel.

Comfort mode

Comfort mode is suitable for driving on roads with poorer surface or for long motorway journeys.

Normal mode

Normal mode is suitable for a normal driving style.

Sports mode

SportsMode is suitable for a sporty driving style, and this makes it possible to use the maximum power of the hybrid drive.

When switched on, the SportsMode is illuminated  in the instrument cluster.

Individual mode

Individual mode allows the individual configuration of certain vehicle systems.

Operation

Select driving mode

- › Press the  button.

In the Infotainment, a driving mode menu appears.

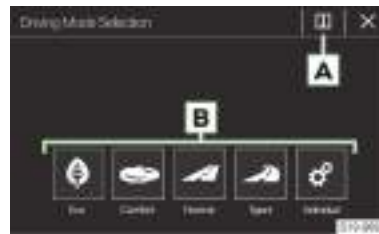

- A** Information on the system settings of the currently selected mode/system settings for the selected Individual mode

- B** Driving mode menu

- › Tap the relevant function surface **B**.



Or:

- › Press the  button again.

- i** Sport mode can also be activated by pressing the button .

Troubleshooting

Adaptive DCC suspension faulty

 illuminates together with .

- › Drive on, exercising appropriate caution. Seek the help of a specialist garage.

Select Drive

Operation

Select drive and use high-voltage battery



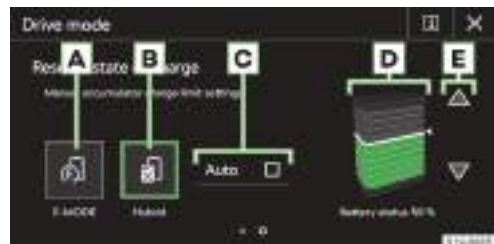

- › Press the  button.

The following menu will be displayed.



- A** Driving using electric drive

 is illuminated in the instrument cluster

- B** Driving with hybrid drive - combination of electric and combustion engine
- C** Use of high-voltage battery
 - ▶ Energy is automatically drawn from the high-voltage battery
 -  is illuminated in the instrument cluster
 - ▶ Manual setting of the desired charging state of the high-voltage battery
 -  is illuminated in the instrument cluster - charging the high-voltage battery
 -  is illuminated in the instrument cluster - Maintains the charging status of the high-voltage battery
 -  is illuminated in the instrument cluster - discharging the high-voltage battery
- D** Charging status of the high-voltage battery
- E** If there is **no** hook in the field **C** set, the arrow keys can be used to select **E** the charging status of the high-voltage battery to be kept by the system. This can lead to increased fuel consumption.

Requirements for driving with electric drive

- ✓ The high-voltage battery charging status is sufficient.
- ✓ The driving speed is lower than 130 km/h.
- ✓ The Sports driving mode is not selected.
- i** At temperatures below -10 °C, the electric drive function may not be available.
-  is illuminated - one of the requirements for driving with electric drive is not met

Requirements for driving with hybrid drive

- ✓ The amount of fuel in the fuel tank is sufficient.

Economical driving style

Tips for economical driving and evaluation of driving economy

Tips for economical driving

- ▶ Avoid unnecessary acceleration and braking.
- ▶ Use the **B** mode of the automatic transmission to decelerate. This will charge the high-voltage battery.
- ▶ Avoid full acceleration and too high speeds.
- ▶ Turn off the engine for longer periods.
- ▶ Observe the prescribed tyre pressure » page 166, *Sticker with prescribed tyre pressures.*

- ▶ Remove unnecessary ballast.
- ▶ Remove the roof rack when it is not needed.
- ▶ Switch on electric consumers for as long as necessary.
- ▶ Do not leave the windows open while driving.



Display of evaluation in the infotainment screen

CAR >  > DriveGreen

Or:

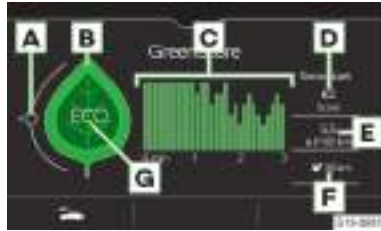
MENU >  >  > Drive Green



- A** **A driving liquid display**
With the driving is fluid, the display is located near the green dot.
- B** **Leaf**
The greener the leaf, the more economic the driving style. Tapping the screen near the leaf displays tips for reducing fuel consumption and energy consumption.
- C** **Driving efficiency chart**
Each bar indicates driving efficiency in 5 second increments. The current bar is on the left. The higher the green bars, the more economical the driving style.
- D** **Point value (0-100)**
The higher the indicated value, the more economical the driving style. Tapping the screen near the value **D** displays a rating for the last 30 minutes of driving.
- E** **Average fuel consumption**
Tapping the screen near the value **E** displays the average consumption during the last 30 minutes of driving.
- F** **Display of the range exclusively with electric drive**
- G** **Information about the current driving style**
 - ▶ **ECO** Economical driving style
 - ▶  The speed has a negative effect on fuel consumption
 - ▶  The ride is not smooth
 - ▶  Recommended gear

Consumption-friendly driving

In the following situations, a small reduction in fuel consumption occurs.  in the instrument cluster lights up.

- ▶ Active cylinder management has temporarily disabled some cylinders in the engine (applies to certain engine types).
- ▶ A vehicle with automatic transmission, rolls in neutral position.

Towing a trailer**What you should be mindful of****⚠ WARNING**

When driving with a trailer, special care is required!

ⓘ NOTICE

With frequent towing, the vehicle is excessively loaded so this must also be checked between service intervals.

Recommendations for using a trailer

- ▶ Adjust the tyre pressure on the vehicle for full load.
- ▶ Do not exceed the maximum permissible total weight of the vehicle and the combination weight specified in the technical vehicle documentation (e.g. in the vehicle registration documentation, in the COC document) and on the type plate.
- ▶ For trailer operation, consider the current load condition of the vehicle as well as the distribution of

the load in the trailer. The coupled trailer increases the rear axle load and can therefore reduce the payload.

- ▶ Adjust the headlight range of the headlights according to the load status of the vehicle. The front of the vehicle may lift up when a trailer is being towed and the headlights may dazzle other road users.
- ▶ A speed of **100 km/h** should not be exceeded.
- ▶ Reduce the speed by releasing the accelerator pedal as soon as a pendulum movement of the trailer is noticeable. Never attempt to stop the trailer from swaying by accelerating.
- ▶ If the traffic area behind the trailer can not be viewed, install additional exterior mirrors.
- ▶ Apply the brakes in good time. If the trailer is fitted with a trailer brake, apply the brakes gently at first, then brake firmly. This will avoid brake jolts resulting from the trailer wheels locking.
- ▶ Select a lower gear before descending to also use the braking force of the engine.

Distribution of the load over the vehicle and trailer combination

- ▶ Secure heavy objects against slipping, as close to the trailer axle as possible.
- ▶ Transport small and light objects in the luggage compartment.

Permitted trailer loads

The details in the technical vehicle documentation take precedence over the information in this Owner's Manual.

⚠ WARNING

Risk of an accident!

- ▶ Do not exceed the permissible trailer load.

| Permissible trailer load, braked (kg) ^{a)} | Permissible trailer load, unbraked (kg) |
|---|---|
| 1600 | 750 |
| ^{a)} With gradients up to 12%. | |

Towing eye and towing procedure

Towing eye

Removing the front cap



- › Press on the cap and remove it.

Removing the rear cap



- › Press on the cap and remove it.

Installing the towing eye



- › Screw in the towing eye.
- › Insert the wheel wrench or similar object through the towing eye.
- › Tighten the towing eye.

After the towing process

- › Unscrew the towing eye.
- › Insert the cover cap.

Towing the vehicle

⚠ WARNING

Risk of an accident!

- ▶ The tow rope must not be twisted.
- ▶ When towing, drive at a speed of max. 50 km/h.

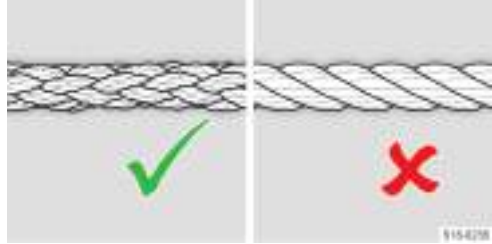

⚠ WARNING

Risk of an accident!

- ▶ Use a braided synthetic fibre rope for towing. Do not use a twisted tow rope.

① NOTICE

- ▶ Always keep the tow rope taut during the towing procedure.
- ▶ Do not exceed a towing distance of 50 km.

① NOTICE

Danger of gearbox damage!

- ▶ If the gearbox no longer contains any oil, the vehicle must only be towed with the front axle raised clear of the ground or transported on a special breakdown vehicle.
- ▶ The vehicle must not be towed when the rear axle is raised.

Where should the tow rope or the tow bar be secured?

- ▶ At the front towing eye.
- ▶ At the rear towing eye.
- ▶ On the ball bar of the factory-installed towing hitch.

Information for the driver of the towing vehicle

- › Drive slowly and smoothly.
- › Only accelerate once the rope is taut.

Information for the driver of the towed vehicle

⚠ WARNING

Risk of an accident!

When the ignition is switched off, the brake booster and the power steering do not work. In addition, there is a risk that the steering lock will engage.

- ▶ If it is not possible to start the engine, switch on the ignition!
- › Move the shift lever to the neutral position or the selector lever to the N position.

Brakes

What you should be mindful of

⚠ WARNING

Problems and faults with the brake system can extend the braking distance of the vehicle!

⚠ DANGER

Danger of the brakes overheating!

- ▶ Do not depress the brake pedal unless braking is required.
- ▶ If the standard front spoiler is damaged, ensure the air supply to the front brakes is guaranteed.

Checking the brake fluid level**Test conditions**

- ✓ Park the vehicle on a horizontal surface.
- ✓ Engine turned off.

Checking

The fill level must be within the marked range.

- ▶ If the level is below the mark **MIN**, do not continue.
- ▶ Do not refill liquid.
- ▶ Seek the help of a specialist garage.

If the brake fluid level is too low, this will be indicated in the instrument cluster by the illumination of

ⓘ. Nevertheless, we recommend checking the brake fluid level regularly directly at the reservoir.

Specification

The brake fluid must comply with the standard VW 501 14 (this standard meets the requirements of the standard FMVSS 116 DOT4).

Have the brake fluid **replaced** by a specialist garage.

⚠ WARNING

Danger of brake failure!

- ▶ If the brake fluid change date is exceeded, heavy braking may cause vapour bubbles to form in the brake system.
- ▶ If the fluid level falls significantly within a short time or drops below the mark **MIN**, the brake system may have become leaky.

Stop driving! Seek the help of a specialist garage.

Troubleshooting**Brake fluid level is too low**

ⓘ illuminates

- ▶ Stop driving! Seek the help of a specialist garage.

Brake system and anti-lock braking system faulty

ⓘ illuminates together with Ⓜ

- ▶ Stop driving! Seek the help of a specialist garage.

Worn brake pads

ⓘ illuminates

- ▶ Drive to a specialist garage, exercising appropriate caution.

Reduced braking effect

Damp, frozen, salt-affected or corroded brakes can impair the braking effect.

- ▶ Clean the brakes by braking several times if traffic conditions allow it.

When the engine is stopped, the brake booster does not work

- ▶ Depress the brake pedal more forcefully.

Electric parking brake**Operation****⚠ WARNING**

Danger of key locking!

- ▶ The recessed grip for the fingers in front of the button ⓘ must remain empty.

Switching on

- ▶ Pull the button ⓘ and hold it.

The following symbols light up.

- ▶ ⓘ in the button.
- ▶ ⓘ in the instrument cluster.

Automatic shut-off

The parking brake switches off automatically when starting up.

If automatic switch-off is to be prevented, e.g. when starting off on a slope, keep the button ⓘ pulled.

Conditions for automatic shutting down

- ✓ Driver's door is closed, in some cases, the driver's seat belt is also fastened.

Manual shut-down

- ▶ With the ignition switched on, press the brake pedal and at the same time push the ⓘ button.

Troubleshooting

Parking brake error

 is illuminated

Message regarding a parking brake error

- › Seek the help of a specialist garage.

Parking on a steep slope

 flashing

Notification regarding parking position on a steep slope

- › Go to another parking spot where there is less of a slope.

Noise when using the parking brake

Noise when using the parking brake is normal. This is not a defect.

The vehicle battery is discharged, the parking brake cannot be switched off

- › Connect the vehicle battery to a power source, such as the battery of another vehicle.

Emergency braking in case of faulty brake system

Switching on



- › Pull the button  and hold it.

The vehicle starts to brake **sharply** and an acoustic signal is sounded.

Switching off

- › Release the button .

Or:

- › Depress the accelerator pedal.

Auto Hold automatic holding function

Usage

Auto Hold automatically secures the vehicle from rolling away when stopped.

Functionality

WARNING

Risk of an accident!

Auto Hold is not able to stop the vehicle under all circumstances, such as on slippery ground, or on gradients.

Secure and release the vehicle

With **Stop**, the vehicle is automatically **secured** using Auto Hold.  is illuminated in the instrument cluster. The brake pedal can be released.

With **Start**, the vehicle is automatically **released** using Auto Hold.

Automatic protection from the parking brake

Under certain circumstances, the vehicle can be secured using the parking brake.  is illuminated in the instrument cluster.

Operating conditions

- ✓ The driver's door is closed.
- ✓ The engine is running.
- ✓ Auto Hold is activated.
- ✓ The selector lever is not in the **N** mode.

Settings

Activation/deactivation

- › Press the  button.

Activation displayed in the button by the illumination of the  symbol.

NOTICE

Disable Auto Hold to allow the vehicle to roll if necessary when driving through a car wash.

Driver assist systems

Braking and stabilising systems

Overview

Electronic Stability Control (ESC)

ESC helps to stabilize the vehicle in borderline situations (e.g. when the vehicle starts to skid). ESC brakes the individual wheels to maintain the direction of travel.



flashing - ESC is engaged

ESC Sport

ESC Sport allows for a sportier driving style.



lit up - ESC Sport is activated

Anti-Slip Regulation (ASR)

ASR helps to stabilize the vehicle when accelerating or driving on low-grip roads. ASR reduces the drive power transmitted to the wheels when the wheels spin.



flashing - ASR is engaged

Anti-lock Braking System (ABS)

ABS helps maintain control of the vehicle during emergency braking. An ABS intervention is noticeable by pulsating movements of the brake pedal.

Motor Slip Regulation (MSR)

MSR helps to maintain control of the vehicle in the event of a sudden reduction in speed, e.g. on icy roads. If the drive wheels lock, MSR increases the engine speed. As a result, the braking effect of the engine is reduced and the wheels can turn freely again.

Electronic Differential Lock (EDL)

EDL helps to stabilize the vehicle when driving on road surfaces with different grip under the individual wheels. EDL brakes a spinning wheel and transmits power to a different drive wheel.

Electronic Differential Lock (XDL+)

XDL + helps to stabilize the vehicle during fast cornering by braking the inside wheel of the driven axle.

Active steering assistance (DSR)

In difficult situations, the DSR provides the driver with a steering recommendation in order to stabilise the vehicle.

Hill Hold Control

Hill Hold Control helps when starting off on uphill gradients by braking the vehicle for about 2 seconds after the brake pedal is released.

Operating conditions

- ✓ The gradient is at least 5%.

- ✓ The driver's door is closed.

Multi-Collision Brake (MCB)

MCB helps to decelerate and stabilize the vehicle after a collision with an obstacle. This reduces the risk of further collisions.

Operating conditions

- ✓ There has been a frontal, side and rear collision of a certain severity.
- ✓ The impact speed was greater than 10 km/h.
- ✓ The brakes, ESC and other required systems remained functional after the impact.
- ✓ The accelerator pedal is not pressed.

Trailer Stability Assist (TSA)

TSA helps to stabilize the trailer. As the trailer begins to lurch, TSA stabilizes the trailer by slowing down the individual vehicle wheels.

Operating conditions

- ✓ The hitch was supplied from the factory or purchased from ŠKODA Genuine Accessories.
- ✓ The trailer is connected to the trailer socket.
- ✓ ASR activated.
- ✓ The driving speed is higher than 60 km/h.

Electromechanical brake booster (electronic brake force distribution)

electronic brake force distribution facilitates operation of the brake pedal. At the same time, charging of the high-voltage battery is made possible through recuperative braking.

After switching off the ignition, the electronic brake force distribution function is either restricted or not available.

i Should the vehicle be delayed by means of an assistance system, pulsating movements of the brake pedal may occur.

Regenerative braking

Regenerative braking produces energy that is stored in the high-voltage battery. The force of the braking effect depends on the selected driving mode, as well as the state of charge of the high-voltage battery.

During regenerative braking, pulsating movements of the brake pedal and fluctuating decelerations of the vehicle can occur.

Settings

Deactivating/activating ASR

The function is deactivated or activated in the following Infotainment menu.

CAR > > >

Or:

MENU > > >

When deactivating  lights up in the instrument cluster.

 goes out on renewed activation.

Deactivating the ASR may be helpful in the following situations.

- ▶ Driving with snow chains.
- ▶ Driving in deep snow or on very loose ground.
- ▶ Starting up a vehicle that is stuck.

Troubleshooting

ESC or ASR faulty/deactivated by the system

 illuminates

- ▶ Stop the engine and start again.



▶ If the indicator light does not go out after covering a short distance, seek the help of a specialist garage.

ABS faulty

 illuminates

- ▶ You may continue driving, exercising appropriate caution. Seek the help of a specialist garage.

Brake system and anti-lock braking system faulty

 illuminates together with 

- ▶ Stop driving! Seek the help of a specialist garage.

Electromechanical brake booster faulty

 illuminates

- ▶ Stop driving! Seek the help of a specialist garage.

Front Assist

Functionality

Front Assist monitors the distance to the vehicle ahead and points out when the safety distance is exceeded. In borderline situations, it helps to avoid a collision by braking interventions.

Status display in the instrument cluster display

 Illuminated - safety distance too small

 Illuminated - warning in case of collision

Automatic braking if there is a risk of a collision

If there is a risk of a collision, the following symbol  is illuminated as a warning. If you do not respond to the warning, the vehicle will slow down.

At a driving speed of up to 45 km/h, the vehicle is braked without prior warning.

Automatic braking can be stopped by pressing the accelerator pedal or by a steering intervention.

With automatic braking, the pressure in the brake system increases. The brake pedal can not be operated by using the pedal as normal.

⚠ WARNING

Risk of an accident!

Front Assist does not respond to crossing or oncoming vehicles.

Operating conditions

- ✓ ASR activated.
- ✓ The driving speed is higher than 5 km/h.

Function restriction

The function may be restricted or unavailable in the following cases.

- ▶ About 30 seconds after starting.
- ▶ When driving around a sharp bend.
- ▶ During an ESC intervention.

Settings

Automatic activation

Front Assist is automatically activated when the ignition is switched on.



Activation/deactivation in the instrument cluster

In the display in the Assist systems menu item.

Activation / deactivation and setting in Infotainment

In the menu: MENU >  > 

Show system deactivation in the display of the instrument cluster

 illuminates together with 

 Deactivate Front Assist when handling the vehicle on a truck, a car ferry etc.

Troubleshooting

Front Assist is not available

- ▶ Clean the front radar sensor.
- ▶ Stop the engine and start again.
- ▶ If Front Assist is still unavailable, check the brake lights on the vehicle or on the attached trailer.
- ▶ Replace the defective bulb.
- ▶ If the brake lights are working and Front Assist is still unavailable, seek the help of a specialist garage.

There was an unfounded warning or system intervention

- › Clean the front radar sensor.
- › If the system is not working properly, disable Front Assist and seek the help of a specialist garage.

Pedestrian detection system

Functionality

Pedestrian recognition helps to prevent a collision with crossing pedestrians by enabling automatic braking interventions.

Status display in the instrument cluster display
 lights up - Danger of collision

Risk of collision in a speed range of 5-30 km/h
 The system triggers automatic braking.

Risk of collision in a speed range of 30-60 km/h
 The system warns of a collision hazard first. If the driver does not respond, the vehicle is automatically braked.

Operating conditions

- ✓ Front Assist activated.
- ✓ Driving speed between 5-60 km/h.

Speed limiter



Functionality

The speed limiter controls the maximum driving speed according to the set speed limit.

If the limit is exceeded when driving downhill, brake the vehicle with the brake pedal.

Status display in the instrument cluster display
 illuminated - the cruise control is activated.

When the control starts,  is highlighted and the set limit is displayed.

 illuminated - cruise control is active
 flashing - the set limit is exceeded



Operating conditions

- ✓ The driving speed is higher than 30 km/h.

Operation

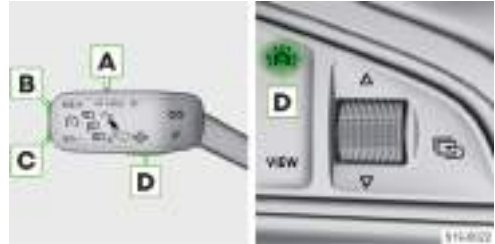
Variant with GRA





- A**  **ON** Activate GRA (condition for the subsequent activation of the limiter).
 To **Enable speed limiter**, press the key **D** and in the instrument cluster choose the menu item *Speed limit*.
OFF Deactivate limiter
CANCEL Interrupt control (sprung position)
- B** **RES/+** Resume control¹⁾/Increase limit
- C** **SET/-** Start control with current speed/Reduce limit
- D**  Show menu of assist systems - Possibility of switching between GRA and speed limiter
 Switching to GRA interrupts the control.

Adjusting the speed limit with the buttons **B and **C****

- By pressing** in steps of 1 km/h.
- By holding** in steps of 10 km/h.

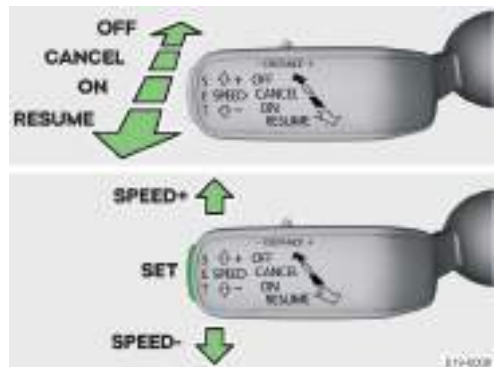
Variant with ACC



- ON** Activate ACC (condition for the subsequent activation of the limiter). To enable the speed limiter, press the key  and in the instrument cluster choose the menu item *Speed limit*.

¹⁾ If no speed limit is set, the current speed is set as the speed limit.

RESUME Resume control¹⁾/Increase limit in steps of 1 km/h (sprung position)

CANCEL Interrupt control (sprung position)

OFF Deactivate the limiter

SPEED+ Increase limit in steps of 10 km/h

SPEED- Decrease limit in steps of 10 km/h

SET Start control/Reduce limit in steps of 1 km/h

Limit exceeded

› Fully depress the accelerator.

Control will continue as soon as the vehicle has decelerated to below the set limit.

Troubleshooting

Speed limiter faulty

LIM illuminates

› Seek the help of a specialist garage.

Cruise control system

Functionality

The cruise control system maintains the set speed without the accelerator pedal having to be operated.

However, this is only done to the extent permitted by engine performance or engine braking.

⚠ WARNING

Risk of the cruise control system starting unintentionally!

▶ Deactivate cruise control after use.

Status display in the instrument cluster display

 illuminated - the cruise control system is activated

 illuminated - cruise control is active
When cruise control starts, the set speed is displayed.

Operating conditions

✓ The driving speed is higher than 20 km/h.

Operation

Operating with the lever

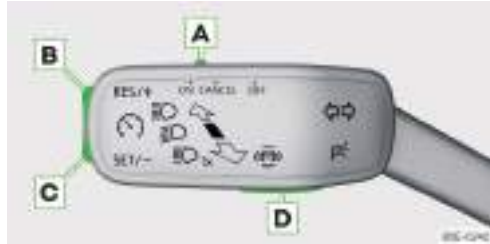

A **ON** Activate cruise control (cruise control deactivated)

OFF Deactivate cruise control

CANCEL Interrupt control (sprung position)

B **RES/+** Resume cruise control²⁾/Increase speed

C **SET/-** Start control with current speed/Reduce limit

D  Show menu of assist systems - Possibility of switching between GRA and speed limiter

Accelerate temporarily

› Depress the accelerator pedal.

After you release the accelerator, the speed drops to the previously stored value.

Interrupting cruise control

▶ After pressing the brake pedal.

▶ After an ESC intervention.

Troubleshooting

Cruise control system faulty

 illuminates

› Seek the help of a specialist garage.

Adaptive Cruise Control (ACC)

Functionality

Control

ACC maintains the set speed. When your vehicle approaches the vehicle in front, ACC will automatically start to maintain the set distance to this vehicle.

Maintaining the set speed and the distance will hereinafter be referred to as **Control**.

¹⁾ If no speed limit is set, the current speed is set as the speed limit.

²⁾ If no speed is set, the current speed is adopted.

⚠ WARNING

ACC does not respond to stationary objects or to crossing or oncoming objects.

▮ ACC is intended primarily for use on motorways.

Speed range

Depending on the equipment, ACC allows a speed setting in the range of 30-160 or 30-210 km/h.

If control is started at a speed of less than 30 km/h on vehicles with an automatic transmission, the speed is automatically increased to 30 km/h or controlled according to the speed of the vehicle ahead.

Distance level

The distance from the vehicle ahead can be adjusted in the range from 1 to 3.6 s in five different levels.

Automatic stop and start

A vehicle with an automatic transmission can be decelerated to a stop using the ACC and start moving again. Control is disconnected in case of longer holding periods.

➤ To resume control, depress the accelerator pedal or move the lever into position **RESUME**.

Overtaking

If your vehicle changes to the fast lane and no vehicle is detected in front, ACC accelerates up to the set speed.

Status display in the instrument cluster display

 Lights up - ACC is activated

 illuminated - Control is active

When the control starts, the set speed is displayed.

 Illuminates - ACC controls the driving speed according to the permissible speed

 Illuminates - ACC controls the driving speed according to the road

 Illuminates - ACC does not decelerate sufficiently

➤ Depress the brake pedal.

Operation

Operating with the lever

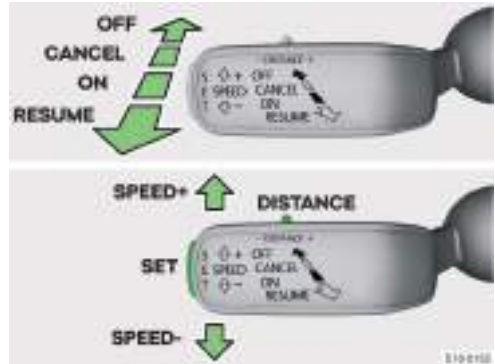

- ON** Activate ACC (control inactive)
- RESUME** Start or resume control/Increase speed in steps of 1 km/h (sprung position)
- CANCEL** Interrupt control (sprung position)
- OFF** Deactivate ACC
- SPEED+** Increase speed in steps of 10 km/h
- SPEED-** Reduce speed in steps of 10 km/h
- DISTANCE** Set distance level
- SET** Start control/Reduce speed in steps of 1 km/h

Starting control with the current speed

➤ Tap on **SET**.

Or:

➤ If no speed is saved, move the lever to the sprung position **RESUME**.

Set distance level

➤ Move the **DISTANCE** switch to the sprung position - or +.



Line **A** appears in the display, indicating the change in distance.

➤ Use the **DISTANCE** switch to set the desired distance level.

For temporary acceleration

➤ Depress the accelerator pedal.

The vehicle accelerates and control is temporarily interrupted. Upon releasing the accelerator, control is resumed.

Interrupting cruise control

- ▶ After pressing the brake pedal.
- ▶ After an ESC intervention.
- ▶ After deactivation of the ASR.

Resuming control

- ▶ If a speed is stored, move the lever to the sprung position **RESUME**.

The vehicle is controlled at the set speed. The set speed is shown in the instrument cluster display.

Function restriction

⚠ WARNING

- ▶ Be particularly attentive and alert in the following situations.

Regulation according to the vehicle in the adjacent lane

If your vehicle is moving faster than the vehicle in the next lane on the driver's side, at a speed of more than 80 km/h, this may cause your vehicle to be controlled according to that vehicle.

When cornering

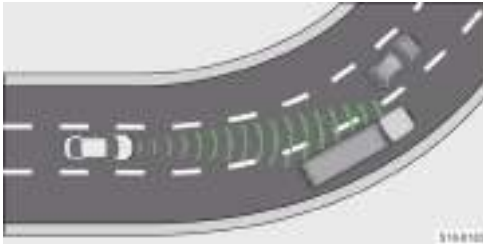

When cornering, a vehicle in the next lane may enter the detected area. Your vehicle will be controlled according to this vehicle.

Narrow or staggered vehicle

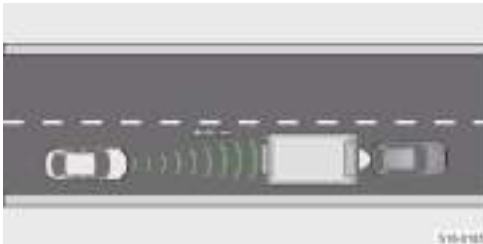

ACC detects a narrow or staggered vehicle only when it is in the area covered by the radar.

Lane change by another vehicle

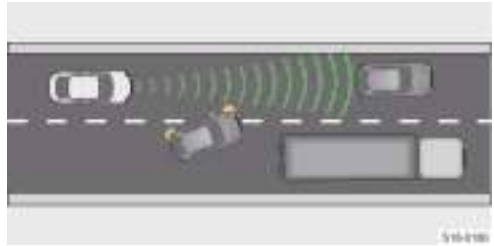

A vehicle that changes to the lane a short distance away may not be recognized by the ACC in time.

Stationary vehicle

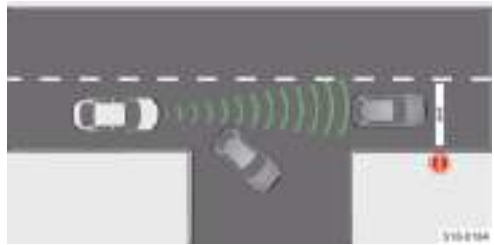

If a vehicle in front turns and there is a stationary vehicle in front of this vehicle, the ACC will not respond to the stationary vehicle.

Vehicles with special load or special bodies

A load or superstructure that protrudes outside the vehicle might not be detected by the ACC.

Settings

In Infotainment, in the following menu.



MENU > >



- ▶ **Driving program:** - Setting the vehicle acceleration when the ACC is switched on (this setting is made for vehicles with driving mode selection » [page 123](#))
- ▶ **Last distance selected** - Switch the last selected distance level on/off
- ▶ **Distance:** - Setting the distance to vehicles in front
- ▶ **Take account of the road profile** - switch the cruise control on/off according to the road profile (e.g. reduce speed before a bend)
- ▶ **Speed limit preview** - Switch the speed control on/off according to the permissible speed

Troubleshooting

ACC not available

 illuminates together with 

- › Stop the engine and start again.
- › If ACC is still unavailable, check the brake lights on the vehicle or on the attached trailer.
- › Replace the defective bulb.
- › If the brake lights are working and ACC is still unavailable, seek the help of a specialist garage.

Lane Assist

Usage

Lane Assist helps to keep the vehicle within the lane. It is based on the boundaries of a lane. These may include lane markings, road edges or objects such as curbs or possibly traffic cones.

The system is intended primarily for use on high-ways.

Functionality

As the vehicle approaches a lane marking, the system executes a steering movement in the opposite direction from the lane marking. The steering intervention can be overridden manually.

No system intervention occurs when changing lane with the turn signal on.

Status display in the instrument cluster display



 lights up - System is activated and ready to intervene

 lights up - System is activated and ready to intervene

 lights up - System intervenes

 lights up - System intervenes

Adaptive lane guidance functionality

This function keeps the driver within the selected position within the lane.  or  lights up in the instrument cluster display.

Display



Lane boundary highlighted on the right: system intervenes on the right when approaching the lane marking.



Both lane boundaries are highlighted: adaptive lane guidance takes place.

Warning through steering wheel vibrations

If the steering wheel vibrates, this means the system is unable to keep the vehicle in the lane.

- › Correct the steering movement.

Operating conditions

- ✓ The driving speed is higher than 60 km/h.
- ✓ The lane markings are clearly visible.

Function restriction

The system function may be restricted in the following cases.

- ▶ The field of view of the sensor is limited by a dirty screen or an obstacle or a preceding vehicle.
- ▶ In the event of unfavourable weather conditions.
- ▶ When driving around a sharp bend.
- ▶ When driving on a steep road or in ruts.
- ▶ Driving lane too narrow.

WARNING

Danger of incorrect steering intervention! Certain objects or markings on the road may be erroneously recognized as lane markings.

- ▶ Always keep your hands on the steering wheel and be prepared to override the steering intervention.

Settings

Activation/deactivation in the instrument cluster

In the display in the Assist systems menu item

Setting in Infotainment

In the menu: MENU ›  › 

Troubleshooting

Message regarding system unavailability

- › Clean the windscreen in the sensor area.
- › Stop the engine and restart again after a short time.
- › If the system is still not available, seek the help of a specialist garage.

Traffic jam assistant

Functionality

The traffic jam assist system helps to keep the vehicle within the lane. At the same time, it maintains the distance from the vehicle in front.

The system is intended primarily for use on highways.

The traffic jam assist system uses the functions of the automatic gearbox, the Lane Assist and the ACC.

⚠ WARNING

Risk of an accident!

- ▶ Always keep your hands on the steering wheel and be ready to take over the steering.
- ▶ The notes in the functional description of Lane Assist and ACC are to be taken into account.

Operating conditions

- ✓ Lane Assist with adaptive guidance is activated and the boundary lines of the traffic lane are recognised.
- ✓ ACC is activated and speed is regulated.
- ✓ The driving speed is lower than 60 km/h.

Lane change assist system Side Assist

Usage

Side Assist monitors the area both beside and behind the vehicle.

The system uses optical signals in the exterior mirror to alert the driver to vehicles that could be dangerous when changing lanes.

Functionality

The system warns of an approaching vehicle through the illumination of the indicator light  in the exterior mirror cover on the vehicle side where the vehicle is detected.

Driving situations in which a system warning occurs

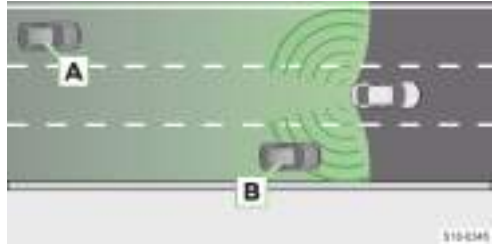

Your vehicle is overtaken by vehicle **A**. The faster vehicle **A** approaches, the sooner the warning is given by the indicator light.

Vehicle **B** is overtaken by your vehicle at a speed that is faster by max. 10 km/h. If the speed increases the overtaking process, no warning will be provided by the indicator light.

Indicator light

 **illuminated** - There is another vehicle behind your vehicle

 **flashing** - There is another vehicle behind your vehicle, and the turn signal on the same side is switched on

For vehicles with Lane Assist, the indicator light will also flash if your vehicle crosses the lane markings in the direction of the approaching vehicle. The system will trigger a steering wheel vibration in this case.

For this, Lane Assist must be activated and the lane marking between the vehicles must be detected.

Operating conditions

- ✓ The driving speed is higher than 15 km/h.
- ✓ No accessories are connected to the trailer socket.

Function restriction

The system cannot detect lane width. For this reason, it may, for example, draw attention to a vehicle in a distant lane in the following cases.

- ▶ Driving on a road with narrow lanes or on the lane edge.
- ▶ Driving round bends.

The system can draw attention to objects along the road, such as high guard rails or noise barriers.

The system might not warn of a vehicle e.g. in the following cases, or a warning may only be issued incorrectly.

- ▶ Unfavourable weather conditions.

- ▶ A very fast approaching vehicle.
- ▶ When going round a sharp bend or a roundabout.

Settings

In the instrument cluster display

The system settings are made in the display of the instrument cluster in menu item *Assist Systems*.

In infotainment

The system settings are made in the infotainment system in the following menu.

CAR >  > 

Or:

MENU >  >  > 

Troubleshooting

Message regarding system unavailability

- ▶ Stop the engine and start again.
- ▶ If the system is still not available, seek the help of a specialist garage.

Traffic sign recognition

Usage

The road sign recognition shows road signs in the display of the instrument cluster. This also indicates exceeding the speed limit.

Functionality

Displayed road signs

- ▶ Speed limit.
- ▶ Overtaking prohibited.
- ▶ Driving bans – one-way traffic.
- ▶ Additional characters, e.g. speed limit in wet conditions.

WARNING

Road signs on the road always have priority over the road signs shown on the display.

Towing a trailer

If a trailer or other accessory is connected to the trailer socket, trailer-relevant road signs are also displayed.

Driving on roads without speed limits

If you are on a road with no speed limits, the road signs  will appear in the display.

Example of road sign display



Example of additional characters



Example of several simultaneously recognised road signs.

Speed units

The speed indications in the road signs shown refer to the speed units that are common in the country.

For example, the  display may refer to 30 km/h or 30 mph depending on the country.



Restriction

The system function may be restricted in the following cases.

- ▶ The sensor is blinded by the sun or oncoming traffic.
- ▶ The field of view of the sensor is limited by an obstacle or a preceding vehicle.
- ▶ In the event of unfavourable weather conditions.
- ▶ At high speeds.
- ▶ The road signs are hidden, damaged, or are non-standard.
- ▶ The road signs are attached to flashing neon signs.
- ▶ Non-current or unavailable map documents for the navigation.

Settings

In Infotainment, in the following menu.

MENU >  > 

■ Road Sign Recognition

- ▶ *Show in instrument cluster* – Activation/deactivation of the additional road signs in the display of the instrument cluster
- ▶ *Speed warning*: – Configures a warning when the speed limit is exceeded
- ▶ *Warning for exceeding* – Increases the speed limit for the warning when exceeding the permitted speed

■ Trailer recognition

- ▶ *Show road signs relevant to trailers* – Activation/deactivation of the display of road signs relevant to trailers
- ▶ *Use for route calculation* – Activation/deactivation taking trailers in account for route calculation in navigation

- ▶ *Maximum speed for trailer* - Set the top speed for towing a trailer

Crew Protect Assist proactive occupant protection

Usage

The Crew Protect Assist system increases occupant protection in the front seats if a collision is imminent.

Functionality

The first level of protection

With a dynamic driving style, the system tightens the front seat belts on the body.

The second level of protection

If the system evaluates the situation as critical:

- ▶ The front seat belts are tightened on the body.
- ▶ Open windows are closed except for a small gap.
- ▶ The sliding/tilting roof is closed.



Settings

Automatic activation

The system is automatically activated when the ignition is switched on.



Deactivation of the first protection level

The first protection level can be deactivated as follows.

- ▶ By activating ESC Sport.
- ▶ By deactivating the ASR.
- ▶ By selecting the driving mode Sport.
- ▶ In Infotainment, in the **MENU** >  >  menu.

Troubleshooting

Crew Protect Assist faulty

 illuminates together with  Message concerning unavailability or functional restriction

- › Seek the help of a specialist garage.

Driver Alert fatigue detection assistant

Functionality

Driver Alert evaluates the steering behaviour. If it detects fatigue in the driver, a break is recommended. In the display of the instrument cluster, the  lights up.

WARNING

There will be no system warning during the so-called micro-sleep.

Resetting the break recommendation

The break recommendation is reset in the following cases.

- ▶ The vehicle stops and the ignition is switched off.
- ▶ The vehicle stops, the seat belt is removed and the driver's door is opened.
- ▶ The vehicle stops for more than 15 minutes.

 In some situations, the system may erroneously issue a break recommendation.

Operating conditions

- ✓ Driving speed between 60-200 km/h.

Settings

Activation/deactivation

In the infotainment system, in menu: **MENU** >  > 

Emergency situation assist systemEmergency Assist

Usage

The assistant for emergencies detects inactivity of the driver, which, for example, can be caused by a sudden loss of consciousness. The system then performs measures as safely as possible to decelerate the vehicle to a stop.

The assist systems are only available for vehicles with an automatic gearbox.

Functionality

When the assist system detects inactivity on the part of the driver

- ▶ An acoustic warning signal sounds and a message appears in the instrument cluster display.
- ▶ If, after repeated warnings, the driver does not take over the steering, the hazard warning lights are switched on and the vehicle automatically brakes.
- ▶ After the vehicle has come to a standstill, the parking brake is switched on.

Interruption of automatic braking

- ▶ By pressing the brake or accelerator pedal.
- ▶ By actively steering.

Operating conditions

- ✓ Lane Assist is activated and the boundary lines of the traffic lane are recognised.
- ✓ ACC is activated and maintains the set speed.

Park Assist systems

Park Pilot parking aid

Functionality

If an obstacle is detected, the Infotainment will display a visible message and an audible signal will sound.

The interval between the signals becomes shorter as the clearance is reduced. At a distance of less than 30 cm from the obstacle, a continuous tone sounds.

If the driver does not respond to the warning, the system triggers automatic emergency braking at speeds below 8 km/h in order to reduce the impact.

Automatic braking can be activated and deactivated in the infotainment.

Display

The recorded areas vary according to the equipment.



A Route controlled at the current steering angle

Acoustic signals on/off

One-time deactivation/activation of automatic braking

Change to the rear view camera display

System fault

Obstacle at a distance of less than 30 cm

Obstacle at a distance of more than 30 cm

Obstacle outside the route

Operating conditions

- ✓ The driving speed is lower than 15 km/h.
- ✓ No accessories are connected to the trailer socket.

Operation

Switching on

› Engage reverse gear.

Or:

- › Press the **PWA** button.

Automatic switch-on during forward travel

When approaching an obstacle at a speed of less than 10 km/h.

Automatic switch-on does not activate automatic braking.

Switching off

- › Disengage reverse gear.

Or:

- › Press the **PWA** button.

Automatic switch off

The driving speed is higher than 15 km/h.

Function restriction

The system might not warn of an obstacle e.g. in the following cases, or a warning may only be issued incorrectly.

- ▶ Unfavourable weather conditions.
- ▶ The detected obstacles are moving.
- ▶ Sensor signals are not reflected by the surface of the obstacles.
- ▶ It is a small obstacle, e.g. a stone or a pillar.

Settings

The system settings are made in the infotainment system in the following menu.

CAR › › **PWA**

Or:

MENU › › › **PWA**

Troubleshooting

After switching on, an audible signal sounds for 3 seconds and there is no obstacle near the vehicle

- › Seek the help of a specialist garage.

After switching on, the symbol **PWA flashes in the button**

- › Seek the help of a specialist garage.

After switching on, not all scanned areas are displayed on the Infotainment screen

- › Move the vehicle a few meters forwards or backwards.
- › If the scanned areas are still not displayed, seek the help of a specialist garage.

Rear view camera

Functionality

When reversing, the area behind the vehicle is displayed in the Infotainment screen complete with orientation lines.

I The camera is equipped with a cleaning system. Cleaning takes place automatically together with the washing of the rear window or with the aid of the functional surface in the vehicle's Infotainment system.

Orientation lines and functional surfaces

Orientation lines

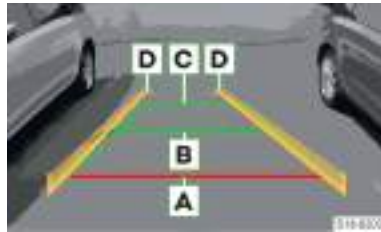

- A** Distance about 40 cm
- B** Distance about 100 cm
- C** Distance about 200 cm
- D** The lane lines terminate approximately 300 cm behind the vehicle. The lines indicate the track, which is controlled at the current steering angle.

The distance between the side lines corresponds approximately to the vehicle width including mirrors.

Function surfaces

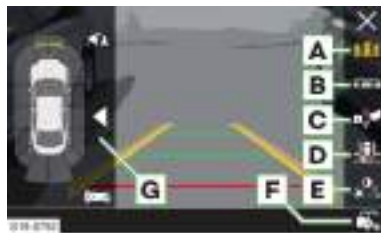

- A** Mode for transverse parking
- B** Mode for parallel parking
- C** Mode for driving up to a trailer/distance monitoring
- D** Mode for monitoring the area behind the vehicle (wide view)

- E** Brightness, contrast and colour settings of the screen
- F** Cleaning the rear view camera
- G** Parking Assist View
 - ◀/▶ Switch the view on / off
 - ⏏ Full Screen
 - 🔊 Switch audible parking signals on/off

Operating conditions

- ✓ The ignition is switched on.
- ✓ The driving speed is lower than 15 km/h.

Operation

Switch on the system

- › Engage reverse gear.

Or:

- › Press the **P** button.

When switching on, an alarm sounds and the symbol **P** lights up in the button.

Mode for transverse parking

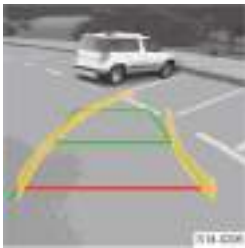

- › Stop the vehicle in front of a suitable parking space.
- › Reverse so that the yellow lines lead into the parking space.
- › At the latest, stop when the red line touches the rear boundary (e.g. curb).

Mode for parallel parking

- › In the screen, select the mode for parallel parking.
- › Turn on the indicator light for the side on which you want to park.

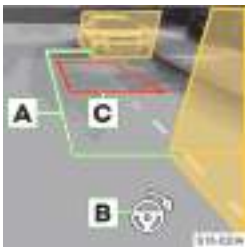

- › Stop the vehicle so that there are no obstructions in the gap between the auxiliary boxes **A** and the rear box does not extend over the side of the parking space (e.g. kerb).
- › Turn the steering wheel in the recommended direction **B** until the red colour of the trapezoidal border **C** turns green.



- › Hold the steering wheel in the adjusted position and reverse.
- › Stop the vehicle if the green line overlaps with the lateral boundary of the parking space (e.g. the curb) or if **P** is displayed.
- › Countersteer until the yellow lane line crosses the red line for the required lane orientation.

- › Hold the steering wheel in the adjusted position and reverse.
- › Stop the vehicle at a safe distance from the obstacle or when **P** is displayed.

Mode for driving up to a trailer/distance monitoring

The screen shows the area behind the vehicle in plan view.

On vehicles with a factory fitted tow-bar, this mode assists the driver when the vehicle is approaching a trailer draw bar. A line for approaching the trailer draw bar and lines for estimating distance are displayed on the screen.

For vehicles without a factory fitted tow bar, a line for monitoring the distance to obstacles is displayed on the screen at a distance of 40 cm behind the vehicle.

Mode for monitoring behind the vehicle

The area behind the vehicle is displayed on the screen.

Switch off the system

- › Press the **P** button.

Or:

- › For vehicles with an automatic gearbox, put the selector lever in the **P** position.

Automatic shut-off

The automatic system shut-off occurs when driving forward at a speed over 15 km/h.

Restriction

The camera image is distorted in contrast to the naked eye. The display may only be used to estimate the distance.

Some items may not be displayed properly on the screen. These include narrow columns, wire mesh fences, grids or road bumps.

Area View environment overview

Usage

The area view assists the driver in parking and manoeuvring by displaying the vehicle area.

Overview

General overview

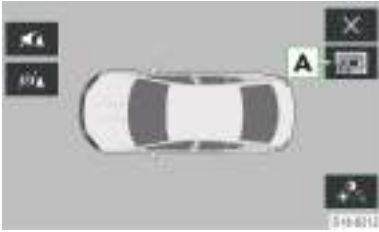

- A** 3D views:
- ☺ Top view
 - 👁️ View obliquely from above
 - 🚗 View from the side
 - 📺 Overall view
- By moving your finger across the screen, you can change the viewing angle.

Camera rear view

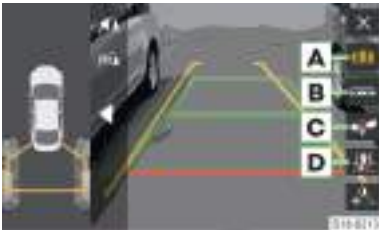

- A** Mode for transverse parking
- B** Mode for parallel parking
- C** Mode for driving up to a trailer/distance monitoring
- D** Mode for monitoring the area behind the vehicle (wide view)

Front camera view



- A** Mode for transverse parking
The orientation lines are used for estimating distance as well as for displaying the route, which is controlled at the current steering angle.
- B** Mode for monitoring the area in front of the vehicle (wide view)
The area right in front of the vehicle is marked by the blue lines.
- C** Distance monitoring mode
The red line marks the distance of about 40 cm from the vehicle.

Side camera view



- A** Left side
- B** Right side
- C** Left and right side

The yellow line is shown at a distance of about 40 cm from the vehicle.

Operating conditions

- ✓ The ignition is switched on.
- ✓ The driving speed is lower than 15 km/h.

Operation

Switching on

- › Engage reverse gear.

Or:

- › Press the  button.

Selecting the camera image

The respective camera image is selected by touching the screen in the Infotainment in the area next to, in front of or behind the vehicle silhouette. The selected area is highlighted on the screen by a yellow border.

Switching off

› Press the  button.

Or:

› For vehicles with an automatic gearbox, put the selector lever in the **P** position.

Automatic shut-off

The automatic system shut-off occurs when driving forward at a speed over 15 km/h.

Restriction

The camera image is distorted in contrast to the naked eye. The display may only be used to estimate the distance.

Some items, such as thin posts, chain link fences, grilles or uneven road surfaces may not be properly displayed.

Objects directly beside the corners of the vehicle may be outside the field of view of the cameras and may therefore not be displayed on the screen.

Rear Traffic Alert

Functionality



When reversing, the Rear Traffic Alert warns of approaching vehicles.

If the driver does not respond to the warning, the vehicle is braked automatically at a speed below 10 km/h.

Vehicle with Park Pilot

If an approaching vehicle is detected in the area behind your vehicle, a graphical warning is displayed in the Infotainment. At the same time, a continuous tone sounds.



■ Vehicle in collision area - danger of collision!

■ Approaching vehicle

Vehicle without Park Pilot

If an approaching vehicle is detected in the area behind your vehicle, the a warning is displayed in the instrument cluster display, indicating to the driver to monitor the traffic behind. At the same time, an acoustic signal sounds.

Operating conditions

✓ No accessories are connected to the trailer socket.

Function restriction

Manoeuvre Assist's functionality may be limited in unfavourable weather conditions.



Settings

The system is activated or deactivated in the instrument cluster display in the *Assist systems* menu item.

The system is activated or deactivated in the following menu in the Infotainment system.

CAR ›  › 

Or:

MENU ›  ›  › 

Troubleshooting

Message regarding system unavailability

› Stop the engine and start again.

› If the system is still not available, seek the help of a specialist garage.

Park steering assistant

Usage

Park Assist helps drivers park in parallel and perpendicular parking places and to manoeuvre out of parallel parking spaces.

What you should be mindful of

Do not use the system in the following cases.

- ▶ On unpaved or slippery surfaces.
- ▶ If snow chains or a spare wheel are mounted on the vehicle.
- ▶ If the system chooses an inappropriate parking space for parking.

Functionality

The system looks for a parking space and only takes over the steering during the parking procedure or when leaving a parking place. The driver operates the pedals and the shift lever/gear selector.

The system displays information and notes on the instrument cluster display.

If the system detects a risk of collision, automatic emergency braking takes place to prevent a collision.

Operating conditions

- ✓ The driving speed is lower than 7 km/h.
- ✓ The ASR is activated and there is no intervention.
- ✓ There is no driver intervention in the automatic steering operation.
- ✓ No accessories are connected to the trailer socket.

Operation

Turn on/turn off

- ▶ Press the **P** button.

When the system is switched on, the symbol lights up in the button **P**.

Select the lane side for the parking procedure

The system automatically searches for a suitable parking space on the passenger side.

- ▶ Press the driver's side indicator to find a parking space on this side of the road.

Operation while searching for a parking space

- ▶ Drive past a number of parked vehicles at a distance of 0.5–1.5 m.
- ▶ To search for a parking space across the road, drive slower than 20 km/h.
- ▶ To search for a parking space along the road, drive slower than 40 km/h.

If the symbol \ominus (km/h) appears in the display, reduce the driving speed. If the system finds a parking space, the display will show the recommended parking mode.

Changing the parking mode

If a suitable parking space is found, the following Park modes can be shown in the display.

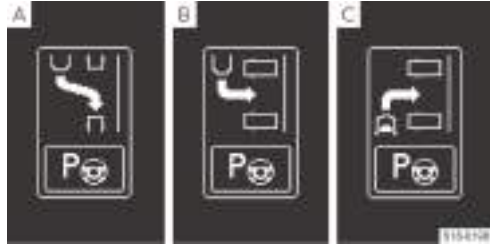

- ▣ A Park backwards longitudinally
- ▣ B Park backwards crosswise
- ▣ C Park forwards across

The parking mode can be changed by pressing the button **P**.

Press the button again **P** and the system is switched off.

- ▶ To return to the original recommended parking mode, press the button **P** again.

Before the parking process

- ▶ If a suitable parking space is found, stop and drive backwards or forwards as indicated by the arrow in the display.
- ▶ When a steering intervention message is displayed, release the steering wheel. The steering operation is taken over by the system.

Parking operation

⚠ CAUTION

Risk of injury!

- ▶ Do not reach between the steering wheel spokes during the parking manoeuvre.
- ▶ Only operate the pedals and the shift / selector lever.
- ▶ Observe the area around the vehicle and drive backwards or forwards in accordance with the arrow in the display.
- ▶ As soon as the symbol \ominus appears in the display and an audible signal sounds, stop the vehicle. The steering wheel is taken over accordingly. The symbol \ominus goes out.
- ▶ Travel backwards or forwards in accordance with the arrow in the display.

As soon as the parking process is completed, the corresponding message is displayed and an audible signal sounds.

The parking procedure can be ended at any time by pressing the button **P**.

I When partially parked in a suitable transverse parking space forward, press button **P**_Ⓜ. The parking process is completed by the system.

Exiting a parking space

› Press the **P**_Ⓜ button.

When the system is switched on, the symbol lights up in the button **P**_Ⓜ.

› Follow the instructions on the screen.

Automatic speed reduction

If a speed of 7 km/h is exceeded during the parking process, the system will reduce the speed.

Upon the speed being exceeded by 7 km/h a second time, the parking process is terminated.

Function restriction

If the parking space is too small, it is not possible to use the system to initiate a parking manoeuvre. A message is shown on the instrument cluster display.

Troubleshooting

Message regarding system unavailability

- › Stop the engine and start again.
- › If the system is still not available, seek the help of a specialist garage.

Incorrect resulting position of the vehicle in the parking space

The correct parking procedure depends on the size of the wheels. If other wheels approved by ŠKODA AUTO are fitted, have the system readjusted by a specialist garage.

Trailer assist trailer manoeuvring aid

Usage

The trailer manoeuvring aid helps the driver when reversing with a trailer.

What you should be mindful of

Use the system extremely carefully in the following cases.

- ▶ On unpaved or slippery surfaces.
- ▶ If snow chains or a spare wheel are mounted on the vehicle.

! NOTICE

The system does not warn of obstacles or monitors the area behind the trailer. The driver must check themselves as to whether there are no obstacles in the area behind the trailer.

Functionality

The rear camera monitors the bending angle of the trailer drawbar. The system executes appropriate steering movements to position the trailer in the desired direction. The driver operates the pedals and the shift lever/gear selector.

The driver sets the desired direction with the external mirror knob.

Operating conditions

- ✓ The driving speed is lower than 5 km/h.
- ✓ The ASR is activated and there is no intervention.
- ✓ The luggage compartment lid is closed.
- ✓ The driver's door is closed.
- ✓ It is a uniaxial or biaxial trailer hitched without a steered axle.
- ✓ The trailer drawbar is not covered.
- ✓ The trailer is not veering too much.

Operation

Before switching on

› Make several turns or cornering with the trailer attached.

The system determines the drawbar length in order to use the maximum yaw rate.

Switch on the system

- › Engage reverse gear.
- › Depress the brake pedal.
- › Release the steering wheel and press the **P**_Ⓜ button.

Manoeuvring



- › Tilt the exterior mirror knob to the right or left.

The setting menu is shown on the instrument cluster display.

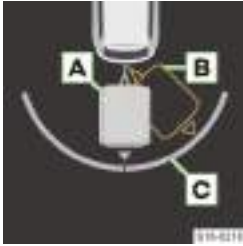

- A** Current trailer position
- B** Target trailer position
- C** Manoeuvring angular dimension

- › Tilt the knob to the right or left to set the trailer's target position.
- › Start reversing.

The setting can be corrected when reversing.

- › Stop as soon as the trailer's target position is reached.

⚠ CAUTION

Risk of injury!

- ▶ Do not reach between the steering wheel spokes during the parking manoeuvre.
- ▶ Only operate the pedals and the shift / selector lever.

Straighten the trailer

- › Tilt the knob backwards.
- › Carefully reverse and drive forwards until the desired position of the trailer combination is achieved.

Switch off the system

- › Press the **P** button.

Automatic system shut-off

If the following situations occur during the manoeuvring process, an automatic system shutdown and a braking intervention take place.

- ▶ The **P** button is pressed.
- ▶ The driver's door is opened.
- ▶ The steering wheel is gripped.
- ▶ The driving speed is too high.
- ▶ The trailer veered too much.

High-voltage system

High-voltage system and high-voltage battery

What you should be mindful of

Warning stickers about high voltage



The warning stickers are located on high-voltage components.

Warning stickers relating to hot surfaces



The warning sticker is located on components that can become noticeably warm.

⚠ DANGER

Improper handling of the high-voltage system and battery can result in burns, injuries or fatal electric shock.

- ▶ It must always be assumed that the high-voltage battery is charged and that the high-voltage system is live. This also applies when the electric drive is switched off and the ignition is switched off.
- ▶ Do not touch the high-voltage cables or the high-voltage battery, even with the aid of other objects.
- ▶ Do not carry out any work on the high-voltage system or the high-voltage battery.
- ▶ Do not open or repair the components of the high-voltage system.
- ▶ Do not replace, remove or disconnect the orange high-voltage cables.
- ▶ Do not open, replace, or remove the cover of the high-voltage battery.
- ▶ Work on the high-voltage system and the systems influenced by it may only be carried out by qualified service technicians.
- ▶ When working on the high-voltage system and the high-voltage battery, the specifications and guidelines of the ŠKODA AUTO company must be adhered to.
- ▶ Before carrying out any work on the vehicle, where there is a risk of damaging the components of the high-voltage system, the vehicle must be free from any voltage. This work may only be carried out by qualified service technicians.
- ▶ Damage to the vehicle or the high-voltage battery can result in the escape of toxic and flammable gases. Open the windows so that any escaping gases can escape from the vehicle. Do not inhale the gases.
- ▶ Avoid contact with liquids and gases leaking from the high-voltage battery.
- ▶ In the event of fire, leave the vehicle and stay at a safe distance. Inform rescuers about the fact that it is a vehicle with a high-voltage battery.

⚠ CAUTION

Touching the floor of the vehicle or an accident may damage the high-voltage battery.

- ▶ Contact a specialist company immediately and ensure the high-voltage battery is checked.

① NOTICE

In the event of a vehicle with a flat high-voltage battery, there is a risk of irreversible damage to the high-voltage battery during extended periods of use

- ▶ A flat high-voltage battery must be recharged immediately!

① NOTICE

If the vehicle is stationary for several months, the high-voltage battery can go flat.

This can lead to the high-voltage battery being damaged at high ambient temperatures and a low charge state.

- ▶ Always ensure there is a sufficient state of charge with the high-voltage battery!

[i] If the battery is left standing for long periods in very cold environments, the low internal temperature of the high-voltage battery can reduce the range and limit the driving performance.

High Voltage System Overview

The high-voltage system in the vehicle consists of the following main components.

- ▶ High-voltage battery.
- ▶ Power electronics.
- ▶ Electric motor.
- ▶ High-voltage air-conditioning compressor.
- ▶ Charger for the high-voltage battery.
- ▶ Charging socket.
- ▶ Orange high-voltage cable and plug.
- ▶ High-voltage heating system.

[i] The high-voltage battery is located under the vehicle floor and is not accessible to users.

Charging of high-voltage battery

What you should be mindful of

⚠ WARNING

Danger of life-threatening electric shock, fire hazard, danger of damage to vehicle.

- ▶ Follow the correct procedure for charging.
- ▶ Connect the charging cable to a power outlet that is protected from both moisture and liquids.
- ▶ Only charge at correctly installed and undamaged sockets and at a faultless electrical installation. Have the sockets and electrical installations checked at regular intervals.
- ▶ Never charge in potentially explosive areas. Components of the charging cable can cause sparks and thus ignite explosive vapours.
- ▶ Protect the charging plugs from moisture and liquids.
- ▶ Do not carry out work on the vehicle while charging.
- ▶ Always remove the charging cable before starting up the vehicle. Fit the protective cap and close the battery charging flap.
- ▶ Never charge several vehicles at the same time at the mains sockets of a fuse circuit.
- ▶ Observe the maximum charge capacity of the fuse circuit used. If the charging cable is plugged into a socket of the same circuit together with other consumers, the circuit may be overloaded and the charging process may be interrupted.

⚠ WARNING

- ▶ Never use damaged charging plugs or charging cables.

ⓘ NOTICE

Long periods with the vehicle left standing with a fully charged high-voltage battery for several months can lead to a permanent reduction in the charging capacity of the high-voltage battery.

- ▶ Avoid prolonged vehicle downtimes when the high-voltage battery is at a high state of charge.
- ⓘ At very low and very high temperatures, there may be restrictions when charging the high-voltage battery. The charging time may be longer.
- ⓘ As the state of charge of the high-voltage battery increases during charging, the ability of the high-voltage battery to absorb energy decreases. This slows down the charging process.

Overview

Charging socket, charging indicator and buttons

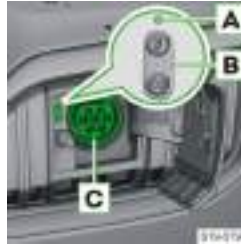

- A** Charging indicator
- B** Immediate charging button and time-delayed charging button
- C** Charging socket

Charging indicator

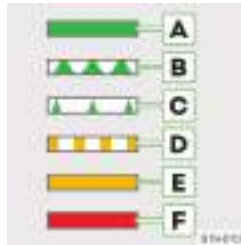

Plate on the interior of the battery flap

- A** **Illuminates in green:** high-voltage battery is charged, charging process is complete
- B** **Pulsating green:** high-voltage battery is charging
- C** **Flashes green** (about 1 minute after connecting the charging cable): time-delayed charging is activated, but has not yet started
- D** **Flashes yellow:** selector lever is not in position **P**
- E** **Lights up yellow for several seconds:** charging plug inserted in charging socket is detected
Continuously illuminated in yellow: Charging plug is plugged into the charging socket, but no mains power was detected. Check the power supply or mains power.
- F** **Lights up red:** Charging plug is not locked into the charging socket. Disconnect the charging plug and insert it again into the charging socket until it stops. If the fault persists, seek the help of a specialist company.

Flashes red: Fault with the charging system of the vehicle. Seek the help of a specialist garage.

Charging options

- ▶ Public charging station (AC alternating current).
- ▶ Home Charging Station - Wall box (AC alternating current).
- ▶ Charge at usual mains socket.

Home Station (Wall box)

When charging with a home charging station, a higher charging power is achieved than using a standard mains socket. The charging time is considerably shortened.

i For information about purchasing a suitable home charging station (Wall box), please ask a ŠKODA partner.

NOTICE

The installation of the home charging station (wall box) must be carried out by qualified personnel.

- ▶ Before installing the home charging station, ensure the electrical installation of the house is checked.
- ▶ Ensure the electrical installation and the home charging station are checked regularly by qualified personnel.

Charging**WARNING**

Risk of electric shock!

- ▶ Follow the correct procedure for charging. Do not disconnect the charging cable during charging.
- ▶ Never use the charging cable with an extension cord, power strip, adapter or timer.

NOTICE

- ▶ To operate the charging station, follow the instructions on the charging station.

Before charging

- › Secure the vehicle with the parking brake.
- › Move the selector lever to position P.
- › Turn off the engine.

i If the ignition does not necessarily need to be switched on, switch it off before charging begins. Leaving the ignition switched on can extend the charging time.

Connect the charging cable

- › Fully unwind the charging station cable.

Or:

- › Fully unwind the charging cable and connect it to the charger socket or to a standard mains socket.
- › Unlock the vehicle. The battery flap is unlocked.



- › Press on the battery flap to open it.



- › Remove the protective cap and place it on the battery charging hatch.
- › Carefully insert the charging plug for the charging cable into the charging socket as far as it will go.
- › The charging plug is locked automatically, and appears in the display of the instrument cluster .



Start the charging process

Charging starts automatically after connecting the charging cable.

Or:

- › If necessary, start off the charging process at the charging station.

Charging indicator

- ▶ The charging indicator on the charging socket pulsates green.
- ▶ In the instrument cluster,  flashes.
- ▶ The remaining charge time is displayed on the instrument cluster display and flashes (depending on the equipment) .

Automatic ending of the charging process

After charging, the charging process is automatically ended. The charging plug remains locked in the charging socket.

End the charging process with the button  on the key.

- › Press the  button on the key.

The charging process is terminated and the charging plug is unlocked in the charging socket for 30 seconds. If the charging plug is not unplugged from the charging socket, charging continues after 30 seconds.

Interrupt or stop the charging process with the  button

- › Press the  button in the charging socket.

The charging process is interrupted. The charging plug remains locked in the charging socket.

- › To continue charging, press the button  again.

Stop the charging process at the charging station

- › At the end of the charging process, follow the instructions at the charging station.

After the charging process

- › Press the  button on the key.

The charging process is terminated and the charging plug is unlocked in the charging socket for 30 seconds.

- › Disconnect the charging plug from the charging socket.
- › Attach the protective cap to the charging socket.
- › Close the battery flap.
- › Where necessary, disconnect the charging cable from the charger or from the mains socket.

[i] If you leave the charging cable connected after charging using alternating current (AC), the high-voltage battery will not be discharged by electrical consumers in the vehicle. These consumers are powered by the charger.

Initial charging and charging for longer service life

If the high-voltage battery is new or has not been charged for a long time, the maximum state of charge of the high-voltage battery may only be reached after several charges. This is due to technical reasons and does not constitute a malfunction.

ⓘ NOTICE

Danger of irreversible damage to the high-voltage battery.

- ▶ If the vehicle is not used for a long period of time, charge the high-voltage battery after a maximum of four months.

Setting the charging process

Adjustments to applications

The following applications can be used, for example, to set the delayed charge (departure time) or the lower battery charge limit.

- ▶ E-Manager » [page 61](#).
- ▶ ŠKODA Connect application (depending on Infotainment)» [page 85](#), or » [page 114](#).

Prerequisites for starting time-delayed charging

- ✓ The vehicle is connected to a charger that supports time-delayed charging.
- ✓ Time-delayed charging is activated in the application or in the E-Manager.

[i] If, after the vehicle has been connected to the charger, the state of charge is lower than the set lower battery charge limit, the high-voltage battery is charged immediately to the set charge limit.

Change between time-delayed charging and instant charging



- A** Immediate charge button
- B** Button for time-delayed charging

For a change to happen, the following pre-requisites must be met.

- ✓ Vehicle unlocked.
- ✓ The vehicle is connected to a charger that supports time-delayed charging.
- ✓ Time-delayed charging has been activated, but has not started yet.

Using the buttons **A** and **B**, it is possible to switch between time-delayed charging and instant charging. The symbol in the respective button is illuminated.

Troubleshooting

Manual release of the charging plug from the charging socket

If the charging plug remains locked in the charging socket after charging is complete and cannot be unplugged, proceed as follows.

- › Check that the charging process is interrupted.
- › Open the engine compartment lid.



- › Remove the cover in the plastic part above the charging socket.
- › Slide the screwdriver **A** from the tool kit into the opening **B** below the panel as far as it will go.
- › Pull the screwdriver in the direction of the arrow to unlock the charging plug.

- › Then disconnect the charging plug **C** from the charging socket.
- › Have the vehicle checked immediately by a specialist garage.

Charging does not start or is cancelled

A message indicating that no charging is possible is displayed.

- › Disconnect the charging cable from the vehicle and plug it in again.

Or:

- › Use another charging option.
- › If the charging process does not start or is interrupted again, seek the help of a specialist garage.

Charging time increases

If the high-voltage battery is too hot after driving, the charging current can be systematically reduced by subsequent charging in order to protect the high-voltage battery from overheating. This lengthens the charging time.

Charging cable

What you should be mindful of

We recommend that you only use charging cables supplied by ŠKODA AUTO. With these, the reliability as well as correct functionality are guaranteed.

⚠ WARNING

Risk of short circuit as well as serious or fatal injuries!

- ▶ Only use a suitable charging cable to charge the high-voltage battery.

ⓘ NOTICE

- ▶ Have the charging cable checked regularly by a qualified service technician.

Information on the use of the charging cable

- ▶ Protect the parts of the charging cable from unwanted stress, e.g. from overrunning, falling, pulling, kinking or bending over sharp edges.
- ▶ When disconnecting from the socket or charger, do not pull on the cable but only on the plug.
- ▶ After using the charging cable, insert the protective caps.
- ▶ Protect the parts of the charging cable from intense sunlight (the outside temperature must not exceed 50 °C).
- ▶ Do not immerse parts of the charging cable in water and ensure it is protected from snow or ice.
- ▶ Before charging at cold temperatures, attach the supplied protective ring to the charging plug. This protects the plug-charging socket connection from freezing.

Before driving abroad

Check whether your charging cable is suitable for the specific procedures in places in each country.

ⓘ In Norway, for example, the construction of electrical systems is based on different technical specifications than those in other European countries.

Functionality

Charging cable type

- ▶ Charging cable for charging stations (Mode 3).
- ▶ Charging cable for standard power outlets (Mode 2).

Charging cable for charging stations (Mode 3)



The charging cable can be used to charge vehicles at public charging stations that do not have an integrated charging cable.

The vehicle can be charged with a maximum charging current of 16 A.

At some charging stations

that offer charging with a charging current of 32 A, charging with a cable intended for charging with a charging current of 16 A is not possible.

Charging cable for standard power outlets (Mode 2)

The charging cable can be used for charging at standard mains sockets.

Control box (Mode 2)

Through the control box, the charging plug is de-energised until it is plugged into the charging socket of the vehicle.

When the charging cable is connected to the power outlet, the control box automatically carries out a self-test. All warning and indicator lights illuminate briefly and go out one after the other.

The current operating status is then displayed.



- A** Indicator light power plug (plugged into the mains socket)
- B** Indicator light control box
- C** Indicator light vehicle
- D** Warning light protective conductor
- E** Warning light mains plug
- F** Warning light control box

Overview of the cable control box

control box

- G** Warning light vehicle
- H** Reset button to reset the fault indications on the control box. Hold down the reset button for at least 3 secs.

Follow the information and safety instructions on the label on the charging cable.

Operating displays (Mode 2)

| Display | Meaning |
|---|---|
| A B illuminates C flashes ^{a)} | High-voltage battery is charging |
| A B C illuminates | Charging cable connected to the mains and to the vehicle. Charging has not started or has already been completed. |
| A B illuminates | Charging cable connected to the mains but not to the vehicle. |
| A illuminates B flashes | Charging cable connected to the mains for along time, but not to the vehicle. |
| ^{a)} If the indicator light C slowly blinks, the charging current is limited. | |

Temperature monitoring (Mode 2)

The charging cable is equipped with a temperature control on the control box and the mains plug.

The temperature monitoring triggers when the charging cable heats up too much, e.g. if it is carried in an overheated luggage compartment or in strong sunlight.

When the charging current through the control box is reduced, the warning light flashes red **E** or **F**. One or more indicator lights **A** **B** **C** light up or flash.

As soon as the charging cable has cooled down sufficiently, the charging current is automatically increased again. If charging is interrupted by the control box, the indicator **C** goes out.

- › Disconnect the charging cable and allow it to cool.
- › If the problem persists, seek the help of a specialist company.

Fault indications (Mode 2)

A fault indication with one or more red warning lights will interrupt the charging process.

- › Seek the help of a specialist garage.

The control box can also recognise the following situations as a fault.

- ▶ A charger is connected to the 12 volt vehicle battery.
- ▶ The vehicle is in close proximity to high voltage power lines.

- ▶ The vehicle is not on its wheels, but, for example, raised up with a lift.

Disruption to the electrical installation (Mode 2)

If the indicator light flashes or lights up **D** yellow or the indicator light **E** flashes or lights up red, charging is interrupted.

- › Check if it is possible to charge it using a different mains socket.
- › Have the mains socket or electrical installation checked by a specialist electrician.

Engine, exhaust system and fuel

Bonnet

Opening the bonnet

Before opening

- › Make sure the windscreen wiper arms are folded down onto the windscreen.
- › Keep everyone away from the engine compartment.

To open



- › Pull the release lever underneath the dash panel.



- › Release the lock.
- › Lift the bonnet so that the gas pressure springs hold it open.

Closing

- › Pull the flap down.
- › Close the flap with a slight push from a distance of about 20 cm.
- › Check that the bonnet is closed.

ⓘ NOTICE

- ▶ Do not press down on an unclosed bonnet.

Engine oil

Checking the fill level and topping up

Test conditions

- ✓ Park the vehicle on a horizontal surface.
- ✓ The parked engine is warm.

Checking the level

- › Wait a few minutes for the engine oil to flow back into the oil sump.
- › Remove the dipstick and wipe with a clean cloth.
- › Insert the dipstick as far as it will go and pull it out again.

- › Read the oil level and push the dipstick back in again.



The oil level must be within the marked range.

ⓘ NOTICE

⚠ Risk of damage to the engine and the exhaust system!

- ▶ The oil level must not be outside the marked range. If it is not possible to top up the engine oil or if the oil level is above the marked range, do not continue driving. Stop the engine and seek the help of a specialist garage.
- ▶ Do not use any oil additives.

Depending on driving style and operating conditions, the engine consumes some oil, up to 0.5 l/1000 km. Consumption may be higher over the next 5000 km.

Refilling

- › Unscrew the cover of the engine oil filler opening.
- › Top up the oil to the correct specification in 0.5 litre portions.
- › Check the oil level.
- › Screw on the cover of the engine oil filler opening.

Specification

Ask a specialist garage for the correct engine oil specification for your vehicle.

If no oil of the correct specification is available, **max. 0.5 l** of oil with the following specifications may be used until the next oil change.

- ▶ VW 504 00, VW 508 00, ACEA C3, ACEA C5.

Changing

Have the oil changed by a specialist garage.

Troubleshooting

Engine oil pressure too low



flashes, lights up at the same time ⚠

- › Check the engine oil level.

The oil level is OK, the warning light continues to flash:

- › Stop the engine and seek the help of a specialist garage.

Engine oil level too low





illuminates together with ⚠

Message regarding required engine oil top up

- › Check the engine oil level, top up with oil if required.

Engine oil level too high



 illuminates together with 
 Message regarding the need to reduce the engine oil level

- › Check the engine oil level.

The oil level is too high:

- › Drive on, exercising appropriate caution.
- › Seek the help of a specialist garage.

Engine oil level sensor impaired

 illuminates together with 
 Message regarding the engine oil sensor

- › Drive on, exercising appropriate caution.
- › Seek the help of a specialist garage.

Coolant

Checking the fill level and topping up

Coolant expansion tank

The vehicle has two cooling circuits with two coolant expansion tanks in the engine compartment.

- ▶ High-voltage system cooling circuit with smaller coolant expansion tank.
- ▶ Combustion engine cooling circuit with larger coolant expansion tank.

Test conditions

- ✓ The vehicle is on a horizontal surface.
- ✓ The engine is turned off and cooled.

Check fill level in tank - high voltage system



The fill level must be within the marked range.

- › If the fill level is below the mark **MIN**, do not top up the coolant.
- › Seek the help of a specialist garage.

 **WARNING**

Risk of coolant entering the high-voltage battery. This can lead to a short circuit, as well as ignition of the high-voltage battery!

- ▶ Never open the cooling circuit tank of the high-voltage system and do not top up with coolant.

Check fill level in tank - combustion engine



The fill level must be within the marked range.

- › If the fill level is below the mark **MIN**, top up the coolant.

 **NOTICE**

Danger of damage to the engine compartment!

- ▶ Do not top up the coolant above the marked area. The coolant could be forced out of the cooling system when heated.

 **NOTICE**

There must be a small quantity of coolant in the tank.

- ▶ Do not add coolant when the tank is empty.
- ▶ Stop driving! Seek the help of a specialist garage.

Refilling

 **CAUTION**

Risk of scalding!

The cooling system is pressurised.

- ▶ Do not open the cap of the coolant expansion tank while the engine is warm. Let the engine cool down.
- › Place a rag on the lid of the tank and carefully unscrew the lid.
- › Refill with coolant of the correct specification.
- › Screw on the cap until it clicks into place.

Specification

Use the G12evo (TL 774 L) additive for refilling.

 **NOTICE**

Risk of damage to the cooling system and the engine!

Adding coolant that does not conform to the correct specification can reduce the corrosion protection of the cooling system.

Troubleshooting

Coolant level is too low



illuminates together with 

Message concerning the required coolant check

- › Check the coolant level.



The coolant level is OK:

- › Check the fuse for radiator fan, replace if required » [page 159, Replacing a fuse.](#)

The fuse is OK, the indicator light comes on again:



- › Stop driving! Seek the help of a specialist garage.

Coolant temperature too high

 illuminates together with 
Report regarding the engine overheating



- › Stop driving.
- › Stop the engine and allow it to cool.
- › Drive on after the indicator light goes out.

Engine fault

 illuminates together with 
› Stop driving!

- › Stop the engine and seek the help of a specialist garage.

High-voltage system cooling circuit faulty

 illuminates together with 
› Stop driving!

- › Stop the engine and seek the help of a specialist garage.

There is no coolant of the correct specification available

- › Top up with distilled or demineralised water.
- › Have the correct coolant mixing ratio corrected by a specialist garage as soon as possible.

Another substance was used for topping up, other than distilled or demineralised water:

- › Have the coolant changed by a specialist garage.

It is not possible to top up with a sufficient amount of coolant

- › Stop driving.
- › Stop the engine and seek the help of a specialist garage.

There is a loss of coolant

- › Top up the coolant and seek the help of a specialist garage.

Engine electronics

Troubleshooting

Hybrid drive system faulty

 illuminates
› You may continue driving, exercising appropriate caution. Seek the help of a specialist garage.

 illuminates
› Stop driving! Seek the help of a specialist garage.

Petrol engine control faulty



EPC illuminates
Driving in emergency mode is possible - a noticeable reduction in engine performance may occur.

- › Continue driving, exercising appropriate caution, and seek the help of a specialist garage.

Particle filter

Troubleshooting

Clogged particle filter

 illuminates together with 

- › Clean the filter.

[i] If the indicator light is illuminated, increased fuel consumption and reduced engine power must be expected.

Filter cleaning

Conditions for cleaning

- ✓ The engine is warm.

Cleaning procedure

- › Drive at a speed of at least 80 km/h at engine speeds between 3000-5000 rpm.
- › Release the accelerator pedal and let the vehicle roll with the gear engaged for a few seconds.
- › Repeat this procedure several times.

If the filter is successfully cleaned, the indicator light  goes off.

If the indicator light  does not go off within 30 minutes, no filter cleaning was performed.

- › Continue driving, exercising appropriate caution, and seek the help of a specialist garage.

Exhaust control system

Troubleshooting

Emission control system faulty

 illuminates
Driving in emergency mode is possible - a noticeable reduction in engine performance may occur.

- › Continue driving, exercising appropriate caution, and seek the help of a specialist garage.

Fuel filler flap

Opening the fuel filler flap

- › Press the button  in the centre console.

The fuel filler flap is unlocked after a few seconds and is partially opened.



› Open the flap.

▶ Do not use petrol with an octane number that **lower** than **91**!

Prescribed petrol 95 / min. 92 or 93 RON / ROZ

We recommend using **95** RON petrol.

92 or **93** RON petrol may be used as an option (low power loss, slightly increased fuel consumption).

In an **emergency**, **91** RON petrol may be used (low power loss, slightly increased fuel consumption).

Prescribed petrol min. 95 RON / ROZ

Use min. **95** petrol.

Using higher octane petrol than 95 RON may result in improved performance and lower fuel consumption.

In an **emergency** **91**, **92** or **93** RON may be used (low power loss, slightly increased fuel consumption).

Prescribed petrol 98 / (95) RON / ROZ

We recommend using **98** RON petrol.

95 RON petrol may be used as an option (low power loss, slightly increased fuel consumption).

In an **emergency** **91**, **92** or **93** RON may be used (low power loss, slightly increased fuel consumption).

Additive

ⓘ **NOTICE**

Risk of damage to the engine and the exhaust system!

▶ Do not use petrol containing metal-based additives, e.g. manganese, iron, lead, and do not use, for example, any LRP petrol – lead replacement petrol.

▶ Do not add any additional additives to the petrol in accordance with EN 228.

▶ If petrol is not used in accordance with EN 228, we recommend obtaining information from a specialist company regarding the possible use of petrol additives approved by ŠKODA AUTO.

Petrol

What you should be mindful of

⚠ **DANGER**

Risk of death!
Fuel and fuel vapours are explosive.

ⓘ **NOTICE**

Risk of damage to the engine and the exhaust system!

› Never empty the fuel tank completely!

If you would like to operate your vehicle in a country other than that intended for vehicle operation, please contact a ŠKODA Partner. They will let you know whether a suitable fuel is offered in the associated country.

Regulations

Standards

Petrol must comply with European standard EN 228 (in Russia, GOST 32513-2013).

Only use **unleaded petrol** that contains **max** 10% bioethanol (**E10**).

ⓘ We recommend using petrol with additives, which is available at petrol stations at the petrol pumps.

Octane number

Use the petrol with the octane number prescribed for your vehicle.

Petrol with an octane number that is one **higher** than the one prescribed for your vehicle can be used without restriction.

ⓘ **NOTICE**

Risk of damage to the engine and the exhaust system!

▶ If petrol is used that has an octane number that is lower than the one prescribed for your vehicle, then drive at moderate speeds with minimal engine stress.

▶ Fill up with the prescribed octane number as soon as possible.

Requirements for refuelling

- ✓ Vehicle unlocked.
- ✓ Ignition switched off.
- ✓ Unlocked fuel flap.

Refilling

› Open the tank flap.



- › Turn the tank cap in the direction of the arrow and remove it.
- › Place the tank cap on the tank flap.
- › Insert the fuel nozzle into the fuel filler neck up to the stop and refuel.
- › Do not continue refueling after the fuel nozzle switches off.

zle switches off.

- › Remove the fuel nozzle and put it back on the petrol pump.
- › Place the fuel cap on the fuel filler neck and turn it in the opposite direction to the arrow until it clicks into place.
- › Close the tank flap and click into place.

Troubleshooting

If fuel other than unleaded petrol has been refueled according to the standards applicable to your vehicle

- › Do not start the engine or switch on the ignition.
- › Seek the help of a specialist garage.

Technical data

The fuel prescribed for your vehicle is indicated on a sticker on the inside of the fuel filler flap.

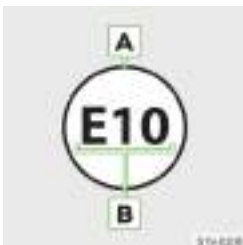

- A** Unleaded petrol
- B** Organic share as a percentage

The fuel tank has a capacity of about 50 litres, including a reserve of approx. 7 litres.



The fuel supply has reached the reserve area.

Vehicle battery and fuses

Vehicle battery

Functionality - Discharge protection

Possible causes of battery discharge

- ▶ Frequent short-distance traffic.
- ▶ Low temperatures.
- ▶ Vehicle stationary for a long period of time.

System-related discharge protection measures

- ▶ Switching off certain consumers or limiting their power.

Checking and charging the vehicle battery

Checking the condition

The battery condition is checked by a specialist garage during servicing.

Requirements for the charging process

- ✓ Ignition switched off.
- ✓ Power consumers switched off.

Vehicle battery charging process

To charge the vehicle battery fully, set a charging current of max. of 0.1 times the battery capacity.



- A** Earth point
- +** ⊕ Pole for battery charging

The ⊕ pole of the vehicle battery is located in the engine compartment under the cover of the fuse box

- › Remove the fuse box cover.
- › Connect the ⊕ terminal of the charger to the ⊕ terminal of the battery charging.
- › Connect the ⊖ terminal of the charger to the earth point **A**.
- › Plug the charger's power cable into the socket and switch on the device.
- › After charging, switch off the charger and unplug the power cable from the socket.
- › Disconnect the charger terminals from the vehicle battery.

⚠ WARNING

Risk of explosion!

- ▶ During charging, hydrogen is released. An explosion can also be caused by sparks, for example, when disconnecting or loosening the cable connector.
- ▶ Never charge a frozen or thawed vehicle battery.
- ▶ Do not carry out the so-called quick charging of the vehicle battery yourself, but have it carried out by a specialist garage.

① NOTICE

A flat vehicle battery can freeze easily!

Troubleshooting

Vehicle battery does not charge while the engine is running



illuminates together with ⚠

- › Seek the help of a specialist garage.

Engine fault



illuminates together with ⚠

- › Stop driving!

- › Stop the engine and seek the help of a specialist garage.

Disconnecting, connecting and replacing

The vehicle battery is located in the luggage compartment behind the side panelling and is not accessible.

Changing

The new vehicle battery must have the same parameters as the original battery. Have the replacement carried out by a specialist garage.

Using the jump-starting cable

What you should be mindful of

⚠ WARNING

Risk of explosion and chemical burns!

- ▶ Do not jump start with the battery of another vehicle under the following conditions.
 - ▶ The discharged vehicle battery is frozen. A discharged vehicle battery can freeze at temperatures just below 0°C.
 - ▶ The battery acid level is too low » [page 157](#).

Use jump leads with a sufficient cross section and insulated terminal clamps.

The rated voltage of both batteries must be 12V. The capacity (in Ah) of the charging battery must not be

significantly lower than the capacity of the discharged battery.

Jump-starting with the battery of another vehicle

⚠ WARNING

Risk of injury and danger of vehicle damage!

- ▶ Lay the jump start cables so that they cannot become caught by rotating parts in the engine compartment.

① NOTICE

Short circuit!

- ▶ The non-insulated parts of the terminal clamps must not touch each other.
- ▶ The cable connected to the positive pole of the battery must not come into contact with electrically conductive vehicle parts.
- ▶ The vehicles must not touch each other.

Connect the jump start cable

- › Connect the terminal clamps of the jump start cables in the order shown in the legend.

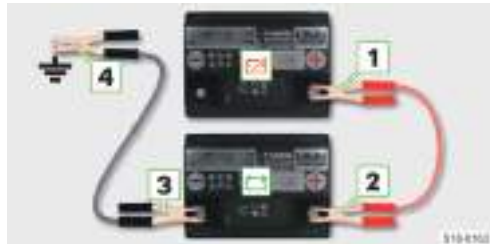

⚠ - flat battery / ⚡ - current-emitting battery

- 1 ⊕ pole of the flat battery
- 2 ⊕ pole of the current-emitting battery
- 3 ⊖ pole of the current-emitting battery
- 4 ⚡ Earth point of the engine to be started



Engine compartment: Earth point and ⊕ pole on vehicles with the battery in the luggage compartment

Start the vehicle

- › Start the engine of the current-giving vehicle and let it idle.
- › Start up the vehicle with the flat battery.

Disconnecting the cable

- › Disconnect the cables in the reverse order from connection.

Fuses

What you should be mindful of

ⓘ NOTICE

Fire hazard and risk of damage to the electrical system.

- ▶ Do not repair fuses or replace them with stronger fuses.
- ▶ Replace the defective fuse with a new fuse with the same amperage.
- ▶ We recommend using replacement fuses from the ŠKODA Genuine Accessories range. These guarantee reliable and safe consumer protection.
- ▶ If a newly inserted fuse blows again, seek the help of a specialist garage.

ⓘ One fuse may belong to several consumers. One consumer may have several fuses.

High-voltage system fuse (fuse for rescue workers)

The high-voltage system fuse is provided with a yellow sticker so that the emergency services can switch off the high-voltage in the vehicle as quickly as possible.

⚠ WARNING

Danger to life or risk of an electric shock and serious burns!

- ▶ Do not change the high-voltage system fuse yourself!
- ▶ Seek the help of a specialist garage.

Functionality

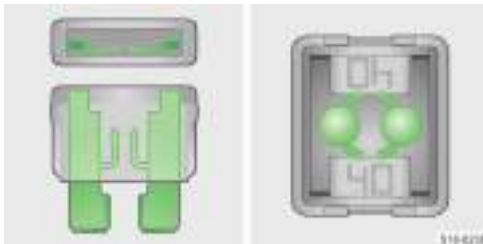

Blown fuse

Conditions for the replacing a fuse

- ✓ Ignition switched off.
- ✓ Driver door opened.
- ✓ All consumers switched off.

Replacing a fuse



- › Replace the fuse with the clamp located on the inside of the fuse box cover in the engine compartment.
- › Use the appropriate end of the clamp according to the fuse dimensions.

Fuses in the dash panel

Overview

Access to fuses – left-hand drive

- › Open the storage compartment on the driver's side.



- › Grasp the side storage compartment in area **A** and open it.
- › Change the fuse.
- › Close the storage compartment.

Access to fuses – right-hand drive

- › Open the storage compartment on the passenger's side.



- › Loosen the brake rod of the storage compartment.



- › Press the locking lugs, the storage compartment folds down.
- › Change the fuse.
- › Insert and lock the brake rod.
- › Close the storage compartment.

Fuses overview

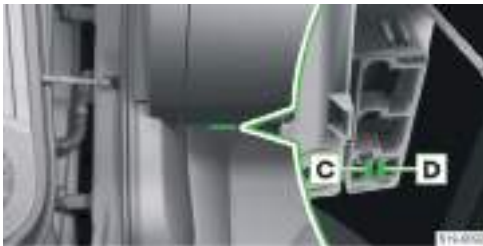

Additional fuses for right hand drive

| Fuse number | Consumer |
|-------------|--|
| 1 | Not used |
| 2 | Heated steering wheel |
| 3 | Not used |
| 4 | Alarm system |
| 5 | Databus |
| 6 | Automatic gearbox |
| 7 | Air conditioning, Heating, Auxiliary heating receiver, Front and rear window heating, clock |
| 8 | Light switch, rain sensor, diagnostic connection, parking brake, ambient lighting, sensor of the alarm system, headlight |
| 9 | USB connections |
| 10 | Infotainment screen |
| 11 | Light - left side |
| 12 | Infotainment |
| 13 | Left side belt tensioner |
| 14 | Air conditioning, heating |
| 15 | Electric steering lock |
| 16 | Phonebox |

| Fuse number | Consumer |
|-------------|--|
| 17 | Instrument cluster, emergency call |
| 18 | Rear view camera, Area View |
| 19 | KESSEY (keyless locking and starting system), sensor in the driver's door handle |
| 20 | Not used |
| 21 | Not used |
| 22 | Tow hitch |
| 23 | Panorama sliding/tilting roof |
| 24 | Light - right side |
| 25 | Central locking (driver's door and rear left door), external mirror driver's side (heating, folding function, mirror surface adjustment) |
| 26 | Heating of the front seats |
| 27 | Interior lighting |
| 28 | Tow hitch |
| 29 | Control lever under the steering wheel |
| 30 | High-voltage battery control system The fuse can only be changed by a specialist company! |
| 31 | Opening the boot lid |
| 32 | Parking aid (Park Assist) |
| 33 | Airbags, switch for hazard warning lights |
| 34 | ESC, ASR, tyre pressure monitor, air conditioning, reversing light switch, mirror with automatic dimming, heated rear seats, parking brake, light switch |
| 35 | Diagnostic connection, camera, radar sensor, "blind spot" detection |
| 36 | Not used |
| 37 | Not used |
| 38 | Tow hitch |
| 39 | Central locking (front passenger door and right rear door), front passenger side exterior mirrors (heating, folding function, mirror surface adjustment) |
| 40 | 12-volt power outlets |
| 41 | Right side belt tensioner |
| 42 | Boot lid, headlight washers, windscreen washer system |
| 43 | Music amplifier |
| 44 | Tow hitch |
| 45 | Electrically adjustable seats |
| 46 | 230 volt socket |
| 47 | Rear window wiper |
| 48 | Engine sound generator |
| 49 | Clutch pedal switch, electric drive and high voltage battery electronics |
| 50 | Not used |
| 51 | Heated rear seats, rear display, rear air conditioning |
| 52 | Shock absorber adjustment (adaptive suspension) |
| 53 | Heated rear window |

| Fuse number | Consumer |
|-------------|---|
| A | Front seat ventilation - left-hand drive |
| B | USB charging - LHD |
| C | USB charging - RHD |
| D | Front seat ventilation - right-hand drive |

Fuses in the engine compartment

Overview

Access to the fuses



- › Simultaneously press the locking buttons on the fuse box cover and remove the cover.
- › Change the fuse.
- › Fit the cover and click into place.

ⓘ NOTICE

Danger of water entering the fuse box.

- ▶ Fit the cover correctly and click into place securely.

Fuses overview

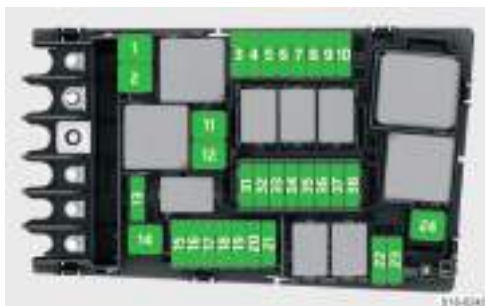

| Fuse number | Consumer |
|-------------|--|
| 1 | ESC, parking brake |
| 2 | ESC |
| 3 | Engine control system |
| 4 | Radiator fan, fuel pressure regulator, oil level and oil temperature sensor, engine components |
| 5 | Engine and high-voltage battery components |
| 6 | Cooling the high-voltage battery |
| 7 | Radiator blinds, charge air cooling pump, crankcase ventilation heating, engine components |

| Fuse number | Consumer |
|-------------|---|
| 8 | Lambda probe |
| 9 | Ignition, engine components |
| 10 | Fuel pump |
| 11 | Electric auxiliary heater |
| 12 | Electric auxiliary heater |
| 13 | Oil pump for automatic gearbox |
| 14 | Heated windscreen |
| 15 | Horn |
| 16 | Electric drive electronics, charging the high-voltage battery |
| 17 | ESC, engine control unit, main relay coil |
| 18 | Databus, battery data module |
| 19 | Windscreen wiper |
| 20 | Brake servo |
| 21 | Automatic gearbox |
| 22 | Not used |
| 23 | Not used |
| 24 | Electric auxiliary heater |
| 31 | Cooling the high-voltage battery |
| 32 | Not used |
| 33 | Not used |
| 34 | Not used |
| 35 | Air Conditioning |
| 36 | Left headlight |
| 37 | Auxiliary heating |
| 38 | Right headlight |

Wheels

Tyres and rims

What you should be mindful of

① NOTICE

- ▶ Protect tyres from contact with lubricants and fuel.
- ▶ Always store wheels or tyres in a cool, dry and, where possible, dark place. Tyres without rims should be stored in an upright position.
- ▶ Alloy rims can be damaged by grit.

Causes of uneven tyre wear

- ▶ Improper tyre pressure.
- ▶ Driving style (e.g. fast cornering, rapid acceleration and deceleration).
- ▶ Wheel alignment error.
- ▶ Incorrect wheel balancing.

Wheel changes

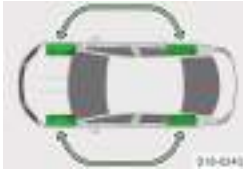

For uniform wear on all tyres, we recommend that you change the wheels every 10,000 km according to the schedule.

Advice for tyre assembly

- › Follow the specified running direction, otherwise the driving characteristics may be impaired. The direction of rotation of the tyres is marked by arrows on the wall of the tyre.
- › Always replace the tyres by the axle.

Additional information

Only fit radial tyres of the same type, size (rolling circumference) and the same tread pattern on one axle.

Approved tyre sizes are specified in the technical vehicle documentation and in the declaration of conformity (in the so-called COC Document).

The declaration of conformity can be obtained from a ŠKODA Partner (valid for some countries and some models).

Overview of tyre labelling

Explanation of tyre markings

e.g. 216/60 R 16 95 V

- 216** Tyre width in mm
- 60** Height/width ratio in %
- R** Code letter for the type of tyre - Radial
- 16** Diameter of wheel in inches
- 95** load index
- V** Speed symbol

load index

The load index indicates the maximum permissible load for each individual tyre

- 91** 615 kg
- 92** 630 kg
- 93** 650 kg
- 94** 670 kg
- 95** 690 kg
- 96** 710 kg
- 97** 730 kg
- 98** 750 kg
- 99** 775 kg

Speed symbol

The speed symbol indicates the maximum permissible speed for a vehicle fitted with tyres in the category concerned

- M** 130 km/h
- T** 190 km/h
- U** 200 km/h
- H** 210 km/h
- V** 240 km/h
- W** 270 km/h
- Y** 300 km/h

⚠ WARNING

- ▶ Do not exceed the maximum permissible load bearing capacity and speed for the tyres fitted.

Tread wear indicators



Wear indicators are located in the profile of the tyres that display the permissible minimum tread depth.

Markings on the walls of the tyres with the letters "TWI" or other symbols (e.g. Δ) indicate the position of the wear indicators.

A tyre is to be regarded as worn out when this wear indicator is flush with the tread.

- ① The tread depth can be measured using a tread depth gauge on the ice scraper. The ice scraper is located on the inside of the fuel filler flap.

⚠ WARNING

Risk of an accident!

- ▶ Do not use worn tyres.

Tyre manufacturing date

The date of manufacture is indicated on the tyre sidewall.

For example, DOT ... 10 19 means that the tyres were produced in the 10th week of the year 2019.

⚠ WARNING

Risk of an accident!

- ▶ Do not use tyres that are older than 6 years.

Troubleshooting**Help with a flat tyre**

- ▶ Changing the wheel and raising the vehicle.
- ▶ Breakdown kit » [page 165](#).

Change of tyre pressure

Illuminated - Tyre pressure change

- ▶ Stop the vehicle.
- ▶ Check the tyres and tyre pressures.

Show tyres with modified pressure

In the following menu, select the menu item for displaying the tyre condition.

MENU > >

Or:

CAR >

All-season or winter tires**Usage**

All-season or winter tyres improve handling in winter weather conditions. They are characterised by 'M+S' and a mountaintop and snowflake symbol

What you should be mindful of

For the best possible handling, use tyres on all four wheels with a minimum tread depth of 4 mm.

Change winter tyres to summer tyres at the appropriate time. Summer tyres have better driving and braking characteristics on snow- and ice-free roads and at temperatures above 7 °C.

Usage conditions

If all-season or winter tyres are installed that have a lower speed category than the actual specified maximum vehicle speed, then proceed as follows.

- ▶ In infotainment, set the speed limit according to the category of tyres fitted.
- ▶ In the driver's field of view, affix a warning label with the maximum value of the speed category intended for the tyres fitted (applies only to certain countries).

Settings

The speed limit setting for tyres is set in the infotainment in the following menu item.

CAR > >

Or:

MENU > >

Snow chains**Usage**

The snow chains improve driving in wintry road conditions.

⚠ WARNING

Risk of accident as well as tyre damage!

- ▶ Do not use chains on routes that are free from snow and ice.

What you should be mindful of

- ▶ Before fitting the snow chains, remove the full wheel trims.
- ▶ Only mount the snow chains on the front wheels.

Technical data

Permitted rim/tyre combinations for mounting of snow chains.

| Rim size | Tyre size |
|--------------|------------|
| 6.5Jx16 ET41 | 215/60 R16 |
| 6.5Jx17 ET41 | 215/55 R17 |

Only fit snow chains with links and locks that are no larger than 13 mm.

SEAL tyres**Usage**

The SEAL tyres have increased resistance to air leakage when punctured.

When replacing SEAL tyres with standard tires, the vehicle must have one of the following pieces of equipment.

- ▶ Spare or emergency spare wheel with corresponding tool for replacing it.
- ▶ Breakdown kit.

Changing the wheel and raising the vehicle

What you should be mindful of

Before changing

- › Park the vehicle securely and secure it from rolling away.
- › Turn off the engine.
- › Let all of the occupants get out. During the wheel change they should not stand on the road, e.g. behind the crash barriers.
- › All doors, the luggage compartment and tailgate close.
- › Uncouple any trailers.

Raise vehicle

⚠ WARNING

Always ensure the base plate of the lifting jack cannot slip!

- ▶ Provide a wide and firm base under the jack on loose surfaces.
- ▶ Create a non-slip base (e.g. a rubber floor mat) under the jack on a smooth surface.
- ▶ Always raise the vehicle with the doors closed.
- ▶ Do not insert any body parts under the raised vehicle.
- ▶ Do not start the engine of the lifted vehicle.

① NOTICE

Danger of damage to vehicle!

- ▶ Make sure that the jack is attached correctly to the bridge of the sill.

After having been changed

- › Check the tyre pressure on the mounted wheel and adjust if necessary.
- › In vehicles with a tyre indicator, save the tyre pressure values in the system.
- › Have the tightening torque of the wheel bolts of the mounted tyres checked with a torque wrench as soon as possible.

The specified tightening torque is 120 Nm.

Drive carefully until the tightening torque is checked.

Replace the damaged tyre. It is not recommended to repair the tyre.

⚠ WARNING

Risk of an accident!

- ▶ Too low a tightening torque may cause the wheel to disengage while driving.
- ▶ Too high a tightening torque can damage the threads and cause the rim to deform.

⚠ WARNING

Risk of an accident!

- ▶ Do not grease or lubricate screws.
- ▶ Do not use corroded or damaged screws.

Changing the wheel and raising the vehicle

Release screws

- › If the vehicle has covers over the wheel bolts or wheel trims, remove them.

⚠ WARNING

- ▶ If you step on the key end when loosening the screw, hold on to the vehicle for better stability.



Some vehicles may have anti-theft wheel bolts that protect the wheels from theft.

- › Insert the upper section on the anti-theft wheel bolt until it stops.



- › Place the key on the wheel bolt or on the attachment piece.
- › Turn the screw a maximum of half a turn so that the wheel does not come loose and fall off.

Jacking points for the jack

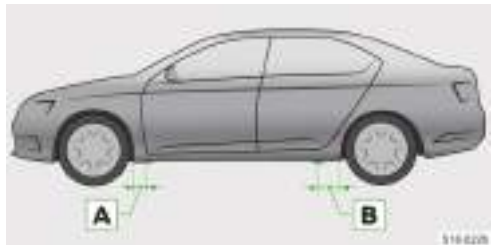

A 16 cm

B 34 cm

Position the jack and lift the vehicle

Use the jack from the tool kit.



- › Position the jack at the jacking point closest to the wheel to be replaced.
- › Insert the crank into the mount on the car jack.
- › Support the base plate of the jack with its full area resting on level ground and ensure that the jack is located in a vertical position at the jacking point.
- › Use the crank to raise the jack until its claw encloses the bar.
- › Continue to lift the vehicle until the wheel is just off the floor.

Changing a wheel

- › Unscrew the screws and place them on a clean surface.
- › Remove the wheel carefully.
- › Attach the wheel.
- › Slightly screw in the screws.
- › Lower the vehicle.

ⓘ NOTICE

- ▶ Applies to wheel trims supplied ex-factory or from ŠKODA Original Accessories: the anti-theft wheel bolt should be installed in the position marked on the back of the wheel trim.

Tighten screws

- › Tighten the opposite wheel bolts including the anti-theft wheel bolt one after the other.
- › Reinstall the cover caps of the wheel bolts or the full wheel covers.

ⓘ Keep the label with the code number of the anti-theft wheel bolts. A replacement upper section can be acquired from ŠKODA original parts based on this.

Breakdown kit

Content overview

The kit is located in a box under the floor covering in the luggage compartment.

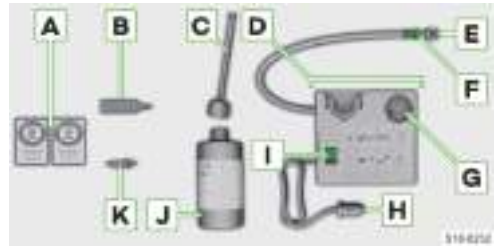

- A** Sticker with speed indication
- B** Valve remover
- C** Inflation hose with plug
- D** Air compressor (the layout of the controls may be different depending on the type of air compressor)
- E** Tyre inflation hose
- F** Button for pressure reduction
- G** Pressure indicator
- H** 12 volt cable connector
- I** ON and OFF switch
- J** Tyre inflation bottle
- K** Replacement valve core

The declaration of conformity is included with the air compressor or the log folder.

Usage conditions

Performing a repair with the breakdown kit not at all intended to replace a permanent repair on the tyre.

The purpose of the repair is to get you to the nearest specialist garage.

Change the tyre repaired by the breakdown kit as soon as possible.

Before using the kit

- › Park the vehicle securely and secure it from rolling away.
- › Turn off the engine.
- › Let all of the occupants get out. During the wheel repair they should not stand on the road, e.g. behind the crash barriers.
- › Close all doors as well as the bonnet and boot lid.
- › Uncouple any trailers.

After using the kit

If a tyre pressure of 2.0 bar can not be achieved, the tyre is too damaged and cannot be sealed with the puncture set.

- › Stop driving. Seek the help of a specialist garage.

Once a tyre pressure of 2.0–2.5 bar is achieved, continue the journey at a maximum speed of 80 km/h (50 mph).

- › Avoid full accelerations, strong braking and fast cornering.

Information for driving with repaired tyres

- › The pressure of the repaired tyre must be checked after driving for 10 minutes.
- › If the tyre pressure is 1.3 bar and less, do not continue! Seek the help of a specialist garage.
- › If the tyre pressure is higher than 1.3 bar, correct the pressure to the correct value of at least 2 bar and continue driving.

① **NOTICE**

Danger of damage to the compressor!

- ▶ After the maximum running time of the air compressor, allow it to cool for a few minutes.

⚠ **WARNING**

Risk of burns!

The tyre inflation hose and the air compressor may become hot when inflated.

- ▶ Allow the air compressor and hose to cool for a few minutes.

Usage restrictions

Do not use the kit in the following cases.

- ▶ The rim is damaged.
- ▶ The outdoor temperature is below the minimum temperature indicated in the manual of the tyre filling bottle.
- ▶ Tyre punctures are greater than 4 mm.
- ▶ There is damage to the tyre wall.
- ▶ The expiry date stated on the tyre inflation bottle has expired.

Self-help

Seal the tyres

- › Unscrew the valve cap from the damaged tyre.
- › Unscrew the valve core with the valve insert and place it on a clean surface.
- › Shake the tyre inflation bottle back and forth with sealant.
- › Screw the inflation hose onto the tyre inflater bottle. The film on the closure is pierced automatically.
- › Remove the plug from the inflation hose and push it fully onto the tyre valve.
- › Hold the bottle with the bottom facing upwards and fill all of the sealing agent into the tyre.
- › Remove the filler plug from the valve.
- › Screw in the valve insert.

Inflate tyres

- › Fit the tyre inflation hose of the air compressor to the tyre valve.
- › Secure the vehicle with the parking brake.
- › Start the engine.
- › Plug the connector into the 12 volt socket .
- › Turn on the air compressor.
- › Once a tyre pressure of 2.0-2.5 bar is reached, turn off the air compressor.

Observe the maximum running time of the air compressor according to the directions of the repair kit manufacturer.

- › If an air pressure of 2.0 - 2.5 bar has not been reached, remove the tyre inflation hose from the valve.
- › Drive approx. 10 metres forwards or backwards to allow the sealing agent to distribute in the tyre.
- › Replace the tyre inflation hose on the valve and repeat the inflation procedure.

Tyre pressure

What you should be mindful of

① **NOTICE**

- ▶ Always adjust the tyre pressure to the load.
- ▶ Check the pressure in all tyres at least once a month and before each longer ride.
- ▶ Check the pressure when the tyres are cold. If necessary, do not reduce the elevated pressure when the tyres are warm.
- ▶ After each change in tyre pressure, save the new values in the tyre control display.

⚠ **WARNING**

Risk of an accident!

- ▶ If tyre pressure loss is very quick, try to stop the vehicle carefully without heavy steering or heavy braking.

Sticker with prescribed tyre pressures

The sticker with prescribed tyre pressures is located on the inside of the fuel filler flap.

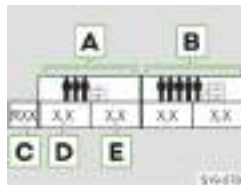

- A** Inflation pressure for half load
- B** Inflation pressure for a full load
- C** Tyre diameter in inches

This information only serves as informa-

tion for the prescribed tyre pressure. This is not a listing of approved tyre sizes for your vehicle. These are listed in the technical vehicle docu-

mentation and in the declaration of conformity (in the so-called COC Document).

- D** Tyre pressure reading for the front axle tyres
- E** Tyre pressure reading for the rear axle tyres

Tyre pressure monitor

Functionality

The tyre pressure monitoring indicator indicates a change in tyre pressure.



Warning when pressure changes

-  Illuminated - Tyre pressure change
 - › Stop the vehicle.

- › Check the tyres and tyre pressures.

Show tyres with modified pressure

- › In the following menu, select the menu item for displaying the tyre condition.

MENU ›  › 

Or:

CAR › 

Function restriction

The system is unable to provide a warning in the event of a very rapid tyre pressure loss, e.g. sudden puncture.

The system function may be restricted in the following cases.

- ▶ Uneven loading of the wheels, e.g. with a trailer attached.
- ▶ Sporty driving style.
- ▶ Driving on dirt roads.
- ▶ Snow chains fitted.



Saving tyre pressure values

Store the tyre pressure values in the infotainment

- › Inflate the tyres to the prescribed inflation pressure.
- › Turn on the ignition.
- › In the following menu, select the menu item for displaying the vehicle condition.

CAR › 

Or:

MENU ›  › 

- › Using the functional surfaces ◀ ▶ select the tyre control display menu.
- › Tap on the functional surface (I) SET.
- › Then follow the instructions on the screen.

Save the tyre pressures in the following cases.

- ▶ Change of tyre pressure.
- ▶ Change of one or more wheels.
- ▶ Change of position of a wheel on the vehicle.
- ▶ Always after covering a distance of 10,000 km or once a year.

Troubleshooting

Tyre pressure display faulty

-  flashes for about 1 minute and stays on
 - › Stop the vehicle, switch off the ignition and start the engine.

If the (I) symbol flashes again after starting the engine, there is a system fault.

- › Continue driving, exercising appropriate caution, and seek the help of a specialist garage.

Tyre pressure monitoring system

Functionality

The system measures tyre pressure while driving using sensors on the wheels.

For correct system function, you must select the tyre type as well as the load condition of the vehicle in the Infotainment.

- I** After switching on the ignition, the last measured tyre pressure values are displayed. This display will be updated at the start of the journey.

Warning when changing the tyre pressure

-  illuminates
 - › Stop the vehicle.
- › Check the tyres and tyre pressures.

Overview

Display in the instrument cluster



- › Select the *Vehicle* menu item.

Display in Infotainment

- › In the following menu, select the menu item for displaying the vehicle condition.

CAR › 

Or:

MENU ›  › 

- › Using the functional surfaces ◀ ▶ choose the Tyre Pressure Monitoring menu item.

Instrument cluster / Infotainment

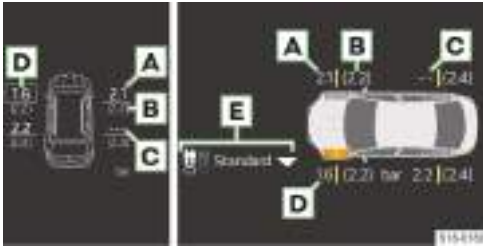

- A** Tyre pressure
- B** Recommended tyre pressure
- C** Tyre pressure not available
- D** Tyre pressure too low
- E** Adjust the vehicle's loading condition

ⓘ The tyres warm up while driving and there is an increase in pressure. This is completely normal, it is not a defect. If the system indicates an increase in pressure while driving, do not reduce the pressure.

Settings

Tyre type

Select the tyre type in the following menu.

CAR > >

Or:

MENU > >

Vehicle loading condition

› In the following menu, select the menu item for displaying the vehicle condition.

CAR >

Or:

MENU > >

- › Using the functional surfaces ◀ ▶ choose the *Tyre Pressure Monitoring* menu item.
- › Tap the ▽ functional area and select the vehicle load condition.

Troubleshooting

Functional restriction / system fault

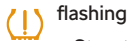

flashing

- › Stop the engine and start again.
- › If the indicator light flashes again after the engine starts, there is a problem with the system.
- › Continue driving, exercising appropriate caution, and seek the help of a specialist garage.

Wheel bolt cover caps

Remove cover caps and install



Disconnecting

- › Push the pull-off clamp onto the cover cap up to the stop.
- › Remove the cover cap.

Installing

- › Push the cover cap onto the wheel bolt to the stop.

Full wheel frame

Removing and installing the trim

Applies to factory built or original accessory trims from ŠKODA.

Disconnecting

- › Hang the clamps for removing the wheel trims at the edge of one of the openings in the trim.
- › Push the wheel wrench through the clamp, support on the tyre and pull off the wheel trim.

Installing

- › Press the wheel trim onto the wheel rim at the designated valve opening.

When using an anti-theft wheel bolt, it must be located at the location indicated on the bezel.

- › Press the trim, starting at the valve, into the rim on both sides until it engages around the entire circumference.

ⓘ **NOTICE**

- ▶ Use hand pressure, do not hit the wheel cover.

Storage space and interior equipment

Equipment in the boot

Overview



- A** Removable light
- B** Lever for folding forward the rear seat backrests
- C** Net
Max. load 1.5 kg
- D** Partition wall of storage compartment
Max. load 2.5 kg
- E** 12 volt socket

Emergency equipment

Overview of the emergency equipment

Emergency equipment in the luggage compartment

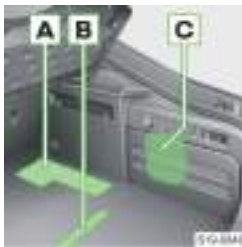

- C** Placing the first-aid kit

- A** Tool kit
► To access the tool kit, fold the rear seat forwards to the right and fold back the floor covering from the passenger compartment.
- B** Placing of the warning triangle

Storage compartment for the reflective vest

The storage compartment for the reflective vest is in the storage compartment of the front door.

Fire extinguisher under the passenger seat



Tool kit

Depending on the equipment, not all of the following components may be included in the tool kit.

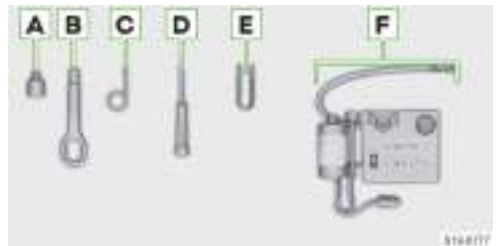

- A** Attachment for the anti-theft wheel bolts
- B** Towing eye
- C** Bracket for removing the full wheel covers
- D** Screwdriver
- E** Removal clip for the wheel bolt cover caps
- F** Breakdown kit

The declaration of conformity is enclosed with the jack or the logbook folder.

Fasteners in the boot

Overview

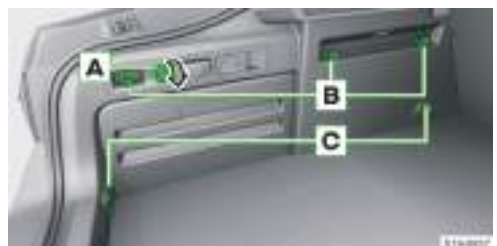

- A** Bag hooks
Max. load 7.5 kg
- B** Fasteners for securing the fastening nets
- C** Lashing eyes for securing the load and the fastening nets

Max. load 350 kg

Other fasteners

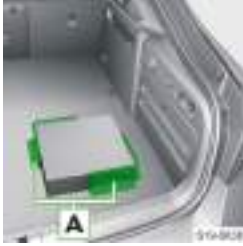

- A** Cargo elements
Max. load 8 kg
A storage compartment for the cargo elements is located under the floor covering in the luggage compartment.
- › Fold up the cargo element and fasten

it to the floor covering in the luggage compartment.

Fastening nets

Overview



The maximum load of the respective fastening nets is 1.5 kg.

Multifunctional pocket

Operation

Unfolding



- › Fold down the front hooks on both sides of the luggage compartment.
- › Fit the rear strip on the hooks.

Folding



- › Remove the rear strip from the hooks.
- › Place the rear strip against the front strip and press them together at both ends.

Remove and insert

Removing

- › Remove the roll-up cover.
- › Take out the folded pocket in an upwards direction.

Inserting



- › Insert the end of the strip marked with **R1** into the right-hand mount and the end of the strip marked with **L1** into the left-hand mount.

Net partition

Attach the net partition

Attach at the back



- › Open the lid of the roll-up cover.



- › Pull out the net partition.
- › Insert the crossbar into the mount on one side and push it forwards.
- › Fix the bar in the same way on the other side.
- › Open the lid of the roll-up cover.

Fasten in the front

The procedure is analogous to the process behind.

Before installing, fold back the rear seat backrests.

Releasing

- › Open the lid of the roll-up cover.
- › Move the rod first to one side and then to the other side, and take it out of the supports.
- › Hold the pole and allow the net partition to slowly roll in.
- › Open the lid of the roll-up cover.

Remove housing and insert**Removal**

- › Fold the rear seat backrests forwards.
- › Open the door at the right rear.



- › Move and swing out the housing.

Inserting

- › Insert the housing into the supports and move it.

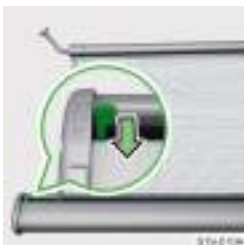
Troubleshooting**Blocked net partition**

- › To unlock, press the lock button.

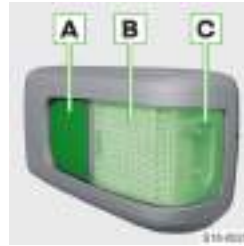
Removable light**Overview**

- A** Button for switching on and off
- B** Light (lights up when the light is in the bracket and the boot lid is open)
- C** Light (lights up when the light is outside the bracket)

i The batteries in the light are charged while the engine is running. A full charge of the batteries takes about 3 hours.

Remove and insert**⚠ NOTICE**

- › Protect the light from moisture.

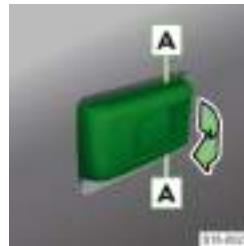
Removing

- › Grasp the light in area **A** and swivel it out.

i Thanks to the integrated magnets, the light can be attached, for example, to the vehicle body.

Inserting

- › Insertion takes place in reverse order.

Replace batteries



- › Pry off the cover with a narrow, pointed object in the area of the arrow.
- › Replace the batteries.
- › Fit the cover and click into place.

ⓘ NOTICE

New batteries must comply with the specifications of the original battery.

Rigid boot cover

Remove and insert

The maximum load of the other fastening nets is 1 kg.

Removing



- › Unhook the straps.

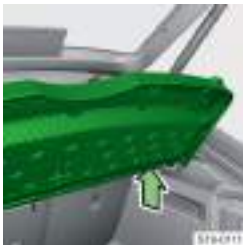

- › Hold the raised cover in place and press the underside of the cover on both sides.
- › Remove the cover.

Inserting



- › Insert the holder with part **A** and then snap part **B** of the receptacle into the recess **C** on both sides of the luggage compartment.
- › Hook in the retaining straps.

Store the cover behind the rear seats



- › Insert the cover behind the rear seats.

Roll-up luggage compartment cover

Operation

Extending



- › Pull out the cover on the handle until it clicks into place.

Retracting



- › Press the cover in the handle area.

The cover rolls up to the intermediate position **A**.

Press again to fully open the cover.

It is possible that the cover rolls more slowly during winter weather

conditions.

Settings

Automatic rewinding of the cover to the intermediate position

The cover automatically rolls into the intermediate position when the boot lid is opened.

The function is activated or deactivated in the following menu in the Infotainment system.

CAR › › ›

Or:

MENU › › ›

Remove and insert

Take out and insert the roll-up cover



- › Press the end of the crossbar and take out or insert the cover.

Through-loading bag

Insert and lock

In the bag, a max. of 4 pairs of skis with poles can be transported.

- › Fold the rear armrest and the cover in the seat backrest downwards.
- › Place the empty bag in the opening in such a way that the end of the bag with the zip is in the boot.
- › Place the skis with the tips facing to the front and the poles with the tips facing to the rear into the bag and close the bag.



- › Tighten the strap A around the skis in front of the bindings.
- › Fold the seat backrest a little forward.



- › Guide the securing strap B through the opening around the upper part of the seat backrest.
- › Fold the seat backrests back until the locking button clicks into place.
- › Insert the securing strap into the lock until it clicks into place.

⚠ WARNING

The maximum weight of the transported skis is 17 kg.

ⓘ NOTICE

Risk of damage to the armrest!

- ▶ Handle the bag and the skis with care.

Overview of passenger compartment

Overview of practical equipment in the front



- A** Make up mirror
- B** Ticket holder
- C** Ticket holder
- D** Spectacles compartment
Max. load 0.25 kg
› To open, press the button.
- E** Storage compartment with air outlet nozzle
Max. load 3 kg
In the compartment, there is a card holder and a pen holder.
› Pull the handle to open the compartment.
› Turn the knob to position ⚙ to open the air outlet nozzle.
- F** Storage tray
▶ Bottle holder with a capacity of max. 1.5 l
▶ Storage compartment for the waste container
▶ Storage compartment for the reflective vest
- G** Storage tray
In the compartment is a 12-volt power outlet and a USB connection.

The USB connection can be used for charging and for data transfer.

▶ Press the strip to open/close the compartment.

H Openable and adjustable armrest with storage compartment

There is a USB connection in the compartment. The USB connection can be used for charging and for data transfer.

- ▶ To open the compartment, lift the armrest.
- ▶ Turn the knob to position  to open the air outlet nozzle.

I Storage tray

Max. load 0.5 kg

A card holder is located in the compartment.

- ▶ Pull on the handle to open.

ⓘ NOTICE

- ▶ Do not leave heat-sensitive objects behind in the glasses compartment **D**.

- ▶ Bottle holder with a capacity of max. 0.5 l
- ▶ Storage compartment for the reflective vest

E Storage pocket

⚠ WARNING

- ▶ Only hang lightweight clothing on the hook. Never leave any heavy or sharp-edged objects in the pockets of the items of clothing.
- ▶ Do not use hangers to hang up the clothes.

Storage compartment under the front seat

Opening the storage compartment



The maximum permissible load for storage compartment is 1.5 kg.

Overview of the practical equipment in the rear



A Coat hook

Max. load 2 kg

B Storage pocket

C Depending on the equipment:

- ▶ 230 volt socket and USB connection
 - The USB connection is for charging only.
- ▶ Storage compartment with 12 volt socket

D Storage tray

Storage compartment for an umbrella

Overview



Phonebox

What you should be mindful of

⚠ CAUTION

Risk of burns during charging.

- ▶ The phone may get warm, remove it carefully from the storage compartment.
- ▶ Do not leave any metal objects in the compartment under the phone. If there is a metallic object in the storage compartment, which has become hot, remove the phone and let it cool down in the storage compartment!

Functionality

Functions of the Phonebox

- ▶ Wireless charging of phones.
- ▶ Amplification of the telephone signal (only valid for some countries).

The Phonebox is located in the storage compartment in the centre console at the front.

Insert a telephone with a maximum size of 146x80 mm into the storage compartment.

Charging Indicator

When the phone is charging, the Φ in the status bar in the infotainment screen will light up.

Recommendations for optimal function

- ✓ The phone is positioned with the screen facing up.
- ✓ The protective cover of the phone is removed.
- ✓ The phone is centred on the phone icon on the pad.

Operating conditions

Conditions for wireless charging

- ✓ Ignition is switched on.
- ✓ The phone supports the Qi standard.
- ✓ There is no object between the pad and the phone.

Troubleshooting

A message has been displayed on the Infotainment screen indicating that the mobile phone cannot be charged.

- ▶ Check that there is no object between the pad and the phone to be charged. If this is the case, remove the phone and the item. Place the phone centrally on the phone symbol on the pad again.
- ▶ Check that the position of the phone to be charged has not changed. If this is the case, remove the phone and put it back in the centre of the phone symbol on the pad.

Cup holder

Overview

Cup holder at the front



- › Press on the bar to open.

In the centre console holder area, a bottle can be opened with one hand.

- › Press the bottle into the holder and unscrew the cap.

Rear cup holder



- › To open it, open the lid.

⚠ CAUTION

Risk of scalding!

- ▶ Never put hot beverage containers in the cup holder.

ⓘ NOTICE

Risk of damage to the electrical system and to the panels due to spilled drinks.

Waste container

Replace bags

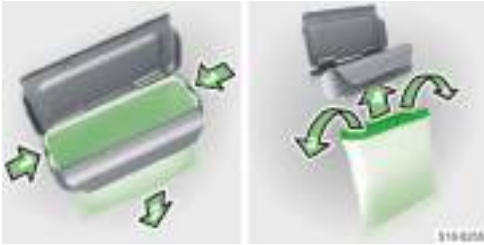

Ashtray and cigarette lighter

What you should be mindful of

⚠ CAUTION

Risk of burning or fire!

- ▶ Do not use the ashtray for storing hot or burning objects.
- ▶ Handle the lighter carefully.

Operation

Removable ashtray



The ashtray is inserted in the cup holder.

ⓘ NOTICE

- ▶ When removing, do not hold the ashtray by the lid.

Ashtray with removable insert



Cigarette lighter



- ▶ Push in the lighter.
- ▶ Wait until the glowing lighter pops back out.
- ▶ Remove the lighter and use.
- ▶ Push the lighter back in.

The socket of the cigarette lighter serves as a 12 V socket.

Ceiling

Remove and insert

The blanket is in a bag that can be attached to one of the following locations.

- ▶ On the guide rods of the front headrests.
- ▶ In the storage pockets on the backs of the front seats.

Display in rear centre console

Overview



- A** Set the temperature
- B** Display

Tablet holder

Settings

Tilt and turn



Adjust size



- › Pull out the locking tab and move the upper part of the holder to the desired position.

Set the minimum size of the empty holder to avoid noise while driving.

Remove and insert

Fasten behind the headrests



- › Place the open adapter on the front guide rods of the headrest and clip in carefully.



- › Clip in the holder in the adapter.

Removal



- › Press the safety button and unfold the holder.



- › Press on the adapter and remove it.

Insert into the rear armrest



- › Clip the holder into the opening.

Removal



- › Press the safety button and unfold the holder.

Technical data

The holder is for fixing a tablet with a height of min. 12.2 cm and max. 19.5 cm.

The maximum load for the holder is 0.75 kg.

Storage compartment for the tablet

Operation



- ▶ Pull **A** to open at the loop.

12-Volt power socket

Operating conditions

① NOTICE

Risk of damage to the electrical system of the vehicle!

- ▶ Use the sockets only for the connection of approved electrical accessories with a total power consumption of up to 120 watts.

① NOTICE

Danger of damage to the connected consumers!

- ▶ Switch off the consumers before switching the ignition on or off and before starting the engine.

230-Volt power socket

Functionality

① NOTICE

Danger of damage to the connected consumers!

- ▶ Do not connect a light with fluorescent lamp to the socket.
- ▶ Switch off the consumers before switching the ignition on or off and before starting the engine.

Status display

- ▶ Lit up in green - the socket is switched on.
- ▶ Blinking green - the socket is still switched on for about 10 minutes after the engine has been switched off, if a consumer was connected before the engine was switched off.

i The socket has a child safety lock. When inserting the plug, the fuse is unlocked and the socket is switched on.

Operating conditions

- ✓ The engine is running.

i On vehicles with the START-STOP system, the socket also works in STOP mode.

Troubleshooting

The indicator light flashes red

The socket is switched off for the following reasons.

- ▶ Excessive current.
- ▶ Low state of charge of the battery.
- ▶ Overheating of the socket.
- ▶ If the reasons given above no longer apply and the socket is still not switched on automatically, disconnect the connected consumer from the socket and reconnect after a short time.

Roof rack and hitch

Roof rack

Overview

The maximum weight of the load incl. roof rack is 100 kg.



Depending on the equipment, the roof bars can be attached at the attachment points **A** and **B** or to the roof rail.

Swivelling hitch

What you should be mindful of

⚠ WARNING

Risk of an accident!

- ▶ Do not manipulate the handle for swinging the tow bar in and out while a trailer or another accessory is coupled to the tow bar. The tow bar could be unlocked.

⚠ CAUTION

Risk of injury!

- ▶ Handle the trailer coupling carefully.
- ▶ When swinging out the tow bar, do not stand in the middle area of the rear bumper.

ⓘ NOTICE

Risk of damage to the trailer coupling!

- ▶ When not using the towing device, swing the tow bar under the bumper.

Tow bar: swivel out/in

Swing out the tow bar



- ▶ Pull on the handle. The tow bar swings out. The indicator light next to the handle flashes red.
- ▶ Slowly retract the handle.



- ▶ Press the tow bar until it audibly clicks into place.

Check latching: the indicator light next to the handle lights up green.

Swivel tow bar

ⓘ NOTICE

- ▶ No trailer or any other accessory can be connected to the tow bar.
- ▶ A socket or adapter may not be plugged into the socket.



- ▶ Pull on the handle. The tow bar is unlocked. The indicator light next to the handle flashes red.
- ▶ Slowly retract the handle.



- ▶ Swing in the tow bar under the bumper until it audibly clicks into place.

Check latching: the indicator light next to the handle lights up green.

Coupling or uncoupling a trailer or accessory

The following information describes the procedure for coupling and uncoupling a trailer. The information also refers to another accessory, e.g. a bike carrier.

⚠ WARNING

Risk of an accident!

- ▶ Do not use the safety eye for towing.
- ▶ Distribute and fix the load correctly.

ⓘ The trailer has a 13-pin electrical socket. If the trailer have a 7-pin connector, use a corresponding adapter from the ŠKODA Original Accessories.

Coupling

- ▶ Swing out the tow bar.
- ▶ Put the trailer drawbar onto the ball head.

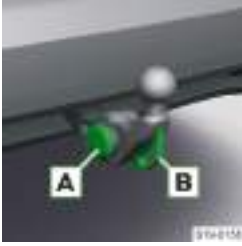

- › Plug the electrical trailer plug into the socket **A**.
- › Hook the tear-off rope of the trailer onto the safety eye **B**. The tear-off rope must sag against the vehicle in all trailer positions.

Uncoupling

Uncoupling takes place in reverse order.

Power supply of the trailer power network

In the electrical connection between the vehicle and trailer, the trailer is powered by the vehicle.

ⓘ NOTICE

Risk of damage to the vehicle electronics!

The total power consumption of all consumers connected to the trailer power supply must not exceed max. 350 watts.

Troubleshooting

Trailer coupling error

The indicator light next to the handle does not light up green, or the tow bar does not lock into place.

- › Do not use the trailer coupling.
- › Seek the help of a specialist garage.

Tow bar not locked



illuminates

- › Engage the tow bar.

Technical data

Maximum vertical load for trailer operation

The maximum vertical load for trailer operation depends on the engine type and the vehicle equipment.

The valid specification for your vehicle can be found in the technical vehicle documentation, (e.g. vehicle approval documentation, COC document) or at a ŠKODA partner.

Other information (e.g. on the nameplate of the trailer device) merely provides information on the test values of the device.

Support load with mounted accessories

When using the accessories (e.g. bicycle carrier), the maximum length and the permissible total weight including load must be considered.

The maximum length of the mounted accessories (from the ball of the towing device) may not exceed 70 cm.

The permissible total weight of the mounted accessories including its load corresponds to the maximum vertical load for trailer operation; the value can be found in the vehicle registration documentation.

If the maximum load in trailer operation is more than 75 kg, then the permissible total weight of the mounted accessories including their load must not exceed 75 kg.

This value applies if the centre of gravity is at a distance of no more than 30 cm from the towing device ball head.

If the distance of the centre gravity of the load to the ball head of the towing device is greater than 30 cm, then the max. permissible total weight of the accessory, including its load, decreases (e.g. at a distance of 60 cm from the ball head, the permissible weight decreases by half).

⚠ WARNING

Risk of an accident!

- › Do not exceed the maximum vertical load.
- › The permissible trailer load and the weight of another accessory, e.g. of the bike carrier, is not to be exceeded.

ⓘ NOTICE

Risk of damage to the trailer and the vehicle itself!

- › When using the accessory (e.g. bicycle carrier), observe the maximum length and the permissible total weight of the accessory incl.

Maintaining and cleaning

Service events

Service intervals

Compliance with service intervals is crucial for the life and value of the vehicle.

You will be notified about a due service appointment by the symbol  and the corresponding message in the instrument cluster display.

The specialist garage will inform you of the type of service interval, the option of changing this and the scope of service.

I All services and the replacement or refilling of operating fluids are chargeable to the customer, even during the warranty period, unless the ŠKODA AUTO warranty conditions or other binding agreements determine otherwise.

Proof of service

A specialist garage stores the proof of service in the information system called Digital Service Plan.



The proof of service can be printed out.

Show service appointment

In Infotainment, select the following menu.

CAR >  > Menu item for the service

Or:

MENU >  >  > Menu item for the service

Resetting information

We recommend that you do not reset the information regarding service events on your own. It can lead to incorrect setting of the service intervals and thus also to possible faults in the vehicle.

For vehicles with a variable service interval, new service interval values calculated according to the previous operating conditions will be displayed after the oil change service indicator is reset. These values will then continue to be adjusted according to the current operating conditions.

Service work, adjustments and technical changes

The instructions and guidelines from ŠKODA AUTO must be observed when carrying out any modifications, repairs or technical alterations to the vehicle.

Adhering to these instructions and guidelines helps ensure road safety and helps keep the vehicle in a good technical condition.

We advise only using ŠKODA Original Accessories and ŠKODA Original Parts which have been expressly approved for use on your vehicle. Reliability, safety

and suitability for your vehicle are guaranteed with these.

ŠKODA Service Partner

All ŠKODA Service Partners operate according to the most recent guidelines and instructions from ŠKODA AUTO. Service and repair work is therefore carried out on time and at the appropriate quality. Adhering to these instructions and guidelines helps ensure road safety and helps keep the vehicle in a good technical condition.

We therefore advise having all modifications, repairs and technical alterations to the vehicle carried out by a ŠKODA Service Partner.

ŠKODA original parts

We recommend the use of ŠKODA Original Parts for your vehicle, as these parts are approved by ŠKODA AUTO. These parts correspond exactly to the ŠKODA AUTO regulations and are identical to the parts used in series production.

ŠKODA AUTO is able to warrant the safety, suitability, and long life of these products.

ŠKODA Service Partners are liable for any defects of ŠKODA Genuine Parts for a period of 2 years after sale in accordance with the materials defect liability, unless agreed otherwise in the purchase agreement.

ŠKODA original accessories

We recommend that you use ŠKODA Genuine Accessories in your vehicle. With these accessories, ŠKODA AUTO stands for safety, reliability and the suitability for your vehicle type.

ŠKODA Service Partners are liable for any defects of ŠKODA Genuine Accessories for a period of 2 years after installation or delivery in accordance with the materials defect liability, unless agreed otherwise in the purchase agreement or any other agreements.

Spoiler

WARNING

Risk of an accident!

- ▶ Only use the original spoiler on the front bumper in combination with the original spoiler on the boot lid.
- ▶ The original spoiler on the front bumper cannot be left on its own without the spoiler on the luggage compartment lid or in combination with an unsuitable spoiler on the luggage compartment lid.
- ▶ We recommend that you consult the ŠKODA Service Partner for any repairs to or replacement, addition or removal of spoilers.

Component protection

Some electronic vehicle components (such as the instrument cluster) are factory-equipped with component protection. This component protection ensures the functional limitation of these components in a

non-legitimate installation in another vehicle (e.g. after a theft) or operation outside the vehicle.

Interior

What you should be mindful of

① NOTICE

- ▶ Use cleaning agents intended for cleaning and care of the individual materials.
- ▶ Do not use aggressive cleaning agents or chemical solvents.

Natural leather / Faux leather / Alcantara® suede / material

① NOTICE

- ▶ Remove impurities as soon as possible.
- ▶ Do not use solvents, floor wax, shoe cream, stain remover or similar agents on Alcantara® suede seat upholstery.
- ▶ Make sure that natural leather is not moistened when cleaning and that no water seeps into the seams.
- ▶ Do not clean the roof cladding with a brush.

① NOTICE

Risk of fading to the cover fabric.

- ▶ If necessary, do not leave the covers for long periods in the blazing sun.

ⓘ

- ▶ During use, the leather and Alcantara® and suede materials may show minor changes (e.g. folds, discolouration).
- ▶ Some clothing fabrics, e.g. dark denim, sometimes do not have sufficient colour fastness. As a result, discolouration that is clearly visible on the seat upholstery can occur. This is not a defect in the fabric.
- ▶ Sharp-edged zippers, rivets, clamps and similar garments can damage the upholstery in the vehicle. Such damages cannot be subsequently recognised as a justified complaint.

Plastic parts

① NOTICE

Risk of damaging the dash panel.

- ▶ Do not attach fragrances and air fresheners to the dash panel.

Windows

① NOTICE

Risk of damage to the filaments or the glass antenna.

- ▶ Do not stick stickers on the heating filaments.

Covers of electrically heated seats

① NOTICE

Risk of damaging the heating system.

- ▶ Do not clean the seats with water or other liquids.
- ▶ Do not dry the seats by switching on the heating.

Seat belts

① NOTICE

Risk of damage to the seat belts.

- ▶ Do not dry clean the seat belts.
- ▶ Allow cleaned belts to dry before rolling up.

Instructions for cleaning

Natural leather / Faux leather / Alcantara® suede / material

- ▶ Remove dust and dirt on the surface with a vacuum cleaner.
- ▶ Remove fresh impurities with water, slightly moistened cotton cloth or woolen cloth; if necessary, use a mild soap solution and wipe with a dry cloth.
- ▶ Remove stubborn stains with a suitable cleaning agent.
- ▶ For regular care of natural leather, use the equipment provided for this purpose. After each clean, use a care cream with light protection and impregnation effect.
- ▶ When looking after Alcantara®, remove stubborn hair from suede and fabric surfaces with a cleaning brush. Remove pills from materials with a brush.

Plastic parts

- ▶ Remove impurities with water, slightly moistened cloth or sponge with a suitable cleaning agent if necessary.

Windows

- ▶ Remove impurities with clean water and dry with a cloth provided for this purpose.

Covers of electrically heated seats

- ▶ Remove impurities with a suitable cleaning agent.

Seat belts

- ▶ Remove impurities with a soft cloth and mild soap solution.

Exterior

What you should be mindful of

⚠ WARNING

Risk of an accident!

After washing the vehicle, the functionality of the brake system may be affected by moisture and, in winter, by ice.

- ▶ Dry and clean the brakes by braking several times.

① NOTICE

- ▶ Bird droppings, insect residues, litter and sea salt residues, overflowed fuel, etc. are to be removed as soon as possible.
- ▶ Do not use rough sponges, scourers or similar to remove dirt.
- ▶ Use cleaning agents intended for cleaning and care of the individual materials.
- ▶ Do not use aggressive cleaning agents or chemical solvents.
- ▶ Do not polish the vehicle in a dusty environment.

① NOTICE

- ▶ Paint damage should be repaired as soon as possible.
- ▶ Do not treat painted parts with or hard waxes.
- ▶ Do not polish panels.
- ▶ Door seals and window guides must not be treated with anything. Exempted from this are products that are ŠKODA Original accessories. These ensure that the protective lacquer layer of the seals and window guides is not attacked.
- ▶ Do not use abrasive cleaners to clean the reversing camera.

Before driving through a car wash

- › Observe the usual specifications of the car wash, e.g. close all windows, fold the mirrors, etc.
- › Move the windscreen wiper lever to position **OFF** to adjust.
- › If there are special attachments on your vehicle, observe the instructions of the car wash operator.

① NOTICE

In vehicles with an electric boot lid, this can open automatically due to the pressure of the washing brushes.

- ▶ Lock the vehicle, e.g. with the central lock button.

After washing with a wax preservation

- › Wipe off the windscreen wiper blades with a dry cloth.

Wash with a pressure washer
① NOTICE

- ▶ Follow the operating instructions for the high-pressure cleaner. This particularly applies to information with respect to the pressure and spray distance from the vehicle surface.
- ▶ Do not direct the water jet directly at the following vehicle parts.
 - ▶ Components of the high-voltage system, for example the charging socket, high-voltage cable etc.
 - ▶ Foils.
 - ▶ Locks.
 - ▶ Columns on the vehicle.
 - ▶ Trailer connection.

- ▶ Swivelling ball bar.
- ▶ Sensors.
- ▶ Camera lenses.
- ▶ Plastic, chromed and anodised parts.

Remove snow and ice
① NOTICE

- ▶ Remove snow and ice with a plastic scraper or a suitable deicing agent.
- ▶ Clean the cameras with a hand brush.
- ▶ Only move the scraper in one direction.
- ▶ Do not use scratchers or other sharp objects for foils.
- ▶ Do not remove snow and ice with hot or warm water.
- ▶ Do not remove snow and ice from surfaces with coarse dirt.

Instructions for cleaning
Notes on the high-voltage system

- › Stop the charging process and fully close the charging socket.
- › Switch off the drive and the ignition.
- › Components of the high-voltage system, such as orange cables, must not be damaged.

Handwash

- › Wash the vehicle from top to bottom with a soft sponge or wash glove and plenty of water, if necessary with additional suitable cleaning agents.
- › For foils and headlights, use a mild soap solution that contains two tablespoons of white neutral soap to one litre of lukewarm water.
- › Use a glass cleaner for the windscreen wiper blades.
- › Wash the cameras with clean water and dry with a suitable clean wipe.

① NOTICE

- ▶ Wash out the sponge or wash mitt regularly.
- ▶ Use a different sponge for wheels, sills and the lower part of the vehicle than that used for the other vehicle parts.
- ▶ Do not wash the vehicle in the blazing sun.
- ▶ Do not dry the headlights or use sharp objects.
- ▶ Do not put pressure on the bodywork when washing.
- ▶ The temperature of the washing water may be a max. 60 °C.

After hand washing

- › Rinse the vehicle and wipe it with a suitable clean cloth.

Vehicle paint

- › Preserve the varnish at least twice a year with hard wax.
- › Use a polish for matt lacquers.

Films

Films will age and become brittle – this is entirely normal: this is not an error.

The following factors have a negative effect on the life or colour fastness of the films.

- ▶ Sun rays.
- ▶ Moisture.
- ▶ Air pollution.
- ▶ Stones, e.g. the rebound of the cargo during transport on the roof rack.

Protection of hollow spaces

Corrosion-prone cavities of the vehicle are permanently protected by preservative wax at the factory.

- › Remove spilled wax with a plastic scraper, clean stains with mineral spirits.

Underseal

The underside is permanently protected by the factory against chemical and mechanical influences.

- › Have the protective coating checked by a specialist garage before starting and at the end of the cold season.

Wheels

- › After washing, preserve the wheels with suitable means.

① **NOTICE**

Severe dirt on the wheels can result in the wheels unbalancing.

Car jack

- › If necessary, treat moving parts with suitable grease.

Tow hitch

- › Coat the ball head of the towing device with a suitable grease whenever necessary.

Technical data and specifications

Requirements for the technical data

The emission standard, information on fuel consumption and other information pertaining to your vehicle can be found listed in the technical vehicle documentation and in the declaration of conformity, in the so-called COC Document. The information can also be requested from a ŠKODA partner.

The declaration of conformity can be obtained from a ŠKODA partner.

The details in the technical vehicle documentation take precedence over the information in this Owner's Manual.

The listed performance values were determined without performance-reducing equipment, e.g. air conditioning system.

The values listed are for the basic model without any optional equipment. The values have been determined in accordance with the rules and conditions specified in statutory or technical regulations for determining operational and technical data for motor vehicles.

Vehicle identification data

Vehicle Identification Number (VIN)

The vehicle identification number is found at the following locations.

- ▶ Directly in the engine compartment on the suspension turret.
- ▶ On a plate under the windscreen in the lower left corner.
- ▶ On the type plate at the bottom of the middle body pillar of the vehicle.



Type plate.



- A** Vehicle manufacturers
- B** Vehicle Identification Number (VIN)

VIN display

The display of the VIN takes place in the infotainment in the following menu item.

CAR > > Menu item for the service

Or:

MENU >  >  > Menu item for the service

Engine number

The engine number is embossed on the engine block.

Maximum permissible weights

The maximum permissible weights are listed on the nameplate.

The type plate is located at the bottom of the middle body pillar of the vehicle.



- A** Maximum permissible gross weight
- B** Maximum permissible towed weight (towing vehicle and trailer)
- C** Maximum permissible front axle load
- D** Maximum permissible rear axle load

Maximum permissible towed weight

The specified value is valid for altitudes up to 1,000 m above sea level.

The engine output falls as the height increases, as does the ability to climb.

Operating weight

| Operating weight (kg) | |
|-----------------------|-----------------|
| Superb iV | Superb iV Combi |
| 1730 | 1752 |

I Ask about the exact vehicle weight in a specialist garage.

Therefore, for every additional 1,000 m in height (or part), the maximum permissible towed weight must be reduced by 10 %.

The towed weight is made up of the actual weights of the loaded towing vehicle and the loaded trailer.

Payloads

It is possible to calculate the approximate maximum payload from the difference between the permissible total weight and the operating weight.

The payload consists of the following components.

- ▶ The weight of the rider.
- ▶ The weight of all luggage and other loads.
- ▶ The weight of the roof, including the roof rack system.
- ▶ The weight of the equipment that are excluded from the operating weight.
- ▶ Trailer bearing load for trailer towing » page 180.

⚠ WARNING

Risk of accident and danger of vehicle damage!

- ▶ Do not exceed the specified values for the maximum permissible weights.

Operating weight

Information about the operating weight

The specification corresponds to the lowest possible operating weight without additional weight-increasing equipment. This includes 75 kg driver's weight, the weight of the operating fluids and the on-board tool kit and a fuel tank filled to min. 90%.

Vehicle dimensions

Dimensions

| Specification | Value (in mm) | |
|---------------------------------------|---------------|-----------------|
| | Superb iV | Superb iV Combi |
| Vehicle height | 1468 | 1477 |
| Vehicle width with folded-in mirrors | 1864 | 1864 |
| Vehicle width with folded-out mirrors | 2031 | 2031 |
| Ground clearance of the vehicle | 137 | 138 |
| Vehicle length | 4869 | 4862 |

Engine specifications

1.4 I / 115 kW TSI Motor and 85 kW electric motor

| | | |
|--|-------------------|-----------------|
| Power of TSI engine (kW at 1/min) | 115/5000-6000 | |
| Power of electric motor (kW) | 85 | |
| Highest torque of TSI engine (Nm at 1/min) | 250/1600-3500 | |
| Highest torque of electric motor (Nm) | 330 | |
| Number of cylinders/displacement (cm ³) | 4/1395 | |
| Transmission | DSG ^{a)} | |
| Body | Superb iV | Superb iV Combi |
| Maximum speed (km/h) | - ^{b)} | - ^{b)} |
| With specified gear engaged | - ^{b)} | - ^{b)} |
| Acceleration 0-100 km/h (s) | - ^{b)} | - ^{b)} |
| ^{a)} Automatic dual-clutch transmission. | | |
| ^{b)} The values were not available at the time of going to press. | | |

Event Data Recorder

The vehicle is equipped with a device that serves as an accident data recorder (referred to solely as “EDR” from this point). The main purpose of the EDR is data recording during a traffic accident or other exceptional traffic conditions (referred to solely as “accident” from this point), where the restraint systems are activated.

The EDR records the accident in a short time (approximately 10 s), by showing the following information, for example:

- ▶ The function of certain systems in the vehicle.
- ▶ The seat belt status of the driver and front passenger.
- ▶ The actuation of the brake and accelerator pedals.

- ▶ The speed of the vehicle at the time of the accident.

The recorded data helps with the analysis of how the vehicle systems were behaving shortly before, during and shortly after the accident, thereby ensuring better information regarding the circumstances under which the accident occurred, which lead to material damage and possibly to personal injury.

The data relating to assist systems in the vehicle is then also recorded. In addition to the information on whether the affected systems were switched on or off at the relevant time, whether these were only partially available or were inactive, there is also the possibility of tracking whether these vehicle functions controlled, accelerated or braked the vehicle

during the accident. Depending on the equipment, these functions are, e.g:

- ▶ Adaptive Cruise Control (ACC).
- ▶ Lane Assist.
- ▶ Park Assist.
- ▶ Emergency brake function (Front Assist).

EDR data is only recorded if an accident causes the restraint systems to be activated. Under normal driving conditions there is no data recording and there is no audio or video recording of the vehicle interior or the vehicle environment. Personal data such as name, gender, age or place where the accident occurred is also not stored in the EDR. However, third parties such as law enforcement authorities may use certain resources to connect EDR content to other data sources, and therefore deduce the identification of some of the people involved in the accident when investigating the causes of the accident.

Reading out the EDR requires special equipment with specific access authorization and a legally prescribed diagnostic connection in the vehicle (“on-board diagnostics”), and the ignition will need to be switched on.

ŠKODA AUTO will not read or otherwise process any accident data from the EDR without the approval of the vehicle owner or other person authorised for use of the vehicle. Exceptions are specified in the contractual arrangements, or these are subject to generally binding regulations.

Due to legal requirements, ŠKODA AUTO is required to monitor the quality and safety of its products, meaning that it is only entitled to use data from the EDR to monitor the product on the market, for further research and development, and to improve the quality of the vehicle's safety systems. For the purpose of research and development, ŠKODA AUTO will also make data available to third parties. This is done exclusively in anonymous form, i.e. without any connection to the specific vehicle, the vehicle owner or any other authorised user.

Information about the radio systems in the vehicle

Your vehicle has various radio systems.

Manufacturers of this radio equipment declare that this equipment complies with the requirements of **Directive 2014/53 / EU** and the **Technical Regulation on Radio Equipment, approved by the Deci-**

sion of the Cabinet of Ministers of Ukraine of 25 May 2017 no. 355.



To display information about **Directive 2014/53 / EU** on the approximation of the laws of the Member States relating to the marketing of radio equipment, **Technical regulation on radio equipment, approved by the decision of the Cabinet of Ministers of Ukraine of May 25, 2017 No. 355** as well as regarding **declaration of conformity**, proceed as follows.

1. Import the QR code or enter the following address in the web browser.
<http://go.skoda.eu/owners-manuals>
2. Click on “Choose your manual”.
3. Select the desired model - a menu with the instructions will be displayed.
4. Select the construction period and the language.
5. Choose the **Information on Directive 2014/53 / EU** or **Information on the Technical Regulations on Radio Systems No. 355** file in PDF format.

Rights arising from defective performance, ŠKODA warranties

Rights arising from defective performance

Your ŠKODA Partner, as a seller, is liable to you for material defects in your new ŠKODA vehicle, ŠKODA Genuine Parts and ŠKODA Genuine Accessories, in accordance with the legal requirements and the purchase contract.

The buyer is entitled to assert the rights arising from defective performance with the responsible ŠKODA partner from the time of vehicle handover. The date of the vehicle handover and the vehicle identification number (VIN) are properly documented in the “Vehicle delivery documentation” chapter in this Owner's Manual.

ŠKODA warranty for new cars

As well as the legal rights arising from defective performance, ŠKODA AUTO a.s. grants you the ŠKODA warranty for new cars (hereinafter referred to as the “ŠKODA Warranty”), according to the conditions described below.

Under the ŠKODA Warranty, the company ŠKODA AUTO shall provide the following services ¹⁾.

- ▶ Free repair of damage due to a defect that occurs in your vehicle within two years of the start of the ŠKODA Warranty.
- ▶ Free repair of damage due to paintwork flaws that occur on your vehicle within three years of the start of the ŠKODA Warranty.
- ▶ Free repair of rust corrosion on the body, which occurs on your vehicle within twelve years of the start of the warranty. In terms of rust corrosion on the body, the ŠKODA Warranty shall cover only rust corrosion through body panels from the inside to the outside.
- ▶ Free repair of the high-voltage battery if it is installed in the vehicle and if the damage occurs within 8 years or before reaching a mileage of 160,000 km/ 100,000 miles (whichever occurs first) from the beginning of the ŠKODA warranty. A reduction in the capacity of the high-voltage battery over time is a natural feature of technology and does not constitute a defect within the meaning of the ŠKODA warranty.

The start of the ŠKODA Warranty is the day on which the new car is handed over for use by a ŠKODA partner to the first buyer who is not a ŠKODA Partner²⁾.

The ŠKODA Partner enters this date into the corresponding systems of the manufacturer. Any one ŠKODA Partner can notify you of this date on request.

Vehicle repairs under the ŠKODA Warranty can be carried out by means of a replacement or repair of the defective parts. The ŠKODA Service Partner decides about the type of vehicle repair. The vehicle repair takes place in accordance with the availability of the ŠKODA Service Partners and within a reasonable period of time. Replaced parts become the property of the ŠKODA Service Partner.

In the event of a claim under the ŠKODA warranty regarding damage to the high-voltage battery, if it is installed in the vehicle, the high-voltage battery is put into a condition corresponding to the age and mileage of the vehicle.

There shall be no further claims arising from the ŠKODA Warranty. In particular, no claim for replacement, no right of withdrawal, no claim to purchase

price reduction, or provision of a replacement car for the duration of repair and compensation.

The ŠKODA Warranty can be claimed at any ŠKODA Service Partner.

There are no claims under the ŠKODA Warranty if vehicle damage has occurred in causal connection with one of the following circumstances.

- ▶ The service work was not carried out on time and professionally according to the provisions of ŠKODA AUTO, or its execution was not proven by the customer when asserting claims under the ŠKODA Warranty.
- ▶ Damage refers to parts that are subject to natural wear, such as tyres, spark plugs, wiper blades, brake pads and brake discs, clutch, bulbs, synchronizer rings, batteries, etc.
- ▶ Installation, connection of parts or accessories, other adaptation or technical modification of the vehicle not approved by ŠKODA AUTO (e.g. tuning).
- ▶ Unauthorized use, improper handling (e.g. use in motor sport competitions or overloading), improper care and maintenance or unauthorized modifications to your vehicle.
- ▶ Non-observance of instructions in the Owner's Manual or in other factory instructions, including, but not limited to, non-observance of instructions regarding the procedure for charging the high-voltage battery if it is installed in the vehicle.
- ▶ Use of the vehicle as a stationary source of electrical energy.
- ▶ External impact or influences (e.g. accident, hail, flood, etc.).
- ▶ Damage has not been reported immediately to a specialist company or has not been properly remedied.

The customer shall prove the lack of causation.

The present ŠKODA Warranty shall not affect the purchaser's statutory rights arising from unsatisfactory performance in respect of the seller of the vehicle and possible claims arising from product liability laws.

ŠKODA Mobility Warranty

The Mobility Warranty provides you with a sense of certainty for journeys in your vehicle.

As part of the Mobility Warranty, if your car breaks down as a result of an unexpected fault when you are on the move, you can access services to ensure

¹⁾ Based on the requirements of generally binding legal regulations or country-specific market requirements, the ŠKODA partner or importer can provide a warranty beyond the scope of the stated ŠKODA Warranty. This local warranty extends the scope of performance in accordance with the specific warranty conditions of ŠKODA partners or importers.

²⁾ Due to the requirements of the generally binding country-specific legal regulations, the date of the first registration can be specified instead of the date of the vehicle handover.

your continued mobility. These services include the following: Breakdown service at the breakdown location and towing to the ŠKODA Service Partner, technical assistance by phone or on-site operation.

If your vehicle is not repaired on the same day, then the ŠKODA Service Partner may, if necessary, arrange additional subsequent services, such as replacement transport (bus, train, etc.), the provision of a replacement vehicle, and the like.

Specific claims for free provision of services under the ŠKODA Mobility Warranty only exist if your vehicle has remained in a causal connection with a defect which is to be remedied on the basis of fulfilment under the ŠKODA Warranty.

Check the conditions for provision of the Mobility Warranty for your vehicle with your ŠKODA Partner. They will also inform you of the detailed terms and conditions of the Mobility Warranty in relation to your vehicle. In the event that your vehicle is not covered by a mobility warranty, he will inform you of the possibilities for subsequent conclusion.

Optional ŠKODA Extended Warranty

If you also purchased a ŠKODA Extended Warranty when purchasing your new car, ŠKODA AUTO will provide you with a free repair of vehicle damage caused by a defect in the vehicle during the warranty period.

The ŠKODA Extended Warranty for your vehicle is valid for the agreed period or until the agreed mileage limit is reached, whichever comes first.

For the assessment of claims from the ŠKODA Extended Warranty, the conditions of the ŠKODA warranty described above apply to the appropriate extent.

The vehicle repair under the ŠKODA Extended Warranty can only be carried out by replacement or repair of the defective parts, whereby the ŠKODA service partner decides on the type of vehicle repair. The vehicle repair takes place in accordance with the availability of the ŠKODA Service Partners and within a reasonable period of time.

There shall in any case be no entitlement to further claims from the ŠKODA Extended Warranty. In particular, no claim for replacement, no right of withdrawal, no claim to purchase price reduction, or provision of a replacement car for the duration of repair and compensation.

The described paint warranty, the warranty against rust penetration and the warranty for the high-voltage battery remain unaffected by the ŠKODA Extended Warranty.

The ŠKODA Extended Warranty does not apply to exterior and interior foils.

Your ŠKODA partner will provide you with information about the detailed conditions of the ŠKODA Extended Warranty.

I The ŠKODA Mobility Warranty and the ŠKODA Extended Warranty are only available in some countries.

Index

A

| | |
|---|----------|
| ABS | 129, 130 |
| ACC | 132-135 |
| Automatic stop and start | 133 |
| Distance adjustment | 133 |
| Interruption of cruise control | 134 |
| Accident data recorder | 186 |
| Adaptive Cruise Control | 132 |
| Adaptive suspension | 123 |
| Air conditioning system | |
| see Climatronic | 54 |
| Airbag | 44 |
| Deployment | 44 |
| Fault | 45 |
| Installation locations | 45 |
| Safety | 18 |
| Switching off front passenger airbag | 45 |
| Turn off airbags | 45 |
| Alarm system | 25 |
| Trailer | 25 |
| All-season tyres | 163 |
| Ambient lighting | 51 |
| Analogue | |
| instrument panel | 57 |
| Analogue instrument cluster | 57 |
| Analogue instrument panel | 57 |
| Android Auto | |
| Infotainment Amundsen | 83 |
| Infotainment Columbus | 112 |
| see electronic version of the manual | 5 |
| Apple CarPlay | |
| Infotainment Amundsen | 83 |
| Infotainment Columbus | 112 |
| see electronic version of the manual | 5 |
| Area View | 142, 143 |
| see Area View | 142 |
| Armrest | |
| Front | 36 |
| Rear | 36 |
| Ashtray | 176 |
| Assist systems | |
| Driver assist | 129 |
| Park Assist | 139 |
| Assistance systems | |
| Safety | 19 |
| Auto Hold | 128 |
| Automatic braking | |
| see Front Assist | 130 |
| Automatic gearbox | 121, 122 |
| Manually changing gear with the selector lever | 122 |
| manually changing gear with the shift paddles on the steering wheel | 122 |
| Automatic gearbox modes | 121 |
| Automatic operation of the Climatronic | 54 |
| Auxiliary heating and ventilation | 55, 56 |

Change the battery in the remote control _____ 57

B

| | |
|--------------------------------------|----------|
| Battery | |
| see vehicle battery | 157 |
| Blinker | |
| see flashing light | 47 |
| Bluetooth | |
| see electronic version of the manual | 5 |
| Bonnet | 153 |
| Boot | 169 |
| Fasteners | 169 |
| Rigid cover | 172 |
| Storage compartments | 169 |
| Transporting objects safely | 18 |
| Boot cover | 172 |
| Boot lid | |
| Automatic locking | 30 |
| Contactless operation | 31, 32 |
| manual operation | 30 |
| Boot storage | |
| see boot compartment lid | 30 |
| Brake fluid | 127 |
| Safety | 16 |
| Brake pads | 127 |
| Brakes | 126, 127 |
| Breakdown kit | 165, 166 |
| Bulbs | 50 |
| Front turn signal - Replacing | 50 |
| Rear turn signal - Replacing | 50 |
| Reversing light - Replacing | 50 |

C

| | |
|--|--------|
| Car adaptations | |
| Recommendations | 181 |
| Cargo elements | 169 |
| Ceiling | 176 |
| Central locking | 23, 24 |
| Central locking button | 23 |
| Central locking system | |
| SAFE function | 23 |
| Centre console | 10 |
| Charging | 148 |
| Troubleshooting | 150 |
| Charging cable | 151 |
| Charging your phone wirelessly | 175 |
| Check the vehicle before your journey | 17 |
| Child lock | 26 |
| Child seat | 41 |
| Fastening using a belt | 43 |
| Grouping | 42 |
| i-Size | 43 |
| Installation | 44 |
| ISOFIX | 42, 44 |
| Keyword child seat | 41 |
| On the passenger seat | 41 |
| Recommended child seats | 42 |
| Safety instructions | 41 |

- Securing children properly _____ 18
 TOP TETHER _____ 44
Cigarette lighter _____ 176
Cleaning the vehicle
 Outside _____ 182, 183
Climatronic _____ 54, 55
 Display in the centre console at the back _____ 176
COMING HOME _____ 49
 Setting _____ 49
Compartments _____ 173, 174
Convenience signalling _____ 47, 48
Coolant
 Checking _____ 154
 Indicator light _____ 154
 Refilling _____ 154
 Safety _____ 16
 Specification _____ 154
 Troubleshooting _____ 155
Crew Protect Assist _____ 138
 see Proactive occupant protection _____ 138
Cruise control _____ 132
Cup holder _____ 175
Cybernetic Security - Infotainment Amundsen _____ 77
Cybernetic Security - Infotainment Columbus _____ 106
- D**
- Daylight running lights** _____ 46
DCC _____ 123
Deactivating the front passenger airbag _____ 45
Digital
 instrument cluster _____ 58
Digital instrument cluster _____ 58
Distribution of the cargo _____ 125
Door
 Opening/closing _____ 26
DriveGreen _____ 124
Driver Alert _____ 138
 fatigue detection assistant _____ 138
Driver's seat _____ 10
Driving data _____ 59–61
 Speed limit warning _____ 62
Driving in neutral _____ 122
Driving with trailer
 Safety _____ 19
 Trailer Stability Assist _____ 129
DSR _____ 129
Dynamic cornering light
 activate _____ 48
 deactivate _____ 48
Dynamic cornering lights _____ 46
Dynamic Light Assist
 see Headlight Assist System _____ 49
- E**
- e-Display** _____ 62
e-Manager _____ 61
E-MODE _____ 123
Earth point _____ 158
Economical driving style _____ 124
EDL _____ 129
Electric parking brake _____ 127, 128
Electric windows _____ 27
 Activation _____ 27
 Force limiter _____ 26
 Operation _____ 27
 Troubleshooting _____ 27
Electronic brake force distribution _____ 129
Emergency
 Emergency call _____ 20
 Using jump start cables _____ 158
Emergency Assist
 see assist systems for emergency situations _____ 138
Emergency Assist System _____ 138, 139
Emergency call _____ 20
Emergency equipment _____ 169
 Jack _____ 169
 Tool kit _____ 169
Engine compartment _____ 11
 Bonnet _____ 153
 Engine oil _____ 153
 Safety _____ 16
 Vehicle battery _____ 157
 Windscreen washer fluid _____ 52
Engine number _____ 184
Engine oil _____ 153
 Changing _____ 153
 Checking _____ 153
 Indicator light _____ 153
 Refilling _____ 153
 Safety _____ 16
 Specification _____ 153
Engine start
 Using jump start cables _____ 158
EPC _____ 155
Equipment in the boot _____ 169
ESC _____ 129, 130
ESC Sport _____ 129
Exhaust control system _____ 155
Explanations _____ 6
Exterior
 lighting _____ 46
Exterior mirror _____ 38, 39
Extinguisher _____ 169
- F**
- Fasteners in the boot** _____ 169
First aid kit _____ 169
Fog light _____ 47
Fog lights _____ 47
Fogged windows _____ 55
Freewheeling
 See Driving in neutral _____ 122
Front Assist _____ 130
Front seats _____ 34
 Memory function for electrically adjustable seats _____ 34

- Front vehicle area** 7
- Fuel**
- Petrol 156
- Fuel filler flap** 155
- Fuel tank**
- Opening the flap 155
- Full LED headlights** 46
- Fuses** 159
- In the dash panel 159
 - In the engine compartment 161
- H**
- Hazard warning light system** 47
- Headlight Assist System** 49, 50
- Activation and deactivation in Infotainment 50
- Headlights** 46, 48
- Full LED setting 48
 - Headlight range control 48
- Headrests** 35
- Heated**
- steering wheel 38
- Heated steering wheel** 38
- Heated windscreen** 29, 30
- HHC**
- see Hill Hold Control 129
- High beam**
- Headlight Assist System 49
- High-beam**
- High-beam assist system 49
- High-beam assist system** 49
- High-voltage battery** 146
- Charging 149
- High-voltage system** 146
- Hill Hold Control** 129
- Hook**
- In the interior 174
- Hooks**
- in the boot 169
- Hotspot**
- see electronic version of the manual 5
- Hybrid** 123
- I**
- i-Size** 43
- Ice scraper** 9
- Images**
- see electronic version of the manual 5
- Images - Infotainment Amundsen** 75, 76
- Main menu overview 75
 - Settings 76
 - Show main menu 75
- Images - Infotainment Columbus** 103, 104
- Immobilizer** 121
- Indicator lights**
- Foreword 11
 - Overview 11
- Infotainment Amundsen** 63–65
- Basic settings 64
- Infotainment Columbus** 92, 93
- Basic settings 92
- Infotainment control centre**
- Infotainment Amundsen 63
- Infotainment Control Centre**
- Infotainment Columbus 92
- Infotainment keyboard**
- see electronic version of the manual 5
- Instrument cluster**
- Instrument cluster display 59
- Instrument cluster display** 59
- Interior**
- lighting 51
- Interior lighting** 51
- Ambient lighting 51
- Interior rear-view mirror** 38
- see interior rear-view mirror 38
- ISOFIX** 44
- eyelets 44
 - Use of child seats 42
- J**
- Jump start cables** 158
- Jump-starting** 158
- K**
- Key** 22
- Key switch for passenger front airbag**
- Key switch faulty 46
- Key switch for switching off airbag** 45
- Keyless locking (KESSY)** 24, 25
- Keypad - Infotainment Amundsen** 66, 67
- Keypad Infotainment Columbus** 94, 95
- Kick-down** 122
- L**
- Lane Assist** 135, 136
- see Lane Assist 135
- Lane change assist system**
- siehe Side Assist 136
- LEAVING HOME** 49
- Setting 49
- Lever**
- Headlight Assist System 50
 - High beam 47
 - High-beam assist 49
 - Turn signal 47
 - Windscreen wiper and washer 52
- Liability for defects**
- see warranty 187
- Light** 46, 47
- Change bulbs 50
 - Changing bulbs 50
 - Clean headlights 52
 - CORNER function 46
 - Driving in the opposite direction of traffic 48
 - Fog light 47
 - Hazard warning lights 47

- Headlight Assist System..... 49
- Headlight range control of the headlights..... 48
- High-beam assist system..... 49
- Indicator light..... 48
- Low beam..... 48
- Parking light..... 47
- Sidelights..... 47
- Switching on and off automatically..... 48
- Troubleshooting..... 48
- Turn signal..... 47
- Light Assist**
see high beam assist system..... 49
- Light switch**..... 47
- Lighting**
Ambient lighting..... 51
- Lighting range**..... 48
- Limiter**
see speed limiter..... 131
- List of radio stations**
see electronic version of the manual..... 5
- Load-through bag**..... 173
- Load-through device**..... 36
- Lock**..... 23, 24
- Locking**..... 23, 24
- Low beam**..... 46, 48
- Luggage compartment**
Fastening nets..... 170
Net partition..... 170
- Luggage Compartment**
Multifunctional pocket..... 170
roll-up cover..... 172
- Luggage compartment lid**..... 30–32
- M**
- Main beam**..... 47
- MATRIX headlights**
see Headlight Assist System..... 49
- MCB**..... 129
- Media**
Playlist..... 72, 100
see electronic version of the manual..... 5
- Media - Infotainment Amundsen**..... 72
Main menu..... 71
Manage favourites..... 72
Service..... 72
Settings..... 72
Traffic news..... 72
what you should be mindful of..... 71
- Media - Infotainment Columbus**..... 99–101
- Memory function of the seat**..... 34
- Mirror**
see exterior mirror..... 38
- MirrorLink**
Infotainment Amundsen..... 83
Infotainment Columbus..... 112
see electronic version of the manual..... 5
- Mirrors**
Set functions..... 39
- Mobile Device Management - Infotainment Amundsen**..... 77–79
- Mobile Device Management - Infotainment Columbus**..... 106, 107
- MSR**..... 129
- Multi-Collision Brake**
see MCB..... 129
- Multifunctional pocket**..... 170
- N**
- Navigation**
see electronic version of the manual..... 5
- Navigation - Infotainment Amundsen**..... 87, 90, 91
- Navigation - Infotainment Columbus**..... 115, 118, 119
- Net partition**..... 170
- Nets**..... 170
- Notes on starting**..... 120
- O**
- Oil**
see engine oil..... 153
- Online Services - Infotainment Amundsen**..... 85, 86
- Online Services - Infotainment Columbus**..... 114
- Operation - Infotainment Amundsen**..... 65
- Operation - Infotainment Columbus**..... 93
- P**
- Park Assist**..... 143–145
Operating conditions..... 144
see park steering assistant..... 144
- Park Assist systems**..... 139
- Parking**
Park steering assistant..... 144
Parking aid..... 139
Parking the vehicle safely..... 19
Rear Traffic Alert..... 143
Reversing camera..... 140
- Parking aid**..... 139, 140
- Parking brake**..... 127
see electric parking brake..... 127
- Parking light**..... 47
- ParkPilot**
see parking aid..... 139
- Particle filter**..... 155
- Particle Filter**
Troubleshooting..... 155
- Passenger seat**..... 10
- Pedestrian Detection**..... 131
- Personalisation - Infotainment Amundsen**..... 76
- Personalisation - Infotainment Columbus**..... 104
- Petrol**..... 156
Prescribed fuel..... 157
Prescribed petrol..... 156
Refilling..... 156
Requirements for refuelling..... 156
standards..... 156
Tank capacity..... 157
Troubleshooting..... 157

| | |
|--|---------------|
| Phonebox | 174, 175 |
| Power steering | 37 |
| Practical equipment | 173, 174 |
| 12 volt socket | 173, 174, 178 |
| 230 volt socket | 174, 178 |
| Ashtray | 176 |
| Cigarette lighter | 176 |
| Coat hook | 174 |
| cup holder | 175 |
| Load-through bag | 173 |
| Make up mirror | 173 |
| Spectacles compartment | 173 |
| Storage compartment for the tablet | 178 |
| Storage compartment for the umbrella | 174 |
| Storage compartment under the front seat | 174 |
| Storage compartments | 173, 174 |
| Storage pockets | 174 |
| Tablet holder | 177 |
| Ticket holder | 173 |

R

| | |
|--|----------|
| Radio | |
| see electronic version of the manual | 5 |
| Radio - Infotainment Amundsen | 68, 69 |
| Find stations manually | 69 |
| SCAN function | 69 |
| Select station | 69 |
| Radio - Infotainment Columbus | 96, 98 |
| Rear fog light | 47 |
| Rear seats | |
| Folding down | 35 |
| Rear Traffic Alert | 143 |
| Rear vehicle area | 9 |
| Rear View Camera | |
| Operation | 141 |
| Recirculated air mode | 54 |
| Refilling | |
| Coolant | 154 |
| Engine oil | 153 |
| Petrol | 156 |
| Reflective vest | 169 |
| Remote control of auxiliary heating and ventilation | |
| Change the battery | 57 |
| Removable light | 171, 172 |
| Reversing camera | 140, 141 |
| Rights arising from defective performance | |
| see warranty | 187 |
| Roll-up luggage compartment cover | 172, 173 |
| Roof rack | 179 |
| Attaching the carrier | 179 |
| Roof load | 179 |
| Safe driving | 19 |
| S | |
| Safe driving | 19 |
| SAFE function | |
| Description | 23 |
| Turn off | 23 |

Safety

| | |
|---|--------|
| Airbag | 18 |
| Assistance systems | 19 |
| Before the journey | 15 |
| Belt webbing arrangement | 17 |
| Car adaptations | 15 |
| Child seat | 18 |
| Correct seating position | 17 |
| Driving through water | 19 |
| Driving with a trailer | 19 |
| Emergency call | 20 |
| Engine compartment | 16 |
| Exiting the vehicle | 19 |
| High-voltage system | 16 |
| Indicator lights | 19 |
| New brake pads | 15 |
| New tyres | 15 |
| Operating fluids | 16 |
| Parking | 19 |
| Roof rack | 19 |
| Running in the engine | 15 |
| safe driving | 19 |
| Sensors and cameras | 15 |
| Sockets | 17 |
| Transporting cargo | 18 |
| Transporting children | 18 |
| Transporting objects | 18 |
| Vehicle battery | 16 |
| weather conditions | 19 |
| What to do after an accident | 20 |
| What to do in the event of a fire | 21 |
| Screen - Infotainment Amundsen | 65 |
| Screen - Infotainment Columbus | 93, 94 |
| SEAL tyres | 163 |
| Seat | |
| Heating | 36 |
| Seat belts | 40 |
| Adjusting the height | 40 |
| Automatic belt retractor | 40 |
| Belt tensioners | 40 |
| Blocked strap | 41 |
| Correct arrangement | 17 |
| Fastening and unfastening | 40 |
| Reversible belt tensioner | 40 |
| status display | 40 |
| Seat heating | 36, 37 |
| Seat massage function | 34 |
| Seat ventilation | 36 |
| Seatback | |
| Load-through device | 36 |
| Seats | 33, 34 |
| Folding down | 35 |
| ISOFIX | 44 |
| Memory function for electrically adjustable seats | |
| | 34 |
| Sitting safely | 17 |
| TOP TETHER | 44 |
| Ventilation | 36 |
| Select Drive | 123 |

- Selector lever** 122
- Service event**
- Interval 181
 - Proof 181
 - Reset information 181
 - Show appointment 181
- Service position for windscreen wiper arms** 53
- Service work** 181
- Set tyre pressure values** 167
- Side Assist** 136, 137
- Sidelights**
- see Parking light 47
- Sliding/tilting sunroof**
- electric operation of the sun blinds 29
- SmartLink**
- Infotainment Columbus 111–113
 - see electronic version of the manual 5
- SmartLink - Infotainment Amundsen** 79
- Android Auto 83
 - Android Auto - Connection via USB 84
 - Android Auto - Disconnection 84
 - Android Auto connection conditions 84
 - Apple CarPlay 83
 - Apple CarPlay - Connection via USB 84
 - Apple CarPlay - Connection via Wi-Fi from Infotainment 84
 - Apple CarPlay - connection via Wi-Fi from mobile devices 84
 - Apple CarPlay - Disconnection 84
 - Apple CarPlay connection conditions 84
 - Change to another connection type 84
 - Change to another device 84
 - Functionality 83
 - General connection conditions 84
 - Main menu 83
 - MirrorLink 83
 - MirrorLink - Connection via USB 84
 - MirrorLink - Disconnection 84
 - MirrorLink connection conditions 84
 - Navigation restriction 84
 - Operating the running MirrorLink application 84
 - Restriction while driving 84
 - Show main menu 83
 - Supported connection types 83
- SmartLink - Infotainment Columbus** 107
- Snow chains** 163
- Sockets**
- 12-volt socket 178
 - 230-volt socket 178
 - Safety 17
- Speed limit** 62
- Speed limit warning** 62
- Speed limiter** 131, 132
- Indicator light 131
- Sport Chassis Preset** 123
- Start** 120
- Start the engine** 121
- Starter button** 120
- Steering column lock** 37
- Steering wheel** 37
- Correct position 18
 - Dials/buttons 59
 - manually changing gear with the shift paddles on the steering wheel 122
- Stopping the engine** 120
- Storage** 173, 174
- Storage compartment for the tablet** 178
- Sun protection** 29
- Activating sunblind operation 29
 - electric operation of the sun blinds 29
 - Operation of the rear sun protection roller blind 29
 - Operation of the sun blinds for the rear door windows 29
- Supported media files**
- see electronic version of the manual 5
- Switching low beam on automatically** 46, 48
- T**
- Tablet holder** 177
- Tailgate**
- Settings 31
- Tank capacity**
- Petrol 157
- TCS** 129, 130
- Technical data** 184, 185
- Technical specifications**
- Dimensions 186
- Telephone - Infotainment Amundsen** 79, 81
- Telephone - Infotainment Columbus** 107–109
- Tilting/sliding sunroof** 28, 29
- Activation after disconnecting the vehicle battery 28
 - Operation 28
- Tips for economical driving** 124
- Tiptronic** 122
- Tool** 169
- TOP TETHER** 44
- eyelets 44
- Topping up**
- Windscreen washer fluid 52, 53
- Tow hitch** 179, 180
- Tow rope** 126
- Towing a trailer** 125
- Towing eye** 126
- Towing the vehicle** 126
- Traffic accident**
- Data recorder 186
 - Emergency call 20
- Traffic jam assistant** 136
- Traffic Sign Recognition** 137
- Trailer** 125
- Alarm system 25
 - Coupling and uncoupling 179
 - Safe driving 19
 - Swing out the tow bar and back in 179
- Trailer Assist** 145

- Trailer attachment**
 - Vertical load _____ 180
 - Trailer manoeuvring system**
 - see Trailer Assist _____ 145
 - Trailer Stability Assist** _____ 129
 - Trailers**
 - Permissible load _____ 125
 - Transport**
 - Transporting objects safely _____ 18
 - Transporting**
 - tow hitch _____ 179
 - Transporting the**
 - roof rack _____ 179
 - TSA**
 - see Trailer Stability Assist _____ 129
 - Turn signal** _____ 47
 - Type plate** _____ 184
 - Tyre pressure monitor** _____ 167, 168
 - Tyres** _____ 162, 163
 - Overview of the labelling _____ 162
 - Pressure _____ 166
 - Snow chains _____ 163
 - Tyre pressure monitor _____ 167
- U**
- Umbrella** _____ 174
 - Unlocking** _____ 23, 24
 - Updating the infotainment system**
 - see electronic version of the manual _____ 5
 - USB** _____ 173, 174
 - see electronic version of the manual _____ 5
 - User account**
 - see electronic version of the manual _____ 5
 - User management**
 - see electronic version of the manual _____ 5
 - User Management - Infotainment Amundsen** _____ 76, 77
 - User management - Infotainment Columbus** _____ 104–106
- V**
- Vehicle battery** _____ 157, 158
 - Charging _____ 157
 - Checking the condition _____ 157
 - Discharge protection _____ 157
 - Disconnecting and connecting _____ 158
 - Safety _____ 16
 - Vehicle cleaning**
 - interior space _____ 182
 - What you should be mindful of _____ 182
 - Vehicle condition** _____ 63
 - Vehicle dimensions** _____ 186
 - Vehicle driving mode** _____ 123
 - Eco _____ 123
 - Individual _____ 123
 - Normal _____ 123
 - Sport _____ 123
 - Vehicle height** _____ 186
 - Vehicle Identification Number (VIN)** _____ 184
 - Vehicle length** _____ 186
 - Vehicle status** _____ 63
 - Vehicle width** _____ 186
 - Vest**
 - see reflective vest _____ 169
 - Video**
 - see electronic version of the manual _____ 5
 - VIN**
 - see vehicle identification number _____ 184
 - Virtual cockpit**
 - see digital instrument cluster _____ 58
 - Voice control - Infotainment Amundsen** _____ 67
 - Voice control - Infotainment Columbus** _____ 95, 96
- W**
- Warning triangle** _____ 169
 - Warranty** _____ 187
 - Mobility Warranty _____ 188
 - Optional Extended Warranty _____ 189
 - Rights arising from defective performance _____ 187
 - Warranty for new cars _____ 187
 - Waste container** _____ 176
 - Weight** _____ 185
 - Wheels** _____ 162
 - Breakdown _____ 163
 - Change _____ 164
 - Change in pressure _____ 163
 - Cover caps for the screws _____ 168
 - Full wheel covers _____ 168
 - Overview of tyre labelling _____ 162
 - Tyre pressure _____ 166
 - Tyre pressure monitor _____ 167
 - Wi-Fi - Infotainment Amundsen**
 - Automatic connection using the QR code _____ 82
 - Automatic WPS connection _____ 82
 - Change password for connection to the
 - Infotainment hotspot _____ 82
 - Change the name of the Infotainment hotspot _____ 82
 - connect a mobile device to the Infotainment
 - hotspot _____ 82
 - Connect Infotainment to the mobile device
 - hotspot _____ 82
 - Data transmission to the connected device _____ 82
 - Function restriction _____ 82
 - Functionality _____ 82
 - Manual WPS connection _____ 82
 - Overview of available hotspots _____ 82
 - Quick connection of the Infotainment to the
 - hotspot _____ 82
 - Security level of the Infotainment hotspot _____ 82
 - Tips for a perfect connection _____ 82
 - Wi-Fi - Infotainment Columbus** _____ 110, 111
 - Window** _____ 27
 - heating _____ 30
 - Windscreen washer system**
 - see windscreen wiper and washer _____ 52
 - Windscreen wiper and washer**

| | |
|--------------------------------------|-----|
| Automatic rear window wiper | 52 |
| Automatic Wiping | 52 |
| Fold away windscreen wiper arms | 53 |
| Refill windscreen washer fluid | 52 |
| Replace the windscreen wiper blade | 53 |
| Windscreen water level too low | 53 |
| Windscreen wipers and washers | 52 |
| Windshield washer fluid | |
| How is the washer fluid refilled? | 52 |
| Level too low | 53 |
| Winter tyres | 163 |
| Wireless network | |
| see electronic version of the manual | 5 |
| X | |
| XDL + | 129 |