



**ZEST**

## Owner's Manual



**TATA MOTORS**

Passenger Vehicle Business Unit (PVBU)

• Mumbai • Pune •

## NOTE

- This manual explains important features and instructions intended to assist you in gaining maximum use and satisfaction. Therefore, always keep this in the vehicle for ready reference.
- All information, illustrations and specifications contained in this manual are based on the latest product information available at the time of publication.
- **TATA MOTORS LIMITED** reserves the right to make changes in design and specifications and/or to make additions or improvements in this product without obligation to install them on the vehicles previously sold.
- This owner's manual includes information on the operation and maintenance of various features installed on the different variants. Please note that this manual applies to all the variants and explains all features including options which may not be applicable to your vehicle.
- All rights reserved. The information in this manual may not be reproduced or copied, in whole or in part, or in any form without prior written permission from **TATA MOTORS**.

© Copyright 2015 TATA MOTORS



***Dear Customer,***

*Welcome to the **TATA MOTORS** family.*

*We congratulate you on the purchase of your new vehicle and are privileged to have you as our valued customer. Your selection of our product exhibits the trust you have in us.*

*This manual will familiarize you with operational, maintenance and safety information of your new vehicle. We urge you to read this manual carefully and follow the recommendations to ensure enjoyable and safe operation of your new vehicle.*

*We recommend that all service and maintenance on your vehicle should be performed by an authorized **TATA MOTORS DEALER / TATA MOTORS Authorised Service Centres (TASCs)** to ensure that only latest methods and genuine replacement parts are used for continued reliability, safety and performance of your vehicle.*

*You are welcome to contact our dealer or Customer Assistance toll free no. in case of any query or support.*

***We wish you a safe and pleasant driving experience.***

**TATA MOTORS LIMITED**

### **Dear Customer,**

In our constant endeavour to provide assistance and complete service backup, **TATA MOTORS** has established an all India customer assistance centre.

In case you have a query regarding any aspect of your vehicle, our Customer Assistance Centre will be glad to assist you on our Toll Free no. **1800-209-7979**

You can also approach nearest **TATA MOTORS** dealer. A separate Dealer network address booklet is provided with the Owner's manual.

**TATA MOTORS 24X7 Roadside Assistance Program** offers technical help in the event of a breakdown. Call to the toll-free Roadside Assistance.

For additional information, refer to "**24X7 Roadside Assistance**" section in the Owner's manual.

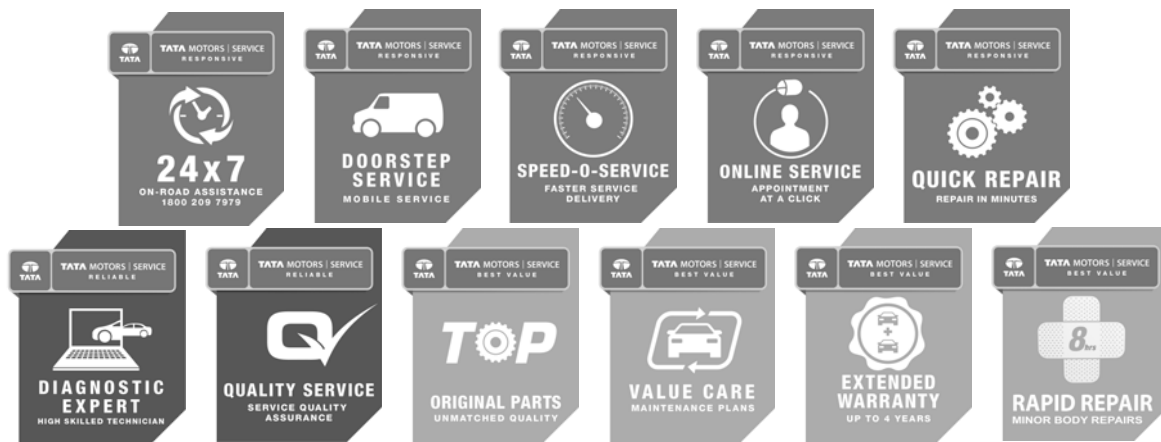

**1 SAFETY & SECURITY**

Important Safety Notes	9
Safety Guidelines	9
Seat Belts	10
Child Restraint System	13
Child lock	17
Anti-theft Device - Immobilizer	18
Supplemental Restraint System - Air Bags	20
Anti-Lock Braking System	22
Electronic Brake Force Distribution	22
Engine Drag Torque Control	22
Cornering Stability Control	22
Driving in Adverse Conditions	23

**2 OPENING & CLOSING**

Keyless Entry - E Key Operation	25
Doors	29
Window Glasses	30
Bonnet	32
Fuel Lid	33
Trunk lid	33

02

**3 INSTRUMENTS & CONTROLS**

Cockpit	34
Instrument Cluster	35
Instruments (Gauges)	37
Driver Information Display.	39
Tell tales (Indicators)	46
Audio Warnings	51
Combination Switch	52
Fascia Switches	55
Steering Wheel Switches	56
Infotainment System	57
Roof Lamp	58
Luggage Compartment Lamp	58

03

## CONTENTS

### 4 STOWAGE & FEATURES

Glove Box	59
Utility Tray & Pockets	59
Cup Holders	59
Power Socket	60
Roof Grab Handle	60
Luggage Compartment	61
Luggage Cover	61

04

### 5 CLIMATE CONTROLS

Air Vents & Distribution	62
Manual HVAC	63
FATC - Fully Automatic Temp. Control	67

05

### 6 STARTING & DRIVING

Pre-driving Checks	73
Safety Checks	74
Fuel Saving Tips	75
Good Driving Practices	76
Running-In Period	76
Seat & Seat Adjustments	77
Rear View Mirrors	79
Sun Visors	80
Steering Wheel Angle Adjustment	81
Preparing to drive	81
Steering Lock cum Ignition Switch	82
Gear Lever & Shifting Pattern	84
Drive Modes	88
Brakes & Braking	90
Parking Brake	91
Vehicle Parking	91
Reverse Park Assist	92

**7** EMERGENCY & BREAK DOWN ASSISTANCE

Hazard Warning Switch	95
First Aid Kit	96
Advance Warning Triangle	96
Tool Kit	97
Jack & Handle	97
Flat Tyre Replacement	98
Spare Wheel	98
Jump Lead Start	101
Towing The Vehicle	103
Fuses	105
Bulb Specifications & Bulb Replacement	111
Electrical Accessory Fitment	117
24 X 7 On Road Assistance	118

**8** MAINTENANCE & SERVICING

Engine Compartment	123
Engine Oil Level	125
Brake Fluid Level	125
Engine Coolant Level	126
Transaxle Oil Level	127
Windshield Washer Fluid Level	127
Spark Plug (Petrol Engine)	128
Tyres	129
Battery	132
Remote Battery	133
On Board Diagnostic (OBD)	134
Routine Service	135
Vehicle Service	136
Service Schedule	137

**9** TECHNICAL INFORMATION

Fuel Specification	140
Lubricants Specification	141
Coolant Specification	141
Lubricants & Coolant Co-branding	142
Technical Specifications	143
Vehicle Dimensions	146
Identification Plates	147

09

## CONTENTS

**10**

### CAR CARE & VALUE ADDED SERVICES

Car Care	149
Washing	149
Waxing	150
Polishing	150
Interior Fabric Cleaning	150
Paint Care	151
Wiper Care	151
Vehicle Parking For Long Duration	152
Value Added Services	153

10

**11**

### WARRANTY - TERMS AND CONDITIONS 161

**12**

### ENVIRONMENT SAFETY 163

**13**

### ALPHABETICAL INDEX 165



**IMPORTANT SAFETY NOTES:**

In this Owner's Manual, you will find the following safety notes.

**NOTE**

*Indicates additional information that will assist you in gaining the optimum benefit and care for your vehicle.*

**⚠ WARNING**

Indicates procedures or information that must be followed precisely in order to avoid the possibility of severe personal injury and serious damage to the vehicle.

**SAFETY GUIDELINES:****Safe driving depends on:**

- How quickly you make decisions to avoid an accident.
- Your ability to concentrate.
- How well you can see and judge objects.

**Few safe driving general tips are listed below.**

- Take into account the traffic, road, and weather conditions, particularly with regard to stopping distance.
- Never drive under the influence of alcohol or drugs.
- Refrain from using a cell phone while driving.
- Fatigue is a result of physical or mental exertion that impairs judgment. Driver fatigue may be due to inadequate sleep, extended work hours, strenuous work or non-work activities or combination of other

factors. Take rest at regular intervals.

- If your vehicle is equipped with a navigation system, set and make changes to your travel route only with the vehicle parked.
- Program radio presets with the vehicle parked, and use your programmed presets to make radio use quicker and simpler.

**SEAT BELTS:**

Seat-belt is a safety device designed to secure the occupant of the vehicle. Use of seat-belt reduces the chance of injury and severity of injury in case of an accident. **TATA MOTORS** strongly recommends that all the occupants should always wear seat-belts while travelling, irrespective of journey duration.

Your vehicle is equipped with seat belts, for front and rear seats as a part of occupant restraint system.

**⚠ WARNING**

Be sure everyone in your vehicle is seated and using a seat belt properly.

In normal driving, the belt lets you move freely in your seat. In case of an accident or sudden braking, inertia reel automatically tightens the belt to help restrain your body.

This vehicle has three point inertia reel type for front and rear seat belts in the out board positions and a lap belt for middle passenger on rear seat. The lap belt has a manually adjusted belt that fits across the hip bone. Make sure that your seat is adjusted to a good driving position and the back of the seat is upright.

**Importance of Wearing Seat Belt :**

1. It will help to keep you in the proper position when the air bag inflates.
2. Reduces the risk of harm in rollover, side or rear impact collisions
3. Reduces the risk of harm in frontal/angular collisions that are not enough to activate the air bag.
4. Reduces the risk of being thrown inside the vehicle in case of a collision.

**NOTE**

*Do not bleach or dye seat belts as this may severely weaken them. In a crash they may not be able to provide adequate protection. Cleaning should be carried out using mild soap and water only.*

**⚠ WARNING**

Make sure that the seat belts are not twisted which can cause injury in a collision as the full width of the belt isn't available to absorb the impact. This puts more force on the bones beneath the belt, which could cause serious injury.

The maximum protection which seat belts can offer is only achieved if you are correctly seated. The seat back should not be tilted too far back.

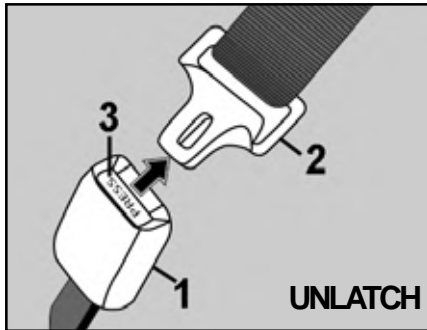
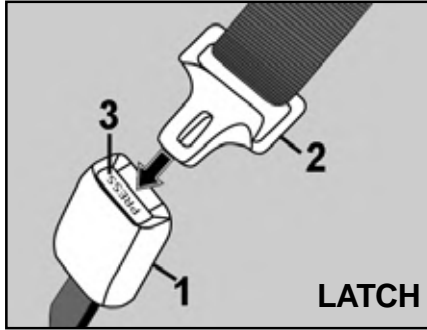
**How to use seat belts:**

1. Buckle 2. Tongue 3. Press Button

1. Pull the belt tongue across your body and insert it into the buckle.
2. Check and ensure that the belt is not twisted.
3. Position the lap portion of the belt as low as possible across your hip bone.
4. Pull up the shoulder part of the belt to remove the slack. Make sure that the belt goes over your collar bones and across chest.
5. To unlatch the belt, press the red button on the buckle. Guide the belt to the pillar as it retracts.

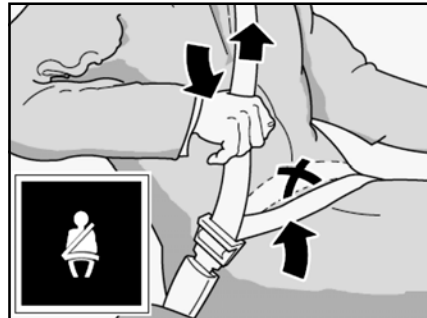
**⚠ WARNING**

1. The belts are intended for adult occupants only.
2. Each belt should be used by one occupant only. The belt must not be put round a child, seated on passengers lap.
3. Use approved child restraint system for children
4. If the belt was in use in a serious accident or shows signs of severe fraying / damage or of having been cut, replace it with an approved belt kit.
5. The belt must not be altered or modified during use and if required to be replaced, then it should be replaced, by **TATA MOTORS** Authorized Service Centre only.

**Lap belt:**

Pull the belt tongue to the desired length. Insert it into the buckle until you hear a click.

Adjust the belt length. To lengthen the belt, hold the tongue at a right angle to the webbing and pull. To shorten, pull the loose end of the webbing. To unfasten, depress the button in the buckle.

**⚠ WARNING**

Positioning the lap portion of the Seat Belt too high can be dangerous as in a collision; this would concentrate the impact force directly on the abdominal area, causing serious injury. Wear the lap portion of the belt snugly and as low as possible.

**Pregnant Woman:**

A pregnant woman should wear a Lap-shoulder belt and the lap portion should be worn as low as possible, below the womb, throughout the pregnancy. When a safety belt is worn properly, it is more likely that the foetus will not be hurt in a crash. Pregnant women should wear the lap part of the belt across the thighs and as snug across the hips as possible. Keep the belt low so that it does not come across the abdomen. By doing this, the strong structure of the hips will take the force if there is a collision.



## SEAT BELTS

**CHILD RESTRAINT SYSTEM (CRS):**

**TATA MOTORS** strongly recommends the use of Child Restraint Systems (CRS) for all children up to the age of 12 (see the Table in the next page for applicability for your child).

**⚠ WARNING**

Children could be endangered in a crash if their CRS are not properly secured in the vehicle. When installing a CRS, be sure to follow the instructions mentioned in the CRS manufacturer's instructions.

**Background :**

In case of an accident, the occupants (either adults or children) experience the collision force. In contrast to adults and teenagers, children's muscles and bones are not yet fully developed.

Children must be transported using CRS especially suited to their size, weight and build.

CRS can help protect children in vehicles in the event of an accident only if they are secured properly.

**Selection of CRS :**

Not every child will fit in the CRS specified for his or her weight group. Likewise, not every CRS will fit in every vehicle. Therefore, always check whether the child fits securely in the CRS and whether the CRS is securely attached in the vehicle.

**⚠ WARNING**

While selecting the CRS, customer should look for the AIS072/ECE R44 certified seats.

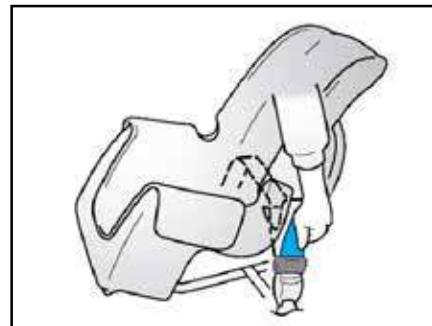

**Booster Seat :**

The CRS are classified according to the child's size, height and weight. Select the appropriate CRS for your child. Always ensure that the child fits securely in the CRS and CRS is securely installed in the vehicle.

Different types of CRS are available in the market; make sure that the CRS you select meets AIS 072 / ECE R44 safety standards.

**Recommended CRS position in the vehicle :**

**TATA MOTORS** recommends installation of CRS in rear seating position. Refer the table for recommended position for your vehicle and CRS.

**NOTE**

*According to accident statistics, children are safer when restrained in a CRS that is secured in rear seating position. While installing in rear seat, push the front seat fully forward so that child's feet do not contact the front seat back.*

However, if it is essential that a child travels in the front seat, push the vehicle seat fully rearward and keep the child in an approved forward facing CRS. Adjust the seat backrest to an upright position.

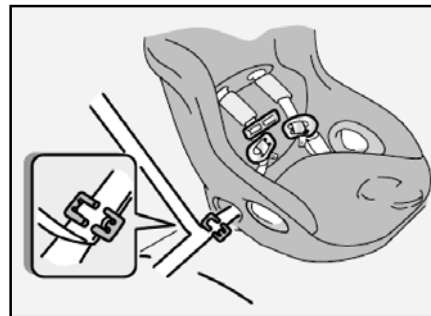
**Installation Procedure :**

Strictly follow the instructions given in the CRS installation manual.

Adjust the seat backrest to an upright position if a CRS is to be used on front seat. Fasten children's seat belts correctly and make sure they assume a correct seating position. Try to move the CRS in all directions, to make sure it is securely installed.

Always secure the child in CRS and CRS in the vehicle safely in accordance with the instructions from CRS manufacturer.



### Storage Procedure for CRS :

An unrestrained CRS could be flung through the vehicle interior in the event of a sudden braking, maneuver or an accident. This could cause injuries to the passengers travelling.

Always secure CRS safely in the car or stow them in the luggage compartment if they are not being used while the vehicle is in motion.

### Instructions for vehicles fitted with airbag :

For vehicles equipped with airbag, it is absolutely necessary to read all of the information concerning airbag system before transporting babies or children in a CRS on the front passenger seat.

#### ⚠ WARNING

If your vehicle is equipped with a front passenger airbag, do not install a rear facing CRS in the front passenger's seat. Inflating front passenger airbag, child in a rear facing CRS could be killed or seriously injured.

If your vehicle is equipped with a side airbag, do not install a CRS in the front passenger's seat. If the passenger airbag inflates, a child in CRS could be injured.



#### ⚠ WARNING

Replace CRS that withstood any force during an accident as they could have sustained damage which may not be visible.

**Check list**

1. Always secure children in the vehicle in a CRS. The CRS must be suitable for the child's height, weight and build.
2. Observe the instructions from the manufacturer of the CRS and always keep them in the vehicle.
3. When securing a CRS using the seat belt, always guide the belt through or around the child seat as described in the instructions from the CRS manufacturer.
4. Always make sure that the seat belt routing is correct for children and they are sitting in the correct position.
5. Whenever possible, fit the CRS on the passenger side seat so that children can exit the vehicle on the kerb side.
6. Do not leave any toys or other objects loose in the CRS or on the seat while the vehicle is in motion.



## SEAT BELTS &amp; CHILD LOCK

The suitability of each passenger's seat position for carriage of children and fitting of child restraint system is shown in the table below. Whenever you carry children less than 12 years of age or 150 cm of height, properly use the child restraints which conform to AIS 072/ ECE R44 norm, the standard for child restraints.

Child restraint system (CRS) suitability for various seat positions

Group	Mass group	Age Group	Front Passenger	Rear Outboard LH	Rear Outboard RH	Rear Center
0	Up to 10 kg	Up to 9 months	X	U	U	X
0+	Up to 13 kg	Up to 24 months	X	U	U	X
I	9 to 18 kg	9 months to 48 months	X	U	U	X
II	15 to 25 kg	Approx. 3 to 7 yrs	X	U	U	X
III	22 to 36 kg	Approx. 6 to 12 yrs	X	U	U	X

**X** : Seat Position not suitable for children in this age group.

**U** : Suitable for “universal” category restraints approved for use in this age group.

**UF** : Suitable for forward facing “universal” category restraints approved for use in this age group.

**NOTE**

*Universal is a category in the AIS072 / ECE R44 norm*

**CHILD LOCK:**

Both the rear doors of the vehicle are provided with a child proof lock. Push the lock lever located on vertical face of the door near the lock downward before closing the door. The door which has been locked by activating the child lock cannot be opened from inside, it can be opened only from the outside.

**NOTE**

*Deactivate the childproof lock when not required.*

**ANTI THEFT DEVICE-IMMOBILIZER:**

Immobilizer system is designed to prevent vehicle theft by electronically disabling the engine ignition system. The engine can be started only with vehicle's original Immobilizer ignition key which has an electronic identification programmed code.

**NOTE**

*Use only E-key, the other should be kept in a safe location. Note down "key Tag no." information (and keep it safe) which is required while getting new / spare keys. Remember that it is not possible to prepare new/ spare keys without the "key Tag number."*

*Take precaution about E-key, as without E-key vehicle cannot be started.*

**Operation of Immobilizer system in Brief:**

VEHICLE CONDITION	STATUS LAMP	VEHICLE STATE	MEANING/ FUNCTION OF THE STATE
Ignition OFF	Blinking	Locked	Vehicle Immobilized and Awaiting Electronic key
Ignition ON	OFF	Unlocked	Normal Condition Ready to start the vehicle
	ON	Locked	<ul style="list-style-type: none"> <li>- Problem with key ( Wrong key used to start vehicle)</li> <li>- Problem with Immobilizer system contact Tata dealer to inspect the system</li> </ul>
Ignition ON	Blinking	Unlocked	<ul style="list-style-type: none"> <li>- Emergency start enabled, to avoid stranded customer</li> <li>- Indicates failure of immobiliser's 'Ignition Supply' line. Contact a <b>TATA MOTORS</b> authorised Service Centre immediately.</li> </ul>

## ANTI-THEFT DEVICE - IMMOBILIZER

**E - KEYS:**

An E-Key is an electronic access and authorization system which is provided as a standard feature on your vehicle. Your vehicle is provided with an E-Key. Each Key is specific to the immobilizer of your vehicle.

**Unlocking principle:**

The transponder which is built into the ignition E-Key carries a unique identification code. The vehicle unlocks when the code on the E-Key matches with the code on the Body Control Module (BCM).

**Engine Starting:**

When the key is inserted and the ignition is switched 'ON', all codes are communicated within concerned components (E-Key, Immobilizer and EMS). The engine will start only if all the codes match.

**Loss of keys :**

If one of the E-Key is lost, contact your nearest **TATA MOTORS** authorised dealer as soon as possible to have the lost key deactivated. The second original E-Key is required for making additional E-Keys. If both the E-Keys are lost contact **TATA MOTORS** authorised dealer.

**⚠ WARNING**

1. Do not turn 'ON' ignition switch by using E-key with any type of metal wound around its grip or in contact with it. This may be detected as abnormal condition by immobilizer and prevent engine from starting.
2. Do not leave the E-key in areas of high temperature. The transponder in it will behave abnormally when reused.
3. Do not try to start the vehicle when the Immobilizer indicator

lamp on the instrument cluster is glowing. In this condition the vehicle will not start and the vehicle's battery will also be drained due to frequent cranking.

### SUPPLEMENTAL RESTRAINT SYSTEM- AIR BAGS : (If fitted)

- The frontal air bags (driver and passenger) are safety devices designed to protect the occupants in the event of a medium or high intensity collision, which acts as a cushion (bag) between the occupant and the steering wheel in the case of driver or the dashboard in case of co-driver.
- In the event of a collision, an airbag ECU is so designed to process signals from the sensor, to detect the severity of collision and accordingly trigger the inflation of air bags at the same time it will unlock all doors with hazard light 'ON' (Continuous blinking). Air bags are not designed to inflate in rollover, rear side or slow speed angular crashes because the necessary protection can be achieved by the seat belt alone.
- Air bags(s) may only deploy when the ignition switch is 'ON'. The inflating air bag deploys out of the steering wheel for the driver and from the dash board for co-driver. This action takes place in a fraction of second.
- The air bags are filled with a propellant gas (nitrogen). The movement of the driver and of the front passenger is cushioned when they make contact with the fully inflated airbag and the risk of injury to head and chest is reduced. The air bag then deflates subsequently to such an extent, after an accident, to again provide a clear view forward. You may hear a noise along with some smoke, dust and smell of burnt propellant immediately after the air bag has inflated. **DO NOT PANIC** as this is normal and is not an indication of fire in the vehicle.

#### WARNING

Always maintain an adequate distance between yourself and the airbags. Always grip the steering wheel on the rim, with your hands in the 3 o'clock and 9 o'clock positions, to minimize the risk of injury to the hands or arms in the event of the airbag being triggered.

#### WARNING

No part of your body (example feet, knees), objects and accessories should be within close proximity to the PAB module as it could obstruct the operation of the air bag.

Deployed air bags and seat belt pre-tensioners cannot protect you in another collision. Have the air bags, seat belt pre-tensioners, replaced by a **TATA MOTORS** Authorized Service Centre immediately.

**NOTE**

*In case of any frontal damage to your vehicle, have the SRS inspected by a **TATA MOTORS** authorised service outlet to ensure it is in proper working condition.*

*Any Maintenance required to be performed on any SRS components or other components located near SRS should be done by **TATA MOTORS** Authorized Service Centre Only. Do not permit anyone else to do any service, inspection, maintenance or repair on any SRS components or wiring.*

*Improper work on the SRS system will result in inadvertent deployment of the air bag or malfunctioning.*

### ANTI- LOCK BRAKING SYSTEM (ABS): (If provided)

ABS allows braking without losing tractional control, prevents wheels from locking up and avoids uncontrolled skidding.

#### NOTE

*When ABS is active, the driver will feel the brake pedal pulsating, which is normal.*

#### NOTE

*If the ABS warning lamp lights up then there is a malfunction in the ABS system (the standard braking system will however function) and the vehicle should be driven cautiously to the nearest **TATA MOTORS** Authorized Service Centre only.*

#### ⚠ WARNING

The fact that a vehicle is fitted with ABS must never tempt the driver into taking risks that could affect his/her

safety or that of others. In all cases it remains the driver's responsibility to drive within safety margins, taking into consideration prevailing weather and traffic conditions.

### ELECTRONIC BRAKE FORCE DISTRIBUTION (EBD) - if provided:

EBD optimizes braking pressure distribution between front and rear axle to ensure vehicle stability.

### ENGINE DRAG TORQUE CONTROL (EDTC) - if provided:

On slippery road conditions during,

1. In- gear Braking or
2. Shift down of gear or
3. Sudden throttle release on a curve road.

This causes high Engine drag on the driven wheel resulting into brake slip situations without any brake application. This makes vehicle highly under-steerable.

EDTC controls such brake slip on the driven wheels by increasing the engine torque to makes the vehicle stable and steerable.

### CORNERING STABILITY CONTROL (CSC) - if if provided:

“Corner stability Control” supports / stabilizes vehicle during partial braking in curves by reducing pressure at required inner wheel of the vehicle.

This helps to reduce probability of vehicle over steering during cornering.

## DRIVING IN ADVERSE CONDITION

**DRIVING IN ADVERSE CONDITION:****Driving Through Water :**

Your vehicle's engine may get seriously damaged if attempted to drive through deep water.

If at all the situation demands that you have to drive through water then;

- Keep engine in higher RPM and crawl the vehicle in low gear.
- After driving through water apply brakes several times to dry liners and to regain original braking.

**Do not attempt to start the engine if vehicle gets flooded due to water. Tow the vehicle to a safe place.**

Take the vehicle to the nearest **TATA MOTORS** authorised workshop to check entry of water in cylinders.

If water has entered the engine, gearbox or transfer case, the lubricants will have to be replaced. Get the starter and alternator checked.

**Driving on a Rainy Day :**

- Check brakes, steering and windows.
- Check tyres for wear and tyre pressure.
- Check wiper blades for proper functioning.
- Avoid harsh braking and sharp turns. It may cause loss of control and lead to a skid.
- For slowing down, shift to lower gears and brake gently.
- Keep lights ON if visibility is poor.

**Night Driving :**

- Dip the head lamp for oncoming traffic during night driving.
- Maintain a speed such that you can stop within illuminated distance of head lamps.
- Use head lamp main/dip beam to alert other road users on turns/cross roads etc.
- Use side indicators for lane change or turning.
- Put on hazard warning switch in case of hazardous parking or if your vehicle is disabled to warn the passing traffic.

**Climbing Sharp Gradients on Loose Surfaces :**

- Start off smoothly in any suitable gear. Apply power smoothly so that there is no loss of traction by over-revving of the engine.
- Select the appropriate gear so that gear changing in the middle of the climb is not required.
- Changing gears in the middle of the climb can cause loss of momentum and engine stalling. Shifting to a lower gear has to be done cautiously to avoid loss of traction.
- If the wheels start to slip within few feet of the end of the climb, motion can be maintained by swinging the steered wheels left and right, thereby providing increased grip.

**Descending Sharp Gradients :**

- Depending on the severity of the gradient, shift into appropriate gear. Use engine braking judiciously without over-revving the engine.
- Brake application under such situations should be done very smoothly to avoid loss of control. Select appropriate gear so that gear changing or clutch disengagement is not involved while descending the gradient.



**KEY LESS ENTRY (if applicable):**

1. **Unlocking the vehicle:**  
Press button 1.
2. **Approach Light :**  
Press button 2.
3. **Locking the vehicle :**  
Press button 3.
4. **Fold key blade IN/OUT :**  
Press button 4.

**NOTE**

*Key Blade should not be folded without pressing the button. Also, it should not be forced in any direction apart from folding direction to avoid damage to Flip Mechanism.*

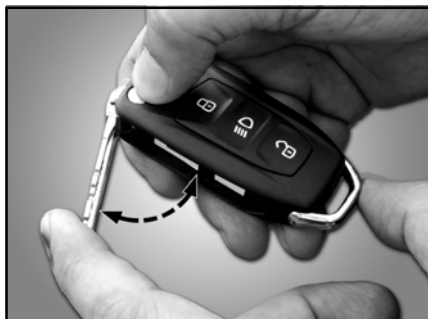
**FEATURES :**

1. **Remote Operated Central Door Locking**  
Pressing the Lock push - button of remote once locks all the doors of the vehicle.
2. **Unlocking through Remote**  
Pressing the unlock push-button of remote will unlock all the Doors.
3. **Manual Operation of Central Door Locking / Unlocking:**  
All doors can be locked/unlocked from the driver door using a key from

outside or driver's door knob from inside.

**4. Approach Light**

Press and release approach button, Red LED will be flashed on the remote. To switch 'OFF' the approach lights, press and release the same button.

**5. Automatic activation of Immobiliser**

If key is removed from ignition, the engine will be immobilised automatically even if you forget to lock the vehicle.

**6. Theft Detection & Perimeter Alarm:**

Once the vehicle is locked with the remote key, theft detection is triggered and alarm gets activated when any of the door is opened or if the ignition is made 'ON' with any other key. Perimeter alarm will also switch 'ON' if the vehicle is locked with the remote key and ignition is

made 'ON' with authorised key without unlocking the vehicle with remote key.

### 7. Visual Indication by flashing of Turn Indicators during Locking / Unlocking

When the vehicle is completely locked, turn indicators flash twice and when the vehicle is unlocked, turn indicators flash once.

### 8. Auto Locking / Unlocking of Doors

Vehicle doors get automatically locked when the vehicle speed crosses 10 kmph .

Also, when ignition key is taken out all the doors get automatically unlocked.

### 9. Anti-grab/Anti-scan coding

The remote control set of this security system is protected against the use of devices called 'scanners' and grabbers' which can record and reproduce some types of remote codes.

### 10. Force Panic Alarm :

Press the LOCK and UNLOCK button simultaneously to activate panic alarm. Press either the LOCK or UNLOCK button to deactivate panic alarm.

### OPERATING INSTRUCTIONS :

#### 1. Locking, Unlocking & Vehicle Search through Remote Unit

##### 1.1. Locking all doors

To activate door locks, press Lock - push button of the remote. Locking will be confirmed by two flash of turn indicators.

If vehicle lock button is pressed on the remote key with the driver door open, a warning sound is audible.

While if any other door is open, the vehicle gets locked but indicators do not flash.

##### 1.2. Unlocking all doors

To disarm the immobiliser, alarm and unlock all Doors, press Unlock

push-button of the remote. Unlocking will be confirmed by single flash of turn indicators.

### 1.3 Vehicle Search

In vehicle lock condition if lock button on remote key is pressed the turn indicators of vehicle flashes 4 times.

#### 2. Manual Operation of Central Door Locking / Unlocking

All doors can be locked / unlocked from driver door lock without using remote.

### NOTE

*In case any push button of the remote is accidentally pressed for more than 25 seconds, the remote stops functioning till the time the push-button is pressed. The LED on the Remote also stops glowing.*

*The function of the remote gets reinstated immediately when the user stops pressing the push-button of remote.*

## TIPS ON USE

DO'S		DONT'S	
1.	Do always keep your vehicle's battery properly charged.	1.	Don't play with Lock/Unlock push-button of remote while in the vicinity of your vehicle, as it could lead to an unintentional unlocking your vehicle.
2.	Do always press the Lock push-button of the remote only after coming out from the vehicle.	2.	Don't lock the vehicle by remote while sitting inside the vehicle.
3.	Do keep the remote in safe and secure place.	3.	Don't use discharged batteries in remote, as it could damage the remote.
4.	In case of any problem, always contact <b>TATA MOTORS</b> authorized service outlet.	4.	Don't remove the battery connection of the vehicle while the vehicle has been locked by remote. First unlock the vehicle by remote, and then remove the battery connection.

## CHECK POINTS FOR TROUBLE SHOOTING

In case of such problem try using the suggestions given below. If the problem still persist, consult the nearest dealer or authorised service centre of **TATA MOTORS**.

PROBLEM	POSSIBLE REASON	SUGGESTED SOLUTION
Significant change in range of remote	Remote battery is low (even in an open space)	Change the remote battery and try again
No locking / unlocking by space	1. Remote battery is discharged / low 2. Vehicle battery is discharged / low 3. Central door locking fuse has blown	1. Change the remote battery. 2. Charge / Change the vehicle battery as required 3. Fit fuse properly. Change fuse (if it has blown)
No locking by remote	Key is in ignition switch	Remove the key from ignition switch and then try
After turning the ignition switch the vehicle still does not start	The system is in the automatic arming mode of engine immobilizer.	Press the Unlock push-button of remote once Check the LED status
Audio alarm and turn indicators continue to blink even after pressing Unlock push-button.	Remote is not working	1. Check for the remote batteries, if required change it 2. Try disarming the system through emergency disarming procedure.

**DOOR OPENING / CLOSING :****Locking / unlocking door with key:**

Front driver door has separate locking facility. All doors can be locked or unlocked from outside using the E-key.

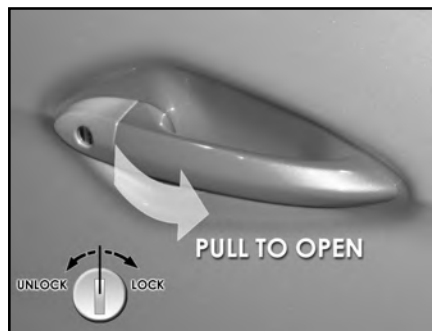

Insert the E-key and turn it anti-clockwise to open or clockwise to lock the door. Pull the Door handle to open the unlocked door.

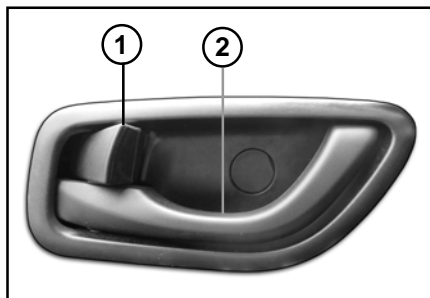
**Locking without a key from inside:**

All the doors can also be locked or unlocked independently from inside by pressing or pulling the knob (1). **Press** to lock and **Pull** to unlock.

**NOTE**

*When locking doors this way, do not leave the key inside the vehicle.*

**Opening the doors from inside :**

All doors can be opened from inside. To open, pull the door opening knob (1) and then lever (2).



Location of door opening / locking lever.

## WINDOW GLASS OPENING & CLOSING :

### Power Windows (if fitted) :

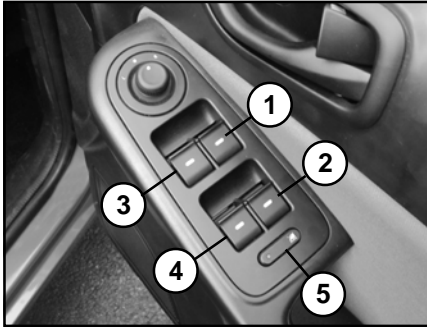

1. Front Right Hand Window Winding Switch
2. Rear Right Hand Window Winding Switch
3. Front Left Hand Window Winding Switch
4. Rear Left Hand Window Winding Switch
5. LOCK / UNLOCK Switch

Glasses on all four windows of your vehicle can be operated by switches provided on the main control panel located on the driver's arm rest. They work only when the key is in the "IGN ON" position.

### NOTE

*Power windows can be operated for 3 minutes in 'IGN OFF' position and when key is taken out.*

Glasses are wound up by pulling the switch and are lowered by pressing it down.

A safety locking arrangement has also been provided and can be activated by a push type switch located at the centre, below the window switches. It has two positions:

**LOCK** : When switch is pressed and red light turns 'ON' the switch is in 'LOCK' position.

The rear and co-driver window switches (located on rear doors and co-driver door) can be operable. It can also be operable from the switches on driver's arm rest.

**UNLOCK** : When switch is released.

It is in 'UNLOCK' position (i.e. when Red light turns 'OFF') co-driver door

switch and rear doors switches cannot be operable. But it can only be operated by using the switches on driver's arm rest.

Individual window winding switches have been provided on co-driver's door as well.

### ⚠ WARNING

While raising the glass, take care to avoid fingers / hands getting trapped between glass and the frame.

**Power window switch (On Rear Doors):**

Individual window winding switches have been provided on the rear doors.

To close the door window glass, pull the switch up and to open the window, push the switch down.

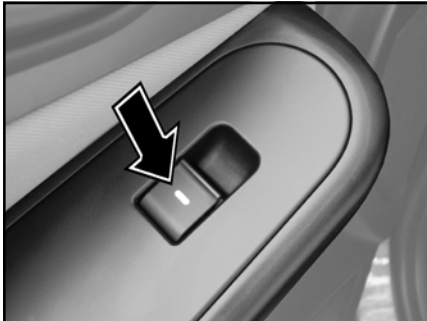

Window Winding Switch on Rear Door

**NOTE**

*This can be operable when switch no.5 is in LOCK condition.*

**Manual Window Winding :**

In some versions, power windows are not provided. Use window winder handle manually for lowering or raising up window glasses manually.



Window Winder Handle

**BONNET - OPENING AND CLOSING:****Opening:**

1. Ensure that the vehicle is in neutral gear with the parking brake applied.
2. Pull the bonnet release lever located under the right hand corner of the dash board. The bonnet will pop up slightly.
3. Raise the bonnet slightly and with your finger slide the secondary lock lever located under the bonnet centre to the left side.
4. Lift the bonnet up. Pull the bonnet stay rod from its clip and insert the free end into the slot in the bonnet, slide stay rod outward to secure.

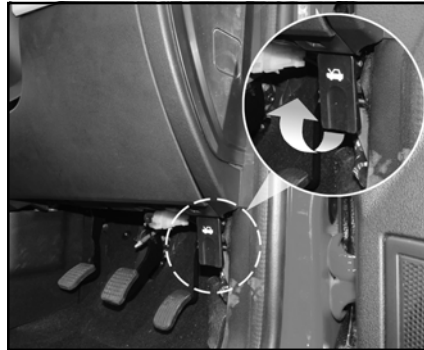
**Location of bonnet release lever****Bonnet release lever****Bonnet release lever location****Closing :**

1. To close the bonnet disengage the stay rod and clamp it properly.
2. Lower the bonnet and drop it from a short height to shut it.

**NOTE**

*Ensure that the bonnet is properly locked before driving. Do not press the bonnet onto the bonnet lock.*



## FUEL LID AND TRUNK LID OPENING & CLOSING :

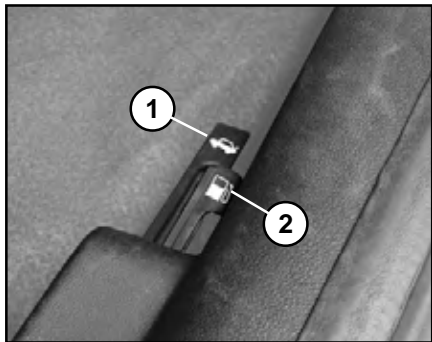

1. Trunk Lid Opening Lever
2. Fuel Flap Opening Lever

The fuel lid is located on the left rear side of the vehicle. This can be opened by pulling the lever (2) located at the right hand side of the driver on floor.

For closing, simply push the fuel flap till it gets locked.

### ⚠ WARNING

Fuel vapour is extremely hazardous. Always stop the engine before refueling and never refill near sparks or open flames.

### NOTE

*Remove the fuel filler cap slowly, and wait for any hissing to stop. If the cap is opened suddenly, the fuel may be under pressure and may spray out, causing injury.*

If fuel cap needs replacement, ensure that it is replaced by a genuine cap at **TATA MOTORS** Authorized Service Centre Only.

## TRUNK LID OPENING & CLOSING :

To open the trunk lid, pull the lever (Shown in fig.) located at the right hand side of the driver's side and lift the trunk lid.



It can also be opened by using door key. The lock is located on the trunk lid.

For closing, pull the trunk lid down and close it with a slight swing.

## DRIVING CONTROLS

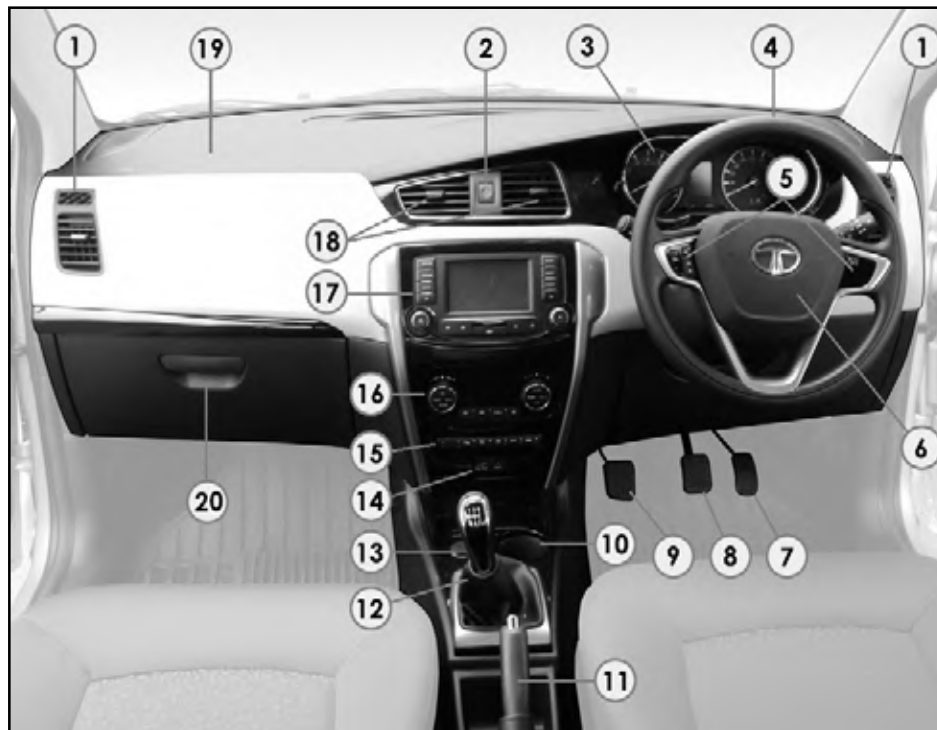

1.	A.C. Air vent (Side)
2.	Hazard Warning Switch
3.	Instrument Cluster
4.	Steering Wheel
5.	Steering Wheel Switches (If fitted)
6.	Horn pad / Air Bag (DAB)-if fitted
7.	Accelerator Pedal
8.	Brake Pedal
9.	Clutch Pedal (Not in AMT)
10.	Cup Holder
11.	Parking Brake Lever
12.	Gear Shift Lever
13.	Plug Socket
14.	USB/AUX Port (if fitted)
15.	Fascia Switches
16.	FATC / HVAC Control panel
17.	Music System (if fitted)
18.	A.C. Air vent (Middle)
19.	Air Bag (PAB) - if fitted
20.	Glove Box

The above shown image is for reference only.

## INSTRUMENT CLUSTER - VERSION-1

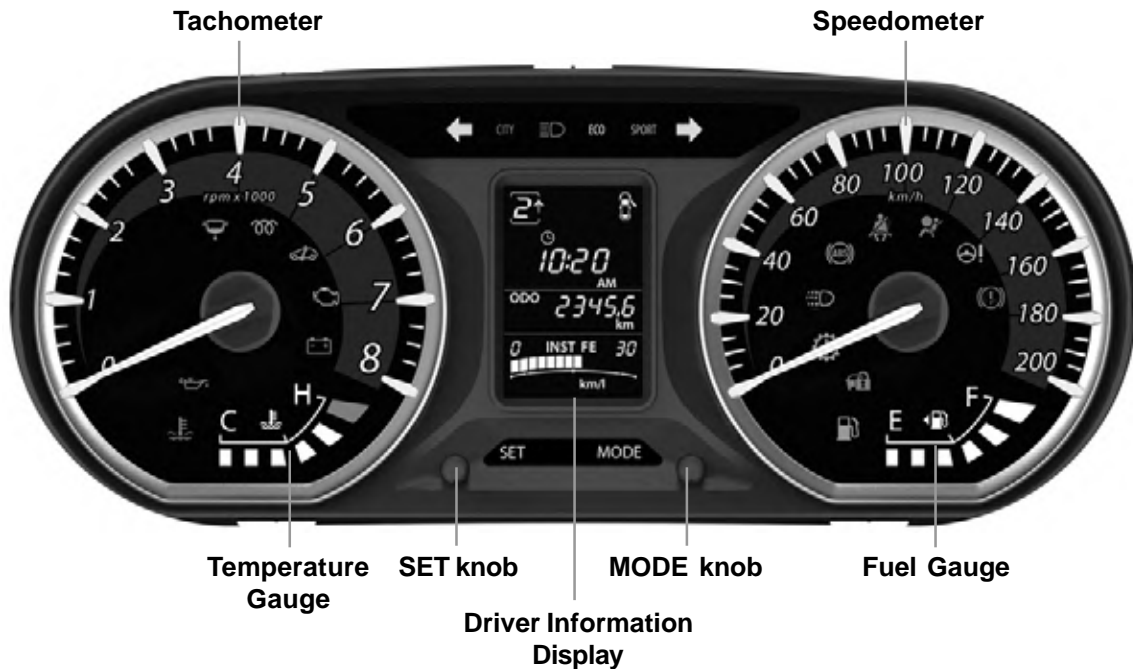

*NOTE : Indicators applicability and arrangement may vary as per model versions.*

## INSTRUMENT CLUSTER - VERSION-2

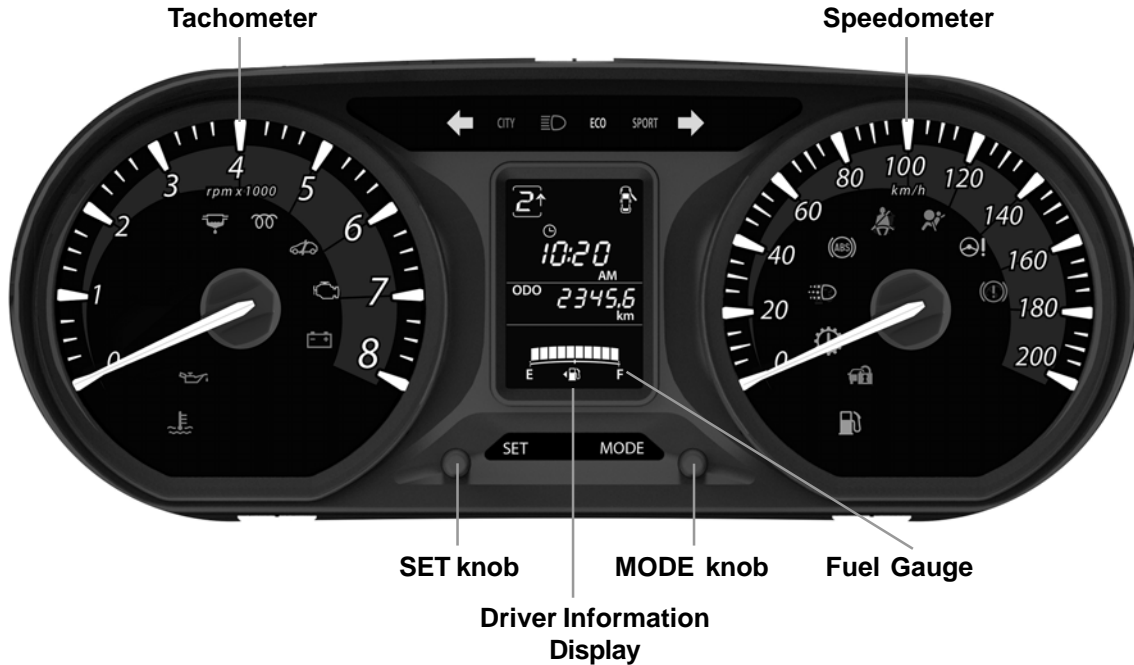

*NOTE : Indicators applicability and arrangement may vary as per model versions.*

**1. Speedometer:**

Speedometer indicates the vehicle speed in km/h.

**NOTE**

*At every key 'IN' and ignition 'ON', the Instrument Cluster needles moves to MAX. and return to '0' position. This is a welcome strategy and a self check feature.*

**2. Tachometer :**

Tachometer Indicates the engine speed in thousands of revolutions per min (rpm).

**⚠ WARNING**

- Do not continuously operate the engine in high rpm. This may cause severe engine damage.
- Whenever engine is accelerated beyond safe RPM, the pointers turn RED. In such a case, reduce the engine RPM immediately.

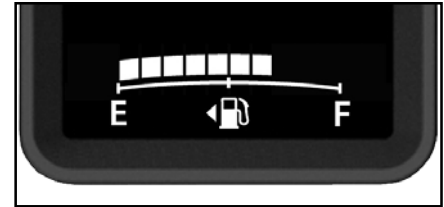
**3. Fuel Gauge:****Version-1****Version-2**

Fuel Gauge Indicates the approximate fuel level in the tank.

- When fuel in the tank is near to empty position, low fuel warning telltale turns on.
- If fuel is not filled even after Low fuel warning telltale is ON, First bar in fuel gauge will start blinking

to indicate more severe low fuel warning.

**For checking correct fuel level, always take following precautions:**

1. Always check the fuel level when the vehicle is on level road.
2. On inclines, curves, braking and sudden acceleration due to the movement of fuel in the tank, the fuel level display may fluctuate or the low fuel warning lamp may illuminate earlier than usual.
3. When the ignition switch is in the 'ON' position, this gauge gives an approximate indication of the amount of fuel in the fuel tank and it takes few seconds to stabilize after the ignition is turned ON. 'F' stands for full and 'E' stands for empty.
4. Do not continue adding fuel after the automatic shut 'OFF' function is operated if it is equipped on the fuel station. The sensor in the fuel tank may misjudge the amount of fuel remaining.

5. Running the fuel tank too low or empty can cause your engine to stall and could endanger you and your passengers. You must stop and obtain additional fuel as soon as possible after low fuel warning telltale turns 'ON'.
6. Low fuel warning symbol will blink if there is any fault in the system. Take your vehicle to the nearest Tata authorized service station if the symbol starts blinking.





**4. Engine Coolant Temperature Gauge: (if provided)**







Indicates the engine coolant temperature of the vehicle. If the coolant temperature reading is very high, the coolant temperature warning tell tale flashes. In this case, stop the vehicle, switch OFF the engine and cool it down for sometime. Contact nearest **TATA MOTORS** Authorized Service Centre immediately for rectification.





**⚠ WARNING**

Driving with an Overheated engine can cause serious damage to the engine components.

Sr. No	Driver Information	System Image	Description
5	Odometer		Indicates distance traveled by a vehicle Range : 0 to 999999 km. Resolution : 1 km The Odometer reading does not over flow to “0” when maximum value is reached, the display will freeze to maximum value 999999 km.
6	Trip meter A & B		Indicates distance traveled by a vehicle in Trip mode, which is resettable by user. Range : 0.0 to 9999.9 km (5 digits) Resolution : 0.1 km Trip meter reading becomes “0.0” after it crosses 9999.9 kms.
7	Average Fuel Economy for Trip A and Trip B		Displays “Average Fuel consumption” since it was last reset Range : 0.0 to 99.9 (3 digits) Resolution : 0.1 km/l
8	Distance To Empty		Indicates distance that your vehicle can travel with available fuel in tank under current Average Fuel consumption rate and it displays as ‘km’ Range : 25 to 1999 DTE will provide rolling text warning as ‘rEFUEL’ below 25 km distance to empty

Sr. No	Driver Information	System Image	Description
9	Instantaneous fuel Economy		Updates display "Instantaneous Fuel consumption" at regular time interval in bar graph.
10	Clock		Indicates current time.
11	Outside Ambient Temperature		Displays outside ambient temperature.
12	Service reminder		Indicates the number of days/kilometers in which service is due. If service is overdue, it will display "0" km or "0" days and spanner symbol will blink. Never reset the display between service intervals otherwise this may results in to incorrect readings. Information is retained in the service interval display also after the vehicle battery is disconnected. <b>NOTE :</b> If Service Reminder warning is displayed in the instrument Cluster, kindly visit at <b>TATA MOTORS Authorized Service Centre</b> for servicing.
13	Gear indicator		Indicates the current gear engaged. Up or down arrow will be displayed, recommending whenever gear should be shifted to up or down. <b>NOTE:</b> If "F" is displayed it means 'Fault' condition. Contact a <b>TATA MOTORS Authorized Service Centre</b> .



Sr. No	Driver Information	System Image	Description
14	Door Ajar		<b>Applicable to XT / XTA / XMA / XEA variants</b> All four door and tailgate are indicated independently when respective door is open
			<b>Applicable to XM / XMI / XMS variants</b> Driver door warning will be indicated when driver door open Co-Driver door warning will be given when any one of the three doors i.e. co-driver, rear left and rear right door is open
15	Drive Mode (As applicable)		<b>Automatic Manual Transmission Vehicle</b> AUTO indicated Auto Drive mode. MAN indicated Manual Drive mode
	Drive Mode (As applicable)		<b>AMT / Manual Transmission Vehicle</b> Indicates the mode in which vehicle is driven. <b>SPORT</b> indicates sport drive. This mode is used to produce more torque from engine <b>ECO</b> indicates Economy drive. This mode is used to achieve better fuel economy <b>CITY</b> mode is default mode.No indication will appear. <b>NOTE :</b> For more information refer 'DRIVE MODES' in starting & driving section.

**1. Instantaneous Fuel Economy:**

Maintain IFE bar graph above 15 km/l to achieve better fuel economy.

**NOTE**

*IFE will vary frequently as per driving pattern.*

The IFE display does not show Fuel Economy of last drive. It indicates Instantaneous Fuel economy of current Drive when Ignition is turned 'ON'.

The display does not show actual value unless vehicle is moving.

The indication on the display may be delayed if fuel consumption is affected by driving pattern.

**2. Average Fuel Economy:**

Average Fuel Consumption will Reset to 0 when respective Trip meter is reset.

Average Fuel Economy will be displayed as '--.-' for initial 0.5 km of respective trip. Once 0.5 km distance is covered, Average Fuel Economy will be displayed.

Even after 0.5 km distance covered for particular trip, Average fuel economy is displayed as '--.-', take your vehicle to **TATA MOTORS** authorized service centre.

**NOTE**

*AFE value is estimate of fuel economy. It may vary significantly based upon driving conditions, driving habits and condition of vehicle.*

*Average Fuel Consumption will get Reset to '0' when Battery is removed and refitted.*

**3. Distance to Empty (DTE):**

DTE value may differ from the actual driving distance available.

**NOTICE**

*If DTE is displayed as '---', take your vehicle to **TATA MOTORS** authorized service centre.*

The DTE will update with new value when fuel is added more than 4 Litres at a time.

The average fuel consumption and distance to empty values may vary significantly based on driving conditions, driving habits, and condition of the vehicle.

The distance to empty value is an estimate of the available driving distance.

If low fuel warning light comes on, fill the fuel tank immediately regardless the value of displayed DTE.

If vehicle is not on level ground and negative of battery has been disturbed, the DTE function may not operate correctly.

OPERATIONS FOR DRIVER INFORMATION ON VEHICLES (VERSION-1):

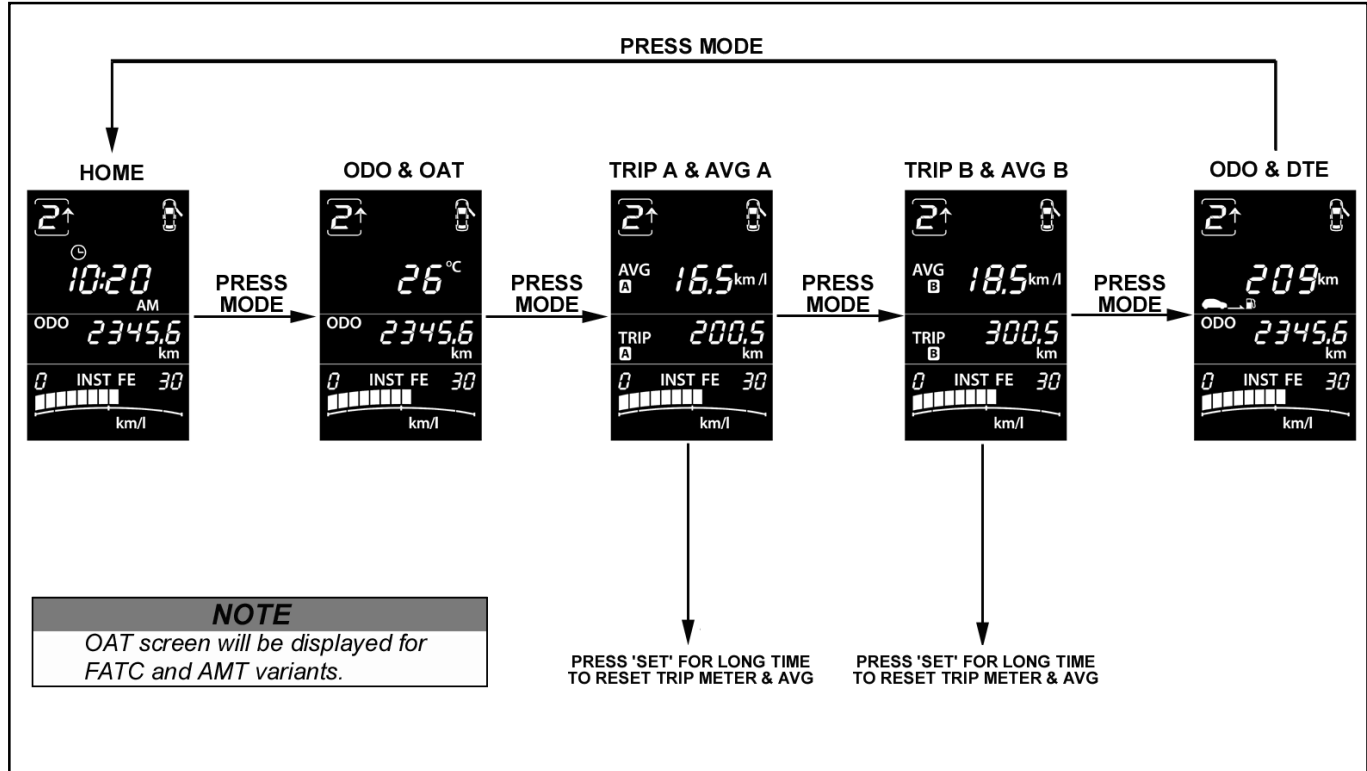

## OPERATIONS FOR DRIVER INFORMATION ON VEHICLES (VERSION-2):

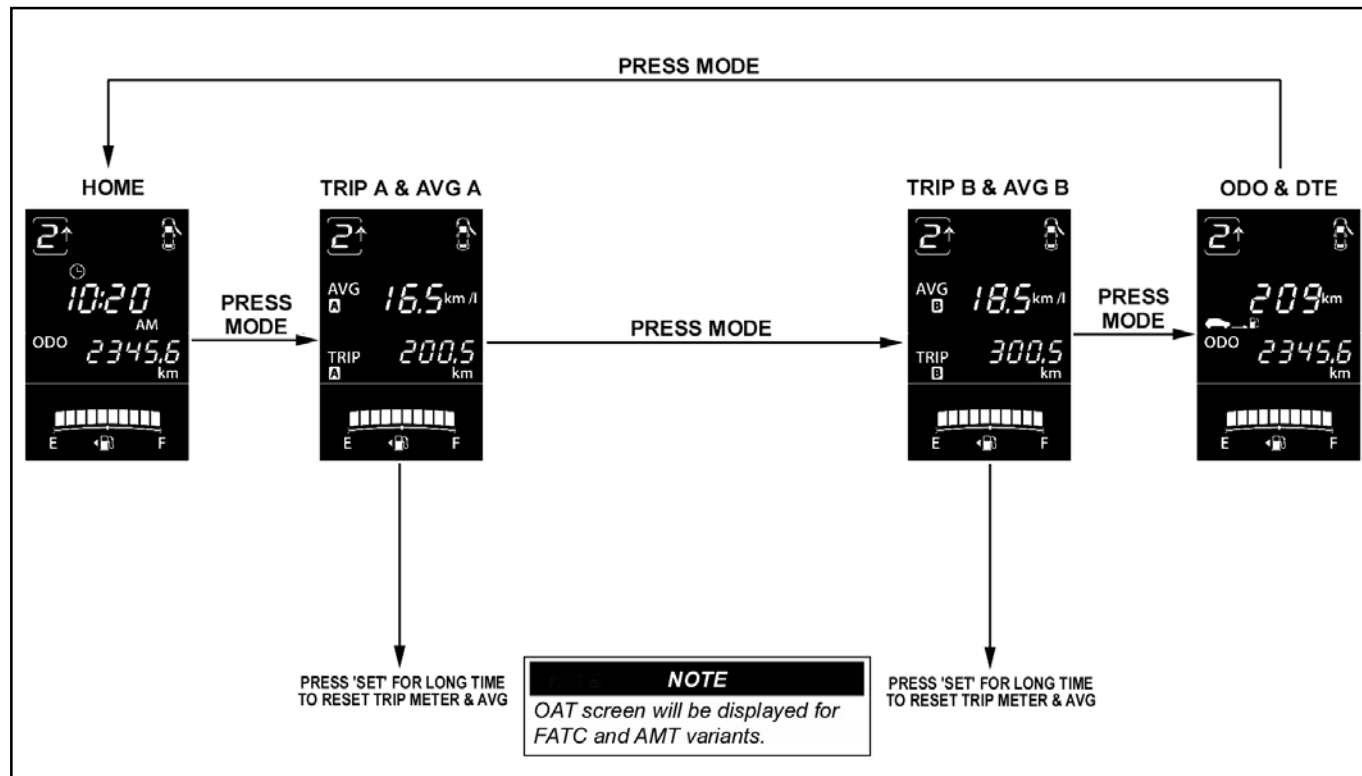

**Digital Clock Setting:**

Digital clock appears on the DIS screen. To adjust the values in Hrs. Min. and AM/PM mode, Press 'SET' knob on Instrument Cluster. A delayed press on the 'SET' knob for a selected value will confirm it and move towards next respective value.





**Instrument Cluster Illumination:**





For Instrument Cluster illumination level settings, it is necessary to turn the Park Lamp 'ON' and then Press the 'SET' knob on Instrument Cluster.





Press 'SET' knob to change the illumination intensity level in 5 steps. A delayed press on the 'SET' knob for a selected intensity will confirm it.

**⚠ WARNING**



The Clock and Instrument Cluster Illumination settings should be done only when the vehicle is in stationary condition for safety purpose.





TELL TALES	COLOR	INDICATOR	REMARKS
<b>Malfunction Indication Lamp ( MIL )</b>	Amber		<ol style="list-style-type: none"> <li>1. Illuminates momentarily when ignition is switched 'ON'. Once engine is cranked, it turns 'OFF'.</li> <li>2. It remains 'ON' for any engine related fault that may increase emission levels of the vehicle beyond the regulatory norms. Contact a <b>TATA MOTORS</b> Authorized Service Centre for rectification.</li> </ol>
<b>Check Engine</b>	Amber		<ol style="list-style-type: none"> <li>1. Illuminates momentarily when ignition is switched 'ON'. Once engine is cranked, it turns 'OFF'.</li> <li>2. Illuminates continuously if a fault arise in Engine Management System. Contact a <b>TATA MOTORS</b> Authorized Service Centre.</li> </ol>
<b>Immobilizer</b>	Red		<ol style="list-style-type: none"> <li>1. Illuminates when the system disables engine start if the original key is not used.</li> <li>2. Lamp blinks: Vehicle is in immobilized condition when key is not inserted.</li> <li>3. Lamp ON: Problem with key/system. Contact a <b>TATA MOTORS</b> Authorized Service Centre.</li> </ol>
<b>Water in fuel (Diesel)</b>	Amber		<ol style="list-style-type: none"> <li>1. Illuminates momentarily when ignition is switched 'ON'. Once engine is cranked, it turns 'OFF'.</li> <li>2. Illuminates continuously if excess water is accumulated in the fuel filter. Contact a <b>TATA MOTORS</b> Authorized Service Centre to drain the water immediately to avoid serious damage to the fuel injection system.</li> </ol>

TELL TALES	COLOR	INDICATOR	REMARKS
<b>Glow Plug (If applicable )</b>	Amber		Illuminates momentarily when ignition is switched 'ON' to indicate that the glow plugs are active. It will continuously illuminate when engine is getting preheated. Start the engine only after the indicator turns 'OFF'.
<b>Turn Signal</b>	Green		Indicates direction indicated by the turn signal. Blinks along with buzzer while operating left/right turn indicator only when ignition is switched 'ON'.
<b>High Beam</b>	Blue		Illuminates when the high beam headlamps are switched 'ON' or flashed.
<b>Low Oil Pressure</b>	Red		1. Illuminates momentarily when ignition is switched 'ON'. 2. Illuminates continuously if engine oil level is less than a pre-defined minimum level. Stop the vehicle as soon as safety permits and switch off the engine. Check engine oil level and top-up if required. Contact <b>TATA MOTORS</b> assistance before starting the engine.
<b>Battery charging</b>	Red		Illuminates momentarily when ignition is switched 'ON'. Once is cranked, it turns 'OFF'. It will continuously illuminate when there is malfunction of charging system. Contact a <b>TATA MOTORS</b> Authorized Service Centre.

TELL TALES	COLOR	INDICATOR	REMARKS
<b>Park Brake / Brake Fluid Low / EBD Fault / ABS</b>	Red		Illuminates momentarily when ignition is switched 'ON'. Once engine is cranked, it turns 'OFF'. It will remain 'ON', it indicates 1. When brake fluid level is low. 2. When park brake is applied & turns 'OFF' when it is released. 3. When ABS/EBD system has a fault.
<b>Seat belt warning</b>	Red		Indicates that seat belt is not fastened when ignition is 'ON'. It will be continuously 'ON' if the seat belt is not fastened (above 4 kmph). When the vehicle speed goes above 25 kmph seat belt alarm will be audible.
<b>Airbag status (If applicable)</b>	Red		Illuminates momentarily when ignition is switched 'ON'. Once engine is cranked, it turns 'OFF'. It will continuously illuminate when there is malfunction of airbag (SRS) system. Contact a <b>TATA MOTORS</b> Authorized Service Centre immediately.
<b>EPAS</b>	Amber		Illuminates momentarily when ignition is switched 'ON'. Once engine is cranked, it turns 'OFF'. Illuminates when there is a fault in the EPAS. Contact a <b>TATA MOTORS</b> Authorized Service Centre immediately.
<b>Low Coolant Temperature (If applicable)</b>	Blue		Indicates that engine coolant temperature is very low. Illuminates when engine coolant temperature is very low and normal, while it turns 'OFF' when engine coolant temperature is normal but not hazardous. Contact a <b>TATA MOTORS</b> Authorized Service Centre immediately.



TELL TALES	COLOR	INDICATOR	REMARKS
<b>High Coolant Temperature</b>	Red		Indicates that engine coolant temperature is very high. Illuminates when engine coolant temperature is very high and continuously flashes along with buzzer if engine coolant temp. is extremely high. Switch off the engine and allow to cool. Contact a <b>TATA MOTORS</b> Authorized Service Centre immediately.
<b>ABS</b> (If applicable)	Amber		Illuminates momentarily when ignition is switched 'ON' once engine is cranked, it turns 'OFF'. Illuminates continuously if there is any malfunction in ABS. Normal braking system will be operational without assistance of ABS. Contact a <b>TATA MOTORS</b> Authorized Service Centre immediately.
<b>Low Fuel</b>	Amber		Illuminates momentarily when ignition is switched 'ON'. Once engine is cranked, it turns 'OFF'. Illuminates when fuel level is low. 1st bar on fuel gauge will start blinking when fuel level is low. Refill the fuel tank as soon as possible. <b>IMPORTANT:</b> The warning light will start flashing if there is any fault in the fuel system. Contact a <b>TATA MOTORS</b> Authorized Service Centre immediately. <b>NOTE:</b> Driving with low fuel level condition can cause the engine to misfire and damage the catalytic converter.

TELL TALES	COLOR	INDICATOR	REMARKS
<b>DRL Indicator</b> (If applicable)	Amber		Illuminates momentarily when ignition is switched 'ON'. Illuminates when the day time running lamps are 'ON'.
<b>AMT Fault</b> (If applicable)	Amber		Illuminates momentarily when ignition is switched 'ON'. Illuminates continuously when there is a fault in Automatic Manual Transmission system. Contact a <b>TATA MOTORS</b> authorized Service Centre immediately.
<b>ECO</b> (As applicable)	Green		ECO indicates Economy drive. This mode is used to achieve better fuel economy
<b>CITY</b> (As applicable)	Blue		CITY indicates City drive mode. This mode is used to achieve optimum torque and better fuel economy
<b>SPORT</b> (As applicable)	Amber		SPORT indicates Sports drive mode. This mode is used to produce more torque from engine.

**AUDIO REMINDERS :****Key In reminder :**

While leaving your vehicle, if you forget the key inside the vehicle in Ignition 'OFF' position, buzzer will provide audio warning. Remove Key to stop the warning.

**Park Lamp 'ON' reminder :**

While leaving your vehicle, if you forget to turn 'OFF' the head lamps, buzzer will provide audio warning. Switch 'OFF' Park Lamps to stop the warning. Do not forget to turn 'OFF' your head lamps as it may drain your vehicle battery.

**Park Brake ON reminder :**

If Park Brake is applied and vehicle is driven, telltale will turn 'ON' and buzzer will provide audio warning continuously. Disengage the park brake to stop audio warning.

**Reverse Gear reminder :**

If Reverse Gear is engaged, audio warning will alert you. This chime is applicable for both Manual and AMT transmission vehicles.

**Seat Belt reminder :**

If seat belt is not buckled and vehicle speed goes above 25 kmph, audio alarm will start and continue for 90 seconds. This will stop when vehicle speed goes below 4 kmph.

If seat belt is still unbuckled for more than 90 seconds, audio alarm 2 will start. This will continue for 90 seconds further and it will stop when vehicle speed goes below 20 kmph. Seat belt telltale will remain continuously 'ON' when audio alarm is active.

**AMT fault reminder (if applicable):**

In case of AMT fault, a 3 sec. audio warning will alert you.

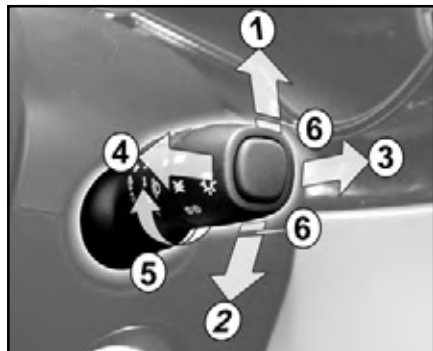
**COMBI-SWITCH (RH STALK):**

- 1) **Left Turn signal:** Push lever upward.
- 2) **Right Turn signal:** Push lever downward.
- 3) **High beam :** Push the Switch forward to select the High Beam function.  
Pull the lever back to select the low beam.
- 4) **High beam Flash (Spring return):**  
To flash the high beams pull the lever towards you from the normal

position with the spring force. This does not require the headlamp to be turned ON. The lever will return to normal position when released.

**5) Headlamp Rotary Switch :****A) OFF Position:**

Day time running lamps (DRL) will be 'ON'.(if provided)

**B) Parking Lamp:**

Rotate to position 'B' to turn 'ON' the Parking lamps.



DRL will be 'OFF'

**C) Low Beam:**

Rotate to position 'C' to turn 'ON' the Low Beam function.



DRL will be 'OFF'

**Head lamp leveling rotary switch:**

Inner rotary switch on right hand stalk is provided for head lamp leveling. With the inner rotary switch, Head lamp leveling can be done with head lamp in Low Beam and in 'ON' position. Depending upon the number of occupants and luggage in the vehicle headlamp focus may change. This can be adjusted by rotating the knob to one of the 3 level positions.

**6. Lane Change Signal:**

To signal a lane change, move the lever up or down to the point where the indicator light begins to flash, but the lever does not latch. The turn signal will flash three times automatically.

**Day Time Running Lamps :  
( if provided)**

Day time Running Lamps (DRL) are provided in front fog lamp console.

It makes your vehicle more visible to other drivers. Daytime running lamps are not designed for use at night.

With the rotary switch in 'OFF' position, the Daytime Running Lamps will switch 'ON' automatically when

- The ignition is 'ON'.
- All lights (position light/front fog lamp/side marker lamp/low beam/high beam) are 'OFF'.

When either of parking lamp / front fog lamp / low beam/ high beam is 'ON', Day time running lamps are 'OFF'.

**NOTE**

*Daytime running lamps can be enabled or disabled by a **TATA MOTORS** authorized service centre if required.*

**NOTE**

*Misting may occur on the inside of a lamp lens due to changes in environmental conditions. This phenomenon is not detrimental to lamp performance and will clear during normal use.*

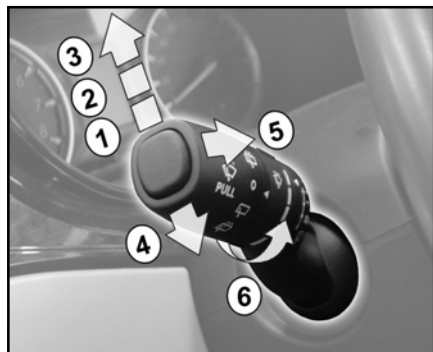
**COMBI-SWITCH (LH STALK):**

1) Intermittent wipe (-----)

2) Slow Wipe (==)

3) Fast Wipe (—)

4) Push the lever downwards for:  
For Flick Wipe  
(spring return):



Hold the lever for continuous wipe. When spring return occurs there will be 4 wipes of wiper and one more wipe after 5 seconds to clean traces of water on windshield.

**5) Front Windshield Washer :**

- Pull the lever little longer, washer fluid will be sprayed on the windshield.
- The windshield wipers operate for 3 cycles after the lever is released and 1 more cycle after 5 seconds.
- When you crank the vehicles engine, the supply to washer motor is momentarily cut off.

**6) Rear Wash and Wipe Rotary Switch :****Rear Windshield Wiper and Washer Switch:**

Turn the rotary knob clockwise and hold it, to operate rear windshield wash and

wipe. It will return to 'OFF' position as soon as released.

**Rear Wipe:**

Turn the rotary knob Counter clockwise such that it aligns its positions with arrow mark to operate rear windshield wash and wipe. It will return to 'Rear Wipe' position as soon as released. Rear wiper will start wiping continuously.

**Rear Windshield Wiper and Washer Switch:**

Turn the rotary knob counter clockwise such that it aligns its positions with arrow mark and hold it, to operate rear windshield wash and wipe. It will return to 'Rear wipe' position as soon as released.

**⚠ WARNING**

If you operate wash and wipe function for more than 15 seconds the controller cuts off the supply to washer motors to avoid overheating.

**FASCIA SWITCHES:**

Fascia switches are provided on the centre console below FATC / HVAC control panel.



1. Reverse Park Assist switch
2. Front fog lamp switch
3. Rear fog lamp switch
4. ECO mode switch
5. SPORT mode switch

**Reverse Park Assist  
(If fitted):**

Refer Vehicle Parking chapter in 'STARTING and DRIVING' section.

**Front Fog Lamps (If fitted):**

Front Fog Lamps are provided on front bumper to provide improved visibility in adverse weather conditions to avoid accidents when visibility is poor.



The front fog lamps can be switched 'ON' with ignition and parking / head lamp is 'ON'.

**Rear Fog Lamp (If fitted) :**

Rear Fog Lamp is provided on rear bumper to provide improved visibility in adverse weather conditions to avoid accidents when visibility is poor.



The rear fog lamp can be switched 'ON' with ignition and headlamp or front fog lamp is 'ON'.

**⚠ WARNING**

The rear fog lamp should only be turned 'ON' if visibility is particularly poor to avoid dazzling to vehicles behind your vehicle.

**ECO mode Switch  
(If fitted):**

Refer DRIVE MODES chapter in 'STARTING and DRIVING' section.

**SPORT mode Switch  
(If fitted):**

Refer DRIVE MODES chapter in 'STARTING and DRIVING' section.



**STEERING WHEEL SWITCHES:  
(LHS) (If fitted):**

**VOLUME** : To increase (+) / decrease (-) volume of music system / radio.



**MUTE / PHONE REJECT** : To reject or hang up a phone call. It is also used to silent the volume of music system / radio.



**SEEK FORWARD / BACKWARD** : To change radio channels.



**SOURCE**: To select the required source in the infotainment (USB,AUX, AM, FM).

**STEERING WHEEL SWITCHES:  
(RHS) (If fitted):**

**PTT / PHONE RECEIVE** : Push to talk (PTT) will enable the infotainment head unit in voice command and reception mode from the user.

This button is also used to accept incoming call when a cell phone is connected via bluetooth.

**NOTE**

*For more information, please refer to the Infotainment Manual provided.*



## INFOTAINMENT SYSTEM: (If fitted)



Infotainment system is provided on the centre console. To operate this system, please refer infotainment manual, which is provided along with the Owner's Manual.

## USB/AUX Port (if fitted) :

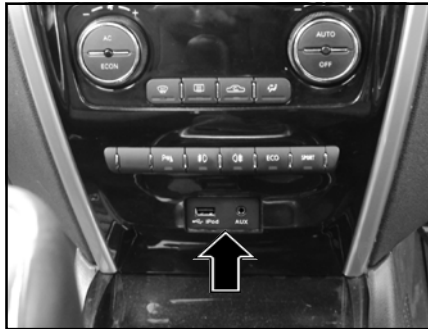

### USB:

External memory devices like memory sticks / Pen Drives, I-Pods can be connected for playing music tracks stored in these devices through the vehicles music system.

### AUX:

Provided to connect Audio input devices for playing music tracks stored in the devices through vehicle's speakers.

## Speakers (if fitted) :

Speakers and tweeters are provided on models with infotainment system. While provisions are given for music system and speakers on models without infotainment system.

## Antenna:

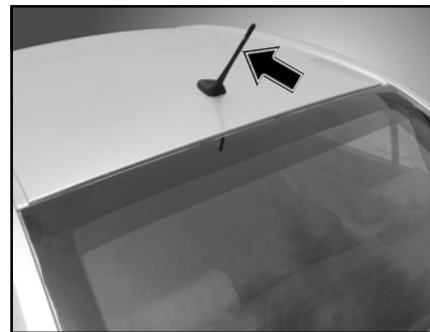

Antenna

Antenna is located on the roof, above the rear windshield glass on selected models. In some models provision is given for fitment.

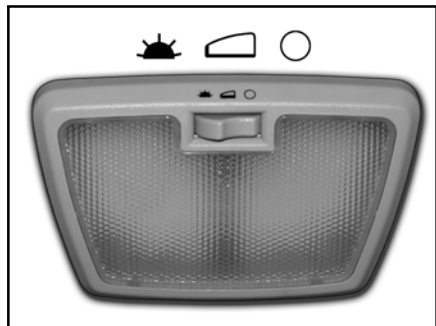
**ROOF LAMP :**

Interior roof lighting lamp is provided on the roof with inbuilt switch.

The central rectangular switch has three positions:

**ON (○)** - The lamp will turn 'ON' as long as the switch is in this position.

**DOOR (☞)** - In this position the lamp turns 'ON' with dimming when either of the doors are opened. When the last door is closed, the lamp will remain 'ON' for 25 sec and turns 'OFF'

with dimming. This helps settling in the seat and inserting the key in the ignition switch. When the key is turned to the 'IGN' position, the lamp goes 'OFF' immediately.

**OFF (☀)** - In this position the lamp will remain 'OFF'.

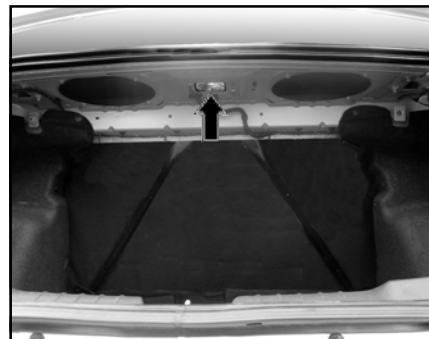
**LUGGAGE COMPARTMENT LAMP : (if fitted)**

Boot lamp is fitted in the luggage compartment to illuminate the luggage area.

It will turn 'ON' when tailgate is opened and turn 'OFF' when closed.

**FRONT STOWAGE COMPARTMENT****A) GLOVE BOX**

The glove box is built into the dashboard, located in front of co-driver seat.

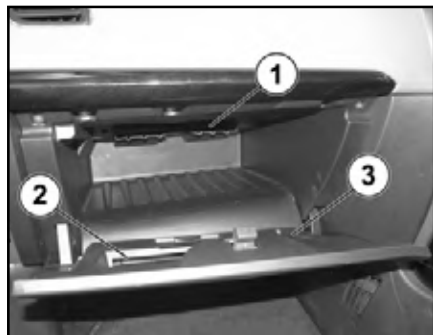

1. Pocket for Owner's Manual
2. Pocket for First Aid Kit
3. Pen Holder

To open, pull the lever outward and open the glove box flap.

To close, push the flap back upwards until it engages.

**B) UTILITY POCKET/BOX**

Front utility pocket / box



Rear utility pocket / box

Utility Pockets are provided on all doors and it can be used to keep magazines/books etc.

**C) CUP HOLDER**

A cup holder is provided on the centre console.



Cup holder

**D) POWER SOCKET****Power Socket for front passengers**

Power Socket is provided on the centre console ahead of the gear shift lever. Power socket can be used to tap 12V (10A) supply for operating external gadgets.

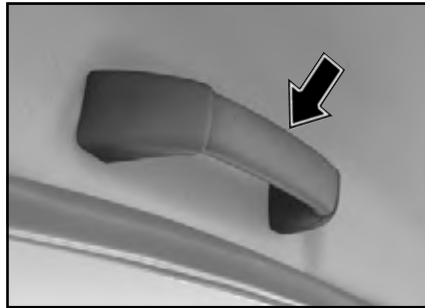
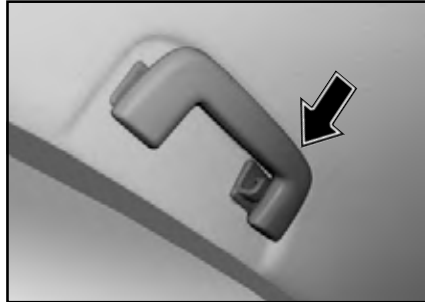
**E) ROOF GRAB HANDLE****Roof Grab Handle (Fixed)****Foldable Roof Grab Handle  
(If applicable)**

These are provided on all seats except driver's seat. This helps in comfortable positioning of passengers during a journey.

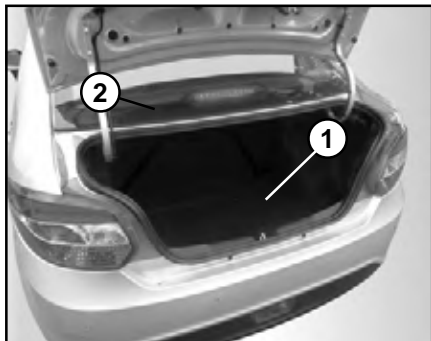
**F) LUGGAGE COMPARTMENT**

1. Luggage Space 2. Luggage Cover

Ample space is provided in the boot of your vehicle.

**G) LUGGAGE COVER :**

Luggage cover is designed only for hiding the luggage compartment.

**⚠ WARNING**

Do not place anything on luggage cover as it could obstruct driver's rear view. Also in case of accident or sudden braking, it could cause an injury to occupants.

**CLIMATE CONTROL**

Climate control regulates the temperature and humidity in the vehicle interior and filters undesirable substances out of the air. It also helps to keep windscreen clear for better visibility. Climate control can only be operated when the engine is running. Optimum operation will be achieved with all doors / windows closed.

**Air distribution :** The incoming air is distributed through the ventilation points in the passenger compartment as shown

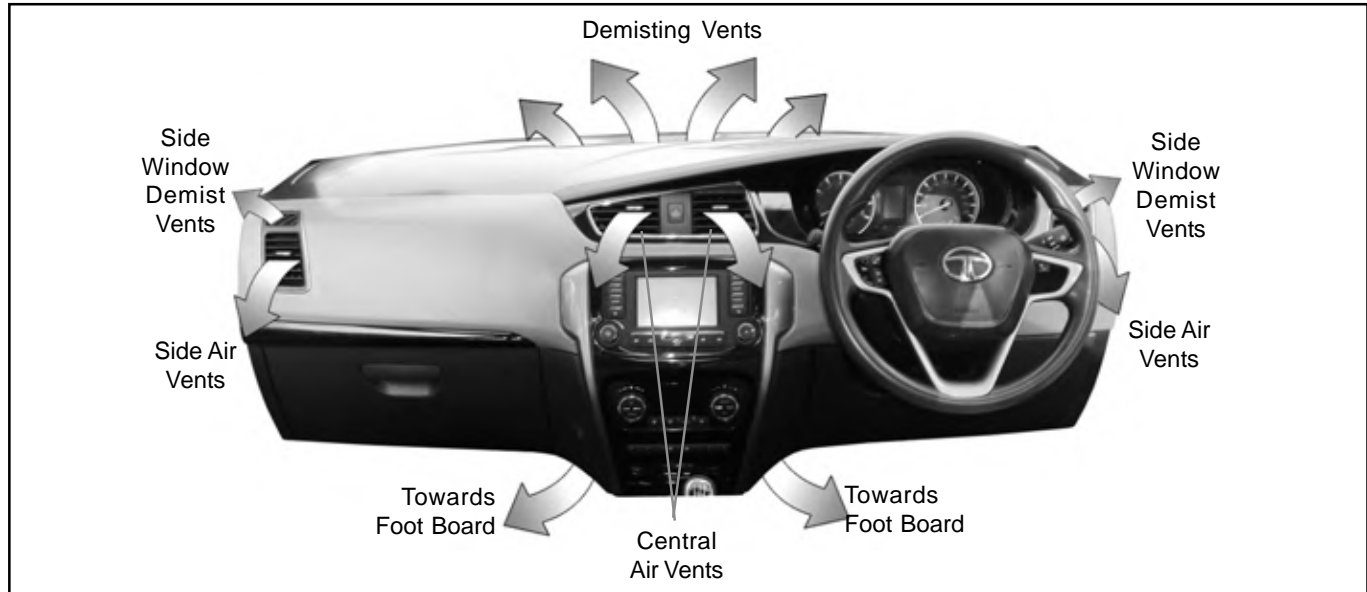

## AIR VENTS &amp; MANUAL HVAC

## AIR VENTS:

Air vents are provided on dashboard. Air flow and its direction can be adjusted with the help of knob provided on respective vent.



Middle air vent



Side air vent

V - Vertical Air Flow  
H - Horizontal Air Flow

## MANUAL HVAC :

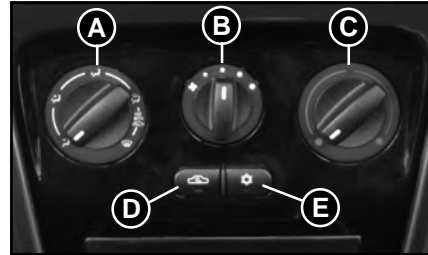

- A. Air Distribution control
- B. Blower Speed Control
- C. Temperature Control
- D. Air Recirculation
- E. AC ON/OFF

## A. Air Distribution Control :



The air flow control knob allows you to select the air flow outlets.

	Air flows from the center and side air vents
	Air flows from the center, side vents and foot well vents
	Air flows from mainly foot well vents
	Air flows from the defroster and foot well vents (always select fresh air mode)
	Air flows from the defroster vents (always select fresh air mode)

## B. Blower Speed control:



The Blower Speed control dial turns the fan ON and OFF, and controls fan speed.

### C. Temperature Control:



The temperature control dial allows you to adjust the temperature of the outlet air. To lower the temperature, turn the dial to the left. To increase the temperature, turn the dial to the right.

### D. Air Recirculation:



### Recirculation mode: Switch 'ON'

 (Indicator light ON): Interior air is re-circulated inside the vehicle.

Always use when :



- Driving on a dusty road.
- On signals or slow traffic to avoid traffic pollution
- Maximum cooling is required.

### Fresh Air mode : Switch 'OFF'

(Indicator light OFF):

Outside air is drawn into the passenger compartment and distributed through the selected outlet.

Always use when:

- Discomfort is felt or windows are fogging up.
- Using  or  air flow modes during demist / defrost.
- Using normal heating mode.

### AC ON/OFF:



Press the  button to turn 'ON' the AC compressor. The indicator light turns 'ON' when the AC compressor is operating.

To turn 'OFF' the AC compressor, push the  button again.

### NOTE







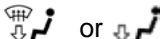

*The AC can be switched 'ON' only if the blower is 'ON' and engine is running.*

When AC is switched ON, engine idling RPM increases marginally to adjust the AC compressor load.

When desired temperature is achieved AC trips OFF automatically.



Recommended basic settings of the control elements of the air conditioning system for the respective operating modes:

FUNCTIONS	CONTROL KNOB POSITION			BUTTON POSITION	
	A. Air Flow Direction	B. Blower Speed	C. Air Temperature	D. Air Recirculation	E. AC ON / OFF
Normal heating	 or 	2 or 3	Desired temp.	Fresh air mode.	Switched OFF
Quick heating		To MAX speed and then 2 or 3	To the right up to the stop	Briefly switch ON to Fresh air mode then Recirculation mode	Switched OFF
Normal Cooling	 or 	1,2 or 3	Desired temperature	Recirculation mode	Switched ON
Quick Cooling	 or 	To MAX speed and then 2 or 3	To the left up to the stop	Recirculation mode	Switched ON
Demisting		2 or 3	Desired temperature	Fresh air mode (Default)	Switched ON (Optional)
Defrosting		4	Desired temperature	Fresh air mode (Default)	Switched ON (Optional)

**⚠ WARNING**

- Never leave children or adults who would normally require the support of others alone in the vehicle.

On hot, sunny days, temperatures in a closed vehicle could quickly become high enough to cause severe or possibly fatal injuries to occupants.

- Do not use the recirculation mode for longer periods as “stale” air may result in fatigue in the driver and occupants, divert your attention and also cause the windows to mist up. Switch to “Fresh” air mode as soon as the windows begin misting up.
- Do not adjust the heating and air conditioning controls while driving so that full attention may be given to vehicle operation.

**NOTE**

- *Condensation starts inside the air conditioning unit when the air conditioner is running, and is safely discharged underneath your vehicle. Traces of water on the ground are therefore normal.*
- *After parking in the sun, drive for 2 or 3 minutes with the windows open to vent hot air from the passenger compartment. Then, close the windows. This allows the air conditioner to cool the interior more quickly.*
- *The air conditioning system should be operated for approx. 10 minutes at least once a month. This helps prevent damage to the system due to lack of lubrication.*

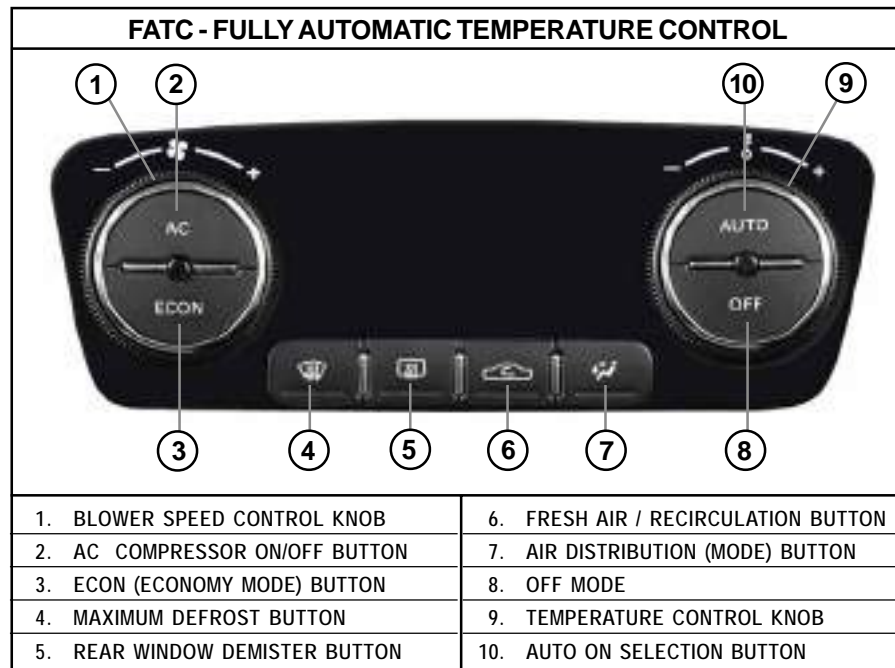
**GENERAL DESCRIPTION :**

FATC system controls the in-cabin Temperature of the vehicle automatically and provides maximum passenger convenience regardless of outside weather conditions.

**NOTE**

*If the display flashes 'ERR' in periodic pattern (Display will show 'ERR' for 5 sec. and set temperature for 30 sec.), It indicates FATC malfunctioning. Switch over to manual mode and contact a **TATA MOTORS** authorized service Centre.*

**DISPLAY UNIT:**

FATC display is shown on main display screen.

FATC functions can be controlled using both the FATC control panel and the touch screen display.

Whenever the user presses any push button or turns the rotary knob, then the display unit will show the relevant Climate Information.



Also, when the display is not in climate mode then climate information will be displayed on the all-time display provide on the bottom bar.

**1. BLOWER SPEED CONTROL KNOB:**

- A. Rotate the knob clockwise to increase the blower speed up to MAX 7 speed, where as anti-clockwise would reduce the speed up to 'SPEED 1'.
- B. In 'AUTO' mode, the FATC system will regulate the blower speed automatically.

## 2. AC COMPRESSOR ON / OFF BUTTON :



Press the AC compressor ON/OFF button to turn the air conditioning ON or OFF. You will see AC text on the display, when AC is ON.

## 3. ECONOMY MODE BUTTON. :



During ECON AC operation, the system automatically cuts off compressor at a higher temperature than normal AC. The operation can be used during mild weather conditions for better fuel efficiency. Comfort level

may be compromised during this operation. By pressing ECON button text will be displayed on display.

## 4. MAX DEFROST BUTTON :



- A. This button directs the main airflow towards windscreen for faster defrosting. (It also overrides any mode selection you may have made.)
- B. When you turn off the button, the system returns to its former settings.

### NOTE

For your safety make sure you have a clear view through all the windows before driving.

## 5. REAR WINDOW DEMISTER BUTTON:



- A. This button turns the rear window demister ON or OFF.

The system will be deactivated after 15 min of continuous operation.

## 6. FRESH AIR / RECIRCULATION BUTTON:



- A. When the recirculation Button or LED is switched 'ON', air from the vehicle's interior is sent through out the system.
- B. When the recirculation button is switched off, air is brought in from outside of the vehicle (fresh mode). Whenever discomfort is felt, switch to fresh air mode.

### NOTE

The out side air intakes for the climate control system are at the base of windscreen. Keep this area clear from leaves and other debris.





The system should be used with recirculation air mode for faster heat up and cool down, however keeping the system in recirculation mode, particularly with AC OFF, can cause the windows fog up.

**NOTE**

It is recommended to run the vehicle in re-circulation mode to avoid clogging of air filter

**7. AIR DISTRIBUTION (MODE) BUTTON :**

- A. In AUTO mode, the FATC system will regulate the mode automatically. However user override is possible with the use of MODE button to select the desired airflow mode. Each time you press the MODE button, the display shows the mode selected.

	Air flows from the center and side air vents
	Air flows from the center, side vents and foot well vents
	Air flows from mainly foot well vents
	Air flows from the defroster and foot well vents (always select fresh air mode)
	Air flows from the defroster vents (always select fresh air mode)

**8. AUTOMATIC OPERATION :**

To put the automatic climate control in fully-automatic mode:

- A. Press the 'AUTO' button.
- B. Set the desired temperature by turning temperature control knob. The display will show all the functions during 'AUTO' mode.
- C. The system automatically selects the proper mix of conditioned and / or heated air that will, as quickly as possible, raise or lower the interior temperature to your preference.
- D. When you set the temperature to its lower limit (Lo) or its upper limit (Hi), the system runs at full cooling or heating only. It doesn't regulate the interior temperature.

**Semi-automatic Operation :**

You can manually select various functions of the climate control system when it is in fully automatic mode. All other features remain automatically controlled. Making any manual selection causes the word 'AUTO' in the display to go OFF and

overridden setting is displayed. System will remain in semiautomatic mode till 'AUTO' is re-pressed.

### 9. TEMPERATURE CONTROL KNOB:



Turning the temperature control knob clockwise increases the temperature of the air. The desired temperature will be increased by steps of 0.5°C. User can select temperature range from 18°C to 30°C. Whereas the anti-clockwise direction decreases the temperature.

When you set the temperature to its lower limit (Lo) or its upper limit (Hi),

the system runs at full cooling or heating only. It doesn't regulate the interior temperature.

### 10. "OFF" BUTTON:



Press the OFF button to switch OFF The system. OFF will be displayed on the display.

### HVAC Sensors :

HVAC system is fitted with three sensors .

1. A solar sensor on top of the dashboard at the right hand side of defroster grill.



2. In-car sensor on control panel.



3. Outside Ambient Temperature (OAT) sensor located under the front bumper grill.

**NOTE**

1. Do not cover or spill any liquid on sensors.
2. Do not cover sensor, this may cause the sensor to malfunction.  
*This may lead to FATC not functioning to desired level.*

**If your vehicle is parked under the sun, you can cool it down fast by following the steps given below :**

- A. Start the engine
- B. Turn on A/C by pressing the button. Make sure the temperature control is set to maximum cool.  
In case of FATC set temperature to 'Low' mode.
- C. Set the fan to maximum speed. (for ETC ,manual HVAC variants)
- D. Open windows half , set air direction towards face and fresh air mode.

- E. When the interior has cooled down to a more comfortable level, close windows and set the controls as required in normal cooling, with recirculation mode ON.



## PRE-DRIVING CHECKS:

CHECK
1. Tyre pressure and condition of tyres.
2. Coolant level.
3. Engine oil level.
4. Brake fluid level.
5. Water in windshield washer reservoir.
6. Battery electrolyte level.
7. Ensure sufficient Fuel.
ADJUST
1. Adjust your seat position.
2. Check adjustment of all rear view mirrors.
3. Check and adjust steering angle.

ENSURE
1. Bonnet is properly closed and locked.
2. All doors are properly closed and locked.
3. Check that the items you may be carrying inside with you are stored properly or fastened securely
4. Seat belts are fastened.
5. All mirrors, windows and outside lights are clean and viewable.
6. All switches and lamps are working.
7. All the gauges and indicators in the instrument cluster are working.
8. Gear shift lever is in neutral position.

VEHICLE STARTING
1. Vehicle starting function is controlled by EMS ECU & it requires “gear in Neutral” and “fully pressed clutch pedal”. These interlocks are included to avoid unintended vehicle movement during cranking as a safety measure.
2. <b>(Revotron engine)</b> Only in case of clutch switch failure, vehicle can be started by pressing “Brake pedal”. The “Check Engine lamp” will lit after 3 driving cycles, to indicate failure of clutch switch. Contact a <b>TATA MOTORS</b> authorised service centre immediately. <b>(Quadrajjet engine)</b> The “Check Engine lamp” will lit after 3 driving cycles, to indicate failure of clutch switch. Contact a <b>TATA MOTORS</b> authorised service centre immediately.

## SAFETY CHECKS

### Windshield/wiper/windshield washer

Always keep windshield glass clean to avoid any distortion in visibility. Ensure proper working of wipers and condition of wiper blade. Ensure that windshield washer reservoir is full. Do not operate wiper alone when the windshield glass is dry, this would damage the windshield and wiper blades.

### Headlights

Keep headlight lenses clean. Check for operation of headlamps in both high/low beam condition. Check for correct focusing of headlamps. Use only recommended type of bulbs. Do not use the high beam unless it is necessary, as its dazzle may blind the driver of an oncoming vehicle, thus causing an accident.

### Side indicators / Hazard warning

Ensure that all side indicators/hazard warning lights are always in working condition and they are used when required.

### Horn

Ensure the horn is working properly. Horn provides safety to other road users by alerting your presence.

### Brakes

Ensure brakes are working properly. Check brake fluid level in reservoir. Do not drive the vehicle when brake warning lamp is 'ON'.

### Tyres

Check the condition of tyres for abnormal wear. Maintain correct tyre pressure, it is very important particularly when subjected to extreme conditions, such as high speed, high load and high outside temperature. Do not use worn or bald tyres, especially on the front wheels.

### First Aid Kit

A first aid kit is provided in your vehicle. This is for use in case of minor injuries. It should be regularly checked and updated.

### Documents

Always carry vehicle registration papers, insurance, valid PUC certificate and driving licence with you.

## FUEL SAVING TIPS

**FUEL SAVING TIPS :**

Your vehicle's fuel economy is mainly dependent on your style of driving.

To operate your vehicle as economically as possible, use the following driving suggestions.

**Avoid Excessive Idling :**

Stop the engine and start it again, if you have to wait for more than a minute. e.g. at traffic signals.

**Avoid fast starts and unnecessary stops :**

Start off slowly from traffic lights or stop signs to prevent increased fuel consumption and shortening of engine life. Avoid unnecessary deceleration (stopping or slowing down) and then acceleration which uses more fuel.

**Gear shifting :**

Always follow the gear shifting recommendations provided on instrument cluster for selected models.

**Always maintain clean air-filter:**

The amount of air supplied will reduce due to clogged air-filter, resulting in wastage of fuel due to incomplete combustion.

**Avoid incorrect tyre pressure :**

Under-inflated tyres result in increased running resistance of the tyres, leading to wastage of fuel.

(Refer tyre maintenance section)

**Proper Driving Practices :**

Keep a safe distance from other vehicles to avoid braking suddenly.

**NOTE**

*Do not rest your foot on the clutch pedal. It does not allow full engine power to be transmitted to the vehicle and reduces clutch life.*

**Fuel economy speeds :****QUADRAJET :**

Gear	Speed (kmph)
1st	15
2nd	25
3rd	35
4th	50
5th	70

**REVOTRON 1.2T :**

Gear	Speed (kmph)
1st	15
2nd	25
3rd	40
4th	55
5th	70

**GOOD DRIVING PRACTICES:**

- Gear shifting should be gradual according to varying speeds. Avoid rapid acceleration and prolonged high speed running of the engine while using the new vehicle for the first 1500-1800 km of operation.
- Slow down before shifting to a lower gear. This will help for avoiding revving of the engine causing damage.
- Avoid frequent brake application which can cause overheating of brakes.
- Slow the vehicle speed while travelling in cross winds. This gives much better control over the vehicle.
- Avoid high speed when cornering or turning.
- Make sure that vehicle is completely stationary before you attempt to shift in reverse gear. This will avoid damage to the transaxle.
- Drive slowly on wet roads.

When the vehicle leaves the roadway, do not steer sharply. Slow down slightly before pulling back into the travel lanes.

**RUNNING-IN PERIOD :**

Avoid rapid acceleration and prolonged high speed running of the engine while using the new vehicle for the first 1500-1800 km of operation.

Do not exceed the following road speeds during running in period.

Gear	Quadrajel	Revotron
	Speed (kmph)	Speed (kmph)
1st	20	20
2nd	30	40
3rd	50	60
4th	70	80
5th	80	100

Before you shift to reverse gear, bring your vehicle to a complete stop and depress the clutch pedal fully.

Do not shift into reverse gear when the vehicle is moving forward.

While shifting the gears, it is recommended to shift at the speeds given in the table.

You can get extra braking from the engine when slowing down by shifting to a lower gear.

This can help you to maintain a safe speed and prevent your brakes from overheating while going down a steep hill.

**NOTE**

*Avoid excessive revving up of engine rpm.*

*Idling the engine for long duration must be avoided.*

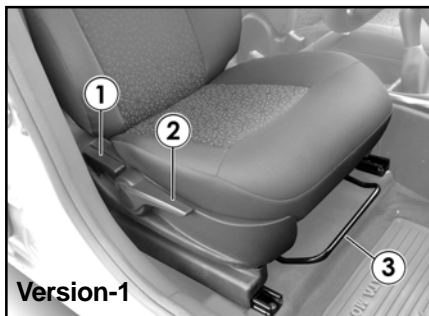
**FRONT SEAT ADJUSTMENTS:**

1. Seat Back Recliner Lever
2. Height Adjustment Lever (if fitted)
3. Lever for Forward and Backward movement

**1. Seat Recliner :**

To change the seat back rest angle, lean forward slightly and pull up the recliner (upper) lever. Relieve pressure on the seat backrest until it reaches desired comfortable position. Make sure that lever returns to its original position.

**2. Height Adjustment (if fitted) :**

The seat height adjuster (lower) lever is located on the outboard side of the seat. To raise the seat, pull and continue pumping the lever in the upward direction until the seat is at the desired height. To lower the seat, pump the lever downward until the seat is at desired height.



**3. Seat Slide :**

To adjust the driver /co-driver seat forward or backward, pull the lift bar beneath the seat upwards and exert slight body pressure to adjust the seat in the desired direction. Release the lift bar to lock the position. Ensure the

seat locking by deliberate movement of your body in the seated condition in forward and backward direction.

**Adjustable Head restraint (if fitted):**

Adjustable head restraints are provided to increase the height and fix at a desired comfortable position. To reduce the height press release button to move downwards. Make sure that the top of restraint is at the same height as the top of the occupants head. This position reduces the chances of a neck injury in a crash.

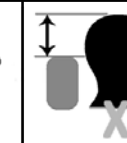
		
<b>CORRECTLY ADJUSTED</b>	<b>INCORRECTLY ADJUSTED</b>	<b>INCORRECTLY ADJUSTED</b>
The head restraint is at the correct height and close enough to the back of the head to help prevent injury.	The head restraint is at the correct height but not close enough to the back of the head.	The head restraint is at the wrong height and also not close enough to the back of the head.

**⚠ WARNING**

Avoid driving the vehicle with the head restraint removed as it is also a safety element. Do not attempt to adjust the head-restraint while driving the vehicle.

To avoid possible loss of vehicle control, all seat, head restraint, steering wheel and rear view mirror adjustments, as well as fastening of seat belts, must be done before setting the vehicle in motion.

**REAR SEAT :**

A bench type fixed seat is provided for rear passengers.

**REAR VIEW MIRRORS:****Inside Rear View Mirrors (IRVM) :****Mirror Adjustment Knob**

An antiglare mirror is fitted inside the vehicle. You can select two positions by operating the knob:

1. Normal position
2. Antiglare position

Use antiglare position only when necessary, as it reduces rear view clarity.

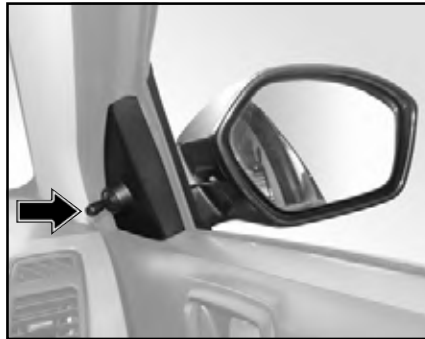
**Outer Rear View Mirror :****Outer Rear View Mirror  
(Manual Adjustment)**

The rear view mirror is fitted on the door from outside and can be adjusted by the lever provided inside the door. The mirrors are provided on both the doors.

**Motorised Outer Rear View Mirrors:  
(If provided)****Operating knob**

Your vehicle is equipped with motorized outer rear view mirrors fitted on both front doors and can be adjusted to the desired position with the help of a switch / knob mounted on the driver's side along with the window winding switches.

Using this switch / knob, the driver can adjust the vehicle's outer rear view mirrors without lowering the glasses and shifting from his / her position.

### Steps to operate the Rear View Mirrors:

1. Rotate the main switch to the left 'dot' to adjust the left side rear view mirror and to the right 'dot' to adjust the right side rear view mirror.
2. Use the 4 positions of the knob (marked by a triangle) to adjust the rear view mirrors to correct angles.

### SUN VISORS:

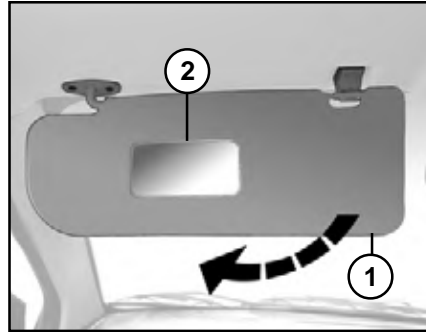

1. Sun visor (Co-driver side)  
2. Vanity Mirror

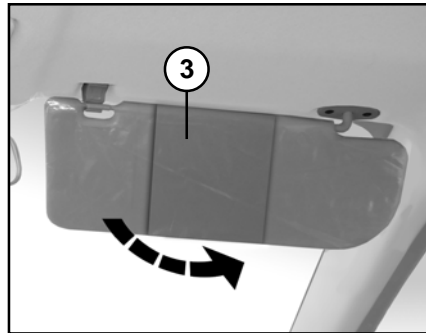

3. Sun visor Pocket (Driver Side)

Two adjustable sun visors are provided inside the cab above the windshield to prevent sun glare. Lower the sun visors to protect the eyes from bright sunlight. The sun visors can also be moved sideways towards door window.

A vanity Mirror has been provided on the back of the Co-driver's sun visor.

Pocket has been provided for keeping documents.

### NOTE

*When not in use, keep the sunvisors in their original position or else, they may block driver's vision.*



## STEERING WHEEL ANGLE ADJUSTMENT :



Steering Angle Adjustment Lever

You can adjust the steering wheel angle position to suit your convenience.

Adjust the steering wheel position as follows before you start driving.

1. Adjust the seat to a comfortable position.
2. To adjust steering wheel position, push down the tilt lever as shown in fig to unlock steering column.

3. Move the steering wheel up or down to the desired position.
4. Lock tilt lever by pulling it up to the lock position. Make sure that steering wheel is securely locked by checking up and down direction.

### NOTE

*Steering wheel should be adjusted only when the vehicle is stationary.*

## PREPARING TO DRIVE:

- Release the parking brake. Ensure the gear is in Neutral position.
- Check that all items that you may be carrying inside are fully secured.
- Ensure that all doors are locked properly.
- Check & adjust seat.
- Fasten seat belt properly.
- Ensure that all gauges and indicators lights are working.
- Check for blind areas being unobstructed in front and rear of the vehicle.
- Before driving off check in the rear view mirror, for approaching traffic.
- Switch on side indicator signal when getting into main stream of traffic.

### STEERING LOCK CUM IGNITION SWITCH :

Key of ignition switch is common for door lock and steering lock .

The ignition switch is on the right side of the steering column. It has four positions. Turn the key clockwise for further functions.

#### Illuminated Key Ring (If fitted) :

To assist you to locate your vehicle's ignition switch in the dark, the steering lock cum ignition switch comes with an illuminated key ring. When the vehicle is unlocked, the illuminated key ring activates.



1. **LOCK** - Steering Locked.  
'KEY IN / OUT' condition.
2. **ACC** - Steering Column Unlock
3. **IGN** - All electrical 'ON'
4. **START** - Engine Crank

1. **LOCK:** The steering column is locked when the key is removed. You can insert or remove the key only in this position.

2. **ACC:** Steering column is unlocked when the key moved from lock to ACC position and activates electrical accessories.

3. **IGN:** All electricals and accessories are switched ON.

4. **START:** Press the clutch pedal fully and turn the key further clockwise to the START position, (spring loaded) to start the engine. As soon as the engine starts, release the ignition key, which returns to ON position. While cranking, all accessories will be momentarily 'OFF'.

#### NOTE

*The Starter Protection System fitted in this vehicle does not allow you to crank the engine until you fully press the clutch pedal.*

Keep the clutch pedal fully pressed and crank the engine, if the engine cranks but fails to start then repeat the above procedure. Release the key as soon as the engine starts.

Ensure that the "MIL" lamp is "OFF". Do not press the accelerator pedal.

**NOTE**

*The Starter Protection System switches off the starter when it is cranked for more than 10 secs. In such a case, get the key back to 'OFF' position & wait for 30 secs.*

**⚠ WARNING**

Running the engine in confined areas is extremely dangerous. The engine consumes oxygen and produces carbon monoxide which is highly toxic and lethal gas.

**NOTE**

*After starting, run the engine in idle speed for atleast 30 sec. Do not press accelerator pedal while starting the engine to avoid damage to the turbocharger.*

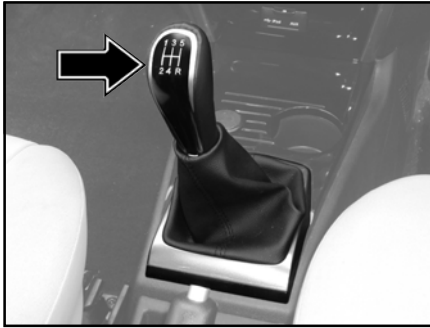
**GEAR LEVER AND SHIFTING:**

The gearshift lever is mounted on the center console between the two front seats. The gearshift pattern is as shown on the gear lever knob. Application of Gear shifting should always be done with clutch pedal pressed.

**NOTE**

*The reverse gear should be engaged only when the vehicle is stationary. Wait for 5 seconds after declutching to ensure smooth engagement of the reverse gear.*

**Current Gear Indication:**

The Driver Information display (DIS) in the Instrument Cluster indicates the current gear position engaged. Up or down arrow will be displayed, recommending whenever gear should be shifted to up or down.

**Gear Recommendation:**

Up or down arrow will be displayed in DIS, recommending whenever gear should be shifted to up or down.

**NOTE**

*If "F" is displayed in DIS of instrument cluster it means 'Fault' condition. Contact a **TATA MOTORS** Authorized Service Centre immediately.*

## GEAR LEVER &amp; SHIFTING (AMT)

**AUTOMATED MANUAL TRANSMISSION (AMT) : (If applicable)**

The 5-speed Automated Manual Transmission (AMT) Gearbox offers a choice of two driving modes:

1. **Automated mode** with the gear lever in position 'A'.
2. **Manual mode** with the gear lever in position 'M'.

**Starting & Driving:**

- a. To start the engine, the gearshift lever has to be in position 'N'.

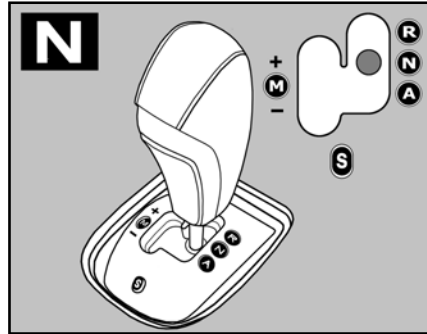

- b. Fully depress the brake pedal.
- c. Turn the Ignition 'ON' and crank the engine.
- d. With the engine running and brake pedal pressed, depending on your requirement shift the lever on **R, A or M**.
- e. Check the position engaged on the Instrument Cluster display.

- f. Release the brake pedal and accelerate.

**NOTE**

*The engine can only be started when the gearshift lever is in 'N' position with the brake pedal firmly pressed.*

**NOTE**

*If 'F' is displayed on the Instrument Cluster display, it means '**Fault**' condition. Contact a **TATA MOTORS** Authorized Service Centre immediately.*

**Driving Modes:****Neutral:**

Vehicle is in neutral gear position. This will be indicated in instrument cluster.

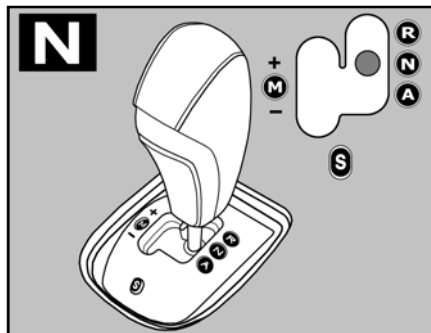
**WARNING**

Always make sure to place the gear-shift lever in the “N” position, when the engine is running and vehicle is stationary.

Do not shift the lever in “N” position, even momentarily, when the vehicle is in motion.

**Reverse:**

It engages in reverse gear only when vehicle is stationary and brake pedal pressed. An audio signal indicates when reverse gear is engaged. ‘R’ will be indicated in instrument cluster.

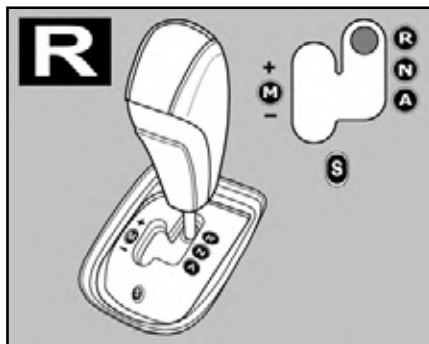
**Automatic Mode:**

Gear Upshift and Downshift will be done automatically while driving.

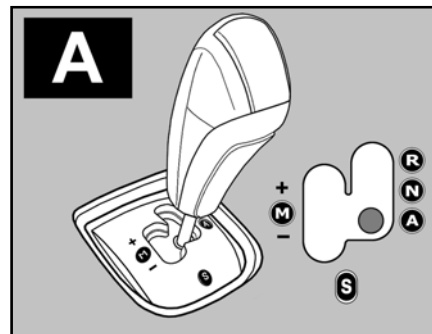

## GEAR LEVER &amp; SHIFTING (AMT)

**Manual Mode:**

Driver should select the desired gear by shifting lever to,

+ : Upshift the gears.

- : Downshift the gears.

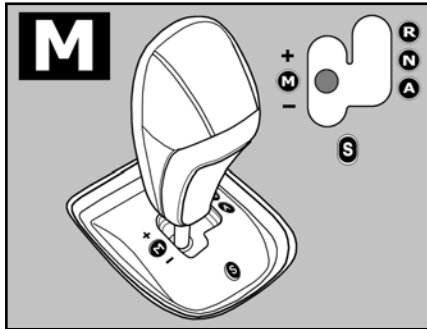

Push the gearshift lever to the '+' direction and release it. Every time the lever is operated, upshifting takes place 1 step in the order of 1st → 2nd → 3rd → 4th → 5th gear.

Pull the gearshift lever to the '-' direction and release it. Every time the lever is operated, downshifting takes

place in the order 5th → 4th → 3rd → 2nd → 1st gear.

In manual mode, gears are not shifted automatically unless the engine RPM threshold is reached.

**Drive Mode:**

Two drive modes 'ECO' and 'SPORT' are provided. These modes can be used to adjust engine characteristics and vehicle performance inline with desired requirement.

To activate, Press 'S' button situated on the gear lever grille.

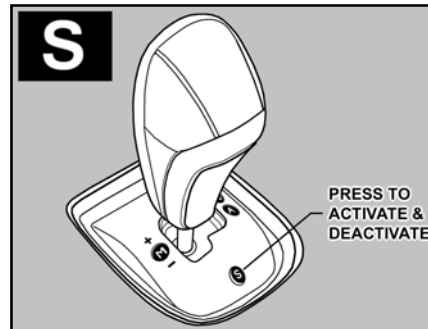

'SPORT' mode activation will be displayed on instrument cluster otherwise 'ECO' mode will be displayed.

It can be activated only in automatic mode.

To deactivate press the 'S' button again.

**Stopping:**

The vehicle can be stopped by depressing the brake pedal regardless of the gear position. This is because the clutch is automatically disengaged to prevent the engine from stopping.

If the gearshift lever is in the 'A' position, the gear will be downshifted to 1st when the vehicle stops.

If the gearshift lever is in the 'M' position, the gear will be downshifted to 1st when the vehicle stops.

**Parking:**

AMT does not have a parking position. The vehicle can be parked with the gearshift lever in any position.

1. Apply the parking brake firmly.
2. While depressing the brake pedal, shift the gearshift lever to the 'R' position on a downhill slope, or to the drive (A) mode or the 'M' position in the manual (M) mode on an uphill slope or flat road and confirm the gear position by checking the gear position indicator on instrument cluster.
3. Stop the engine.

**DRIVE MODES: (Applicable for Revotron 1.2T) :**

Three drive modes 'ECO', 'CITY' and 'SPORT' are provided. These modes can be used to adjust engine characteristics and vehicle performance inline with desired requirement.

Drive mode selection switches are provided on dashboard fascia to activate the programs. Selected drive mode will be displayed on instrument cluster.

**NOTE**



*Default mode is 'CITY' and will not be displayed.*

*Select the desired mode as per driving feasibility.*



**Drive Mode Switches**



Drive Mode	Desired performance	Switches
<b>ECO</b> (As applicable)	Optimum engine Torque and Power output for FUEL EFFICIENT performance.	
<b>CITY</b> (default) (As applicable)	Increased engine Torque and Power output for BALANCED performance.	
<b>SPORT</b> (As applicable)	Max engine Torque and Power output for SPORTY performance.	

**BRAKES & BRAKING:**

The brake system on your vehicle is an advanced dual circuit, diagonal split vacuum assisted hydraulic brake system.

**⚠ WARNING**

Never use the brake pedal as a footrest. Never depress the brake pedal and the accelerator pedal at the same time.

**Water on brake discs and brake pads affects braking:**

Driving in rain and slush or in a vehicle wash can cause water to collect on the brake discs and pads. This will cause a delay in braking effect when the pedal is pressed. To avoid such a delay when the brakes are needed, depress the pedal occasionally when driving through rain, slush etc.

This will remove the water from the brakes. Check that brake application feels normal. This should also be done

after washing or starting in very damp or cold weather.

**Severe strain on the brake system:**

The brakes will be subject to severe strain when driving in mountains or hilly areas, or when towing. Vehicle speed is usually slower, which means that the cooling of the brakes is less efficient than when driving on level roads. To reduce the strain on the brakes, shift into a lower gear and let the engine help with the braking. Do not forget that, if you are towing, the brakes will be subjected to a greater than normal load.

**⚠ WARNING**

If you shift gear down on a slippery road surface in an attempt to increase the engine's braking effect, the wheels could lose their grip. This may lead to increased danger of skidding and accidents. Do not shift down for additional engine braking on a slippery road surface.

**STOPPING THE ENGINE:**

Before switching off the engine, run the engine in idle condition for at least 30 seconds and then switch off. This will allow the engine oil to lubricate the turbocharger, till its speed is fully reduced and also allow the unit to cool down.

**⚠ WARNING**

A quick burst on the accelerator before turning off the engine serves absolutely no practical purpose, it wastes fuel and is damaging especially to turbocharged engine.

The above precautions will ensure satisfactory life and performance from the turbocharger, till its speed is fully reduced and also allow the unit to cool down.

**⚠ WARNING**

Do not switch the engine off when it is running at high speed. If you do, the turbocharger will continue running after the engine oil pressure

has dropped to zero. This will lead to premature turbocharger bearing wear.

**NOTE**

*If the engine fails to start, try to restart the engine after few minutes. Continuous cranking will cause damage to the starter motor. If the engine fails to start, Contact **TATA MOTORS** Authorized Service Centre.*

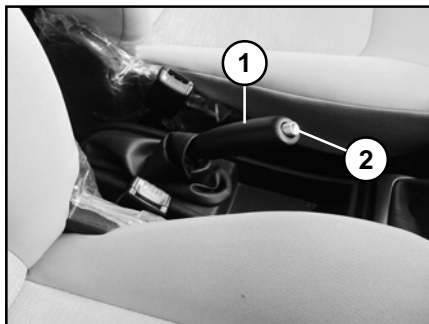
**PARKING BRAKE:**

1. Parking Brake Lever
2. Release Button

Mechanical parking brake acting only on the rear wheels is provided on the vehicle. The parking brake lever is located behind the gearshift lever. To apply the parking brake, pull the lever up fully. The parking brakes tell tale illuminates on the instrument cluster. To release it, pull the lever up slightly, press the release button and push the lever down. Parking brakes tell tale on the instrument cluster will go 'OFF' when the lever is fully released.

**NOTE**

Apply the parking brake properly before leaving the vehicle and release it before moving.

**VEHICLE PARKING:**

- Park the vehicle in a safe place. Switch on the indicator signal before turning to park.
- Apply the parking brake.
- Ensure that all window glasses are closed and all lamps are turned 'OFF'.
- At night, put on the parking lights if required.
- Remove the key from the ignition switch.
- Place wheel chocks at the wheels if parked on a slope.

**NOTE**

*When parking on a downhill gradient, place the gear lever in 'Reverse' position. While parking on uphill gradient, place the gear lever in the '1st' position.*

**REVERSE PARK ASSIST : (if fitted)**

Reverse Park Assist system is an electronic parking aid that will assist you to park your vehicle safely when in reverse gear mode. It provides audio and visual information through the vehicles infotainment system.



There are 4 ultrasonic sensors placed on the rear bumper of the vehicle. Once the system is activated, the sensors will detect the proximity of an obstacle approximately 0 cm to 150 cm from the bumper, and this information would be displayed on the vehicles infotainment system.

Distance range from Bumper (in cm)	Visual Information	Audible Information
0-50	Red Zone	Continuous beep
51-100	Yellow Zone	Fast beep
101-150	Green Zone	Slow beep

**⚠ WARNING**

0-25cm obstacle detection performance is not guaranteed due to ultrasonic sensor technology limitation.

**Operation :**

Activation- There are 3 ways to activate the reverse guidance system.

**1. Reverse gear:**

Park assist feature will automatically start functioning once you engage reverse gear.

**2. Reverse Park Assist Switch :**

By pressing the 'Reverse Park Assist Switch' on the fascia, the feature gets activated. Once activated yellow LED will glow until the feature is deactivated.

**LED Indications:**

- On start of ignition, if the LED turns 'ON' for a second, then Reverse Park Assist system is healthy.
- On start of ignition, if the LED turns 'ON' and 'OFF' 10 times, then Reverse Park Assist system is unhealthy. Contact your nearest **TATA MOTORS** authorised service centre to resolve the problem.

**3. Infotainment music system touch display:**

**Go to "Set Up -> Vehicle Setup -> Park Assist -> Enable Park Assist"**

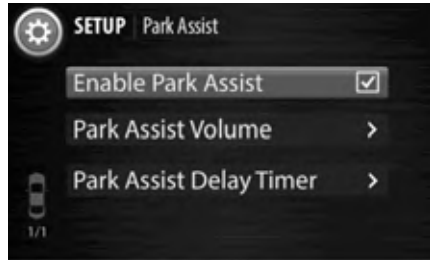

The reverse park assist system is integrated with your vehicle's infotainment system. Please refer the Infotainment manual for instructions on Park Assist settings.

**Deactivation :** Following table indicates the deactivation methods of Reverse Park Assist System.

		You can deactivate by		
		Reverse Gear	Park Assist	Music System Button user interface X button
If you activate by	Reverse Gear	✓	✓	✓
	Park Assist Switch	✗	✓	✓
	Music System user interface	✗	✓	✓

#### NOTE

*Turning the ignition 'OFF' while the Park assist feature is running would disable the feature.*

If you turn 'ON' the ignition in reverse gear mode, Reverse park assist feature will start automatically.

There is no way to permanently disable Reverse park assist feature in the vehicle.

#### Park Assist Indications:

In case of Reverse park assist system malfunctions, the following screens may appear on the infotainment system.

#### Critical Fault



Reason for this fault may be

- Park assist control failure
- Sensor Malfunction
- Partner components such as Infotainment music system, Instrument Cluster or Body Control Module failure

### WARNINGS



Reasons for this fault may be

- Vehicle speed too high for Reverse Park Assist system to function.
- If the system is affected by any surrounding ultrasonic sound.

### REVERSE PARK ASSIST LIMITATIONS:

Reverse Park Assist system is not a collision avoiding system. It is solely the driver's responsibility to park the vehicle safely.

Reverse Park Assist feature works on ultra sound echo technology, due to which performance is not guaranteed in following scenarios :

- If the object has a sharp edge surface, where surface may divert echoes from sensor reception.
- If object is mesh fence made up of thin wires, where echoes can't be given by the surface.
- Fast moving objects passes in the sensor field of detection, where echoes are not processed by the system.
- If object is made/covered by foam or sponge or snow where ultrasonic sound signals are absorbed.

Objects close to the rear bumper can go undetected by the Reverse Park Assist field of detection. Driver should use extreme caution while parking the vehicle.

### ⚠ WARNING

Due to any reason, if the sensor gets misaligned or loses its intended fitment position, contact your dealer for re fitment

### Reverse Park Assist System Preventive maintenance:

- Regularly clean the sensors and keep them free from dust, ice, mud, water, chewing gum etc. for proper working of the system. Use a smooth cloth for cleaning.
- Do not use water at high pressure for cleaning the sensor.
- Do not cover the sensor surface with any additional fitment. This will degrade park assist performance.

## HAZARD WARNING SWITCH

**HAZARD WARNING SWITCH :**

When the situation is under control switch off the hazard warning indicator.

In case of a break-down at night, use hazard warning indicators. Try to park the vehicle on the side of the road to avoid collision with or inconvenience for others.

While driving in emergency or under adverse conditions, it is advisable to switch 'ON' Hazard warning indicators.

Hazard warning switch remains functional even while ignition switch is in OFF condition.

**EMERGENCY EQUIPMENTS :****NOTE**

*You should be familiar with the location of the emergency equipments provided in the vehicle and how to use it.*

*Check all the emergency equipments periodically and ensure that it is in proper working condition and is in its place.*

**FIRST AID KIT :**

The first aid kit is kept inside the glove box compartment.

The kit contains items that can be used in case of minor injuries only.

**NOTE**

*Check contents of the kit periodically and replenish consumed or expired items.*

**ADVANCE WARNING TRIANGLE :**

An advance warning triangle is kept in the luggage compartment.

- Remove the advance warning triangle from the bag and assemble. Refer instructions given on the bag.
- Place the triangle on the road at least 50M behind the vehicle.
- Distance between triangle and the vehicle must be at least 50 meters in the same lane of traffic.

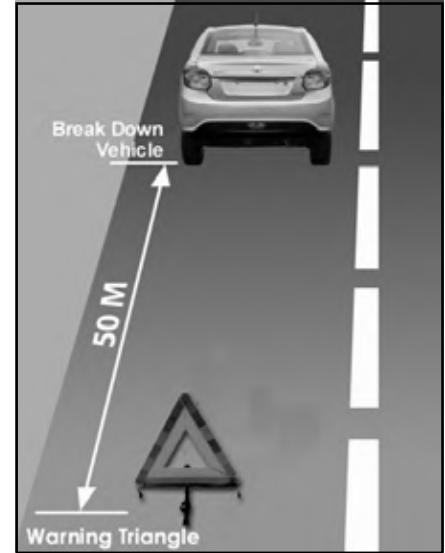

- Increase the distance to 150 meters if stranded on a highway or if the vehicle view is obscured.

**NOTE**

*Tie the warning triangle with the strap firmly and keep it inside the bag to avoid rattling noise.*



**TOOL KIT :**

A tool kit is kept in luggage compartment at LH side.

**NOTE**

*The tool kit should be properly secured after usage.*

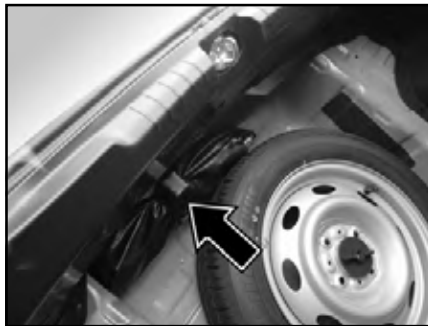
**JACK AND HANDLE :**

A scissors jack with handle is kept inside the luggage compartment and mounted on the trunk lid outer sill panel.

**FLAT TYRE REPLACEMENT :**

In case of a flat tyre, reduce vehicle speed gradually, keeping it in a straight line. Move cautiously off the road to a safe place away from traffic.

Park the vehicle on a level and firm ground. Apply parking brake and engage 1st gear. Turn on Hazard warning switch. Keep advance-warning triangles at suitable distance behind the vehicle as an indication of breakdown. Take out the tool kit, jack and handle from the vehicle.

**SPARE WHEEL :**

1. Spare Wheel 2. Retaining Bolt

Spare wheel is located in the luggage compartment.

To access the spare wheel open the tail gate, fold lift and hook up the floor cover.

To remove the spare wheel, unscrew and remove retaining bolt, which is provided to hold the spare wheel. Lift and take out the spare wheel.

**CHANGING FLAT TYRE:**

- Slacken but do not remove the wheel nuts using wheel spanner provided in tool kit before raising the vehicle.



- Set the jack properly at correct jacking point as shown for front or rear wheel. The jacking points are indicated on the vehicle ( Refer jacking point location ). Slowly lift the vehicle with the help of a jack handle.

## Front jacking point

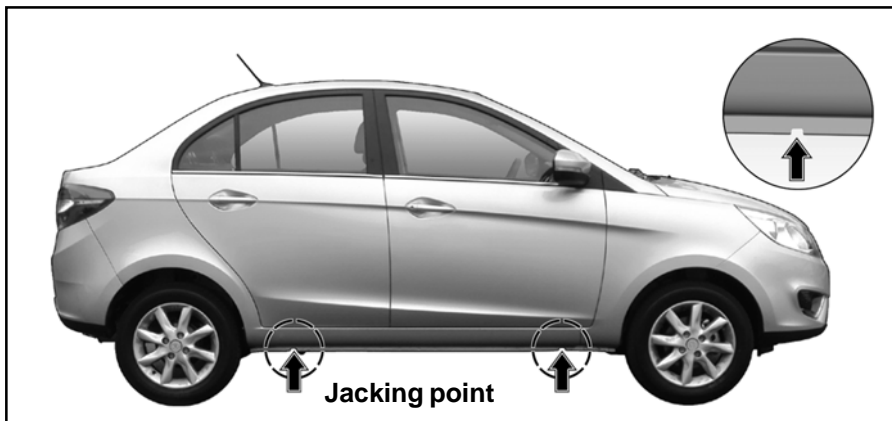

## Rear jacking point

**NOTE**

- *Make sure the jack is positioned firmly on a level surface and correct jacking point.*
- *Never work under a raised vehicle that is supported only by a jack. This may cause an injury.*
- *If required to change the wheel on slope, then block the wheel.*
- *Do not use oil or grease on studs or nuts, which may cause the breakage and slip of the wheel stud.*
- *Do not start or run the vehicle while supported by a jack.*
- Remove wheel-mounting nuts and take out flat tyre.
- Roll the spare wheel into position and align the holes in the wheel studs.
- Then reinstall the wheel nuts. Engage threads properly by hand and tighten it firmly by wheel spanner.

**NOTE**

- *Before using the jack, please read the instructions on the sticker provided on the jack.*
- *Lower the jack completely then tighten the wheel nuts one by one using wheel spanner.*
- *Press fit the wheel cover back (if fitted).*
- *Restore all the tools and jack at their respective location.*
- *Place the flat tyre at spare wheel location as described.*

**NOTE**

*Check and correct the tyre pressure and nut tightness of the changed wheel at nearest service station. Get the flat tyre repaired at the earliest.*

## JUMP LEAD STARTING

**JUMP LEAD STARTING :**

The engine with a discharged battery may be started by transferring electrical power from a battery in another vehicle.

**⚠ WARNING**

Any deviation from the following instructions could lead to personal injury resulting from any battery explosion, as well as damage to the electrical systems in both vehicle.

Do not allow battery electrolyte to come in contact with eyes, skin, fabrics or painted surfaces. The fluid contains sulphuric acid which can cause injury and severe damage. Wear rubber gloves, to avoid risk of contact.

To lessen the risk of injury, wear eye protection when working near any battery.

- Make sure that the battery providing the jump start has the same rated voltage as the battery in your vehicle (12 V). Its capacity must be approximately the same as the original battery capacity. The rated voltage and capacity are given on the batteries.
- Do not disconnect the discharged battery from the vehicle.
- Switch off all unnecessary electrical loads.
- Do not lean over the battery during jump starting.
- Do not allow the terminals of one lead to touch those of the other lead.
- Apply the hand brake. Keep the gearshift lever in neutral.
- Do not connect the lead to the negative terminal of the discharged battery.
- The connection of the -ve lead point should be as far as away from the discharged battery as possible and close to the starter motor.
- Route the leads so that they cannot get caught by the rotating parts in the engine compartment.
- The engine of the vehicle providing the jump start can be allowed to run during starting.

Attempts to start the engine of the vehicle with the discharged battery should be made at intervals of one minute and should not last more than 15 seconds. After starting, allow both engines to idle for approximately 3 minutes with the leads still connected.

Following order should be followed while connecting battery leads :

1. Positive (+) of Good battery to Positive (+) of discharged battery.
2. Negative (-) of Good battery to a solid metal patch attached to engine block OR unpainted metal (Engine) part which is away from the discharged battery on the vehicle to be started.
3. Crank and start the engine.
4. While disconnecting follow reverse order i.e. disconnect Negative (-) lead followed by Positive (+) lead.

#### NOTE

*Do not connect negative ( - ) terminal if jump start battery (Good battery) to the negative ( - ) terminal of discharged battery. This may lead to an explosion.*

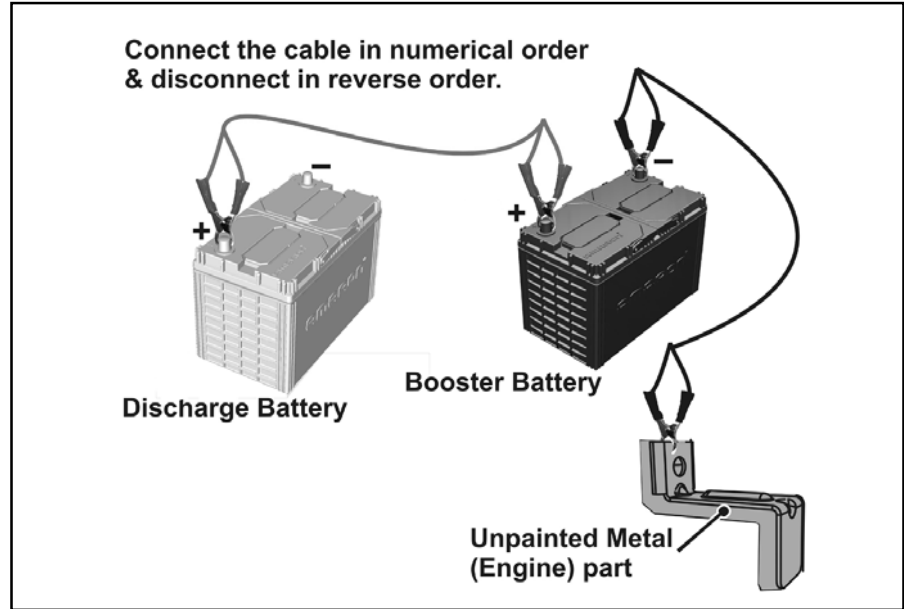

Connect leads in the order as shown in figure.

## TOWING THE VEHICLE

**TOWING THE VEHICLE :**

It is necessary to tow a break down vehicle, certain precautions and procedures must be taken to prevent damage to the vehicle and/or components. Failure to use standard towing precautionary measures when lifting or towing a disabled vehicle could result in an unsafe operating condition.

To ensure proper towing and to prevent accidental damage to your vehicle, take help of a **TATA MOTORS** authorized dealer or a commercial tow-truck service.

**⚠ WARNING**

- Never get under your vehicle after it has been lifted by a tow truck.
- For towing a vehicle, the best way is to use a wrecker. Alternatively use a rigid tow bar.
- Switch 'ON' the hazard warning indicators of both the vehicles to warn other road users.

- Put the gearshift lever in the NEUTRAL position.
- Limit the speed to 20-30 kmph.
- In case of brake failure, use the parking brake to control the vehicle.
- Do not use flexible cable or rope for towing as your vehicle may crash into the towing vehicle, when it applies sudden brake.

**Recommended Towing :**

We recommend that your vehicle be towed with the driving wheels off the ground or place the vehicle on a flat bed truck as shown.

**⚠ WARNING**

- Never tow your vehicle with the front wheels on the ground or four wheels on the ground (forward or backward), as this may cause serious and expensive damage to the transmission.
- When towing with the rear wheels on the ground or on towing dollies, place the ignition switch in the ACC or ON position, and secure the steering wheel in the straight-ahead position with a rope or similar device.

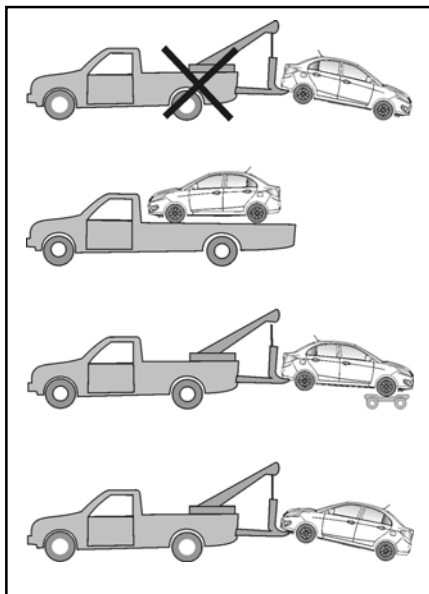

### Emergency towing :

The towing hook is provided inside the tool bag kit which is kept in luggage area.

### Towing Process :

- Open the tailgate and remove the towing hook from the tool bag.
- Remove the tow hook cover provided on the front bumper by pressing / pulling it.
- Install the towing hook by turning it clockwise into the hole until it is fully installed.
- After towing, remove the towing hook and fit the cover.

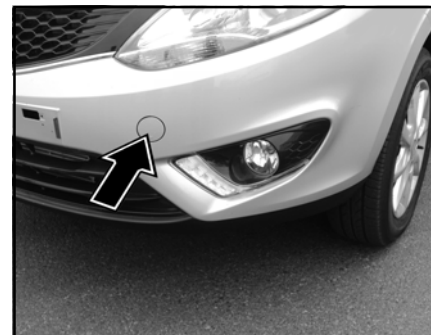

**Tow Hook Location at Front**

### NOTE

*The power steering functions only when engine is running. Hence, during towing the steering efforts will be more.*



**FUSES:**

Your vehicle has fuse boxes at three locations.

The vehicles electrical circuits have fuses to protect the wiring from short circuits or sustained overload.

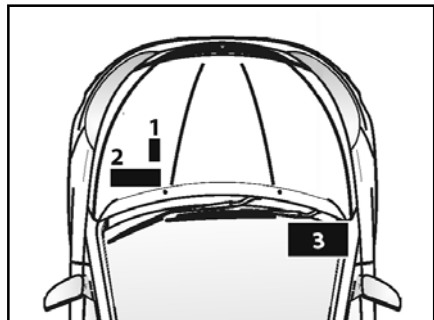

1. **Battery Mounted Fuse Box.**
2. **Engine Compartment Fuse Box.**
3. **Cabin Compartment Fuse Box.**

**Checking and Replacing Fuses:**

If any electrical unit in your vehicle is not functioning, check the fuses first.

Please follow the steps below that will guide you to check and replace them .

- Turn the ignition key to the 'LOCK' position.
- Identify the defective fuse from its melted wire.

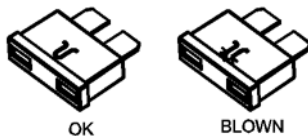

- Remove the blown fuse by “fuse puller”. The fuse puller is located in the cabin compartment fuse box.
- Replace the blown fuse with same rated “Spare Fuse”. (Spare fuses are located in the engine compartment fuse box.)

**NOTE**

*Always ensure that the spare fuses are replenished.*

- Ensure that all other fuses are pressed firmly in position.
- If the replaced fuse blows out in short time, there is probably an electrical problem in your vehicle. Get the vehicle attended to the nearest **TATA MOTORS** Authorised Service Centre immediately.

**⚠ WARNING**

The electrical system is protected by fuses that are designed to fail and prevent damage to wiring harness. Always replace blown fuse with the same rating as specified to prevent wiring damage that can result in a possible fire.

**BATTERY MOUNTED FUSE BOX:**

Fuse No.	Function	Fuse Rating
PF1	STARTER MOTOR	CAL 1

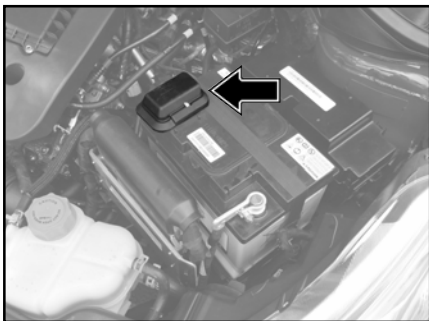
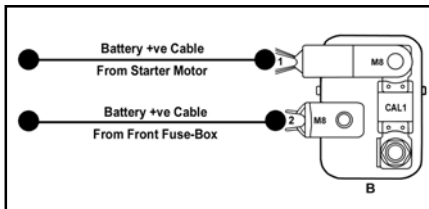
**Battery Mounted Fuse Box**

Fix Fuse-Box cover to Battery Mounted Fuse-Box, if removed.

**⚠ WARNING**

If Fuse box cover is removed for any reason, it should be refitted properly at its original position.

**ENGINE COMPARTMENT FUSE BOX:****Fuse Box - Engine Compartment****NOTE**

The fuse box layout is for reference purpose only. Please refer the sticker provided inside the fuse box cover.

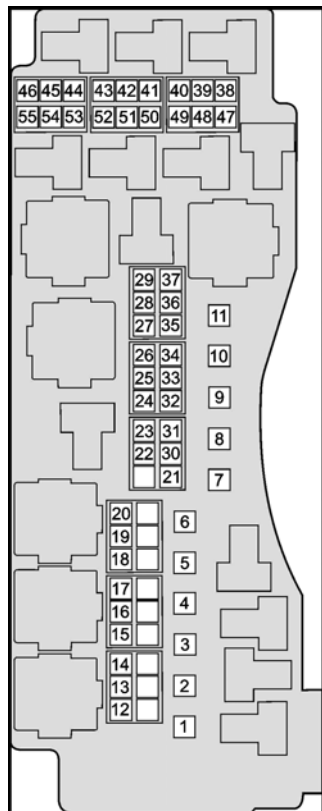

FUSE NO	FUNCTION	FUSE RATING
1	INTERIOR F/B 2 IGNITION	60A
2	ABS	40A
3	GLOW PLUG	60A
4	COOLING FAN FAST	40A
5	EPAS	60A
6	-	-
7	INTERIOR F/B 1 BATTERY	60A
8	UNDER BONNET F/R BOX	60A
9	-	-
10	IGNITION LOAD	60A
11	-	-
12	COMPRESSOR	10A
13	STARTER SOLENOID	20A
14	ABS ECU	25A
15	TCU	15A
16	HORN HIGH / LOW TONE	15A
17	FRONT FOG	10A
18	EMS BATTERY	10A
19	AMT HYD PUMP	30A
20	FUEL PUMP	20A

21	BRAKE LAMP	10A
22	RELAY COIL	5A
23	-	-
24	FRONT WIPER MOTOR	20A
25	ABS	5A
26	WASHER MOTOR	10A
27	TCU	10A
28	REVERSE & BRAKE LAMP	10A
29	REAR WIPER	10A
38	EMS ECU (SDE)	20A
39	EMS ECU	15A
40	EMS ECU (DIESEL)	10A
	EMS ECU (PETROL)	20A
41	-	-
42	HEAD LAMP LOW	15A
43	EMS IGN	10A
44	COOLING FAN SLOW	20A
45	-	-
46	HEAD LAMP HIGH	15A

**CABIN COMPARTMENT FUSE BOX:****Cover removal procedure:**

Fuse box is located inside the cover below steering column. To access the fuse box, remove cover as per procedure given below.

1. Fuse box cover is mounted on dash board with the help of 4 lugs on top and 2 plastic rivets at bottom.

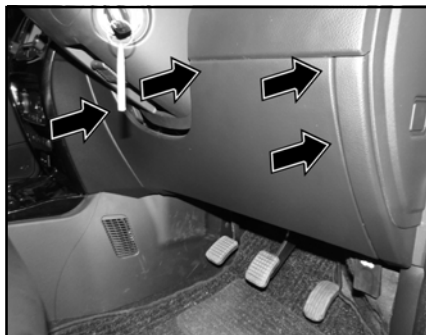

2. To remove plastic rivets, first pull center pin and then rivet.



3. After removing rivets, slowly and carefully pull out cover from bottom to disengage top mounting lugs. Take out cover.



**Re-fitment procedure:**

1. Align and engage the top mounting lugs with respective slots on dash board and gently press.

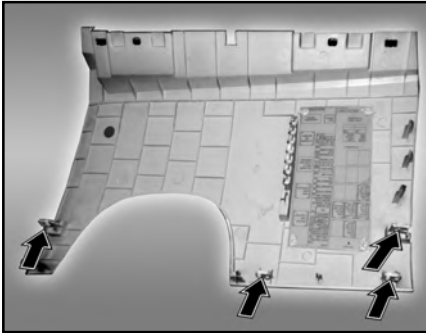

2. Similarly align the bottom rivet mounting holes and insert rivets and press center pin to lock.

**NOTE**

*Pull the center pin of rivet before fitment*

## CABIN COMPARTMENT FUSE BOX:

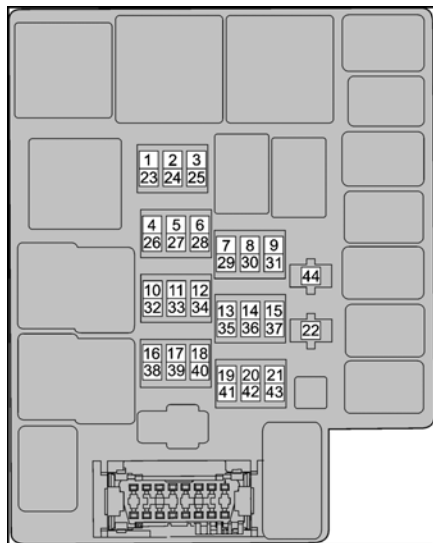

Fuse Box - Cabin Compartment

FUSE NO	FUNCTION	FUSE RATING
1	RESTRAIN CONTROL MODULE	10A
2	ACCESSORY	10A
3	-	-
4	BCM	15A
5	INTERIOR LAMP	5A
6	MIRROR ADJUST MOTOR	5A
7	BCM /POSITION LAMP	15A/5A
8	CLUSTER / OBD	10A
9	BCM /POSITION & PARK LAMP	15A/5A

10	KEY IN AFTER MARKET	5A
11	IMMO / EPAS	5A
12	-	-
13	BLOWER MOTOR	30A
14	CDL / ACCESSORY	15A
15	POWER SOCKET 1	15A
16	RELAY COILS	5A
17	-	-
18	HVAC	10A
19	HRW / FLASHER	25A/10A
20	IGN SUPPLY	10A
21	-	-
22	TRANSIT / INFOTAINMENT	15A

**BULB SPECIFICATION :**

Sr.No	Description	Rating	Type	Quantity
1	HIGH BEAM	12V, 55W	H1	2
2	LOW BEAM	12V, 55W	H7	2
3	PARKING LAMP FRONT	12V, 5W	W5W	2
4	TURN SIGNAL FRONT	12V, 21W	PY21W	2
5	FOG LAMP FRONT	12V, 19W	H16	2
6	STOP + POSITION REAR	12V, 21/5W	P21/5W	2
7	TURN SIGNAL REAR	12V, 21W	PY21W	2
8	REVERSE LAMP	12V, 21W	P21W	2
9	FOG LAMP REAR	12V, 21W	P21W	1
10	REAR REGISTRATION PLATE LAMP	LED	LED MODULE	2
11	SIDE REPEATER LAMP	12V, 5W	WY5W	2
12	ROOF LAMP	12V, 10W	Festoon Bulb	1
13	ROOF SPOT LAMP (If Applicable)	12V, 5W	W5W	2
14	HIGH MOUNTED STOP LAMP	LED	LED MODULE	1
15	REAR BOOT LAMP	12V, 5W	W5W	1
16	HIGH MOUNTED STOP LAMP	12V, 5W	W5W	5
17	DRL	LED	LED MODULE	2

**BULB REPLACEMENT :****⚠ WARNING**

- The engine should not be running when changing bulbs.
- If the engine has been running just prior to replacing bulbs in the headlight housing, please keep in mind that components in the engine compartment will be hot.

Your vehicle's headlamps have replaceable halogen bulbs. Headlamp bulbs can be replaced without even disturbing or removing the entire headlamp unit.

**⚠ WARNING**

It is dangerous if a halogen bulb breaks. These bulbs contain pressurized gas and if broken, will explode causing serious injury by the flying glass. Halogen bulbs can break if the glass portion is touched with bare hands, body oil could cause the bulb to heat unevenly and

explode when lit. Never touch the glass portion of the bulb with your bare hands and always wear eye protection when handling or working around halogen bulbs. Always keep halogen bulbs out of the reach of children.

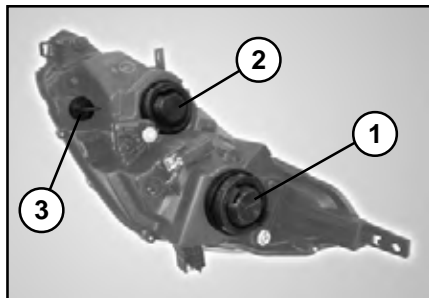
**Location of the head lamp bulbs :**

1. Low beam lamp
2. High beam lamp / Parking / Position lamp
3. Turn indicator lamp

**Replacing the low beam bulb (halogen lamp):**

- Lift the bonnet to access the bulbs.
- Remove the dust cover by simply pulling it off. **(Fig. 1)**
- Pull the connectors from the bulb. **(Fig. 2)**
- To free the headlamp bulb from the socket, press and swing the retaining spring and pull it straight back. **(Fig. 3)**
- Pull out the bulb from the socket. **(Fig. 4)**
- Insert the new bulb (without touching the glass) into the socket.
- Move the retaining spring up and push it slightly until it lock properly. **(Fig. 5)**
- Press the connector into the bulb.
- Press the dust cap on headlamp housing until it fits properly.



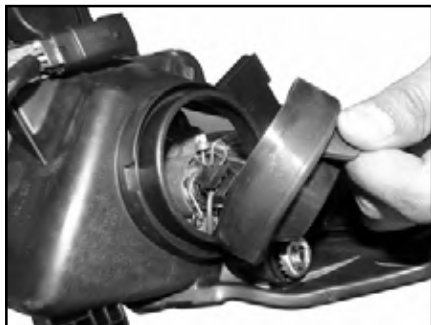

*Fig. 1*



*Fig. 2*



*Fig. 3*



*Fig. 4*



*Fig. 5*

### Replacing the High beam (halogen lamp):

- Lift the bonnet to access the bulbs.
- Remove the dust cover by simply pulling it off. **(Fig. 1)**
- Pull the connectors from the bulb. **(Fig. 2)**
- To free the headlamp bulb from the socket, press and swing the retaining spring and pull it straight back. **(Fig. 3)**
- Pull out the bulb from the socket. **(Fig. 4)**
- Insert the new bulb (without touching the glass) into the socket.
- Move the retaining spring up and push it slightly until it lock properly.
- Press the connector into the bulb.
- Press the dust cap on headlamp housing until it fits properly.



**Fig. 1**



**Fig. 2**



**Fig. 3**



**Fig. 4**

## BULB REPLACEMENT

**Parking lamp bulb (if fitted) :**

- Lift the bonnet to access the bulb.
- Remove the high beam bulb dust cover by simply pulling it off.
- Pull out the bulb holder by gently pressing the side clips of the holder.
- Remove the bulb from the bulb holder.



- Insert the new bulb (without touching the glass) into the bulb holder.



- Press fit the bulb holder with the bulb.
- Press the high beam bulb dust cover on headlamp housing until it fits properly.

**Replacing the Front Turn indicator Bulb:**

- Lift the bonnet to access the bulb.
- Rotate the front turn signal socket plug assembly anticlockwise and pull it straight back.



- Pull the bulb holder along with bulb.



- Remove the bulb from the bulb holder.



- Insert the new bulb (without touching the glass) into the bulb holder.
- To lock the socket on headlamp housing, rotate the front turn signal socket plug assembly clockwise until it fits properly.

### Replacing turn indicator, reverse, stop lamp :

- Lift the trunk lid to access the tail lamp's mounting screws inside the boot carpet.
- Slightly remove the boot carpet by pulling out the plastic rivets. To

remove plastic rivets, first pull the center pin and then rivet.

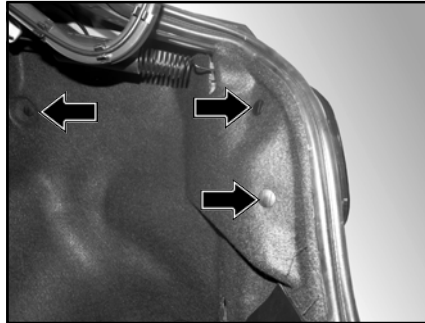

- Remove the tail lamp mounting screws.

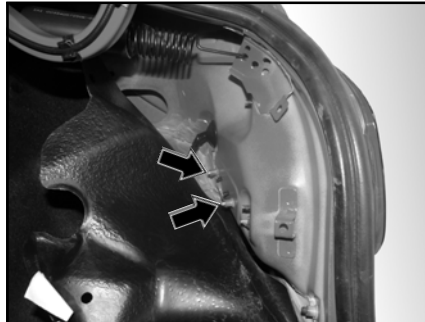

- Carefully slide out tail lamp assembly to release the two mounting lugs and tail lamp catcher provided as shown in fig. Take out the tail lamp assembly.

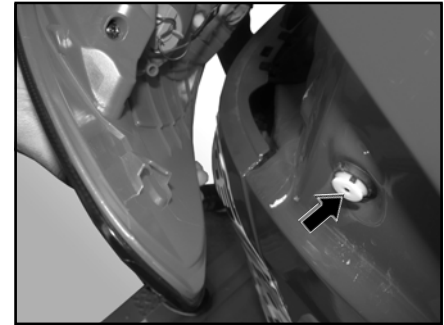

### Tail lamp catcher

- Rotate the bulb holder in anti-clockwise direction to unlock the bulb holder.

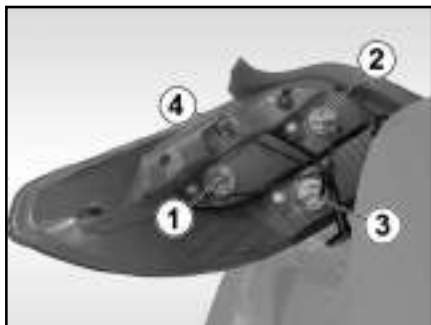

1. **Turn Indicator lamp**
2. **Reverse lamp**
3. **Stop Lamp**
4. **Tail Lamp**

- Remove & replace the bulb.
- Rotate the bulb holder in clock wise direction to lock the bulb holder on lamp.
- While fitment, first engage tail lamp catcher and then mounting bolts. Tighten the mounting nuts and properly refit boot carpet. For rivet fitment, pull center pin, engage rivet

and then press the center pin of rivet.

#### NOTE

*Tail lamp is LED and can not be replaced.*

#### ELECTRICAL ACCESSORY FITMENT : (if applicable)

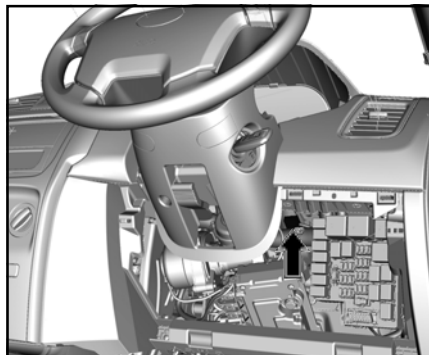

Provision has been made in your vehicle wiring to fit the following electrical accessories.

1. Music System.
2. Speakers.
3. Central Door Locking.
4. Reverse Parking Sensors.
5. Accessories Supply ( Fuse Protected) upto 7A.

A plug socket is provided behind the dash board near the cockpit wiring harness.

For details of fitment please contact **TATA MOTORS** Authorized Service Centre's (TASCs) only.

**24 X 7 ROAD ASSISTANCE :****Dear Customer,**

It is our responsibility and our endeavour to ensure that you have our complete service backup if ever, wherever and whenever you need the same. When you have a road network that spans wide area, the probability of a breakdown happening within hailing distance of a **TATA MOTORS** Authorized Workshop is very low.

It is Precisely for this reason, we have tied up with My TVS, who will provide breakdown assistance including towing to the nearest **TATA MOTORS** Authorized Workshop through their Authorized Service Providers (ASP)

The **24X7 On Road Assistance** Program shall be automatically available to your vehicle for the duration of



Warranty period. The program shall also be available, if you avail the same post warranty.

**Response Time \*\* for the On Road Assistance Program**

Within City Limits	60 minutes
On State or National Highways	90 minutes
Ghat Roads and other places	120 minutes +/-

\*\* (The response time will depend on the location, terrain, traffic density and the time of the day.)

**Standard procedure when calling for On Road Assistance in case of a breakdown:**

- Dial the toll free help line number – **1 800 209 7979**
- Identify your vehicle with the Vehicle chassis number that is available in the Owners Service manual.
- Explain your exact location with landmarks and tell us about the problem you face with the vehicle.
- Park your vehicle on the edge of the road, open the bonnet and put on the hazard warning signal.
- Place the advance warning triangle supplied with the vehicle approx. 3 m from the vehicle in the direction of on coming traffic.

### COVERAGE UNDER THE 24 X 7 ON ROAD ASSISTANCE PROGRAM

I. The **24x7 On Road Assistance** Program Service covers the following services on your vehicle during warranty period.

- Wheel change through spare wheel.
- Arrangement of fuel. (Fuel cost will be chargeable at actual cost)
- Re-opening the vehicle in cases of key lock out.
- Rectification of electrical problems related to battery, fuses etc.
- On spot repairs for complaints repairable at site. ^
- Vehicle to vehicle towing or winching & towing for non accident cases up to the nearest **TATA MOTORS** authorized workshop. Towing charges at actual cost beyond the same to be paid to the ASP in cash. (Any ferry or toll charges levied in relation to the vehicle being towed to be paid by the customers in actuals in cash).

For accident cases, towing charges to be borne by the customer.

II. The **24x7 On Road Assistance** Program coverage on availing the 24X7 policy, post warranty is upto maximum of 6 instance of assistance in one year for both the plans- Basic and Premium. In the premium plan, this includes 1 instance of towing upto the nearest **TATA MOTORS** authorised workshop.

### EXCLUSIONS

#### **24x7 On Road Assistance Program does not apply to**

- Cost of parts consumables and labour for such repairs not covered under warranty\*. These charges are to be settled with ASP in cash.
- Toll or ferry charges paid by ASP in reaching to the breakdown site to be settled with ASP in actuals in cash.
- Cases involving accident, fire, theft, vandalism, riots, lightening, earthquake, windstorm, hail, tsunami, unusual weather conditions, other acts of God, flood, etc.
- Vehicles that are unattended, un-registered, impounded or abandoned.
- Breakdown/defects caused by misuse, abuse, negligence, alterations or modifications made to the vehicle.

- Lack of maintenance as per the maintenance schedule as detailed in the owner's manual.
- Cases involving racing, rallies, vehicle testing or practice for such events..

#### Disclaimer

- The service is not available in some parts of J&K and in Union Territories of Andaman & Nicobar Islands and Lakshwadeep.
- \*\*The reach time is indicative & the actual reach time will be conveyed by the call centre at the time of breakdown call.
- The reach time can vary depending on the traffic density & time of the day.
- The reach time indicated does not account for delays due to but not limited to acts of God, laws, rules & regulations for time being in force, orders of statutory or Govt. authorities, industrial disputes, inclement weather, heavy down pour, floods, storms, natural calamities, road blocks due to accidents, general strife and law & order conditions viz. fire, arson, riots, strikes, terrorist attacks, war etc.
- ^ On spot repairs at breakdown site shall depend on nature of complaints & will be as per the discretion of the ASP.
- \*The decision for free of charge repairs will be as per the warranty policy & procedures of **TATA MOTORS LTD.** and as per the interpretation of the same by ASP. You will be duly informed by the ASP & call centre for the charge applicable if any.
- All charges wherever applicable need to be settled directly with the ASP.



**EXCLUSION OF LIABILITIES :**

- It is understood that **TATA MOTORS** shall be under no liability whatsoever in respect of any loss or damage arising directly or indirectly out of any delay in or non delivery of, defect/deficiency in service/parts provided by ASP.
- In case vehicle cannot be repaired on-site, customers are advised to use the towing facility for taking their vehicle to the nearest **TATA MOTORS** authorized workshop only. In no condition will the vehicle be towed to any unauthorized workshop. **TATA MOTORS** will not be responsible for any repairs carried out in such unauthorized workshop.
- Customer are advised to take acknowledgment from the ASP for the list of accessories/extra fittings and other belongings in the vehicle as well as the current condition related to dents/scratches breakages of parts/fitments of the vehicle at the time of ASP taking possession of the vehicle & to verify these items when delivery is taken back by them, Claim for loss of or damage to items, if any should be taken up with ASP directly. **TATA MOTORS** shall not be responsible for any such claims, damages/loss or any deficiency of service of the ASP.
- Vehicles will be handled, repaired & towed as per the customer's risk & **TATA MOTORS** shall not be liable for any damages / claims as a result of the same.
- Services entitled to the customers can be refused or cancelled on account of abusive behaviour, fraudulent representation, malicious intent and refusal to pay the charges for any charges related services and spare parts during service or on previous occasion on part of the customer.
- On site repairs may be temporary in nature. The completion of repairs does not certify the road worthiness of the vehicle. The customer is advised to ensure temporary repairs carried out onsite is followed by permanent repairs at a **TATA MOTORS** Authorized Workshop at the earliest.
- Terms and conditions and service coverage, exclusions etc. are subject to change without notice.

Have your vehicle serviced regularly to help maintain its roadworthiness and resale value. There is a large network of **TATA MOTORS** Authorized Service Centers to help you with their professional servicing expertise. We believe that their specially trained technicians are best qualified to service your vehicle properly and expertly. They are supported by a wide range of highly specialized tools developed specifically for servicing your vehicle. To help you service your vehicle, we provide scheduled maintenance information which makes tracking routine service easy.

#### **Maintenance:**

If your vehicle requires professional service, your authorized dealer can provide the necessary parts and service. Check your warranty information to find out which parts and services are covered.

Use only recommended fuels, lubricants, fluids and service parts conforming to specifications.

#### **Precautions:**

- Do not work on a hot engine.
- Make sure that nothing gets caught in moving parts.
- Do not work on a vehicle with the engine running in an enclosed space, unless you are sure you have enough ventilation.
- Keep all open flames and other burning material (such as cigarettes) away from the battery and all fuel related parts.

#### **Working with the Engine Off:**

1. Apply the parking brake.
2. Turn off the engine and remove the key.
3. Block the wheels.

#### **⚠ WARNING**

To reduce the risk of vehicle damage and/or personal burn injuries, do not start your engine with the air cleaner removed and do not remove it while the engine is running.

1. Apply the parking brake.
2. Block the wheels.

## ENGINE COMPARTMENT - QUADRAJET

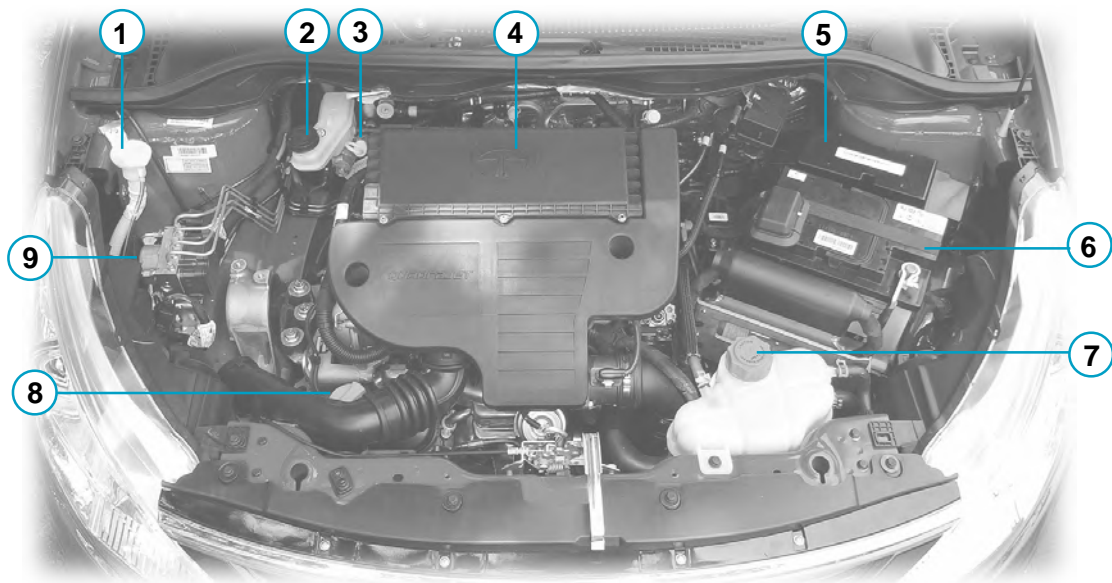

1. Wind shield washer container

2. Brake fluid reservoir

3. Dip Stick - Engine Oil

4. Air Filter

5. Fuse & relay box

6. Battery

7. Auxiliary tank

8. Engine oil filling cap

9. ABS HCU (if fitted)

## ENGINE COMPARTMENT - REVOTRON 1.2T

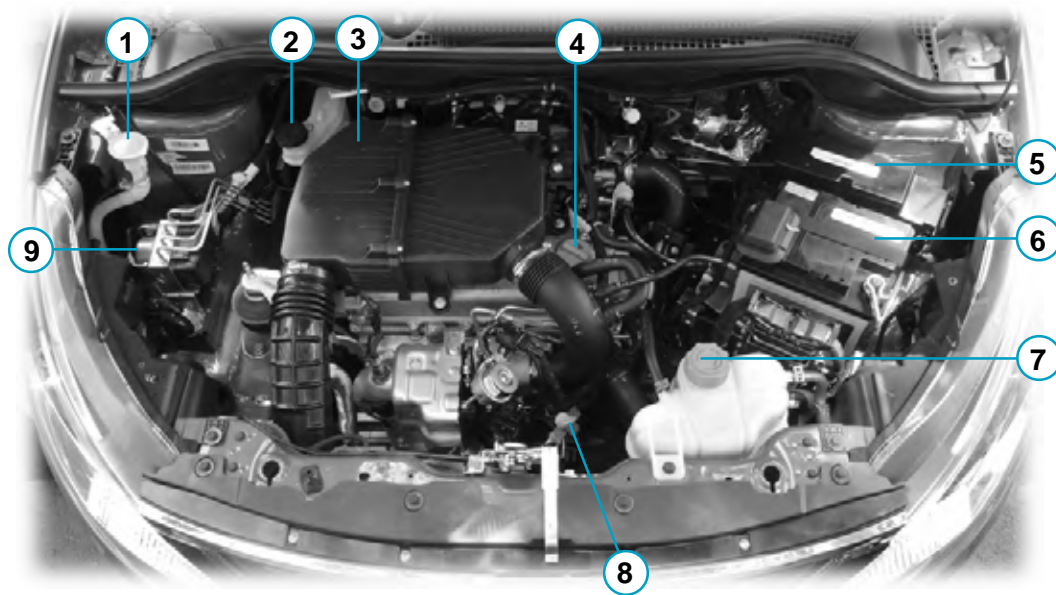

1. Wind shield washer container

2. Brake fluid reservoir

3. Air Filter

4. Engine oil filling cap

5. Fuse &amp; relay box

6. Battery

7. Auxiliary tank

8. Dip Stick - Engine Oil

9. ABS HCU (if fitted)

## ENGINE OIL LEVEL &amp; BRAKE FLUID LEVEL

**ENGINE OIL LEVEL :**

Warm up the engine to normal operating temperature.

Turn it off and wait for 5 minutes for the oil to return to the oil pan. Be sure the vehicle is on a level surface.

Pull out the dipstick, wipe it clean, and reinsert if fully.

Pull it out again and examine the oil level. It should be between 'MIN' and 'MAX' level. If not, top up with recommended engine oil.

**NOTE**

*The oil consumption depends upon the driving style and the conditions under which the vehicle is used.*

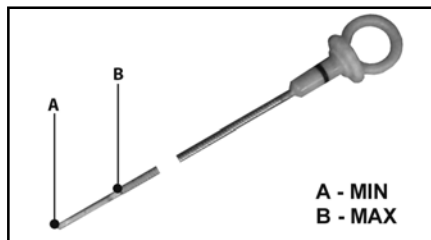
**NOTE**

*Do not remove the filler cap when the engine is running.*

*Do not add oil further than the MAX. mark. Oil levels above the MAX. mark may cause engine damage.*

*For location of Engine oil filling cap & dip stick, please refer respective Engine Compartment pages.*

**BRAKE FLUID LEVEL :**

The level of the brake fluid must be between the min. and max. marks on the side of the brake fluid container. If the level falls below the min. mark, add recommended brake fluid. (Refer chapter - Fuels, coolants and lubricants) In case of spongy or hard pedal or low brake efficiency, please contact the nearest TATA MOTORS authorized Service outlet.

**⚠ WARNING**

1. Do not allow brake fluid to make contact with the skin or eyes.
2. Do not allow brake fluid to splash or spill on the paint surface as it will damage the paint. In case of spillage, wipe it off immediately.

*For location of Brake Fluid Container & filling cap , please refer respective Engine compartment pages.*

**ENGINE COOLANT LEVEL :**

Check whether the coolant level is between the 'MIN' and 'MAX' marks on the coolant reservoir.

When the coolant levels is low, slowly pour 50% mixture of demineralized water & recommended coolant through filler of auxiliary tank until the level approaches the max level line.

**NOTE**

*In case of emergency, a large amount of water without engine coolant may be added in order to reach a vehicle service location.*

Whenever coolant has been added, the coolant level in the coolant reservoir should be checked the next few times you drive the vehicle. If necessary, add enough engine coolant to bring the coolant level to the proper level.

For location of Engine coolant container & filler cap, please refer respective Engine compartment pages.

**NOTE**

*Topping of the coolant should be done in the auxiliary tank only.*

Do not mix different colors or types of coolant in your vehicle. Make sure that only recommended coolant is used. Mixing of engine coolants may harm your engine's cooling system and its components. This may void the warranty. Use recommended engine coolant meeting the **TATA MOTORS** specification.

Do not add extra inhibitors or additives to the coolant. These can be harmful and compromise the corrosion protection of the engine coolant.

**⚠ WARNING**

1. Do not add/check coolant when the engine is hot. Steam and scalding liquids released from a hot cooling system can burn you badly. Also, you can be burned if coolant is spilt on the hot engine parts.

2. Coolant expands when it is hot. The level may extend beyond the MAX mark.

***For location of Engine coolant container & filler cap, please refer respective Engine compartment pages.***

## TRANAXLE OIL &amp; WINDSHIELD WASHER FLUID LEVEL

## TRANAXLE OIL LEVEL :

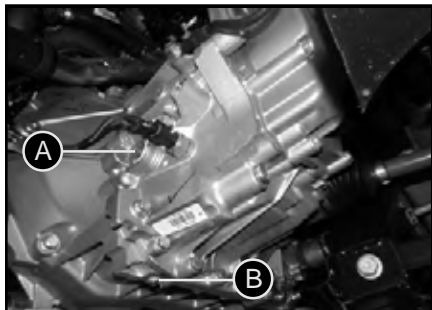

TRANAXLE (QUADRAJET)

A. OIL LEVEL PLUG B. DRAIN PLUG

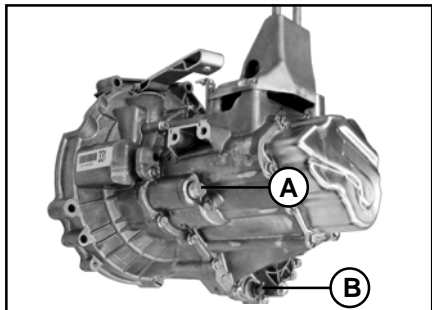

TRANAXLE (REVOTRON 1.2T)

A. OIL LEVEL PLUG B. DRAIN PLUG

## WINDSHIELD WASHER FLUID LEVEL:

Windshield washer fluid container is located behind the front right hand side panel and its filler neck is provided near the auxiliary tank in the engine compartment.

**NOTE**

*Do not add detergent or any solvent in the windshield washing water.*

*For location of Windshield Washer Container & filling cap , please refer respective Engine compartment pages.*

**SPARK PLUG (PETROL) :**

**Spark Plug** - BOSCH  
**Spark Plug No.** - YR7ME  
**Spark Plug Gap** - 0.7 mm to 0.8 mm  
**Tightening Torque** - 25 Nm

You should inspect the spark plugs periodically for carbon deposits. When carbon accumulates on the spark plug, a strong spark will not be produced. Remove carbon deposits using a spark plug cleaner.

**Spark Plug Replacement :**

1. Remove air filter assembly to access spark plug.
1. Clean up any dirt or oil that is collected around the spark plug caps.
2. Pull out the spark plug cables by gripping at the connector.
3. Remove the spark plug with the help of a special socket.
4. Check and adjust the gap, it should be 0.7 mm to 0.8 mm.
5. Replace the spark plug if the gap is more than 1.1 mm.
6. Fix the spark plug and tighten it to the torque of 25 Nm (dry).
7. Fit the spark plug cable, until a 'click' sound is heard. Repeat the procedure for the other spark plugs.

*cable can affect combustion and cause damage to engine and catalytic converter.*

**NOTICE**

*Tighten the spark plug carefully. Overtightening can damage the threads in the cylinder head. A loose spark plug or loose spark plug*



## TYRES :

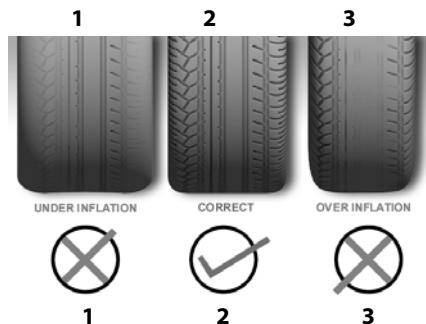

1.	Under inflation	Excessive Side Tread Wear
2.	Correct Tyre Tyre Wear	Pressure Uniform
3.	Over inflation	Excessive Centre Tread Wear

Check for inflation and condition of your vehicle tyres periodically.

**Inflation :**

Check the pressure in the tyres when they are cold.

You should have your own tyre pressure gauge and use it at all times. This

makes it easier for you to tell if pressure loss is caused by a tyre problem and not by variation between gauges.

Keeping the tyres properly inflated gives you the best combination of riding comfort, handling, tyre life and better fuel efficiency.

Over inflation of tyres makes the vehicle ride bumpy and harsh. Tyres are more prone to uneven wear and damage from road hazards.

Under inflated tyres reduce your comfort in vehicle handling and are prone to failures due to high temperature. They also cause uneven wear and more fuel consumption.

**Recommended Tyre Pressures (185/60 R15)**

WHEELS	TYRE PRESSURE
Front	34 psi / 2.35 bar
Rear	34 psi / 2.35 bar
Spare Wheel	34 psi / 2.35 bar

**NOTE**

*Every time you check inflation pressure, you should also examine tyres for damage, trapping of foreign objects in the treads and wear.*

The recommended tyre pressure is mentioned as a permissible range in which tyre pressure can be adjusted. The higher value is recommended for getting better fuel economy and lower value is for better ride comfort.

**Tyre Pressure Sticker Location :****NOTE**

- *If you notice bumps or bulges in the tread or the side of the tyre, replace the tyre.*
- *If there are cuts, splits or cracks in the side of the tyre, replace the tyre.*
- *Replace tyre if excessive tread wear or non uniform tyre wear is noticed.*

**Special care for tubeless tyres :**

1. While removing tyre from wheel rim and mounting it back on wheel rim, take precautions not to damage tyre bead. Use tyre removal and assembly machines. Damage or cut on tyre bead may cause gradual loss of air and deflation of tyre.
2. Do not scratch inside of tubeless tyre with metallic or sharp object. Tubeless tyres are coated with impermeable layer of rubber from inside which holds the air inside the tyre. Removal of this layer due to scratching may cause gradual loss of air and deflation.
3. If wheel rim gets damaged in service, get the wheel rim repaired/ replaced immediately. Running the vehicle with damaged rim may cause deflation of tyre and subsequent dislodging of tyre from rim.

4. Maintain recommended inflation pressure. Over-inflation, in particular, may cause puncture or bursting of tyre.

**NOTE**

*Life and wear pattern of tyres depends on various parameters like tyre pressure, wheel alignment, wheel balancing, tyre rotation, etc. It also largely depends on vehicle speed, load carried, usage, driving habits, road conditions, tyre quality, etc. In case fault is suspected to be due to poor quality of tyres, the same may be taken up with concerned tyre manufacturer.*

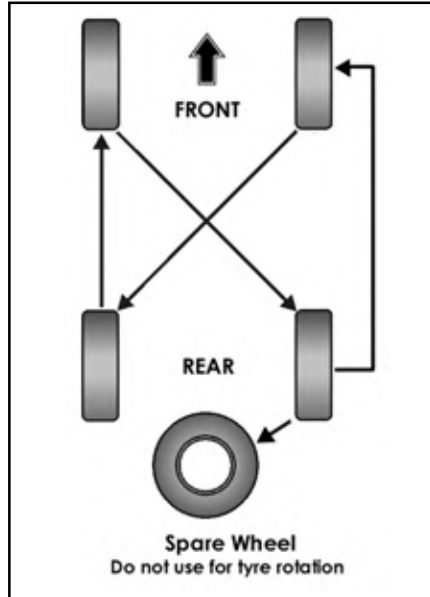
**Tyre Rotation :**

To help increase tyre life and distribute wear more evenly you should have tyres rotated at specified intervals or earlier depending on the operation of vehicle.

The illustrations shows how to rotate tyres when normal spare wheel is included in tyre rotation.

**Wheel alignment :**

Incorrect wheel alignment causes excessive and uneven tyre wear. Check wheel alignment at specified intervals. Wheel alignment values are given below :

	Front	Rear
<b>Caster</b>	$3.1^{\circ} \pm 45'$	---
<b>Camber</b>	$30' \pm 30'$	$-52' \pm 1^{\circ}$
<b>Toe in</b>	-	$-7' \text{ to } +31'$
<b>Toe Out</b>	$0' \text{ to } -13'$	-

Check and maintain tyre pressure periodically to obtain longer tyre life.

**Wheel Balancing :**

Wheels of your vehicle are balanced for better ride comfort and longer tyre life. Balancing needs to be done whenever tyre is removed from rim.

1. Permissible imbalance for tyre with rim = 250 gm-cm max.
2. Total balance weight should be within 140 gms on each side.
3. Relocate the tyre if the weight required to balance is more than 140 gm.
4. Balance weights are available from 10 gms to 140 gms in steps of every 10 gms and from 15 gms to 135 gms in steps of every 10 gms.
5. Do not use more than one balance weight on one side.

**BATTERY :**

Check the battery for proper electrolyte level.

1. Check the battery for electrolyte level against the marking on the battery outer case.
2. Check the battery terminals for corrosion (a white or yellowish powder). To remove it, cover the terminals with a solution of baking soda. It will bubble up and turn brown.
3. When this stops, wash it off with plain water. Dry off the battery with a cloth or paper towel.
4. Coat the terminals with petroleum jelly to prevent future corrosion.

Use a proper wrench to loosen and remove cables from the terminals.

**Always disconnect the negative (-ve) cable first and reconnect it last.**

Clean the battery terminals with a terminal cleaning tool or wire brush.

Reconnect and tighten the cables, coat the terminals with petroleum jelly.

Ensure that the battery is securely mounted.

If you need to connect the battery to a charger, disconnect both cables to prevent damage to the vehicle's electrical system.

**NOTE**

*During normal operation, the battery generates gas which is explosive in nature. A spark or open flame can cause the battery to explode causing very serious injuries.*

*Keep all sparks and open flames and smoking materials away from the battery.*

*Getting electrolyte in your eyes or on the skin can cause severe burns. Wear protective clothing and a face*

*shield or have a skilled technician to do the battery maintenance.*

*The battery contains sulphuric acid (electrolyte) which is poisonous and highly corrosive in nature.*

## REMOTE BATTERY

**REMOTE BATTERY :****Battery changing procedure for Remote Key :**

Remote control key contains a battery which is housed under the cover.

If red LED remote flashes for 5 times after placing and releasing any button on remote. It is recommended to replace battery at a **TATA MOTORS** authorized service center.

You should, however, proceed as follows if you wish to replace the discharged battery yourself:

1. Open the key.
2. Press off the battery cover with your thumb or using a flat screw driver at the points of the arrows 1.
3. Remove the discharged battery from the key by pressing the battery downwards at the point of the arrow.

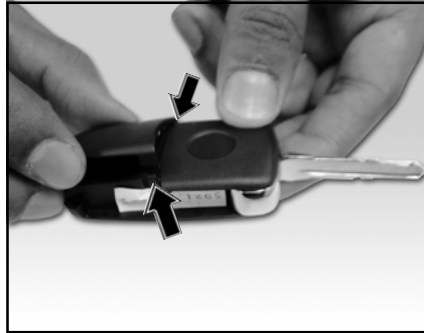

4. Insert the new battery.

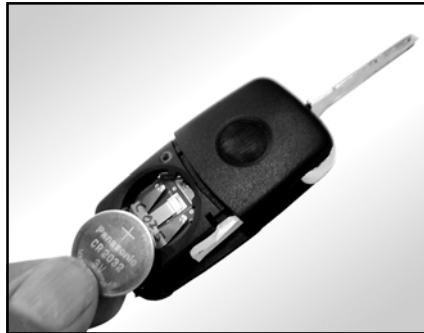

5. Ensure that the "+" symbol on the battery is facing upwards.

6. The correct polarity is shown on the battery cover.

Position the battery cover on the key and press on it until it is heard to lock in place.

**NOTE**

*Use CR 2032 battery only.*

### ON BOARD DIAGNOSTIC (OBD) SYSTEM:

On board Diagnostics or OBD is an automotive term referring to a vehicle's self Diagnostic and reporting capability. The OBD system allows continuous diagnosis of the components of the vehicle correlated with emissions. This system warns the driver, by turning "ON" the Malfunction Indication lamp (MIL) on the instrument cluster, when a fault causes emission levels to increase.

The OBD system also has a diagnostic connector that can be interfaced with appropriate diagnostic tools, which makes it possible to read the fault codes stored in the Electronic Control Unit, together with a series of specific parameters for Engine operation and Diagnosis. This check can also be carried out by the traffic police.

To access the diagnostic connector, open the fuse box cover which is

located on the cockpit at RHS of the steering wheel.



### ROUTINE SERVICE BY OWNER OF THE VEHICLE :

We highly recommend that the following items are to be inspected periodically.

1. Engine Oil Level
2. Engine coolant Level
3. Brake Fluid Level
4. Washer Fluid Level
5. Battery Electrolyte Level
6. Tyre inflation pressure including spare wheel

#### Do it Yourself Service

Improper or incomplete service may result in problems.

Several maintenance procedures can be done only by a qualified service technician with special tools. Improperly done 'do-it- yourself' maintenance during the warranty period may affect warranty coverage. If you're unsure about any servicing or

maintenance procedure, have it done by a **TATA MOTORS** Authorized Dealer / TASC.

#### WARNING

Performing maintenance work on a vehicle can be dangerous. You can be seriously injured while performing some maintenance procedures. If you lack sufficient knowledge and experience or the proper tools and equipment to do the work, have it done by qualified technician.

## SERVICE INSTRUCTIONS

The **TATA ZEST** has been manufactured to give you economical and trouble free performance. To achieve this please follow the instructions as stated.

**Your vehicle is entitled to three free services (labour only). The free service coupons are attached to the sales invoice. Please present these coupons to the servicing dealer while availing free services.**

**1st free service** - At **4500-5500 km. OR 3 months** whichever is earlier

**2nd free service** - At **14500-15500 km. OR 12 months** whichever is earlier

**3rd free service** - At **29500-30500 km. OR 24 months** whichever is earlier

All services other than free services are chargeable.

Servicing of the vehicle can be done at any **TATA MOTORS** Authorised Dealer Workshop, **TATA MOTORS** Authorised Service Centre (TASC) or **TATA MOTORS** Authorised Service Point (TASP). The details of their locations are given in this manual.

Warranty claims can be settled by any **TATA MOTORS** Authorised Dealer for all failures, while all warranty claims excluding the consideration on the replacement of major aggregates, can be settled by any TASC which is authorised for handling warranty claims. TASPs will not handle warranty repairs.



SR. NO.	MAINTENANCE SCHEDULE OPERATIONS	FREQUENCY KM	FREQUENCY							
			5000-5500	15000- 15500	30000-30500	45000-45500	60000-60500	75000-75500	90000-90500	105000-105500
	<b>GENERAL</b>									
1	Wash the vehicle and Clean Condenser Fins	EVERY Service	•	•	•	•	•	•	•	•
2	Drain water from Fuel Filter Bowl (Diesel)	EVERY Service	•	•	•	•	•	•	•	•
3	Check and Top up Fluids (If required): Coolant, Brake Fluid, Battery Electrolyte, Wind Screen washer fluid	EVERY Service	•	•	•	•	•	•	•	•
4	Check fuel lines for leakage	EVERY Service	•	•	•	•	•	•	•	•
5	Check clutch pedal height and cable	EVERY Service	•	•	•	•	•	•	•	•
6	All standard checks as per job card	EVERY Service	•	•	•	•	•	•	•	•
7	Check rubber boots and bushes for damages and replace, if required	30,000			•		•		•	
8	Check rubber hanger (Muffler) and replace, if damaged	EVERY Service	•	•	•	•	•	•	•	•
	<b>ENGINE (Quadraj et )</b>									
1	Clean air filter element (More frequently for vehicle operating in severe condition)	15,000	•	•	•		•	•		•
2	Change engine oil and Oil filter. (15,000 Kms or 12 months, whichever is earlier)	15,000		•	•	•	•	•	•	•
3	Check for the DTCs in the "Engine Control Unit". Take corrective action, if required	15,000	•	•	•	•	•	•	•	•
4	Change fuel filter	15,000		•	•	•	•	•	•	•
5	Replace air filter element (More frequently for vehicle operating in severe condition)	45,000				•			•	
6	Change coolant (60,000 Kms or 24 months, whichever is earlier)	60, 000					•			
7	Replace Timing chain (For Quadraj et 90 PS only)	60, 000					•			

SR. NO.	MAINTENANCE SCHEDULE OPERATIONS	FREQUENCY KM	FREQUENCY							
			5000-5500	15000- 15500	30000-30500	45000-45500	60000-60500	75000-75500	90000-90500	105000-105500
<b>ENGINE (REVOTRON 1.2T)</b>										
1	Clean air filter element (More frequently for vehicle operating in severe condition)	15,000	•	•	•		•	•		•
2	Replace air filter element (More frequently for vehicle operating in severe condition)	45,000				•			•	
3	Change engine oil and oil filter (15,000 Kms or 12 months, whichever is earlier)	15,000		•	•	•	•	•	•	•
4	Change fuel filter	30,000			•		•		•	
5	Check accessory drive belts for tension, wear or damage & replace if required	15,000		•	•	•		•	•	•
6	Replace accessory drive belts	60, 000					•			
7	Change coolant (60,000 Kms or 24 months, whichever is earlier)	60, 000					•			
8	Replace timing belt (1,05,000 Kms or 60 months, whichever is earlier)	1,05,000								•
9	Replace Spark Plugs	30,000			•		•		•	
10	Check Valve Clearance (At ambient temperature) and adjust, if necessary	30,000			•		•		•	
<b>TRANSAXLE</b>										
1	Check oil level and top up if necessary (Quadrajel with C549)	75,000						•		
2	Change oil (Revotron with TA 65°)	15,000		•	•	•	•	•	•	•
<b>BRAKES</b>										
1	Check front brake pads & rear brake linings. Replace, if required	15,000		•	•	•	•	•	•	•
2	Replace brake fluid (45,000 Kms or 24 months, whichever is earlier) Check brake system components for leakage	45,000				•			•	
3	Check parking brake adjustment	15,000		•	•	•	•	•	•	•

SR. NO.	MAINTENANCE SCHEDULE OPERATIONS	FREQUENCY KM	5000-5500	15000- 15500	30000-30500	45000-45500	60000-60500	75000-75500	90000-90500	105000-105500
	<b>WHEELS &amp; TYRES</b>									
1	Rotate tyres	15,000		•	•	•	•	•	•	•
	<b>FRONT &amp; REAR SUSPENSION</b>									
1	Check and adjust Wheel Alignment and Balancing	15,000		•	•	•	•	•	•	•
	<b>ELECTRICAL</b>									
1	Check headlamp focusing and adjust, if required	30,000			•		•		•	
	<b>A.C. SYSTEM</b>									
1	Check Airconditioning/HVAC System for satisfactory performance, Clean A/c Filter	EVERY Service	•	•	•	•	•	•	•	•

**FUEL (DIESEL) :**

Normal grade BS IV compliant diesel conforming to IS1460 or EN 590 or equivalent is recommended to be used as fuel.

Do not use premium diesels available in the market for **example extra premium / Turbojet etc.**

**Recommended Fuel Specification.**

Parameter	Unit	BS IV
Cetane Number (min)	CN	51
Sulphur content mg/kg	3	50
Lubricity (HFRR) micron		460

**NOTICE**

*Where oxidation catalytic converter is fitted, it is mandatory to use Diesel fuel with sulphur contents as given above. Use of any other diesel fuel can increase the pollutants.*

At very low temperature, fluidity of diesel may become insufficient due to paraffin separation. It is therefore necessary to mix supplementary fuel with summer or winter grade diesel. The supplementary fuel to be used is kerosene or aviation turbine fuel. Ratio for mixing of supplementary fuel and diesel are shown in the table.

Ambient Temperature upto Deg C.	Percentage	
	Summer grade diesel	Supplementary fuel
Upto 0	100	0
0 to -10	70	30
-10 to -15	50	50

Care should be taken that diesel and supplementary fuel are thoroughly mixed before filling.

Ambient Temperature upto Deg C.	Percentage	
	Winter grade diesel	Supplementary fuel
Upto -15	100	0
-15 to -20	70	30
-20 and below	50	50

**⚠ WARNING**

Do not mix gasoline or alcohol with diesel. This mixture can cause an explosion.

**FUEL (PETROL) :**

Unleaded regular grade petrol conforming to IS 2796:2008 and BS IV specification and RON not less than 91 is recommended. It is always recommended to use correct fuel to get optimum emission performance.

**NOTE**

*Always use petrol of a correct specification in a vehicle fitted with catalytic converter. Even single fill of leaded petrol will seriously damage the catalytic converter.*

**LUBRICANTS :**

**Engine oil :** Recommended grade of engine oil conforming to 5W30 A5/B5 specification and range of ambient temperature at which these can be used are given in the table below :

Ambient temp. in deg.C	Engine oil grade
-10 deg. & above	SAE 20W/40 or SAE 20W/50
-15 deg. to 40 deg.	SAE 15W/40 or SAE 15W/50
-20 deg. to 40 deg.	SAE 10W/40 or SAE 10W/50
-35 deg. to 40 deg.	SAE 5W/30

**Brand names :** As per chart given in the manual.

**Transaxle :** Use recommended brand of 80W API GL-4 gear oil (REVOTRON 1.2T) and Semi-synthetic SAE 75W80 (Quadrajel).

**Grease for axle bearings :** Lithium base grease IPOL IPLEX LC Grease 2

**Brake fluid :** SAE J 1703, DOT 4

**COOLANTS :**

Presence of dirt in coolant chokes up passages in radiator, cylinder head and crankcase, thereby causing overheating of engine.

To prevent rust formation and freezing of coolant inside the passages of radiator, crankcase and cylinder head use premixed coolant as recommended. It is recommended that the entire cooling system should be drained and filled with fresh premixed coolant.

Engine coolant antifreeze coolant as per class II, JIS K2234

**Windscreen Washer Antifrost**

Make - Antifrost- K  
 Concentration - 1 : 5 For 0°C  
                           1 : 1 For 10°C  
                           2 : 5 For 16°C  
                           1 : 0 For 37°C

**NOTE :** We strongly recommend to refill your vehicle's engine coolant only at a TATA Authorised service centre.

**PLEASE USE FOLLOWING GENUINE FLUIDS, COOLANTS AND LUBRICANTS  
RECOMMENDED BY TATA MOTORS FOR OPTIMUM PERFORMANCE OF YOUR VEHICLE**

ITEM	SPECIFICATION	COMPANY AND BRAND	QTY
ENGINE OIL (REVOTRON 1.2T)	ACEA 5W30 A5/B5	CASTROL Magnatec Professional T 5W30	4.0 Litres
ENGINE OIL (QUADRAJET)		PETRONAS- Syntium 5000 TM 5W30	3.2 Litres
COOLANT (Pre-mixed) (Antifreeze agent + Soft water 50 : 50 ratio)	Class II/JIS K2234 TATA SS7700	SUNSTAR CCI - Golden Cruiser LLC 2200NP IOCL - Servo Cool TM Plus ANSYSCO - Puroblue	6.0 Litres (Revotron 1.2T) 7.5 Litres (Quadrajt)
TRANSAXLE (REVOTRON 1.2T)	Monograde SAE 80 W API GL4	HPCL - HP Gear Oil EP 80 CASTROL - HYPOY 80 EPT	1.8 Litres
TRANSAXLE (QUADRAJET)	Semi-Synthetic SAE 75W80	PETRONAS Tutela ZC75FF	2.2 Litres
BRAKE / CLUTCH FLUID	SAE J 1703, DOT 4	PETRONAS- Tutela - TOP 45 DOT 4 CASTROL - UBF DOT 4 (Optional)	As required

**TECHNICAL SPECIFICATION :**

<b>PARAMETER</b>	<b>ZEST DIESEL</b>		<b>ZEST PETROL</b>
<b>ENGINE</b>	<b>1.3L FIAT SDE 75 PS</b>	<b>1.3L FIAT SDE 90PS</b>	<b>REVOTRON 1.2T</b>
Type	1.3L SDE TURBO INTERCOOLED DIESEL	1.3L SDE TURBO INTERCOOLED DIESEL	Gasoline 4-stroke turbocharged intercooled MPFI, with 2 valves per cylinder.
Bore / Stroke (mm)	69.6 X 82		75 X 67.5
No. of cylinders	4 inline		
Capacity	1248 CC		1193 CC
Max. Engine Output	75 PS @ 4000 RPM	90PS @ 4000 RPM	90PS @ 5000 RPM
Max. Torque	190 Nm @1750-3000 RPM	200 Nm @1750-3000 RPM	140 Nm @ 1750-3500 RPM
<b>CLUTCH</b>	<b>1.3L FIAT SDE 75 PS</b>	<b>1.3L FIAT SDE 90PS</b>	<b>REVOTRON 1.2T</b>
Type	Single plate dry friction diaphragm type		
<b>TRANSAXLE</b>	<b>1.3L FIAT SDE 75 PS</b>	<b>1.3L FIAT SDE 90PS</b>	<b>REVOTRON 1.2T</b>
Model	EVO-2		TA65*
Type	Synchromesh with overdrive		
No. of gears	5-Forward,1-Reverse		
<b>STEERING</b>	<b>1.3L FIAT SDE 75 PS</b>	<b>1.3L FIAT SDE 90PS</b>	<b>REVOTRON 1.2T</b>
Type	Electric Power Assisted Steering ( Column mounted)		
<b>BRAKES</b>	<b>1.3L FIAT SDE 75 PS</b>	<b>1.3L FIAT SDE 90PS</b>	<b>REVOTRON 1.2T</b>
Service Brakes	Vacuum assisted independent dual circuit diagonal split hydraulic brakes through tandem master cylinder (Front : Disc brake & Rear : Drum brake)		

Parking Brake	Lever type console mounted cable operated mechanical linkages acting on rear wheels		
<b>SUSPENSION</b>	<b>1.3L FIAT SDE 75 PS</b>	<b>1.3L FIAT SDE 90PS</b>	<b>REVOTRON 1.2T</b>
Front	Independent lower wishbone McPherson strut with coil spring		
Rear	Semi independent, twist beam with coil spring and shock absorber		
<b>WHEELS &amp; TYRE</b>	<b>1.3L FIAT SDE 75 PS</b>	<b>1.3L FIAT SDE 90PS</b>	<b>REVOTRON 1.2T</b>
Tyres	185 / 60 R15		
Wheel Rims	5.5 J x 15"		
<b>FUEL TANK</b>	<b>1.3L FIAT SDE 75 PS</b>	<b>1.3L FIAT SDE 90PS</b>	<b>REVOTRON 1.2T</b>
Capacity	44 liters		
<b>CAB/BODY</b>	<b>1.3L FIAT SDE 75 PS</b>	<b>1.3L FIAT SDE 90PS</b>	<b>REVOTRON 1.2T</b>
Type	Compact Sedan, Five Door, Steel monocoque body, Passenger vehicle		
<b>ELECTRICAL SYSTEM</b>	<b>1.3L FIAT SDE 75 PS</b>	<b>1.3L FIAT SDE 90PS</b>	<b>REVOTRON 1.2T</b>
System Voltage	12 Volts (-ve earth)	12 Volts (-ve earth)	12 Volts (-ve earth)
Alternator Capacity	12V, 110 Amp	12V, 110 Amp	12V, 90 Amp
Battery	12V, 47.5 Ah	12V, 47.5 Ah	12V, 44 Ah



<b>MAIN CHASSIS DIMENSION (IN MM)</b>			
Wheel Base	2470		
Track Front	1450		
Track Rear	1440		
Overall Length	3995		
Overall Height	1570		
Max. width	1706		
Ground Clearance	175		
<b>PERFORMANCE</b>	<b>1.3L FIAT SDE 75 PS</b>	<b>1.3L FIAT SDE 90PS</b>	<b>REVOTRON 1.2T</b>
Max. speed	150 kmph	158 kmph	155 kmph
Max. recommended gradeability	7.1 <sup>o</sup>	17.2 <sup>o</sup>	14.5 <sup>o</sup>
Minimum Turning Circle Dia in mm as per IS:12222	10200		
Minimum Turning circle Clearance dia. In mm as per IS:12222	10900		
<b>WEIGHT (IN KG)</b>	<b>1.3L FIAT SDE 75 PS</b>	<b>1.3L FIAT SDE 90PS</b>	<b>REVOTRON 1.2T</b>
Gross Vehicle Weight	1602 (XE) ,1605 (XM / XMI),1617 (XMS),1620 (XT) 1620 (XMA),1635 (XTA)		1565(XE) ,1572 (XM / XMI), 1582 (XMS),1585 (XT)
Kerb Weight(Unladen)	1152 (XE) ,1155 (XM / XMI), 1167 (XMS),1170 (XT) 1170 (XMA),1185 (XTA)		1115 (XE) ,1122 (XM / XMI), 1132 (XMS),1135 (XT)

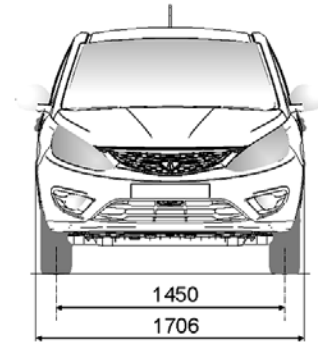
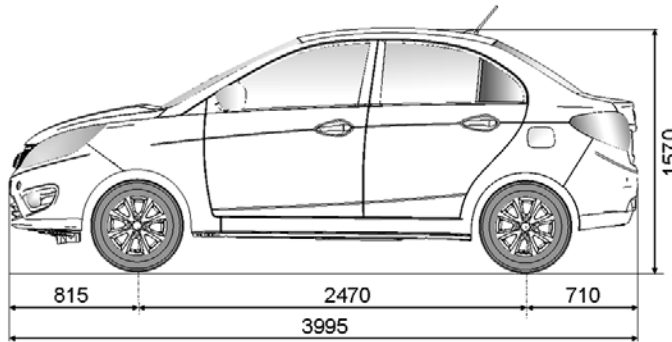

All vehicle dimensions are in mm (unladen condition)

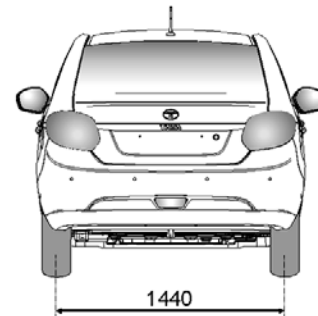
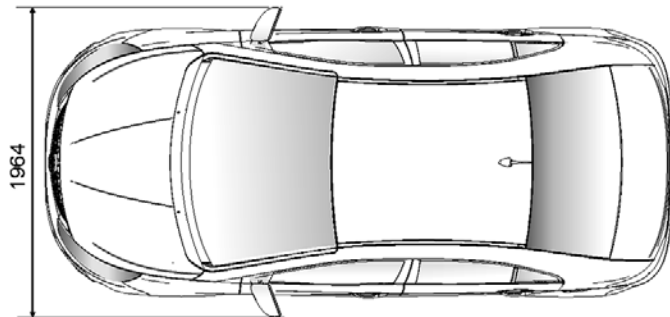



Chassis No. on 'B' pillar



Chassis No. below Driver's seat  
(If applicable)

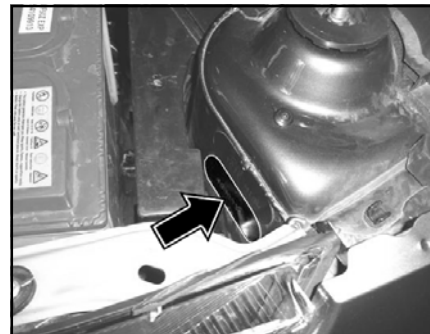

Cab No.

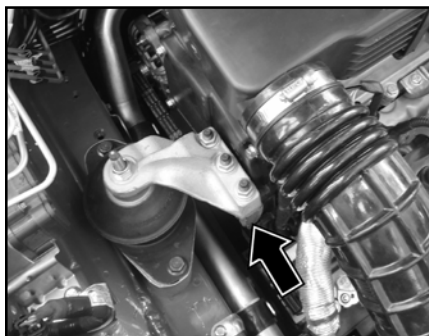

Engine Number (Revotron 1.2T)

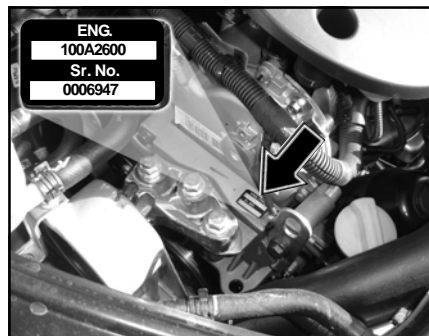

Engine Number (Quadrajets)

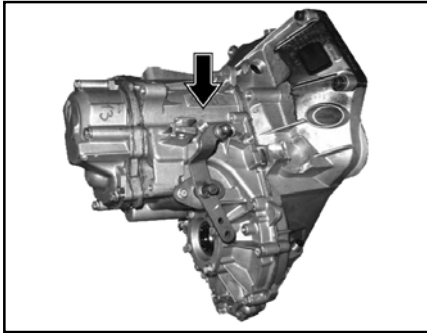

Transaxle No. (Quadrajets)

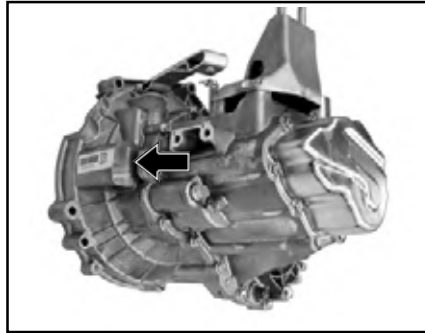

Transaxle No. (Revotron 1.2T)

**CAR CARE :**

Your vehicle is subjected to many external influences such as climate, road conditions, industrial pollution and proximity to the sea. These conditions demand regular care of the vehicle body. Dirt, insects, bird droppings, oil, grease, fuel and stone chippings should be removed as soon as possible.

**WASHING :**

***Following these tips while washing your vehicle.***

**HAND WASH :**

1. Always wash your vehicle in shade and the surface is at room temperature.
2. Wash with mild vehicle wash soap like 'Car Shampoo' and use a soft bristle brush, sponge or soft cloth and rinse it frequently while washing to avoid scratches.

3. To avoid scratches, please wear soft gloves . Remove finger rings, nails, wrist watch while washing.
4. To remove stubborn stains and contaminants like tar, use turpentine or cleaners like 'Stain remover' which are safe for paint surfaces.
5. Avoid substances like petrol, diesel, kerosene, benzene, thinner or other solvents that cause damage to paint.
6. Dry your vehicle thoroughly to prevent any damp spots.
7. Rinse all surfaces thoroughly to prevent any traces of soap and other cleaners as this may lead to the formation of stains on the painted surface later.

**⚠ WARNING**

Do not direct high pressure washer fluid/ water jets (Pressure above 0.5

Bar) at electrical devices and connector during wasing. This is to prevent malfunction / failure of electrical system due to water ingress.

After drying the vehicle, inspect it for chips and scratches that could allow corrosion to start. Apply touch up paint where necessary.

**Cleaning of Carpets :**

Vacuum clean the carpet regularly to remove dirt. Dirt will make the carpet wear out faster. Periodically shampoo the carpet to keep it looking new.

Use carpet cleaners (preferably foam type). Follow the instructions that come with the cleaner. Apply it with a sponge or soft brush. Keep the carpeting as dry as possible by not adding water to the foam.

**NOTE**

*Avoid wiping of painted surface in dry condition as it may leave scratches on the painted surface.*

**Cleaning of Windows, Front and Rear Glasses :**

Clean the windows inside and outside with commercially available glass cleaners.

This will remove the haze that builds up on the inside of windows. Use a soft cloth or paper towels to clean all glass and plastic surfaces.

RFID TAG is pasted on front windshield from the inside. It enables Electronic toll collection.



**DO NOT TRY TO PEEL OFF RFID TAG  
IT WILL BE PERMANENTLY DAMAGED.**

**NOTE**

*Do not attempt to rip or tamper the tag. It will disable the functionality of the tag.*

**WAXING :**

Waxing and polishing is recommended to maintain the gloss and wet-look appearance of your paint finish.

1. Use good quality polish and wax for your vehicle.
2. Re-wax your vehicle when the water does not slip off the surface but collects over the surface in patches.

**POLISHING :**

Polishes and cleaners can restore shine to the painted surface that has oxidised and become dull. They normally contain mild abrasives and solvents that remove the top layer of the finish coat. Polish your vehicle, if the finish does not regain its original shine after using wax.

**INTERIOR FABRIC CLEANING TIPS:**

1. Stains should be treated immediately. If left for a long time, they can leave a permanent mark.
2. Cleaning the stains immediately is important especially for stains which contain artificial colors in the stain creating liquid or semisolid substance. The colorant may leave a stain if kept for longer time.
3. Stain should not be removed by rubbing. As far as possible, try to blot or lift the stain with cloth or plastic spatula and then clean the remaining stain with cloth or sponge.
4. If the stain has dried, then gently brush off the material and then press with damp cloth or sponge till it disappears.
5. Do not use household detergents to clean the fabric.
6. Always use clean cotton cloth for cleaning.

**PAINT CARE :**

**FOLLOWING GUIDELINES WILL HELP YOU TO PROTECT YOUR VEHICLE FROM CORROSION EFFECTIVELY.**

**PROPER CLEANING :**

In order to protect your vehicle from corrosion it is recommended that you wash your vehicle thoroughly and frequently in case :

- There is an heavy accumulation of dirt and mud especially on the underbody.
- It is driven in areas having high atmospheric pollution due to smoke, soot, dust, iron dust and other chemical pollutants.
- It is driven in coastal areas.
- The underbody must be thoroughly pressure washed after every three months.

In addition to regularly washing your car, the following precautions need to be taken.

**PERIODIC INSPECTION :**

- Regularly inspect your vehicle for any damage in the paint film such as deep scratches and immediately get them repaired from an authorised service outlet, as these defects tend to accelerate corrosion.
- Inspect mud liners for damages.
- Keep all drain holes clear from clogging.

**PROPER PARKING :**

- Always park your vehicle in shade to protect it from harsh sunlight or in a well-ventilated garage so that there is no dampness on any part of the vehicle.

**WIPER CARE :**

Wiper blade attack angle on windshield glass should be 90° i.e. perpendicular.

Remove wiper blade and root wiper arm on windshield glass in the centre position. Check the gap between arm strip and glass.

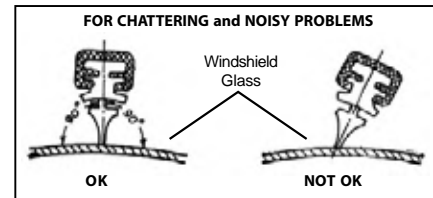

**VEHICLE PARKING AT ONE PLACE FOR LONG DURATION ( Non use maintenances) :**

***If you want to park your vehicle at one place for long duration, following care is to be taken :***

1. Park the vehicle in covered, dry and if possible well-ventilated premises. Engage a gear.
2. Remove the battery terminal cables (first remove the cable from the negative terminal).
3. Block the wheel or engage in the gear mode.
4. Clean and protect the painted parts using protective wax.
5. Clean and protect the shiny metal parts using commercially available special compounds.
6. Sprinkle talcum powder on the rubber windscreen wiper and lift them off the glass.
7. Slightly open the windows.
8. Cover the vehicle with a cloth or perforated plastic sheet. Do not use sheets of imperforated plastic as they do not allow moisture on the vehicle body to evaporate.
9. Inflate the tyres to 0.5 bar above the normal specified pressure and check it at regular intervals.
10. Check the battery charge every six weeks.
11. Do not drain the engine cooling system.



## VALUE ADDED SERVICE

**TATA MOTORS** recommends the purchase of its Extended warranty program.

**Coverage :** Mechanical + Electrical

**Benifits :**

- Insures you against unforeseen break down repair bills.
- Documentation is simple and hassle free.
- Near cashless & speedy claim settlement.

**Term :**

- **36 + 12 months or 150000 kms** whichever occurs first

**Extended Warranty is** available in the dealership from where you have purchased your vehicle. We strongly recommend purchase of Extended Warranty at time of purchase of your vehicle. **Extended Warranty can be availed till 421 days from date of purchase of vehicle.** The Dealer Service Marketing Executive shall explain to you the Terms and conditions, Coverage and Owner's responsibility.

### Extended Warranty Booklet & Cover Note :

The Extended Warranty booklet and cover note is the basis of the contract between **TATA MOTORS LIMITED** and the Owner of the vehicle shown on the Extended Warranty booklet. The Customer is to retain this booklet and the same to be produced to the dealer while claiming benefits under Extended Warranty.



**Note :**

- The 12 months extended warranty does not follow the 36 months Manufacturer's warranty.
- The extended warranty comes into force once the manufacturer's warranty expires e.g. after 36 Months.
- It is more restrictive as by the time it comes into force the vehicle is already 36 months old.

**What is covered ?**

- Mechanical / Electrical break down as defined in this warranty and confirmed by the dealer within the stipulated terms and conditions.
- Tata Motors dealer shall either repair or replace any part found to be defective with a new part or an equivalent at no cost to the owner for parts or labour.
- Such defective parts which have been replaced will become property of **TATA MOTORS LIMITED**.
- Comprehensive list of parts covered is mentioned in the page 9-12 of the Extended Warranty Booklet.

**What is not covered ?**

Please refer the Extended Warranty Booklet for details of the exclusion list.

**Owner's Responsibility :**

- Proper use, maintenance and care of the vehicle in accordance with the instructions contained in the Owner's Manual and Service Booklet. The records of the same to be ensured in Owner's Manual.
- Retention of maintenance service bills.

---

I / We have been explained the Terms and conditions, Coverage and Owner's responsibility by the Dealer Service Marketing Executive.

I wish to avail /  Do not wish to avail extended warranty policy.

---

Customer's Sign

---

Dealer's Sign

**Why are Corrosion Protection Waxes necessary?*****Corrosion is caused by:***

Water / salt water acid rain & atmospheric fallouts.

***Critical areas are:***

Cavities: joints, crevices, spot welds, underbody

- Corrosion is the most important factor when we talk about the vehicle life. If you treat your car you can prolong the life.
- It is very dangerous to drive around in a corroded vehicle.
- The corrosion creeps onto the vehicle from the inside and from the outside. The most dangerous kind of corrosion is often not discovered until it is too late.

***Benefits of Anti -Rust treatment :***

- A professionally applied range of world class products offering real value to the new and used vehicle customer.
- The treatment has been developed to withstand the harshest environmental and climatic conditions (rust, Pollutants, stone and gravel impact, etc)
- Insulate cabin space from external noises.
- Expensive tin work and Denting / Painting avoided.
- Higher resale value for the vehicle.
- Higher safety – uncorroded vehicle
- 10 free checkups available



**Engine Wax Treatment :**

Engine Wax is a beige coloured transparent lacquer coating on the engine compartment.

- Corrosion Prevention for the Engine compartment
- Neat, clean and New Look to Engine compartment
- No effect on MPFI vehicles
- Engine wax can withstand upto 200 degrees temp
- No need of cleaning the engine compartment with diesel once engine wax is sprayed
- Life of over a year

**Sound Deadening System :**

Door vibration deadeners - These pads when stuck on the insides of the sheet metal increase sheet metal rigidity, reduce vibrations and increase riding comfort.

- Used for reducing the sheet metal vibration in a vehicle.
- Product to be used once in the life of the vehicle - Life Time Warranty
- Effect is Life long i.e. until & unless pads are physically removed.
- Negligible increase in Weight & hence no effect on fuel consumption.
- Areas covered - four doors, rear quarter panels & dicky. In case of diesel vehicles, can be used in the bonnet.

**TATA MOTORS** has tied up with **M/s Wuerth , M/s Autokrom, M/s 3M India Ltd & M/s Bardahl** for these world class treatment at affordable prices. These treatments are available in all authorized workshops. The Dealer Service Marketing Executive will explain to you the benefits and terms and conditions of this treatment.

---

I / We have been explained the Benefits, Terms and conditions and the prices of these treatments by the Dealer Service

Marketing Executive

I wish to avail /  Do not wish to avail these treatment

\_\_\_\_\_  
Customer Signature

\_\_\_\_\_  
Dealer Signature

**Vehicle Exterior Enrichment :*****Why vehicles are painted?***

- For Corrosion protection of the metal surfaces.
- Ease of application from other corrosion protection treatments.
- Cheaper than other corrosion protection methods eg.galvanizing, anodizing.
- For decoration and identification.

**Various Environmental Hazards affecting paints :**

- Environmental hazards: destroy your vehicle's finish.
- Even as your new vehicle rolls off the assembly line, the paint is not protected.

**The enemy :**

Ultraviolet Rays, Pollution, Tree Sap, Bird Droppings, Car Wash Chemicals, Road Salt, Acid Rain.

**Benefits:** Vehicle Exterior Enrichment

- Removal of medium scratches, orange peel, oxidation , dust nibs etc & swirl marks from painted surface.
- Restoration of original gloss levels, UV protection after gloss is restored.
- Cleaning & dressing of tyres, Bumpers & all exterior plastic moldings/trims.

**Tata Motors** has tied up with **M/s Autokrom, M/s 3M & M/s Wuerth** for this world class treatment at affordable prices. This treatment is available in all authorized workshops. The Dealer Service Marketing Executive will explain to you the benefits and terms and conditions of this treatment.



## Vehicle Interior Enrichment

### *Why protect your new car's fabric interior ?*

- Someone will soil your vehicle's fabric carpet or seats.
- A significant detractor from your vehicle's resale value.
- A permanent stain on your vehicle's interior fabric.

### **The enemy :**

Drink Spills - Food Stains - Mud - Ultraviolet Rays Pets - Traffic

### **Benefits:** Vehicle Interior Enrichment

- Removal of medium stains and dirt from all interior parts of the car i.e carpet, upholstery and roof lining.
- Cleaning of windshield and all windows (inside and outside)
- Dressing of all internal plastics (eg: door pad trims )and rubber parts.
- The treatment involves cleaning and dressing of All parts of the exposed interiors.
- Specialised protection for seat fabric from liquid spills.

**TATA MOTORS** has tied up with **M/s Wurth and M/s M/s Autokrom** for this world class treatment at affordable prices. This treatment is available in all authorized workshops. The Dealer Service Marketing Executive will explain to you the benefits and terms and conditions of this treatment.

---

I / We have been explained the Terms and conditions, Coverage and Owner's responsibility by the Dealer Service Marketing Executive.

I wish to avail /  Do not wish to avail extended warranty

---

**Customer's Sign**

---

**Dealer's Sign**

### Why de-carbonisation is required in Diesel engines?

Carbon deposits accumulate over time in injector pump, fuel injectors, combustion chambers & intake valves. This causes rough idle, vibration at idle, loss of power, hesitation, misfire, decreased mileage, increased smoke, slowed throttle response.

Decarbonisation process is designed to remove these deposits

- Clean fuel injectors
- Clean throttle body
- Clean plenum and air-intake
- Clean intake valves and ports
- Remove combustion chamber deposits
- In maintaining correct balance of fuel and air in system



### Resulting in

- Comprehensive clean-up of combustion chamber, induction system & fuel injector deposits
- Better fuel economy
- Increased engine performance and response
- Smooth Starts, idles and quieter run
- Better combustion & increased power
- Faster starting & warm-up
- Reduced emissions
- Reduced injector & pump wear, thereby resulting in savings in maintenance costs

It is approved for low sulphur diesel fuel and EGR equipped diesel engines

**Please note:** These are symptomatic treatments to be availed beyond 20000 kms and only when you have problems in your car as mentioned in first paragraph and are to be done only after **you give your consent** for carrying out these treatments

**Engine Flush treatment helps in**

- Safely and effectively cleaning and removing oxidised particles and fluid contamination left behind from previous oil changes
- Preventing further deposits
- Freeing sticky lifters and rings
- Chemically “tuning” the engine during driving
- Restoring pep and power
- Removing sludge from valve train
- Promoting fuel economy and improving overall engine operation

**Special Products used for improving Compression**

To fortify new oil and seal rings for optimum performance, special products from BG (RF7) and Bardhal (Special Duty) are added to new engine oil. This makes it suitable for petrol and diesel engine applications

**Resulting in:**

- Improved engine compression
- Increased power and increased fuel economy
- Reduced start-up wear
- Increased engine life, especially under severe service conditions
- Reduced emissions and oil consumption
- Improved power & performance of older engines
- Prevention of sludge, gum and varnish formation on engine parts both petrol & diesel engines

**Please note:** These are symptomatic treatments to be availed beyond 20000 kms and only when you have problems in your car as mentioned in first paragraph and are to be done only after you give your consent for carrying out these treatments

Tata Motors has tied up with **M/s HOEC Bardahl India Ltd and M/s BG** for these world class treatment at affordable prices. These treatments are available in all authorized workshops. The Dealer Service Marketing Executive will explain to you the benefits and terms and conditions of this treatment.

---

I / We have been explained the Benefits, Terms and conditions and the prices of these treatments by the Dealer Service

Marketing Executive

I wish to avail /  Do not wish to avail these treatment

---

**Customer's Sign**

---

**Dealer's Sign**



We WARRANT each **TATA ZEST** vehicle and parts thereof manufactured by us to be free from defect in material and workmanship subject to the following terms and conditions:

1. This warranty shall be for a period of **36 months from the date of sale of the car or a mileage of 100000 Kms whichever occurs earlier.**
2. Our obligation under this warranty shall be limited to repairing or replacing, free of charge, such parts of the car which, in our opinion, are defective, on the car being brought to us or to our dealers within the period. The parts so repaired or replaced shall also be warranted for quality and workmanship but such warranty shall be co-terminus with this original warranty.
3. Any part which is found to be defective and is replaced by us under the warranty shall be our property.
4. As for such parts as Tyres, Batteries, Audio and / or Video equipment (if any), etc. not manufactured by us but supplied by other parties, this warranty shall not apply, but buyers of the car shall be entitled to, so far as permissible by law, all such rights as we may have against such parties under their warranties in respect of such parts.
5. This warranty shall not apply if the car or any part thereof is repaired or altered otherwise than in accordance with our standard repair procedure or by any person other than from our sales or service establishments, our authorized dealers, service centres or service points in any way so as, in our judgment which shall be final and binding, to affect its reliability, nor shall it apply if, in our opinion which shall be final and binding, the car is subjected to misuse, negligence, improper or inadequate maintenance or accident or loading in excess of such carrying capacity as certified by us, or such services as prescribed in our Owner's Manual are not carried out by the buyer through our sales or service establishments, our authorized dealers, service centres or service points.
6. **This warranty shall not apply to the replacement of normal wear parts, including without limitation, spark plugs, drive belts, hoses, wiper blades, fuses, clutch disc, brake shoes, brake pads, cables and all rubber parts (except oil seal and glass run).**
7. This warranty shall not cover any inherent normal deterioration of the car or any of its parts arising from the actual use of the car or any damage due to negligent or improper operation or storage of the car.
8. This warranty shall not apply to normal maintenance services like oils & fluid changes, head lamps focusing, fastener retightening, wheel balancing and alignment,

- tyre rotation, adjustment of valve clearance, fuel timing, ignition timing and consumables like bulbs, fuel, air & oil filters and gas leaks in case of air conditioned cars.
9. This warranty shall not apply to any damage or deterioration caused by environmental pollution or bird droppings. Slight irregularities not recognized as affecting the function or quality of the vehicle or parts, such as slight noise or vibration, defects appearing only under particular or irregular operations are items considered characteristics of the vehicle.
  10. This warranty shall be null and void if the car is subjected to abnormal use such as rallying, racing or participation in any other competitive sport. This warranty shall not apply to any repair or replacements as a result of accident or collision.
  11. This warranty is expressly in lieu of all warranties, whether by law or otherwise, expressed or implied, and all other obligations or liabilities on our part and we neither assume, nor authorize any person to assume on our behalf, any other liability arising from the sale of the car or any agreement in relation thereto.
  12. The buyer shall have no other rights except those set out above and have, in particular, no right to repudiate the sale, or any agreement or to claim any reduction in the purchase price of the car, or to demand any damages or compensation for losses, incidental or indirect, or inconvenience or consequential damages, loss of car, or loss of time, or otherwise, incurred or accrued.
  13. Any claim arising from this warranty shall be recognized only if it is notified in writing to us or to our authorized dealer without any delay soon after such defects as covered & ascertained under this warranty.
  14. **This warranty is fully transferable to subsequent vehicle owner. Only unexpired remaining period of warranty applies.**
  15. We reserve our rights to make any change or modification in design of the car or its parts or to introduce any improvement therein or to incorporate in the car any additional part or accessory at any time without incurring any obligation to incorporate the same in the cars previously sold.

**TATA MOTORS**

**TATA MOTORS LTD.** is committed to produce vehicles using environmentally sustainable technology. A number of features have been incorporated in Tata Motors passenger vehicles which have been designed to ensure environmental compatibility throughout the life cycle of the vehicle. We would like to inform you that your vehicle meets emission norms and this is being regularly validated at the manufacturing stages.

As a user you too can protect the environment by operating your vehicle in a proactive manner. A lot depends on your driving style and the way you maintain your vehicle. We have given a few tips for your guidance.

### DRIVING

- Avoid frequent and violent acceleration.
- Do not carry any unnecessary weight in the vehicle as it overloads the engine. Avoid using devices requiring high power consumption during slow city traffic condition.
- Monitor the vehicle's fuel consumption regularly and if showing rising trend get the car immediately attended at the Company's Authorised Service Outlets.
- Switch off the engine during long stops at traffic jams or signals. If you need to keep the engine running, avoid unnecessary revving it up or stopping and starting.
- It is not necessary to rev up the engine before turning it off as it unnecessarily burns the fuel.
- Shift to higher gears as soon as it is possible. Use each gear upto 2/3<sup>rd</sup> of its maximum engine speed. A chart indicating gear shifting speeds is given in this book.

### MAINTENANCE

- Ensure that recommended maintenance is carried out on the vehicle regularly at the Authorised Service Outlets.
- As soon as you see any leakages of oil or fuel in the vehicle we recommend to get it attended immediately.
- Use only recommended grades and specified quantity of lubricants.
- Get your vehicle checked for emission periodically by an authorised dealer

- Ensure that fuel filter, oil filter and breather are checked periodically and replaced, if required, as recommended by **TATA MOTORS**.
- Do not pour used oils or coolants into the sewage drains, garden soil or open streams. Dispose the used filters and batteries in compliance with the current legislation.
- Do not allow unauthorised person to tamper with engine settings or to carry modifications on the vehicle.
- Never allow the vehicle to run out of fuel.
- Parts like brake liners, clutch discs should be vacuum cleaned. Do not use compressed air for cleaning these parts which may spread dust in the atmosphere.
- **While carrying out servicing or repairs of your vehicle, you should pay keen attention to some of the important engine aggregates and wiring harness which greatly affect emission. These components are :**
  1. Fuel injection equipments - pump & Injectors.
  2. Air Intake & Exhaust system, especially for leakages.
  3. Cylinder head for valve leakage.
  4. All filters such as air, oil and fuel filters (check periodically).
  5. Turbocharger
  6. Electrical connections
  7. If the 'Service' lamp continuously glows, please take the vehicle to a **TATA MOTORS** authorized service outlet.
  8. Catalytic Converter
  9. EMS wiring harness i.e. electrical connections to all sensors and actuators.

This Owner's manual contains further information on driving precautions and maintenance care leading to environment protection. Please familiarise yourself with these aspects before driving.

<b>A</b>	
Advance Warning Triangle	96
Air Vents & Distribution	62
Anti-lock Braking System	22
Anti-theft Device - Immobilizer	18
<b>B</b>	
Battery	132
Bonnet	32
Brake Fluid Level	125
Brakes & Braking	90
Bulb Specifications & Bulb Replacement	111
<b>C</b>	
Car Care	149
Child lock	17
Cockpit	34
Combination Switch	51
Coolant Specification	141
Cup Holders	59
<b>D</b>	
Doors	29
Drive Modes	88
Driver Information Display	39
Driving in Adverse Conditions	23

<b>E</b>	
Engine Compartment	123
Engine Coolant Level	126
Engine Oil Level	125
Environment Safety	164
<b>F</b>	
Fascia Switches	55
FATC - Fully Automatic Temp. Control	67
First Aid Kit	96
Flat Tyre Replacement	98
Fuel Lid	33
Fuel Saving Tips	76
Fuel Specification	140
Fuses	105
<b>G</b>	
Gear Lever & Shifting Pattern	84
Glove Box	59
Good Driving Practices	77
<b>H</b>	
Hazard Warning Switch	95
<b>I</b>	
Identification Plates	147
Important Safety Notes	9
Infotainment System	57

Instrument Cluster	35
Instruments (Gauges)	37
Interior Fabric Cleaning	150
<b>J</b>	
Jack & Handle	97
Jump Lead Start	101
<b>K</b>	
Key	25
Keyless Entry - E Key Operation	25
<b>L</b>	
Lubricants & Coolant Co-branding	142
Lubricants Specification	141
Luggage Compartment Lamp	58
Luggage Compartment	61
Luggage Cover	61
<b>M</b>	
Manual HVAC	63
<b>O</b>	
On Board Diagnostic (OBD)	134
On Road Assistance	118
<b>P</b>	
Paint Care	151
Parking Brake	91

Polishing	150
Power Socket	60
Pre-driving Checks	74
Preparing to drive	82
<b>R</b>	
Rear View Mirrors	80
Remote Battery	133
Reverse Park Assist	92
Roof Grab Handle	60
Roof Lamp	58
Routine Service	135
Running-In Period	77
<b>S</b>	
Safety Checks	75
Safety Guidelines	9
Seat & Seat Adjustments	78
Seat Belts	10
Service Schedule	137
Spare Wheel	98
Spark Plug (Petrol Engine)	128
Steering Lock cum Ignition Switch	83
Steering Wheel Switches	57
Steering Wheel Angle Adjustment	82

Sun Visors	81
Supplemental Restraint System - Air Bags	20
<b>T</b>	
Technical Specifications	143
Tell tales (Indicators)	46
Tool Kit	97
Towing The Vehicle	103
Transaxle Oil Level	127
Trunk lid	33
Tyres	129
<b>U</b>	
Utility Tray & Pockets	59
<b>V</b>	
Value Added Services	153
Vehicle Dimensions	146
Vehicle Parking For Long Duration	152
Vehicle Parking	91
Vehicle Service	136
<b>W</b>	
Warranty-Terms & Conditions	162
Washing	149
Waxing	150

Window Glasses	30
Windshield Washer Fluid Level	127
Wiper Care	151