

QUICK REFERENCE GUIDE



Mirai

2020

2020

MIRAI

This Quick Reference Guide is a summary of basic vehicle operations. It contains brief descriptions of fundamental operations so you can locate and use the vehicle's main equipment quickly and easily.

The Quick Reference Guide is not intended as a substitute for the Owner's Manual located in your vehicle's glove box. We strongly encourage you to review the Owner's Manual and supplementary manuals so you will have a better understanding of your vehicle's capabilities and limitations.

Your dealership and the entire staff of Toyota Motor North America, Inc. wish you many years of satisfied driving in your new Mirai.

A word about safe vehicle operations

This Quick Reference Guide is not a full description of Mirai operations. Every Mirai owner should review the Owner's Manual that accompanies this vehicle.

Pay special attention to the boxed information highlighted in color throughout the Owner's Manual. Each box contains safe operating instructions to help you avoid injury or equipment malfunction.

All information in this Quick Reference Guide is current at the time of printing. Toyota reserves the right to make changes at any time without notice.

INDEX

OVERVIEW

Fuel door release button & cap	8
Indicator symbols	4-5
Instrument cluster	4
Instrument panel	2-3
Instrument panel light control	8
Keyless entry ^{1,2}	6-7
Smart Key System ^{1,2}	7

HYDROGEN FUEL CELL SYSTEM & SAFETY FEATURES

Hydrogen Fuel Cell System	9-11
Water release (H ₂ O) switch	12

FEATURES & OPERATIONS

Audio	22
Auto lock/unlock ^{1,2}	13
Air conditioning/heating	20
Automatic transmission	14-15
Blind Spot Monitor with Rear Cross Traffic Alert (BSM w/RCTA)	28
Clock	19
Door locks	15
Front and Rear Parking Assist with Automated Braking	27
Garage door opener (Homelink ^{®3})	27
Intuitive parking assist	26
Lights ¹ & turn signals	18
Luggage security system	19
Multi-Information Display (MID)	25
Parking brake	13
Power outlet-12V DC	21
Qi wireless charger	23
Rear view monitor system	29
Seat adjustments-Front	16
Seat heaters	21
Seats-Head restraints	16
Steering wheel-Heater	18
Steering wheel switches & telephone controls (Bluetooth [®])	24

FEATURES & OPERATIONS (continued)

Tilt & telescopic steering wheel	15
USB charge-ports	21
USB media/AUX port	22
Vehicle Stability Control (VSC)/TRAC OFF switch	29
Windows-Power	17
Windshield wipers & washer	17

TOYOTA SAFETY SENSE™ 2.0 (TSS 2.0)

Automatic High Beams (AHB)	41
Dynamic Radar Cruise Control (DRCC)	38-40
Lane Departure Alert with Steering Assist (LDA w/SA)	34-37
Pre-Collision System with Pedestrian Detection (PCS w/PD)	31-33
Quick overview-	
Toyota Safety Sense™ 2.0 (TSS 2.0)	30
Road Sign Assist (RSA)	42
Sensors	31

SAFETY & EMERGENCY FEATURES

Emergency tire puncture repair kit	44
Floor mat installation	47
Rear door child safety locks	43
Safety Connect [®]	43
Seat belts	45
Seat belts-Shoulder belt anchor	45
Star Safety System™	46-47
Tire Pressure Monitoring (warning) System (TPMS)	44
Trunk-Internal release	45

BLUETOOTH® DEVICE PAIRING SECTION

¹ Visit your Toyota dealer for information on customizing this feature.

² Programmable by customer. Refer to the Owner's Manual for instructions and more information.

³ HomeLink[®] is a registered trademark of Gentex Corporation.

Instrument panel

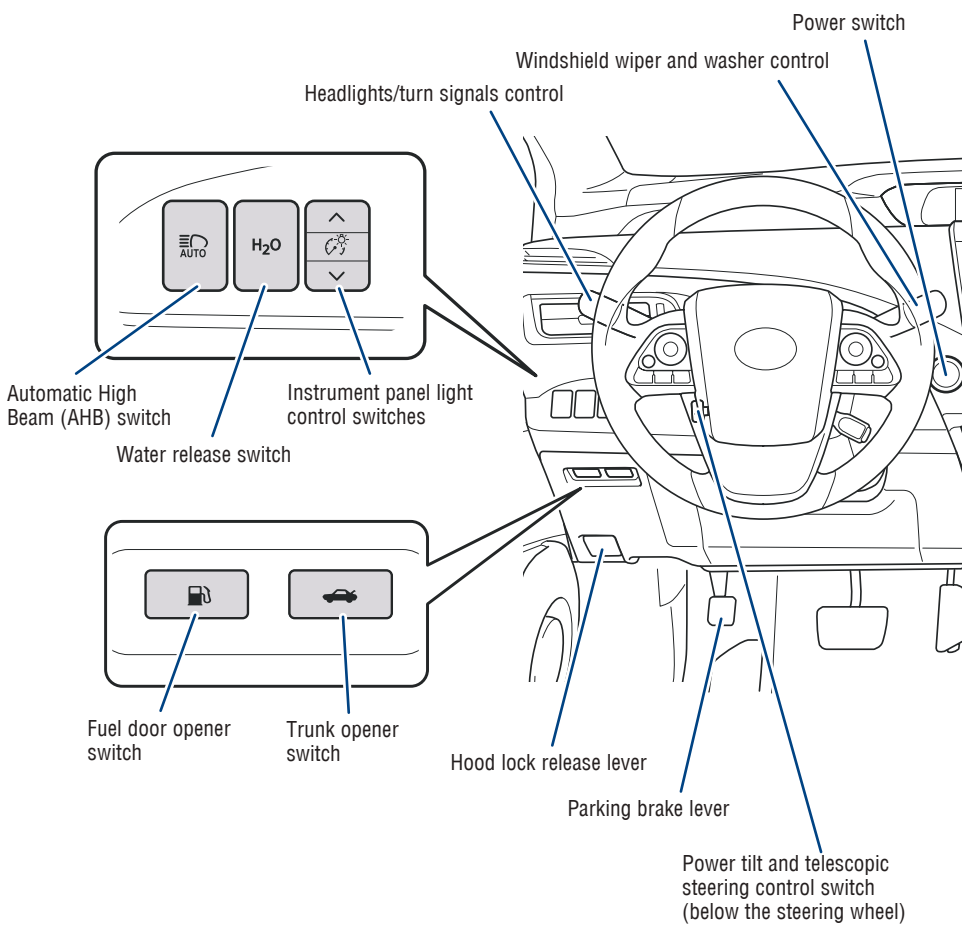

¹ For details, refer to the “Navigation and Multimedia System Owner’s Manual” or visit www.toyota.com/audio-multimedia for additional resources.

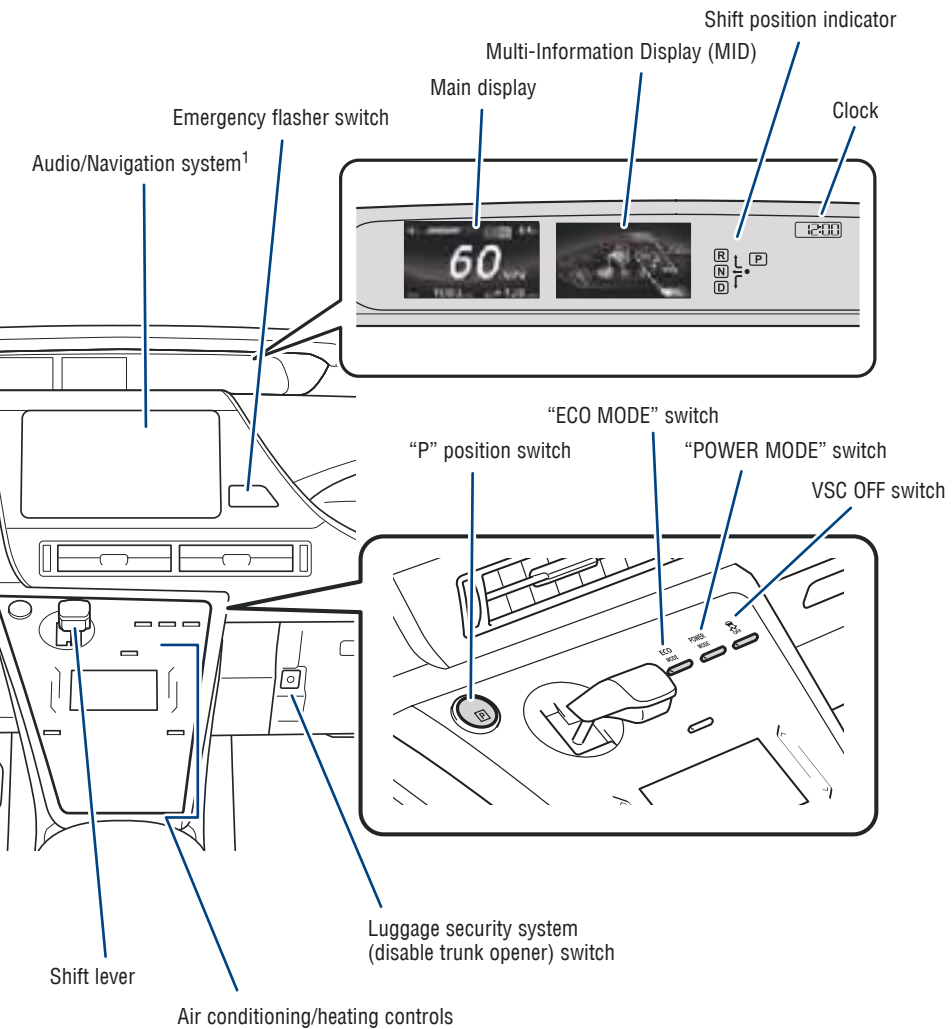

OVERVIEW

Instrument cluster

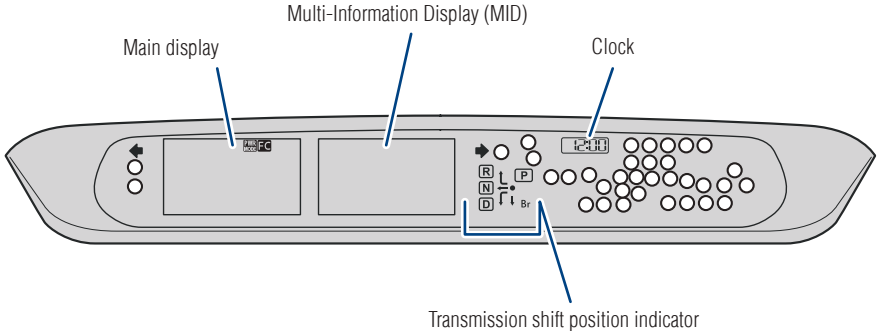

○ Service indicators and reminders

Indicator symbols

For details, refer to "Indicators and warning lights," Section 3, 2020 Owner's Manual.



Airbag ON/OFF indicator¹



Airbag SRS warning¹



Anti-lock Brake System (ABS) warning¹



Automatic high beam (AHB) indicator



Blind Spot Monitor (BSM) indicator



Blind Spot Monitor (BSM) outside rearview mirror indicator



Br mode indicator































Brake Override System/Drive-Start Control/
Front and Rear Parking Assist with
Automated Braking^{4,5} warning light



Brake system warning¹



Brake system warning¹
[yellow indicator]

	Charging system warning		Parking brake warning
	SET Constant speed cruise control indicator/Constant speed cruise control SET indicator		Front and Rear Parking Assist with Automated Braking OFF indicator ^{1,2,4,5}
	Driver's and front passenger's seat belt reminder (alarm will sound if speed is over 12 mph)		POWER mode indicator
	SET Dynamic Radar Cruise Control (DRCC) indicator/DRCC SET indicator		Power restriction indicator [Blue/yellow]
	ECO mode indicator		Pre-Collision System (PCS) warning ^{1,2}
	Electric power steering system warning ¹ [Red/yellow]		READY indicator
	Headlight low/high beam indicator		Security indicator
	High coolant temperature warning ¹		Shift position indicator
	Hydrogen leak warning ¹		Slip indicator ^{1,3}
	H ₂ O indicator		Steering control indicator
	Intuitive parking assist indicator		Turn signal indicator
	Lane Departure Alert (LDA) indicator [Green/yellow]		Vehicle Stability Control OFF indicator ¹
	Low fuel level warning		
	Low tire pressure warning ¹		
	Master warning ¹		
	Open door warning		

¹ If the indicator does not turn off within a few seconds of starting the fuel cell system, there may be a malfunction. Have the vehicle inspected by your Toyota dealer.

² If the indicator flashes, there may be a malfunction. Refer to the Owner's Manual.

³ If the indicator flashes, it indicates that the system is operating.

⁴ If equipped.

⁵ Refer to section PKSB (Parking Support Braking function) in the Owner's Manual.

OVERVIEW

Keyless entry

UNLOCKING

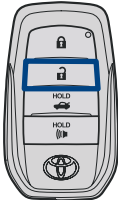

Push
ONCE: Driver door
TWICE: All doors

Carry Smart
Key remote

Driver door unlock*

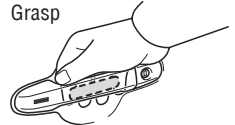

NOTE: If a door is not opened within 60 seconds of unlocking, all doors will relock for safety.

LOCKING

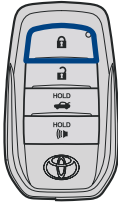

Push

Carry Smart
Key remote

All-door lock

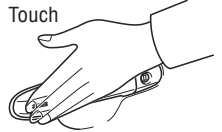

TRUNK LID

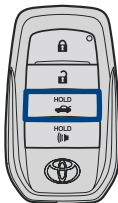

HOLD



Push and hold

Carry Smart
Key remote

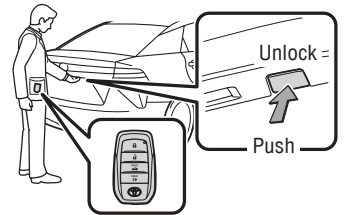

* Driver door unlocking function can be programmed to unlock driver door only, or all doors. Grasping passenger door handle will unlock all doors.

NOTE: Doors may also be locked/unlocked using remote.

PANIC BUTTON

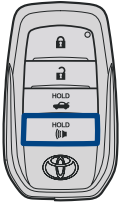

HOLD

Push and hold



Smart Key system

START FUNCTION

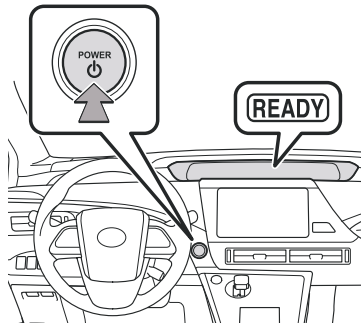

NOTE: The Smart Key must be carried to enable the start function. With the gear shift lever in Park and the brake pedal depressed, push the “POWER” switch.

POWER (WITHOUT STARTING THE FUEL CELL SYSTEM)

Without depressing the brake pedal, pressing the “POWER” switch will change the operation mode in succession from:

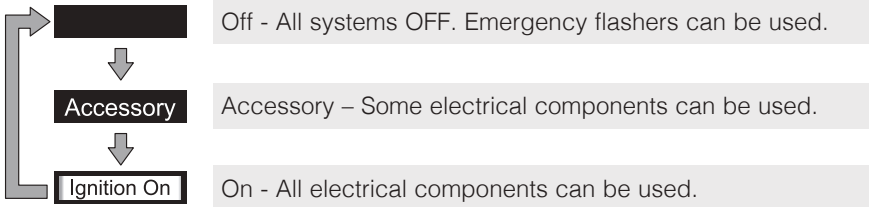

Instrument panel light control

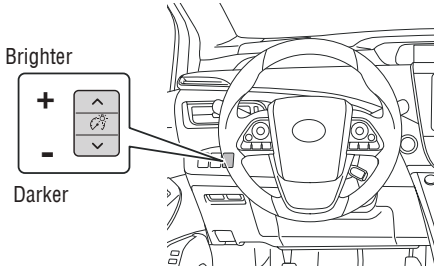

Fuel door release button & cap

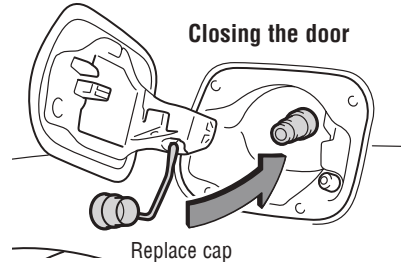
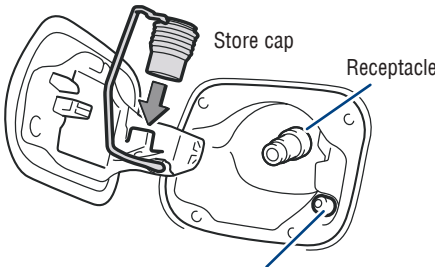
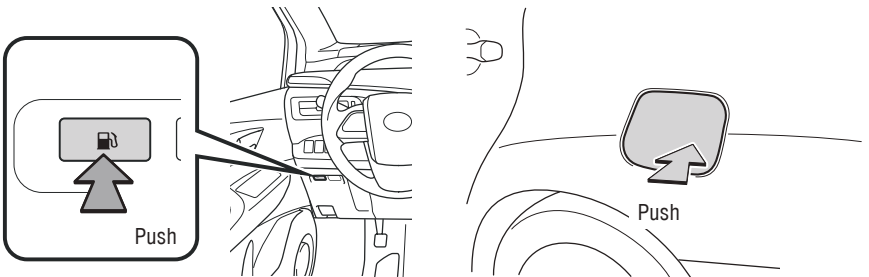

Do not press the interlock button.
The fuel door sensor may malfunction.

Alternate fuel door release (located in left rear of trunk)

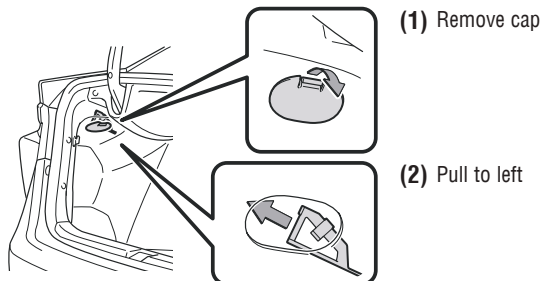

When the fuel door is open, the fuel cell system will not start. When the "READY" indicator is on, the fuel door will not open.

HYDROGEN FUEL CELL SYSTEM & SAFETY FEATURES

Hydrogen Fuel Cell System

Fuel cell vehicles efficiently use electricity, which is generated by a chemical reaction between hydrogen and oxygen in a fuel cell stack. Excess electricity is stored in a traction battery that is used to power high voltage systems and assist on initial acceleration.

The fuel is H₂ (compressed hydrogen gas), so the exhaust, when running, is only water and water vapor. As they do not emit CO₂ (Carbon Dioxide) and NO_x (Nitrogen Oxides) at the tailpipe, fuel cell vehicles are considered zero emission vehicles.

NOTE: Fuel consumption and energy information of the Hydrogen Fuel Cell System are shown on the Multi-Information Display.

TIPS FOR IMPROVED FUEL ECONOMY

- Ensure tire pressures are maintained at levels specified in the Owner's Manual.
- Drive vehicle smoothly. Avoid abrupt acceleration and deceleration.
- Avoid driving at speeds that are higher than necessary, especially on the highway.
- When possible, avoid sudden stops to maximize regenerative braking energy.
- Minimize use of the air conditioning.

Fill with fuel at hydrogen stations compliant with SAE J2601.

If you have questions about hydrogen station compliance, consult your Authorized Mirai Fuel Cell Toyota Dealer.

Observe the notices and cautions shown at the hydrogen station.

The filling time and amount may differ depending on the equipment of the hydrogen station. It may make the possible driving distance shorter.

BEFORE FUELING

When you arrive at the station, prepare for fueling:

- 1) Ensure the vehicle is OFF and in Park with parking brake set.
- 2) Press the fuel door release button and refer to instructions in 'Fuel door release button & cap section' to prepare the vehicle to accept hydrogen fuel.

Note: Fuel door will not open if the READY indicator is on. The fuel door will automatically re-lock if you don't open within 30 seconds.

- 3) Now you are ready to refuel. Outside the vehicle at the pump, use the station's best practice guidelines and instructions on how to refuel using their nozzle.

For assistance, call Customer Support toll free at 1-800-331-4331 (option 8.)

HYDROGEN FUEL CELL SYSTEM & SAFETY FEATURES

WEH H70 HYDROGEN GAS NOZZLE

H70 allows for a full fill-up on the Toyota Mirai, and is the preferred fueling method.

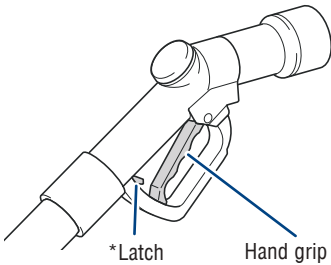

***The integrated hand grip locks and unlocks the nozzle, creating a secure connection for safe fueling.**

Seat nozzle on receptacle

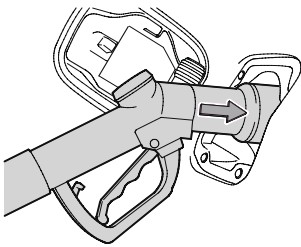

- (1) Seat the nozzle onto the receptacle fully. (This is the first step to help create a secure connection for safe fueling.)

- (2) To lock the nozzle, squeeze the hand grip until the latch is engaged.

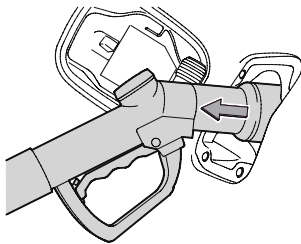
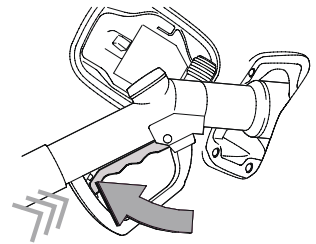

- (3) Gently pull back on the nozzle to ensure it is locked onto the receptacle. (Be careful not to squeeze or contact the hand grip when checking if the nozzle is secure, as it may unlock the nozzle.)

Once the nozzle is secure, you can follow the station's instructions to begin dispensing fuel.

CAUTION: Ensure that the nozzle lock is properly engaged to the vehicle. Failure to do this may result in the nozzle **coming off when the flow of hydrogen begins**. This may result in damage to the nozzle, station, vehicle, your own person or people near the fueling station.

- (4) After fueling is complete, pull the latch to unlock the hand grip and remove the nozzle.

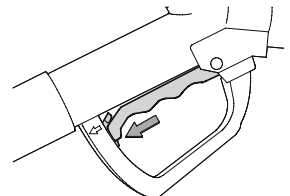

WEH H35 HYDROGEN GAS NOZZLE

H35 allows for up to a half tank fill from empty.

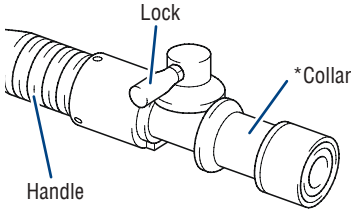

***Integrated collar snaps into place with a 'click.' Rotate the lock clockwise to secure connection for safe fueling.**

Seat nozzle on receptacle

(1) Make sure the lock is in the OFF position.

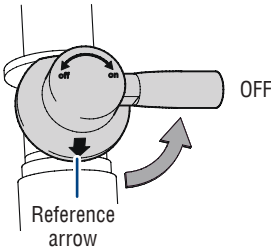

(2) Holding the handle, fully seat the nozzle onto the receptacle.

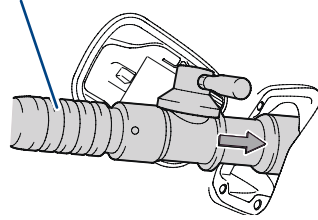

(3) Rotate the lock fully clockwise to the ON position to lock the nozzle.

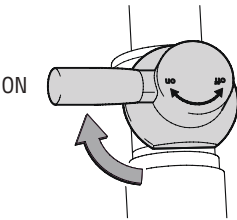

(4) Holding the handle, gently pull back on the collar to ensure the nozzle is securely locked. Once the nozzle is secure, you can follow the station's instructions to begin dispensing fuel.

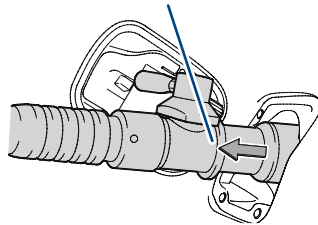

Remove nozzle

(5) After filling is complete, rotate the lock back to the OFF position.

(6) Holding the handle and collar, pull back on the collar to unlock and remove the fuel nozzle.

TIP-AFTER REFUELING

NOTE: If the nozzle cannot be removed after fueling, it may be frozen to the vehicle. Wait for the hydrogen nozzle to thaw before attempting to remove. Do not pull or rotate the hydrogen nozzle forcibly or damage will occur.

Refer to the Refueling section in the Owner's Manual for additional information.

HYDROGEN FUEL CELL SYSTEM & SAFETY FEATURES

Water release (H₂O) switch

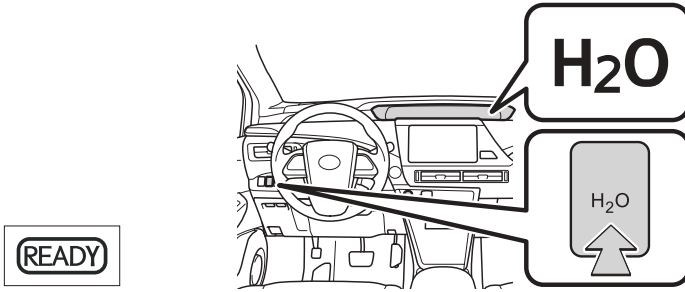

Water is a natural by-product of the fuel cell process. The system is designed to automatically purge water from the drain pipe at the rear of the vehicle while driving and sometimes while it is shut off.

Water can be manually purged before parking in certain situations by pressing the "H₂O" switch with the vehicle in "READY" mode. The system will regulate water levels automatically. Drivers should typically let the vehicle handle this as opposed to using this switch.

Refer to the Owner's Manual for more details on this system before attempting to use it.

FEATURES & OPERATIONS

Auto lock/unlock

Automatic door locks can be programmed to operate in different modes, or turned OFF.

Shift position linked door locking/unlocking function

- Doors lock when shifting to any positions other than P.
- Doors unlock when shifting into P.

Speed linked door locking function

- Doors lock when the vehicle speed is approximately 12 mph or higher.

Driver's door linked door unlocking function

- Doors unlock when the driver's door is opened.

Refer to the Owner's Manual for more details.

Parking brake

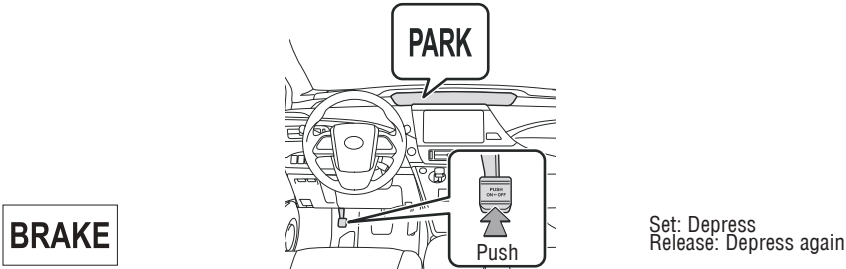

P POSITION SWITCH

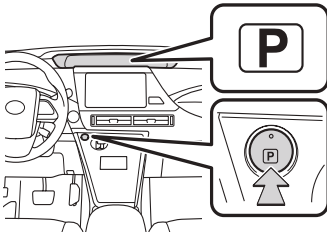

- (1) Fully stop the vehicle
- (2) Keep depressing the brake pedal
- (3) Press the P position switch.

The shift position can be changed to P through the use of the P position switch.

FEATURES & OPERATIONS

Automatic transmission

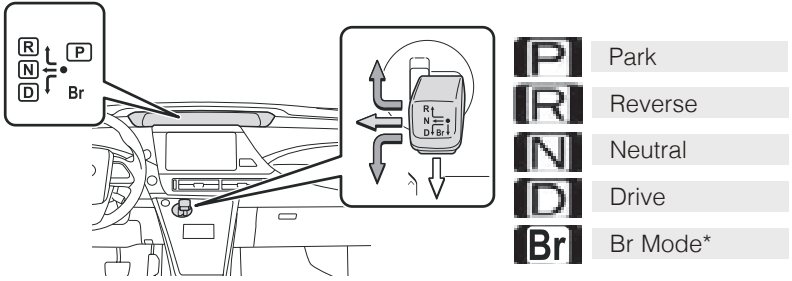

* Br Mode is the equivalent of downshifting. Shift to “Br” when strong regenerative braking is desired (i.e. downhill driving, coasting to a stop, etc.).

ECO MODE

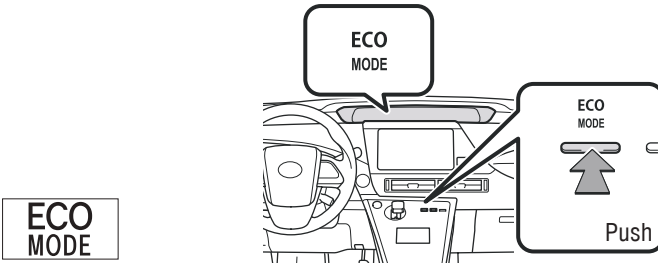

ECO Mode helps achieve low fuel consumption during trips that involve frequent accelerating and braking.

POWER MODE

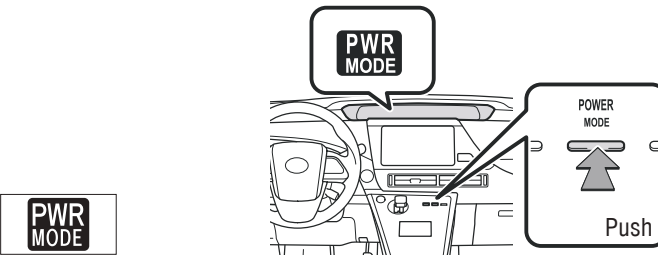

Use when a higher level of response is desired, such as when driving in mountainous regions or overtaking.

Br

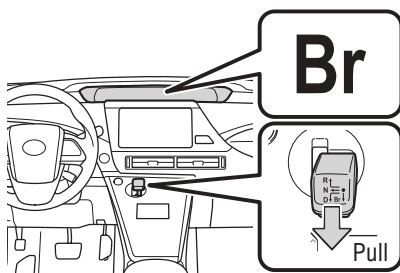

Suitable for driving that requires strong regenerative braking, such as down-hill driving, etc. To select Br mode, shift the shift lever down.

Tilt & telescopic steering wheel

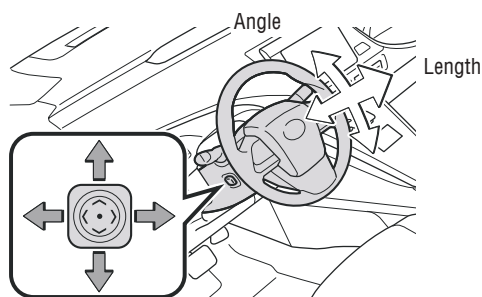

Push lever to move steering wheel:

- up, down to adjust angle
- left, right to adjust length (toward driver and away from driver)

NOTE: Do not attempt to adjust while the vehicle is in motion.

Door locks

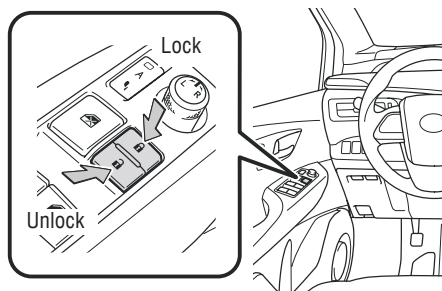

Seat adjustments-Front

DRIVER'S SIDE

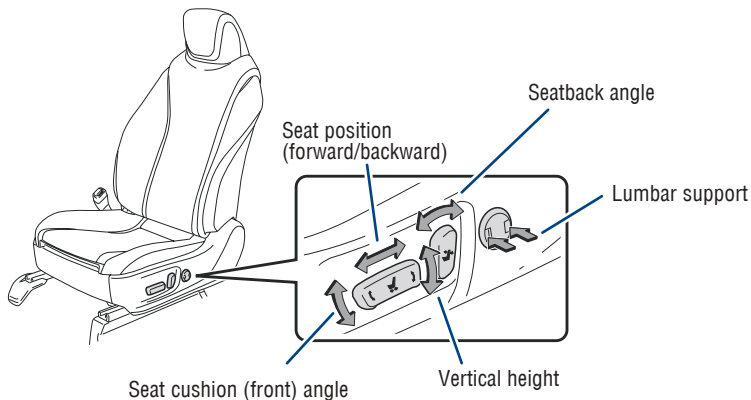

Note: Be careful to not allow the head rest to touch the ceiling.

Seats-Head restraints

Front vertical adjust

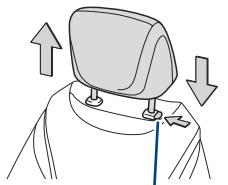

Lock release button

Front horizontal adjust

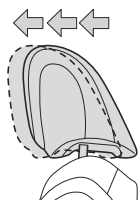

Rear vertical adjust

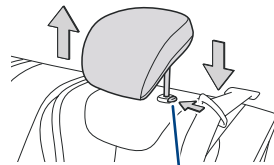

Lock release button

Windshield wipers & washer

OPERATING WIPER LEVER

* When AUTO is selected, wipers will operate automatically when sensor detects falling rain.

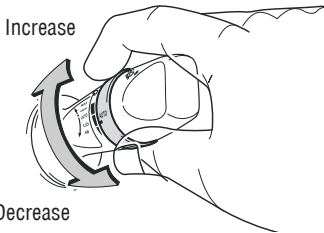
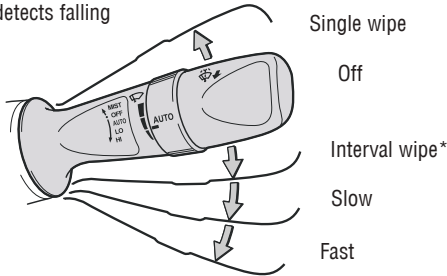

Select AUTO to increase or decrease sensor sensitivity.

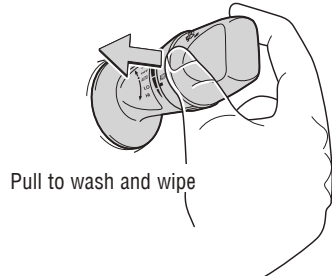

Windows-Power

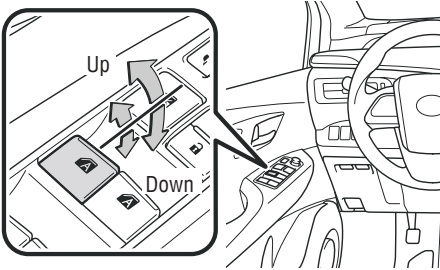

Window lock switch

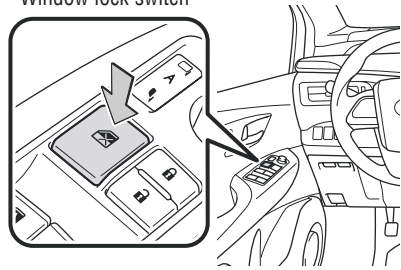

All window auto up/down Push the switch completely down or pull it completely up and release to fully open or close. To stop the window partway, operate the switch in the opposite direction.

Window lock switch Deactivates all passenger windows. Driver's window remains operable.

FEATURES & OPERATIONS

Lights & turn signals

HEADLIGHTS

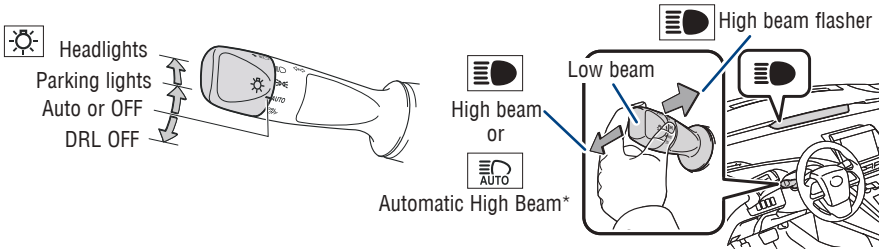

Daytime Running Light system (DRL) Automatically turns on under certain conditions to make vehicle more visible to other drivers. Not for use at night.

Automatic light cut off system Automatically turns lights off after 30 second delay, or the lock switch on remote is pushed after all doors are locked.

Automatic High Beam (AHB) system Automatically switches between high and low beams as appropriate to enhance vision at night.

Refer to *Toyota Safety Sense™ 2.0 (TSS 2.0)* in this guide or the *Owner's Manual* for more details on the Automatic High Beam feature.

* Operating conditions must be met. Refer to the *Owner's Manual* for details.

TURN SIGNALS

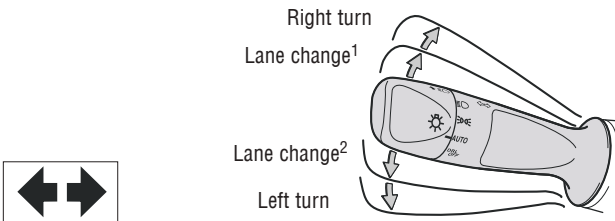

¹ The right hand signals will flash three times.

² The left hand signals will flash three times.

Steering wheel-heater

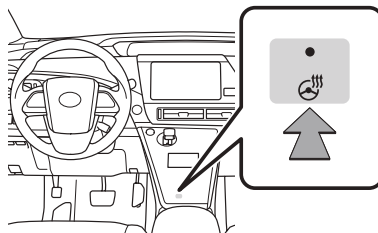

The "POWER" switch must be in the "IGNITION ON" mode for use.

Clock

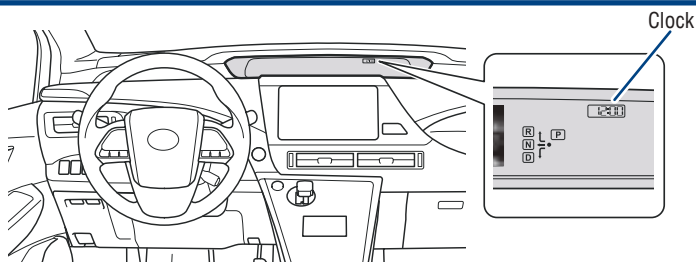

Using steering wheel switches, select "Home" from multi-information screen, then select "⚙️" to set clock:

- (1) Round to the nearest hour, press \blacktriangledown or \blacktriangle , select and press \odot .
- (2) Time adjustment, press \blacktriangledown or \blacktriangle , select and press \odot .
- (3) Press \blacktriangleleft or \blacktriangleright , select hours and minutes or press \blacktriangledown or \blacktriangle , to select 12-24 hour clock and adjust.
- (4) Press \blackrightarrow when finished.

Luggage security system

To protect luggage stored in the trunk against theft, the luggage security system can be set to on.

Trunk opener main switch (in the glove box)

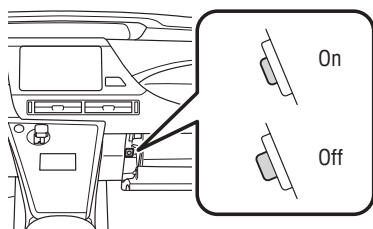

To disable the trunk opener switch, turn the main switch.

When the main switch is off, the trunk lid cannot be opened even with the wireless remote control or the entry function.

FEATURES & OPERATIONS

Air conditioning/heating

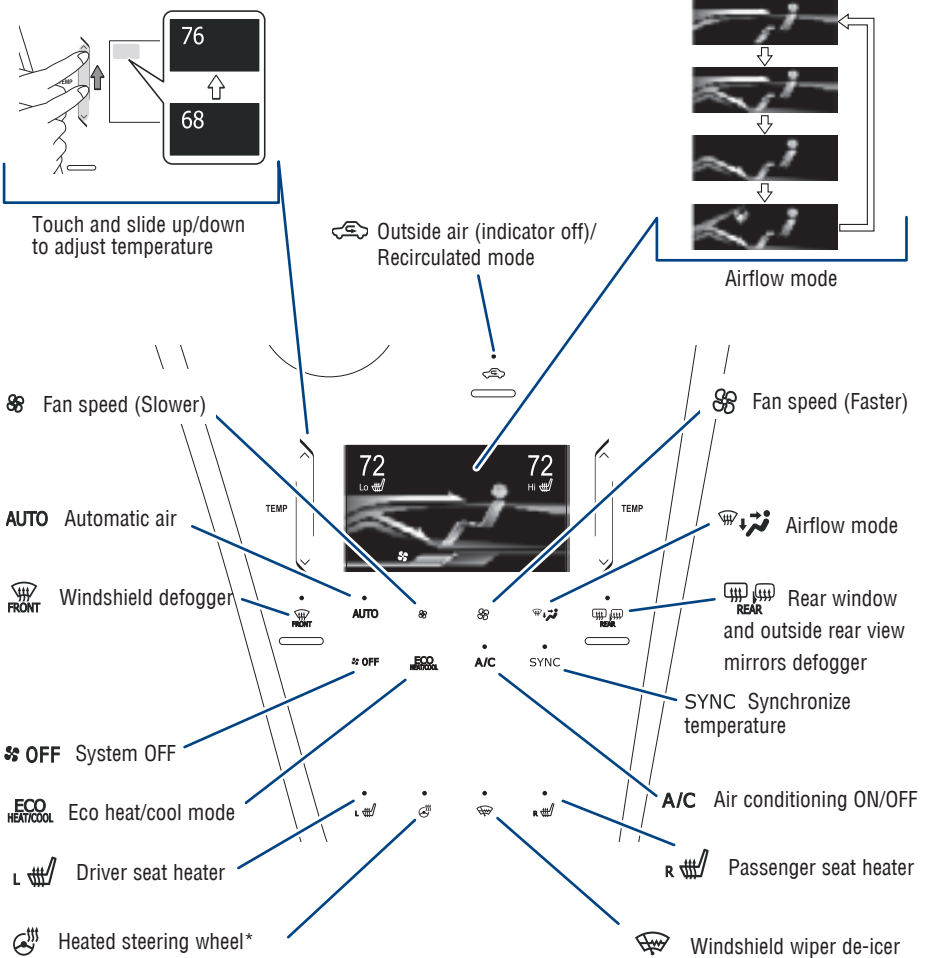

When adjusting the temperature setting a sound buzzes and automatically sets temperature, fan outlet and speed.

*Turns off automatically after 30 minutes

Seat heaters

Front seat

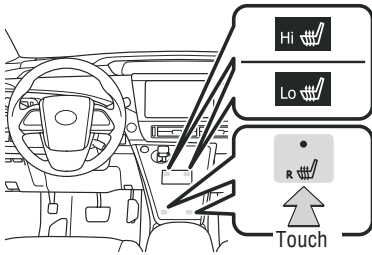

Touch switch to change temperature intensity.

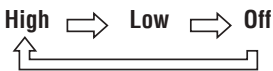

The "POWER" switch must be in the "IGNITION ON" mode for use.

Rear passenger seat

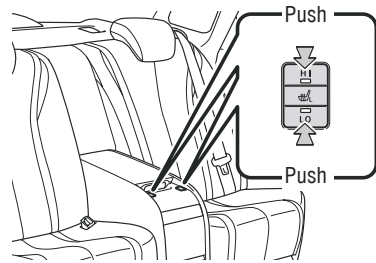

Push button to change temperature intensity. Depress again and light indicates heater is off.

Power outlet-12V DC

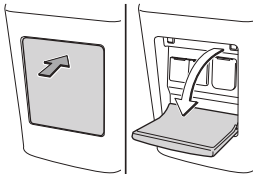

Push to open cover



The "POWER" switch must be in the "ACCESSORY" or "IGNITION ON" mode for use.

USB charge-ports

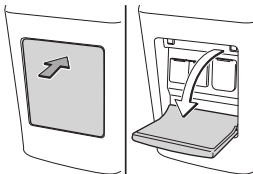

Push to open cover

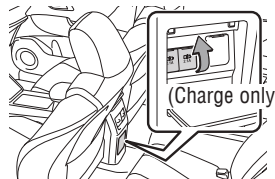

The "POWER" switch must be in the "ACCESSORY" or "IGNITION ON" mode for use.

FEATURES & OPERATIONS

Audio

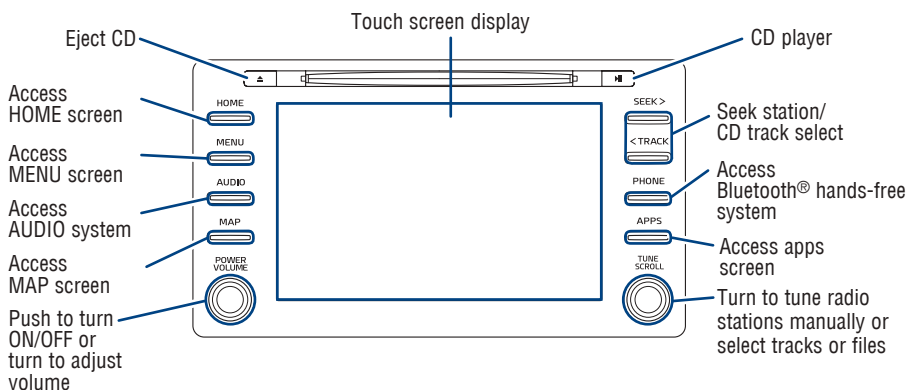

Refer to the “Navigation and Multimedia System Owner’s Manual” or visit www.toyota.com/audio-multimedia for additional resources.

NOTE: Concentrating on the road should always be your first priority while driving. Do not use the Audio Multimedia System if it will distract you.

USB media/AUX port

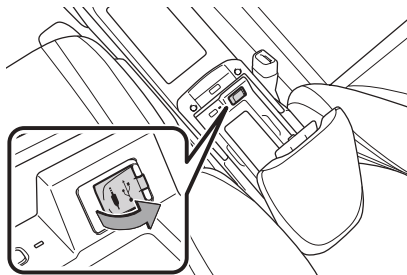

USB media port

Connecting a compatible device and cable into the USB media port will support charging and music playback through the audio multimedia system.

AUX port

By inserting an AUX cable into the AUX port, you can listen to music from a portable audio device through the vehicle’s speaker system while in AUX mode.

Qi Wireless charger

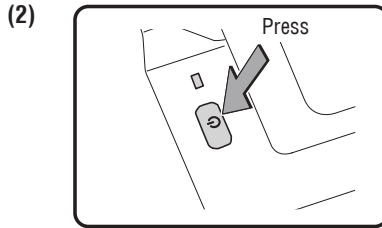
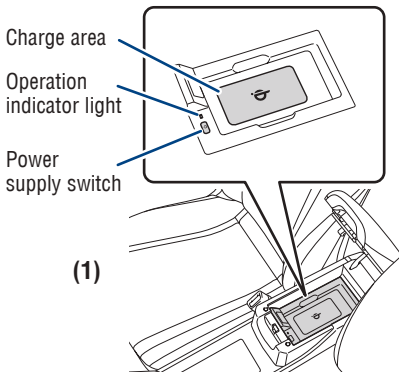

When the fuel cell system is turned off, the last state (ON/OFF) of the charger is memorized.

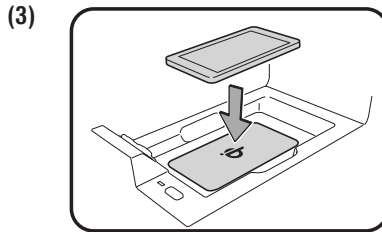

Place device nearest the center of charging area for best results. Moving device may result in stopping or restarting the charging process.

A mobile device can be charged wirelessly on the tray. **(1)** Open the console box. **(2)** Press the power supply switch and the green operation indicator light turns on. **(3)** Place a compatible mobile device on the tray as shown in the illustration. An amber indicator illuminates while charging is in progress. When charging is complete, the indicator illuminates green. Some phones, cases or cover type wireless chargers may not cause the green indicator to illuminate even though it is fully charged.

Refer to the Owner's Manual for limitations and more details on this system before attempting to use it.

FEATURES & OPERATIONS

Steering wheel switches & telephone controls (Bluetooth®)

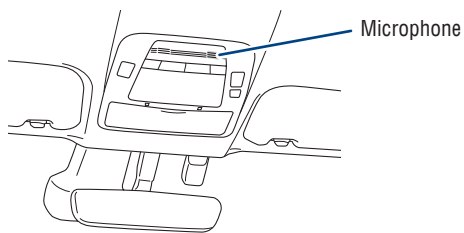
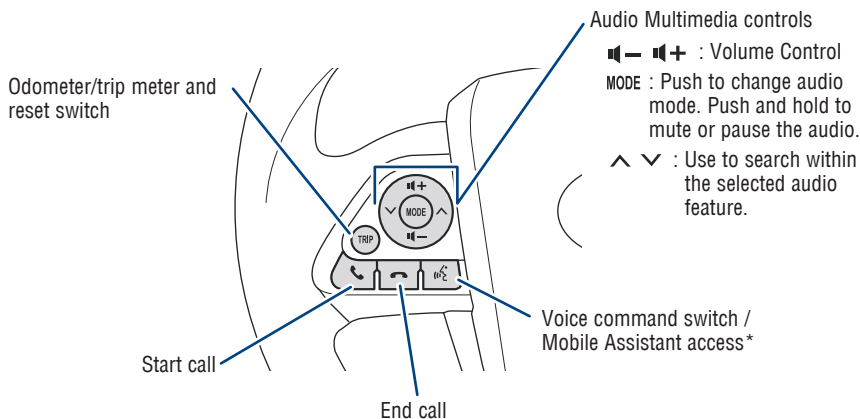

Bluetooth® technology allows dialing or receipt of calls without removing your hands from the steering wheel.

* Push and hold to access Mobile Assistant. When a compatible smartphone is Bluetooth® connected push and hold the Voice command switch 2-3 seconds to access Siri® Eyes Free.

Refer to the “Bluetooth® Device Pairing Section” in this guide for more information about phone connections and compatibility.

Refer to the “Navigation and Multimedia System Owner’s Manual” for more details.

NOTE: Concentrating on the road should always be your first priority while driving. Do not use the Audio Multimedia system if it will distract you.

Multi-Information Display (MID)

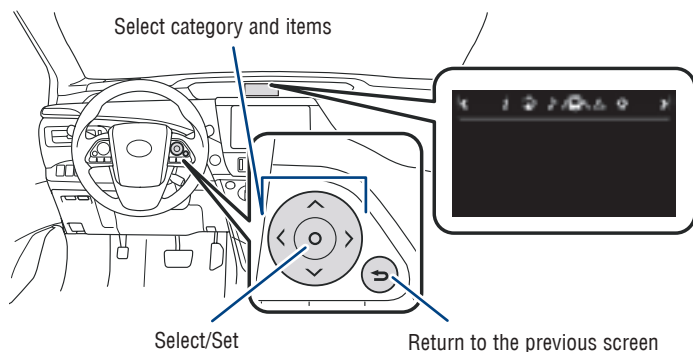

Drive information

- Energy monitor
- Fuel cell system indicator and ECO score
- Fuel consumption record
- Drive monitor
- ECO diary
- Power meter

Navigation system-linked display

Select to display the following navigation system-linked information.

- Route guidance
- Compass display (north-up display/heading-up display)

Audio system-linked display

Select to enable selection of an audio source or track on the display using the meter control switches.

Driving assist systems display

Displays when each driving assistance system is used.

- Dynamic Radar Cruise Control (DRCC)
- Lane Departure Alert (LDA)

Warning message display

Select to display warning messages and measures to be taken if a malfunction is detected.



Setting display

Select to change the meter display settings and the operation settings of some vehicle functions.

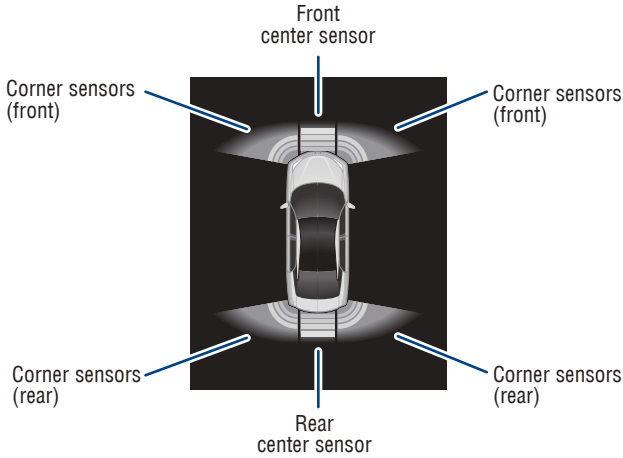
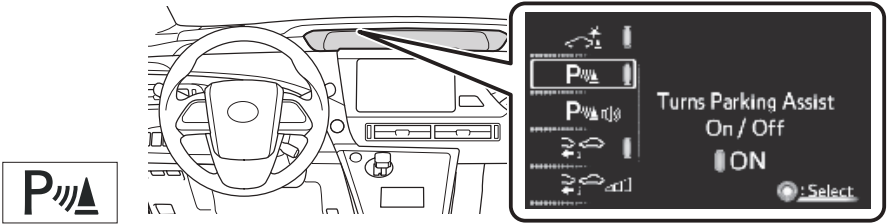
Intuitive parking assist



If the sensors detect an obstacle, the buzzer and MID display informs the driver of the approximate position and distance of the obstacle by illuminating continuously (far) or blinking (near).

Note: Use \langle / \rangle , \wedge / \vee and \odot of the meter control switches to select  and  in the Multi-Information Display (MID) to change settings. The system will continue in the last state it was in (ON or OFF) when the ignition is turned on again.



Refer to the Owner's Manual for limitations and more details.

Front and Rear Parking Assist with Automated Braking (if equipped)

When a collision may occur with an obstacle while parking or traveling at low speeds, when the vehicle suddenly moves forward due to mistaken accelerator pedal operation, or when the vehicle moves due to the wrong shift position being selected, the sensors are designed to detect obstacles to the front or rear in the traveling direction of the vehicle, and the system operates to lessen impact with obstacles such as walls, and reduce resulting damage.

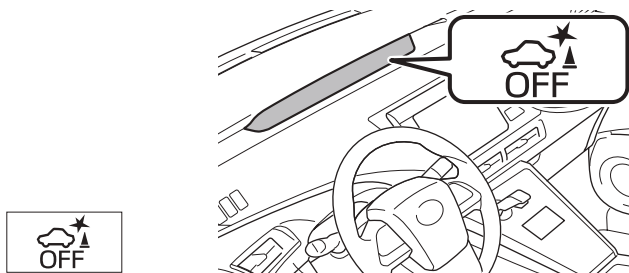
CHANGE SETTINGS



Note: Use </>, ^/∨ and Ⓞ of the meter control switches to select  and  in the Multi-Information Display (MID) to change settings. The system will continue in the last state it was in (ON or OFF) when the ignition is turned on again.

Refer to section PKSB (Parking Support Brake function) in the Owner's Manual for limitations and more details.

Garage door opener (Homelink®)*

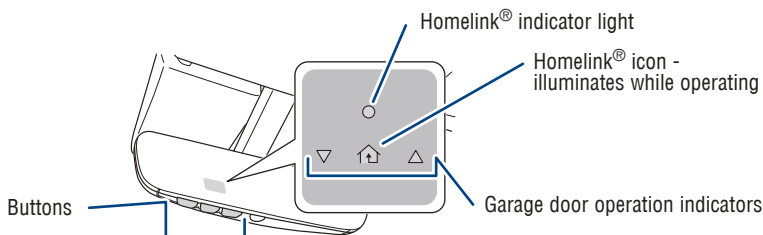

Garage door openers manufactured under license from HomeLink®* can be programmed to operate garage doors, estate gates, security lighting, etc.

Refer to "Garage door opener," Section 6-4 in the Owner's Manual for more details.

For programming assistance, contact HomeLink® at 1-800-355-3515, or visit <http://www.homelink.com/toyota>.

* HomeLink® is a registered trademark of Gentex Corporation.

FEATURES & OPERATIONS

Blind Spot Monitor with Rear Cross Traffic Alert (BSM w/RCTA)

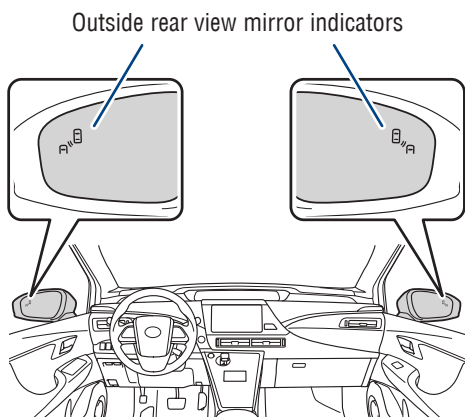

Buzzer (RCTA only)

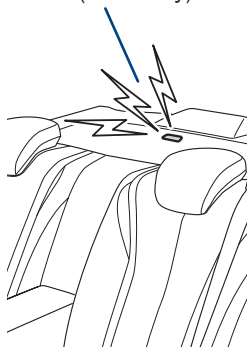

The Blind Spot Monitor is a system that has two functions:

- The Blind Spot Monitor function (assists the driver in making the decision when to change lanes)
- The Rear Cross Traffic Alert function (assists the driver when backing up)

The system is designed to use radar sensors to detect vehicles traveling in the Mirai's blind spot. If a vehicle is detected, the driver will be alerted via the outside rear view side mirror indicators.

Rear Cross Traffic Alert function:

While in reverse, when a vehicle approaching from the right or left rear of the Mirai is detected, the outside rear view mirror indicators flash.

Refer to the Owner's Manual for limitation and more details on this system before attempting to use it.

TURN THE BSM SYSTEM ON

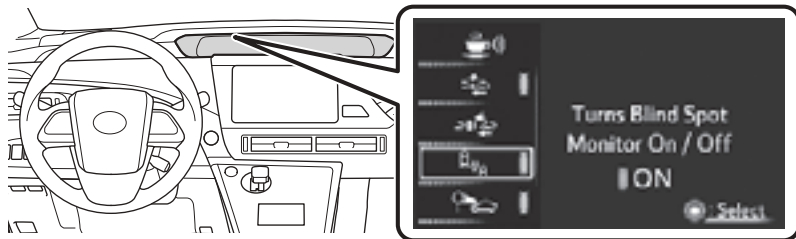

Use \leftarrow / \rightarrow , \wedge / \vee and \odot of the meter control switches to select  and  in the Multi-Information Display (MID) to change settings.

Vehicle Stability Control (VSC)/ TRAC OFF switch

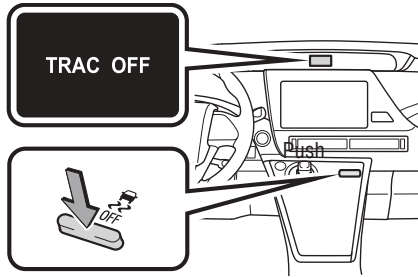

The VSC OFF switch can be used to help free a stuck vehicle in surroundings like mud, dirt or snow. While the vehicle is stopped, press switch to disable the TRAC system.

To disable both VSC and TRAC systems, press and hold the switch for at least 3 seconds.

Refer to the Owner's Manual for limitations and more details.

Rear view monitor system

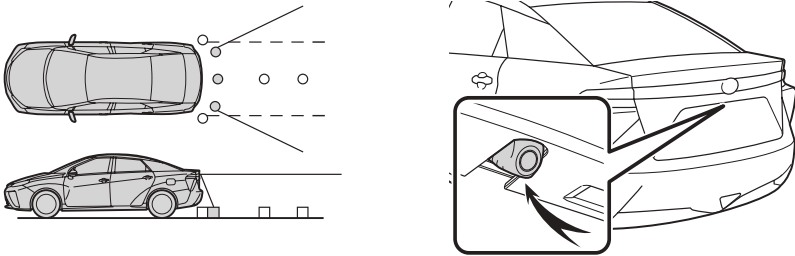

The rear view monitor system displays an image of the view from the bumper of the rear area of the vehicle. The camera for the rear view monitor system is located above the license plate.

To adjust the image on the rear view monitor screen, press the "MENU" button and select "Display". Select "Camera" to adjust the screen contrast and brightness.

Refer to the Navigation and Multimedia Owner's Manual for limitations and more details on this system.

Quick overview-Toyota Safety Sense™ 2.0

Toyota Safety Sense™ 2.0 (TSS 2.0) is a set of active safety technologies designed to help mitigate or prevent collisions across a wide range of traffic situations, in certain conditions. TSS 2.0 is designed to help support the driver's awareness, decision making and vehicle operation contributing to a safe driving experience.

Refer to the Owner's Manual for operation, setting adjustments, limitations and more details to understand these functions and complete safety precautions. For more information, please go to <http://www.toyota.com/safety-sense>



Pre-Collision System with Pedestrian Detection (PCS w/PD)

PCS w/PD is designed to provide alert, mitigation, and/or avoidance support in certain conditions, when the system detects a potential collision with a preceding vehicle is likely to occur.

The advanced millimeter-wave radar sensor system is designed to work with the camera sensor to help recognize a preceding pedestrian or bicyclist, and provide an alert, mitigation and/or avoidance support in certain conditions.



Lane Departure Alert with Steering Assist (LDA w/SA)

LDA w/SA is designed to provide notification when the system detects an unintended lane departure.

The Steering Assist function is designed to provide small corrective steering inputs to the steering wheel for a short period of time to help keep the vehicle in its lane.

The Sway Warning function is designed to detect vehicle swaying (based on the vehicle location and steering wheel operation) and alert the driver with an audio and visual alert, urging them to take a break.



Dynamic Radar Cruise Control (DRCC)

DRCC is designed to help maintain a pre-set distance to a preceding vehicle when the preceding vehicle is traveling at a lower speed.



Automatic High Beams (AHB)

AHB is designed to detect the headlights of oncoming vehicles and the tail lights of preceding vehicles and switch between high beams and low beams as appropriate.



Road Sign Assist (RSA)

RSA is designed to recognize specific road signs using the forward facing camera to provide information to the driver via the display.

Sensors

TSS 2.0 combines an in-vehicle camera mounted in front of the inside rear view mirror and a radar mounted in the front grill. These sensors support the driver assist systems.

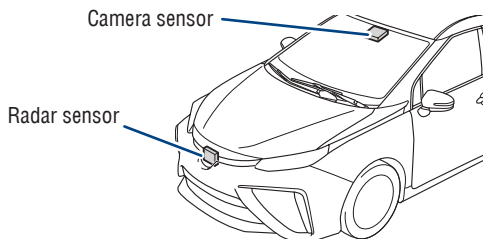

Pre-Collision System with Pedestrian Detection (PCS w/PD)



The Pre-Collision System uses a radar sensor and camera sensor to help detect a vehicle or pedestrian or bicyclist in front of your vehicle.

As there is a limit to the degree of recognition accuracy and control performance that this system can provide, do not overly rely on this system. This system will not prevent collisions or lessen collision damage or injury in every situation. Do not use PCS instead of normal braking operations under any circumstances. Do not attempt to test the operation of the Pre-Collision System yourself, as the system may not operate or engage, possibly leading to an accident. In some situations, such as when driving in inclement weather such as heavy rain, fog, snow or a sandstorm or while driving on a curve and for a few seconds after driving on a curve, a vehicle or pedestrian or bicyclist may not be detected by the radar and camera sensors, preventing the system from operating or engaging properly.

Refer to the Toyota Owner's Manual for a list of additional situations in which the system may not operate properly.

Pre-Collision Warning

When the system determines that the possibility of a frontal collision is high, a buzzer will sound and a warning message will be displayed on the Multi-Information Display (MID) to urge the driver to take evasive action.

Pre-Collision Brake Assist

If the driver notices the hazard and brakes, the system may provide additional braking force using Brake Assist. This system may prime the brakes and may apply greater braking force in relation to how strongly the brake pedal is depressed.

PRE-COLLISION SYSTEM (CONTINUED)

Pre-Collision Braking

If the driver does not brake in a set time and the system determines that the possibility of a frontal collision with a preceding vehicle is extremely high, the system may automatically apply the brakes, reducing speed in order to help the driver reduce the impact and in certain cases avoid the collision.

Refer to the Toyota Owner's Manual for additional information on PCS operation, settings adjustments, limitations, and precautions before attempting to use it.

PCS PEDESTRIAN DETECTION

Under certain conditions, the PCS system included with the TSS 2.0 package may also help to detect a pedestrian or bicyclist in front of your vehicle using the in-vehicle camera and front grille-mounted radar. The in-vehicle camera of PCS detects a potential pedestrian or bicyclist based on size, profile, and motion of the detected pedestrian or bicyclist. However, a pedestrian or bicyclist may not be detected depending on the conditions, including the surrounding brightness and the motion, posture, size, and angle of the potential detected pedestrian or bicyclist, preventing the system from operating or engaging.

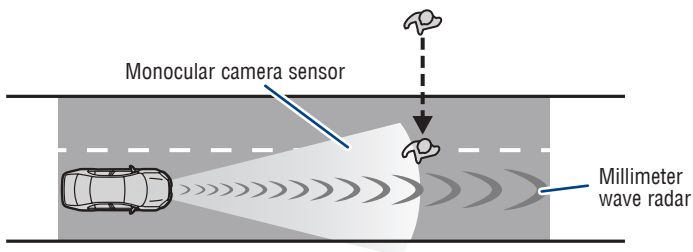

As part of the Pre-Collision System, this function is also designed to first provide an alert and then automatic braking if needed.

Refer to the Toyota Owner's Manual for additional limitations and information.

CHANGING PRE-COLLISION ALERT TIMING

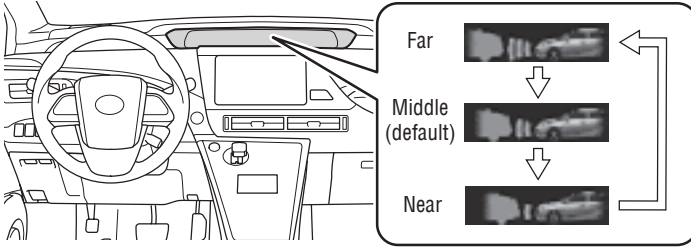

Each time the PCS switch is pressed, the response to the PCS alert timing changes.

- (1) Press “◀▶” switches and select  from the Multi-Information Display (MID).
- (2) Press “◀▶” switches and select  from the MID and then press “⊙”.



The setting screen is displayed.

- (3) Press “⊙” each time to change the setting. Each time it is pressed, the response to the PCS alert timing changes as shown above. You can press “➡” to go back to the menu.

Note: PCS is enabled each time the ignition switch is turned to Ignition On. The system can be disabled/enabled and the alert timing of the system can be changed. (Alert timing only, brake operation remains the same).

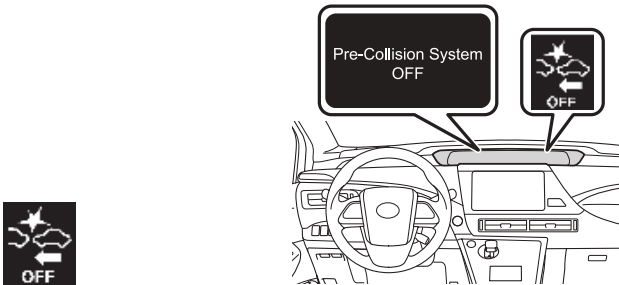
DISABLING PRE-COLLISION SYSTEM (PCS)



- (1) Press “◀▶” switches and select  from the Multi-Information Display (MID).
- (2) Press “◀▶” switches and select  from the MID and then press “⊙”.

The setting screen is displayed.

- (3) Press “➡” to go back to the menu.

Note: The system is enabled each time the power switch is turned to ON mode.

Refer to the Toyota Owner's Manual for additional information on PCS operation, settings adjustments, limitations, and precautions before attempting to use it.

Lane Departure Alert with Steering Assist (LDA w/SA)

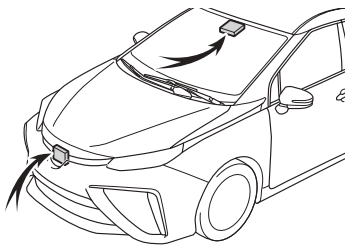

LDA in TSS 2.0 uses an in-vehicle camera designed to detect visible white and yellow lane markers or road edge in front of the vehicle and the vehicle's position on the road. If the system determines that the vehicle is starting to unintentionally deviate from its lane, the system alerts the driver with an audio and visual alert. When the alerts occur, the driver must check the surrounding road situation and carefully operate the steering wheel to move the vehicle back to the center part of their lane.

LDA is designed to function at speeds of approximately 32 mph (50 km/h) or higher on relatively straight roadways.

In addition to the alert function, LDA w/SA also features a steering assist function. When enabled, if the system determines that the vehicle is on a path to unintentionally depart from its lane, the system may provide small corrective steering inputs to the steering wheel for a short period of time to help keep the vehicle in its lane.

If the vehicle repeatedly deviates from the lane, the vehicle drifts within the lane due to inattention, or the driver abruptly operates the steering wheel after an inattentive period, when enabled, the vehicle sway warning function alerts the driver with an audio and visual alert, urging them to take a break.

TURNING THE LDA SYSTEM ON/OFF

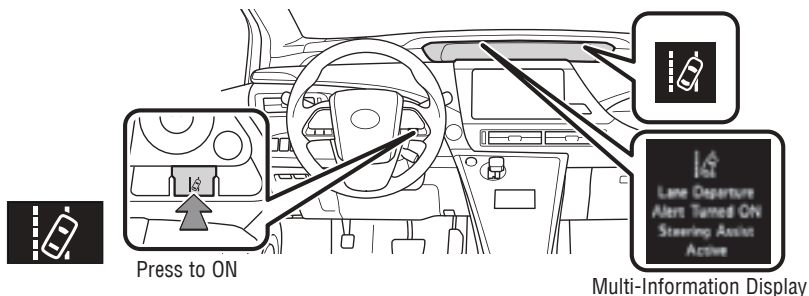

Press the LDA switch to turn the LDA system on. Depress again to turn it off.

Note: Operation of the LDA system and setting adjustments continues in the same condition regardless of ignition cycle until changed by the driver or the system is reset.

Refer to the Toyota Owner's Manual for additional information on LDA operation, settings adjustments, limitations, and precautions before attempting to use it.

LDA function display

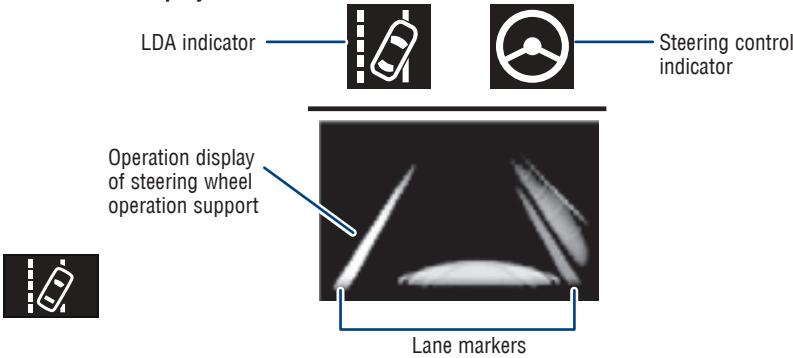

Lane Departure Alert (LDA) indicator flashes orange when operating.



(1)



(2)

The LDA function  displays when the Multi-Information Display (MID) is switched to the driving assist system information screen.



(1) The system displays solid white lines on the LDA indicator when visible lane markers on the road are detected. A side flashes orange to alert the driver when the vehicle deviates from its lane.

(2) The system displays outlines on the LDA indicator when lane markers on the road are not detected or the function is temporarily cancelled.

Note: When operation conditions are no longer met, a function may be temporarily canceled. However, when the operation conditions are met again, operation of the function is automatically restored. For example, LDA may not function on the side(s) where white/yellow lines are not detectable.

Refer to the Toyota Owner's Manual for additional information on LDA operation, settings adjustments, limitations, and precautions before attempting to use it.

DISABLING STEERING ASSIST

- (1) Press “<>” switches and select  from the Multi-Information Display (MID).
- (2) Press “⏏” switches and select the  setting function and then press “⊙.”
- (3) Press “⊙” each time to change the setting.
- (4) Press “➡” to go back to the menu.



Note: Operation of the LDA system and setting adjustments continues in the same condition regardless of ignition cycle until changed by the driver or the system is reset.

ADJUSTING LDA ALERT SENSITIVITY

The driver can adjust the sensitivity of the LDA (warning) function from the Multi-Information Display (MID) customization screen.

High - Is designed to warn approximately before the front tire crosses the lane marker.

Normal - Is designed to warn approximately when the front tire crosses the lane marker.

- (1) Press “<>” switches and select  from the Multi-Information Display (MID).
- (2) Press “⏏” switches and select the  setting function and then press “⊙.”
- (3) Press “⊙” each time to change the setting.
- (4) Press “➡” to go back to the menu.

SWAY WARNING SYSTEM



Continuous lane deviations from swaying.





Gentle swaying from driver's inattentiveness.



Acute steering wheel operation after the number of operations decrease due to driver's inattentiveness.



SWS is a function of LDA and is designed to detect swaying based on the vehicle location in the lane and the driver's steering wheel operation. To help prevent swaying, the system alerts the driver using a buzzer sound and a warning displays in the MID.

DISABLING LDA SWAY WARNING SYSTEM

- (1) Press “<>” switches and select  from the Multi-Information Display (MID).
- (2) Press “<^>” switches and select the  setting function and then press “○”.
- (3) Press “○” each time to change the setting.
- (4) Press “>” to go back to the menu.

Note: Operation of the LDA system and setting adjustments continues in the same condition regardless of Ignition cycle until changed by the driver or the system is reset.

ADJUSTING SWAY ALERT SENSITIVITY

- (1) Press “<>” switches and select  from the Multi-Information Display (MID).
- (2) Press “<^>” switches and select the  setting function and then press “○”.
- (3) Press “○” each time to change the setting.
- (4) Press “>” to go back to the menu.

Dynamic Radar Cruise Control (DRCC)

DRCC helps maintain a pre-set distance to a preceding vehicle when the preceding vehicle is traveling at a lower speed. This mode is always selected first when the cruise control button is depressed. Constant speed cruise control mode is also available. DRCC is designed to function at speeds between approximately 30 to 110 MPH and is intended for highway use.

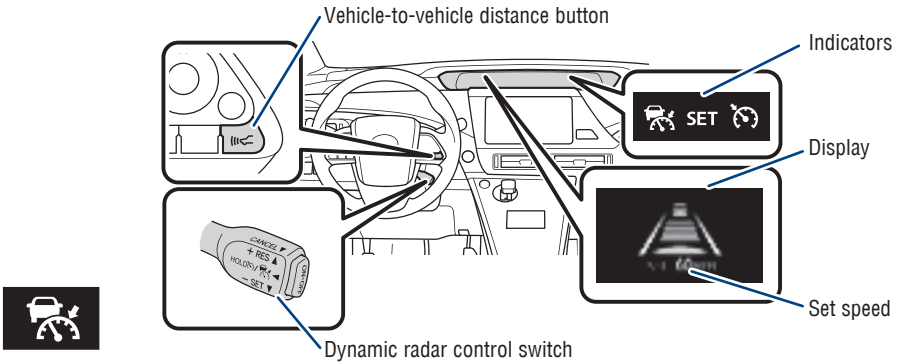

TURNING SYSTEM ON/OFF

(1)

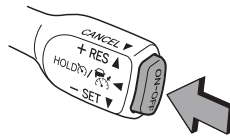

Push once: On
Push twice: Off

Refer to page 40 for switching to Constant Speed (Cruise) Control Mode.

ADJUSTING SET SPEED

(2)

Resume²

(3)

Increase speed

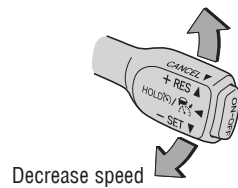
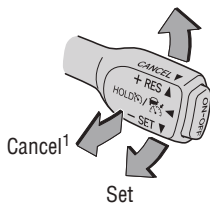

Vehicle will cruise at a set speed, decelerate to maintain selected distance from a slower vehicle traveling in front and accelerate back up to the selected speed if the vehicle in front changes lanes or speeds up.

- (1) Push the ON-OFF button. The “RADAR READY” and “” indicator will come on.
- (2) Push the lever down to SET speed, push it up to Resume and pull it or depress brake to Cancel.
- (3) Push up to increase the speed control, push down to decrease (1 mph [1.6 km/h] or 1 km/h [0.6 mph] increments).

¹ The speed control may also be cancelled by depressing the brake pedal.

² The speed control may be resumed once vehicle speed exceeds 16 mph.

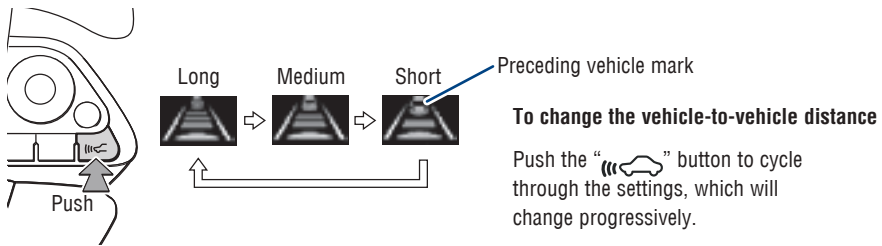

This mode employs a radar sensor to detect the presence of a preceding vehicle up to approximately 328 ft (100 m) ahead, determines the current vehicle-to-vehicle following distance and operates to maintain a preset following distance from the vehicle ahead. These distances vary based on vehicle speed.

Note: Vehicle-to-vehicle distance will close in when traveling on long downhill slopes.

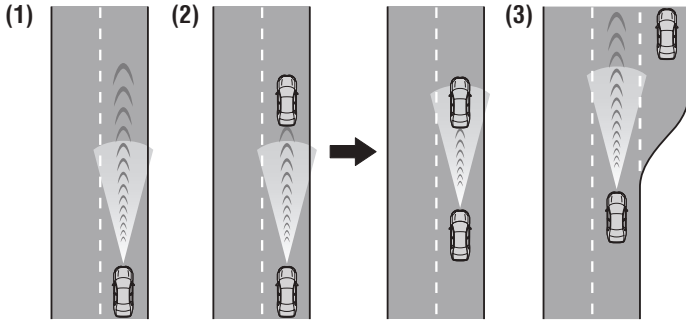

(1) Constant speed cruising when there are no vehicles ahead

The vehicle travels at the speed set by the driver. The desired vehicle-to-vehicle distance can also be set by operating the vehicle-to-vehicle distance control.

(2) Deceleration cruising and follow-up cruising when a preceding vehicle driving slower than the set speed appears

When a vehicle is detected running ahead of you, the system automatically decelerates your vehicle. When a greater reduction in vehicle speed is necessary, the system applies the brakes (the brake lights will come on at this time). The system will respond to changes in the speed of the vehicle ahead in order to maintain the vehicle-to-vehicle distance set by the driver. A warning tone warns you when the system cannot decelerate sufficiently to prevent your vehicle from closing in on the vehicle ahead.

TOYOTA SAFETY SENSE™

ADJUSTING DISTANCE (CONTINUED)

(3) Acceleration when there are no longer any preceding vehicles driving slower than the set speed

The system accelerates until the set speed is reached. The system then returns to constant speed cruising.

Note: When your vehicle is too close to a vehicle ahead, and sufficient automatic deceleration via the cruise control is not possible, the display will flash and the buzzer will sound to alert the driver. An example of this would be if another driver cuts in front of you while you are following a vehicle. Depress the brake pedal to ensure an appropriate vehicle-to-vehicle distance.

SWITCHING TO CONSTANT SPEED (CRUISE) CONTROL MODE

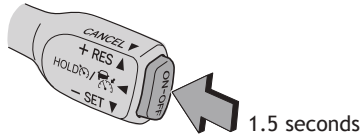

If you are already using DRCC “”, push ON-OFF button to turn the system off first, then push and hold ON-OFF button for at least 1.5 seconds to switch.

Note: When the ignition is turned off, it will automatically default to DRCC.

SETTING CONSTANT SPEED (CRUISE) CONTROL

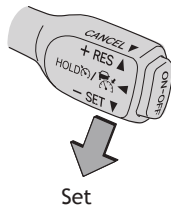

To adjust speed or cancel, see steps (2) and (3) of ADJUSTING SET SPEED on page 38.

Refer to the Toyota Owner's Manual for additional information on DRCC operation, settings adjustments, limitations, and precautions before attempting to use it.

Automatic High Beams (AHB)

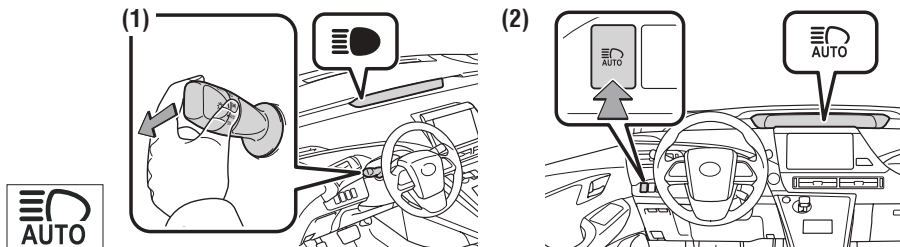

AHB is a safety system designed to help drivers see more of what's ahead at nighttime while reducing glare for oncoming drivers. AHB uses an in-vehicle camera to help detect the headlights of oncoming vehicles and tail lights of preceding vehicles, then automatically switches between high and low beams as appropriate to provide the most light possible and enhance forward visibility. By using high beams more frequently, the system may allow earlier detection of pedestrians and obstacles.



Refer to the *Toyota Owner's Manual* for additional information on AHB operation, settings adjustments, limitations, and precautions before attempting to use it.

ACTIVATING THE AHB SYSTEM

- (1) Push lever away from you with the headlight switch is in the “” or “AUTO” position.
- (2) Press the “” switch.

The AHB indicator will come on when the headlights are turned on automatically to indicate that the system is active.

Note: Pull the lever back toward you or press the AHB switch to turn the AHB system off.

The AHB indicator will turn off. To turn switch to “” position and the manual high beam indicator “” turns on.

CONDITIONS WHERE AHB WILL TURN ON/OFF AUTOMATICALLY

When all of these conditions are met, high beams will be automatically turned on (after approximately 1 second):

- Vehicle speed is above approximately 21 mph (34 km/h).
- The area ahead of the vehicle is dark.
- There are no oncoming or preceding vehicles with headlights or tail lights turned on.
- There are few streetlights on the road ahead.

If any of these conditions occur, high beams will be automatically turned off:

- Vehicle speed drops below approximately 17 mph (27 km/h).
- The area ahead of the vehicle is not dark.
- Oncoming or preceding vehicles have headlights or tail lights turned on.
- There are many streetlights on the road ahead.

Road Sign Assist (RSA)

Road Sign Assist is designed to help ensure drivers are kept informed. The RSA system recognizes specific road signs using a forward-facing intelligent camera to provide information to the driver via a Multi-information Display (MID). If the system judges that the vehicle is being driven over the speed limit, or performing actions prohibited by other support types of road signs, it alerts the driver using a warning display and may sound a warning buzzer.

RSA DISPLAY



When the driving assist systems display is selected, a maximum of 2 signs can be displayed.

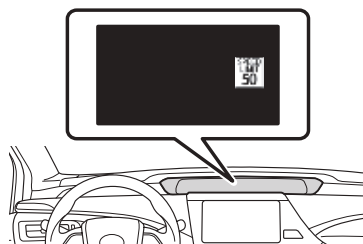

When a tab other than the driving assist systems display is selected, only a recognized speed limit sign or do not enter sign (when notification is necessary) will be displayed.

SUPPORTED TYPES OF ROAD SIGNS



Speed limit



Stop





Do Not Enter



Yield

SETTING RSA

- (1) Press “<>” switches and select  from the Multi-Information Display (MID).
- (2) Press “◇” switches and select the  setting function and then press “○.”
- (3) Press “○” each time to change the setting.
- (4) Press “➡” to go back to the menu.

Note: If the ignition switch was last turned off while a speed limit sign was displayed on the multi-information display, the same sign displays again when the ignition switch is turned back ON.

Refer to the Owner's Manual for additional information on RSA operation, settings adjustments, limitations, and precautions before attempting to use it.

Safety Connect®

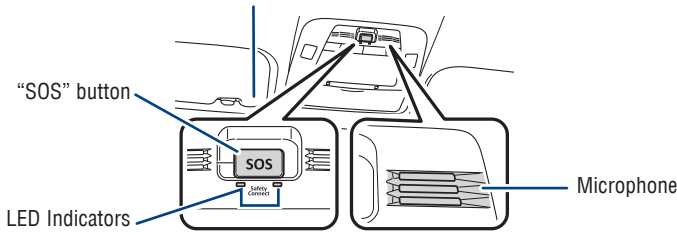

Safety Connect® is a subscription-based telematics service that uses Global Positioning System (GPS) data and embedded cellular technology to provide safety and security features to subscribers. Safety Connect® is staffed with live agents at the Toyota response center, which operates 24 hours per day, 7 days per week.

Services for subscribers include:

- Automatic collision notification
- Stolen vehicle locator
- Emergency assistance (“SOS” button)
- Enhanced roadside assistance

For additional information, refer to the “Owner’s Manual” or visit www.Toyota.com/connected-services.

Rear door child safety locks

Rear door

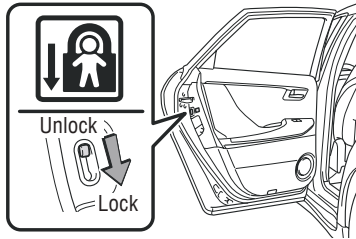

Moving the lever to lock position will allow the door to be opened only from the outside.

SAFETY & EMERGENCY FEATURES

Emergency tire puncture repair kit

Your vehicle is not equipped with a spare tire, but instead is equipped with an emergency tire puncture repair kit (bottle of sealant and compressor.)

After temporarily repairing the tire with the repair kit, have the tire repaired or replaced by your Toyota dealer.

Refer to the Owner's Manual for more details.

LOCATION

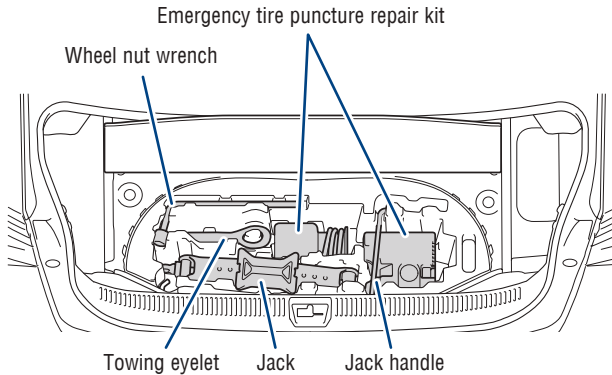

Tire Pressure Monitoring (warning) System (TPMS)

If the Tire Pressure Warning indicator “” illuminates without blinking, adjust tire pressures to factory-specified levels.* The light will turn off after a few minutes. The warning light is designed to turn on when tire pressure is critically low, but it may also come on due to temperature changes or changes in tire pressure from natural air leakage.

If the tire pressure indicator flashes for more than 60 seconds and then remains on, take the vehicle to your local Toyota dealer.

Refer to the Owner's Manual for more details.

** Refer to load label on door jamb or the Owner's Manual for tire inflation specifications.*

Seat belts

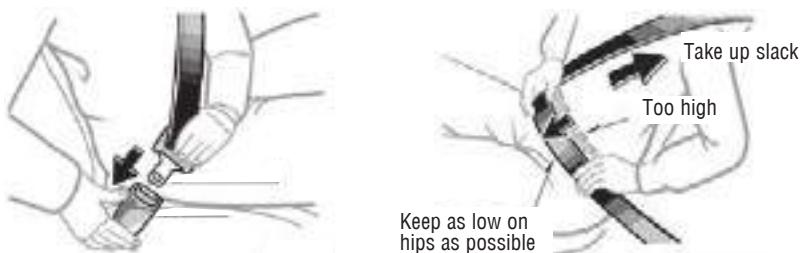

NOTE: If a passenger's seat belt is fully extended, then retracted even slightly, the Automatic locking retractor (ALR) will prevent it from being re-extended beyond that point, unless fully retracted again. This feature is used to help hold child restraint systems securely.

To find more information about seat belts, and how to install a child restraint system, refer to the Owner's Manual.

Seat belts-Shoulder belt anchor

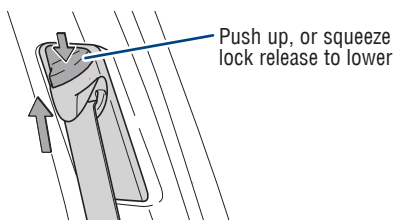

Trunk-Internal release

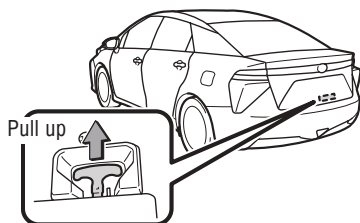

SAFETY & EMERGENCY FEATURES

Star Safety System™

Your vehicle comes standard with the Star Safety System™, which combines Anti-lock Braking System (ABS), Brake Assist (BA), Electronic Brake-force Distribution (EBD), Smart Stop Technology (SST), Traction Control (TRAC) and Vehicle Stability Control (VSC).

Refer to the Owner's Manual for more details and important information on limitations to these systems.

ANTI-LOCK BRAKE SYSTEM (ABS)

Toyota's ABS sensors detect which wheels are locking up and limits wheel lockup by "pulsing" each wheel's brakes independently. Pulsing releases brake pressure repeatedly for fractions of a second. This helps the tires attain the traction that current road conditions will allow, helping you to stay in directional control.

BRAKE ASSIST (BA)

Brake Assist is designed to detect sudden or "panic" braking, and then add braking pressure to help decrease the vehicle's stopping distance. When there's only a split second to react, Brake Assist can add additional brake pressure more quickly than just the driver alone can.

ELECTRONIC BRAKE FORCE DISTRIBUTION (EBD)

Toyota's ABS technology has Electronic Brake-force Distribution (EBD) to help maintain control and balance when braking. EBD responds to sudden stops by redistributing brake force to enhance the braking effectiveness of all four wheels.

SMART STOP TECHNOLOGY (SST)

Smart Stop Technology automatically reduces motor power when the accelerator and brake pedals are pressed simultaneously under certain conditions.

SST engages when the accelerator is depressed first and the brakes are applied firmly for longer than one-half second at speeds greater than five miles per hour.

SST doesn't engage if the brake pedal is depressed before the accelerator pedal, allowing vehicles to start on a steep hill and safely accelerate without rolling backward.

ENHANCED VEHICLE STABILITY CONTROL (VSC)

Enhanced Vehicle Stability Control provides cooperative control of the ABS, TRAC, VSC and EPS.

Enhanced VSC helps to maintain directional stability when loss of traction occurs during a turn.

TRACTION CONTROL (TRAC)

VSC helps prevent loss of traction during cornering by reducing Motor power output, and Traction Control helps maintain traction on loose gravel and wet, icy, or uneven surfaces by applying brake force to the spinning wheel(s).

Toyota's TRAC sensors are activated when one of the drive wheels starts to slip. TRAC limits Motor power output and applies the brakes to the spinning wheel. This transfers power to the wheels that still have traction to help keep you on track.

Floor mat installation

There are two types of Toyota floor mats: carpeted and all-weather. Each vehicle has model-specific floor mats. Installation is easy.

To keep your floor mat properly positioned, follow these steps:

- Only use Toyota floor mats designed for your specific model.
- Use only one floor mat at a time, using the retaining hooks to keep the mat in place.
- Install floor mats right side up.

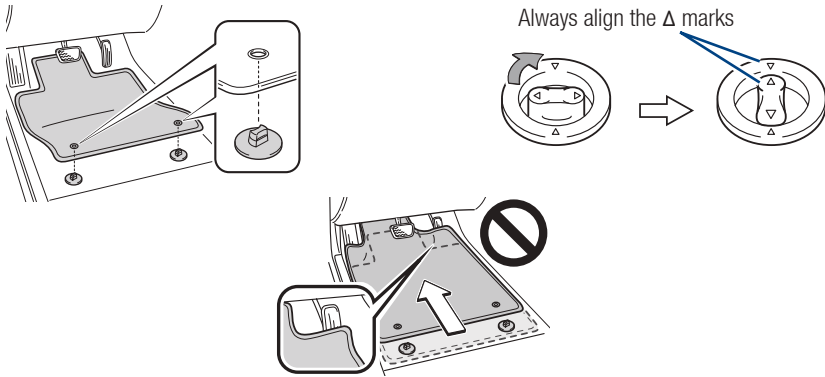

BLUETOOTH® DEVICE PAIRING SECTION

Do not attempt the Bluetooth® Pairing process while driving.

To begin the Bluetooth® Pairing process, press the HOME button on the faceplate of your multimedia system.

Bluetooth® Pairing for your phone

Pairing your phone is the first step in connecting with your Toyota for hands-free calling and for audio streaming via Bluetooth. This pairing process is quick and easy. All you have to do is setup the phone and multimedia system to form a connection.¹



Premium Audio

STEP 1 Press [MENU] on the audio system faceplate, then select "Setup" on display screen.



iPhone bluetooth Menu



Android bluetooth Menu



STEP 2 Ensure Bluetooth is turned on for your device.

STEP 3 Select "Bluetooth", then select "Add New Device" on display screen.



STEP 4 Select "Device Name".



STEP 5 Check the display on your smart phone. Does the PIN XXXX match the PIN displayed? If it does select "Pair".

¹ Some Android devices may have slightly different SETTINGS screen layout depending on manufacturer of device and Android OS version.

Bluetooth® Pairing for your phone (cont.)



STEP 6 "Connecting" displays while device is forming the connection to your multimedia system.



STEP 7 Enable Notifications (text message). While pairing your phone a message will be displayed: **"You may need to allow message access on your phone"**.

Note: You may also select "Skip" on display screen to skip enabling notifications. If skipped proceed to **Step 8**.

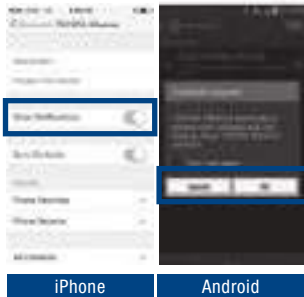

STEP 8 Turn on "Show Notifications" for iPhone or "ON" for Android.



STEP 9 A confirmation will appear once your phone has been paired and connected.

NOTES

NOTES



Mirai

Quick Reference Guide 2020



00505QRG20MIR

toyota.com



Printed in U.S.A. 11/19
19-MKG-14040