

QUICK REFERENCE GUIDE



TUNDRA

2020



2020

TUNDRA

This Quick Reference Guide is a summary of basic vehicle operations. It contains brief descriptions of fundamental operations so you can locate and use the vehicle's main equipment quickly and easily.

The Quick Reference Guide is not intended as a substitute for the Owner's Manual located in your vehicle's glove box. We strongly encourage you to review the Owner's Manual and supplementary manuals so you will have a better understanding of your vehicle's capabilities and limitations.

Your dealership and the entire staff of Toyota Motor North America, Inc. wish you many years of satisfied driving in your new Tundra.

A word about safe vehicle operations

This Quick Reference Guide is not a full description of Tundra operations. Every Tundra owner should review the Owner's Manual that accompanies this vehicle.

Pay special attention to the boxed information highlighted in color throughout the Owner's Manual. Each box contains safe operating instructions to help you avoid injury or equipment malfunction.

All information in this Quick Reference Guide is current at the time of printing. Toyota reserves the right to make changes at any time without notice.

INDEX

OVERVIEW

Engine maintenance	8
Fuel tank door release & cap	7
Hood release	8
Indicator symbols	4-5
Instrument cluster	4
Instrument panel	2-3
Instrument panel light control	8
Keyless entry ¹	6
Smart Key system ^{1,2}	7

FEATURES & OPERATIONS

Air conditioning/heating	18
Audio	20
Auto lock/unlock ¹	9
Automatic transmission	10
Bottle holders	28
Blind Spot Monitor with Rear	
Cross Traffic Alert (BSM w/RCTA)	26
Cup holders	29
Door locks	11
Garage door opener (HomeLink®) ³	28
Headlight leveling dial	13
Intuitive parking assist	27
Lights ¹ & turn signals	12
Mirrors-Power outside rear view	9
Moonroof	14
Multi-Information Display (MID) ²	21
Parking brake	14
Power outlets-12V DC	22
Rear view monitor system	19
Seat adjustments-Front	16-17
Seat folding-Rear	17
Seat heaters/ventilators	19
Seats-Head restraints	17
Steering lock release	14
Steering wheel switches & telephone controls (Bluetooth®)	23
Tilt & telescopic steering wheel	11
TOW/HAUL switch	25

FEATURES & OPERATIONS (continued)

Trailer brake controller	24
Two & four-wheel drive selector	24
USB charge-ports	20
USB media port	21
Vehicle Stability Control (VSC)	
OFF switch	26
Window-Power back	15
Windows-Power	15
Windshield wipers & washers	13

TOYOTA SAFETY SENSE™ P (TSS-P)

Automatic High Beams (AHB)	40
Dynamic Radar	
Cruise Control (DRCC)	37-39
Lane Departure Alert (LDA)	33-36
Pre-Collision System with Pedestrian Detection (PCS w/PD)	31-33
Quick overview-	
Toyota Safety Sense™ P (TSS-P)	30
Sensors	30

SAFETY & EMERGENCY FEATURES

Floor mat installation	45
Rear door child safety locks	42
Safety Connect	42
Seat belts	41
Seat belts-Shoulder belt anchor	41
Spare tire & tools	43
Star Safety System	44-45
Trailer Sway Control	45
Tire Pressure Monitoring (warning) System (TPMS)	41

BLUETOOTH® DEVICE PAIRING SECTION

46-48

¹ Visit your Toyota dealer for information on customizing this feature.

² Programmable by customer. Refer to the Owner's Manual for instructions and more information.

³ HomeLink® is a registered trademark of Gentex Corporation.

Instrument panel

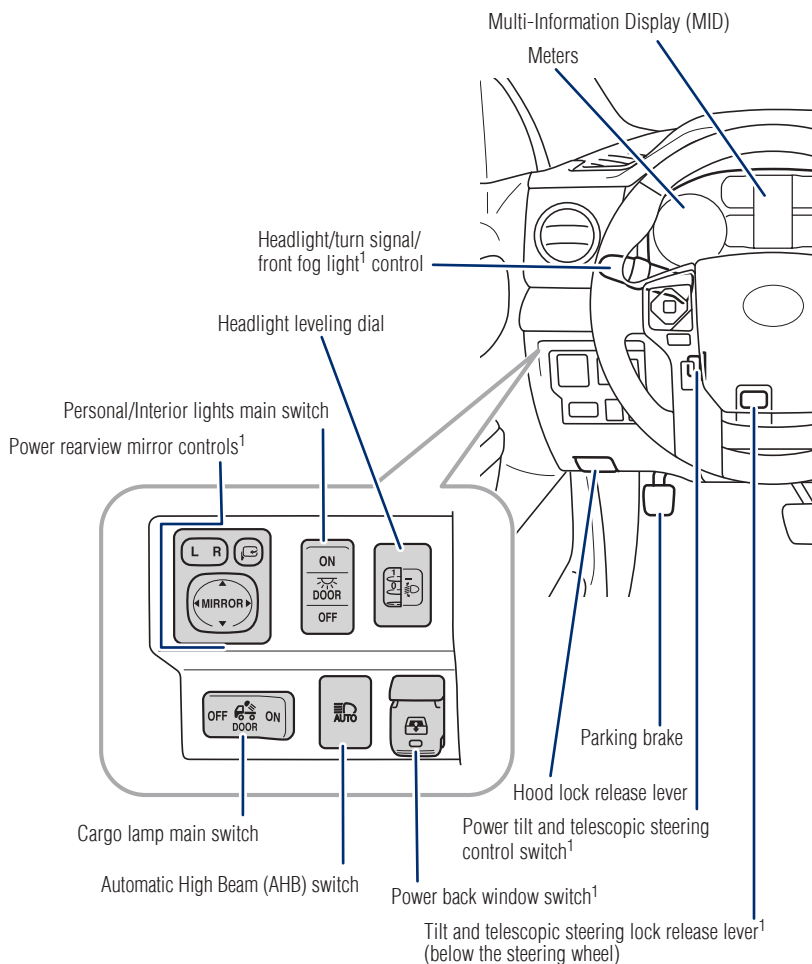
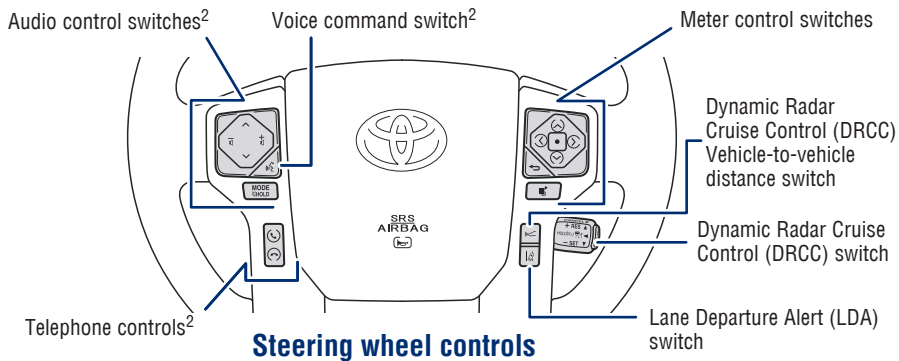

¹ If equipped.

² For details, refer to the “Navigation and Multimedia System Owner’s Manual” or visit www.toyota.com/audio-multimedia for additional resources.

NOTE: Instrument panel features depend on the seat option, split seats or bench. Refer to the Owner’s Manual for more details.

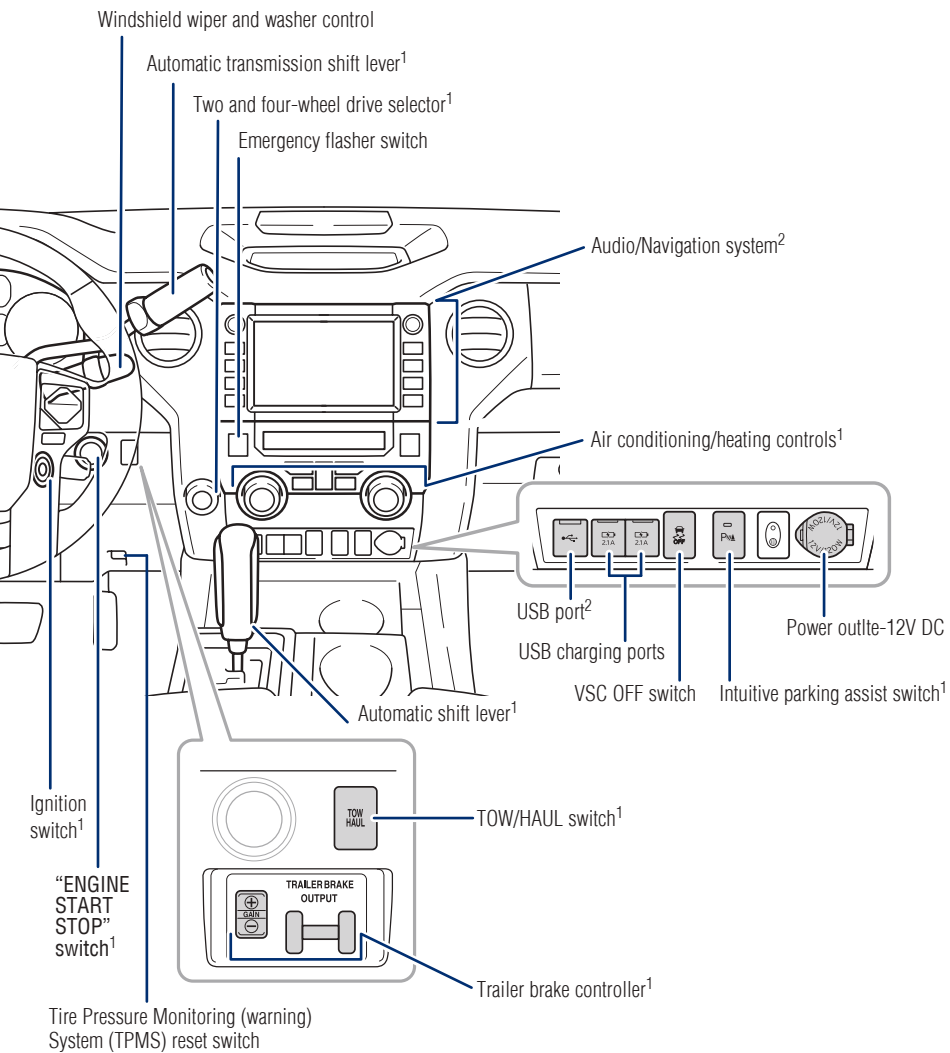



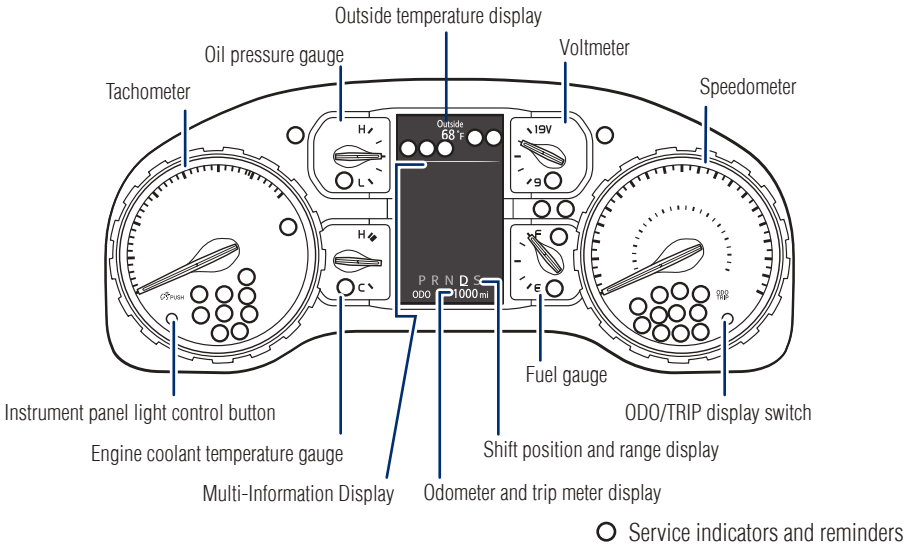























Instrument cluster











Indicator symbols

For details, refer to “Indicators and warning lights,” Section 2, 2020 Owner’s Manual.

-  AIR BAG ON and AIR BAG OFF indicators¹
-  Air bag SRS warning¹
-  ABS Anti-lock Brake System (ABS) warning¹
-  Arrow direction indicates fuel tank door position
-  AUTO LSD AUTO Limited Slip Differential (LSD) indicator¹
-  AUTO AHB Automatic High Beam (AHB) indicator
-  BSM Blind Spot Monitor (BSM) indicator⁴
-  BSM outside rearview mirror indicators⁴

 RCTA	BSM w/Rear Cross Traffic Alert (RCTA) ⁴
	Brake Override System/ Drive-Start Control warning
 BRAKE	Brake system warning ¹
	Charging system warning ¹
 SET	Constant speed cruise control indicator/Constant speed cruise control SET indicator
 SET	Dynamic Radar Cruise Control (DRCC) indicator/DRCC SET indicator
	Driver/Front passenger's seat belt reminder (alarm will sound if speed is over 12 mph)
 F	Fog light indicator
	Headlight low/high beam indicators
	High engine coolant temperature warning
 4HI	High/Low speed four-wheel drive indicator ⁴
 4LO	
	Lane Departure Alert (LDA) indicator [Green/Yellow ³]
	Low fuel level warning
	Low outside temperature indicator
	Low Tire Pressure Warning ¹
	Low windshield washer fluid warning
 CHECK	Malfunction/Check Engine indicator ¹
	Master warning ^{1,2}

 PARK	Parking brake indicator ^{1,2}
 OFF	Pre-Collision System (PCS) warning ^{1,2}
	Security indicator
	Slip indicator ^{1,3}
 TOW HAUL	TOW/HAUL mode indicator
 TRAC OFF	TRAC OFF indicator ¹
	Trailer connection indicator ⁴ (green)
	Turn signal indicator
 OFF	Vehicle Stability Control (VSC) OFF indicator ¹

¹ If the indicator does not turn off within a few seconds of starting the engine, there may be a malfunction. Have the vehicle inspected by your Toyota dealer.

² If the indicator flashes, there may be a malfunction. Refer to the Owner's Manual.

³ If the indicator flashes, it indicates that the system is operating.

⁴ If equipped.

OVERVIEW

Keyless entry

UNLOCKING OPERATION

Smart Key

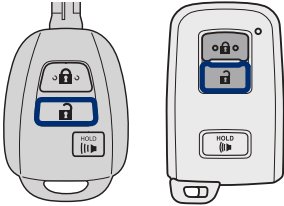

Push

Push **ONCE**: Driver door
Push **TWICE**: All doors

Carry Smart Key remote

Front door unlock*

Grasp



NOTE: If a door is not opened within 60 seconds of unlocking, all doors will relock for safety.

LOCKING OPERATION

Smart Key

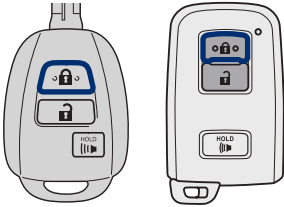

Push

Carry Smart Key remote

All-door lock

Touch

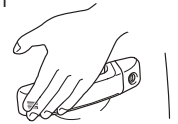

PANIC BUTTON

Smart Key

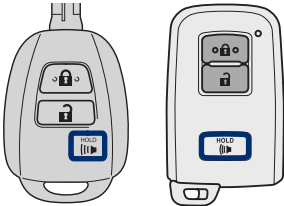

HOLD



Push and hold



* Driver door unlocking function can be programmed to unlock driver door only, or all doors. In some models, grasping front passenger door handle will unlock all doors.

Please refer to the Owner's Manual for more details on how to program the doors.

NOTE: Doors may also be locked/unlocked using remote.

Smart Key system

START FUNCTION

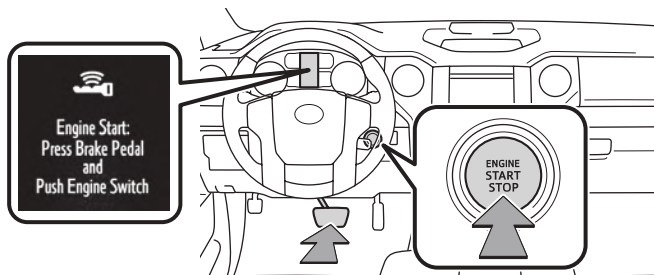

NOTE: The Smart Key must be carried to enable the start function. With the gear shift lever in Park and the brake pedal depressed, push the “ENGINE START STOP” switch.

POWER (WITHOUT STARTING ENGINE)

Without depressing the brake pedal, pressing the “ENGINE START STOP” switch will change the operation mode in succession from:

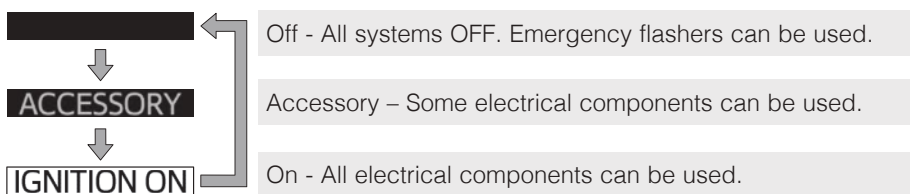

Fuel tank door release & cap

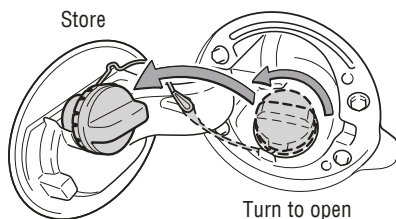
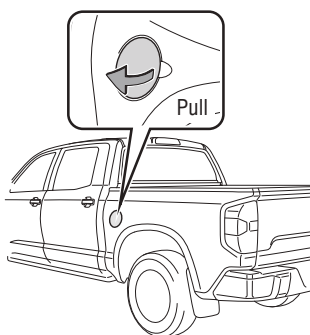

NOTE: Tighten until one click is heard. If the cap is not tightened enough, Check Engine “” indicator may illuminate.

Instrument panel light control

Brightness control

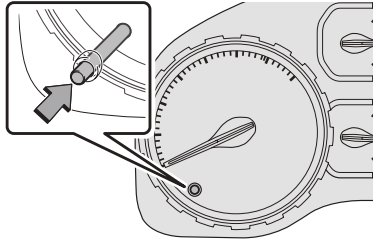

Hood release

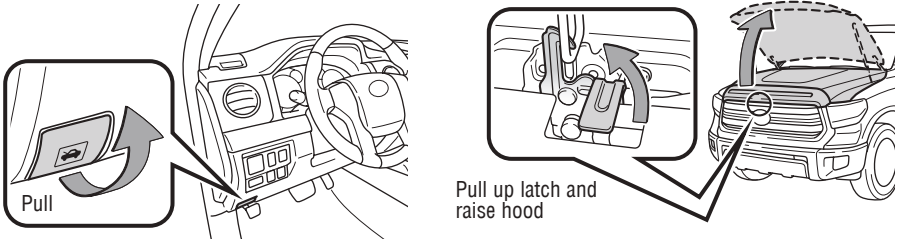

Engine maintenance

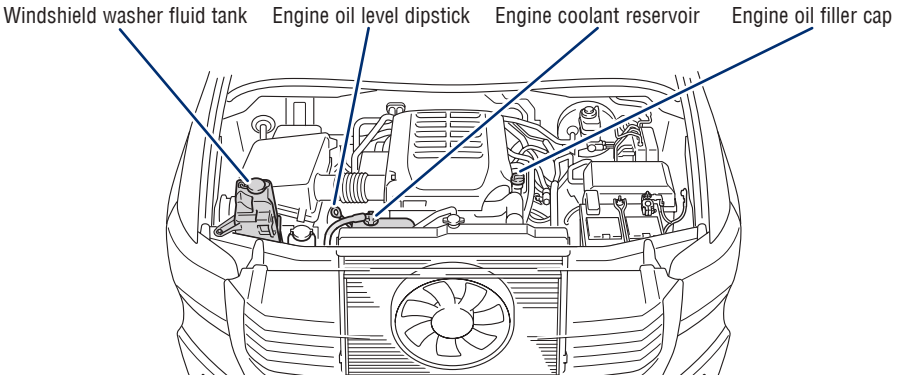

NOTE: Regularly scheduled maintenance, including oil changes, will help extend the life of your vehicle and maintain performance. Please refer to the "Warranty & Maintenance Guide."

FEATURES & OPERATIONS

Auto lock/unlock

Automatic door locks can be programmed to operate in different modes, or turned OFF.

Shift position linked door locking/unlocking function

Doors lock when shifting from Park.
Doors unlock when shifting into Park.

Speed linked door locking function

Doors lock when the vehicle speed goes above approximately 12 mph (20 km/h).

Driver's door linked door unlocking function

Doors unlock within 10 seconds after the engine switch is turned to "OFF" and driver's door is opened.

Refer to the *Owner's Manual* for more details.

Mirrors-Power outside rear view (if equipped)

ADJUST AND FOLD

Type A

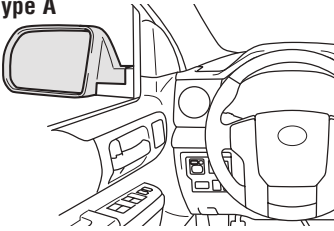

Type B

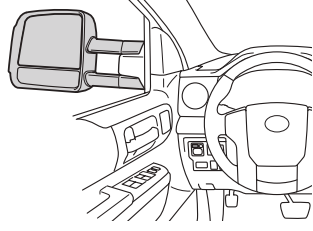

Type A Folding from inside (if equipped)

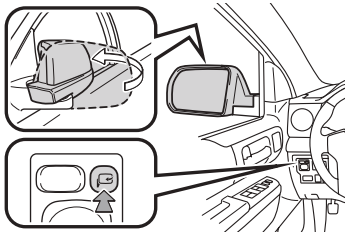

Adjusting mirrors

Select left or right

Adjust up, down, left and right

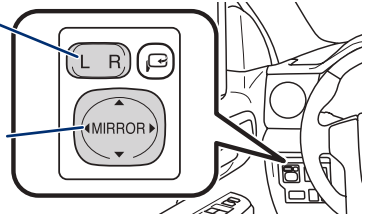

Key must be in the "ACC" or "ON" position.
Refer to the *Owner's Manual* for more details.

EXTEND (IF EQUIPPED)

Type B



Mirrors can be manually slid outward to improve visibility while towing.

FEATURES & OPERATIONS

Automatic transmission

FLOOR SHIFT TYPE

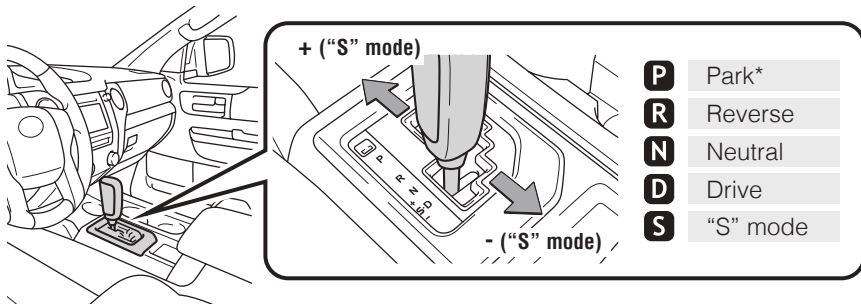

COLUMN SHIFT TYPE

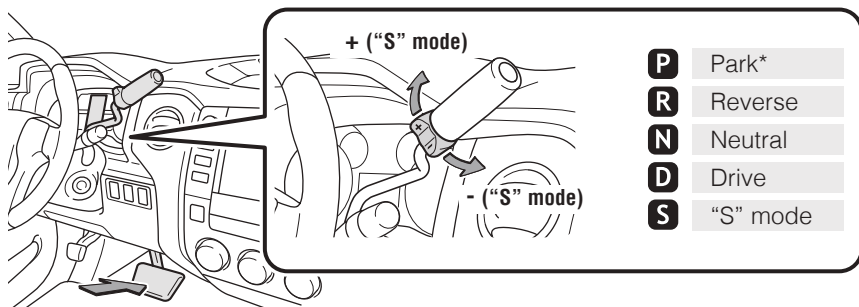

* The engine switch must be in the "ON" position (without Smart Key)/"IGNITION ON" mode (with Smart Key) and the brake pedal depressed to shift from Park.

"S" (SEQUENTIAL) MODE

Shift the shift lever to "S" position from "D" position.

Floor shift type:

- + : Upshift (push and release)
- : Downshift (pull and release)

Column shift type:

- + : Upshift (push and release)
- : Downshift (push and release)

Downshifting increases power going uphill, or provides engine braking downhill. For best fuel economy during normal driving conditions, always drive with the shift lever in the "D" position.

Tilt & telescopic steering wheel

MANUAL (IF EQUIPPED)

Tilt steering wheel

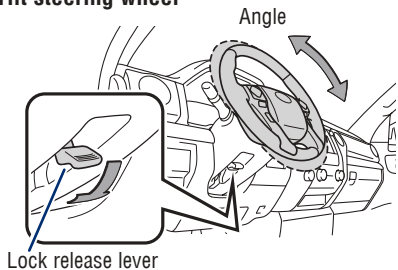

Tilt and telescopic steering wheel

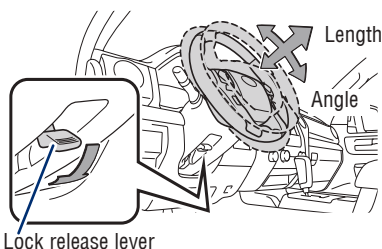

Hold wheel, push lever down, set angle and length, and return lever.

POWER (IF EQUIPPED)

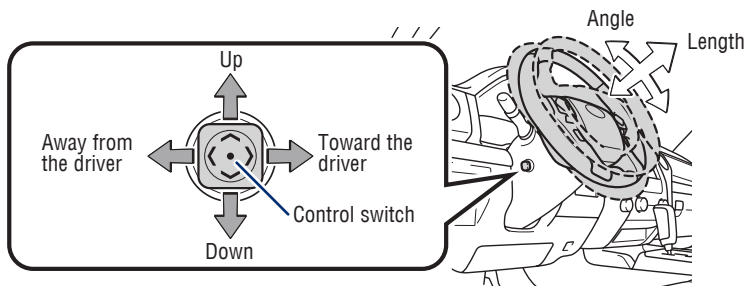

Push the control switch, set angle and length.

NOTE: Do not attempt to adjust while the vehicle is in motion.

When ignition key removed, the steering wheel moves up and away from driver and stows, but returns to its position when key is inserted (power-adjustable type).

Door locks

Driver side

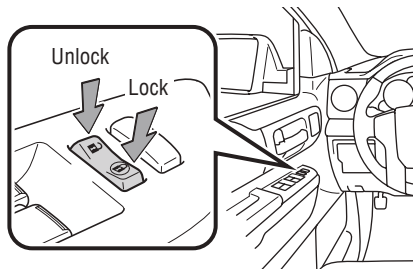

Front passenger side

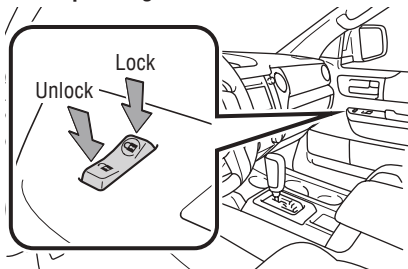

FEATURES & OPERATIONS

Lights & turn signals

HEADLIGHTS

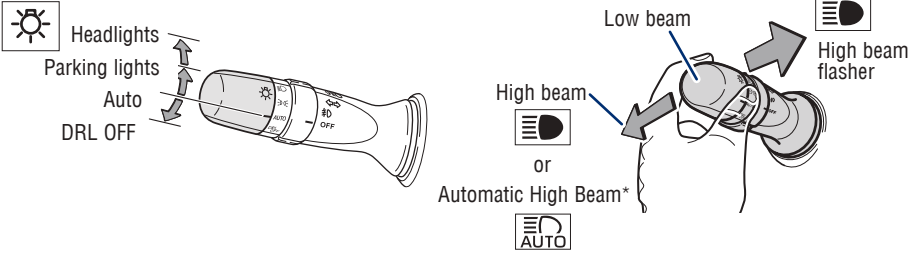

Daytime Running Light system (DRL) Automatically turns on under certain conditions to make vehicle more visible to other drivers. Not for use at night.

Automatic light cut off system (AUTO) Automatically turns lights off after 30 second delay, or lock switch on remote is pushed after locking.

Automatic High Beam system (AHB) Automatically switches between high and low beams as appropriate to enhance vision at night.

Refer to Toyota Safety Sense™ P (TSS-P) in this guide or the Owner's Manual for more details on the Automatic High Beam feature.

* Operating conditions must be met. Refer to the Owner's Manual for details.

FOG LIGHTS (IF EQUIPPED)

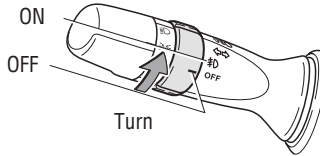

Front fog lights come on only when the headlights are on low beam.

TURN SIGNALS

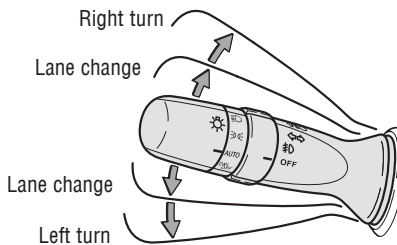

Headlight leveling dial

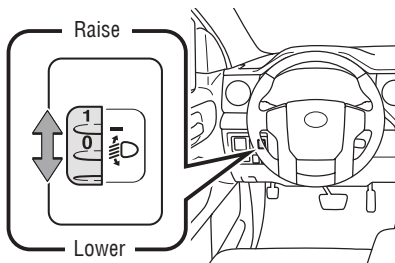

Windshield wipers & washers

WITH INTERMITTENT WIPER

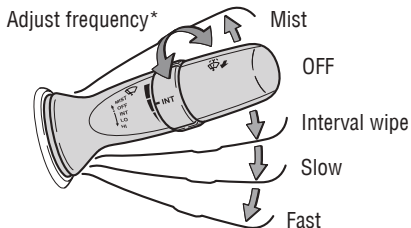

Pull to wash and wipe

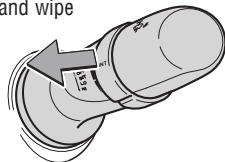

* Intermittent windshield wiper frequency adjustment Rotate to increase/decrease wipe frequency.

WITHOUT INTERMITTENT WIPER

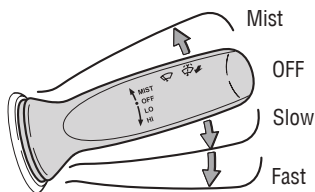

Pull to wash and wipe

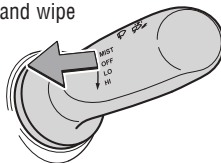

FEATURES & OPERATIONS

Moonroof (if equipped)

SLIDING OPERATION

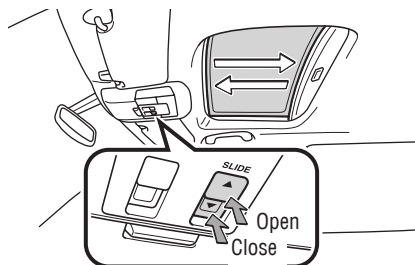

TILTING OPERATION

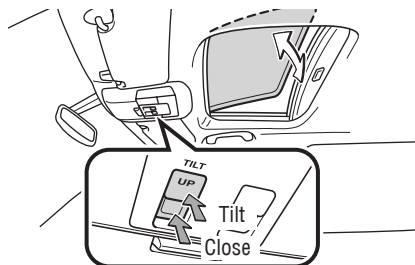

Push once to open/close completely.

Lightly press either side of the moonroof switch while opening/tilting is in progress, the moonroof stops partway.

Parking brake

PARK

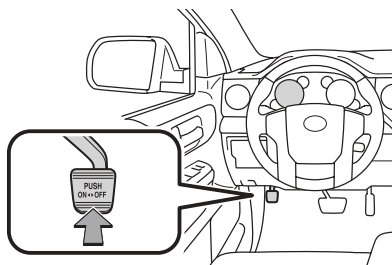

Set: Depress
Release: Depress again

Steering lock release

Without Smart Key system

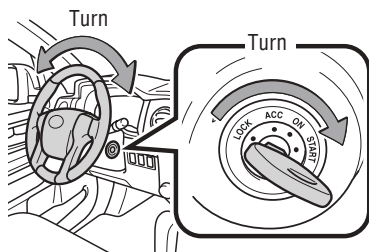

When starting the engine, the engine switch may seem stuck in the OFF. To free it, turn the key while turning the steering wheel slightly left and right.

With Smart Key system

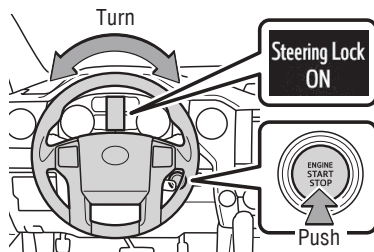

A message will be displayed on the multi-information display. Check that the shift lever is in P. Press the engine switch while turning the steering wheel left and right.

Windows-Power

Driver side (Type A)

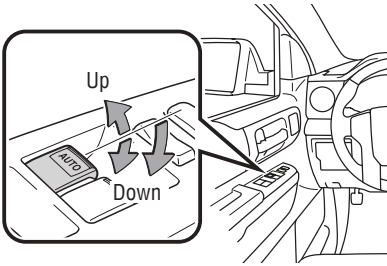

Driver side (Type B)

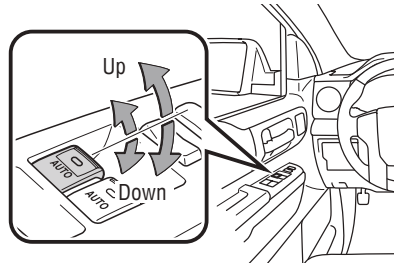

Window lock switch

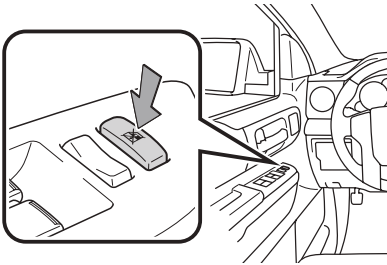

All window up/down (passenger side for some models and driver side) Push the switch completely down or pull it completely up and release to fully open or close.* To stop window part way, lightly push the switch in the opposite direction.

Window lock switch Deactivates all passenger windows. Driver's window remains operable.

* Not all models are equipped with one-touch close function.

Window-Power back (if equipped)

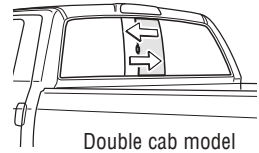
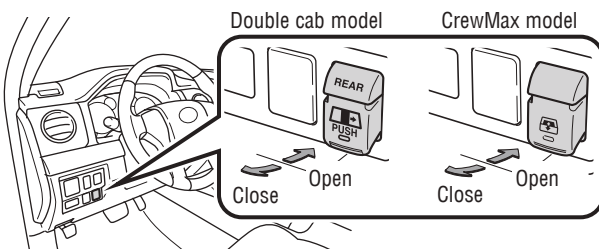

Double cab model

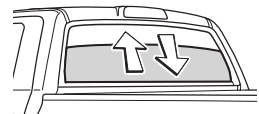

CrewMax model

FEATURES & OPERATIONS

Seat adjustments-Front (if equipped)

MANUAL SEAT

Split seat (passenger side)

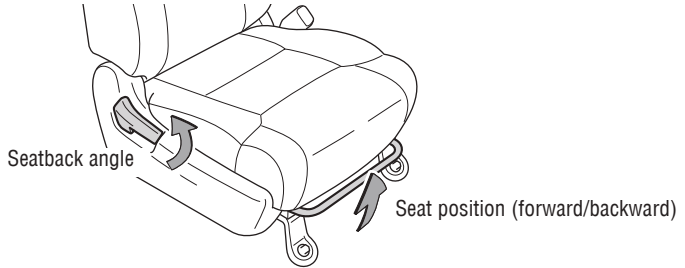

Bench seat

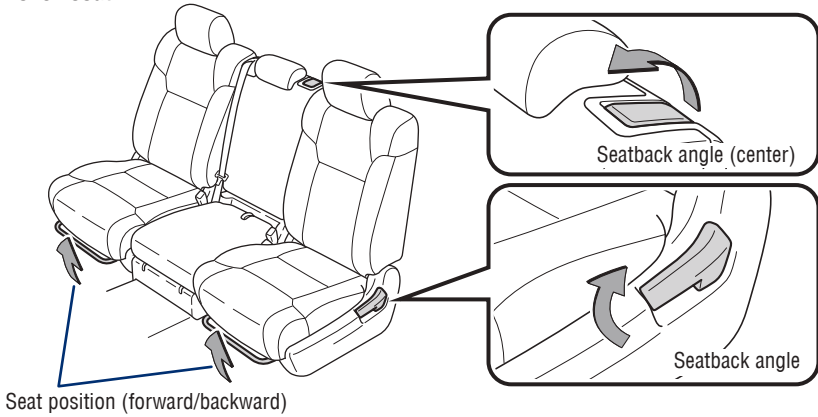

POWER - DRIVER'S SEAT

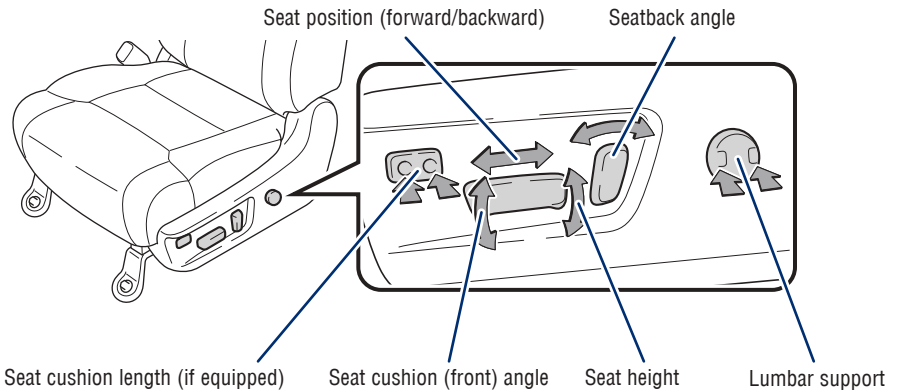

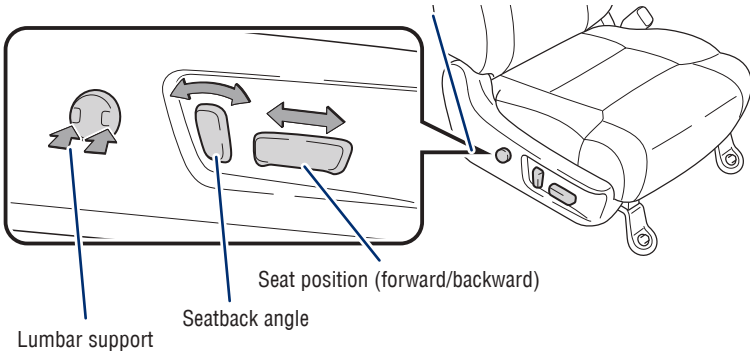

Seat folding-Rear

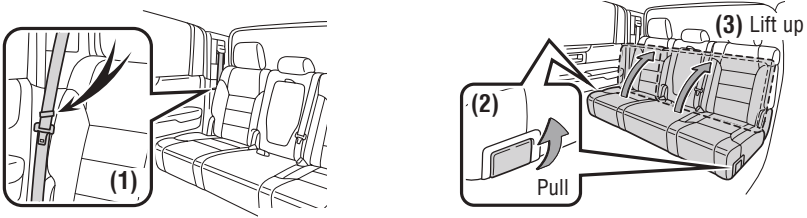

Seats-Head restraints

Front

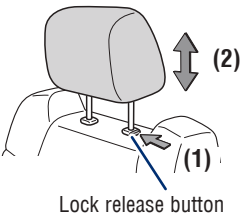

Rear-Center seat (Double Cab models)

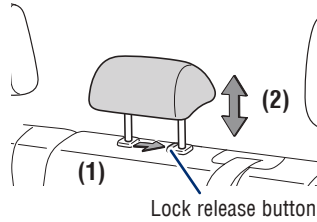

Rear-Center seat (CrewMax models)

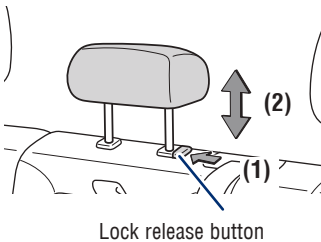

Rear-Outer seat

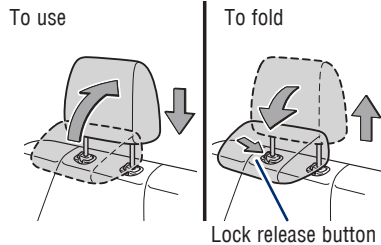

FEATURES & OPERATIONS

Air conditioning/heating

MANUAL AIR CONDITIONING (IF EQUIPPED)

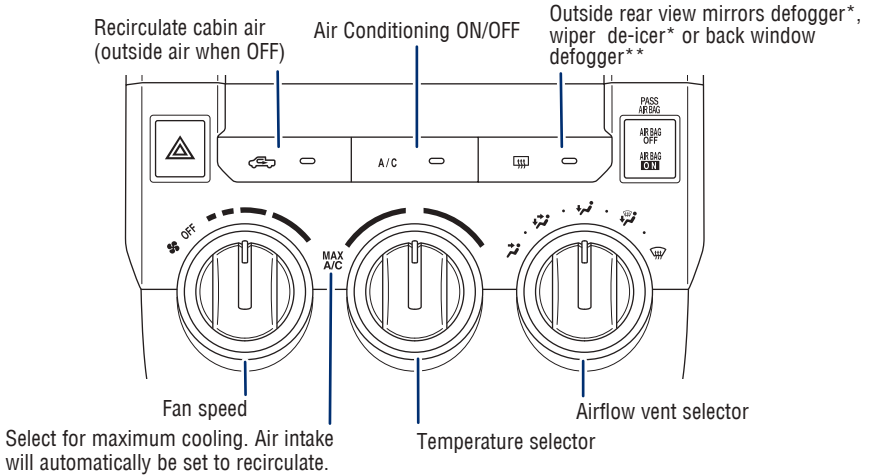

*If equipped

**CrewMax models only

AUTOMATIC AIR CONDITIONING (IF EQUIPPED)

Automatic climate control ON

Adjusting the temperature setting will cause the airflow vents, air intake and fan to adjust automatically to set temperature.

Outside rear view mirrors defogger*, wiper de-icer* or back window defogger**

Synchronize temperature settings for driver and passenger.

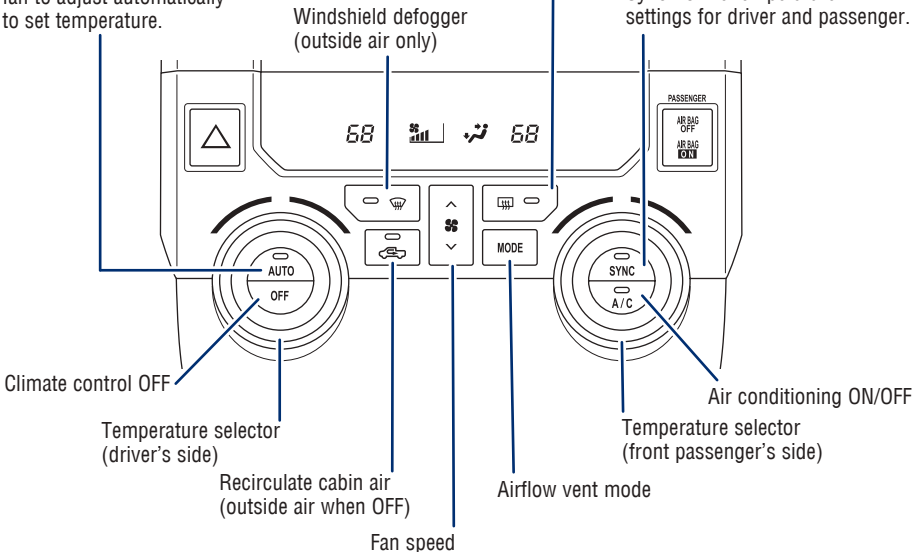

*If equipped

**CrewMax models only

Seat heaters/ventilators

SEAT HEATERS (IF EQUIPPED)

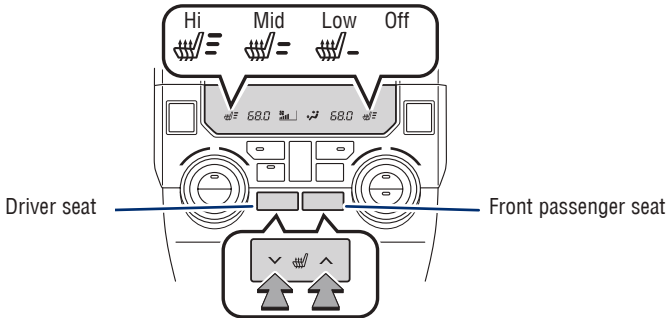

SEAT HEATERS & VENTILATORS (IF EQUIPPED)

Seat heaters

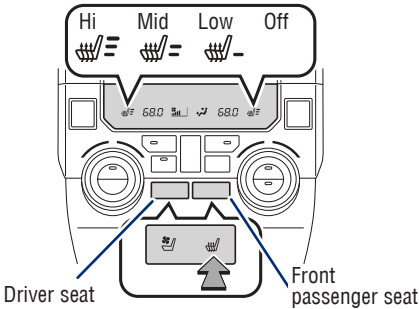

Seat ventilators

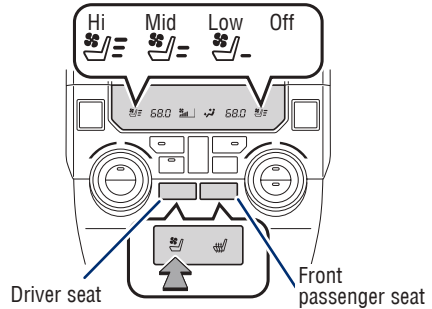

The engine switch must be in the "ON" position (without Smart Key) / "IGNITION ON" mode (with Smart Key) for use.

Rear view monitor system

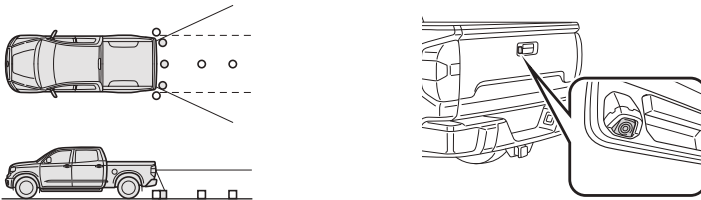

The rear view monitor system displays an image of the view from the bumper of the rear area of the vehicle. The camera for the rear view monitor system is located above the license plate.

To adjust the image on the rear view monitor screen, press the "MENU" button and select "Display". Select "Camera" to adjust the screen contrast and brightness.

Refer to the *Navigation and Multimedia System Owner's Manual* for limitations and more details on this system.

FEATURES & OPERATIONS

Audio

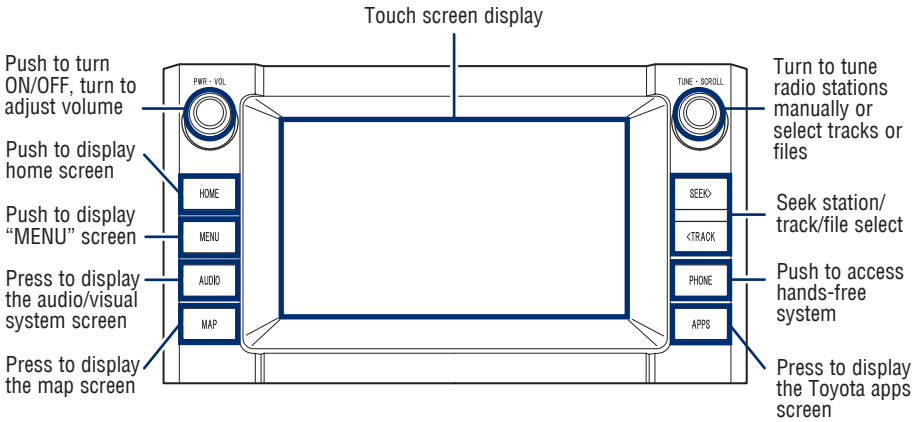

Refer to the "Navigation and Multimedia System Owner's Manual" or visit www.toyota.com/audio-multimedia for additional resources.

USB charging-ports

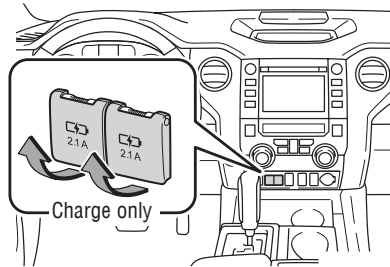

The engine switch must be in the "ACC" or "ON" position (without Smart Key) / "ACCESSARY" or "IGNITION ON" mode (with Smart Key) for use.

USB media port

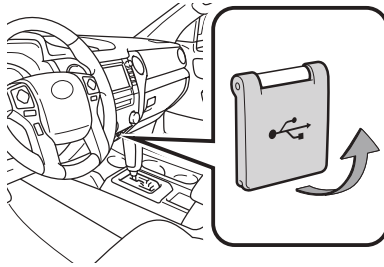





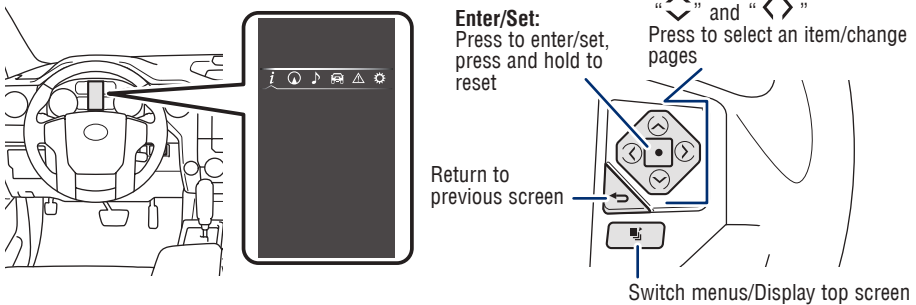

Connecting a compatible device and cable into the USB media port will support charging and music playback through the audio multimedia system.

Multi-Information Display (MID)



Push “DISP” to scroll through the following:

-  Drive information
-  Navigation system-linked display including compass display (if equipped)
-  Audio system-linked display
-  Vehicle information
-  Warning message display
-  Settings display

Refer to your Owner's Manual for complete details.

Power outlets-12V DC

Key must be in the “ACC” or “ON” position to use.

Instrument panel (Type A)

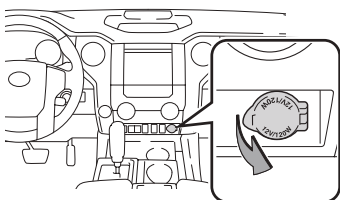

Back of the front center seatback (Type B)

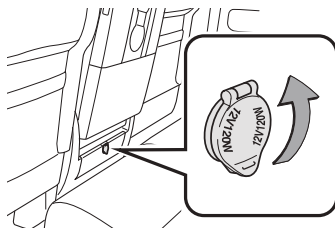

Back of the front center seatback (Type C)

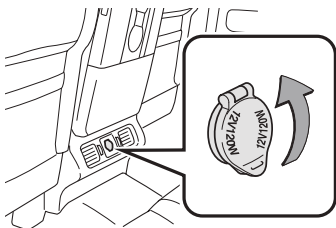

Inside of console box (Type D)

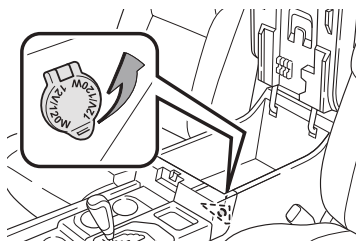

Back of the console box (Type E)

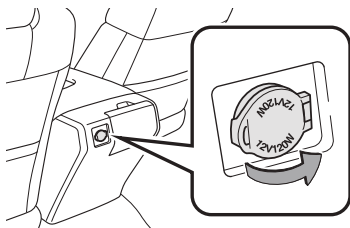

Back of the console box (Type F)

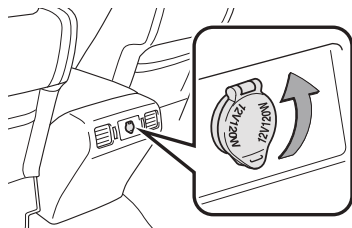

The engine switch must be in the “ACC” or “ON” position (without Smart Key) / “ACCESSARY” or “IGNITION ON” mode (with Smart Key) for use.

Steering wheel switches & telephone controls (Bluetooth®)

Steering wheel telephone switches



Use to search within the selected audio feature.

“MODE/HOLD”

Push and hold to mute or pause current operation or change audio source.

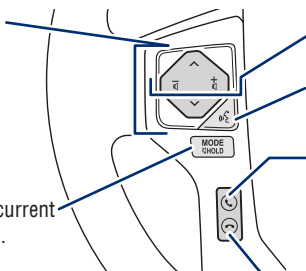

“- , +”
Volume control

Voice command switch

- Make a call
- Receive a call
- Display “Phone” screen

- End a call
- Refuse a call

Microphone

Microphone location may vary by vehicle.

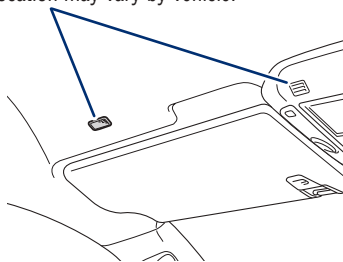

Bluetooth® technology allows dialing or receipt of calls without removing your hands from the steering wheel.

Refer to the Bluetooth® device pairing in this guide or the Navigation and Multimedia System Owner's Manual for additional user instructions.

NOTE: Concentrating on the road should always be your first priority while driving. Do not use the Audio Multimedia System if it will distract you.

Two & four-wheel drive selector (if equipped)

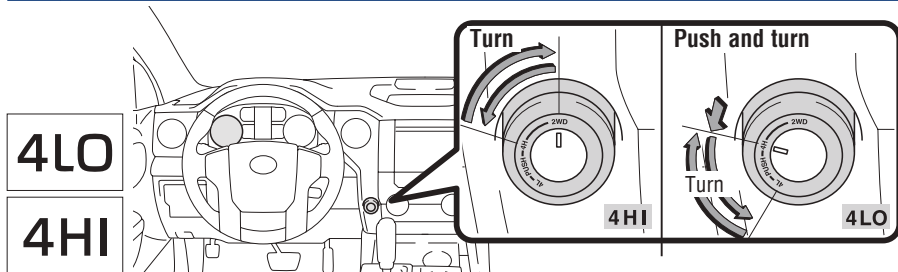

2WD

High speed (2WD) Normal driving on dry hard-surfaced roads.

4H

High speed (4WD) For driving only on roads that permit the tires to slide, like off-road, icy or snow-covered roads.

4L

Low speed (4WD)

For maximum power and traction when climbing or descending steep hills, off-road driving, and hard pulling in sand, mud or deep snow.

Shifting between “2WD” and “4H”

Reduce speed to less than 62 mph, then turn control to “2WD” or “4H.”

Shifting between “4H” and “4L”

When stopped shift to “N” position, then push and turn to “4L” from “4H.”

NOTE: For best fuel economy and performance under normal driving conditions, keep in “2WD” position.

Trailer brake controller (if equipped)

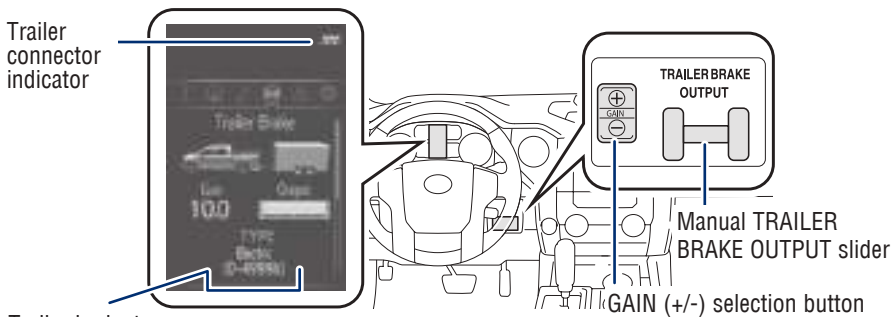

The trailer brakes can be controlled by the Trailer brake controller via the 7-pin connector. By selecting the type of brakes that are being used on the trailer (electric or electric-over-hydraulic) and setting the gain for the controller, the manual TRAILER BRAKE OUTPUT slider is used to slow just the trailer. The vehicle brake pedal will also slow down as well as stop the trailer when applied. Gain values, manual brake outputs, trailer brake types and the trailer connection status are displayed in the multi-information display.

Refer to the Owner's Manual for more details.

TOW/HAUL switch (if equipped)

Floor shift type

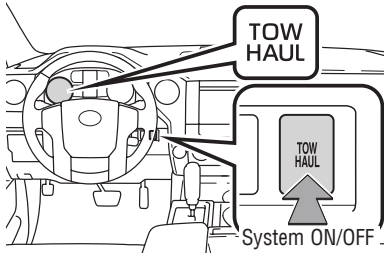

Column shift type

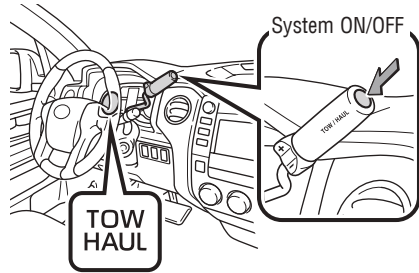

**TOW
HAUL**

**TOW
HAUL**

“Tow/Haul” mode is ideal for use when carrying heavy loads. When the TOW/HAUL switch is pressed, throttle response and transmission control are optimized for the high performance operation. As fuel economy is reduced while in “Tow/Haul” mode, deactivating when driving without a load is recommended.

ENGINE CONTROL

When Tow/Haul is engaged, the opening angle of the electronically controlled throttle is wider for any given accelerator pedal position than normal, enhancing acceleration feeling and response.

ENHANCED SHIFT CONTROL

- Upshifts occur at higher engine speeds to expand the use of lower gear ranges, enhancing power performance during towing and preventing repeated gear changes.
- Downshifts occur at a greater accelerator pedal angle to allow the vehicle to stay in a higher gear, reducing repeated gear changes.
- Downshifts occur at a lower accelerator pedal angle to allow the vehicle to stay in a lower gear, enhancing towing ability.
- When the accelerator pedal is wide open, upshift timing is optimized to effectively use the maximum engine power range available.

UPHILL/DOWNHILL SHIFT FEATURES

- During uphill driving, the gear position is held to prevent repeated upshifting.
- During downhill driving, downshifting to lower gears will occur to effectively use engine braking.

Refer to the Owner's Manual for more details on this system before attempting to use it.

Vehicle Stability Control (VSC) OFF switch

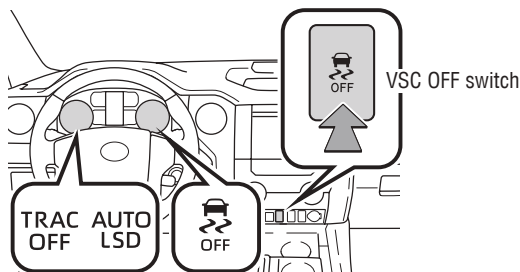

The VSC OFF switch is used to switch between modes related to the TRAC, VSC and Auto LSD functions.

Refer to the Owner's Manual for limitations and more details.

Blind Spot Monitor with Rear Cross Traffic Alert (BSM w/RCTA) (if equipped)

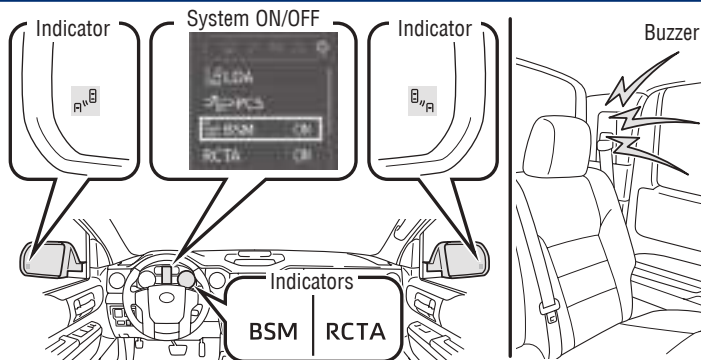

The BSM is a system that has two functions:

- **The Blind Spot Monitor function** (assists the driver in decision making when to change lanes)
- **The Rear Cross Traffic Alert function** (assists the driver when backing up)

The system uses radar sensors to detect vehicles that are traveling in the Tundra's blind spot. If a vehicle is detected, the driver will be alerted via the outside rear view side mirror indicators.

Rear Cross Traffic Alert function:

While in reverse, when a vehicle approaching from the right or left rear of the vehicle is detected, the outside rear view mirror indicators flash.

Refer to the Owner's Manual for limitations and more details on this system before attempting to use it.

Intuitive parking assist (if equipped)

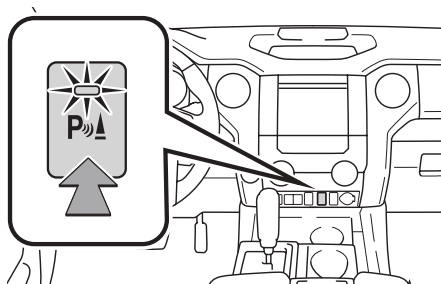

Front corner sensors

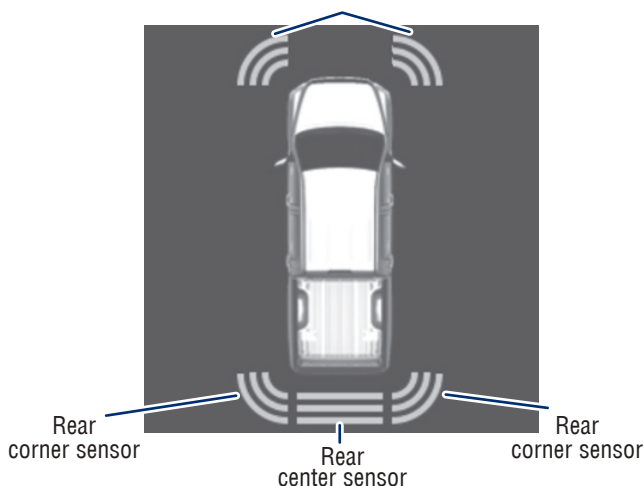

The parking assist sonar system operates when the vehicle approaches an obstacle. The distance from your vehicle to nearby obstacles when parallel parking or maneuvering into a garage is measured by sensors and communicated via the Multi-Information Display (MID) and audible beeps.

When the sensor detects an obstacle, the direction of and the approximate distance to the obstacle are displayed on the MID display by illuminating continuously (far) or blinking (near), and beeping sounds will switch from intermittent to continuous as you approach and get closer to a detected obstacle. When the sensors detect two or more obstacles, the audible alerts will respond to the nearest zone.

Always check the surrounding area when using this system.

Refer to "Intuitive parking assist" section in the Owner's Manual for more details.

Garage door opener (HomeLink®)* (if equipped)

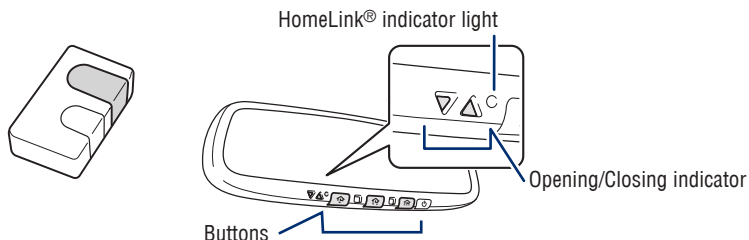

Garage door openers manufactured under license from HomeLink®* can be programmed to operate garage doors, estate gates, security lighting, etc.

Refer to "Garage door opener," Section 6-4 in the Owner's Manual for more details.

For programming assistance, contact HomeLink® at 1-800-355-3515, or visit <http://www.homelink.com/toyota>.

* HomeLink® is a registered trademark of Gentex Corporation.

Bottle holders

Front door

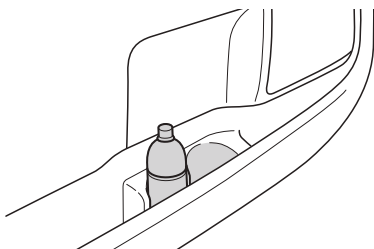

Rear door (CrewMax models)



Cup holders

FRONT SEAT

Split seat - Center console

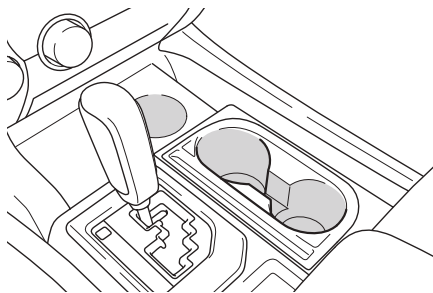

Bench seat - Front center seat

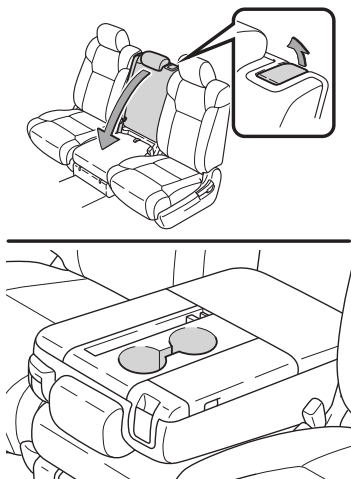

REAR SEAT

Split seat - Double cab model

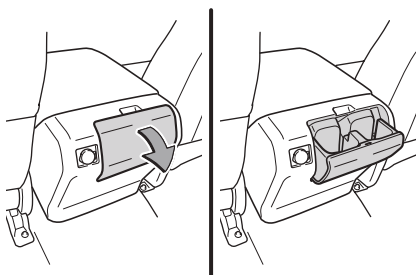

(Back of the center console box)

Bench seat - Double cab model

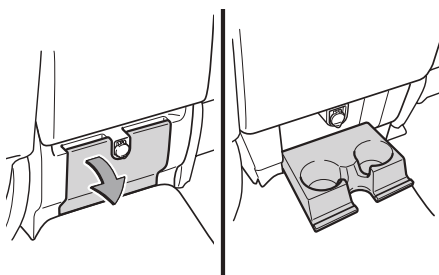

(Back of the center console box)

CrewMax model

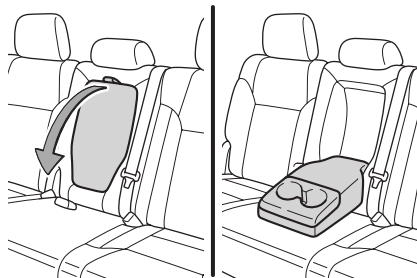

Quick overview-Toyota Safety Sense™ P (TSS-P)

Toyota Safety Sense™ P (TSS-P) is a set of active safety technologies designed to help mitigate or prevent collisions across a wide range of traffic situations, in certain conditions. TSS-P is designed to help support the driver's awareness, decision making and vehicle operation contributing to a safe driving experience.

Refer to the Owner's Manual for operation, setting adjustments, limitations and more details to understand these functions and complete safety precautions. For more information, please go to <http://www.toyota.com/safety-sense>

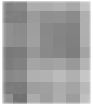

Pre-Collision System with Pedestrian Detection (PCS w/PD)

PCS w/PD is designed to provide alert, mitigation, and/or avoidance support in certain conditions, when the system detects a potential collision with a preceding vehicle is likely to occur.

The advanced millimeter-wave radar sensor system is designed to work with the camera sensor to help recognize a preceding pedestrian, and provide an alert, mitigation and/or avoidance support in certain conditions.

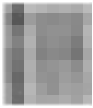

Lane Departure Alert (LDA)

LDA is designed to provide notification when the system detects an unintended lane departure.

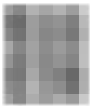

Dynamic Radar Cruise Control (DRCC)

DRCC is designed to help maintain a pre-set distance to a preceding vehicle when the preceding vehicle is traveling at a lower speed.



Automatic High Beams (AHB)

AHB is designed to detect the headlights of oncoming vehicles and the tail lights of preceding vehicles and switch between high beams and low beams as appropriate.

Sensors

TSS-P combines an in-vehicle camera mounted in front of the inside rear view mirror and a millimeter-wave radar mounted in the front grill. These sensors support the driver assist systems.

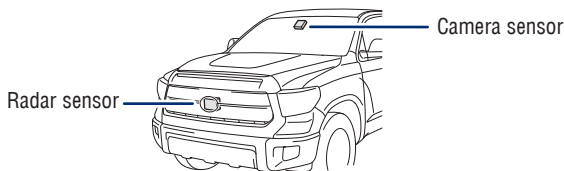

Pre-Collision System with Pedestrian Detection (PCS w/PD)

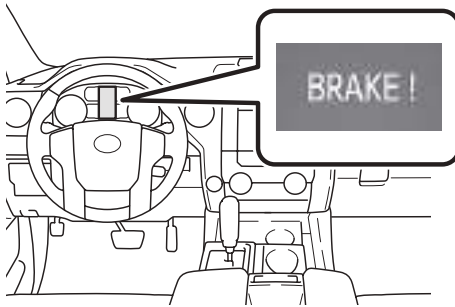

The Pre-Collision System uses a radar sensor and camera sensor to help detect a vehicle or pedestrian in front of your vehicle.

As there is a limit to the degree of recognition accuracy and control performance that this system can provide, do not overly rely on this system. This system will not prevent collisions or lessen collision damage or injury in every situation. Do not use PCS instead of normal braking operations under any circumstances. Do not attempt to test the operation of the pre-collision system yourself, as the system may not operate or engage, possibly leading to an accident. In some situations, such as when driving in inclement weather such as heavy rain, fog, snow or a sandstorm or while driving on a curve and for a few seconds after driving on a curve, a vehicle or pedestrian may not be detected by the radar and camera sensors, preventing the system from operating or engaging properly.

Refer to the Toyota Owner's Manual for a list of additional situations in which the system may not operate properly.

Pre-Collision Warning

When the system determines that the possibility of a frontal collision is high, a buzzer will sound and a warning message will be displayed on the Multi-Information Display (MID) to urge the driver to take evasive action.

Pre-Collision Brake Assist

If the driver notices the hazard and brakes, the system may provide additional braking force using Brake Assist. This system may prime the brakes and may apply greater braking force in relation to how strongly the brake pedal is depressed.

Pre-Collision Braking

If the driver does not brake in a set time and the system determines that the possibility of a frontal collision with a preceding vehicle is extremely high, the system may automatically apply the brakes, reducing speed in order to help the driver reduce the impact and in certain cases avoid the collision.

Refer to the Toyota Owner's Manual for additional information on PCS w/PD operation, settings adjustments, limitations, and precautions before attempting to use it.

TOYOTA SAFETY SENSE™

PCS PEDESTRIAN DETECTION

Under certain conditions, the PCS system included with the TSS-P package may also help to detect a pedestrian in front of your vehicle using the in-vehicle camera and front grille-mounted radar. The in-vehicle camera of PCS detects a potential pedestrian based on size, profile, and motion of the detected pedestrian. However, a pedestrian may not be detected depending on the conditions, including the surrounding brightness and the motion, posture, size, and angle of the potential detected pedestrian, preventing the system from operating or engaging.

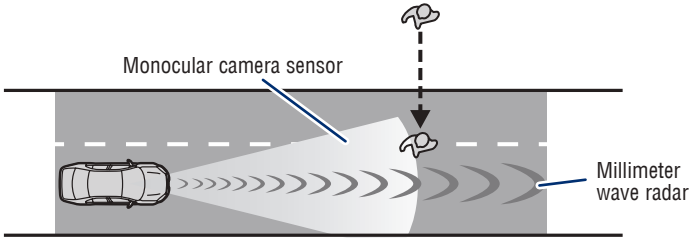



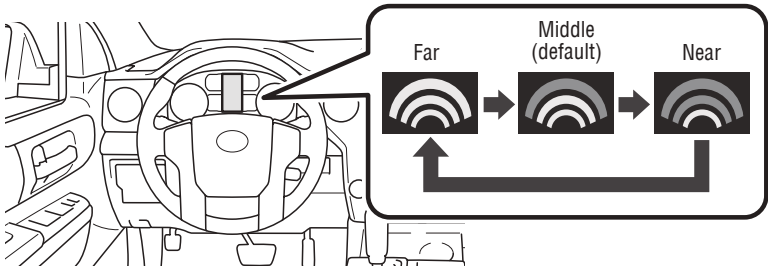

As part of the Pre-Collision System, this function is also designed to first provide an alert and then automatic braking if needed.

Refer to the Toyota Owner's Manual for additional limitations and information.

CHANGING PCS SENSITIVITY



- (1) Press “<>” switches and select  from the Multi-Information Display (MID).
- (2) Press “<” switches and select “PCS” and then press “”.
- (3) Press “<” switches and select “Sensitivity” and then press “” to select the desired setting.
- (4) Press “>” to go back to the menu. Also, use “” to switch menus or display top screen.

Note: PCS is enabled each time the engine switch is turned to Ignition On. The system can be disabled/enabled and the alert timing of the system can be changed. (Alert timing only, brake operation remains the same).

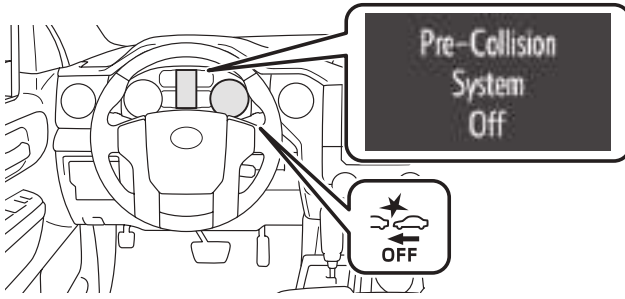

- (1) Press “◀▶” switches and select  from the Multi-Information Display (MID).
- (2) Press “⏪” switches and select “PCS” from the MID and then press “◻”.
- (3) Press “⏩” switches and select “PCS” and then press “◼” to select the desired setting ON/OFF.
- (4) Press “↩” to go back to the menu. Also, use “⏮” to switch menus or display top screen.

Refer to the Toyota Owner's Manual for additional information on PCS operation, settings adjustments, limitations, and precautions before attempting to use it.

Lane Departure Alert (LDA)



LDA in TSS-P uses an in-vehicle camera designed to detect visible white and yellow lane markers in front of the vehicle and the vehicle's position on the road. If the system determines that the vehicle is starting to unintentionally deviate from its lane, the system alerts the driver with an audio and visual alert. When the alerts occur, the driver must check the surrounding road situation and carefully operate the steering wheel to move the vehicle back to the center part of their lane.

LDA is designed to function at speeds of approximately 32 mph (50 km/h) or higher on relatively straight roadways.

TOYOTA SAFETY SENSE™

TURNING THE LDA SYSTEM ON/OFF

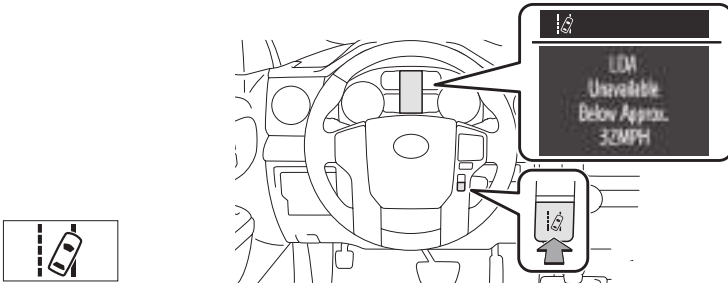

Press the LDA switch to turn the LDA system on. Depress again to turn it off.

Note: Operation of the LDA system and setting adjustments continues in the same condition regardless of ignition cycle until changed by the driver or the system is reset.

Refer to the Toyota Owner's Manual for additional information on LDA operation, settings adjustments, limitations, and precautions before attempting to use it.

LANE DEPARTURE ALERT

LDA function display



Lane Departure Alert (LDA) indicator flashes orange when operating.



(1)



(2)

LANE DEPARTURE ALERT (CONTINUED)

The LDA function displays when the Multi-Information Display (MID) is switched to the driving assist system information screen.

- (1) The system displays solid white lines on the LDA indicator when visible lane markers on the road are detected. A side flashes orange to alert the driver when the vehicle deviates from its lane.
- (2) The system displays outlines on the LDA indicator when lane markers on the road are not detected or the function is temporarily cancelled.





Note: When operation conditions are no longer met, a function may be temporarily canceled. However, when the operation conditions are met again, operation of the function is automatically restored. For example, LDA may not function on the side(s) where white/yellow lines are not detectable.

ADJUSTING LDA ALERT SENSITIVITY

The driver can adjust the sensitivity of the LDA (warning) function from the Multi-Information Display (MID) customization screen.

High - Is designed to warn approximately before the front tire crosses the lane marker.

Normal - Is designed to warn approximately when the front tire crosses the lane marker.

- (1) Press “<>” switches and select  from the Multi-Information Display (MID).
- (2) Press “<” switches and select “LDA” and then press “”.
- (3) Press “<” switches and select “LDA sensitivity” and then press “” to select the desired setting.
- (4) Press “>” to go back to the menu. Also, use “” to switch menus or display top screen.

Note: Operation of the LDA system and setting adjustments continues in the same condition regardless of Ignition cycle until changed by the driver or the system is reset.

SWAY WARNING SYSTEM



Continuous lane deviations from swaying.





Gentle swaying from driver's inattentiveness.





Acute steering wheel operation after the number of operations decrease due to driver's inattentiveness.

SWS is a function of LDA and is designed to detect swaying based on the vehicle location in the lane and the driver's steering wheel operation. To help prevent swaying, the system alerts the driver using a buzzer sound and a warning displays in the MID.

DISABLING LDA SWAY WARNING SYSTEM

- (1) Press “<>” switches and select  from the Multi-Information Display (MID).
- (2) Press “◇” switches and select the  setting function and then press “□.”
- (3) Press “↶” to go back to the menu. Also, use “” to switch menus or display top screen.

ADJUSTING SWAY ALERT SENSITIVITY

- (1) Press “<>” switches and select  from the Multi-Information Display (MID).
- (2) Press “◇” switches and select “LDA” and then press “□.”
- (3) Press “◇” switches and select “SWAY warning sensitivity” and then press “□.” to select the desired setting.
- (4) Press “↶” to go back to the menu. Also, use “” to switch menus or display top screen.

Note: Operation of the LDA system and setting adjustments continues in the same condition regardless of Ignition cycle until changed by the driver or the system is reset.

Dynamic Radar Cruise Control (DRCC)

DRCC helps maintain a pre-set distance to a preceding vehicle when the preceding vehicle is traveling at a lower speed. This mode is always selected first when the cruise control button is depressed. Constant speed cruise control mode is also available. DRCC is designed to function at speeds between approximately 30 to 110 MPH and is intended for highway use.

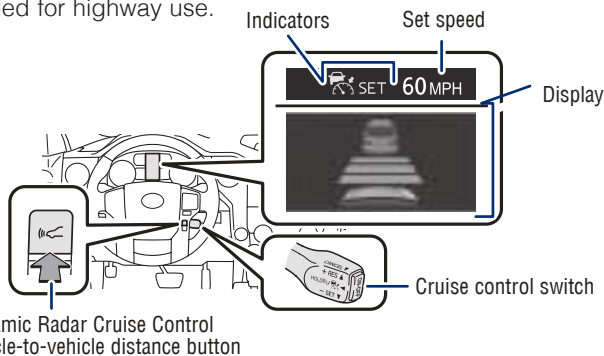

Dynamic Radar Cruise Control vehicle-to-vehicle distance button

TURNING SYSTEM ON/OFF

(1)

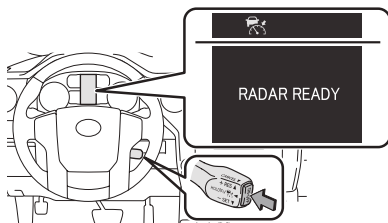
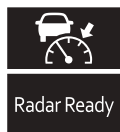

Push once: On
Push twice: Off

Refer to page 39 for switching to Constant Speed (Cruise) Control Mode.

ADJUSTING SET SPEED

(2)

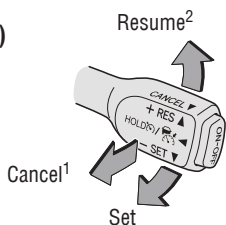

(3)

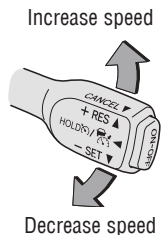

Vehicle will cruise at a set speed, decelerate to maintain selected distance from a slower vehicle traveling in front and accelerate back up to the selected speed if the vehicle in front changes lanes or speeds up.

(1) Push the ON-OFF button. The “RADAR READY” and “” indicator will come on.

(2) Push the lever down to SET speed, push it up to Resume and pull it or depress brake to Cancel.

(3) Push up to increase the set speed, push down to decrease (1 mph [1.6 km/h] or 1 km/h [0.6 mph] increments).

¹ The set speed may also be cancelled by depressing the brake pedal.

² The set speed may be resumed once vehicle speed exceeds 25 mph (40 km/h).

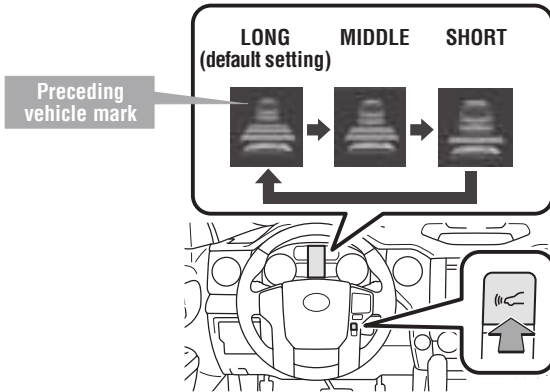

To change the vehicle-to-vehicle distance

Push the “” button to cycle through the settings, which will change progressively.

This mode employs a radar sensor to detect the presence of a preceding vehicle up to approximately 328 ft (100 m) ahead, determines the current vehicle-to-vehicle following distance and operates to maintain a preset following distance from the vehicle ahead. These distances vary based on vehicle speed.

Note: Vehicle-to-vehicle distance will close in when traveling on long downhill slopes.

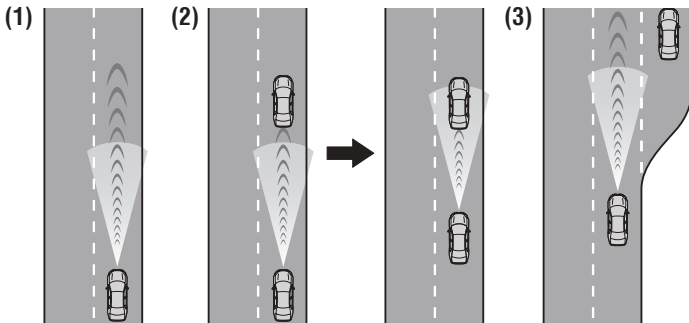

(1) Constant speed cruising when there are no vehicles ahead

The vehicle travels at the speed set by the driver. The desired vehicle-to-vehicle distance can also be set by operating the vehicle-to-vehicle distance control.

(2) Deceleration cruising and follow-up cruising when a preceding vehicle driving slower than the set speed appears

When a vehicle is detected running ahead of you, the system automatically decelerates your vehicle. When a greater reduction in vehicle speed is necessary, the system applies the brakes (the brake lights will come on at this time). The system will respond to changes in the speed of the vehicle ahead in order to maintain the vehicle-to-vehicle distance set by the driver. A warning tone warns you when the system cannot decelerate sufficiently to prevent your vehicle from closing in on the vehicle ahead.

DRCC ADJUSTING DISTANCE (CONTINUED)

(3) Acceleration when there are no longer any preceding vehicles driving slower than the set speed

The system accelerates until the set speed is reached. The system then returns to constant speed cruising.

Note: When your vehicle is too close to a vehicle ahead, and sufficient automatic deceleration via the cruise control is not possible, the display will flash and the buzzer will sound to alert the driver. An example of this would be if another driver cuts in front of you while you are following a vehicle. Depress the brake pedal to ensure an appropriate vehicle-to-vehicle distance.

SWITCHING TO CONSTANT SPEED (CRUISE) CONTROL MODE

(1)

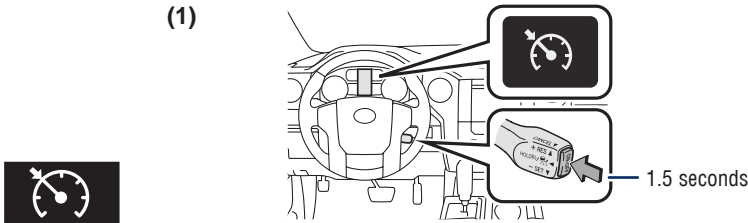

If you are already using DRCC “”, push button again to turn the system off first, then push and hold button for at least 1.5 seconds to switch.

Note: When the engine is turned off, it will automatically default to DRCC.

SETTING CONSTANT SPEED (CRUISE) CONTROL

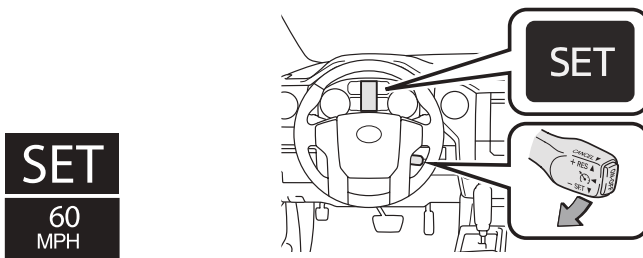

To adjust speed or cancel, see steps (2) and (3) of ADJUSTING SET SPEED on page 37.

Refer to the Toyota Owner's Manual for additional information on DRCC operation, settings adjustments, limitations, and precautions before attempting to use it.

Automatic High Beams (AHB)

(1)

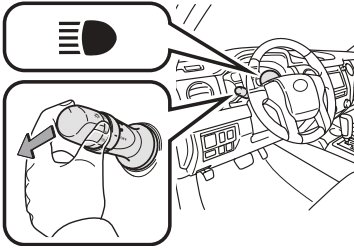

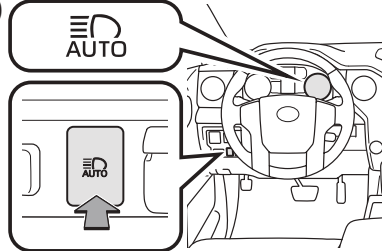

(2)



AHB is a safety system designed to help drivers see more of what's ahead at nighttime while reducing glare for oncoming drivers. When enabled, AHB uses an in-vehicle camera to help detect the headlights of oncoming vehicles and tail lights of preceding vehicles, then automatically switches between high and low beams as appropriate to provide the most light possible and enhance forward visibility. By using high beams more frequently, the system may allow earlier detection of pedestrians and obstacles.



Refer to the Toyota Owner's Manual for additional information on AHB operation, settings adjustments, limitations, and precautions before attempting to use it.

ACTIVATING THE AHB SYSTEM

- (1) With the engine switch in IGNITION ON mode, turn the headlight switch to “” or “AUTO” position.
- (2) Push lever away from you.
- (3) Press the “” switch.

The AHB indicator will come on when the headlights are turned on automatically to indicate that the system is active.

Note: Pull the lever back toward you to turn the AHB system off.

The AHB indicator will turn off. To turn switch to “” position and the manual high beam indicator “” turns on.

CONDITIONS WHERE AHB WILL TURN ON/OFF AUTOMATICALLY

When all of these conditions are met, high beams will be automatically turned on (after approximately 1 second):

- Vehicle speed is above approximately 21 mph (34 km/h.)
- The area ahead of the vehicle is dark.
- There are no oncoming or preceding vehicles with headlights or tail lights turned on.
- There are few street lights on the road ahead.

If any of these conditions occur, the system is designed to automatically turn off high beams:

- Vehicle speed drops below approximately 17 mph (27 km/h.)
- The area ahead of the vehicle is not dark.
- Oncoming or preceding vehicles have headlights or tail lights turned on.
- There are many streetlights on the road ahead.

Seat belts



Keep as low on hips as possible

NOTE: If a passenger's seat belt is fully extended, then retracted even slightly, the Automatic locking retractor (ALR) will prevent it from being re-extended beyond that point, unless fully retracted again. This feature is used to help hold child restraint systems securely.

To find more information about seat belts, and how to install a child restraint system, refer to the Owner's Manual.

Seat belts-Shoulder belt anchor

Front seats

Push up, or squeeze lock release to lower

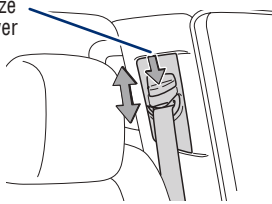

Rear seats (CrewMax models)

Push up, or squeeze lock release to lower

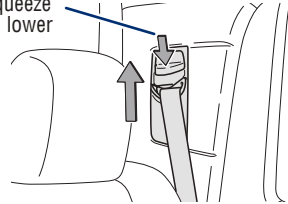

Tire Pressure Monitoring (warning) System (TPMS)

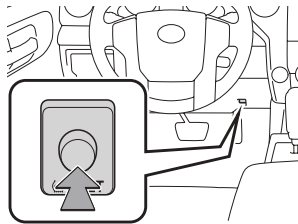

System reset initialization

1. Push and hold "SET" button until the indicator blinks three times.
2. Wait several minutes to allow initialization to complete.

After adjusting tire pressures, or after tires have been rotated or replaced, turn the ignition switch to "ON" and press and hold the "SET" button until indicator blinks three times. Let the vehicle sit for a few minutes to allow initialization to complete.

Refer to the load label on the door jamb or the Owner's Manual for tire inflation specifications.

If the tire pressure indicator flashes for more than 60 seconds and then remains on, take the vehicle to your local Toyota dealer.

NOTE: The warning light may come on due to temperature changes or changes in tire pressure from natural air leakage. If the system has not been initialized recently, setting the tire pressures to factory specifications should turn off the light.

SAFETY & EMERGENCY FEATURES

Rear door child safety locks

CrewMax & double cab models

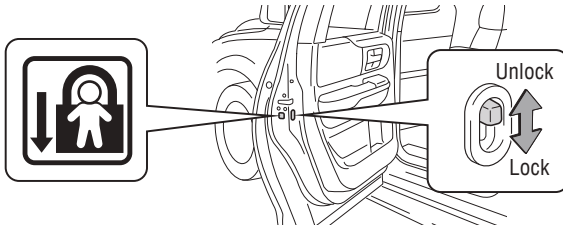

Safety Connect (if equipped)

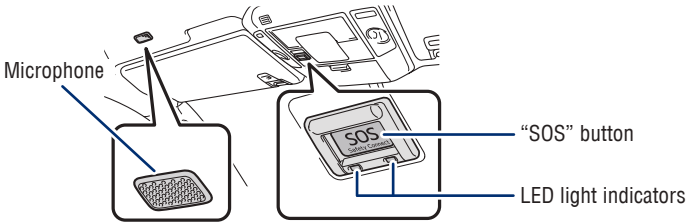

Safety Connect is a subscription-based telematics service that uses Global Positioning System (GPS) data and embedded cellular technology to provide safety and security features to subscribers. Safety Connect is staffed with live agents at the Toyota response center, which operates 24 hours per day, 7 days per week.

Services for subscribers include:

- Automatic collision notification
- Stolen vehicle locator
- Emergency assistance ("SOS" button)
- Enhanced roadside assistance

For additional information refer to the "Owner's Manual" or visit www.Toyota.com/connected-services.

Spare tire & tools

TOOL LOCATION

CrewMax models (behind the right rear seatback)

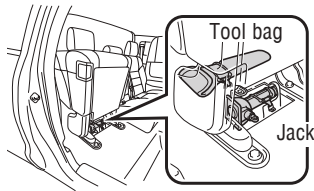

Double cab models (under the right rear seats without storage box)

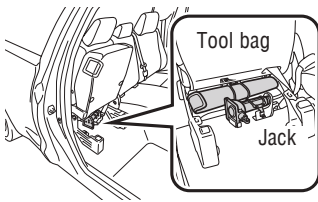

Double cab models (under the right rear seats with storage box)

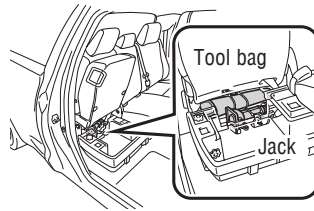

REMOVING THE SPARE TIRE

(1)

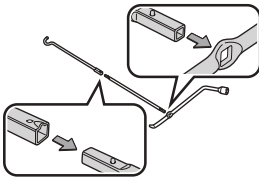

(2)

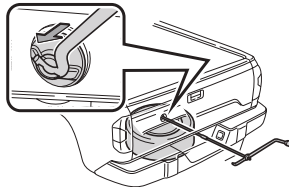

(3)

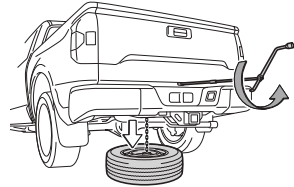

- (1) Assemble the jack handle.
- (2) Insert the jack handle end into the lowering screw.
- (3) Turn the jack handle counterclockwise.

Refer to the Owner's Manual for tire changing and jack positioning procedures.

SAFETY & EMERGENCY FEATURES

Star Safety System™

Your vehicle comes standard with the Star Safety System™, which combines Anti-lock Braking System (ABS), Brake Assist (BA), Electronic Brake-force Distribution (EBD), Smart Stop Technology (SST), Traction Control (TRAC) and Vehicle Stability Control (VSC).

Refer to the Owner's Manual for more details and important information on limitations to these systems.

ANTI-LOCK BRAKE SYSTEM (ABS)

Toyota's ABS sensors detect which wheels are locking up and limits wheel lockup by "pulsing" each wheel's brakes independently. Pulsing releases brake pressure repeatedly for fractions of a second. This helps the tires attain the traction that current road conditions will allow, helping you to stay in directional control.

BRAKE ASSIST (BA)

Brake Assist is designed to detect sudden or "panic" braking, and then add braking pressure to help decrease the vehicle's stopping distance. When there's only a split second to react, Brake Assist can add additional brake pressure more quickly than just the driver alone can.

ELECTRONIC BRAKE FORCE DISTRIBUTION (EBD)

Toyota's ABS technology has Electronic Brake-force Distribution (EBD) to help maintain control and balance when braking. EBD responds to sudden stops by redistributing brake force to enhance the braking effectiveness of all four wheels.

SMART STOP TECHNOLOGY (SST)

Smart Stop Technology automatically reduces engine power when the accelerator and brake pedals are pressed simultaneously under certain conditions.

SST engages when the accelerator is depressed first and the brakes are applied firmly for longer than one-half second at speeds greater than five miles per hour.

SST doesn't engage if the brake pedal is depressed before the accelerator pedal, allowing vehicles to start on a steep hill and safely accelerate without rolling backward.

VEHICLE STABILITY CONTROL (VSC)

VSC helps prevent loss of traction during cornering by reducing engine power and applying brake force to selected wheels.

Toyota's VSC monitors steering angle and the direction your vehicle is traveling. When it senses that the front or rear wheels begin to lose traction, VSC reduces engine power and applies braking to selected wheels. This helps restore traction and vehicle control.

TRACTION CONTROL (TRAC)

VSC helps prevent loss of traction during cornering by reducing engine power, and Traction Control helps maintain traction on loose gravel and wet, icy, or uneven surfaces by applying brake force to the spinning wheel(s).

Toyota's TRAC sensors are activated when one of the drive wheels starts to slip. TRAC limits engine output and applies the brakes to the spinning wheel. This transfers power to the wheels that still have traction to help keep you on track.

Trailer Sway Control

Trailer sway may occur when towing a trailer due to strong crosswinds, uneven and/or winding road conditions or the driver's steering input.

Trailer Sway Control uses sensors to detect trailer sway and then simultaneously and automatically helps to suppress the swaying motion of the trailer by integrating brake and engine torque control to reduce speed and to help quickly control the swaying motion of the trailer.

Floor mat installation

There are two types of Toyota floor mats: carpeted and all-weather. Each vehicle has model-specific floor mats. Installation is easy.

To keep your floor mat properly positioned, follow these steps:

- Only use Toyota floor mats designed for your specific model.
- Use only one floor mat at a time, using the retaining hooks to keep the mat in place.
- Install floor mats right side up.

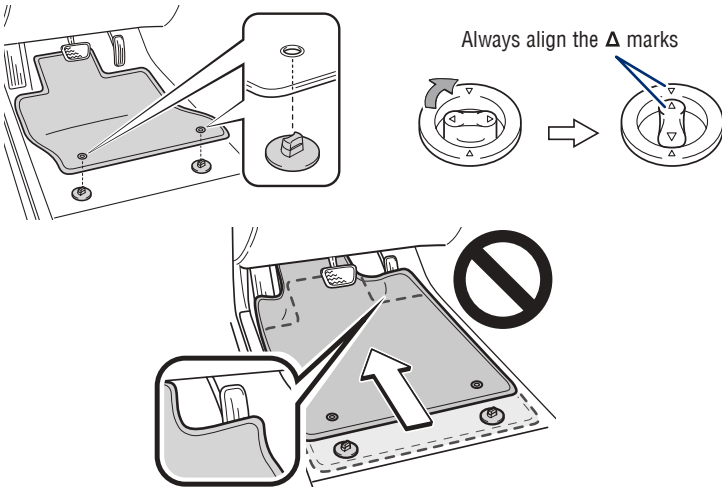

BLUETOOTH® DEVICE PAIRING SECTION

Do not attempt the Bluetooth® Pairing process while driving.

To begin the Bluetooth® Pairing process, press the HOME button on the faceplate of your multimedia system.

Bluetooth® Pairing for your phone

Pairing your phone is the first step in connecting with your Toyota. This pairing process is quick and easy. All you have to do is setup the phone and multimedia system to form a connection.¹



Audio / Audio Plus / Premium Audio

STEP 1 Press [MENU] on the audio system faceplate, then select "Setup" on display screen.



iPhone bluetooth Menu

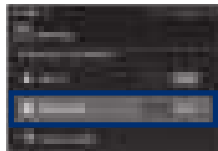

Android bluetooth Menu



STEP 2 Ensure Bluetooth is turned on for your device.

STEP 3 Select "Bluetooth", then select "Add New Device" on display screen.



STEP 4 Select "Device Name".



STEP 5 Check the display on your smart phone. Does the PIN XXXX match the PIN displayed in TOC #10: Phone-7? If it does select "Pair".

¹ Some Android devices may have slightly different SETTINGS screen layout depending on manufacturer of device and Android OS version.

BLUETOOTH® DEVICE PAIRING

Bluetooth® Pairing for your phone (cont.)



STEP 6 "Connecting" displays while device is forming the connection to your multimedia system.



STEP 7 Enable Notifications (text message). While pairing your phone a message will be displayed: **"You may need to allow message access on your phone"**.

Note: You may also select "Skip" on display screen to skip enabling notifications. If skipped proceed to **Step 8**.

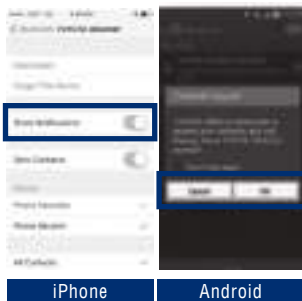

STEP 8 Turn on "Show Notifications" for iPhone or "ON" for Android.



STEP 9 A confirmation will appear once your phone has been paired and connected.

NOTES



TUNDRA

Quick Reference Guide 2020



00505QRG20TUN

toyota.com

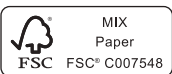

Printed in U.S.A. 8/19
19-MKG-13483