



FR-S

2016 QUICK
REFERENCE
GUIDE



what moves you

2016 Scion FR-S

This *Quick Reference Guide* is a summary of basic vehicle operations. It contains brief descriptions of fundamental operations so you can locate and use the vehicle's main equipment quickly and easily.

The *Quick Reference Guide* is not intended as a substitute for the *Owner's Manual* located in the vehicle's glove box. We strongly encourage you to review the *Owner's Manual* and supplementary manuals so you will have a better understanding of the vehicle's capabilities and limitations.

Your dealership and the entire staff of Scion, a marque of Toyota Motor Sales, U.S.A., Inc., wish you many years of satisfied driving in your new SCION FR-S.

A word about safe vehicle operations

This *Quick Reference Guide* is not a full description of SCION FR-S operations. Every SCION FR-S owner should review the *Owner's Manual* that accompanies this vehicle.

Pay special attention to the boxed information highlighted in color throughout the *Owner's Manual*. Each box contains safe operating instructions to help you avoid injury or equipment malfunction.

All information in this *Quick Reference Guide* is current at the time of printing. Toyota reserves the right to make changes at any time without notice.

INDEX

OVERVIEW

Engine maintenance	8
Fuel tank door release and cap	6
Hood release	8
Indicator symbols	4-5
Instrument cluster	4
Instrument panel	2-3
Keyless entry	6
Light control-instrument panel	7
Trunk release	7

FEATURES/OPERATIONS

Air Conditioning/Heating	14
Automatic Transmission	9
AUX port/USB port	14
Bottle holder	15
Clock	13
Cruise control	11
Cup holders	15
Lights & turn signals	11
Multi-Information Display	12
Parking brake	9
Power outlets	15
Rear view monitor system	16-18
Seat adjustments-Front	10
Seats-Fold down rear seats	10
Seats-Head restraints	10
Tilt steering wheel	9
Windows	13
Windshield wipers & washers	12

SAFETY AND EMERGENCY FEATURES

Door locks	19
Floor mat installation	22
Seat belts	19
Spare tire & tools	20
Star Safety System™	21-22
Tire Pressure Monitoring (warning) System	19

OVERVIEW

Instrument panel

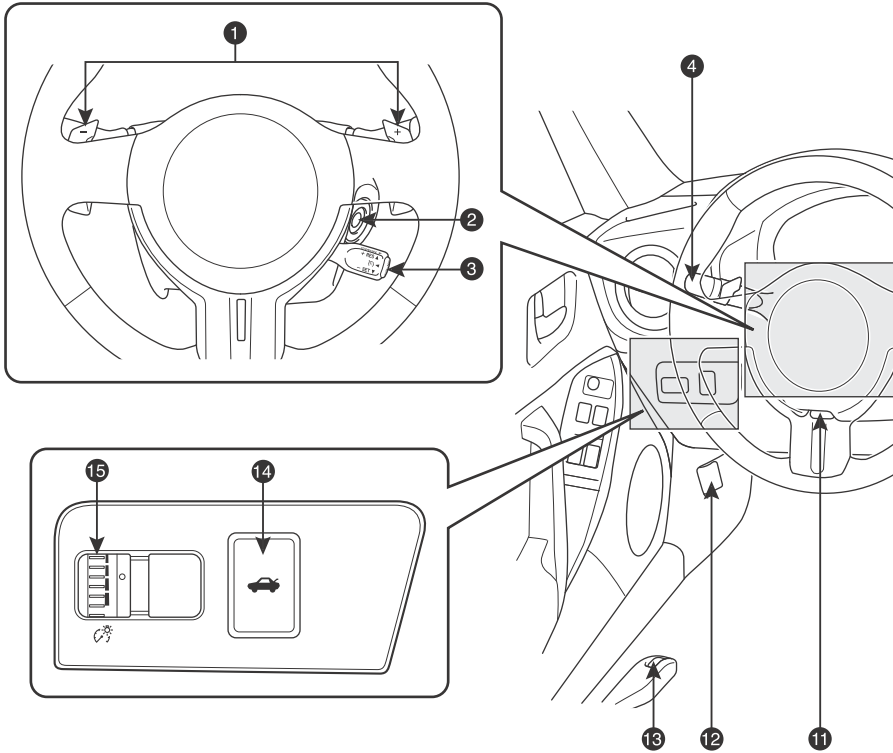

- ① Paddle shift switches*
- ② Ignition switch
- ③ Cruise control
- ④ Headlight and turn signal controls
- ⑤ Wiper and washer controls
- ⑥ Clock
- ⑦ Emergency flasher switch
- ⑧ Air Conditioning controls
- ⑨ Rear window defogger switch

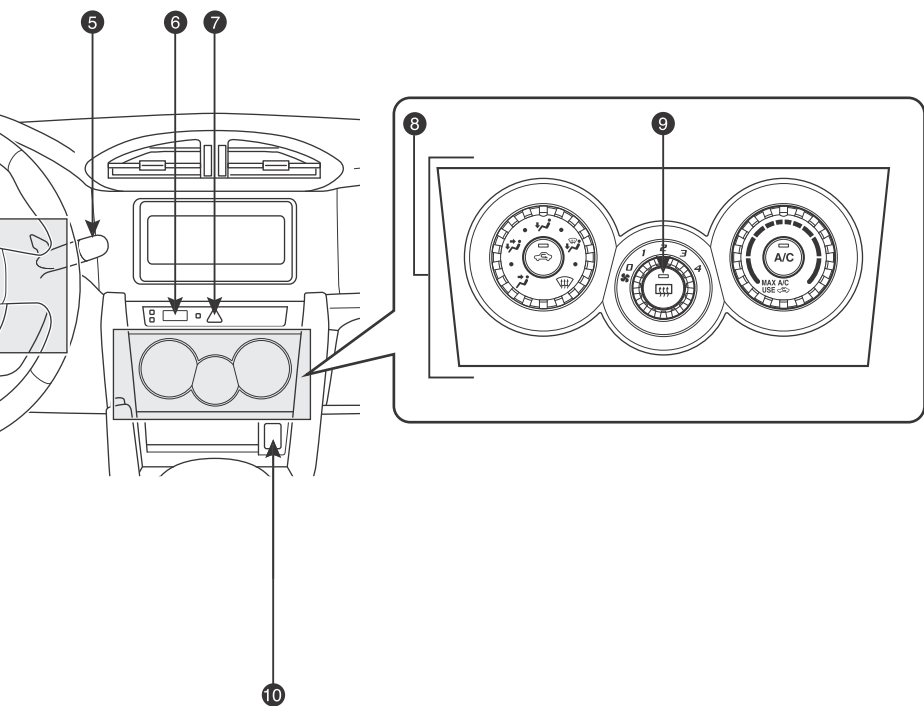

- 10 AUX port/USB port
- 11 Tilt and telescopic steering lock release
- 12 Hood release
- 13 Fuel filler door opener
- 14 Trunk opener
- 15 Instrument panel light control

* If equipped



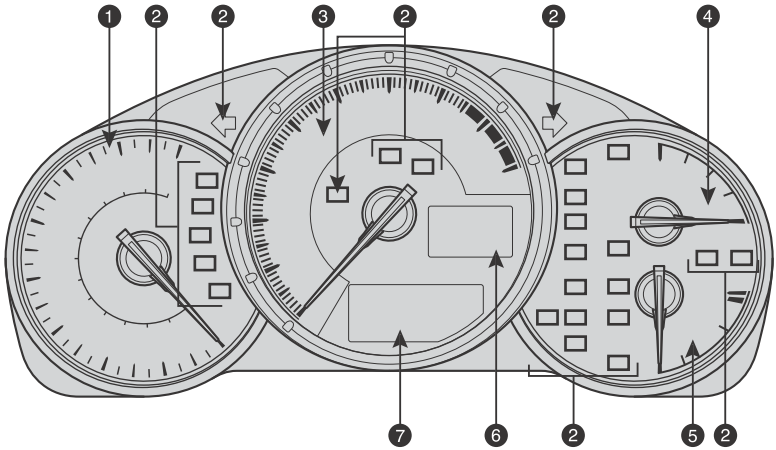





Instrument cluster



















- ❶ Analog speedometer
- ❷ Indicators and warning lights
- ❸ Tachometer
- ❹ Fuel gauge
- ❺ Engine coolant temperature gauge
- ❻ Digital speedometer
- ❼ Odometer/Trip meter/Multi-Information Display

Indicator symbols

For details, refer to “Indicators and warning lights,” Section 2-2, 2016 Owner’s Manual.

-  BRAKE Brake system warning¹
-   Seat belt reminder (alarm will sound if speed is over 12 mph)
-  Charging system warning¹
-  CHECK Malfunction/Check Engine indicator¹
-  Low engine oil pressure warning¹
-  Open door warning
-  PASSENGER AIR BAG ON and AIR BAG OFF indicator

¹ If indicator does not turn off within a few seconds of starting engine, there may be a malfunction. Have vehicle inspected by your Scion or Toyota dealer.

	Airbag SRS warning ¹
	Low Tire Pressure Warning ¹
	Turn signal indicators
	Headlight high beam indicator
	Cruise control indicator ²
SET	Cruise control SET indicator
ABS	Anti-lock Brake System warning ¹
	Electric power steering system warning ¹
	Slip indicator ¹
	Low fuel level warning ¹
A/T OIL TEMP	Automatic Transmission fluid temperature warning ¹
VSC SPORT	Vehicle Stability Control SPORT indicator ¹
	Vehicle Stability Control OFF indicator ¹
TRAC OFF	Traction Control OFF indicator ¹
	Security indicator
	Shift position and shift range indicator
	Upshift/downshift indicator
	Shift position indicator
	Shift-up indicator
SPORT	SPORT indicator
SNOW	SNOW indicator
	REV (engine RPM) indicator
	Arrow direction indicates fuel tank door position

² If this light come on in yellow, refer to “Cruise control” Section 2-4, 2016 Owner’s Manual.

Keyless entry

Locking operation

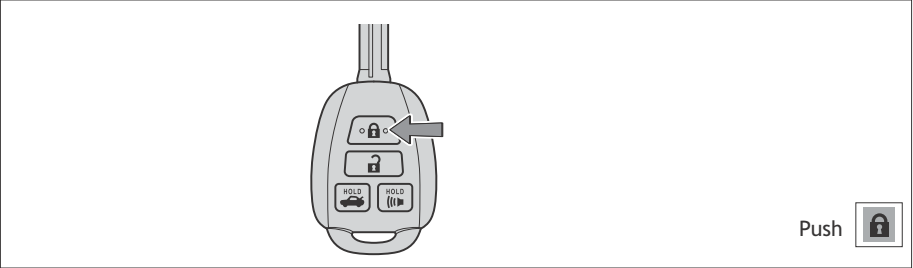

Unlocking operation

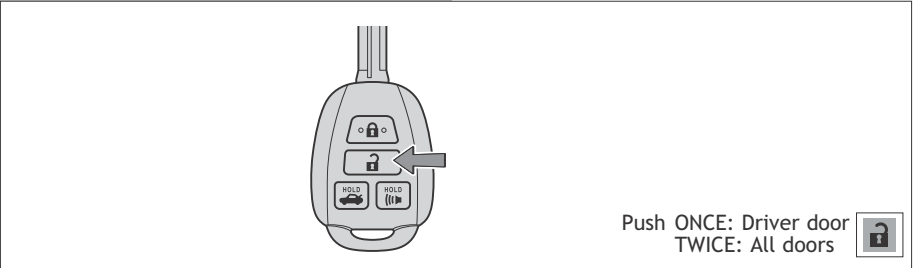

NOTE: If a door is not opened within 60 seconds of unlocking, all doors will relock for safety.

Fuel tank door release and cap

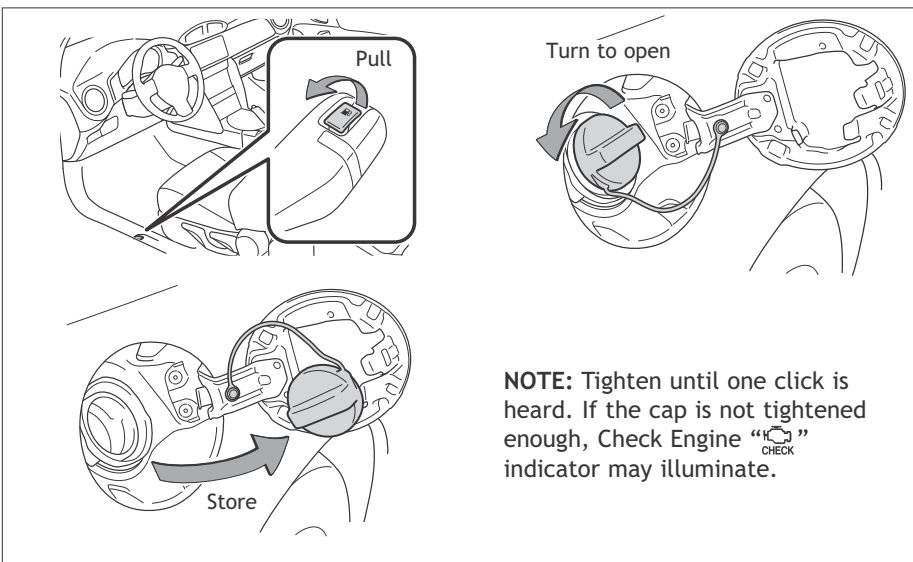

Trunk release

Trunk opener

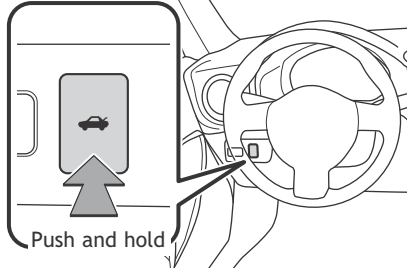

Light control-Instrument panel

Brightness control

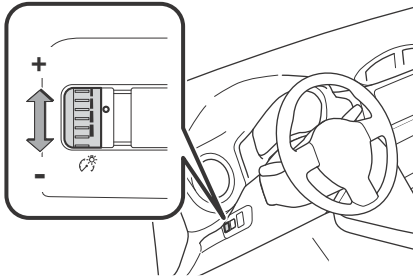

OVERVIEW

Hood release

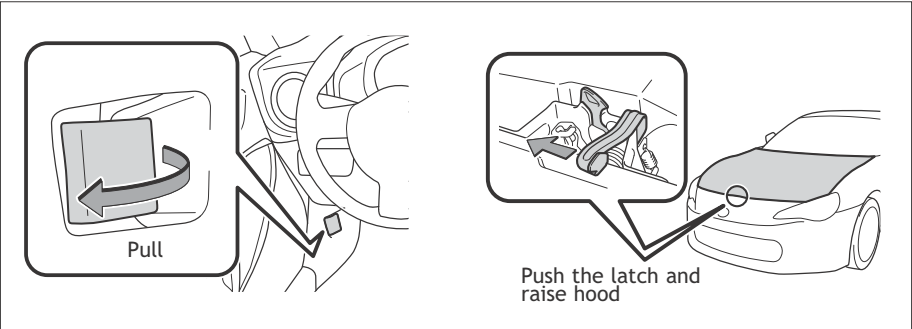

Engine maintenance

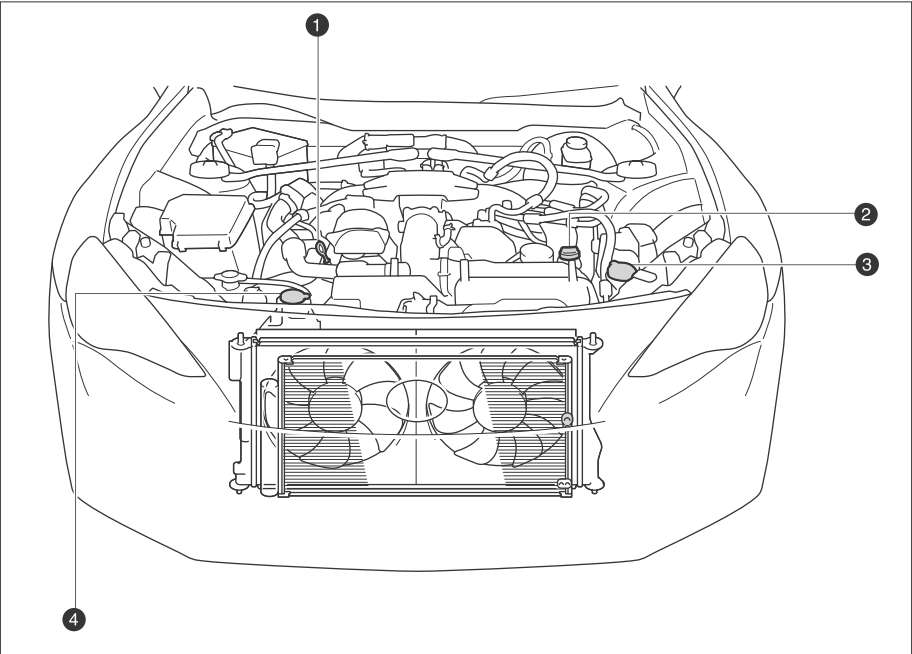

- 1 Engine oil level dipstick
- 2 Engine oil filler cap
- 3 Windshield washer fluid tank
- 4 Engine coolant reservoir

NOTE: Regularly scheduled maintenance, including oil changes, will help extend the life of your vehicle and maintain performance. Please refer to the “Warranty Maintenance Guide.”

FEATURES/OPERATIONS

Automatic Transmission (if equipped)

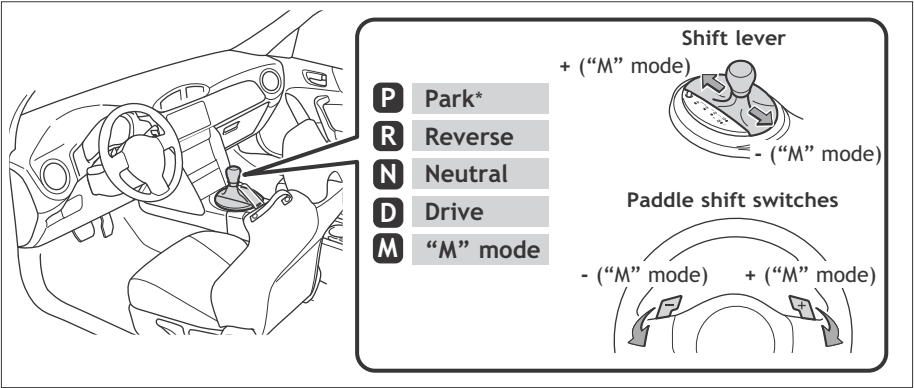

* The ignition switch must be "ON" and the brake pedal depressed to shift from Park.

"M" (Manual) mode

Shift the shift lever to "M" position from "D" position.

- +: Upshifting
- : Downshifting

Refer to the *Owner's Manual* for more details.

Tilt steering wheel

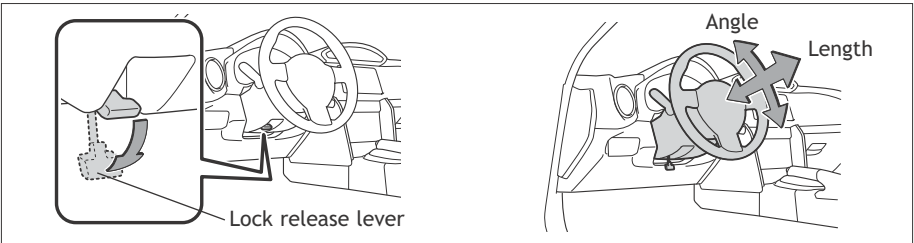

Hold wheel, push lever down, set angle and length, and return lever.

NOTE: Do not attempt to adjust while the vehicle is in motion.

Parking brake

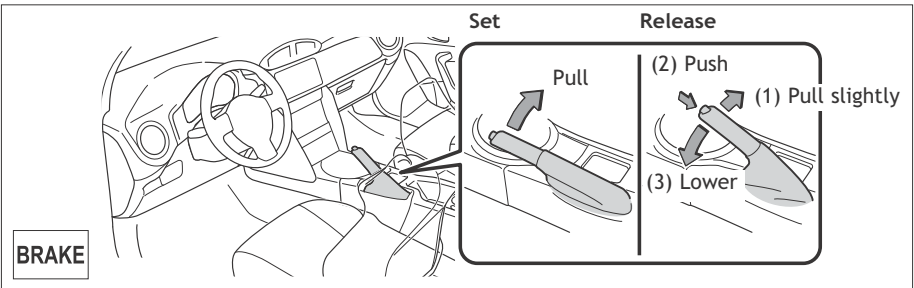

Seat adjustments-Front

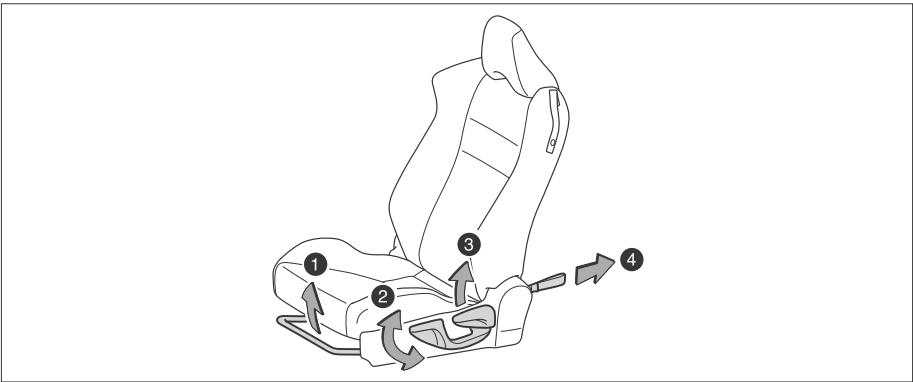

- ① Seat position (forward/backward)
- ② Height crank (driver side only)
- ③ Seatback angle
- ④ Seatback lock release

Seats-Fold down rear seats

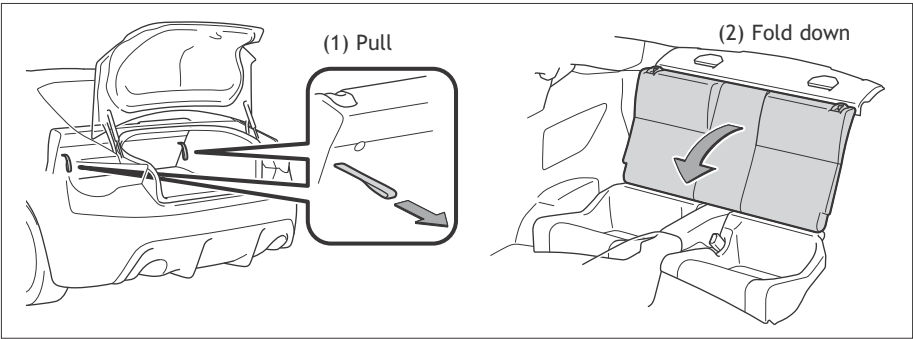

Seats-Head restraints

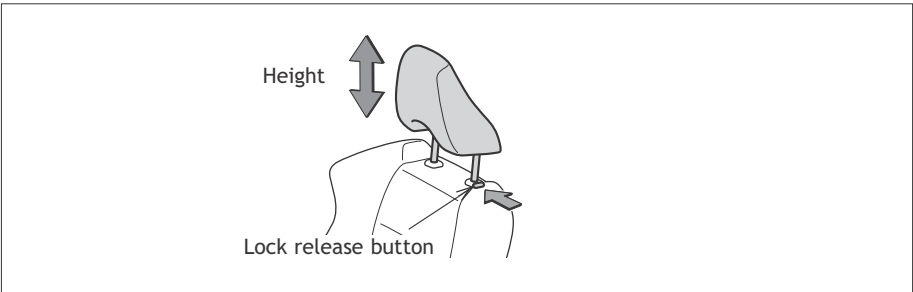

Cruise control

Turning system ON/OFF

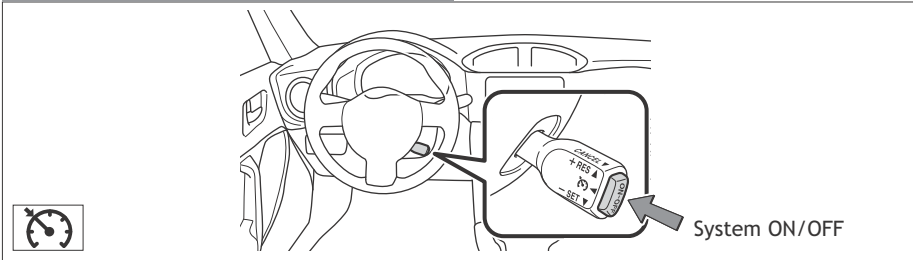

Functions

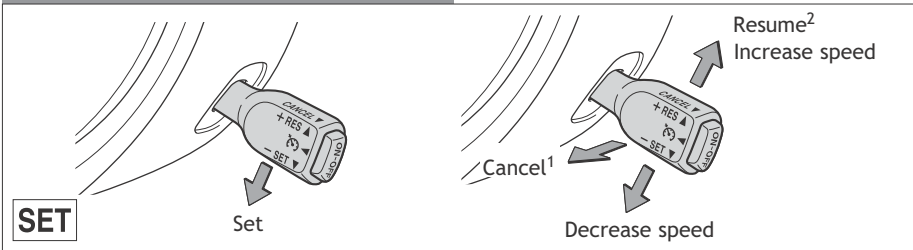

¹ The set speed may also be cancelled by depressing the brake pedal.

² The set speed may be resumed once vehicle speed exceeds 20 mph.

Lights & turn signals

Headlights

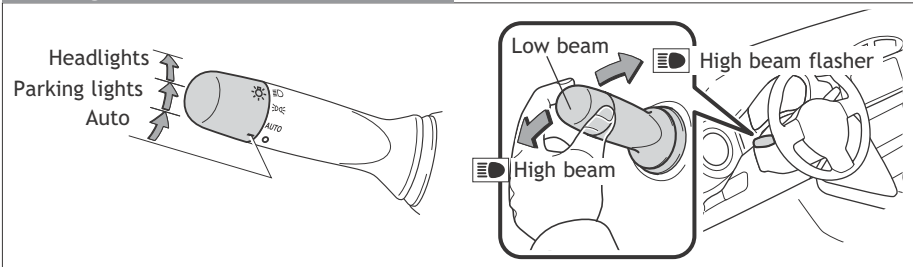

Automatic light cut off system Automatically turns lights off after 30-second delay, or lock switch on remote may be pushed after locking.

Turn signals

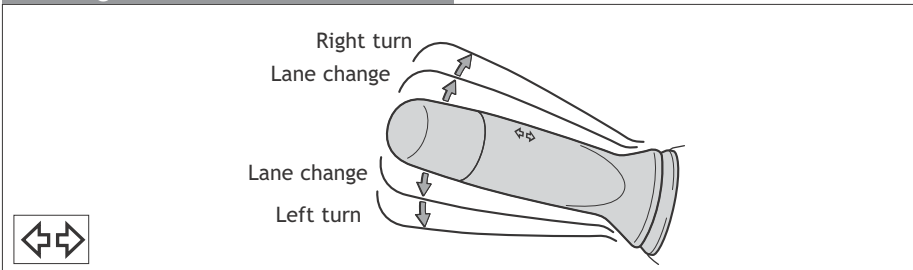

Multi-Information Display

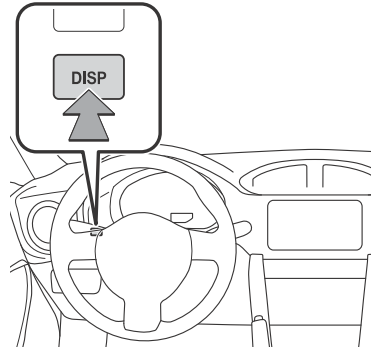
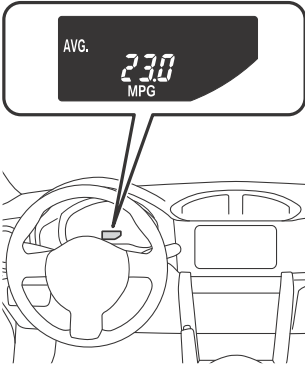

Push “DISP” to change information in the following:

- (1) Outside temperature
- (2) Current fuel consumption
- (3) Average fuel consumption
- (4) Setting screen for the REV (engine RPM) indicator*

* Only displayed when the vehicle is stopped.

Windshield wipers & washers

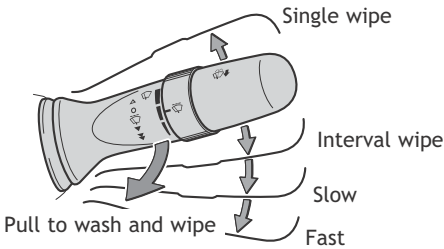

Intermittent windshield wiper frequency adjustment

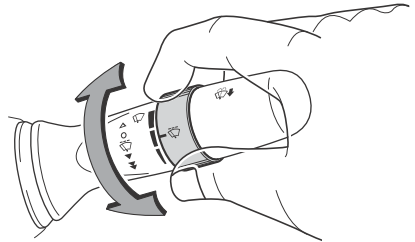

Rotate to increase/ decrease wipe frequency

Windows

Driver door window controls

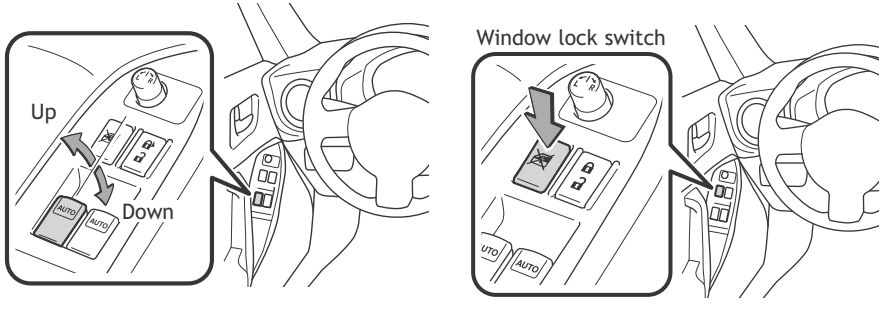

Automatic operation Push the switch completely down or pull it completely up and release to fully open. To stop window midway, lightly push the switch in the opposite direction.

Window lock switch Deactivates all passenger windows. Driver's window remains operable.

Clock

- ① Hour set
- ② Minute set
- ③ Round off minutes

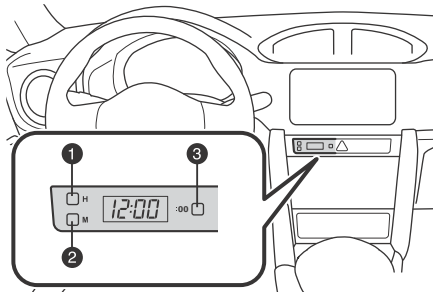

* The ignition switch must be "ON."

Air Conditioning/Heating

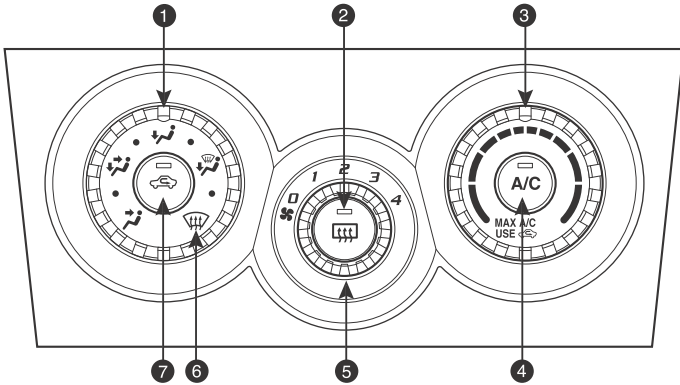

- ① Airflow vent
“” and “” mode uses fresh air only
- ② Rear window defogger
- ③ Temperature selector
- ④ Air Conditioning ON/OFF
- ⑤ Fan speed
- ⑥ Windshield airflow
- ⑦ Recirculate cabin air (fresh air when OFF)

AUX port/USB port

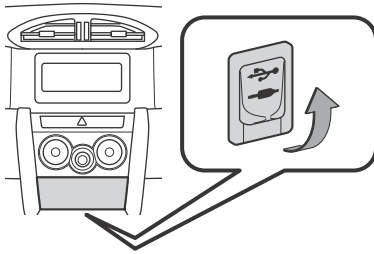

AUX port

By inserting a mini plug (not included) into the AUX port, you can listen to music from a portable audio device through the vehicle's speaker system while in AUX mode.

USB port

By connecting a USB memory or USB-compatible portable audio device to the USB port, you can listen to music from the portable audio device or USB memory through the vehicle's speaker system.

Refer to the *SCION Audio Manual* or *Scion.com* for more details.

Power outlets

Console tray

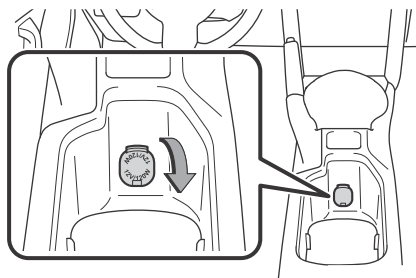

Glove box

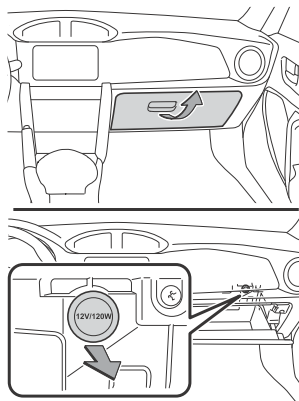

Designed for car accessories. Ignition switch must be in the "ACC" or "ON" position to be used.

Cup holders

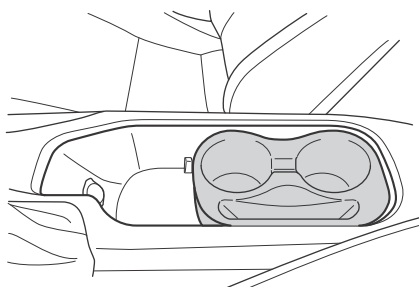

Bottle holder

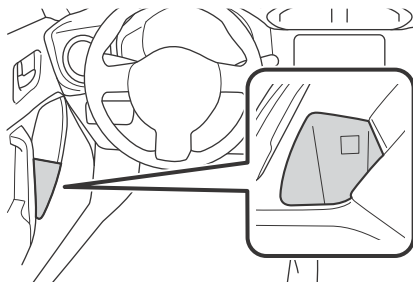

Rear view monitor system

The rear view monitor system assists the driver by displaying an image of the camera's view behind the vehicle when in reverse.

To see the camera's image of the view behind the vehicle on the monitor screen, the vehicle ignition switch must be in the ON position and the gear selector must be in the REVERSE position.

If you shift the vehicle out of the "R" position, the screen returns to the previous image.

The rear view monitor system is a device intended to supplement the driver when motoring in reverse and should not be relied upon solely. Drivers should check behind the vehicle before entering and are reminded to use the rear view and side mirrors once seated to ensure the intended path is clear before moving the vehicle.



NOTICE

If the vehicle is hit, the position and mounting angle of the camera may change. Be sure to have the camera position and mounting angle checked at your local Toyota dealer.

The camera is of water proof construction. Do not detach, disassemble or modify it. Any of these activities may cause the system to malfunction.

If the temperature changes rapidly, such as pouring hot water on the vehicle in cold temperatures, the system may not operate normally.

Do not hit the camera or expose it to strong impact as this may cause its position and mounting angle to change.

Do not rub the camera lens strongly. If the lens is scratched it cannot transmit a clear image.

Do not allow organic solvent, car wax, window cleaner or glass coat to adhere to the camera. If contact is made with one of these substances wipe it off as soon as possible.

When replacing tires on the vehicle, please consult your Toyota dealer. If you replace the tires, the area displayed on the screen may change.

Do not use a high-pressure car-wash machine type wand to spray the camera or camera area as this may cause serious damage to the rear view camera. Using intensive bursts of water may result in the camera malfunctioning.

CAUTION

The image on the screen is different from actual conditions. Depicted distances between objects and flat surfaces will differ from actual distance. If you back up looking only at the screen monitor, you may hit an object, vehicle or person.

Use your own eyes to confirm the vehicle's surroundings, as the displayed image may become faint or dark, and moving images will be distorted or not entirely visible when the outside temperature is low.

INFORMATION

If the camera lens becomes dirty, it cannot transmit a clear image. If water droplets, snow or mud adhere to the lens rinse with water and wipe with a soft clean cloth. If the lens is extremely dirty, wash it with a mild cleaner and rinse immediately.

AREA DISPLAYED ON SCREEN

The image displayed on the screen is an approximation only.

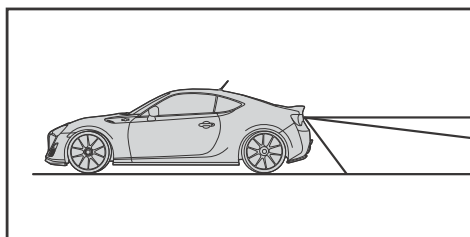
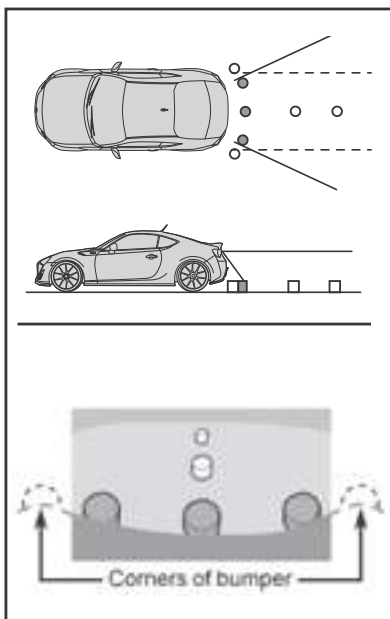
**INFORMATION**

The area displayed on the screen may vary according to vehicle orientation or road conditions.

The area detected by the camera is limited. The camera does not detect objects which are close to either corner of the bumper or under the bumper.

FEATURES/OPERATIONS

REAR VIEW MONITOR SYSTEM CAMERA

The rear view monitor system camera is located as shown in the illustration.

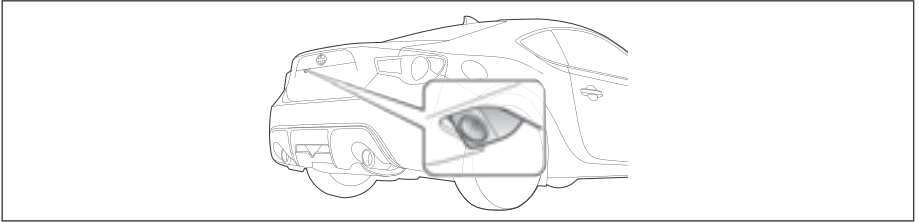

The camera for the rear view monitor system is located near the license plate. To adjust the image on the rear view monitor screen, press the setup button “⚙️” on the left side of screen and select “Display” on the setup screen. Then select “Camera” to adjust the screen brightness and contrast.

Refer to Scion.com to download the *Owner’s Manual* for more details on this system.

INFORMATION

The camera uses a special lens. The distance of the image that appears on the screen differs from the actual distance.

When the camera is used under fluorescent lights, sodium lights or mercury lights etc., the lights and the illuminated areas may appear to flicker.

In the following cases, it may become difficult to see the images on the screen, even when the system is functioning:

- In the dark (for example, at night)
- When the temperature near the lens is high or low
- When water droplets are adhering to the camera, or when humidity is high (for example, when it rains)
- When foreign matter (for example, snow or mud) is adhering to the camera
- When the camera has scratches or dirt on it
- When the sun or the beam of headlights is shining directly into the camera lens

INFORMATION



If a bright light (for example, sunlight reflected off the vehicle body) is picked up by the camera, a Smear effect* may occur.

*Smear effect

A phenomenon that occurs when a bright light (for example, sunlight reflected off the vehicle body) is picked up by the camera; when transmitted by the camera, the light source appears to have a vertical streak above and below it.

SAFETY AND EMERGENCY FEATURES

Door locks

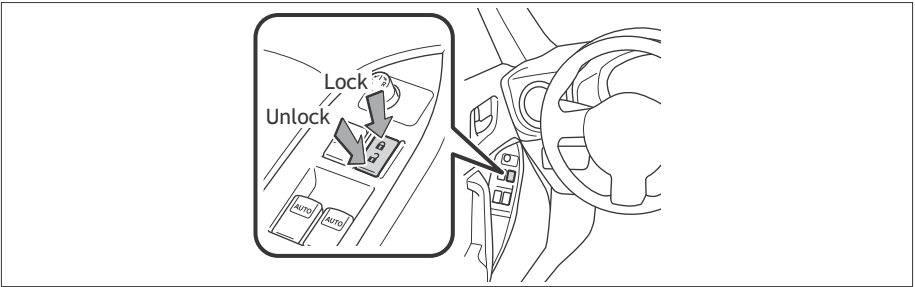

Seat belts

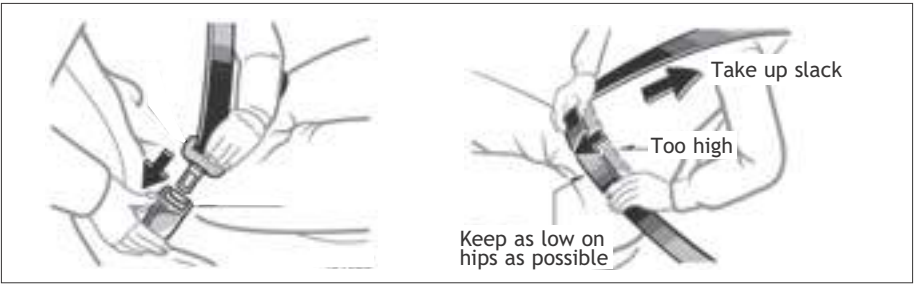

If belt is fully extended, then retracted even slightly, it cannot be re-extended beyond that point, unless fully retracted again. This feature is used to help hold child restraint systems securely.

To find more information about seat belts, and how to install a child restraint system, refer to the *Owner's Manual*.

Tire Pressure Monitoring (warning) System

If tire pressure becomes critically low on any of the tires (excluding the spare), “” indicator will illuminate. Correctly adjusting tire inflation will turn off the light after a few minutes. If the light does not turn off, have the system checked by your Scion or Toyota dealer.

Refer to the *Owner's Manual* for more details.

Spare tire & tools

Tool location

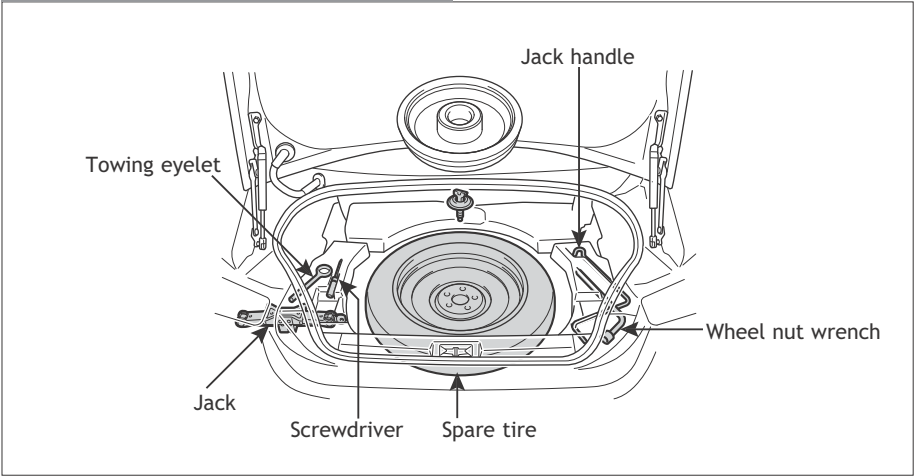

Removing the spare tire

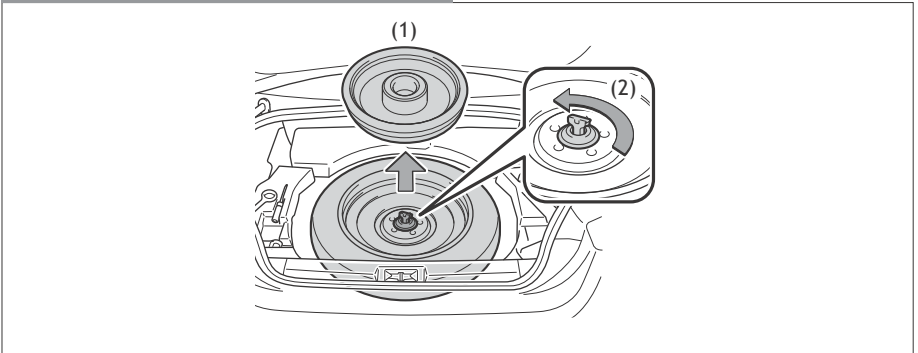

(1) Remove the spare tire cover.

(2) Loosen and remove the bolt.

Refer to the *Owner's Manual* for jack positioning and tire changing procedures.

Star Safety System™

Your new Scion vehicle comes standard with the Star Safety System™, which combines Traction Control (TRAC), Electronic Brake-force Distribution (EBD), Vehicle Stability Control (VSC), Brake Assist (BA) and an Anti-lock Braking System (ABS).

Vehicle Stability Control (VSC)

VSC helps prevent loss of traction during cornering by reducing engine power and applying brake force to selected wheels.

Toyota's VSC monitors steering angle and the direction your vehicle is traveling. When it senses that the front or rear wheels begin to lose traction, VSC reduces engine power and applies braking to selected wheels. This helps restore traction and vehicle control.

Traction Control (TRAC)

VSC helps prevent loss of traction during cornering by reducing engine power, and Traction Control helps maintain traction on loose gravel and wet, icy, or uneven surfaces by applying brake force to the spinning wheel(s).

Toyota's TRAC sensors are activated when one of the drive wheels starts to slip. TRAC limits engine output and applies the brakes to the spinning wheel. This transfers power to the wheels that still have traction to help keep you on track.

Brake Assist (BA)

Brake Assist is designed to detect sudden or "panic" braking, and then add braking pressure to help decrease the vehicle's stopping distance. When there's only a split second to react, Brake Assist can add additional brake pressure more quickly than just the driver alone can.

Electronic Brake Force Distribution (EBD)

Toyota's ABS technology has Electronic Brake-force Distribution (EBD) to help maintain control and balance when braking. Abrupt stops can cause a vehicle to tilt forward, reducing the braking power of the rear wheels. EBD responds to sudden stops by redistributing brake force to enhance the braking effectiveness of all four wheels.

Anti-Lock Brake System (ABS)

ABS helps prevent brakes from locking up by "pulsing" brake pressure to each wheel. This limits brake lockup and helps provide directional control for the current road conditions.

Toyota's ABS sensors detect which wheels are locking up and limits wheel lockup by "pulsing" each wheel's brakes independently. Pulsing releases brake pressure repeatedly for fractions of a second. This helps the tires attain the traction that current road conditions will allow, helping you to stay in directional control.

SAFETY AND EMERGENCY FEATURES

Smart Stop Technology (SST)

Smart Stop Technology automatically reduces engine power when the accelerator and brake pedals are pressed simultaneously under certain conditions.

SST engages when the accelerator is depressed first and the brakes are applied firmly for longer than one-half second at speeds greater than five miles per hour.

SST doesn't engage if the brake pedal is depressed before the accelerator pedal, allowing vehicles to start on a steep hill and safely accelerate without rolling backward.

Floor mat installation

Each vehicle has model-specific floor mats. Installation is easy.

To keep your floor mat properly positioned, follow these steps:

- Only use floor mats designed for your specific model.
- Use only one floor mat at a time, using the retaining hooks to keep the mat in place.
- Install floor mats right side up.

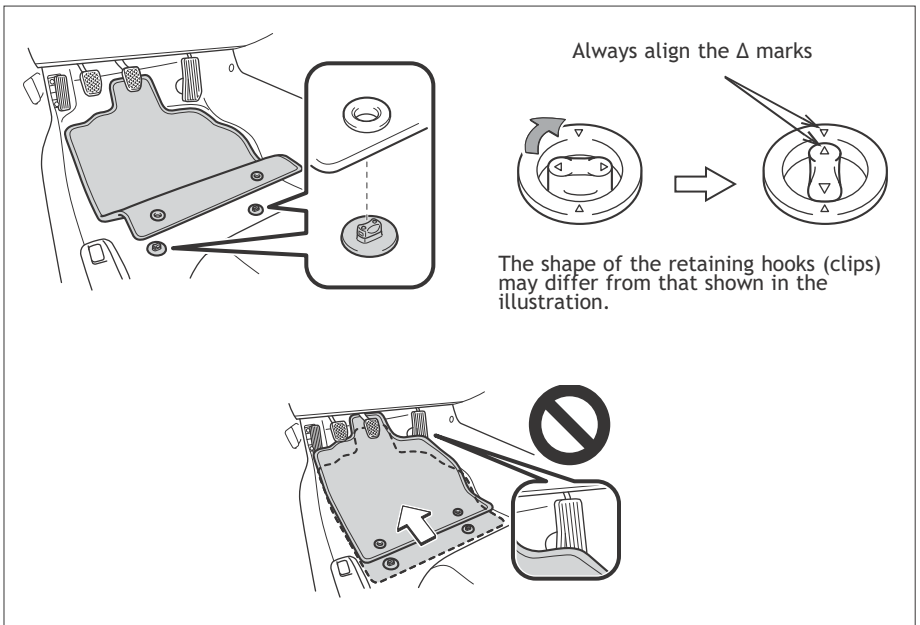

NOTES

WEBSITE

WWW.SCION.COM

PHONE

1.866.70.SCION

ADDRESS

19001 S. WESTERN AVE.
D102, P.O. BOX 2742
TORRANCE, CA 90509-2742
USA

