



2016 QUICK REFERENCE GUIDE



what moves you

2016 Scion iM

This *Quick Reference Guide* is a summary of basic vehicle operations. It contains brief descriptions of fundamental operations so you can locate and use the vehicle's main equipment quickly and easily.

The *Quick Reference Guide* is not intended as a substitute for the *Owner's Manual* located in the vehicle's glove box. We strongly encourage you to review the *Owner's Manual* and supplementary manuals so you will have a better understanding of the vehicle's capabilities and limitations.

Your dealership and the entire staff of Toyota Motor Sales, U.S.A., Inc. wish you many years of satisfied driving in your new Scion iM.

A word about safe vehicle operations

This *Quick Reference Guide* is not a full description of Scion iM operations. Every Scion iM owner should review the *Owner's Manual* that accompanies this vehicle.

Pay special attention to the boxed information highlighted in color throughout the *Owner's Manual*. Each box contains safe operating instructions to help you avoid injury or equipment malfunction.

All information in this *Quick Reference Guide* is current at the time of printing. Toyota reserves the right to make changes at any time without notice.

INDEX

OVERVIEW

Engine maintenance	7
Fuel tank door release and cap	7
Hood release	6
Indicator symbols	4-5
Instrument cluster	4
Instrument panel	2-3
Keyless entry*	6

FEATURES/OPERATIONS

Air Conditioning/Heating	13
Automatic Transmission	8
AUX port/USB port	12
Bottle holders/Cup holders	9
Cruise control	11
Lights & turn signals	10
Manual Transmission	8
Multi-Information Display	18
Parking brake	8
Power outlet	12
Rear view monitor system	14-16
Seat adjustments-Front	9
Seat-Folding down rear seat	9
Seats-Head restraints	9
Steering wheel switches	17
Tilt steering wheel	12
Trip information/Meter light control	18
Windows	11
Windshield wipers & washers	10

SAFETY AND EMERGENCY FEATURES

Door locks	19
Doors-Child safety locks	19
Floor mat installation	23
Seat belts	20
Seat belts-Shoulder belt anchor	19
Spare tire & tools	21
Star Safety System™	22-23
Tire Pressure Monitoring (warning) System	20

* Visit your Scion dealer for information on customizing this feature.

OVERVIEW

Instrument panel

Steering wheel

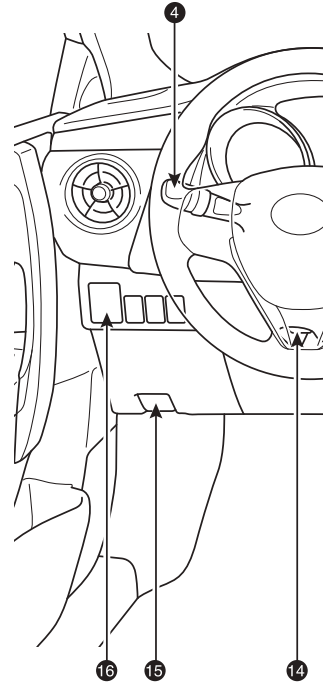
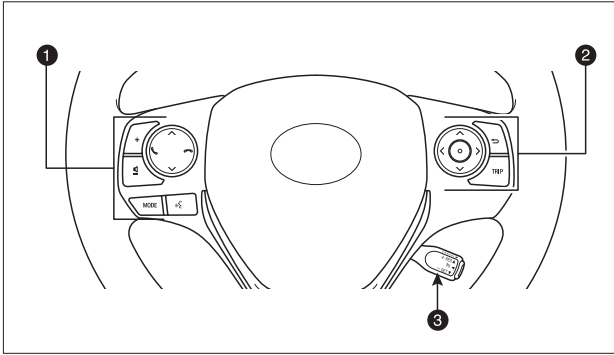

- ① Multimedia controls¹
- ② Multi-information display controls
- ③ Cruise control
- ④ Headlight and turn signal controls
- ⑤ Wiper and washer controls
- ⑥ Emergency flasher button
- ⑦ Front passenger occupant classification indicator/
Front passenger seat belt reminder light
- ⑧ “VSC OFF” (vehicle stability control) switch

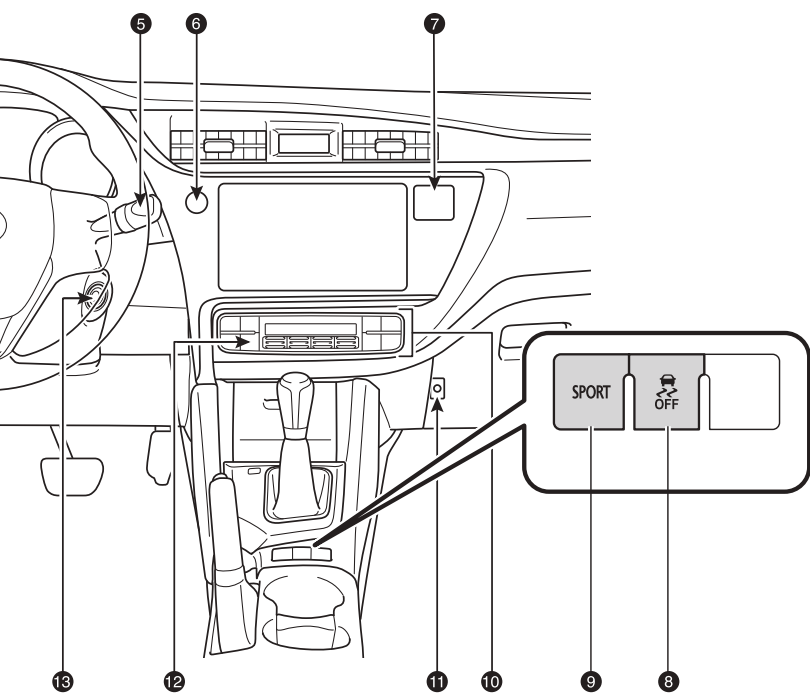

- 9 "SPORT" mode switch²
- 10 Air Conditioning controls
- 11 Tire pressure warning reset switch (inside glovebox)
- 12 Rear window and outside rearview mirror defogger button
- 13 Ignition switch
- 14 Tilt and telescopic steering lock release lever
- 15 Hood lock release lever
- 16 Power outside rearview mirror controls

¹ For more information, refer to Scion.com to download the *SCION Audio System Owner's Manual*.

² If equipped.

Instrument cluster

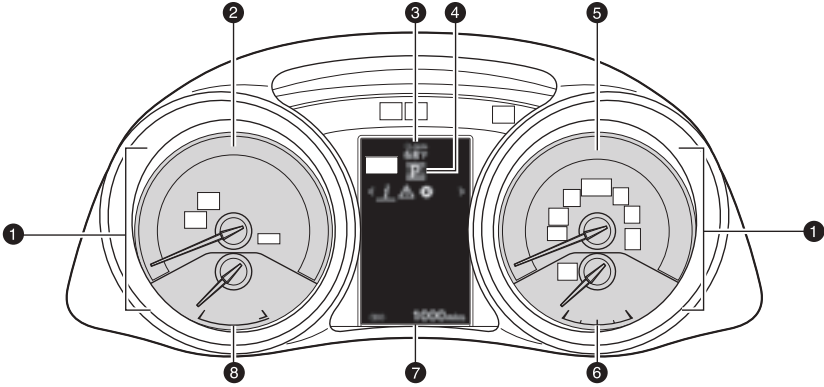













- 1 Indicators and warning lights
- 2 Tachometer
- 3 Outside temperature
- 4 Shift and gear position indicator
- 5 Speedometer
- 6 Fuel gauge
- 7 Multi-Information Display
- 8 Engine coolant temperature gauge

Indicator symbols

For details, refer to “Indicators and warning lights,” Section 2-2, 2016 Owner’s Manual.

	Brake system warning*
	Driver seat belt reminder (alarm will sound if speed is over 12 mph)
	Front passenger seat belt reminder (alarm will sound if speed is over 12 mph)
	Malfunction/Check Engine indicator*
	Airbag SRS warning*
	Low Tire Pressure Warning*
	Front passenger occupant classification indicator*
	Headlight low beam indicator

* If indicator does not come on or turn off within a few seconds of starting engine, there may be a malfunction. Have vehicle inspected by your Scion dealer.

	Headlight high beam indicator
	Turn signal indicator
	Low fuel level warning
	Slip indicator*
	Vehicle Stability Control OFF indicator*
	Cruise control indicator
	Cruise control SET indicator
	Electric power steering system warning*
	Anti-lock Brake System warning*
	Low outside temperature indicator
	Engine immobilizer indicator
	ECO driving indicator light*
	Fuel tank door position

Keyless entry

Locking operation



Push 

Unlocking operation



Push ONCE: Driver door 
TWICE: ALL doors

Panic button



Push and hold 

NOTE: If a door is not opened within 60 seconds of unlocking, all doors will relock for safety.

Hood release

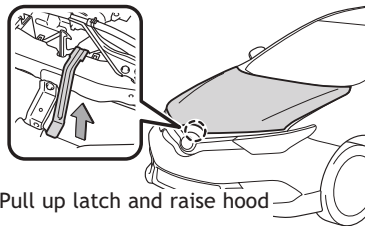
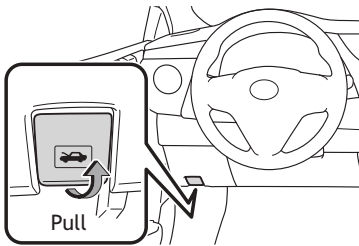

Engage support rod

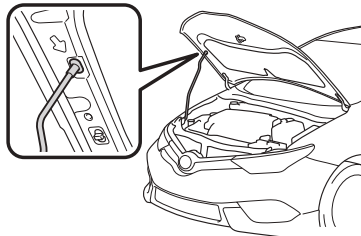

Fuel tank door release and cap

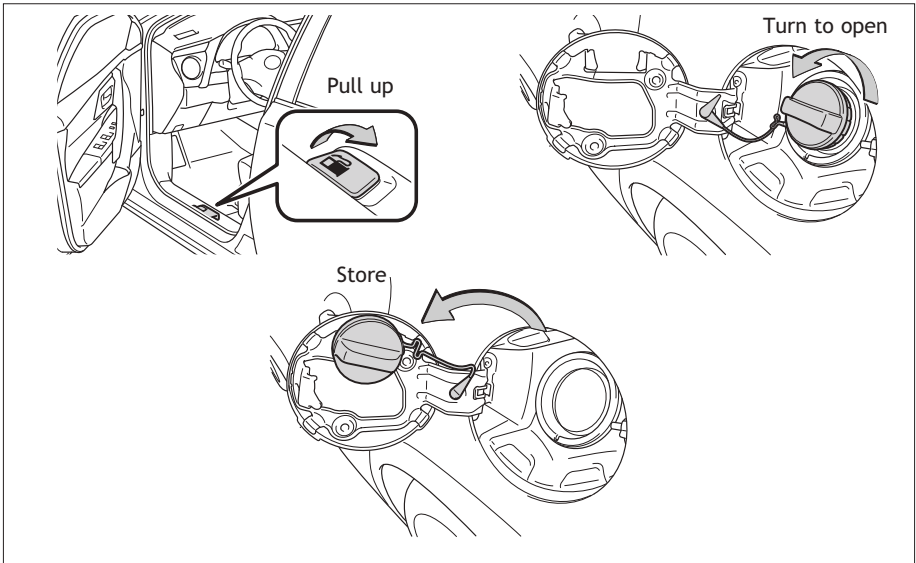

Engine maintenance

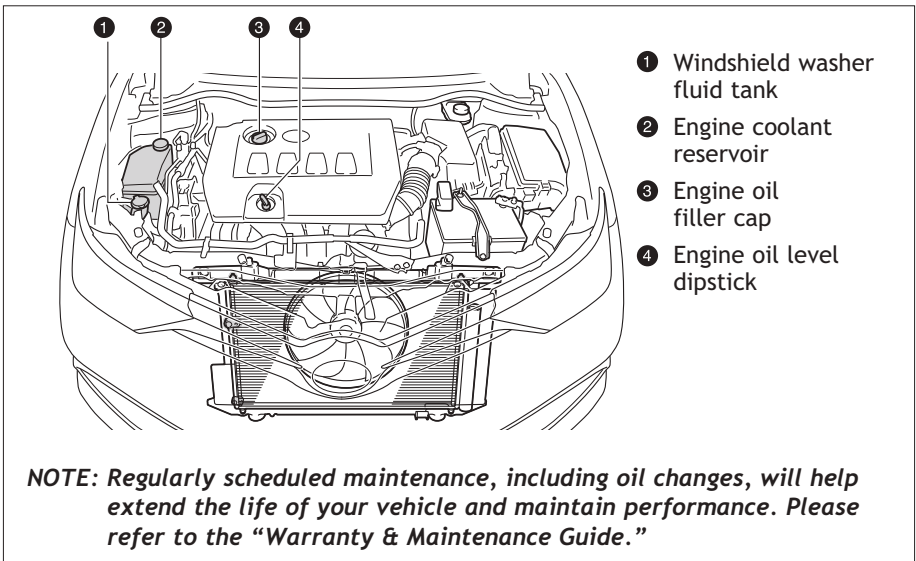

FEATURES/OPERATIONS

Automatic transmission (if equipped)

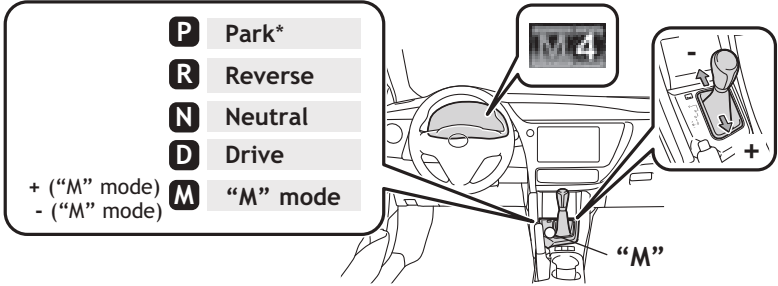

* The ignition switch must be "ON" and the brake pedal depressed to shift from Park.

"M" 7-speed sport sequential shiftmatic mode

Push shift lever to the left from "D" position, to "M" position.

- + : Upshift (push and release)
- : Downshift (pull and release)

Downshifting increases power going uphill, or provides engine braking downhill. For best fuel economy during normal driving conditions, always drive with the shift lever in the "D" position.

Manual transmission (if equipped)

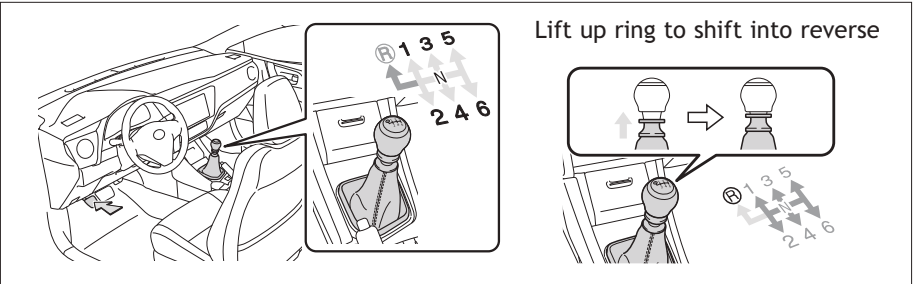

Parking brake

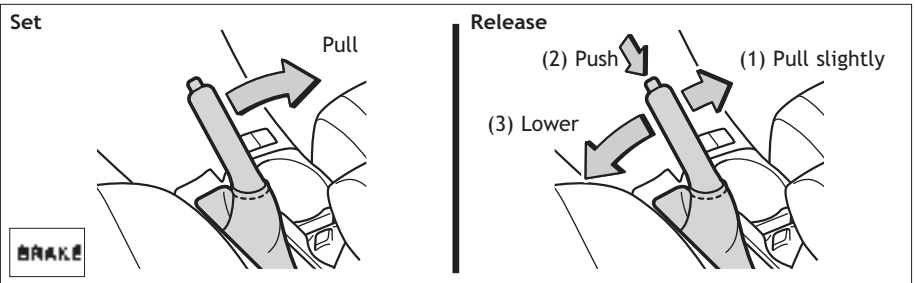

Seats-Head restraints

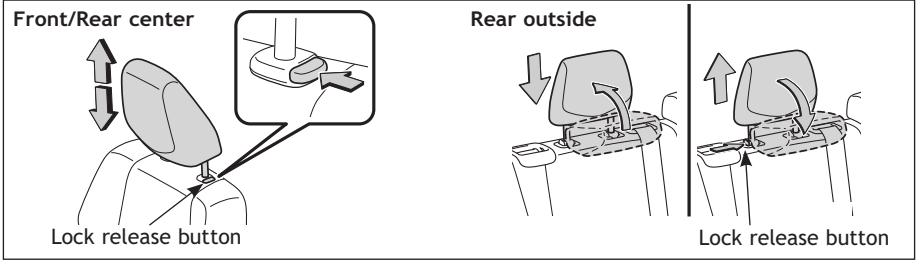

Seat adjustments-Front

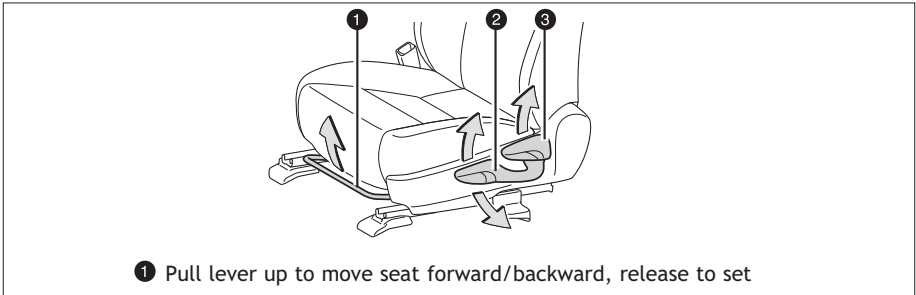

- 1 Seat position (forward/backward)
- 2 Height crank (driver side only)
- 3 Seatback angle

Seat-Folding down rear seat

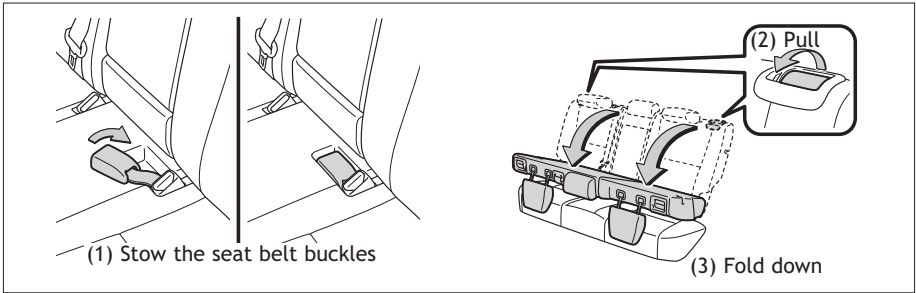

Bottle holders/Cup holders

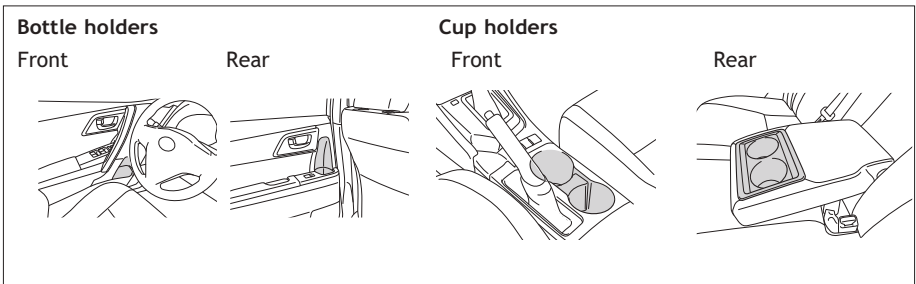

Lights & turn signals

Headlights

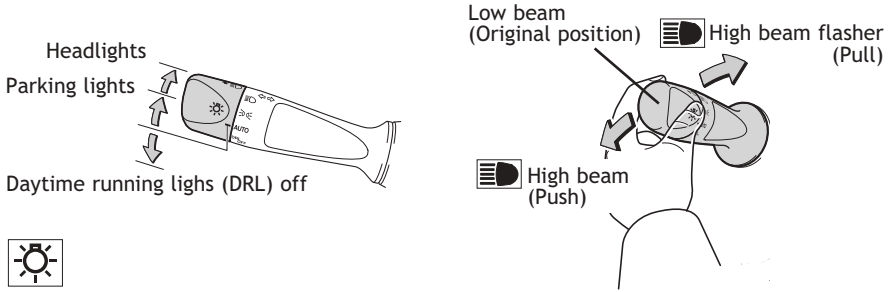

Turn signals

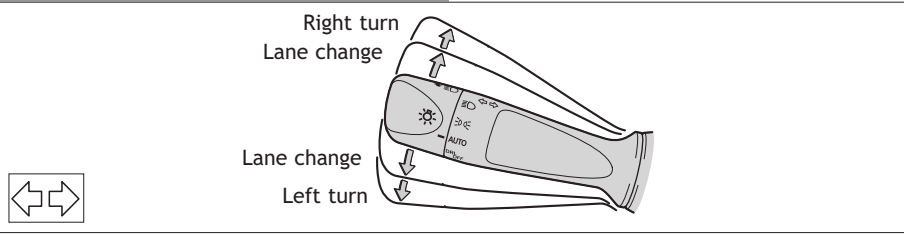

Windshield wipers & washer

Front

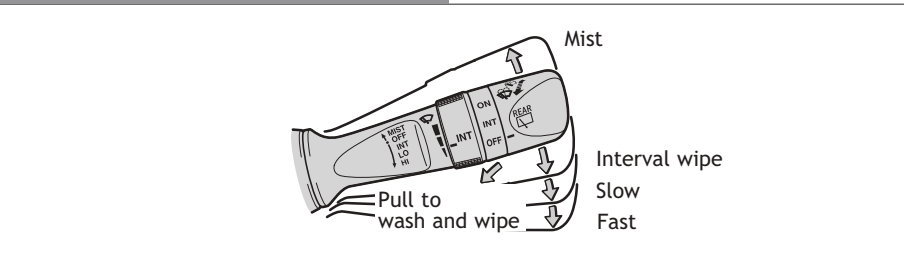

Rear

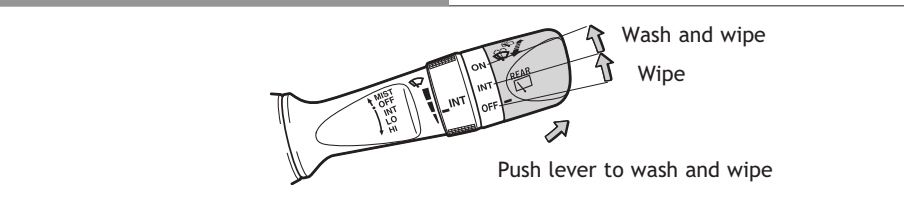

Windows

Driver side

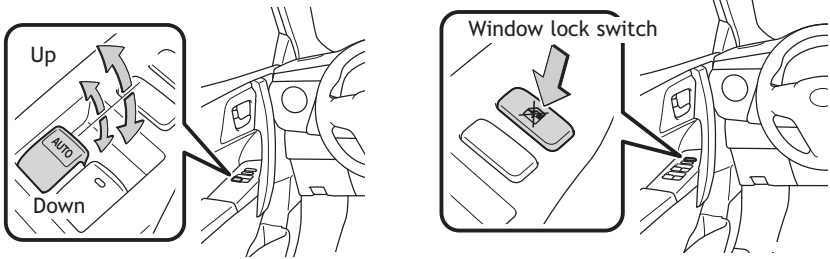

Automatic operation (driver's window only) Push the switch completely down and release to fully open. To stop the window partway, operate the switch in the opposite direction.

Window lock switch Deactivates all passenger windows. Driver's window remains operable.

Cruise control

System ON/OFF

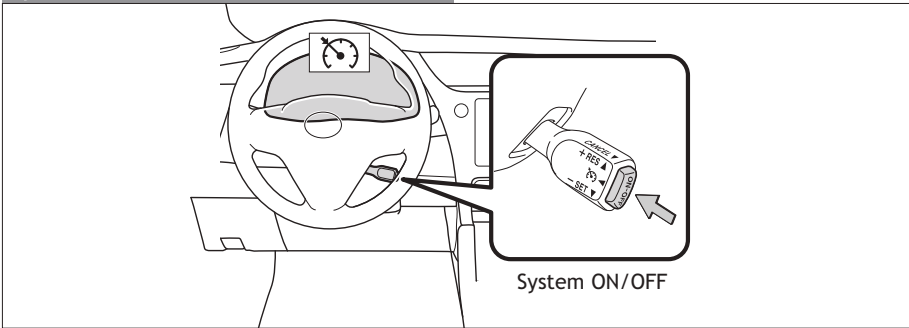

Functions

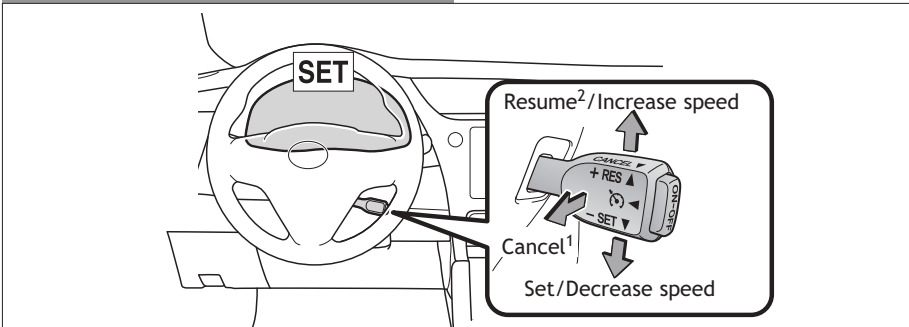

¹ The set speed may also be cancelled by depressing the brake pedal or the clutch pedal (manual transmission only).

² The set speed may be resumed once vehicle speed reaches approximately 25 mph.

Tilt steering wheel

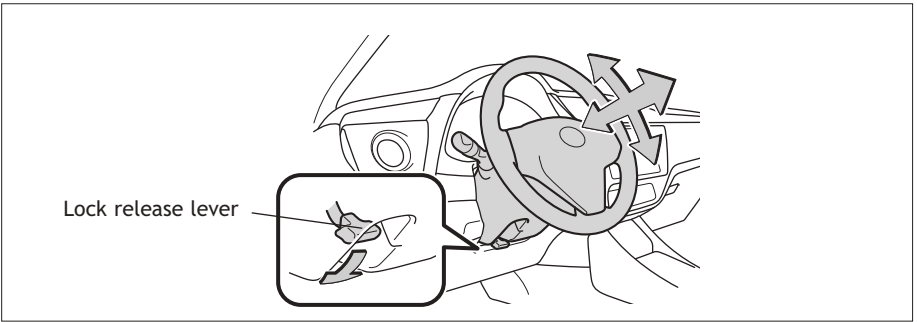

Hold wheel, push lever down, set angle and return lever.

NOTE: Do not attempt to adjust while the vehicle is in motion.

AUX port/USB port

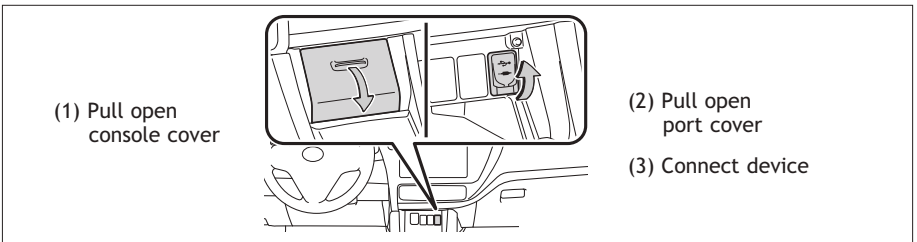

Use this port to connect a portable audio device and listen to it through the vehicle's speakers.

For more information, refer to Scion.com to download the *SCION Audio System Owner's Manual* or *Scion Bespoke Audio with Navigation Owner's Manual*.

Power outlet

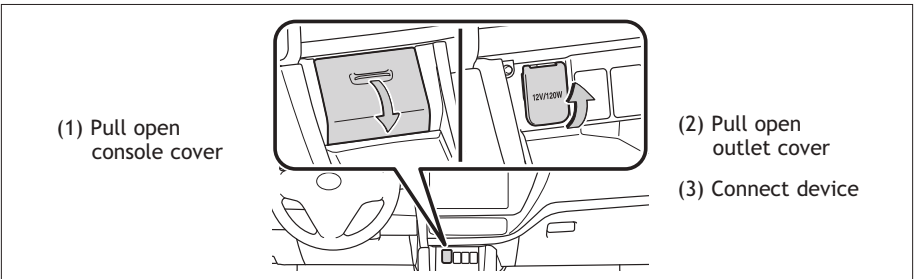

Designed for car accessories. Ignition switch must be in the "ACC" or "ON" position to use.

Air Conditioning/Heating

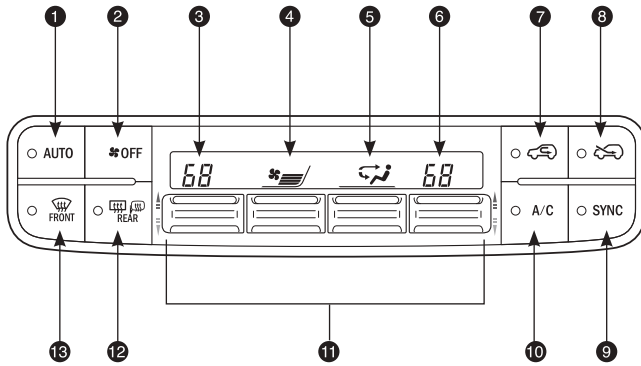

- 1 Auto
- 2 OFF
- 3 Driver side temperature
- 4 Fan speed
- 5 Airflow mode selector
- 6 Passenger side temperature
- 7 Recirculate cabin air
- 8 Outside air
- 9 Sync driver side and passenger side
- 10 Air Conditioning ON/OFF
 Use outside air to quickly cool interior, then change to recirculate for cooler air.
- 11 Adjusters
 UP: Increase temperature/ change mode
 DOWN: Decrease temperature/ change mode
- 12 Rear window and outside rearview mirrors defogger
- 13 Front window defogger
 “” and “” mode uses outside air, use “” indicator “ON” to reduce window fogging

Rear View Monitor System

The rear view monitor system assists the driver by displaying an image of the camera's view behind the vehicle when in reverse.

To see the camera's image of the view behind the vehicle on the monitor screen, the vehicle ignition switch must be in the "ON" position and the gear selector must be in the "R" position.

If you shift the vehicle out of the "R" position, the screen returns to the previous image.

The rear view monitor system is a device intended to supplement the driver when motoring in reverse and should not be relied upon solely. Drivers should check behind the vehicle before entering and are reminded to use the rear view and side mirrors once seated to ensure the intended path is clear before moving the vehicle.

AREA DISPLAYED ON SCREEN

The image displayed on the screen is an approximation only.

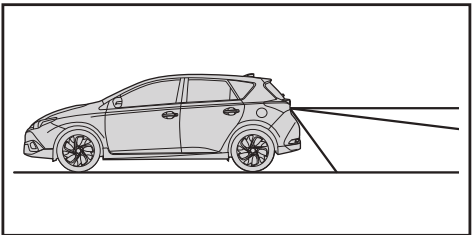
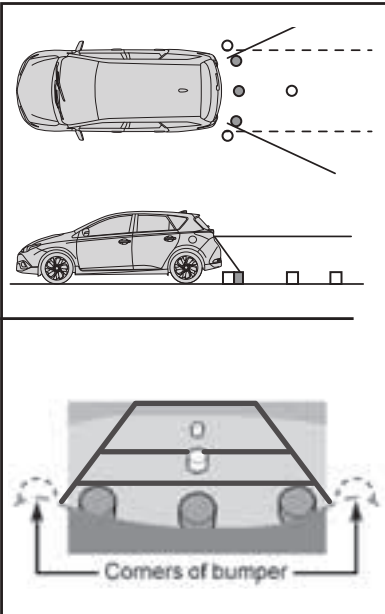

INFORMATION

The area displayed on the screen may vary according to vehicle orientation or road conditions.

The area detected by the camera is limited. The camera does not detect objects which are close to either corner of the bumper or under the bumper.

INFORMATION

If the camera lens becomes dirty, it cannot transmit a clear image. If water droplets, snow or mud adhere to the lens, rinse with water and wipe with a soft clean cloth. If the lens is extremely dirty, wash it with a mild cleaner and rinse immediately.

REAR VIEW MONITOR SYSTEM CAMERA

The rear view monitor system camera is located as shown in the illustration.

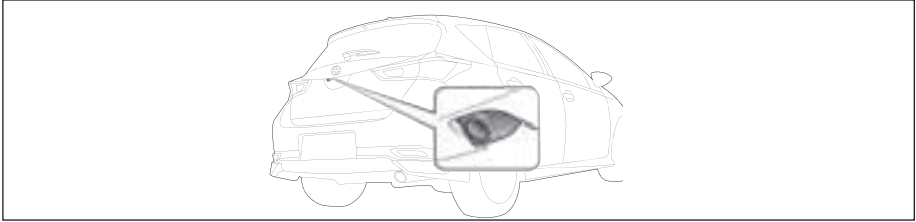

The camera for the rear view monitor system is located near the license plate. To adjust the image on the rear view monitor screen, press the setup button “⚙” on the left side of screen and select “Display” on the setup screen. Then select “Camera” to adjust the screen brightness and contrast.

For more information, refer to Scion.com to download the *SCION Audio System Owner’s Manual* or *Scion Bespoke Audio with Navigation Owner’s Manual*.

INFORMATION

The camera uses a special lens. The distance of the image that appears on the screen differs from the actual distance.

When the camera is used under fluorescent lights, sodium lights or mercury lights etc., the lights and the illuminated areas may appear to flicker.

In the following cases, it may become difficult to see the images on the screen, even when the system is functioning:

- In the dark (for example, at night)
- When the temperature near the lens is high or low
- When water droplets are adhering to the camera, or when humidity is high (for example, when it rains)
- When foreign matter (for example, snow or mud) is adhering to the camera
- When the camera has scratches or dirt on it
- When the sun or the beam of headlights is shining directly into the camera lens

INFORMATION



If a bright light (for example, sunlight reflected off the vehicle body) is picked up by the camera, a Smear effect* may occur.

*Smear effect

A phenomenon that occurs when a bright light (for example, sunlight reflected off the vehicle body) is picked up by the camera; when transmitted by the camera, the light source appears to have a vertical streak above and below it.

FEATURES/OPERATIONS



NOTICE

If the vehicle is hit, the position and mounting angle of the camera may change. Be sure to have the camera position and mounting angle checked at your local Scion dealer.

The camera is of water proof construction. Do not detach, disassemble or modify it. Any of these activities may cause the system to malfunction.

If the temperature changes rapidly, such as pouring hot water on the vehicle in cold temperatures, the system may not operate normally.

Do not hit the camera or expose it to strong impact as this may cause its position and mounting angle to change.

Do not rub the camera lens too hard. If the lens is scratched it cannot transmit a clear image.

Do not allow organic solvent, car wax, window cleaner or glass coat to adhere to the camera. If contact is made with one of these substances wipe it off as soon as possible.

When replacing tires on the vehicle, please consult your Scion dealer. If you replace the tires, the area displayed on the screen may change.

Do not use a high-pressure car-wash machine type wand to spray the camera or camera area as this may cause serious damage to the rear view camera. Using intensive bursts of water may result in the camera malfunctioning.



CAUTION

The image on the screen is different from actual conditions. Depicted distances between objects and flat surfaces will differ from actual distance. If you back up looking only at the screen monitor, you may hit an object, vehicle or person.

Use your own eyes to confirm the vehicle's surroundings, as the displayed image may become faint or dark, and moving images will be distorted or not entirely visible when the outside temperature is low.

Steering wheel switches

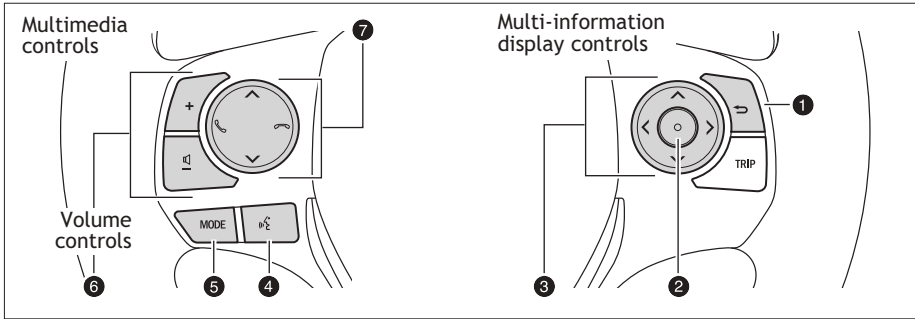

Multi-information display control

- 1 “↶”
Return to the previous screen
- 2 “○”
Push to select within the multi-information display screens.
- 3 “▲ ▼” and “< >”
Use to search within the selected multi-information display screens.

Multimedia controls



- 4 “🗣️”
Push to use voice commands.
- 5 “MODE”
Push to turn audio ON and select an audio mode. Push and hold to turn the audio system OFF.
- 6 “+” and “-”
Push to increase or lessen volume.
- 7 “▲ ▼”
Use to search within the selected audio medium (AM, FM, AHA, etc).
“☎️” and “📞”
Push to make a call or hang up.

For details, refer to Scion.com to download the *SCION Audio System Owner's Manual* or *SCION Navigation System Owner's Manual*.

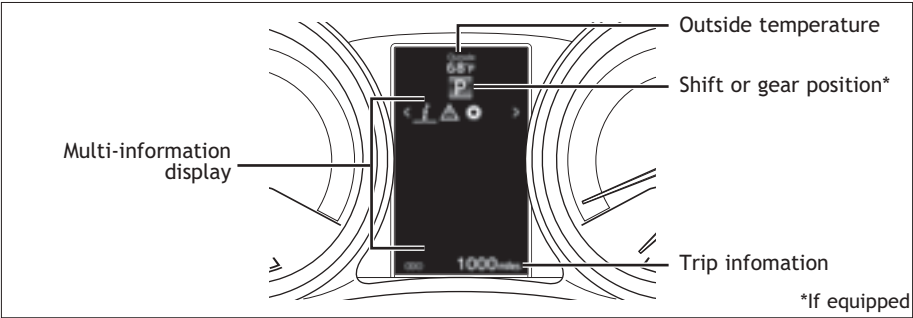
Multi-Information Display



Push “▲ ▼” or “< >” and “○” on steering wheel to change and select information displayed:

-  Drive information 1: Current fuel consumption/ Average fuel economy
Drive information 2: Distance (driving range)/ Average vehicle speed
 -  Warning message display: system malfunctions, incorrectly performed operations, maintenance required
 -  Settings display
- For details, refer to *Owner’s Manual*.

Trip information/Meter light control

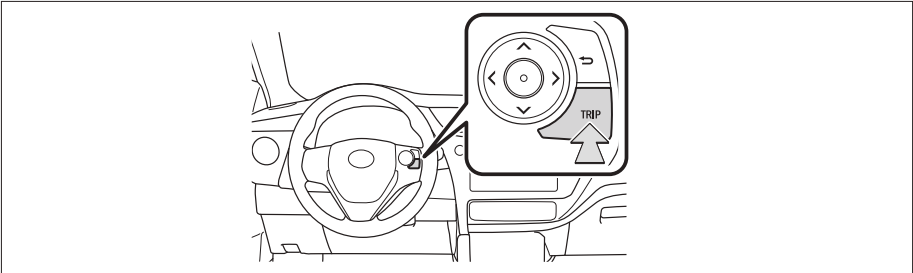

- Push to change display
- Odometer
 - Trip meter A/trip meter B
 - Meter light control

SAFETY AND EMERGENCY FEATURES

Door locks

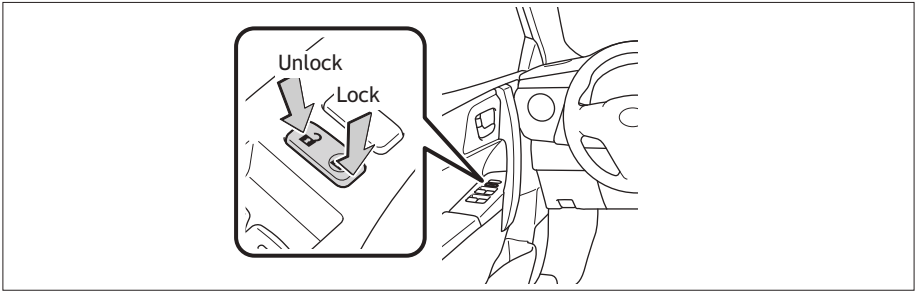

Doors-Child safety locks

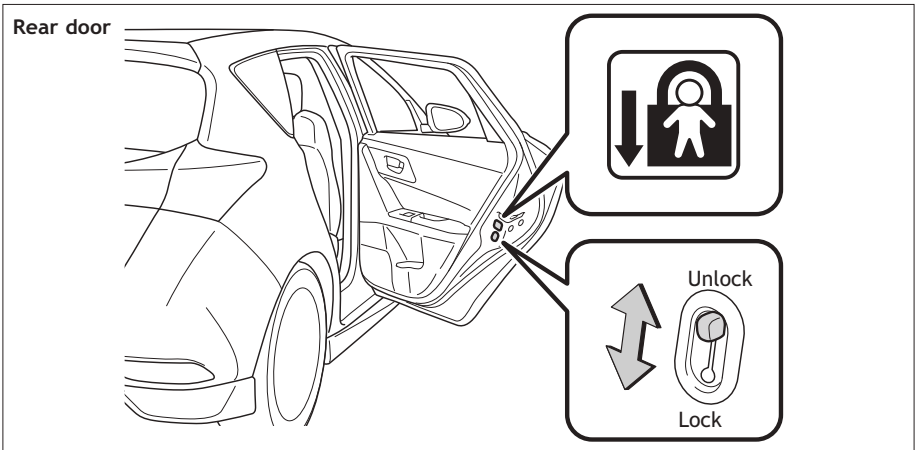

Moving the lever downward will allow the door to be opened only from the outside.

Seat belts-Shoulder belt anchor

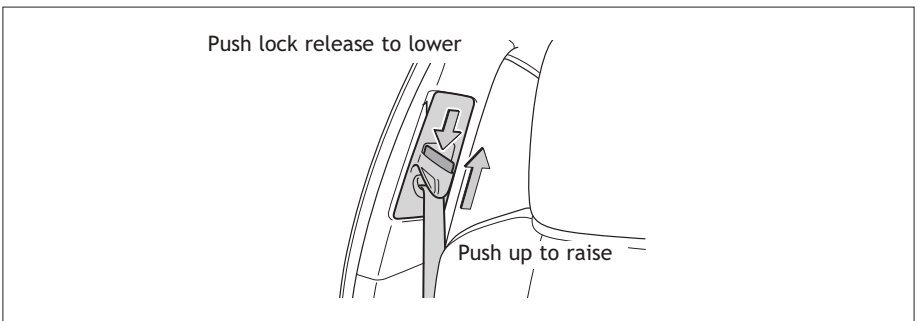

SAFETY AND EMERGENCY FEATURES

Seat belts

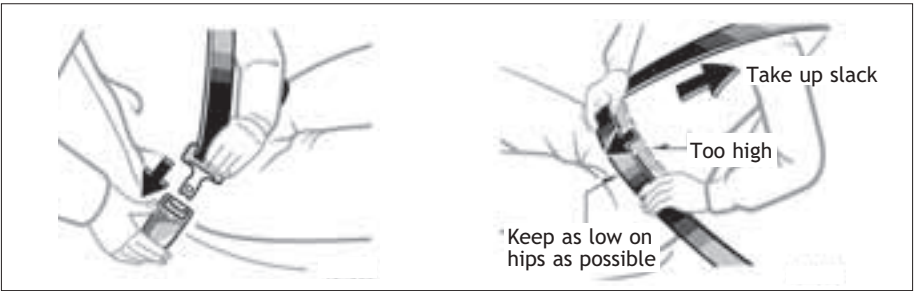

NOTE: If a passenger's seat belt is fully extended, then retracted even slightly, the Automatic locking retractor (ALR) will prevent it from being re-extended beyond that point, unless fully retracted again. This feature is used to help hold child restraint systems securely.

To find more information about seat belts, and how to install a child restraint system, refer to the *Owner's Manual*.

Tire Pressure Monitoring (warning) System

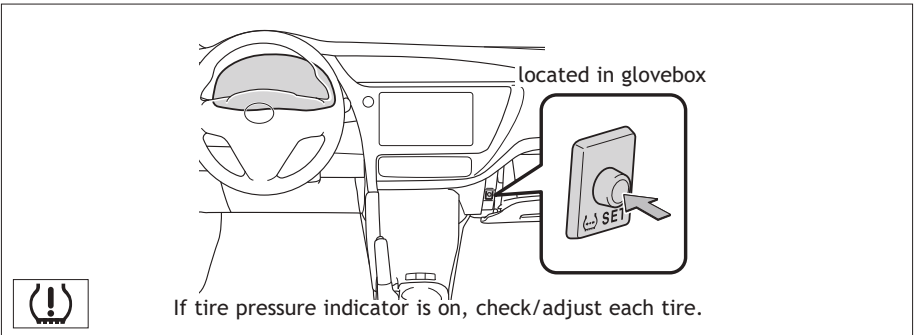

After adjusting tire pressures, or after tires have been rotated or replaced, turn the ignition switch to "ON" and press and hold the "SET" button until indicator blinks three times. Let the vehicle sit for a few minutes to allow initialization to complete.

Refer to the load label on the door jamb or the *Owner's Manual* for tire inflation specifications.

If the tire pressure indicator flashes for more than 60 seconds and then remains on, take the vehicle to your local Scion dealer.

Spare tire & tools

Tool and spare tire location

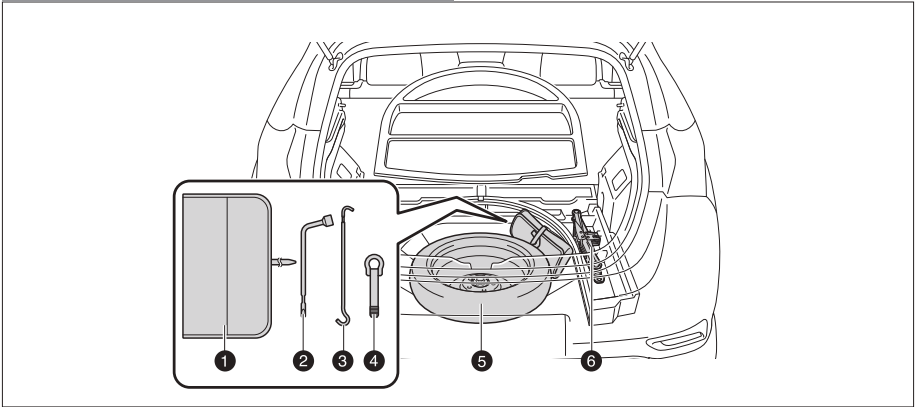

- 1 Tool bag
- 2 Wheel nut wrench
- 3 Jack handle
- 4 Towing eyelet
- 5 Spare tire
- 6 Jack

Removing the spare tire

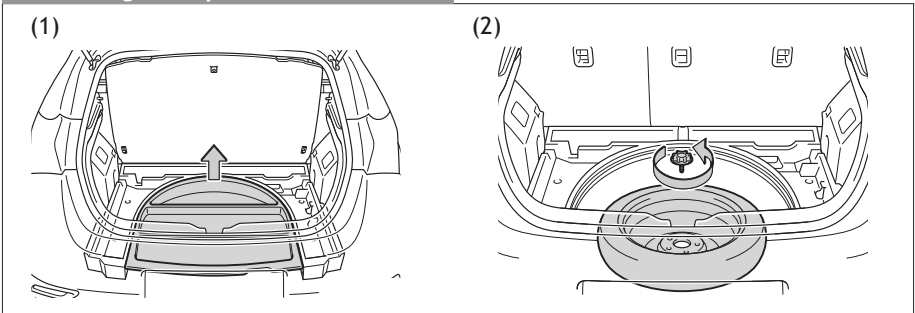

- (1) Remove the luggage mat and remove the center auxiliary boxes.
- (2) Loosen the center fastener that secures the spare tire.

Refer to the *Owner's Manual* for jack positioning and tire changing procedures.

SAFETY AND EMERGENCY FEATURES

Star Safety System™

Your new Scion vehicle comes standard with the Star Safety System™, which combines Traction Control (TRAC), Electronic Brake-force Distribution (EBD), Vehicle Stability Control (VSC), Brake Assist (BA), an Anti-lock Braking System (ABS) and Smart Stop Technology (SST).

Vehicle Stability Control (VSC)

VSC helps prevent loss of traction during cornering by reducing engine power and applying brake force to selected wheels.

Toyota's VSC monitors steering angle and the direction your vehicle is traveling. When it senses that the front or rear wheels begin to lose traction, VSC reduces engine power and applies braking to selected wheels. This helps restore traction and vehicle control.

Traction Control (TRAC)

VSC helps prevent loss of traction during cornering by reducing engine power, and Traction Control helps maintain traction on loose gravel and wet, icy, or uneven surfaces by applying brake force to the spinning wheel(s).

Toyota's TRAC sensors are activated when one of the drive wheels starts to slip. TRAC limits engine output and applies the brakes to the spinning wheel. This transfers power to the wheels that still have traction to help keep you on track.

Brake Assist (BA)

Brake Assist is designed to detect sudden or "panic" braking, and then add braking pressure to help decrease the vehicle's stopping distance. When there's only a split second to react, Brake Assist can add additional brake pressure more quickly than just the driver alone can.

Electronic Brake Force Distribution (EBD)

Toyota's ABS technology has Electronic Brake-force Distribution (EBD) to help maintain control and balance when braking. Abrupt stops can cause a vehicle to tilt forward, reducing the braking power of the rear wheels. EBD responds to sudden stops by redistributing brake force to enhance the braking effectiveness of all four wheels.

Anti-Lock Brake System (ABS)

ABS helps prevent brakes from locking up by "pulsing" brake pressure to each wheel. This limits brake lockup and helps provide directional control for the current road conditions.

Toyota's ABS sensors detect which wheels are locking up and limits wheel lockup by "pulsing" each wheel's brakes independently. Pulsing releases brake pressure repeatedly for fractions of a second. This helps the tires attain the traction that current road conditions will allow, helping you to stay in directional control.

Smart Stop Technology (SST)

Smart Stop Technology automatically reduces driving torque when the accelerator and brake pedals are pressed simultaneously under certain conditions.

SST engages when the accelerator is depressed first and the brakes are applied firmly for longer than one-half second at speeds greater than five miles per hour.

SST doesn't engage if the brake pedal is depressed before the accelerator pedal, allowing vehicles to start on a steep hill and safely accelerate without rolling backward.

Floor mat installation

Each vehicle has model-specific floor mats. Installation is easy.

To keep your floor mat properly positioned, follow these steps:

- Only use floor mats designed for your specific model.
- Use only one floor mat at a time, using the retaining hooks to keep the mat in place.
- Install floor mats right side up.

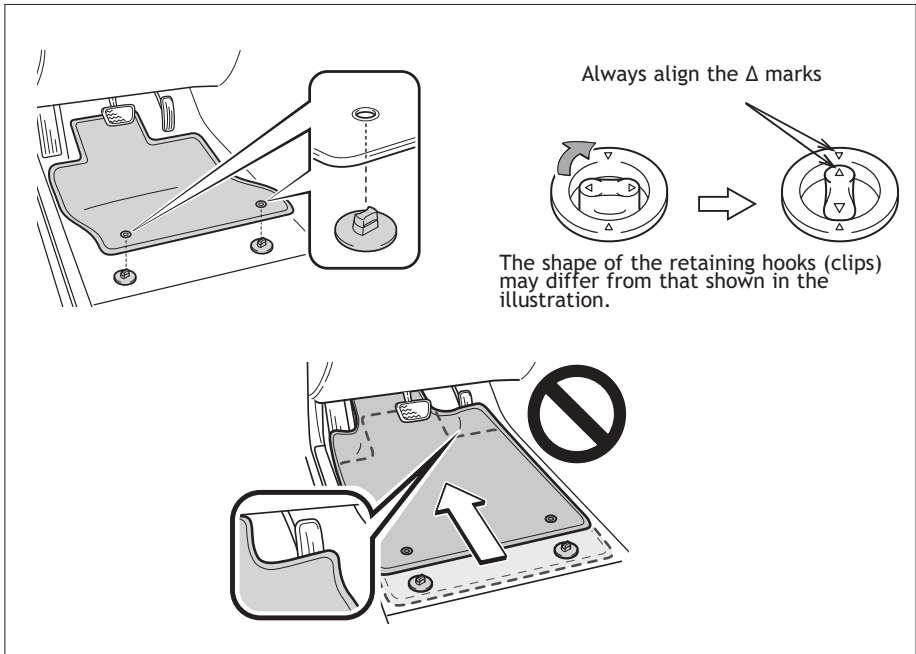

NOTES

WEBSITE

WWW.SCION.COM

PHONE

1.866.70.SCION

ADDRESS

19001 S. WESTERN AVE.
D102, P.O. BOX 2742
TORRANCE, CA 90509-2742
USA



©2015 Scion, a marque of Toyota Motor Sales, U.S.A., Inc.
Printed in U.S.A. 7/15
15-TCS-08747

00505QRG16IM