



**tC**

2016 QUICK  
REFERENCE  
GUIDE



what moves you

# 2016 Scion tC

This *Quick Reference Guide* is a summary of basic vehicle operations. It contains brief descriptions of fundamental operations so you can locate and use the vehicle's main equipment quickly and easily.

The *Quick Reference Guide* is not intended as a substitute for the *Owner's Manual* located in the vehicle's glove box. We strongly encourage you to review the *Owner's Manual* and supplementary manuals so you will have a better understanding of the vehicle's capabilities and limitations.

Your dealership and the entire staff of Scion, a marque of Toyota Motor Sales, U.S.A., Inc., wish you many years of satisfied driving in your new Scion tC.

## A word about safe vehicle operation

This *Quick Reference Guide* is not a full description of Scion tC operations. Every Scion tC owner should review the *Owner's Manual* that accompanies this vehicle.

Pay special attention to the boxed information highlighted in color throughout the *Owner's Manual*. Each box contains safe operating instructions to help you avoid injury or equipment malfunction.

All information in this *Quick Reference Guide* is current at the time of printing. Scion reserves the right to make changes at any time without notice.

# INDEX

## OVERVIEW

Auto lock/unlock	6
Engine maintenance	8
Fuel tank door opener and cap	8
Hood release	8
Indicator symbols	4-5
Instrument cluster	4
Instrument panel	2-3
Keyless entry	6
Smart key system	7

## FEATURES/OPERATIONS

Air Conditioning/Heating	15
Automatic Transmission	9
AUX port/USB port	15
Bottle holders / Cup holders	14
Clock	14
Cruise control	11
Light control-Instrument panel	12
Lights & turn signals	11
Manual Transmission	9
Moonroof	14
Parking brake	16
Power outlet	16
Seat adjustments-Front	10
Seat adjustments-Rear	10
Seats-Head restraints	10
Steering wheel switches	16
Tilt steering wheel	13
Windows	13
Windshield wipers & washers	12

## SAFETY AND

## EMERGENCY FEATURES

Door locks	17
Floor mat installation	20
Seat belts	17
Spare tire & tools	18
Star Safety System™	19-20
Tire Pressure Monitoring (warning) System	17

# OVERVIEW

## Instrument panel

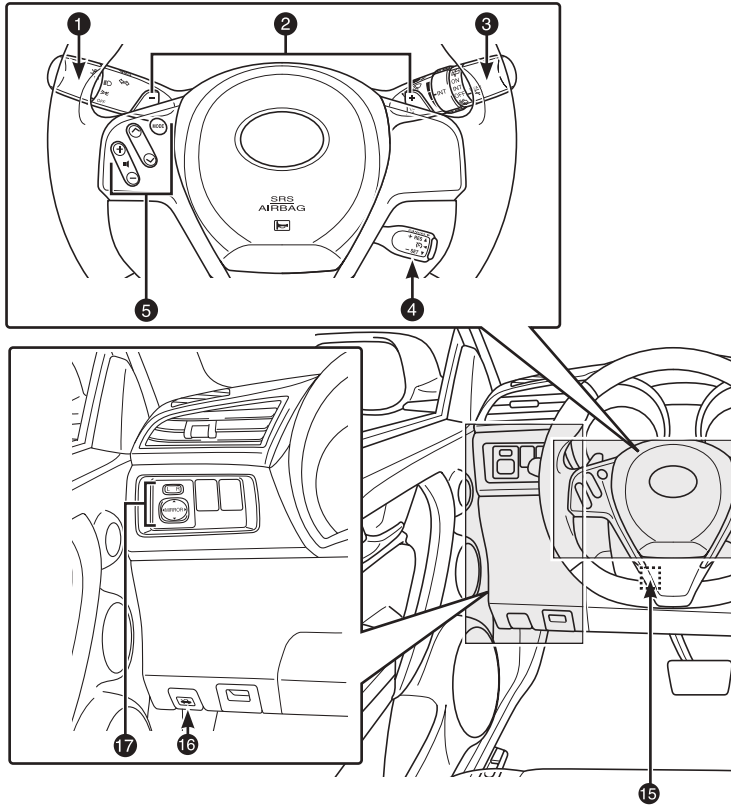

- ① Headlight and turn signal controls
- ② Paddle shift switches<sup>1</sup>
- ③ Wiper and washer controls
- ④ Cruise control<sup>1</sup>
- ⑤ Steering wheel audio controls<sup>2</sup>
- ⑥ Air Conditioning controls
- ⑦ Rear window defogger switch
- ⑧ Emergency flasher switch
- ⑨ Clock

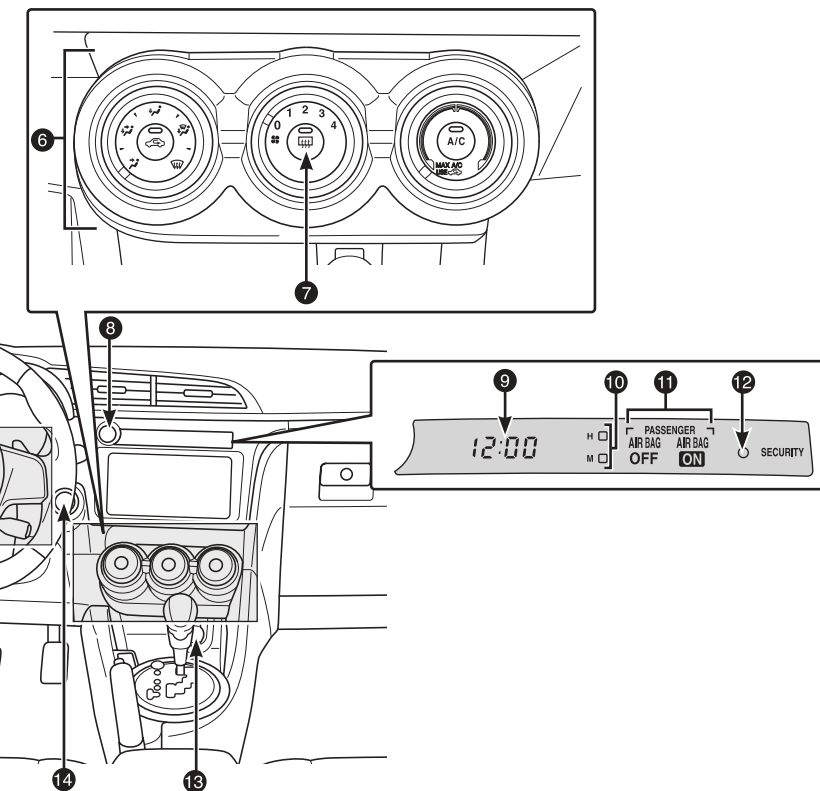

- 10 Clock adjustment buttons
- 11 Front passenger occupant classification indicator
- 12 Engine immobilizer system indicator
- 13 Power outlet
- 14 “ENGINE START STOP” button
- 15 Tilt and telescopic steering lock release
- 16 Hood release
- 17 Power outside rearview mirror controls

<sup>1</sup> If equipped

<sup>2</sup> For details, refer to [Scion.com](http://Scion.com) to download the *SCION Audio System Owner’s Manual* or *Scion Bespoke Audio with Navigation Owner’s Manual*.



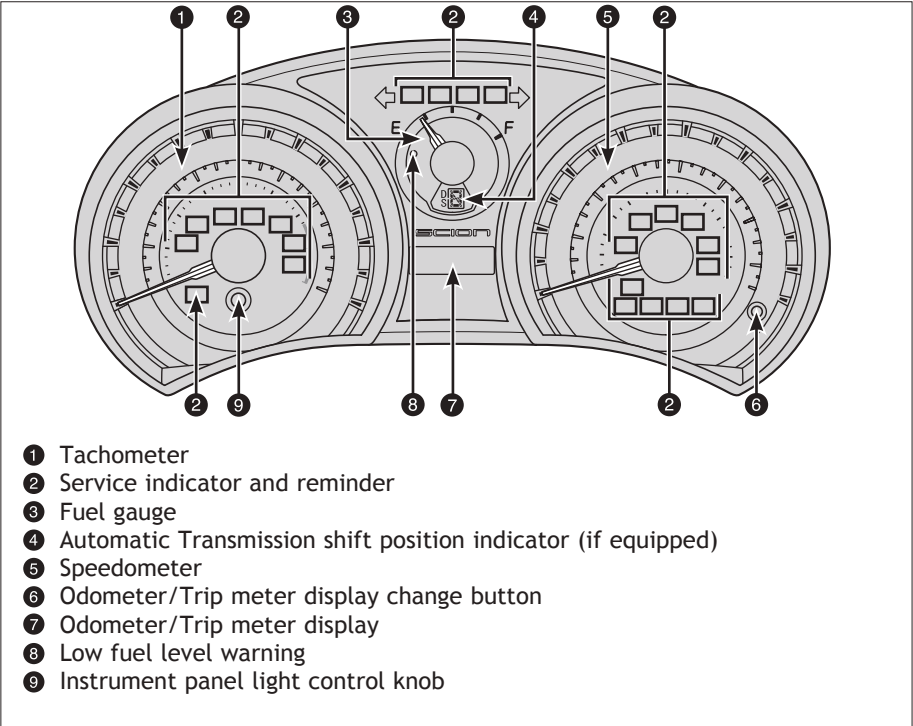



**Instrument cluster**





















- ❶ Tachometer
- ❷ Service indicator and reminder
- ❸ Fuel gauge
- ❹ Automatic Transmission shift position indicator (if equipped)
- ❺ Speedometer
- ❻ Odometer/Trip meter display change button
- ❼ Odometer/Trip meter display
- ❽ Low fuel level warning
- ❾ Instrument panel light control knob

**Indicator symbols**

For details, refer to “Indicators and warning lights,” Section 2-2, 2015 *Owner’s Manual*.

- BRAKE** Brake system warning<sup>1</sup>
-  Seat belt reminder  
(alarm will sound if speed is over 12 mph)
-  Charging system warning<sup>1</sup>
-  Malfunction/Check Engine indicator<sup>1</sup>
-  Low engine oil pressure warning<sup>1</sup>
-  Open door warning
-  PASSENGER AIR BAG OFF AIR BAG ON AIR BAG OFF indicator

	Airbag SRS warning <sup>1</sup>
	Low Tire Pressure Warning <sup>1</sup>
	Engine oil replacement reminder <sup>1</sup>
	Turn signal indicators
	Headlight low/high beam indicator
	Cruise control indicator <sup>2</sup>
	Cruise control “SET” indicator
	Anti-lock Brake System warning <sup>1</sup>
	High coolant temperature warning <sup>1</sup>
	Low engine coolant temperature indicator
	Electric power steering system warning <sup>1</sup>
	Slip indicator <sup>1</sup>
	Low fuel level warning
	Automatic Transmission fluid temperature warning <sup>1,3</sup>
	Vehicle Stability Control OFF indicator <sup>1</sup>
	ECO driving indicator <sup>1</sup>
	Engine immobilizer system indicator
	Traction Control OFF indicator <sup>1</sup>

<sup>1</sup> If indicator does not turn off within a few seconds of starting engine, there may be a malfunction. Have vehicle inspected by your Scion dealer.

<sup>2</sup> If this light flashes, refer to “Cruise control” Section 2-4, 2016 Owner’s Manual.

<sup>3</sup> Only available on Automatic Transmission equipped vehicle

# OVERVIEW

## Keyless entry

### Locking operation



Push 

### Unlocking operation





Push ONCE: Driver door  
TWICE: All doors 

**NOTE:** If a door is not opened within 60 seconds of unlocking, all doors will relock for safety.

### Panic button



Push and hold   

## Auto lock/unlock

Automatic door locks can be programmed to operate in four different modes, or turned OFF.

- Doors lock when shifting from Park (Automatic Transmission only).
- Doors lock when the vehicle speed goes above approximately 12 mph.
- Doors unlock when shifting into Park (Automatic Transmission only).
- Doors unlock when the ignition switch is set from “ON” to “ACC” or “LOCK” and driver’s door is opened.

See dealer for details for more details.



## Smart Key system

### Start function

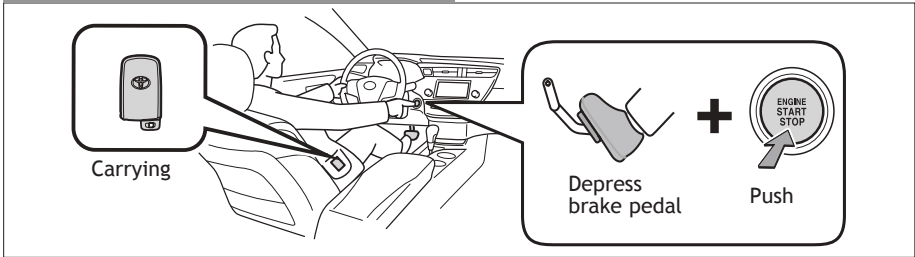

**NOTE:** Gear shift lever must be in Park and brake pedal depressed.

### Power (without starting engine)

Without depressing the brake pedal, pressing the “ENGINE START STOP” switch will change the operation mode in succession from:

#### ACCESSORY

Accessories such as the radio will operate.

#### ON

Power ON; the engine not running.

#### OFF

All systems OFF.

### Locking operation

#### Front door lock<sup>1</sup>

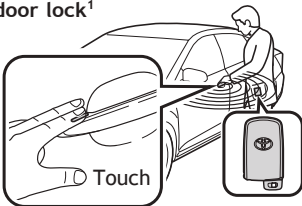

Carry remote to lock

### Unlocking operation

#### Front door unlock<sup>2</sup>

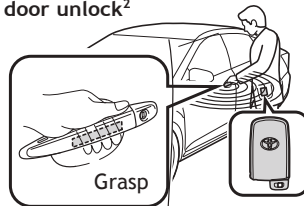

Carry remote to unlock

### Trunk unlock

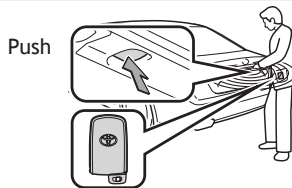

Carry remote to unlock

\* Driver door unlocking function can be programmed to unlock driver door only, or all doors. Grasping front passenger door handle will unlock all doors.

**NOTE:** Doors may also be locked/unlocked using remote.

## Engine maintenance

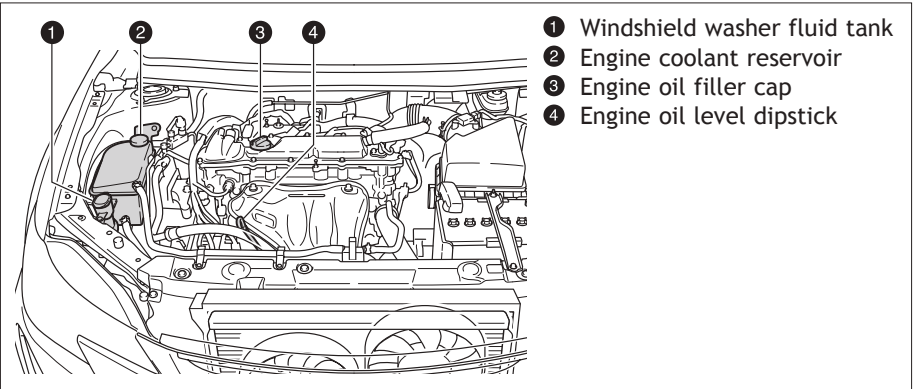

**NOTE:** Regularly scheduled maintenance, including oil changes, will help extend the life of your vehicle and maintain performance. Please refer to the “Warranty Maintenance Guide.”

## Fuel tank door opener and cap

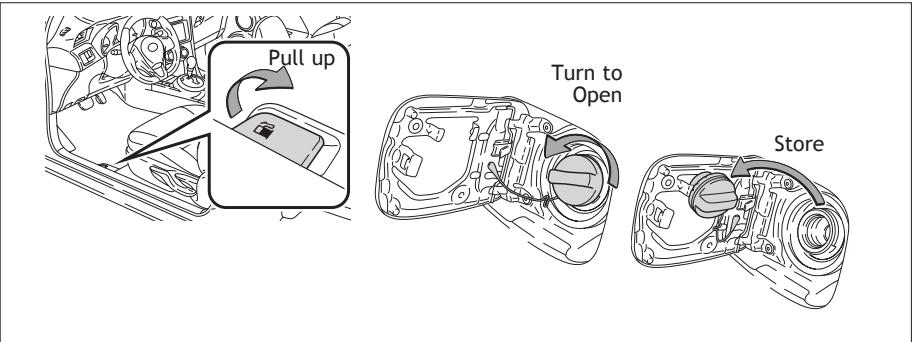

**NOTE:** Tighten cap until one click is heard. If the cap is not tightened enough, Check Engine “” indicator may illuminate.

## Hood release

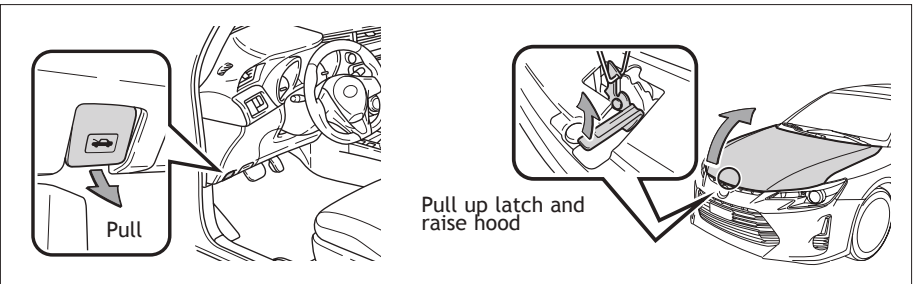

# FEATURES/OPERATIONS

## Automatic Transmission (if equipped)

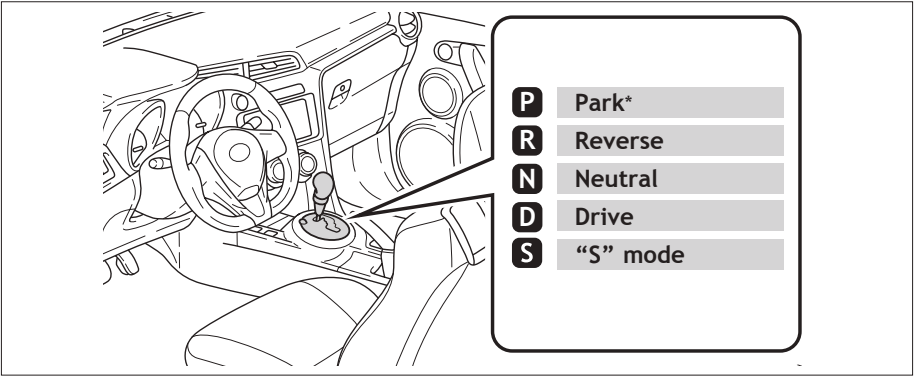

\* The ignition switch must be “ON” and the brake pedal depressed to shift from Park.

Downshifting increases power going uphill, or provides engine braking downhill. For best fuel economy during normal driving conditions, always drive with the shift lever in the “D” position.

## Manual Transmission (if equipped)

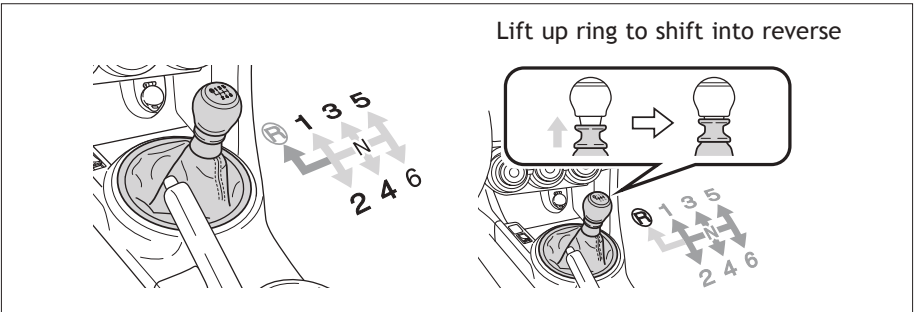

### Seat adjustments-Front

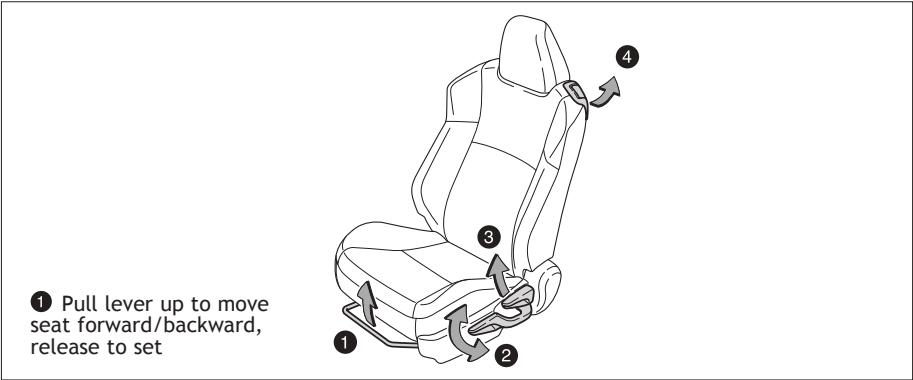

- 1 Seat position (forward/backward)
- 2 Height crank (driver side only)
- 3 Seatback angle
- 4 Seatback lock release

### Seat adjustments-Rear

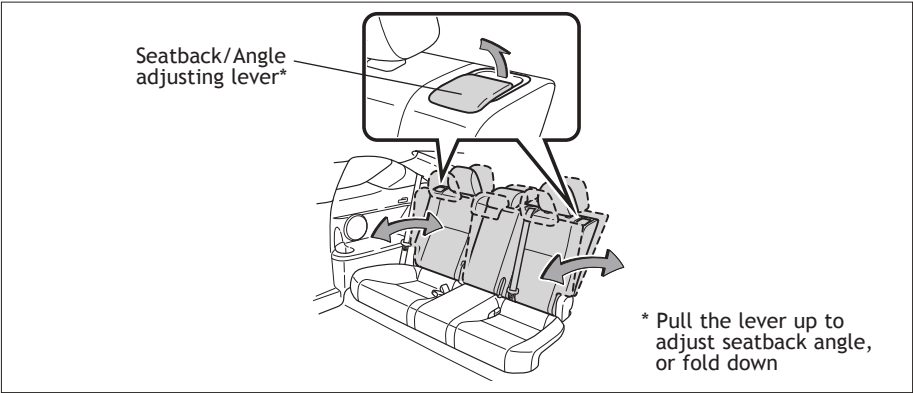

### Seats-Head restraints

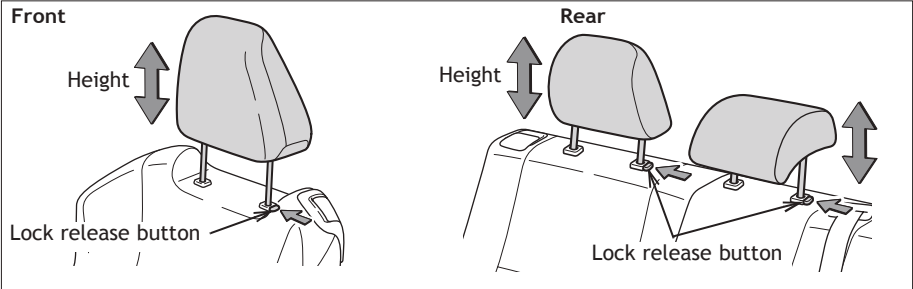

## Cruise control

### Turning system ON/OFF

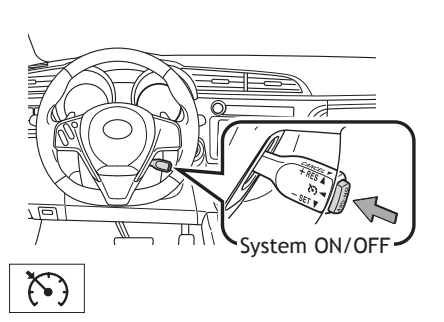

### Functions

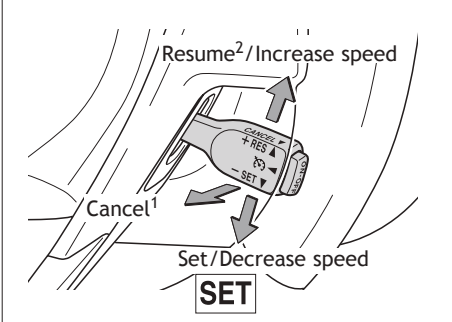

<sup>1</sup> The set speed may also be cancelled by depressing the brake pedal.

<sup>2</sup> The set speed may be resumed once vehicle speed reaches 25 mph.

## Lights & turn signals

### Headlights

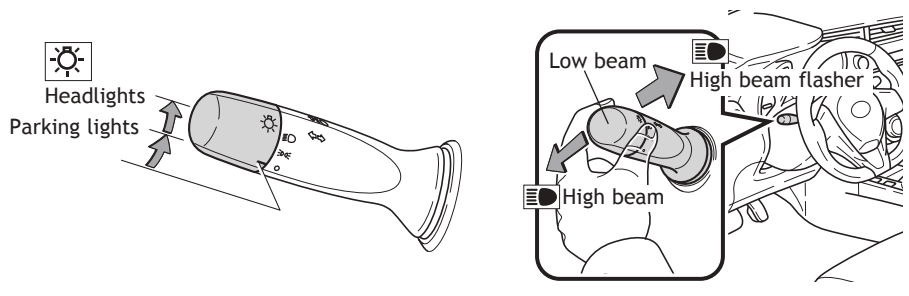

### Turn signals

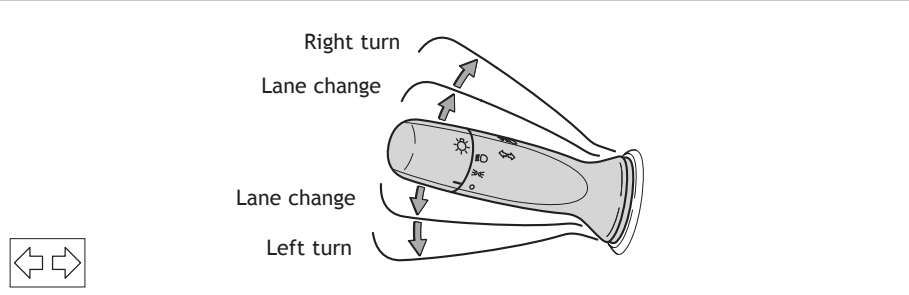

### Windshield wipers & washers

#### Front

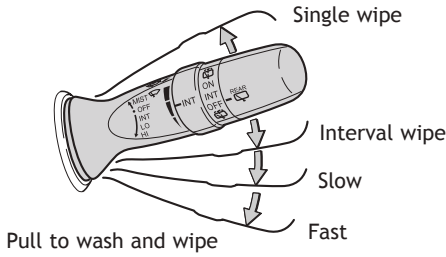

#### Intermittent windshield wiper frequency adjustment

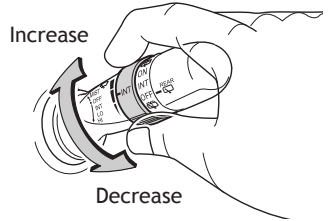

#### Rear

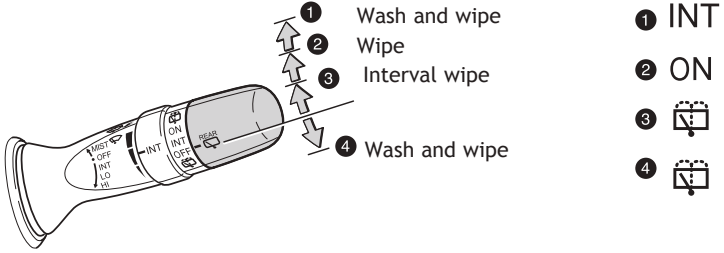

### Light control-Instrument panel

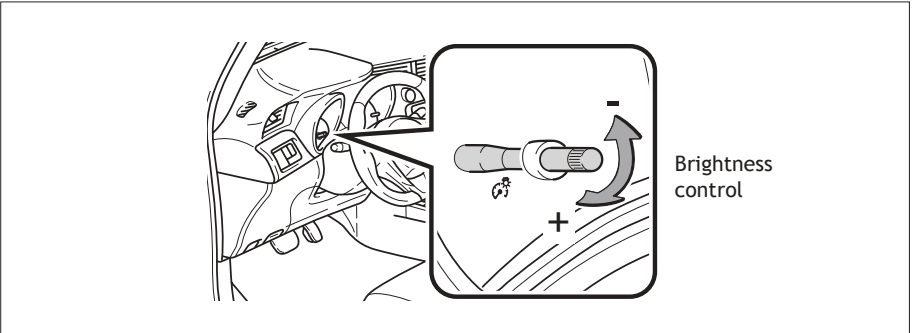

## Windows

Driver door window controls

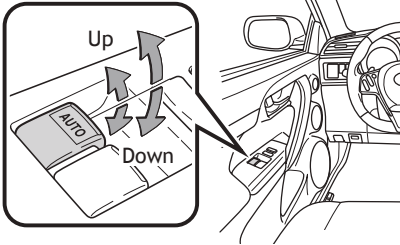

Window lock switch

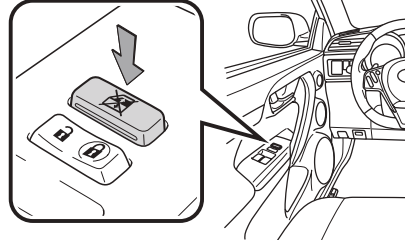

**Automatic operation (driver's window)** Push the switch completely down or pull it completely up and release to fully open or close. To stop the window partway, operate the switch in the opposite direction.

**Window lock switch** Deactivates all passenger windows. Driver's window remains operable.

## Tilt steering wheel

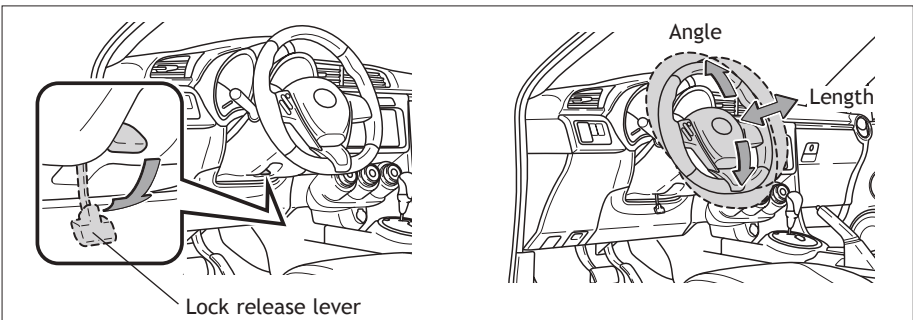

Lock release lever

Hold wheel, push lever down, set angle and length, and return lever.

**NOTE:** Do not attempt to adjust while the vehicle is in motion.

## Moonroof

**Opening operation**

Push once to tilt up; again to open

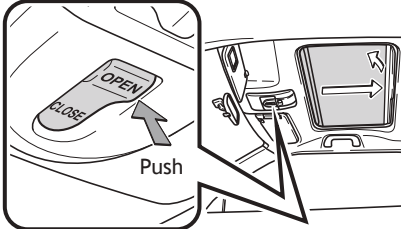

**Closing operation**

Push once to partially close; again to fully close

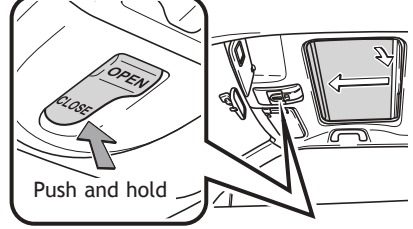

## Clock

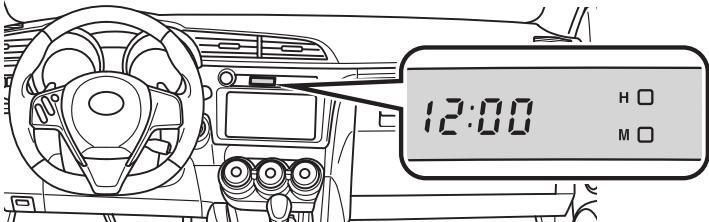

H  H-Hour set  
M  M-Minute set

## Bottle holders / Cup holders

**Bottle holders front**

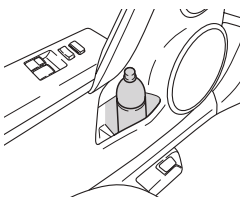

**Rear**

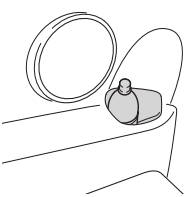

**Cup holder front**

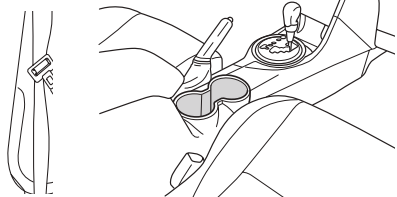



## Air Conditioning/Heating

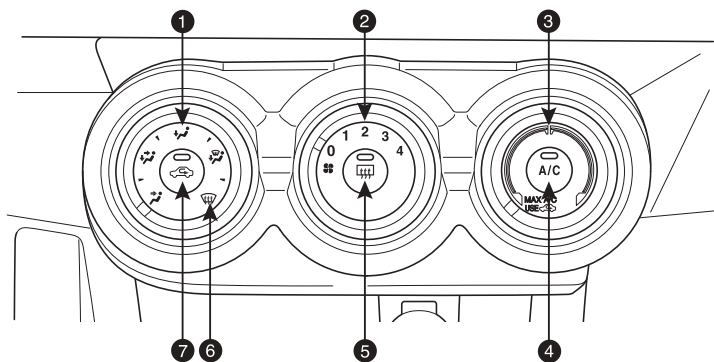

- ① Airflow vent  
“” mode uses outside air (“” indicator OFF) to reduce window fogging.
- ② Fan speed
- ③ Temperature selector
- ④ Air Conditioning ON/OFF
- ⑤ Rear window defogger
- ⑥ Windshield airflow
- ⑦ Recirculate cabin air (outside air when OFF)

## AUX port/USB port

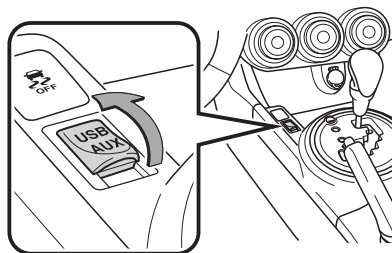

### AUX port

By inserting a mini plug (not included) into the AUX port, you can listen to music from a portable audio device through the vehicle's speaker system while in AUX mode.

### USB port

By connecting a USB memory or USB-compatible portable audio device to the USB port, you can listen to music from the portable audio device or USB memory through the vehicle's speaker system.

For details, refer to [Scion.com](http://Scion.com) to download the *SCION Audio System Owner's Manual* or *Scion Bespoke Audio with Navigation Owner's Manual*.

## Steering wheel switches

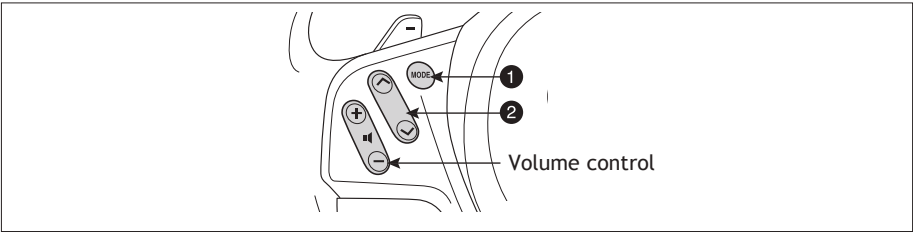

- 1 **“MODE”**  
Push to turn audio ON and select an audio mode. Push and hold to turn audio system OFF.
  - 2 **“ V A ”**  
Use to search within the selected audio medium (radio, strike CD, aha™, etc.).
- Refer to [Scion.com](http://Scion.com) to download the *SCION Audio System Owner’s Manual* or *Scion Bespoke Audio with Navigation Owner’s Manual*.

## Power outlet

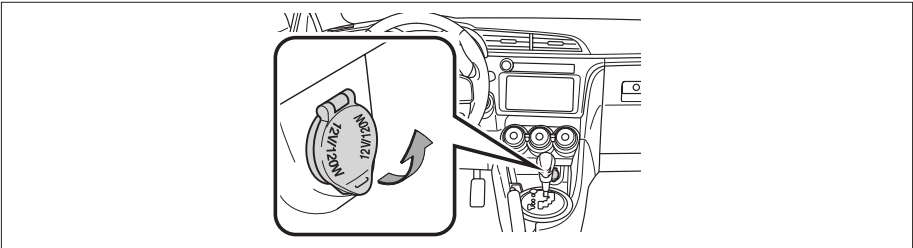

Designed for car accessories. Ignition switch must be in the “ACC” or “ON” position for use.

## Parking brake

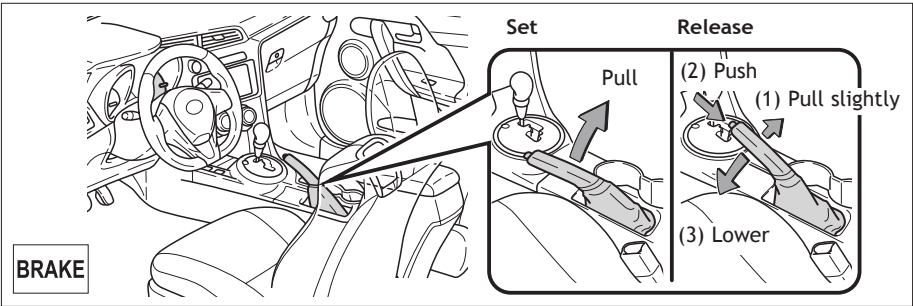

# SAFETY AND EMERGENCY FEATURES

## Door locks

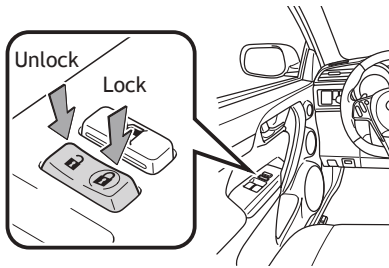

## Seat belts

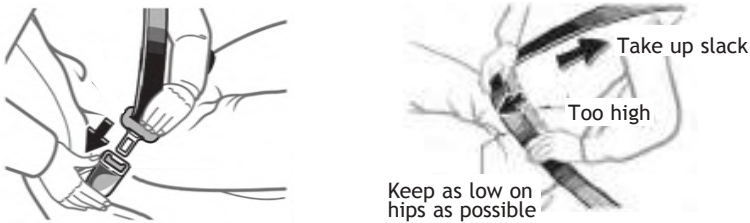

NOTE: If a passenger's seat belt is fully extended, then retracted even slightly, the Automatic locking retractor (ALR) will prevent it from being re-extended beyond that point, unless fully retracted again. This feature is used to help hold child restraint systems securely.

To find more information about seat belts, and how to install a child restraint system, refer to the *Owner's Manual*.

## Tire Pressure Monitoring (warning) System

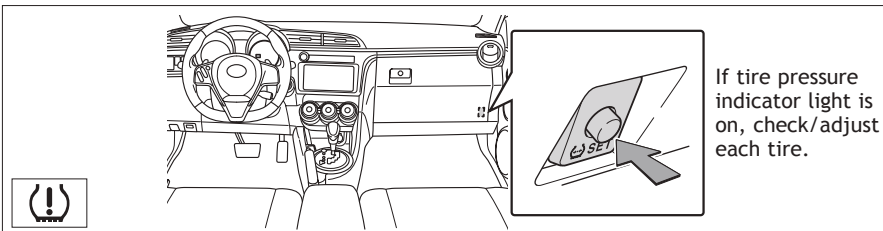

After adjusting tire pressures, or after tires have been rotated or replaced, turn the ignition switch to "ON" and press and hold the "SET" button until indicator blinks three times. Then allow the vehicle to sit for a few minutes to allow initialization to complete.

Refer to the load label on the door jamb or the *Owner's Manual* for tire inflation specifications.

If the tire pressure indicator flashes for more than 60 seconds and then remains on, take the vehicle to your local Scion dealer.

## Spare tire & tools

### Tool location

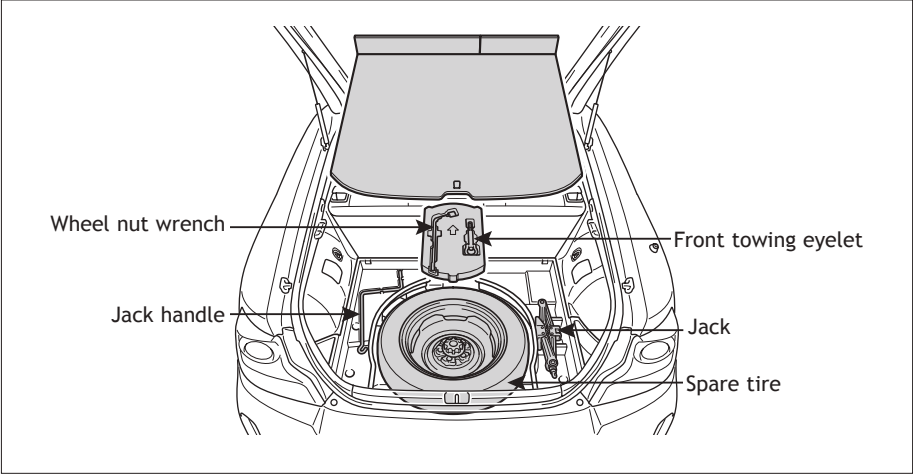

### Removing the spare tire

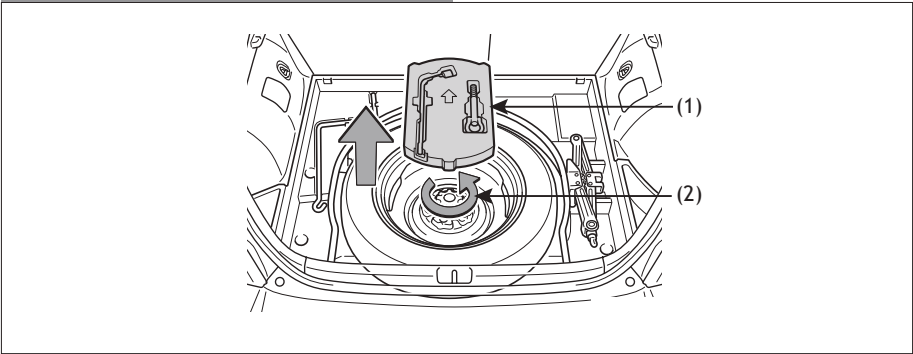

- (1) Remove the spare tire cover.
- (2) Loosen and remove the bolt.

Refer to the *Owner's Manual* for jack positioning and tire changing procedures.

## Star Safety System™

All new Scion vehicles come standard with the Star Safety System™, which combines Vehicle Stability Control (VSC), Traction Control (TRAC), Anti-lock Braking System (ABS), Electronic Brake-force Distribution (EBD), Brake Assist (BA) and Smart Stop Technology (SST).

### Vehicle Stability Control (VSC)

VSC helps prevent loss of traction during cornering by reducing engine power and applying brake force to selected wheels.

Toyota's VSC monitors steering angle and the direction your vehicle is traveling. When it senses that the front or rear wheels begin to lose traction, VSC reduces engine power and applies braking to selected wheels. This helps restore traction and vehicle control.

### Traction Control (TRAC)

VSC helps prevent loss of traction during cornering by reducing engine power, and Traction Control helps maintain traction on loose gravel and wet, icy, or uneven surfaces by applying brake force to the spinning wheel(s).

Toyota's TRAC sensors are activated when one of the drive wheels starts to slip. TRAC limits engine output and applies the brakes to the spinning wheel. This transfers power to the wheels that still have traction to help keep you on track.

### Brake Assist (BA)

Brake Assist is designed to detect sudden or "panic" braking, and then add braking pressure to help decrease the vehicle's stopping distance. When there's only a split second to react, Brake Assist can add additional brake pressure more quickly than just the driver alone can.

### Electronic Brake Force Distribution (EBD)

Toyota's ABS technology has Electronic Brake-force Distribution (EBD) to help maintain control and balance when braking. Abrupt stops can cause a vehicle to tilt forward, reducing the braking power of the rear wheels. EBD responds to sudden stops by redistributing brake force to enhance the braking effectiveness of all four wheels.

### Anti-Lock Brake System (ABS)

ABS helps prevent brakes from locking up by "pulsing" brake pressure to each wheel. This limits brake lockup and helps provide directional control for the current road conditions.

Toyota's ABS sensors detect which wheels are locking up and limits wheel lockup by "pulsing" each wheel's brakes independently. Pulsing releases brake pressure repeatedly for fractions of a second. This helps the tires attain the traction that current road conditions will allow, helping you to stay in directional control.

# SAFETY AND EMERGENCY FEATURES

## Smart Stop Technology (SST)

Smart Stop Technology automatically reduces engine power when the accelerator and brake pedals are pressed simultaneously under certain conditions.

SST engages when the accelerator is depressed first and the brakes are applied firmly for longer than one-half second at speeds greater than five miles per hour.

SST doesn't engage if the brake pedal is depressed before the accelerator pedal, allowing vehicles to start on a steep hill and safely accelerate without rolling backward.

## Floor mat installation

There are two types of Scion floor mats: carpeted and all-weather. Each vehicle has model-specific floor mats. Installation is easy.

To keep your floor mat properly positioned, follow these steps:

- Only use floor mats designed for your specific model.
- Use only one floor mat at a time, using the retaining hooks to keep the mat in place.
- Install floor mats right side up.

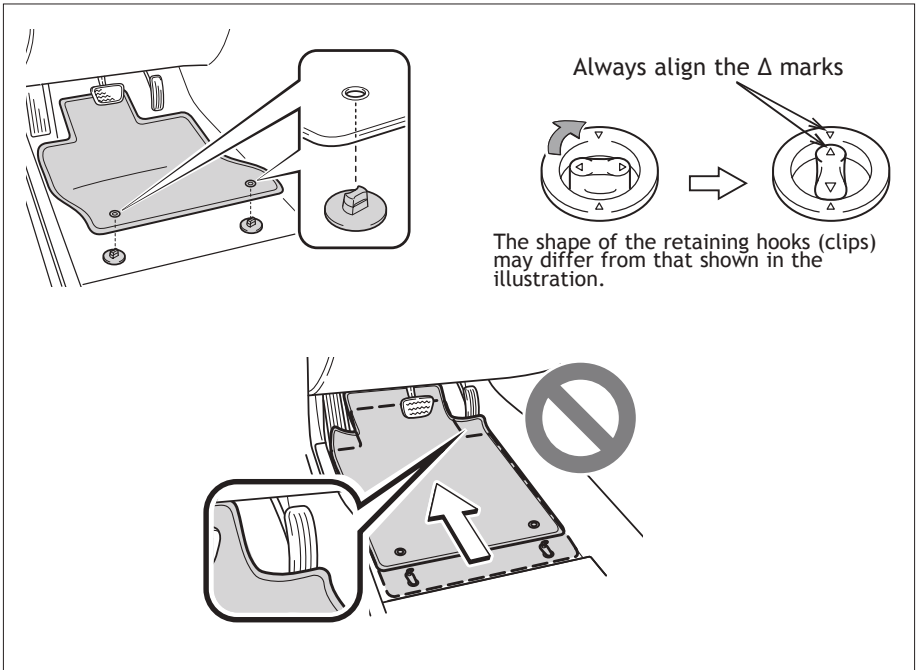



**WEBSITE**

WWW.SCION.COM

**PHONE**

1.866.70.SCION

**ADDRESS**

19001 S. WESTERN AVE.  
D102, P.O. BOX 2742  
TORRANCE, CA 90509-2742  
USA



©2015 Scion, a marque of Toyota Motor Sales, U.S.A., Inc.  
Printed in U.S.A. 7/15  
15-TCS-08748

00505-QRG16-TC