

VOLVO
XC90

VOLVO
for life

WEB EDITION



Volvo Service

Certain service measures, which affect the car's electrical system, can only be carried out using electronic equipment specially developed for your car. Always contact your Volvo workshop before beginning or carrying out service work which affects the electrical system.

Installing accessories

Incorrect connection and installation of accessories can negatively affect the car's electrical system. Certain accessories only function when the appropriate software has been programmed into the car's electrical system. Always contact your Volvo workshop before installing accessories which are connected to or affect the electrical system.

Recording vehicle data

One or several of the computers in your Volvo are capable of recording detailed information which may include specific – without being limited to – details regarding; frequency of seat belt use by the driver and passenger, information on various vehicle system/module functions and information regarding engine, throttle, steering, brakes and other system status.

This information may include details regarding the manner in which the driver operates the vehicle. This type of information can include specific – without being limited to – details regarding vehicle speed, use of the brakes, accelerator pedal or steering wheel position. This information can be stored while the car is being driven, during a collision or a near-collision.

The stored information may be read and used by:

- Volvo Car Corporation
- Service and repair facilities
- Police and other authorities
- Other interested parties who are entitled – or receive your permission for – access to this information.

Introduction



Contents

This Owner's Manual offers you advice and tips on how your car works and how it should be maintained. There is also important information regarding the safety of you and your passengers.

In addition to standard equipment, this manual also describes equipment that is optional or an accessory. Certain countries may have statutory requirements that affect the level of equipment.

The Owner's Manual is used as follows

Use this Owner's Manual to better acquaint yourself with the functions of the car and to look for specific information. The Owner's Manual will help you enjoy your new Volvo to the best possible extent.

The alphabetical index at the back of the manual can be used to search for words and corresponding page numbers, where you can read more information.

NOTE! Some models may be equipped differently depending on local or national regulations.

Thank you for choosing Volvo!

The specifications, design features and illustrations in this Owner's Manual are not binding. We reserve the right to make modifications without prior notice.

©Volvo Car Corporation

Contents

Safety	9
Instruments and controls	29
Climate control	53
Interior	67
Locks and alarm	87
Starting and driving	97
Wheels and tyres	121
Car care	129
Maintenance and service	135
Infotainment	159
Specifications	203
Alphabetical index	213

Dashboard

Left-hand drive

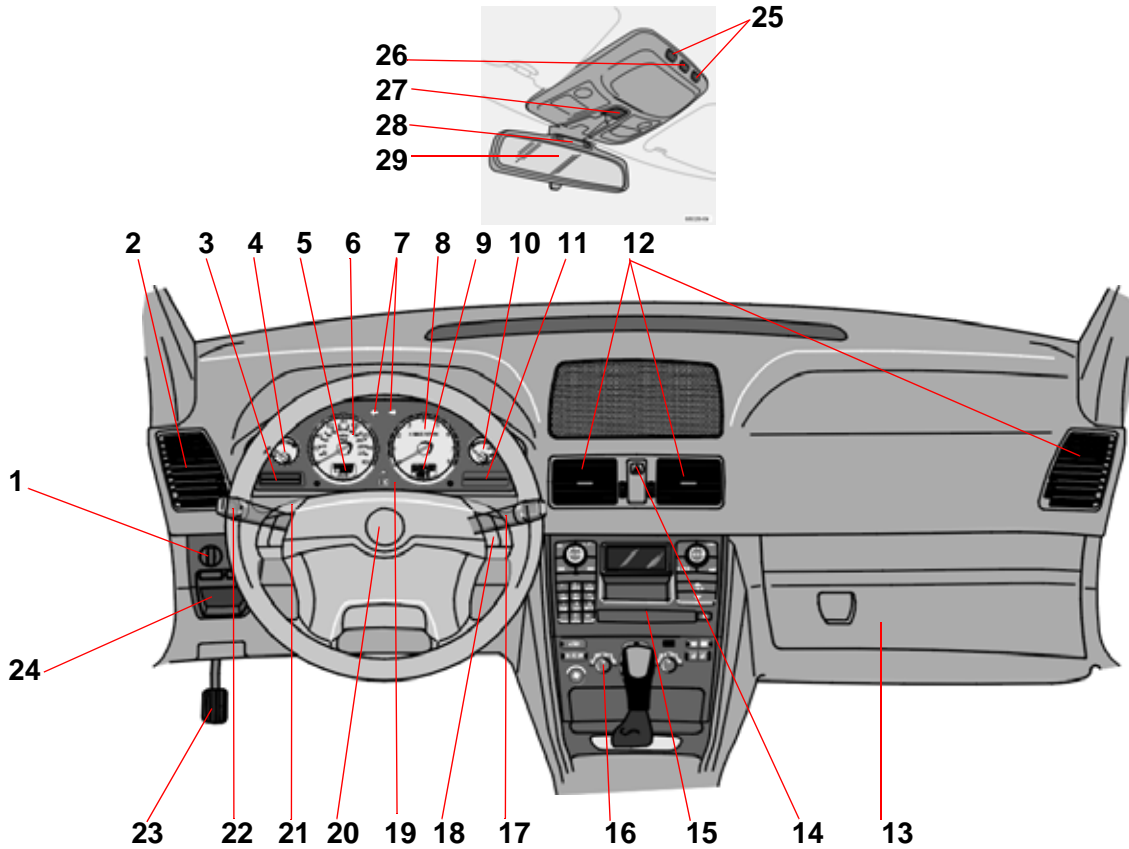

	<i>Page</i>		
1. Lighting panel	38	24. Parking brake release	45
2. Air vent	55	25. Reading lamp buttons	74
3. Display	35	26. Interior lighting	74
4. Temperature gauge	30	27. Sunroof control	50
5. Odometer/Trip odometer/ Cruise control	30	28. Seat belt reminder	33
6. Speedometer	30	29. Rearview mirror	49
7. Direction indicators	30	30. Lock button for all doors	90
8. Tachometer	30	31. Blocking power windows in the rear doors	47
9. Outside temperature/Clock/ Gear position	30	32. Power window controls	47
10. Fuel gauge	30	33. Door mirror control	49
11. Indicator and warning symbols	31		
12. Air vents	55		
13. Glovebox	77		
14. Hazard warning flashers	42		
15. Audio system	165		
16. Climate control	56, 60		
17. Windscreen wipers	40		
18. Telephone/Audio keypad	162		
19. Combined instrument panel	30		
20. Horn	4		
21. Cruise control	44		
22. Direction indicators/Beam selection/Read button	39, 35		
23. Parking brake	45		

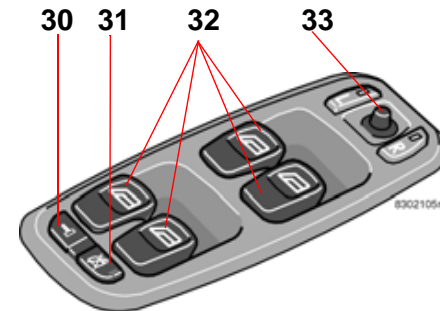

Control panel in the driver's door.

Right-hand drive

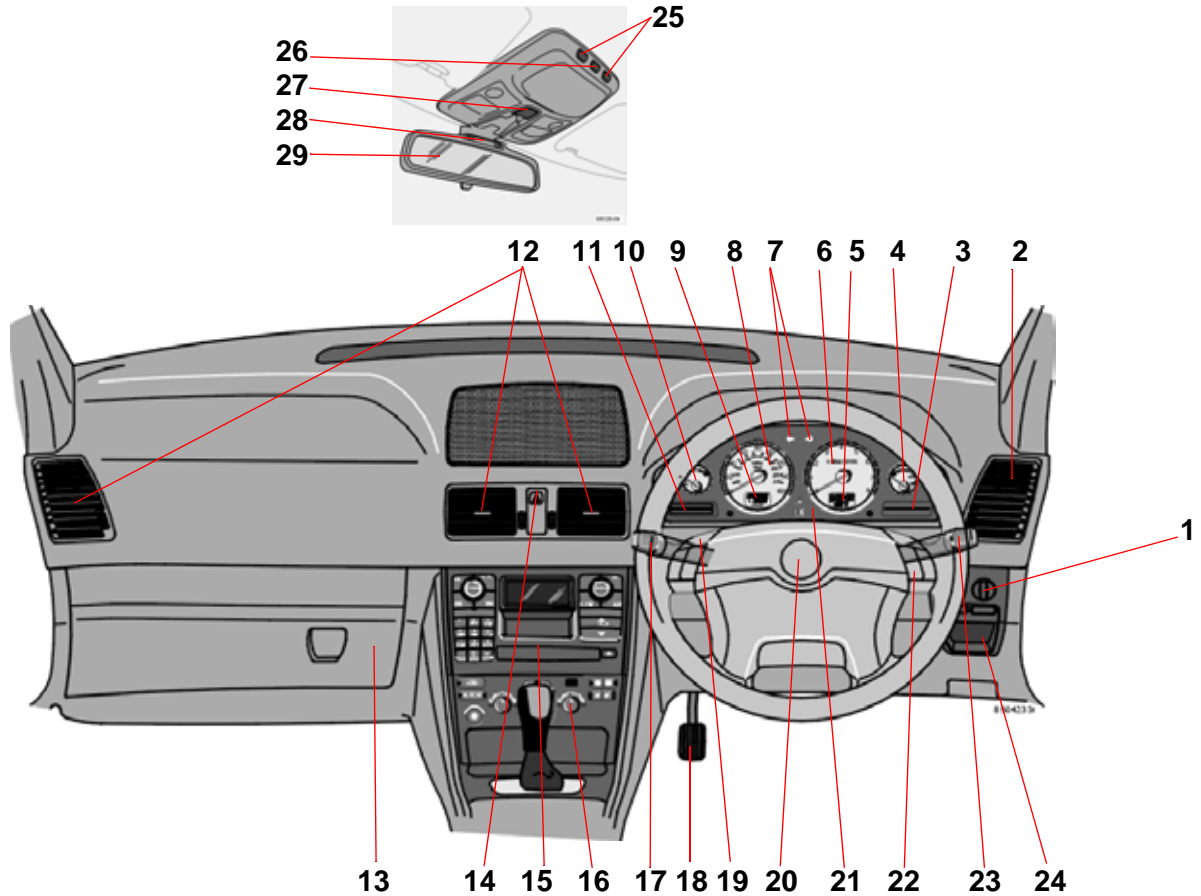

	<i>Page</i>		
1. Lighting panel	38	23. Windscreen wipers	40
2. Air vent	55	24. Parking brake release	45
3. Indicator and warning symbols	31	25. Reading lamp buttons	74
4. Fuel gauge	30	26. Interior lighting	74
5. Outside temperature/Clock/ Gear position	30	27. Sunroof control	50
6. Tachometer	30	28. Seat belt reminder	33
7. Direction indicators	30	29. Rearview mirror	49
8. Speedometer	30	30. Lock button for all doors	90
9. Odometer/Trip odometer/ Cruise control	30	31. Blocking power windows in the rear doors	47
10. Temperature gauge	30	32. Power window controls	47
11. Display	35	33. Door mirror control	49
12. Air vents	55		
13. Glovebox	77		
14. Hazard warning flashers	42		
15. Audio system	165		
16. Climate control	56, 60		
17. Direction indicators/Beam selection/Read button	39, 35		
18. Parking brake	45		
19. Cruise control	44		
20. Horn	6		
21. Combined instrument panel	30		
22. Telephone/Audio keypad	162		

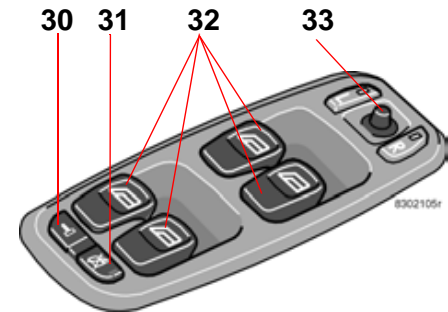

Control panel in the driver's door.

Safety

Seat belts	10
Airbags (SRS)	12
Side airbags (SIPS bag)	15
Roll-Over Protection System (ROPS)	17
Inflatable Curtain (IC)	18
WHIPS	19
When are the safety systems activated?	21
Inspection of airbags, inflatable curtains and seat belt tensioners	22
Child safety	23

Seat belts

Use your seat belt for all types of driving

Even hard braking can have dangerous consequences if you are not wearing a seat belt! Always ask your passengers to use seat belts! Otherwise, rear seat passengers may be thrown into the front seat backrests in a collision. Everyone in the car could then be hurt.

Use the seat belt as follows: pull the belt out slowly and secure it by inserting the locking tab into the lock. A loud "click" indicates that the belt is locked.

The belt is not normally restricted and you can move freely.

The belt is restricted and cannot be pulled out further...

- ...if it is pulled out too fast
- ...during braking and acceleration
- ...if the car leans excessively

It is important that the belt lies against the body so it can provide maximum protection. Do not lean the backrest too far back. The seat belt is designed to protect in a normal seating position.

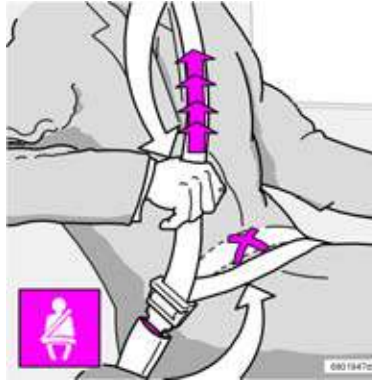

Extending the lap belt

Keep in mind the following:

- do not use clips or anything else that prevents the belt from lying correctly.
- ensure the belt is not twisted or caught on anything.
- the lap belt should sit low - not over the abdomen.
- stretch the lap belt over the lap by pulling the diagonal shoulder belt as illustrated above.

Each belt is intended for **one** person only!

To release the belt: Press the red button in the lock and allow the reel to pull the belt in. If it does not pull in the belt completely, feed the belt in manually so that it does not hang loose.

Seat belt reminder

The seat belt warning symbol in the combined instrument panel and above the rearview mirror flashes until the driver and front seat passenger put on their seat belts. The seat belt reminder switches off after 6 seconds if speed is lower than 10 km/h. If the driver or front seat passenger have not put on their seat belts, the reminder switches on if speed exceeds 10 km/h and switches off if speed drops below 5 km/h. If you take off your belt, the function reactivates when speed exceeds 10 km/h.

NOTE! The seat belt reminder is intended for an adult sitting in the front seat. If a belt-fitted child seat is fitted in the front seat, the seat belt reminder does not switch on.



Seat belts and seat belt tensioners

All seat belts are equipped with seat belt tensioners. A small mechanism, built into the seat belt reel, triggers at the moment of impact to tension the belt around the body and reduce slack from clothing, etc. The belt thus restrains the passenger more quickly.

Marking on seat belts with seat belt tensioners



Pregnant women

Pregnant women should be especially careful when using seat belts! Always remember to position the belt so that there is no unnecessary pressure on the womb. The lap belt of the three-point seat belt should be low.

WARNING!

If the seat belt has been subjected to large stresses, such as in a collision, the entire seat belt assembly including reel, mountings, bolts and lock must be replaced. Even if the belt appears undamaged, some of the protective properties may have been lost. Replace the seat belt if it is worn or damaged.

Never make any modifications or repairs to the seat belt yourself. Let an authorised Volvo workshop perform this work.

Airbags (SRS)

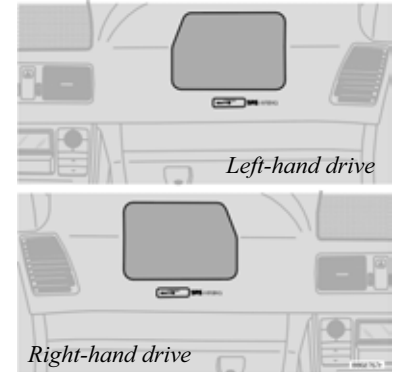
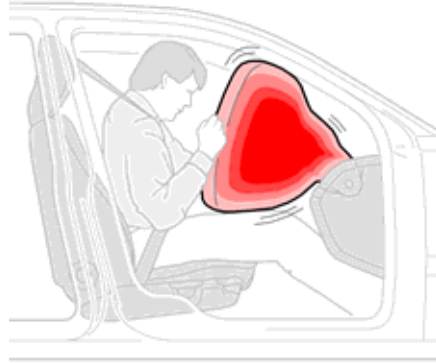

Location of front passenger airbag

Driver's airbag

To further increase interior safety, your car is equipped with an airbag (SRS¹) as a complement to the three-point seat belt. The inflatable airbag is installed folded up in the centre of the steering wheel. The wheel is marked SRS.

When the airbag is inflated, its volume is approx. 60 litres. The volume of the driver's airbag is less than that of the airbag on the passenger side.

Front passenger airbag

The airbag on the passenger side is folded up in a compartment above the glovebox. The panel is marked SRS. The volume of the inflated airbag is approximately 140 litres.

WARNING!

Do not attach clips or any other equipment to the dashboard or steering wheel!
This can result in injury and/or compromise the intended protection of the airbag when it is inflated.

WARNING!

Airbags (SRS) are designed to provide additional protection and do not replace seat belts. For maximum safety: **Always use a seat belt.**

1. Supplemental Restraint System (SRS)

WARNING!

Airbag – passenger side

- **Never** put a child seat or booster cushion in the front seat if the car is equipped with an airbag (SRS) on the passenger side.
- **Never** allow a child to stand or sit in front of the front passenger seat.
- **No one** shorter than 140 cm should sit in the front passenger seat.
- Passengers should sit as upright as possible with their feet on the floor and backs against the backrests. Seat belts should be secured.
- No objects or accessories may be positioned or stuck on or near the SRS panel (above the glovebox) or in the area affected by the airbag.
- Do not place loose objects on the floor, seat or dashboard.
- Never interfere with SRS components in the steering wheel hub or the panel above the glovebox.

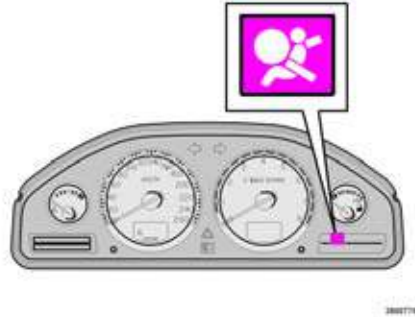

Warning lamp in the combined instrument panel

The sensor/control module continuously monitors the SRS system and there is a warning lamp in the combined instrument panel. This lamp lights when the ignition key is turned to position I, II or III. The lamp goes out when the sensor/control module has checked that the SRS system is fault-free. This normally takes about 7 seconds.

WARNING!

If the SRS warning lamp remains lit or lights while driving, it means that the SRS system is not functioning fully. Contact an authorised Volvo workshop.

Airbags (SRS) (Contd)

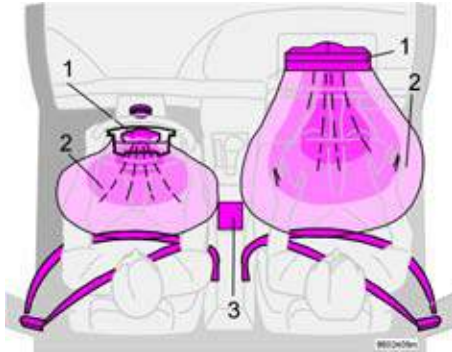

SRS system, left-hand drive

SRS System

The system consists of a gas generator (1) surrounded by the inflatable airbag (2). Upon a sufficiently violent collision, a sensor (3) reacts, activating the gas generator ignitor and the airbag inflates as it heats up. To cushion the impact, the airbag deflates when compressed. When this occurs, smoke escapes into the car. This is completely normal. The entire process, including inflation and deflation of the airbag, occurs in tenths of a second.

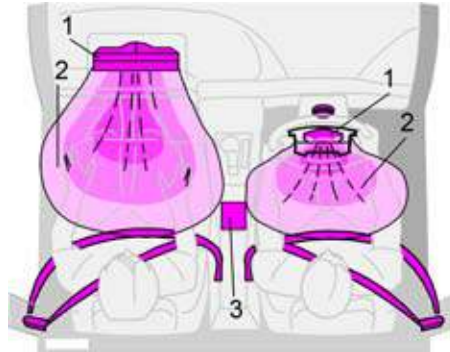

SRS system, right-hand drive

NOTE! The sensor (3) reacts differently depending on the severity of the collision and whether the driver or passenger side seat belts are in use. Crash situations may occur where only one airbag is deployed. Never buckle the front passenger seat belt into the driver's side belt buckle!

The SRS system senses the collision in the level of braking and speed reduction caused by the collision. The sensors determine if the collision is of the character and nature requiring airbag deployment to protect the occupants.

Volvo Dual-Stage Airbag

(Dual-stage airbags)

If a collision is mild but sufficiently violent that there is a risk of personal injury, the airbags are partially inflated. If the collision is more severe, the airbags are inflated fully.

WARNING!

Never try to repair any part of the SRS or SIPS bag systems yourself. Any interference in the system could cause malfunction and serious injury. Any work should only be performed by an authorised Volvo workshop.

Side airbags (SIPS bag)

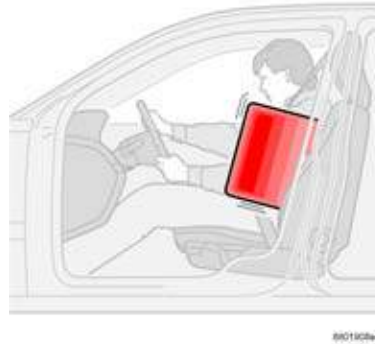

Inflated SIPS airbag

Side airbags – SIPS bags

Side airbags further increase interior safety.

The SIPS airbag system consists of two main components: side airbags and sensors. The side airbags are installed in the frames of the front seat backrests and the sensors are located in the insides of the centre pillars. The volume of an inflated side airbag is about 12 litres.

WARNING!

Side airbags (SIPS bags) are an addition to the existing SIPS system (Side Impact Protection System). For maximum protection: **Always use a seat belt.**

Child seat and SIPS airbag

If the car is only equipped with SIPS airbags and does not have a front airbag (SRS) on the passenger side, child seats/booster cushions can be located in the front seat.

WARNING!

SIPS airbag

- Never interfere with the SIPS airbag system.
- Extra seat covers must not be used on the front seats if they are not Volvo Genuine covers or Volvo approved seat covers for SIPS airbags.
- No objects or accessories may be placed between the outer side of the seat and the door panel because this area may be affected by the SIPS airbag.

Side airbags (SIPS bag) (Contd)

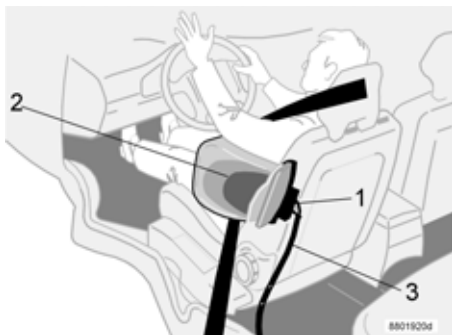

Left-hand drive

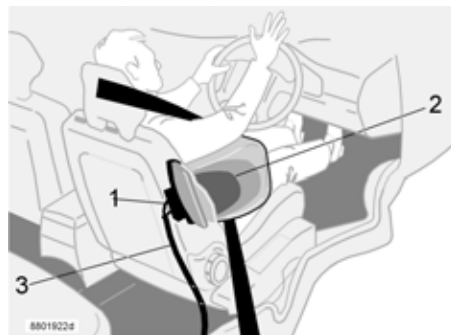

Right-hand drive

The SIPS airbag system

The SIPS bag system consists of a gas generator (1), electronic sensors, cables (3) and the side airbags (2). Upon a sufficiently violent collision, the sensors react, activating the gas generator, which inflates the side airbag. The airbag inflates between the occupant and the door panel, cushioning the impact at the moment of collision, and then deflates. Normally, only the side airbag on the side of the collision inflates.

Roll-Over Protection System (ROPS)

Volvo's Roll-Over Protection System has been designed to reduce the risk of the car overturning and to provide the best possible protection in the event of an accident.

The system consists of:

- A stabiliser system, RSC (Roll Stability Control) that minimises the risk of overturning during sudden evasive manoeuvres or the like or if the car skids.
- Increased protection for the driver and passengers through a reinforced body, inflatable curtains and seat belt tensioners in all seats. See page 11 and page 18.

The RSC system uses a gyro sensor which registers changes in the car's lateral inclination angle. This information is then used to calculate the risk for overturning. If a risk is detected, the DSTC system is engaged, engine speed is reduced and one or more wheels are braked until the car returns to a stable position.

For more information on the DSTC system, see page 34 and page 108.



WARNING!

Under normal driving conditions, the RSC system improves the car's road safety, but this should not be taken as a reason to increase speed. Always follow the usual precautions for safe driving.

Inflatable Curtain (IC)

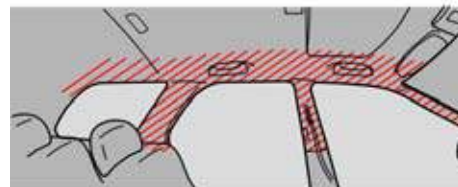
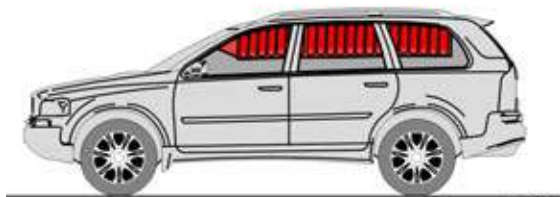

Inflatable Curtain (IC)

(Inflatable Curtain)

The inflatable curtain reduces the risk of head injuries by preventing the head from hitting the inside of the car and protecting against objects with which the car collides, such as another vehicle or a pole. The inflatable curtain protects those travelling in both the front and outer rear seats. It also prevents passengers from being completely or partially thrown from the car in the event of an accident. The inflatable curtain is concealed in the headlining and covers the upper part of the car interior at the front and rear seats.

The inflatable curtain may be activated when the car is hit from the side, overturns or rolls. The curtain then fills with gas from the gas generator, which is located in the rear of the curtain.

WARNING!

The Inflatable Curtain (IC) is designed to provide additional protection, not as a seat belt replacement. For maximum safety: **Always use seat belts** . Keep in mind that the Inflatable Curtain protects the occupant's head from side impact – not impacts occurring from above.

In Volvo XC90, the inflatable curtains have been further developed to protect occupants in the event of overturning. The curtain also covers those travelling in the third row of seats in the variant that seats seven.

WARNING!

- Do not screw or mount anything to the headlining, door pillars or side panels. The intended protection may be compromised. Only Volvo Genuine parts that are approved for placement in these areas should be used.
- If the rear seat backrests are lowered, do not load higher than the bottom edge of the side windows. Leave 10 cm free space from the window inwards. Otherwise, the intended protection of the inflatable curtain hidden in the headlining may be compromised.

WHIPS

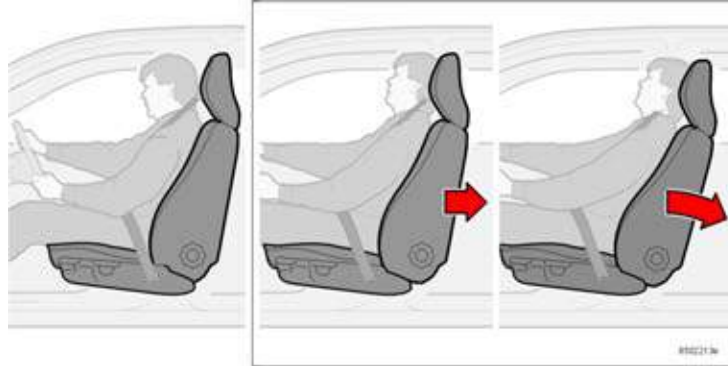

Whiplash Protection System

This system consists of energy absorbing backrests and specially developed head restraints in both front seats.

WHIPS seat

WHIPS is activated upon a collision from behind based on the collision angle, speed and nature of the colliding vehicle. Upon activation, the backrests of the front seats, if occupied, move backward and the seating position of the occupants in the front seats is altered. This diminishes the risk of whiplash injury.

Correct seating position

For the best possible protection, you and your front seat passenger should sit in the centre of your seats with as little distance as possible between the head restraints and your heads.

WARNING!

WHIPS is designed to provide additional protection and does not replace seat belts. For maximum safety: **Always use a seat belt.**

WHIPS and child seat

The WHIPS system does not negatively affect the protective properties of the car with regard to child seats. As long as there is no airbag (SRS) on the passenger side, a Volvo child seat may be located in the front passenger seat. The WHIPS system still functions if a rear-facing child seat is placed on the rear seat and supported against the front seat backrest.

WHIPS (Contd)

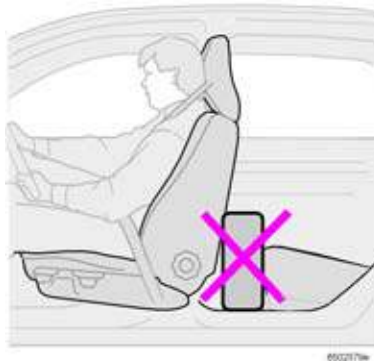
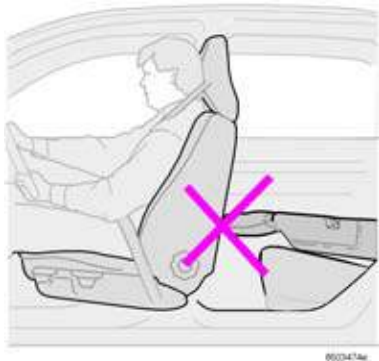

WARNING!

Be sure to never hinder the function of the WHIPS system!

- If a rear backrest is folded down, the corresponding front seat must be adjusted so that it is not in contact with the folded backrest.
- Avoid placing boxes or similar cargo so that it is clamped between the seat cushion of the rear seat and the backrest of the front seat.

WARNING!

If the seat has been exposed to a heavy load strain, such as in a rear-end collision, the WHIPS system should be inspected by an authorised Volvo workshop. Even if the seat does not appear damaged, the WHIPS system may have deployed without causing visible damage to the seat. The protective capacity of the WHIPS system may be impaired. Have the system checked at an authorised Volvo workshop even after minor rear-end collisions. Never modify or repair the seat or WHIPS system yourself!

When are the safety systems activated?

System

Triggered

Seat belt tensioner	In the event of a head-on collision or overturning. The belt is tensioned around the body to reduce slack from clothing, etc. The belt thus restrains the passenger more quickly.
Airbags (SRS)	In collisions if there is a risk that front seat passengers could be injured by hitting the dashboard or steering wheel.
Side airbags	In side-on collisions if the car is hit with sufficient force.
Inflatable Curtain (IC)	In side-on collisions or if the car overturns. The curtain reduces the risk of head injuries.
WHIPS	When hit from behind. Reduces the risk of neck injuries, i.e. whiplash.
RSC	During sudden evasive manoeuvres or the like or if the car skids. Reduces the risk of overturning.

WARNING!

The SRS system sensor is located in the centre console. If the floor of the passenger compartment has been drenched with water, disconnect the battery cables in the cargo compartment. Do not try to start the car; the airbags may deploy. Have the car towed to an authorised Volvo workshop.

WARNING!

Never drive with deployed airbags! This may make the car difficult to steer. Other safety systems may also be damaged. Intense exposure to the smoke and dust released when the air bags are deployed can cause skin and eye irritation. In case of problems, wash with cold water and contact a doctor. The speed of the deployment and the airbag fabric may cause friction burns on the skin.

NOTE! The SRS, SIPS and IC systems are only deployed once in a collision. If the airbags have been deployed, we recommend the following:

- Tow the car to a Volvo workshop. Do not drive the car with the airbags deployed even if the car can be driven after an accident.
- Let an authorised Volvo workshop replace components in the SRS, SIPS, and IC systems.

The bodywork of the car could be greatly deformed in a collision without airbag deployment. This does not indicate a fault in the airbags. This means that the function was not needed at that moment and the occupants were protected by the other safety systems of the car.

Inspection of airbags, inflatable curtains and seat belt tensioners

The year and month specified on the decal in the door pillar(s) is the date you should contact your Volvo workshop to inspect, and if necessary, replace the airbags and seat belt tensioners. If you have any questions concerning either system, contact an authorised Volvo workshop.

This decal is located in the rear left door opening.

Date for inspection of:

Driver's airbag

Front passenger airbag

Side airbag on the driver's side

Side airbag on the passenger side

Inflatable curtain on the driver's side

Inflatable curtain on the passenger side



Child safety

Children should sit comfortably and safely

Remember that children, regardless of age or size, should always be securely strapped into the car. Never allow a child to sit on the knee of a passenger!

The weight and height of the child must be taken into consideration when selecting equipment and its location. See page 24.

Volvo's own child safety equipment is designed for your car. If you select Volvo equipment, you can be sure that the mounting points and attachments are correctly positioned and sufficiently strong.

Children up to 3 years of age sit safest in a rear-facing child seat.

NOTE! Many countries have regulations regarding where children should be located in the car. Find out what laws apply in the countries you will be visiting.

WARNING!

Never put a child seat/booster cushion in the front seat if the car is equipped with SRS (airbag) on the passenger side.

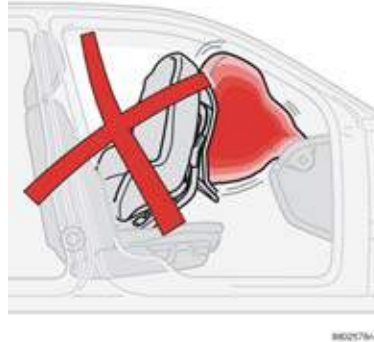

Airbags and child seats are not compatible!

Child seat and airbag

If the car has a passenger airbag, the child seat must be placed in the rear seat.

If seated in a child seat in front of a passenger airbag and the airbag inflates, the child could be seriously injured.

Passengers shorter than 140 cm must **never** sit in the front passenger seat if the car has a passenger airbag.

Child seat and seat belt reminder

If a rear-facing infant or child seat is placed in the front seat and secured using the seat belt, the seat belt reminder might not be activated.

Always check that the belt is locked before driving off!

Child safety (Contd)

Position of child in car

Weight/age	Front seat with passenger airbag*	Front seat without passenger airbag (option)
<10 kg (0 –9 months)	Not suitable for this age group.	<p>Alternatives:</p> <ul style="list-style-type: none"> • Rear-facing child seat, secured with seatbelt and mounting strap. <i>Type approval: E503135¹</i> • Rear-facing infant seat, secured with seatbelt. <i>Type approval: E5 03160¹</i> • Rear-facing infant seat, secured in Isofix attachment. <i>Type approval: E5 03162¹</i>
9–18 kg (9 –36 months)	Not suitable for this age group.	<p>Alternatives:</p> <ul style="list-style-type: none"> • Rear-facing child seat, secured with seatbelt and mounting strap. <i>Type approval: E5 03135¹</i> • Rear-facing child seat, secured with seatbelt. <i>Type approval: E5 03161¹</i> • Rear-facing child seat, secured in Isofix attachment. <i>Type approval: E5 03163¹</i>
15 –36 kg (3 –12 years)	Not suitable for this age group.	<ul style="list-style-type: none"> • Booster cushion with or without backrest. <i>Type approval: E5 03139</i>



WARNING!

* NEVER place a child seat or booster cushion in the front seat of a car equipped with a passenger airbag.

1. Suitable for certain child seats as listed in the specified type approval. Child seats may be vehicle-specific, limited, semi-universal or universal.

Weight/age	Second row of seats, outer seats*	Second row of seats, centre seat*	Third row of seats in cars seating seven.
<10 kg (0 –9 months)	<p>Alternatives:</p> <ul style="list-style-type: none"> • Rear-facing child seat, secured with seatbelt, support and mounting strap. <i>Type approval: E5 03135¹</i> • Rear-facing infant seat, secured with seatbelt and support. <i>Type approval: E5 03160¹</i> • Rear-facing infant seat, secured with Isofix attachment and support. <i>Type approval: E5 03162¹</i> 	<ul style="list-style-type: none"> • Rear-facing child seat, secured with seatbelt, support and mounting strap. <i>Type approval: E5 03135¹</i> 	Not suitable for this age group.
9–18 kg (9 –36 months)	<p>Alternatives:</p> <ul style="list-style-type: none"> • Rear-facing child seat, secured with seatbelt, support and mounting strap. <i>Type approval: E5 03135¹</i> • Rear-facing child seat, secured with seatbelt and support. <i>Type approval: E5 03161¹</i> • Rear-facing child seat, secured with Isofix attachment and support. <i>Type approval: E5 03163¹</i> 	<ul style="list-style-type: none"> • Rear-facing child seat, secured with seatbelt, support and mounting strap. <i>Type approval: E5 03135¹</i> 	Not suitable for this age group.
15 –36 kg (3 –12 years)	<ul style="list-style-type: none"> • Booster cushion with or without backrest. <i>Type approval: E5 03139¹</i> 	<p>Alternatives:</p> <ul style="list-style-type: none"> • Booster cushion with or without backrest. <i>Type approval: E5 03139¹</i> • Integrated booster cushion. <i>Type approval: E5 03167²</i> 	<ul style="list-style-type: none"> • Booster cushion with or without backrest. <i>Type approval: E5 03139¹</i>

1. Suitable for certain child seats as listed in the specified type approval. Child seats may be vehicle-specific, limited, semi-universal or universal.
2. Integrated and approved child safety equipment for this age group.

*In cars seating seven, the seat row must be in its rearmost position when using a child seat.



WARNING!

NEVER place a child seat or booster cushion in the front seat of a car equipped with a passenger airbag.

Child safety (Contd)

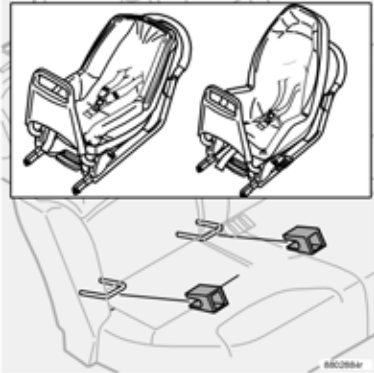

Isofix mountings and Isofix guide

Isofix mounting system for child seats

The outer rear seats (second row of seats) are factory fitted with Isofix mountings. Contact your Volvo dealer for further information on child safety equipment.

Isofix mountings are located in both outer rear seats. The Isofix guide can be moved from one side to the other as needed.



Integrated centre seat booster cushion (option for cars seating five, standard for cars seating seven)

Volvo's integrated booster cushion is specially designed to provide optimum safety and comfort for children. When used with the regular seat belt, the booster cushion is approved for children weighing between 15 and 36 kg.

Check that...

- the seat belt is locked
- the head restraint position is carefully adjusted for the child's head
- the belt is in contact with the child's body and is not slack or twisted
- the belt lies correctly over the shoulder and not below it
- the lap belt is low over the pelvis for optimum protection.

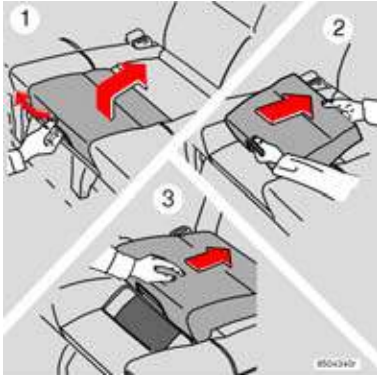

Raising the booster cushion

1. Pull that handle to raise the booster cushion.
2. Grasp the cushion with both hands and move it rearwards.
3. Move the seat belt buckle aside; press the cushion until it locks in place.

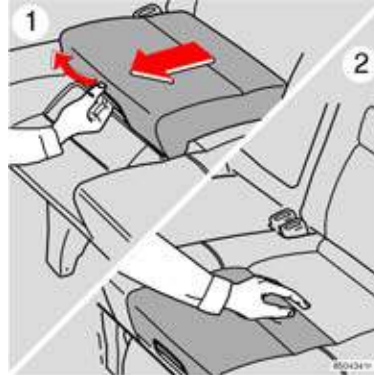

Lowering the booster cushion

1. Pull the handle.
2. Move the seat down and press until it locks.

Remember to first stow the booster cushion if you wish to lower the seat's backrest.

WARNING!

If an integrated booster cushion has been subjected to great stress, such as in a collision, the entire booster cushion, including the seat belt and bolts, must be replaced. Even if the integrated booster cushion appears undamaged, it may not afford the same level of protection.

The booster cushion should also be replaced if it is worn or damaged. Note, however, that the cushion should only be replaced by a professional as it is vital for passenger safety that the booster cushion is correctly installed. Therefore, replacement and any repairs to the cushion should be referred to an authorised Volvo workshop. If the cushion becomes dirty, try to clean it in situ. If the upholstery is so dirty that it needs to be washed separately, the instructions provided above for replacing and installing the cushion should be followed.

Do not modify or adapt the booster cushion in any way.

Child safety (Contd)

Important tips!

When using other child safety products that are available on the market, it is **important** to read the installation instructions that accompany the product and follow them carefully. Here are some points you should consider:

- Volvo has child safety products that are designed for and tested by Volvo.
- The child seat must always be placed according to the manufacturer's directions. See the child seat instruction manual for further installation instructions.
- Do not attach the child seat straps to the horizontal adjustment bar, springs or any of the rails and struts under the seat that may have sharp edges.
- Allow the backrest of the child seat to rest against the dashboard (Applies to cars **without** an airbag (SRS) on the passenger side).
- Never place a child seat in the front seat if the car is equipped with an airbag (SRS) on the passenger side.

NOTE! If there are any problems with installation of child safety products, contact the manufacturer for clearer installation instructions.



WARNING!

Support cushions/child seats with steel frames or another design that can lie against the seatbelt release button must not be used because they can cause accidental release of the seatbelt. Do not allow the top of the child seat to rest against the windscreen.

Instruments and controls

Combined instrument panel	30
Indicator and warning symbols	31
Switches in the centre console	36
Lighting panel	38
Direction indicator lever	39
Windscreen wipers/washer	40
Hazard warning flashers, rear window and door mirror defrosters, heated front seats	42
Trip computer	43
Cruise control	44
Parking brake, bonnet, electric socket, etc.	45
Power windows	47
Rearview mirror/door mirrors	49
Power sunroof (option)	50

Combined instrument panel

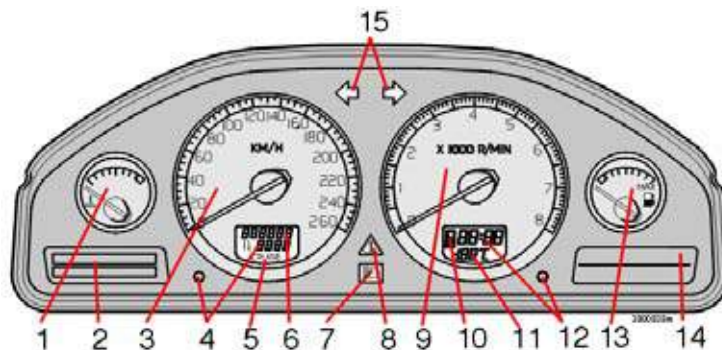

1. Temperature gauge

Displays the temperature of the engine cooling system. If the temperature is abnormally high and the needle enters the red zone, a message is shown in the display. Bear in mind that extra lamps in front of the air intake reduce the cooling capacity at high outside temperature and high engine loads.

2. Display

The display shows information and warning messages.

3. Speedometer

Shows the speed of the car.

4. Trip odometers, T1 and T2

The trip odometers are used for measuring short distances. The right-hand digit displays tenths of a kilometre. Press the button for more than 2 seconds to reset. Change between trip odometers by briefly pressing the button once.

5. Cruise control indicator

See page 44.

6. Odometer

The odometer indicates the total distance the car has travelled.

7. Main beam on/off

8. Warning symbol

If a fault arises, the symbol lights up and a message is shown in the display.

9. Tachometer

Indicates engine speed in thousands of revolutions per minute (RPM). Do not allow the needle of the tachometer to enter the red field.

10. Automatic gearbox indicator

The selected gearshift programme is displayed here.

11. Outside temperature gauge

Displays outside temperature. When the temperature lies between +2°C and -5°C, a snowflake symbol is shown in the display. This symbol serves as a warning for slippery road surfaces.

When the car is or was stationary, the outside temperature gauge may read a higher reading than actual.

12. Clock

Turn the button to set the clock.

13. Fuel gauge



The fuel tank holds approx. 70 litres. Approx. 8 litres of fuel remain when the lamp in the instrument panel lights.

14. Indicator and warning symbols

15. Direction indicators – left/right

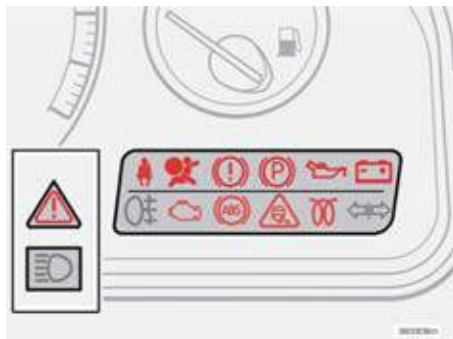
Indicator and warning symbols



The indicator and warning symbols light when you turn the ignition key to the driving position (position II) before starting. This shows that the symbols are functioning. When the engine is started, all symbols go out. If the engine is not started within 5 seconds, all symbols except  and  go out. Certain symbols may not have the function indicated, depending on the car's equipment. The symbol for the parking brake goes out when the parking brake is released.

Warning symbol in centre of dashboard

The symbol lights with a red or orange glow depending on the severity of the fault.

- Red symbol: Stop the car. Read the message in the display.
- Orange symbol: Read the message in the display. Remedy!



Fault in the ABS system

If the ABS symbol lights, the ABS system is malfunctioning. The car's normal braking system continues to work, but without the ABS function.

- Stop the car in a safe place and switch off the engine. Restart the engine.
- If the warning symbol goes out, continue driving. It was an indicator error.
- If the warning symbol remains lit, drive to an authorised Volvo workshop to have the ABS system checked.



Fault in braking system

If the BRAKE symbol lights, the brake fluid level may be too low.

- Stop the car in a safe place and check the brake fluid reservoir level.
- If the reservoir level is below MIN, the car should not be driven further. Have it towed to an authorised Volvo workshop to have the brake system checked.

Indicator and warning symbols (Contd)



If the **BRAKE** and **ABS** warning symbols light at the same time, there may be a problem in the brake force distribution.



- Stop the car in a safe place and switch off the engine. Restart the engine.

- If both symbols go out, it was an indicator error.
- If the warning symbols remain lit, check the brake fluid reservoir level.
- If the reservoir level is below MIN, the car should not be driven further. Have it towed to an authorised Volvo workshop to have the brake system checked.
- If the brake fluid level is normal and the lamps remain lit, carefully drive the car to the nearest authorised Volvo workshop to have the brake system checked.



WARNING!

If the **BRAKE** and **ABS** warning symbols light at the same time, there is a risk that the rear end will have a tendency to slide during heavy braking.

**Seat belt reminder**

The lamp remains lit until the driver and front seat passenger put on their seat belts.

**Fault in SRS**

If the symbol remains lit or lights while driving, a fault has been detected in the SRS system. Drive to an authorised Volvo workshop to have the system checked.

**Parking brake applied**

Bear in mind that the lamp only indicates that the parking brake is applied, not how hard. Check by depressing the pedal! If the pedal is set when driving, a signal will be heard as a reminder.

**Low oil pressure**

If the lamp lights while driving, engine oil pressure is too low. Stop the engine immediately and check the oil level. If the lamp lights but the oil level is normal, stop the car and contact an authorised Volvo workshop.

**Generator not charging**

If this lamp lights while driving, there is probably a fault in the electrical system. Contact an authorised Volvo workshop.

**Rear fog lamp**

This lamp lights when the fog lamp is on.

**Fault in emissions system**

Contact an authorised Volvo workshop to have the system checked.

**Engine preheater (diesel)**

This lamp lights to indicate that the engine is being preheated. You can start the car when the lamp goes out. Applies to cars with diesel engines only.

**Trailer indicator lamp**

Flashes when the direction indicators of the car and trailer are used. If the lamp does not flash, one of the direction indicators on the trailer or car is defective.

Indicator and warning symbols (Contd)

DSTC with RSC

The DSTC system (Dynamic Stability and Traction Control) with RSC (Roll Stability Control) is described in more detail on page 36 and page 108. The system comprises several different functions:

Reduced traction control

This symbol lights and shines with a constant glow when the DSTC system has reduced function due to high brake temperature. The text "TRACTION CONTROL TEMPORARILY OFF" is shown in the display.

Reduced stability control

The LED in the button goes out when function of the DSTC system has been reduced with the DSTC button in the centre console. The text "DSTC SPIN CONTROL OFF" is shown in the display.

Fault in DSTC system

If the warning symbol lights and shines with a constant glow even though you did not switch off the system, it indicates a fault in one of the systems. The text "ANTI-SKID SERVICE REQUIRED" is shown in the display.

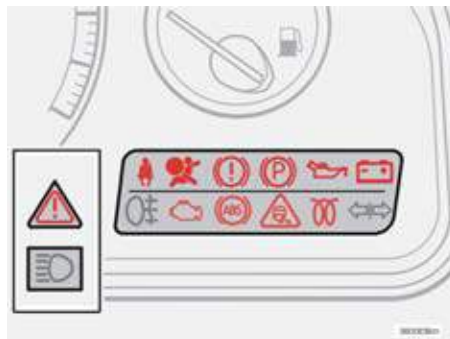

- Stop the car in a safe place and switch off the engine. Restart the engine.
- If the warning symbol goes out, the fault was temporary and it is not necessary to visit a workshop.
- If the warning symbol remains lit, drive to an authorised Volvo workshop to have the system checked.

WARNING!

Under normal driving conditions, the DSTC system improves the car's road safety, but this should not be taken as a reason to increase speed. Always follow the usual precautions for safe cornering and driving on slippery surfaces.

Messages in the display

Any warning or indicator symbol that appears is accompanied by a message in the display. Once you have read and understood the message, press the READ button (A). Messages which have been read are cleared from the display and stored in the car's memory. Fault messages will remain in the memory until the fault has been remedied.

Very serious fault messages cannot be erased from the display. They remain in the display until the fault is remedied.

Message	Meaning:
STOP SAFELY	Stop and switch off the engine. Serious risk of damage.
STOP ENGINE	Stop and switch off the engine. Serious risk of damage.
SERVICE URGENT	Take your car in for service immediately.
SEE MANUAL	Consult your Owner's Manual.
SERVICE REQUIRED	Take your car in for service as soon as possible.
FIX NEXT SERVICE	Have your car checked at the next service interval.
TIME FOR REGULAR SERVICE	When this message is shown, the car is due for a service. When the message is displayed is affected by the distance travelled, number of months since last service and engine running time.

Messages stored in the memory can be read again. Press the READ button (A) to see stored messages. Scroll through the messages stored in the memory by pressing the READ button. Press the READ button to return read messages to the memory.

NOTE! If a warning message interrupts when you are in the trip computer menu or wish to use the telephone, you must first acknowledge the message by pressing the READ button (A).

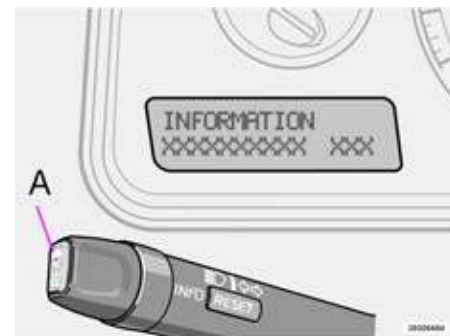

Switches in the centre console

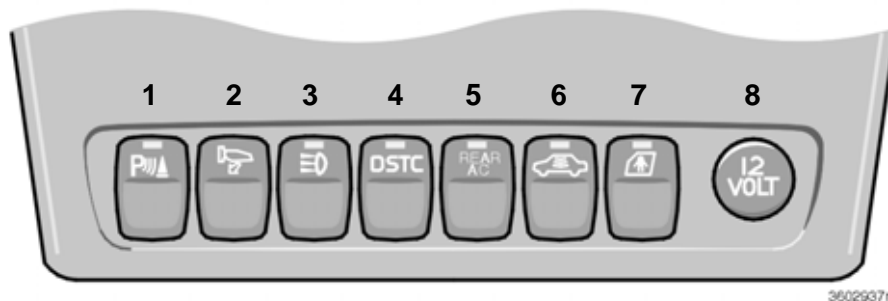

NOTE! The order of the buttons may vary

1. Parking assistance system (option)

This system is always activated when the car is started. Press the button to activate/deactivate the parking assistance system.

2. Retractable door mirrors (option)

This button is used to fold in the door mirrors if they are folded out or to fold them out if they are folded in.

Do as follows if a door mirror has been accidentally folded in or out:

- Manually adjust the appropriate door mirror to its normal position.
- Turn the ignition key to position II.
- Fold the door mirror inward and then outward using the button. The door

mirrors have now returned to their original fixed positions.

3. Auxiliary lamps (option)

Use this button to switch the auxiliary lamps on with main beam or to switch them off. The LED in the button is lit when the function is activated.

4. DSTC system

This button is used to reduce or reactivate the functions of the DSTC system. When the LED in the button is lit, the DSTC system is activated (assuming there is no fault).

NOTE! For reasons of safety, the button to reduce the function of the DSTC system must be depressed for at least half a second.

The text "DSTC SPIN CONTROL OFF" is shown in the display.

Reduce the system function if you must use a wheel of a different size than the other wheels. When the engine is restarted, the DSTC system will be reactivated.



WARNING!

Keep in mind that the driving characteristics of the car change if you deactivate the DSTC system.

5. Air conditioning in the rear of the passenger compartment (option)

Press the button to activate the air conditioning in the rear of the passenger compartment. Rear air conditioning is deactivated when the ignition is completely switched off.

6. Deactivating the deadlock function and detectors

Use this button if you wish to switch off the deadlock function (deadlock means that the doors cannot be opened from the inside when they are locked). This button is also used to deactivate the movement and tilt detectors in the alarm system. The LED lights when these systems are deactivated.

7. Child safety locks in the rear doors (option)

Use this button when you wish to activate or deactivate the electric child safety locks in the rear doors. The ignition key must be in position I or II. When the child safety locks are activated, the LED in the button lights. A message is shown in the display when you activate or deactivate the child safety locks.

8. Electric socket (standard)/ Cigarette lighter (option)

The electric socket can be used for various 12V accessories, such as mobile phones or coolers. The cigarette lighter is activated by pushing in the button . Once the lighter has been heated, the button pops out again. Pull out the lighter

and use the heated coils. For reasons of safety, always keep the cover on the socket when it is not in use. The maximum current is 10A.

Lighting panel

A - Headlamps and position/parking lamps

O All lighting off.

Cars with daytime running lights (certain countries)

Ignition key in position II: Dipped beam on (plus front and rear position/parking lamps, numberplate lighting and instrument illumination). Dipped beam lights automatically when the ignition key is switched to the driving position and cannot be switched off. Before trips to certain countries, your Volvo workshop can help you deactivate the daytime running lights.

 Front and rear position/parking lamps.

 **Ignition key in position 0:** All lighting off.

Ignition key in position II: Headlamps light (plus front and rear position/parking lamps, numberplate lighting and instrument illumination).

NOTE! You must always turn the light switch to this position to switch on the main beam.

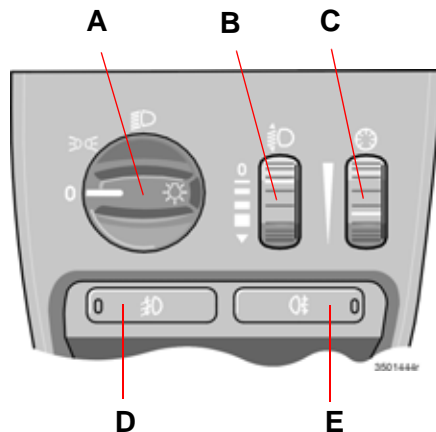

B - Headlamp levelling

To allow for headlamp beam adjustment to compensate for different loads, certain cars come equipped with an actuator motor for each headlamp. Adjust the headlamps using the headlamp levelling control on the dashboard.

Cars with Bi-Xenon lighting (option) have automatic headlamp levelling.

C - Instrument illumination

Move the control upward – brighter lighting.

Move the control downward – dimmer lighting.

A twilight sensor (see page 60) automatically adjusts the brightness of instrument illumination.

D - Front fog lamps

Ignition key in position II. Press the button. The fog lamps light in combination with the position/parking lamps and main/dipped beam. The LED in the button is lit while the fog lamps are on.

NOTE! In some countries, dipped beam may not be used in combination with front fog lamps.

E - Rear fog lamps

Ignition key in position II. Press the button. The rear fog lamp lights in combination with the main/dipped beam. The LED in the button and the symbol in the combined instrument panel light at the same time.

Please remember: Regulations for use of front and rear fog lamps vary from country to country.

Direction indicator lever

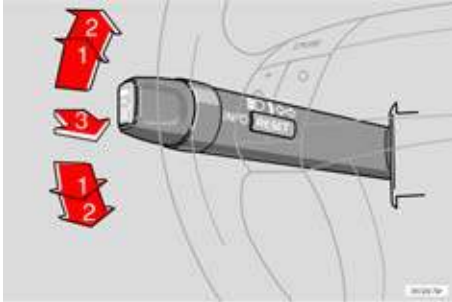

1. Resistance point position

When changing lanes or overtaking, move the lever until you feel a distinct resistance. The lever returns when released.

2. Normal turns

The direction indicators light when you move the lever in the direction the wheel moves during the turn. When the wheel returns after a turn, the direction indicators switch off automatically.

3. Main beam "flash"

Pull the lever lightly towards you (until you feel a slight resistance). The main beam remains lit until the lever is released.

3. Switching, main/ dipped beam

Pull the lever towards you past the "flash position" and release it to change between main and dipped beam.

3. Approach lighting

Do as follows when you leave your car when it is dark out:

- Remove the key from the ignition.
- Pull the left lever (direction indicator) towards you.
- Exit the car.
- Lock the doors.

Dipped beam, position/parking lamps, number-plate lighting and the lamps in the door mirrors (option) now light and remain lit for 30, 60 or 90 seconds. An authorised Volvo workshop can set a suitable duration for your car.

Windscreen wipers/washer

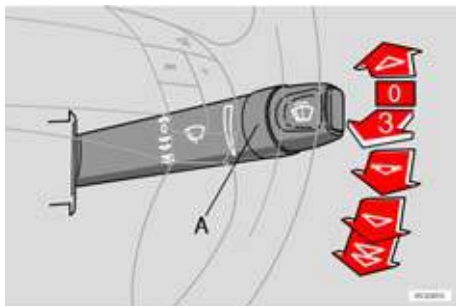

Wiper/washer function – windscreen

Windscreen wipers

0 Windscreen wipers off

If the lever is in the 0 position and you move it upwards, the wipers will sweep one stroke at a time for as long as you hold the lever up.

Intermittent wiping

You can adjust and set a suitable speed for intermittent wiping. Twisting the ring (see A in illustration) upwards increases the frequency of wiper strokes. Twisting the ring towards you decreases the frequency of wiper strokes.

Rain sensor (option)

The rain sensor replaces the intermittent function. The windscreen wipers automatically increase or decrease speed based on how much water the sensor indicates is on the windscreen. **Sensitivity** can be adjusted using the ring (see illustration).

To activate the rain sensor:

- Turn on the ignition.
- Move the lever from the 0 position to the position for intermittent wiping.

The rain sensor is deactivated when the ignition is switched off. To reactivate the rain sensor:

- Turn on the ignition.
- Move the lever to the 0 position and then to the position for intermittent wiping.

NOTE! When using a car wash: Disengage the rain sensor (move the lever to position 0) or switch off the ignition completely. Otherwise the windscreen wipers will begin swiping and can be damaged.

 Wipers operate at "normal" speed

 Wipers operate at "high" speed

3 – Windscreen washer/ headlamp washers

Pull the lever towards the steering wheel to start the windscreen and headlamp washers.

Headlamp washing

High-pressure washing of the headlamps consumes vast amounts of washer fluid. To save fluid, the headlamps are only washed every fifth time (within a 2-minute period).

If 2 minutes have elapsed since the previous windscreen washing, the headlamps are again high-pressure washed then next time the windscreen is washed.

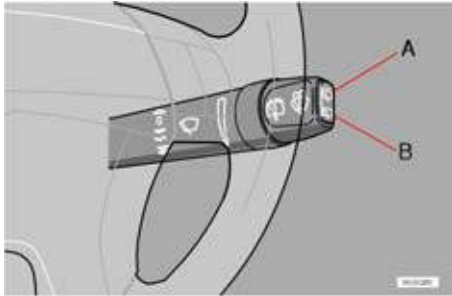

Windscreen wipers – reversing

If you engage reverse gear when the windscreen wipers are already activated, the rear window wipers will go into intermittent wiping mode*. If the rear window wiper is already engaged at normal speed, there is no change to the selected function.

*This function (intermittent wiping when reversing) can be switched off. Consult your Volvo workshop.

Wiper/washer function – rear window

Rear window washer

Push the lever **forward** to start the rear window washer.

- A. Rear window wiper – intermittent wiping
- B. Rear window wiper – normal speed

Hazard warning flashers, rear window and door mirror defrosters, heated front seats



Hazard warning flashers

Use the hazard warning flashers (all direction indicators flash) should you be forced to stop or park where the car constitutes a possible traffic hazard or obstruction.

Please remember: Regulations for use of hazard warning flashers vary from country to country.

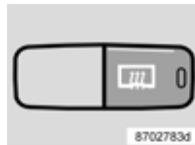

Rear window and door mirror defrosters

Use the defroster to remove ice and misting from the rear window and door mirrors.

Pressing the switch starts defrosting of the rear window and door mirrors simultaneously. The

LED in the switch lights to indicate this. A built-in timer automatically disconnects the defroster from the door mirrors after about 4 minutes and from the rear window after about 12 minutes.



Heated front seats

See page 59 or 63 for further information.

Trip computer

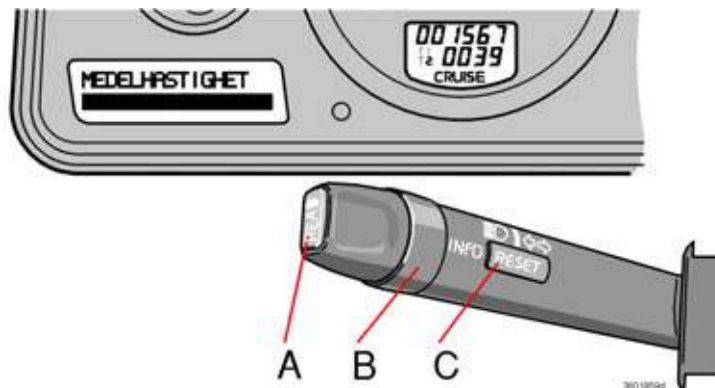

Controls

To access the trip computer information, you must turn the ring (B) in steps, either forward or backward. By turning again, you return to the starting point.

NOTE! If a warning message interrupts while you are using the trip computer, you must first acknowledge the message by pressing the READ button (A) to return to the trip computer.

Functions

The trip computer receives a great deal of data that is continuously evaluated by a microprocessor. The system has four functions which are shown in the display:

- Average speed
- Current fuel consumption
- Average fuel consumption
- Range to empty fuel tank

Average speed

The average speed since the last reset (RESET). When the ignition is switched off, the average speed is stored and used as the basis of the new value when you continue driving. This can be reset with the RESET button (C) on the lever.

Current fuel consumption

Continuous information on current fuel consumption. Fuel consumption is calculated every second. The figure in the display is updated every couple of seconds. When the car is stationary, "----" is shown in the display.

NOTE: The displayed value may be slightly off if a fuel-driven heater is used.

Average fuel consumption

The average fuel consumption since the last reset (RESET). When the ignition is switched off, the average fuel consumption is stored and remains until reset with the RESET button (C) on the lever.

NOTE: The displayed value may be slightly off if a fuel-driven heater is used.

Range to empty fuel tank

Displays the approximate distance that can be driven with the remaining fuel, calculated using the average fuel consumption over the last 30 km and the remaining quantity of fuel. When the range to empty is less than 20 km, "----" is shown in the display.

NOTE: The displayed value may be slightly off if a fuel-driven heater is used.

Cruise control

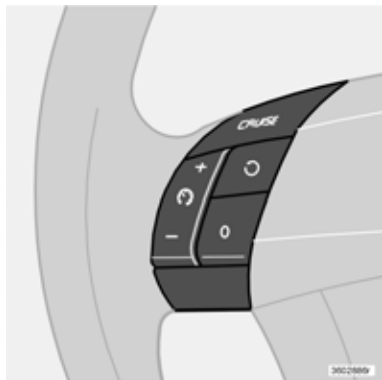

Activating

The controls for cruise control are to the left of the steering wheel.

Setting desired speed:

- Press the CRUISE button. "CRUISE" is displayed on the combined instrument panel.
- Increase or decrease to the desired speed by pressing + or –.
NOTE: Cruise control cannot be engaged at speeds under 35 km/h.
- Lightly press + or – to lock the desired speed.

Temporary disengagement

Press **0** to temporarily disengage the cruise control.

Depressing the brake or clutch pedal disengages the cruise control. The previously set speed is stored in the memory.

The cruise control is also temporarily disengaged when...

- the speed drops below the lower limit for activation
- the gear selector is moved to position N
- upon a wheel spinning or locking.

Return to a speed

Press  to resume the previously set speed.

Acceleration

A temporary increase in speed, e.g. during overtaking, does not affect the cruise control setting. The car will resume the previously set speed. If cruise control is engaged, increase or decrease speed with the + or – button. A short press corresponds to approx. 1 k m/h. The speed which the car has achieved at the time the button is released will be programmed instead.

Disengagement

Press CRUISE to switch off the cruise control. "CRUISE" will disappear from the combined instrument panel.

The cruise control is automatically disengaged when the ignition is switched off.

NOTE! If one of the cruise control buttons is depressed for more than one minute, the system will be disengaged. You must then turn the ignition off to reset the cruise control.

Parking brake, bonnet, electric socket, etc.

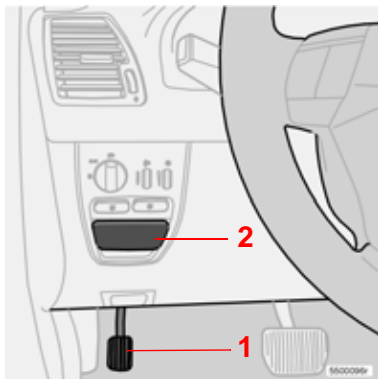

Parking brake, LHD car

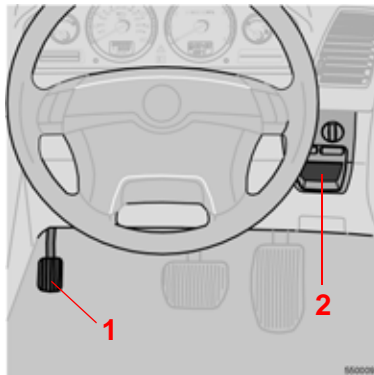

Parking brake, RHD car

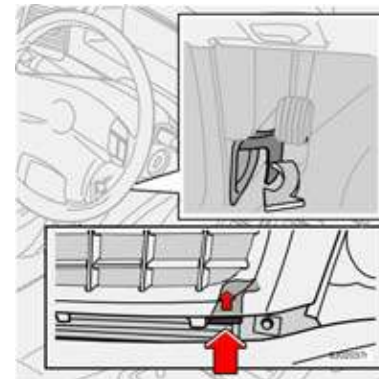

Opening the bonnet

Pull the handle towards you to release the bonnet lock mechanism.

Parking brake

The parking brake pedal is located to the left at floor level. Apply the parking brake by depressing the pedal (1). Release the brake by pulling the handle (2).

The parking brake holds the rear wheels. When the brake is applied, the warning symbol lights in the combined instrument panel.

Remember that the warning symbol in the combined instrument panel lights even if the parking brake is only "slightly" applied.

WARNING!

Close the bonnet by placing your hand on its top and pressing down. Do not close it by holding the grille. Engine components on the inside could injure your fingers.

Parking brake, bonnet, electric socket, etc. (Contd)



Electric socket for rear seat passengers (option)

The electric socket can be used for various 12 V accessories, such as mobile phones or CD players. The maximum current is 10 A.

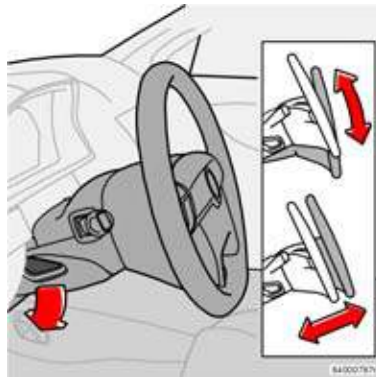

Steering wheel adjustment

The steering wheel can be adjusted both vertically and front-rear. Press down the control on the left-hand side of the steering column. Then adjust the steering wheel to the position that suits you best. Press the control back into place to lock the steering wheel. If this is difficult, press the steering wheel slightly while pressing the control back.

 **WARNING!**

Adjust the steering wheel before driving, never while driving. Ensure that the steering wheel is locked.

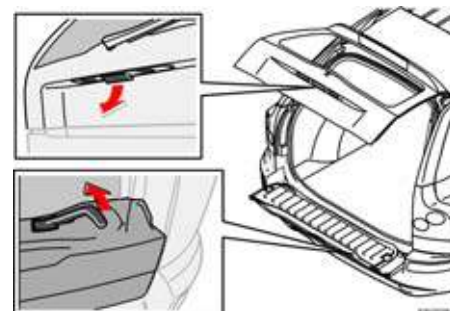

Opening the tailgate

Open the tailgate by pulling the handle indicated in the illustration. Fold down the rear flap by lifting the handle up.

Power windows

The power windows are operated using the controls in the door armrests. The ignition key must be in position I or II for the power windows to work. Once you finish driving and remove the ignition key, the windows can still be opened or closed as long as neither of the front doors has been opened.

Open a window by depressing the front of the control, and close it by pulling up the front of the control.

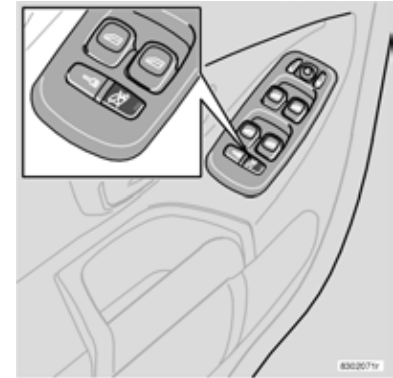
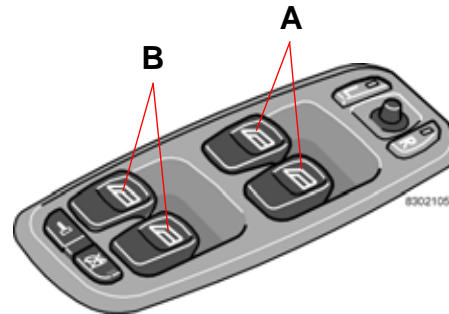

Power windows in the front doors

Windows can be opened or closed from the front seat two ways.

1. Press the control (A) **slightly** down or pull it **slightly** up. The power windows go up or down as long as the switch is actuated.
2. Press the control (A) **all the way** down or pull it **all the way** up, and then **release**. The windows then open or close automatically. Movement is stopped if the window is blocked in any way.

NOTE! The function **auto up** for the passenger side is only available in certain markets.

Controls (B) to operate windows in the rear doors.

Blocking power windows in the rear doors

The power windows in the rear seat can be blocked with the switch on the driver's door control panel. Always remember to switch off current to the power windows (i.e. remove the ignition key) if you leave children in the car unattended.

LED in the switch is unlit

Rear door windows can be operated both by the controls on the doors and the control on the driver's door.

LED in the switch is lit

Rear door windows can only be operated from the driver's door.

Power windows (Contd)

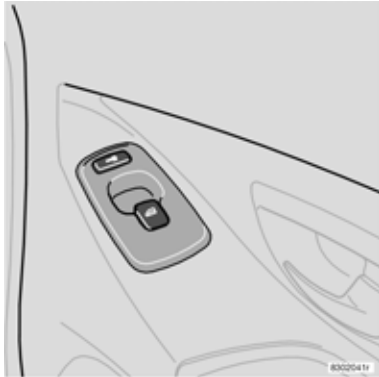

WARNING!

If rear door windows are being operated from the driver's door, check that no rear seat passenger are in danger of getting pinched when the windows close.

Power window in the front passenger seat

The control for the power window at the front passenger seat operates that window only.

Power windows in the rear doors

The rear door windows can be operated with the controls on the doors and the switch on the driver's door. If the LED in the switch for blocking power windows in the rear doors (located in the driver's door control panel) is lit, the rear door windows can only be operated from the driver's door.

Rearview mirror/door mirrors

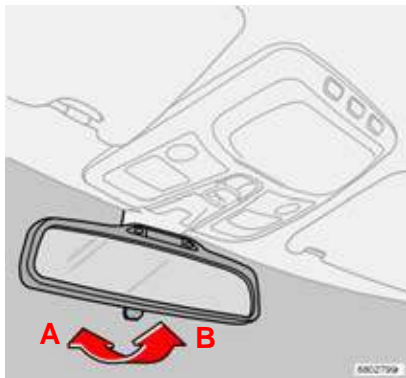

Rearview mirror

A. Normal position.

B. Dimming position. Use this if headlamps from the car behind you is irritating.

Certain models have an **autodim** function (option), which means that dimming occurs automatically based on comparative light relationships. Your Volvo workshop can adjust the sensitivity.

WARNING!

Adjust the mirrors before you begin driving!

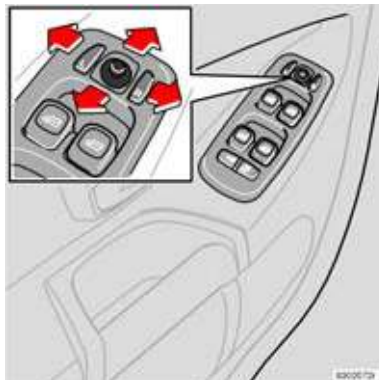

Door mirrors

The controls for setting the two door mirrors are at the front of the armrest on the driver's door.

- Press the L or R button (L = left door mirror, R = right door mirror). The LED in the button lights.
- Adjust the position with the adjustment control in the centre. Press the button again. The LED should no longer be lit.

Do not use ice scrapers with steel blades to remove ice from the mirrors as the glass could be scratched!

Door mirrors with memory function (option)

If the car is equipped with door mirrors with memory function, they work together with the memory function of the seat, page 70.

Memory function in the remote control

When you unlock the car with the remote control and change the setting of the door mirrors, these new settings are saved in the remote control. The next time you unlock the car with the same remote control and open the driver's door within two minutes, the mirrors will assume their stored positions. This only applies to the two remote controls that are delivered with the car, page 88.

Power sunroof (option)

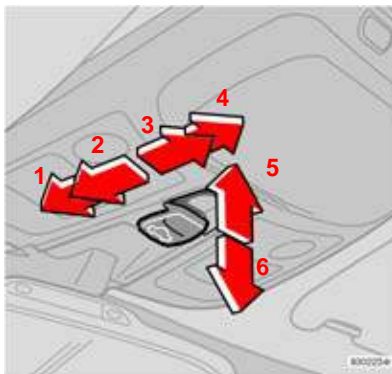
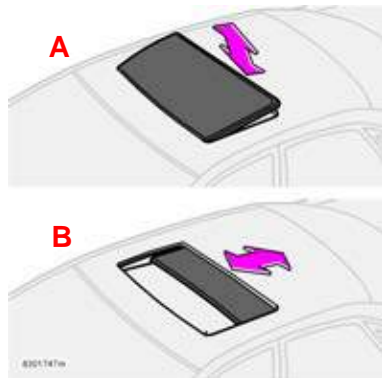

Opening positions

Sunroof controls are located in the headlining. The sunroof can be operated in two different ways:

A: Raise/lower trailing edge – ventilation position

B: Rearwards/forwards – opening position/comfort position*

The ignition key must be in position I or II.

Ventilation position

Open: Push the trailing edge of the control (5) upward.

Close: Pull the trailing edge of the control (6) downward.

Switch from **ventilation position** to **comfort position***: pull the control rearwards to its end position (4) and release.

1. *Automatic closing*
2. *Manual closing*
3. *Manual opening*
4. *Automatic opening*
5. *Opening ventilation position*
6. *Closing ventilation position*

Opening position/comfort position*

Automatic operation

Move the control over the resistance point position (3) to the rear end position (4) or over the resistance point position (2) to the forward end position (1) and release. The sunroof will open to the **comfort position*** or will close completely.

In order to open from **comfort position*** to maximum opening: Pull the control to the rear once more to the end position (4) and release.

Manual operation

Open: Pull the control rearwards to the resistance point position (3). The sunroof will move towards maximum opening position as long as the control is held in this position.

Close: Press the control forwards to the resistance point (2). The sunroof will move towards closing position as long as the control is held in this position.



WARNING!

If you have children in the car, make sure that their hands are clear when closing the sunroof.

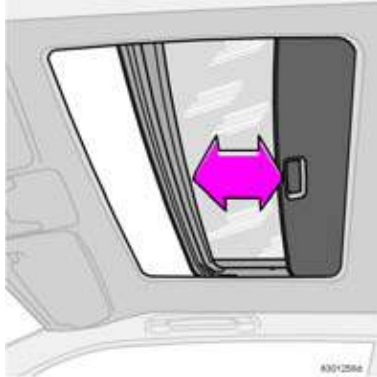

Sun screen

The sunroof also features a manually-operated sliding inner sun screen. The sun screen slides back automatically when the sunroof is opened. Close the sun screen: Grasp the handle and slide the screen forwards.

Pinch protection

The sunroof pinch protection function is activated if the hatch is blocked by an object. If blocked, the sunroof will stop and automatically open to the previous position.



WARNING!

Pinch protection functions only in the opening position – not in ventilation position.

Make sure the sunroof is properly closed before leaving the car.

Climate control

General on climate control	54
Manual climate control with air conditioning, AC	56
Electronic Climate Control (ECC)	60
Parking heater (option)	64

General on climate control

Misting on window interiors

A good way to reduce the problem of misting on the insides of the windscreen and other windows is to clean them. Use a normal window cleaner.

Bear in mind that you must clean them more often if someone smokes in the car.

Particle filter

Make sure the particle filter is replaced regularly. Consult your Volvo workshop.

Ice and snow

Remove ice and snow from the climate control air intake (the grille between the bonnet and the windscreen).

Fault tracing

Your Volvo workshop has the instruments and tools required for any fault tracing or repair of your climate control system. Entrust checks and repairs only to trained personnel.

Environmental care

Refrigerant R134a is in the air conditioning system. This contains no chlorine, which means it is harmless to the ozone layer.

Only use R134a when filling/changing refrigerant. This work should be carried out by an accredited workshop.

Cars with ECC

Actual temperature – ECC

The temperature you select corresponds to the physical experience with reference to air speed, humidity, exposure to sun, etc. which affect the interior and exterior of the car.

Sensors – ECC

The sun sensor is on the upper portion of the dashboard. Remember not to cover it. Do not cover the passenger compartment temperature sensor on the climate control panel.

Side windows and sunroof

To ensure that the air conditioning works satisfactorily, close all side windows and the sunroof (if fitted).

Acceleration

The air conditioning system switches off temporarily at full acceleration. You may feel a temporary rise in temperature.

Condensation/Drying

In warm weather, condensation from the air conditioning system may drip under the car. This is normal. If necessary, the fan will start 50 minutes after the ignition switch is turned to position 0 to dry the climate control system for seven minutes. The fan then switches off automatically.

Fuel economy - Electronic climate control ECC

With ECC, the air conditioning system is controlled automatically and is used just enough to cool the passenger compartment and dehumidify the incoming air. This provides better fuel economy compared to conventional systems where the air conditioning cools the air to just above freezing point.

Fan function to reduce risk of battery discharge

When the engine is switched off (even if the ignition key is in position I or II), the fan will be switched off automatically. To activate the fan, turn the knob and set the desired speed. After two minutes, the fan will reduce to a lower speed. This is one way to avoid discharging the battery when the engine is switched off.

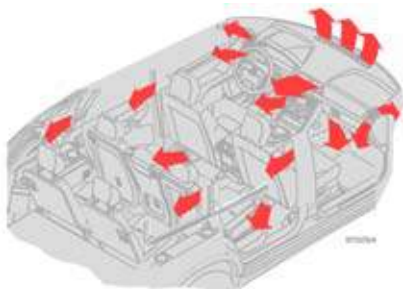

Air distribution

Incoming air is distributed through several different vents located throughout the car.

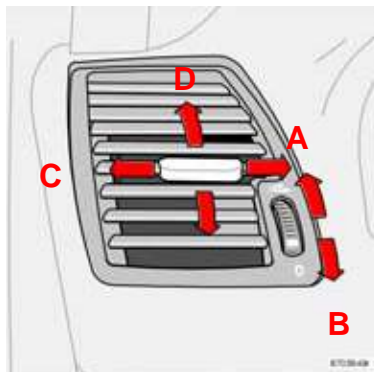

Air vents in the dashboard

- A. Open
- B. Closed
- C. Directing airflow laterally
- D. Directing airflow vertically

- Aim the outer vents towards the side windows to remove misting.
- In cold climates: close the centre vents for the most comfortable climate and best demisting.

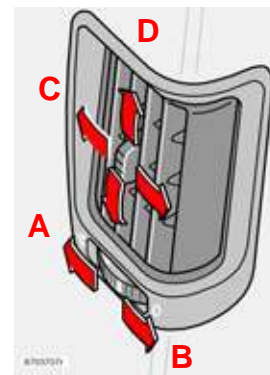

Air vents in the door pillars

- A. Open
- B. Closed
- C. Directing airflow laterally
- D. Directing airflow vertically

- Aim the vents toward the rear side windows to remove misting.
- Aim the vents inwards in the car for a comfortable climate in the rear seat.

Bear in mind that small children can be sensitive to airflow and draughts.

Manual climate control with air conditioning, AC

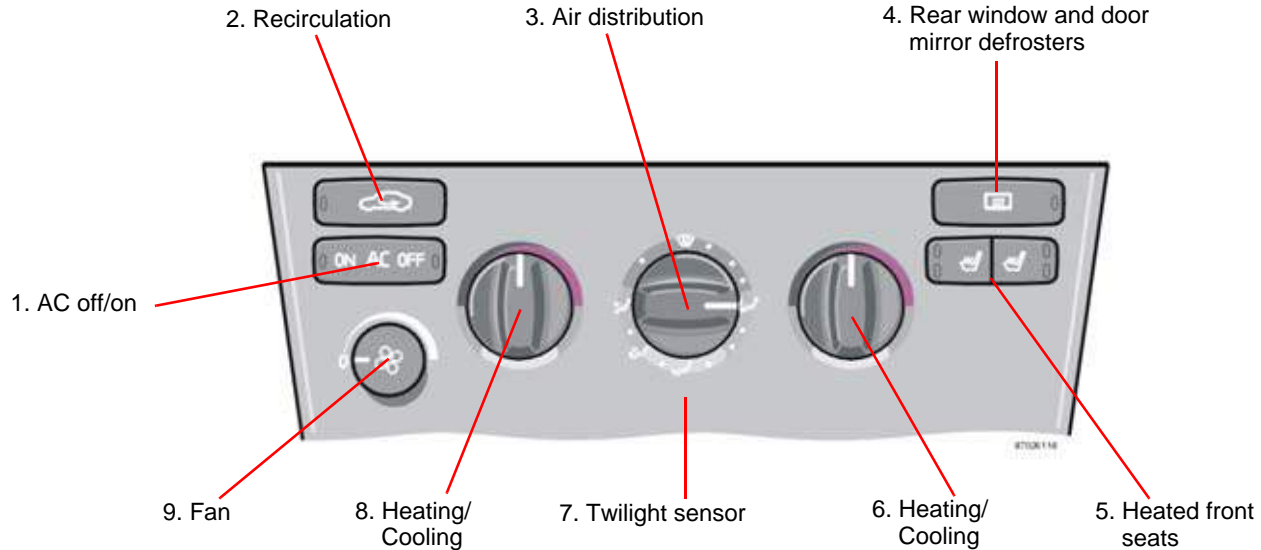

- You must turn the fan knob (9) from the 0 position to connect the air conditioning.
- Use the air conditioning at low temperatures (0 - 15°C) to dehumidify incoming air.

1. AC - ON/OFF

The air conditioning is connected to the cooling and dehumidification function with the ON LED lights. The air conditioning is disconnected with the OFF LED lights.



When you select Defroster , the air conditioning is connected as long as the fan is not set to position 0.

2. Recirculation

Recirculation can be used to shut out bad air, exhaust, etc. from the passenger compartment. The air in the passenger compartment is then recirculated, i.e. no air from outside the car is taken into the car when this function is activated. Recirculation (together with the air conditioning system) cools the passenger compartment more quickly in a warm climate.

If you allow the air in the car to recirculate, there is a risk of icing and misting, especially in winter. The timer function minimises the risk of ice, misting and bad air.

Activate the function as follows:

- Press  for more than 3 seconds. The LED flashes for 5 seconds. The air recirculates in the car for 3-12 minutes depending on the outside temperature.
- The timer function is activated each time you press .





To switch off the timer function:

- Press  again for more than 3 seconds. The LED lights for 5 seconds to confirm your selection.

Recirculation is always disconnected when you select  Defroster.

3. Air distribution

Use the air distribution control positions (marked with dots) between the different symbols to fine-tune air distribution for maximum comfort.

Air distribution	Use
 Air through front and rear air vents.	When you want good cooling in a warm climate.
 Air to windows. Air is not recirculated in this position. Air conditioning is always connected. There is a certain amount of airflow to the air vents.	When you want to remove ice and misting. High fan speed is good for this.
 Air to both floor and windows. There is a certain amount of airflow to the air vents.	When you want comfortable conditions and good demisting in a cold climate. Not too low a fan speed.
 Air to floor. There is a certain amount of airflow to the air vents and the defroster vents for the windscreen and side windows.	When you want to warm your feet.
 Air to floor and air vents.	In sunny weather with cool outside temperatures.

Manual climate control with air conditioning, AC (Contd)

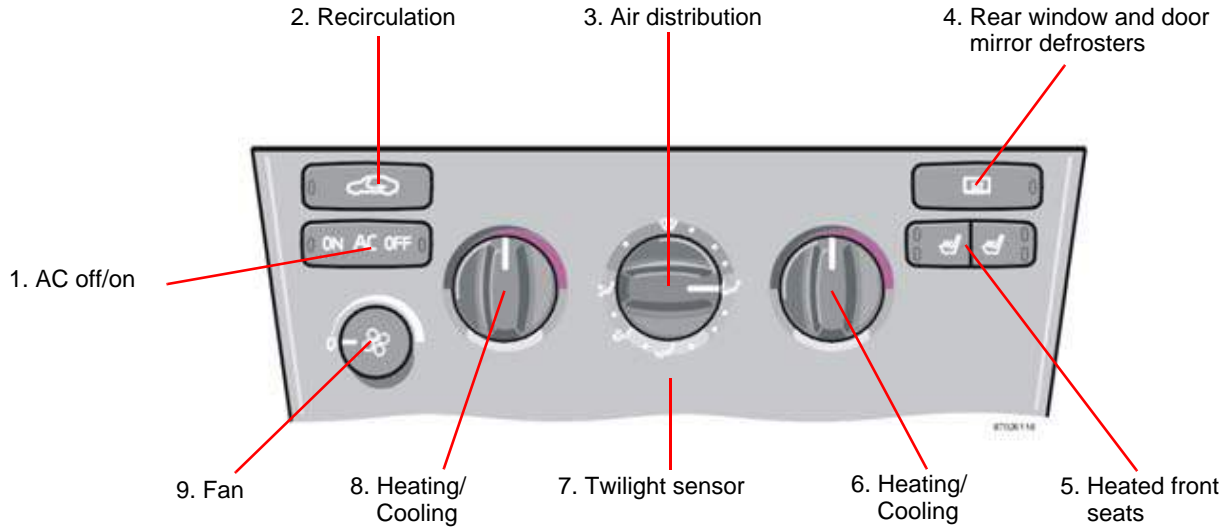

4. Rear window and door mirror defrosters

Use this button to quickly remove misting and ice from the rear window and door mirrors, see page 42 for more information about this function.

5. Heated front seats

Do as follows for heated front seat(s):

- Press once: High heat – both LEDs in the switch light up.
- Press once again: Low heat – one LED in the switch lights up.
- Press yet again: Heating is switched off – no LEDs in the switch are lit.

Your Volvo workshop can adjust the temperature.

6. and 8. Heating/Cooling – left/right side

Turn to set how warm or cold the incoming air should be. For cooler air, the air conditioning must be connected.

7. Twilight sensor

Automatically adjusts the brightness of instrument illumination.

9. Fan

Fan speed can be increased or decreased by turning the knob.

Electronic Climate Control (ECC)

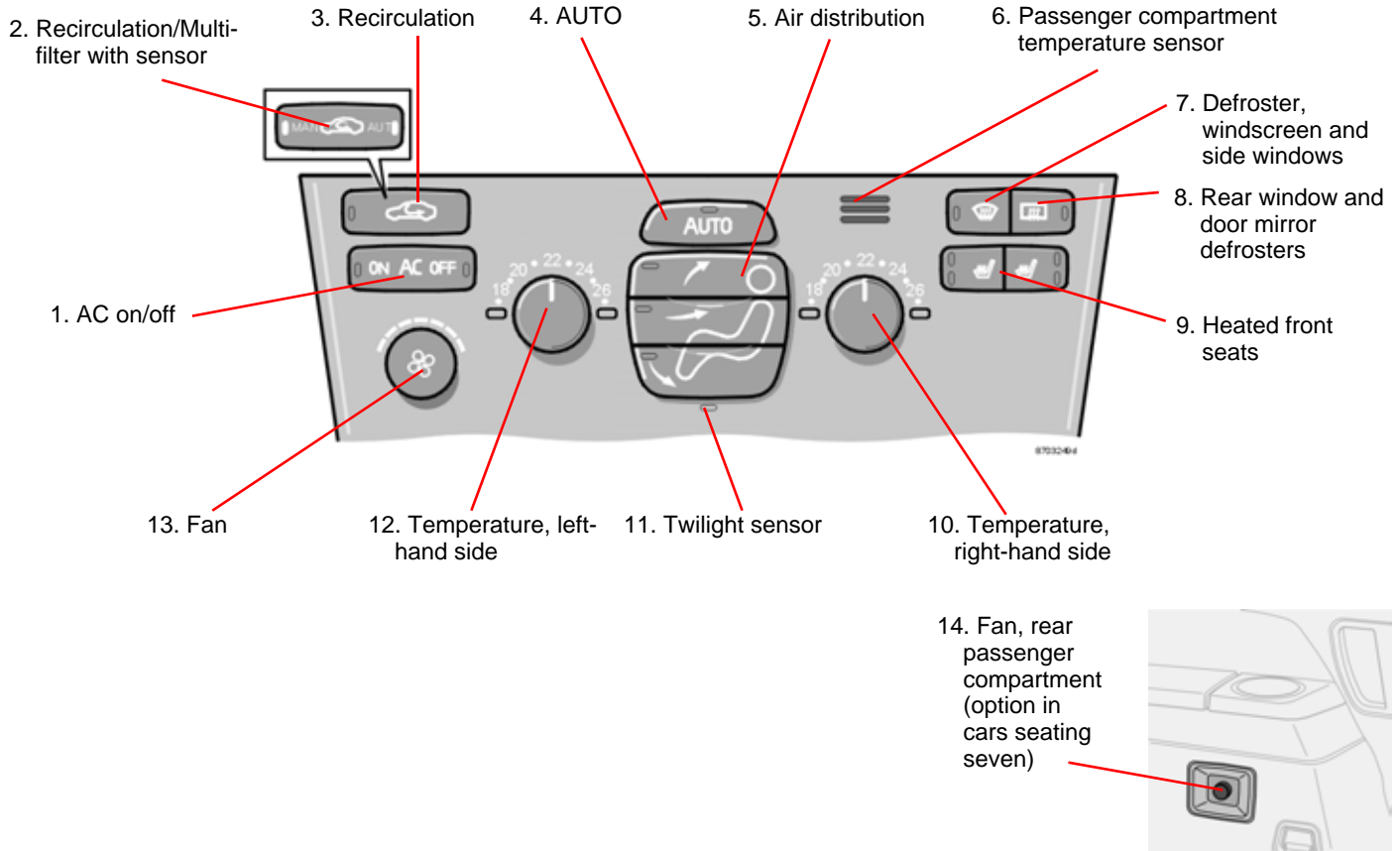

1. AC – ON/OFF

The air conditioning system is controlled automatically by the system when the ON LED is lit. This way, incoming air is cooled and dehumidified sufficiently. When AC OFF is selected and the OFF LED lights, the air conditioning system is disconnected; other functions are still controlled automatically. The air conditioning system operates down to approximately 0°C.

When you select Defroster, the air conditioning system is controlled so that air is maximally dehumidified.

2. Air quality sensor with multifilter (option in certain markets)

Certain cars are equipped with a "Multifilter" and air quality sensor. The Multifilter separates gases and particles, thus reducing the volume of odours and pollutants entering the car. The air quality sensor detects increased levels of contaminants in the outside air. When the air quality sensor detects contaminated outside air, the air intake is closed and the air in the compartment is recirculated. The Multifilter also cleans the air recirculating in the compartment.

When the air quality sensor is active, the green AUT LED lights in .

Operation

Press  to activate the air quality sensor (normal setting).

Or:

Select one of the following three functions by pressing  repeatedly.

- AUT LED lit: The air quality sensor is now activated.
- No LED lit: Recirculation is not activated unless needed to cool in a warm climate.
- MAN LED lit: Recirculation is now activated.

Keep in mind the following:

- Make it a rule to have the air quality sensor activated at all times.
- Recirculation is limited in cold climates to avoid misting.
- If misting occurs, you should deactivate the air quality sensor.
- If misting occurs, you can use the defroster functions for the windscreen, side windows and rear window. See page 63.
- Follow the Volvo Service Programme for the recommended replacement interval of the Multifilter. If the car is used in a severely contaminated environment, it may be necessary to change the Multifilter more often.

Electronic Climate Control (ECC) (Contd)

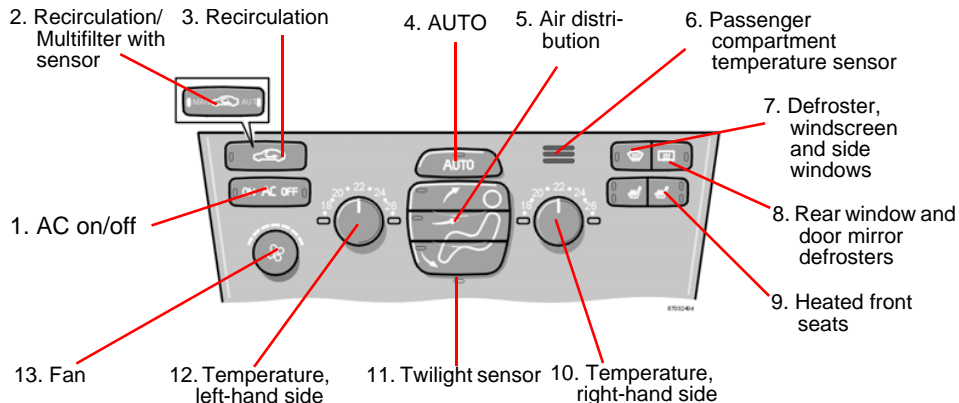

14. Fan, rear passenger compartment (option in cars seating seven)





3. Recirculation

Recirculation can be used to shut out bad air, exhaust, etc. from the passenger compartment. The air in the passenger compartment is then recirculated, i.e. no air from outside the car is taken into the car when this function is activated.

If you allow the air in the car to recirculate, there is a risk of icing and misting, especially in winter.

The **timer function** (cars with Multifilter and air quality sensor have no timer function) minimises the risk for ice, misting and bad air.

Activate the function as follows:

- Press  for more than 3 seconds. The LED flashes for 5 seconds. The air recirculates in the car for 3-12 minutes depending on the outside temperature.
- The timer function is activated each time you press .

To switch off the timer function:

- Press  again for more than 3 seconds. The LED lights for 5 seconds to confirm your selection.

Recirculation is always disconnected when you select  Defroster.

4. AUTO

The AUTO function automatically regulates climate control so that the desired temperature is attained. The automatic function controls heating, air conditioning, fan speed, recirculation, and air distribution. If you select one or more functions manually, the other functions continue operating automatically. All manual settings are switched off when AUTO is switched on.

5. Air distribution

- When the top button is depressed, air is directed to the windows.
- When the centre button is depressed, air is directed to the head and body.
- When the lower button is depressed, air is directed to the legs and feet.

Press AUTO to return to automatic air distribution.

6. Passenger compartment temperature sensor

The passenger compartment temperature sensor monitors the temperature inside the car.

7. Defroster – windscreen and side windows

Use this button to quickly remove misting and ice from the windscreen and side windows. The air flows to the windows at high fan speed. The LED in the defroster button lights when this function is activated. The air conditioning system is now controlled so that the air is maximally dehumidified. The air is not recirculated.

8. Rear window and door mirror defrosters

Use this button to quickly remove misting and ice from the rear window and door mirrors, see page 42 for more information about this function.

9. Heated front seats

Do as follows for heated front seat(s):

- Press once: High heat – both LEDs in the switch light up.
- Press once again: Low heat – one LED in the switch lights up.
- Press yet again: Heating is switched off - no LEDs in the switch are lit.

Your Volvo workshop can adjust the temperature.

10 and 12. Temperature

The two knobs can be used to set the temperature for the passenger and driver's sides of the car. Remember that the car does not heat up or cool down any more quickly even if you select a higher or lower temperature than you want in the passenger compartment.

11. Twilight sensor

Automatically adjusts the brightness of instrument illumination.

13. Fan

Fan speed can be increased or decreased by turning the knob. If AUTO is selected, fan speed is controlled automatically. The previously set fan speed is disconnected.

If the knob for the fan is turned so far to the left that only the left LED above the knob lights with an orange glow, the fan and air conditioning are switched off.

14. Fan, rear passenger compartment

Fan speed can be increased or decreased by turning the knob. This only applies if AC is selected in both the front (1) and rear; see page 37.

Parking heater (option)

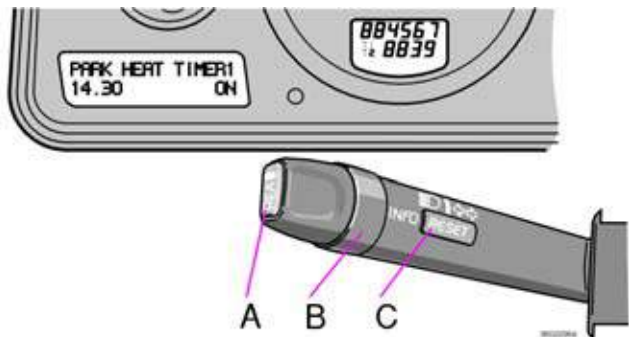

The parking heater can be started immediately or set to two different start times using TIMER 1 and TIMER 2.

Here, start time refers to the time point the car should be completely warmed up.

Vehicle electronics calculates start time based on current outside temperature. If the outside temperature exceeds 25°C, heating is not switched on.

At temperatures of -7°C and below, the parking heater runs a maximum of 60 minutes.

If repeated attempts to start the parking heater are unsuccessful, an error message is shown in the display - contact a Volvo workshop.

Brief press of RESET (C)	setting of hours and minutes
Long press of RESET	timer activated (ON)
Long press of RESET	timer switched off (OFF)
ON lamp lights	the timer is activated
ON lamp flashes	the parking heater is activated

The car must be outdoors

Remember that the car must be outdoors when using petrol and diesel heaters.

Parking on a hill

If you park your car on a steep incline, the front of the car should be facing up the slope to ensure the supply of fuel to the parking heater.

Direct start of heater

- Use the thumb wheel (B) to select DIRECT START.
- Press the RESET button (C) to make ON and OFF selections available.

Select ON. The heater will now run for 60 minutes. Heating of the passenger compartment will begin as soon as the engine coolant has reached a temperature of 20°C.

Deactivation of heater after direct start

- Use the thumb wheel (B) to select DIRECT START.
- Press the RESET button (C) to make ON and OFF selections available.
- Select OFF.

Setting TIMER 1 or 2

For reasons of safety, you can only programme times for the following 24 hours, not several days in a row.

1. Use the thumb wheel (B) to select TIMER 1.
2. Briefly press the RESET button (C) so that the hours setting starts to flash.
3. Use the thumb wheel to set the desired number of hours.
4. Give the RESET button (C) a short press to come to the flashing minutes setting.
5. Use the thumb wheel to set the desired number of minutes.
6. Give the RESET button (C) a short press to confirm your setting.
7. Press the RESET button (C) to activate the timer.

Once you have set TIMER 1 you can toggle to TIMER 2. Make settings the same way as for TIMER 1.

Deactivation of timer-started heater

Do as follows to manually switch off the heater before the set time has elapsed:

1. Press the READ button (A)
2. Use the thumb wheel (B) to scroll to the text PARK HEAT TIMER 1 or 2. The text ON flashes.
3. Press the RESET button (C). The text OFF is displayed with a steady glow and the heater is switched off.

Messages in the display

Once TIMER 1, TIMER 2 and Immediate start are activated, the amber symbol in the combined instrument panel lights and explanatory text is shown in the display.

When you leave the car, you will receive a message regarding the current settings of the system.

Car clock/timer

For reasons of safety, all timer settings will be deactivated if the car clock is reset after timer settings have been made.

Battery and fuel

If the battery is not sufficiently charged or the petrol tank is close to empty, the parking heater will be switched off.

If this is the case, you will receive a message in the display. Confirm the message using the READ button (A).

Important!

Repeated use of the parking heater in combination with short trips can lead to battery discharge and thereby difficulty starting.

If the heater is used regularly, the car should be driven for the same amount of time as the heater was used in order to ensure that the generator is able to produce enough energy to compensate for the amount consumed.

Interior

Front seats	68
Rear seats	72
Interior lighting	74
Storage compartments in the passenger compartment	76
Cargo compartmen	80
cargo compartment	85
Warning triangle (certain countries)	86

Front seats

Height adjustment – front seat

The front edges of the driver's and passenger seats can be adjusted to seven different settings and the rear edges to nine different settings.

Front control (A): Adjusting the front edge of the seat.

Rear control (B): Adjusting the rear edge of the seat.

Front-rear adjustment

The seat can be moved front or back when the bracket is lifted.

Check that the seat has locked into position after adjusting.

WARNING!

Adjust the seat before you begin driving.

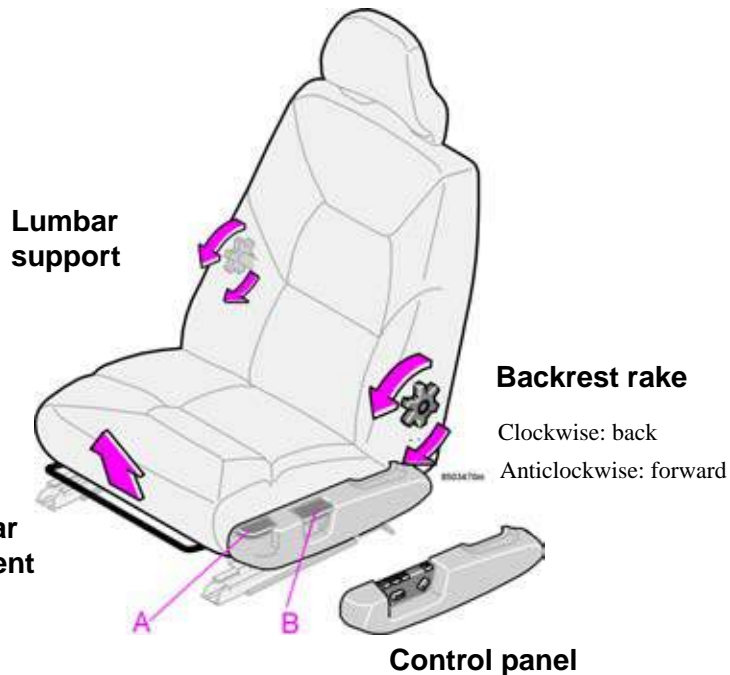

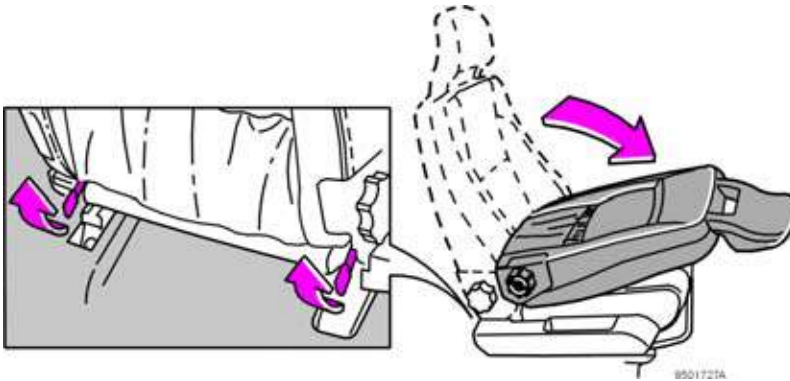

Lowering the front seat backrest

The front passenger seat backrest can be folded to a horizontal position to make room for a long load. Fold the backrest as follows:

- Move the seat as far back as possible.
- Adjust the backrest to the upright position.
- Lift the catches on the rear of the backrest.
- Fold the backrest forward.

Power seat (option)

Preparations

Passenger seat: The seat can only be adjusted if the ignition key is in position I or II.

Driver's seat: The seat can be adjusted if the ignition key is in position I or II. It can also be adjusted in the following circumstances:

1. Within 40 seconds of the ignition key being turned to position 0 or removed from the ignition switch.
2. After you have unlocked the driver's door with the key or remote control, the driver's seat can be adjusted during a 10 minute period **if the door remains open**. If the door is closed, the seat can be adjusted for 40 seconds.

The ignition key can be in position 0 or not yet inserted in the ignition switch.

Memory function in the remote control (option)

When you change the position of the driver's seat, the new setting is saved in the remote control when you lock the car door. The next time you unlock the car using that remote control and open the driver's door within two minutes, the driver's seat will assume its stored position. This only applies to the two remote controls that are delivered with the car, page 88.

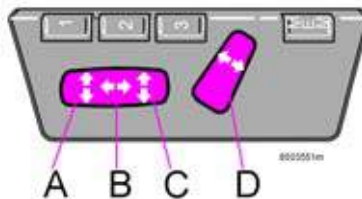

Seat adjustment

If your Volvo is equipped with power seats, the following may be adjusted with the two switches at the side of the seat:

- A. Height of seat front edge
- B. Front - rear
- C. Height of seat rear edge
- D. Backrest rake

NOTE! The power seats have an overload protector that activates if a seat is blocked by any object. If this occurs, switch off the ignition (key in position 0) and wait about 20 seconds before using the seat again.

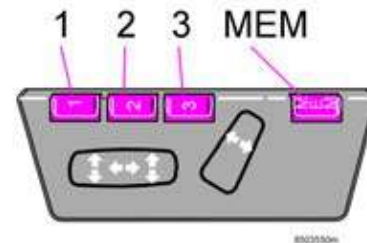

Seats with memory function (option)

Three positions can be stored. After adjusting the seat and the door mirrors, hold the MEM button depressed while pressing button 1. Further seat and door mirror settings can be stored in the memory using buttons 2 and 3.

Setting preset positions

Hold memory button 1, 2 or 3 pressed until the seat stops.

For reasons of safety, the seat will stop moving if one of the setting buttons is released.

Emergency stop

If the seat accidentally begins to move, press one of the buttons to stop the seat.



WARNING!

When adjusting, ensure that there are no objects in front of or behind the seat. Ensure that none of the rear seat passengers will be pinched. To avoid this possibility, ensure that children do not play with the switches.

Rear seats

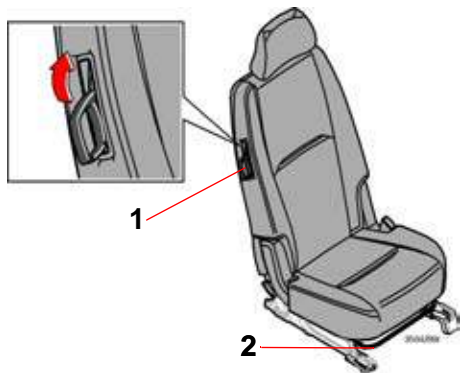

Rear seats – second row (cars seating seven)

Lowering the backrest for entry into the car

- Lift/pull the handle (1) up while pushing the backrest forward. Do the reverse to return the seat to its original position.

Adjusting the seat front - rear

- Lift the bracket (2) to move the seat front or back.

Sliding seat (cars seating seven)

The centre seat in the second row can be slid farther forward than the other seats. Sliding the seat completely forward improves contact between a child sitting on the integrated booster cushion and front seat occupants.

Lift the bracket (A) to move the seat front or back.

Removing the centre console

The centre console must first be removed if you wish to slide the centre seat in the second row forward.

- Remove the centre console by pulling the catch straight out as illustrated above.
- Then lift the console out of the way.



 **WARNING!**

The lowest position should only be used when the backrest is to be folded down or when no one is sitting in this seat. After raising the backrests in the second and third row of seats, it is important to make sure that the backrests have locked into place. Otherwise the protective system of the seats may be compromised.

Rear seat head restraint – centre seat

The centre seat head restraint can be adjusted to four different heights. Slide the head restraint up as desired. Press in the release button to lower it. See illustration!

Note that the head restraint cannot be removed completely!

Interior lighting



General lighting

General lighting can be switched on and off in all situations by briefly pressing the centre button. General lighting has a built-in automatic function, which means that it lights up and remains lit for 30 seconds or 10 minutes if the engine is switched off.

General lighting lights up and remains lit for 30 seconds when you...

- unlock the car from the outside using the key or remote control.
- stop the engine and turn the ignition key to position 0.

General lighting lights up and remains lit for 10 minutes when...

- one of the doors is open.
- unless general lighting is switched off.

General lighting goes out when...

- the engine is started.
- you lock the car from outside using the key or remote control.

General lighting can be switched on or off in all situations by briefly pressing the button.

Unless switched off manually, general lighting goes out automatically 10 minutes after the engine is switched off.

You can switch off the timer by pressing the button for more than 3 seconds. When you then briefly press the button again, the timer reconnects.

The pre-programmed times of 30 seconds and 10 minutes can be changed. Contact an authorised Volvo workshop.



Reading lamps

Reading lamps can be switched on or off by pressing the respective button. For cars seating seven, both reading lamps for the third row of seats are switched on or off when one of the buttons is pressed. Unless switched off manually, reading lamps are switched off automatically 10 minutes after the ignition is switched off.

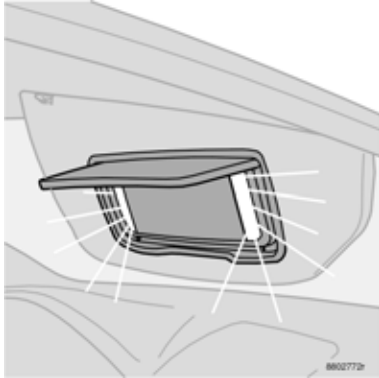

Floor mats

Volvo offers floor mats specially manufactured for your car. They must be properly placed and secured in the mat clips so that they do not get caught in or under the pedals at the driver's seat.

Vanity mirror

The lamp comes on when you open the cover.

Storage compartments in the passenger compartment

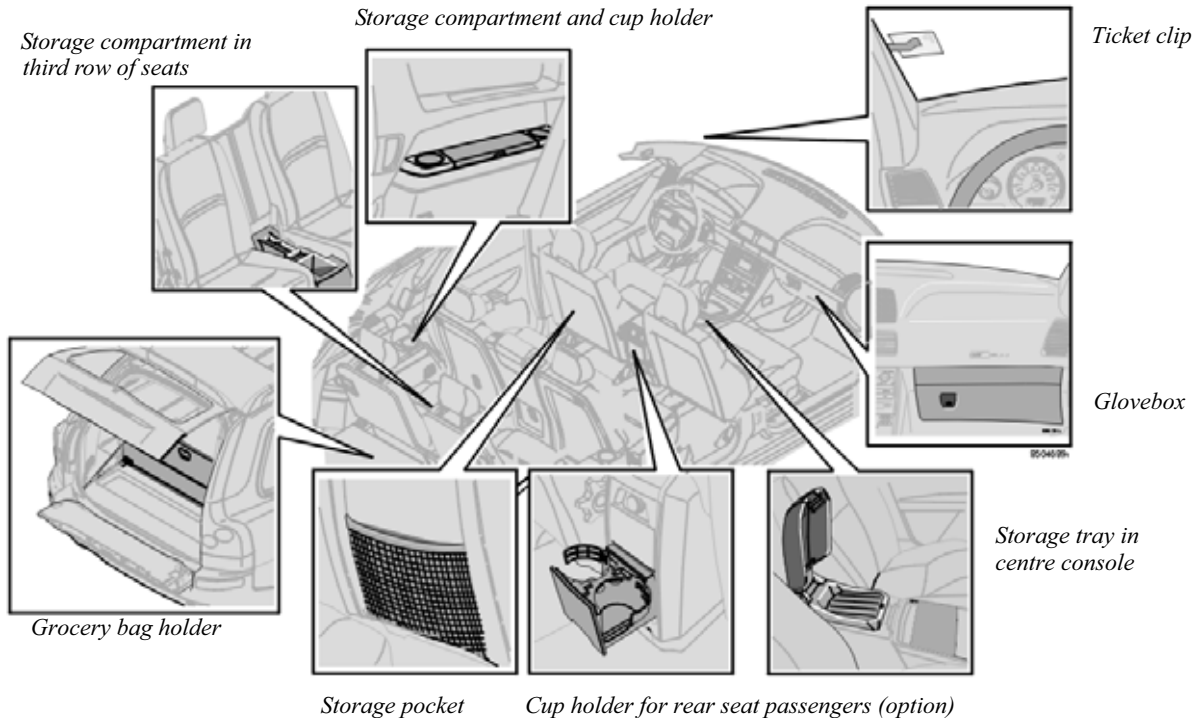

 **WARNING!**

Make sure that no hard, sharp or heavy objects lie or protrude in such a way that they could cause injuries during heavy braking. Always secure large, heavy loads with one of the seat belts.



Pen holder

The dashboard contains a compartment for pens.



Glovebox

The glovebox can be used to store things such as the Owner's Manual, maps, pens and petrol cards.



Coat hanger

Use the coat hanger for clothes of normal weight.

Storage compartments in the passenger compartment (Contd)



Ashtray for rear seat passengers (option)

Open the ashtray by pulling the top edge outwards.

To empty:

- Open the ashtray.
- Press the cover outwards and tip it back.
- Then lift it out.

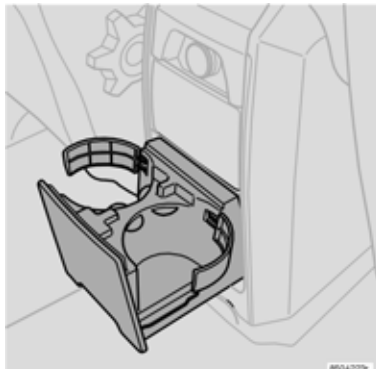

Cup/bottle holder for rear seat passengers (option)

Pull the bottom edge of the insert to open. The cup holder insert can be removed: Detach the two clips so the holder can be used for large bottles.



Storage compartment and cup holder (cars seating seven)

This storage compartment can be used for CDs, books and the like.



Centre console centre console

The centre console contains a storage tray for food and drinks, for example. The armrest can be folded back to make a "table" for rear seat passengers.

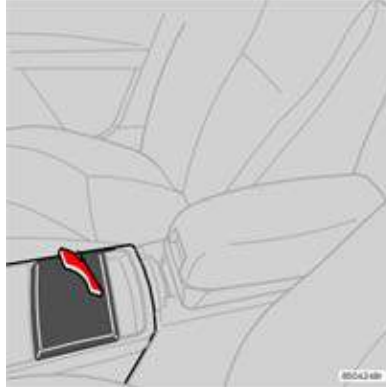

Cup holder

Cup holder for front seat passengers.

Ashtray (option)

Pull out the insert to empty the astray.



Storage compartment in the third row of seats (cars seating seven)

This storage compartment can be used for pens and other small items.

Cargo compartmen

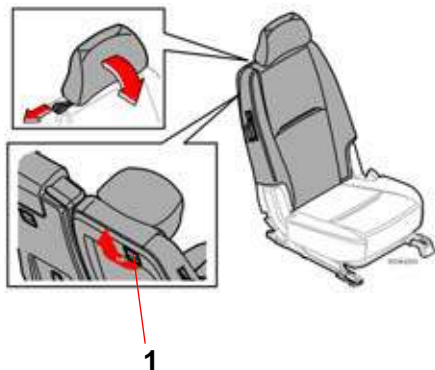

Extending the cargo compartment – second row of seats

1. Set the seats in their rearmost positions (applies only to cars seating seven).
2. Lower the head restraint.
3. Release the catch (1) and fold down the backrest. Press down to lock the backrest in its folded position.

WARNING!

For reasons of safety, no passengers should sit in the third row of seats if the outer head restraints in the second row are lowered.

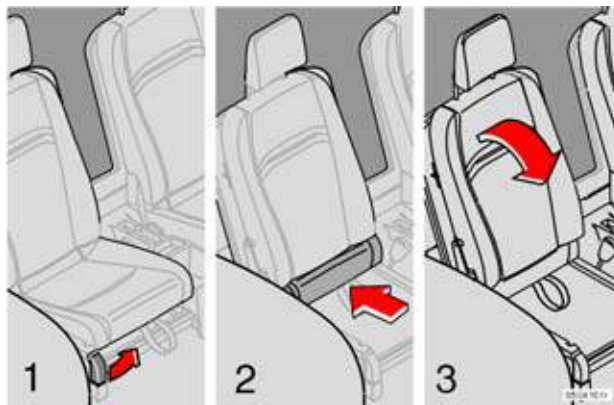

Extending the cargo compartment – third row of seats (cars seating seven)

Place the rear seats in the entrance/exit position., see page 72.

1. Pull the handle up.
2. Slide the seat cushion to its rearmost position. Fold in the right and left-hand cargo eyes in order to avoid damage when lowering the backrest.
3. Fold down the backrest (The head restraint folds in automatically when the backrest is folded).

Repositioning the seats in the third row

- Raise the backrest to its normal position.
- Take hold of the eyes and pull out the seat cushion until you hear a click.
- The seat is now secured in its normal position.

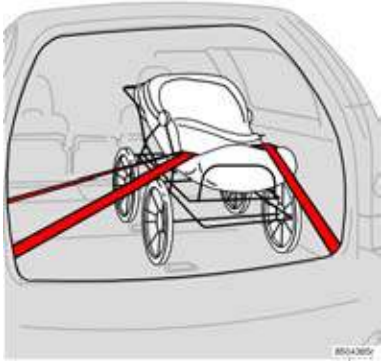

Loading the cargo compartment

The seat belts and airbags provide the driver and passengers substantial protection, especially in head-on collisions. But, you must also remember to protect yourself from injuries from behind. When loading cargo, bear in mind that improperly secured or incorrectly loaded objects in the cargo compartment could be thrown forward with great speed and force in the event of a collision or sudden braking, causing serious injuries.

Bear in mind that if an object weighing 20 kg is subjected to a head-on collision at a speed of 50 km/h, its impact weight will be 1000 kg.

Think about the following when loading:

- Place the load by the backrest.
- Position heavy loads as low as possible.

- Position wide loads on each side of the division in the backrest.
- Secure the load with retaining straps using the car's lashing eyes.
- Never load above the backrest without a load net.

WARNING!

- Do not load extremely heavy objects up by the front seats. The lowered backrest will be pressed down unnecessarily hard.
- Never load cargo above the backrests! If you do so, the load could be thrown forward in the event of sudden braking or a collision and severely injure you or your passengers. Remember to always secure (bind) the load properly.
- If the rear seat backrest is lowered, do not load the car higher than 50 mm under the top edge of the rear passenger windows. Leave 10 cm of free space from the windows inwards. Otherwise, the intended protection of the inflatable curtain, which is hidden in the headlining, may be compromised.

WARNING!

- Always secure the load. During heavy braking the load may otherwise shift, causing personal injury.
- Cover sharp edges with something soft.
- Turn off the engine and apply the parking brake when loading or unloading long objects! You may accidentally knock the gear lever or gear selector with the load and cause a gear to engage and the car to move off.

Cargo compartment (Contd)

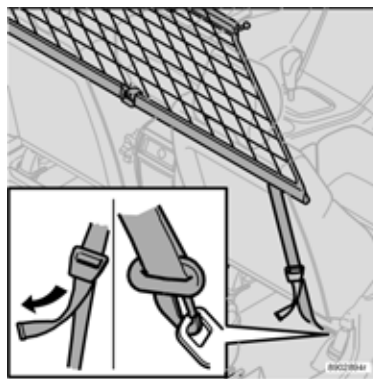

Safety net

The safety net prevents luggage and cargo from being thrown forward in the passenger compartment during heavy braking.

The net is made of a strong nylon fabric and can be secured two different ways:

1. Behind the rear seat backrest
2. Behind the front seats if the rear seat is lowered.

Fitting the safety net

1. If the car is equipped with a privacy panel, remove it before fitting the safety net.
2. Hook the upper rod in the front or rear roof mounting.

3. Hook the other end of the rod in the roof mounting on the other side.
4. Secure the safety net anchoring straps in the eyes on the floor if the net is secured in the rear roof mountings.
Use the eyes in the seat slide rail if the net is secured in the front roof mountings.

Applies only to cars seating seven:

- Make sure the net lies in front of the side panel armrest when securing.
5. Tension the safety net using the anchoring straps.

Folding up the safety net

The safety net can be folded up and placed in the cargo compartment floor (for cars seating five).

- Press the buttons (1) in the safety net hinges to release the hinges and fold up the net.

WARNING!

- Make sure that the upper mountings of the safety net are correctly fitted and that the anchoring straps are securely fastened.
- Do not use a damaged net.

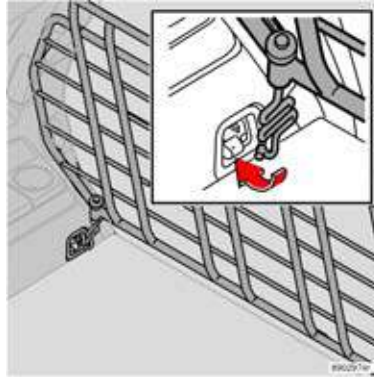
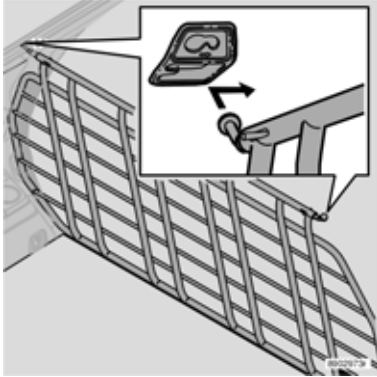

⚠ WARNING!

For cars seating seven: For reasons of safety, no passengers should sit in the third row of seats if the protective grille is positioned behind the second row of seats.

Protective steel grille (option)

The protective grille in the cargo compartment prevents cargo or pets from being thrown forward in the passenger compartment in the event of heavy braking.

For reasons of safety, the protective grille must always be mounted and secured correctly.

Fit the protective grille as follows:

1. Lift in the protective grille through the tailgate opening or one of the rear doorways (fold down the seats in the second row if necessary).
2. Insert one of the protective grille mountings in its bracket above the rear door behind the second row of seats.
3. Slide the protective grille mounting to the front position of the bracket.
4. Place the other protective grille mounting in its bracket above the other rear door and slide it to the front position.
5. Insert the attaching brace through the lower mounting in the protective grille from underneath, as indicated in the illustration.
6. Fit the spring on the attaching brace and screw in the knob.
7. Fit the attaching brace hook in the load anchorage and tighten the knob until the attaching brace takes hold in the load anchorage.
8. Do the same on the other side.
9. Tighten both attaching braces alternately.
10. Fit protective caps on the exposed screw threads above the knobs.

Cargo compartmen (Contd)

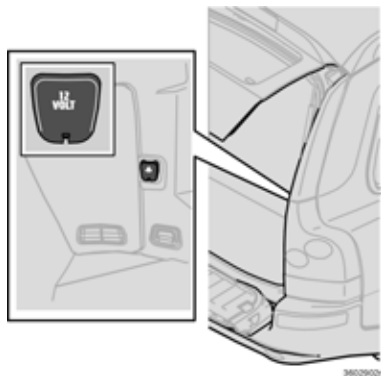

Electric socket in the cargo compartment

Slide down the cover when you wish to use the socket. It works regardless of whether the ignition is on or off.

If the ignition is switched off and a load with power consumption greater than 0.1 A is connected to the electric socket, a warning message is shown in the display.

The maximum current for the electric socket is 15 A.

Do not use the electric socket with the ignition switched off as there is a risk of the battery becoming discharged.

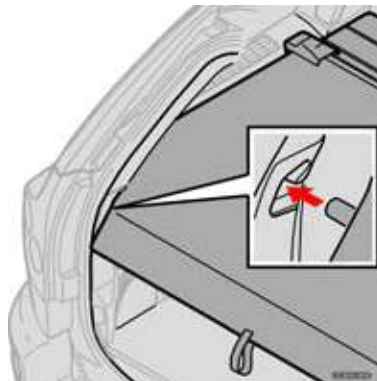

Privacy panel (option 7-seat)

Pull out the privacy panel, pull it over the cargo and hook it into the holes in the rear pillars of the cargo compartment.

Removing the privacy panel

Press the end pieces of the privacy panel inwards, pull up and release. When fitting, press the end pieces of the privacy panel down into the holders.

WARNING!

Do not place objects on the privacy panel. They could injure passengers during braking or evasive manoeuvres.

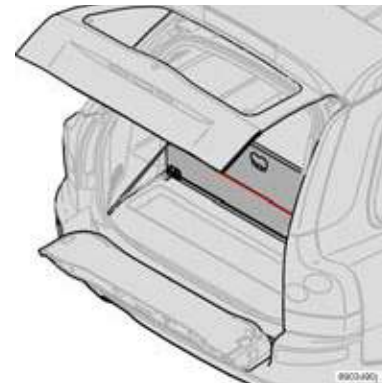

Grocery bag holder

Open the tailgate. Hang or secure your grocery bags using the tensioning straps or holders.

Cargo compartment

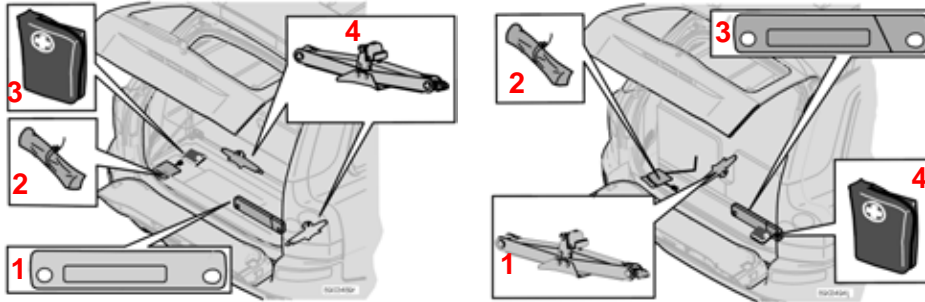

NOTE! Do not put anything in the area the cushions fold into. Cushions and seat mechanisms could be damaged.

Cars seating five

Compartment in cargo compartment floor (cars seating five)

- Lift up the hatch in the cargo compartment floor.

If the car is equipped with a grocery bag holder:

- Lift the floor hatch and loosen the grocery bag holder retaining straps.

The following is housed in the floor compartment:

1. Warning triangle (certain markets)
2. Tool kit
3. First-aid kit (certain markets)
4. Jack (alternate location)

Cars seating seven

Compartment in cargo compartment floor (cars seating seven)

- Lift up the floor hatch.

If the car is equipped with a grocery bag holder:

- Raise the upper floor hatch, loosen the retaining straps of the grocery bag holder and raise the lower floor hatch.

The following is housed in the floor compartment:

1. Jack
2. Tool kit
3. Warning triangle
4. First-aid kit

Warning triangle (certain countries)

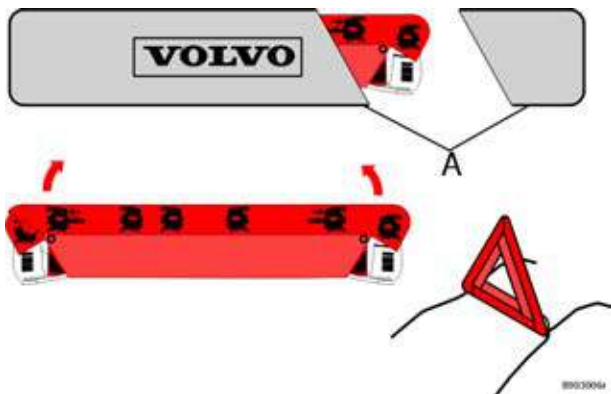

Warning triangle

Follow the warning triangle regulations of the country you are in.

Do as follows to use the warning triangle:

- Detach the warning triangle case. It is held in place with a velcro strap.
- Remove the warning triangle from its case (A).
- Fold out the four support legs on the warning triangle.
- Fold out both red sides of the warning triangle. Place the warning triangle in a location that is appropriate for the traffic situation.

After use:

- Pack everything in reverse order.
- Make sure that the warning triangle with case is securely fastened in the compartment.

Locks and alarm

Keys and remote control	88
Locking and unlocking	90
Child safety locks	93
The alarm system	95

Keys and remote control

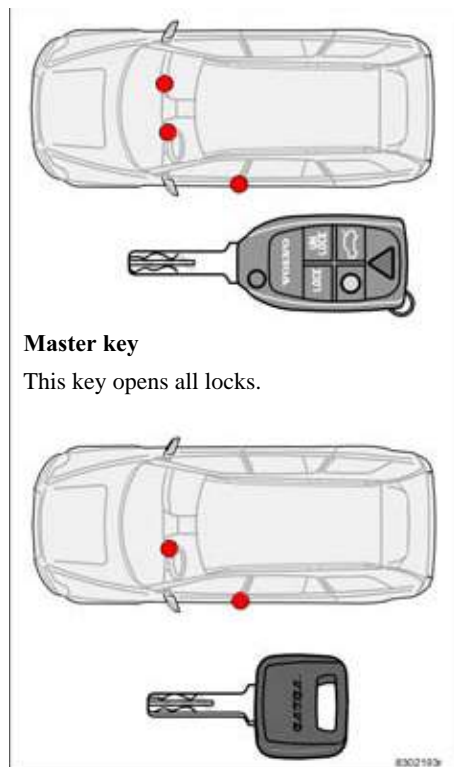

Master key

This key opens all locks.

Service key*

Key to front door, ignition switch and steering wheel lock.

*: certain markets only

Keys – Immobilizer

Your car is delivered with two master keys and one service key. One of the master keys is foldable and equipped with an integrated remote control.

If you lose one of your keys, take all other keys to an authorised Volvo workshop. As a crime prevention measure, the code of the lost key is erased from the system. At the same time, the other keys must be re-coded in the system.

The mechanical key codes are recorded on a separate label accompanying the keys. Store the label in a safe place. Take the label to your Volvo dealer if you wish to order new keys. A maximum of six remote controls/keys can be programmed and used.

Immobilizer

The keys are equipped with coded chips. This code must match the reader in the ignition switch. The car can only be started if the correct key with the correct code is used.

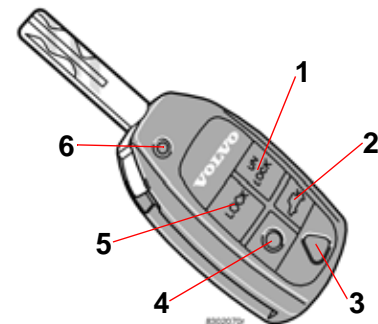

- 1. Unlock
- 2. Open tailgate
- 3. Alarm function
- 4. Approach lighting
- 5. Lock
- 6. Fold/open key

Remote control functions

1. Unlocking

Button 1 unlocks all doors, the tailgate and the fuel filler flap.

2. Tailgate

Press button 2 to unlock the tailgate only.

3. Alarm function

The alarm function can be used to attract attention during emergency situations. If the red (3) button is held for at least 3 seconds or pressed twice in succession during the same amount of time, the direction indicators, interior lighting and horn will be activated. The alarm

can be deactivated with any of the remote control buttons or it will shut off automatically after 25 seconds.

4. Approach lighting

Do as follows when approaching your car:

- Press the yellow button (4) on the remote control.

The interior lighting, position/parking lamps, numberplate lighting, door mirror lamps (option) and trailer lighting will switch on and remain lit for 30, 60 or 90 seconds. Your authorised Volvo workshop can select a suitable time setting for your car.

To switch off the home safe lighting:

- Press the yellow button again.

5. Locking

Lock all doors, tailgate and fuel filler flap with button 5. There is a delay of approx. 10 minutes for the fuel filler flap.

6. Folding/opening key

The key can be folded by pressing button 6 while folding the key blade into the keypad.

The folding key will open automatically with one press of the button.

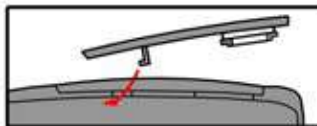
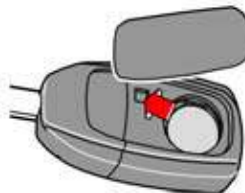

Changing the remote control battery

If the locks repeatedly fail to react to signals from the remote control at a normal distance, the battery should be replaced.

- Remove the cover by carefully prising up the rear edge of with a small screwdriver.
- Change the battery (type CR 2032, 3 volt); – the plus side should face up. Avoid touching the battery and its contact surfaces with your fingers.
- Refit the cover. Make sure the rubber seal is properly fitted and free from damage to prevent water from entering.
- Turn the old battery in to your Volvo workshop so that it is disposed of in an environmentally friendly way.

Locking and unlocking

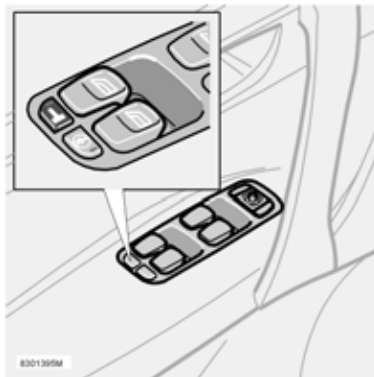

Locking and unlocking the car from the outside

Using the master key or its remote control, all doors and the tailgate can be unlocked simultaneously – from the outside –. In this mode, the door lock buttons and interior door handles are inoperative.

The fuel filler flap can be opened when the car is unlocked. The flap remains unlocked for 10 minutes after the car has been locked.

Locking and unlocking the car from the inside

Using the control in the door panel, you can lock or unlock all doors and the tailgate simultaneously.

All doors can also be locked or unlocked with the lock buttons.

The above applies only if the car was not locked from the outside!

Locking the glove box

The glovebox can be locked /opened with the master key only – not with the service key.

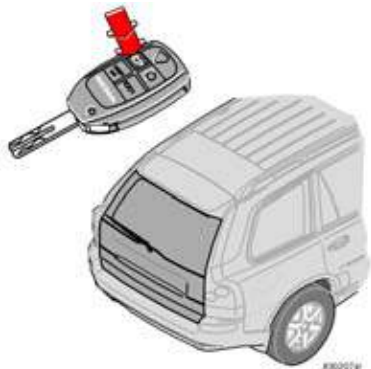

Automatic re-locking

If none of the doors or the tailgate are opened within two minutes of unlocking from the outside with the remote control, all locks re-lock automatically. This function prevents you from unintentionally leaving the car unlocked.

For cars with alarms, see page 95.

Locking/unlocking the tailgate with the remote control

Do as follows to unlock the tailgate only:

- Press the button on the remote control (see illustration) slowly twice within 3 seconds.
- If all doors are locked when you close the tailgate, it remains unlocked and its alarm is not armed when you close it. The other doors remain locked with their alarms armed.
- To arm the alarm and lock the tailgate only when you close it, press the LOCK button again.

NOTE! If you use this button to unlock the tailgate, but do *not* open it, the tailgate will re-lock automatically after two minutes.

Locking and unlocking (Contd)

Deadlocks

Your car has a special deadlock function, which means that the doors cannot be opened from the inside if they are locked.

Deadlocks can only be activated from the outside by the driver's door being locked with the key or remote control. All doors must be closed before deadlocks can be activated. Once activated, the doors cannot be opened from the inside. The car can only be unlocked from the outside via the driver's door or by using the remote control.

Deadlocks are engaged after a 25 second delay once the the doors are locked.

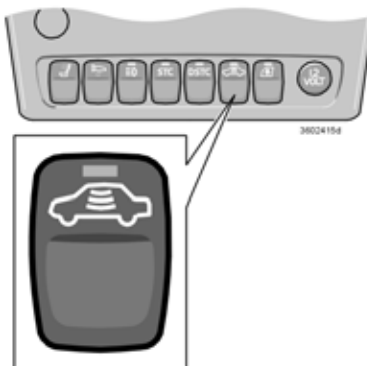

Temporary deactivation of deadlocks and any detectors.

If others prefer to remain seated in the car with the doors locked from the outside – e.g. during transport by ferry, – it is possible to deactivate the deadlocks.

- Insert the key in the ignition switch, turn it to position II and then back to position I or 0.
- Press the button (see illustration).

If the car is equipped with an alarm, movement and tilt detectors are also deactivated. See page 96.

The LED in the button lights until you lock the car with the key or remote control. A message is shown in the display as long as the key remains in the ignition switch. The sensors will be reactivated the next time you switch on the ignition.



WARNING!

Do not allow anyone to remain in the car without first deactivating the deadlock.

Child safety locks

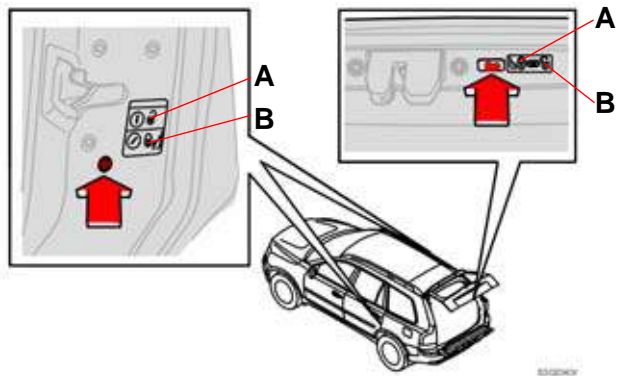

Manual child safety locks – rear doors and tailgate

The controls for the child safety locks are in the rear edges of the rear doors and the bottom edge of the tailgate (certain markets). Each control is only accessible when the door or tailgate is open. Use the ignition key to turn the control, thereby activating or deactivating the child safety lock.

- A. The door can be opened from inside.
- B. The door cannot be opened from inside.

WARNING!

Remember that in the event of an accident, rear seat passengers cannot open rear doors from the inside if the child safety locks are activated. **Therefore, keep the doors unlocked while driving.** In the event of an accident, rescue personnel will then be able to quickly get into the car from the outside.

Child safety locks (Contd)

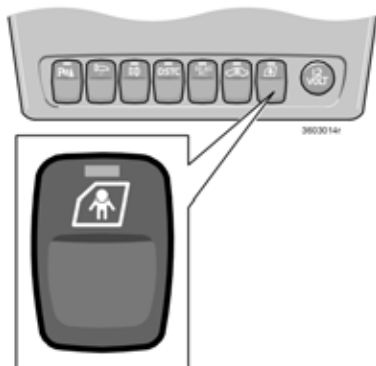

NOTE! All settings in the manual child safety system are set aside when you **activate** the electric child safety locks.

Electric child safety locks – rear doors (option - certain markets)

Use the button in the centre console to activate or deactivate the child safety locks in the rear doors. The ignition key must be in position I or II. The LED in the button comes on when the child safety lock is activated. A message appears in the display when you activate or deactivate the child safety lock.

NOTE! The rear doors cannot be opened from the inside as long as the **electric** child safety locks are activated.

The alarm system

When the alarm is connected, it continually monitors all alarm points. The alarm is triggered if...

- the bonnet is opened
- the tailgate is opened
- a side door is opened
- the ignition switch is turned with a non-approved key or subjected to force
- if movement is detected in the passenger compartment
- the car is raised or towed away (if fitted with a tilt detector – option)
- the battery cable is disconnected
- anyone tries to disconnect the siren.

Activating the alarm

Press the LOCK button on the remote control. A long flash from the car's direction indicators confirms that the alarm is armed and that all doors are closed.

Deactivating the alarm

Press the UNLOCK button on the remote control. Two short flashes from the car's direction indicators confirm that the alarm has been deactivated.

Automatic alarm activation

If none of the doors or the tailgate is opened within two minutes of the alarm being deactivated, and the car was unlocked with the remote control, the car reactivates the alarm automatically. The car locks at the same time. This function prevents you from accidentally leaving the car without the alarm on.

Automatic alarm activation

In certain countries (e.g. Belgium, Israel) the alarm is activated after a certain delay if the driver's door was opened and closed but the car was not re-locked.

Deactivating a triggered alarm

Press the UNLOCK button on the remote control if the alarm sounds and you wish to deactivate it. Two short flashes of the direction indicators are given as confirmation.

Alarm signals

An audible signal is given from a siren with a reserve battery. Each alarm signal lasts 25 seconds.

When the alarm is triggered, all direction indicators flash for 5 minutes or until the alarm is deactivated as described earlier.

NOTE! Even if your remote control does not work or you have lost it, you can start the car as follows: open the driver's door with the key. The alarm is triggered and the siren sounds. Start the car as usual. The alarm will then be deactivated.

The alarm system (Contd)



Temporary deactivation of detectors and deadlocks

To avoid inadvertently triggering the alarm, for example when leaving a dog in the car or during a ferry crossing, the movement and tilt detectors can be temporarily deactivated:

- Insert the key in the ignition switch, turn it to position II and then back to position I or 0.
- Press the button.

The LED in the button lights until you lock the car with the key or remote control.

A message is shown in the display as long as the key remains in the ignition switch. This

temporary deactivation ends the next time you switch on the ignition.

If your car has deadlocks, they are reactivated at the same time. See page 92.

Alarm LED in the dashboard

An alarm LED at the top of the dashboard (see illustration) indicates the status of the alarm system:

- Lamp not lit: Alarm is deactivated.
- Lamp flashes once a second: The alarm is activated.
- Lamp flashes quickly, after deactivating the alarm and until the ignition is switched on: The alarm has been triggered.
- If a fault has occurred in the alarm system, a message is shown in the display.
If the alarm system does not function properly, have your car checked by an authorised Volvo workshop.

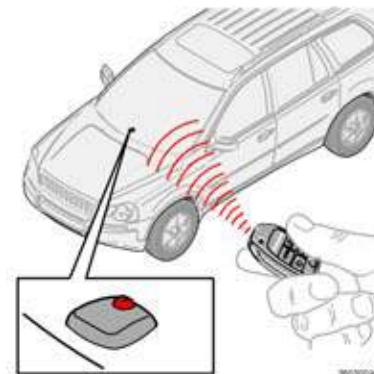

WARNING!

Do not attempt to repair or modify alarm system components. All such attempts may affect terms of insurance.

Starting and driving

General	98
Refuelling	100
Starting the car	101
Manual gearbox	102
Automatic gearbox AW5 and GM with Geartronic	103
All-wheel drive	105
Brake system	106
Stability system	108
Parking assistance system (option)	110
Towing	111
Jump starting	112
Driving with a trailer	113
Towing bracket (option)	115
Load on the roof	119

General

Economical driving

Economical driving results from driving gently with anticipation and adapting your driving style and speed to the situation.

Keep in mind the following:

- Drive the engine to operating temperature as soon as possible! That is to say: do not let the engine idle, but drive with a light load as soon as you can.
- A cold engine consumes more fuel than a warm one.
- Avoid driving short distances where the engine never has time to reach operating temperature.
- Drive gently! Avoid unnecessary quick accelerations and heavy braking.
- Do not drive with unnecessary, heavy loads in the car.
- Do not use winter tyres when the roads are clear and dry.
- Remove the load carrier when it is not in use.
- Do not open side windows unnecessarily.

Your new car – slippery road surfaces

Driving in slippery conditions may feel different depending on whether your car has a manual or an automatic gearbox. Practice driving in mock slippery conditions in order to determine how your new car will react.

Driving on rough roads

The Volvo XC90 is primarily designed for driving on main roads, but also has good handling properties on uneven or rough roads. Keep the following in mind in order to preserve the service life of your car:

- Drive slowly on rough roads so you do not damage the car's underbody.
- If the ground is loose or is made up of dry sand or snow, it is always best to keep the car moving at all times and avoid shifting. Do not stop the car.
- If the road is extremely steep and there is a risk of overturning, never try to turn the car around. Reverse back down. Do not drive diagonally across an incline. Drive in the direction of the incline.

NOTE! Avoid driving on steep slopes with a low fuel level. The catalytic converter may be damaged if the engine does not receive a sufficient supply of fuel.

When driving on extremely steep inclines, make sure that the tank is at least half full so as not to risk engine malfunction.

Wading

The car can be driven through water with a depth of no more than 48 cm.

NOTE! In greater depths, water can enter the differentials and the transmission. This reduces the lubricating ability of the oil and shortens the service life of the systems.

When driving through shallow water, maintain a low speed and do not stop the car. Once you have passed through the water, apply a light pressure to the brake pedal and check brake function. Water, mud and the like can dampen brake linings, resulting in delayed braking action.

Clean the electric contacts of the electric engine heater and trailer coupling after driving in water and mud.

NOTE! Do not let the car stand with water over the sills for any long period of time. This could cause electrical malfunctions.

Power consumption – saving energy

The electrical functions of the car load the battery to varying degrees. Avoid leaving the ignition key in position II when the engine is switched off. Use position I instead. Less power will then be consumed.

Examples of functions that draw a lot of current are: fan, windscreen wipers, audio system (high volume) and parking lamp. Be aware of different accessories that load the electrical system. Do not use functions that draw a lot of current when the engine is switched off.

If the battery charge is low, a message is shown in the display. You should charge the battery by starting the engine.

Do not allow the engine and cooling system to overheat

Under certain conditions, e.g. when driving in hilly terrain or with a heavy load, especially in warm weather, there is a risk of the engine and cooling system overheating.

To avoid the cooling system overheating

- Drive at low speeds if driving with a trailer up a long incline.
- Do not turn the engine off immediately you stop, if the car has been driven hard.
- Remove any auxiliary lamps from in front of the grille if driving in extreme high temperatures.

To avoid the engine overheating

Do not exceed engine speeds of 4500 rpm if driving with a trailer or caravan in hilly terrain. The oil temperature can become too high.

Do not drive with an open tailgate!

If you drive with the tailgate open, some of the exhaust gases and poisonous carbon monoxide could be sucked into the car through the cargo compartment. If you must drive a short distance with the tailgate open, do as follows:

- Close all windows.
- Distribute the air between the windscreen and floor while running the fan at high speed.

Automatic gearbox

Cold start

When starting in low temperatures, shifting may feel harder. This is due to viscosity of the gearbox oil at low temperatures.

To minimise engine emissions, the gearbox shifts up later than normal if the engine has been started at low temperature.

When the engine is cold, the transmission shifts gears at higher engine speeds than normal. This is to help the catalytic converter reach normal operating temperature quickly.

Adaptive systems

The gearbox is controlled by "adaptive systems". The control module continually "learns" how the gearbox behaves. It senses how the gearbox shifts gears and achieves optimal gear shifts each time. The control module also senses the way you drive, such as how hard you depress the accelerator, and adjusts the sensitivity of the shift schedule to your driving style.

Safety systems

Cars with automatic gearbox have special safety systems:

Keylock

The ignition key must be in position I to move the gear selector from position P to other gear positions. The gear selector must be in position P to remove the ignition key after driving.

Shiftlock

The brake pedal must be depressed to move the gear selector from position P to other gear positions when the key is in position I or II.

If you have started the engine and the car remains stationary:

Hold your foot on the brake pedal when moving the gear selector to another position.

Refuelling



Opening the fuel filler flap

The fuel filler flap can be opened when the car is unlocked.

NOTE! The filler flap remains unlocked for ten minutes after the car is locked. It then locks automatically.

Fuel cap

The fuel cap is inside the fuel filler flap on the right rear wing.

There may be overpressure in the tank if outdoor temperatures are high. Open the cap slowly. Do not overfill the fuel tank. Stop refuelling when the pump cuts out for the first time! If the tank is overfilled fuel may overflow at high temperatures!

After refuelling, replace the fuel cap and turn until one or more clicks is heard.



WARNING!

Always **switch off** your mobile telephone during refuelling – the ring signal can cause sparks which may ignite petrol fumes and lead to fires or personal injury.

Refuelling

NOTE! Do not add cleaning additives yourself unless specifically recommended to do so by a Volvo workshop.

Important!

Petrol-powered cars must always be refuelled with unleaded petrol so as not to damage the catalytic converter.

Filling up with diesel

At low temperatures, paraffin can precipitate out of diesel fuel (-5°C – -40°C). This can cause problems when starting. Make sure you use a special winter grade fuel during cold periods.

Starting the car

Starting the engine (petrol)

1. Depress the parking brake.
2. **Automatic gearbox:** Gear selector in position P or N.
Manual gearbox: Gear lever in neutral and the clutch pedal completely depressed. This is especially important in severe cold.
3. Turn the ignition key to the start position. If the engine does not start within 5-10 seconds, release the key and try again.

NOTE! Depending on the engine temperature at the time of the start attempt, engine speed after a cold start may be higher than normal – for a short time period – for certain engine types. This is because Volvo strives to minimise exhaust emissions by having the engine exhaust system reach the correct operating temperature as quickly as possible.

Starting the engine (Diesel)

1. Depress the parking brake.
2. **Automatic gearbox:** Gear selector in position P or N.
Manual gearbox: Gear lever in neutral and the clutch pedal completely depressed. This is especially important in severe cold.
3. Turn the ignition key to the driving position. An lamp on the combined instrument panel will come on indicating that the engine preheater is activated. Turn the key to the start position when the lamp extinguishes.

Ignition keys and immobilizer

Do not let several ignition keys, each containing a chip, dangle on the same keyring when inserting the key in the ignition switch. The immobilizer could be activated. If this happens, take away the excess keys and restart the car.

Never rev the engine hard straight after a cold start! If the engine does not start or misfires, contact your nearest Volvo workshop!



WARNING!

Never switch off the ignition (position 0 or 1) or remove the ignition key when the vehicle is in motion. This could activate the steering wheel lock, making the car impossible to steer.

Always remove the ignition key from the ignition switch before leaving the vehicle – especially if children remain in the car.

Ignition switch and steering wheel lock

0 – Locked position

The steering wheel locks when the ignition key is removed.

I – Intermediate position - "radio position"

Certain electrical components can be connected. The engine electrical system is not connected.

II – Driving position

The key position when driving. The car's entire electrical system is connected.

III – Start position

The starter motor is connected. Release the key once the engine has started. The key automatically springs back to the driving position. If the key is hard to turn, the front wheels may be turned in such a way that there is tension in the steering wheel lock. Turn the wheel back and forth to make it easier to turn the key.

Make sure the steering wheel locks when you leave the car. This reduces the risk of theft.

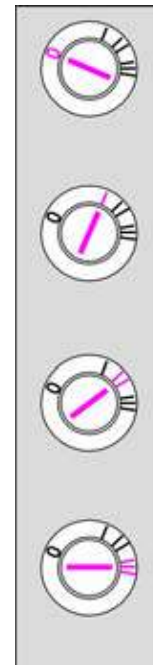

Manual gearbox



Gear positions

Depress the clutch pedal fully with each gear change. Remove your foot from the clutch pedal between gear changes! Follow the appropriate shifting pattern.

Use 6th gear as often as possible for the best possible fuel economy.

Reverse gear inhibitor

Engage reverse gear when the car is stationary or at very low speeds!

Automatic gearbox AW5 and GM with Geartronic



P – Park

Select this position when you wish to start the engine or park the car.

The car should be stationary when you select P!

In P, the gearbox is mechanically blocked. Apply the parking brake when parking.

R – Reverse

The car should be stationary when you select R!



N – Neutral

N is the neutral position. The engine can be started but no gear is engaged. Apply the parking brake when the car is stationary with **the gear selector in N.**

D – Drive

D is the normal driving position. The car automatically shifts between the different gears of the gearbox based on the level of acceleration and speed. The car should be stationary when selecting **D** from position **R**.

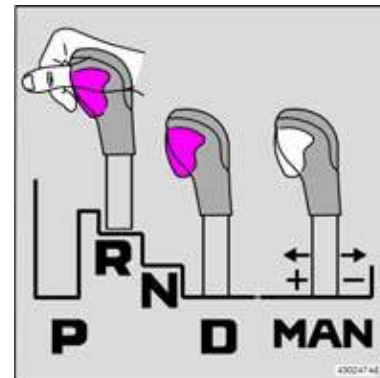

- 5-cylinder turbo engine; 5-speed
- 6-cylinder turbo engine; 4-speed

Gear selector inhibitor

It is always possible to move the gear selector freely forwards and backwards between **N** and **D**. Other positions are locked with a catch which can be controlled with the inhibitor button on the gear selector. Press the inhibitor button to move the gear selector forwards or backwards between **R** and **N** as well as between **D**, **3**, **2** and **L**.

Gear selector manual positions

To move from automatic **D** to the manual gears, press the gear selector to the left. To move from **MAN** back to **D**, press the gear selector to the right to **D**.

Gears 3, 4 and 5 have a lock-up function (locked gears) which provides better engine braking and lower fuel consumption. Only 5-cylinder motors are 5-speed.

While driving

Manual gear positions can be selected at anytime during your trip. The engaged gear is locked until you select another gear. The car will only shift if you slow to a very low speed.

If you move the gear selector to minus (-), the car downshifts automatically one gear at a time while engine braking. If you move the gear selector to plus (+), the car upshifts one gear at a time.

Third gear is the highest gear that can be used when starting.



W – Winter

Use the button to switch the W programme on and off.

Use this programme when starting and driving on slippery surfaces.

The LED in the button is lit when the programme is activated.

W is displayed in the combined instrument panel.

Note that the button is on the left-hand side of the gear lever on right-hand drive cars.



"Kick-down"

When you press the accelerator all the way down – beyond the position normally regarded as full acceleration – a lower gear is automatically engaged. This is called "kick-down" downshifting. When you reach the maximum speed for the gear or release the accelerator pedal from the "kick-down" position, there is an automatic upshift. Use "kick-down" when you want maximum acceleration, such as when overtaking.

The gearbox is equipped with a downshift inhibitor on all gears.

All-wheel drive

AWD – All-Wheel Drive

The all-wheel drive system in your Volvo is constantly engaged and meets very high technical requirements. Used correctly, all-wheel drive provides the driver better control on various road surfaces than conventional rear-wheel drive.

All-wheel drive means that all four road wheels are driven at the same time. Power is automatically distributed between front and rear wheels. An electronically controlled clutch system distributes the power to the pair of wheels that grips best. This provides the best traction and prevents wheel spin.

Under normal driving conditions, the majority of power is transmitted to the front wheels.

The greater traction improves driving safety in rain, snow and icy conditions.

Tyre sizes and pressures

Volvo recommends that you only drive with tyres of the same brand, size, specifications, load designation, and speed designation. Tyre sizes and pressures are specified in the table on the inside of the fuel filler flap and in the Owner's Manual. See page 125.

Snow chains

Snow chains may only be fitted to the front wheels on all-wheel drive cars.

NOTE! To avoid damaging wheel housing components, only use chains specially designed and adapted for Volvo XC90.

Brake system



If a brake circuit fails

The brake pedal can be depressed further and feels softer than usual.

It also requires more pressure on the pedal to achieve a normal braking effect.

The brake servo only works when the engine is running.

If the car is rolling or being towed with the engine switched off, you must apply approximately 5 times more pressure on the brake pedal than when the engine is running. **The brake pedal feels rigid and hard.**

NOTE! When braking with a switched off engine, depress the brake pedal one time hard and distinct – not repeatedly.

Moisture on the brake discs and brake lining alter braking characteristics!

Brake components become wet when the car is driven in heavy rain or through pools of water or when the car is washed. This alters brake pad friction characteristics so that there is a delay before braking effect is noticed. Depress the brake pedal lightly from time to time when driving long distances in rain or slush and before parking your car in such conditions. This helps the brake lining warm up and dry out. You should also do this when driving after washing the car and when starting in damp or cold weather conditions.

If the brakes are heavily loaded

When driving in the Alps or other roads with similar characteristics, the car's brakes are heavily loaded even if you are not pressing the pedal especially hard. Because speed is often low, the brakes are not cooled as effectively as when driving on flat roads.

In order to prevent abnormal brake stress, shift down and use the same gear uphill and downhill instead of using the brake (manual gearbox). Thus, engine braking works more efficiently and brake use will be necessary during short periods only.

Keep in mind that the brakes are even more heavily loaded when driving with a trailer.



Antilock braking system (ABS)

The ABS system (Anti-lock Brake System) is designed so that the wheels do not lock when braking. This retains the best possible steering response when braking. This improves your ability to swerve to avoid obstacles. The ABS system does not increase your total braking capacity. However, as the driver you have increased ability to steer and thus better control over the car, which in turn increases safety.

After the engine has started and reached a speed of about 20 km/h, a short self-test can be both heard and felt. When the ABS system functions, you can hear and feel pulses in the brake pedal. This is completely normal.



NOTE! You must depress the brake pedal fully to take maximum advantage of the ABS system. Do not release the pedal when you hear and feel the ABS pulses. Practice braking with the ABS system in a untrafficked area.

The ABS symbol lights and shines with a constant glow...

- for approximately two seconds when you start the car to test the system.
- if the ABS system has shut down due to a fault.

Electronic Brakeforce Distribution (EBD)

The Electronic Brakeforce Distribution system (EBD) is an integrated part of the ABS system. The EBD system controls the brake force to the rear wheels so that the best possible braking force is always available. Pulses will be heard and felt through the brake pedal when the system regulates brake force.

If the **BRAKE**  and **ABS**  warning symbols light at the same time, there is a risk that the rear end will have a tendency to slide during heavy braking. If the brake fluid level is normal, carefully drive the car to the nearest authorised Volvo workshop to have the brake system checked.

Stability system



DSTC – Dynamic Stability and Traction Control

The Dynamic Stability and Traction Control system (DSTC) comprises several different functions:

- **Traction Control (TC)**

The Traction Control function transfers power from the spinning drive wheel to the drive wheel which has grip by braking the spinning drive wheel. To increase forward traction in this situation, you may need to depress the accelerator more than usual. A pulsing sound is heard when Traction Control is working. This is completely normal. The TC function is most active at low speeds. It cannot be switched off.

- **Stability Control (SC)**

The Stability Control function is designed to prevent the drive wheels from slipping during acceleration by lowering engine torque. This improves navigation and road safety on slippery surfaces. Under certain conditions, such as when driving with snow chains or in deep snow or sand, it may be beneficial to switch off

the SC function to increase traction. This is done using the DSTC button.

- **Active Yaw Control (AYC)**

The Active Yaw Control function automatically brakes one or more of the wheels to stabilise the car in the event of a skid. If you were to depress the brake pedal in this situation, it would feel more rigid than usual and a pulsing sound would be heard. For reasons of safety, the AYC function is always active and cannot be switched off.

- **Roll Stability Control (RSC)**

The Roll Stability Control function automatically brakes one or more wheels. This stabilises the car laterally so as to minimise the risk of overturning due to a skid or the like. If you were to depress the brake pedal in this situation, it would feel more rigid and a pulsing sound would be heard. For reasons of safety, the RSC function is always active and cannot be switched off.

DSTC button

The DSTC button in the centre console is used to reduce or reactivate the DSTC system.

Reducing the system means that the Stability Control (SC) and Active Yaw Control (AYC) functions are reduced. Other functions are not affected.

When the LED in the button is lit, the DSTC system is activated (assuming there is no fault).

NOTE! For reasons of safety, the button must be depressed for at least one half second to reduce the DSTC system function.

NOTE! The LED in the button is extinguished and "DSTC SPIN CONTROL OFF" is shown in the display.

The DSTC system is automatically reactivated each time the engine is started.

The warning symbol flashes when...

- The SC function works to keep the car's drive wheels from slipping.
- The TC function works to improve the car's traction.
- The AYC function works to keep the car from skidding.
- The RSC function works to prevent the car from overturning.

The warning symbol  lights and goes out again after 2 seconds when...

- the car is started. (The lamp lights for a system check.)

The LED in the button goes out and the text "DSTC SPIN CONTROL OFF" is shown in the display when...

- The SC function of the DSTC system has been reduced with the DSTC button.

The warning symbol  shines with a steady amber glow and the text "TRACTION CONTROL TEMPORARILY OFF" is shown in the display when...

- the TC function of the brake system has been temporarily reduced due to high brake temperature. The TC function is reactivated automatically when the brake temperature returns to normal levels.

The warning symbol  shines with a steady amber glow and the text "ANTI-SKID SERVICE REQUIRED" is shown in the display when...

- The DSTC system has shut down due to a fault.

Emergency Brake Assistance (EBA)

The (EBA) function is integrated in the DSTC system and is designed to provide immediate maximum braking force whenever rapid brake application is necessary. The system detects the need for heavier braking by registering how quickly the brake pedal is applied.

The EBA function is active at all speeds. For reasons of safety, it cannot be switched off.

NOTE! When the EBA function is activated, the brake pedal sinks while maximum braking force is applied. Continue braking without releasing the brake pedal. The EBA function disengages when the pressure on the brake pedal is released.

WARNING!

Under normal driving conditions, the DSTC system improves the car's road safety, but this should not be taken as a reason to increase speed. Always follow the usual precautions for safe cornering and driving on slippery surfaces.

Parking assistance system (option)

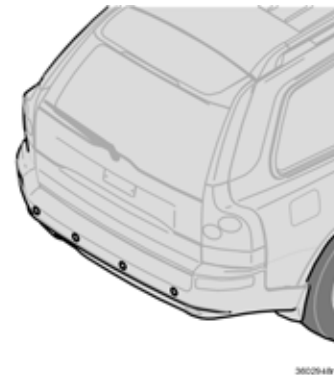
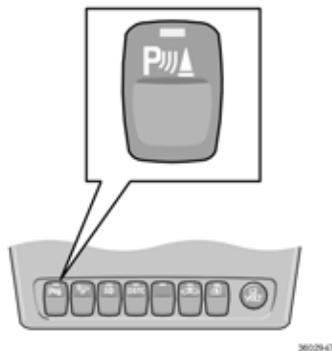
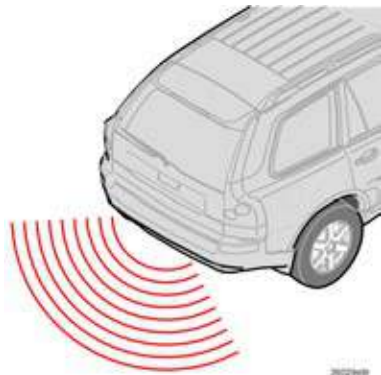

Function of the parking assistance system

The parking assistance system is used as a parking aid. A tone from the audio system speaker indicates the distance to the detected object. The volume of any other sound from the audio system is muted. The closer you come to the object, the more frequent the tone. At a distance of about 30 cm, the tone is constant. Distance is measured using ultrasound technology via sensors in the bumper. The measurement area straight behind the car is about 1.5 m.

NOTE! Switch off the system when driving with a trailer or a bicycle rack on the towing bracket. Otherwise, the sensors will react.

Activating/deactivating the parking assistance system

Unless deactivated with the button in the switch panel, the parking assistance system is activated when reverse gear is engaged. The LED in the button lights when the system is active.

Fault indication

If a fault should arise in the system, the LED in the button will go out. A text message will be shown in the combined instrument panel display.

Cleaning the sensors

The sensors must be cleaned regularly to ensure that they work properly. Clean them with water and car shampoo.

WARNING!

The parking assistance system is a parking aid, but can never replace the driver's responsibility when parking. The sensors have blind spots where objects may not be detected. Be aware of children or animals in the vicinity of the car.

Towing

Do not tow start (bump start) the engine

If you bump start a car with manual gearbox, the catalytic converter(s) may be damaged. Cars with an automatic gearbox cannot be bump started. Use a booster battery if the battery is flat.

If the car must be towed

- Unlock the steering wheel lock so that the car can be steered.
- **Keep in mind the highest legally permissible speed.**
- Remember that the brake and power steering servos do not function with the engine switched off! You must exert approximately five times more pressure on the brake pedal and steering is considerably heavier than usual.
- Drive gently. Keep the towline taut to avoid unnecessary jerking.

For automatic gearboxes

- The gear selector should be in position N.
- Highest permissible speed for cars with automatic gearbox (with the car raised): 80 km/h. Longest permissible distance: 80 km.
- Only tow with the car facing forward.
- The engine cannot be towed to start (bump started). See "Jump starting" on the next page.

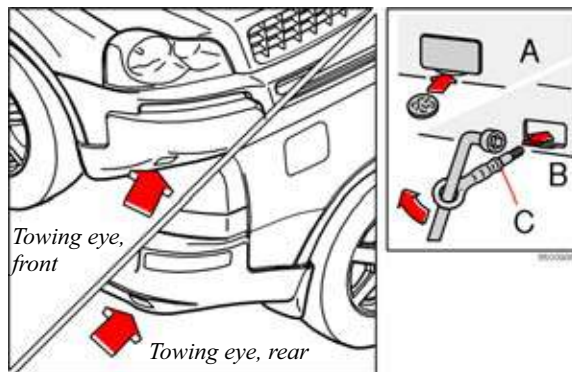

Towing eye

The towing eye is in the tool kit in the cargo compartment. You must screw the towing eye into place before towing. The socket and cover for the towing eye are on the right-hand side of each bumper.

Remove the cover as follows:

- Loosen the bottom edge of the cover with a coin.
- Screw the towing eye securely into place up to the flange (C). You can use a wheelbrace.

After use, unscrew the towing eye and refit the cover.

NOTE! Use the towing eye for towing on roads only, not for recovery after driving into a ditch or the like. Consult a professional whenever towing is necessary.

Jump starting

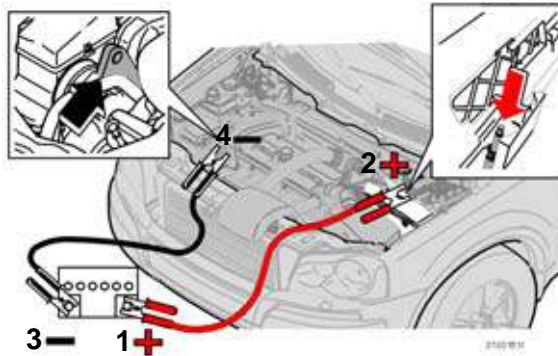

Jump start with a booster battery as follows...

If for some reason the battery in your car is discharged, you can "borrow" current from a spare battery or another car's battery to start the engine. Always check that the clamps are secure so that there are no sparks during the start attempt.

To avoid the risk of explosion, we recommend you do exactly as follows.

- Turn the ignition key to position 0.
- Ensure that the booster battery has **12 volt current**.
- If the booster battery is in another car, stop the engine of that car and make sure the cars are not touching.
- Connect the red cable to the positive terminal (1+) of the booster battery and the red connection in your car's engine compartment (2+). Connect the clamp to the contact point under a small black cover which has a plus sign on it. The cover is integrated with the fuse box cover.
- Connect one clamp of the black cable to the negative terminal of the booster battery (3-).
- Connect the other clamp of the black cable to the lifting eye on your car's engine (4-).

- Start the engine of the "booster car". Let the engine run a few minutes at a speed slightly higher than idle, 1500 rpm.
- Start the engine of the car with the discharged battery.
- Remove the clamps in reverse order.

NOTE! Do not remove the clamps during the start attempt; risk of spark build-up.

WARNING!

Remember that batteries, especially the booster battery, contain oxyhydrogen which is highly explosive. A spark, which can be caused if you incorrectly fit the jump leads, is enough to cause the battery to explode and both damage the car and injure you. The battery also contains sulphuric acid, which can cause serious corrosive damage. If the acid comes into contact with your eyes, skin or clothes, flush with large quantities of water. If acid splashes into your eyes contact a doctor immediately.

Driving with a trailer

- The car's towing bracket must be of an approved type.
- If the towing bracket is fitted by Volvo, the car is delivered with the necessary equipment to drive with a trailer. If retrofitting, check with your Volvo dealer to ensure that the car is fully equipped to drive with a trailer.
- Distribute the load in the trailer so that the weight on the towing bracket is approximately 50 kg for trailer weights under 1200 kg and approximately 90 kg for trailer weights over 1200 kg.
NOTE: The weight on the towing bracket (50/90 kg) is part of the vehicle's load capacity.
The load in the cargo compartment may need to be reduced so that axle load and/or total weight do not exceed the maximum limits when driving with a trailer.
- Increase tyre pressure to correspond to the pressure for full load. See the tyre pressure table!
- Clean the towing bracket regularly and grease the towball* and all moving parts to prevent unnecessary wear.
- Do not drive with a heavy trailer when your car is brand new! Wait until it has gone at least 1000 km.

- The brakes are loaded much more than usual on long and steep downhill slopes. Downshift to a lower gear and adjust your speed.
- If the car is driven with a heavy load in a hot climate, the engine and gearbox may overheat. The temperature gauge in the combined instrument panel goes into the red zone when the car overheats. Stop and let the engine idle a few minutes.
- If the car overheats, the air conditioning system can be temporarily switched off.
- The gearbox reacts with a built-in protection function if the car overheats. See the message in the display!
- The engine is loaded more heavily than usual when driving with a trailer.
- For reasons of safety, you should not drive faster than 80 km/h, even if the laws of certain countries permit higher speeds.
- The maximum permissible trailer weight for a trailer without brakes is 750 kg.
- Select position P (automatic gear box) or engage a gear (manual gearbox) when parking with a trailer and always apply the parking brake. If you are parking on a steep incline, place chocks behind the wheels.

* Does not apply to ball hitch with vibration damper.

Maximum permissible trailer weight for a trailer with brakes

0-1200 kg

2250 kg

Ball pressure

50 kg

90 kg

NOTE! The above are the highest trailer weights permitted by Volvo Car Corporation. Remember that national traffic regulations may further limit trailer weight and speed. Towbars may be certified for higher tow weights than the car may tow.



WARNING!

If you do not follow the given recommendations, the trailer and car may be difficult to control during evasive manoeuvres and braking. This could be dangerous to you and others on the road.

Driving with trailer and automatic gearbox

- When parking on hills, you should apply the parking brake before moving the gear selector to P. When you start on a hill, you should first put the gear selector in drive and then release the parking brake.
- Select a low gear in the gearbox when driving on steep inclines or when driving slowly. This prevents the gearbox from upshifting. The gearbox oil will be cooler.
- Do not use a higher manual gear than the engine can "handle". It is not always economical to drive in high gears.
- Avoid driving with trailer and automatic gearbox on inclines exceeding 15%.

NOTE! Some models require an oil cooler for the automatic gearbox when driving with a trailer.

Check with your nearest Volvo dealer as to what applies to your car if you have a retrofitted towbar.



Levelling (option on cars seating five, standard on cars seating seven)

If your car is equipped with automatic levelling, the rear suspension always retains the correct ride height regardless of the load. When the car is stationary, the rear suspension sinks, which is completely normal.

Towing bracket (option)

NOTE! Check that the car is equipped with transmission oil cooling if the towing bracket is retrofitted.

Fixed towbar (A)

Always remember to fasten the trailer's safety cable to the attachment. See the illustration!

Detachable towbar (B)

Always follow mounting instructions carefully.

Always remember to fasten the trailer's safety cable to the attachment. See the illustration!

Always remember to clean and grease the connector pin regularly.

Use recommended grease 8624203.

NOTE! Your car may have a towing bracket with a 13 pin contact that you must connect to a trailer with a 7 pin contact. In such a case, use a Volvo Genuine adapter cable. Make sure that the cable does not drag on the ground.

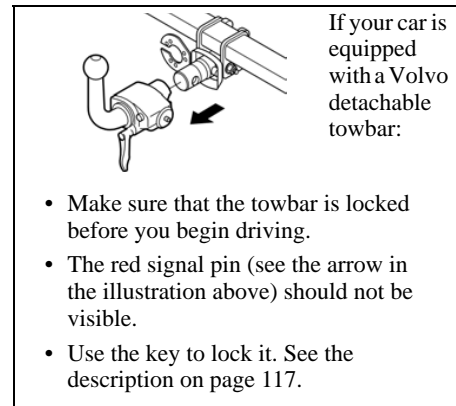
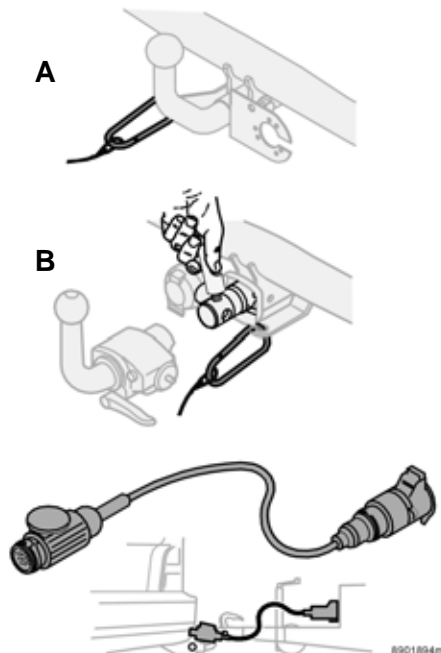

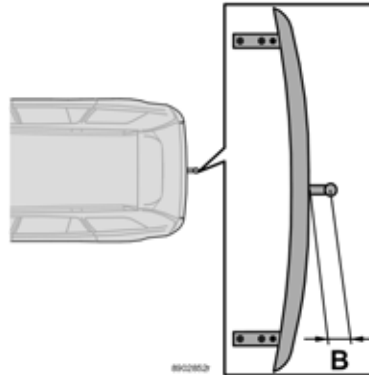
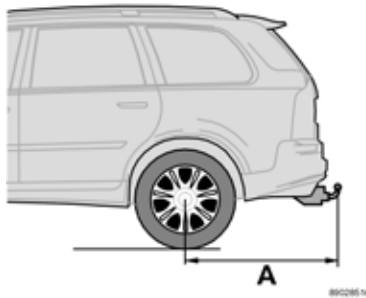

Attachment points under the car

Specifications

Distance A above:

Fixed towbar:	1124 mm
Detachable towbar:	1124 mm

Distance B above:

Fixed towbar:	80 mm
Detachable towbar:	80 mm

Max. permissible ball pressure: 90 kg

Detachable towbar – mounting

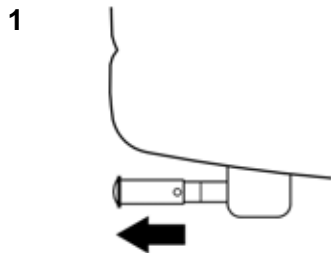

Remove the connector pin cover.

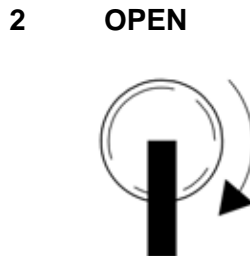

Put in the key and turn it clockwise to the unlocked position.

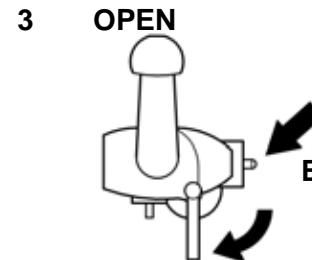

Hold the towball section and turn the handle clockwise until it stops.

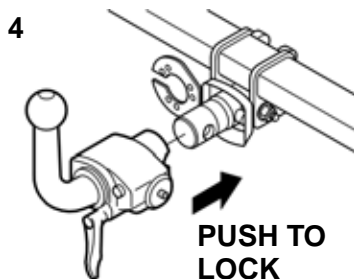

Push the towball section in until it locks. Be careful of the handle as it can quickly change position!

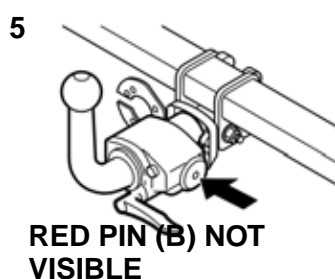

Check that the signal pin (B) is pushed in.

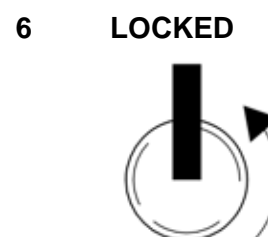

Turn the key anticlockwise to the locked position and remove it from the lock.

Detachable towbar – removing

1 **OPEN**



Put in the key and turn it clockwise to the unlocked position.

2 **OPEN**

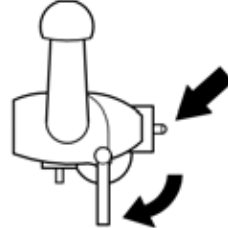

Turn the handle clockwise until it stops.

3

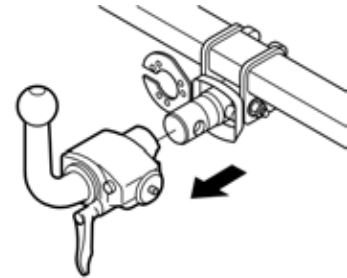

Pull the towball section off of the connector pin.

4 **LOCKED**

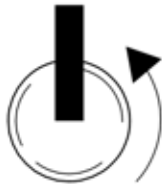

Turn the key anticlockwise to the locked position and remove it from the lock.

5

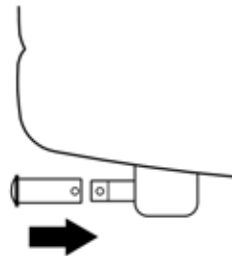

Refit the connector pin cover as in the illustration.

Load on the roof

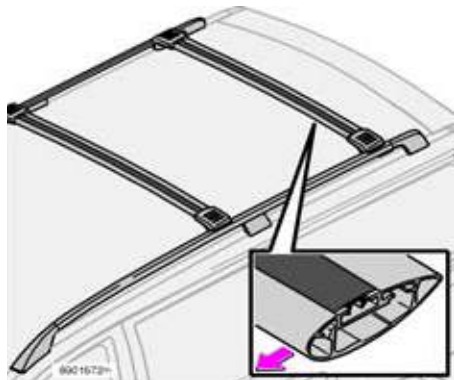

Load carrier placement (accessory)

Make sure that the load carrier is placed in the right direction on the roof rails. Load carriers can be placed along the entire roof rail. When driving without a load, the front load carrier should be situated about 200 mm in front of the centre rail base and the rear load carrier should be between the centre and the rear rail base (see above illustration) to minimise wind noise. The longer load carrier should be in the front.

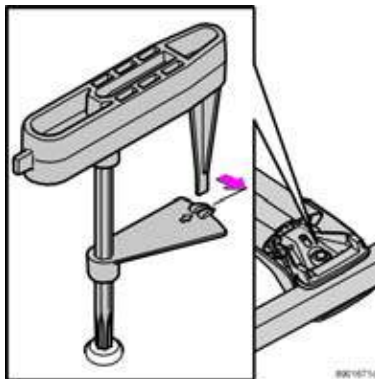

Fitting load carriers

Make sure that the load carrier sits correctly against the roof rail. Screw on the load carrier using its torque wrench. Tighten to the marking on the torque wrench (corresponds to 6 Nm). See illustration!

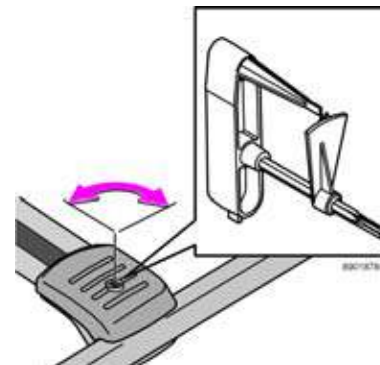

Load carrier cover

Use the end of the torque wrench (see illustration) or the ignition key to loosen or secure the cover. Rotate $\frac{1}{4}$ turn.

Using load carriers

- To avoid damaging your car and to achieve the best level of safety when driving, we recommend that you only use load carriers that Volvo has specially designed for your car.
- Check periodically that the load carriers and load are properly secured. Lash the load securely with retaining straps!
- You can carry a maximum of 100 kg on the roof (including load carriers).
- Distribute the load evenly over the load carriers. Do not load lopsidedly! Place the heaviest items at the bottom.
- Remember that the car's centre of gravity and driving characteristics change if you have a load on the roof.
- Keep in mind that the car's wind resistance and fuel consumption increase in proportion to the size of the load.
- Drive gently! Avoid quick accelerations, heavy braking and taking curves hard.

Wheels and tyres

General	122
Tyre pressure	125
Changing wheels	126

General

General information about wheels and tyres

A size designation is available for all tyres.

Example designation: **225/70R16 102H**.

These tyre size designations, which are used by all tyre manufacturers, can be interpreted as follows:

225	section width (mm)
70	relationship between section height and width (%)
R	means radial tyre
16	wheel rim diameter in inches (")
102	code digits for maximum permissible tyre load, in this case 850 kg
H	specifies that the tyre is manufactured for speeds up to 210 km/h

Your car is fully approved, which means that you may not deviate from those dimensions and performance ratings indicated in the vehicle registration. The only exception from these regulations concerns winter tyres and studded tyres, which may have different dimensions and a different speed rating than indicated in the registration. If you select tyres with different dimensions, do not drive at speeds faster than those permitted. The most common speed ratings are indicated in the following table:

Note: maximum permissible speeds indicated.

Q	160 km/h, used most often with studded tyres
T	190 km/h
H	210 km/h
V	240 km/h
W	270 km/h

NOTE! Follow these rules carefully in order to replace tyres with tyres of the same type; radial tyres, tyre dimension and designations should be the same. Ideally, the tyres should be of the same brand or there is a risk that the car's driving characteristics may be altered. Check with your dealer regarding which sizes are available for your car.

Keep in mind that the road surface conditions determine how fast you may drive, not the tyre speed rating.

NOTE! This is extremely important for all-wheel drive models (AWD) since even small size differences can cause transmission damage.

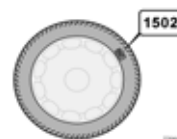

New tyres

Keep in mind that tyres are perishable goods – they will begin to harden after a few years and their friction properties will be reduced.

Try to use fresh tyres when changing, which is especially important for winter tyres. The week and year of manufacture is indicated with 4 digits, for example 1502. The tyres shown in the illustration were manufactured week 15, 2002.



WARNING!

The only Volvo approved "special wheel rims" are those that are tested by Volvo and are **Volvo Genuine accessories**.

Winter tyres

Volvo recommends winter tyres of size 225/70 R16 for all XC90 cars except those seating seven and those with T6 engines. Size 235/65R17 is recommended for these instead.

Always use winter tyres on all four wheels!

NOTE! Consult your Volvo dealer for advice on which rim and tyre type you should use for your car.

Studded tyres

Studded winter tyres should be carefully "broken in" over a distance of 500-1000 km so that the studs become properly positioned in the tyre. This will provide both the tyres and studs with a longer service life while contributing to a quieter ride.

Remember that regulations for use of studded tyres vary from country to country.

Snow chains

Snow chains may only be used on the front wheels.

NOTE! Always use Volvo-approved snow chains only; other snow chains can damage your car.

Never drive faster than 50 km/h with snow chains!

Do not drive on bare roads unnecessarily as this causes heavy wear on both snow chains and tyres.

NOTE! Never use "quick links" because the space between the disc brakes and the wheels is too small.

Tyres with tread wear indicators

Tread wear indicators are narrow, raised areas located at right angles to the tread (TWI is printed on the side of the tyre). When the tyre is sufficiently worn (1.6 mm tread remains), the indicators are clearly visible and you should replace them with new tyres **immediately**. Keep in mind that as soon as 3-4 mm of the tread remains, traction and water drainage capacity are greatly affected.

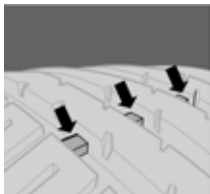

Driving characteristics and tyres

Tyres affect driving characteristics greatly. Tyre type, size and pressure are important to how the car performs. When you change wheels, be sure to use the same type, size and brand on all four wheels. Follow the recommendations regarding tyre pressure.

Changing wheels – summer/winter

When shifting between summer and winter wheels, mark the wheels to indicate where they sat on the car, e.g. L = left, R = right.

NOTE:

Tyres should have the same rotational direction throughout their service life.

Tyres with tread that are designed in such a way that they should only roll in one direction are marked with an arrow.

Incorrectly mounted tyres impair the car's braking properties and ability to press aside snow and slush.

IMPORTANT!

Regardless of whether the car is rear-wheel or front-wheel drive, the tyres with the deepest tread should always be mounted in the rear.

Consult with your Volvo dealer if you are unsure.

Wheels should be stored hanging up or on their sides, never standing.

Spare wheel "Temporary Spare"

The "Temporary Spare" should only be used for the short time it takes to repair or replace the normal tyre.

By law, it is only legal to use the spare wheel/tyre temporarily in connection with damage to a tyre. A wheel/tyre of this type should be replaced with a normal wheel/tyre as soon as possible.

Bear in mind that this tyre, when used in combination with the other tyres, can affect driving characteristics. Therefore, maximum speed with a "Temporary Spare" is 80 km/h. The transmission in AWD cars can sustain damage if this speed limit is exceeded.

NOTE! Only use the car's original spare wheel! Tyres of other sizes could damage your car. Use only **one** spare wheel at a time.

Tyre pressure

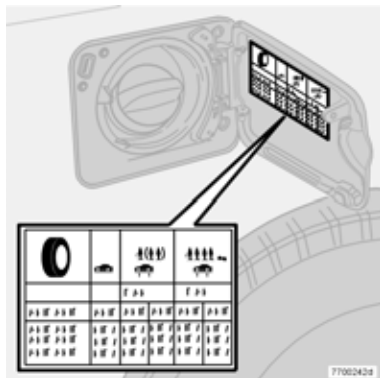

Tyre pressure

The decal located on the inside of the fuel filler flap indicates the correct tyre pressure.

Tyre pressure is important!

Check tyre pressure regularly.

If you drive on tyres with incorrect air pressure, the car's driving characteristics are impaired and tyre wear increases.

Note that the values in the table refer to cold tyres (outside temperature). Tyres get warm and pressure increases after just a few kilometres driving. This is normal, so do not let out air if you check the pressure when the tyres are warm. However, you should increase pressure if it is too low.

Remember that tyre pressure can vary depending on the outside temperature. Therefore check tyre pressure outdoors when the tyres are cold.

Changing wheels

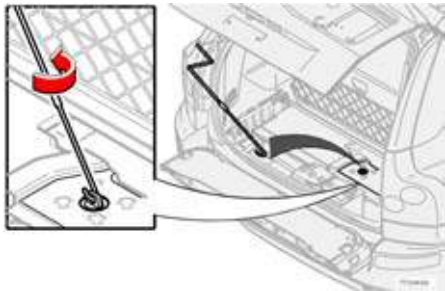

Spare wheel – removing

The spare wheel is located underneath the car and can be detached with the crank found in the tool kit or underneath the floor hatch, see page 85. Detach the spare wheel as follows:

1. Lower the bottom of the tailgate.
2. Lift up the floor hatch in the cargo compartment
3. Remove and assemble the two parts of the crank.
4. Fit the crank in the winch.
5. Loosen the tyre by cranking anticlockwise until you reach the stop.
6. Release the wheel from the cable.
7. Rewind up the cable (clockwise).

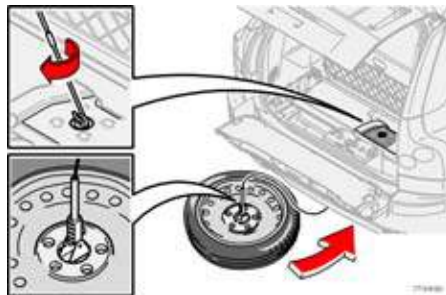

Spare wheel – refitting

It is best to have two people put the spare wheel back in place. One person to crank and the other to guide the wheel.

1. Crank out the cable and place its anchor in the centre hole of the wheel.
2. Slowly crank (clockwise) the cable in a bit.
3. Angle the wheel so that it comes in over the exhaust system.
4. Hold down the rear edge of the wheel while cranking it in.
5. Place the wheel above the rear axle, against the floor.
6. Crank until you reach the stop.

NOTE! Check that the wheel is properly secured!

NOTE! The cable could damage the car if it hangs free while driving.

8. Place the punctured tyre in the cargo compartment. The tool kit contains a plastic bag for the tyre.

NOTE! The spot under the car is only intended for the car's original spare wheel. Do not place any other wheels there.

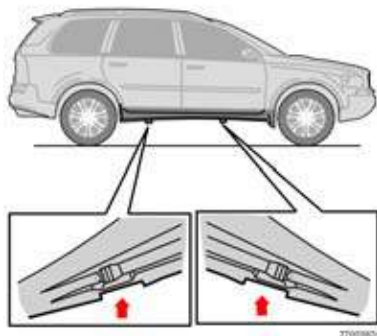

The jacking points are centred under the bottom of the doors.

Changing wheels

Remember to set out the warning triangle if you must change a wheel in a trafficked area. There are two jacking points on each side of the car, centred under the bottom of the doors.

WARNING!

Check that the right attachment points are being used. A production anchorage with pin is located between the jacking points. This is not strong enough to use to lift the car. If you are unsure about the location of the jacking points, contact your Volvo workshop. An incorrectly fitted jack could damage the door and body.

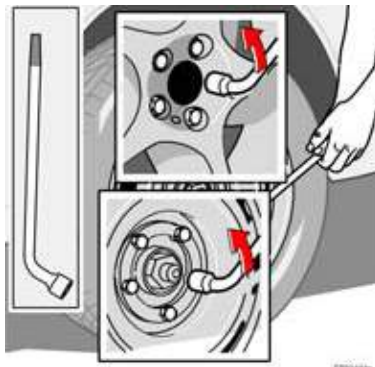

1. Park the car on an even, firm surface with no incline.
2. Apply the parking brake and engage 1st gear (manual gearbox) or move the gear selector to P (automatic gearbox). Place chocks on either side of the wheels remaining on the ground - use stones or wooden blocks.
3. Remove the jack and crank. See page 85 for location.
4. Loosen the wheel bolts $\frac{1}{2}$ -1 turn with the wheel nut wrench. Turn anticlockwise.

WARNING!

- Never crawl under the car when it is raised on a jack! The car could fall, causing injuries.
- The car's original jack should only be used when changing wheels. All other work on the car should be done using workshop jacks and axle stands under the part of the car that is raised.
- The jack screw should be kept well lubricated.
- If the surface is too soft, the jack could slide to the side and the car could fall. No one should be in the car when the wheel is being changed.

Changing wheels (Contd)

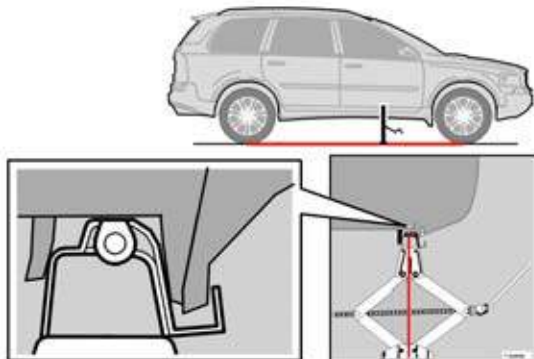

5. Place the jack under the jacking point and crank it up towards the car floor. Check that the jack sits securely in the anchorage. Then adjust the jack so that its foot is positioned vertically under the anchorage. See illustration. Do not place wood blocks or the like under the jack as you will not achieve full bearing capacity.
6. Lift the car until the wheel is free.
7. Remove the wheel bolts and lift off the wheel.

WARNING!

If the jack is positioned incorrectly, the car could fall. Risk of injury!

Fitting the wheel

1. Clean the contact surfaces on the wheel and hub.
2. Fit the wheel. Screw the wheel nuts.
3. Lower the car so that the wheels cannot rotate.
4. Tighten the wheel bolts alternately and in torque steps. Tightening torque: 140 Nm (14.0 kpm). It is important that they are tightened to the correct torque. Check with a torque wrench.
5. Screw the jack all the way down before returning it to the cargo compartment. Then secure it in place.
6. Check that the new tyre has the correct amount of pressure.

NOTE! There are two different types of wheel bolts depending on whether or not your car has steel or aluminium rims; bolts used with aluminium rims have a loose, rotating ring. Bolts used with steel rims have no rotating ring. Make sure to use the correct type of bolt. If you are unsure, check with the nearest Volvo workshop.

Car care

Cleaning	130
Repairing paintwork damage	132
Rustproofing	133

Cleaning

Wash the car often!

Wash the car as soon as it becomes dirty, especially in the winter when road salt and moisture can lead to corrosion.

Wash the car as follows:

- Thoroughly rinse dirt off the underbody of the car.
- Rinse the entire car until the dirt has softened. When using high pressure washer: Make sure nozzle of the high pressure washer does not come closer than 30 cm from the bodywork. Do not spray the locks directly or the fuel filler flap at an angle from behind.
- Wash with a sponge using a lot of water with or without detergent.
- You can use lukewarm (maximum 35°C) but not hot water.
- If the dirt is ingrained, you can wash the car with cold degreasing agent, but then be sure that there is a drain separator where you are washing the car. When using cold degreasing agent, ensure that the car is not in direct sunlight or that the paint is warm from sunlight or a warm engine. Sunlight and heat can cause permanent damage. Consult your Volvo workshop.
- Dry the car with a clean, soft chamois.

- Clean the wiper blades with a lukewarm soap solution.

Suitable detergent

Car shampoo.

Bear in mind:

Always wash **bird droppings** off the paintwork as soon as possible.

Bird droppings contain chemicals that affect and discolour paintwork quickly. The discoloration cannot be polished off.

Clean the electric contacts of the electric engine heater and trailer coupling (option).

WARNING!

Do not wash the engine when it is warm. Risk of fire! Allow an authorised Volvo workshop to wash the engine.

Automatic car wash

An automatic car wash is a simple and quick way of washing the car. Bear in mind, however, that an automatic car wash can never replace a proper handwashing – the brushes of a car wash cannot reach everywhere. During the first months of the car's life we recommend that you handwash the car.

WARNING!

After washing: Always test the brakes so that moisture and corrosion do not affect the brake lining and impair the brakes! Lightly depress the brake pedal now and then when driving long distances in rain or slush so that the brake lining warms and dries. You should also do this when you begin driving after damp or cold weather.

Cleaning the upholstery

Treating marks on fabric

A special cleaning agent available at your Volvo dealer is recommended when cleaning fabric upholstery. Other chemicals can impair the fire retardant qualities of the upholstery.

Treating marks on vinyl

Never scrape or rub a mark. **Never** use strong stain remover. Wash with a weak soap solution and lukewarm water.

Treating marks on leather

A special cleaning agent available at your Volvo dealer is recommended when cleaning leather upholstery.

Use the Volvo leather care kit once or twice a year to preserve suppleness and comfort.

Never use strong detergent, petrol, alcohol, white spirit, etc. as such strong substances can damage fabric, vinyl and leather upholstery.

Cleaning seat belts

Use water and synthetic detergent.

Polishing and waxing

Polish and wax the car when you feel the paintwork is matte and when you wish to give the paintwork extra protection, such as before winter.

The car does not usually need polishing until after one year. It can be waxed earlier.

Wash and dry the car thoroughly before you begin polishing and/or waxing. Clean off asphalt and tar stains with white spirit. More stubborn marks can be removed with fine rubbing paste designed for paintwork. Polish first with a polish and then wax with liquid or solid wax. Carefully follow the instructions on the package. Many preparations contain both polish and wax.

Do not polish or wax surfaces warmer than 45°C.

Repairing paintwork damage

Paint

Paint is an important part of the car's rustproofing and should therefore be checked regularly. Repair paintwork damage immediately so that it does not start to rust. The most common types of paintwork damage that you can repair yourself are:

- minor stone chips and scratches
- damage to wing edges and door

When repairing paintwork, the car should be clean and dry with a temperature above 15°C.

Colour code

Make sure you have the right colour. The colour code number is on the data plate in the engine compartment.

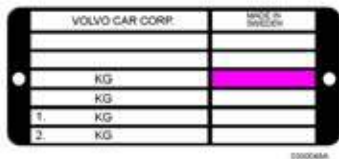

Minor stone chips and scratches

Material:

- Primer in a can
- Paint in a can or a touch-up pen
- Brush
- Masking tape
- If the stone chip has not gone down to the bare metal and an unpainted colour coat remains, you can add paint immediately after removing dirt.

Do as follows if the stone chip went down to the bare metal

- Fasten a piece of masking tape over the damaged surface. Then remove the tape, removing any paint residue (illustration 1).
- Stir the primer thoroughly and apply using a fine brush or matchstick (illustration 2).
- When the primer is dry, apply the surface coat with a brush.
- Make sure the paint is well stirred and apply several thin coats; allowing it to dry between coats.
- The procedure is the same for scratches, but masking tape can be used to protect undamaged paintwork (illustration 3).
- Wait a day or so and then finish the repair by polishing. Use a soft rag and apply lapping paste sparingly.

Remove any paint residue with tape

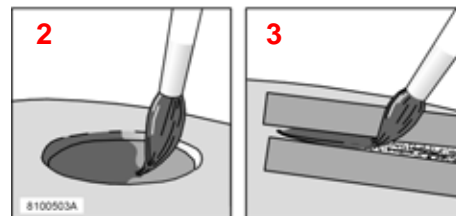
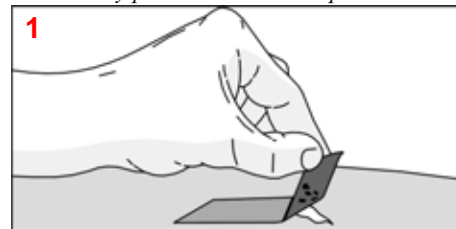

Mask if necessary

Rustproofing

Rustproofing – check and repair

Your car received a thorough and complete rustproofing at the factory. Parts of the body are made of galvanised sheet metal. The underbody is protected by a wear-resistant anti-corrosion compound. Members, cavities and enclosed sections are sprayed with a thin, penetrating rust inhibitor.

The car's rustproofing is maintained by doing the following:

- Keep the car clean! Hose down the underbody. When high pressure washing, hold the nozzle at least 30 cm from painted surfaces!
- Regularly check and touch-up the rustproofing treatment as necessary.

The car's rustproofing does not normally require treatment for approximately 8 years. After that time, it should be treated at three year intervals. If your car requires treatment, consult your Volvo workshop.

Repair

If you want to repair the rustproofing yourself, make sure the area is clean and dry. Hose down, wash and dry the car thoroughly. Use a rustproofing agent in a spray can or one that is intended for brush application.

There are two different types of rustproofing agents:

- a) thin (colourless), for visible areas
- b) thick, for areas prone to wear on the underbody

Possible repair areas with these agents:

- Visible welds and sheet metal joints; thin fluid
- Underbody; thick fluid
- Door hinges; thin fluid
- Bonnet hinges and catch; thin fluid

Once you have finished treatment, excess rustproofing can be wiped off with a rag dipped in a recommended cleaning agent. Parts of the engine and suspension strut mountings in the engine compartment are treated at the factory with a wax-based, colourless rustproofing. This withstands normal detergents without dissolving and losing its rustproofing ability.

If you wash the engine using aromatic solvents, such as turpentine or white spirit (especially those that do not contain emulsifiers), the protective wax should be renewed after washing. Your Volvo dealer handles such waxes.

Maintenance and service

Volvo service	136
Maintenance	137
Bonnet and engine compartment	138
Diesel	139
Oils and fluids	140
Wiper blades	144
Battery	145
Bulbs	147
Replacing bulbs	148
Fuses	155

Volvo service

Volvo service programme

Before the car left the factory, it was thoroughly test driven. It was checked again in accordance with Volvo Car Corporation regulations before it was handed over to you.

To keep your Volvo as safe and reliable as possible, follow the Volvo service programme specified in the Service and Warranty Manual. We advise that you always let an authorised Volvo workshop perform service and maintenance work. Your Volvo workshop has the personnel, special tools and service literature that guarantee the highest quality of service. Your Volvo workshop always uses Volvo Genuine parts. The Volvo service programme is developed for normal driving conditions.

IMPORTANT!

For the Volvo warranty to apply, check and follow the instructions in the Service and Warranty Manuals.

Adverse driving conditions

Change engine oil and replace air and oil filters more often than recommended in the Service and Warranty manual when driving in adverse conditions.

Adverse driving conditions include:

- Prolonged driving in dusty/sandy conditions
- Prolonged driving with caravan and/or trailer
- Prolonged driving in mountainous areas
- Prolonged driving at high speeds
- Prolonged idling and/or driving at low speeds
- Driving in low temperatures
 - below 0°C – along shorter distances; less than 10 km.

Environmental care

There are many examples of environmental care within the Volvo field of activity. We use a chlorine-free refrigerant in our climate control systems that is harmless to the ozone layer and contributes very little to the greenhouse effect. Asbestos-free brakes, engines with catalytic converters and biogas operation are other examples of what Volvo Car Corporation is doing for the environment.

Our specific services are also of importance to the environment, such as using Volvo Genuine parts, maintaining ignition and fuel systems, and other measures that directly reduce exhaust emission. We would also like to point out the care taken by our Volvo workshops in regards to handling environmentally dangerous substances.

Maintenance

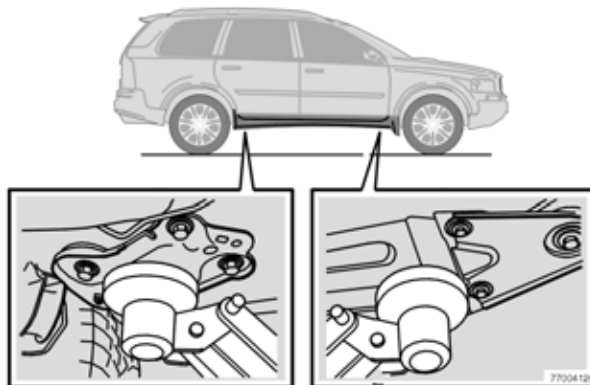

Note the following before you begin working on your car

Battery

- Ensure that the battery cables are correctly connected and tightened.
- Never disconnect the battery when the engine is running (e.g. when replacing the battery).
- Never use a fast charger to charge the battery. The battery cables should be disconnected while charging.
- The battery contains acid that is both corrosive and poisonous. It is important that

- the battery is handled in an environmentally friendly way. Let your Volvo dealer assist you.

Lifting the car

If the car is lifted with a workshop jack; position the jack with the front edge on the engine support frame.

Do not damage the splashguard under the engine. Ensure that the jack is positioned so that the car cannot slide off. Always use axle stands or the like.

- If you lift the car using a two pillar workshop lift, ensure that the front and rear lift arms are fixed under the lifting points on the door sill. See the illustration.

WARNING!

Never try to repair any part of the SRS or SIPS bag systems yourself. Any interference in the system could cause malfunction and serious injury. Any work should only be performed by an authorised Volvo workshop.

WARNING!

The car ignition system has very high voltage!

The voltage in the ignition system is dangerous!

Do not touch spark plugs or ignition coils when the engine is running or the ignition is switched on!

The ignition should be switched off when:

- Conducting engine tests.
- Replacing ignition system components, such as spark plugs, ignition coils, etc.

Bonnet and engine compartment

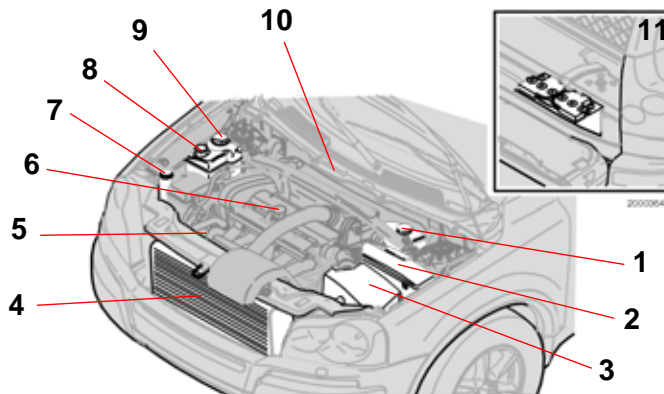
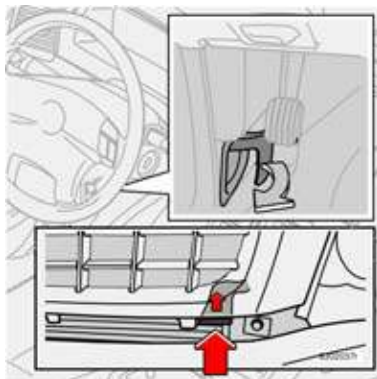

Opening the bonnet

1. Pull the handle on the far left (or right if the car is RHD) under the dashboard. You will hear when the lock releases.
2. Insert your hand to the right under the front edge of the bonnet (below the grille).
3. Press up the safety catch handle.
4. Release the handle.
5. Open the bonnet.

WARNING!

Check that the bonnet locks properly when you close it!

Engine compartment

1. Clutch and brake fluid reservoir
2. Relays and fuses
3. Air filter
4. Radiator
5. Engine oil dipstick
6. Engine oil filling
7. Washer fluid reservoir
8. Power steering fluid reservoir
9. Expansion tank, cooling system
10. Chassis data plate
11. Battery (in cargo compartment)

WARNING!

The radiator fan behind the radiator (4) can start automatically some time **after** the engine has been switched off! Risk of injury!

WARNING!

Do not wash the engine when it is warm. Risk of fire! Allow an authorised Volvo workshop to wash the engine.

Diesel

Fuel system

Diesel engines are sensitive to contaminants. Only use diesel from a well-known oil company. Never fill up with diesel if the quality is dubious. Special diesel for winter use is available from the large oil companies. This fuel is less viscous at low temperatures and reduces the risk of wax building up in the fuel system.

The risk of condensation building up in the tank is reduced if the tank is kept well filled. When refuelling, check that the area around the fuel filler pipe is clean.

Avoid spilling onto the paintwork. Wash off any spills with detergent and water.

Empty tank

No special procedures are required if the tank runs dry. The fuel system is bled automatically.

RME (Rape Methyl Ester)

- Diesel may be mixed with max. 5% RME.

NOTE! A risk for engine damage occurs if the RME concentration is greater than 5%.

Draining condensation from the fuel filter

The fuel filter removes condensation, which could otherwise affect engine function, from the fuel. The fuel filter should be drained as specified in the Service and Warranty Book, and when you suspect that the car has been filled with contaminated fuel.

Oils and fluids

Oil grade:

Petrol engines: ACEA A1

ACEA A3 grade oil can also be used. Note that the same oil can comply with both ACEA A1 and ACEA B1, regardless of whether it is a mineral, semi-synthetic or fully synthetic oil.

Diesel engines: ACEA B4

Note that the same oil can comply with ACEA A3, ACEA B3 and ACEA B4, regardless of whether the oil is mineral, semi-synthetic or fully synthetic.

Do not use extra additives. These can damage the engine.

Castrol® fully synthetic engine oil is recommended for cars with turbocharged petrol and diesel engines.

Changing the oil and oil filter

Your Service and Warranty Manuals contain instructions regarding suitable intervals for changing oil and oil filters.

Shorter intervals are recommended for driving in adverse conditions, see page 136.

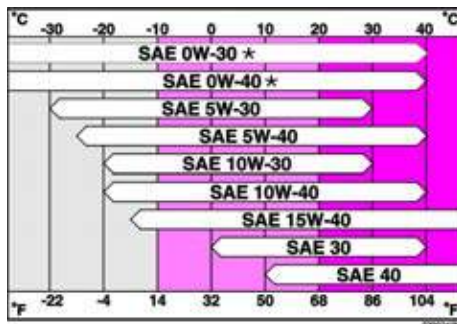

Viscosity

(assumes constant air temperature)

In extreme driving conditions that give abnormally high oil temperature or oil consumption, such as driving in the mountains with a great deal of engine braking and motorway driving at high speed, oils fulfilling the requirements of ACEA A3 (petrol engines) are recommended.

* Oils with a viscosity of 0W-30 and 0W-40 must fulfil the requirements of ACEA A3 (petrol engines).

Volvo recommends Castrol® oil products.

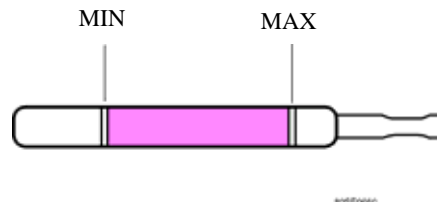
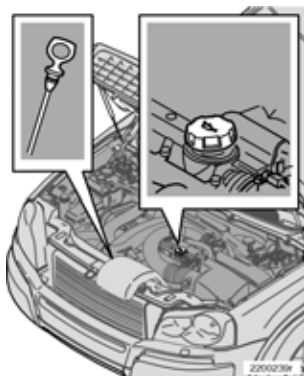

Approx. 1.5 litres for petrol engines
 Approx. 2.0 litres for diesel engines

Check the oil level

Volvo recommends that the oil level is checked every 2500 km.

Checking the engine oil level is especially important before the first scheduled oil change. Park the car on a level surface and wait at least 5 minutes after switching off the engine so that the oil has time to run back to the oil sump. The most accurate measurement is made on a cold engine before starting. Wipe the dipstick before checking.

The oil level should fall within the markings on the dipstick.

The distance between MIN and MAX on the stick corresponds to 1.5 litres for petrol engines and approx. 2.0 litres for diesel engines.

If the oil level is at MIN, top up with:

- cold engine - 1.0 litre
- warm engine - 0.5 litres

WARNING!

Do not spill oil on the hot exhaust pipes.
 Rise of fire!

Oils and fluids (Contd)

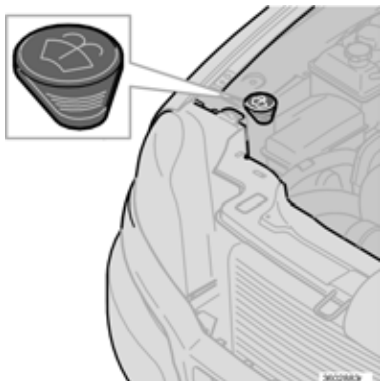

Washer fluid reservoir

Washer fluid reservoir

The windscreen and headlamps washers share the same fluid reservoir. It is located under the bonnet and has a capacity of 6.5 litres.

When there is less than approx. 1 litre of washer fluid, only the windscreen washer will work.

Add frost protection in the winter so that the fluid does not freeze in the pump, reservoir and hoses.



Coolant reservoir

Coolant

Never top up with ordinary water only! Use a mixture of half water, half Volvo coolant all year round. It is important to use equal amounts. The risk of freezing increases with both too little and too much coolant.

NOTE! Certain engine components are manufactured of aluminium alloy. It is therefore very important that Volvo coolant is always used. This has especially good anti-corrosion properties! When the car is new, it is filled with coolant that can withstand approximately -35°C .

Check coolant regularly!

The level should lie between the MIN and MAX marks on the expansion tank. If the system is not filled sufficiently, high local temperatures could occur, causing a risk of damage (cracks) to the cylinder head. Top up the coolant when the level falls to the MIN mark.



WARNING!

If you need to top up the coolant when the engine is warm, unscrew the expansion tank cap slowly so that the overpressure dissipates.

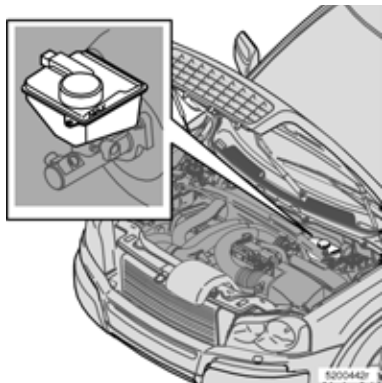

NOTE! The fluid should be changed annually on cars that drive in conditions requiring hard, frequent braking, such as driving in mountains or tropical climates with high humidity. This change is not part of a service schedule, but should be done in connection with a service at your Volvo workshop.

Clutch and brake fluid reservoir

The brake and clutch have the same reservoir. The location of the reservoir differs between right and left-hand drive cars.

The level should lie between the MIN and MAX marks.

Fluid grade: Brake fluid DOT 4+.

Check the level regularly

Change the fluid every other year or at every other regular service interval.



Power steer power steering fluid

The level should lie between the MIN and MAX marks.

Grade: Power steering fluid of type Pentosin CHF 11S or the like.

Check the level at every service. It is not necessary to change the fluid.

NOTE!

If a fault should arise in the power steering system or if the car is without power and must be towed, it can still be steered. Be aware that steering is much heavier than normal and more force is needed to turn the steering wheel.

Wiper blades

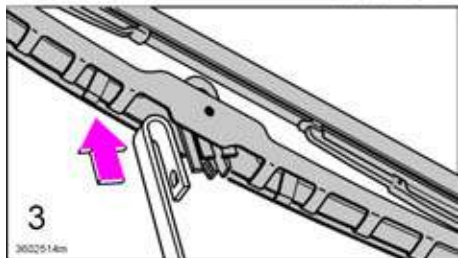
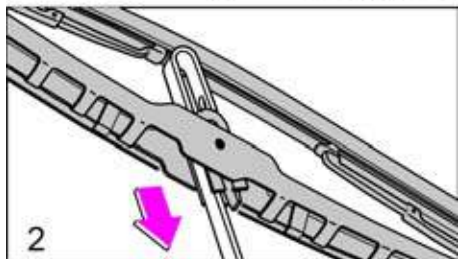
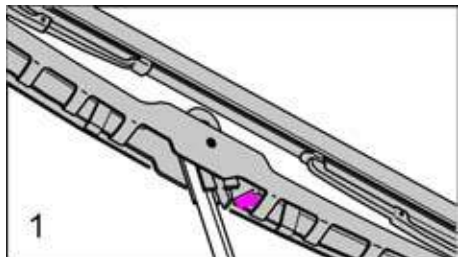

Changing windscreen wiper blades

1. Fold out the wiper arm and hold the wiper blade at 45° to the wiper arm. Press in the spring on the wiper blade.
2. Press the entire wiper blade down so that the wiper arm eye passes through the hold in the wiper blade mounting.
3. Then pull the blade up so that the wiper arm eye passes beside the wiper blade mounting. Fit the new blade in reverse order and **check that it is securely in place.**

NOTE! Keep in mind that the wiper blade on the driver's side is straight and has a spoiler while the one on the passenger side is curved. The spoiler on the driver's side should sit on the lower side of the blade. The curve of the blade should follow the curve of the bottom edge of the windscreen.

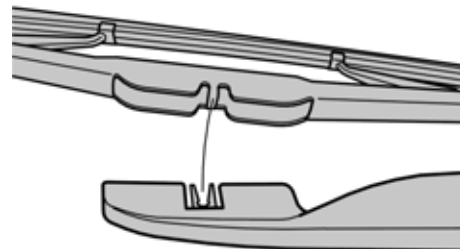

Replacing rear window wiper blades

1. Fold out the wiper arm.
2. Remove the wiper blade by pulling it outwards towards the tailgate.
3. Press the new wiper blade into position. Check that the blade fits securely!

Battery

Battery care

The function and life of the battery are affected by driving conditions, driving style, number of starts, climate conditions, etc.

NOTE! The number of times the battery is run flat negatively affects its service life

Important!

Repeated use of the parking heater and other great power consumers in combination with short trips can lead to battery discharge and thereby difficulty starting.

If great power consumers are used regularly, the car should be driven for the same amount of time as these consumers were connected in order to ensure that the generator is able to produce enough energy to compensate for the amount consumed.



WARNING!

Remember that the battery contains oxyhydrogen, which is highly explosive. An open flame or smoking near the battery is enough to cause the battery to explode and cause you injury and/or damage the car. The battery also contains sulphuric acid, which can cause serious corrosive damage. If the acid comes into contact with your eyes, skin or clothes, flush with large quantities of water. If acid splashes into your eyes contact a doctor immediately.

Symbols:



Use protective goggles



Further information in the owner's manual.



Store the battery out of the reach of children.



The battery contains corrosive acid.



Avoid sparks and open flames.



Risk of explosion.

Battery (Contd)

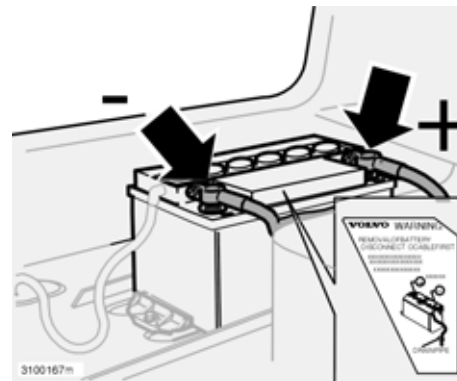
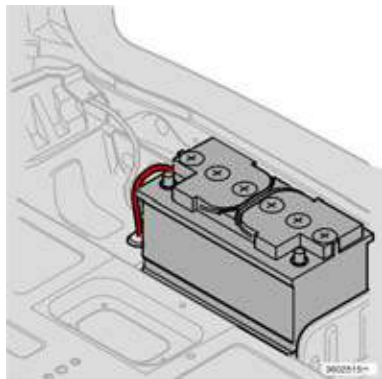

Removing oxyhydrogen gas

The battery can develop oxyhydrogen, which is highly explosive. An evacuation hose draws any oxyhydrogen gas from around the battery out of the car and prevents gas from accumulating in the passenger and cargo compartments. If you must change the battery for some reason, it is imperative that the evacuation hose is connected to the new battery and that it is routed to the outlet in the bodywork.

Replacing the battery

Do as follows once you have unscrewed the console and battery cover and wish to remove the battery:

- Check that the ignition is switched off.
- **Wait** at least 5 minutes before touching any electrical terminals (so that the information in the car's electrical system can be stored in the different control modules).
- **Disconnect the negative lead first.**
- Then disconnect the positive lead and the evacuation hose for the oxyhydrogen.

Do as follows when installing the battery:

- Set the battery in place.
- **Connect the positive lead first.**
- Then connect the negative lead.
- Make sure the evacuation hose is correctly connected to both the battery and the outlet in the bodywork.

WARNING!

The battery contains oxyhydrogen, which is highly explosive. Be sure that the evacuation hose is correctly connected!

Bulbs

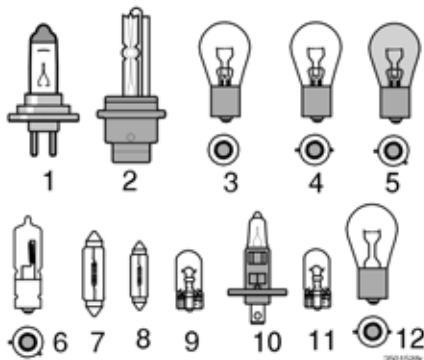

The following bulbs are used in the car

- | | |
|--------------------------------------|-----------|
| 1. Dipped and main beam bulb | 55W H7 |
| Main beam | 55W H7 |
| 2. Xenon (option) | 35W D2R |
| (gas discharge bulb) | |
| 3. Reversing lamp | 21W BA 15 |
| 4. Brake light | 21W BA15 |
| 5. Rear direction indicator (orange) | PY21W |
| 6. Front direction indicator | H21W |
| 7. Courtesy lighting | W5W |
| Cargo compartment lighting | W5W |
| 8. Vanity mirror | 1.2W |

- | | |
|-----------------------------------|---------|
| 9. Numberplate lighting | W5W |
| Position/Parking lamp | W5W |
| in headlamp | |
| Side marker light | W5W |
| Side direction indicator (orange) | W5W |
| 10. Fog lamps | 55W H1 |
| 11. Rear fog lamp | 21W BA5 |
| 12. Rear position lamp | P21 4W. |

NOTE! Do not touch the glass of bulbs 1, 2, 3 and 10 directly with your fingers. Grease and oils from your fingers are vaporised by the heat, coating and damaging the reflector. Because Xenon bulbs contain slight traces of mercury, used bulbs must be handled correctly. Consult your Volvo dealer or Volvo workshop.

WARNING!

If your car is equipped with Bi-Xenon headlamps (option), the bulbs must be replaced by a Volvo workshop due to the high voltage.

Replacing bulbs

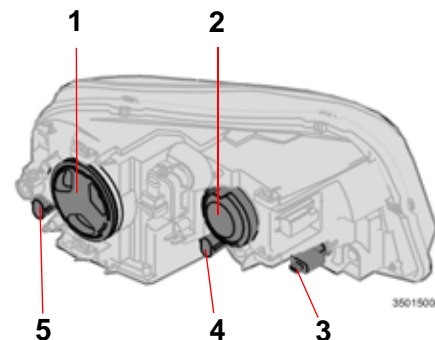
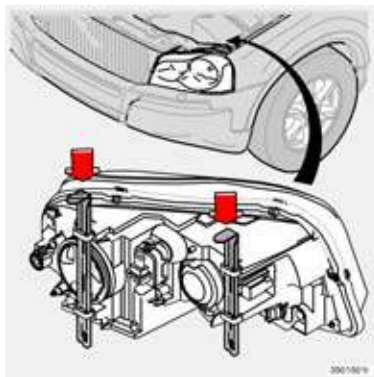
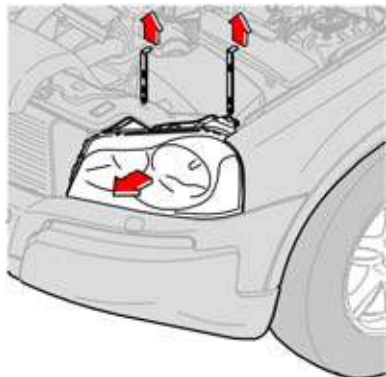

Dipped beam, main beam, position/parking lamp and side marker light

The entire lamp insert must first be removed when replacing dipped beam, main beam and position/parking lamp bulbs. To replace one of these bulbs, do the following and then consult the instructions for the specific lamp.

1. Switch off all lights and turn ignition key to position 0.
2. Open the bonnet.
3. Release the insert by pulling up the two lock pins holding it in place.
4. Lift the insert straight out.

5. Unplug the connector by first pressing in the catch from underneath and then pulling it up a bit from above.
6. Lift out the entire headlamp insert and place it on a soft surface so as not to damage the lens.

Refit the headlamp insert in reverse order. Check that the lock pins are correctly situated.

Location of bulbs in front lamp

1. Dipped beam
2. Main beam
3. Direction indicator
4. Position/Parking lamp
5. Side marker light

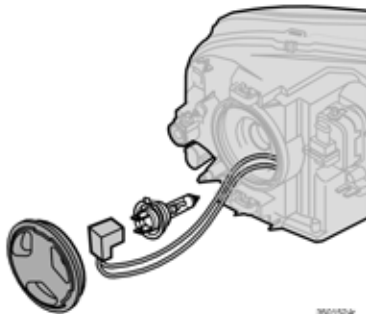

3501524r

Dipped beam bulb

1. Undo the outer cover by turning it anticlockwise.
2. Unplug the connector.
3. Disconnect the spring clamp. First push to the right so that the spring clamp disconnects, then out and down.
4. Pull out the bulb.
5. Fit the new bulb. It can only be fitted in one position.
6. Press the spring clamp up and a little to the left so that it fastens in its catch.
7. Press the connector back in place.
8. Screw the cover back into place; the marking "HAUT" should be at the top.

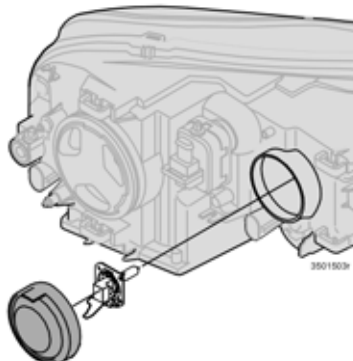

3501503r

Main beam bulb

1. Undo the outer cover by pulling it straight out.
2. Unplug the connector.
3. Disconnect the spring clamp. First push to the right so that the spring clamp disconnects, then out and down.
4. Pull out the bulb.
5. Fit the new bulb. It can only be fitted in one position.
6. Press the spring clamp up and a little to the left so that it fastens in its catch.
7. Press the connector back in place.
8. Refit the cover.

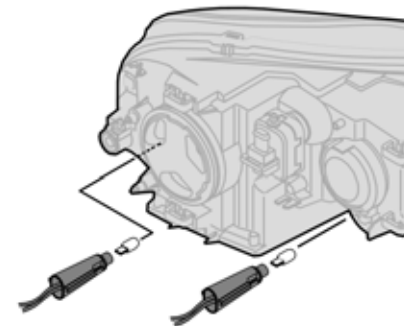

3501504r

Side marker light and position/ parking lamp

The bulbs are housed in bayonet holders.

1. Turn the bulb holder anticlockwise and remove.
2. Pull the bulb straight out.
3. Fit the new bulb by carefully pressing it into the recess.
4. Fit the bulb holder back in place and turn clockwise.

Replacing bulbs (Contd)

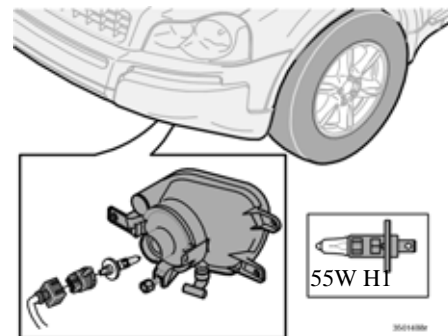
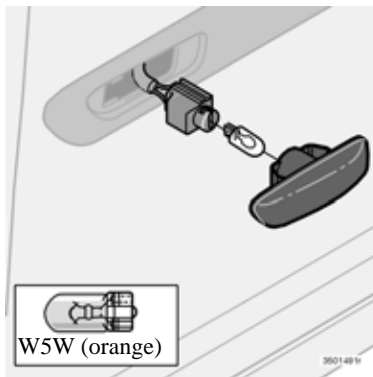
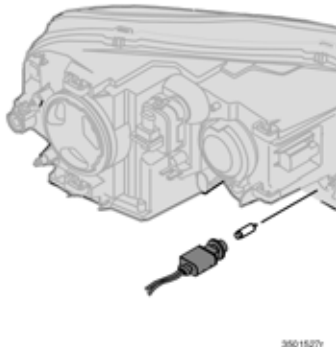

Direction indicator

The bulbs are housed in bayonet holders.

1. Turn the bulb holder anticlockwise and remove.
2. Press in the bulb, turn anticlockwise and remove.
3. Fit the new bulb by pressing it into the recess and then turning clockwise.

Side direction indicator

1. Switch off all lights and turn ignition key to position 0.
2. Prise out the lamp housing from underneath using a small slotted screwdriver.
3. Turn the bulb holder ¼turn anticlockwise and pull straight out.
4. Pull the defective bulb straight out.
5. Replace with a new bulb and press the lamp straight in.

Front fog lamp

1. Switch off all lights and turn ignition key to position 0.
2. Turn the bulb holder slightly anticlockwise.
3. Remove the bulb.
4. Put the new bulb in place. The profile of the bulb holder matches the one on the foot of the lamp.
5. Refit the bulb holder by turning slightly clockwise. "TOP" should be up!

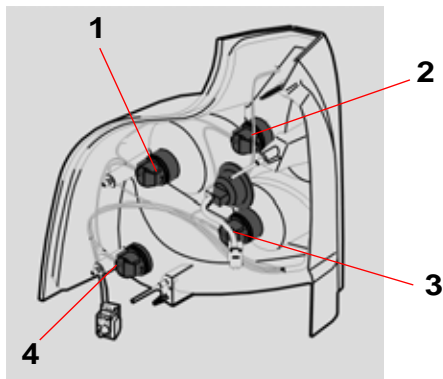

Location of bulbs in rear lamp cluster

- | | |
|------------------------|------------------|
| 1. Direction indicator | PY 21 W (orange) |
| 2. Brake light | 21 W BA 15 |
| 3. Reversing lamp | 21 W BA 15 |
| 4. Position lamp | P21/4W |

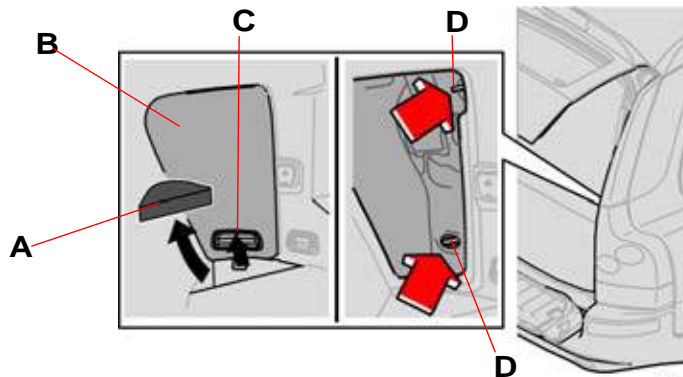

Bulbs in rear lamp cluster

- Switch off all lights and turn ignition key to position 0.
- Lower the bottom of the tailgate and open the floor hatch.
- If the car is equipped with a grocery bag holder (option), loosen the holder's retaining straps.
- Remove the corner piece (A).
- Open the hatch (B) in the side panel by pulling the catch (C) up and towards you.
- Take spanner no. 10 out of the tool kit.
- Loosen the nuts (D).
- Pull the entire insert straight back.
- Loosen the extra length of cable for better accessibility.
- Place the insert on a soft surface so as not to scratch the glass.
- Turn the bulb holder anticlockwise and pull it out.
- Turn the bulb anticlockwise to loosen it.
- Replace the bulb.
- Refit the bulb holder in the recess and turn clockwise.
- Press back the extra length of cable.
- Refit the insert against the bolt holes. Press the insert into place.
- Tighten the nuts.
- Refit the side panel and corner piece.

Replacing bulbs (Contd)

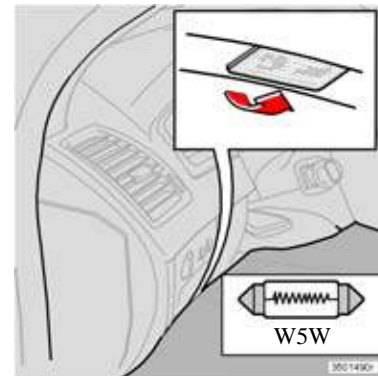
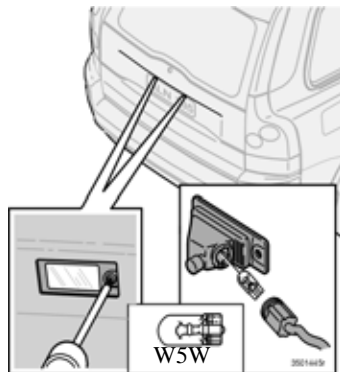
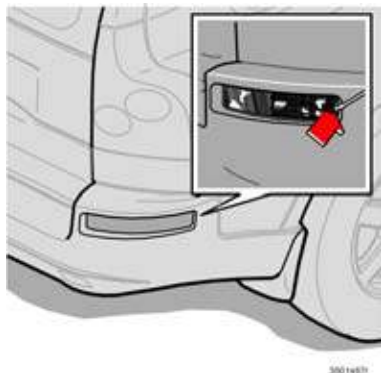

Rear fog lamp

1. Insert a slotted screwdriver as indicated by the arrow in the illustration.
2. Prise out the lamp insert.
3. Turn the lamp insert anticlockwise and pull out the bulb.
4. Replace the bulb.

Numberplate lighting

1. Switch off all lights and turn ignition key to position 0!
2. Remove the screw with a screwdriver.
3. Carefully remove the entire lamp housing and pull it out. Turn the contact anticlockwise and pull out the bulb.
4. Replace the bulb.
5. Refit the contact and turn clockwise.
6. Refit the entire lamp housing and screw it into place.

Courtesy lighting

Courtesy lighting is found under the dashboard on the driver and passenger side. Do as follows to replace the bulb:

1. Insert a screwdriver and gently turn so that the lamp housing loosens.
2. Remove the faulty bulb.
3. Replace the bulb. Check that the bulb lights.
4. Refit the lamp housing.

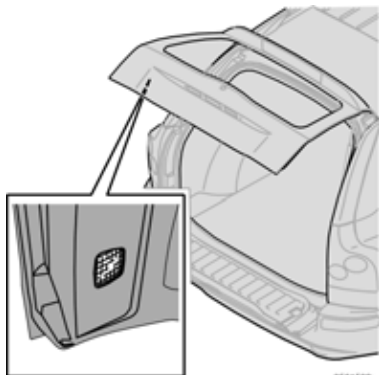

Bulbs in the cargo compartment

1. Insert a screwdriver and gently turn so that the lamp housing loosens.
2. Remove the faulty bulb.
3. Replace the bulb. Check that the bulb lights.
4. Refit the lamp housing.

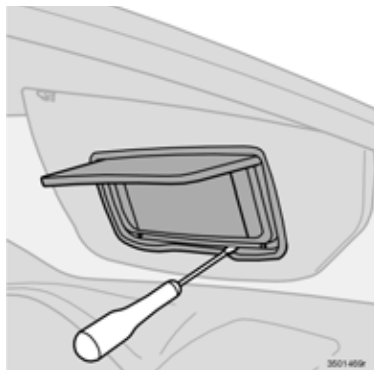

Vanity mirror

1. Insert a slotted screwdriver at the side of the centre clip in the bottom edge of the mirror. Lift up so the centre clip releases.
2. Slide the screwdriver from side to side so that the outer clips release.
3. Lift out the mirror insert.
4. Replace the bulbs.
5. Refit the insert top edge first. Be sure that the upper clips are properly depressed before pressing the insert back.



Ceiling lighting with Ceiling lighting with front reading lamps

These bulbs are of a special type.

We recommend that you ask your Volvo workshop to replace them.

Replacing bulbs (Contd)



Rear reading lamps

These bulbs are of a special type.

We recommend that you ask your Volvo workshop to replace them.

Fuses

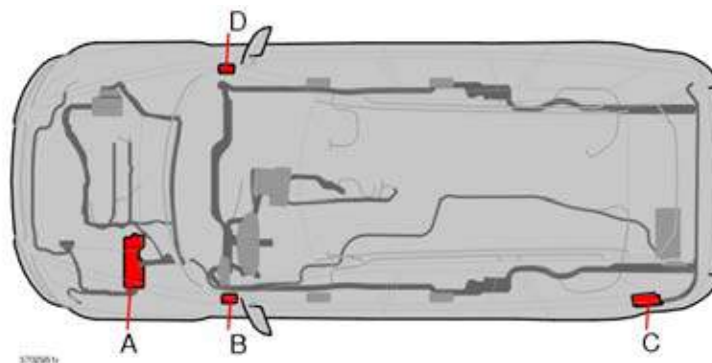

All electrical functions and components are protected with a number of fuses to protect your car's electrical system from damage by short-circuits or overloads.

Fuses are located in three different locations in the car:

- A. Relay/fuse box in the engine compartment.**
- B. Fuse box in the passenger compartment.**
- C. Relay/fuse box in the cargo compartment.**
- D. Fuse box in the passenger compartment – right-hand drive**

If an electrical component or function does not work, it could be because the component's fuse was temporarily overloaded and blew. Look in the fuse diagram to locate the affected fuse. Pull out the fuse and look at it from the side to see if the curved wire is burned out. If this is the case, replace it with a new fuse **of the same colour and amperage**. The fuse boxes in the engine compartment and passenger compartment contain a number of spare fuses. There are also fuse pliers to assist you in removing and replacing fuses.

If the same fuse blows repeatedly, there is a fault in the component and you should contact an authorised Volvo workshop to have it checked.

Fuses (Contd)

A. Relay/fuse box in engine compartment

The fuse box in the engine compartment has 24 fuse positions. Be sure to replace a blown fuse with a new fuse of the same colour and amperage.

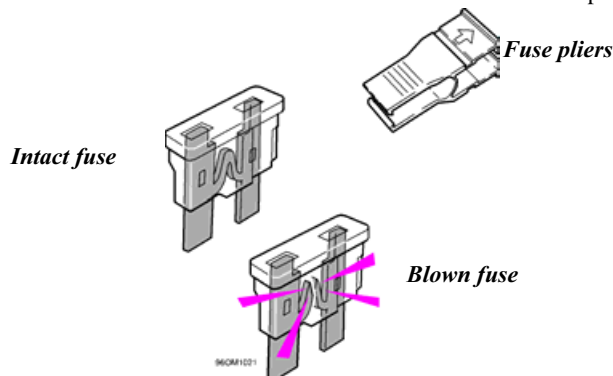

Fuses in the engine compartment

No.	Amperage
1. Parking heater (option)	25
2. Auxiliary lamps (option)	20
3. -	
4. Oxygen sensors, engine control module (diesel), high pressure valve (diesel)	20
5. Crankcase ventilation heater, solenoid valves, pump - fuel leak check	10
6. Mass air flow sensor, Engine Control Module, injectors.....	15
Mass air flow sensor (diesel)	5
7. -	
8. AC compressor, accelerator pedal sensor, fan electronic box.....	10
9. Horn	15
10. Rear window washer	10

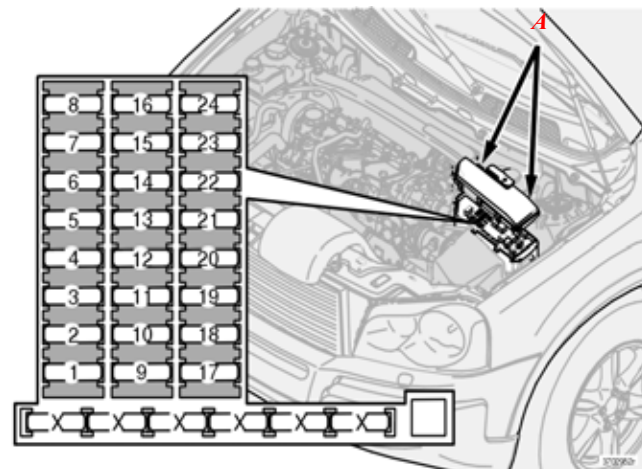

A. Press in the plastic catches on the back of the box and pull the cover up.

11. AC compressor, ignition coils, solenoid valves (diesel).....	20
12. Brake light contact	5
13. Windscreen wipers	25
14. DSTC, ABS.....	30
15. Headlamp washer.....	30
16. Wiper (windscreen).....	15
17. Dipped beam (right).....	10
18. Dipped beam (left)	10
19. ABS, DSTC.....	30
20. Main beam (left)	15
21. Main beam (right)	15
22. Starter motor	40
23. Engine Control Module, system relay	5
24.	-

B. Fuse box in the passenger compartment

The fuses are located inside the access panel on the end face of the dashboard. There are also a number of spare fuses.

No.	Amperage
1. Climate control system fan	30
2. Audio amplifier	30
3. Power seat (driver)	30
4. Power seat (passenger)	30
5. Central locking, power window, door mirror (front left)	25
6. Central locking, power window, door mirror (front right)	25
7. Power windows (rear), child safety lock	30
8. -	
9. Headlamp levelling	15
10. Power seat (passenger)	5
11. Electric socket 12V	15
12. Ignition switch (30-feed), Central Electronic Module, starter motor relay, SRS, antenna ring, engine management system	10
13. -	
14. Electronic module (roof), interior lighting (ceiling)	10
15. Telephone (option)	10
16. Speed-dependent power steering (option), vacuum pump	15
17. DSTC, ABS	5
18. Heated seat (front left)	15
19. Heated seat (front right)	15
20. Infotainment	10
21. Extended D1-feed, climate control system, power seat (driver), combined instrument panel, parking heater (option)	10
22. Light switch unit, climate control unit, diagnostic socket, steering wheel lever control unit	5
23. Direction indicators	20

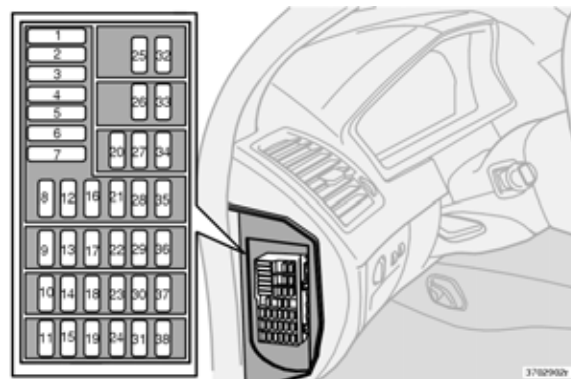

24. Automatic gearbox, shiftlock (extended D2 feed)	10
25. Fuel pump	15
26. Sunroof	15
27. Central electronic module, vanity mirror lighting, general lighting, glovebox lighting, alarm siren	10
28. Alarm siren	5
29. -	
30. Daytime running lights (DRL)	10
31. Daytime running lights (DRL)	10
32. Position/parking lamps (left - front and rear)	7,5
33. Position/parking lamps (right - front and rear), numberplate lighting	7,5
34. Fog lamps (front)	15
35. -	
36. Headlamps (main beam)	20
37. RTI display (option), media player	10
38. Headlamps (dipped beam), Bi-Xenon (option)	15

Fuses (Contd)

C. Relay/fuse box in the cargo compartment

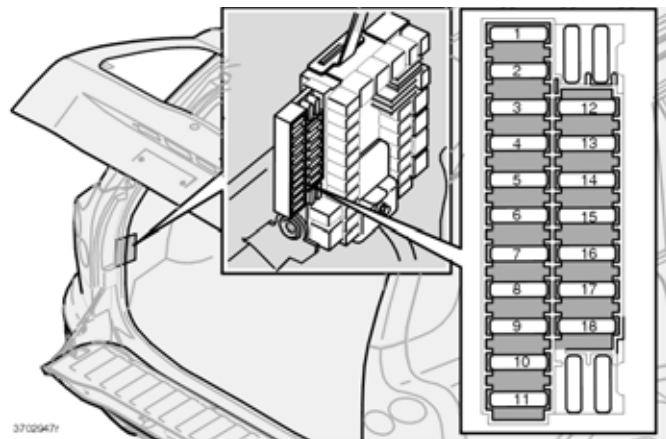
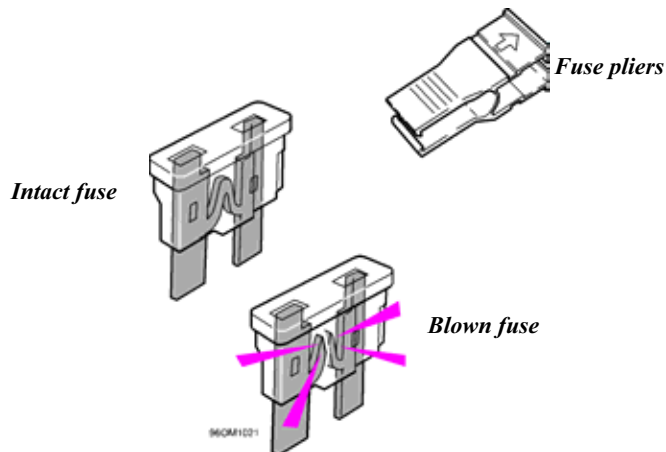

No.	Amperage	
1.	Rear Electronic Module (REM), lighting (cargo compartment) ...	10
2.	Rear fog lamp	10
3.	Brake light	15
4.	Reversing lamp.....	10
5.	Rear window defroster, relay 15I-feed (rear).....	5
6.	Tailgate opening	10
7.	Cargo compartment socket.....	15
8.	Rear door locking, fuel filler flap.....	20
9.	Towbar (30 feed)	15
10.	Antenna	5
11.	Accessory Electronic Module - AEM (option)	15
12.	Wiper, rear window	15
13.	Subwoofer/Rear AC	15
14.	Brake light	7.5
15.	Towing bracket (15I-feed), parking assistance.....	20
16.	-	
17.	Heated fuel filter (diesel), All-wheel drive (AWD) control module	7.5
18.	Heated fuel filter (diesel).....	15

Infotainment

Infotainment	160
Control panels	161
Audio functions	165
Radio functions	170
CD/MD (option)	182
CD changer (option)	184
Menu settings and selections – Audio	187
Telephone system	189
Telephone functions (option)	191
Menu settings and selections – Telephone	199

Infotainment

Information – Entertainment

Infotainment is a system with integrated audio and telephone functions.

You can easily and conveniently use your Infotainment system using the joint control panel or the steering wheel keypad.

The control panel display indicates the current function.

The XC90 is equipped with Dolby Surround Pro Logic II (option) which provides optimum sound experience with an expansive and realistic audio profile.

The system also allows your passengers to use headphones (option) with separate sound sources.

Control panels

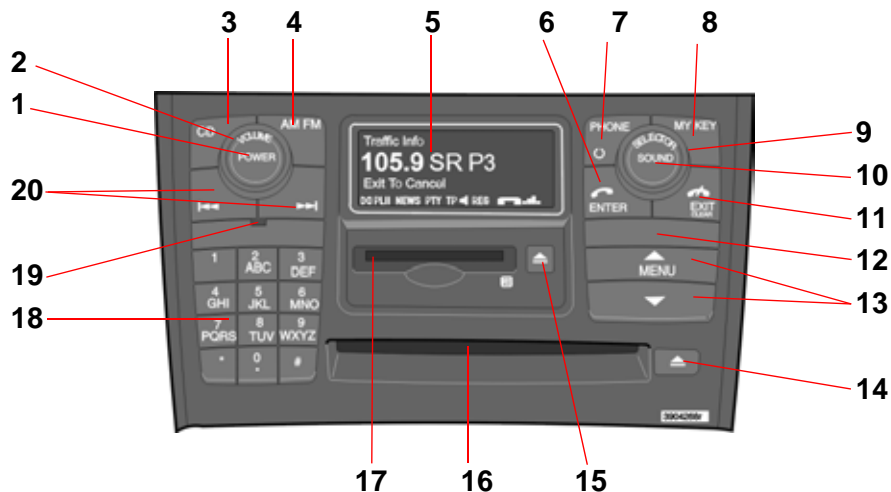

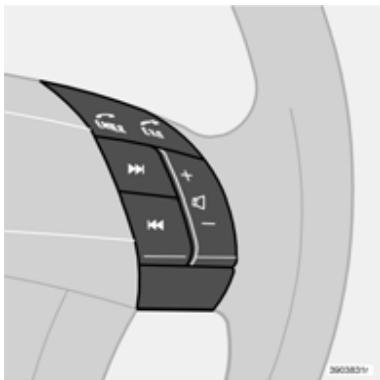

- | | | |
|---|--|---|
| <ul style="list-style-type: none"> 1. On/Off - Audio 2. Volume 3. CD – shortcut button 4. AM/FM - shortcut button to switch between FM1, FM2 and AM 5. Display 6. ENTER – select in the menu, activate a selection or activate the telephone from standby mode 7. On/Off/Standby – Telephone | <ul style="list-style-type: none"> 8. MY KEY – programmable shortcut key for your favourite function 9. SELECTOR – select sound source 10. SOUND – make sound settings 11. EXIT/CLEAR – scroll back in the menu, cancel a selection, put the telephone in standby mode, or erase the previous character when entering text and numbers. 12. SIM card holder 13. Menu selection buttons. 14. CD and CD changer eject | <ul style="list-style-type: none"> 15. MD eject 16. CD player and CD changer (option) 17. MD player (option) 18. Station setting buttons/selecting CD changer position (1-6), number/character buttons for the telephone and menu shortcuts 19. IR receiver for remote controls (option) 20. Seek/change tracks/stations or scroll forward and back when entering text and digits |
|---|--|---|

Control panels (Contd)



Steering wheel keypad (option) Audio – Telephone

The four buttons at the bottom of the steering wheel keypad control both the radio and the telephone. The function of the respective button depends on which system is active. The steering wheel keypad can be used to adjust volume, shift between preset stations and change CD/MD tracks.

By holding the  or  button depressed you can fast forward or rewind in a song or search for a radio station.



Selecting in the menu

In menu mode, you can check or modify settings and programme new functions in the system. The different menu alternatives are shown in the display. Menu alternatives followed by periods indicate that there are several submenus.

Press the MENU button (1) to activate menu mode.

The following applies in menu mode:





- The menu selection buttons are used to scroll up or down in the menu.
- A long press on EXIT/CLEAR allows you to leave menu mode.
- A brief press on EXIT/CLEAR allows you to clear, cancel, decline an alternative or go back one step in the menu structure.
- A press on ENTER allows you to confirm, select or scroll from a submenu to the next submenu.



Headphone sockets (option)

The door panels behind the second row of seats contain headphone sockets. This means that several passengers can listen to different sound sources, such as CDs or the radio, at the same time without disturbing each other.

Two sets of headphones can be connected to each socket.

- Switch sound source with the SEL button.
- Use the arrow keys,  or , to change CD/MD tracks or switch between preset stations.
- Hold the  or  button depressed to fast forward/rewind or search for the next strong station.

- Hold the SEL button depressed to switch off the system.
- Use the volume control button to adjust the volume of the respective headphones.

All headphones are switched off automatically when the audio system is switched off with the ignition key and must be activated manually when the car is restarted.

For the best sound reproduction, we recommend headphones with impedance between 16-32 ohm. The sensitivity of these should be equal to or greater than 102 dB. The headphone socket is intended for 3.5 mm contacts and is located on the bottom of the headphone panel (1).

Headphones – limitations

- If a set of headphones is connected to the same source that is being sent through the speakers, the headphones controls cannot be used to change track or station. This is so the driver is not surprised by an unexpected change in music.
- If the driver uses the control panel to select the same sound source as someone wearing headphones, the driver takes control of the sound source.
- Headphone users can choose from among the presets of the frequency (AM, FM1, FM2) previously set by the driver. In some cases, this means that the driver will not receive NEWS or traffic information even if TP/NEWS is selected.
- The CD changer can only play one disc and one song at a time.

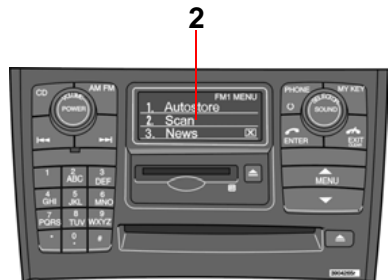

Display

The display (2) shows the current function, such as menu alternatives, messages, telephone numbers, or settings.

Clean the display with a soft, dry cloth. Do not use cleaner.

Control panels (Contd)

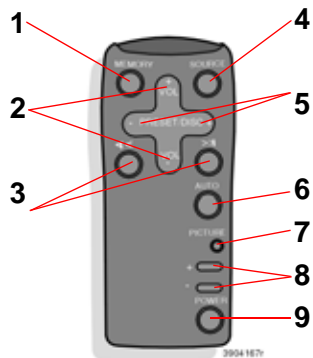

Remote control (option)

1. **Memory – Stores radio stations. To store a station:**
 - Press the Memory button
 - Select Preset using Preset/Disc (5)
 - Confirm your selection using the Memory button
2. **Volume**
3. **Seek/change tracks forward or back**
4. **Source – switch sound source**
5. **Preset/Disc – select CD changer position or preset radio station**

6. **Auto – find and store the strongest stations**
7. **Function not available**
8. **Function not available**
9. **On/Off – Audio**

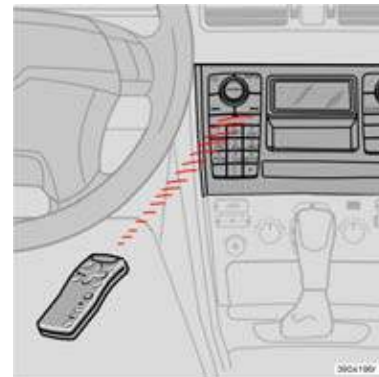

Direct the remote control towards the IR receiver (see illustration) that is located in the dashboard.

NOTE! The remote control contains AAA or R03 batteries. If the remote control does not work, first try replacing the batteries.

Audio functions

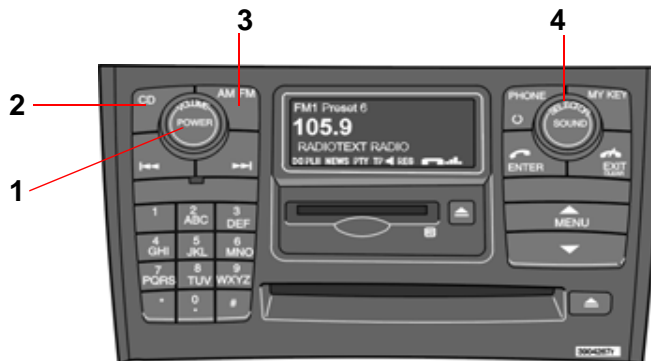

On/Off switch – Audio

Press the POWER button (1) to switch the audio system on or off.

If the audio system is active when the ignition is switched off, it will reactivate automatically when the car is restarted.

Selecting sound source

There are two ways to select sound source:

By using the shortcut buttons CD (2), AM/FM (3) or by using the SELECTOR knob (4):

- Turn the SELECTOR knob to select Radio (FM1, FM2 or AM), CD/CD changer (option) or MD (option).
- Press the AM/FM button repeatedly to shift between FM1, FM2 and AM.

The selected sound source is shown in the display.

MD can only be chosen using the SELECTOR knob.

Audio functions (Contd)



Volume control

Turn the knob (1) clockwise or anticlockwise to raise or lower the volume, respectively. The volume control is electronic and has no end position. Volume can also be raised (+) or lowered (-) using the steering wheel keypad.

Pause mode

When volume is in position zero, the CD/MD player is put in pause mode. Reactivate the player by turning up the volume.

Volume control – TP/PTY/NEWS/ALARM

If a CD or the like is playing when the radio receives a traffic bulletin, the CD player is put in pause mode. The message is played at the volume selected for that type of message. Playback of the originally selected sound source is then resumed at the previous volume. If volume is adjusted while the bulletin is played, the new volume is saved and used for the next bulletin.



Sound setting

1. Press the SOUND button (1).
2. Press the SOUND button repeatedly until you come to the function you wish to set. Choose BASS, TREBLE, FADER, BALANCE, SUBWOOFER (option), CENTRE (option) or SURROUND (option).
3. Use the SELECTOR knob (2) to adjust the level. The display shows a scale from min. to max. position. The middle indicates the normal position.

NOTE! The level of the centre speaker can only be set if Dolby Pro Logic II (DPL II) or three-channel stereo (3-CH) has been selected in the menu.

The level for Surround can only be set if Dolby Pro Logic II has been selected in the menu.

The level for Subwoofer can only be set if Subwoofer is activated.

Sound setting	Shown in the display
Bass	BASS
Treble	TREBLE
Balance between the right and left-hand speakers	BALANCE
Balance between the front and rear speakers	FADER
Level for bass speaker	SUBWOOFER (option)
Level for centre speaker	CENTRE (option)
Level for surround sound	SURROUND (option)

Audio functions (Contd)

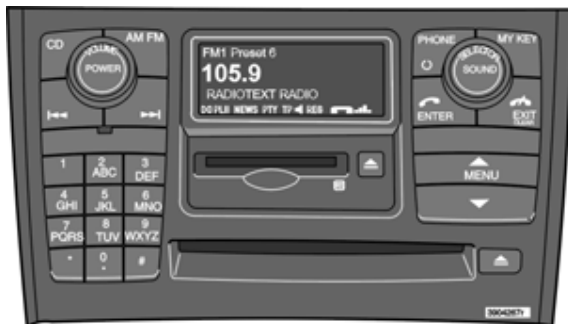

SURROUND (option) **Dolby Surround Pro Logic II**

Dolby Surround Pro Logic II with centre dashboard speaker provides a more realistic audio experience. The normal left-right stereo channels, divided into left-centre-right, are coupled with surround sound from the rear speakers. Surround sound can be described as the types of residual tones which are audible in a concert hall. Dolby Surround Pro Logic II functions in CD and MD modes. 3-Channel stereo is recommended for AM and FM radio broadcasts. Dolby Surround Pro Logic II is available for Premium Sound audio only.

1. Select AUDIO SETTINGS in the menu and press ENTER.
2. Select SURROUND and press ENTER.
3. Select Dolby AM/FM or Dolby CD/MD and press ENTER.
4. Select PRO LOGIC II, 3 CHANNEL or OFF and press ENTER.

- The symbol  PL II is shown in the display if Pro Logic II has been selected.
- 3 CH is shown in the display if 3 CHANNEL has been selected.
- OFF means the audio system is in normal stereo mode.

 Dolby Surround Pro Logic II is a trademark of Dolby Laboratories Licensing Corporation. Dolby Pro Logic II Surround System is manufactured under license from Dolby Laboratories Licensing Corporation.



Bass speaker – SUBWOOFER (option)

The subwoofer helps the system provide fuller sound and deeper bass.

1. Select AUDIO SETTINGS in the menu and press ENTER.
2. Select SUBWOOFER and press ENTER. A check in the box indicates that SUBWOOFER is activated.

Equalizer FR (option)

This function is used to fine-tune the sound from the front speakers.

1. Select AUDIO SETTINGS in the menu and press ENTER.
2. Select Equalizer FR and press ENTER.
3. Use the menu selection buttons or the SELECTOR knob to set the level.
4. Press ENTER to select the next frequency. You can select five frequencies.
5. Press ENTER until you come to menu mode to save any changes.

Equalizer RR (option)

This function is used to fine-tune the sound from the rear speakers.

1. Select AUDIO SETTINGS in the menu and press ENTER.
2. Select Equalizer RR and press ENTER.
3. Use the menu selection buttons or the SELECTOR knob to set the level.
4. Press ENTER to select the next frequency. You can select five frequencies.
5. Press ENTER until you come to menu mode to save any changes.

Radio functions

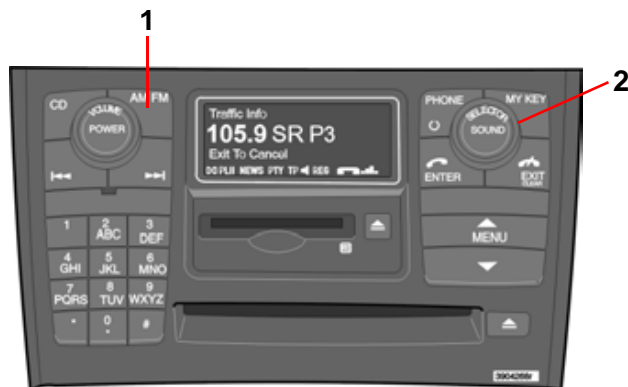

Station search

- Choose radio mode AM/FM1/FM2 using the SELECTOR knob (2) or the AM/FM button (1).
- A short press on the or button is used to search for the next strong station.
- Press one of the buttons again to search again.

Manually seek a known frequency

1. Hold the or button depressed. MAN is shown in the display. The radio scans slowly in the selected direction and increases tempo after a few seconds.
2. Release the button when the desired frequency shows in the display.
3. Frequency can be adjusted with a short press on one of the arrow keys, or .
4. Manual adjustment mode stays in effect five seconds after the last press.



Storing stations

To store a selected station under one of the station setting buttons 0-9 (1):

1. Set the desired station.
2. Press the button under which the station is to be stored and keep it depressed. The sound will disappear for a few seconds and **STATION STORED** will be shown in the display. The station is now stored.

You can store up to 10 stations each for AM, FM1 and FM2, i.e. a total of 30 stations.

Radio

Frequency band

FM	87.5 - 108 MHz
AM(LW)	153 - 279 kHz
AM(MW)	522 - 1611 kHz

Radio functions (Contd)



Storing stations automatically – AUTOSTORE

This function automatically finds and stores up to ten strong AM or FM stations in a separate memory. If more than ten stations are found, the ten strongest are stored. This function is especially beneficial in areas in which you are not acquainted with radio stations or their frequencies.

1. Choose radio mode using the SELECTOR knob or the AM/FM button.
2. Select AUTOSTORE in the menu and press ENTER.
3. Select AST SEARCH and press ENTER.
4. AUTOSTORING is shown in the display and a number of strong stations (max. 10) from the set frequency band are now stored in the autostore memory. If there are no stations with sufficient signal strength, NO AST FOUND is shown.
5. The preset stations can be selected with buttons 0-9.
6. When the radio is in autostore mode, AUTO is shown in the display. AUTO disappears when you return to the ordinary radio mode.
7. Return to the ordinary radio mode by pressing the AM/FM button or EXIT/CLEAR.
8. In order to gain access to a previously-stored setting, follow steps 1-2 but select AST MODE in step 3 and press ENTER.



Scanning – SCAN

The scan function automatically searches for AM or FM station signals. When the radio finds a station, scanning stops for approx. 8 seconds and then resumes.

1. Choose radio mode using the SELECTOR knob or the AM/FM button.
2. Select SCAN in the menu and press ENTER.
3. SCAN is shown in the display.
4. Press the EXIT/CLEAR button to exit.

Radio Data System – RDS

RDS is a system which links specific network transmitters together and is used, for example, to assist motorists by setting the correct frequency irrespective of the transmitter to which the car occupants are listening or the active audio source (e.g. CD). The system can also be used for receiving traffic information and for finding broadcasts of a specific type. Radiotext, which is also a part of RDS, is used by radio stations to send information regarding broadcasts already in progress.

NOTE! Certain radio stations feature neither RDS nor specific parts of RDS broadcast possibilities.

Automatic search for program information - PI Seek

When listening to an RDS transmitter, various information, such as traffic information, is stored in the radio.

When a preselected RDS transmitter is later selected, the radio updates the transmitter's RDS information. If the radio is in the boundary area or just outside of the transmitter's range, the radio automatically searches for the strongest possible transmitter of this station.

If there is no transmitter within "listening distance", the radio becomes silent and "PI SEEK PRESS EXIT TO CANCEL" is shown in the display until a station is found.

If you press EXIT (1), the radio begins to play the selected transmitter, but without updated RDS information.

Radio functions (Contd)



News – NEWS

This function interrupts other sound sources, e.g. CD, when a news broadcast starts.

1. Choose radio mode using the SELECTOR knob or the AM/FM button.
2. Select NEWS in the menu and press ENTER.
3. NEWS is shown in the display.
4. Select NEWS again and press ENTER to deactivate the NEWS function.

With this function, programmes from RDS stations that are news-coded will interrupt other audio sources using the volume setting for this specific purpose. As soon as the news broadcast is finished, the audio system returns to the previous audio source and resumes the previous volume setting.

- If you do not wish to listen to a news item in progress, press the EXIT button. The NEWS function remains active and the radio waits for the next news programme.



Traffic information – TP

This function interrupts other audio sources in order to broadcast traffic information from RDS stations; the message is heard at the volume set for this specific purpose. As soon as the message ends, the audio system returns to the previous audio source and resumes the previous volume setting.

1. Select TP in the menu and press ENTER.
2. TP is shown in the display.
3. Select TP again and press ENTER to deactivate the TP function.

TP is shown in the display when this function is active. If the set station can send traffic information,))) is shown in the display. Traffic information will only interrupt the sound source if TP))) is shown in the display.

- If you do not wish to listen to a traffic bulletin, press the EXIT button. The TP function, however, remains active and the radio waits for the next traffic bulletin.

TP Search

This function allows you to listen to traffic information when travelling between different countries and states in Europe without needing to select a station.

1. Select RADIO SETTINGS in the menu and press ENTER.
2. Select TP and press ENTER.
3. Select TP Search and press ENTER.
4. To deactivate the function, select TP Search again and press ENTER.

Radio functions (Contd)



Radio text

Some RDS stations send information on programme content, artists, etc. This information can be indicated with text in the display.

1. Press the MENU button.
2. Select RADIOTEXT in the menu and press ENTER.
3. Select RADIOTEXT again and press ENTER to deactivate.

Alarm

Alarm is sent out automatically. The function cannot be deactivated.

" Alarm! " is shown in the radio display when an alarm message is sent. This function is used to warn motorists of major accidents and catastrophes, such as a bridge collapse or an accident at a nuclear plant.



Programme type – PTY

The PTY function allows you to select programmes that fit your taste. Use the PTY function to select from among the different programme types shown in the list.

Show PTY

Which PTY does the set station have?

1. Select RADIO SETTINGS in the menu and press ENTER.
2. Select PTY in the menu and press ENTER.
3. Select SHOW PTY and press ENTER. The PTY of the selected station is now shown in the display.

NOTE! Not all radio stations have a PTY designation.

Programme type	Shown in the display
Current affairs	CURRENT AFFAIRS
Information	INFORMATION
Sports	SPORT
Education	EDUCATION
Theatre	DRAMA
Culture and Art	CULTURES
Science	SCIENCE
Varied discussions	VARIED SPEECH
Pop music	POP MUSIC
Rock music	ROCK MUSIC
Easy listening	EASY LISTENING
Light classical	LIGHT CLASSIC
Classical music	SERIOUS CLASSIC
Other music	OTHER MUSIC

Programme type	Shown in the display
Weather	WEATHER
Economy	FINANCE
For children	CHILDREN
Social issues	SOCIAL AFFAIRS
Spiritual issues	RELIGION
Telephone watch	PHONE IN
Travel and holiday	TRAVEL
Leisure and hobby	LEISURE & HOBBY
Jazz music	JAZZ MUSIC
Country music	COUNTRY MUSIC
National music	NATIONAL MUSIC
Golden oldies	OLDIES MUSIC
Folk music	FOLK MUSIC
Documentary	DOCUMENTARY



Radio functions (Contd)



Search for a specific programme type – PTY

This function helps you find programmes with a specific focus by searching the entire frequency band.

1. Select FM1 or FM2 and press the MENU button.
2. Select RADIO SETTINGS and press ENTER.
3. Select PTY and press ENTER.
4. Choose SELECT PTY and press ENTER.
5. Press ENTER for one or more of the listed programme types you desire. The PTY symbol in the display lights up when the first selection is made and the radio continues in standby for PTY.

6. Once you have selected all desired types, select EXIT/CLEAR to exit the PTY list.
7. Select SEARCH PTY and press ENTER. If the radio finds a station with the selected programme type, it is played through the speakers.
8. If the radio finds a station that is unsuitable, continue the search with the  and  buttons.
9. If no stations with the selected programme type are found, the radio resumes its previous frequency. PTY then remains in standby mode until the selected programme type is aired, at which time the radio automatically switches to the station sending the selected programme type.

10. In order to deactivate PTY standby, enter the menu and select CLEAR ALL PTY. The symbol is removed from the display and the radio resumes normal mode.

PTY standby

To continue with the radio in PTY standby, repeat steps 1-6.



Traffic information – TP STATION

Here, you set from which station traffic information is to be heeded.

Note that))) must be shown in the display for this to work.

1. Listen to the station from which traffic information is to be heeded.
2. Select RADIO SETTINGS in the menu and press ENTER.
3. Select TP and press ENTER.
4. Select TP STATION and press ENTER.
5. Select SET CURRENT and press ENTER.

NOTE! Now only traffic information from the stored station will be played.

News – NEWS STATION

Here, you set from which station news is to be heeded.

Note that the set station in question must be an RDS station for this to work.

1. Listen to the station from which news is to be heeded.
2. Select RADIO SETTINGS in the menu and press ENTER.
3. Select NEWS STATION and press ENTER.
4. Select SET CURRENT and press ENTER.

NOTE! Now only news from the stored station will be played.

Deactivate TP STATION/NEWS STATION

1. Select RADIO SETTINGS in the menu and press ENTER.
2. Select TP/NEWS STATION and press ENTER.
3. Select RESET STATION and press ENTER.

Radio functions (Contd)



Automatic frequency update – AF

The AF function is usually active and makes sure that the strongest available transmitter for a radio station is used.

1. Select RADIO SETTINGS in the menu and press ENTER.
2. Select AF and press ENTER.
3. To deactivate AF, select AF and press ENTER.

Regional radio programme – REG

The REG function is usually deactivated. It makes it possible to stay tuned to a regional transmitter even if signals are weak.

1. Select RADIO SETTINGS in the menu and press ENTER.
2. Select REGIONAL and press ENTER.
3. REG is shown in the display.
4. To deactivate REG, select REG again and press ENTER.



EON – LOCAL /DISTANT (Enhanced Other Networks)

Normally, the EON function is in DISTANT mode and determines if interruption of the radio broadcast to which you are listening is necessary for e.g. traffic information or news broadcasts (if these functions have been selected). The function has two levels: LOCAL, which interrupts only if the signal is strong and DISTANT which even interrupts with weaker signals.

No interruptions occur when OFF is selected.

1. Select RADIO SETTINGS in the menu and press ENTER.
2. Select EON and press ENTER.
3. Select LOCAL, DISTANT or OFF and press ENTER.

Resetting RDS functions – RESET ALL

This function restores all radio settings to the original factory settings.

1. Select RADIO SETTINGS in the menu and press ENTER.
2. Select RESET ALL in the menu and press ENTER.
3. Press ENTER again to confirm your selection.

CD/MD (option)

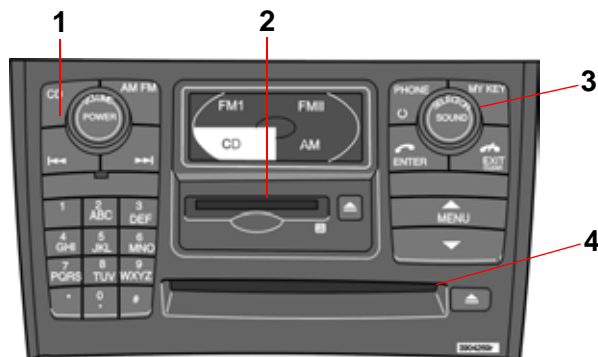

Starting the CD/MD player

- Start the CD player with the SELECTOR knob (3) or by pressing the CD button (1). Insert a disc in the CD player (4).
- Start the MD player with the SELECTOR knob (3). Insert a disc in the MD player (2).

Changing tracks

Press **▶▶** to skip to the next track or **◀◀** to skip to the previous track. The track number is shown in the display. If you have a keypad in the steering wheel, you can also use the corresponding buttons.

Fast forward/rewind

Press and hold down **▶▶▶** or **◀◀◀** to search within a track or the whole disc. The search continues as long as the button is depressed. If you have a keypad in the steering wheel, you can also use the corresponding buttons.

Random – RANDOM

This function chooses a CD track in no particular order (shuffle).

1. Select RANDOM in the menu and press ENTER.
2. RND is shown in the display as long as the function is activated.
3. Select RANDOM OFF or press the EXIT button to exit.

NOTE! Do not use CDs with that have disc labels. The heat from the CD player could cause the label to come loose from the disc. The CD player could then be damaged.

Use only 12 cm CDs, no smaller! If the quality of the CD does not comply with the requirements of standard EN60908 or if it has been recorded using poor equipment, sound quality may be poor or playback interrupted.





Scan

This function plays the first ten seconds of each song or track.

1. Select SCAN in the menu and press ENTER.
2. Press EXIT/CLEAR when you find a song or track you wish to listen to.

Disc text (MD only)

Certain discs contain information on album and song titles. This information is shown in the display in text form if the function DISCTEXT is activated.

1. Select DISCTEXT in the menu and press ENTER.
2. If information is stored on the disc, it is shown in the display.
3. To deactivate the function, select DISCTEXT and press ENTER.

MD eject

If you press the button (1), the MD player stops and ejects the disc.

CD eject

If you press the button (2), the CD player stops and ejects the disc.

For reasons of traffic safety, you have 12 seconds to handle the ejected disc or it will be re-fed into the CD player.

For reasons of traffic safety, the ejected CD remains out no more than 12 seconds. The CD player then pulls it back in. To reactivate the CD player, press the CD button (3).

CD changer (option)



Starting the CD changer

The CD changer can hold up to six discs.

1. Choose CD mode using the SELECTOR knob (2) or the CD button (1).
2. Select an empty position using the numbered buttons 1-6 (3). The display shows which are empty.
3. Insert a disc into the changer.

Make sure INSERT DISC is shown before you insert a new disc.

Selecting position

Select which disc is to be played using numbered buttons 1-6 (3). The number of the disc and track are shown in the display.

Changing tracks

Press **[<<<]** to skip to the next track or **[>>>]** to skip to the previous track. The track number is shown in the display. If you have a keypad in the steering wheel, you can also use the corresponding buttons.



Fast forward/rewind

Press and hold down **⏩** or **⏮** to search within a track or the whole disc. The search continues as long as the button is depressed. If you have a keypad in the steering wheel, you can also use the corresponding buttons.

Scan

This function plays the first ten seconds of each song or track.

1. Press the MENU button.
2. Select SCAN and press ENTER.
3. Press EXIT/CLEAR when you find a song or track you wish to listen to.

Scan only works on the selected disc.

Random – RANDOM

This function chooses a CD track in no particular order.

1. Select RANDOM in the menu and press ENTER.
2. Select SINGLE DISC or ALL DISCS for the player to randomly choose from one or all discs in the CD changer.
3. RND or RND ALL is shown in the display while the function is active.
4. Press EXIT to exit.

Press **⏩** to select the next random track.

NOTE! You can only select the next random track on the disc in question.

CD changer (option) (Contd)



Disctext

Certain discs contain information on album and song titles. This information is shown in the display in text form if the function DISCTEXT is activated.

1. Press the MENU button.
2. Select DISCTEXT in the menu and press ENTER.
3. If information is stored on the disc, it is shown in the display instead of the current track.
4. To deactivate the function, select DISCTEXT and press ENTER.

CD eject

If you press the button (1), the CD player stops and ejects the disc.

For reasons of traffic safety, you have 12 seconds to handle the ejected disc or it will be re-fed into the CD player.

Eject All

A long press on the EJECT button (1) starts EJECT ALL. This empties the entire magazine disc by disc. The text EJECTING ALL is shown in the display.

This function can only be activated when the car is stationary and is interrupted if the car starts to move.

For reasons of traffic safety, you have 12 seconds to handle the ejected disc or the function will be cancelled.

NOTE! Do not use CDs with that have disc labels. The heat from the CD player could cause the label to come loose from the disc. The CD player could then be damaged.

Use only 12 cm CDs, no smaller! If the quality of the CD does not comply with the requirements of standard EN60908 or if it has been recorded using poor equipment, sound quality may be poor or playback interrupted.

Menu settings and selections – Audio

Main menu/submenus

RADIO

1. AUTOSTORE*
 - 1.1. AST Mode
 - 1.2. AST Search
 - 1.2.1. AUTOSTORING
2. SCAN* ON/OFF**
3. NEWS* ON/OFF**
4. TP* ON/OFF**
5. RADIO TEXT* ON/OFF**
6. RADIO SETTINGS
 - 6.1. PTY
 - 6.1.1. SELECT PTY
 - 6.1.2. SEARCH PT Y*
 - 6.1.3. SHOW PTY ON/OFF**
 - 6.2. TP
 - 6.2.1. TP STATION
- SET CURRENT/RESET STN
 - 6.2.2. TP SEARCH ON/OFF**
- 6.3. NEWS STATION
 - 6.3.1. SET CURRENT/RESET STN
- 6.4. AF* ON**/OFF
- 6.5. REGIONAL* ON/OFF**
- 6.6. EON
 - 6.6.1. OFF

- 6.6.2. LOCAL
- 6.6.3. DISTANT**
- 6.7. RESET All
7. AUDIO SETTINGS (option)
 - 7.1. Dolby AM/FM
 - 7.1.1. Pro Logic II
 - 7.1.2. 3CH
 - 7.1.3. OFF**
 - 7.2. Dolby CD/MD
 - 7.2.1. Pro Logic II**
 - 7.2.2. 3CH
 - 7.2.3. OFF
 - 7.3. SUBWOOFER* ON**/OFF (option)
 - 7.4. EQUALIZER Fr (option)
 - 7.5. EQUALIZER Rr (option)
 - 7.6. RESET ALL

CD

1. RANDOM*
2. SCAN*
3. NEWS* ON/OFF**
4. TP* ON/OFF**
5. AUDIO SETTINGS
 - 5.1. Dolby AM/FM
 - 5.1.1. Pro Logic II
 - 5.1.2. 3 Channel
 - 5.1.3. Off**
 - 5.2. Dolby CD/MD
 - 5.2.1. Pro Logic II**
 - 5.2.2. 3 Channel
 - 5.2.3. Off
 - 5.3. SUBWOOFER* ON**/OFF (option)
 - 5.4. EQUALIZER Fr (option)
 - 5.5. EQUALIZER Rr (option)
 - 5.6. RESET ALL

*Programmable with MY KEY

**Default

Main menu/submenus

CDX

1. RANDOM*
 - 1.1. Off**
 - 1.2. Single Disc
 - 1.3. All Discs
2. SCAN*
3. NEWS* ON/OFF**
4. TP* ON/OFF**
5. DISC TEXT* ON/OFF**
6. AUDIO SETTINGS
 - 6.1. Dolby AM/FM
 - 6.1.1. Pro Logic II
 - 6.1.2. 3 Channel
 - 6.1.3. Off**
 - 6.2. Dolby CD/MD
 - 6.2.1. Pro Logic II**
 - 6.2.2. 3 Channel
 - 6.2.3. Off
 - 6.3. SUBWOOFER* ON**/OFF (option)
 - 6.4. EQUALIZER Fr (option)
 - 6.5. EQUALIZER Rr (option)
 - 6.6. Reset All

MD

1. RANDOM*
2. SCAN*
3. NEWS*
4. TP*
5. DISC TEXT* ON/OFF**
6. AUDIO SETTINGS
 - 6.1. SURROUND*
 - 6.1.1. Pro Logic II
 - 6.1.2. 3 Channel
 - 6.1.3. Off**
 - 6.2. SUBWOOFER* ON**/OFF (option)
 - 6.3. EQUALIZER Fr (option)
 - 6.4. EQUALIZER Rr (option)
 - 6.5. Reset All

*Programmable with MY KEY
 **Default



My own shortcut button – MY KEY

The MY KEY button (1) can be used to store your favourite menu functions, such as SCAN, AUTOSTORE or TP.

- Use the menu selection buttons to scroll among the functions.
- Select the function to be stored by holding the MY KEY button depressed for more than two seconds.
- When MY KEY STORED is shown in the display, the function has been stored.
- Activate the function by briefly pressing the MY KEY button.
- Repeat steps 1-4 to store a new function for the button.

Telephone system

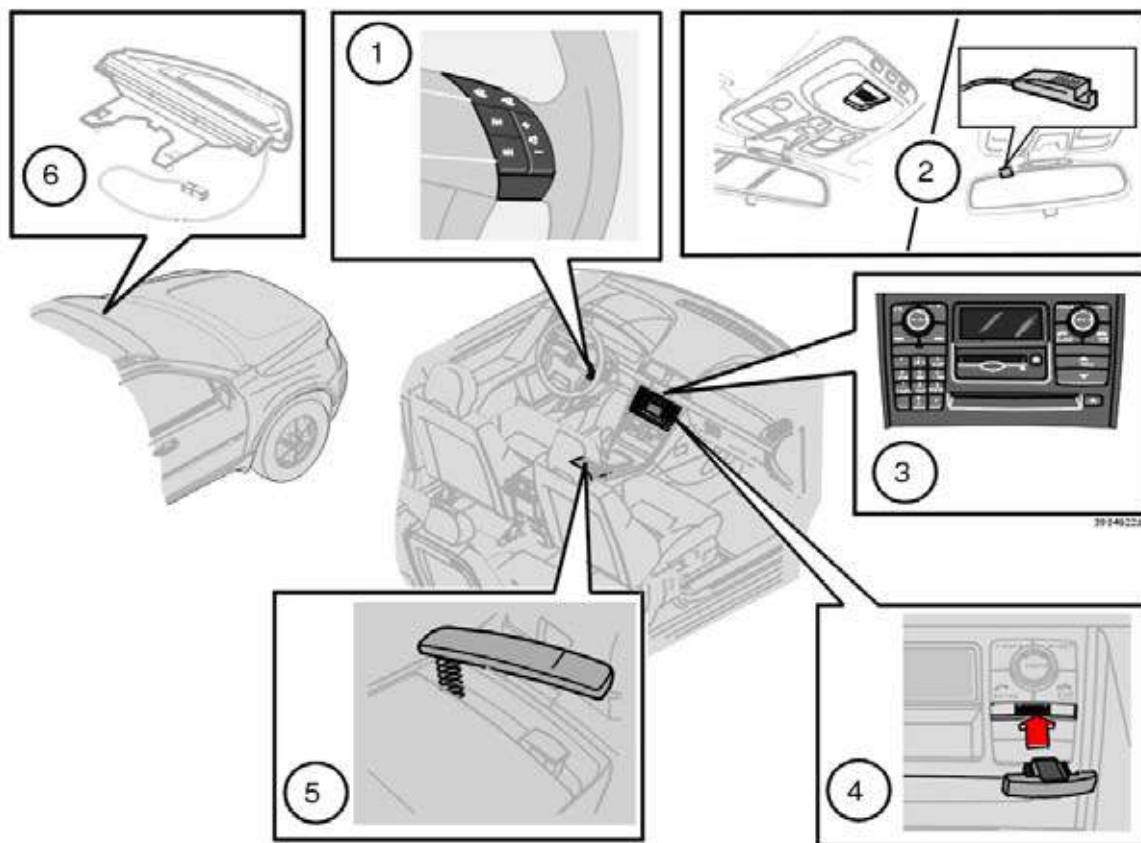

1. Steering wheel keypad

You can control the majority of telephone functions using the steering wheel keypad. When the telephone is active, the steering wheel keypad can only be used for telephone functions. When in active mode, telephone information is always shown in the control panel display.

2. Microphone

The handsfree microphone is integrated in the rearview mirror or roof panel.

3. Control panel

All telephone system functions, except call volume, can be controlled from the control panel keypad. The display shows menu functions, messages, telephone numbers, etc.

4. SIM card

The SIM card is inserted into the front of the control panel.

5. Privacy handset

The privacy handset can be used when you do not wish to be disturbed.

6. Antenna

The antenna is mounted against the windscreen in front of the rearview mirror.

Speaker

The telephone uses the speaker in the driver's door or the centre speaker of the audio system (if there is one).

General rules

- Put traffic safety first! If as the driver you need to use the privacy handset, park the car in a safe place first.
- Switch off the system when refuelling the car.
- Switch off the system near blasting work.
- Let only authorised personnel service your telephone system.

Emergency calls

Emergency calls to alarm centres can be made without a SIM card as long as there is coverage by a GSM operator.

- Activate the telephone.
- Ring the emergency number that applies to your region (within EU: 112).
- Press the ENTER button on the control panel or steering wheel.

Telephone functions (option)

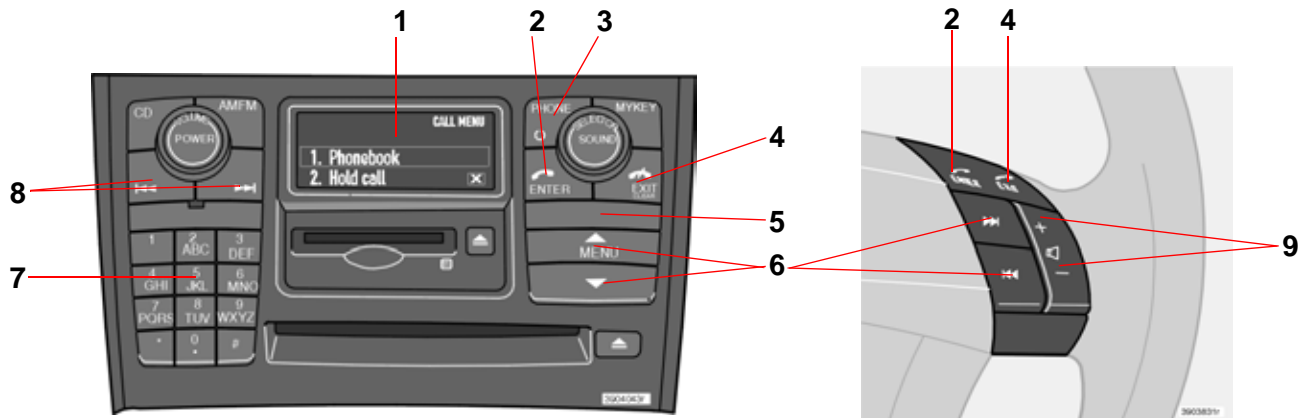

- | | |
|---|---|
| <ul style="list-style-type: none"> 1. Display 2. ENTER – accept a call, make a menu selection or activate the telephone from standby mode 3. On/Off/Standby 4. EXIT/CLEAR – terminate/refuse a call, scroll back in the menu, cancel a selection or erase entered digits/characters. 5. SIM card holder 6. Menu selection buttons | <ul style="list-style-type: none"> 7. Number/character buttons and menu shortcuts 8. Seek – scroll forward or back when entering text and numbers. 9. Increase/decrease call volume during a call |
|---|---|

Telephone functions (option) (Contd)

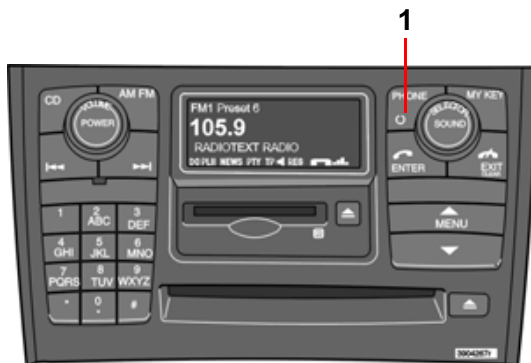

Switch, On/Off/Standby – Telephone

To activate the system:

- Press the PHONE button (1) to activate the telephone system.

To switch off the system:

- Hold the PHONE button depressed to switch off the telephone system

Continuing with system in standby mode:

- The telephone will continue in standby mode with a brief press of the PHONE button or if you press EXIT/CLEAR.
- Reactivate the system with the PHONE button.

When the telephone system is active or in standby mode, a handset is shown in the display.

NOTE! With the Performance audio system, it is not possible to listen to the radio, CD, MD or receive traffic messages during a telephone call.

If you switch off the car's ignition with the telephone system on, it will be on the next time you switch on the ignition. No calls can be received when the telephone system is switched off.

Volume reduction during telephone call

If the telephone rings when the radio is switched on, the volume is lowered when the call is answered. When the call is concluded, the volume returns to the previously-set level. Radio volume can also be adjusted during a telephone call, whereby the newly-selected level will resume when the call is concluded. Audio system volume can be switched off completely during a telephone call. See menu 5.5.3 on page 199.

This function only applies to the Volvo integrated telephone system.



Standby mode

In standby mode, you can receive calls while the audio system is active and information from audio system sources is shown in the display.

To use other functions of the telephone system, the phone must be in active mode.

Menu shortcuts

Once you have used the menu button to enter the menu system, you can use numbers instead of the arrows and the ENTER button to select the right menu in the main menu level. Each menu selection is numbered. The numbers are shown in the display together with the menu alternative.

Traffic safety

For reasons of safety, parts of the telephone menu system cannot be accessed at speeds in excess of 8 km/h. You may only complete menu system activities that have already been started.

The speed limiter can be disconnected using menu function 5.6.

Telephone functions (option) (Contd)



SIM card

The telephone can only be used with a valid SIM card (Subscriber Identity Module). Your network operator supplies this card.

Always insert the SIM card when you wish to use the telephone.

- Switch off the telephone.
- Open the SIM card holder with a short press.
- Insert the card with the metallic surface down.
- Make sure that the bevelled corner of the SIM card matches the bevel of the holder.
- Press in the holder.



Contact your network operator if you experience difficulties with the SIM card.

Making and receiving calls

To call:

- Dial the number and press ENTER on the steering wheel or the control panel keypad (or lift the handset).

To receive an incoming call:

- Press ENTER (or lift the handset). You can also use Automatic Answer. See menu function 4.3.

The car audio system can be muted automatically while a telephone conversation is in progress. See menu alternative 5.6.3.

Ending a call

Press EXIT/CLEAR on the steering wheel or control panel keypad or hang up the handset. The audio system resumes its previous activity.

Refuse an incoming call by pressing EXIT/CLEAR.

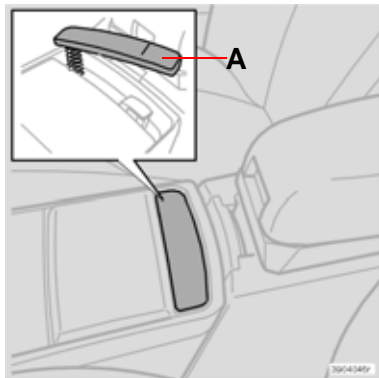

Privacy handset

If you wish to speak without disruptions, use the privacy handset. Lift the handset and press (A).

1. Select the desired telephone number using the centre console keypad and lift the handset to place the call. Adjust the volume with the dial on the side of the handset.
2. The call is ended when you replace the handset in its holder.

If you wish to switch to a handsfree unit without ending the call: press **[+]** on the steering wheel keypad (or control panel menu buttons) and select Handsfree. Press ENTER and replace the handset in its cradle. If the handset is already removed from its cradle, the ringing party will be audible in the handsfree system. Press the

MENU button, scroll to Handset and press ENTER in order to transfer to the handset.

Last number called

The telephone automatically stores the last telephone numbers/names called.

1. Press ENTER in the steering wheel or control panel keypad.
2. Use the menu buttons to scroll forward or back through the last numbers dialed. They are shown in the display.
3. Press ENTER.

Speed dial

Storing speed dial numbers

A number stored in the phone book can be linked to a speed dial button (1-9) as follows:

1. Select Phone book in the menu and press ENTER.
2. Scroll to Speed dial (Menu 3.3) and press ENTER.
3. Select which number is to be the speed dial number. Press ENTER to confirm.
4. Search for the desired name or phone number in the phone book. Press ENTER to select.

Using speed dial

To make a call, hold the desired speed dial button depressed for two seconds or press the button briefly and then press ENTER.

NOTE! Once you switch on the telephone, wait a moment before using speed dial.

If you wish to use a speed dial number, Menu 3.3.1 must be activated.

Call waiting

If you hear two beeps in your speaker during a phone call, someone else is calling. This function can be selected or deselected in the menu.

In this mode, you can choose to either take the call or refuse it. If you **do not** wish to take the call, press EXIT/CLEAR or do nothing.

If you **do** wish to take the call, press ENTER. Your current call will be put in "park mode". If you press EXIT/CLEAR, both calls will be terminated.

Functions during a call

The following functions are available **during a call** (scroll with the arrows and press ENTER to make a selection):

Secret mode/ Secret mode off	Secret mode
Park/Resume	Choose if the call is to be parked or resumed.
Handset/ Handsfree	Use the handset or handsfree
Phone book	Show phone book

The following functions are available when you have a **current call** and a **parked call** (scroll with the arrows and press ENTER to make a selection):

Secret mode/ Secret mode off	Secret mode
Handset/ Handsfree	Use the handset or handsfree
Phone book	Show phone book
Three-way calling	Speak with both parties simultaneously (conference call)
Switch	Switch between the two calls

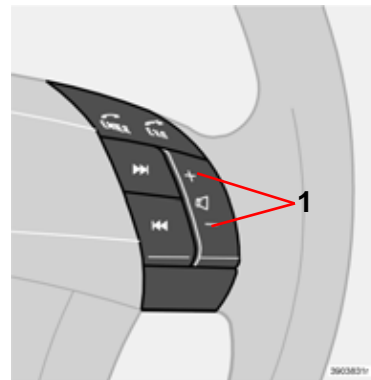

Call volume

Increase or decrease call volume by pressing the + or – button (1) of the steering wheel keypad during a call.

When the telephone is activated, the steering wheel keypad only controls the telephone functions.

The telephone must be in standby mode in order to adjust the audio system with these buttons, see page 192

Phone book

Telephone numbers and names can be stored in either the telephone memory or the SIM card memory.

If the number of the person calling is found in the phone book, his or her name is shown in the display.





The telephone memory can store up to 255 names.







Storing telephone numbers with names

1. Press the MENU button, select Phone book and press ENTER.
2. Scroll to Enter item and press ENTER.
3. Enter a name and press ENTER.
4. Enter a number and press ENTER.
5. Choose in which memory to save and press ENTER.

Enter a name (or message)

Press the button with the desired character: once for the first character, twice for the second, etc. Press 1 to enter a space.

	space 1- ? ! , . : " ' ()
	a b c 2 ä å à á â æ ç
	d e f 3 è é ê ë
	g h i 4 ì í î ï

	j k l 5
	m n o 6 ñ ò ó ô õ
	p q r s 7 ß
	t u v 8 ü ú û ü
	w x y z 9
	if you enter two letters in a row from the same button, press * between them or wait a few seconds

 + 0 @ * # & \$ £ / %

 switch between upper and lower case

 delete the last letter or number entered. If you press for a long time, the enter number or text is deleted.

Interrupting text input

1. Clear all entered characters with a long press on the EXIT/CLEAR button.
2. Return to the menu with an additional long press on the EXIT/CLEAR button.

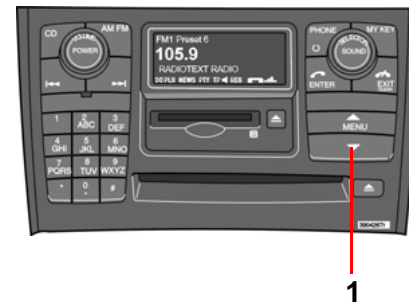

Calling from the memory

1. Press the MENU button's down arrow (1) or  in the steering wheel to search in the phone book.
2. Choose from the following alternatives:
 - Press ENTER and scroll with the arrows until you find the desired name.
 - Press the key for the first letter of the name (or enter the entire name) and press ENTER.
3. Press ENTER to call the selected number.



Double SIM card

Many network operators offer double SIM cards, one for your car and one for another telephone. A double SIM card allows you to have the same number for two different telephones. Ask your network operator about the offers available and the use of double SIM cards.

Specification

Output	2 W
SIM card	small, 3V
Memory positions	255 a
SMS (Short Message Service)	Yes
Computer/Fax	No
Dualband	Yes (900/ 1800)

a. The telephone memory is capable of storing 255 items. The number of SIM card memory positions varies according to the subscription.

IMEI number

In order to block the telephone, you must provide your network operator with the telephone's IMEI number which is a 15-digit serial number that is programmed in the phone. To display this number, press *#06#. Make a note of this number and keep it in a safe place.

Menu settings and selections – Telephone

1. Call log - CALL
 - 1.1. Missed calls
 - 1.2. Received calls
 - 1.3. Outgoing calls
 - 1.4. Erase list
 - 1.4.1. All calls
 - 1.4.2. Missed calls
 - 1.4.3. Received calls
 - 1.4.4. Outgoing calls
 - 1.5. Call duration
 - 1.5.1. Last call
 - 1.5.2. Number of calls
 - 1.5.3. Total time
 - 1.5.4. Reset time
2. Messages
 - 2.1. Read
 - 2.2. Create new
 - 2.3. Message settings
 - 2.3.1. SMSC number
 - 2.3.2. Validity period
 - 2.3.3. Message type
3. Phone book
 - 3.1. Enter item
 - 3.2. Search
 - 3.3. Copy all
 - 3.3.1. SIM to phone
 - 3.3.2. Phone to SIM
 - 3.4. Speed dial
 - 3.4.1. Active
 - 3.4.2. Select number
- 3.5. Clear SIM
- 3.6. Clear memory
- 3.7. Memory status
4. Call options
 - 4.1. Transmit number
 - 4.2. Call waiting
 - 4.3. Automatic answer
 - 4.4. Automatic redial
 - 4.5. Call divert
 - 4.5.1. All calls
 - 4.5.2. When busy
 - 4.5.3. When not answered
 - 4.5.4. If unreachable
 - 4.5.5. Fax calls
 - 4.5.6. Computer calls
 - 4.5.7. Cancel all divers
5. Tel. settings
 - 5.1. Network selection
 - 5.1.1. Automatic
 - 5.1.2. Manual
 - 5.2. Language
 - 5.2.1. Dansk
 - 5.2.2. Deutsch
 - 5.2.3. English UK
 - 5.2.4. English US
 - 5.2.5. Español
 - 5.2.6. Français CAN
 - 5.2.7. Français FR
 - 5.2.8. Italiano
 - 5.2.9. Nederlands
 - 5.2.10. Português BR
 - 5.2.11. Português P
 - 5.2.12. Suomi
 - 5.2.13. Svenska
 - 5.3. SIM security
 - 5.3.1. On
 - 5.3.2. Off
 - 5.3.3. Automatic
 - 5.4. Change codes
 - 5.4.1. PIN code
 - 5.4.2. Telephone code
 - 5.5. Volume
 - 5.5.1. Ringer volume
 - 5.5.2. Ringer tone
 - 5.5.3. Mute radio
 - 5.5.4. Message beep
 - 5.6. Traffic safety
 - 5.7. Factory settings

Menu 1. Call log

1.1. Missed calls

A list of missed calls is shown here. You can choose to call, erase or store the number in the phone book.

1.2. Received calls

A list of received calls is shown here. You can choose to call, erase or store the number in the phone book.

1.3. Outgoing calls

A list of dialled numbers is shown here. You can choose to call, erase or store the number in the phone book.

1.4. Erase list

This option can be used to erase the list of menus 1.1, 1.2 and 1.3 as follows.

- 1.4.1. All
- 1.4.2. Missed
- 1.4.3. Received
- 1.4.4. Outgoing

1.5. Call duration

Here you can see the duration of all your calls or the most recent. You can also see the number of calls and clear the call timer.

- 1.5.1. Last call
- 1.5.2. Number of calls
- 1.5.3. Total time
- 1.5.4. Reset time.

Resetting the call timer requires the telephone code (see Menu 5.5).

Menu 2. Messages

2.1. Read

Here you can read received text messages. You can then choose to erase the message, forward it, change or save the entire message or parts of it.

2.2. Create new

You can write a text message using the keypad. Then choose to save or send it.

2.3. Message settings

Enter the number (SMSC number) of the message centre to which you want your messages transferred as well as how long they are to be saved at the message centre.

- 2.3.1. SMSC number
- 2.3.2. Validity period
- 2.3.3. Message type

Contact your service provider for information on these settings and for an SMSC number. Normally, these settings should not be altered.

Menu 3. Phone book

3.1. Enter item

You can store names and telephone numbers in the phone book. See the section on phone book functions for more information.

3.2. Search

3.3. Copy all

Copy SIM telephone numbers and names to the telephone memory.

- 3.3.1. From SIM to telephone memory
- 3.3.2. From phone to SIM memory

3.4. Speed dial

A number stored in the telephone book can be stored as a speed dial number.

3.5. Clear SIM

The entire memory of the SIM card can be erased.

3.6. Clear memory

The entire memory of the phone can be erased.

3.7. Memory status

See how many places in the SIM card or telephone memory are occupied by names and numbers.

Menu 4. Call options

4.1. Transmit number

Choose whether or not your own number should be displayed to the person you call. Contact your network operator regarding ex-directory numbers.

4.2. Call waiting

Choose whether or not you want to be alerted during a phone call that there is another call coming in.

4.3. Automatic answer

Choose to automatically accept incoming calls.

4.4. Automatic redial

Call a previously-dialled number that was engaged.

4.5. Call divert service

Choose when and what type of calls are to be diverted to a specified telephone number.

- 4.5.1. All calls (this setting only applies during the call in progress).
- 4.5.2. When busy
- 4.5.3. When not answered
- 4.5.4. If unreachable
- 4.5.5. Fax calls
- 4.5.6. Computer calls
- 4.5.7. Cancel all diverts

Menu 5. Telephone settings

5.1. Network selection

Choose a network automatically or manually. The selected operator is shown in the display in the telephone's basic mode.

- 5.1.1. AUTO
- 5.1.2. Manual

5.2. Language

Here you can choose which language the telephone is to display.

- 5.2.1. Dansk
- 5.2.2. Deutsch
- 5.2.3. English UK
- 5.2.4. English US
- 5.2.5. Español
- 5.2.6. Français CAN
- 5.2.7. Français FR
- 5.2.8. Italiano
- 5.2.9. Nederlands
- 5.2.10. Português BR
- 5.2.11. Português P
- 5.2.12. Suomi
- 5.2.13. Svenska

5.3. SIM security

Select if the PIN code should be on, off or if the telephone should automatically give the PIN code.

- 5.3.1. On
- 5.3.2. Off
- 5.3.3. Automatic

5.4. Change codes

Change the PIN code or telephone code.

- 5.4.1. PIN code
- 5.4.2. Telephone code (use 1234 until you change to your own code). The telephone code is used to reset the call timer.

NOTE! Make a note of your code as save it in a safe place.

5.5. Volume

- 5.5.1. Ringer volume: Here you can choose the volume of the ringer for incoming calls.
- 5.5.2. Ringer tone: There are eight different ringer tones to choose from.
- 5.5.3. Mute radio: On/Off
- 5.5.4. Speed volume: Choose whether the volume should be adjusted according to speed.
- 5.5.5. Message beep

5.6. Traffic safety

Here you can choose to disengage the speed limiter, i.e. have access to the entire menu system even while driving.

5.7. Factory settings

Function to return to the system's factory settings.

Specifications

Type designations	204
Measurements, weights, capacities	205
Lubricants	206
Cooling system	206
Catalytic converter	207
Petrol	208
Suspension, spring suspension	209
Electrical system	210
Engine specifications	211

Type designations

When contacting your Volvo dealer about your car and when ordering spare parts and accessories, it makes things easier if you know your car's type designation, vehicle identification number and engine number.

1. VIN

Stamped in the engine compartment underneath the windscreen.

2. Type designation, vehicle identification number, maximum permissible weights, codes for colour and upholstery and type approval number.

Plate on the wing liner behind the left-hand headlamp.

3. Engine type designation, component and serial number

On the right-hand side of the engine

4. Gearbox type designation and serial number

a: Automatic gearbox GM: on the rear

b: Automatic gearbox AW: on the upper side

c: Manual gearbox: on the upper side

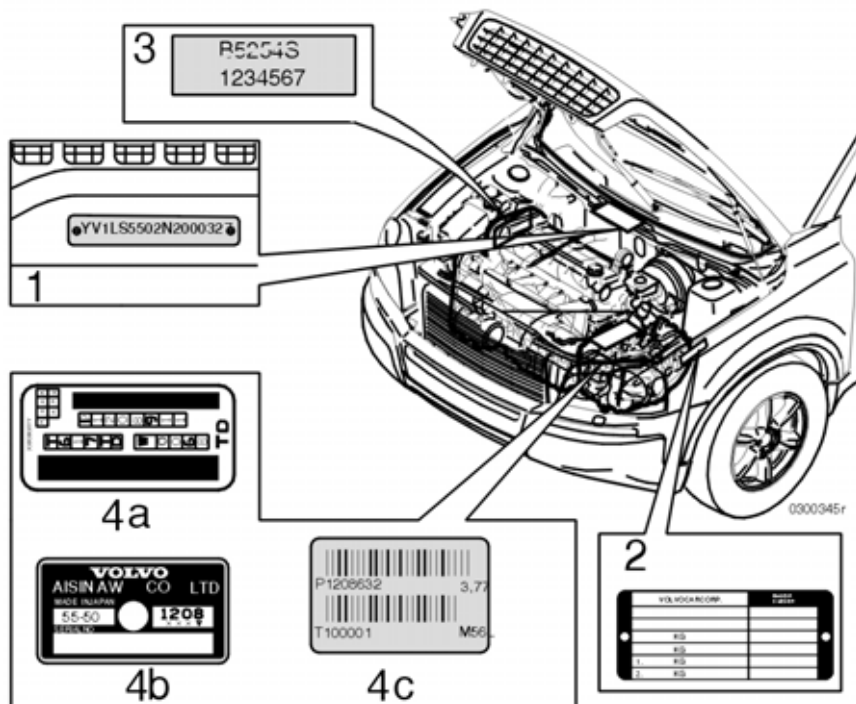

Measurements, weights, capacities

Measurements and weights

Length	480 cm
Width	190 cm
Height	178 cm
Wheelbase	286 cm
Front track	163 cm
Rear track	162 cm

Permissible weight (excluding driver) = Total weight-service weight

Chassis data plate with weight specification on the plate in the engine compartment

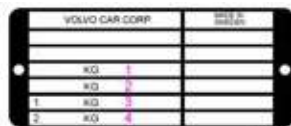

1. Max. total weight
2. Max. train weight (car+trailer)
3. Max. front axle load
4. Max. rear axle load

Max. load, see registration papers

Maximum roof load	100 kg
Maximum trailer weight	2250 kg

Capacities

Fuel tank (litres)	approx.
Petrol	72
Diesel	68

Engine oil, incl filter change¹ (litres)

B5254T2 2.5T	5.5
B6294T T6	6.5
D5244T D5	7.0

Gearbox oil (litres)

Manual	2.0
Automatic	7.5

Miscellaneous

Power steering	0.9 litres
Windscreen washer reservoir	6.5 litres
Brake and clutch fluid	0.6 litres
Air conditioning system	1000 grams
Air conditioning system with AC in rear passenger compartment	1300 grams

¹:To verify which engine is in the car - see the type designation stamped into the engine compartment (previous page, point 3).

Important!

After changing the oil, use the dipstick to check that the engine has the correct amount of oil. Warm up the engine and then check the oil a few minutes after the engine is switched off.

Lubricants

Engine

Petrol engines: ACEA A1

ACEA A3 grade oil can also be used. Note that the same oil can comply with both ACEA A1 and ACEA B1, regardless of whether it is a mineral, semi-synthetic or fully synthetic oil.

Diesel engines: ACEA B4

Note that the same oil can comply with ACEA A3, ACEA B3 and ACEA B4, regardless of whether the oil is mineral, semi-synthetic or fully synthetic.

Volvo fully synthetic engine oil is recommended for cars with turbocharged petrol engines and turbo diesel engines.

Do not use extra additives. These can damage the engine.

Viscosity

(assumes constant air temperature)

In extreme driving conditions that give abnormally high oil temperature or oil consumption, such as driving in the mountains with a great deal of engine braking and motorway driving at high speed, oils fulfilling the requirements of ACEA A3 (petrol engines) are recommended.

NOTE! Oils with a viscosity of 0W-30 and 0W-40 must fulfil the requirements of ACEA A3 (petrol engines).

Gearbox

Oil grade:

Manual: Volvo synthetic gearbox oil.

Geartronic: GM4T65EV
Volvo synthetic gearbox oil (fulfils requirement specifications for Dexron IIIIG).

Automatic: AW55-51
Only Volvo gearbox oil part no. 1161540-8. Do not blend with any other oil!

Power steering

Grade: Power steering fluid of type Pentosin CHF 11S or the like.

Volume: approx. 0.9 litres

Brake fluid

Fluid type: Brake fluid DOT 4+

Volume: approx. 0.6 litres

Cooling system

Engine		Volume (litres)
Petrol 5-cyl	2.5T	approx. 9.0
Petrol 6-cyl	T6	approx. 10.5
Diesel	D5	approx. 12.5

All systems are closed overpressure systems. The thermostat starts to open at 90°C.

Important!

If in doubt about the correct oil grade - contact a Volvo workshop

Catalytic converter

Catalytic converter

The catalytic converter is an additional part of the exhaust system. Its purpose is to purify exhaust. The converter primarily consists of a housing with two monoliths that are designed so that the exhaust gases pass through a honeycomb of channels. The channel walls are lined with a thin layer of platinum, rhodium and palladium. These metals act as catalysts, i.e. they participate in and accelerate a chemical reaction without being used up themselves.

Lambda-sond™ (heated oxygen sensor, petrol engines only)

The lambda sensor is part of a management system intended to reduce emissions and improve fuel economy. An oxygen sensor monitors the oxygen content of the exhaust gases leaving the engine. These values are fed into an electronic system that continuously controls the injectors. The ratio of air to fuel is continuously adjusted. These adjustments create optimal conditions for efficient combustion, and together with the three-way catalytic converter reduce harmful emissions (hydrocarbons, carbon monoxide and nitrous oxides).

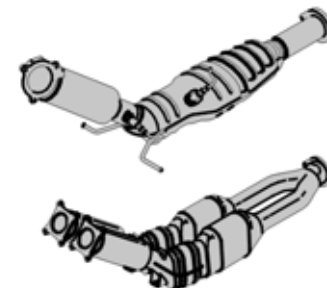

2501324r

Petrol

Petrol

The engine can be run with octane ratings of 91, 95 and 98 RON.

- 98 RON is recommended for maximum effect and minimum fuel consumption.
- 95 RON can be used for normal driving.
- 91 RON should only be used as an exception. However, the engine will not be damaged by this fuel grade.

Standard DIN 51600

Min. 91 Octane RON Unleaded

Fuel consumption and carbon dioxide

Engine		Gearbox	Consumption in litres/100 km	Carbon dioxide emission (CO ₂) g/km
B5254T2	2.5T	Manuel	11.1-11.4	266-273
		Automatic	11.8-12.0	282-287
B6294T	T6	Automatic	12.7-12.9	304-309
D5244T	D5	Manuel	8.2 - 8.3	216 - 219
		Automatic	9.0-9.1	239-242

Diesel

Standard EN 590

NOTE: The aforementioned engines are not available in all markets.

Official fuel consumption figures are based on a standard driving cycle; EU directive 80/1268 comb.

Fuel consumption figures may be altered if the car is equipped with extra options which affect car weight. The manner in which the car is driven and other non-technical factors can affect fuel consumption.

Suspension, spring suspension

Front end

MacPherson-type spring strut. Unitary construction of shock absorbers and spring. Rack and pinion steering. Safety type steering shaft.

Rear suspension

Independent suspension with individually sprung wheels with shock absorbers. The suspension consists of trailing arms, upper and lower control arms, track rods and anti-roll bar.

Electrical system

12-volt system with voltage regulated alternating current generator. Single pole system in which the chassis and engine block are used as conductors. The negative pole is connected to the chassis.

Battery

If you must replace your battery, be sure to replace it with a battery of the same cold start capacity and reserve capacity as the original (see the decal on the battery).

Engine	2.5T	T6	D5
Voltage	12 V	12 V	12 V (diesel)
Cold start capacity (CCA)	520 A*	600 A*	800 A
Reserve capacity (RC)	90 min	115 min	170 min
Generator max. current	140 A**	160 A	140 A**
Starter motor, power	1.4 kW	1.7 kW	2.2 kW

Bulbs	Output	Socket
Main beam	55 W	H 7
Dipped beam	55 W	H 7
Bi-Xenon	35 W	D2R
Fog lamps	55 W	H 1
Front position/parking lamp	W 5 W	W 2.1x9.5 d
Direction indicator, front	H21 W	BAY9s
Rear direction indicator (orange)	PY21 W	BA 15
Side marker light	W 5 W	W2.1x9.5d
Brake light	21 W	BA 15
Reversing lamp	21 W	BA 15
Rear fog lamp, rear position/ parking lamp	P21/4 W	BA15
Numberplate lighting	W 5 W	W 2.1x9.5 d
Courtesy lighting, front	W 5 W	SV 8.5
Cargo compartment	W 5 W	SV 8.5
Glovebox lighting	W 3 W	BA 9
Vanity mirror	1.2 W	SV 5.5

*Cars with parking heaters have an 800 A battery.

** Cars with AC in the rear passenger compartment have 160 A.

Engine specifications

	B5254T2	B6294T	D5244T
	2.5T	T6	D5
Output* (kW/rps)	154/83	200/85	120/67
(hp/rpm)	210/5000	272/5100	163/4000
Torque* (Nm/rps)	320/25-75	380/30-83	340/29-50
(kpm/rpm)	32.6/1500-4500	38.8/1800-5000	34.7/1750-3000
No. of cylinders	5	6	5
Bore (mm)	83	83	81
Stroke (mm)	93.2	90	93.2
Cylinder displacement (cm ³)	2521	2922	2401
Compression ratio	9.0:1	8.5:1	18.0:1

NOTE! The aforementioned engines are not available in all markets.

*: Output and torque as per testing standard EU 80/1269. For petrol engines, 98 octane is used for this test.

To verify which engine is in the car - see the type designation stamped into the engine compartment (Type designations - page 204, point 3).

Alphabetical index

A	
ABS	31, 107
AC	57
Advanced user function	177
Advanced user menu	180
Air distribution	57
Air quality sensor	61, 62
Air vents	55
Airbags	12
Alarm function	88
Alarm LED	96
All-Wheel Drive	105
Antenna	190
Ashtray	79
AUTO	62
Automatic gearbox	99
Auxiliary lamps	36
Average fuel consumption	43
Average speed	43
AWD	105
B	
Backrest	69
Bass	167
Battery	137, 145, 210
Bonnet	138
Boost starting	112
Booster cushion	26
Brake circuit	106
Brake fluid	143
Brake light	151
Brake system	106
Braking system	31
Bulbs	147, 210
C	
Capacities	205
Carbon dioxide emissions	208
Cargo compartment	80
Cargo compartment lighting	152
Cargo compartment storage	85
Catalytic converter	207
CD player	161
Ceiling lighting	153
Changing wheels	126
Child safety	23
Child safety locks	37, 93
Child seat	23
Cigarette lighter	37
Cleaning	130
Clock	30
Cold start	99
Colour code	132
Comfort position	50
Control panel	190
Coolant	142
Cooling system	206

Courtesy lighting	152
Cruise control	44
Cup holder	79
Current fuel consumption	43
D	
Deactivating the deadlock function	37
Deadlocks	92
Defroster	63
Diesel	139, 208
Dipped beam	39
Dipped beam bulb	149
Direction indicator	150, 151
Direction indicators	30, 39
Display	163
Dolby Pro Logic II (DPL II)	167
Door mirror defroster	42
Door mirrors	36
DSTC	34, 108
E	
EBA	109
EBD	107
ECC	60
Economical driving	98
Electric child safety locks	94
Electric socket	37, 45, 46, 84
Electrical system	210
Electronically controlled system	105

Emergency Brake Assistance	109	Headphones	163	Lubricants	206
Emergency calls	190	Heated front seats	63	M	
Emissions system	33	I		Main beam	30, 39
Engine compartment	138	IC	18	Main beam "flash"	39
Engine preheater	33	Ignition switch and steering wheel lock	101	Main beam bulb	149
Engine specifications	211	Immobilizer	101	Manual climate control	56
F		Indicator and warning symbols	30, 31	Manual gearbox	102
Fader	167	Inflatable Curtain	18	Measurements and weights	205
Fan	63	Infotainment	160	Message in the display	35, 64
Filling up with diesel	100	Instrument illumination	38	Microphone	190
First-aid kit	85	Integrated booster cushion	26	N	
Floor mats	75	Interior lighting	74	Normal turns	39
Fog lamps	33	Intermittent wiping	40	Numberplate lighting	152
Front fog lamp	150	Interrupted text input	197	O	
Front seats	68	Isofix	26	Odometer	30
Fuel cap	100	J		Oil	140
Fuel consumption	208	Jack	85	Oil filter	140
Fuel gauge	30	Jump starting	112	Oil pressure	33
Fuel tank	205	K		Outside temperature gauge	30
Fuses	154, 155	Keylock	99	Overview - telephone system	190
G		Keys	88	Oxyhydrogen gas	146
Gear positions	102	L		P	
General lighting	74	Lambda-sond TM	207	Paint	132
Grocery bag holder	84	Levelling	114	Paintwork damage	132
H		Lighting panel	38	Parking	45
Hazard warning flashers	42	Load carrier	119	Parking assistance system	110
Head restraint	73	Load on the roof	119	Parking brake	33, 45
Headlamp washers	40	Locking	90	Parking heater	64
Headlamps	38				

Parking/position lamp38, 149, 151
 Particle filter54
 Pen holder77
 Petrol208
 Polishing130
 Position/Parking lamps38, 149, 151
 Power seat70
 Power windows47
 Privacy panel84
 Protective grille83

R

Radiator fan138
 Rain sensor40
 Range to empty fuel tank43
 Reading lamp74, 153
 Reading lamps153
 Rear fog lamp152
 Rear fog lamps38
 Rear window defroster42, 59, 63
 Rearview mirror/door mirrors49
 Recirculation57
 Recovery111
 Refuelling100
 Remote control88, 89
 Resistance point position39
 Reverse gear inhibitor102
 Reversing lamp151
 RFD109
 RME139
 Rustproofing133

S

Safe approach lighting39
 Safety net82
 Seat belt reminder10, 33
 Seat belt tensioners11
 Seat belts10
 SEL button163
 Service136
 Shiftlock99
 Side airbags15
 Side direction indicator150
 SIM card190, 198
 SIPS bag15
 Size designation122
 Snow chains105, 123
 Spare wheel124
 Speaker190
 Specifications203
 Speedometer30
 SRS12
 Stability system108
 Start inhibitor.....101
 Starting the car101
 Steering wheel adjustment46
 Stone chips132
 Storage compartment79
 Storage facilities in the passenger
 compartment76
 Storage tray in79
 Studded tyres123
 Sunroof50

Suspension209
 Switches in the centre console36

T

Tachometer30
 Tailgate46
 Telephone190
 Temperature63
 Temperature gauge30
 Temporary Spare124
 Tool kit85
 Towbar115
 Towing111
 Towing bracket115
 Towing eye111
 Trailer113
 Trailer indicator lamp33
 Tread wear indicators124
 Treble167
 Trip computer43
 Trip odometer30
 Type designations204
 Tyre pressure125
 Tyres122

U

Unlocking90
 Upholstery131

V

Vanity mirror75, 152
 Ventilation position50

Viscosity 140

W

Warning symbol 31

Warning triangle 85, 86

Washer fluid reservoir 142

Washing the car 130

Waxing 131

Wheels 122

WHIPS 19

Windscreen washer 40

Windscreen wiper blades 144

Windscreen wipers 40

Winter tyres 123

Wiper blades 144

Check regularly

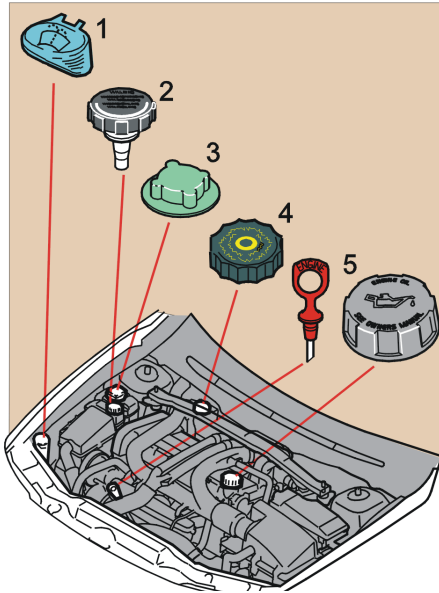

1. Washer fluid: Make sure that the reservoir is always well filled. Add frost protection in the winter! See page 142.

2. Power steering: The fluid level should lie between the MIN and MAX marks. See page 143.

3. Coolant: The fluid level should lie between the MIN and MAX marks on the expansion tank. See page 142.

4. Brake fluid: The level should lie between the MIN and MAX marks. See page 141.

5. Oil level: The level should lie between the marks on the dipstick. See page 141.

VOLVO

Volvo Car Corporation
S-40531 Gothenburg, Sweden

Bulbs

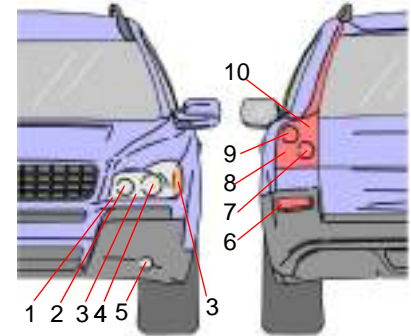

1. Direction indicator	H21W (orange)
2. Main beam	55W H7
3. Position/Parking lamp	W5W
4. Dipped beam	55W H7
5. Front fog lamp	55W H1
6. Rear fog lamp	21W BA5
7. Reversing lamp	21W BA15
8. Position/Parking lamp and tail lamp	P21 4W
9. Direction indicator	PY21W (orange)
10. Brake lamp	21W BA15