

Power Source

- \* 1 : w/ Entry & Start System
- \* 2 : w/o Entry & Start System
- \* 3 : Gasoline
- \* 4 : Diesel
- \* 5 : 1ZR-FE, 2ZR-FE, 4ZZ-FE
- \* 6 : 1AD-FTV, 2AD-FHV
- \* 7 : 1ND-TV
- \* 8 : Except \*7
- \* 9 : HID Type
- \* 10 : Except HID Type
- \* 11 : TMC Made
- \* 12 : Except TMC Made

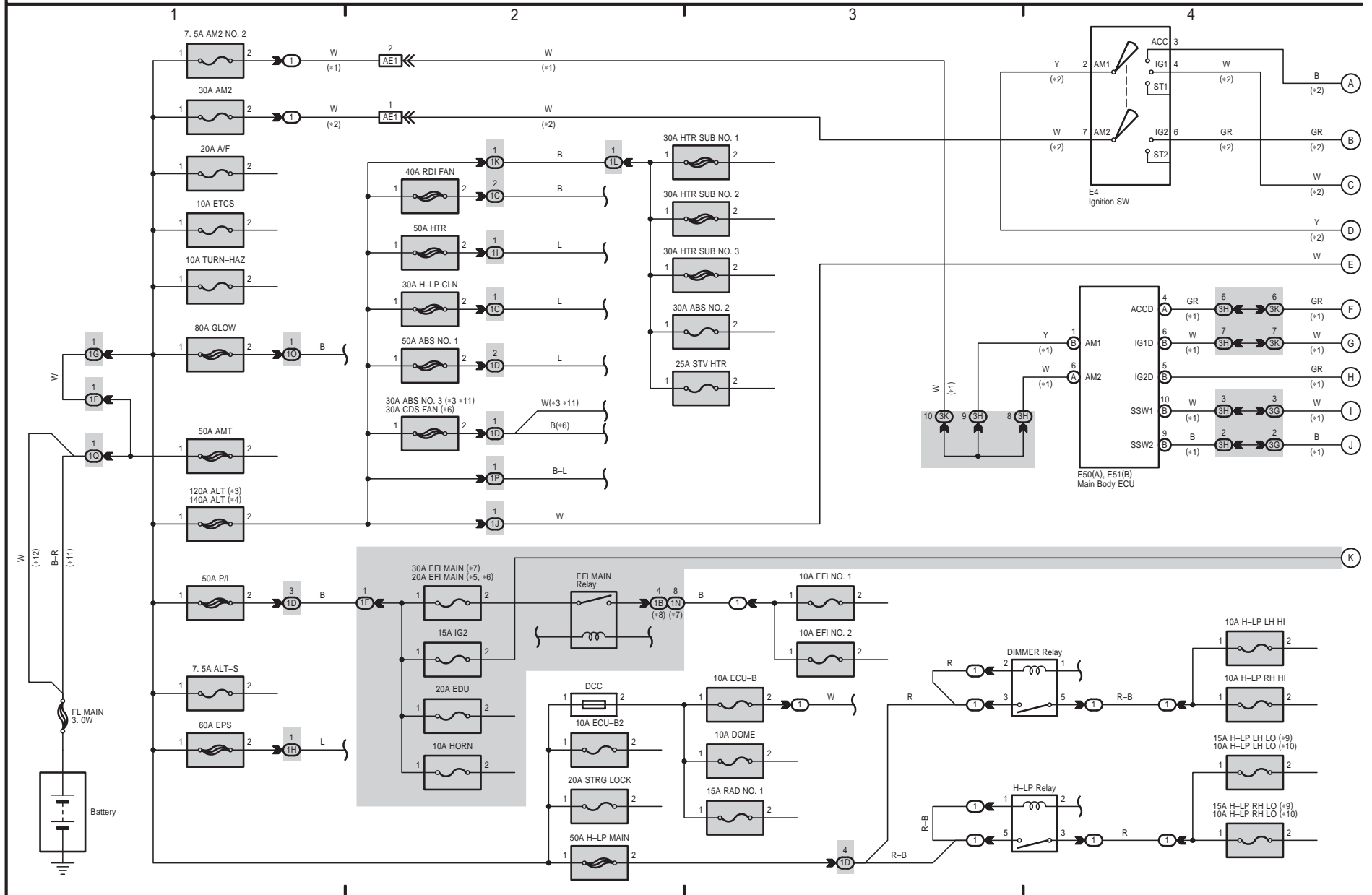

1 COROLLA / AURIS (Cont' d)

COROLLA / AURIS (EM04F1E)

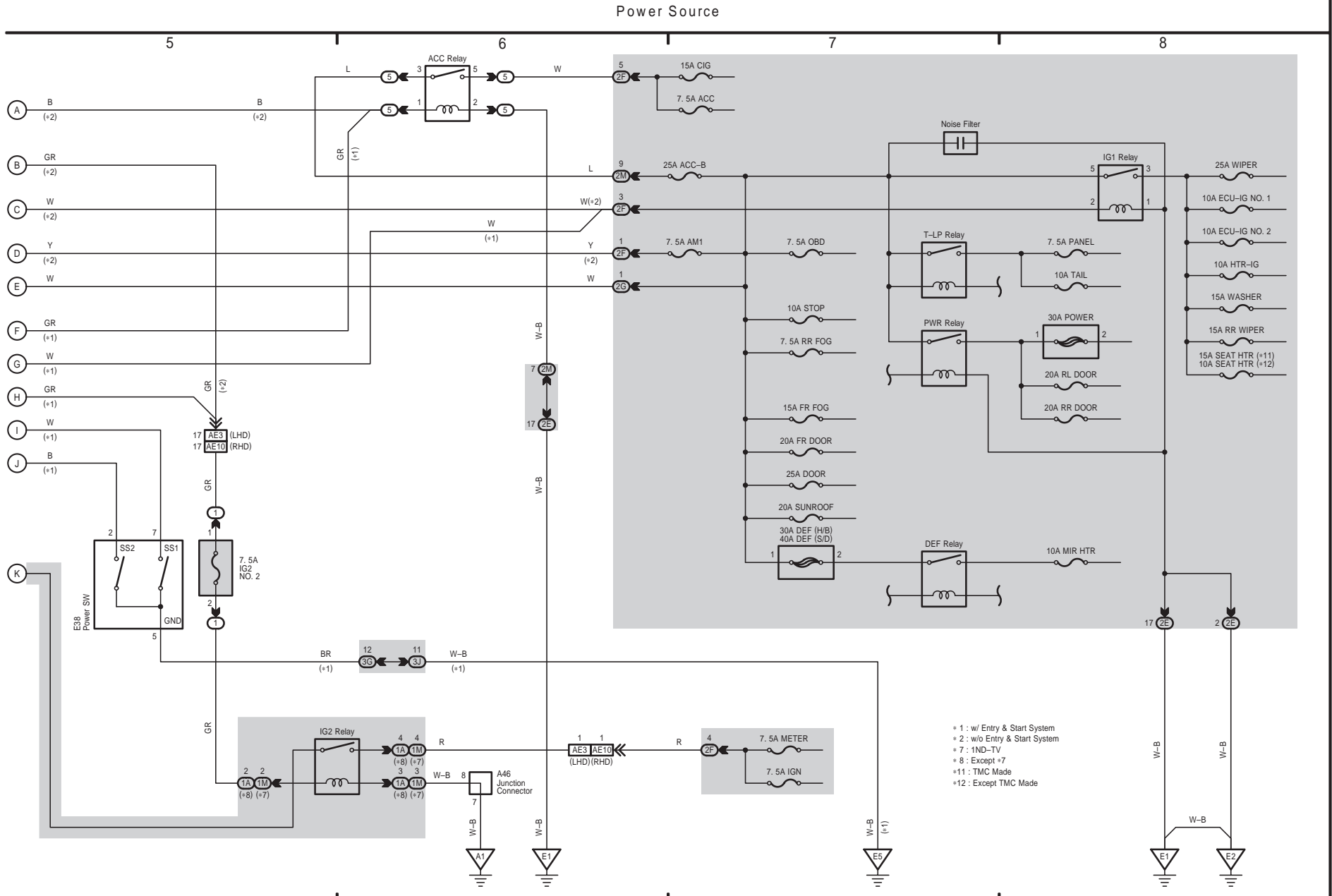

- \* 1 : w/ Entry & Start System
- \* 2 : w/o Entry & Start System
- \* 7 : 1ND-TV
- \* 8 : Except +7
- \* 11 : TMC Made
- \* 12 : Except TMC Made



Multiplex Communication System (CAN LHD)

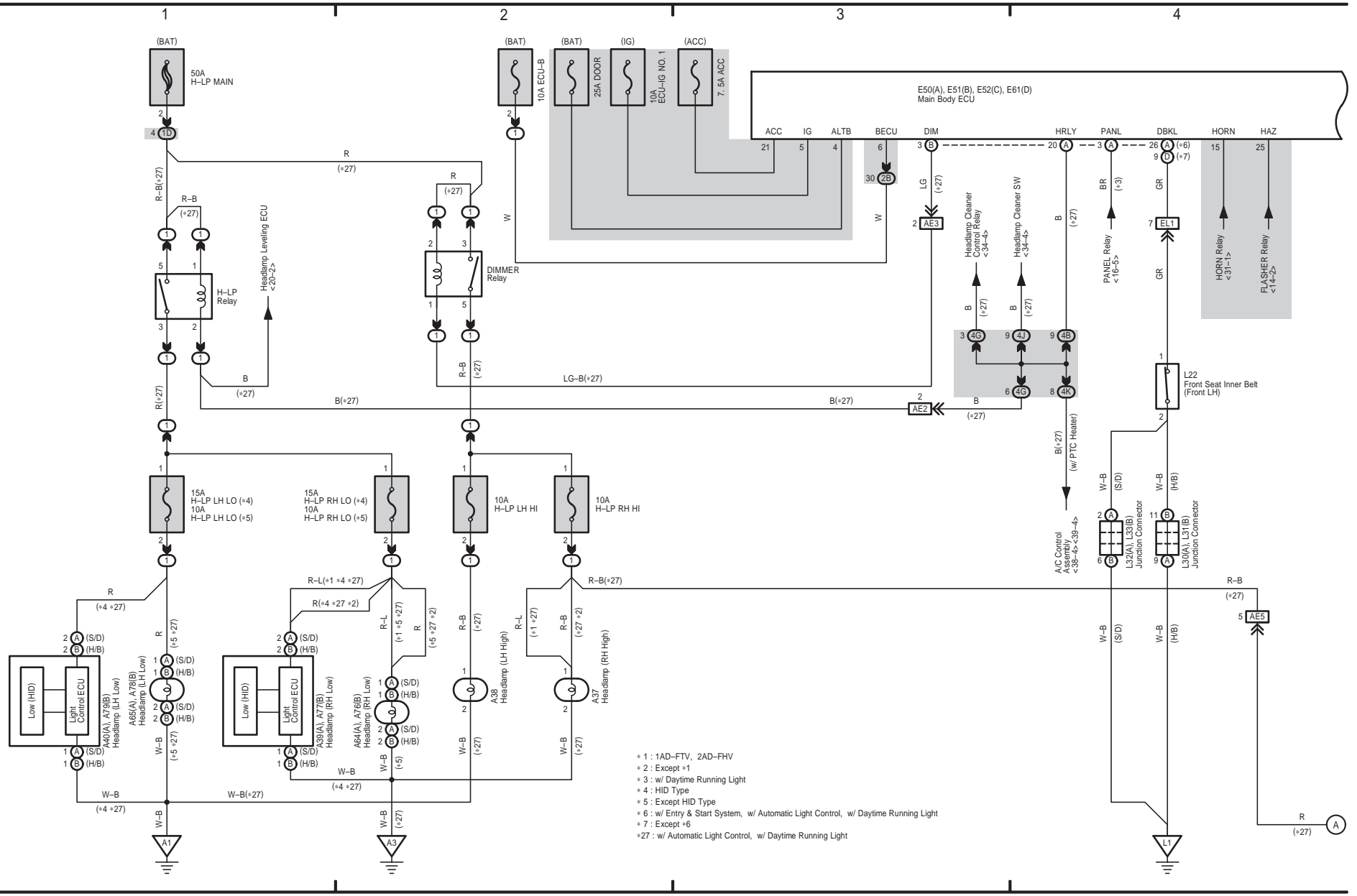

Multiplex Communication System (CAN LHD)

- \* 6 : w/ Entry & Start System, w/ Automatic Light Control, w/ Daytime Running Light
- \* 7 : Except \*6
- \* 8 : w/ Entry & Start System
- \* 9 : w/o Entry & Start System
- \* 27 : w/ Automatic Light Control,
- \* 28 : w/ Automatic Light Control

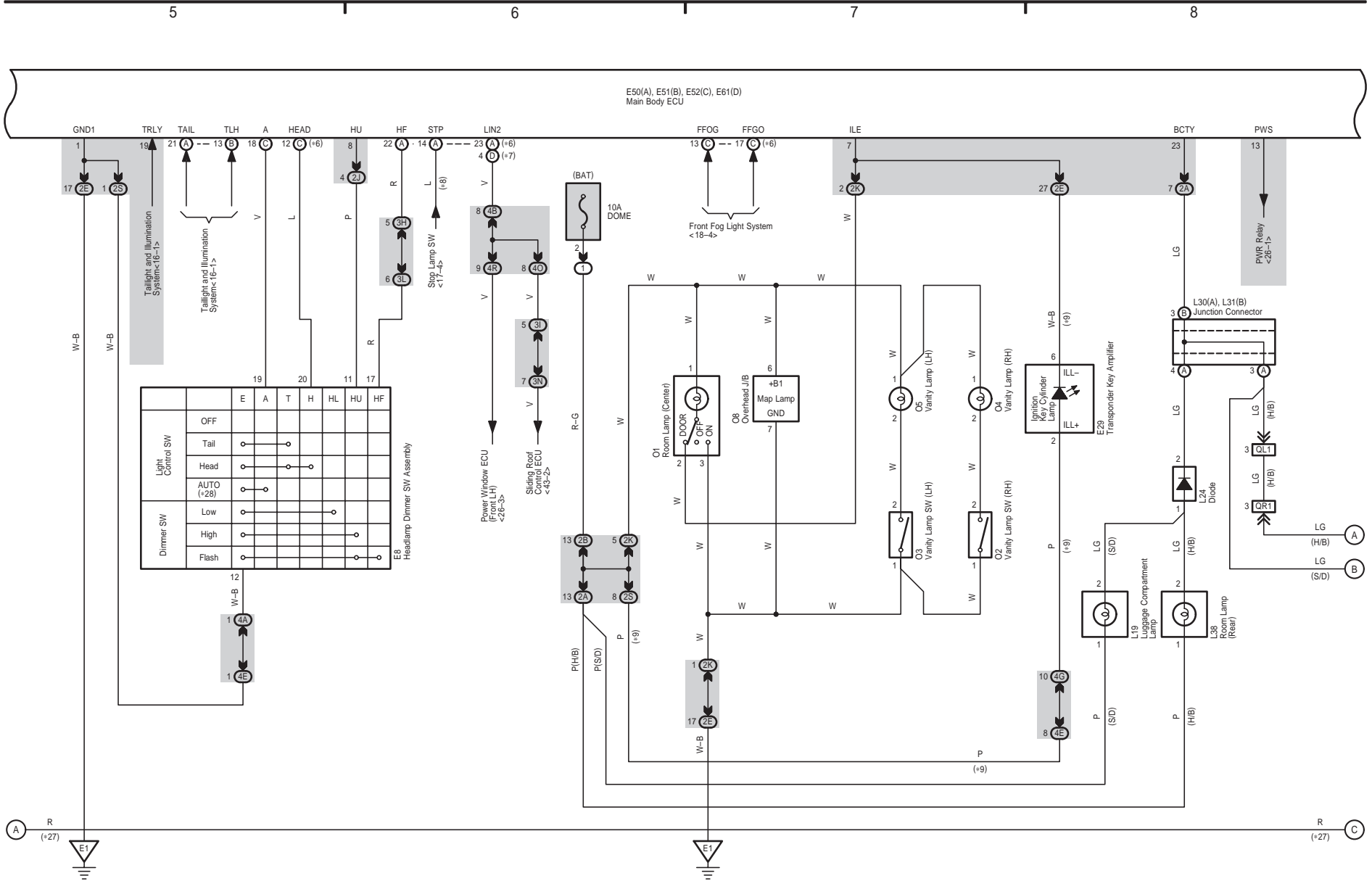

COROLLA / AURIS (EM04F1E)



Multiplex Communication System (CAN LHD)

- \* 6 : w/ Entry & Start System, w/ Automatic Light Control, w/ Daytime Running Light
- \* 7 : Except +6
- \* 8 : w/ Entry & Start System
- \*27 : w/ Automatic Light Control, w/ Daytime Running Light

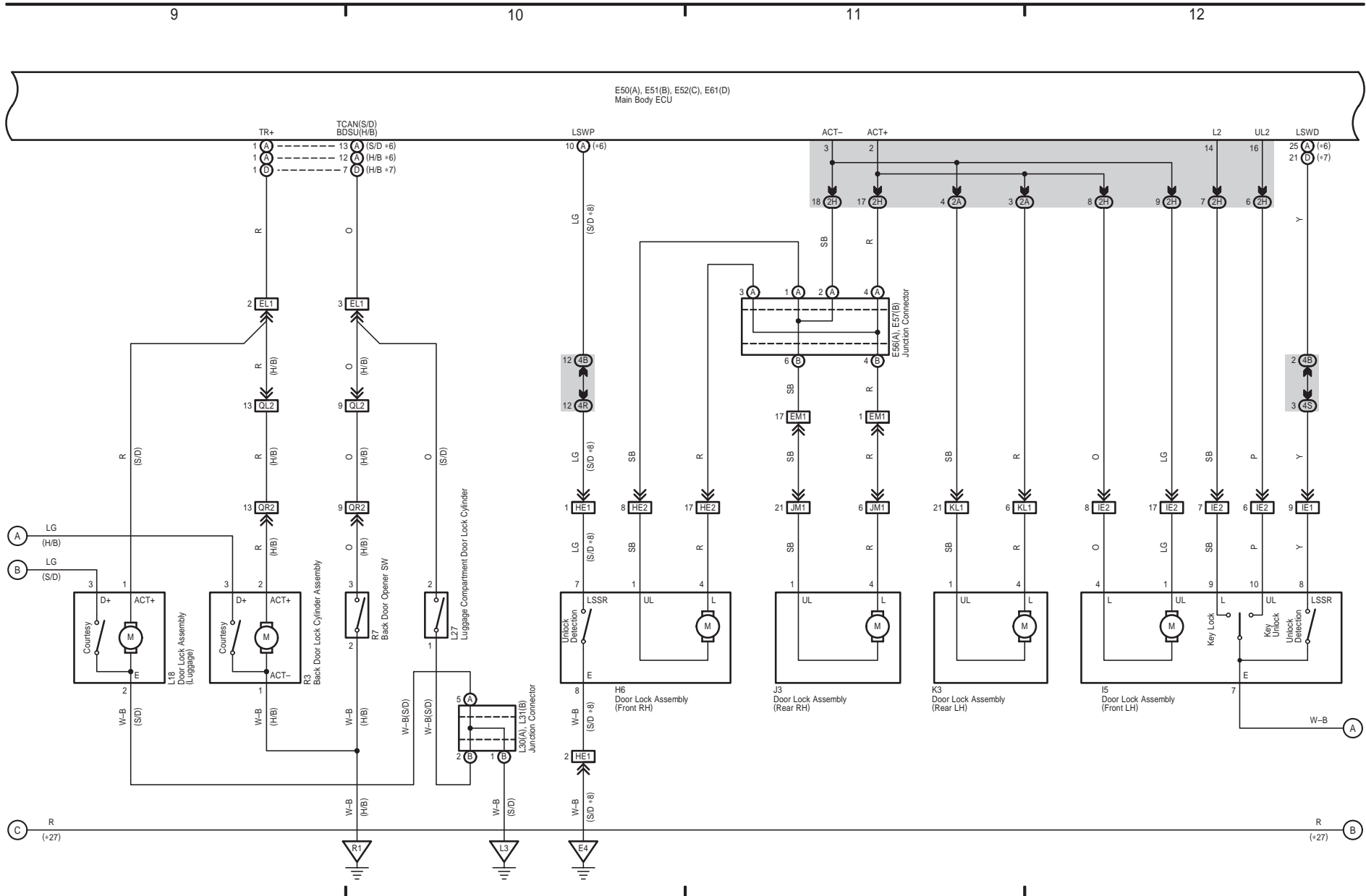

Multiplex Communication System (CAN LHD)

13 14 15 16

COROLLA / AURIS (EM04F1E)

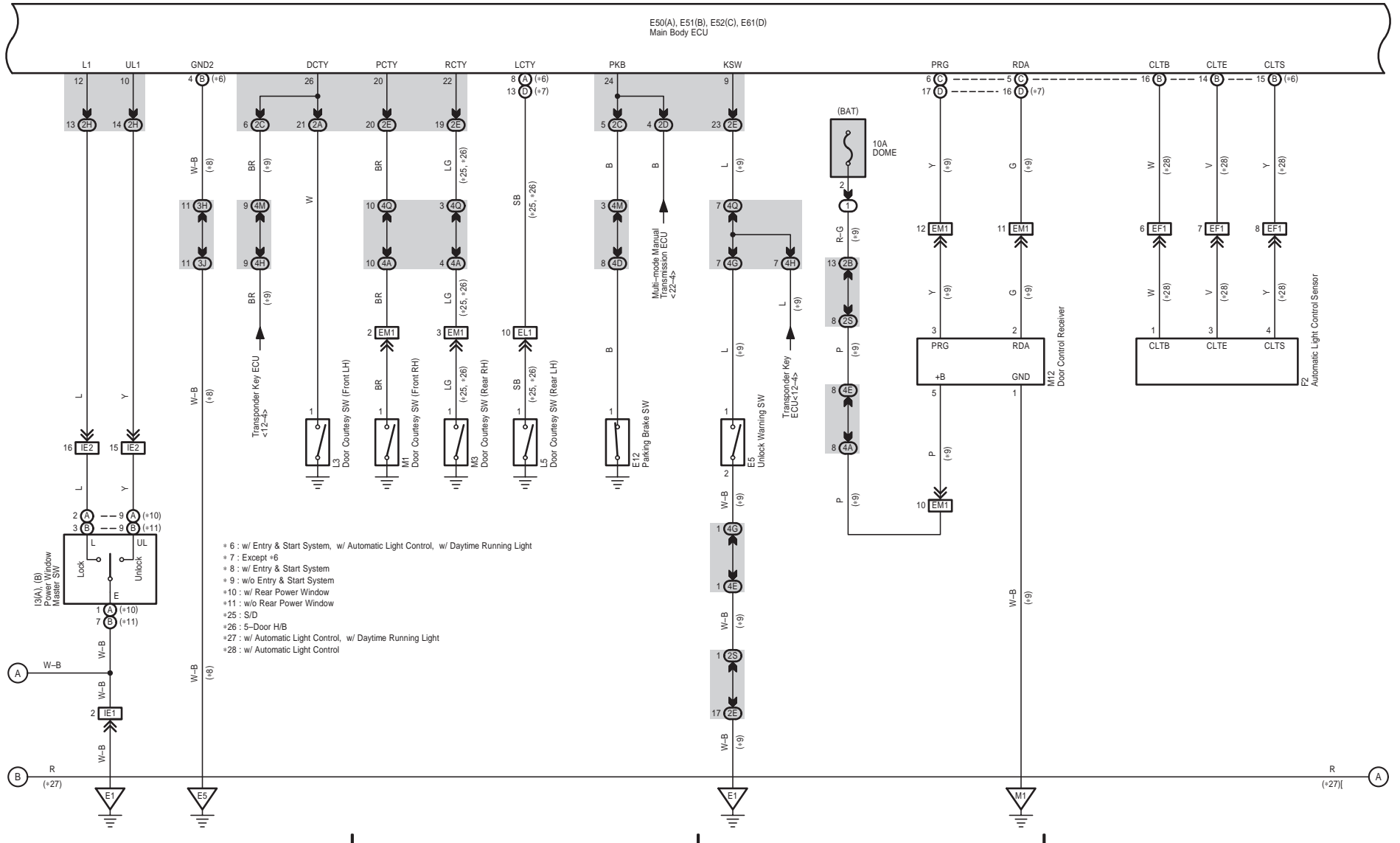

Multiplex Communication System (CAN LHD)

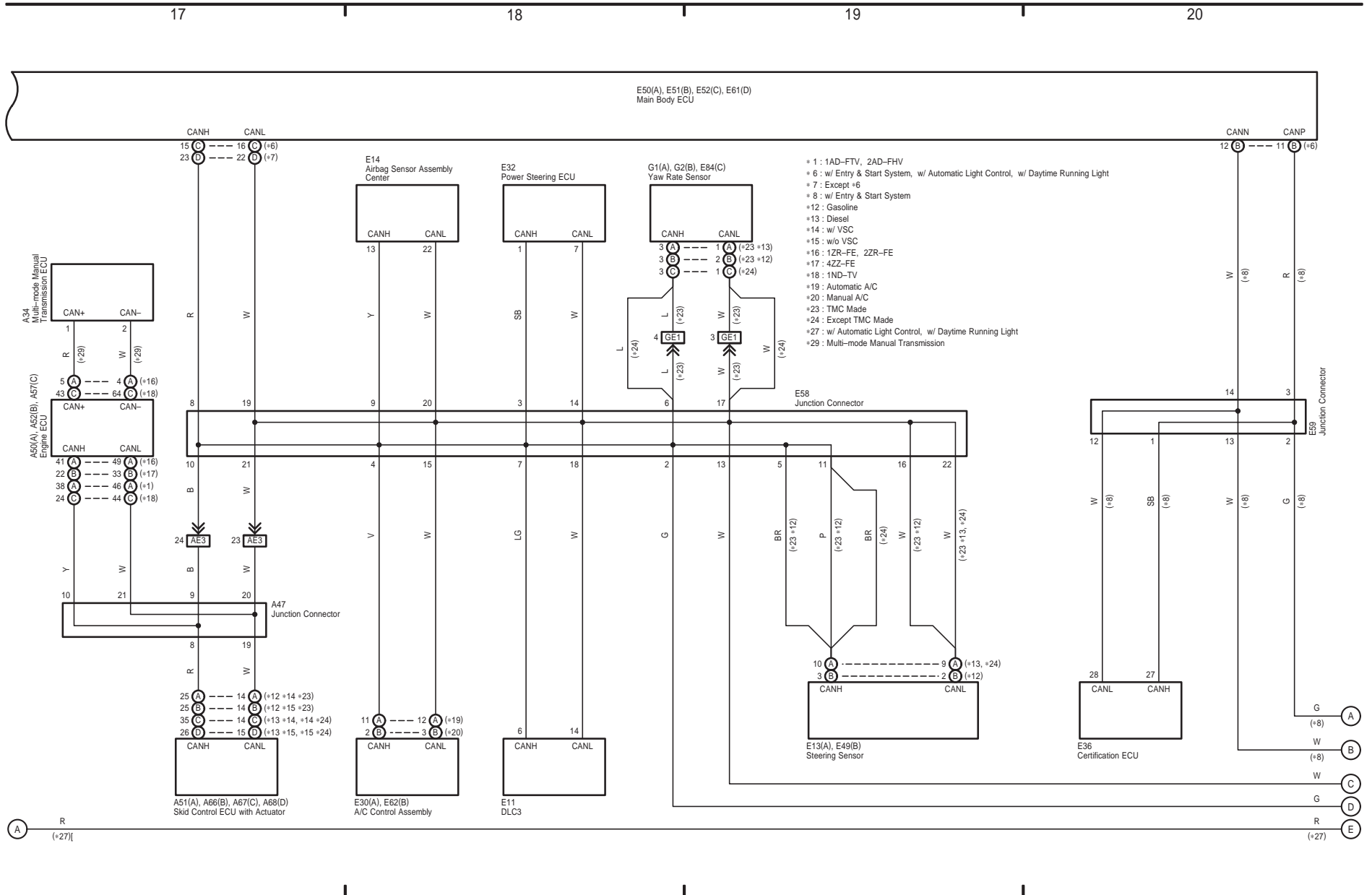

2 COROLLA / AURIS (Cont' d)

Multiplex Communication System (CAN LHD)

- \* 8 : w/ Entry & Start System
- \* 21 : Optitron Meter
- \* 22 : Except \* 21
- \* 27 : w/ Automatic Light Control, w/ Daytime Running Light

21

22

23

24

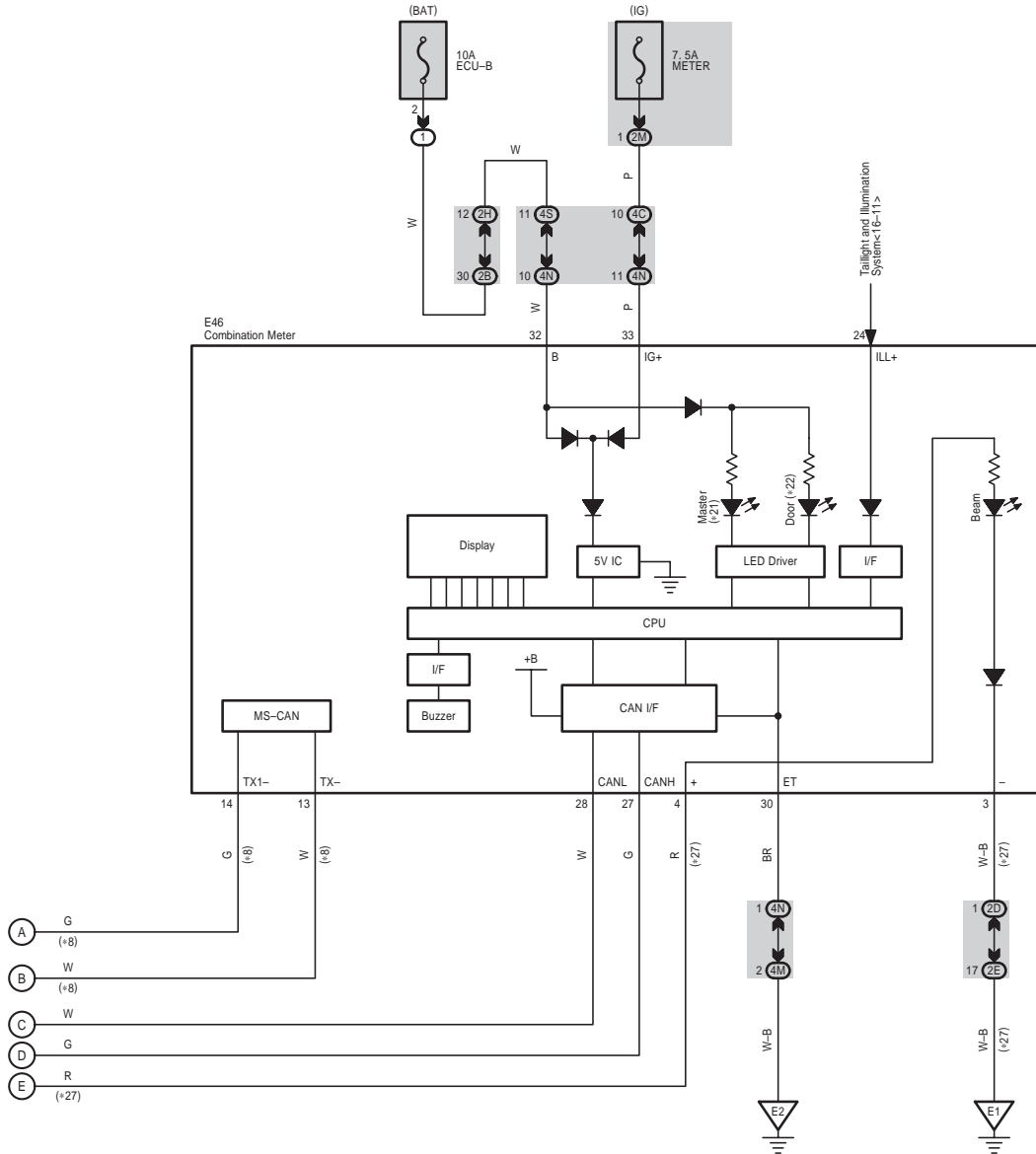

COROLLA / AURIS (EM04F1E)





Multiplex Communication System (CAN RHD)

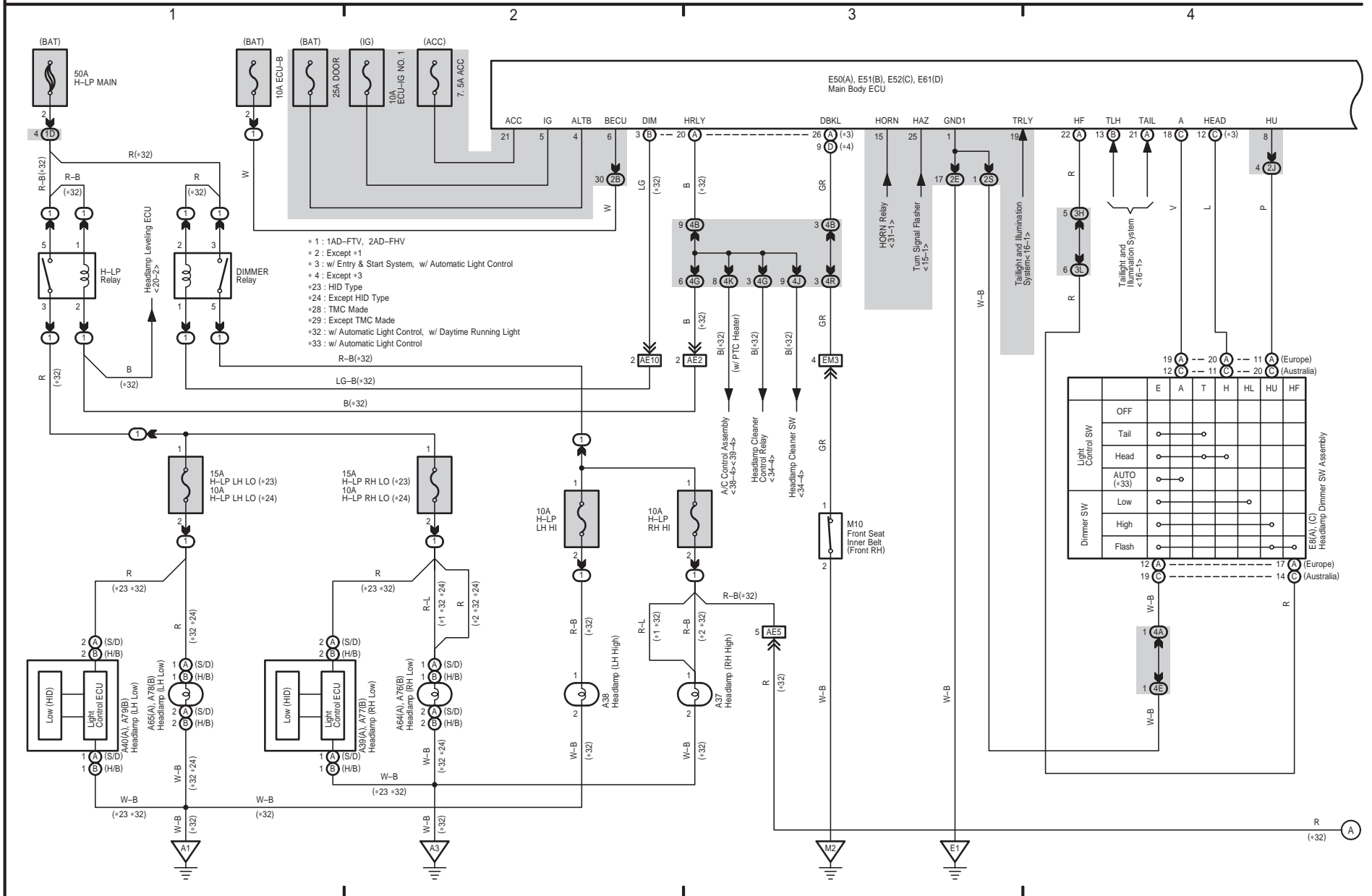

- + 1 : 1AD-FTV, 2AD-FHV
- + 2 : Except + 1
- + 3 : w/ Entry & Start System, w/ Automatic Light Control
- + 4 : Except + 3
- + 23 : HID Type
- + 24 : Except HID Type
- + 28 : TMC Made
- + 29 : Except TMC Made
- + 32 : w/ Automatic Light Control, w/ Daytime Running Light
- + 33 : w/ Automatic Light Control

	E	A	T	H	HL	HU	HF
Light Control SW	OFF						
	Tail						
	Head						
	AUTO (+33)						
Dimmer SW	Low						
	High						
	Flash						

Multiplex Communication System (CAN RHD)

- \* 3 : w/ Entry & Start System, w/ Automatic Light Control
- \* 4 : Except \*3
- \* 5 : w/ Entry & Start System
- \* 6 : w/o Entry & Start System
- \* 32 : w/ Automatic Light Control, w/ Daytime Running Light

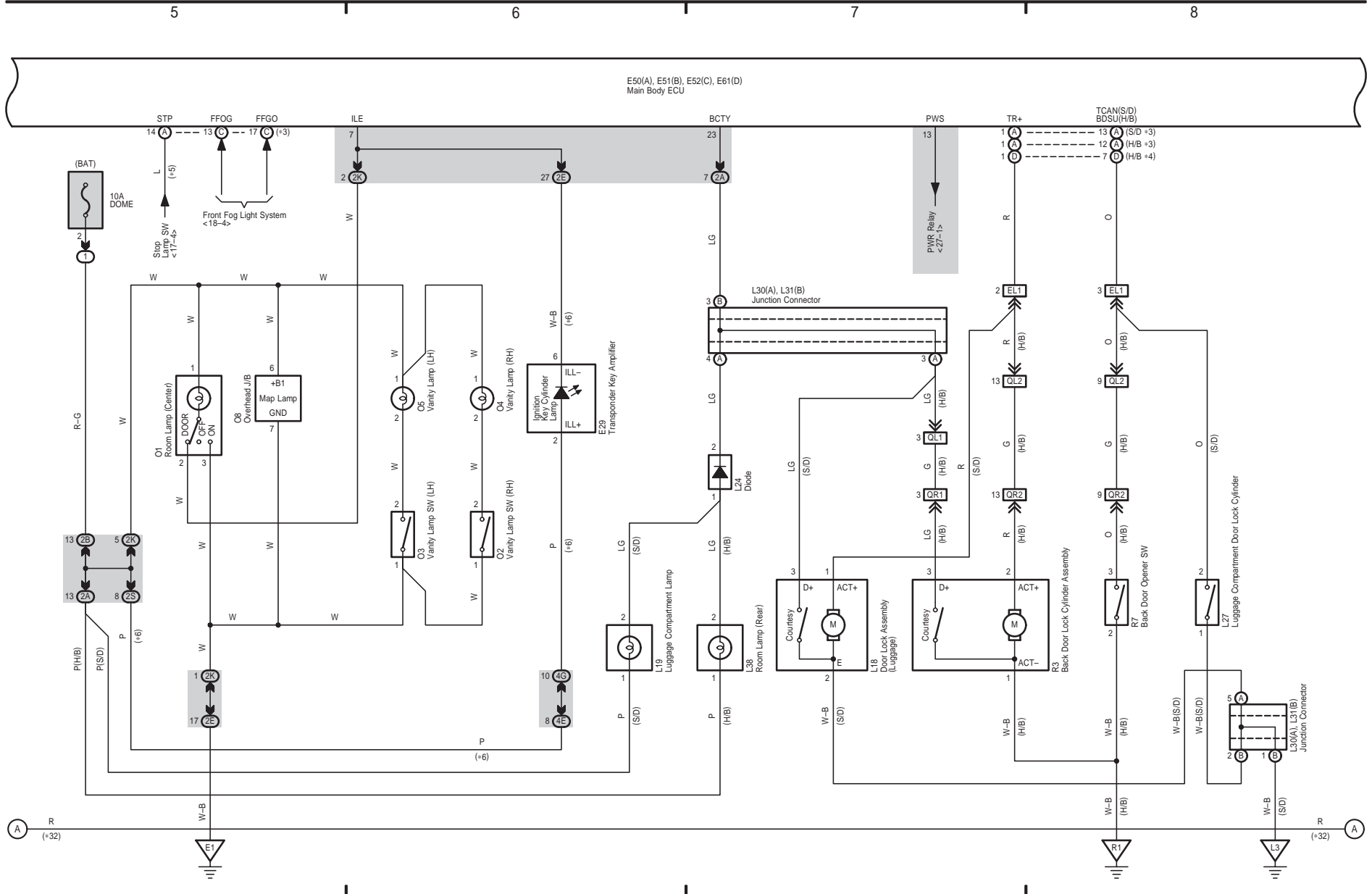

COROLLA / AURIS (EM04F1E)



Multiplex Communication System (CAN RHD)

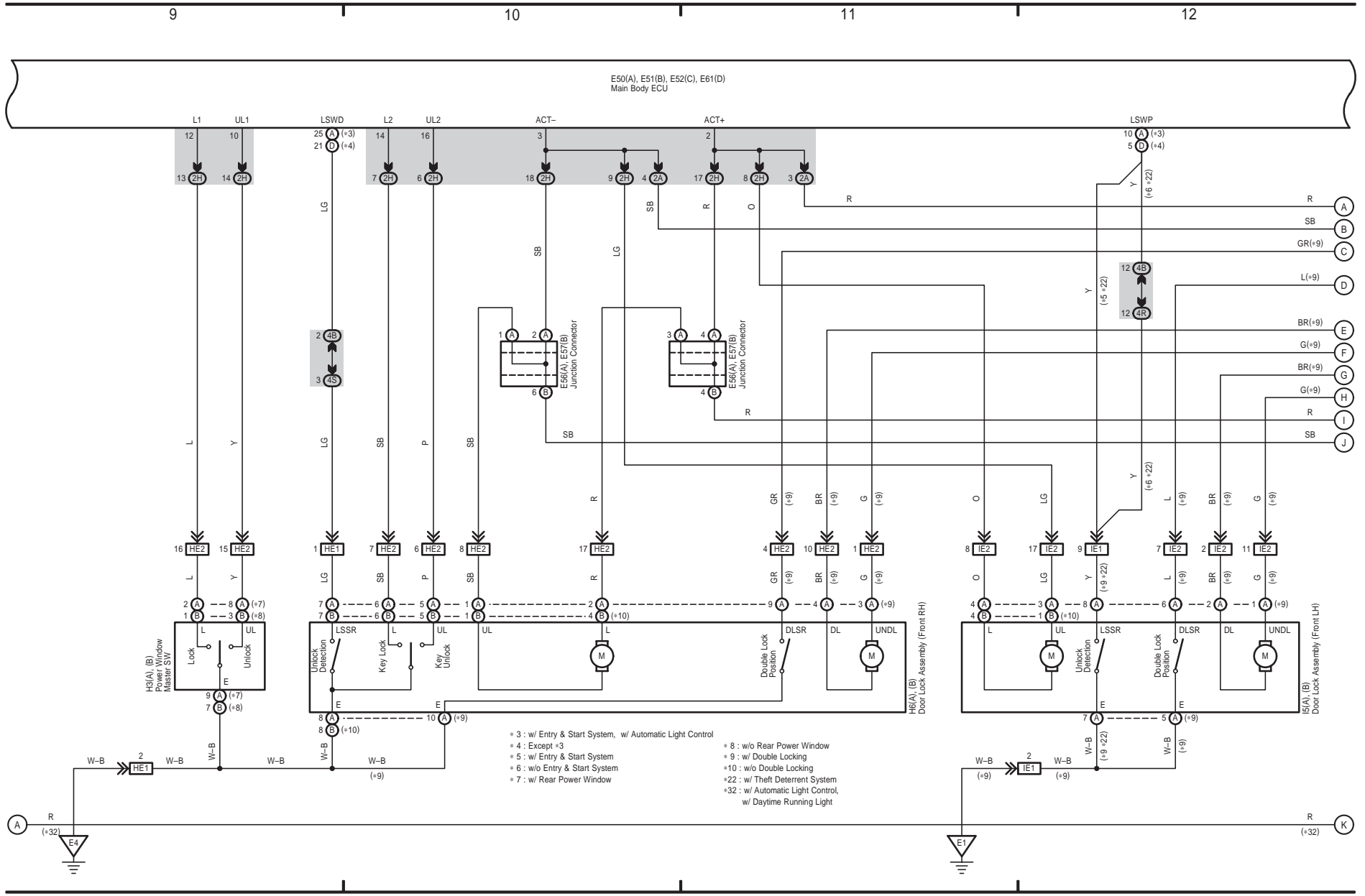

Multiplex Communication System (CAN RHD)

- \* 9 : w/ Double Locking
- \* 10 : w/o Double Locking
- \* 22 : w/ Theft Deterrent System
- \* 32 : w/ Automatic Light Control, w/ Daytime Running Light

13

14

15

16

E50(A), E51(B), E52(C), E61(D)  
Main Body ECU

COROLLA / AURIS (EM04F1E)

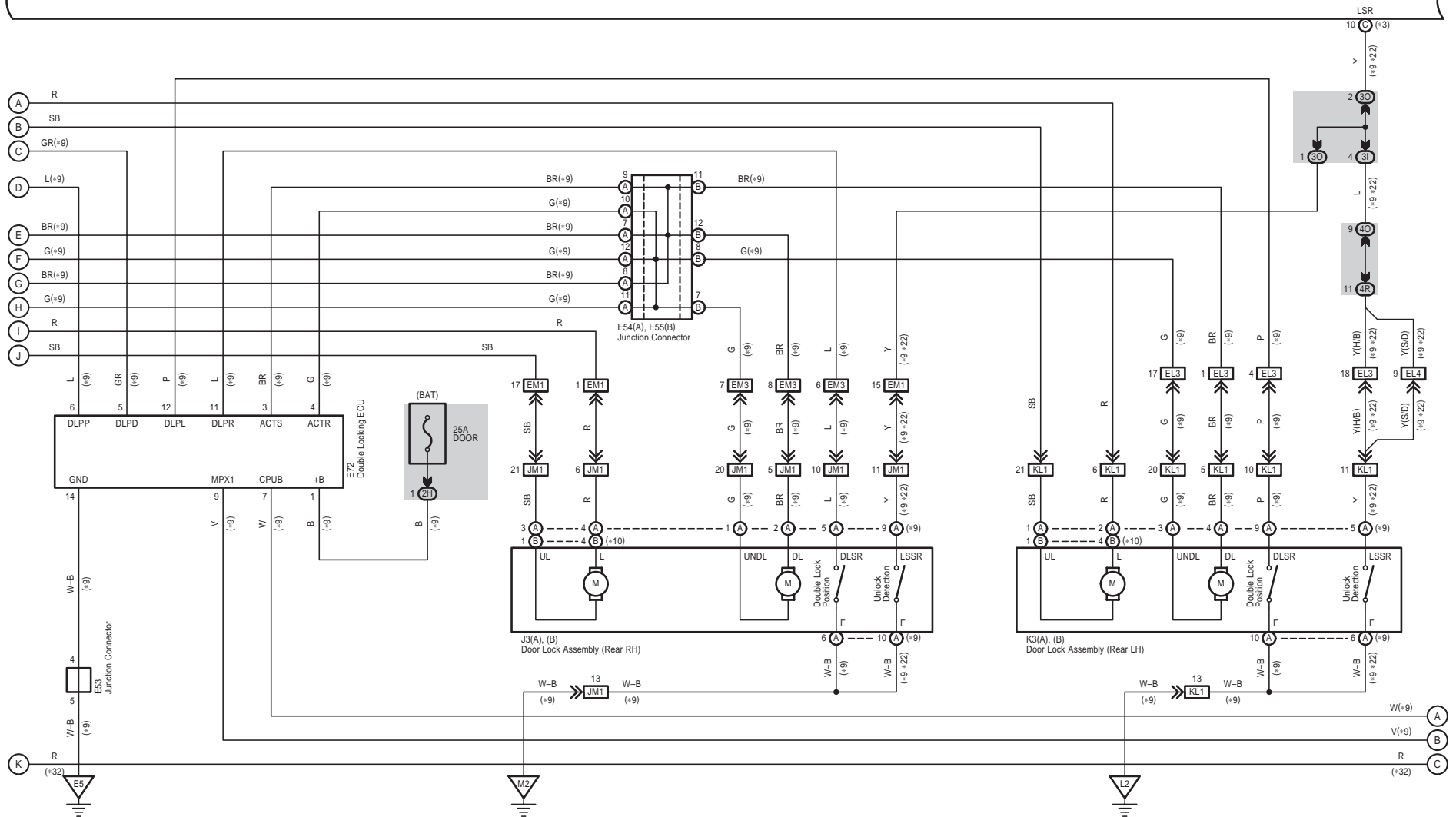

731



Multiplex Communication System (CAN RHD)

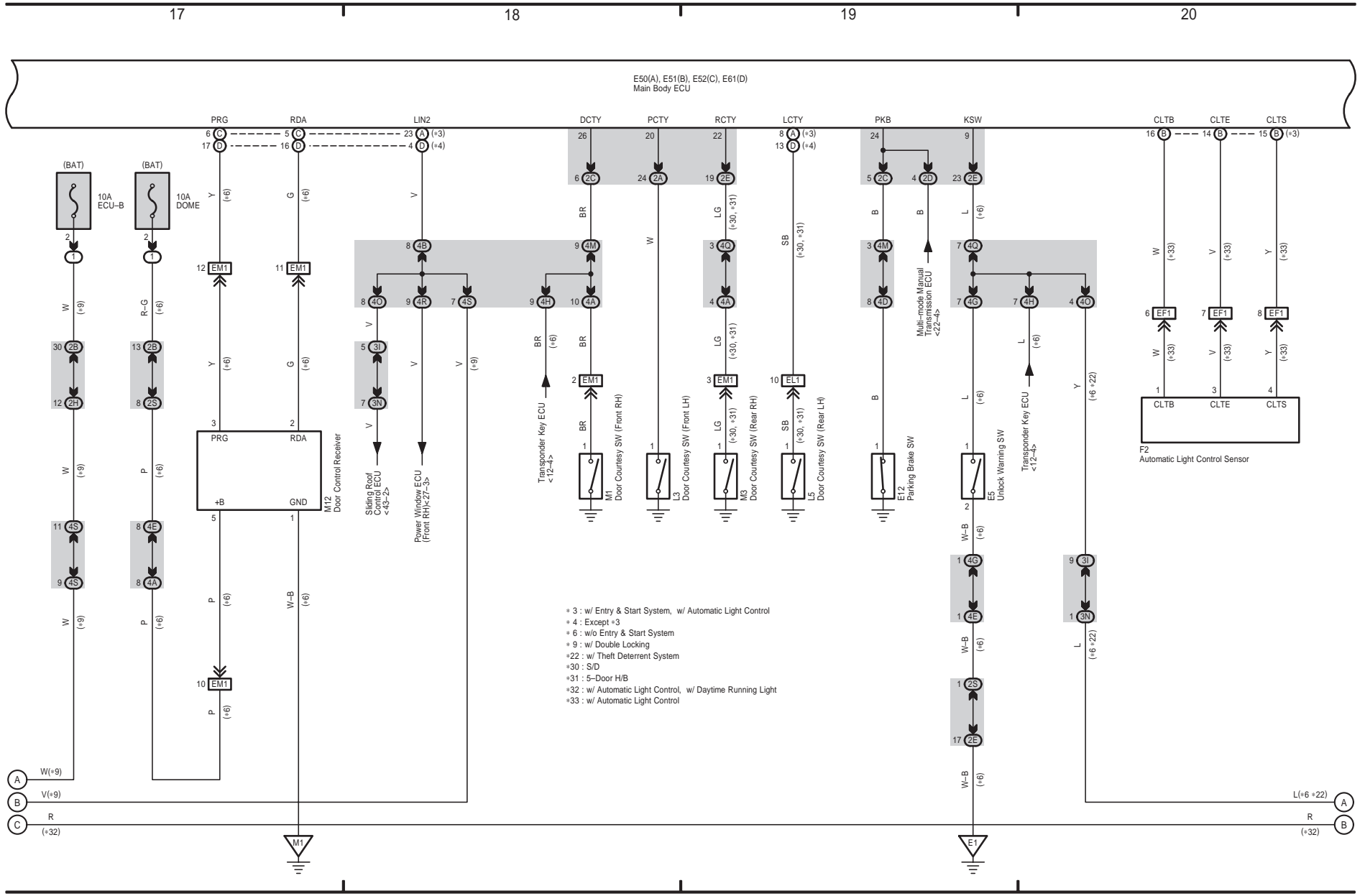

- \* 3 : w/ Entry & Start System, w/ Automatic Light Control
- \* 4 : Except \* 3
- \* 6 : w/o Entry & Start System
- \* 9 : w/ Double Locking
- \* 22 : w/ Theft Deterrent System
- \* 30 : S/D
- \* 31 : 5-Door H/B
- \* 32 : w/ Automatic Light Control, w/ Daytime Running Light
- \* 33 : w/ Automatic Light Control

Multiplex Communication System (CAN RHD)

21

22

23

24

COROLLA / AURIS (EM04F1E)

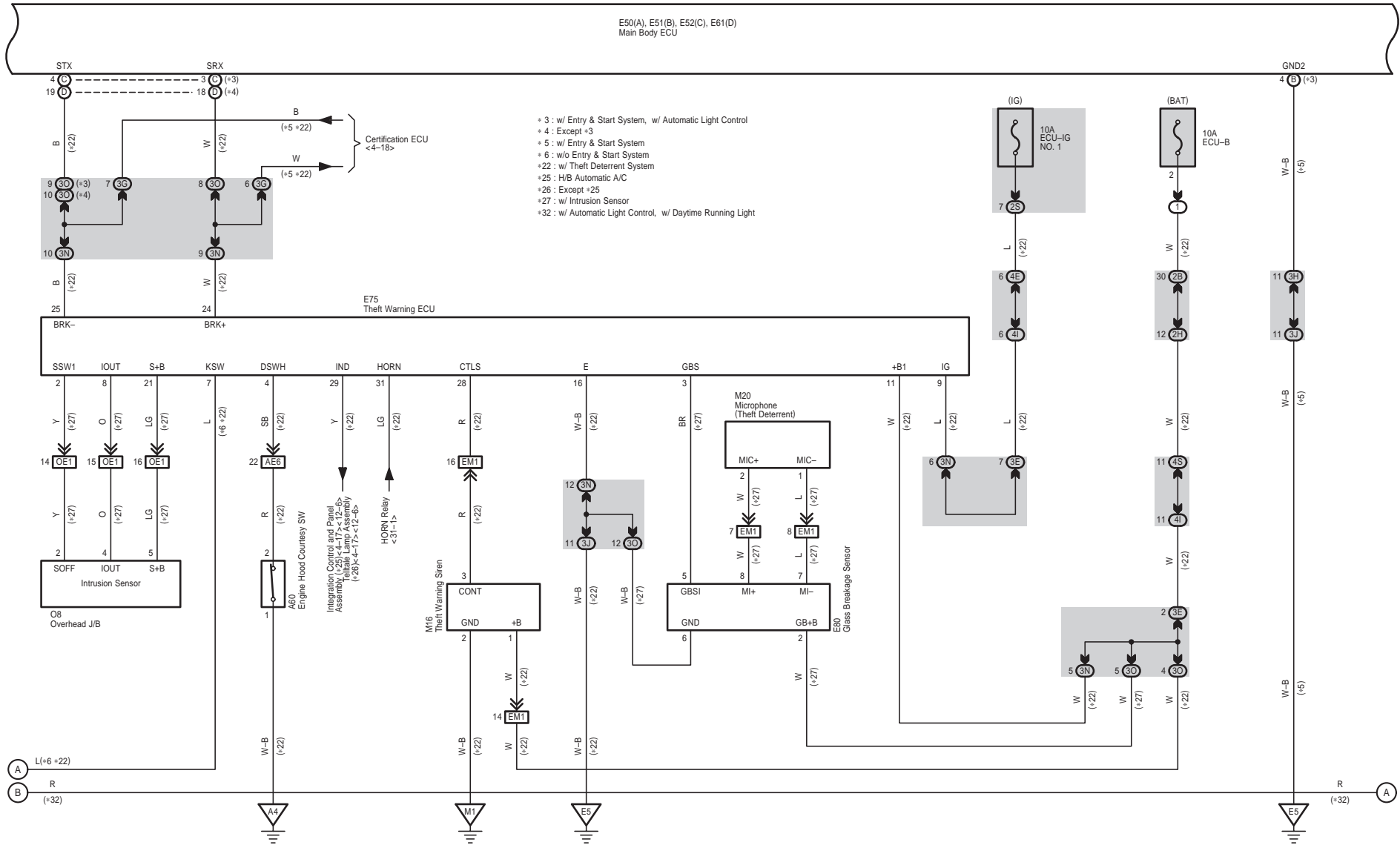

Multiplex Communication System (CAN RHD)

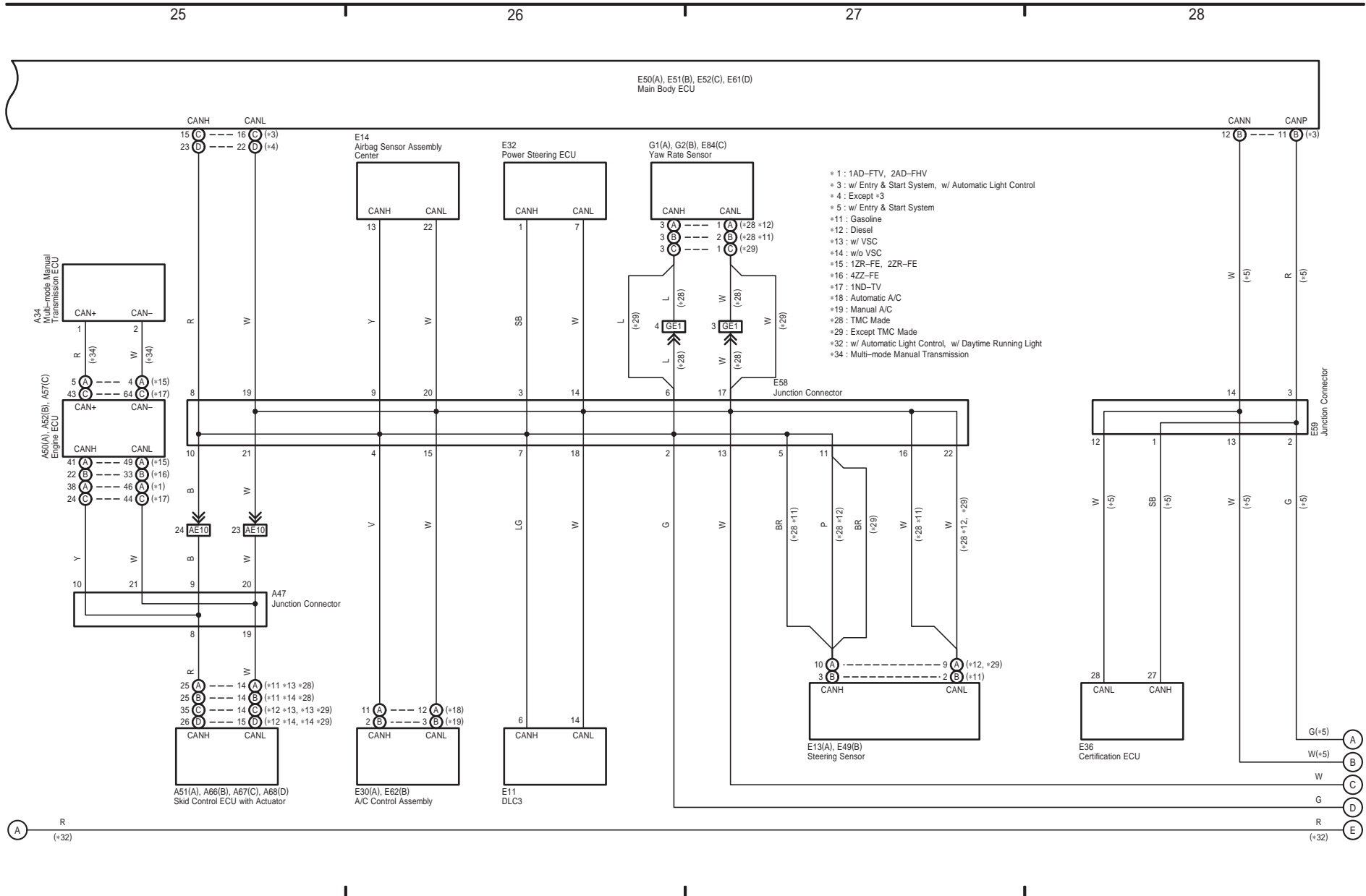

Multiplex Communication System (CAN RHD)

\* 5 : w/ Entry & Start System  
 \*20 : Optitron Meter  
 \*21 : Except \*20  
 \*32 : w/ Automatic Light Control, w/ Daytime Running Light

29 30 31 32

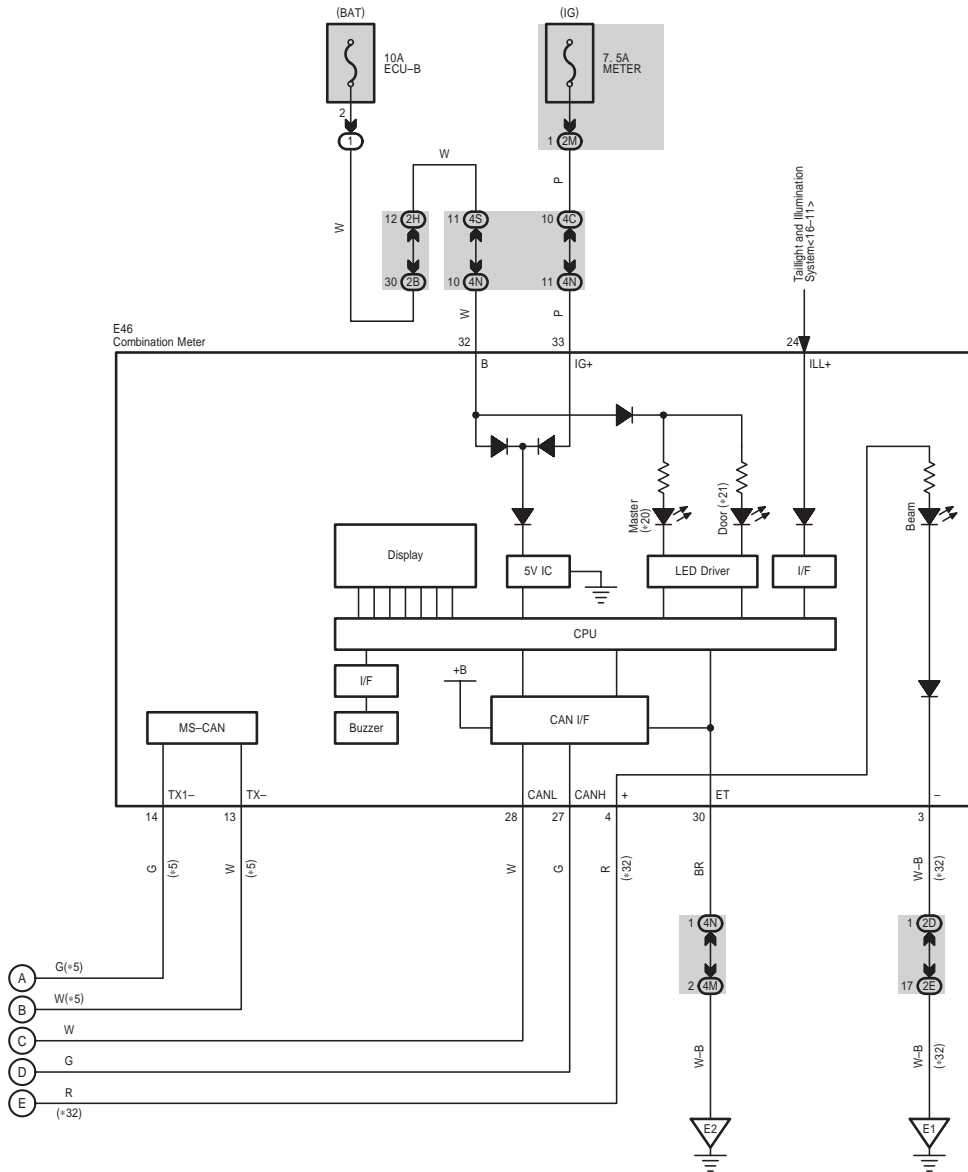

COROLLA / AURIS (EM04F1E)



Entry & Start System

- \* 1 : 1ZR-FE, 2ZR-FE
- \* 2 : 1AD-FTV, 2AD-FHV
- \* 3 : Multi-mode Manual Transmission
- \* 10 : TMC Made
- \* 11 : Except TMC Made

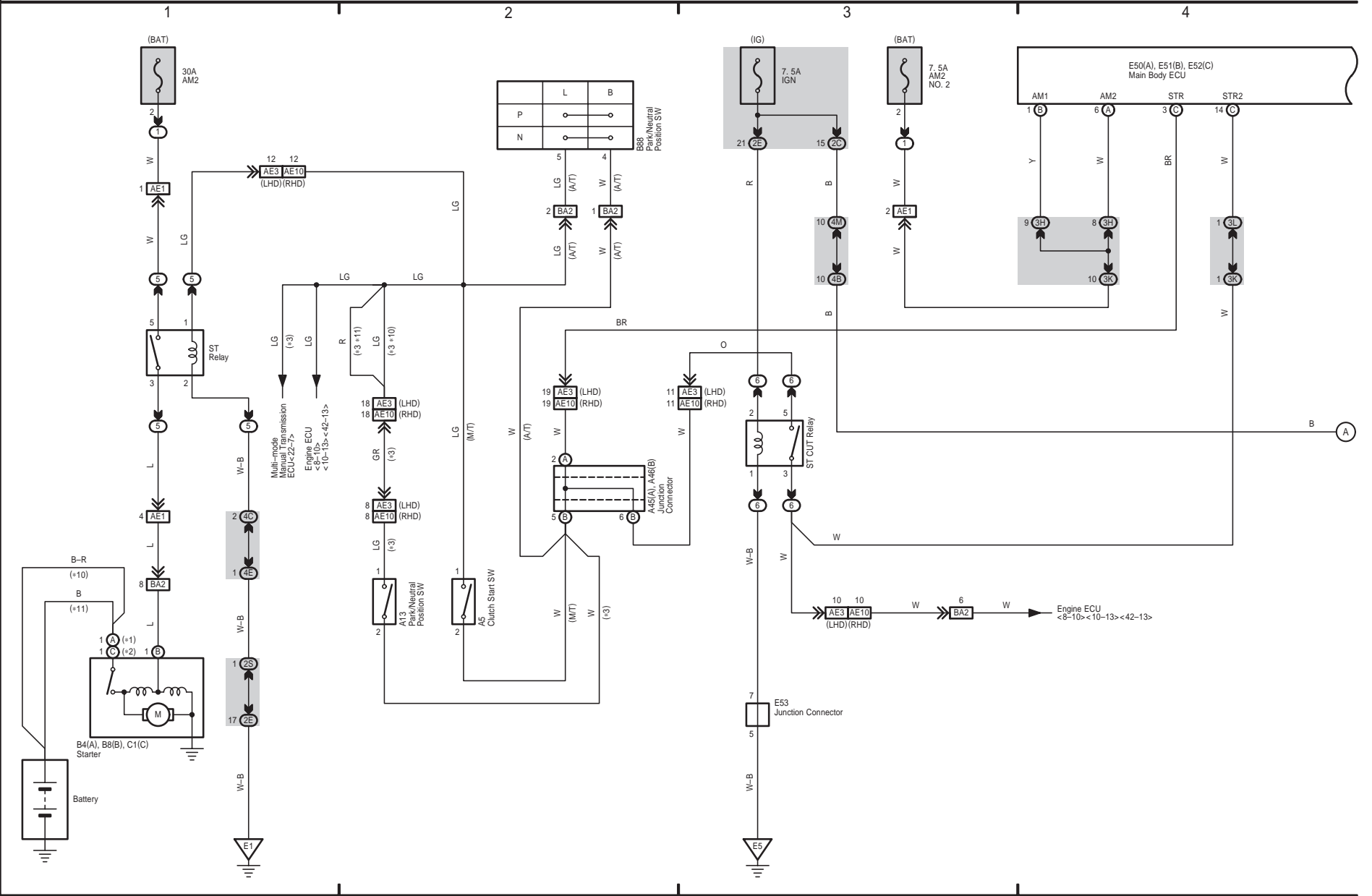

Entry & Start System

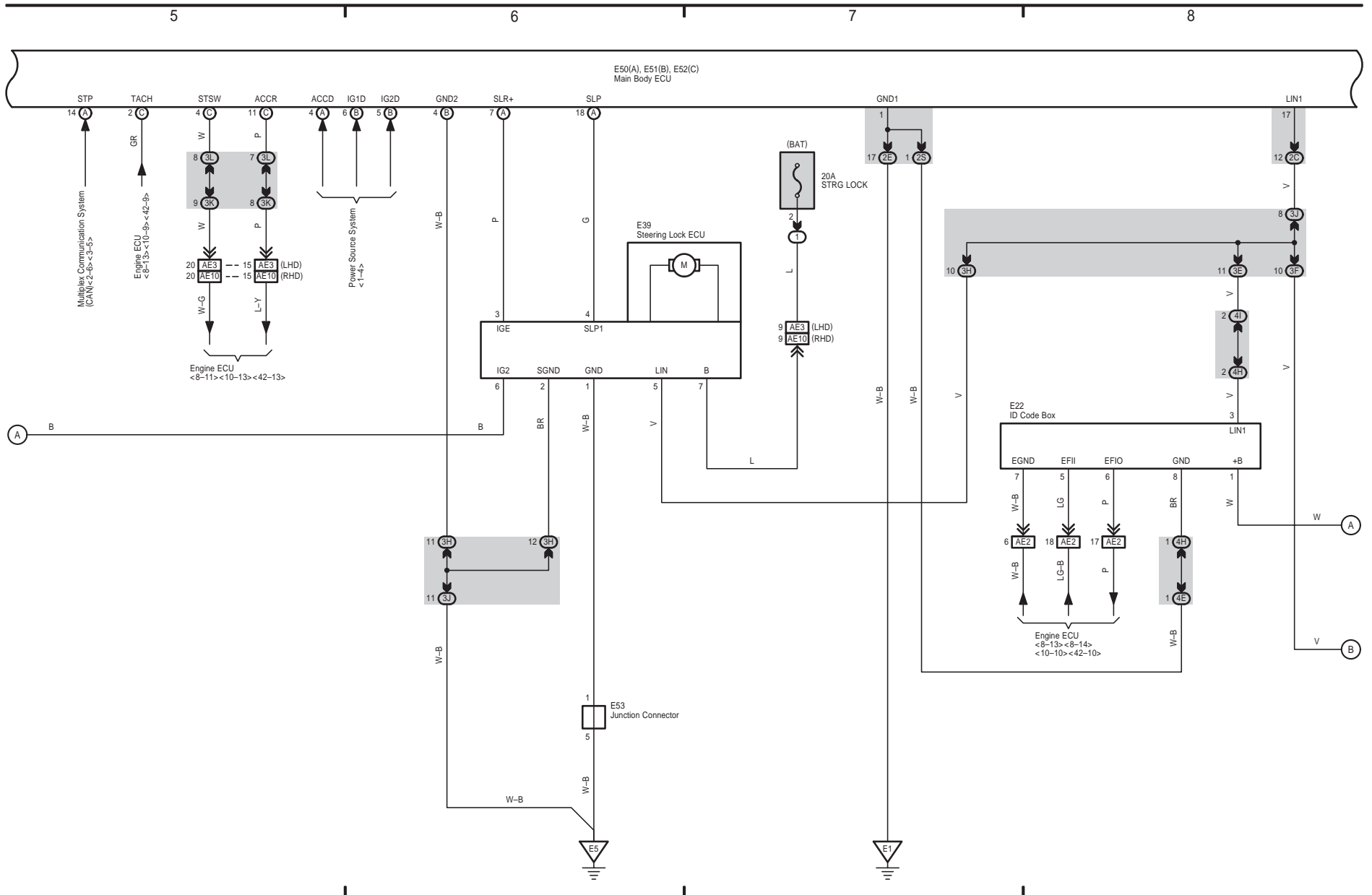

COROLLA / AURIS (EM04F1E)



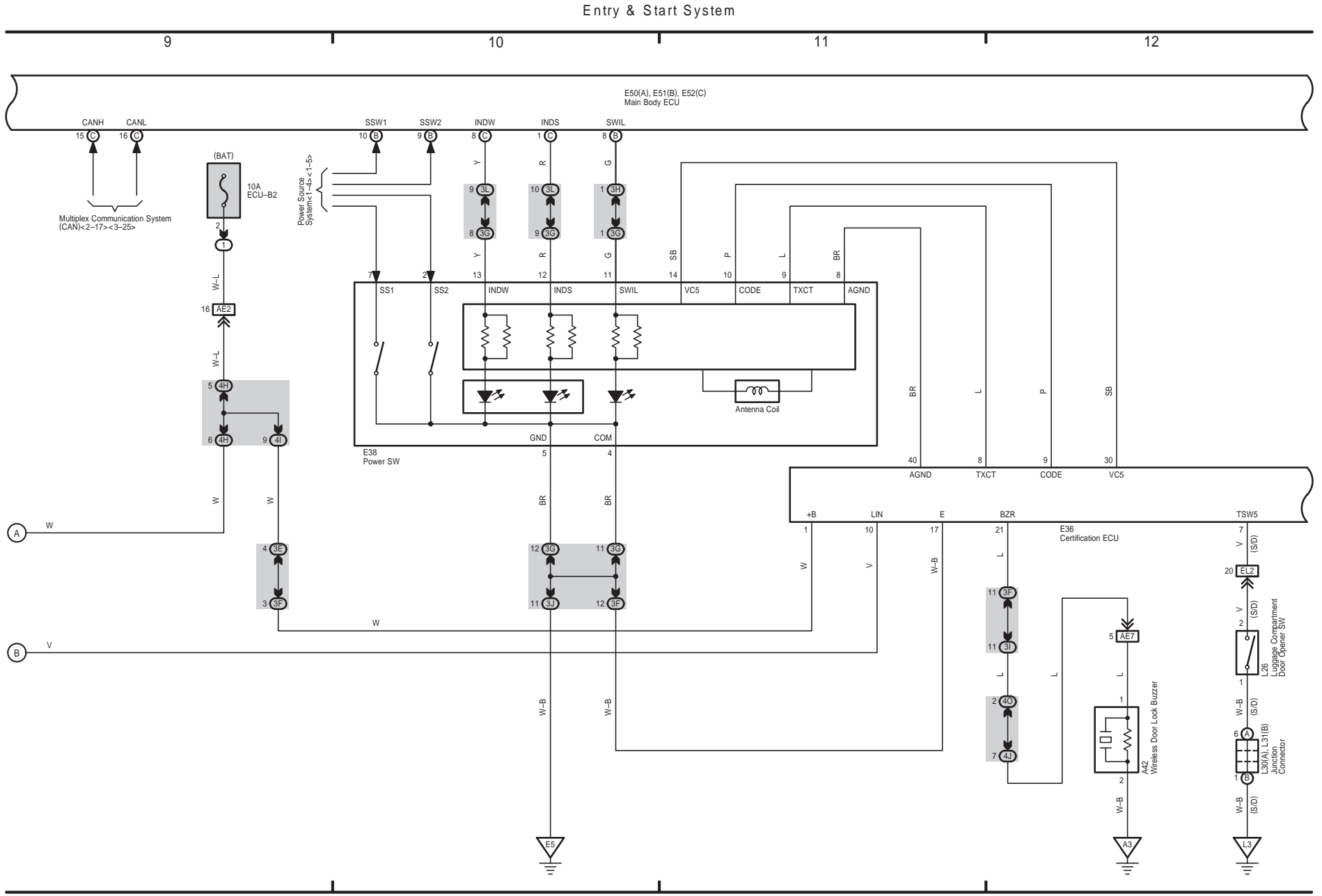

Entry & Start System

\* 5 : RHD S/D

13

14

15

16

E50(A), E51(B), E52(C)  
Main Body ECU

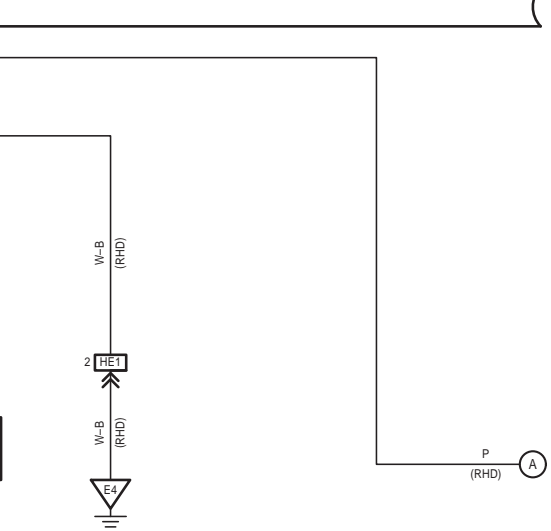
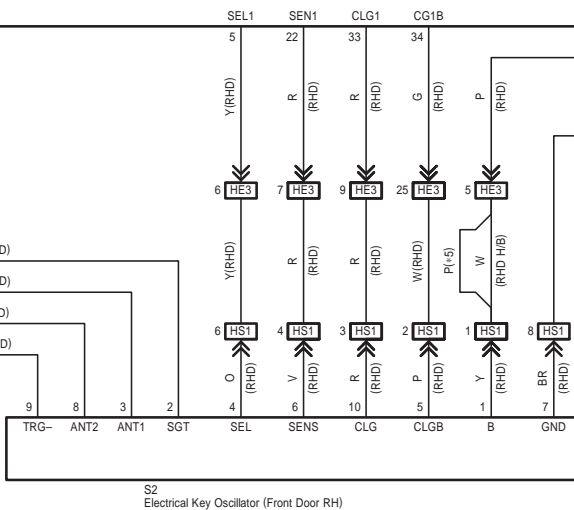
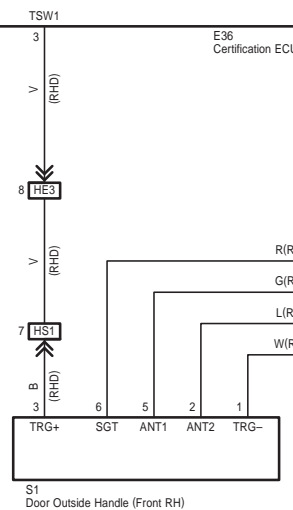
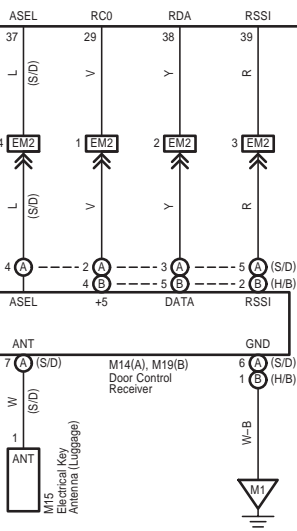
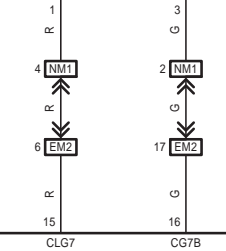
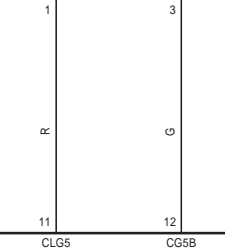
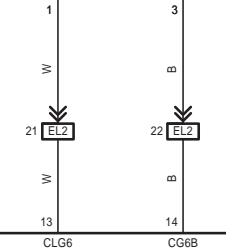
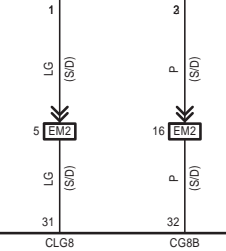
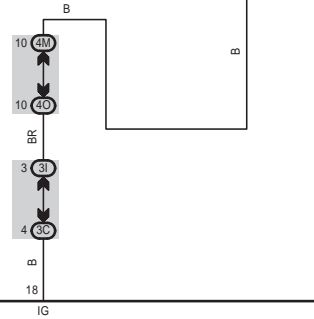
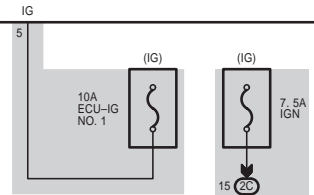
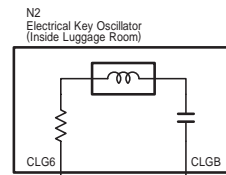
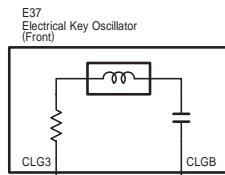
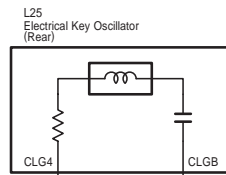
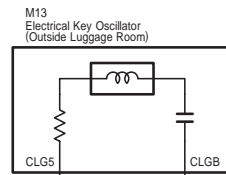
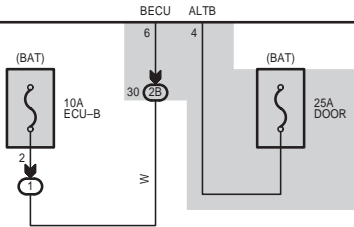

Entry & Start System

- \* 6 : LHD S/D
- \* 7 : w/ Theft Deterrent System
- \* 8 : H/B Automatic A/C
- \* 9 : Except \*8

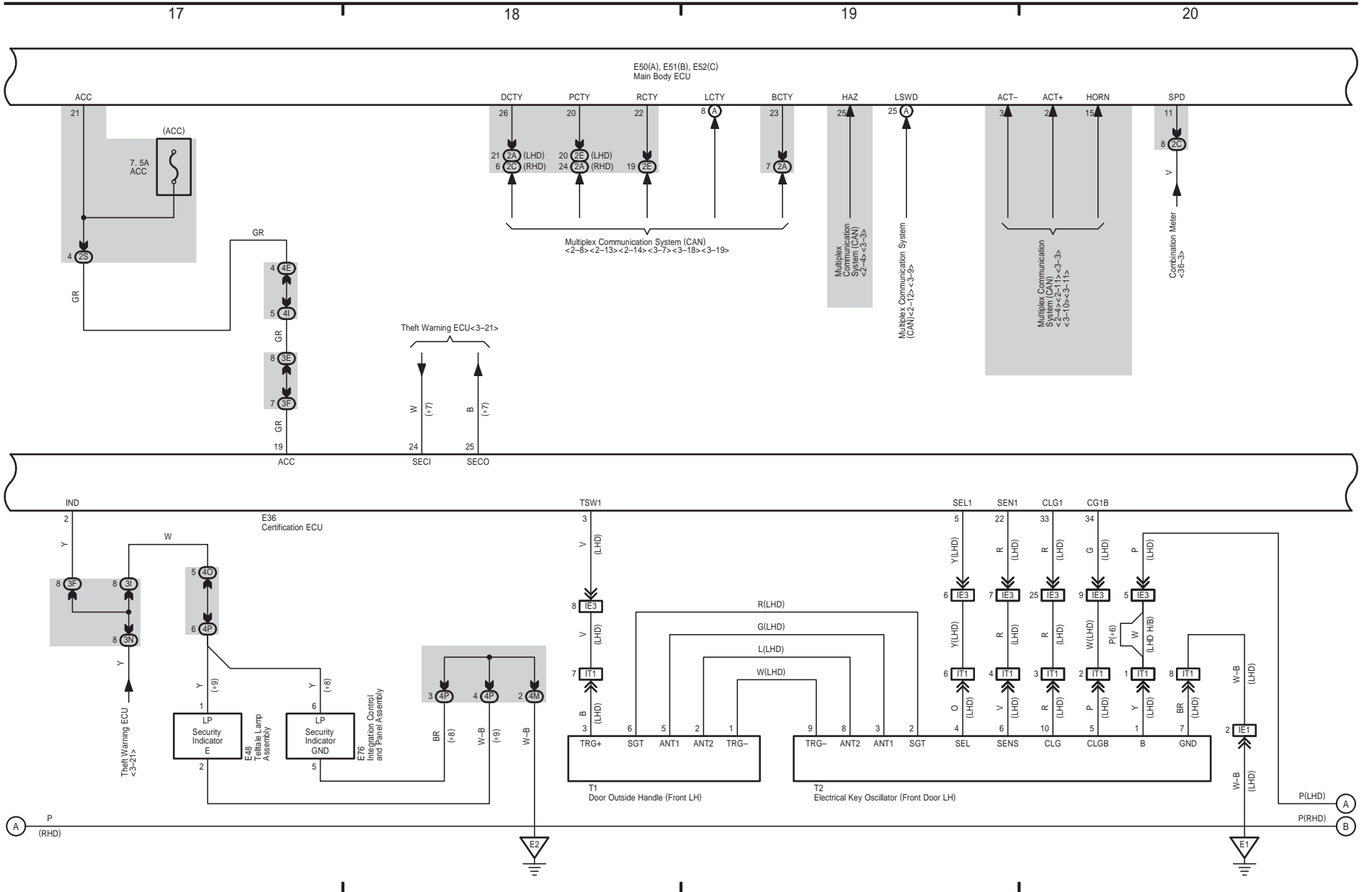

Entry & Start System

\* 5 : RHD S/D  
 \* 6 : LHD S/D

21 | 22 | 23 | 24

E50(A), E51(B), E52(C)  
 Main Body ECU

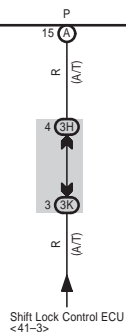

E36  
 Certification ECU

27 CANH  
 28 CANL

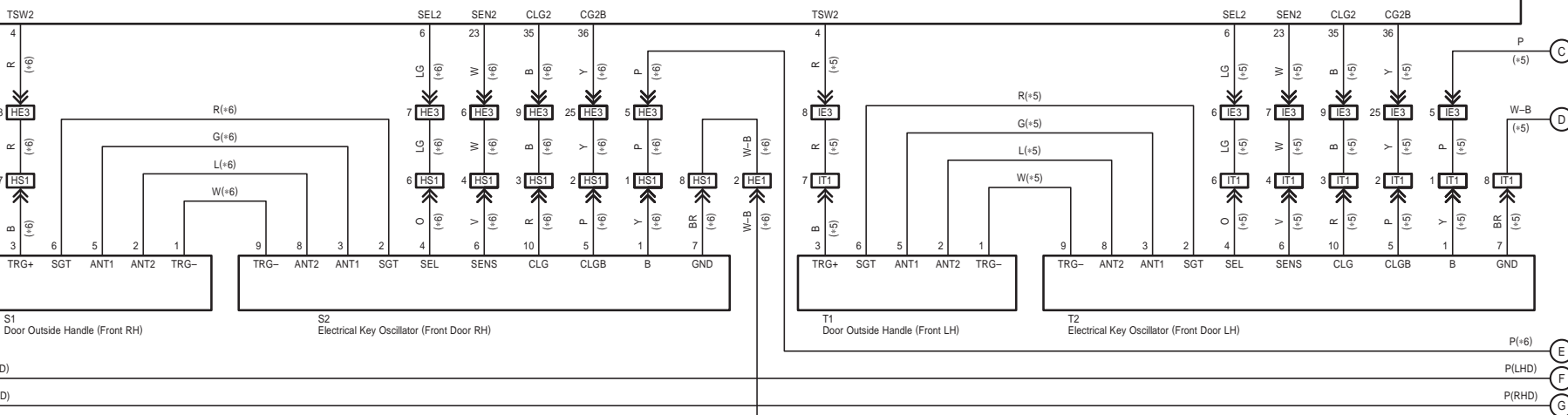

COROLLA / AURIS (EM04F1E)



4 COROLLA / AURIS (Cont' d)

Entry & Start System

\* 5 : RHD S/D  
\* 6 : LHD S/D

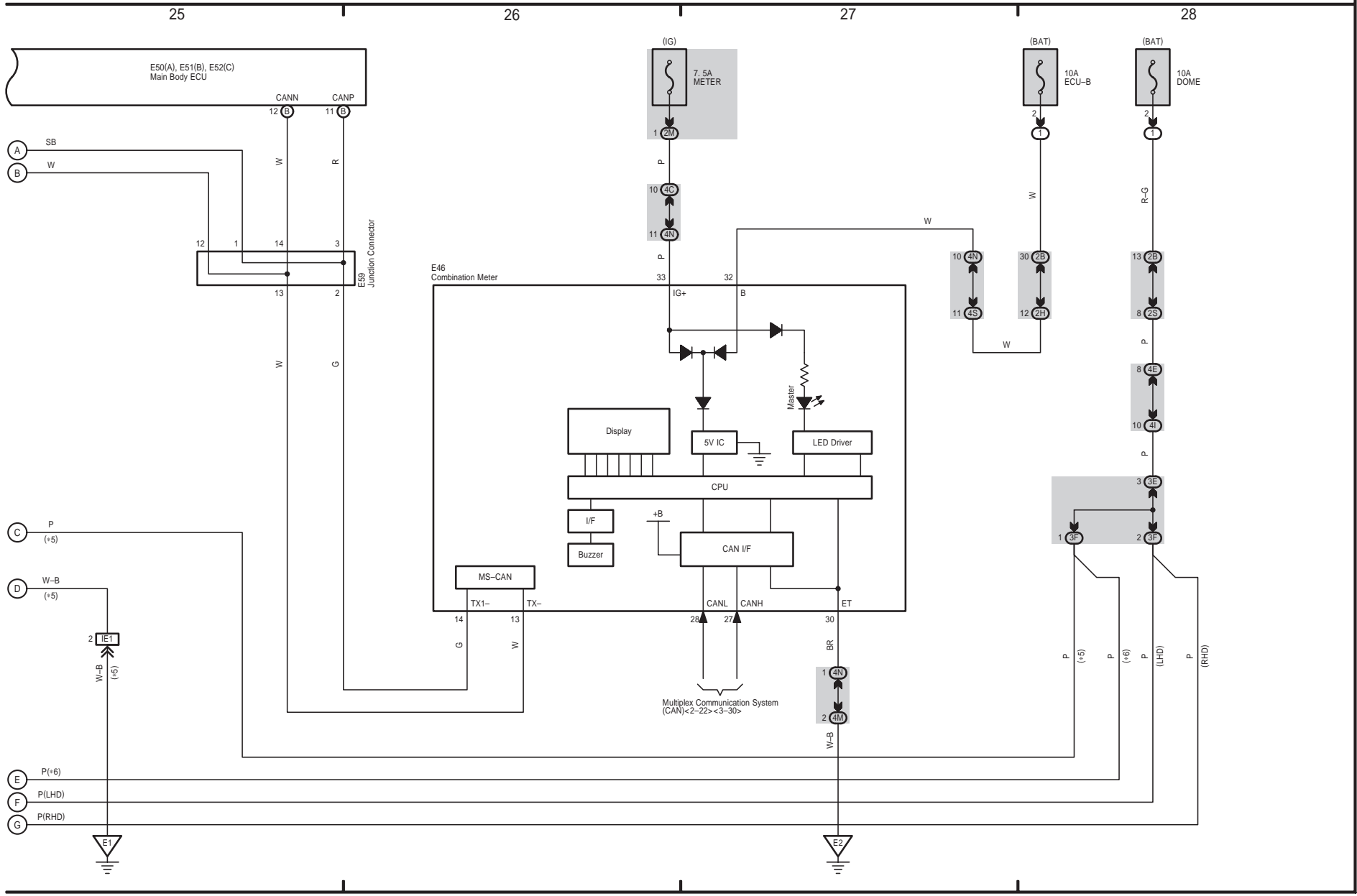

Starting (w/o Entry & Start System)

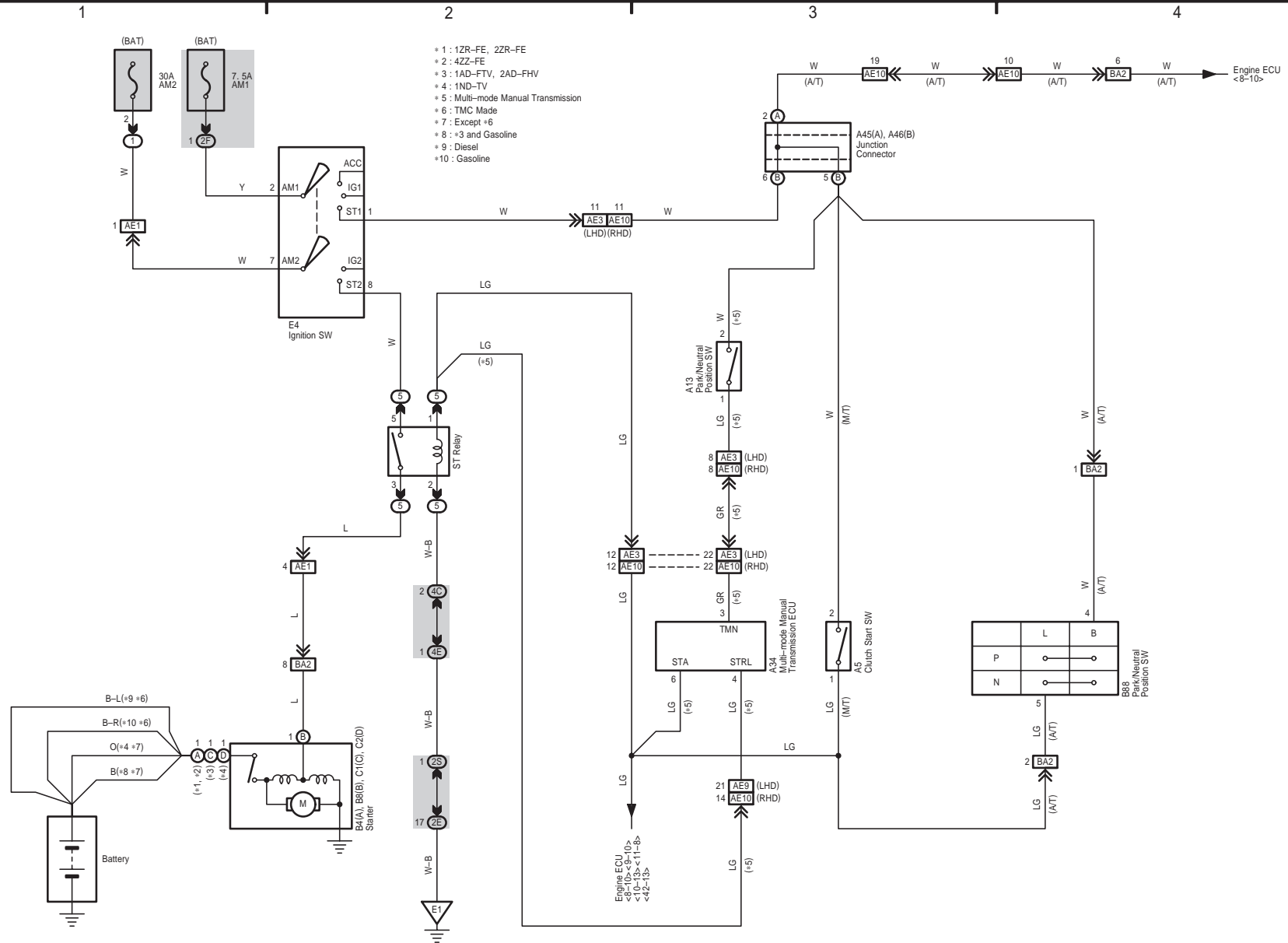



6 COROLLA / AURIS

Charging

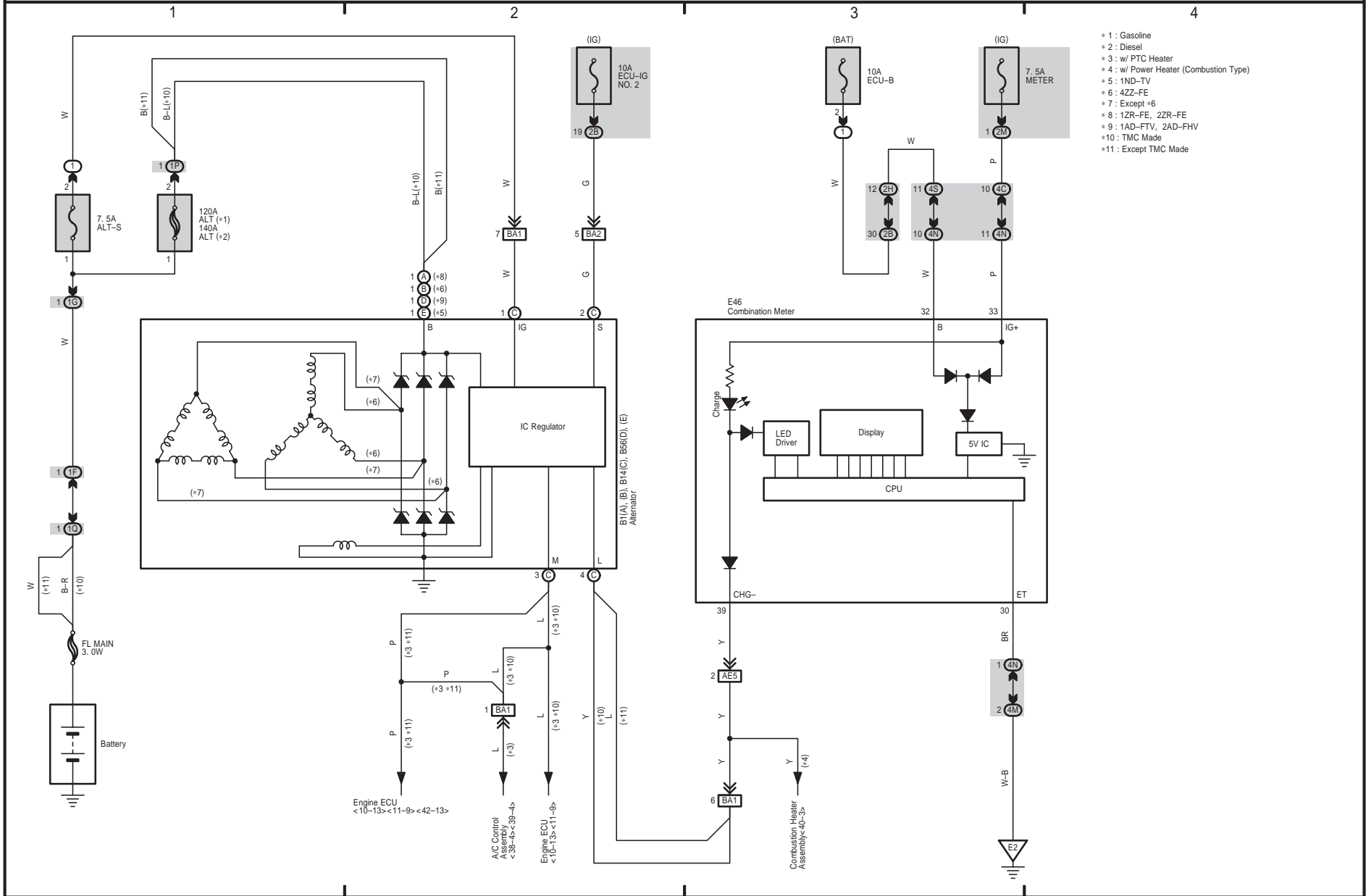

7 COROLLA / AURIS

Ignition

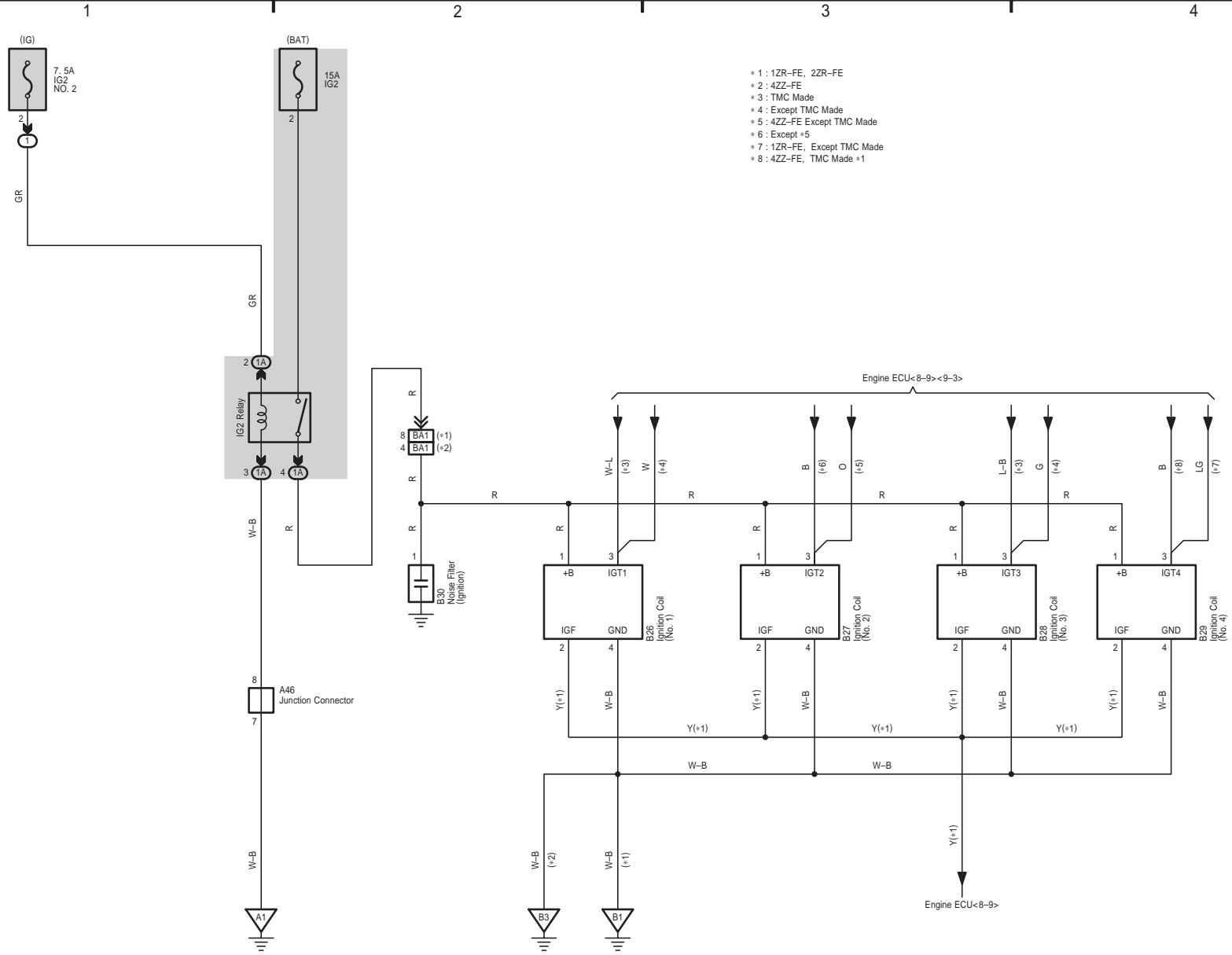

- \* 1 : 1ZR-FE, 2ZR-FE
- \* 2 : 4ZZ-FE
- \* 3 : TMC Made
- \* 4 : Except TMC Made
- \* 5 : 4ZZ-FE Except TMC Made
- \* 6 : Except +5
- \* 7 : 1ZR-FE, Except TMC Made
- \* 8 : 4ZZ-FE, TMC Made +1

COROLLA / AURIS (EM04F1E)



Engine Control (1ZR-FE, 2ZR-FE)

\* 8 : TMC Made  
\* 9 : Except TMC Made

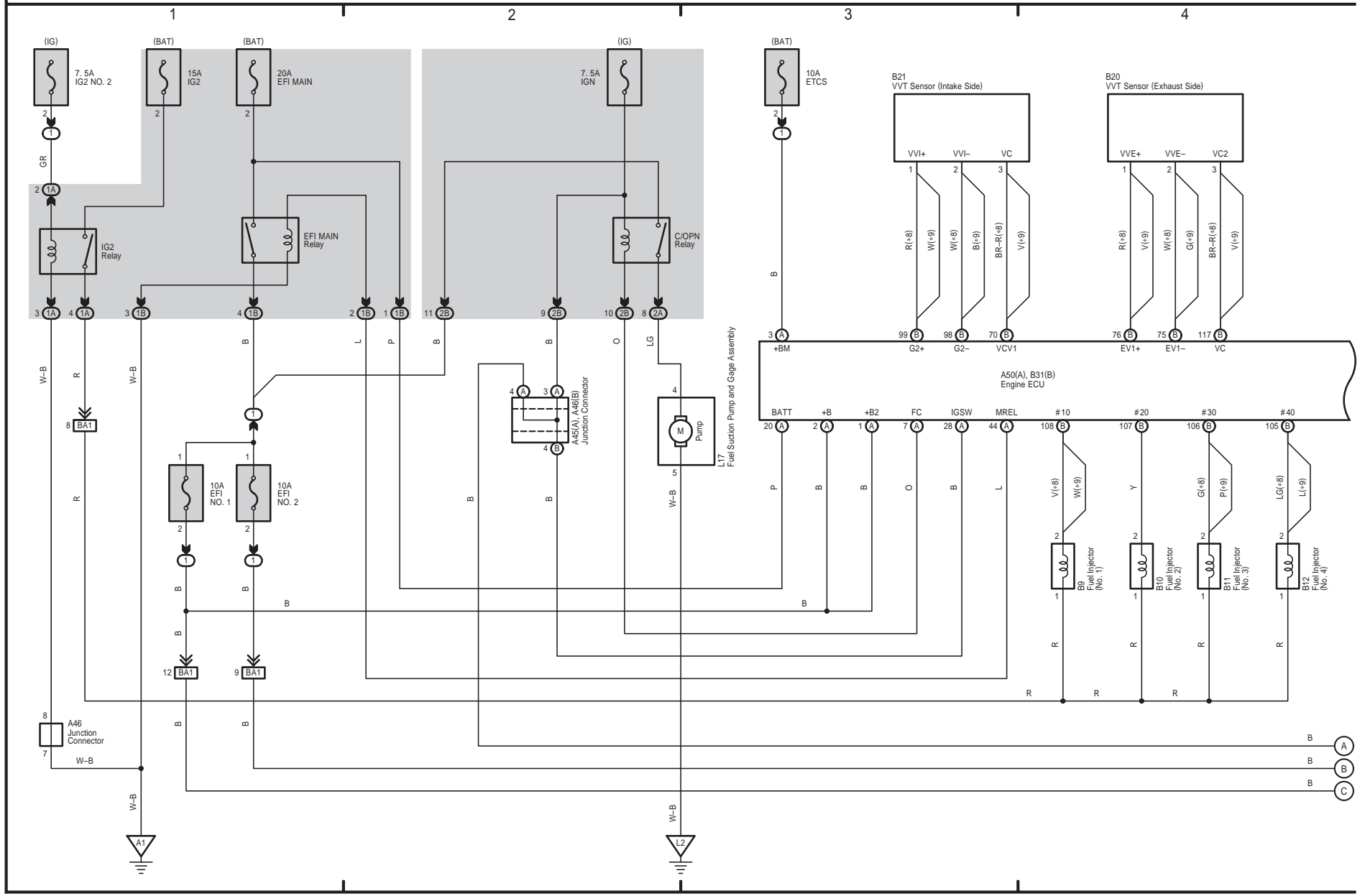

Engine Control (1ZR-FE, 2ZR-FE)

- \* 1 : Shielded
- \* 4 : 1ZR-FE
- \* 5 : 2ZR-FE
- \* 8 : TMC Made
- \* 9 : Except TMC Made

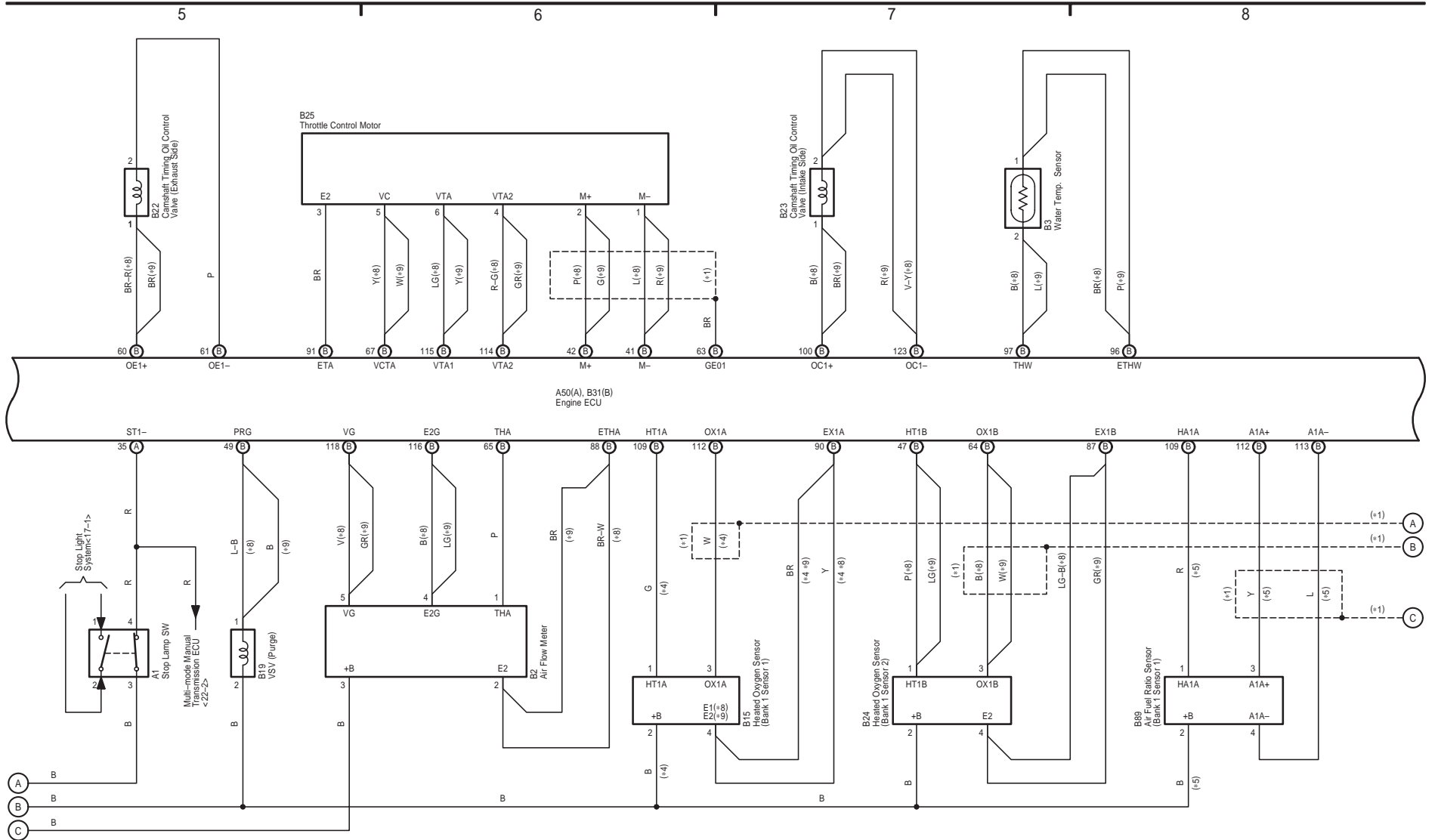

Engine Control (1ZR-FE, 2ZR-FE)

- \* 1 : Shielded
- \* 2 : w/ Entry & Start System
- \* 3 : w/o Entry & Start System
- \* 6 : Multi-mode Manual Transmission
- \* 7 : Except Multi-mode Manual Transmission
- \* 8 : TMC Made
- \* 9 : Except TMC Made

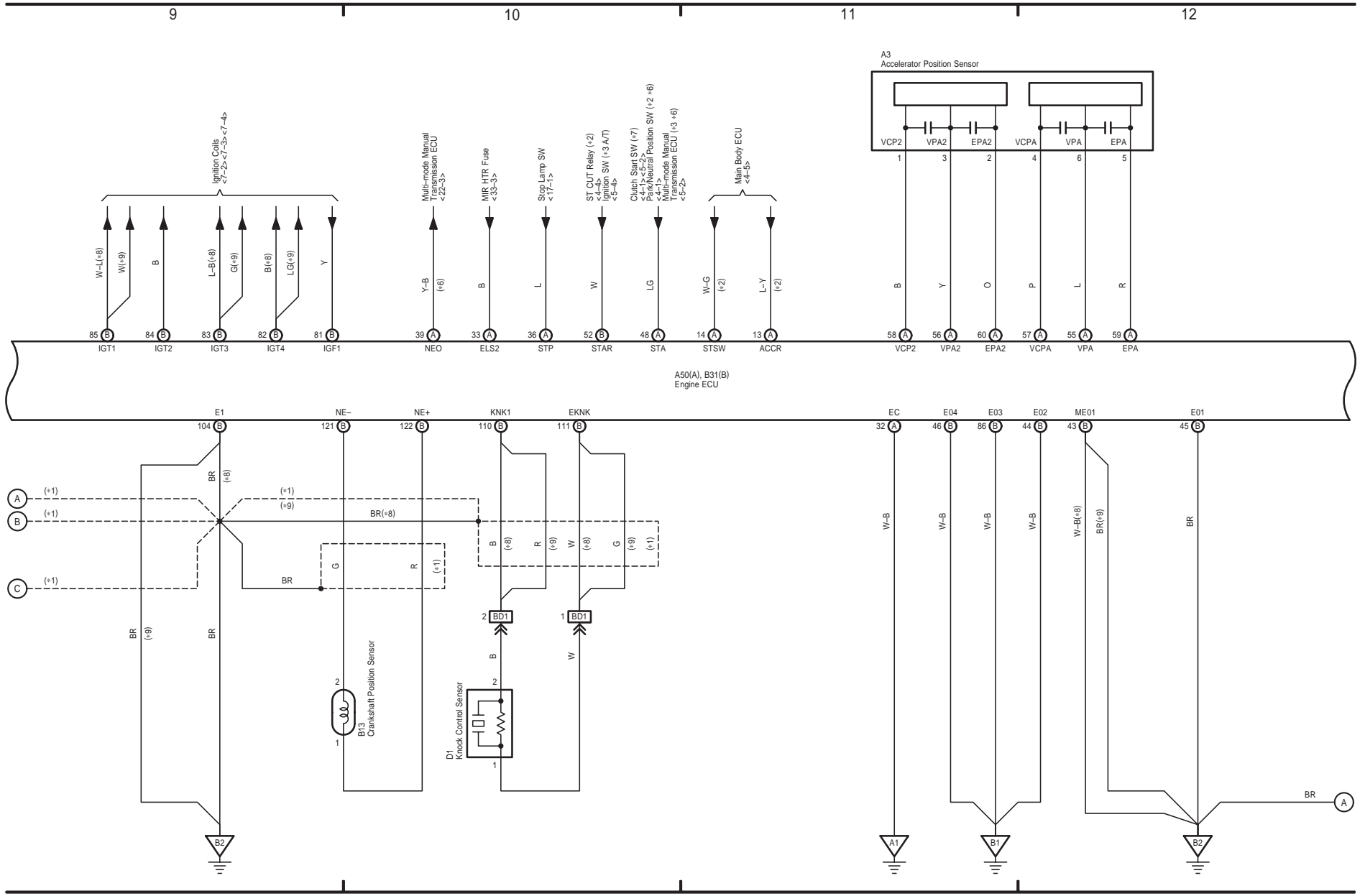

Cruise Control (1ZR-FE, 2ZR-FE)

ECT and A/T Indicator (2ZR-FE)

13

14

15

16

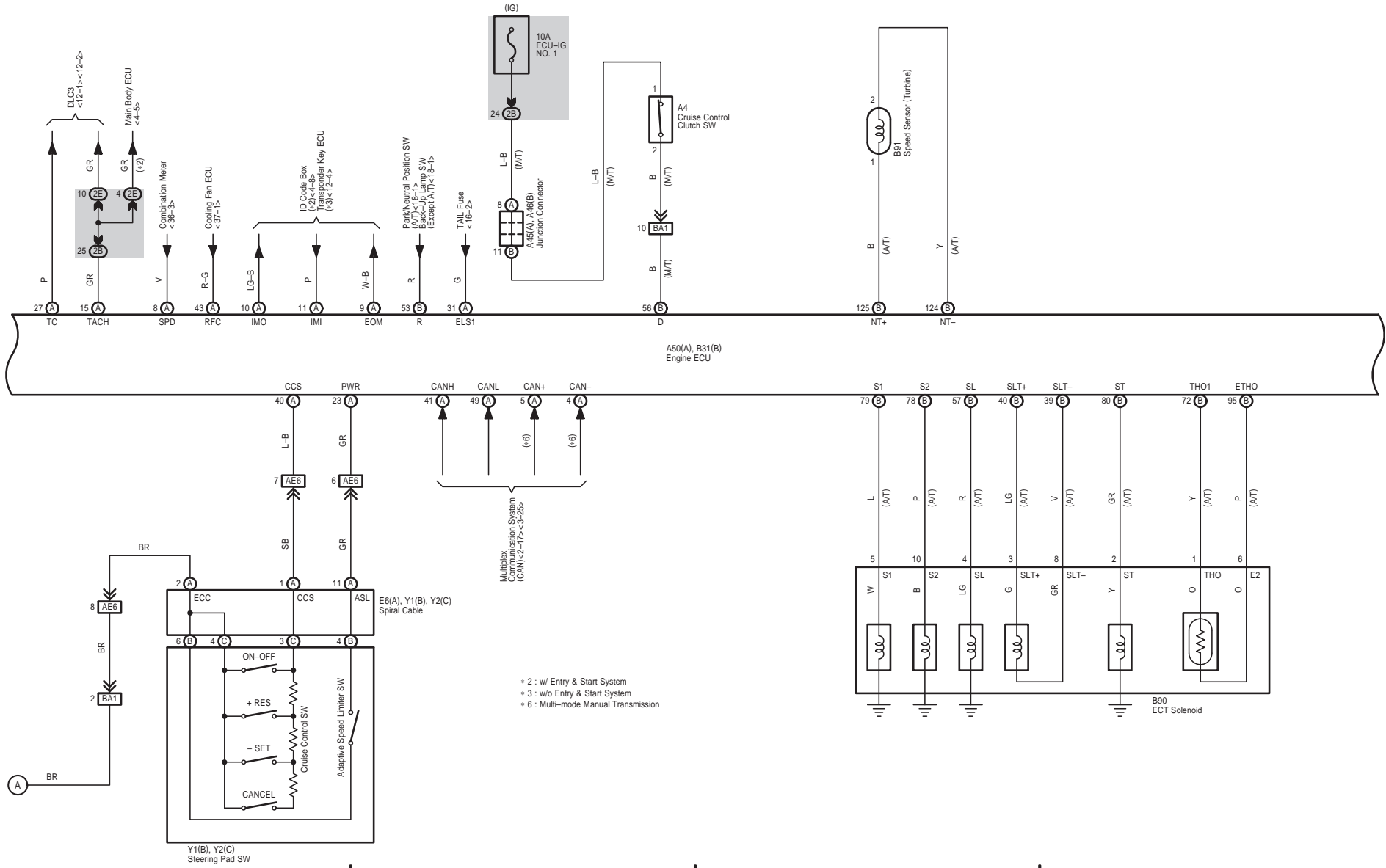

COROLLA / AURIS (EM04F1E)



8 COROLLA / AURIS (Cont' d)

ECT and A/T Indicator (2ZR-FE)

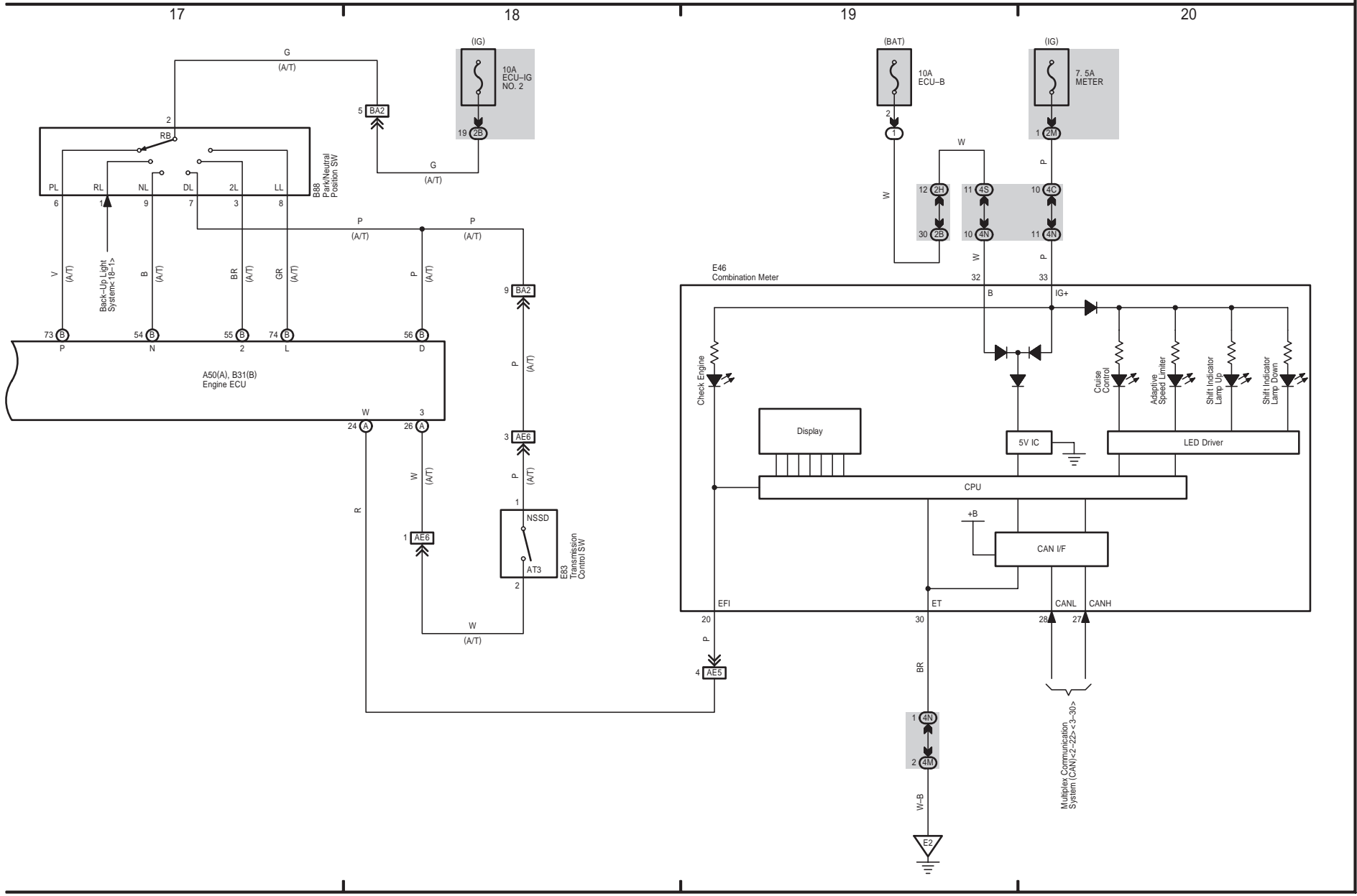

Engine Control (4ZZ-FE)

\* 1 : TMC Made  
\* 2 : Except TMC Made

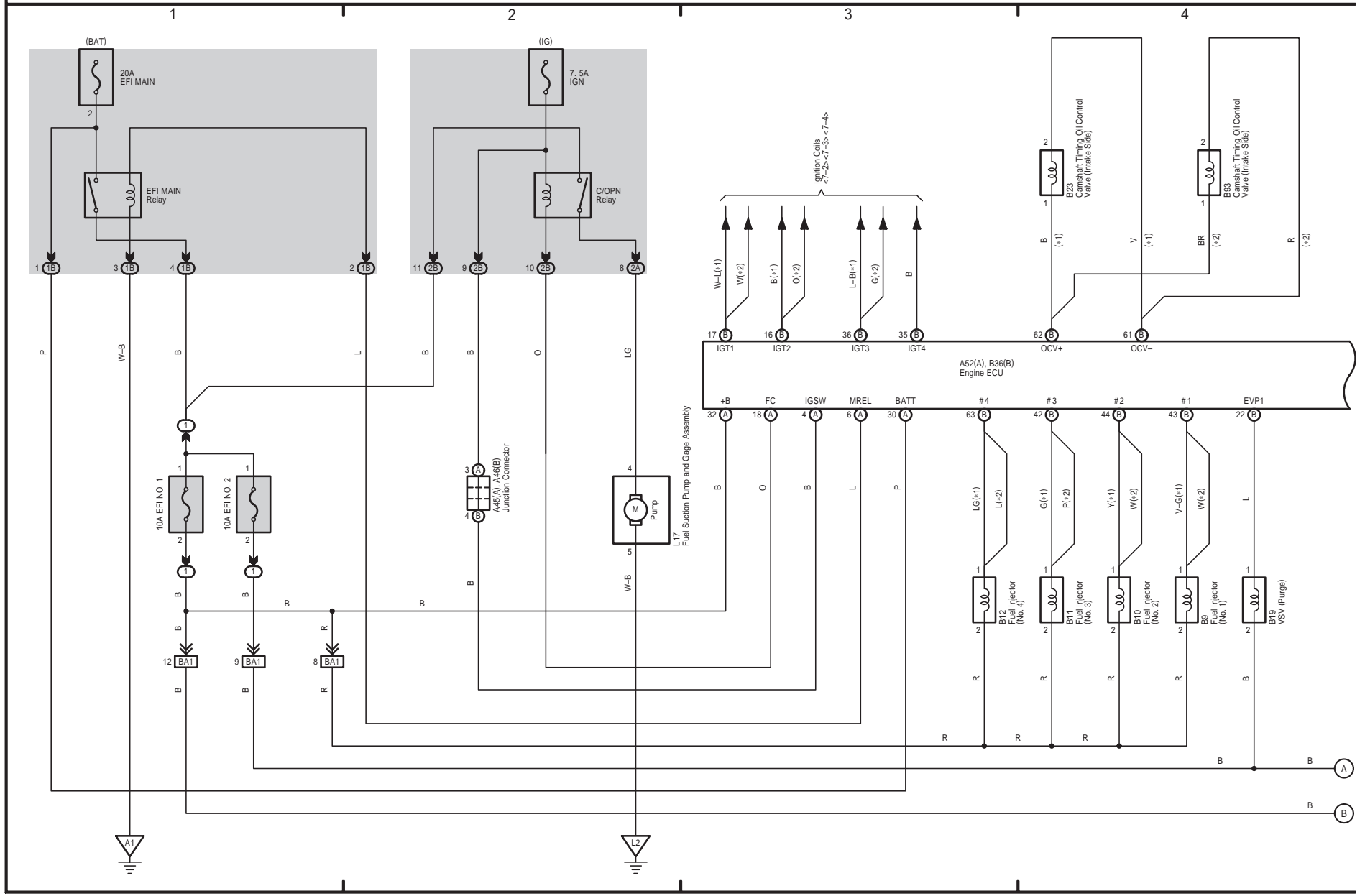



Engine Control (4ZZ-FE)

\* 1 : TMC Made  
\* 2 : Except TMC Made

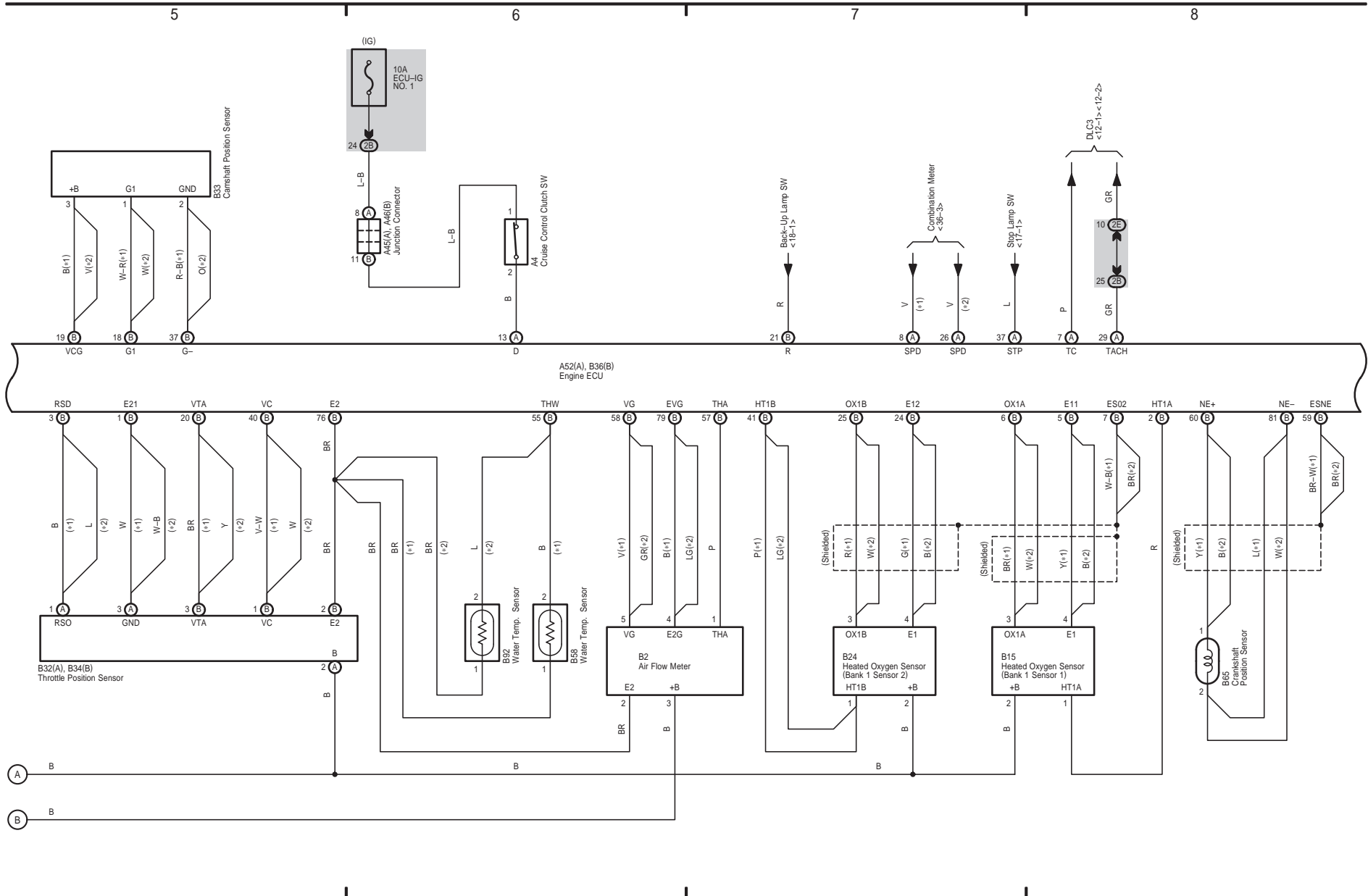

COROLLA / AURIS (EM04F1E)



9 COROLLA / AURIS (Cont' d)

Engine Control (4ZZ-FE)

\* 1 : TMC Made  
\* 2 : Except TMC Made

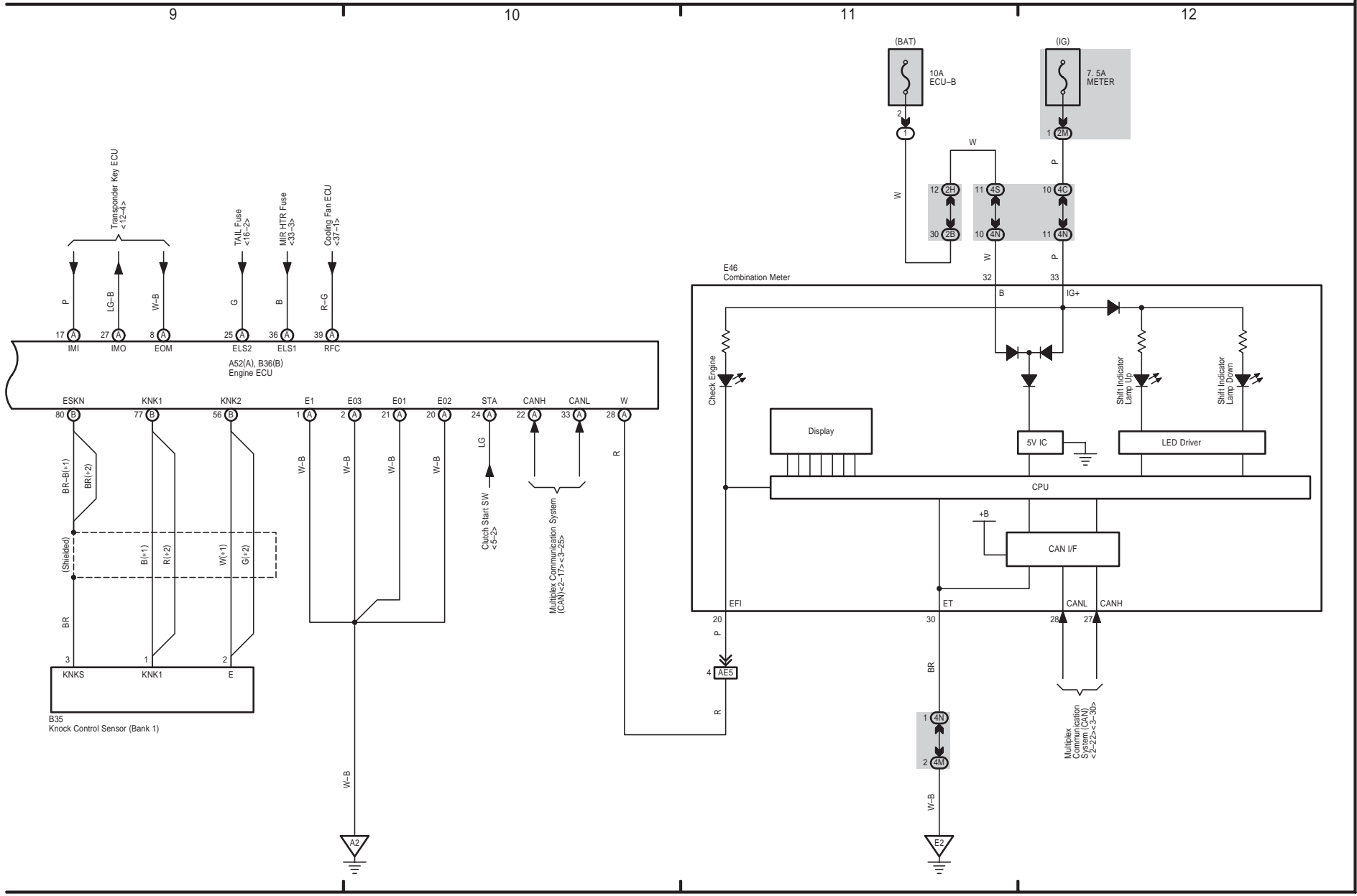

Engine Control (1AD-FTV)

- \* 2 : w/ Air Fuel Ratio Sensor
- \* 4 : TMC Made
- \* 5 : Except TMC Made

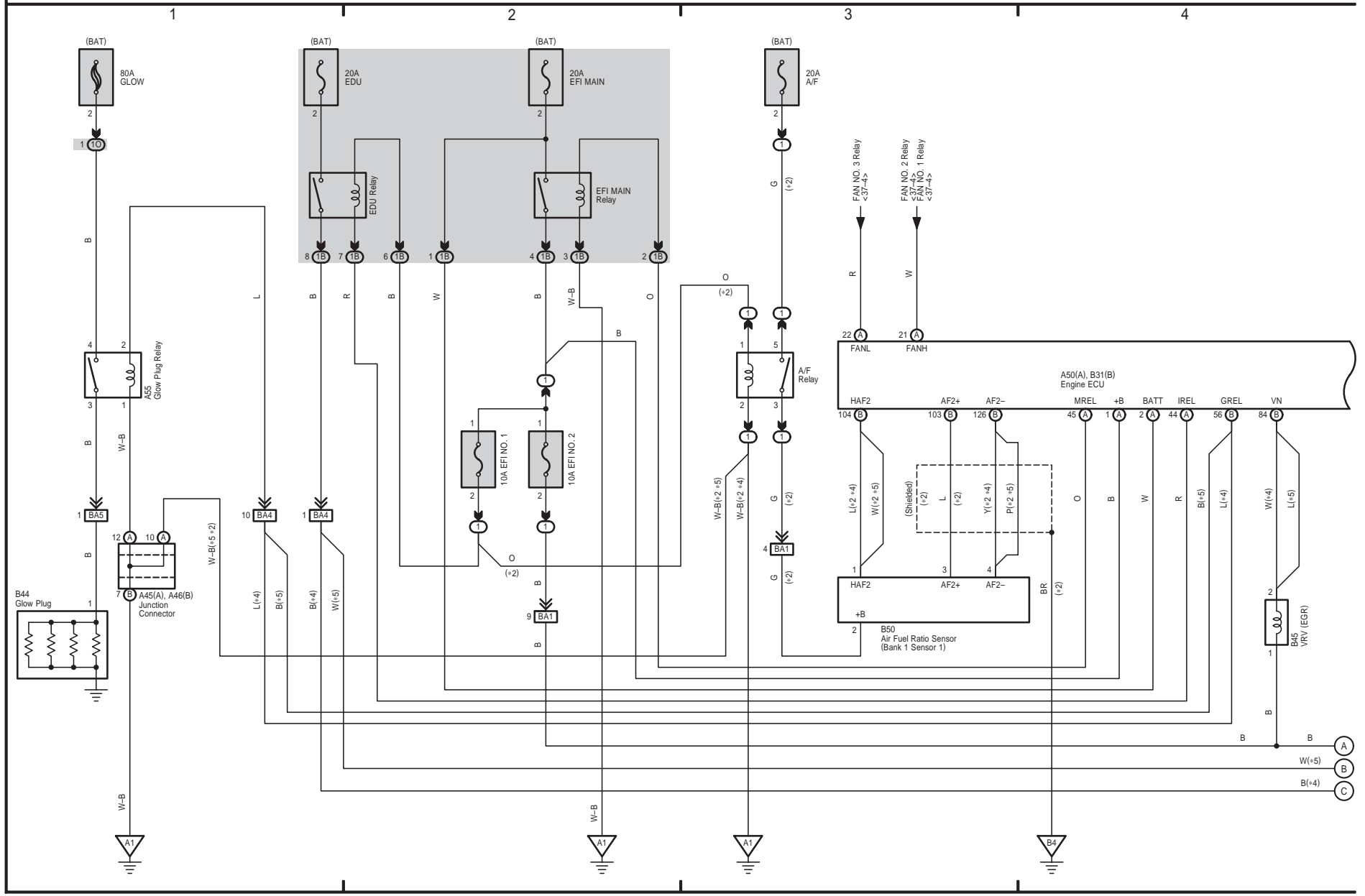

Engine Control (1AD-FTV)

- \* 2 : w/ Air Fuel Ratio Sensor
- \* 4 : TMC Made
- \* 5 : Except TMC Made

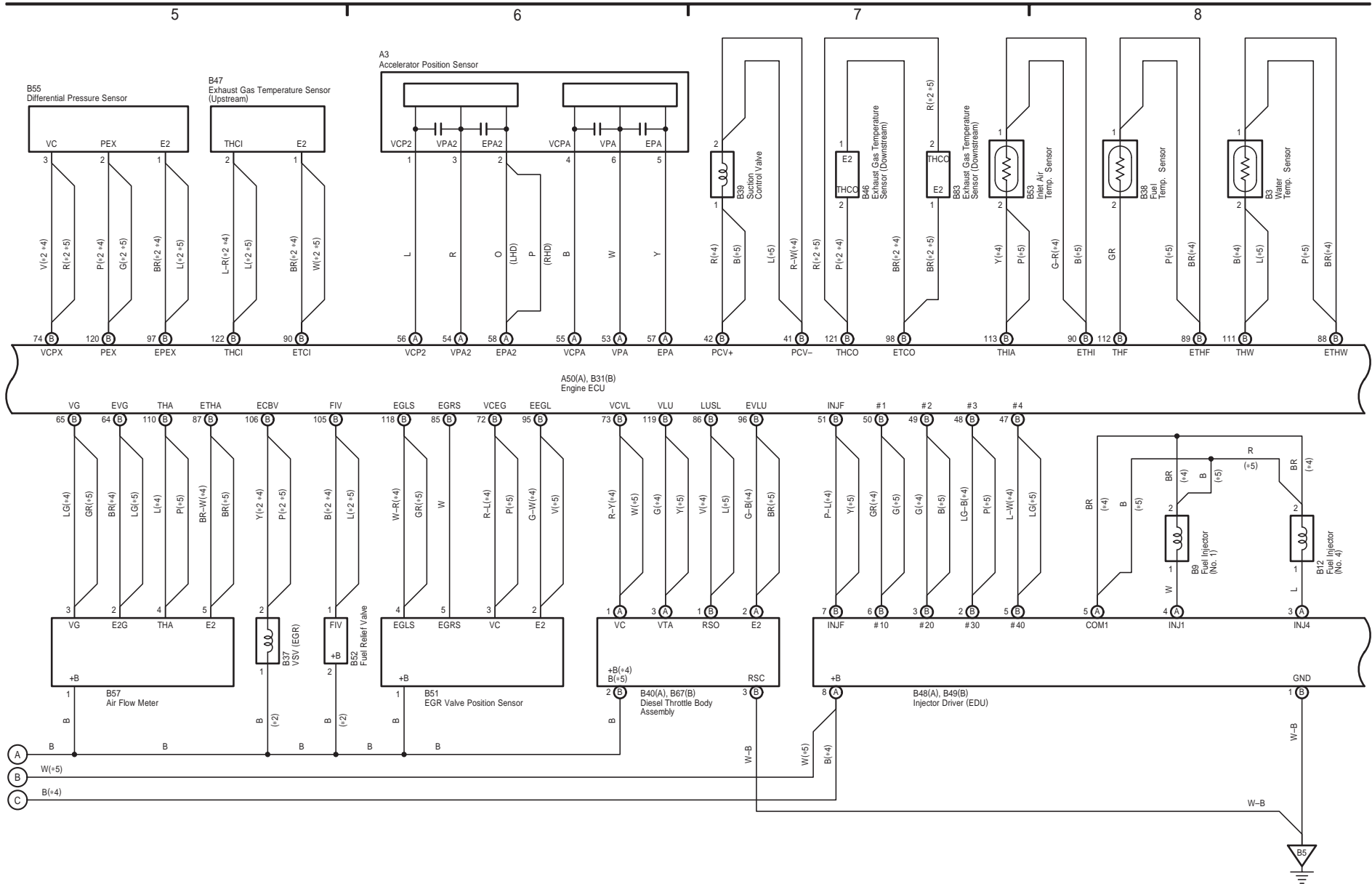

COROLLA / AURIS (EM04F1E)



Engine Control (1AD-FTV)

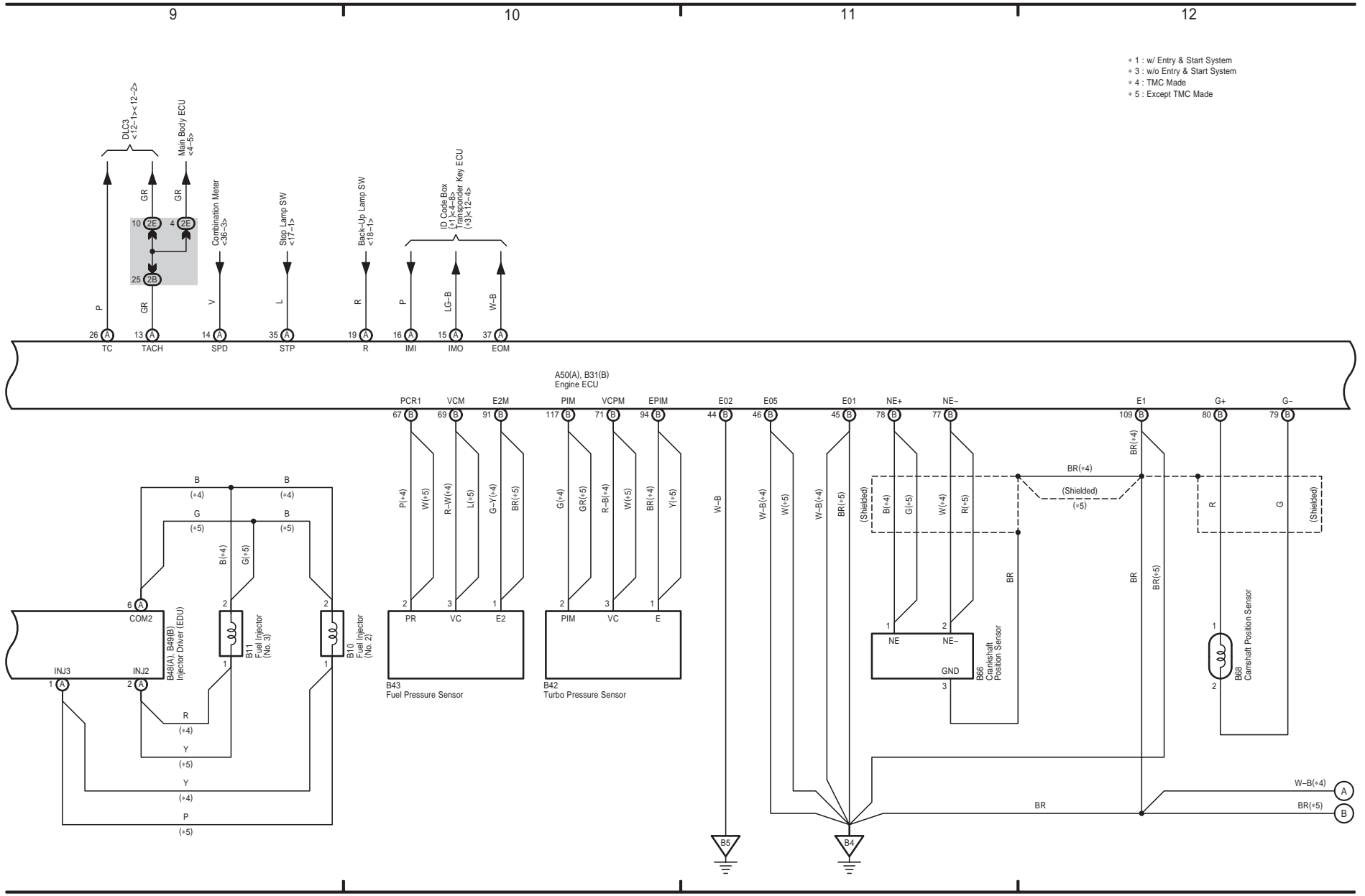

Cruise Control (1AD-FTV)

COROLLA / AURIS (EM04F1E)

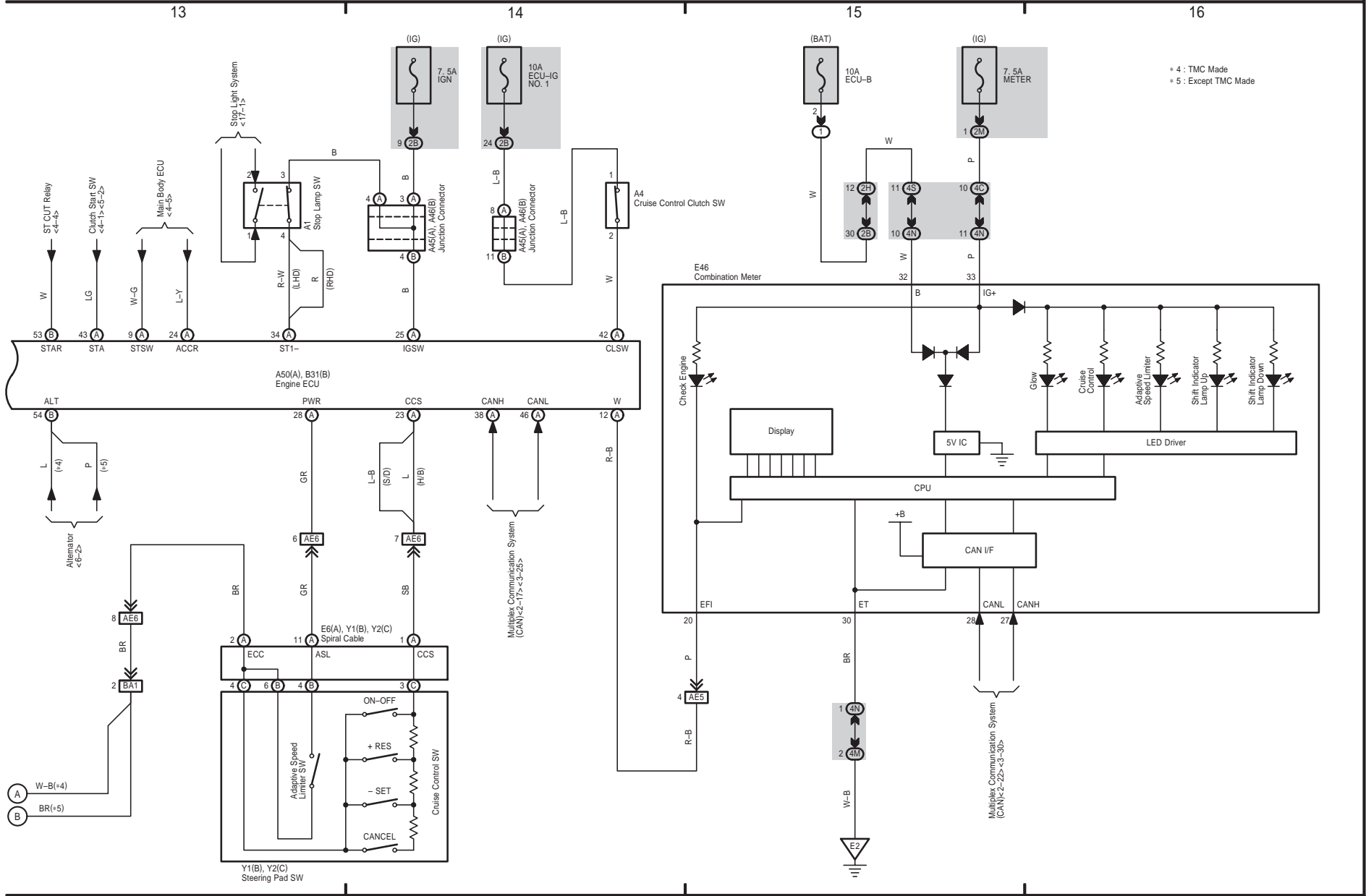

Engine Control (1ND-TV)

\* 3 : TMC Made  
\* 4 : Except TMC Made

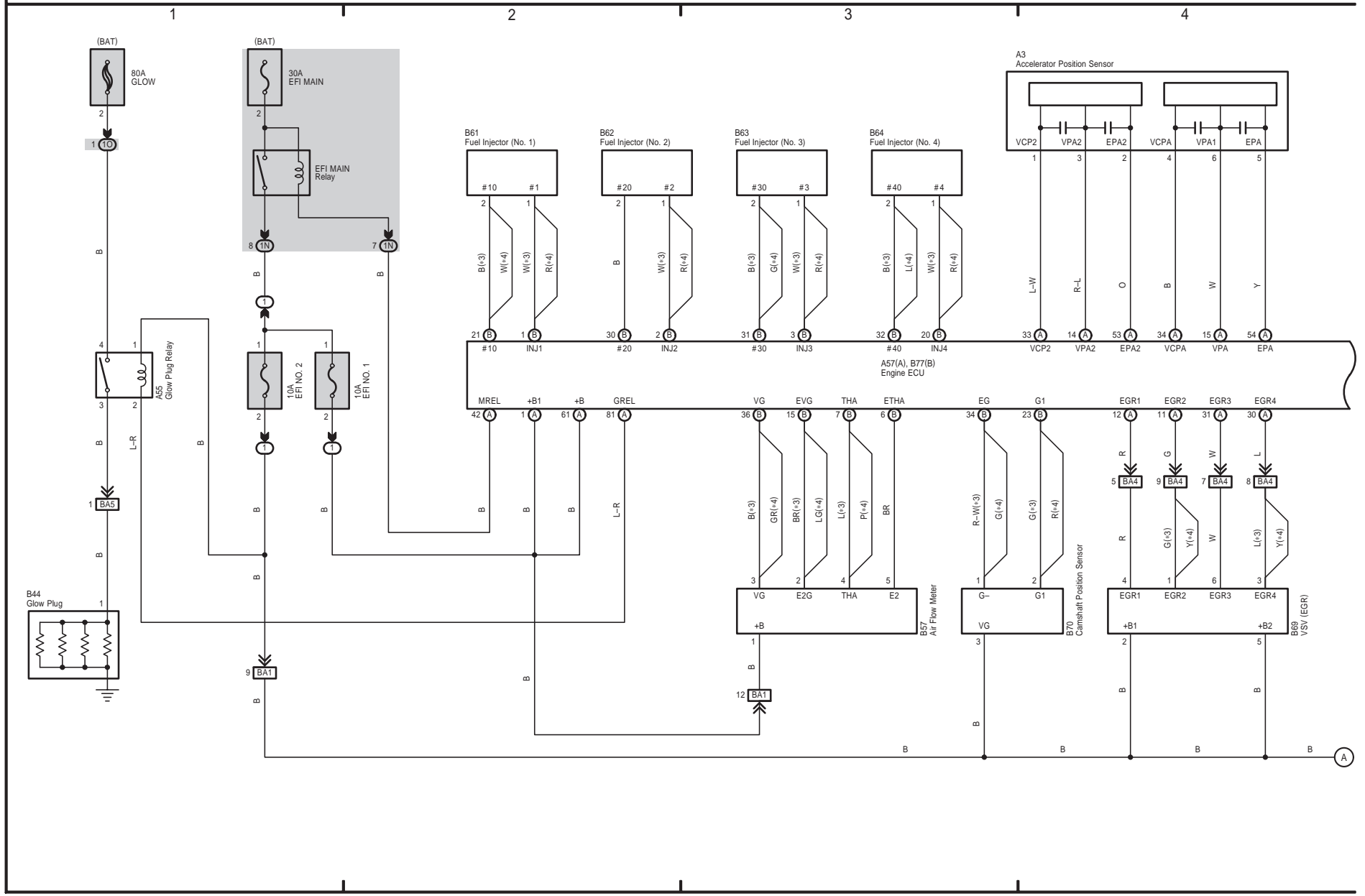

- 1 : Multi-mode Manual Transmission
- 2 : Except Multi-mode Manual Transmission
- 3 : TMC Made
- 4 : Except TMC Made
- 5 : w/ Power Heater (Combustion Type)

Engine Control (1ND-TV)

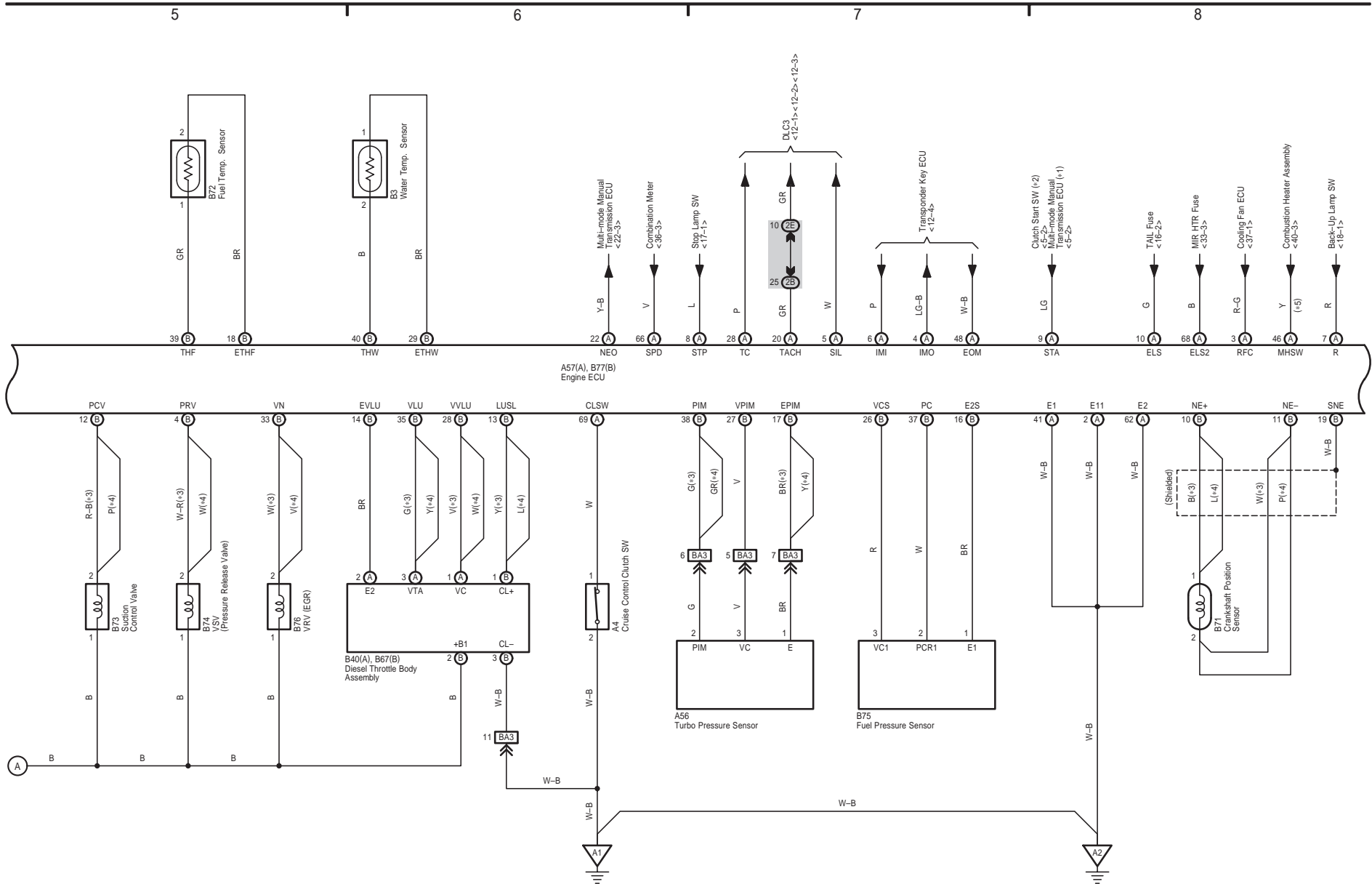

COROLLA / AURIS (EM04F1E)





11 COROLLA / AURIS (Cont' d)

Engine Control (1ND-TV)

- \* 1 : Multi-mode Manual Transmission
- \* 2 : Except Multi-mode Manual Transmission
- \* 3 : TMC Made
- \* 4 : Except TMC Made

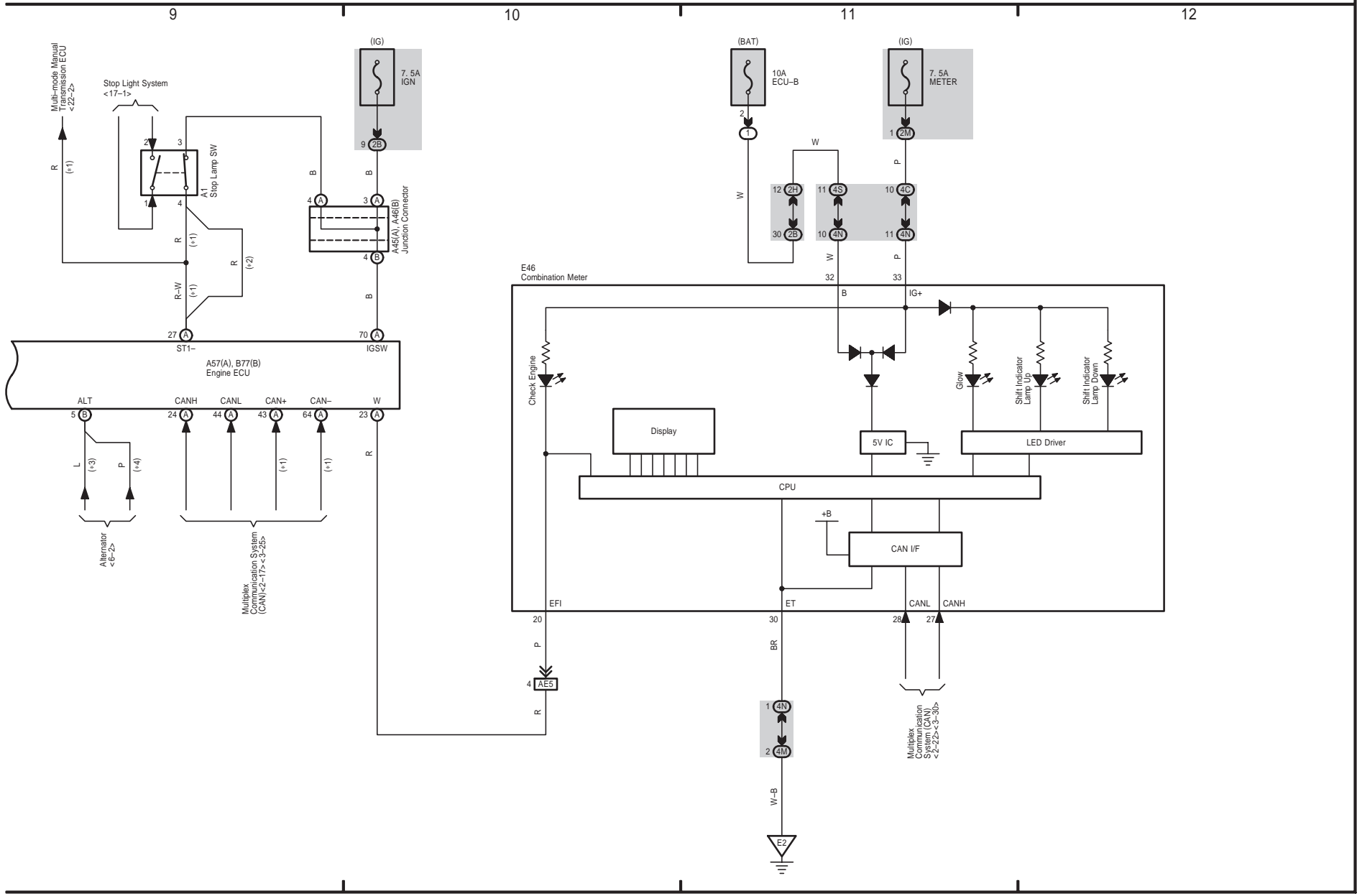

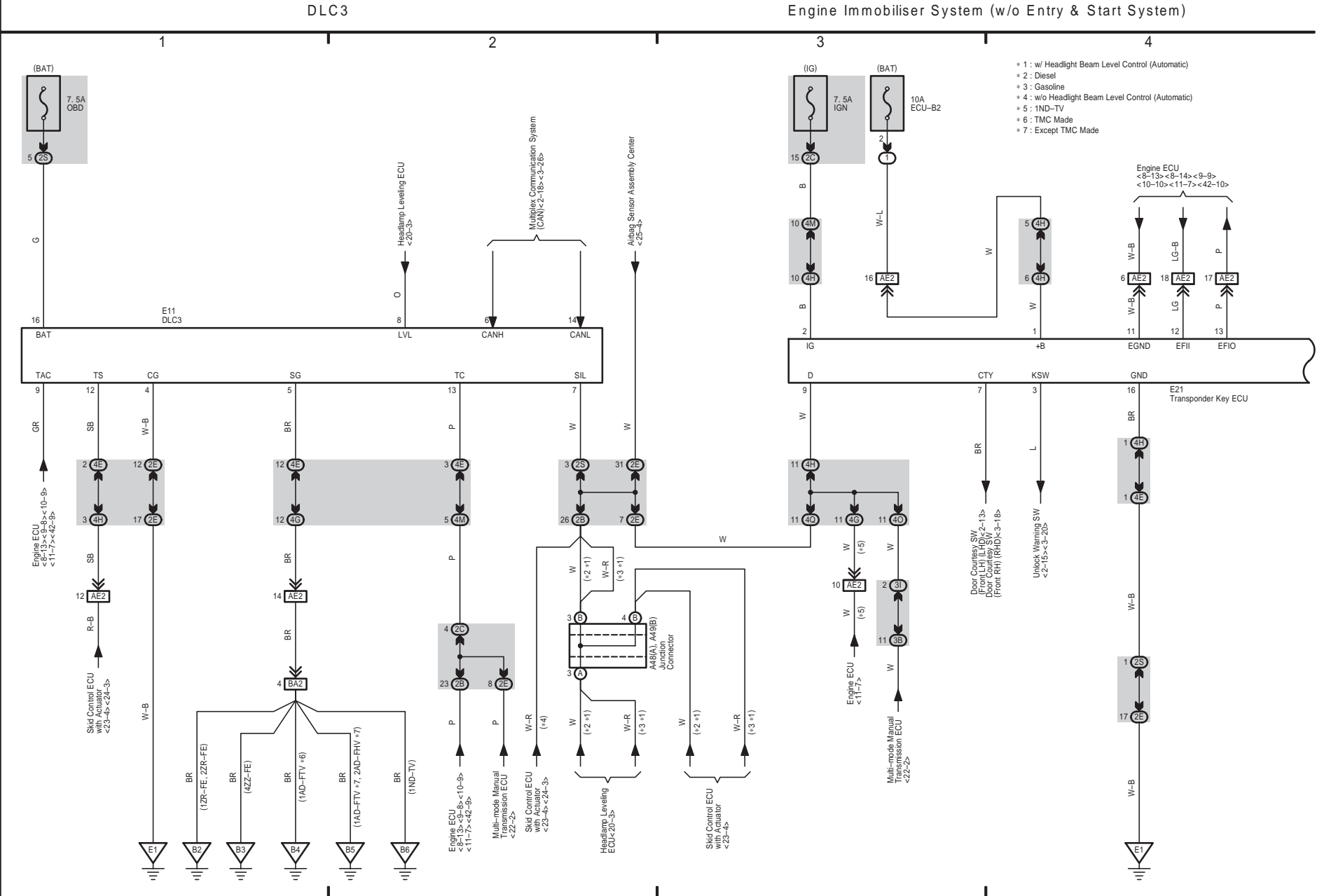

Engine Immobiliser System (w/o Entry & Start System)

• 8 : H/B Automatic A/C  
 • 9 : S/D, H/B Except Automatic A/C

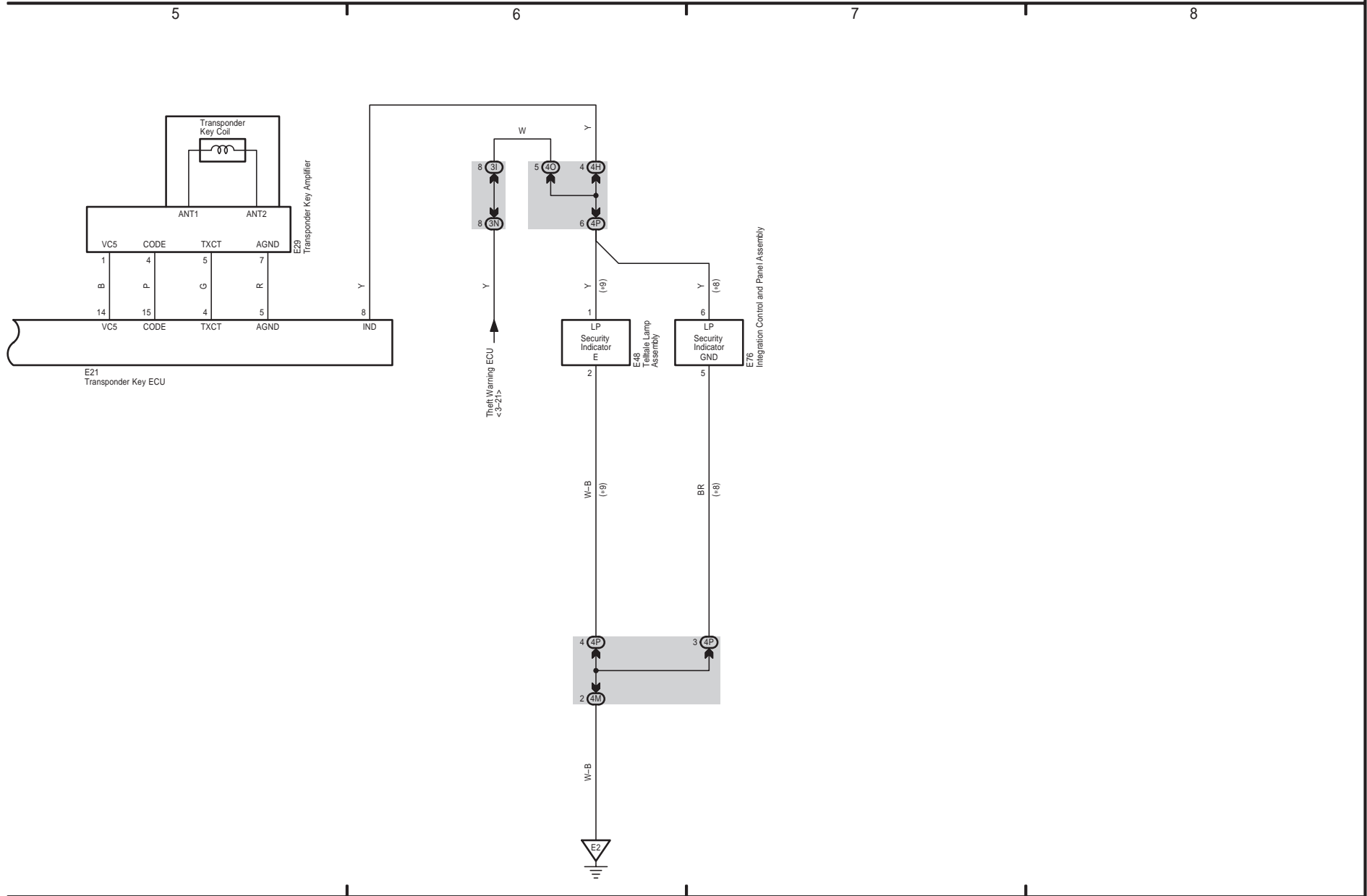

Headlight (w/o Automatic Light Control w/o Daytime Running Light)

- \* 1 : HID Type
- \* 2 : Except HID Type
- \* 3 : 1AD-FTV, 2AD-FHV
- \* 4 : Except \*3
- \* 5 : w/ PTC Heater

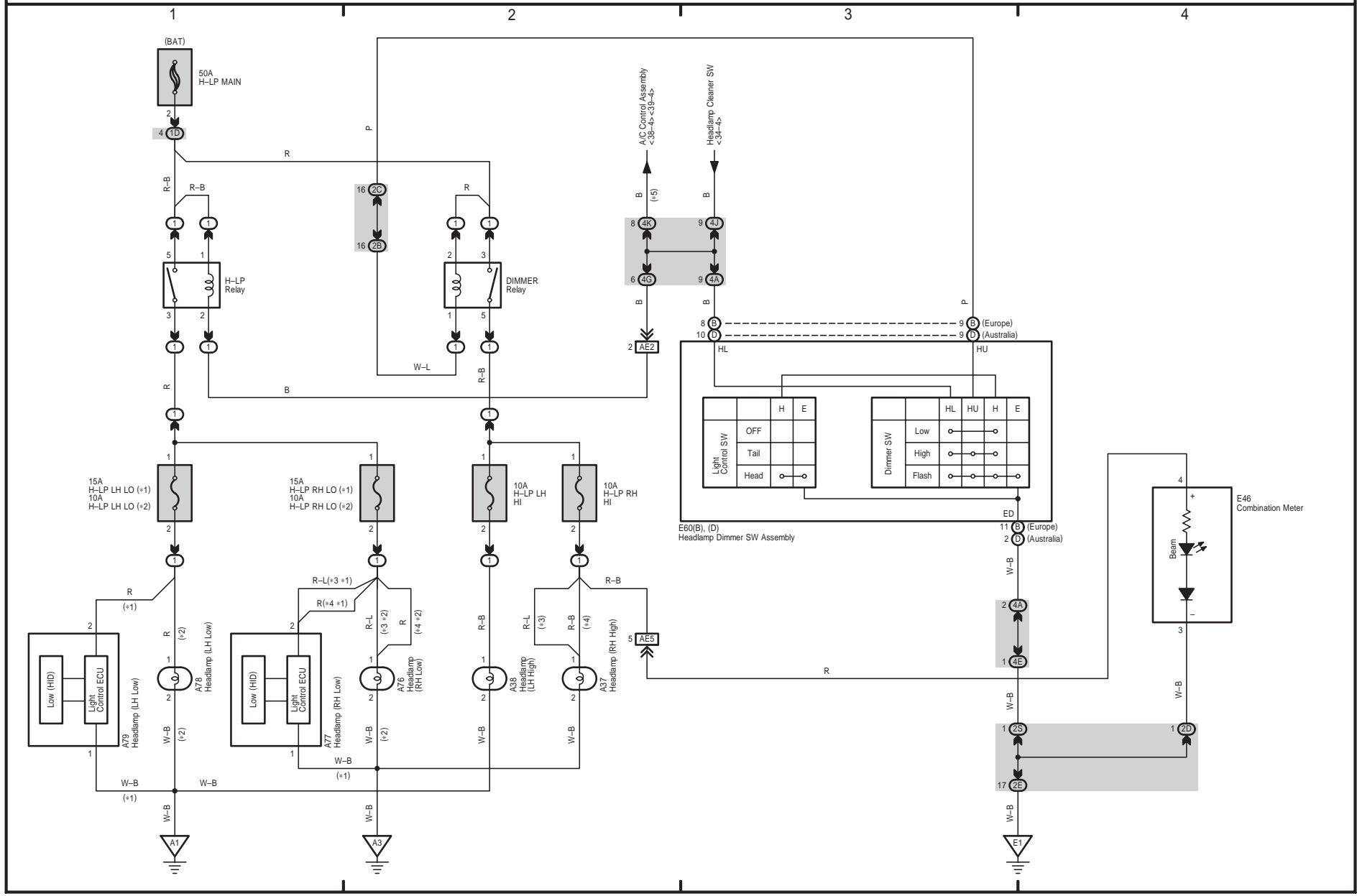

Turn Signal and Hazard Warning Light (LHD)

\* 1 : w/ Automatic Light Control, w/ Daytime Running Light  
 \* 2 : Except \*1

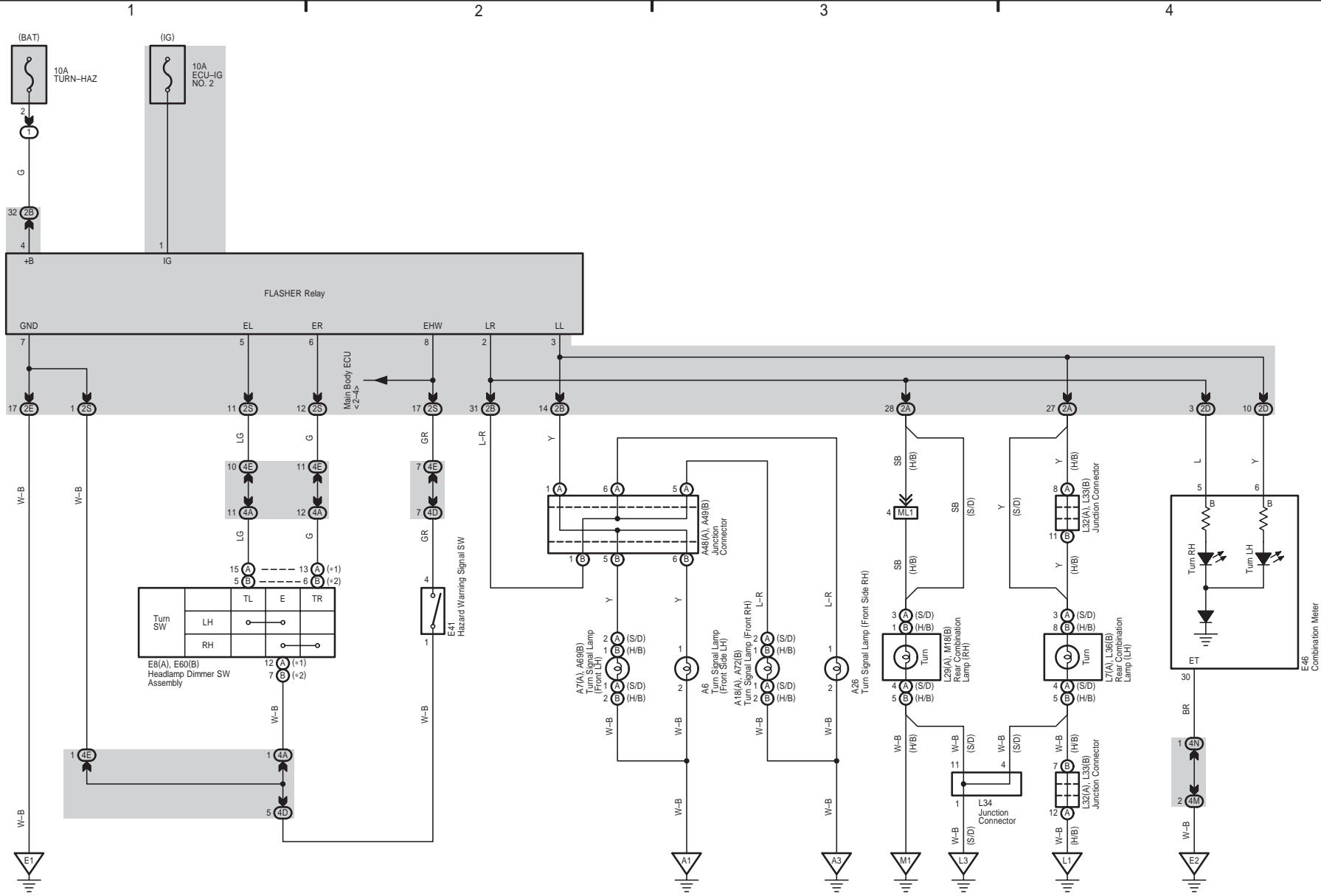

COROLLA / AURIS (EM04F1E)



15 COROLLA / AURIS

Turn Signal and Hazard Warning Light (RHD)

\* 1 : w/ Automatic Light Control  
\* 2 : Except \*1

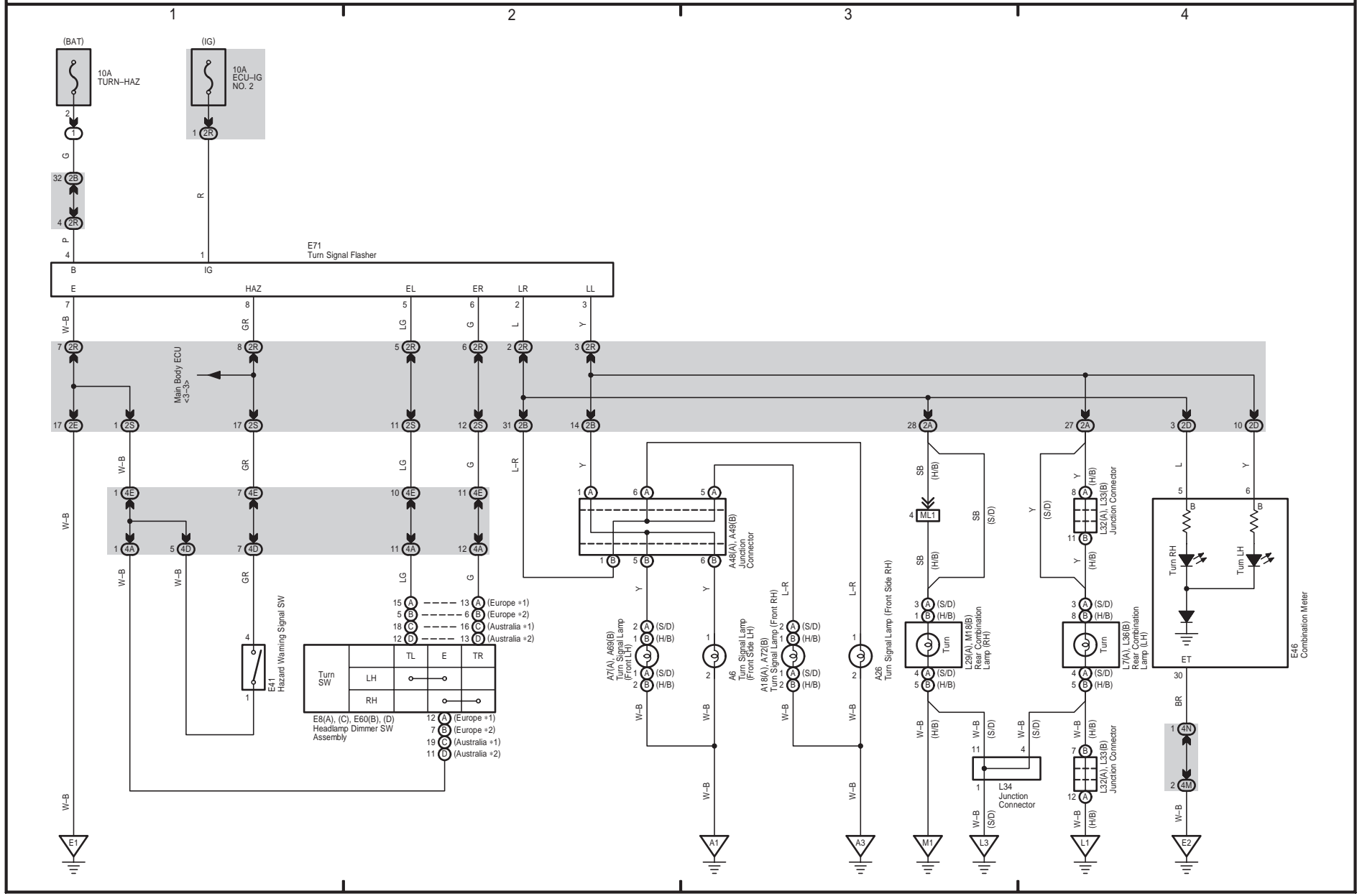

Taillight and Illumination

- \* 1 : w/ Automatic Light Control, w/ Daytime Running Light
- \* 2 : Except +1
- \* 3 : w/ Entry & Start System +2
- \* 4 : w/ Daytime Running Light
- \* 5 : w/o Daytime Running Light
- \* 8 : Except TMC Made
- \* 9 : TMC Made
- \* 10 : w/ Automatic Light Control

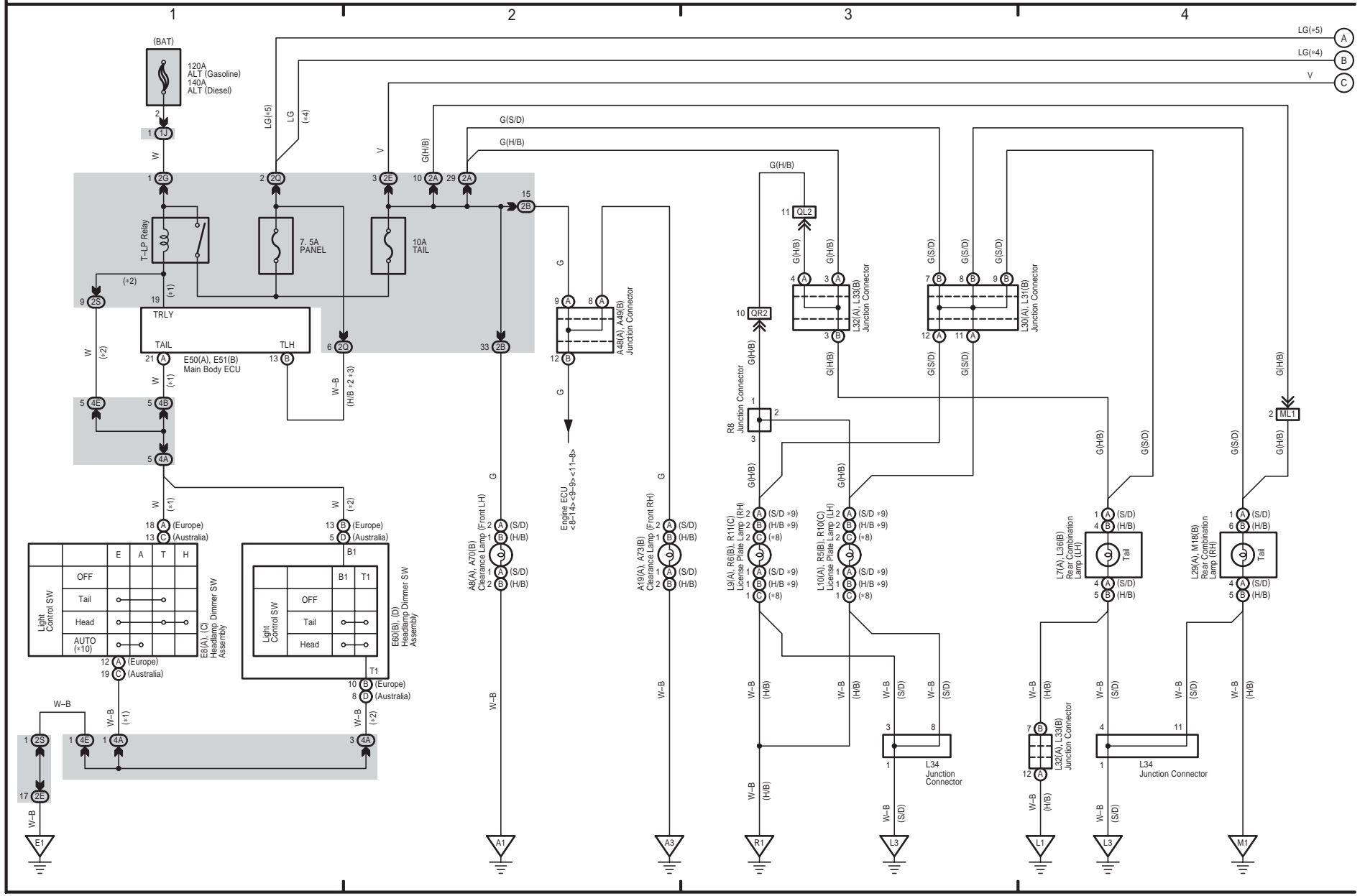

Taillight and Illumination

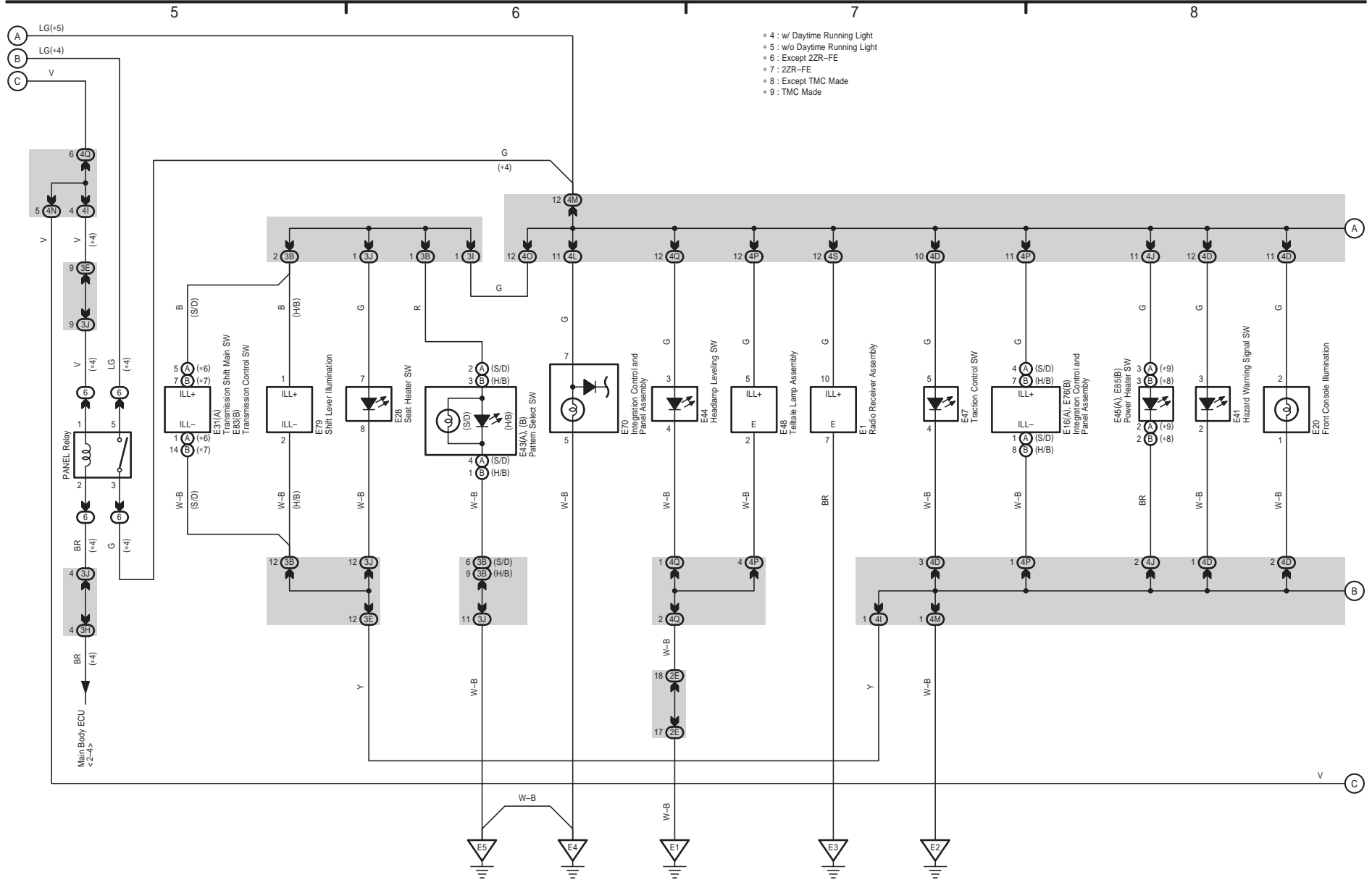

- \* 4 : w/ Daytime Running Light
- \* 5 : w/o Daytime Running Light
- \* 6 : Except 2ZR-FE
- \* 7 : 2ZR-FE
- \* 8 : Except TMC Made
- \* 9 : TMC Made

COROLLA / AURIS (EM04F1E)





16 COROLLA / AURIS (Cont' d)

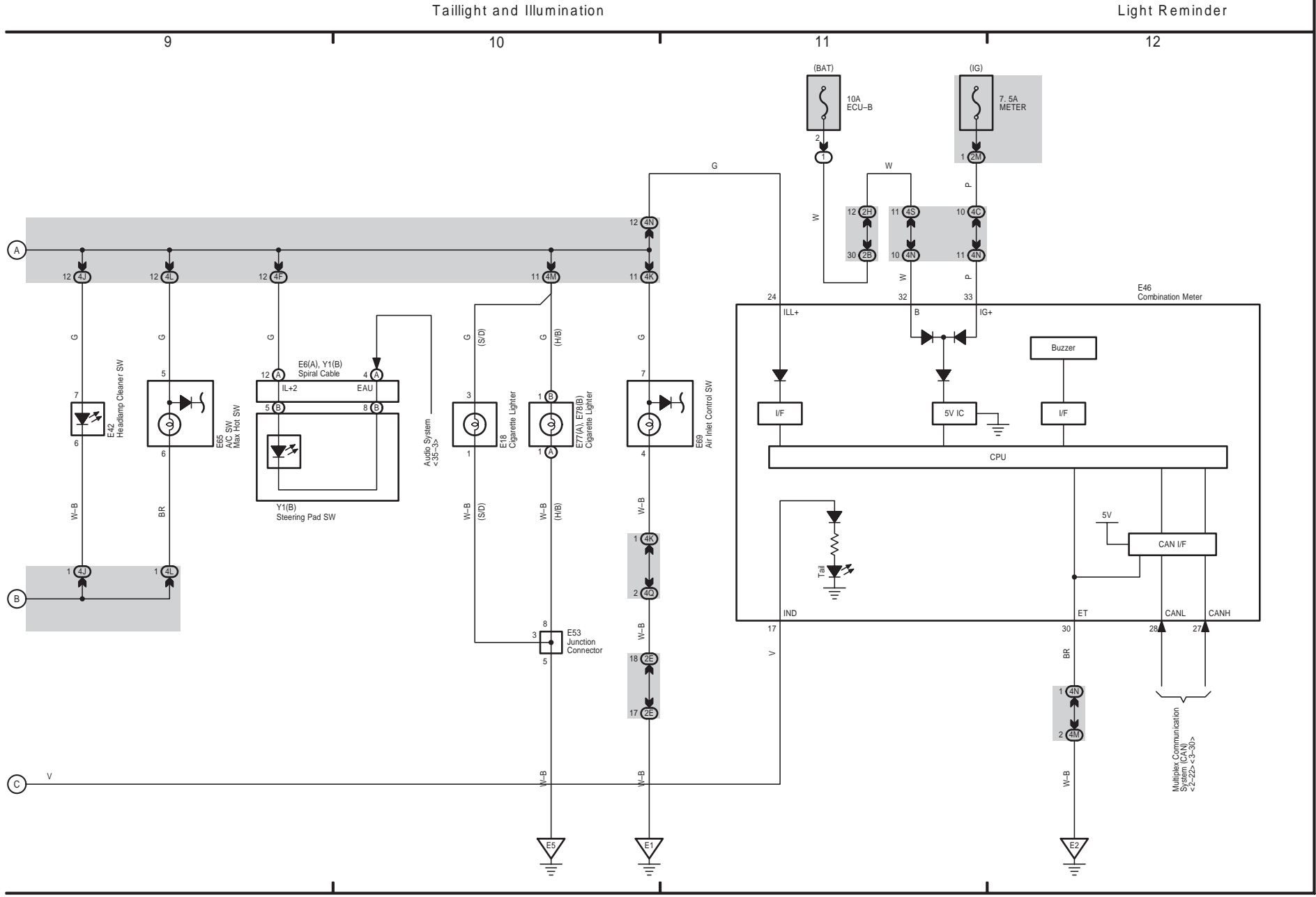

Stop Light

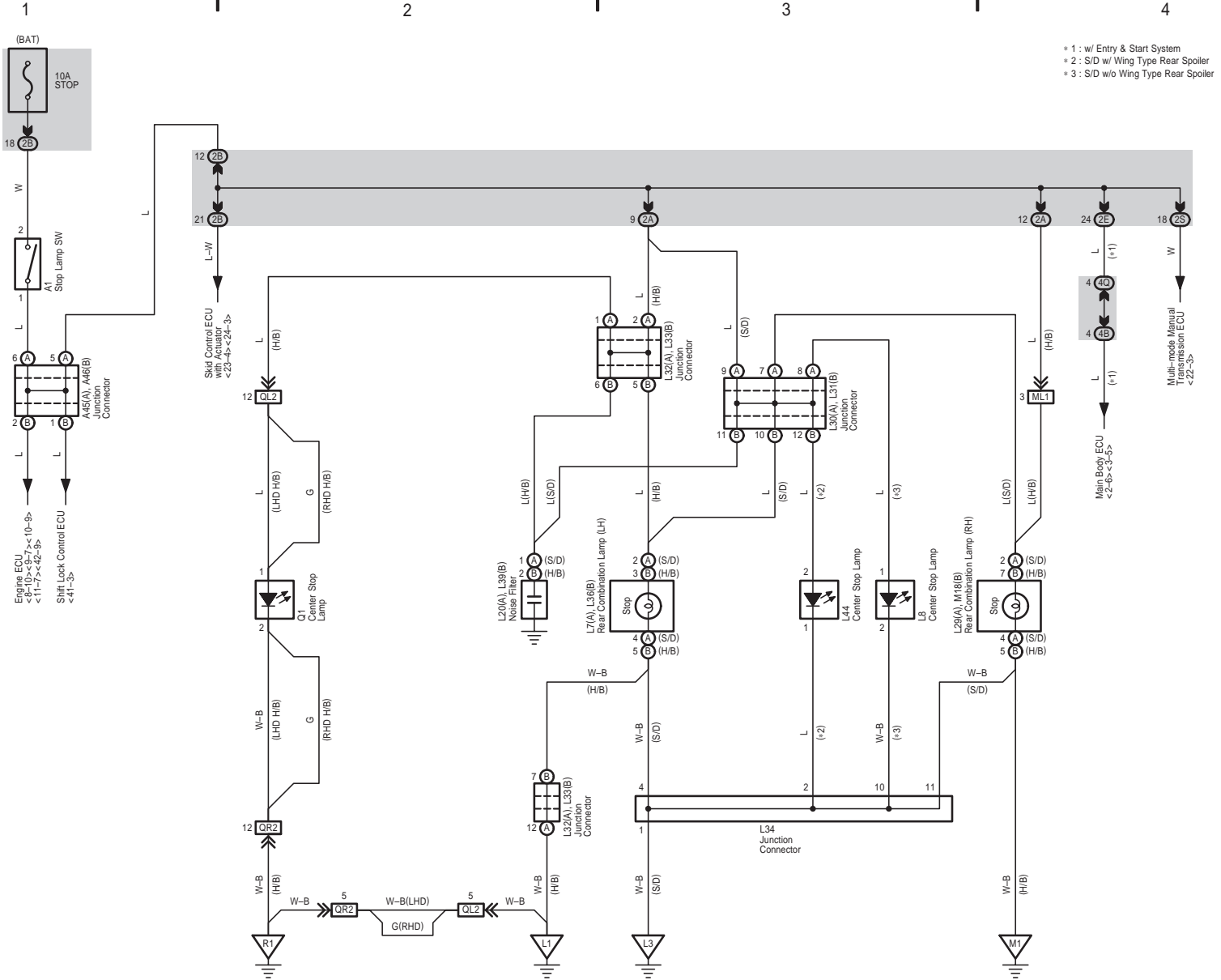

- \* 1 : w/ Entry & Start System
- \* 2 : S/D w/ Wing Type Rear Spoiler
- \* 3 : S/D w/o Wing Type Rear Spoiler



18 COROLLA / AURIS

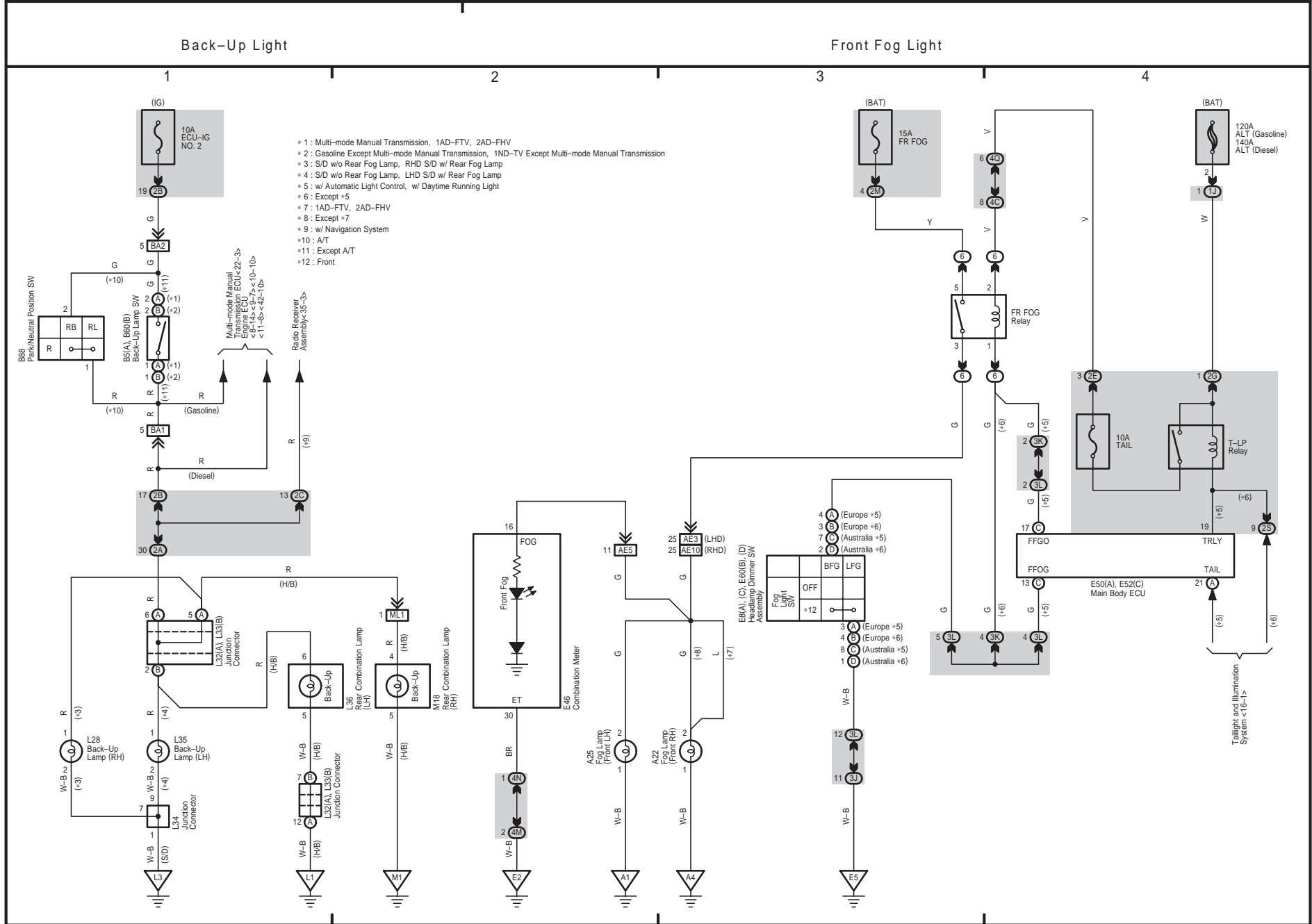

Rear Fog Light

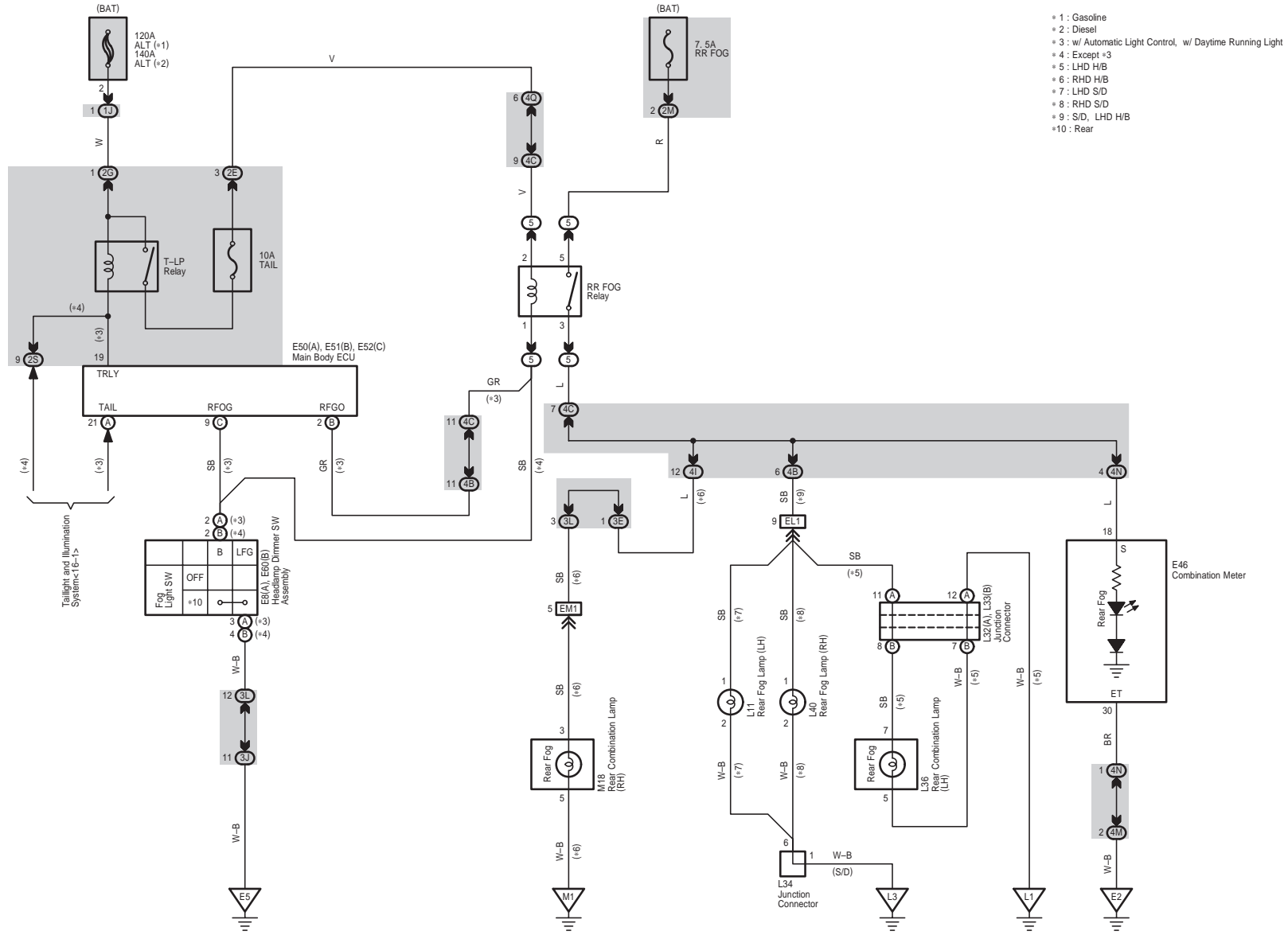

- \* 1 : Gasoline
- \* 2 : Diesel
- \* 3 : w/ Automatic Light Control, w/ Daytime Running Light
- \* 4 : Except +3
- \* 5 : LHD H/B
- \* 6 : RHD H/B
- \* 7 : LHD S/D
- \* 8 : RHD S/D
- \* 9 : S/D, LHD H/B
- \* 10 : Rear



20 COROLLA / AURIS

Headlight Beam Level Control (Automatic)

\* 1 : Diesel  
\* 2 : Gasoline

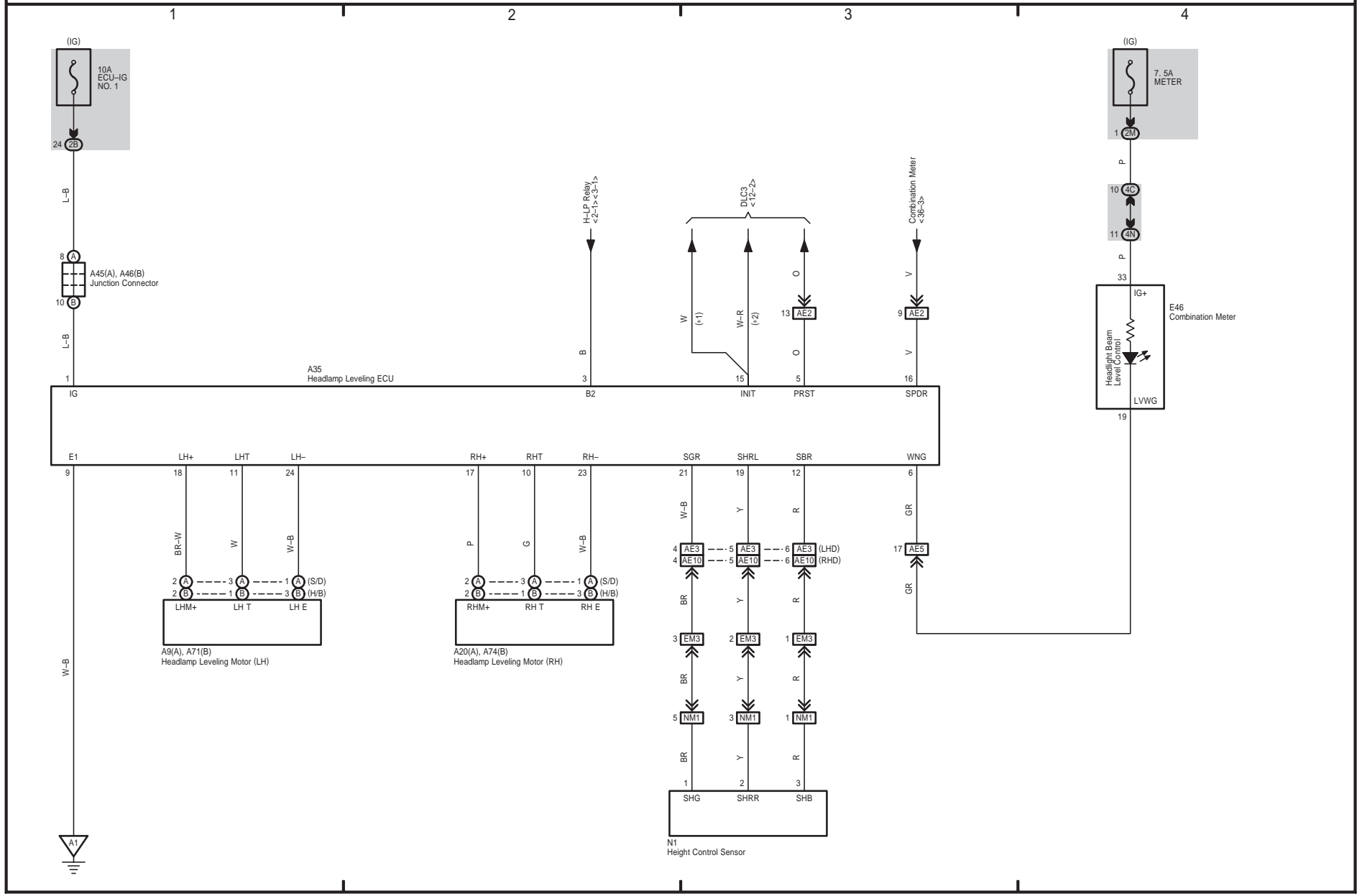

Headlight Beam Level Control (Manual)

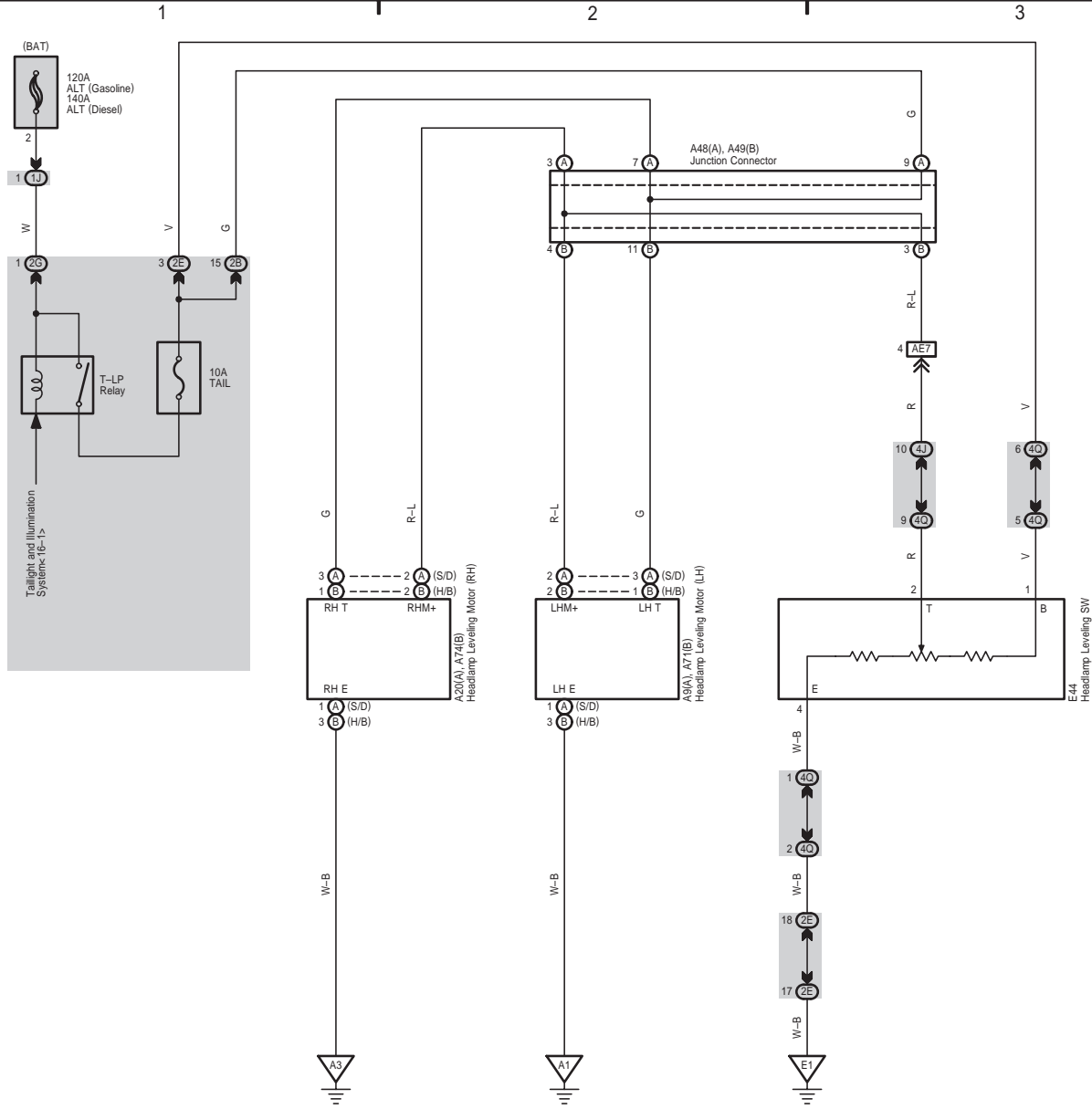

COROLLA / AURIS (EM04F1E)



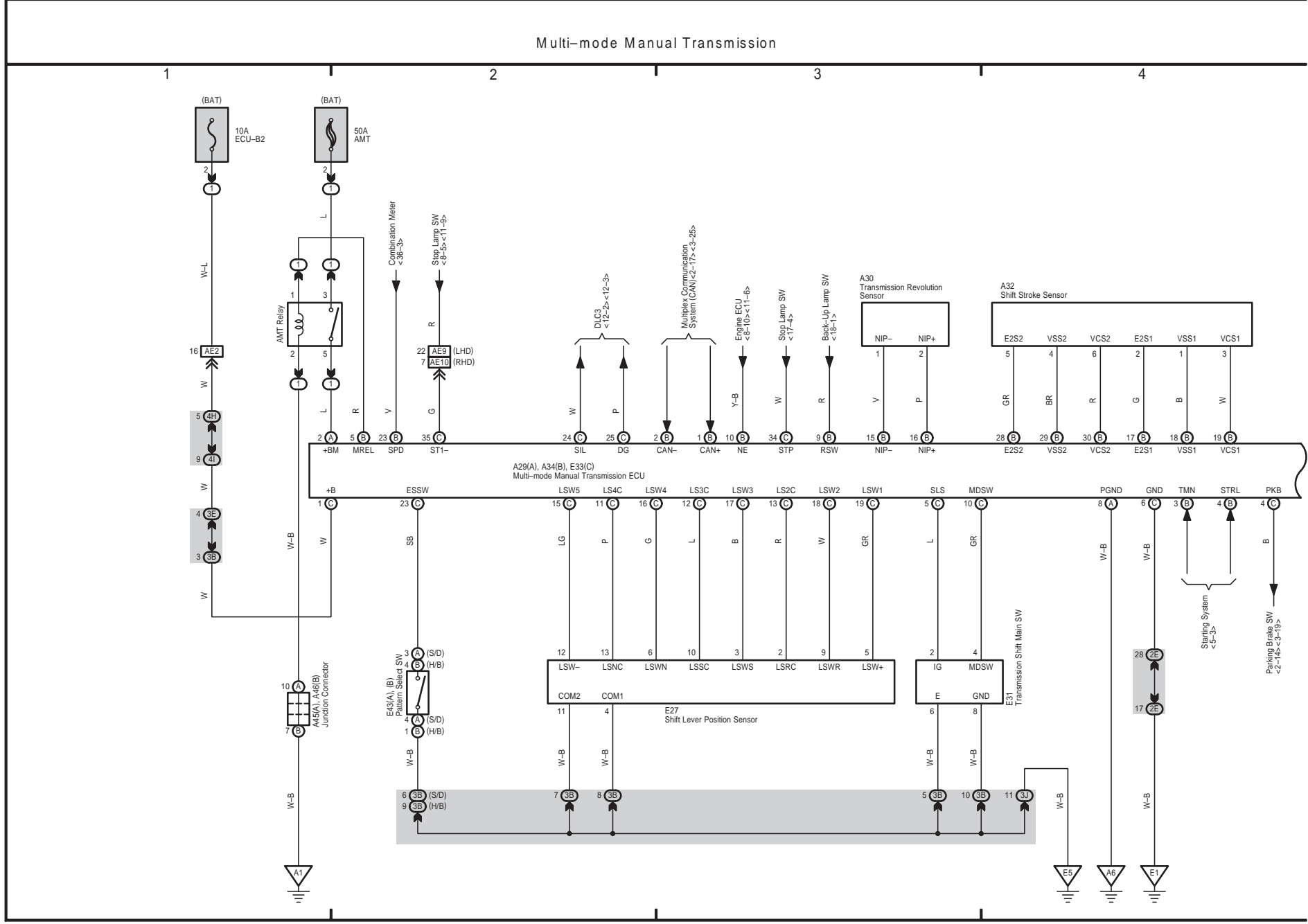

Multi-mode Manual Transmission

- \* 1 : Optitron Meter
- \* 2 : w/ Entry & Start System
- \* 3 : w/o Entry & Start System
- \* 4 : TMC Made
- \* 5 : Except TMC Made
- \* 6 : 1ZR-FE, 2ZR-FE

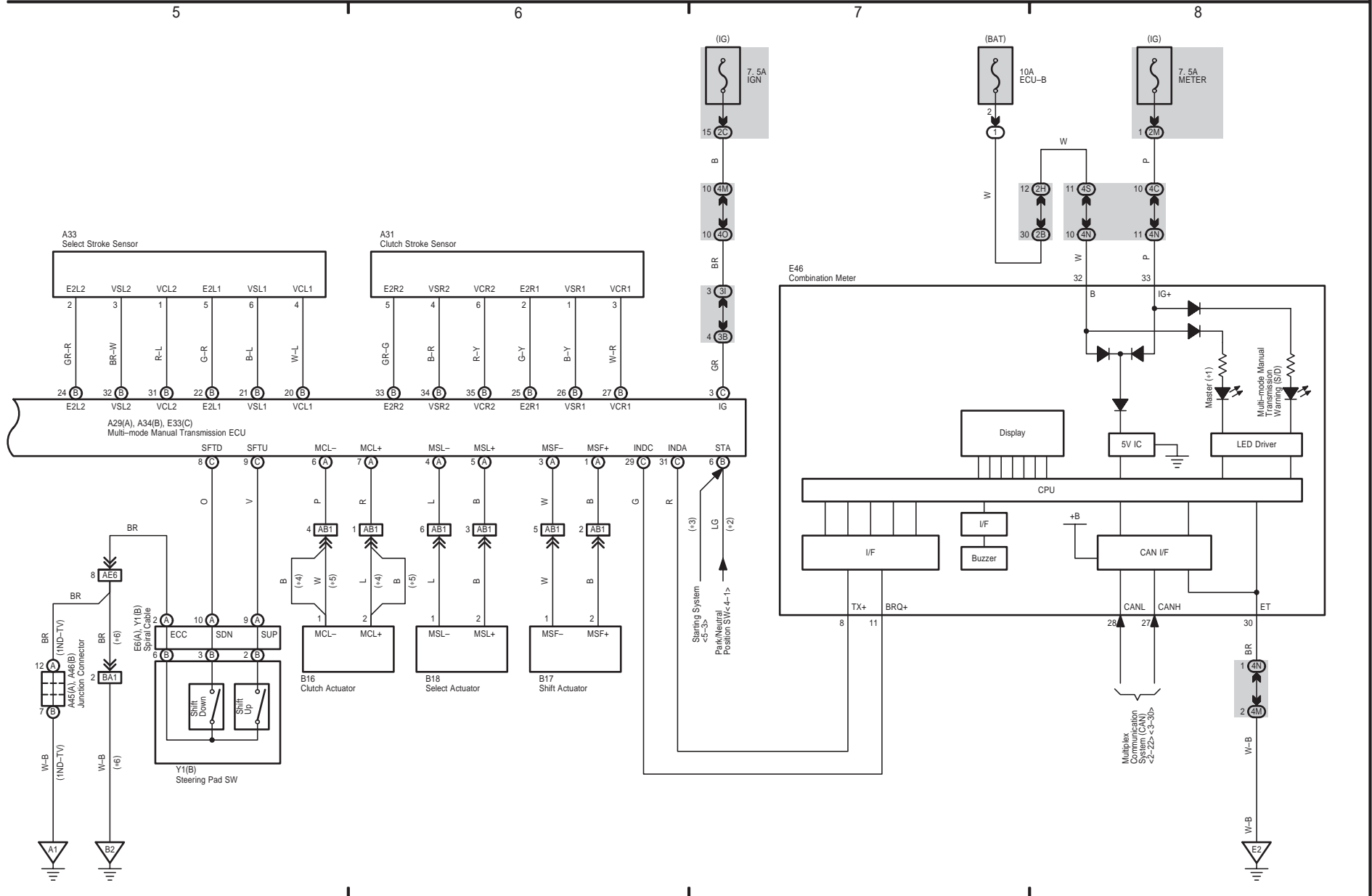

COROLLA / AURIS (EM04F1E)





ABS (w/ VSC), TRC and VSC

- \* 1 : Gasoline
- \* 2 : Diesel
- \* 3 : 1AD-FTV, 2AD-FHV
- \* 4 : Except +3
- \* 7 : TMC Made
- \* 8 : Except TMC Made
- \* 9 : Diesel w/ Headlight Beam Level Control (Automatic)
- \* 10 : Except +9
- \* 11 : TMC Made Gasoline
- \* 12 : Except +11

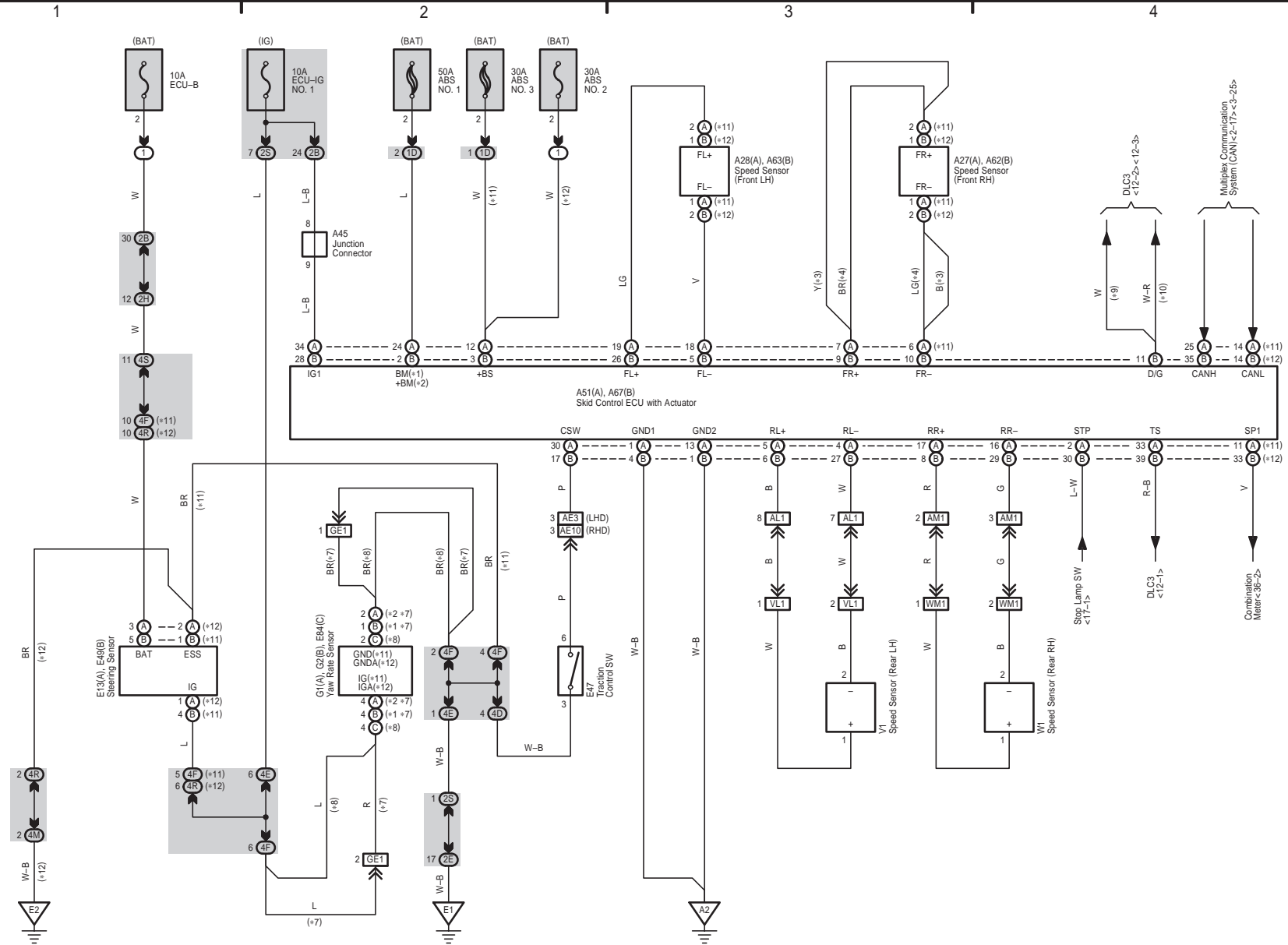

ABS (w/ VSC), TRC and VSC

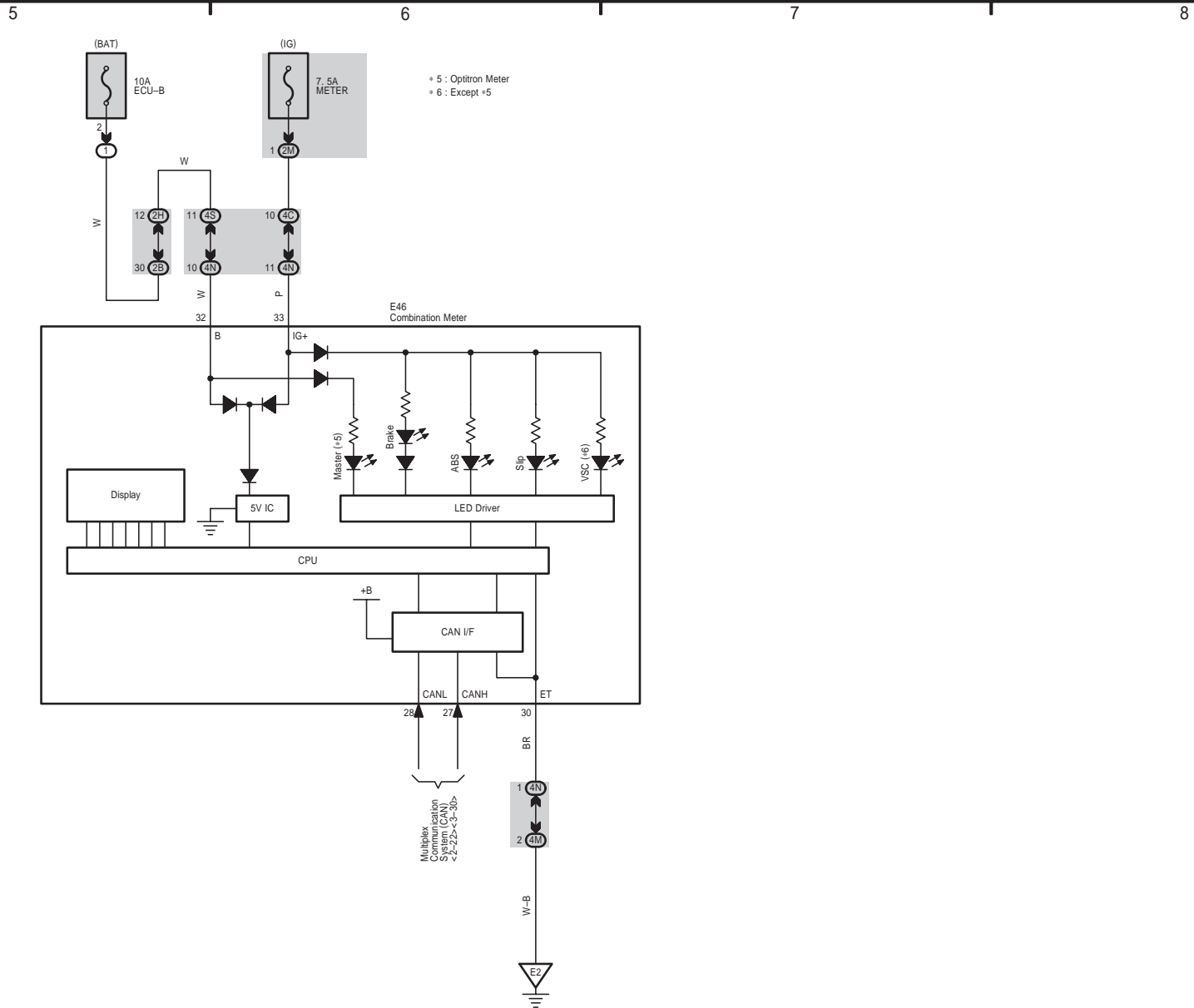

COROLLA / AURIS (EM04F1E)

24 COROLLA / AURIS

ABS (w/o VSC)

- \* 1 : TMC Made Gasoline
- \* 2 : Except #1
- \* 3 : 1AD-FTV, 2AD-FHV
- \* 4 : Except #3

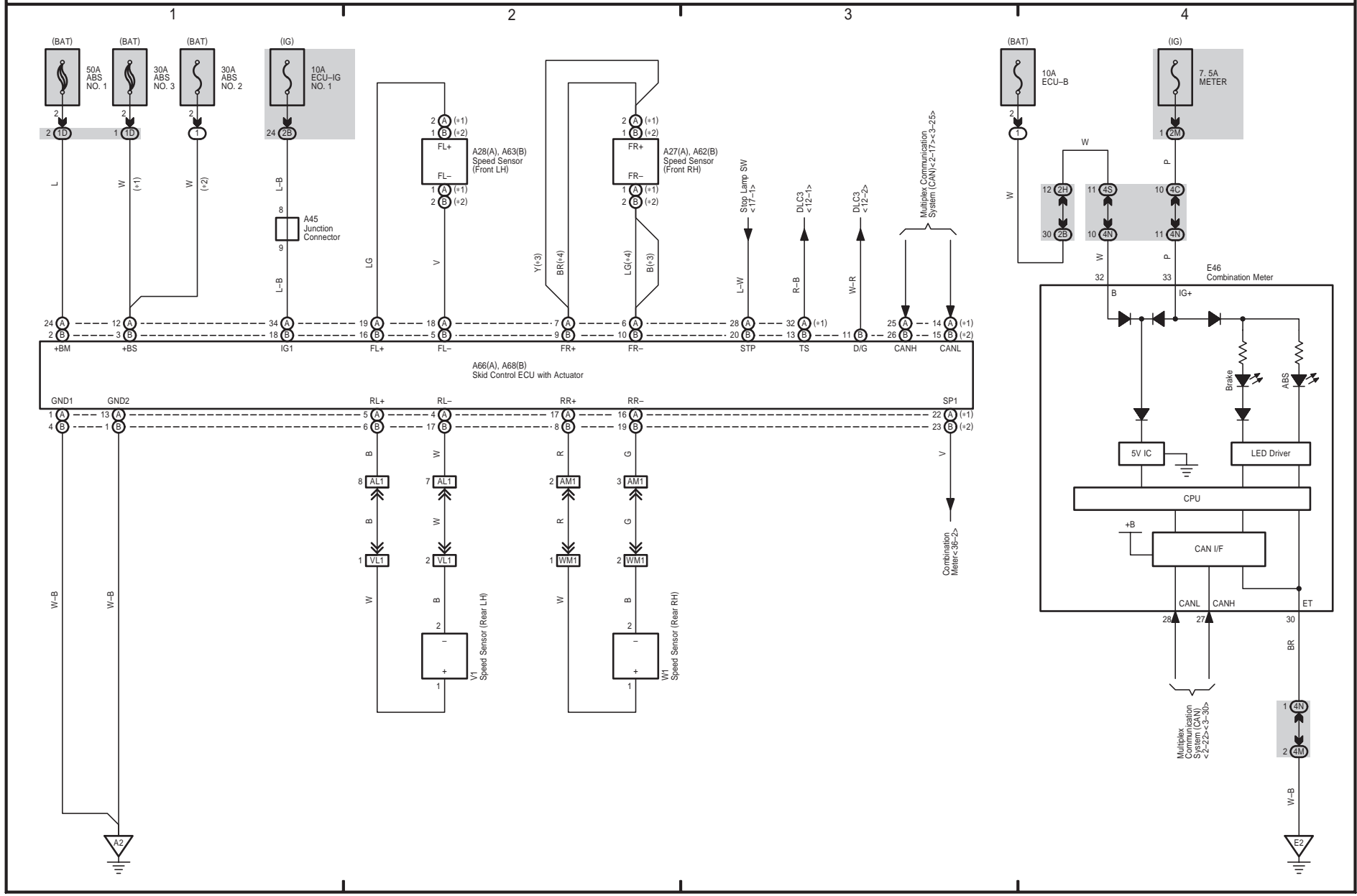

SRS

- \* 1 : w/ Side Airbag w/ Curtain Shield Airbag
- \* 2 : w/ Side Airbag w/o Curtain Shield Airbag
- \* 3 : w/ Side Airbag

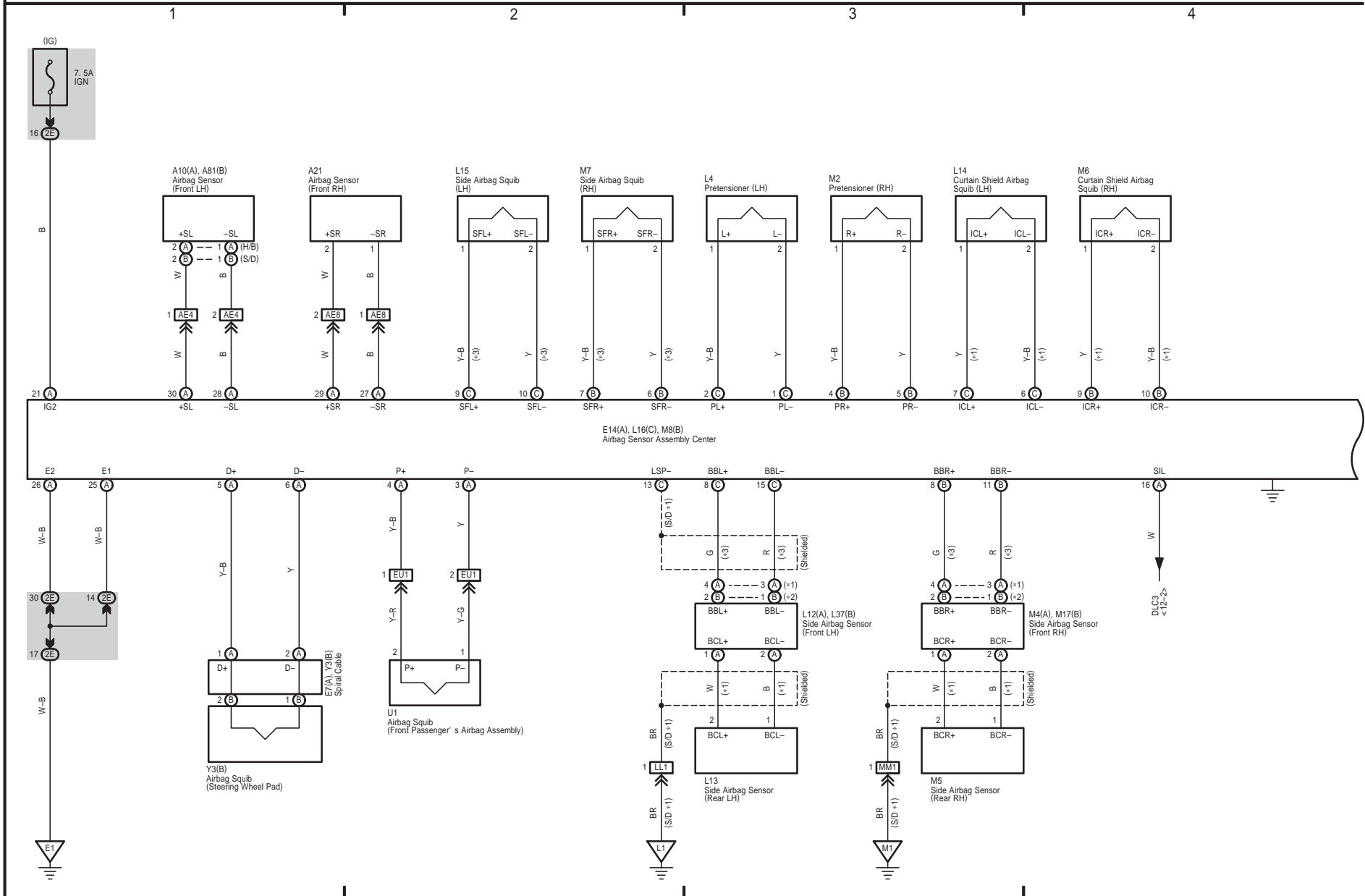

- 4 : H/B Automatic A/C
- 5 : S/D, H/B Manual A/C
- 6 : w/ Knee Airbag
- 7 : w/ Airbag Cut Off SW

COROLLA / AURIS (EM04F1E)

785

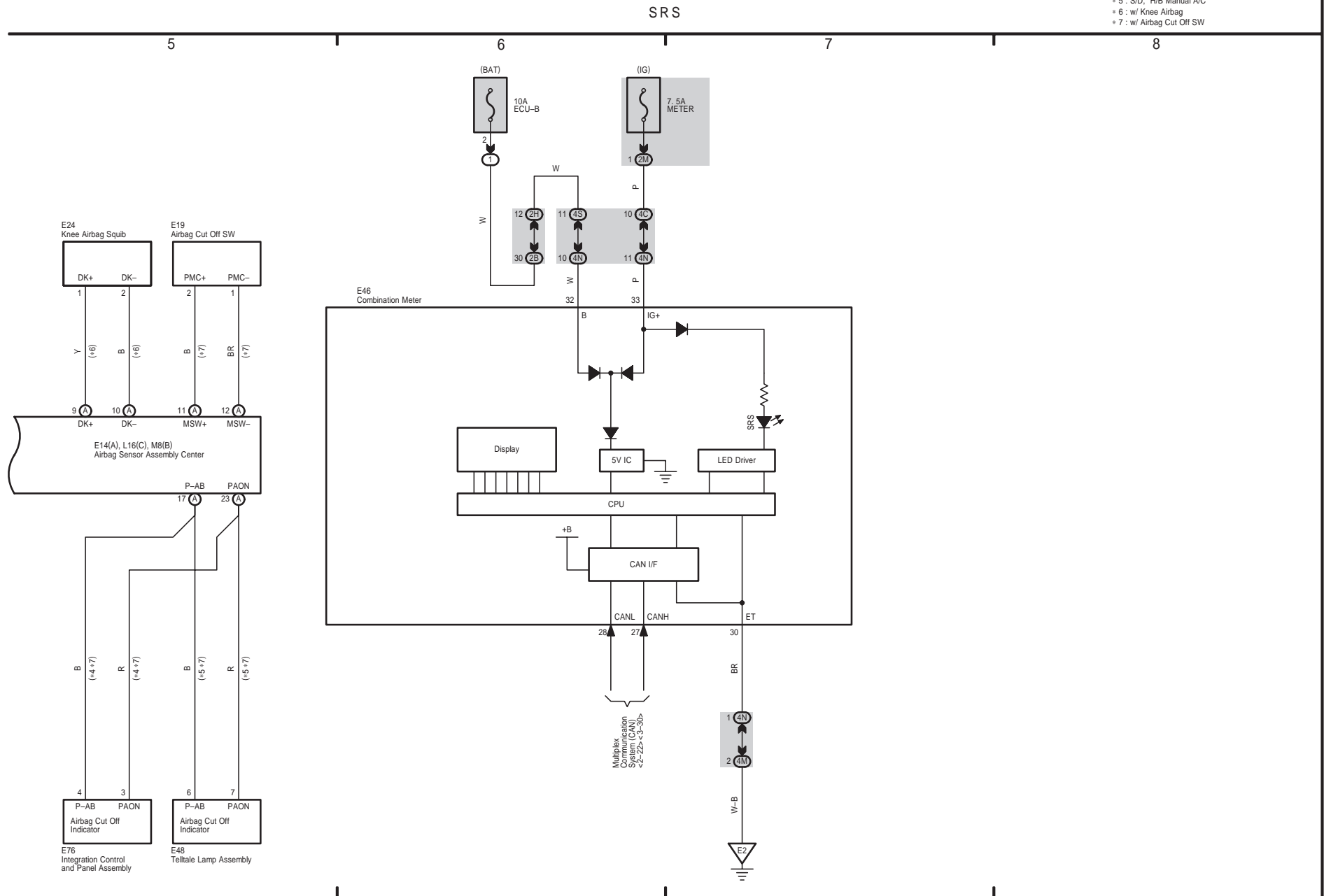

Power Window (LHD)

\* 1 : w/ Rear Power Window  
\* 2 : w/o Rear Power Window

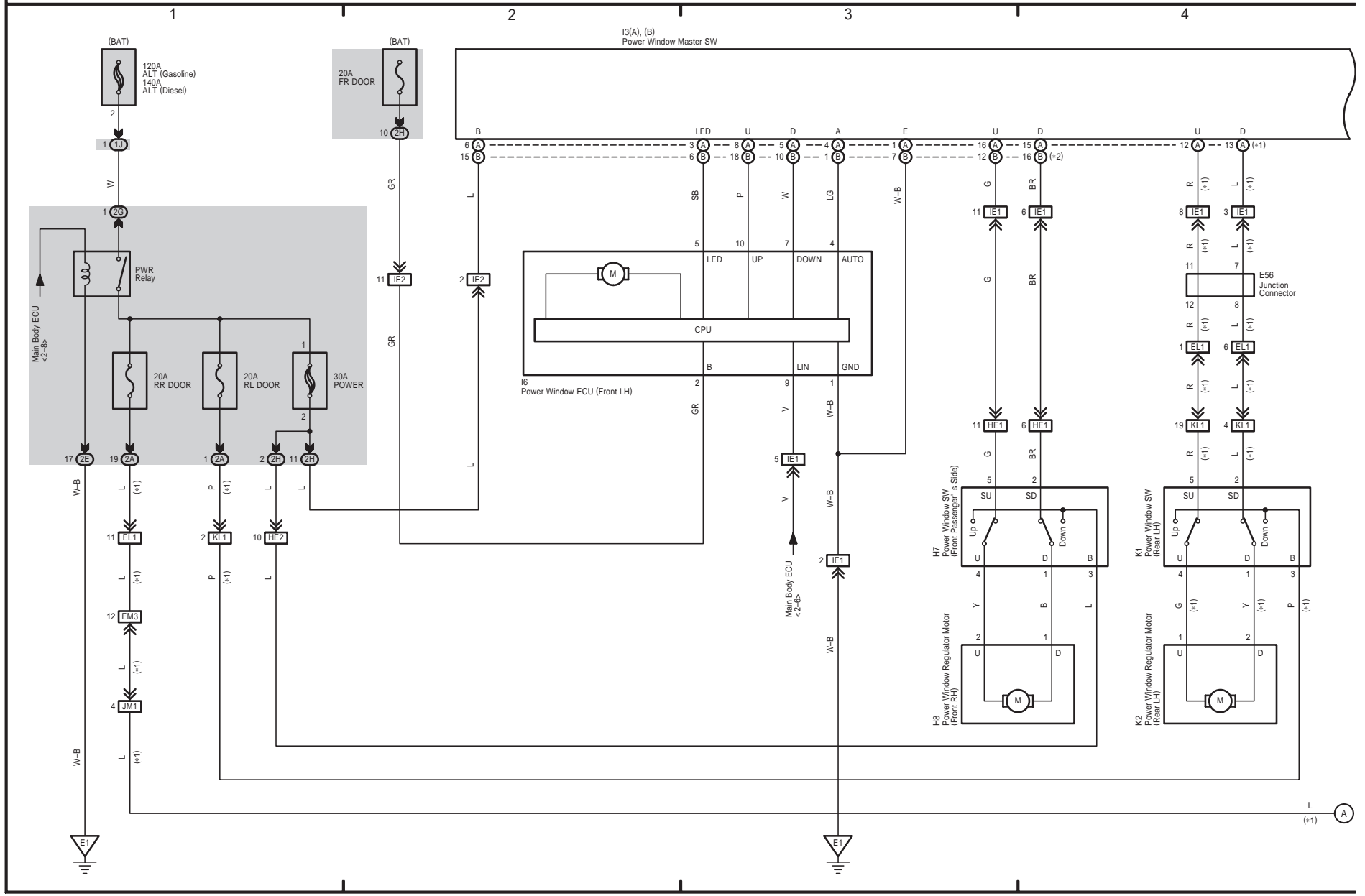

Power Window (LHD)

\* 1 : w/ Rear Power Window

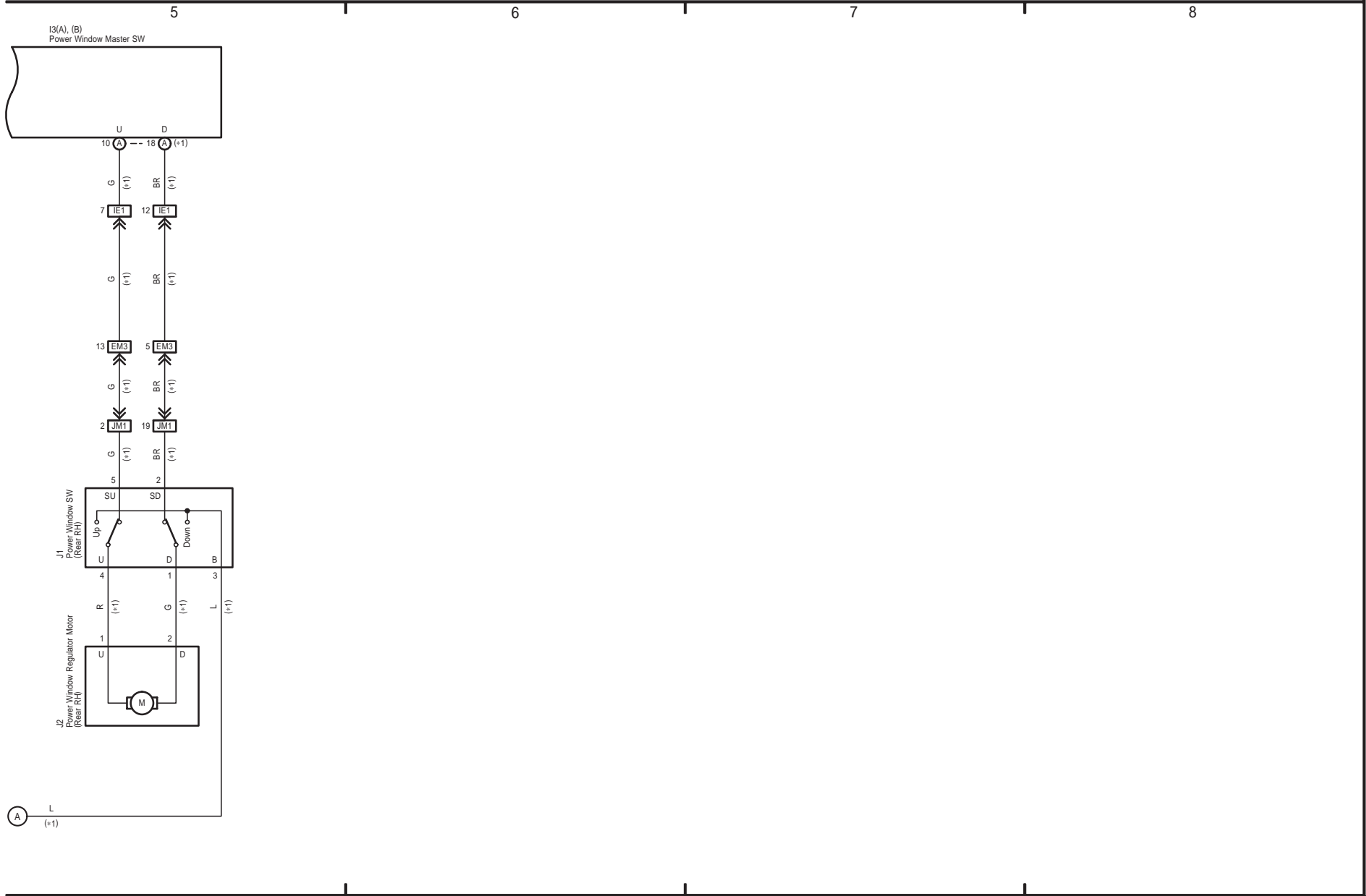

COROLLA / AURIS (EM04F1E)

Power Window (RHD)

\* 1 : w/ Rear Power Window  
\* 2 : w/o Rear Power Window

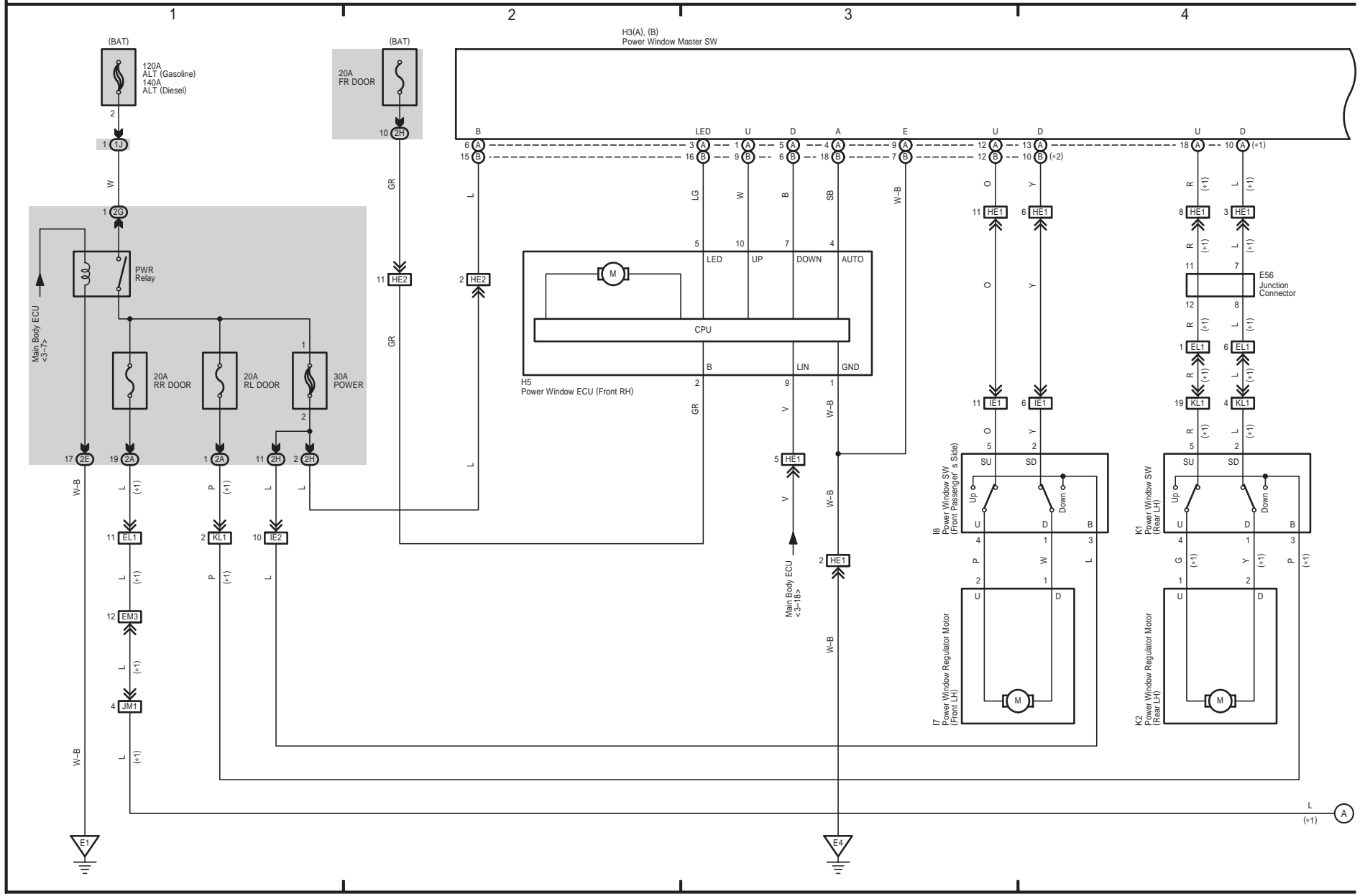



Power Window (RHD)

\* 1 : w/ Rear Power Window

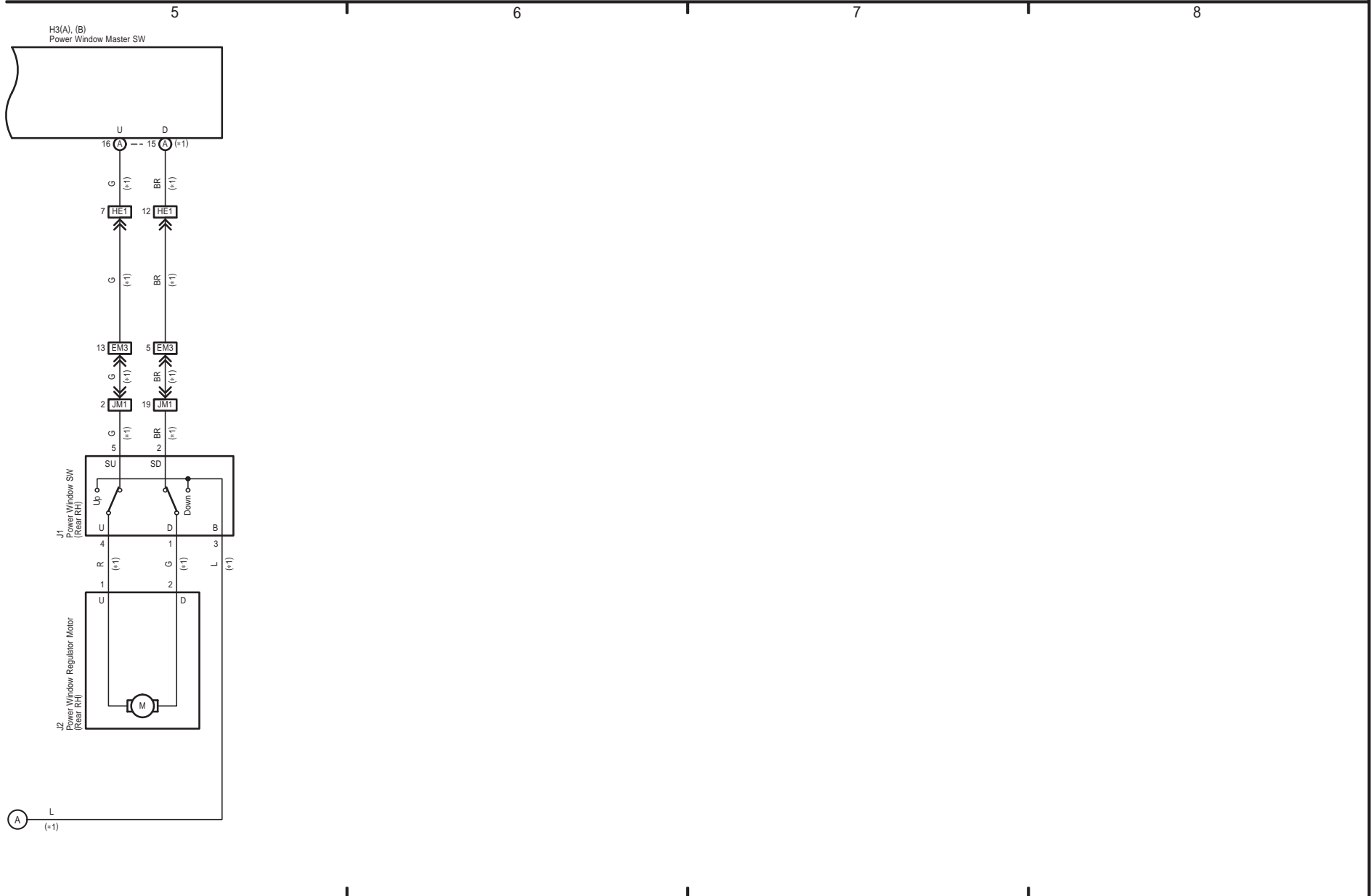

COROLLA / AURIS (EM04F1E)

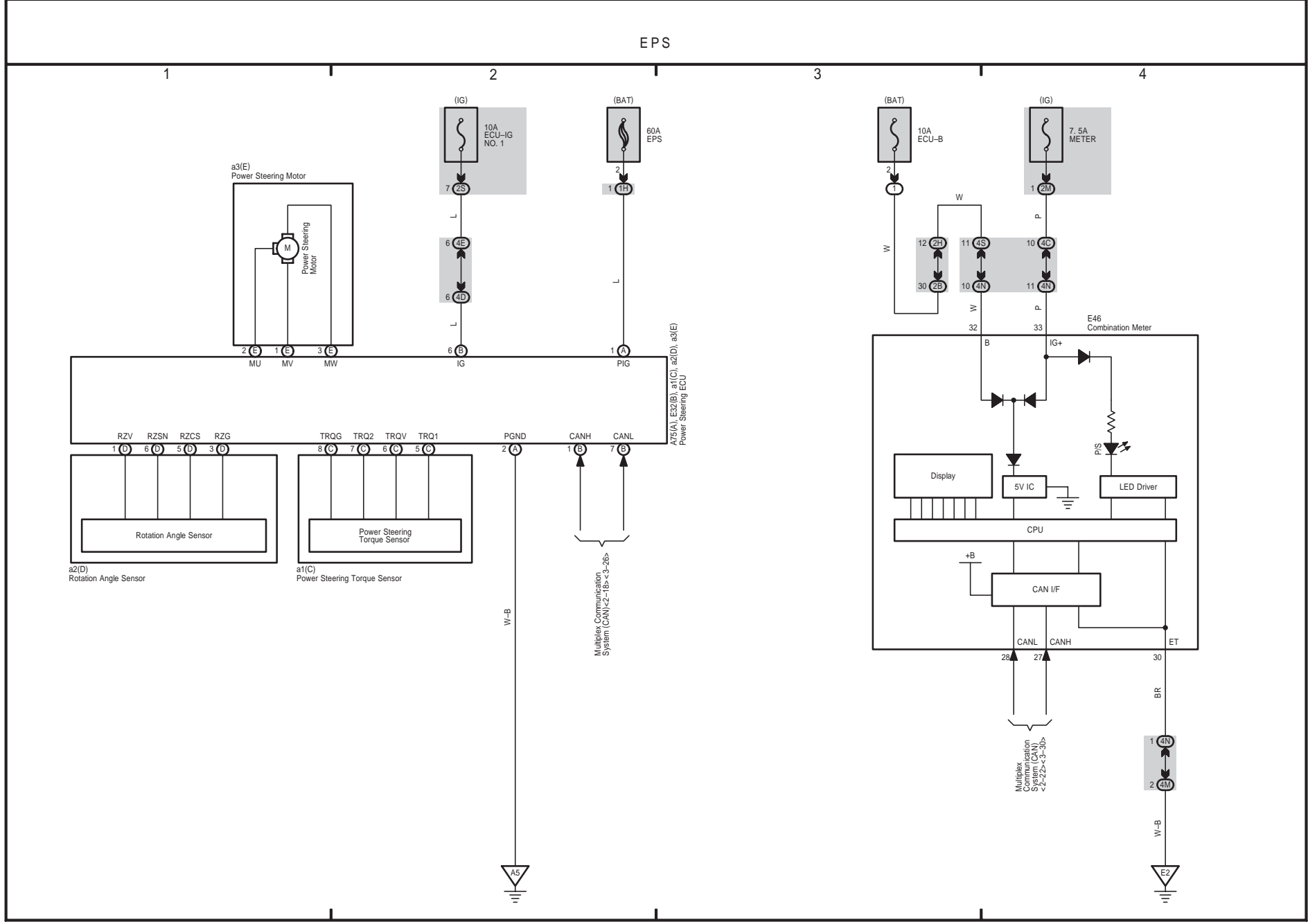

Front Wiper and Washer (w/ Auto Wiper System)

- \* 1 : LHD, RHD S/D
- \* 2 : RHD H/B

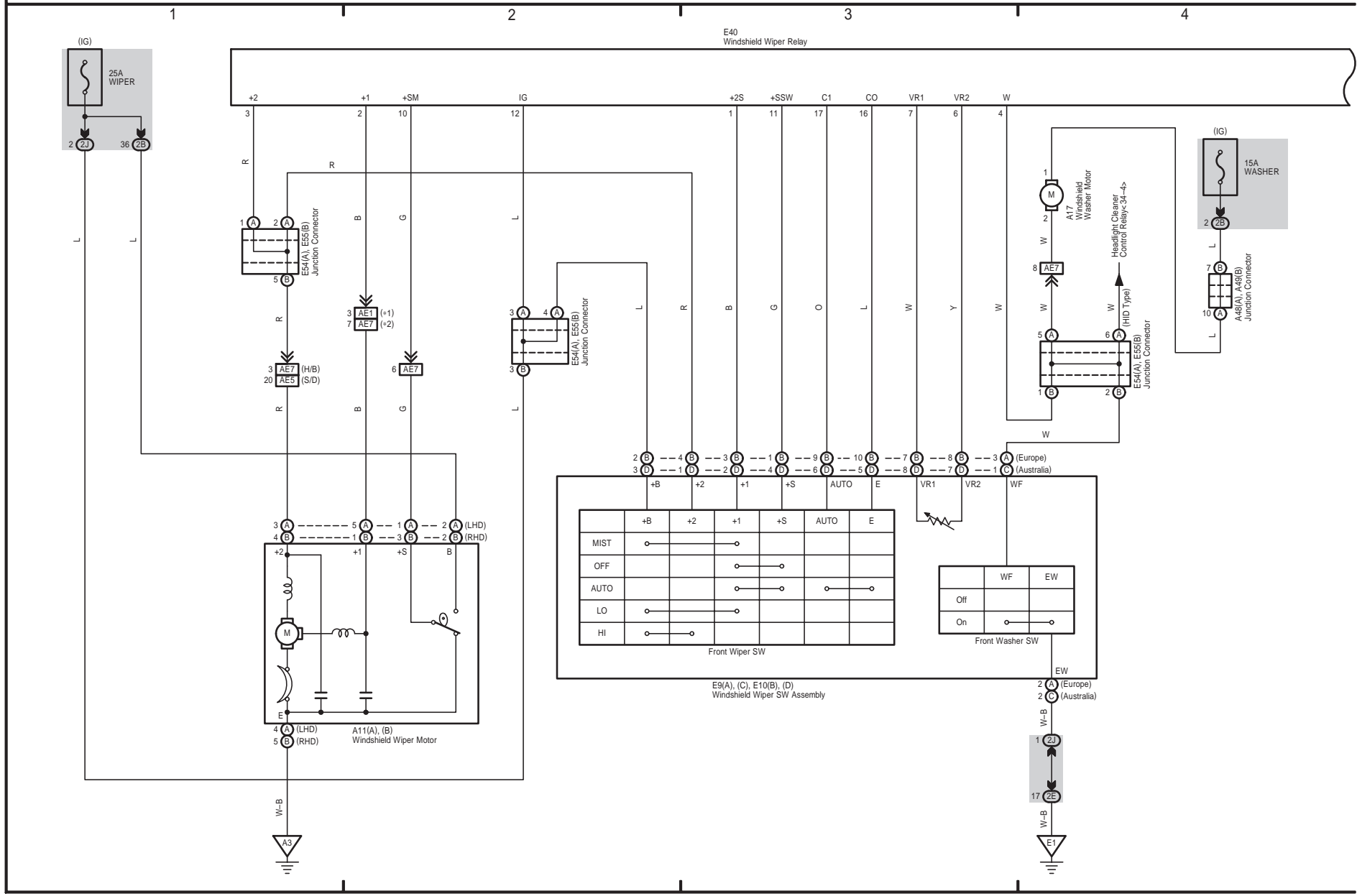

Front Wiper and Washer (w/ Auto Wiper System)

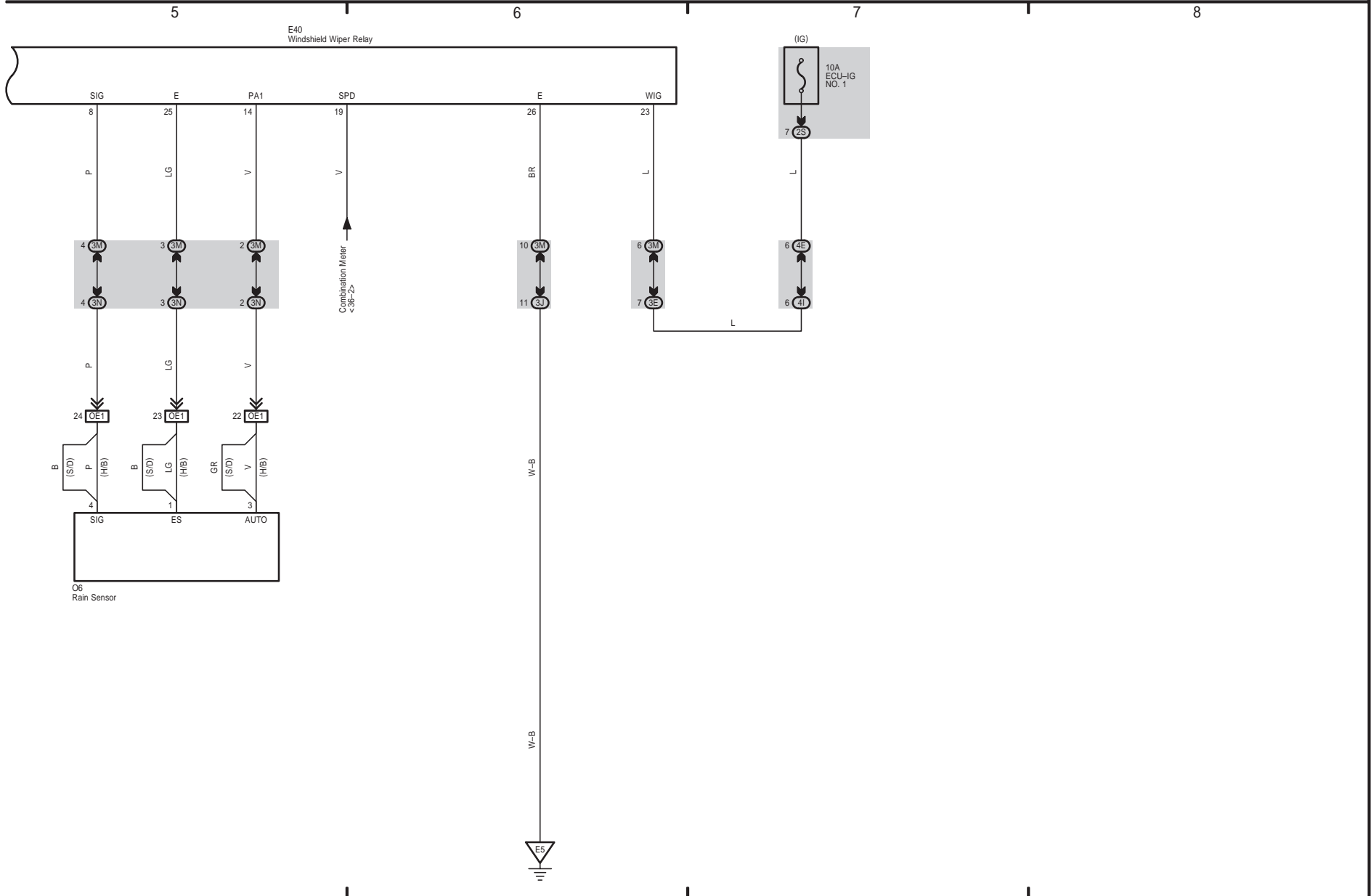

COROLLA / AURIS (EM04F1E)

30 COROLLA / AURIS

Front Wiper and Washer (w/o Auto Wiper System)

Rear Wiper and Washer

- \* 1 : S/D Australia, S/D Europe HID Type, H/B HID Type
- \* 2 : Except +1
- \* 3 : LHD, RHD S/D
- \* 4 : RHD H/B
- \* 5 : TMC Made
- \* 6 : Except TMC Made

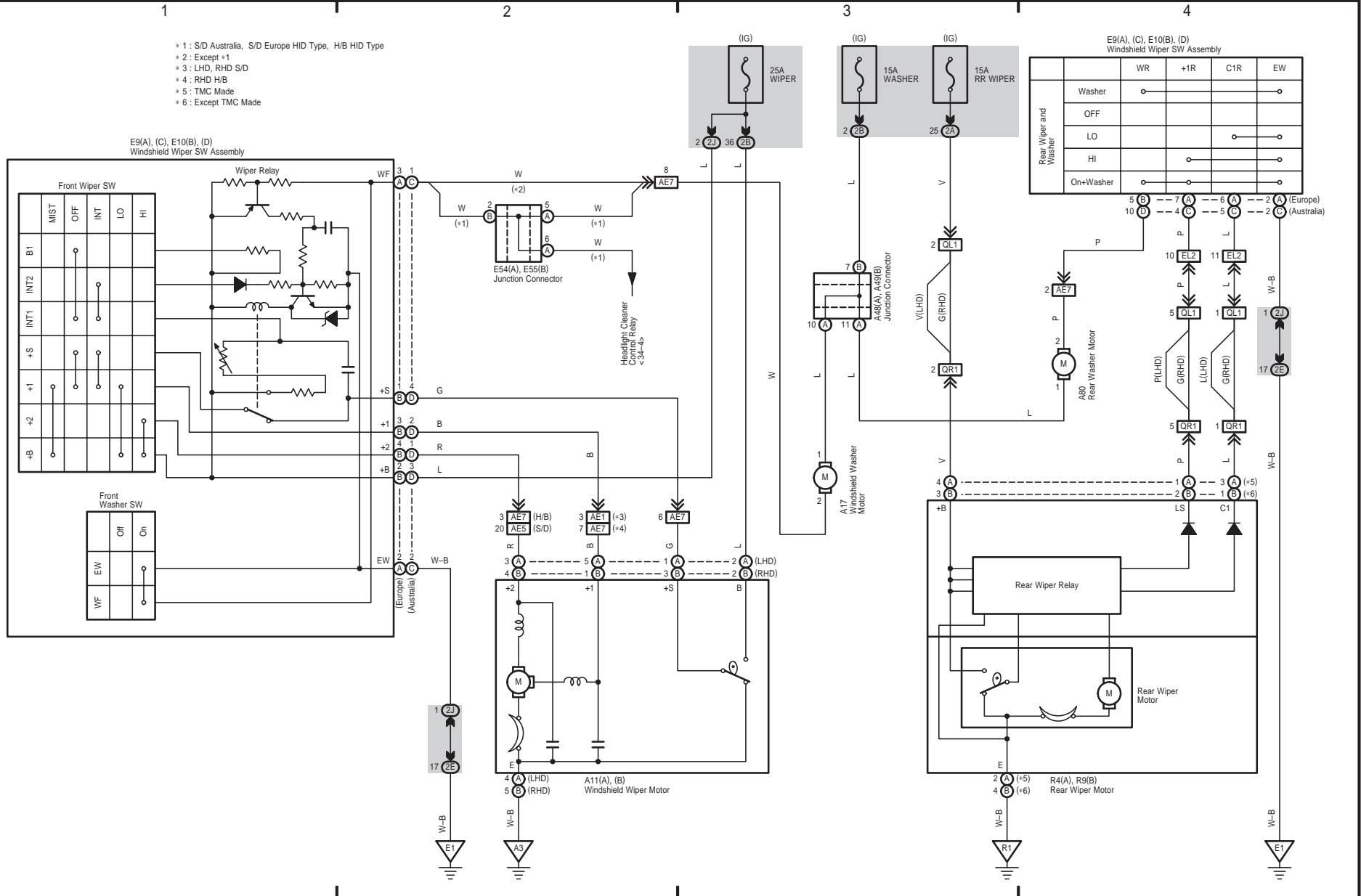

Horn

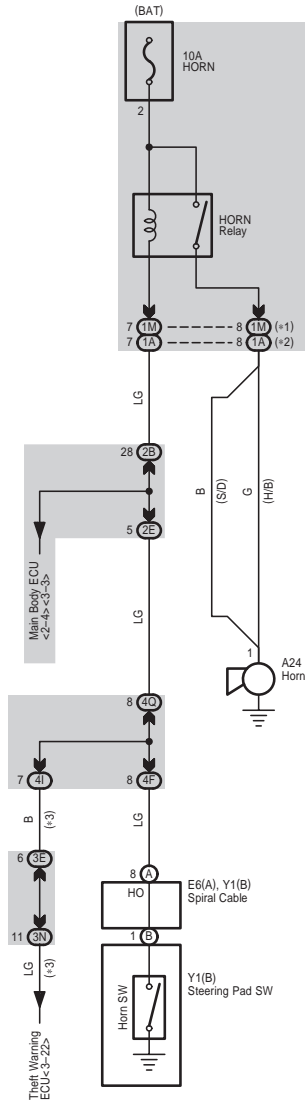

Automatic Glare-Resistant EC Mirror

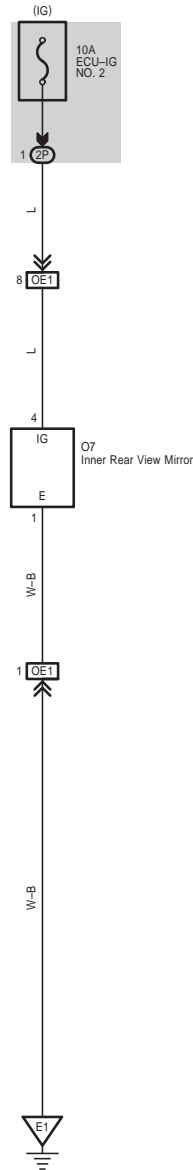

Remote Control Mirror

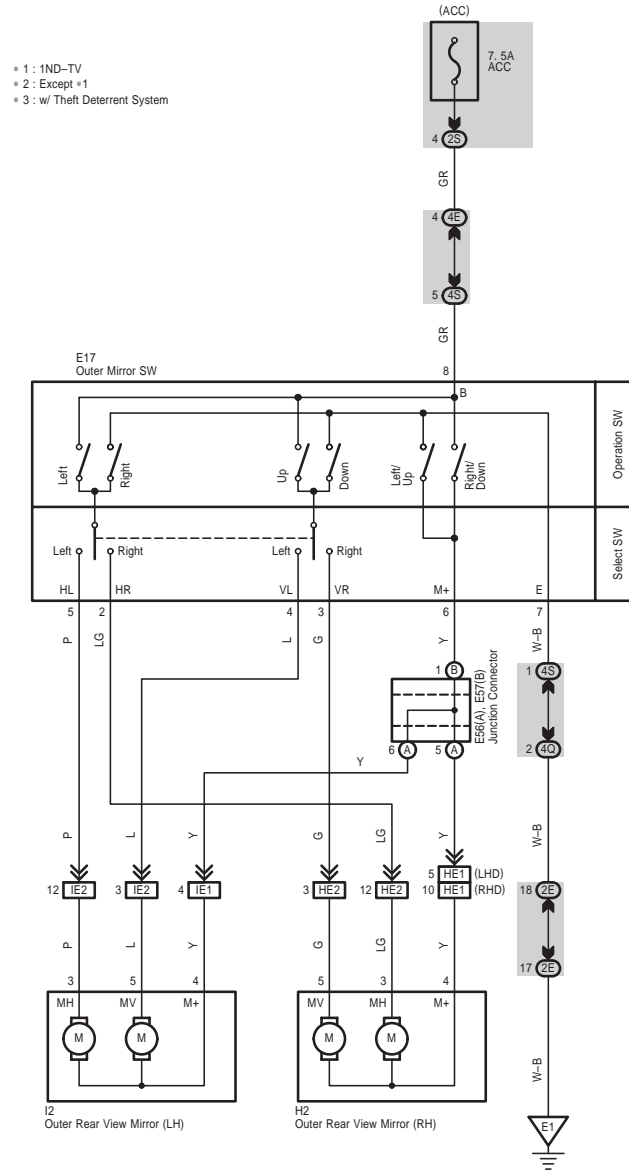

- \* 1 : 1ND-TV
- \* 2 : Except \*1
- \* 3 : w/ Theft Deterrent System



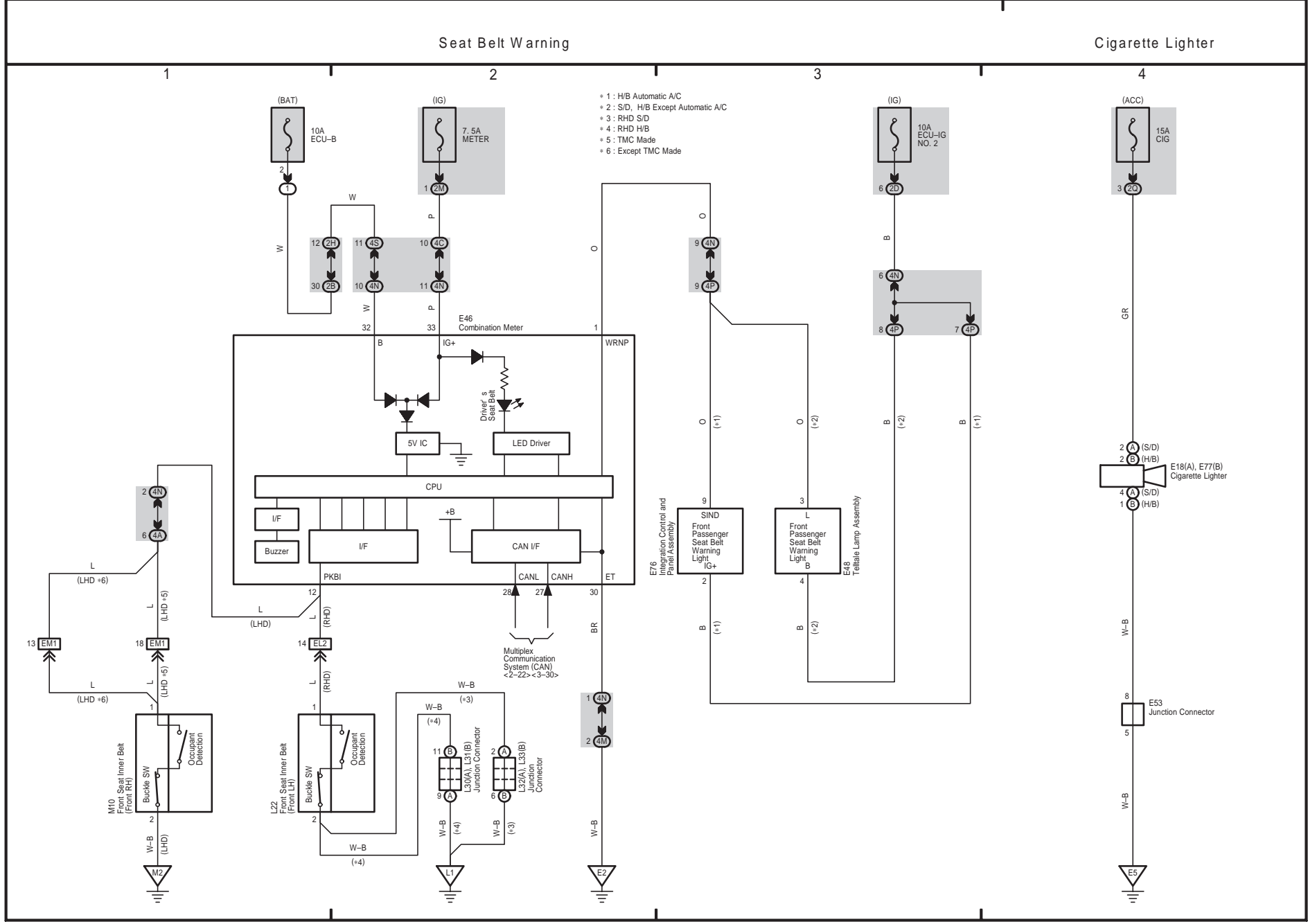

Rear Window Defogger and Mirror Heater

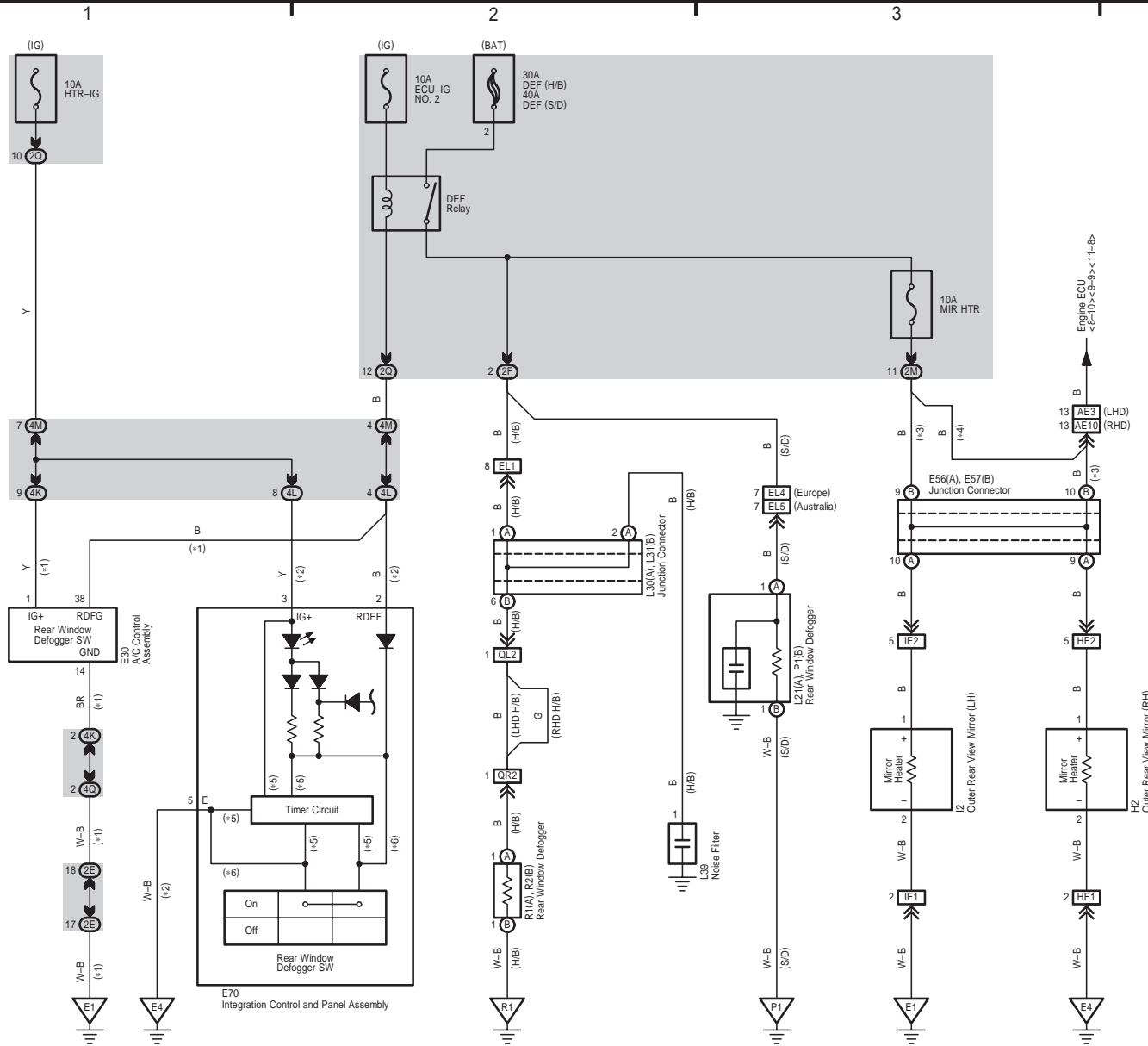

- \* 1 : Automatic A/C
- \* 2 : Except +1
- \* 3 : w/ Mirror Heater
- \* 4 : w/o Mirror Heater
- \* 5 : w/ Timer Circuit
- \* 6 : w/o Timer Circuit





34 COROLLA / AURIS

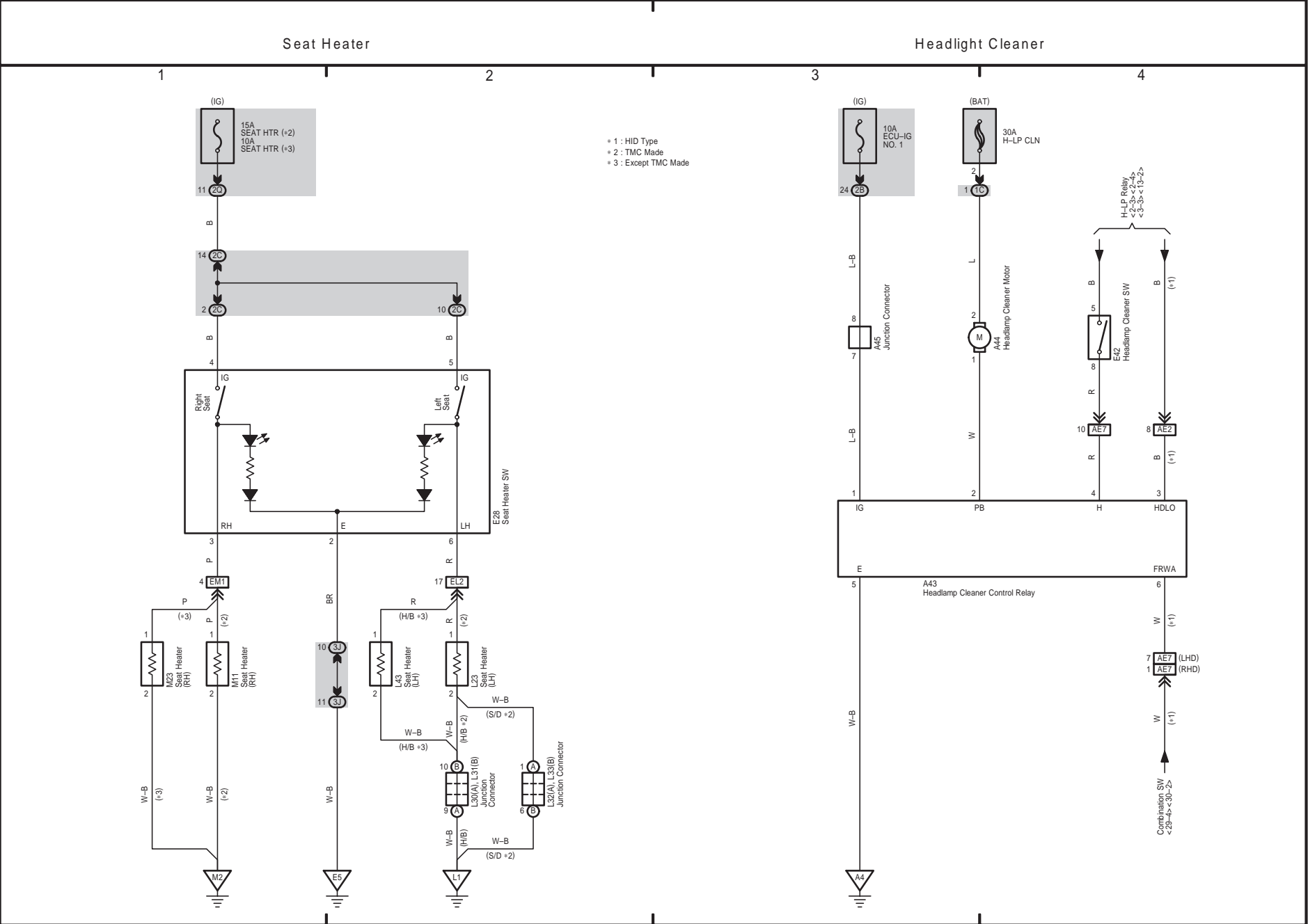

Audio System and Navigation System

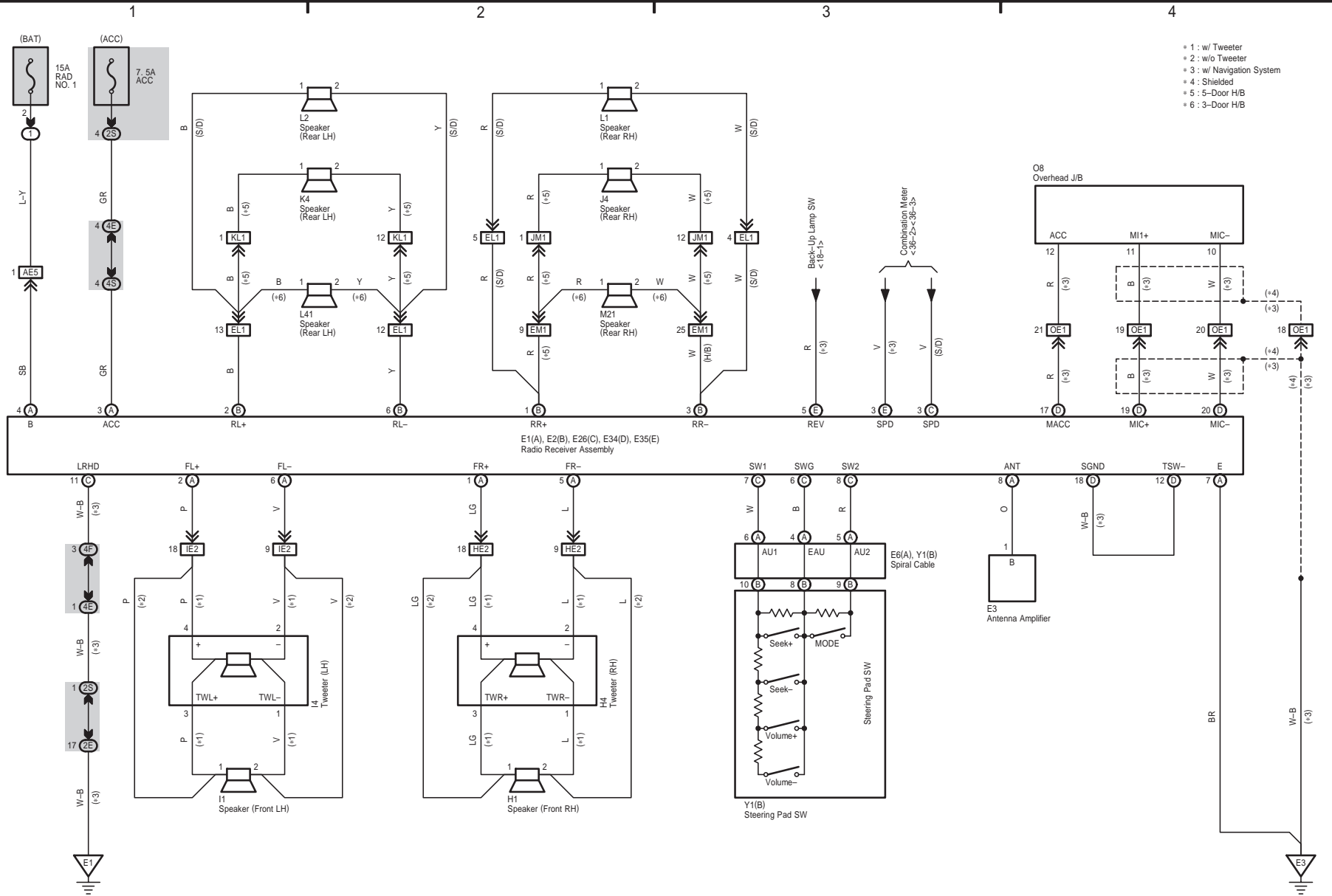

COROLLA / AURIS (EM04F1E)





Combination Meter

- \* 1 : Optitron Meter
- \* 2 : Except \*1
- \* 3 : Gasoline
- \* 4 : Diesel
- \* 6 : TMC Made
- \* 7 : Except TMC Made
- \*10 : 2AD-FTV, 1AD-FTV

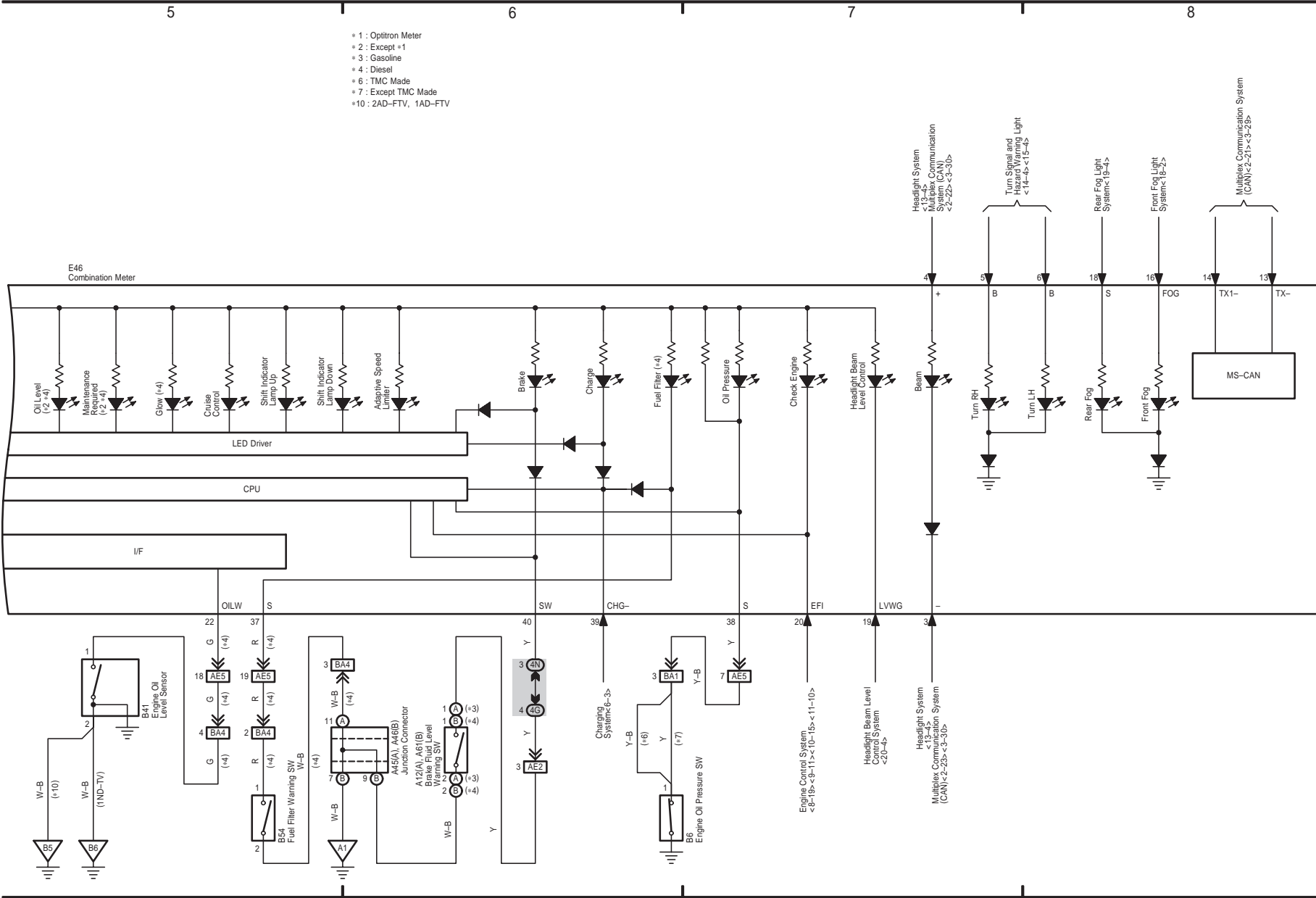

COROLLA / AURIS (EM04F1E)



37 COROLLA / AURIS

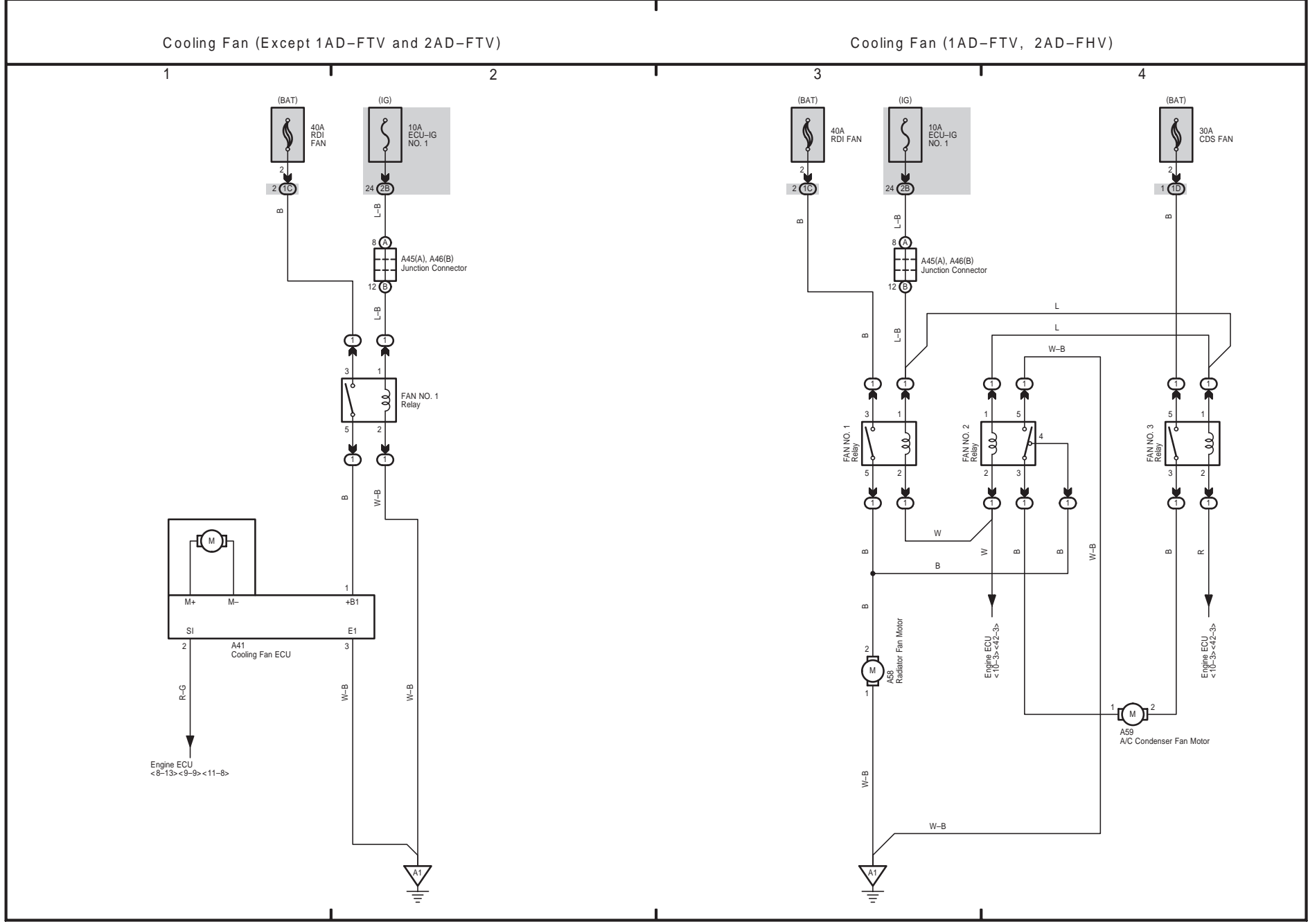

Air Conditioner (Automatic A/C)

- \* 1 : 1ZR-FE, 2ZR-FE
- \* 2 : 4ZZ-FE
- \* 3 : 1AD-FTV, 2AD-FHV
- \* 4 : 1ND-TV
- \* 5 : w/ PTC Heater
- \* 6 : H/B Europe
- \* 7 : S/D, H/B Australia
- \* 8 : S/D, RHD H/B

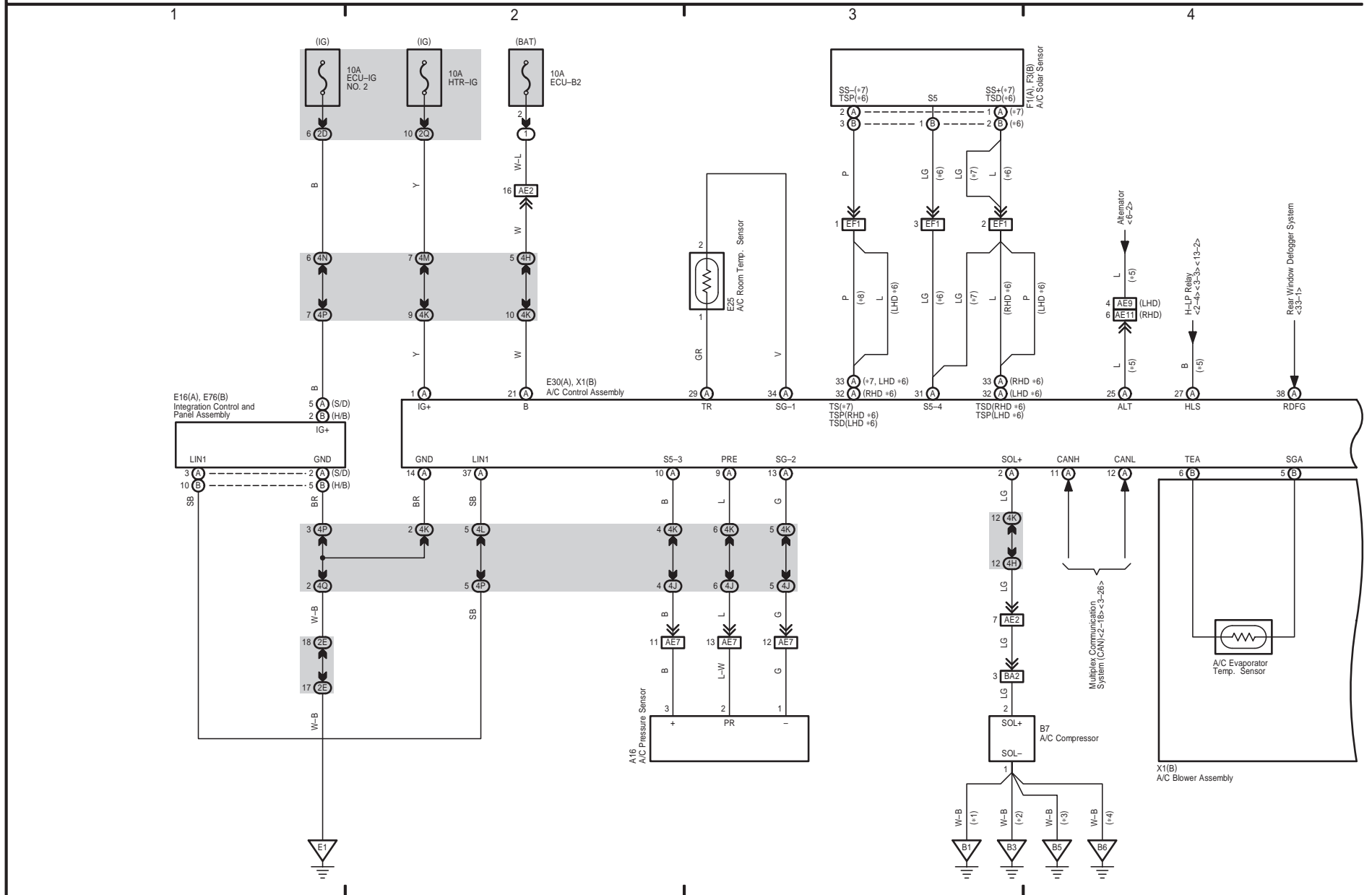

Air Conditioner (Automatic A/C)

5 6 7 8

\* 5 : w/ PTC Heater

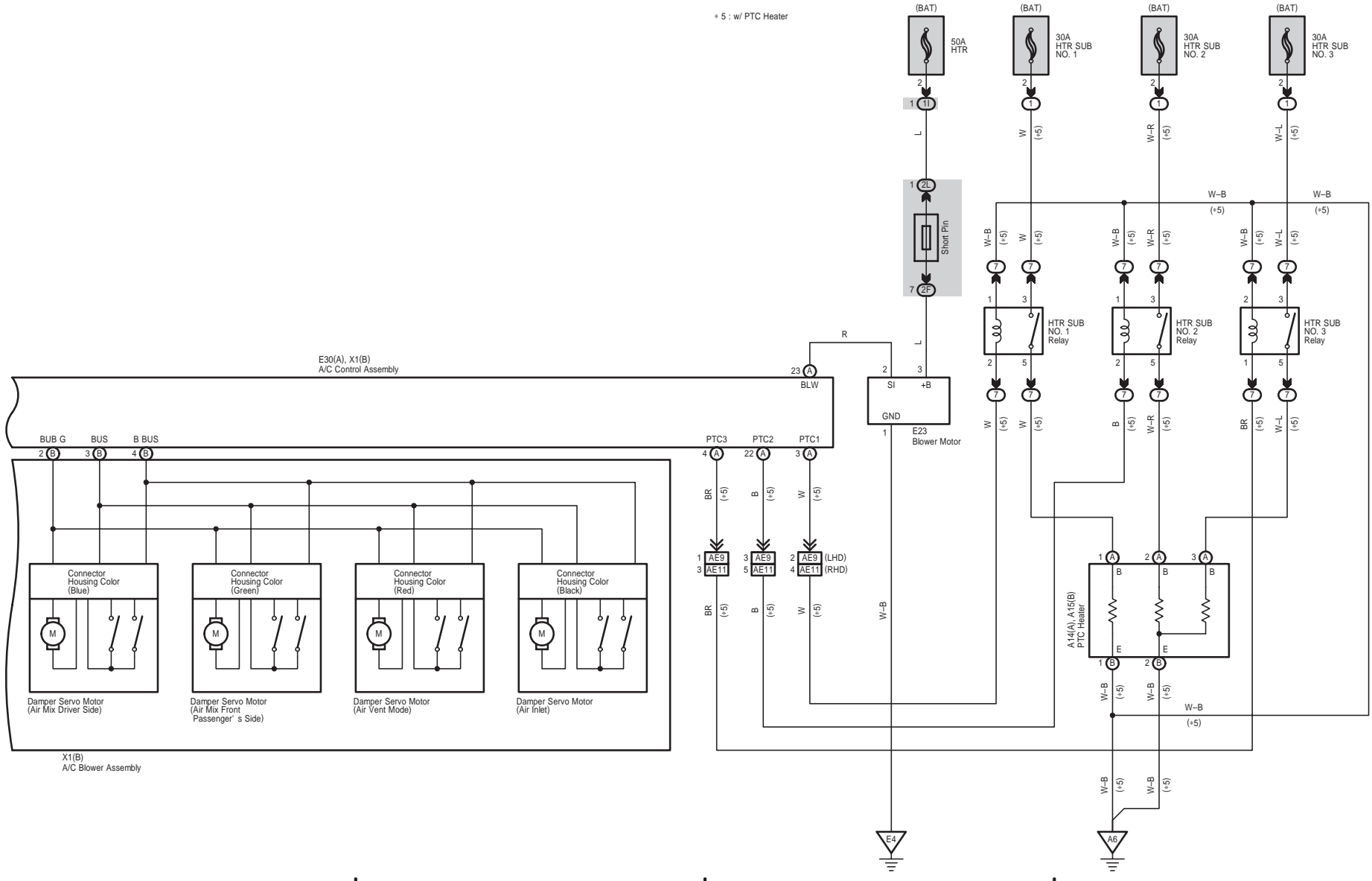

COROLLA / AURIS (EM04F1E)

805



Air Conditioner (Except Automatic A/C)

- \* 1 : 1ZR-FE, 2ZR-FE
- \* 2 : 4ZZ-FE
- \* 3 : 1AD-FTV, 2AD-FHV
- \* 4 : 1ND-TV
- \* 5 : w/ PTC Heater

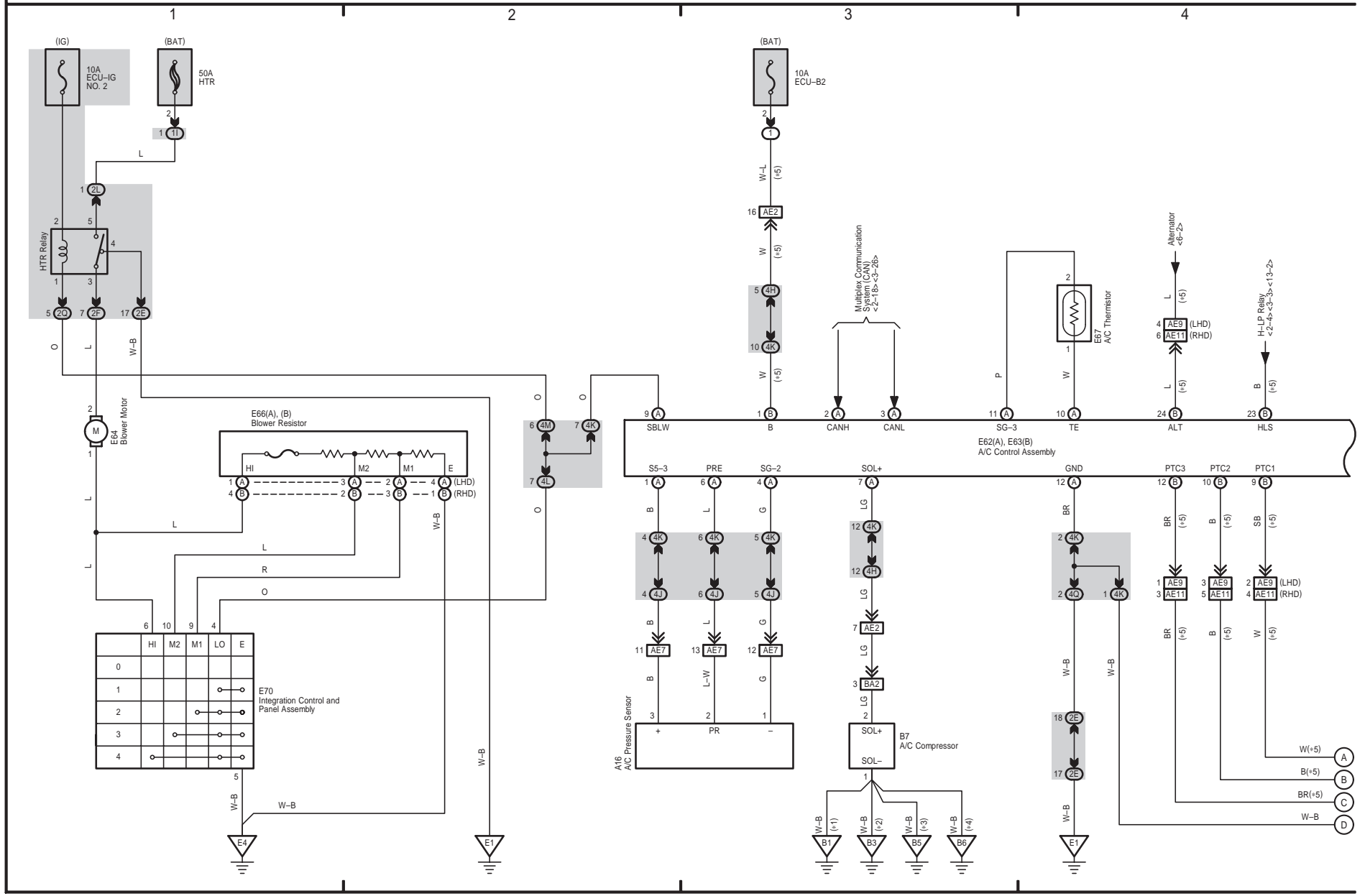



Air Conditioner (Except Automatic A/C)

\* 5 : w/ PTC Heater

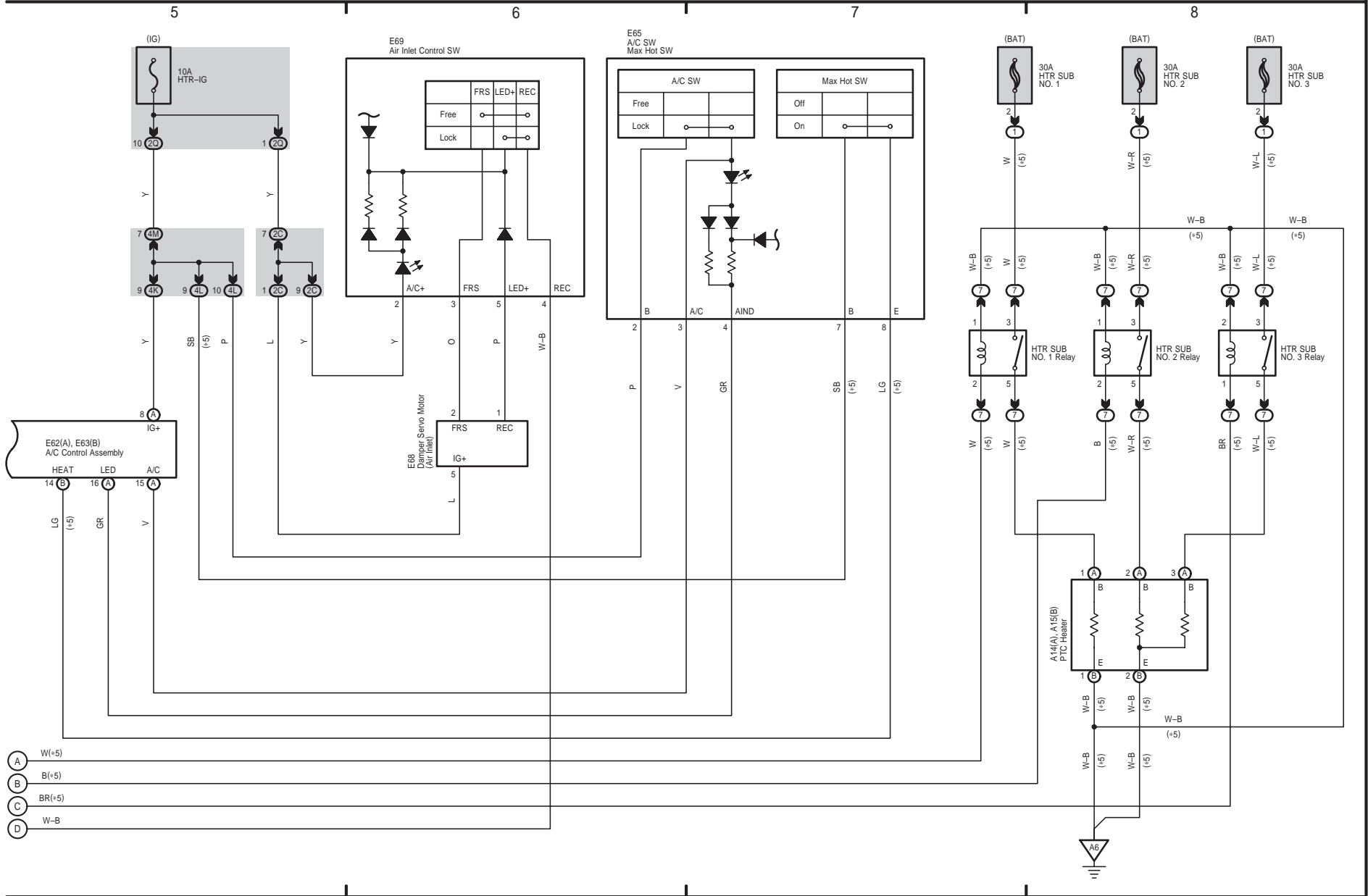

COROLLA / AURIS (EM04F1E)



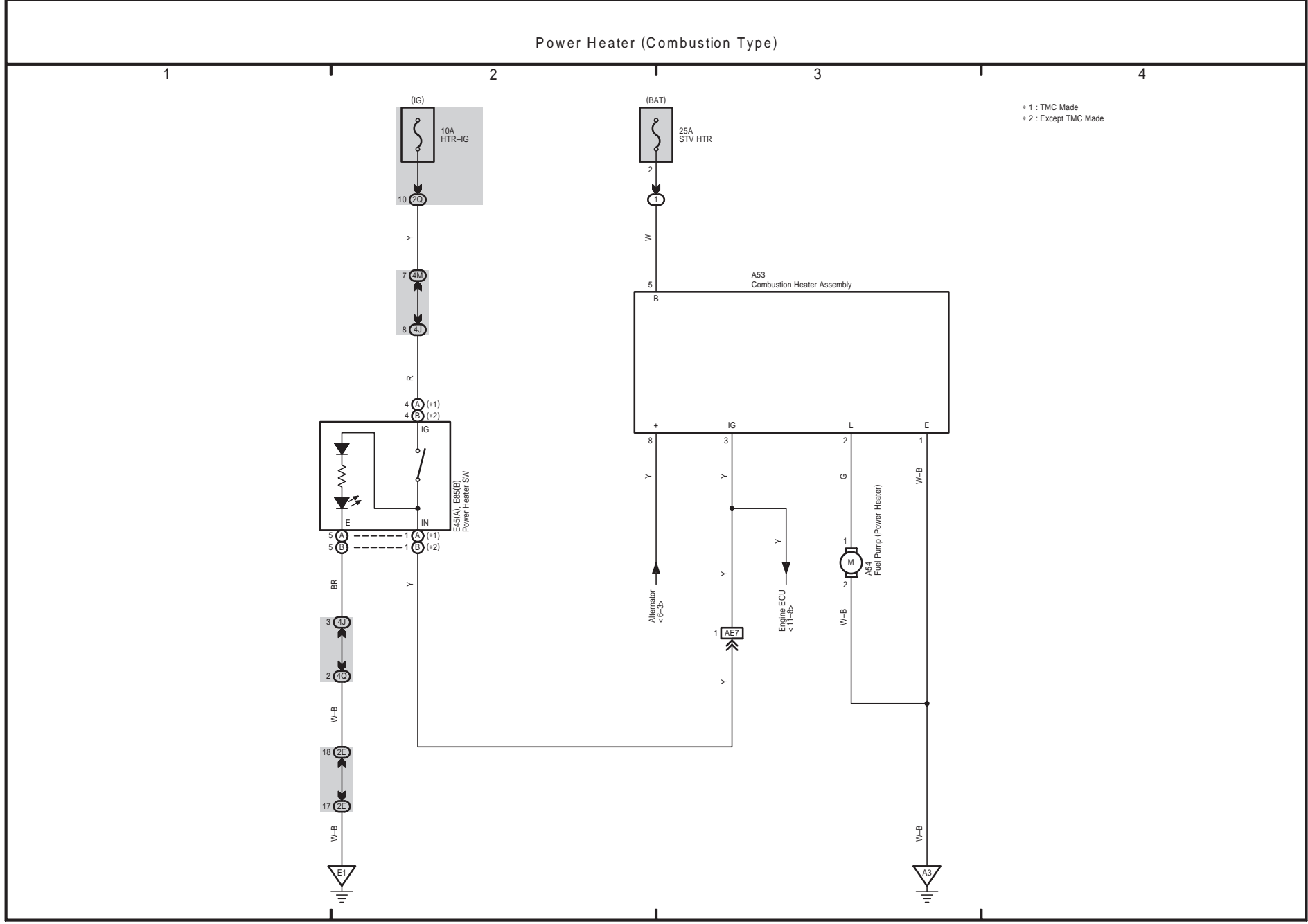

Shift Lock

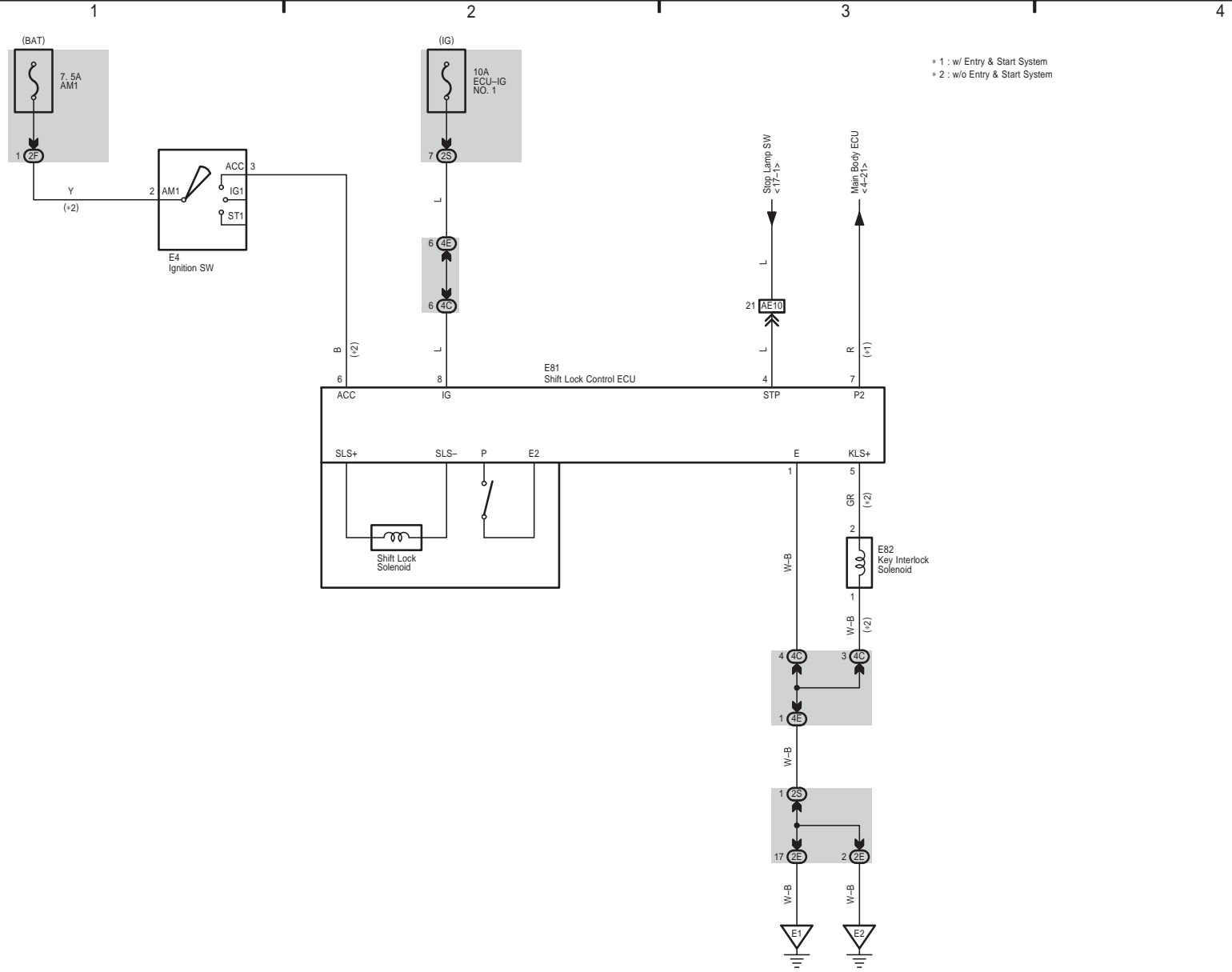

\* 1 : w/ Entry & Start System  
 \* 2 : w/o Entry & Start System

COROLLA / AURIS (EM04F1E)



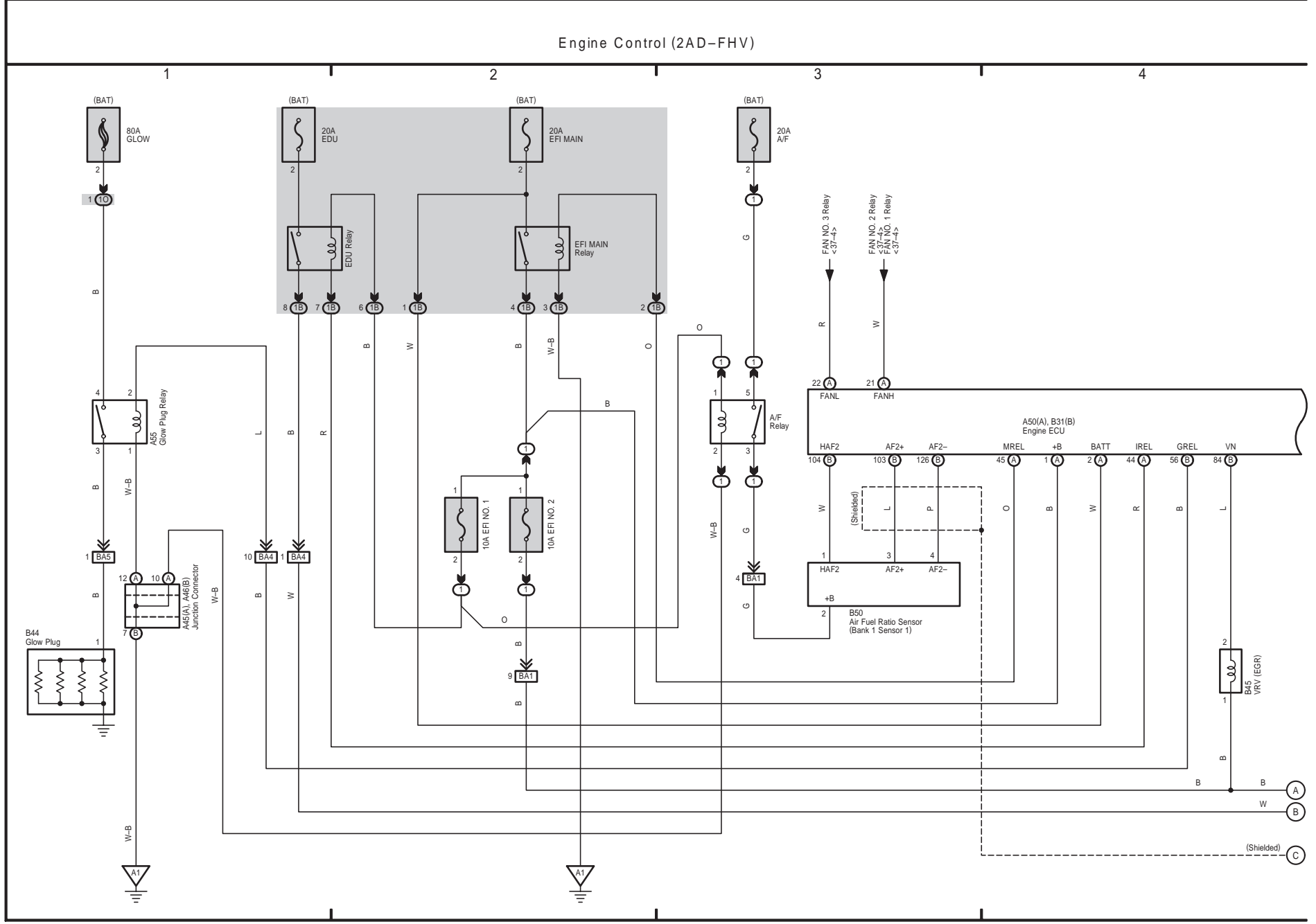

Engine Control (2AD-FHV)

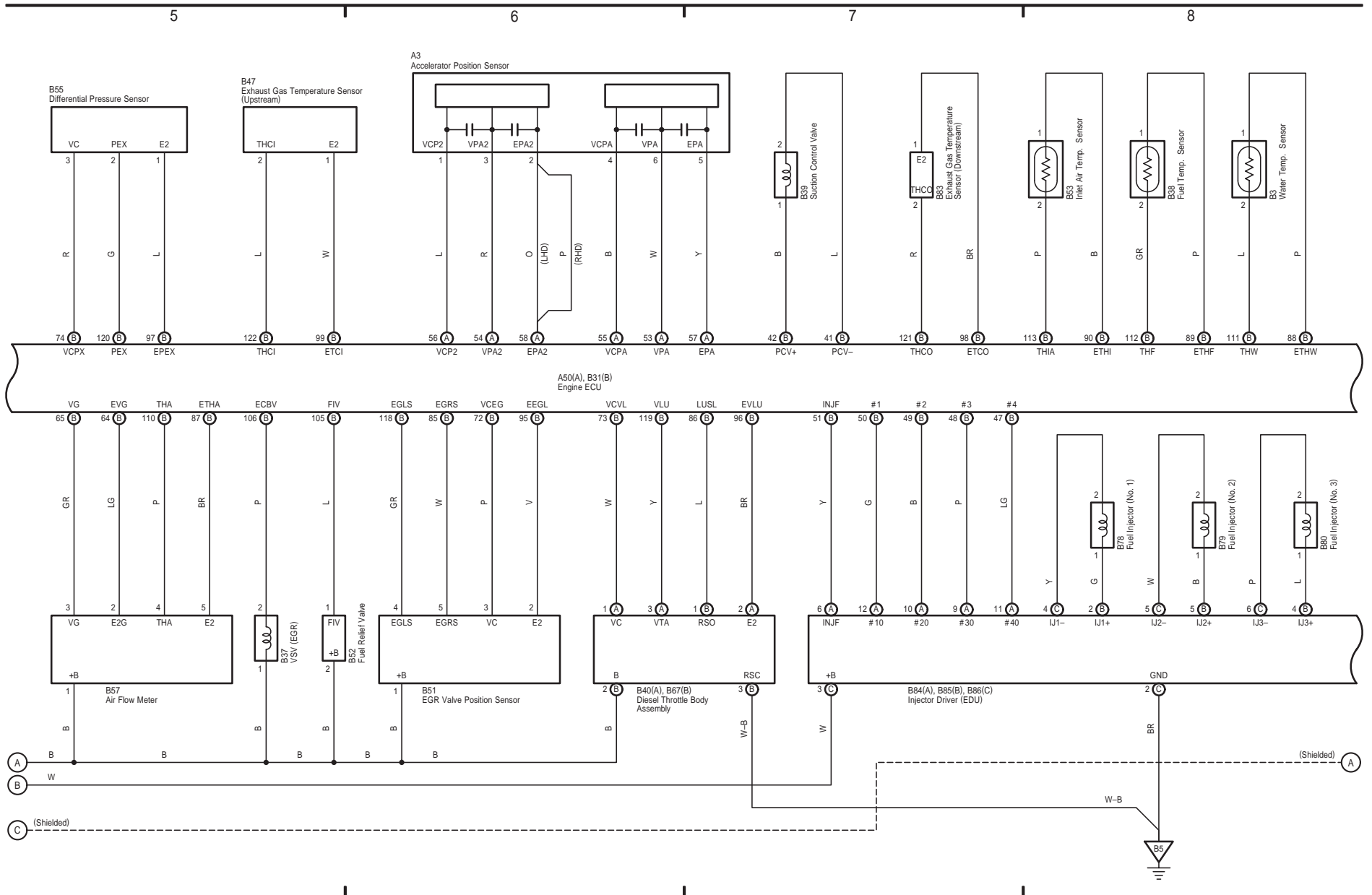

COROLLA / AURIS (EM04F1E)



Engine Control (2AD-FHV)

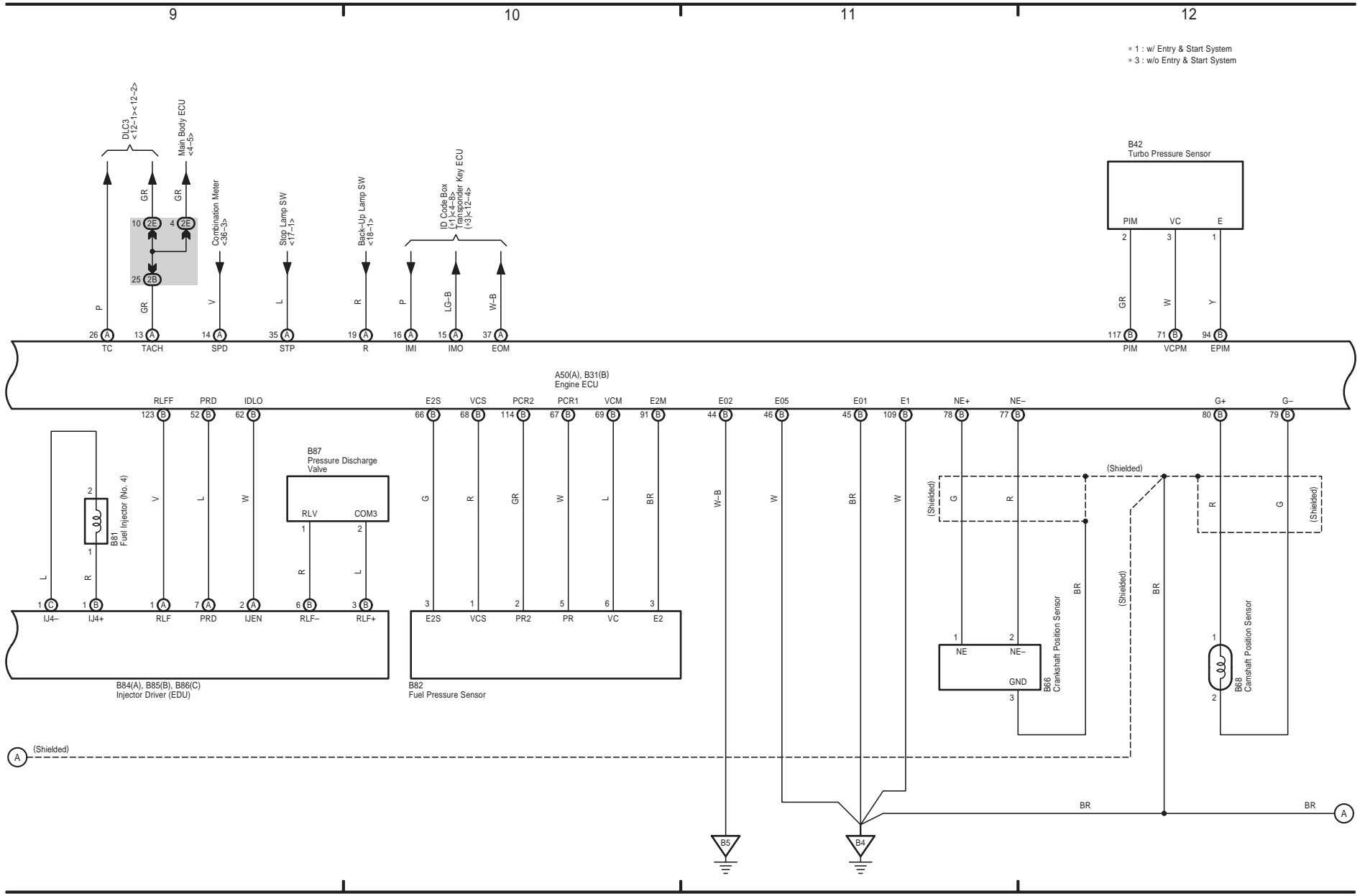

Cruise Control (2AD-FHV)

COROLLA / AURIS (EM04F1E)

