



**BUICK**  
PREMIUM AMERICAN  
MOTORCARS



*Riviera*



# The 1995 Buick Riviera Owner's Manual

<b>Seats and Restraint Systems</b> .....	1-1
This section tells you how to use your seats and safety belts properly. It also explains the "SRS" system.	
<b>Features and Controls</b> .....	2-1
This section explains how to start and operate your Buick.	
<b>Comfort Controls and Audio Systems</b> .....	3-1
This section tells you how to adjust the ventilation and comfort controls and how to operate your sound system.	
<b>Your Driving and the Road</b> .....	4-1
Here you'll find helpful information and tips about the road and how to drive under different conditions.	
<b>Problems on the Road</b> .....	5-1
This section tells you what to do if you have a problem while driving, such as a flat tire or overheated engine, etc.	
<b>Service and Appearance Care</b> .....	6-1
Here the manual tells you how to keep your Buick running properly and looking good.	
<b>Maintenance Schedule</b> .....	7-1
This section tells you when to perform vehicle maintenance and what fluids and lubricants to use.	
<b>Customer Assistance Information</b> .....	8-1
This section tells you how to contact Buick for assistance and how to get service publications. It also gives you information on "Reporting Safety Defects" on page 8-4.	
<b>Index</b> .....	9-1
Here's an alphabetical listing of almost every subject in this manual. You can use it to quickly find something you want to read.	



GENERAL MOTORS, GM and the GM Emblem, BUICK, and the BUICK Emblem are registered trademarks of General Motors Corporation.

This manual includes the latest information at the time it was printed. We reserve the right to make changes in the product after that time without further notice. For vehicles first sold in Canada, substitute the name "General Motors of Canada Limited" for Buick Motor Division whenever it appears in this manual.

Please keep this manual in your Buick, so it will be there if you ever need it when you're on the road. If you sell the vehicle, please leave this manual in it so the new owner can use it.



We support voluntary technician certification.

## For Canadian Owners Who Prefer a French Language Manual:

Aux propriétaires canadiens: Vous pouvez vous procurer un exemplaire de ce guide en français chez votre concessionnaire ou au DGN Marketing Services Ltd., 1500 Bonhill Rd., Mississauga, Ontario L5T 1C7.



*1908 Buick  
Runabout*

*Buick Motor Division  
provides one of the most dramatic  
and important chapters in the history  
of the American automobile*

# Buick



*David Dunbar Buick*



*Walter Marr and Thomas Buick*

Buick's chief engineer, Walter L. Marr (left), and Thomas D. Buick, son of founder David Dunbar Buick, drove the first Flint Buick in a successful Flint-Detroit round trip in July 1904.

David Buick was building gasoline engines by 1899, and Marr, his engineer, apparently built the first auto to be called a Buick in 1900. However, Buick traditionally dates its beginnings to 1903. That was the year the company was reorganized, refinanced and moved from Detroit to Flint. Buick has always been a product innovator. Buick engineers developed the

“valve-in-head” engine, a light, powerful and reliable engine which would eventually influence the entire automotive industry.

William C. Durant was instrumental in promoting Buicks across the country using his Durant-Dort Carriage Co. outlets and salespeople as the nucleus of a giant distribution system. He knew the Buick as a “self-seller.” If automobiles could be this good, he thought, maybe it was time to switch from the horse and buggy business to automobiles.



*William C. (Billy) Durant*

At the 1905 New York Auto Show, Durant took orders for 1,000 Buicks before the company had built 40. On Buick's success, Durant created a holding company, September 16, 1908. He called it General Motors.

Durant also created a racing team that won 500 racing trophies in 1909 and 1910, including successes at Indianapolis two years before the Indy 500 began.

The success of Buick engines was visible not only on the race track, but in endurance tests across the country and around the world. Buick was the only car to complete a 1,000-mile Chicago-to-New York race in 1906. And a Buick was the first car to travel across South America, driven from Buenos Aires, Argentina, over the Andes to Santiago, Chile in 1914.



*1911 Model 21 Touring Car on Buick's Test Hill*

Buick drew plenty of attention because it could climb hills and run through mud like no other car. Buick's endurance and reliability were world famous.

During World War I, Buick built Liberty aircraft engines as well as Red Cross ambulances so successfully that one Buick ambulance was awarded the Croix de Guerre by the French government.

As a builder of premier automobiles, Buick was hard hit by the Great Depression. However, new General Manager Harlow H. Curtice created popular new models including the Special and the Roadmaster. Buick sales soon flourished.



*First Buick Factory*

In World War II, Buick built aircraft engines, tanks and other military hardware. This post-war period brought great styling and engineering changes which resulted in increased sales. The torque converter automatic transmission, Dynaflo, was introduced in the 1948 Roadmaster. Buick's famous "portholes" came along in 1949.



*1949 Roadmaster*

A high-compression V-8 engine was introduced in 1953. And Buick's famous vertical pillar "toothy" grille, (introduced in 1942), became more massive in the post-war era.



*1953 Skylark*

Motor Trend magazine named the 1962 Buick Special "Car of the Year." The first production V-6 engine was used in the Special.



### *1962 Buick Special*

Built inside the walls of the old buildings in Buick's former Flint complex, which formed the cornerstone of General Motors, Buick City is a state-of-the-art assembly facility with more than 200 robots and other high-tech equipment. It was completed in the fall of 1985.

Buicks are, and will continue to be, premium American motorcars with smooth power, high performance, rich detail and comfortable accommodation.



### *Ed Mertz, General Manager, Buick Motor Division*

Our mission is simple:

"Buick will provide Premium American Motorcars backed with services that exceed our customers' expectations, throughout the purchase, ownership, service and repurchase experience."

Buicks are SUBSTANTIAL.

Buicks are DISTINCTIVE.

Buicks are POWERFUL.

Buicks are MATURE.



## How to Use this Manual

Many people read their owner's manual from beginning to end when they first receive their new vehicle. This will help you learn about the features and controls for your vehicle. In this manual, you'll find that pictures and words work together to explain things quickly.

## Index

A good place to look for what you need is the Index in the back of the manual. It's an alphabetical list of all that's in the manual, and the page number where you'll find it.

## Safety Warnings and Symbols

You will find a number of safety cautions in this book. We use a box with gray background and the word CAUTION to tell you about things that could hurt you if you were to ignore the warning.



### CAUTION:

**These mean there is something that could hurt you or other people.**

In the gray caution area, we tell you what the hazard is. Then we tell you what to do to help avoid or reduce the hazard. Please read these cautions. If you don't, you or others could be hurt.



You will also find a circle with a slash through it in this book.

This safety symbol means "Don't," "Don't do this," or "Don't let this happen."

## Vehicle Damage Warnings

Also, in this book you will find these notices:

### **NOTICE:**

**These mean there is something that  
could damage your vehicle.**

In the notice area, we tell you about something that can damage your vehicle. Many times, this damage would not be covered by your warranty, and it could be costly. But the notice will tell you what to do to help avoid the damage.

When you read other manuals, you might see CAUTION and NOTICE warnings in different colors or in different words.

You'll also see warning labels on your vehicle. They use yellow for cautions, blue for notices and the words CAUTION or NOTICE.

## Vehicle Symbols

These are some of the symbols you may find on your vehicle.

For example, these symbols are used on an original battery:

CAUTION  
POSSIBLE  
INJURY



PROTECT  
EYES BY  
SHIELDING



CAUSTIC  
BATTERY  
ACID COULD  
CAUSE  
BURNS



AVOID  
SPARKS OR  
FLAMES



SPARK OR  
FLAME  
COULD  
EXPLODE  
BATTERY



These symbols are important for you and your passengers whenever your vehicle is driven:

DOOR LOCK  
UNLOCK



FASTEN  
SEAT  
BELTS



POWER  
WINDOW



AIR BAG



These symbols have to do with your lights:

MASTER  
LIGHTING  
SWITCH



TURN  
SIGNALS



PARKING  
LAMPS



HAZARD  
WARNING  
FLASHER



LAMPS OR  
HIGH BEAM



FOG LAMPS



These symbols are on some of your controls:

WINDSHIELD  
WIPER



WINDSHIELD  
WASHER



WINDSHIELD  
DEFROSTER



REAR  
WINDOW  
DEFOGGER



VENTILATING  
FAN



These symbols are used on warning and indicator lights:

ENGINE  
COOLANT  
TEMP



BATTERY  
CHARGING  
SYSTEM



BRAKE



RADIATOR  
COOLANT



FUEL



ENGINE OIL  
PRESSURE



ENGINE OIL  
TEMP



ANTI-LOCK  
BRAKE



Here are some other symbols you may see:

FUSE



HOOD  
RELEASE



RADIO  
VOLUME



AIR  
CONDITIONING



TRUNK  
RELEASE



LIGHTER



HORN



SPEAKER





## Section 1 Seats and Restraint Systems

Here you'll find information about the seats in your Buick and how to use your safety belts properly. You can also learn about some things you should *not* do with air bags and safety belts.

### Seats and Seat Controls

This section tells you about the seats -- how to adjust them, and also about memory seats, reclining seatbacks and head restraints.

### Power Seat

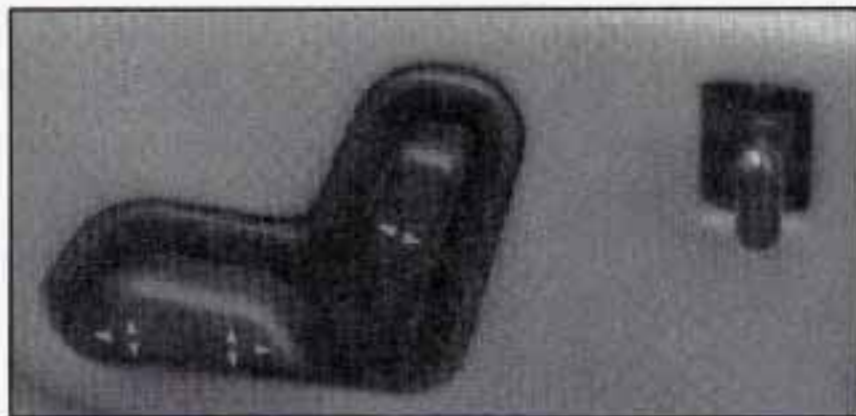

- Raise or lower the front of the seat by holding the front part of the horizontal control up or down.
- Raise or lower the rear of the seat by holding the rear part of the horizontal control up or down.

- Raise or lower the entire seat by holding the whole control up or down.
- Move the seat forward or back by holding the control to the front or back.

### **Power Lumbar (Option)**

If you have this option, the driver's seatback lumbar support can be adjusted by moving the single switch located on the side of the seat. To increase or decrease support, hold the switch forward or rearward.

### **Memory Seat and Mirrors (Option)**



To set your memory seat and mirrors:

1. Adjust the driver's seat to your desired position. Adjust both outside mirrors to suit you. See "Mirrors" in the Index.
2. Press the SET button and then press the 1 or 2 side of the MEMORY switch within five seconds. You will hear one beep when you press the SET button and two beeps when you press the MEMORY button to confirm that the mirror and seat positions are entered into memory.

When your Buick is in PARK (P) with the ignition ON or OFF, press the same side of the MEMORY switch to recall the seat and mirror setting.

To do the same thing for a second driver, follow the preceding steps but press the other side of the MEMORY switch.

The EXIT button allows you to get out of the car easily. When the gear shift selector is in PARK (P) with the ignition ON or OFF, push EXIT and the seat will go all the way down and back.

## Reclining Front Seatback(s)



The power recline vertical control is located on the side of the seat. Push it forward to bring the seat to a more upright position. Push it rearward to recline the seatback.



But don't have a seatback reclined if your vehicle is moving.

**⚠ CAUTION:**

Sitting in a reclined position when your vehicle is in motion can be dangerous. Even if you buckle up, your safety belts can't do their job when you're reclined like this.

The shoulder belt can't do its job. In a crash you could go into it, receiving neck or other injuries.

The lap belt can't do its job either. In a crash the belt could go up over your abdomen. The belt forces would be there, not at your pelvic bones. This could cause serious internal injuries.

For proper protection when the vehicle is in motion, have the seatback upright. Then sit well back in the seat and wear your safety belt properly.

## Heated Seat (Option)



If your vehicle has this option, the switch is on the driver's armrest. Press the button once and the seat will warm up. The HI light on the button will come on.

Press the button a second time and the LO light will come on. The seat will warm to a lower temperature.

Press the button a third time to turn OFF the heated seat.

## Head Restraints

Slide the head restraint up or down so that the top of the restraint is closest to the top of your ears.

This position reduces the chance of a neck injury in a crash.

## Front Seatback Latches

The front seatback folds forward to let people get into the back seat. Your seatback will move back and forth freely, unless you come to a sudden stop. Then it will lock in place.

There's one time the seatback may not fold without some help from you. That's if your vehicle is parked going down a fairly steep hill.



To fold a seatback forward if it does lock in place, push the seatback toward the rear as you lift this latch. Then the seatback will fold forward. The latch must be down for the seat to work properly.



## Safety Belts: They're for Everyone

This part of the manual tells you how to use safety belts properly. It also tells you some things you should not do with safety belts.

And it explains the Supplemental Restraint System, or "air bag" system.

### CAUTION:

**Don't let anyone ride where he or she can't wear a safety belt properly. If you are in a crash and you're not wearing a safety belt, your injuries can be much worse. You can hit things inside the vehicle or be ejected from it. You can be seriously injured or killed. In the same crash, you might not be if you are buckled up. Always fasten your safety belt, and check that your passengers' belts are fastened properly too.**



Your vehicle has a light that comes on as a reminder to buckle up. (See "Safety Belt Reminder Light" in the Index.)

In many states and Canadian provinces, the law says to wear safety belts. Here's why: *They work.*

You never know if you'll be in a crash. If you do have a crash, you don't know if it will be a bad one.

A few crashes are mild, and some crashes can be so serious that even buckled up a person wouldn't survive. But most crashes are in between. In many of them, people who buckle up can survive and sometimes walk away. Without belts they could have been badly hurt or killed.

After more than 25 years of safety belts in vehicles, the facts are clear. In most crashes buckling up does matter ... a lot!

## Why Safety Belts Work

When you ride in or on anything, you go as fast as it goes.

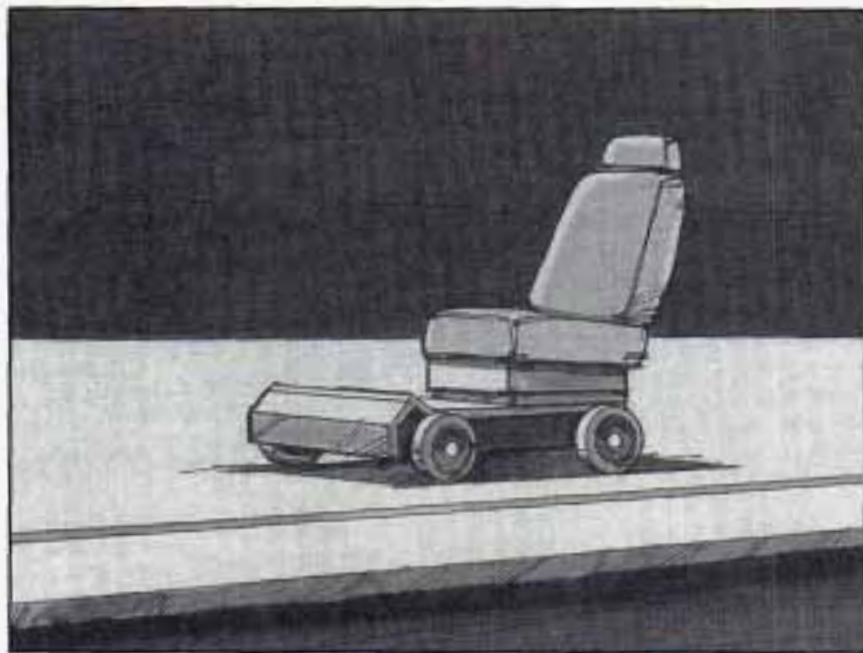

Take the simplest vehicle. Suppose it's just a seat on wheels.

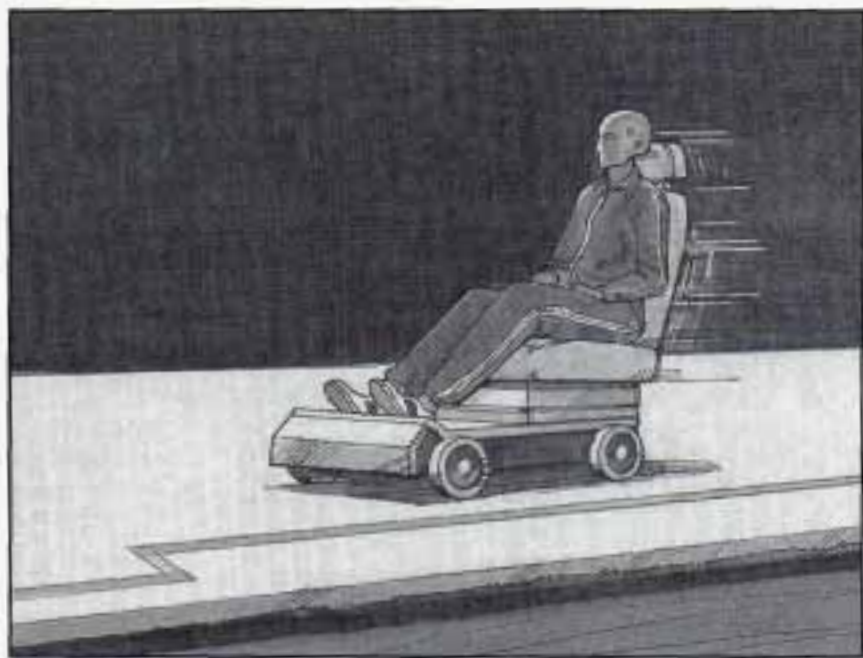

Put someone on it.

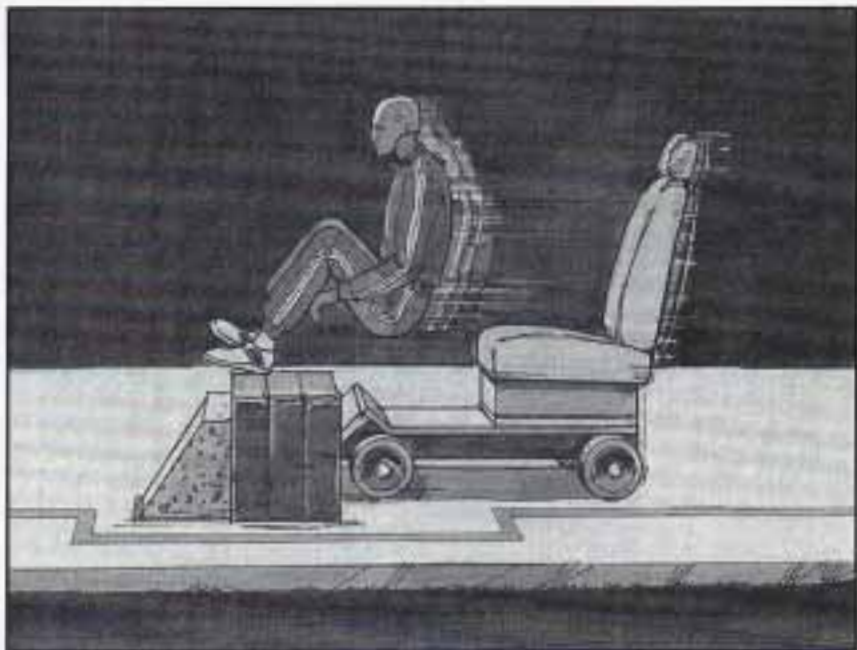

Get it up to speed. Then stop the vehicle. The rider doesn't stop.



The person keeps going until stopped by something. In a real vehicle, it could be the windshield ...



or the instrument panel ...



or the safety belts!

With safety belts, you slow down as the vehicle does. You get more time to stop. You stop over more distance, and your strongest bones take the forces. That's why safety belts make such good sense.

## Here Are Questions Many People Ask About Safety Belts -- and the Answers

**Q:** Won't I be trapped in the vehicle after an accident if I'm wearing a safety belt?

**A:** You *could* be -- whether you're wearing a safety belt or not. But you can unbuckle a safety belt, even if you're upside down. And your chance of being conscious during and after an accident, so you *can* unbuckle and get out, is *much* greater if you are belted.

**Q:** Why don't they just put in air bags so people won't have to wear safety belts?

**A:** Air bags are in many vehicles today and will be in more of them in the future. But they are supplemental systems only; so they work *with* safety belts -- not instead of them. Every air bag system ever offered for sale has required the use of safety belts. Even if you're in a vehicle that has air bags, you still have to buckle up to get the most protection. That's true not only in frontal collisions, but especially in side and other collisions.

**Q:** If I'm a good driver, and I never drive far from home, why should I wear safety belts?

**A:** You may be an excellent driver, but if you're in an accident -- even one that isn't your fault -- you and your passengers can be hurt. Being a good driver doesn't protect you from things beyond your control, such as bad drivers.

Most accidents occur within 25 miles (40 km) of home. And the greatest number of serious injuries and deaths occur at speeds of less than 40 mph (65 km/h).

Safety belts are for everyone.

## How to Wear Safety Belts Properly

### Adults

This part is only for people of adult size.

Be aware that there are special things to know about safety belts and children. And there are different rules for smaller children and babies. If a child will be riding in your Buick, see the part of this manual called “Children.” Follow those rules for everyone’s protection.

First, you’ll want to know which restraint systems your vehicle has.

We’ll start with the driver position.

## Driver Position

This part describes the driver’s restraint system.

### Lap-Shoulder Belt

The driver has a lap-shoulder belt. The shoulder portion of the belt has an energy management loop. It is designed to open and help protect you in certain crashes. If it opens, you will see a label on the safety belt that says to replace the belt. Be sure to do so. If you don’t, the safety belt won’t work properly and won’t protect you in another crash. For more information on replacing safety belts after a crash, see “Replacing Safety Belts” in the Index.

Here’s how to wear the lap-shoulder belt properly.

1. Close and lock the door.
2. Adjust the seat (to see how, see “Seats” in the Index) so you can sit up straight.

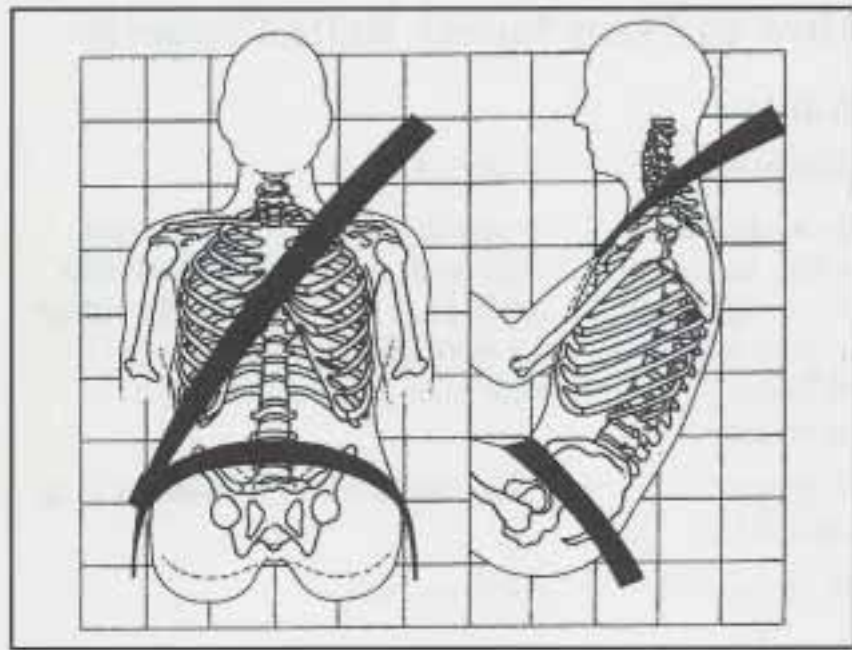

3. Pick up the latch plate and pull the belt across you. Don't let it get twisted.
4. Push the latch plate into the buckle until it clicks.  
Pull up on the latch plate to make sure it is secure. If the belt isn't long enough, see "Safety Belt Extender" at the end of this section.  
Make sure the release button on the buckle is positioned so you would be able to unbuckle the safety belt quickly if you ever had to.

The lap part of the belt should be worn low and snug on the hips, just touching the thighs. In a crash, this applies force to the strong pelvic bones. And you'd be less likely to slide under the lap belt. If you slid under it, the belt would apply force at your abdomen. This could cause serious or even fatal injuries. The shoulder belt should go over the shoulder and across the chest. These parts of the body are best able to take belt restraining forces.

The safety belt locks if there's a sudden stop or crash.

## Shoulder Belt Tightness Adjustment

Your car has a shoulder belt tightness adjustment feature. If the shoulder belt seems too tight, adjust it before you begin to drive.

1. Sit well back in the seat.
2. Start pulling the shoulder belt out.



3. Just before it reaches the end, give it a quick pull.

4. Let the belt go back all the way. You should hear a slight clicking sound. If you don't, the adjustment feature won't set, and you'll have to start again.



5. Now you can add a small amount of slack. Lean forward slightly, then sit back. If you've added more than 1 inch (25 mm) of slack, pull the shoulder belt out as you did before and start again.

If you move around in the vehicle enough, pull out the shoulder belt, or open your door, the belt will become tight again. If this happens, you can reset it.



**Q:** What's wrong with this?

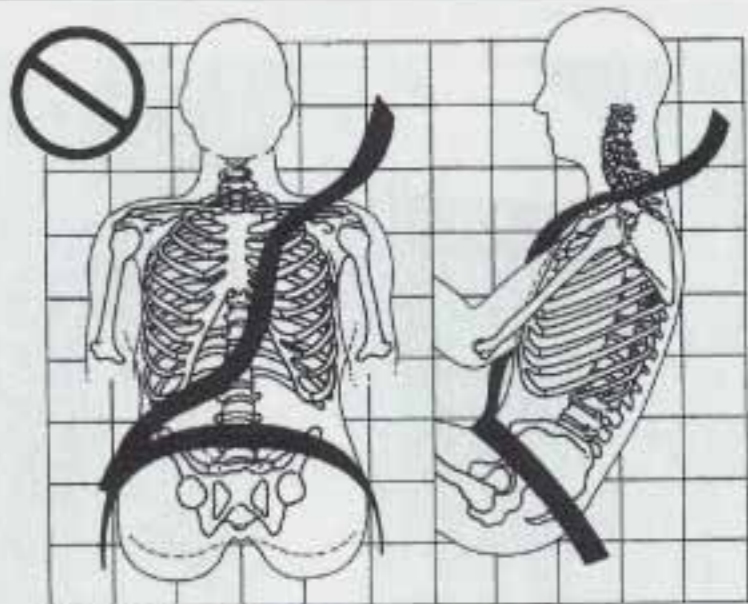

**⚠ CAUTION:**

You can be seriously hurt if your shoulder belt is too loose. In a crash you would move forward too much, which could increase injury. The shoulder belt should fit against your body. Don't allow more than 1 inch (25 mm) of slack.

**A:** The shoulder belt is too loose. It won't give nearly as much protection this way.

**Q:** What's wrong with this?

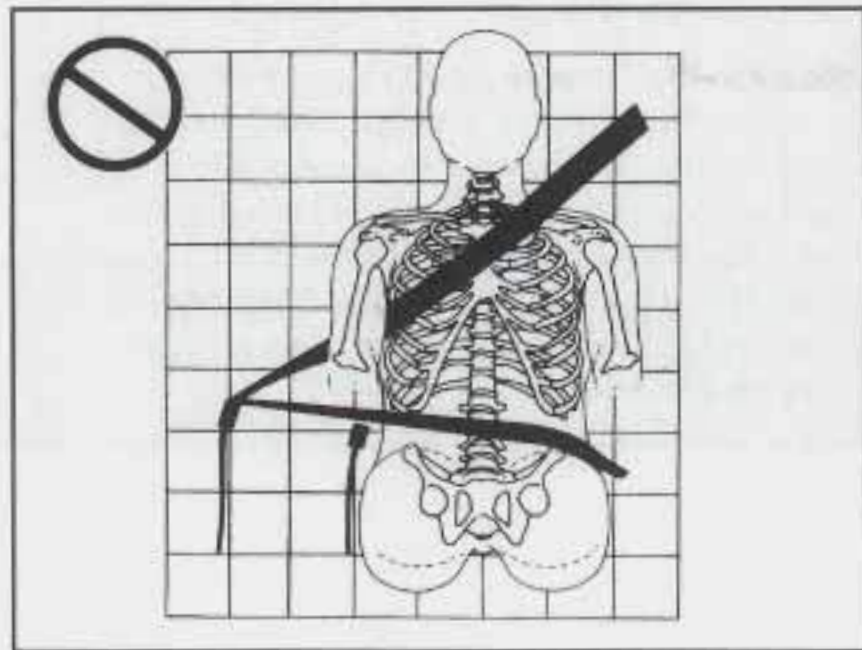

**⚠ CAUTION:**

You can be seriously injured if your belt is buckled in the wrong place like this. In a crash, the belt would go up over your abdomen. The belt forces would be there, not at the pelvic bones. This could cause serious internal injuries. Always buckle your belt into the buckle nearest you.

**A:** The belt is buckled in the wrong place.

**Q:** What's wrong with this?

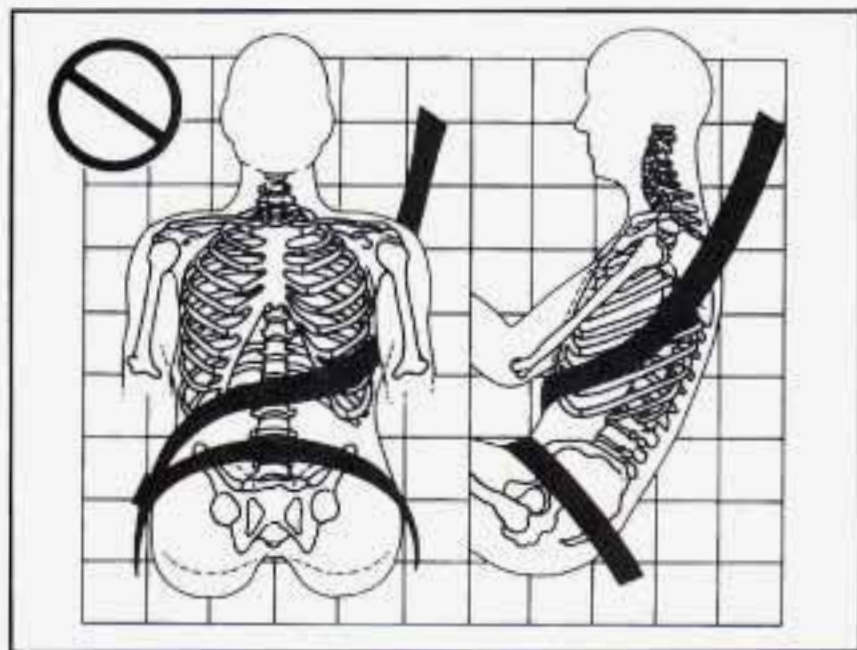

**⚠ CAUTION:**

You can be seriously injured if you wear the shoulder belt under your arm. In a crash, your body would move too far forward, which would increase the chance of head and neck injury. Also, the belt would apply too much force to the ribs, which aren't as strong as shoulder bones. You could also severely injure internal organs like your liver or spleen.

**A:** The shoulder belt is worn under the arm. It should be worn over the shoulder at all times.

**Q:** What's wrong with this?

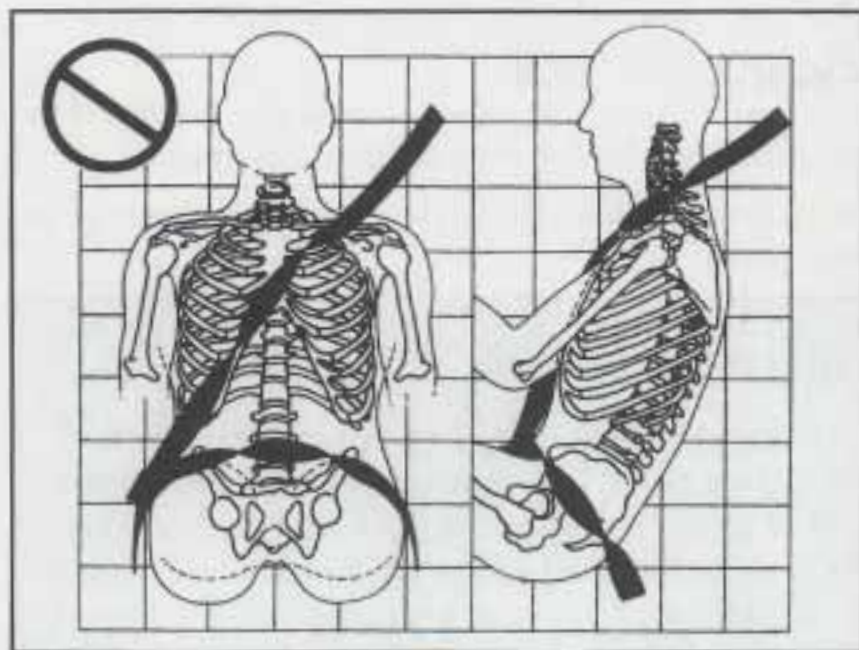

**A:** The belt is twisted across the body.

**⚠ CAUTION:**

You can be seriously injured by a twisted belt. In a crash, you wouldn't have the full width of the belt to spread impact forces. If a belt is twisted, make it straight so it can work properly, or ask your dealer to fix it.

To unlatch the belt, just push the button on the buckle. The belt should go back out of the way.



Before you close the door, be sure the belt is out of the way. If you slam the door on it, you can damage both the belt and your vehicle.

## Supplemental Restraint System (SRS)

This part explains the Supplemental Restraint System (SRS), or air bag system.

Your Buick has two air bags -- one air bag for the driver and another air bag for the right front passenger.

Here are the most important things to know about the air bag system:

### CAUTION:

You can be severely injured or killed in a crash if you aren't wearing your safety belt -- even if you have an air bag. Wearing your safety belt during a crash helps reduce your chance of hitting things inside the vehicle or being ejected from it. The air bag is only a "supplemental restraint." That is, it works with safety belts but doesn't replace them. Air bags are designed to work only in moderate to severe crashes where the front of your vehicle hits something. They aren't designed to inflate at all in rollover, rear, side, or low-speed frontal crashes. Everyone in your vehicle, including the driver, should wear a safety belt properly -- whether or not there's an air bag for that person.

**⚠ CAUTION:**

Air bags inflate with great force, faster than the blink of an eye. If you're too close to an inflating air bag, it could seriously injure you. Safety belts help keep you in position for an air bag inflation in a crash. Always wear your safety belt, even with an air bag. The driver should sit as far back as possible while still maintaining control of the vehicle.

**⚠ CAUTION:**

An inflating air bag can seriously injure small children. Always secure children properly in your vehicle. To read how, see the part of this manual called "Children" and the caution label on the right front passenger's safety belt.



There is an air bag readiness light on the instrument panel, which shows AIR BAG.

The system checks the air bag's electrical system for malfunctions. The light tells you if there is an electrical problem. See "Air Bag Readiness Light" in the Index for more information.

## How the Air Bag System Works



### Where is the air bag?

The driver's air bag is in the middle of the steering wheel.



The right front passenger's air bag is in the instrument panel on the passenger's side.



## **CAUTION:**

**Don't put anything on, or attach anything to, the steering wheel or instrument panel. Also, don't put anything (such as pets, or objects) between any occupant and the steering wheel or instrument panel. If something is between an occupant and an air bag, it could affect the performance of the air bag -- or worse, it could cause injury.**

### **When should an air bag inflate?**

The air bag is designed to inflate in moderate to severe frontal or near-frontal crashes. The air bag will inflate only if the impact speed is above the system's designed "threshold level." If your vehicle goes straight into a wall that doesn't move or deform, the threshold level is about 8 to 11 mph (13 to 18 km/h). The threshold level can vary, however, with specific vehicle design, so that it can be somewhat above or below this range. If your vehicle strikes something that will move or deform, such as a parked car, the threshold level will be higher. The

air bag is not designed to inflate in rollovers, side impacts, or rear impacts, because inflation would not help the occupant.

It is possible that in a crash only one of the two air bags in your Riviera will deploy. This is rare, but can happen in a crash just severe enough to make an air bag inflate.

In any particular crash, no one can say whether an air bag should have inflated simply because of the damage to a vehicle or because of what the repair costs were. Inflation is determined by the angle of the impact and the vehicle's deceleration. Vehicle damage is only one indication of this.

### **What makes an air bag inflate?**

In a frontal or near-frontal impact of sufficient severity, the air bag sensing system detects that the vehicle is suddenly stopping as a result of a crash. The sensing system triggers a chemical reaction of the sodium azide sealed in the inflator. The reaction produces nitrogen gas, which inflates the air bag. The inflator, air bag, and related hardware are all part of the air bag modules packed inside the steering wheel and in the instrument panel in front of the right front passenger.



## How does an air bag restrain?

In moderate to severe frontal or near-frontal collisions, even belted occupants can contact the steering wheel or the instrument panel. The air bag supplements the protection provided by safety belts. Air bags distribute the force of the impact more evenly over the occupant's upper body, stopping the occupant more gradually. But air bags would not help you in many types of collisions, including rollovers and rear and side impacts, primarily because an occupant's motion is not toward the air bag. Air bags should never be regarded as anything more than a supplement to safety belts, and then only in moderate to severe frontal or near-frontal collisions.

## What will you see after an air bag inflates?

After the air bag inflates, it quickly deflates. This occurs so quickly that some people may not even realize the air bag inflated. Some components of the air bag module in the steering wheel hub for the driver's air bag, or the instrument panel for the right front passenger's bag, will be hot for a short time, but the part of the bag that comes into contact with you will not be hot to the touch. There will be some smoke and dust coming from vents in the deflated air bags. Air bag inflation will not prevent the driver from seeing or from being able to steer the vehicle, nor will it stop people from leaving the vehicle.

## CAUTION:

**When an air bag inflates, there is dust in the air. This dust could cause breathing problems for people with a history of asthma or other breathing trouble. To avoid this, everyone in the vehicle should get out as soon as it is safe to do so. If you have breathing problems but can't get out of the vehicle after an air bag inflates, then get fresh air by opening a window or door.**

In many crashes severe enough to inflate an air bag, windshields are broken by vehicle deformation. Additional windshield breakage may also occur from the right front passenger air bag.

- The air bags are designed to inflate only once. After they inflate, you'll need some new parts for your air bag system. If you don't get them, the air bag system won't be there to help protect you in another crash. A new system will include air bag modules and possibly other parts. The service manual for your vehicle covers the need to replace other parts.

- Your vehicle is equipped with a diagnostic module, which records information about the air bag system. The module records information about the readiness of the system, when the sensors are activated and driver's safety belt usage at deployment.
- Let only qualified technicians work on your air bag system. Improper service can mean that your air bag system won't work properly. See your dealer for service.

### **NOTICE:**

**If you damage the cover for the driver's or the right front passenger's air bag, they may not work properly. You may have to replace the air bag module in the steering wheel or both the air bag module and the instrument panel for the right front passenger's air bag. Do not open or break the air bag covers.**

## **Servicing Your Air Bag-Equipped Buick**

Air bags affect how your Buick should be serviced. There are parts of the air bag system in several places around your vehicle. You don't want the system to inflate while someone is working on your vehicle. Your Buick dealer and the 1995 Riviera Service Manual have information about servicing your vehicle and the air bag system. To purchase a service manual, see "Service and Owner Publications" in the Index.

The air bag system does not need regular maintenance.



### **CAUTION:**

**For up to 2 minutes after the ignition key is turned off and the battery is disconnected, an air bag can still inflate during improper service. You can be injured if you are close to an air bag when it inflates. Avoid wires wrapped with yellow tape, or yellow connectors. They are probably part of the air bag system. Be sure to follow proper service procedures, and make sure the person performing work for you is qualified to do so.**

## Safety Belt Use During Pregnancy

Safety belts work for everyone, including pregnant women. Like all occupants, they are more likely to be seriously injured if they don't wear safety belts.

A pregnant woman should wear a lap-shoulder belt, and the lap portion should be worn as low as possible throughout the pregnancy.

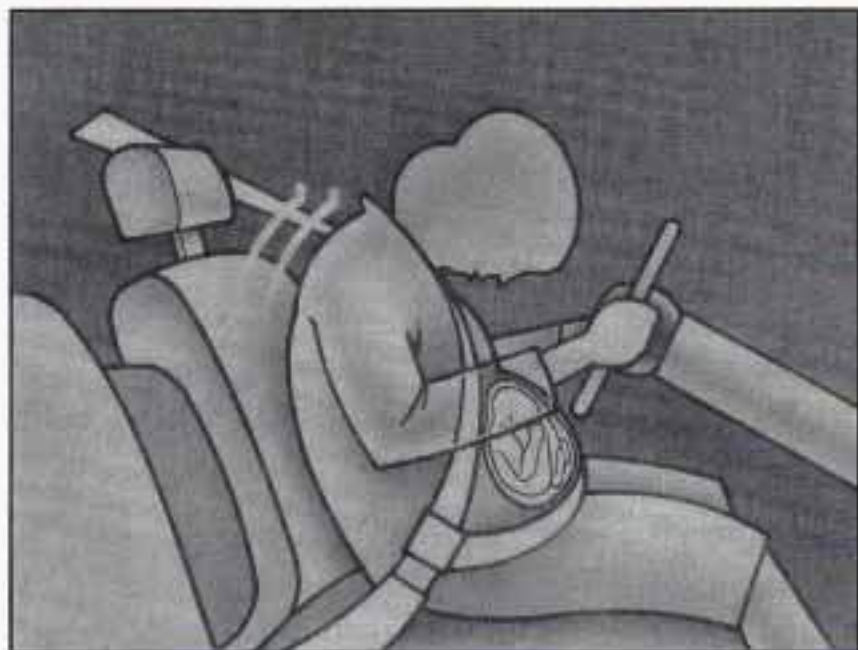

The best way to protect the fetus is to protect the mother. When a safety belt is worn properly, it's more likely that the fetus won't be hurt in a crash. For pregnant women, as for anyone, the key to making safety belts effective is wearing them properly.

## Right Front Passenger Position

The right front passenger's safety belt works the same way as the driver's safety belt. See "Driver Position," earlier in this section.

When the lap portion of the belt is pulled out all the way, it will lock. If it does, let it go back all the way and start again.

If your vehicle has a center passenger position, be sure to use the correct buckle when buckling your lap-shoulder belt. If you find that the latch plate will not go fully into the buckle, see if you are using the buckle for the center passenger position.

## Center Passenger Position

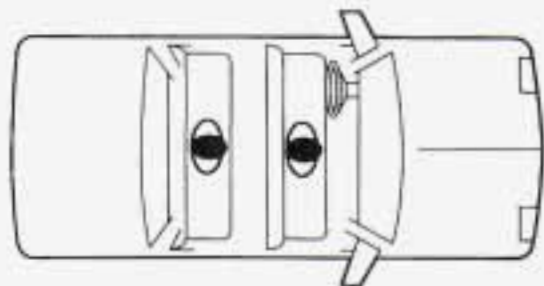

## Lap Belt

If your vehicle has a front split seat and a rear bench seat, someone can sit in the center positions.

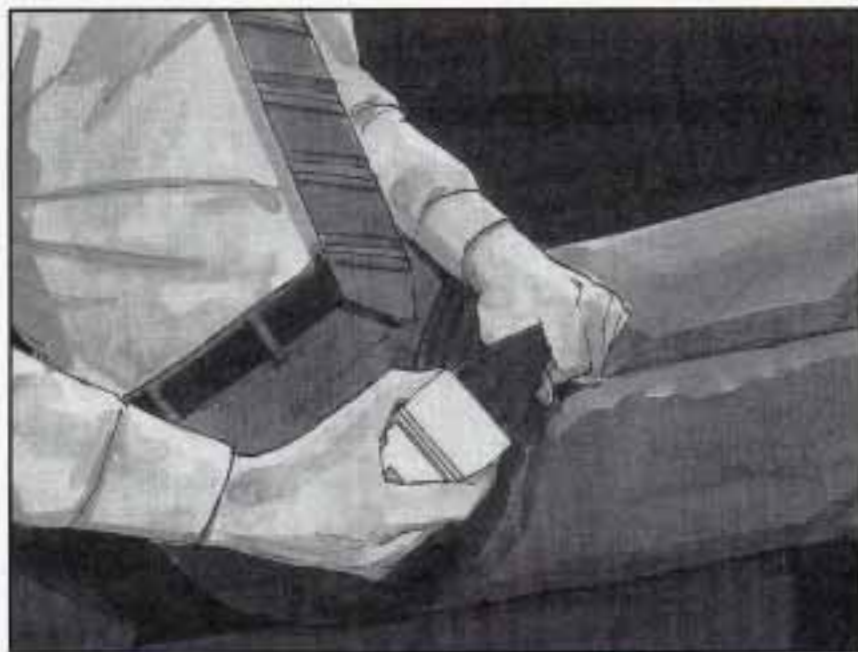

When you sit in a center seating position, you have a lap safety belt, which has no retractor. To make the belt longer, tilt the latch plate and pull it along the belt.

To make the belt shorter, pull its free end as shown until the belt is snug.



Buckle, position and release it the same way as the lap part of a lap-shoulder belt. If the belt isn't long enough, see "Safety Belt Extender" at the end of this section.

Make sure the release button on the buckle is positioned so you would be able to unbuckle the safety belt quickly if you ever had to.

## Rear Seat Passengers

It's very important for rear seat passengers to buckle up! Accident statistics show that unbelted people in the rear seat are hurt more often in crashes than those who are wearing safety belts.

Rear passengers who aren't safety belted can be thrown out of the vehicle in a crash. And they can strike others in the vehicle who are wearing safety belts.

## Rear Seat Outside Passenger Positions

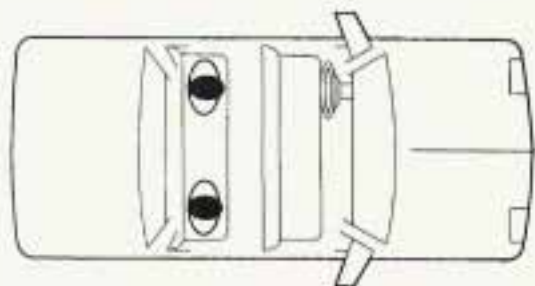

## Lap-Shoulder Belt

The positions next to the windows have lap-shoulder belts. Here's how to wear one properly.



1. Pick up the latch plate and pull the belt across you. Don't let it get twisted.
2. Push the latch plate into the buckle until it clicks.



If the belt stops before it reaches the buckle, tilt the latch plate and keep pulling until you can buckle it.

Pull up on the latch plate to make sure it is secure.

If the belt is not long enough, see "Safety Belt Extender" at the end of this section. Make sure the release button on the buckle is positioned so you would be able to unbuckle the safety belt quickly if you ever had to.



3. To make the lap part tight, pull down on the buckle end of the belt as you pull up on the shoulder part.

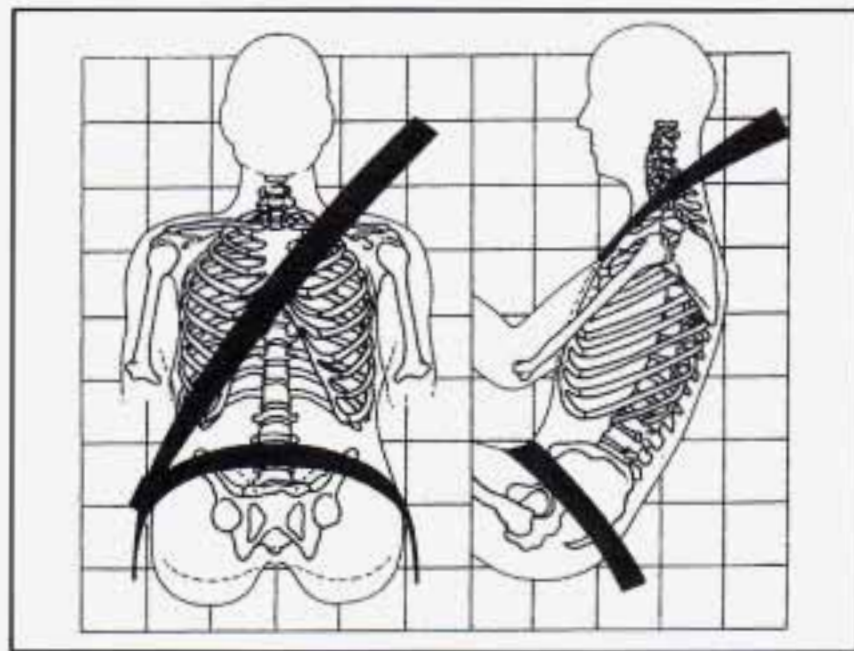

The lap part of the belt should be worn low and snug on the hips, just touching the thighs. In a crash, this applies force to the strong pelvic bones. And you'd be less likely to slide under the lap belt. If you slid under it, the belt would apply force at your abdomen. This could cause serious or even fatal injuries. The shoulder belt should go over the shoulder and across the chest. These parts of the body are best able to take belt restraining forces.

The safety belt locks if there's a sudden stop or a crash.

 **CAUTION:**

You can be seriously hurt if your shoulder belt is too loose. In a crash you would move forward too much, which could increase injury. The shoulder belt should fit against your body.



To unlatch the belt, just push the button on the buckle.



## Rear Safety Belt Comfort Guides for Children and Small Adults

Rear shoulder belt comfort guides will provide added comfort for children who have outgrown child restraints and for small adults. The comfort guides pull the shoulder belts away from the neck and head.

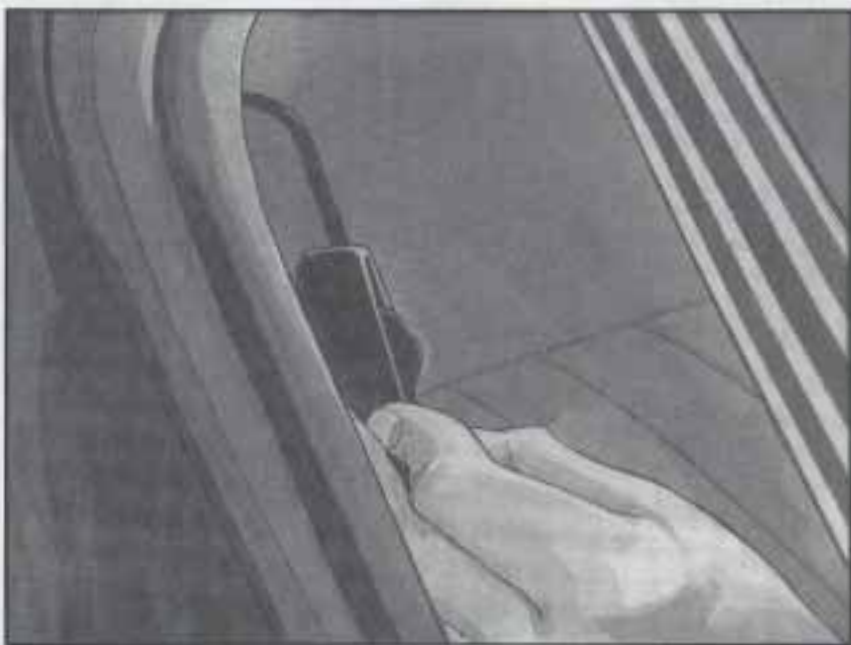

There is one guide for each outside passenger position in the rear seat. You will find them tucked in between the seatback and the interior body, about half-way down the edge of the seatback. Here is how you should install the comfort guides on the shoulder belts:

1. Pull the elastic cord out from between the edge of the seatback and the interior body to remove the guide from its storage clip.



- Slide the guide under and past the belt. The elastic cord must be under the belt. Then, place the guide over the belt, and insert the two edges of the belt into the slots of the guide.

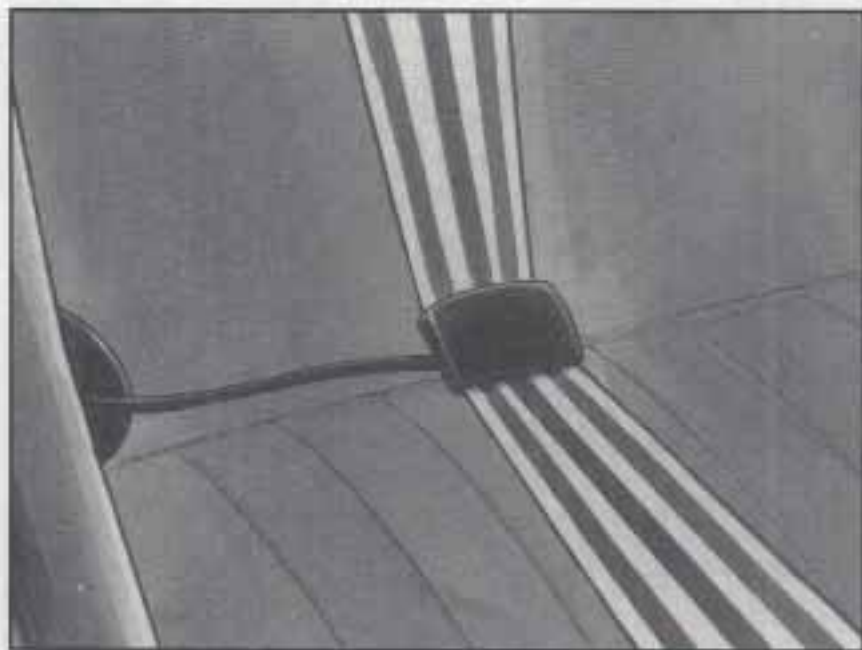

- Be sure that the belt is not twisted and it lies flat. The elastic cord must be under the belt and the guide on top.



- Buckle the belt around the child, and make sure that both the lap belt and the shoulder belt are secured properly. Make sure that the shoulder belt crosses the shoulder. See "Safety Belts, Rear Seat Passengers" in the Index.

To remove and store the comfort guides, just perform these steps in reverse order. Squeeze the belt edges together so that you can take them out from the guides. Pull the guide upward to expose its storage clip, and then slide the guide onto the clip. Rotate the guide and clip inward and in between the seatback and the interior body, leaving only the loop of elastic cord exposed.

## Children

Everyone in a vehicle needs protection! That includes infants and all children smaller than adult size. In fact, the law in every state in the United States and in every Canadian province says children up to some age must be restrained while in a vehicle.

### Smaller Children and Babies

#### CAUTION:

Smaller children and babies should always be restrained in a child or infant restraint. The instructions for the restraint will say whether it is the right type and size for your child. A very young child's hip bones are so small that a regular belt might not stay low on the hips, as it should. Instead, the belt will likely be over the child's abdomen. In a crash the belt would apply force right on the child's abdomen, which could cause serious or fatal injuries. So, be sure that any child small enough for one is always properly restrained in a child or infant restraint.



#### CAUTION:

Never hold a baby in your arms while riding in a vehicle. A baby doesn't weigh much -- until a crash. During a crash a baby will become so heavy you can't hold it. For example, in a crash at only 25 mph (40 km/h), a 12-pound (5.5 kg)

CAUTION: (Continued)

**CAUTION: (Continued)**

**baby will suddenly become a 240-pound (110 kg) force on your arms. The baby would be almost impossible to hold.**

**Secure the baby in an infant restraint.**



## Child Restraints

Be sure to follow the instructions for the restraint. You may find these instructions on the restraint itself or in a booklet, or both. These restraints use the belt system in your vehicle, but the child also has to be secured within the restraint to help reduce the chance of personal injury. The instructions that come with the infant or child restraint will show you how to do that.

### Where to Put the Restraint

Accident statistics show that children are safer if they are restrained in the rear rather than the front seat. We at General Motors therefore recommend that you put your child restraint in the rear seat. *Never* put a rear-facing child restraint in the front passenger seat. Here's why:

 **CAUTION:**

A child in a rear-facing child restraint can be seriously injured if the right front passenger's air bag inflates. This is because the back of a rear-facing child restraint would be very close to the inflating air bag. Always secure a rear-facing child restraint in the rear seat.

You may, however, secure a forward-facing child restraint in the right front seat. Before you secure a forward-facing child restraint, always move the front passenger seat as far back as it will go. Or, secure the child restraint in the rear seat.

 **CAUTION:**

A child in a child restraint in the center front seat can be badly injured by the passenger air bag if it inflates. Never use a child restraint in the center front seat. It's always better to secure a child restraint in the rear seat. You may, however, secure a forward-facing child restraint in the right front passenger seat, but only with the seat moved all the way back.

Wherever you install it, be sure to secure the child restraint properly.

Keep in mind that an unsecured child restraint can move around in a collision or sudden stop and injure people in the vehicle. Be sure to properly secure any child restraint in your vehicle -- even when no child is in it.

## Top Strap



If your child restraint has a top strap, it should be anchored.

If you need to have an anchor installed, you can ask your Buick dealer to put it in for you. If you want to install an anchor yourself, your dealer can tell you how to do it.

For cars first sold in Canada, child restraints with a top strap must be anchored according to Canadian Law.

Your dealer can obtain the hardware kit and install it for you, or you may install it yourself using the instructions provided in the kit.

Use the tether hardware kit available from the dealer. The hardware and installation instructions were specifically designed for this vehicle.

## Securing a Child Restraint in a Rear Outside Seat Position

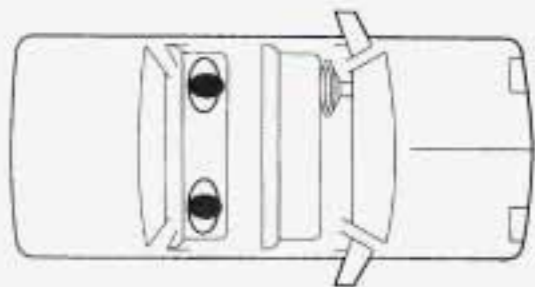

You'll be using the lap-shoulder belt. See the earlier part about the top strap if the child restraint has one.

1. Put the restraint on the seat. Follow the instructions for the child restraint.
2. Secure the child in the child restraint as the instructions say.
3. Pick up the latch plate, and run the lap and shoulder portions of the vehicle's safety belt through or around the restraint. The child restraint instructions will show you how. Tilt the latch plate to adjust the belt if needed.

If the shoulder belt goes in front of the child's face or neck, put it behind the child restraint.

4. Buckle the belt. Make sure the release button is positioned so you would be able to unbuckle the safety belt quickly if you ever had to.



5. To tighten the belt, pull up on the shoulder belt while you push down on the child restraint.



6. Push and pull the child restraint in different directions to be sure it is secure.

To remove the child restraint, just unbuckle the vehicle's safety belt and let it go back all the way. The safety belt will move freely again and be ready to work for an adult or larger child passenger.

## Securing a Child Restraint in the Center Rear Seat Position

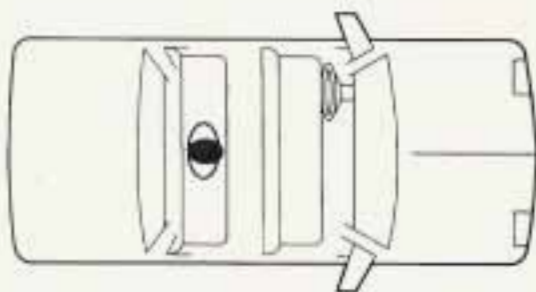

You'll be using the lap belt.

### CAUTION:

A child in a child restraint in the center front seat can be badly injured by the right front passenger air bag if it inflates. Never secure a child restraint in the center front seat. It's always better to secure a child restraint in the rear seat. You may, however, secure a forward-facing child restraint in the right front passenger seat, but only with the seat moved all the way back.



See the earlier part about the top strap if the child restraint has one.

1. Make the belt as long as possible by tilting the latch plate and pulling it along the belt.

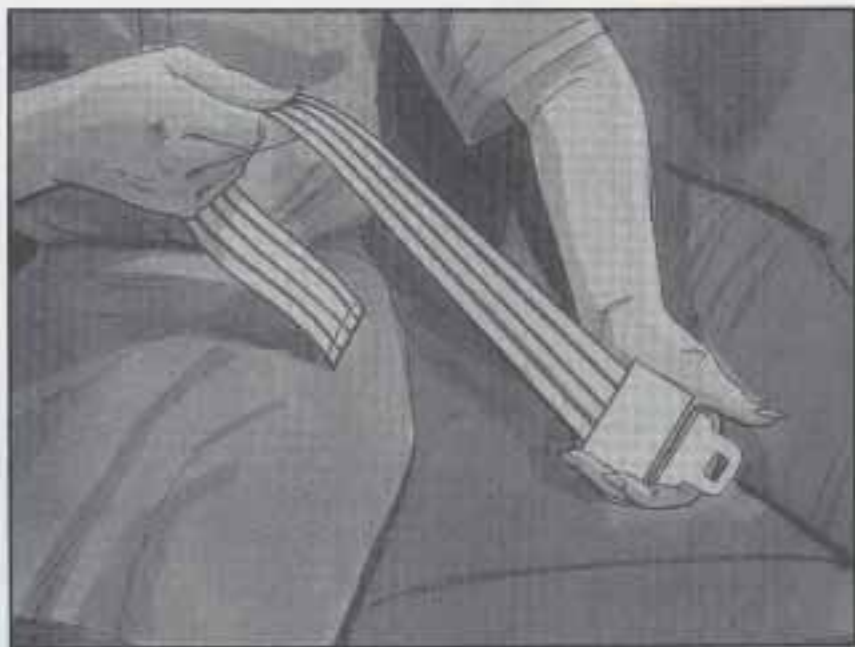

2. Put the restraint on the seat. Follow the instructions for the child restraint.
3. Secure the child in the child restraint as the instructions say.

4. Run the vehicle's safety belt through or around the restraint. The child restraint instructions will show you how.



5. Buckle the belt. Make sure the release button is positioned so you would be able to unbuckle the safety belt quickly if you ever had to.
6. To tighten the belt, pull its free end while you push down on the child restraint.

7. Push and pull the child restraint in different directions to be sure it is secure. If the child restraint isn't secure, turn the latch plate over and buckle it again. Then see if it is secure. If it isn't, secure the restraint in a different place in the vehicle and contact the child restraint maker for their advice about how to attach the child restraint properly.

To remove the child restraint, just unbuckle the vehicle's safety belt. It will be ready to work for an adult or larger child passenger.

### Securing a Child Restraint in the Right Front Seat Position

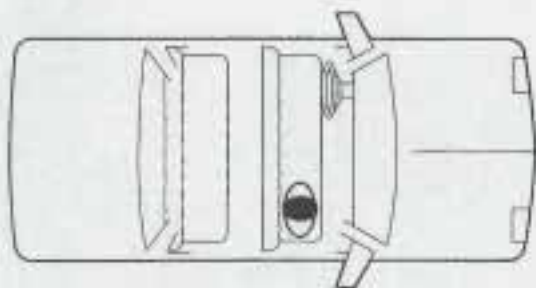

Your vehicle has a right front passenger air bag. *Never* put a rear-facing child restraint in this seat. Here's why:

### CAUTION:

A child in a rear-facing child restraint can be seriously injured if the right front passenger's air bag inflates. This is because the back of a rear-facing child restraint would be very close to the inflating air bag. Always secure a rear-facing child restraint in the rear seat.

You'll be using the lap-shoulder belt. See the earlier part about the top strap if the child restraint has one.

1. Because your vehicle has a right front passenger air bag, always move the seat as far back as it will go before securing a forward-facing child restraint. (See "Seats" in the Index.)
2. Put the restraint on the seat. Follow the instructions for the child restraint.
3. Secure the child in the child restraint as the instructions say.

- Pick up the latch plate, and run the lap and shoulder portions of the vehicle's safety belt through or around the restraint. The child restraint instructions will show you how.

If the shoulder belt goes in front of the child's face or neck, put it behind the child restraint.



- Buckle the belt.

Make sure the release button is positioned so you would be able to unbuckle the safety belt quickly if you ever had to.

- Pull the rest of the lap belt all the way out of the retractor to set the lock.



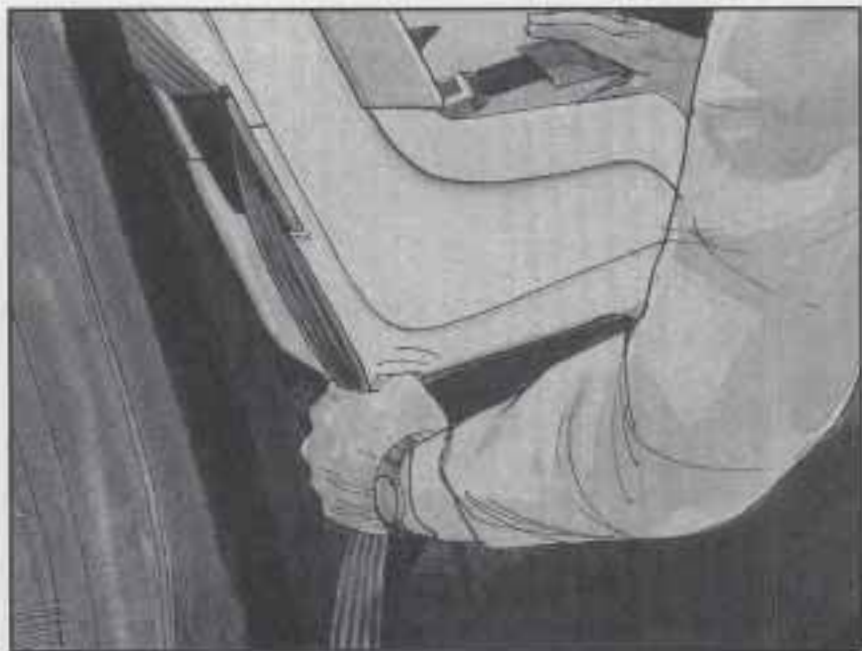

7. To tighten the belt, feed the lap belt back into the retractor while you push down on the child restraint.

8. Push and pull the child restraint in different directions to be sure it is secure.

To remove the child restraint, just unbuckle the vehicle's safety belt and let it go back all the way.

The safety belt will move freely again and be ready to work for an adult or larger child passenger.

## Larger Children



Children who have outgrown child restraints should wear the vehicle's safety belts.

If you have the choice, a child should sit next to a window so the child can wear a lap-shoulder belt and get the additional restraint a shoulder belt can provide.

Accident statistics show that children are safer if they are restrained in the rear seat. But they need to use the safety belts properly.

- Children who aren't buckled up can be thrown out in a crash.
- Children who aren't buckled up can strike other people who are.

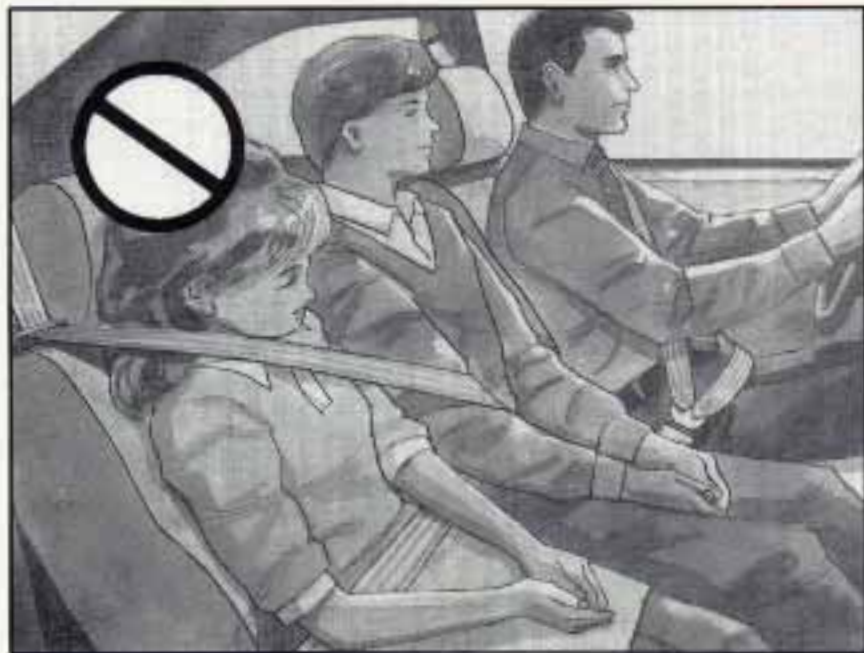

**Q:** What if a child is wearing a lap-shoulder belt, but the child is so small that the shoulder belt is very close to the child's face or neck?

**A:** Move the child toward the center of the vehicle, but be sure that the shoulder belt still is on the child's shoulder, so that in a crash the child's upper body would have the restraint that belts provide. If the child is sitting in a rear seat outside position, see "Rear Safety Belt Comfort Guides" in the Index. If the child is so small that the shoulder belt is still very close to the child's face or neck, you might want to place the child in the center seat position, the one that has only a lap belt.



### **CAUTION:**

**Never do this.**

Here two children are wearing the same belt. The belt can't properly spread the impact forces. In a crash, the two children can be crushed together and seriously injured. A belt must be used by only one person at a time.



**⚠ CAUTION:**

**Never do this.**

Here a child is sitting in a seat that has a lap-shoulder belt, but the shoulder part is behind the child. If the child wears the belt in this way, in a crash the child might slide under the belt. The belt's force would then be applied right on the child's abdomen. That could cause serious or fatal injuries.

Wherever the child sits, the lap portion of the belt should be worn low and snug on the hips, just touching the child's thighs. This applies belt force to the child's pelvic bones in a crash.

## Safety Belt Extender

If the vehicle's safety belt will fasten around you, you should use it.

But if a safety belt isn't long enough to fasten, your dealer will order you an extender. It's free. When you go in to order it, take the heaviest coat you will wear, so the extender will be long enough for you. The extender will be just for you, and just for the seat in your vehicle that you choose. Don't let someone else use it, and use it only for the seat it is made to fit. To wear it, just attach it to the regular safety belt.

## Checking Your Restraint Systems

Now and then, make sure all your belts, buckles, latch plates, retractors, anchorages and reminder systems are working properly. Look for any other loose or damaged restraint system parts. If you see anything that might keep a restraint system from doing its job, have it repaired.

Torn or frayed belts may not protect you in a crash. They can rip apart under impact forces. If a belt is torn or frayed, get a new one right away.



## Replacing Seat and Restraint System Parts After a Crash

If you've had a crash, do you need new belts?

After a very minor collision, nothing may be necessary. But if the belts were stretched, as they would be if worn during a more severe crash, then you need new belts.

If you ever see a label on the driver's or the right front passenger's safety belt that says to replace the belt, be sure to do so. Then the new belt will be there to help protect you in an accident. You would see this label on the belt near the latch plate.

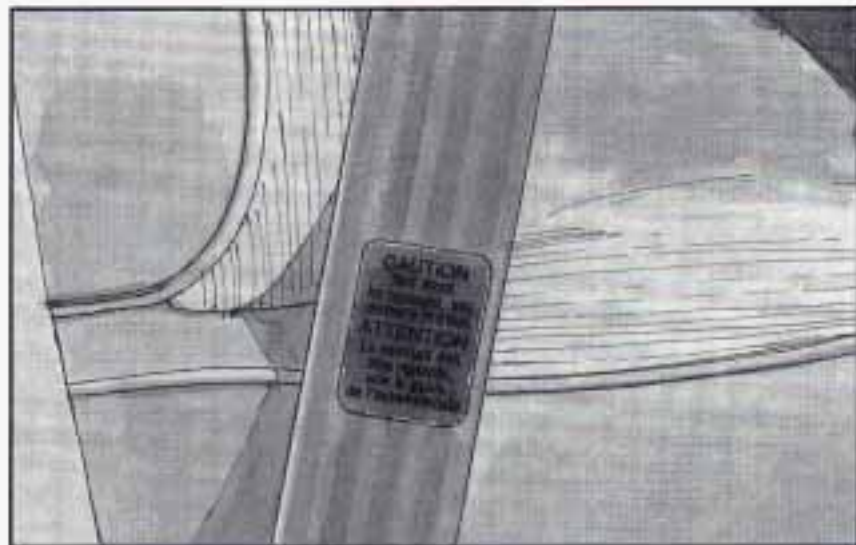

If belts are cut or damaged, replace them. Collision damage also may mean you will need to have safety belt or seat parts repaired or replaced. New parts and repairs may be necessary even if the belt wasn't being used at the time of the collision.

If your seat adjuster won't work after a crash, the special part of the safety belt that goes through the seat to the adjuster may need to be replaced.



## Section 2 Features and Controls

Here you can learn about the many standard and optional features on your Buick, and information on starting, shifting and braking. Also explained are the instrument panel and the warning systems that tell you if everything is working properly -- and what to do if you have a problem.

### Keys

#### CAUTION:

Leaving young children in a vehicle with the ignition key is dangerous for many reasons. A child or others could be badly injured or even killed.

They could operate power windows or other controls or even make the vehicle move. Don't leave the keys in a vehicle with young children.





The ignition key is for the ignition only.



The door key is for the doors and all other locks.

When a new Riviera is delivered, the dealer removes the plugs from the keys, and gives them to the first owner. However, if the ignition key does not have a plug, there may be a bar-coded key tag instead.

Each plug or bar-coded key tag has a code on it that tells your dealer or a qualified locksmith how to make extra keys. Keep the tags or plugs in a safe place. If you lose your keys, you'll be able to have new ones made easily using these tags or plugs. If your ignition keys don't have tags or plugs, go to your Buick dealer for the correct key code if you need a new ignition key.

### **NOTICE:**

**Your Buick has a number of new features that can help prevent theft. But you can have a lot of trouble getting into your vehicle if you ever lock your keys inside. You may even have to damage your vehicle to get in. So be sure you have extra keys.**

## Key Reminder Warning

If you leave your keys in the ignition, you will hear a warning chime when you turn off the ignition and open the driver's door.

## Door Locks

### CAUTION:

Unlocked doors can be dangerous.

Passengers -- especially children -- can easily open the doors and fall out. When a door is locked, the inside handle won't open it.

Outsiders can easily enter through an unlocked door when you slow down or stop your vehicle.

This may not be so obvious: You increase the chance of being thrown out of the vehicle in a crash if the doors aren't locked. Wear safety belts properly, lock your doors, and you will be far better off whenever you drive your vehicle.

There are several ways to lock and unlock your vehicle:



From the outside: Use your door key.

If your vehicle has a theft deterrent system and it is activated, unlock the doors only with the key or Remote Keyless Entry System. This will avoid setting off the alarm.

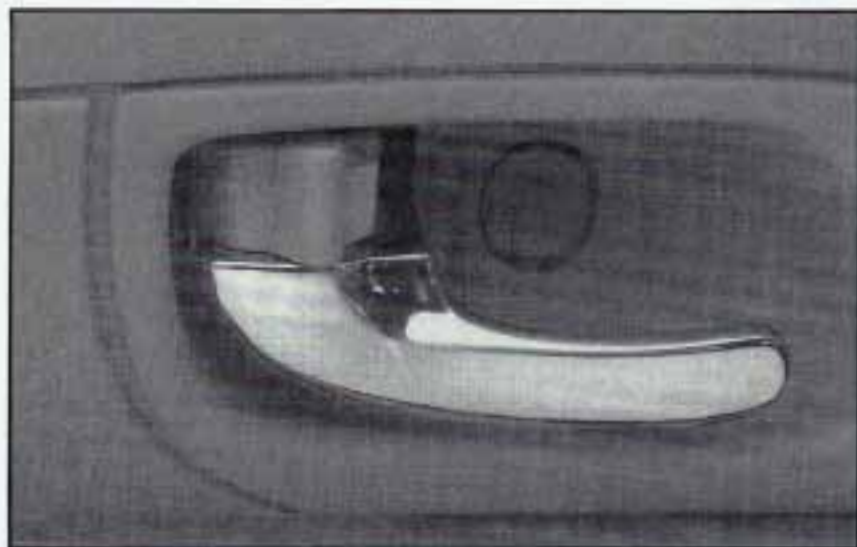

From the inside: To lock the door, move the lock control on the door forward.

To unlock the door, move the lock control toward the rear of the vehicle. There is a red mark on the lock control which shows when the door is unlocked.

## Power Door Locks



Push the power DOOR LOCK/UNLOCK switch to lock or unlock both doors at once.

## Programmable Automatic Door Locks (Option)

Close your doors and turn on the ignition. Every time you move your shift lever out of PARK (P) all of the doors will lock. And, every time you stop and move your shift lever into PARK (P), your doors will unlock. If someone needs to get out while you're not in PARK (P), have that person use the manual or power lock. When the door is closed again, it will not lock automatically. Just use the manual or power lock to lock the door again.

You can program the automatic door lock feature to allow the doors to remain locked after you shift into PARK (P).

To program the automatic door locks:

1. Close your doors and turn the ignition ON.
2. Keep your foot on the brake pedal.
3. Press and hold the driver's power DOOR LOCK switch.
4. Move your shift lever out of PARK (P), then move the shift lever back into PARK (P).
5. Release the LOCK switch.

Your doors will now lock when you shift out of PARK (P) and remain locked until you use the manual or power door lock switch.

To reprogram the door locks to lock and unlock when you shift in and out of PARK (P), do the following:

1. Close your doors and turn the ignition ON.
2. Keep your foot on the brake pedal.
3. Press and hold the driver's power DOOR UNLOCK switch.
4. Move the shift lever out of PARK (P), then move the shift lever back into PARK (P).
5. Release the UNLOCK switch.

## **Leaving Your Vehicle**

If you are leaving the vehicle, take your keys, open your door and set the locks from inside. Then get out and close the door.

If your vehicle has a theft deterrent system, see "Universal Theft Deterrent" in the Index.

## Remote Keyless Entry System



You can lock and unlock your doors or unlock your trunk from up to 15 feet (5 m) away using the key chain transmitter supplied with your vehicle.

Your Remote Keyless Entry System operates on a radio frequency subject to Federal Communications Commission (FCC) Rules.

This device complies with Part 15 of the FCC Rules. Operation is subject to the following two conditions:  
(1) This device may not cause harmful interference, and  
(2) This device must accept any interference received, including interference that may cause undesired operation.

Should interference to this system occur, try this:

- Check to determine if battery replacement is necessary. See the instructions on battery replacement.
- Check the distance. You may be too far from your vehicle. This product has a maximum range.
- Check the location. Other vehicles or objects may be blocking the signal.
- See your Buick dealer or a qualified technician for service.

Changes or modifications to this system by other than an authorized service facility could void authorization to use this equipment.

## Operation

The driver's door will unlock when UNLOCK is pressed.

If UNLOCK is pressed twice quickly, both doors will unlock.

Both doors will lock when LOCK is pressed.

The trunk will unlock when the opened trunk symbol is pressed, but only when the ignition is OFF.

## Illuminated Entry System

Touch any button on the key tag and the interior courtesy lamps will come on and stay on for 15 to 30 seconds.

## Theft Deterrent System

If your Buick has this option, the key tag will arm it when the doors are closed and you push the LOCK button. It will disarm the system when you push the UNLOCK button on the key tag.

## Matching Transmitter(s) To Your Vehicle

Each key chain transmitter is coded to prevent another transmitter from unlocking your vehicle. If a transmitter is lost or stolen, a replacement can be purchased through your dealer. Remember to bring any remaining transmitters with you when you go to your dealer. When the dealer matches the replacement transmitter to your vehicle, the remaining transmitters must also be matched. Once the new transmitter is coded, the lost transmitter will not unlock your vehicle.

You can match a transmitter to as many different vehicles as you own, provided they are equipped with *exactly the same model system*. (General Motors offers several different models of these systems on their vehicles.) Each vehicle can have only two transmitters matched to it.

See your dealer to match transmitters to another vehicle.



## Battery Replacement

Under normal use, the batteries in your key chain transmitter should last about two years.

You can tell the batteries are weak if the transmitter won't work at the normal range in any location. If you have to get close to your vehicle before the transmitter works, it's probably time to change the batteries.



For battery replacement, use two Duracell<sup>®</sup> batteries, type DL-2016, or a similar type.

To replace the batteries:

1. Remove the screw from the back cover.
2. Lift off the front cover, bottom half first.

3. Remove and replace the batteries. Put them in as the instructions under the cover indicate.
4. Replace the front cover. Make sure the cover is on tightly, so water won't get in. Replace the screw in the back cover.

## Trunk

### Remote Trunk Release



Press the TRUNK release button located below the driver's door handle to release the trunk lid. The trunk will open if the transaxle is in PARK (P) and if the trunk security release is not in the OFF position.

If you have the Remote Keyless Entry System, it also will unlock your trunk if the ignition is OFF.

## Trunk Security Release

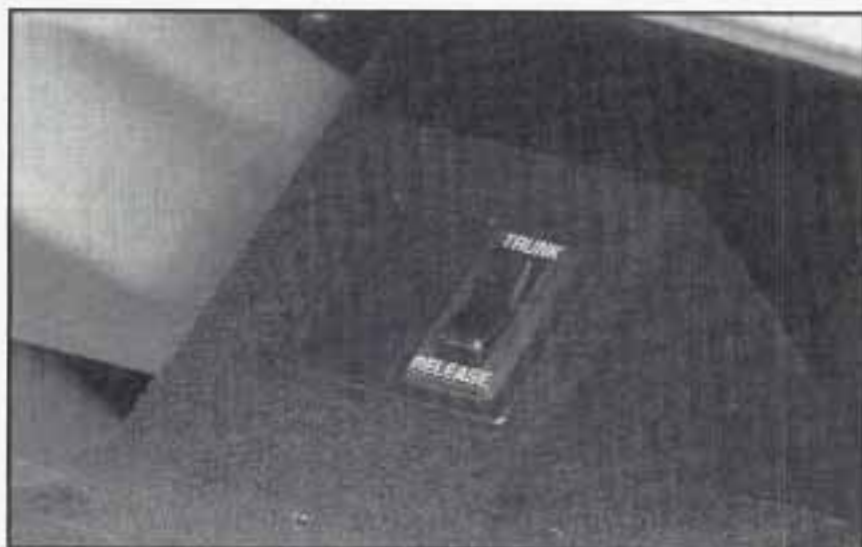

The trunk release switch in the glove box allows you to secure items in the trunk. Move the trunk release switch to off, lock the glove box and take the key with you. Now the trunk release on the driver's door will not open the trunk.

### CAUTION:

It can be dangerous to drive with the trunk lid open because carbon monoxide (CO) gas can come into your vehicle. You can't see or smell CO. It can cause unconsciousness and even death. If you must drive with the trunk lid open or if electrical wiring or other cable connections must pass through the seal between the body and the trunk lid:

- Make sure all windows are shut.
- Turn the fan on your heating or cooling system to its highest speed with the setting on ECON. That will force outside air into your vehicle. See "Comfort Controls" in the Index.
- If you have air outlets on or under the instrument panel, open them all the way. See "Engine Exhaust" in the Index.

## Theft

Vehicle theft is big business, especially in some cities. Although your Buick has a number of theft deterrent features, we know that nothing we put on it can make it impossible to steal. However, there are ways you can help.

### Key in the Ignition

If you walk away from your vehicle with the keys inside, it's an easy target for joy riders or professional thieves -- so don't do it.

When you park your Buick and open the driver's door, you'll hear a chime reminding you to remove your key from the ignition and take it with you. Always do this. Your steering wheel will be locked, and so will your ignition and transaxle. And remember to lock the doors.

## Parking at Night

Park in a lighted spot, close all windows and lock your vehicle. Remember to keep your valuables out of sight. Put them in a storage area, or take them with you.

### Parking Lots

If you park in a lot where someone will be watching your vehicle, it's best to lock it up and take your keys. But what if you have to leave your ignition key? What if you have to leave something valuable in your vehicle?

- Put your valuables in a storage area, like your trunk or glove box.
- Lock the glove box.
- Lock all the doors except the driver's.
- Then take the door key with you.

## Universal Theft Deterrent (Option)

If your Buick has this option, it has a theft deterrent alarm system. With this system, the SECURITY light will flash as you open the door (if your ignition is off).

This light reminds you to activate the theft deterrent system. Here's how to do it:

1. Open the door.
2. Lock the door with the power door lock switch or Remote Keyless Entry System. The SECURITY light should come on and stay on.
3. Close all doors. The SECURITY light should go off after about 30 seconds. The security system is not armed until the SECURITY light is off. If the SECURITY light stays on when the ignition is turned on, there is a problem with the system and the vehicle should be serviced.

If a door or the trunk is opened without the key or Remote Keyless Entry System, the alarm will go off. It will also go off if the trunk lock is damaged. Your vehicle's lamps will flash and the horn will sound for several minutes, then will go off to save battery power.

Remember, the theft deterrent system won't be activated if you lock the doors with a key or manual door lock. It only activates if you use a power door lock switch or Remote Keyless Entry System. You should also remember that you can start your vehicle with the correct ignition key if the alarm has been set off, but this does not shut off the alarm.

Here's how to avoid setting off the alarm by accident:

- If you don't want to activate the theft deterrent system, the vehicle should be locked *after* the doors are closed.
- Always unlock a door with a key, or use the Remote Keyless Entry System. Unlocking a door any other way will set off the alarm.

*If you set off the alarm by accident, unlock any door with your key.*

You can also turn off the alarm by using the Keyless Entry System. The alarm won't stop if you try to unlock a door any other way.

## How to Test the Alarm

The alarm can be tested by first having the driver's window down. Activate the system by locking the doors with the power door lock switch or the Remote Keyless Entry System. Get out of the car and close the door and wait for the SECURITY light to go out. Then reach in through the window, unlock the door with the manual door lock, and open the door. This should set off the alarm.

If the alarm does not sound when it should, check to see if the horn works. The horn fuse may be blown. To replace the fuse, see "Fuses and Circuit Breakers" in the Index.

To reduce the possibility of theft, always activate the theft deterrent system when leaving your vehicle.

## PASS-Key<sup>®</sup> II



Your vehicle is equipped with the PASS-Key<sup>®</sup> II (Personalized Automotive Security System) theft deterrent system. PASS-Key<sup>®</sup> II is a passive theft deterrent system.

This means you don't have to do anything different to arm or disarm the system. It works when you insert or remove the key from the ignition. PASS-Key<sup>®</sup> II uses a resistor pellet in the ignition key that matches a decoder in your vehicle.

When the PASS-Key® II system senses that someone is using the wrong key, it shuts down the vehicle's starter and fuel systems. For about three minutes, the starter won't work and fuel won't go to the engine. If someone tries to start your vehicle again or uses another key during this time, the vehicle will not start. This discourages someone from randomly trying different keys with different resistor pellets in an attempt to make a match.

The ignition key must be clean and dry before it's inserted in the ignition or the engine may not start. If the engine does not start and the SECURITY light comes on, the key may be dirty or wet. Turn the ignition off.

Clean and dry the key. Wait about three minutes and try again. The SECURITY light may remain on during this time. If the starter still won't work, and the key appears to be clean and dry, wait about three minutes and try another ignition key. At this time, you may also want to check the fuse (see "Fuses and Circuit Breakers" in the Index). If the starter won't work with the other key, your

vehicle needs service. If your vehicle does start, the first ignition key may be faulty. See your Buick dealer or a locksmith who can service the PASS-Key® II.

If you accidentally use a key that has a damaged or missing resistor pellet, the starter won't work and the SECURITY light will flash. But you don't have to wait three minutes before trying another ignition key.

See your Buick dealer or a locksmith who can service the PASS-Key® II to have a new key made.

If you're ever driving and the SECURITY light comes on, you will be able to restart your engine if you turn it off. Your PASS-Key® II system, however, is not working properly and must be serviced by your Buick dealer. Your vehicle is not protected by the PASS-Key® II system.

If you lose or damage a PASS-Key® II ignition key, see your Buick dealer or a locksmith who can service PASS-Key® II to have a new key made.

## New Vehicle “Break-In”

### **NOTICE:**

Your modern Buick doesn't need an elaborate “break-in.” But it will perform better in the long run if you follow these guidelines:

- Don't drive at any one speed -- fast or slow -- for the first 500 miles (804 km). Don't make full-throttle starts.
- Avoid making hard stops for the first 200 miles (322 km) or so. During this time your new brake linings aren't yet broken in. Hard stops with new linings can mean premature wear and earlier replacement. Follow this “breaking-in” guideline every time you get new brake linings.
- Don't tow a trailer during “break-in.” See “Towing a Trailer” in the Index for more information.

## Ignition Key Positions



The key with the black plastic head operates the ignition lock.

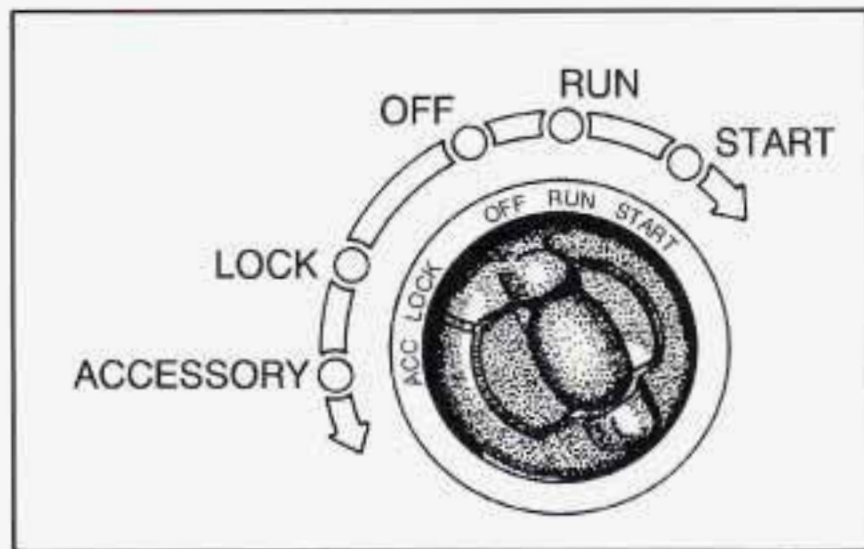

With the ignition key in the ignition switch, you can turn the switch to five different positions:

**ACC (Accessory):** This position lets you use things like the radio and the windshield wipers when the engine is off. To use, push in the key and turn it toward you. Your steering wheel will remain locked, just as it was before you inserted the key.

**LOCK:** Before you put the key in, your ignition will be in the LOCK position. This position locks your ignition, steering wheel and transaxle. It's a theft deterrent feature.

**OFF:** This position lets you turn off the engine but still turn the steering wheel. It doesn't lock the steering wheel like LOCK. Use OFF if you must have your car in motion while the engine is not running.

**RUN:** This is the position for driving.

**START:** This key position starts your engine.

### **NOTICE:**

If your key seems stuck in LOCK and you can't turn it, be sure it is all the way in. If it is, then turn the steering wheel left and right while you turn the key hard. But turn the key only with your hand. Using a tool to force it could break the key or the ignition switch. If none of this works, then your vehicle needs service.



## Retained Accessory Power

After the ignition is turned off, and before any door is opened, the following systems will work for 10 minutes:

- Power windows
- Radio
- Clock (with radio off)
- Astrorooftop (option)

## Starting Your Engine

Move your shift lever to PARK (P) or NEUTRAL (N). Your engine won't start in any other position -- that's a safety feature. To restart when you're already moving, use NEUTRAL (N) only.

### **NOTICE:**

**Don't try to shift to PARK (P) if your Buick is moving. If you do, you could damage the transaxle. Shift to PARK (P) only when your vehicle is stopped.**

1. Without pushing the accelerator pedal, turn your ignition key to START. When the engine starts, let go of the key. The idle speed will go down as your engine gets warm.

### **NOTICE:**

**Holding your key in START for longer than 15 seconds at a time will cause your battery to be drained much sooner. And the excessive heat can damage your starter motor.**

2. If it doesn't start right away, hold your key in START for about three to five seconds at a time until your engine starts. Wait about 15 seconds between each try to help avoid draining your battery.
3. If your engine still won't start (or starts but then stops), it could be flooded with too much gasoline. Try pushing your accelerator pedal all the way to the floor and holding it there as you hold the key in START for about three seconds. If the vehicle starts briefly but then stops again, do the same thing, but this time keep the pedal down for five or six seconds. This clears the extra gasoline from the engine. After waiting about 15 seconds, repeat the normal starting procedure.

## **NOTICE:**

Your engine is designed to work with the electronics in your vehicle. If you add electrical parts or accessories, you could change the way the fuel injection system operates. Before adding electrical equipment, check with your dealer. If you don't, your engine might not perform properly.

If you ever have to have your vehicle towed, see the part of this manual that tells how to do it without damaging your vehicle. See "Towing Your Vehicle" in the Index.

## **Driving Through Deep Standing Water**

### **NOTICE:**

If you drive too quickly through deep puddles or standing water, water can come in through your engine's air intake and badly damage your engine. Never drive through water that is slightly lower than the underbody of your vehicle. If you can't avoid deep puddles or standing water, drive through them very slowly.

## Engine Coolant Heater (Option)

In very cold weather, 0°F (-18°C) or colder, the engine coolant heater can help. You'll get easier starting and better fuel economy during engine warm-up. Usually, the coolant heater should be plugged in a minimum of four hours prior to starting your vehicle.

### To use the coolant heater:

1. Turn off the engine.
2. Open the hood and unwrap the electrical cord.
3. Plug it into a normal, grounded 110-volt outlet.

### CAUTION:

Plugging the cord into an ungrounded outlet could cause an electrical shock. Also, the wrong kind of extension cord could overheat and cause a fire. You could be seriously injured. Plug the cord into a properly grounded three-prong 110-volt outlet. If the cord won't reach, use a heavy-duty three-prong extension cord rated for at least 15 amps.

### NOTICE:

**After you've used the coolant heater, be sure to store the cord as it was before to keep it away from moving engine parts. If you don't, it could be damaged.**

How long should you keep the coolant heater plugged in? The answer depends on the weather, the kind of oil you have, and some other things. Instead of trying to list everything here, we ask that you contact your Buick dealer in the area where you'll be parking your vehicle. The dealer can give you the best advice for that particular area.

## Automatic Transaxle



There are several different positions for your shift lever.

**PARK (P):** This locks your front wheels. It's the best position to use when you start your engine because your vehicle can't move easily.

### **CAUTION:**

It is dangerous to get out of your vehicle if the shift lever is not fully in PARK (P) with the parking brake firmly set. Your vehicle can roll.

Don't leave your vehicle when the engine is running unless you have to. If you have left the engine running, the vehicle can move suddenly. You or others could be injured. To be sure your vehicle won't move, even when you're on fairly level ground, always set your parking brake and move the shift lever to PARK (P).

See "Shifting Into PARK (P)" in the Index. If you're pulling a trailer, see "Towing a Trailer" in the Index.

Ensure the shift lever is fully in PARK (P) range before starting the engine. Your Buick has a brake-transaxle shift interlock. You have to fully *apply* your regular brakes *before* you can shift from PARK (P) when the ignition key is in the RUN position. If you cannot shift out of PARK (P), ease pressure on the shift lever -- push the shift lever all the way into PARK (P) and also release the shift lever button on floor shift console

models as you maintain brake application. Then move the shift lever into the gear you wish. (Press the shift lever button before moving the shift lever on floor shift console models.) See “Shifting Out of PARK (P)” in this section.

**REVERSE (R):** Use this gear to back up.

### **NOTICE:**

**Shifting to REVERSE (R) while your vehicle is moving forward could damage your transaxle. Shift to REVERSE (R) only after your vehicle is stopped.**

To rock your vehicle back and forth to get out of snow, ice or sand without damaging your transaxle, see “If You’re Stuck: In Sand, Mud, Ice or Snow” in the Index.

**NEUTRAL (N):** In this position, your engine doesn’t connect with the wheels. To restart when you’re already moving, use NEUTRAL (N) only. Also, use NEUTRAL (N) when your vehicle is being towed.



### **CAUTION:**

**Shifting out of PARK (P) or NEUTRAL (N) while your engine is “racing” (running at high speed) is dangerous. Unless your foot is firmly on the brake pedal, your vehicle could move very rapidly. You could lose control and hit people or objects. Don’t shift out of PARK (P) or NEUTRAL (N) while your engine is racing.**

### **NOTICE:**

**Damage to your transaxle caused by shifting out of PARK (P) or NEUTRAL (N) with the engine racing isn’t covered by your warranty.**

**AUTOMATIC OVERDRIVE (Ⓢ):** This position is for normal driving. If you need more power for passing, and you're:

- Going less than approximately 35 mph (56 km/h), push your accelerator pedal about halfway down.
- Going about 35 mph (56 km/h) or more, push the accelerator all the way down.

You'll shift down to the next gear and have more power.

**THIRD (3):** This is like AUTOMATIC OVERDRIVE (Ⓢ), but you never go into Overdrive. Here are some times you might choose THIRD (3) instead of AUTOMATIC OVERDRIVE (Ⓢ):

- When driving on hilly, winding roads
- When towing a trailer, so there is less shifting between gears
- When going down a steep hill

**SECOND (2):** This position gives you more power but lower fuel economy. You can use SECOND (2) on hills. It can help control your speed as you go down steep mountain roads, but then you would also want to use your brakes off and on.

### **NOTICE:**

**Don't drive in SECOND (2) for more than 5 miles (8 km), or at speeds over 55 mph (88 km/h), or you can damage your transaxle. Use AUTOMATIC OVERDRIVE (Ⓢ) or THIRD (3) as much as possible.**

**Don't shift into SECOND (2) unless you are going slower than 65 mph (105 km/h), or you can damage your engine.**

**FIRST (1):** This position gives you even more power (but lower fuel economy) than **SECOND (2)**. You can use it on very steep hills, or in deep snow or mud. If the selector lever is put in **FIRST (1)**, the transaxle won't shift into **FIRST (1)** until the vehicle is going slowly enough.

### **NOTICE:**

**If your front wheels can't rotate, don't try to drive. This might happen if you were stuck in very deep sand or mud or were up against a solid object. You could damage your transaxle.**

**Also, if you stop when going uphill, don't hold your vehicle there with only the accelerator pedal. This could overheat and damage the transaxle. Use your brakes or shift into **PARK (P)** to hold your vehicle in position on a hill.**

## **Parking Brake**



**To set the parking brake:** Hold the regular brake pedal down with your right foot. Push down the parking brake pedal with your left foot. If the ignition is on, the brake system warning light will come on.

The parking brake uses the brakes on the rear wheels.

**To release the parking brake:** This vehicle has a push to release parking brake pedal. Hold the regular brake pedal down and push the parking brake pedal with your left foot. This will unlock the pedal. When you lift your left foot, the parking brake pedal will follow it to the release position.

If you try to drive off with the parking brake on, the brake light stays on and a chime sounds until you release the parking brake or recycle the ignition.

### **NOTICE:**

**Driving with the parking brake on can cause your rear brakes to overheat. You may have to replace them, and you could also damage other parts of your vehicle.**

If you are towing a trailer and are parking on a hill, see "Towing a Trailer" in the Index. That section shows what to do first to keep the trailer from moving.

## **Shifting Into PARK (P)**

### **CAUTION:**

**It can be dangerous to get out of your vehicle if the shift lever is not fully in PARK (P) with the parking brake firmly set. Your vehicle can roll. If you have left the engine running, the vehicle can move suddenly. You or others could be injured. To be sure your vehicle won't move, even when you're on fairly level ground, use the steps that follow. If you're pulling a trailer, see "Towing a Trailer" in the Index.**

### **Steering Column Shift Lever**

1. Hold the brake pedal down with your right foot and set the parking brake.



2. Move the shift lever into the PARK (P) position like this:



- Pull the lever toward you.



- Move the lever up as far as it will go.
3. Move the ignition key to LOCK.
  4. Remove the key and take it with you. If you can walk away from your vehicle with the ignition key in your hand, your vehicle is in PARK (P).

## Console Shift Lever

1. Hold the brake pedal down with your right foot and set the parking brake.
2. Move the shift lever into the PARK (P) position like this:
  - Hold in the button on the lever and push the lever all the way toward the front of your vehicle.



3. Move the ignition key to LOCK.
4. Remove the key and take it with you. If you can walk away from your vehicle with the ignition key in your hand, your vehicle is in PARK (P).

## Leaving Your Vehicle with the Engine Running



### CAUTION:

It can be dangerous to leave your vehicle with the engine running. Your vehicle could move suddenly if the shift lever is not fully in PARK (P) with the parking brake firmly set. And, if you leave the vehicle with the engine running, it could overheat and even catch fire. You or others could be injured. Don't leave your vehicle with the engine running unless you have to.

If you have to leave your vehicle with the engine running, be sure your vehicle is in PARK (P) and your parking brake is firmly set before you leave it. After you've moved the shift lever into the PARK (P) position, hold the regular brake pedal down. Then, see if you can move the shift lever away from PARK (P) without first pushing the button. If you can, it means that the shift lever wasn't fully locked into PARK (P).

## Torque Lock

If you are parking on a hill and you don't shift your transaxle into PARK (P) properly, the weight of the vehicle may put too much force on the parking pawl in the transaxle. You may find it difficult to pull the shift lever out of PARK (P). This is called "torque lock." To prevent torque lock, set the parking brake and then shift into PARK (P) properly before you leave the driver's seat. To find out how, see "Shifting Into PARK (P)" in the Index.

When you are ready to drive, move the shift lever out of PARK (P) *before* you release the parking brake.

If "torque lock" does occur, you may need to have another vehicle push yours a little uphill to take some of the pressure from the transaxle, so you can pull the shift lever out of PARK (P).

## Shifting Out of PARK (P)

Your Buick has a brake-transaxle shift interlock. You have to fully *apply* your regular brake *before* you can shift from PARK (P) when the ignition is in the RUN position. See "Automatic Transaxle" in the Index.

Your vehicle has a BRAKE TO SHIFT reminder light. This light comes on to remind you to apply the brake pedal before you can shift from PARK (P).

If you cannot shift out of PARK (P), ease pressure on the shift lever -- push the shift lever all the way into PARK (P) and also release the shift lever button on floor shift models as you maintain brake application. Then move the shift lever into the gear you want. (Press the shift lever button before moving the shift lever.) If you ever hold the brake pedal down but still can't shift out of PARK (P), try this:

1. Turn the key to OFF. Open and close the driver's door to turn off the Retained Accessory Power feature.
2. Apply and hold the brake until the end of Step 4.
3. Shift to NEUTRAL (N).
4. Start the vehicle and then shift to the drive gear you want.
5. Have the vehicle fixed as soon as you can.

## Parking Over Things That Burn

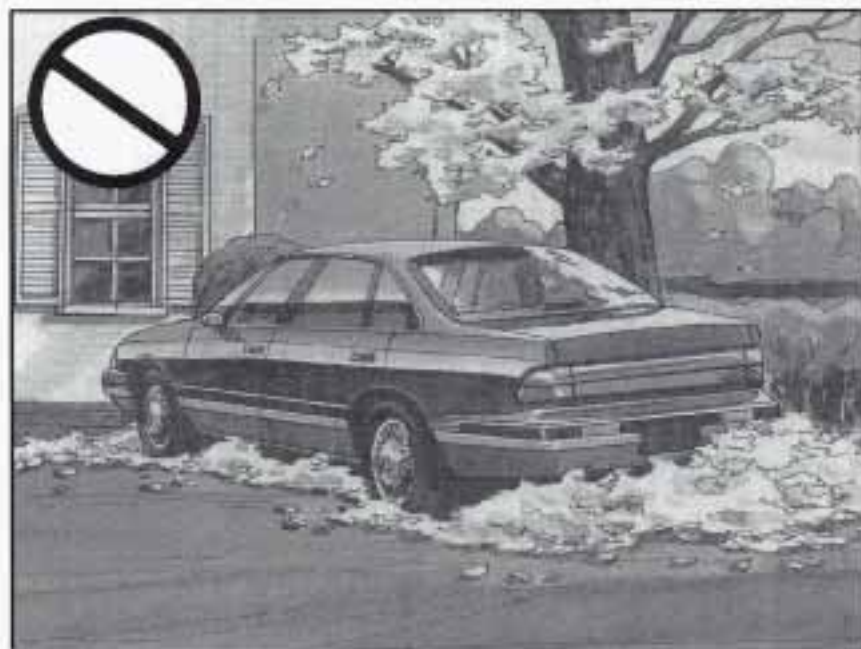

### CAUTION:

Things that can burn could touch hot exhaust parts under your vehicle and ignite. Don't park over papers, leaves, dry grass or other things that can burn.

## Engine Exhaust

### CAUTION:

Engine exhaust can kill. It contains the gas carbon monoxide (CO), which you can't see or smell. It can cause unconsciousness and death.

You might have exhaust coming in if:

- Your exhaust system sounds strange or different.
- Your vehicle gets rusty underneath.
- Your vehicle was damaged in a collision.
- Your vehicle was damaged when driving over high points on the road or over road debris.
- Repairs weren't done correctly.
- Your vehicle or exhaust system had been modified improperly.

If you ever suspect exhaust is coming into your vehicle:

- Drive it only with all the windows down to blow out any CO; and
- Have your vehicle fixed immediately.

## Running Your Engine While You're Parked

It's better not to park with the engine running. But if you ever have to, here are some things to know.

### CAUTION:

Idling the engine with the air system control off could allow dangerous exhaust into your vehicle (see the earlier Caution under "Engine Exhaust").

Also, idling in a closed-in place can let deadly carbon monoxide (CO) into your vehicle even if the fan switch is at the highest setting. One place this can happen is a garage. Exhaust -- with CO -- can come in easily. NEVER park in a garage with the engine running.

Another closed-in place can be a blizzard. (See "Blizzard" in the Index.)

### CAUTION:

It can be dangerous to get out of your vehicle if the shift lever is not fully in PARK (P) with the parking brake firmly set. Your vehicle can roll. Don't leave your vehicle when the engine is running unless you have to. If you've left the engine running, the vehicle can move suddenly. You or others could be injured. To be sure your vehicle won't move, even when you're on fairly level ground, always set your parking brake and move the shift lever to PARK (P).

Follow the proper steps to be sure your vehicle won't move. See "Shifting Into PARK (P)" in the Index.

If you are parking on a hill and if you're pulling a trailer, also see "Towing a Trailer" in the Index.

## Power Windows



Your power window controls are on the armrest. The switch for the driver's window has an express-down feature. Pull the switch back all the way, release it and the window will lower automatically. To stop the window from lowering, push the switch forward. To partially open the window, pull the switch back and quickly release it.

To lower the passenger window, pull back on the right switch. The window will lower as long as the switch is held. To raise either window, push the switch forward.

## Horn

To sound the horn, press the pad with the horn symbol on the steering wheel.

## Magnetic Variable Effort Steering

Your vehicle is equipped with Magnetic Variable Effort Steering, a steering system that continuously adjusts the effort you feel when steering at all vehicle speeds. It provides ease when parking yet a firm, solid feel at highway speeds.

## Tilt Wheel



A tilt steering wheel allows you to adjust the steering wheel before you drive.

You can also raise it to the highest level to give your legs more room when you exit and enter the vehicle.

To tilt the wheel, hold the steering wheel and pull the lever toward you. Move the steering wheel to a comfortable level, then release the lever to lock the wheel in place.

## Turn Signal/Headlamp Beam Lever

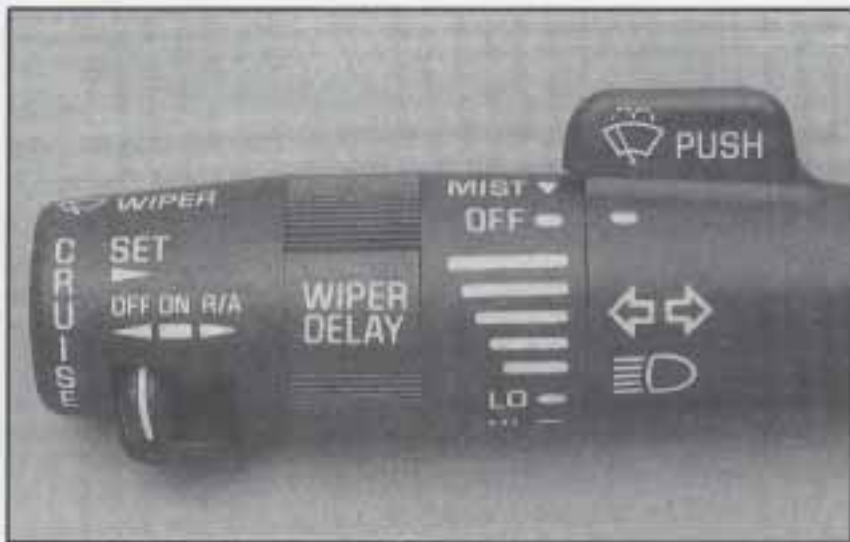

The lever on the left side of the steering column includes your:

- Turn Signal and Lane Change Indicator
- Headlamp High-Low Beam
- Flash-To-Pass Feature
- Windshield Wipers
- Windshield Washer
- Cruise Control

## Turn Signal and Lane Change Indicator

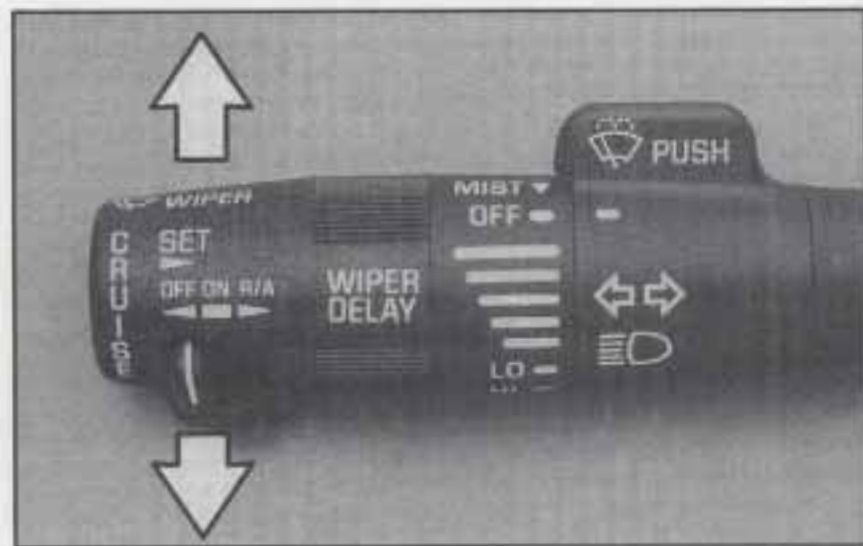

The turn signal has two upward (for right) and two downward (for left) positions. These positions allow you to signal a turn or a lane change.

To signal a turn, move the lever all the way up or down. When the turn is finished, the lever will return automatically.

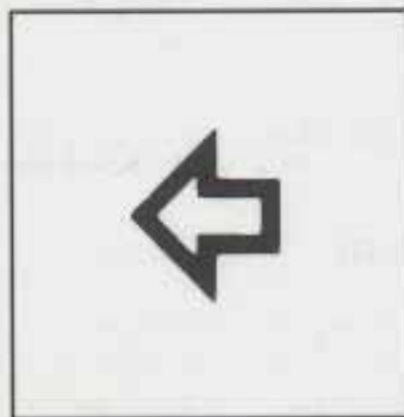

A green arrow on the instrument panel will flash in the direction of the turn or lane change.

To signal a lane change, just raise or lower the lever until the green arrow starts to flash. Hold it there until you complete your lane change. The lever will return by itself when you release it.

As you signal a turn or a lane change, if the arrows don't flash but just stay on, a signal bulb may be burned out and other drivers won't see your turn signal.

If a bulb is burned out, replace it to help avoid an accident. If the green arrows don't go on at all when you signal a turn, check the fuse and check for burned-out bulbs. See "Fuses" in the Index.



## Turn Signal Reminder

If your turn signal is left on for more than 3/4 of a mile, a chime will sound. To turn off the chime, move the turn signal lever to the off position.

## Headlamp High-Low Beam



To change the headlamps from low beam to high or high to low, pull the turn signal lever toward you. Then release it. When the high beams are on, this blue light on the instrument panel will also be on.

## Flash-To-Pass Feature

This feature lets you use your high beam headlamps to signal a driver in front of you that you want to pass. It works even if your headlamps are off.

To use it, pull the turn signal lever toward you a little, but not so far that you hear a click.

If your headlamps are off or on low beam, your high beam headlamps will turn on. They'll stay on as long as you hold the lever toward you and the high beam indicator on the dash will come on. Release the lever to turn the high beam headlamps off.

## Windshield Wipers

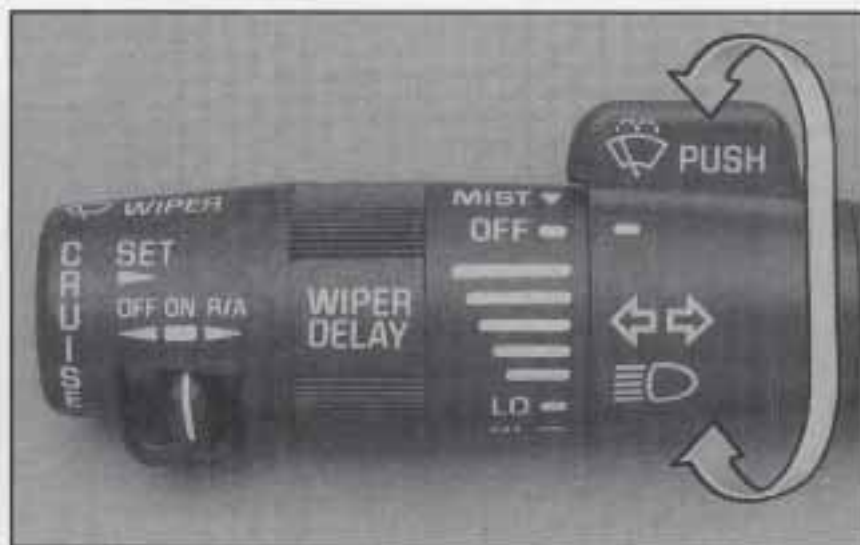

You control the windshield wipers by turning the band marked WIPER DELAY.

For a single wiping cycle, turn the band to MIST. Hold it there until the wipers start, then let go. The wipers will stop after one cycle. If you want more cycles, hold the band on MIST longer.

You can set the wiper speed for a long or short delay between wipes. This can be very useful in light rain or snow. Turn the band to choose the delay time. The closer to LO, the shorter the delay.

For steady wiping at low speed, turn the band away from you to the LO position. For high speed wiping, turn the band further, to HI. To stop the wipers, move the band to OFF.

Remember that damaged wiper blades may prevent you from seeing well enough to drive safely. To avoid damage, be sure to clear ice and snow from the wiper blades before using them. If they're frozen to the windshield, carefully loosen or thaw them. If your blades do become damaged, get new blades or blade inserts.

Heavy snow or ice can overload your wiper motor. A circuit breaker will stop the motor until it cools. Clear away snow or ice to prevent an overload.

## Windshield Washer

At the top of the turn signal lever there's a paddle with the word PUSH on it. To spray washer fluid on the windshield, just push the paddle for less than a second. The washer will spray several times, then stop. Unless they are already turned on, the wipers will operate at low speed for several sweeps, then turn off.

To get more fluid on the windshield, push and hold the paddle. Spraying will continue as long as the paddle is held.

**LOW  
WASHER  
FLUID**

When you get to a low fluid condition and you push the paddle to spray washer fluid on the windshield, the LOW WASHER FLUID light will come on briefly to remind you to get more washer fluid soon.

Driving without washer fluid can be dangerous. A bad mud splash can block your vision. You could hit another vehicle or go off the road. Check your washer fluid level often.



### **CAUTION:**

**In freezing weather, don't use your washer until the windshield is warmed. Otherwise the washer fluid can form ice on the windshield, blocking your vision.**

## NOTICE:

- When using concentrated washer fluid, follow the manufacturer's instructions for adding water.
- Don't mix water with ready-to-use washer fluid. Water can cause the solution to freeze and damage your washer fluid tank and other parts of the washer system. Also, water doesn't clean as well as washer fluid.
- Fill your washer fluid tank only 3/4 full when it's very cold. This allows for expansion, which could damage the tank if it is completely full.
- Don't use radiator antifreeze in your windshield washer. It can damage your washer system and paint.

## Cruise Control



With cruise control, you can maintain a speed of about 25 mph (40 km/h) or more without keeping your foot on the accelerator. This can really help on long trips.

Cruise control does not work at speeds below about 25 mph (40 km/h).

When you apply your brakes, the cruise control shuts off.

**⚠ CAUTION:**

- Cruise control can be dangerous where you can't drive safely at a steady speed. So, don't use your cruise control on winding roads or in heavy traffic.
- Cruise control can be dangerous on slippery roads. On such roads, fast changes in tire traction can cause needless wheel spinning, and you could lose control. Don't use cruise control on slippery roads.

If your vehicle is in cruise control when the optional traction control system begins to limit wheel spin, the cruise control will automatically disengage. (See "Traction Control System" in the Index.) When road conditions allow you to safely use it again, you may turn the cruise control back on.

## To Set Cruise Control

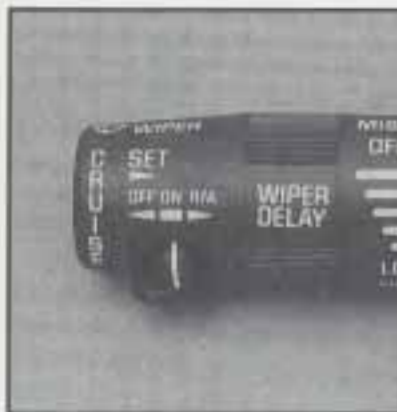

1. Move the cruise control switch to ON.

**⚠ CAUTION:**

If you leave your cruise control switch on when you're not using cruise, you might hit a button and go into cruise when you don't want to. You could be startled and even lose control. Keep the cruise control switch OFF until you want to use it.

2. Get up to the speed you want.



3. Push in the button at the end of the lever and release it. The CRUISE light on the instrument panel will come on.
4. Take your foot off the accelerator pedal.

## To Resume a Set Speed

Suppose you set your cruise control at a desired speed and then you apply the brake. This, of course, shuts off the cruise control. But you don't need to reset it.

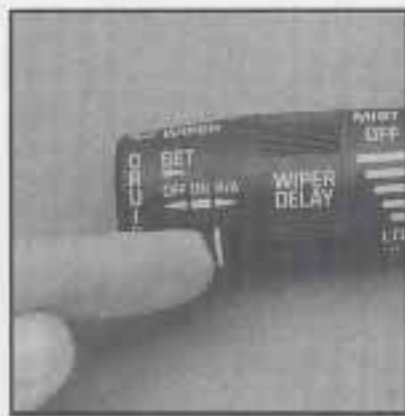

Once you're going about 25 mph (40 km/h) or more, you can move the cruise control switch from ON to R/A (Resume/Accelerate) for about half a second. You'll go right back up to your chosen speed and stay there.

Remember, if you hold the switch at R/A longer than half a second, the vehicle will keep going faster until you release the switch or apply the brake. You could be startled and even lose control. So unless you want to go faster, don't hold the switch at R/A.

## To Increase Speed While Using Cruise Control

There are two ways to go to a higher speed. Here's the first:

1. Use the accelerator pedal to get to the higher speed.



2. Push the button at the end of the lever, then release the button and the accelerator pedal. You'll now cruise at the higher speed.

Here's the second way to go to a higher speed:



1. Move the cruise switch from ON to R/A. Hold it there until you get up to the speed you want, and then release the switch.

2. To increase your speed in very small amounts, move the switch to R/A for less than half a second and then release it. Each time you do this, your vehicle will go about 1 mph (1.6 km/h) faster.

The accelerate feature will only work after you have set the cruise control speed by pushing the SET button.

## To Reduce Speed While Using Cruise Control

There are two ways to reduce your speed while using cruise control:

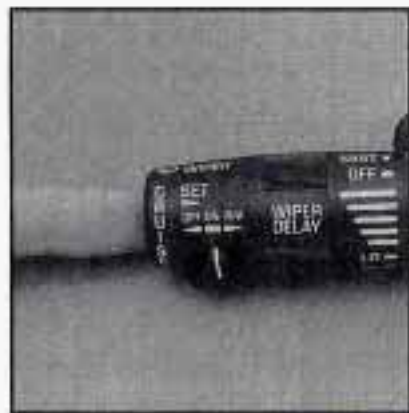

- Push in the button at the end of the lever until you reach the lower speed you want, then release it.

- To slow down in very small amounts, push the button for less than half a second. Each time you do this, you'll go 1 mph (1.6 km/h) slower.

## Passing Another Vehicle While Using Cruise Control

Use the accelerator pedal to increase your speed. When you take your foot off the pedal, your vehicle will slow down to the cruise control speed you set earlier.

## Using Cruise Control on Hills

How well your cruise control will work on hills depends upon your speed, load, and the steepness of the hills. When going up steep hills, you may have to step on the accelerator pedal to maintain your speed. When going downhill, you may have to brake or shift to a lower gear to keep your speed down. Of course, applying the brake takes you out of cruise control. Many drivers find this to be too much trouble and don't use cruise control on steep hills.

## To Erase Speed Memory

When you turn off the cruise control or the ignition, or shift into PARK (P), your cruise control set speed memory is erased.

## To Get Out of Cruise Control

There are two ways to turn off the cruise control:

- Step lightly on the brake pedal, *or*
- move the cruise switch to OFF. The CRUISE light will also go out.



## Lamps



 : This switch controls these systems:

- Headlamps
- Taillamps
- Parking Lamps
- License Lamps
- Sidemarkers Lamps
- Instrument Panel Lights
- Interior Courtesy Lamps

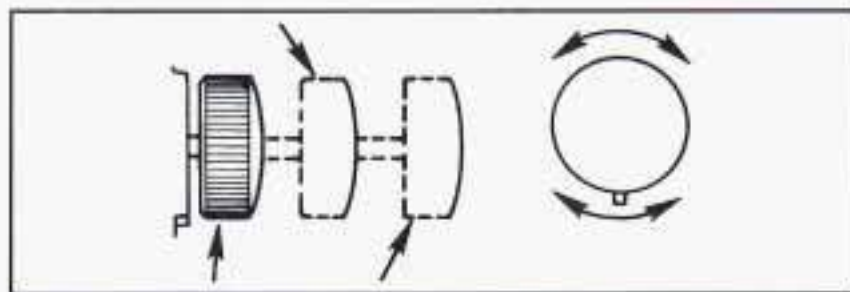

Pull the knob toward you to the first setting to turn on the parking lamps. Pull the knob toward you to the second setting to turn on the headlamps.

By rotating the knob you can make the instrument panel lights bright or dim and turn the courtesy lamps on or off.

### Headlamp Warning

If the headlamp switch is left on you'll hear a warning chime when you turn the ignition off and open the driver's door.

### Courtesy Lamps

When any door is opened, several lamps go on. They make it easy for you to enter and leave the car. To turn on these lamps, rotate the headlamp knob.

## Time Out Feature

The interior lamps will automatically shut off after 10 minutes if a door is left open. This feature is designed to help eliminate battery wear down.

## Twilight Sentinel (Option)

Twilight sentinel turns your headlamps, taillamps and parking lamps on and off by sensing how dark it is outside.

To operate it, leave the switch off and move the twilight sentinel control toward AUTO MAX.

If you move the control all the way to AUTO MAX, your lamps will remain on for three minutes after you turn off your engine. If you move the control toward AUTO MIN, the lamps will go off quickly when you turn off your engine. You can set this delay time for only a few seconds or up to three minutes.

Your twilight sentinel and Daytime Running Lamps (Canada Only) work with the light sensor on top of the instrument panel. Don't cover it up. If you do it will read "dark" and the headlamps will come on.

## Daytime Running Lamps (Canada Only)

Daytime Running Lamps (DRL) can make it easier for others to see the front of your vehicle during the day. DRL can be helpful in many different driving conditions, but they can be especially helpful in the short periods after dawn and before sunset.

A light sensor on top of the instrument panel makes the DRL work, so be sure it isn't covered.

The DRL system will make your low beam headlamps come on at reduced brightness in daylight when:

- The ignition is ON,
- The headlamp switch is OFF, and
- The transaxle is not in PARK (P).

When the DRL are on, only your low beam headlamps will be on. The parking lamps, taillamps, sidemarker and other lamps won't be on. Your instrument panel won't be lit up either.

When it's dark enough outside, your low beam headlamps will change to full brightness. The other lamps that come on with your headlamps will also come on. When it's bright enough outside, the regular lamps will go off, and your low beam headlamps change to the reduced brightness of DRL.

To idle your vehicle with the DRL off, shift the transaxle into PARK (P). The DRL will stay off until you shift out of PARK (P).

To turn off all exterior lighting at night when you are parked, turn off the headlamps and move the twilight sentinel control all the way toward AUTO MIN.

As with any vehicle, you should turn on the regular headlamp system when you need it.

## Front Seat Reading Lamps



Turn on the front seat reading lamp by pressing the switch. Press it again to turn off the lamp.

## Mirrors

### Manual Inside Mirror

When you are sitting in a comfortable driving position, adjust the mirror so you can see clearly behind your car. Grip the mirror in the center to move it up or down and side to side. The day-night adjustment allows you to adjust the mirror to avoid glare from the lights behind you. Pull the tab forward for daytime use; push it back for night use.

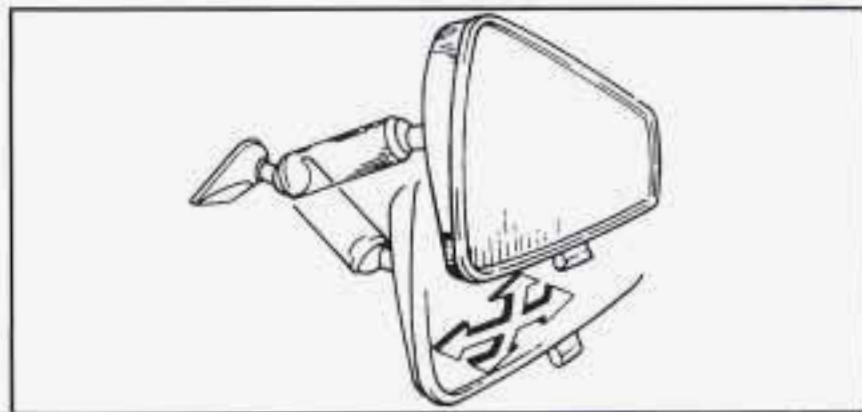

### Automatic Inside Mirror (Option)



Your Buick may have an automatic inside mirror.

The automatic mirror adjusts for the glare of headlamps behind you. It detects changes in light, and then adjusts for day or night operation.

During the day the mirror reflects all the light from behind your car. At night, when the glare is too high, it changes to the night mode. Then, it reflects only part of the light from behind you. When the mirror changes to the night mode, it holds that position until glare is no longer present.

There is an automatic and an off setting. When the button on the bottom of the mirror is pressed up, the mirror reacts to glare conditions automatically. Press the button again to turn off the automatic setting.

### **Time Delay**

The automatic mirror has a time delay feature which prevents unnecessary switching from the night back to the day position. This delay prevents rapid changing of the mirror as you drive under lights and through traffic.

### **Reverse Gear Day Mode**

The reverse mode is another important feature of the automatic mirror. When the shift lever is placed in REVERSE (R), the mirror changes to the day mode. This gives you a bright image in the mirror as you back up.

## **Outside Mirrors**

### **Electric Mirror Control**

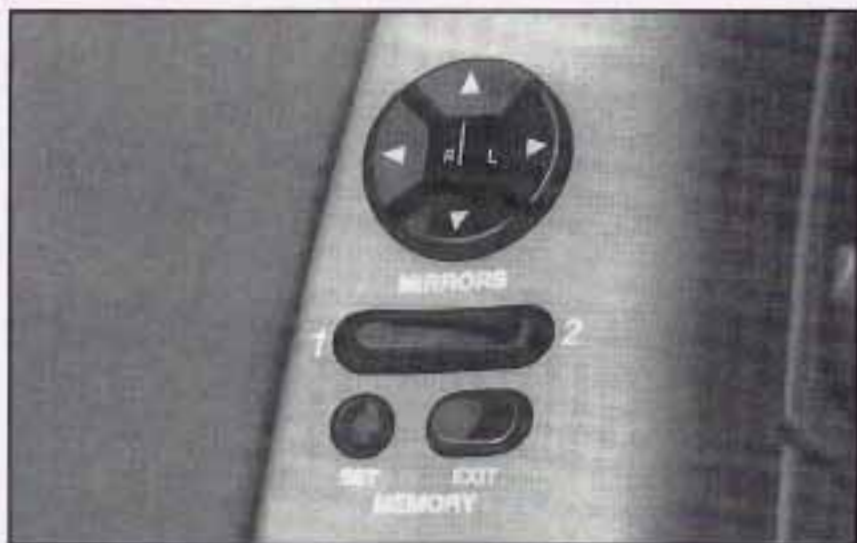

Your Buick has an electric mirror control located on the driver's door armrest.

Move the switch to the right (R) or left (L) to choose a mirror. Press any of the four buttons to move the mirror in the direction desired.

Adjust each mirror so you can just see the side of your car and the area behind your car.

## Convex Outside Mirror

Your passenger's side mirror is convex.

A convex mirror's surface is curved so you can see more from the driver's seat.

### CAUTION:

A convex mirror can make things (like other vehicles) look farther away than they really are. If you cut too sharply into the right lane, you could hit a vehicle on your right. Check your inside mirror or glance over your shoulder before changing lanes.

## Convenience Net



Your vehicle has a convenience net. You'll see it just inside the back wall of the trunk.

Put small loads, like grocery bags, behind the net. It can help keep them from falling over during sharp turns or quick starts and stops. For heavier loads, store them in the trunk as far forward as you can.

There are six retainers to secure the convenience net, allowing two different placements for the net. You can unhook the net so that it will lie flat when you're not using it. When reinstalling the net, make sure the label points toward the upper retainer.

## Auxiliary Power Receptacle

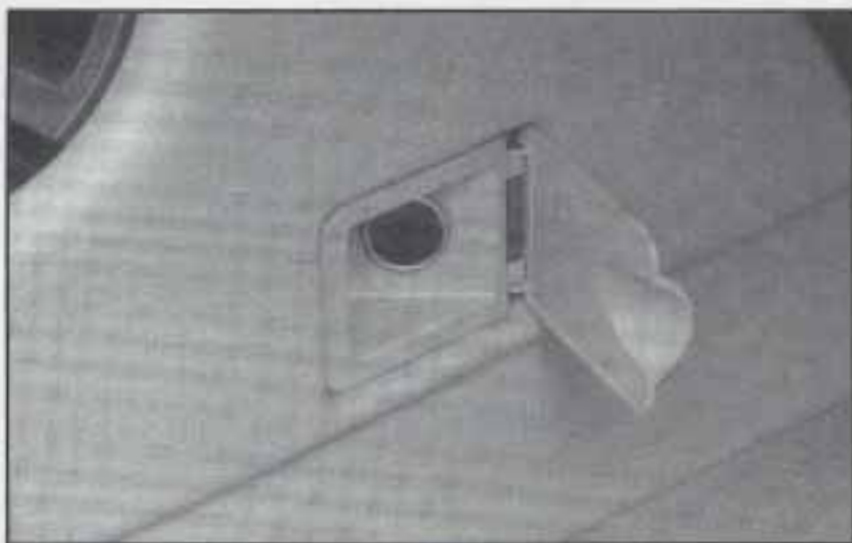

An auxiliary power receptacle is located on the lower right side of the console. When the ignition is ON, you can plug in accessories requiring electrical power.

If your Riviera has no console, the auxiliary power receptacle is opposite the cigarette lighter in the ashtray area.

## Astrorooft (Option)



If your vehicle has the astrorooft option, the switch is on the roof between the sun visors. It will open the astrorooft when the ignition is ON, or when in Retained Accessory Power.

To fully open the glass panel and sunshade, press the switch rearward and release. To stop the panel in a partially open position, press the switch again at the desired point. To continue to open fully, press the switch rearward again and release. The sunshade can be opened manually.

To close the glass panel, press and hold the switch forward. The sunshade must be manually closed.

Once the astrorooft is closed, it can be opened to a vent position. Press the switch forward to vent. To close, press the switch rearward.

## Garage Door Opener Storage



The garage door opener storage area is located in the headliner near the reading lamps. The following chart and instructions will help you install your garage door opener.

1. To install your garage door opener in the storage area, push the extended tab, which is located above the GARAGE button, and open the cover.



2. Remove the square height adapters from the cover. Reference the chart to determine the number and location of the height adapters for your garage door opener. If your unit does not appear on the chart, you will have to try different adapter number and location combinations.



Your Garage Door Transmitter			Vehicle Console Door	
Name	Model	Button	Position For Adapter(s)	Number Of Adapter(s)
CHAMBERLAIN	G-3684	1	5	4
CRUSADER	1-BUTTON	1	9	3
GENIE	AT85P	1	3	3
GENIE	AT85	1	5	4
GENIE	AT90	1	5	4
GENIE	MAT85	1	6	4
GENIE	MAT90	1	6	4
GENIE	AT285P	1	10	3
		2	1	3
GENIE	AT95	1	10	3
		2	3	3
		3	1	3
LIFTMASTER	G3446	1	2	3
LIFTMASTER	G3456	1	2	3
LINEAR	DT2A	1	6	3
		2	6	3
LINEAR	D22A	1	4	3
LINEAR	EK-11/H	1	4	2
LINEAR	ET-2	1	6	4
LINEAR	D22B	1	6	3
		2	6	3

Your Garage Door Transmitter			Vehicle Console Door	
Name	Model	Button	Position For Adapter(s)	Number Of Adapter(s)
LINEAR	DT4	1	10	3
		2	8	3
		3	3	3
		4	1	3
LINEAR	D4B	1	10	3
		2	8	3
		3	3	3
		4	1	3
MICOM	ESP-T-9R	1	6	3
MICOM	ESP-T-9	1	6	3
MULTIELMAC	3010	1	6	3
MULTIELMAC	3089	1	4	3
MULTIELMAC	3070	1	6	4
		2	6	3
MULTIELMAC	3032	1	6	3
		2	6	3
MULTIELMAC	1054	1	6	3
MULTIELMAC	3034	1	—	—
		2	6	3
		3	6	3
		4	—	—

Your Garage Door Transmitter			Vehicle Console Door	
Name	Model	Button	Position For Adapter(s)	Number Of Adapter(s)
MULTIELMAC	3033	1	—	—
		2	6	3
		3	6	3
		4	—	—
MULTIELMAC	1048	1	4	2
MULTIELMAC	1087	1	5	2
MULTIELMAC	3060	1	6	4
MULTIELMAC	1098	1	5	2
		2	7	2
OVERHEAD DOOR	1-BTN 223	1	1 OR 10	3
OVERHEAD DOOR	2-BTN 265	1	10	3
		2	1	3
OVERHEAD DOOR	3-BTN 242	1	10	3
		2	10	3
		3	1	3
OVERHEAD DOOR	4-BTN 232	1	10	3
		2	10	3
		3	1	3
		4	1	3
PULSAR	921	1	4	3
PULSAR	931	1	4	3

Your Garage Door Transmitter			Vehicle Console Door	
Name	Model	Button	Position For Adapter(s)	Number Of Adapter(s)
PULSAR	832	1	9	3
		2	3	3
PULSAR	833	1	9	3
		2	3	3
PULSAR	832C	1	4	3
		2	3	3
		3	1	3
PULSAR	833B	1	5	4
PULSAR	PDX-9921	1	4	3
SEARS	9B53738	1	6	4
SEARS	9B53708	1	2	2
SHIMA	RT-18	1	4	3
STANLEY	1047	1	5	3
STANLEY	1050	1	6	3
STANLEY	1076	1	6	3
		2	6	3
STANLEY	1079	1	6	3
		2	6	3
STANLEY	1075	1	6	3
		2	6	3
STANLEY	331-1052	1	6	4

Your Garage Door Transmitter			Vehicle Console Door	
Name	Model	Button	Position For Adapter(s)	Number Of Adapter(s)
STANLEY	331-1077	1	6	3
		2	6	3
TELECTRON	TP-21	1	4	3
TELECTRON	T-80	1	6	3
TELECTRON	T-80G	1	5	3
		2	7	3
TELECTRON	T-22A	1	9	3
		2	2	3
TOUCH-N-GO	2-BUTTON	1	9	3
		2	2	3

- Place the height adapters on the proper peg using the suggested combinations or by lining up the height adapters and the transmitter button on your garage door opener.

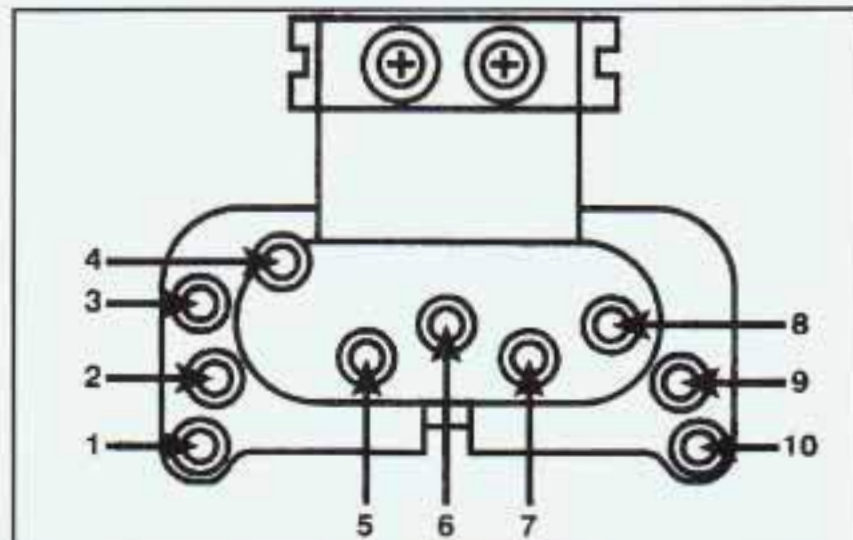

- Use the Velcro<sup>®</sup> found in the storage area and attach the garage door opener securely inside the console. Line up the transmitter button with the height adapters.
- Close the cover and test the GARAGE button.

If your garage door opener doesn't work after it is installed, try another combination.

## HomeLink™ Universal Transmitter (Option)



Your vehicle may come equipped with this transmitter located in the overhead console. It allows you to consolidate the functions of up to three individual hand-held transmitters. It will “learn” and transmit the frequencies of most current transmitters and is powered by your vehicle’s battery and charging systems.

This device complies with Part 15 of the FCC Rules. Operation is subject to the following two conditions:

- (1) This device may not cause harmful interference, and
- (2) This device must accept any interference received, including interference that may cause undesired operation.

### Programming the Transmitter

*Be sure that people and objects are clear of the garage door you are programming!*

Then follow these steps:

1. Press one of the buttons on the HomeLink™ Universal Transmitter until the red light begins to flash. Continue to hold this button down through the end of Step 4.
2. Hold the end of your hand-held transmitter against the bottom surface of the HomeLink™ Universal Transmitter.
3. While continuing to hold the button on the HomeLink™ Universal Transmitter, press the button on your old remote.
4. Hold down both buttons until you see the red light on the HomeLink™ Universal Transmitter flash rapidly. The rapid flashing means that the system has been programmed.
5. Release the buttons.

Repeat this procedure to program the other two channels.

If you have trouble programming the garage door opener, make sure that you have followed the directions exactly as described and that the batteries in the hand-held transmitter are not dead. If you still cannot program it, rotate your hand-held transmitter end-over-end and try again. In a limited number of older installations, due to legislated changes in transmission frequencies, it may also be necessary to obtain a new receiver and have it connected to your existing garage door opener. If you cannot program the transmitter after repeated attempts, consult your Buick dealer.

## Operating the Transmitter

Simply press the appropriate button on the HomeLink™ Universal Transmitter to operate the system. The red light comes on while the signal is being transmitted.

## Erasing Channels

To erase all three programmed channels, hold down the two outside buttons until the red light begins to flash (approximately 20 seconds). Individual channels cannot be erased, but can be reprogrammed using the procedure for programming the transmitter explained earlier.

## Accessories

Accessories for your Homelink™ Universal Transmitter are available from the manufacturer of the unit. If you would like additional information or are interested in purchasing other home lighting or security products, please call 1-800-355-3515.

## Ashtrays



The front center ashtray may be lifted out for cleaning.



To remove the rear ashtray for cleaning, press down on the snuffer as you pull the ashtray down and out.

### **NOTICE:**

**Don't put papers or other flammable things into your ashtrays. Hot cigarettes or other smoking materials could ignite them, causing a damaging fire.**

## **Cigarette Lighter**

The lighter is near the ashtray. To use the cigarette lighter, push it all the way in and let it go. When it's ready, it will pop back by itself.

### **NOTICE:**

**If you hold a cigarette lighter in with your hand while it is heating, it won't be able to back away from the heating element when it's ready. That can make it overheat, damaging the lighter and the heating element.**

## **Electronic Level Control**

This feature keeps the rear of your car level as the load changes. It is automatic -- you don't need to adjust anything.

## Visor Vanity Mirror

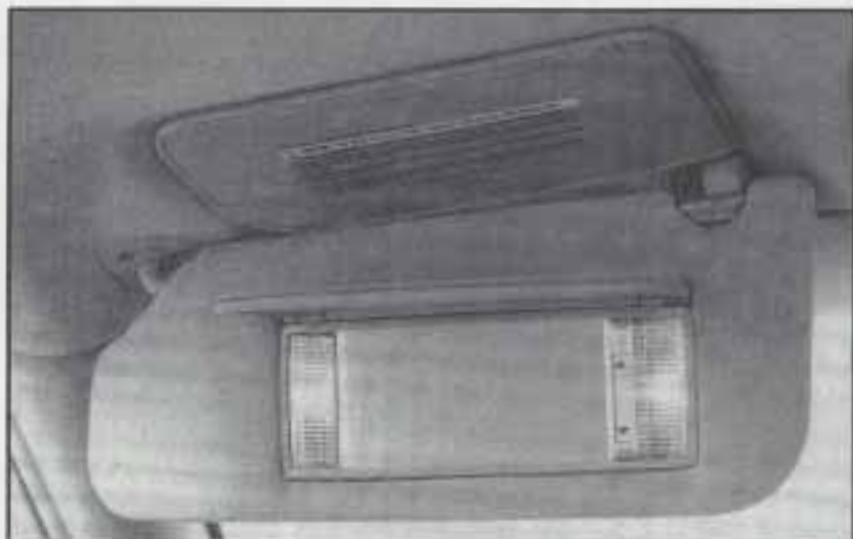

This mirror is on the larger of the passenger's sun visors. It may also be on the larger of the driver's sun visors. When you open it, the lamps turn on. The brightness of the lamps can be adjusted by sliding the switch up or down.

## Console and Cupholder



The center console has space for cassette storage, a removable coinholder and a cupholder. The cupholder is in front of the storage console. Push forward on the cover of the front storage area and it will open. Press the cover and it will close.

## Rear License Plate Holder

To use it, open the trunk lid and slide your license plate into the slot. Always close the trunk to prevent theft of the plate.

## The Instrument Panel: Your Information System



Your instrument panel is designed to let you know at a glance how your car is running. You'll know how fast you're going, how much fuel you're using, and many other things you'll need to know to drive safely and economically.

### Speedometer and Odometer

Your speedometer lets you see your speed in both miles per hour (mph) and kilometers per hour (km/h). Your

odometer shows how far your vehicle has been driven, in either miles (used in the United States) or kilometers (used in Canada).

### Trip Odometer



A trip odometer can tell you how many miles you have driven since you last set it back to zero.



To reset the trip odometer, push the TRIP RESET button.



## Warning Lights, Gages and Indicators

This part describes the warning lights and gages that may be on your vehicle. The pictures will help you locate them.

Warning lights and gages can signal that something is wrong before it becomes serious enough to cause an expensive repair or replacement. Paying attention to your warning lights and gages could also save you or others from injury.

Warning lights come on when there may be or is a problem with one of your vehicle's functions. As you will see in the details on the next few pages, some warning lights come on briefly when you start the engine just to let you know they're working. If you are familiar with this section, you should not be alarmed when this happens.

Gages can indicate when there may be or is a problem with one of your vehicle's functions. Often gages and warning lights work together to let you know when there's a problem with your vehicle.

When one of the warning lights comes on and stays on when you are driving, or when one of the gages shows there may be a problem, check the section that tells you what to do about it. Please follow this manual's advice. Waiting to do repairs can be costly -- and even dangerous. So please get to know your warning lights and gages. They're a big help.

## Safety Belt Reminder Light



When the key is turned to RUN or START, a chime will come on for about eight seconds to remind people to fasten their safety belts. The safety belt light will also come on and stay on for about 70 seconds. If the driver's belt is already buckled, neither the chime nor the light will come on.

## Air Bag Readiness Light

There is an air bag readiness light on the instrument panel, which shows AIR BAG. The system checks the air bag's electrical system for malfunctions. The light tells you if there is an electrical problem. The system check includes the air bag sensors and modules, the wiring and the diagnostic module. For more information on the air bag system, see "Air Bag" in the Index.



You will see this light flash for a few seconds when you turn your ignition to RUN or START. Then the light should go out. This means the system is ready.

If the air bag readiness light doesn't come on when you start your vehicle, or stays on, or comes on when you are driving, your air bag system may not work properly. Have your vehicle serviced right away.

## Battery Light

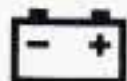

When you turn the key to RUN, this light will come on briefly, to show that your alternator and battery charging systems are working.

If the light stays on, you need service and should take your Buick to the dealer at once. To save your battery until you get there, turn off all accessories, and set your air system to OFF.

## Brake System Warning Light



Your Buick's hydraulic brake system is divided into two parts. If one part isn't working, the other part can still work and stop you. For good braking, though, you need both parts working well.

If the warning light comes on, there could be a brake problem. Have your brake system inspected right away.

This light should come on briefly as you start the vehicle. If it doesn't come on then, have it fixed so it will be ready to warn you if there's a problem.

If the light and chime come on while you are driving, pull off the road and stop carefully. You may notice that the pedal is harder to push. Or, the pedal may go closer to the floor. It may take longer to stop. If the light is still on, have the vehicle towed for service. (See "Towing Your Vehicle" in the Index.)



## CAUTION:

Your brake system may not be working properly if the brake system warning light is on. Driving with the brake system warning light on can lead to an accident. If the light is still on after you've pulled off the road and stopped carefully, have the vehicle towed for service.

The brake system warning light will also come on when you set your parking brake, and it will stay on if your parking brake doesn't release fully. If you try to drive off with the parking brake set, a chime will also come on until you release the parking brake. If the light and chime stay on after your parking brake is fully released, it means you have a brake problem.

## Anti-Lock Brake System Warning Light



With the anti-lock brake system, this light will come on when you start your engine and may stay on for several seconds. That's normal. If the light doesn't come on, have it fixed so it will be ready to warn you if there is a problem.

If the light stays on, turn the ignition off. Or, if the light comes on when you're driving, stop as soon as possible and turn the ignition off. Then start the engine again to reset the system. If the light still stays on, or comes on again while you're driving, your Buick needs service. If the regular brake system warning light isn't on, you still have brakes, but you don't have anti-lock brakes. If the regular brake system warning light is also on, you don't have anti-lock brakes and there's a problem with your regular brakes. See "Brake System Warning Light" earlier in this part.

## Traction Control System Warning Light (Option)



TRACTION  
OFF

This warning light should come on briefly as you start the engine. If the warning light doesn't come on then, have it fixed so it will be ready to warn you if there's a problem. If it stays on, or comes on when you're driving, there may be a problem with your traction control system and your vehicle may need service. When this warning light is on, the system will not limit wheel spin. Adjust your driving accordingly.

The traction control system warning light may come on for the following reasons:

- If you turn the system off by pressing the OFF/ON traction control button located to the left of the steering column, the warning light will come on and stay on. To turn the system back on, press the button again. The warning light should go off. (See "Traction Control System" in the Index for more information.)
- If there's a brake system problem that is specifically related to traction control, the traction control system will turn off and the warning light will come on. If your brakes begin to overheat, the traction control system will turn off and the warning light will come on until your brakes cool down.
- If the traction control system is affected by an engine-related problem, the system will turn off and the warning light will come on.

If the traction control system warning light comes on and stays on for an extended period of time when the system is turned on, your vehicle needs service.

## Engine Coolant Temperature Warning Light

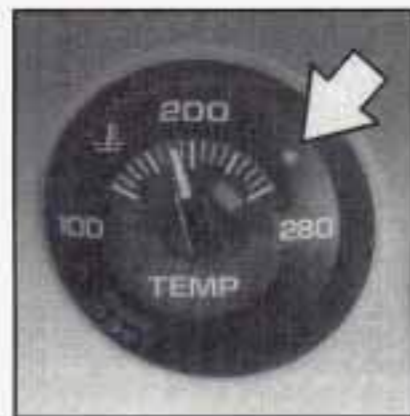

This light tells you that your engine coolant has overheated or your radiator cooling fan is not working. If you have been operating your vehicle under normal driving conditions, you should pull off the road, stop your vehicle and turn the engine off as soon as possible.

The chapter “Problems on the Road” in this manual explains what to do. See “Engine Overheating” in the Index.

## Engine Coolant Temperature Gage

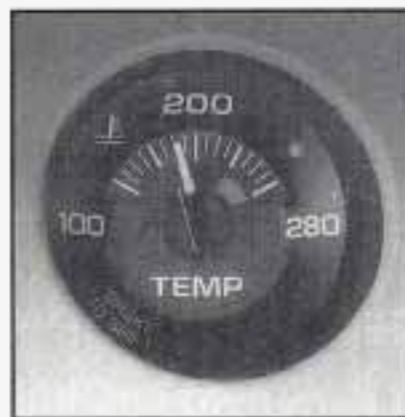

Your vehicle has a gage that shows the engine coolant temperature. If the gage pointer moves into the red area, your engine is too hot!

That reading means the same thing as the warning light. It means that your engine coolant has overheated. If you have been operating your vehicle under normal driving conditions, you should pull off the road, stop your vehicle and turn off the engine as soon as possible.

The chapter “Problems on the Road” in this manual explains what to do. See “Engine Overheating” in the Index.

## Low Coolant Warning Light

**LOW  
COOLANT**

When this light comes on, the cooling system is low on coolant. As a bulb check, it will come on for two to four seconds and then go off when the ignition is in the RUN position. If the light doesn't come on, have the vehicle serviced.

If the coolant level is low, the light will come back on and a warning chime will sound. If this happens, see "Engine Coolant" in the Index for proper cooling system fill.

After the coolant level is returned to its proper level, the LOW COOLANT light will go off after 20 seconds or remain off during the next ignition cycle.

## Malfunction Indicator Lamp (Service Engine Soon Light)

**SERVICE  
ENGINE SOON**

A computer monitors operation of your fuel, ignition and emission control systems. This light should come on when the ignition is on and the engine is not running, as a check to show you it is working.

If it does not come on at all, have it fixed right away. If it stays on, or it comes on while you are driving, the computer is indicating that you have a problem. You should take your vehicle in for service soon.

### **NOTICE:**

**If you keep driving your vehicle with this light on, after a while the emission controls won't work as well, your fuel economy won't be as good and your engine may not run as smoothly. This could lead to costly repairs not covered by your warranty.**

## Door Ajar Light

DOOR AJAR

When the ignition is ON, this light will stay on until all the doors are closed and completely latched.

## Engine Oil Pressure Light



This light tells you if there could be a problem with your engine oil pressure.

When this light *comes* on and *stays* on, it means oil isn't going through your engine properly. You could be low on oil, or you might have some other oil problem.



### **CAUTION:**

**Don't keep driving if the oil pressure is low. If you do, your engine can become so hot that it catches fire. You or others could be burned. Check your oil as soon as possible and have your vehicle serviced.**



## **NOTICE:**

**Damage to your engine from neglected oil problems can be costly and is not covered by your warranty.**

There are three ways this light can come on briefly, which are normal and don't show a problem. They are:

1. The light comes on as a bulb check when you turn your key to RUN. If it doesn't, be sure to have it fixed so it will be there to warn you if something goes wrong.
2. If you're idling at a stop sign, the light may blink on and then off.
3. If you make a hard stop, the light may come on for a moment.

## **Check Oil Level Light**



**CHECK OIL  
LEVEL**

The CHECK OIL LEVEL light is lit for two to four seconds as a bulb check each time the ignition key is turned to the RUN position. If the light doesn't come on, have your vehicle serviced.

If the engine oil is more than one quart low, the light will come on briefly, then go off for 15-25 seconds, and then come back on for 20-40 seconds.

However, the system will not register low engine oil if it has not been more than eight minutes since the engine was last shut off.

If the CHECK OIL LEVEL light comes back on, the engine oil should be checked at the dipstick then brought up to the proper level if necessary. See "Engine Oil" in the Index.

## Tachometer



### **NOTICE:**

Do not operate the engine with the tachometer in the red area, or engine damage may occur.

The tachometer tells you how fast the engine is running. It displays engine speed in revolutions per minute (RPM).

## Fuel Gage



The fuel gage shows about how much fuel is in your tank.

It works only when the ignition is ON. When the indicator nears Empty (E) you still have a little fuel left. You need to get more fuel right away.

Here are some concerns some owners have had about the fuel gage. All these situations are normal and indicate nothing wrong with the fuel gage.

- At the gas station, the gas pump shuts off before the gage reads Full (F).
- It takes more (or less) gas to fill up than the gage indicated. For example, the gage may have indicated 1/2 full, but it took more (or less) than half of the tank's capacity to fill it.
- The gage moves a little when you turn a corner, speed up, or stop your vehicle.
- When you turn the engine OFF, the gage doesn't go all the way back to Empty (E).

### Low Fuel Light

A yellow light near the Empty (E) mark on the fuel gage comes on when your vehicle is low on fuel. You should get more fuel as soon as you can.



## Section 3 Comfort Controls and Audio Systems

In this section you'll find out how to operate the comfort control systems and audio systems offered with your Buick. Be sure to read about the particular system supplied with your vehicle.

### Your Buick Comfort Control System

This section describes the operation of the heating and air conditioning system. This system uses the new ozone-friendly R-134a refrigerant.

When the vehicle is moving, fresh air flows through the air outlets. When the vehicle is not moving, you can get fresh air by selecting any air choice (except the rear window defogger) and any fan speed.



Adjust the direction of air flow by moving the louvered air outlets.



You can also adjust the direction of the air flow to the rear seating area.

Your Buick has a Dual Automatic ComforTemp Climate Control system.

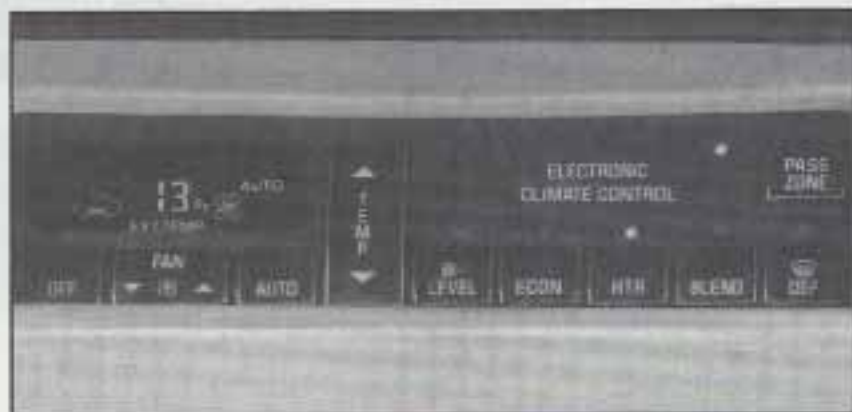

**OFF:** When the system is OFF, air will flow through your Buick when the vehicle is moving. The system will try to keep the air at a chosen temperature. The outside temperature will show in the display area when the system is OFF.

**FAN:** The speed of the blower fan is controlled automatically if the fan is on AUTO.

The blower fan will run at a lower speed by pushing FAN ▼. If you want to raise the blower speed, push FAN ▲. The blower speed will change with every push of the button until the lowest or highest speed is reached.

**AUTO:** Use AUTO when you want the system to adjust automatically to changes in temperature. When the system is set for automatic, air will come from the floor outlets, the instrument panel outlets, or the windshield outlets.

Fan speed will vary as the system gets to and maintains the temperature setting you have selected.

To find your comfort zone, start with 75 AUTO, give the car about 20 minutes to stabilize, then adjust the temperature setting if necessary. The display will show the set temperature and fan speed. The control setting will be remembered the next time the car is started.

In cold weather the system will delay turning on the fan, to avoid blowing cold air. The length of the delay depends on engine coolant temperature, outside temperature and time since the engine was last started. Pushing the ▼ FAN ▲ button will override this delay and cause the fan to start.

To rid the system of stale air in warm weather, air will come out of the floor outlets for a short time.

**TEMP:** To choose the temperature you want maintained inside the vehicle, press the TEMP ▲ or ▼.

You can choose from 60°F (16°C), for maximum cooling, to 90°F (33°C), for maximum heating. It is not necessary to choose the extreme temperature to get the system to heat or cool. The system does it automatically.

If you have the steering wheel controls, you can change the desired temperature by pressing ▲ TEMP ▼.

**BI-LEVEL:** This setting is designed for use on sunny days when the weather is moderately warm or cool. On days like these, the sun may adequately warm your upper body, but your lower body may not be warm enough.

The BI-LEVEL setting directs outside air into your vehicle in two ways. Cool air is directed toward your upper body through the front instrument panel outlets, while slightly warmed air is directed through the heater outlet at your feet.

The air conditioner compressor operates in all air conditioning positions and the DEF position when the outside temperature is above 40°F (5°C).

**ECON:** Use ECON when you don't need to cool the outside air coming into your vehicle. The system will work like AUTO without cooling.

**HTR:** To direct the air out of the heater outlets, press HTR and adjust the temperature and fan speeds for your comfort. Most of the air will come from the floor outlets. Some of the air will flow through the windshield and side window outlets.

**BLEND:** This setting divides air flow equally between the heater ducts and the windshield defroster vents.

**DEF:** This setting will direct the most air toward the windshield when there is fog or ice on the windshield. Some air will flow through the heater and side window outlets.

DEF will work better if any ice or snow is cleared from the air inlet area between the hood and the windshield.

Blower speed will be controlled automatically, or you can choose another speed by pushing the FAN button.

## Passenger Zone Comfort Control



The front seat passenger can control the air temperature in their seating area. Press the PASS ZONE button on the main control panel to activate the passenger comfort control.

This system can also be activated by turning the COMFORT CONTROL knob on the passenger's door.

Adjust the temperature using the COMFORT CONTROL knob. Turn the control toward COOLER or WARMER. This control can be set up to 5°F cooler or warmer than the primary setting. Notice the lighted display above the control which indicates the difference from the main temperature setting.

Push the PASS ZONE button again to turn off this part of the system.

## Rear Window Defogger



The lines you see on the rear window will warm the glass. Press the bottom part of the button shown here to start warming your window. After approximately 10 minutes, the rear window defogger will go off by itself.

Pressing the button again during the heating cycle will also shut it off. If you need additional warming time, push the button again.

### **NOTICE:**

**Scraping the inside of your rear window could cut and damage the heater. Your warranty would not cover this damage. And don't put decals there; you might have to scrape them off.**

## Audio Systems

Your Delco® audio system has been designed to operate easily and give years of listening pleasure. But you will get the most enjoyment out of it if you acquaint yourself with it first. Find out what your Delco® system can do and how to operate all its controls, to be sure you're getting the most out of the advanced engineering that went into it.



## Radio with Cassette Tape Player



### Playing the Radio

**Upper Knob:** The upper knob does the following:

- Turns the radio on or off. Turn the knob clockwise to turn on the radio.
- Controls the volume. Rotate clockwise to increase the volume.
- Tells you the time. When the ignition is off, press to display the time.
- Allows you to recall the frequency when the radio is playing by pushing the knob.

- Allows you to hear the other side of a tape. Press the upper knob while a cassette is playing.

**BAL:** The BAL control behind the upper knob allows you to balance the sound between the right and left speakers.

**Lower Knob:** Turn the lower knob to tune radio stations. Push it to get AM or FM.

**FADE:** The FADE control behind the lower knob moves the sound between the front and rear speakers.

### Finding a Station

**SEEK:** Press the SEEK button to cause the receiver to seek the next higher station and stop.

**SCAN:** When you press SCAN, the radio will go to the next station, pause and keep scanning until you press SCAN again.

**Presets:** The four pushbuttons let you return to favorite stations. You can set the pushbuttons for up to 14 stations (seven AM and seven FM).

1. Tune in the desired station.
2. Press the SET pushbutton. (SET appears in the display.)

3. Within five seconds, push one of the four pushbuttons.

Whenever you press that button, the preset station will return. In addition to the four stations set as above, up to three additional stations may be preset on each band by pressing two adjacent buttons at the same time.

1. Tune in the desired station.
2. Press the SET pushbutton. (SET appears in the display.)
3. Within five seconds, push any two adjacent pushbuttons at the same time. (The station will return when the same adjacent buttons are pressed again.)

### Setting the Tone

**TREB:** Slide the TREB lever up to increase the treble response. If the station is weak or noisy, slide the treble lever down to reduce the noise.

**BASS:** Slide the BASS lever up to increase the bass response. Adjust the bass lever to give a pleasing sound to your ear.

### Setting the Clock

1. Press the SET pushbutton.
2. Within five seconds, press and hold SCAN until the correct hour appears on the display.
3. Press and hold SEEK until the correct minute appears on the display.

### Playing a Cassette Tape

Your tape player is built to work best with tapes that are 30 to 45 minutes long on each side. Longer tapes are so thin they may not work well in this player.

With the radio on, push a tape into the slot marked AUTO REVERSE (tape side goes in first).

When the tape is playing, use the upper and lower knobs for volume, balance and fade just as you did for the radio. The lighted arrows indicate which side of the tape is being played.

This tape player has an AUTO REVERSE feature which automatically plays the other side of the tape.

**Forward:** Press ► and the tape will rapidly go forward until you press the STOP-EJECT button lightly.

**Reverse:** Press ◀ and the tape will rapidly reverse until you press the STOP-EJECT button lightly.

**MS:** Press the MS button to the recessed position to select music search. To search for the beginning of the next selection, push ►. Push ◀ and the tape will reverse to the beginning of the current selection.

**RCL/PROG:** To go from one side of the tape to the other, press the upper knob.

**STOP-EJECT:** To remove the tape or stop the tape and listen to the radio, press the STOP-EJECT button.

## Radio with Cassette Tape and Compact Disc Players

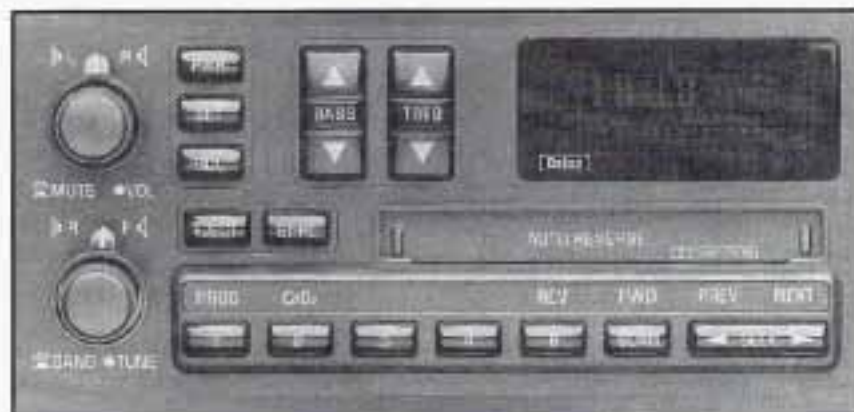

### Playing the Radio

**PWR:** Press PWR to turn the radio on or off when the ignition is on.

**Upper Knob:** The upper knob does the following:

- Controls the volume. The VOL knob increases or decreases the volume when it is held slightly rotated against the spring load. Volume is graphically displayed.
- Allows you to MUTE the radio or tape player. Press to mute; press again to listen. During mute, only volume up will work.

**Balance:** The control behind the upper knob allows you to balance the sound between the right and left speakers. Balance is graphically displayed.

**Lower Knob:** The lower knob does the following:

- Turn the lower knob to tune radio stations. If you hold the TUNE knob in the tune position, it will begin to tune rapidly.
- Push the lower knob to get AM, FM1 or FM2. Note the graphic display.
- The control behind the lower knob fades the sound between the front and rear speakers. The balance between speakers is graphically displayed.

### Finding a Station

◀ **SEEK** ▶: Press SEEK to search for the next lower or higher station and stop.

**SCAN:** When SCAN is pressed, the radio will go to the next station, pause and keep scanning until you press SCAN again.

**RCL:** Press RCL to change the display between the clock and the radio station frequency when the radio is on. To display the time with the ignition off, press RCL.

**Presets:** The five (1-5) pushbuttons can be used to preset up to 15 radio stations (five AM, five FM1 and five FM2 stations).

1. Tune in the desired station.
2. Push SET.
3. Within five seconds, push one of the five pushbuttons. Whenever you push that button, the preset station will return.
4. Repeat these steps for each pushbutton.

### Setting the Tone

▲ **BASS** ▼: Press BASS to increase or decrease bass tones. For the BASS preset setting, press the center of the control.

▲ **TREB** ▼: Press TREB to increase or decrease treble tones. Press the center of the TREB control for the preset level.

### Setting the Clock

1. Push SET with the ignition on and the radio off.
2. Within five seconds, push and hold SCAN until the correct hour appears.
3. Press and hold SEEK ◀ or ▶ until the correct minute appears.

## Playing a Cassette Tape

Your tape player is built to work best with tapes that are 30 to 45 minutes long on each side. Tapes longer than that are so thin they may not work well in this player.

With the radio on, press a tape into the slot marked **AUTO REVERSE** (tape side goes in first).

Once the tape is playing, use the upper and lower knobs for volume, balance and fade just as you did for the radio. The arrow in the graphic display shows which side of the tape is being played.

This audio system has automatic  Dolby<sup>®</sup> B NR to reduce background noise on Dolby encoded tapes. Dolby is a registered trademark of Dolby Laboratories.

**PROG:** To go from one side of the tape to the other, press the PROG button.

**CrO<sub>2</sub>:** This button sets the tape bias. When playing high-bias chrome or metal tapes, press the CrO<sub>2</sub> button (the button will light). When playing standard tapes, press CrO<sub>2</sub> again to turn it off.

**REV:** Press REV to reverse the tape rapidly. Press REV or PROG again to play the tape. (The radio plays while a tape is rewinding.)

**FWD:** Press FWD to advance the tape rapidly. Press FWD or PROG again to play the tape. (The radio plays while a tape is advancing.)

**PREV:** To hear the passage on the tape that has just played, press PREV. The tape will back up and stop at the first four-second quiet spot in the tape or the spot at which you press PROG or PREV.

**NEXT:** To go immediately to the next selection on the tape, press NEXT. The tape will stop at the first four-second quiet spot in the tape or the spot at which you press PROG or PREV.

**ST-PL:** To switch from tape to radio immediately, press the ST-PL button and the radio will resume playing the station that was tuned in when you inserted a tape. Pressing ST-PL again will allow the tape to resume where it stopped.

**EJECT:** To remove or stop the tape and listen to the radio, press the EJECT button. Tapes may be ejected even when the radio is off.

## Playing a Compact Disc



Before you begin, please note: *Do not* use mini-discs that are called singles. They won't eject. *Use full-size compact discs only.*

Press PWR to turn the system on.

Insert a disc part way into the slot, label side up. The player will pull it in. Wait a few seconds and the disc should play.

If the disc comes back out and "Err" appears on the display, it could be that:

- The disc is upside down.
- It is dirty, scratched, or wet.
- There's too much moisture in the air. (If there is, wait about one hour and try again.)
- The disc player is too hot. If the disc player is hot, or if you're driving on a very rough road, the disc may come out or not play. As soon as things get back to normal, the disc should play again.

**◀ TRAK ▶:** Press and release TRAK ▶ to advance the disc to the next track. Press TRAK ◀ to reverse the disc to the next track.

**RCL:** Press RCL to see what track is playing. Press it again within five seconds to see how long it has been playing.

The track number also appears when you change the volume or when a new track starts to play.

**COMP:** Pressing the COMP button makes soft and loud passages more equal in volume.

**SCAN:** Press SCAN to hear the first eight seconds of each track. Press it again to stop scanning.

**STOP:** Press STOP to stop the disc and play the radio. Press STOP again to restart the disc at the point where it stopped when the system is turned back on.

Press the PWR button or turn the ignition off to stop the disc player. The disc stays in the player and will resume playing at the point where it stopped when the system is turned back on.

**EJCT:** Press EJCT to eject the disc and play the radio. The disc will start at track 1 when you reinsert the disc.

As a feature to protect the disc, if you turn off the ignition with the disc partway out of the slot (after eject), it will be drawn back into the player in about 30 seconds. The disc will play at track 1 when the radio is turned on again.

## Radio with Compact Disc Player

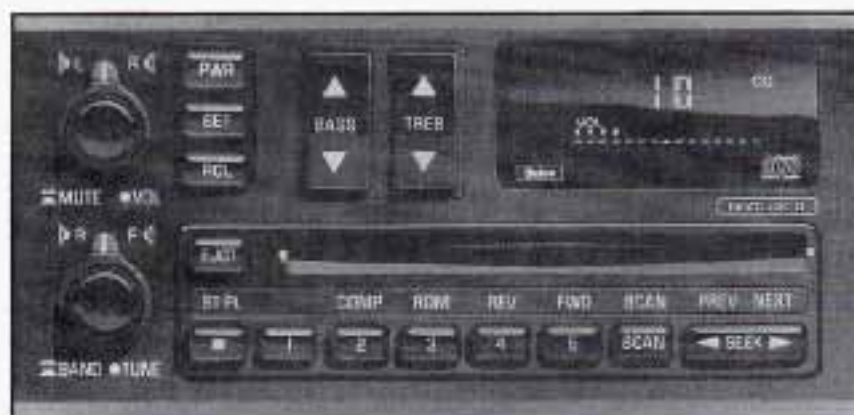

### Playing the Radio

**PWR:** To turn the radio on, press the PWR button.

**Upper Knob:** The upper knob does the following:

- Controls the volume. The VOL knob increases or decreases the volume when it is held slightly rotated against the spring load. Volume is graphically displayed.
- Allows you to MUTE the radio or the CD. Press to mute; press again to listen. During mute, only volume up will work.

**Balance:** The control behind the upper knob allows you to balance the sound between the right and left speakers. Balance is graphically displayed.

**Lower Knob:** The lower knob does the following:

- Turn the lower knob to tune radio stations. The TUNE knob increases and decreases station frequency when it is held slightly rotated against the spring load. Turn the knob to tune slowly. If you hold the knob in the position, it will begin to tune rapidly.
- Push BAND to get AM, FM1 or FM2.
- The control behind the lower knob fades the sound between the front and rear speakers. When the control is held, the position is graphically displayed.

**RCL:** Push RCL to display the time when the ignition is off. With the radio on, and the time displayed, push RCL to display the frequency.

### Finding a Station

**SEEK:** Press SEEK ◀ or ▶ to cause the receiver to search for the next lower or higher listenable station and stop.

**SCAN:** When you press SCAN, the radio will go to the next station, pause and keep scanning until you press SCAN again.

**Presets:** The five (1-5) pushbuttons let you return to favorite stations. You can set the pushbuttons for up to 15 radio stations (five AM, five FM1 and five FM2).

1. Tune in the desired station.
2. Push the SET button.
3. Within five seconds, push one of the five pushbuttons. Whenever you push that pushbutton, the preset station will return.

### Setting the Clock

1. Press the SET button with the ignition on and the radio off.
2. Within five seconds, push and hold SCAN until the correct hour appears.
3. Press and hold SEEK ◀ or ▶ until the correct minute appears.

### Setting the Tone

**BASS:** Press BASS ▲ or ▼ to increase or decrease bass tones. For the BASS preset level, press the center of the control. The bass setting is graphically displayed for a few seconds.

**TREB:** Press TREB ▲ or ▼ to increase or decrease treble tones. Press the center of the TREB control for the preset level. The treble setting is graphically displayed for a few seconds.



## Playing a Compact Disc

Before you begin, please note: *Do not* use mini-discs that are called singles. They won't eject. *Use full-size compact discs only.*

Press PWR to turn the system on.

Insert a disc part way into the slot, label side up. The player will pull it in. Wait a few seconds and the disc should play.

If the disc comes back out and "Err" appears on the display, it could be that:

- The disc is upside down.
- It is dirty, scratched, or wet.
- There's too much moisture in the air. (If there is, wait about one hour and try again.)
- The disc player is too hot. If the disc player is very hot, or if you're driving on a very rough road, the disc may come out or not play. As soon as things get back to normal, the disc should play again.

**RCL:** Press RCL to see what track is playing. Press it again within five seconds to see how long the CD has been playing that track. The display will automatically return to the time of day.

The track number also appears when you change the volume or when a new track starts to play.

**COMP:** Pressing the COMP button makes soft and loud passages more equal in volume. Comp will appear in the display.

**RDM:** When the RDM button is pressed, the CD player will play the tracks in random order rather than sequential 1,2,3... order. Pressing RDM again will play the disc in sequential order.

**REV:** Press and hold REV to return rapidly to a favorite passage in a track. Release it to play the passage. Note the seconds counter reading in the display.

**FWD:** Press and hold FWD to advance quickly within a track. Release it to resume playing. Watch the display to stop at a specific passage.

**SCAN:** Press SCAN to sample tracks on the disc, each for eight seconds. The player will continue to advance and sample until SCAN is pressed again.

**PREV:** Press PREV to hear the previous track. If you hold this button or press it more than once, the disc will retreat to previous tracks.

**NEXT:** Press NEXT to hear the next track now (instead of waiting until the present track is finished). If you hold this button, or press it more than once, the disc will advance further.

**ST-PL:** Press ST-PL to stop the disc and play the radio. Press ST-PL again to restart the disc at the point where it stopped.

Press the PWR button or turn the ignition off to stop the disc player. The disc stays in the player and will resume playing at the point where it stopped.

**EJCT:** Press EJCT and the disc will eject and the radio will play. The disc will start at track 1 when you reinsert the disc.

As a feature to protect the disc, if you turn off the ignition with the disc partway out of the slot (after eject), it will be drawn back into the player in about 30 seconds. The disc will play at track 1 when the system is turned on again.

## Steering Wheel Controls (Option)



If your vehicle has this feature, you can control certain radio and comfort control functions using the pads on the steering wheel.

**SEEK:** Press SEEK ▼ to go to a lower frequency station. Press SEEK ▲ to go to a higher frequency station. SEEK also functions as PREV and NEXT when playing a tape or disc.

**PROG:** Press PROG to hear the stations preset on your radio pushbuttons. Each time the button is pressed, the radio will advance to the next preset station.

**BAND:** To choose AM, FM1 or FM2 radio stations, press the pad marked BAND.

**VOL:** To increase or decrease the volume, press the pad marked VOL ▲ or ▼.

**TEMP:** Press TEMP ▲ or ▼ to increase or decrease the comfort control system temperature. Note the display reading.

## Anti-Theft Feature

Delco-Loc II is a security feature for the compact disc player. It can be used or ignored. If ignored, the system plays normally. If the security system is used, your player won't be usable if it's ever stolen, because it won't turn on.

The instructions below tell you how to enter your personal secret code into the system. If your vehicle loses battery power *for any reason*, you must unlock the system with the secret code again before the system will turn on.

Be sure to read through the entire procedure and become familiar with the appropriate buttons and knobs before starting.

1. Write down any six-digit number and keep it in a safe place.
2. Turn the ignition to the ACC or RUN position.
3. Press PWR to turn the radio *off*.
4. Press preset buttons 1 and 4 together. Hold them until “---” shows on the display (at least five seconds).

You are now ready to enter your secret code. If you pause more than 15 seconds between steps you may have to start over.

5. Press SET and “000” will appear on the display.
6. Press SCAN and hold it until the first digit of your code appears. Release the button.

7. Press SEEK ◀ or ▶ and hold it until the second and third digits of your code appear. Release the button.
8. Press the AM-FM knob and “000” will appear. Now you are ready to enter the second three digits of the code.
9. Press SCAN and hold it until the fourth digit of your code appears. Release the button.
10. Press SEEK ◀ or ▶ and hold until the fifth and sixth digits of your code appear. Release the button.
11. Press the AM-FM knob. The display will show “rEP” for five seconds, and then “000” will appear.
12. For verification, repeat Steps 6 through 11.
13. If the display shows SEC, the verification process was successful and the system is secure. If the display shows “---,” the verification steps were not successful and the entire sequence must be started again from Step 4.

## Unlocking the System After a Power Loss

When battery power is reapplied to a secured radio, the radio won't turn on and LOC will appear on the display.

Enter your secret code as follows. Pause no more than 15 seconds between steps.

1. Turn the ignition switch to the ACC or RUN position.
2. Press the SET button. The display will show “000.”
3. Press SCAN and hold it until the first digit of your code appears. Release the button.
4. Press SEEK ◀ or ▶ and hold until the second and third digits of your code appear. Release the button.
5. Press the AM-FM button. The radio will display “000”.
6. Press SCAN and hold it until the fourth digit of your code appears. Release the button.
7. Press SEEK ◀ or ▶ and hold until the fifth and sixth digits of your code appear. Release the button.
8. Press the AM-FM knob. SEC will appear on the display indicating the unit will work. If LOC appears on the display, the numbers did not match and the unit is still secured.

## Disabling The Theft System

If your audio system is secured (SEC shows on the display) and you wish to disable it, enter your security code as follows. Do not pause more than 15 seconds between steps.

1. Turn the ignition ON (radio off). The time will show on the display.
2. Press preset buttons 1 and 4 together until SEC shows on the display.
3. Press SET. The display will show "000."
4. Press SCAN and hold it until the first digit of your code appears. Release the button.
5. Press SEEK ◀ or ▶ and hold until the second and third digits of your code appear. Release the button.
6. Press the AM-FM knob. The radio will display "000."
7. Press SCAN and hold it until the fourth digit of your code appears. Release the button.
8. Press SEEK ◀ or ▶ and hold until the fifth and sixth digits of your code appear. Release the button.

9. Press the AM-FM button. If the display shows "---," the disabling sequence was successful. (The numbers matched the user-selected code or the factory back-up code and the unit is in the unsecured mode.) If the display shows SEC, the disabling sequence was unsuccessful and the numbers did not match either of the codes. The unit will then remain in the secured mode.

## Understanding Radio Reception

### FM Stereo

FM stereo will give you the best sound, but FM signals will reach only about 10 to 40 miles (16 to 65 km). And, tall buildings or hills can interfere with FM signals, causing the sound to come and go.

### AM

The range for most AM stations is greater than for FM, especially at night. The longer range can, however, cause stations to interfere with each other. AM can pick up noise from things like storms and power lines. Try reducing the treble to reduce this noise.

## AM Stereo

This means the Delco® system can receive C-QUAM® stereo broadcasts. Many AM stations around the country use C-QUAM® to produce stereo, though some do not. (C-QUAM® is a registered trademark of Motorola, Inc.) If your Delco® system can get C-QUAM®, your STEREO light will come on when you're receiving it.

Be aware that hearing damage from loud noise is almost undetectable until it is too late. Your hearing can adapt to higher volumes of sound. Sound that seems normal can be loud and harmful to your hearing. Take precautions by adjusting the volume control on your radio to a safe sound level before your hearing adapts to it.

To help avoid hearing loss or damage:

- Adjust the volume control to the lowest setting.
- Increase volume slowly until you hear comfortably and clearly.

## NOTICE:

**Before you add any sound equipment to your vehicle -- like a tape player, CB radio, mobile telephone or two-way radio -- be sure you can add what you want. If you can, it's very important to do it properly. Added sound equipment may interfere with the operation of your vehicle's engine, Delco® radio or other systems, and even damage them. And, your vehicle's systems may interfere with the operation of sound equipment that has been added improperly.**

**So, before adding sound equipment, check with your dealer and be sure to check Federal rules covering mobile radio and telephone units.**

## Cassette Tape Player Care

A tape player that is not cleaned regularly can cause reduced sound quality, ruined cassettes, or a damaged mechanism. Cassette tapes should be stored in their cases away from contaminants, direct sunlight, and extreme heat. If they aren't, they may not operate properly or may cause failure of the tape player.

Your tape player should be cleaned regularly after every 50 hours of use. If you notice a reduction in sound quality, try a known good cassette to see if the tape or the tape player is at fault. If this other cassette has no improvement in sound quality, clean the tape player.

A CLN message may appear on the radio display. If it does, your cassette tape player needs to be cleaned. It will still play tapes, but you should clean it as soon as possible to prevent damage to your tapes and player. After you clean the player, press and hold EJECT or EJCT for five seconds to reset the CLN indicator. “- - -” will appear in the display to show the indicator was reset.

The recommended tape player cleaning method is with a scrubbing-action, non-abrasive cleaning cassette. This is a wet-type cleaning system that uses a cleaning cassette with pads which scrub the tape head as the hubs of the cleaner cassette turn. If you use this type of cleaner, the radio may eject the cartridge. This is normal and is the result of an added feature in the tape player that detects broken tapes. If the cleaning cassette is ejected, you will need to insert it a total of at least three times to thoroughly clean the tape player.

You may prefer to use a non-scrubbing action, wet-type cleaner. This type of cleaner uses a cassette with a fabric belt which cleans the tape head. This type of cleaning cassette will not be ejected, but it may not clean the tape player as thoroughly as the scrubbing-type cleaner described above.

Cassettes are subject to wear and the sound quality may degrade over time. Always make sure that the cassette tape is in good condition before you have your tape player serviced.

## Compact Disc Care

Handle discs carefully. Store them in their original cases or other protective cases and away from direct sunlight and dust. If the surface of a disc is soiled, dampen a clean, soft cloth in a mild, neutral detergent solution and clean it, wiping only from the center to the edge.

Be sure *never* to touch the signal surface when handling discs. Pick up discs by grasping the outer edges or the edge of the hole and the outer edge.

## Power Antenna Mast Care

Your power antenna will look its best and work well if it's cleaned from time to time.

### To Clean the Antenna Mast

1. Turn on the ignition and radio to raise the antenna to full mast extension.
2. Dampen a clean cloth with mineral spirits or an equivalent solvent.

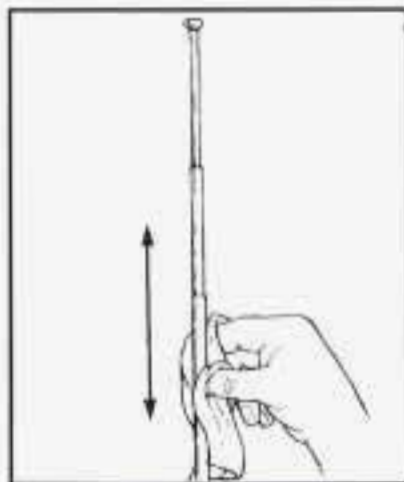

3. Wipe the cloth over the mast sections, removing any dirt.



4. Wipe the antenna dry with a clean cloth before retracting.
5. Make the antenna go up and down by turning the radio or ignition on and off.
6. Then repeat if necessary.

### **NOTICE:**

**Don't lubricate the power antenna. Lubrication could damage it.**

### **NOTICE:**

**Before entering an automatic car wash, turn off your radio to make the power antenna go down. This will prevent the mast from possibly getting damaged. If the antenna does not go down when you turn the radio off, it may be damaged or need to be cleaned. In either case, lower the antenna by hand by carefully pressing the antenna down.**

If the mast portion of your antenna is damaged, you can easily replace it. See your dealer for a replacement kit and follow the instructions in the kit.



## Section 4 Your Driving and the Road

Here you'll find information about driving on different kinds of roads and in varying weather conditions. We've also included many other useful tips on driving.



### Defensive Driving

The best advice anyone can give about driving is: Drive defensively.

Please start with a very important safety device in your Buick: Buckle up. (See "Safety Belts" in the Index.)

Defensive driving really means "be ready for anything." On city streets, rural roads, or freeways, it means "always expect the unexpected."

Assume that pedestrians or other drivers are going to be careless and make mistakes. Anticipate what they might do. Be ready for their mistakes.

Rear-end collisions are about the most preventable of accidents. Yet they are common. Allow enough following distance. It's the best defensive driving maneuver, in both city and rural driving. You never know when the vehicle in front of you is going to brake or turn suddenly.

## Drunken Driving

Death and injury associated with drinking and driving is a national tragedy. It's the number one contributor to the highway death toll, claiming thousands of victims every year.

Alcohol affects four things that anyone needs to drive a vehicle:

- Judgment
- Muscular Coordination
- Vision
- Attentiveness

Police records show that almost half of all motor vehicle-related deaths involve alcohol. In most cases, these deaths are the result of someone who was drinking and driving. In recent years, some 18,000 annual motor vehicle-related deaths have been associated with the use of alcohol, with more than 300,000 people injured.

Many adults -- by some estimates, nearly half the adult population -- choose never to drink alcohol, so they never drive after drinking. For persons under 21, it's against the law in every U.S. state to drink alcohol. There are good medical, psychological and developmental reasons for these laws.

The obvious way to solve this highway safety problem is for people never to drink alcohol and then drive. But what if people do? How much is "too much" if the driver plans to drive? It's a lot less than many might think. Although it depends on each person and situation, here is some general information on the problem.

The Blood Alcohol Concentration (BAC) of someone who is drinking depends upon four things:

- How much alcohol consumed
- The drinker's body weight
- The amount of food that is consumed before and during drinking
- The length of time it has taken the drinker to consume the alcohol

According to the American Medical Association, a 180-pound (82 kg) person who drinks three 12-ounce (355 ml) bottles of beer in an hour will end up with a BAC of about 0.06 percent. The person would reach the same BAC by drinking three 4-ounce (120 ml) glasses of wine or three mixed drinks if each had 1-1/2 ounces (45 ml) of a liquor like whiskey, gin or vodka.

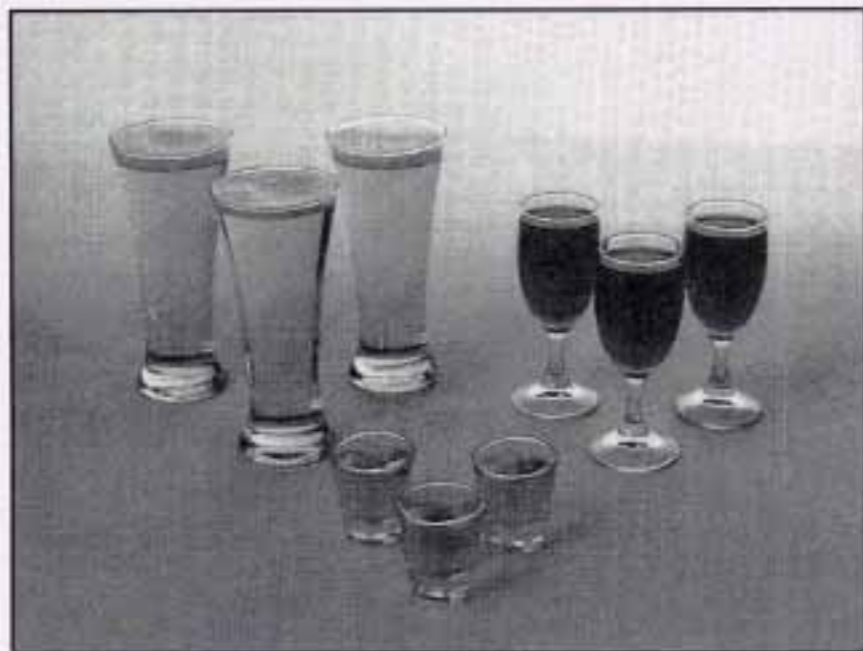

It's the amount of alcohol that counts. For example, if the same person drank three double martinis (3 ounces or 90 ml of liquor each) within an hour, the person's BAC would be close to 0.12 percent. A person who consumes food just before or during drinking will have a somewhat lower BAC level.

There is a gender difference, too. Women generally have a lower relative percentage of body water than men. Since alcohol is carried in body water, this means that a

woman generally will reach a higher BAC level than a man of her same body weight when each has the same number of drinks.

The law in many U.S. states sets the legal limit at a BAC of 0.10 percent. In a growing number of U.S. states, and throughout Canada, the limit is 0.08 percent. In some other countries it's even lower. The BAC limit for all commercial drivers in the U.S. is 0.04 percent.

The BAC will be over 0.10 percent after three to six drinks (in one hour). Of course, as we've seen, it depends on how much alcohol is in the drinks, and how quickly the person drinks them.

But the ability to drive is affected well below a BAC of 0.10 percent. Research shows that the driving skills of many people are impaired at a BAC approaching 0.05 percent, and that the effects are worse at night. All drivers are impaired at BAC levels above 0.05 percent. Statistics show that the chance of being in a collision increases sharply for drivers who have a BAC of 0.05 percent or above. A driver with a BAC level of 0.06 percent has doubled his or her chance of having a collision. At a BAC level of 0.10 percent, the chance of this driver having a collision is twelve times greater; at a level of 0.15 percent, the chance is twenty-five times greater!

The body takes about an hour to rid itself of the alcohol in one drink. No amount of coffee or number of cold showers will speed that up. "I'll be careful" isn't the right answer. What if there's an emergency, a need to take sudden action, as when a child darts into the street? A person with even a moderate BAC might not be able to react quickly enough to avoid the collision.

There's something else about drinking and driving that many people don't know. Medical research shows that alcohol in a person's system can make crash injuries worse, especially injuries to the brain, spinal cord or heart. This means that when anyone who has been drinking -- driver or passenger -- is in a crash, that person's chance of being killed or permanently disabled is higher than if the person had not been drinking.



## **CAUTION:**

**Drinking and then driving is very dangerous. Your reflexes, perceptions, attentiveness and judgment can be affected by even a small amount of alcohol. You can have a serious -- or even fatal -- collision if you drive after drinking. Please don't drink and drive or ride with a driver who has been drinking. Ride home in a cab; or if you're with a group, designate a driver who will not drink.**

## Control of a Vehicle

You have three systems that make your vehicle go where you want it to go. They are the brakes, the steering and the accelerator. All three systems have to do their work at the places where the tires meet the road.



Sometimes, as when you're driving on snow or ice, it's easy to ask more of those control systems than the tires and road can provide. That means you can lose control of your vehicle.

## Braking

Braking action involves *perception time* and *reaction time*.

First, you have to decide to push on the brake pedal. That's *perception time*. Then you have to bring up your foot and do it. That's *reaction time*.

Average *reaction time* is about  $3/4$  of a second. But that's only an average. It might be less with one driver and as long as two or three seconds or more with another. Age, physical condition, alertness, coordination, and eyesight all play a part. So do alcohol, drugs and frustration. But even in  $3/4$  of a second, a vehicle moving at 60 mph (100 km/h) travels 66 feet (20 m). That could be a lot of distance in an emergency, so keeping enough space between your vehicle and others is important.

And, of course, actual stopping distances vary greatly with the surface of the road (whether it's pavement or gravel); the condition of the road (wet, dry, icy); tire tread; and the condition of your brakes.

Avoid needless heavy braking. Some people drive in spurts -- heavy acceleration followed by heavy braking -- rather than keeping pace with traffic. This is a mistake. Your brakes may not have time to cool between hard stops. Your brakes will wear out much faster if you do a lot of heavy braking. If you keep pace with the traffic and allow realistic following distances, you will eliminate a lot of unnecessary braking. That means better braking and longer brake life.

If your engine ever stops while you're driving, brake normally but don't pump your brakes. If you do, the pedal may get harder to push down. If your engine stops, you will still have some power brake assist. But you will use it when you brake. Once the power assist is used up, it may take longer to stop and the brake pedal will be harder to push.

## Anti-Lock Brakes (ABS)

Your Buick has an advanced electronic braking system that will help prevent a braking skid.

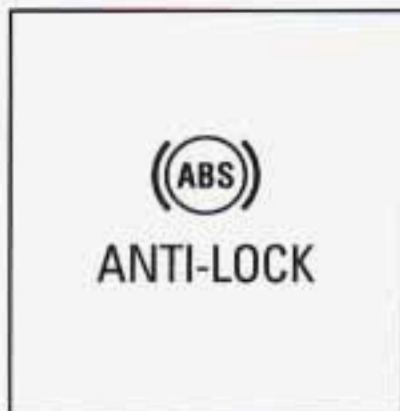

This light on the instrument panel will come on briefly when you start your vehicle.

When you start your vehicle and begin to drive away, you may hear a momentary motor or clicking noise. And you may even notice that your brake pedal moves a little while this is going on. This is the ABS system testing itself. If there's a problem with the anti-lock brake system, the anti-lock brake system warning light will stay on.

See "Anti-Lock Brake System Warning Light" in the Index.



Here's how anti-lock works. Let's say the road is wet. You're driving safely. Suddenly an animal jumps out in front of you.

You slam on the brakes. Here's what happens with ABS.

A computer senses that wheels are slowing down. If one of the wheels is about to stop rolling, the computer will separately work the brakes at each front wheel and at the rear wheels.

The anti-lock system can change the brake pressure faster than any driver could. The computer is programmed to make the most of available tire and road conditions.



You can steer around the obstacle while braking hard.

As you brake, your computer keeps receiving updates on wheel speed and controls braking pressure accordingly.

Remember: Anti-lock doesn't change the time you need to get your foot up to the brake pedal. If you get too



close to the vehicle in front of you, you won't have time to apply your brakes if that vehicle suddenly slows or stops. Always leave enough room up ahead to stop, even though you have anti-lock brakes.

### **To Use Anti-Lock**

Don't pump the brakes. Just hold the brake pedal down and let anti-lock work for you. You may hear a motor or clicking noise during a hard stop, but this is normal.

### **Traction Control System (Option)**

Your vehicle may have a traction control system that limits wheel spin. This is especially useful in slippery road conditions. The system operates only if it senses that one or both of the front wheels are spinning or beginning to lose traction. When this happens, the system works the front brakes and reduces engine power (by shutting off fuel injectors and managing engine spark) to limit wheel spin.

You may feel the system working, or you may notice some noise, but this is normal. If your vehicle is in cruise control when the traction control system begins to limit wheel spin, the cruise control will automatically disengage. When road conditions allow you to safely use it again, you may re-engage the cruise control. (See "Cruise Control" in the Index.)



When the system is on, the TRACTION OFF warning light will come on to let you know if there's a problem with your traction control system.

See "Traction Control System Warning Light" in the Index. When this warning light is on, the system will not limit wheel spin. Adjust your driving accordingly.

The traction control system automatically comes on whenever you start your vehicle. To limit wheel spin, especially in slippery road conditions, you should always leave the system on. But you can turn the traction control system off if you ever need to. (You should turn the system off if your vehicle ever gets stuck in sand, mud, ice or snow. See "Rocking Your Vehicle" in the Index.)



To turn the system off, press the OFF/ON traction control button located to the lower left of the steering column.

The TRACTION OFF warning light will come on and stay on. If the system is limiting wheel spin when you press the button, the system won't turn off right away. It will wait until there's no longer a current need to limit wheel spin.

You can turn the system back on at any time by pressing the button again. The TRACTION OFF warning light should go off.

## **Braking in Emergencies**

Use your anti-lock braking system when you need to. With anti-lock, you can steer and brake at the same time. In many emergencies, steering can help you more than even the very best braking.

## **Steering**

### **Power Steering**

If you lose power steering assist because the engine stops or the system is not functioning, you can steer but it will take much more effort.

### **Steering Tips**

#### **Driving on Curves**

It's important to take curves at a reasonable speed.

A lot of the "driver lost control" accidents mentioned on the news happen on curves. Here's why:

Experienced driver or beginner, each of us is subject to the same laws of physics when driving on curves. The traction of the tires against the road surface makes it possible for the vehicle to change its path when you turn the front wheels. If there's no traction, inertia will keep the vehicle going in the same direction. If you've ever tried to steer a vehicle on wet ice, you'll understand this.

The traction you can get in a curve depends on the condition of your tires and the road surface, the angle at which the curve is banked, and your speed. While you're in a curve, speed is the one factor you can control.

Suppose you're steering through a sharp curve. Then you suddenly accelerate. Both control systems -- steering and acceleration -- have to do their work where the tires meet the road. Unless you have traction control and the system is on, adding the sudden acceleration can demand too much of those places. You can lose control.

Speed limit signs near curves warn that you should adjust your speed. Of course, the posted speeds are based on good weather and road conditions. Under less favorable conditions you'll want to go slower.

If you need to reduce your speed as you approach a curve, do it before you enter the curve, while your front wheels are straight ahead.

Try to adjust your speed so you can "drive" through the curve. Maintain a reasonable, steady speed. Wait to accelerate until you are out of the curve, and then accelerate gently into the straightaway.

## Steering in Emergencies

There are times when steering can be more effective than braking. For example, you come over a hill and find a truck stopped in your lane, or a car suddenly pulls out from nowhere, or a child darts out from between parked cars and stops right in front of you. You can avoid these problems by braking -- if you can stop in time. But sometimes you can't; there isn't room. That's the time for evasive action -- steering around the problem.

Your Buick can perform very well in emergencies like these. First apply your brakes. (See "Braking in Emergencies" earlier in this section.) It is better to remove as much speed as you can from a possible collision. Then steer around the problem, to the left or right depending on the space available.

An emergency like this requires close attention and a quick decision. If you are holding the steering wheel at the recommended 9 and 3 o'clock positions, you can turn it a full 180 degrees very quickly without removing either hand. But you have to act fast, steer quickly, and just as quickly straighten the wheel once you have avoided the object.



The fact that such emergency situations are always possible is a good reason to practice defensive driving at all times and wear safety belts properly.

## Off-Road Recovery

You may find sometime that your right wheels have dropped off the edge of a road onto the shoulder while you're driving.

If the level of the shoulder is only slightly below the pavement, recovery should be fairly easy. Ease off the accelerator and then, if there is nothing in the way, steer so that your vehicle straddles the edge of the pavement. You can turn the steering wheel up to 1/4 turn until the right front tire contacts the pavement edge. Then turn your steering wheel to go straight down the roadway.

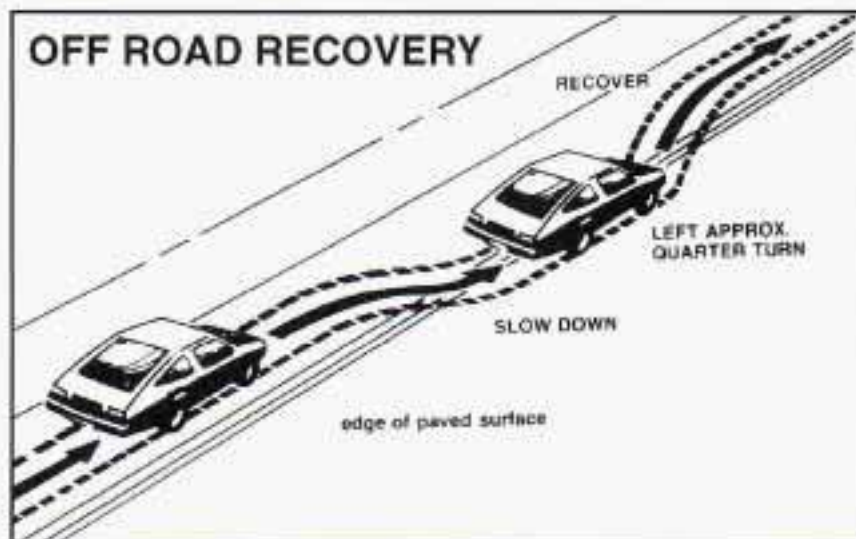

## Passing

The driver of a vehicle about to pass another on a two-lane highway waits for just the right moment, accelerates, moves around the vehicle ahead, then goes back into the right lane again. A simple maneuver?

Not necessarily! Passing another vehicle on a two-lane highway is a potentially dangerous move, since the passing vehicle occupies the same lane as oncoming traffic for several seconds. A miscalculation, an error in judgment, or a brief surrender to frustration or anger can suddenly put the passing driver face to face with the worst of all traffic accidents -- the head-on collision.

So here are some tips for passing:

- “Drive ahead.” Look down the road, to the sides, and to crossroads for situations that might affect your passing patterns. If you have any doubt whatsoever about making a successful pass, wait for a better time.
- Watch for traffic signs, pavement markings, and lines. If you can see a sign up ahead that might indicate a turn or an intersection, delay your pass. A broken center line usually indicates it’s all right to pass (providing the road ahead is clear). Never cross a solid line on your side of the lane or a double solid line, even if the road seems empty of approaching traffic.
- Do not get too close to the vehicle you want to pass while you’re awaiting an opportunity. For one thing, following too closely reduces your area of vision, especially if you’re following a larger vehicle. Also, you won’t have adequate space if the vehicle ahead suddenly slows or stops. Keep back a reasonable distance.
- When it looks like a chance to pass is coming up, start to accelerate but stay in the right lane and don’t get too close. Time your move so you will be increasing speed as the time comes to move into the other lane. If the way is clear to pass, you will have a “running start” that more than makes up for the distance you would lose by dropping back. And if something happens to cause you to cancel your pass, you need only slow down and drop back again and wait for another opportunity.
- If other cars are lined up to pass a slow vehicle, wait your turn. But take care that someone isn’t trying to pass you as you pull out to pass the slow vehicle. Remember to glance over your shoulder and check the blind spot.

- Check your mirrors, glance over your shoulder, and start your left lane change signal before moving out of the right lane to pass. When you are far enough ahead of the passed vehicle to see its front in your inside mirror, activate your right lane change signal and move back into the right lane. (Remember that your right outside mirror is convex. The vehicle you just passed may seem to be farther away from you than it really is.)
- Try not to pass more than one vehicle at a time on two-lane roads. Reconsider before passing the next vehicle.
- Don't overtake a slowly moving vehicle too rapidly. Even though the brake lights are not flashing, it may be slowing down or starting to turn.
- If you're being passed, make it easy for the following driver to get ahead of you. Perhaps you can ease a little to the right.

## Loss of Control

Let's review what driving experts say about what happens when the three control systems (brakes, steering and acceleration) don't have enough friction where the tires meet the road to do what the driver has asked.

In any emergency, don't give up. Keep trying to steer and constantly seek an escape route or area of less danger.

## Skidding

In a skid, a driver can lose control of the vehicle. Defensive drivers avoid most skids by taking reasonable care suited to existing conditions, and by not "overdriving" those conditions. But skids are always possible.

The three types of skids correspond to your Buick's three control systems. In the braking skid your wheels aren't rolling. In the steering or cornering skid, too much speed or steering in a curve causes tires to slip and lose cornering force. And in the acceleration skid too much throttle causes the driving wheels to spin.

A cornering skid is best handled by easing your foot off the accelerator pedal.

If you have the traction control system, remember: It helps avoid only the acceleration skid.

If you do not have traction control, or if the system is off, then an acceleration skid is also best handled by easing your foot off the accelerator pedal.

If your vehicle starts to slide, ease your foot off the accelerator pedal and quickly steer the way you want the vehicle to go. If you start steering quickly enough, your vehicle may straighten out. Always be ready for a second skid if it occurs.

Of course, traction is reduced when water, snow, ice, gravel, or other material is on the road. For safety, you'll want to slow down and adjust your driving to these conditions. It is important to slow down on slippery surfaces because stopping distance will be longer and vehicle control more limited.

While driving on a surface with reduced traction, try your best to avoid sudden steering, acceleration, or braking (including engine braking by shifting to a lower gear). Any sudden changes could cause the tires to slide. You may not realize the surface is slippery until your vehicle is skidding. Learn to recognize warning clues -- such as enough water, ice or packed snow on the road to make a "mirrored surface" -- and slow down when you have any doubt.

Remember: Any anti-lock brake system (ABS) helps avoid only the braking skid.

## Driving at Night

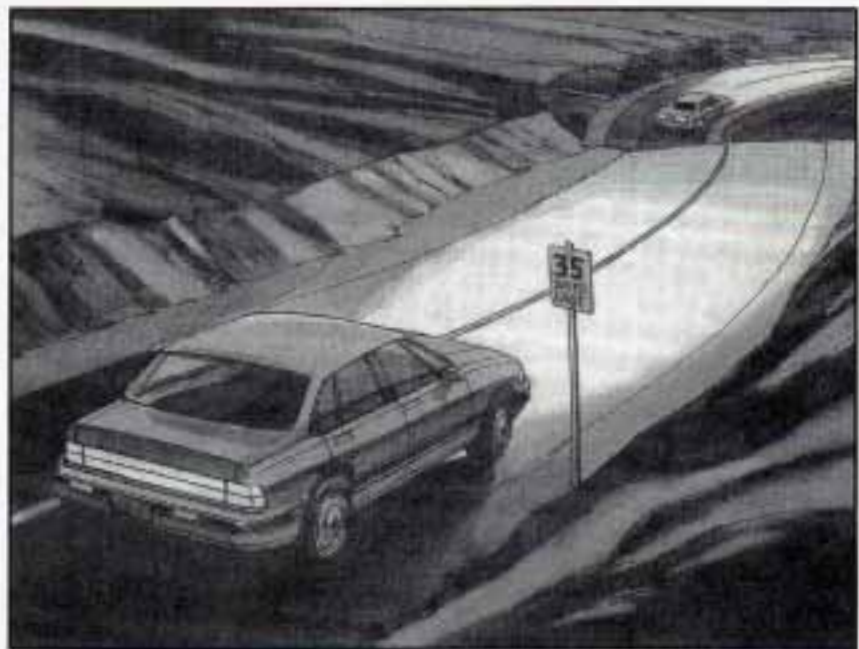

Night driving is more dangerous than day driving. One reason is that some drivers are likely to be impaired -- by alcohol or drugs, with night vision problems, or by fatigue.

Here are some tips on night driving.

- Drive defensively.
- Don't drink and drive.
- Adjust your inside rearview mirror to reduce the glare from headlamps behind you.
- Since you can't see as well, you may need to slow down and keep more space between you and other vehicles.
- Slow down, especially on higher speed roads. Your headlamps can light up only so much road ahead.
- In remote areas, watch for animals.
- If you're tired, pull off the road in a safe place and rest.

## Night Vision

No one can see as well at night as in the daytime. But as we get older these differences increase. A 50-year-old driver may require at least twice as much light to see the same thing at night as a 20-year-old.

What you do in the daytime can also affect your night vision. For example, if you spend the day in bright sunshine you are wise to wear sunglasses. Your eyes will

have less trouble adjusting to night. But if you're driving, don't wear sunglasses at night. They may cut down on glare from headlamps, but they also make a lot of things invisible.

You can be temporarily blinded by approaching lights. It can take a second or two, or even several seconds, for your eyes to readjust to the dark. When you are faced with severe glare (as from a driver who doesn't lower the high beams, or a vehicle with misaimed headlamps), slow down a little. Avoid staring directly into the approaching lights.

Keep your windshield and all the glass on your vehicle clean -- inside and out. Glare at night is made much worse by dirt on the glass. Even the inside of the glass can build up a film caused by dust. Dirty glass makes lights dazzle and flash more than clean glass would, making the pupils of your eyes contract repeatedly.

Remember that your headlamps light up far less of a roadway when you are in a turn or curve. Keep your eyes moving; that way, it's easier to pick out dimly lighted objects. Just as your headlamps should be checked regularly for proper aim, so should your eyes be examined regularly. Some drivers suffer from night blindness -- the inability to see in dim light -- and aren't even aware of it.



## Driving in the Rain



Rain and wet roads can mean driving trouble. On a wet road you can't stop, accelerate or turn as well because your tire-to-road traction isn't as good as on dry roads. And, if your tires don't have much tread left, you'll get even less traction. It's always wise to go slower and be cautious if rain starts to fall while you are driving. The surface may get wet suddenly when your reflexes are tuned for driving on dry pavement.

The heavier the rain, the harder it is to see. Even if your windshield wiper blades are in good shape, a heavy rain can make it harder to see road signs and traffic signals, pavement markings, the edge of the road, and even people walking.

It's wise to keep your wiping equipment in good shape and keep your windshield washer tank filled. Replace your windshield wiper inserts when they show signs of streaking or missing areas on the windshield, or when strips of rubber start to separate from the inserts.



Driving too fast through large water puddles or even going through some car washes can cause problems, too. The water may affect your brakes. Try to avoid puddles. But if you can't, try to slow down before you hit them.

 **CAUTION:**

Wet brakes can cause accidents. They won't work well in a quick stop and may cause pulling to one side. You could lose control of the vehicle.

After driving through a large puddle of water or a car wash, apply your brake pedal lightly until your brakes work normally.

## Hydroplaning

Hydroplaning is dangerous. So much water can build up under your tires that they can actually ride on the water. This can happen if the road is wet enough and you're going fast enough. When your vehicle is hydroplaning, it has little or no contact with the road.

Hydroplaning doesn't happen often. But it can if your tires haven't much tread or if the pressure in one or more is low. It can happen if a lot of water is standing on the road. If you can see reflections from trees, telephone poles, or other vehicles, and raindrops "dimple" the water's surface, there could be hydroplaning.

Hydroplaning usually happens at higher speeds. There just isn't a hard and fast rule about hydroplaning. The best advice is to slow down when it is raining.

## Some Other Rainy Weather Tips

- Turn on your low-beam headlamps -- not just your parking lamps -- to help make you more visible to others.
- Besides slowing down, allow some extra following distance. And be especially careful when you pass another vehicle. Allow yourself more clear room ahead, and be prepared to have your view restricted by road spray.
- Have good tires with proper tread depth. (See "Tires" in the Index.)

## City Driving



One of the biggest problems with city streets is the amount of traffic on them. You'll want to watch out for what the other drivers are doing and pay attention to traffic signals.

Here are ways to increase your safety in city driving:

- Know the best way to get to where you are going. Get a city map and plan your trip into an unknown part of the city just as you would for a cross-country trip.
- Try to use the freeways that rim and crisscross most large cities. You'll save time and energy. (See the next part, "Freeway Driving.")
- Treat a green light as a warning signal. A traffic light is there because the corner is busy enough to need it. When a light turns green, and just before you start to move, check both ways for vehicles that have not cleared the intersection or may be running the red light.

## Freeway Driving

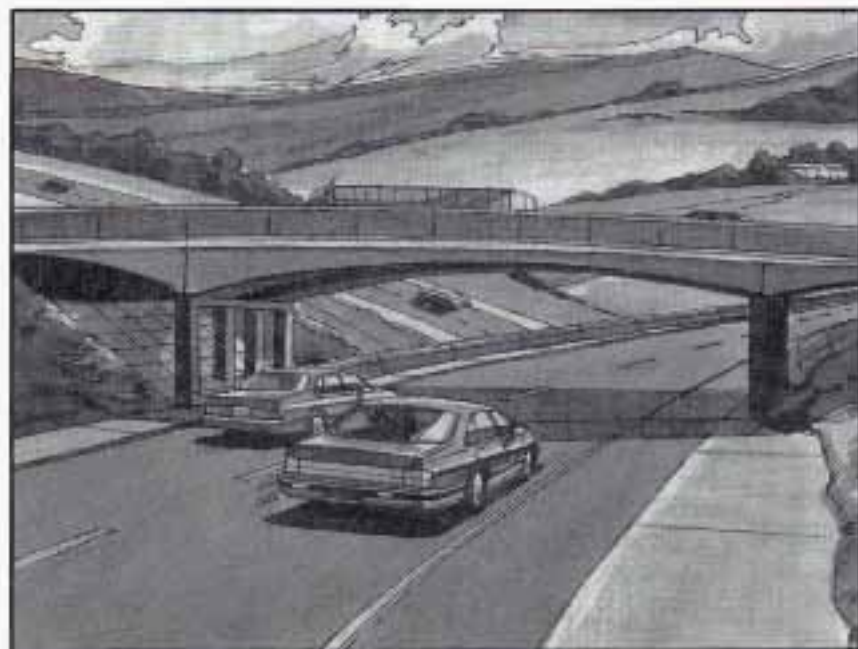

Mile for mile, freeways (also called thruways, parkways, expressways, turnpikes, or superhighways) are the safest of all roads. But they have their own special rules.

The most important advice on freeway driving is: Keep up with traffic and keep to the right. Drive at the same speed most of the other drivers are driving. Too-fast or too-slow driving breaks a smooth traffic flow. Treat the left lane on a freeway as a passing lane.

At the entrance there is usually a ramp that leads to the freeway. If you have a clear view of the freeway as you drive along the entrance ramp, you should begin to check traffic. Try to determine where you expect to blend with the flow. Try to merge into the gap at close to the prevailing speed. Switch on your turn signal, check your mirrors and glance over your shoulder as often as necessary. Try to blend smoothly with the traffic flow.

Once you are on the freeway, adjust your speed to the posted limit or to the prevailing rate if it's slower. Stay in the right lane unless you want to pass.

Before changing lanes, check your mirrors. Then use your turn signal.

Just before you leave the lane, glance quickly over your shoulder to make sure there isn't another vehicle in your "blind" spot.

Once you are moving on the freeway, make certain you allow a reasonable following distance. Expect to move slightly slower at night.

When you want to leave the freeway, move to the proper lane well in advance. If you miss your exit do not, under any circumstances, stop and back up. Drive on to the next exit.

The exit ramp can be curved, sometimes quite sharply.

The exit speed is usually posted.

Reduce your speed according to your speedometer, not to your sense of motion. After driving for any distance at higher speeds, you may tend to think you are going slower than you actually are.

## **Before Leaving on a Long Trip**

Make sure you're ready. Try to be well rested. If you must start when you're not fresh -- such as after a day's work -- don't plan to make too many miles that first part of the journey. Wear comfortable clothing and shoes you can easily drive in.

Is your vehicle ready for a long trip? If you keep it serviced and maintained, it's ready to go. If it needs service, have it done before starting out. Of course, you'll find experienced and able service experts in Buick dealers all across North America. They'll be ready and willing to help if you need it.

Here are some things you can check before a trip:

- *Windshield Washer Fluid:* Is the reservoir full? Are all windows clean inside and outside?
- *Wiper Blades:* Are they in good shape?
- *Fuel, Engine Oil, Other Fluids:* Have you checked all levels?
- *Lamps:* Are they all working? Are the lenses clean?
- *Tires:* They are vitally important to a safe, trouble-free trip. Is the tread good enough for long-distance driving? Are the tires all inflated to the recommended pressure?
- *Weather Forecasts:* What's the weather outlook along your route? Should you delay your trip a short time to avoid a major storm system?
- *Maps:* Do you have up-to-date maps?

## Highway Hypnosis

Is there actually such a condition as “highway hypnosis”? Or is it just plain falling asleep at the wheel? Call it highway hypnosis, lack of awareness, or whatever.

There is something about an easy stretch of road with the same scenery, along with the hum of the tires on the road, the drone of the engine, and the rush of the wind against the vehicle that can make you sleepy. Don't let it happen to you! If it does, your vehicle can leave the road in *less than a second*, and you could crash and be injured.

What can you do about highway hypnosis? First, be aware that it can happen.

Then here are some tips:

- Make sure your vehicle is well ventilated, with a comfortably cool interior.
- Keep your eyes moving. Scan the road ahead and to the sides. Check your rearview mirrors and your instruments frequently.
- If you get sleepy, pull off the road into a rest, service, or parking area and take a nap, get some exercise, or both. For safety, treat drowsiness on the highway as an emergency.

## Hill and Mountain Roads



Driving on steep hills or mountains is different from driving in flat or rolling terrain.

If you drive regularly in steep country, or if you're planning to visit there, here are some tips that can make your trips safer and more enjoyable.

- Keep your vehicle in good shape. Check all fluid levels and also the brakes, tires, cooling system and transaxle. These parts can work hard on mountain roads.
- Know how to go down hills. The most important thing to know is this: let your engine do some of the slowing down. Shift to a lower gear when you go down a steep or long hill.

 **CAUTION:**

**If you don't shift down, your brakes could get so hot that they wouldn't work well. You would then have poor braking or even none going down a hill. You could crash. Shift down to let your engine assist your brakes on a steep downhill slope.**

 **CAUTION:**

**Coasting downhill in NEUTRAL (N) or with the ignition off is dangerous. Your brakes will have to do all the work of slowing down. They could get so hot that they wouldn't work well. You could crash. Always have your engine running and your vehicle in gear when you go downhill.**

- Know how to go uphill. Shift down to THIRD (3). This will help cool your engine and transaxle, and you can climb the hill better.
- Stay in your own lane when driving on two-lane roads in hills or mountains. Don't swing wide or cut across the center of the road. Drive at speeds that let you stay in your own lane.
- As you go over the top of a hill, be alert. There could be something in your lane, like a stalled car or an accident.
- You may see highway signs on mountains that warn of special problems. Examples are long grades, passing or no-passing zones, a falling rocks area, or winding roads. Be alert to these and take appropriate action.



## Winter Driving



Here are some tips for winter driving:

- Have your Buick in good shape for winter. Be sure your engine coolant mix is correct.
- You may want to put winter emergency supplies in your trunk.

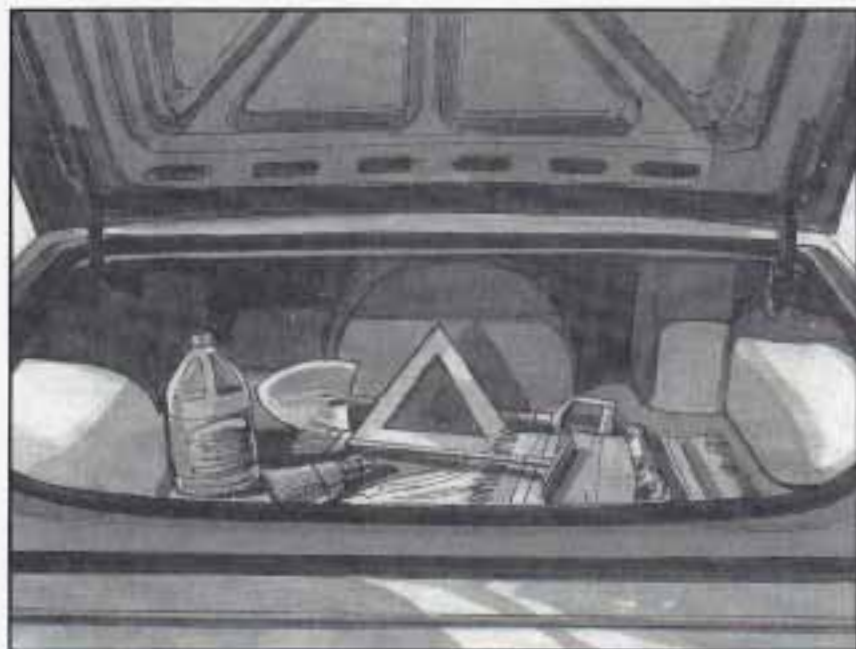

Include an ice scraper, a small brush or broom, a supply of windshield washer fluid, a rag, some winter outer clothing, a small shovel, a flashlight, a red cloth, and a couple of reflective warning triangles. And, if you will be driving under severe conditions, include a small bag of sand, a piece of old carpet or a couple of burlap bags to help provide traction. Be sure you properly secure these items in your vehicle.

## Driving on Snow or Ice

Most of the time, those places where your tires meet the road probably have good traction.

However, if there is snow or ice between your tires and the road, you can have a very slippery situation. You'll have a lot less traction or "grip" and will need to be very careful.



What's the worst time for this? "Wet ice." Very cold snow or ice can be slick and hard to drive on. But wet ice can be even more trouble because it may offer the least traction of all. You can get "wet ice" when it's about freezing (32°F; 0°C) and freezing rain begins to fall. Try to avoid driving on wet ice until salt and sand crews can get there.

Whatever the condition -- smooth ice, packed, blowing or loose snow -- drive with caution.

If you have traction control, keep the system on. It will improve your ability to accelerate when driving on a slippery road. Even though your vehicle has a traction control system, you'll want to slow down and adjust your driving to the road conditions. See "Traction Control System" in the Index.

If you don't have the traction control system, accelerate gently. Try not to break the fragile traction. If you accelerate too fast, the drive wheels will spin and polish the surface under the tires even more.

Your anti-lock brakes improve your ability to make a hard stop on a slippery road. Even though you have the anti-lock braking system, you'll want to begin stopping sooner than you would on dry pavement. See "Anti-Lock" in the Index.

- Allow greater following distance on any slippery road.
- Watch for slippery spots. The road might be fine until you hit a spot that's covered with ice. On an otherwise clear road, ice patches may appear in shaded areas where the sun can't reach: around clumps of trees, behind buildings, or under bridges. Sometimes the surface of a curve or an overpass may remain icy when the surrounding roads are clear. If you see a patch of ice ahead of you, brake before you are on it. Try not to brake while you're actually on the ice, and avoid sudden steering maneuvers.

## If You're Caught in a Blizzard

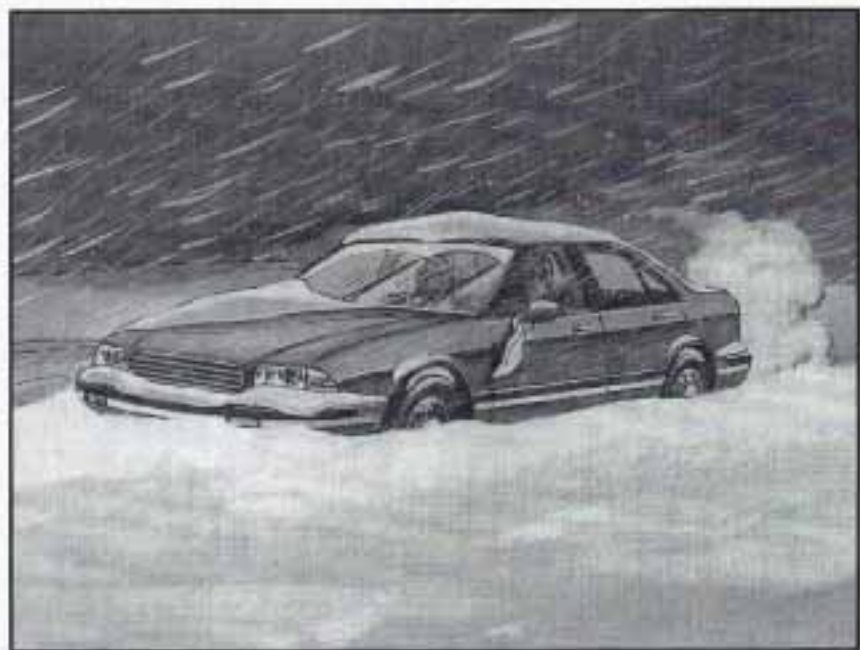

If you are stopped by heavy snow, you could be in a serious situation. You should probably stay with your vehicle unless you know for sure that you are near help and you can hike through the snow. Here are some things to do to summon help and keep yourself and your passengers safe: Turn on your hazard flashers. Tie a red

cloth to your vehicle to alert police that you've been stopped by the snow. Put on extra clothing or wrap a blanket around you. If you have no blankets or extra clothing, make body insulators from newspapers, burlap bags, rags, floor mats -- anything you can wrap around yourself or tuck under your clothing to keep warm.

You can run the engine to keep warm, but be careful.

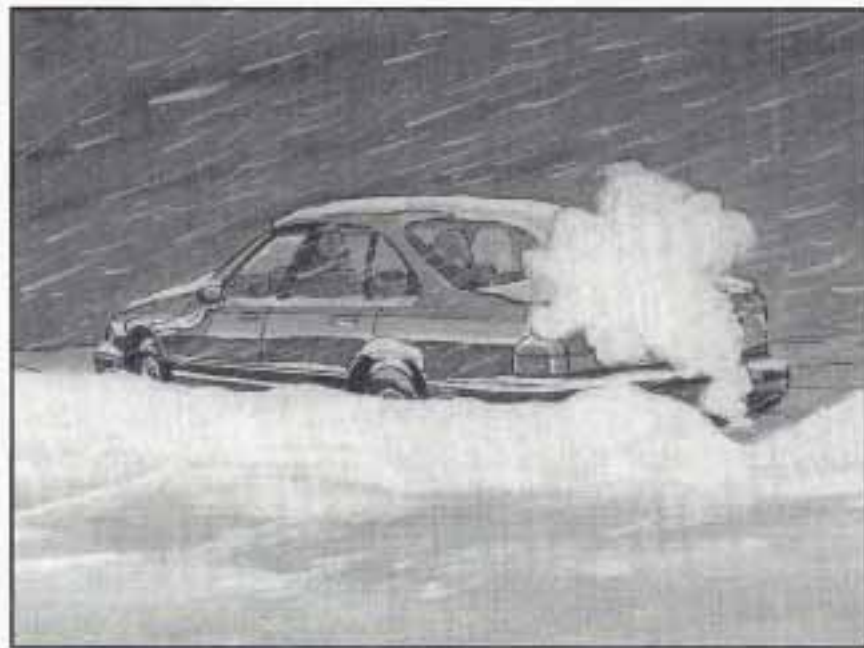

## CAUTION:

**Snow can trap exhaust gases under your vehicle. This can cause deadly CO (carbon monoxide) gas to get inside. CO could overcome you and kill you. You can't see it or smell it, so you might not know it is in your vehicle. Clear away snow from around the base of your vehicle, especially any that is blocking your exhaust pipe. And check around again from time to time to be sure snow doesn't collect there.**

**Open a window just a little on the side of the vehicle that's away from the wind. This will help keep CO out.**





MFD BY GENERAL MOTORS CORP  
DATE GVWR GAWR FRT GAWR RR

THIS VEHICLE CONFORMS TO ALL APPLICABLE U.S. FEDERAL MOTOR VEHICLE SAFETY, BUMPER, AND THEFT PREVENTION STANDARDS IN EFFECT ON THE DATE OF MANUFACTURE SHOWN ABOVE.

The other label is the Certification label, also found on the rear edge of the driver's door. It tells you the gross weight capacity of your vehicle, called the GVWR (Gross Vehicle Weight Rating). The GVWR includes the weight of the vehicle, all occupants, fuel and cargo. Never exceed the GVWR for your vehicle, or the Gross Axle Weight Rating (GAWR) for either the front or rear axle.

And, if you do have a heavy load, you should spread it out. Don't carry more than 176 pounds (80 kilograms) in your trunk.



## CAUTION:

Do not load your vehicle any heavier than the GVWR, or either the maximum front or rear GAWR. If you do, parts on your vehicle can break, or it can change the way your vehicle handles. These could cause you to lose control. Also, overloading can shorten the life of your vehicle.

## NOTICE:

Your warranty does not cover parts or components that fail because of overloading.

If you put things inside your vehicle -- like suitcases, tools, packages, or anything else -- they will go as fast as the vehicle goes. If you have to stop or turn quickly, or if there is a crash, they'll keep going.

 **CAUTION:**

Things you put inside your vehicle can strike and injure people in a sudden stop or turn, or in a crash.

- Put things in the trunk of your vehicle. In a trunk, put them as far forward as you can. Try to spread the weight evenly.
- Never stack heavier things, like suitcases, inside the vehicle so that some of them are above the tops of the seats.
- Don't leave an unsecured child restraint in your vehicle.
- When you carry something inside the vehicle, secure it whenever you can.

## Towing a Trailer

 **CAUTION:**

If you don't use the correct equipment and drive properly, you can lose control when you pull a trailer. For example, if the trailer is too heavy, the brakes may not work well -- or even at all. You and your passengers could be seriously injured. Pull a trailer only if you have followed all the steps in this section. Ask your Buick dealer for advice and information about towing a trailer with your vehicle.

**NOTICE:**

Pulling a trailer improperly can damage your vehicle and result in costly repairs not covered by your warranty. To pull a trailer correctly, follow the advice in this part, and see your Buick dealer for important information about towing a trailer with your vehicle.

Your vehicle can tow a trailer if it is equipped with the 3800 (L36) engine or Supercharged (L67) engine and proper trailer towing equipment. To identify what the vehicle trailering capacity is for your vehicle, you should read the information in “Weight of the Trailer” that appears later in this section. But trailering is different than just driving your vehicle by itself. Trailering means changes in handling, durability, and fuel economy. Successful, safe trailering takes correct equipment, and it has to be used properly.

That’s the reason for this part. In it are many time-tested, important trailering tips and safety rules. Many of these are important for your safety and that of your passengers. So please read this section carefully before you pull a trailer.

Load-pulling components such as the engine, transaxle, wheel assemblies, and tires are forced to work harder against the drag of the added weight. The engine is required to operate at relatively higher speeds and under greater loads, generating extra heat. What’s more, the trailer adds considerably to wind resistance, increasing the pulling requirements.

## **If You Do Decide To Pull A Trailer**

If you do, here are some important points.

- There are many different laws, including speed limit restrictions, having to do with trailering. Make sure your rig will be legal, not only where you live but also where you’ll be driving. A good source for this information can be state or provincial police.

- Consider using a sway control.

You can ask a hitch dealer about sway controls.

- Don’t tow a trailer at all during the first 1,000 miles (1 600 km) your new vehicle is driven. Your engine, axle or other parts could be damaged.
- Then, during the first 500 miles (800 km) that you tow a trailer, don’t drive over 50 mph (80 km/h) and don’t make starts at full throttle. This helps your engine and other parts of your vehicle wear in at the heavier loads.
- Obey speed limit restrictions when towing a trailer. Don’t drive faster than the maximum posted speed for trailers (or no more than 55 mph (90 km/h)) to save wear on your vehicle’s parts.



Three important considerations have to do with weight:

## Weight of the Trailer

How heavy can a trailer safely be?

It should never weigh more than 1,000 pounds (450 kg). But even that can be too heavy.

It depends on how you plan to use your rig. For example, speed, altitude, road grades, outside temperature and how much your vehicle is used to pull a trailer are all important. And, it can also depend on any special equipment that you have on your vehicle.

You can ask your dealer for our trailering information or advice, or you can write us at:

Buick Motor Division  
Customer Assistance Center  
902 E. Hamilton Avenue  
Flint, MI 48550

In Canada, write to:

General Motors of Canada Limited  
Customer Assistance Center  
1908 Colonel Sam Drive, Oshawa  
Ontario L1H 8P7

## Weight of the Trailer Tongue

The tongue load (A) of any trailer is an important weight to measure because it affects the total capacity weight of your vehicle. The capacity weight includes the curb weight of the vehicle, any cargo you may carry in it, and the people who will be riding in the vehicle. And if you will tow a trailer, you must subtract the tongue load from your vehicle's capacity weight because your vehicle will be carrying that weight, too. See "Loading Your Vehicle" in the Index for more information about your vehicle's maximum load capacity.

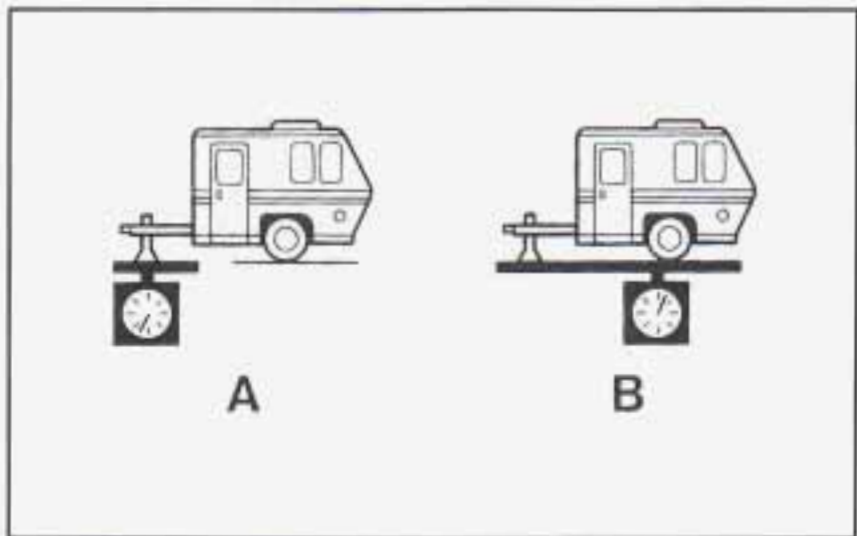

If you're using a "dead-weight" hitch, the trailer tongue (A) should weigh 10% of the total loaded trailer weight (B). If you have a "weight-distributing" hitch, the trailer tongue (A) should weigh 12% of the total loaded trailer weight (B).

After you've loaded your trailer, weigh the trailer and then the tongue, separately, to see if the weights are proper. If they aren't, you may be able to get them right simply by moving some items around in the trailer.

### **Total Weight on Your Vehicle's Tires**

Be sure your vehicle's tires are inflated to the recommended pressure for cold tires. You'll find these numbers on the Certification label at the rear edge of the driver's door or see "Loading Your Vehicle" in the Index. Then be sure you don't go over the GVW limit for your vehicle, including the weight of the trailer tongue.

### **Hitches**

It's important to have the correct hitch equipment. Crosswinds, large trucks going by, and rough roads are a few reasons why you'll need the right hitch. Here are some rules to follow:

- Will you have to make any holes in the body of your vehicle when you install a trailer hitch? If you do, then be sure to seal the holes later when you remove the hitch. If you don't seal them, deadly carbon monoxide (CO) from your exhaust can get into your vehicle (see "Carbon Monoxide" in the Index). Dirt and water can, too.
- The bumpers on your vehicle are not intended for hitches. Do not attach rental hitches or other bumper-type hitches to them. Use only a frame-mounted hitch that does not attach to the bumper.

## Safety Chains

You should always attach chains between your vehicle and your trailer. Cross the safety chains under the tongue of the trailer so that the tongue will not drop to the road if it becomes separated from the hitch. Instructions about safety chains may be provided by the hitch manufacturer or by the trailer manufacturer. Follow the manufacturer's recommendation for attaching safety chains and do not attach them to the bumper. Always leave just enough slack so you can turn with your rig. And, never allow safety chains to drag on the ground.

## Trailer Brakes

Does your trailer have its own brakes? Be sure to read and follow the instructions for the trailer brakes so you'll be able to install, adjust and maintain them properly. Because you have anti-lock brakes, do not try to tap into your vehicle's brake system. If you do, both brake systems won't work well, or at all.

## Driving with a Trailer

Towing a trailer requires a certain amount of experience. Before setting out for the open road, you'll want to get to know your rig. Acquaint yourself with the feel of handling and braking with the added weight of the trailer. And always keep in mind that the vehicle you are driving is now a good deal longer and not nearly as responsive as your vehicle is by itself.

Before you start, check the trailer hitch and platform (and attachments), safety chains, electrical connector, lamps, tires and mirror adjustment. If the trailer has electric brakes, start your vehicle and trailer moving and then apply the trailer brake controller by hand to be sure the brakes are working. This lets you check your electrical connection at the same time.

During your trip, check occasionally to be sure that the load is secure, and that the lamps and any trailer brakes are still working.

## Following Distance

Stay at least twice as far behind the vehicle ahead as you would when driving your vehicle without a trailer. This can help you avoid situations that require heavy braking and sudden turns.

## Passing

You'll need more passing distance up ahead when you're towing a trailer. And, because you're a good deal longer, you'll need to go much farther beyond the passed vehicle before you can return to your lane.

## Backing Up

Hold the bottom of the steering wheel with one hand. Then, to move the trailer to the left, just move that hand to the left. To move the trailer to the right, move your hand to the right. Always back up slowly and, if possible, have someone guide you.

## Making Turns

### **NOTICE:**

**Making very sharp turns while trailering could cause the trailer to come in contact with the vehicle. Your vehicle could be damaged. Avoid making very sharp turns while trailering.**

When you're turning with a trailer, make wider turns than normal. Do this so your trailer won't strike soft shoulders, curbs, road signs, trees, or other objects. Avoid jerky or sudden maneuvers. Signal well in advance.

## Turn Signals When Towing a Trailer

When you tow a trailer, your vehicle has to have a different turn signal flasher and extra wiring. The green arrows on your instrument panel will flash whenever you signal a turn or lane change. Properly hooked up, the trailer lamps will also flash, telling other drivers you're about to turn, change lanes or stop.

When towing a trailer, the green arrows on your instrument panel will flash for turns even if the bulbs on the trailer are burned out. Thus, you may think drivers behind you are seeing your signal when they are not. It's important to check occasionally to be sure the trailer bulbs are still working.

## Driving On Grades

Reduce speed and shift to a lower gear *before* you start down a long or steep downgrade. If you don't shift down, you might have to use your brakes so much that they would get hot and no longer work well.

On a long uphill grade, use the highest gear possible. If you cannot maintain posted speeds, driving at a lower speed may help avoid overheating your engine and transaxle.

## Parking on Hills

You really should not park your vehicle, with a trailer attached, on a hill. If something goes wrong, your rig could start to move. People can be injured, and both your vehicle and the trailer can be damaged.

But if you ever have to park your rig on a hill, here's how to do it:

1. Apply your regular brakes, but don't shift into PARK (P) yet.
2. Have someone place chocks under the trailer wheels.
3. When the wheel chocks are in place, release the regular brake until the chocks absorb the load.
4. Reapply the regular brakes. Then apply your parking brake, and then shift to PARK (P).
5. Release the regular brakes.

## When You Are Ready to Leave After Parking on a Hill

1. Apply your regular brakes and hold the pedal down while you:
  - Start your engine;
  - Shift into a gear; and
  - Release the parking brake.
2. Let up on the brake pedal.
3. Drive slowly until the trailer is clear of the chocks.
4. Stop and have someone pick up and store the chocks.

## Maintenance When Trailer Towing

Your vehicle will need service more often when you're pulling a trailer. See the Maintenance Schedule for more on this. Things that are especially important in trailer operation are automatic transaxle fluid (don't overfill), engine oil, belts, cooling system, and brake adjustment. Each of these is covered in this manual, and the Index will help you find them quickly. If you're trailering, it's a good idea to review these sections before you start your trip.

Check periodically to see that all hitch nuts and bolts are tight.



## Section 5 Problems on the Road

Here you'll find what to do about some problems that can occur on the road.

### Hazard Warning Flashers

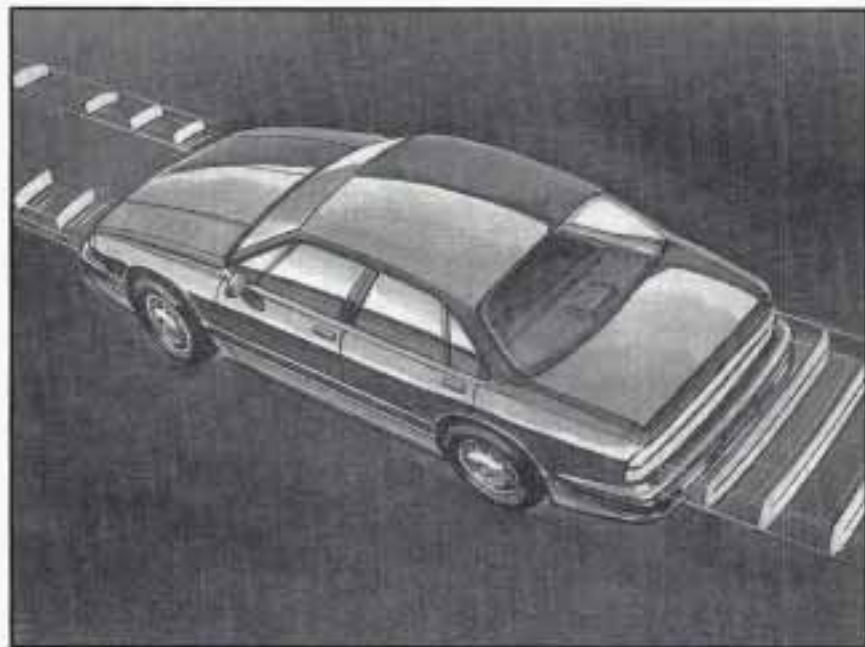

Your hazard warning flashers let you warn others. They also let police know you have a problem. Your front and rear turn signal lamps will flash on and off.



Press down on the button located on top of the steering column to make your front and rear turn signal lamps flash on and off.

Your hazard warning flashers work no matter what position your key is in, and even if the key isn't in.

To turn off the flashers, press down on the button again. When the hazard warning flashers are on, your turn signals won't work.

## Other Warning Devices

If you carry reflective triangles, you can set one up at the side of the road about 300 feet (100 m) behind your vehicle.

## Jump Starting

If your battery has run down, you may want to use another vehicle and some jumper cables to start your Buick. But please use the following steps to do it safely.

### CAUTION:

Batteries can hurt you. They can be dangerous because:

- They contain acid that can burn you.
- They contain gas that can explode or ignite.
- They contain enough electricity to burn you.

If you don't follow these steps exactly, some or all of these things can hurt you.

### NOTICE:

Ignoring these steps could result in costly damage to your vehicle that wouldn't be covered by your warranty.

Trying to start your Buick by pushing or pulling it won't work, and it could damage your vehicle.

## To Jump Start Your Buick

1. Check the other vehicle. It must have a 12-volt battery with a negative ground system.

### NOTICE:

If the other system isn't a 12-volt system with a negative ground, both vehicles can be damaged.

2. Get the vehicles close enough so the jumper cables can reach, but be sure the vehicles aren't touching each other. If they are, it could cause a ground connection you don't want. You wouldn't be able to start your Buick, and the bad grounding could damage the electrical systems.

You could be injured if the vehicles roll. Set the parking brake firmly on each vehicle. Put an automatic transaxle in PARK (P) or a manual transaxle in NEUTRAL (N).

3. Turn off the ignition on both vehicles. Turn off all lamps that aren't needed, and radios. This will avoid sparks and help save both batteries. And it could save your radio!

### **NOTICE:**

**If you leave your radio on, it could be badly damaged. The repairs wouldn't be covered by your warranty.**

4. Open the hoods and locate the batteries. Find the positive (+) and negative (-) terminals on each battery. Your Riviera has a remote positive (+) terminal for this purpose. (The battery is under the back seat.)

### **CAUTION:**

**An electric fan can start up even when the engine is not running and can injure you. Keep hands, clothing and tools away from any underhood electric fan.**

### **CAUTION:**

**Using a match near a battery can cause battery gas to explode. People have been hurt doing this, and some have been blinded. Use a flashlight if you need more light.**

**Be sure the battery has enough water. You don't need to add water to the Delco Freedom<sup>®</sup> battery installed in every new GM vehicle. But if a battery has filler caps, be sure the right amount of fluid is there. If it is low, add water to take care of that first. If you don't, explosive gas could be present.**

**Battery fluid contains acid that can burn you. Don't get it on you. If you accidentally get it in your eyes or on your skin, flush the place with water and get medical help immediately.**



5. Check that the jumper cables don't have loose or missing insulation. If they do, you could get a shock. The vehicles could be damaged, too.

Before you connect the cables, here are some basic things you should know. Positive (+) will go to positive (+) and negative (-) will go to negative (-) or a metal engine part. Don't connect (+) to (-) or you'll get a short that would damage the battery and maybe other parts, too.

**⚠ CAUTION:**

**Fans or other moving engine parts can injure you badly. Keep your hands away from moving parts once the engines are running.**



6. Connect the red positive (+) cable to the remote positive (+) terminal of the vehicle with the dead battery.



7. Don't let the other end touch metal. Connect it to the positive (+) terminal of the good battery. Use a remote positive (+) terminal if the vehicle has one.



8. Now connect the black negative (-) cable to the good battery's negative (-) terminal.

Don't let the other end touch anything until the next step. The other end of the negative cable *doesn't* go to the dead battery. It goes to a heavy unpainted metal part on the engine of the vehicle with the dead battery.

9. Attach the cable at least 18 inches (45 cm) away from the dead battery, but not near engine parts that move. The electrical connection is just as good there, but the chance of sparks getting back to the battery is much less.

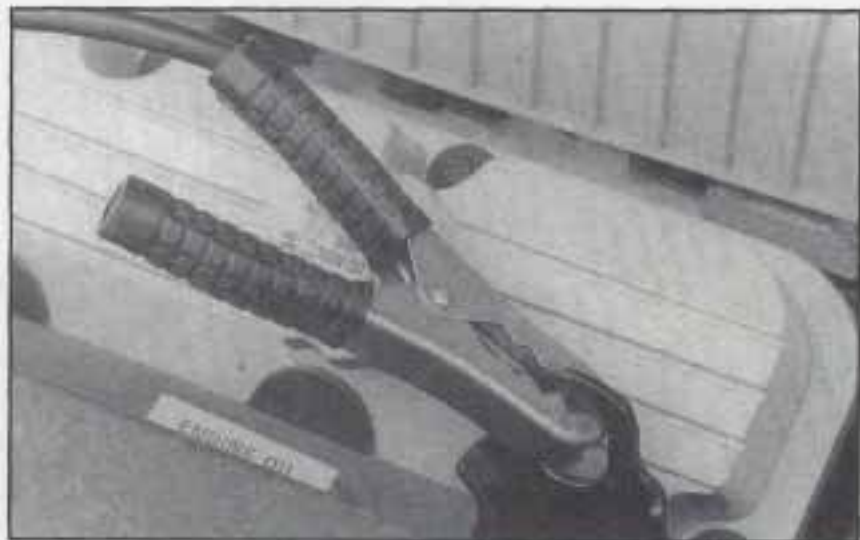

10. Now start the vehicle with the good battery and run the engine for a while.
11. Try to start the vehicle with the dead battery.  
If it won't start after a few tries, it probably needs service.

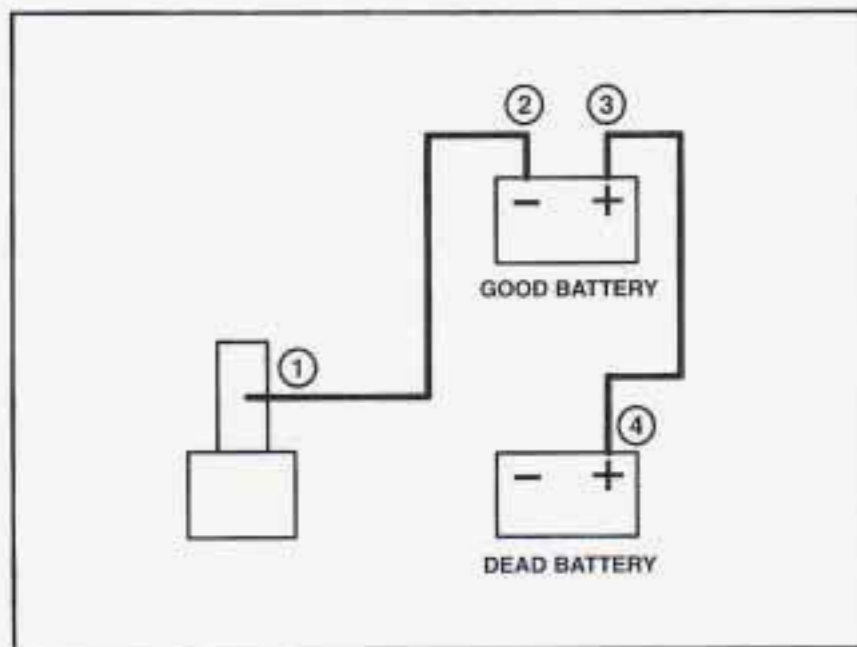

12. Remove the cables in reverse order to prevent electrical shorting. Take care that they don't touch each other or any other metal.

## Towing Your Vehicle

Try to have a GM dealer or a professional towing service tow your Buick. The usual towing equipment is a sling-type (A) or wheel-lift (B) or car carrier (C) tow truck.

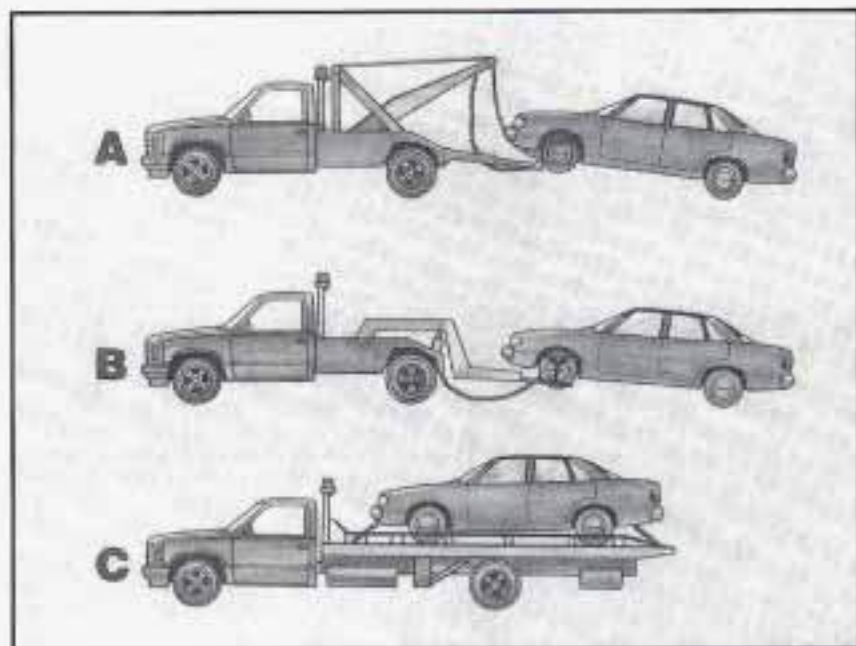

If your vehicle has been changed or modified since it was factory-new by adding aftermarket items like fog lamps, aero skirting, or special tires and wheels, these instructions and illustrations may not be correct.

Before you do anything, turn on the hazard warning flashers.

When you call, tell the towing service:

- That your vehicle has front-wheel drive.
- The make, model, and year of your vehicle.
- Whether you can still move the shift lever.
- If there was an accident, what was damaged.

When the towing service arrives, let the tow operator know that this manual contains detailed towing instructions and illustrations. The operator may want to see them.

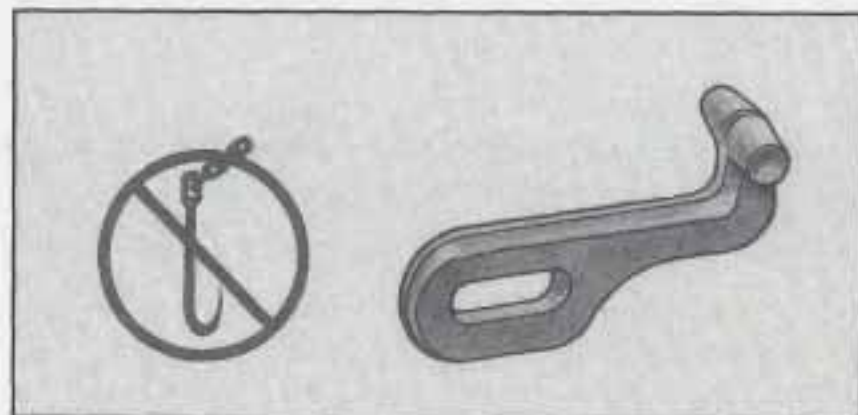

 **CAUTION:**

To help avoid injury to you or others:

- Never let passengers ride in a vehicle that is being towed.
- Never tow faster than safe or posted speeds.
- Never tow with damaged parts not fully secured.
- Never get under your vehicle after it has been lifted by the tow truck.

**CAUTION:** (Continued)

**CAUTION: (Continued)**

- Always secure the vehicle on each side with separate safety chains when towing it.
- Never use J-hooks. Use T-hooks instead.

When your vehicle is being towed, have the ignition key off. The steering wheel should be clamped in a straight-ahead position, with a clamping device designed for towing service. Do not use the vehicle's steering column lock for this. The transaxle should be in NEUTRAL (N) and the parking brake released.

Don't have your vehicle towed on the front wheels, unless you must. If the vehicle must be towed on the front wheels, don't go more than *55 mph (88 km/h)* or farther than *500 miles (800 km)* or your transaxle will be damaged. If these limits must be exceeded, then the front wheels have to be supported on a dolly.



**CAUTION:**

A vehicle can fall from a car carrier if it isn't adequately secured. This can cause a collision, serious personal injury and vehicle damage. The vehicle should be tightly secured with chains or steel cables before it is transported.

**Don't use substitutes (ropes, leather straps, canvas webbing, etc.) that can be cut by sharp edges underneath the towed vehicle. Always use T-hooks inserted in the T-hook slots. Never use J-hooks. They will damage drivetrain and suspension components.**

## Front Towing

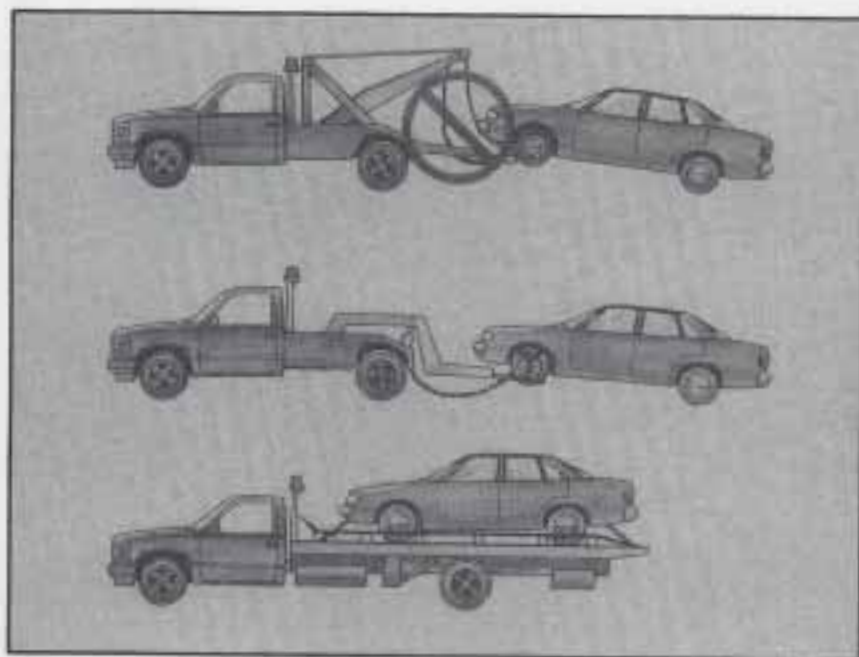

Use a wheel lift or car carrier equipment. Additional ramping may be required for the car carrier equipment. Use safety chains and wheel straps.

### **NOTICE:**

**Do not tow with sling-type equipment or fascia/fog lamp damage will occur.**

**Towing a vehicle over rough surfaces could damage a vehicle. Damage can occur from vehicle to ground or vehicle to wheel-lift equipment. To help avoid damage, install a towing dolly and raise the vehicle until adequate clearance is obtained between the ground and/or wheel-lift equipment.**

**Do not attach winch cables or J-hooks to suspension components when using car carrier equipment. Always use T-hooks inserted in the T-hook slots.**

## Rear Towing Hookups

**TOW LIMITS - 55 MPH (88 KM/H), 500 MILES (800 KM)**

Attach "T" hook chains to the slots in the bottom of the floor pan just ahead of the rear wheels on both sides.

Position the lower sling crossbar directly under the fascia. A 4" x 4" wood beam is *not* needed.

Attach a separate safety chain around the outboard end of each lower control arm.

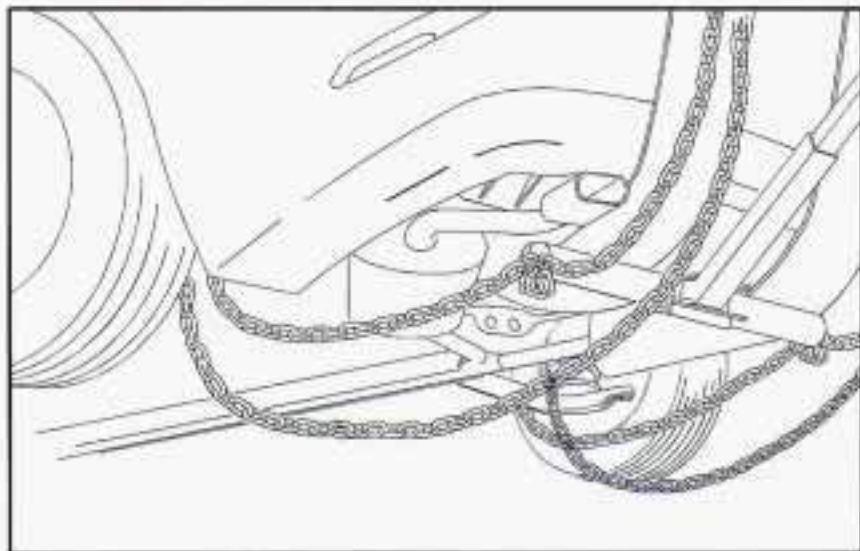
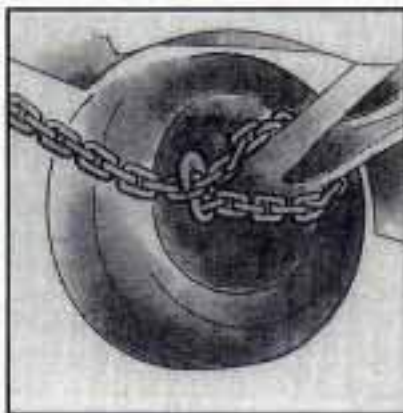
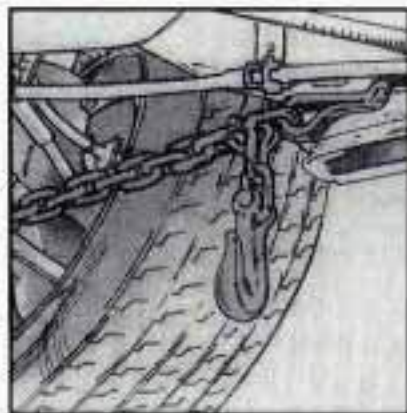

## Engine Overheating

You will find a coolant temperature gage and the warning light about a hot engine on your instrument panel.

### If Steam Is Coming From Your Engine



#### CAUTION:

Steam from an overheated engine can burn you badly, even if you just open the hood. Stay away from the engine if you see or hear steam coming from it. Just turn it off and get everyone away from the vehicle until it cools down. Wait until there is no sign of steam or coolant before opening the hood.

If you keep driving when your engine is overheated, the liquids in it can catch fire. You or others could be badly burned. Stop your engine if it overheats, and get out of the vehicle until the engine is cool.

#### NOTICE:

If your engine catches fire because you keep driving with no coolant, your vehicle can be badly damaged. The costly repairs would not be covered by your warranty.

### If No Steam Is Coming From Your Engine

If you get the overheat warning but see or hear no steam, the problem may not be too serious. Sometimes the engine can get a little too hot when you:

- Climb a long hill on a hot day.
- Stop after high speed driving.
- Idle for long periods in traffic.
- Tow a trailer.

If you get the overheat warning with no sign of steam, try this for a minute or so:

1. Turn off your air conditioner.



2. Turn on your heater to full hot at the highest fan speed and open the window as necessary.
3. If you're in a traffic jam, shift to NEUTRAL (N); otherwise, shift to the highest gear while driving -- AUTOMATIC OVERDRIVE (Ⓢ) or THIRD (3).

If you no longer have the overheat warning, you can drive. Just to be safe, drive slower for about 10 minutes. If the warning doesn't come back on, you can drive normally.

If the warning continues, pull over, stop, and park your vehicle right away.

If there's still no sign of steam, you can idle the engine for two or three minutes while you're parked, to see if the warning stops. But then, if you still have the warning, *turn off the engine and get everyone out of the vehicle* until it cools down.

You may decide not to lift the hood but to get service help right away.



When you decide it's safe to lift the hood, here's what you'll see:

- Coolant recovery tank
- Radiator pressure cap
- Electric engine fans

**⚠ CAUTION:**

An electric fan under the hood can start up even when the engine is not running and can injure you. Keep hands, clothing and tools away from any underhood electric fan.

If the coolant inside the coolant recovery tank is boiling, don't do anything else until it cools down.

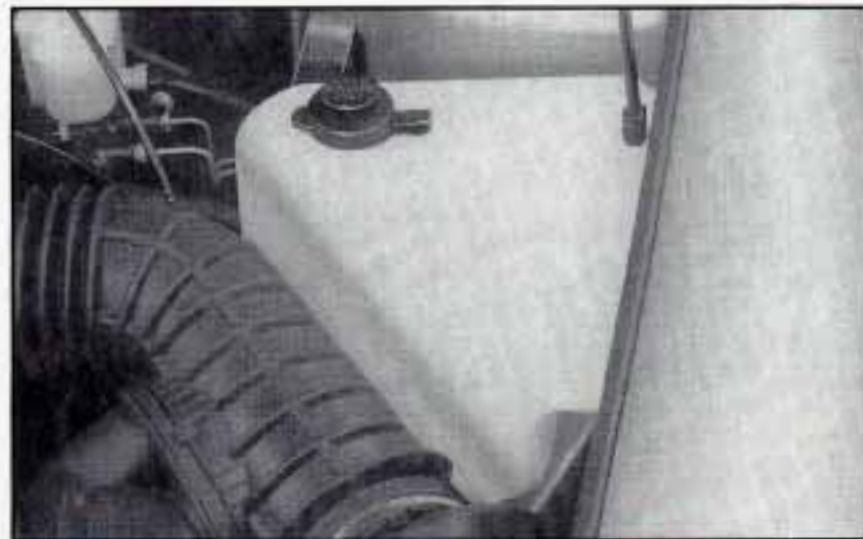

The coolant level should be at or above FULL COLD. If it isn't, you may have a leak in the radiator hoses, heater hoses, radiator, water pump or somewhere else in the cooling system.

**⚠ CAUTION:**

Heater and radiator hoses, and other engine parts, can be very hot. Don't touch them. If you do, you can be burned.

Don't run the engine if there is a leak. If you run the engine, it could lose all coolant. That could cause an engine fire, and you could be burned. Get any leak fixed before you drive the vehicle.

**NOTICE:**

Engine damage from running your engine without coolant isn't covered by your warranty.

If there seems to be no leak, with the engine on check to see if the electric engine fans are running. If the engine is overheating, both fans should be running. If they aren't, your vehicle needs service.

## How to Add Coolant to the Coolant Recovery Tank

If you haven't found a problem yet, but the coolant level isn't at FULL COLD, add a 50/50 mixture of *clean water* (preferably distilled) and a proper antifreeze at the coolant recovery tank. (See "Engine Coolant" in the Index for more information about the proper coolant mix.)

### CAUTION:

Adding only plain water to your cooling system can be dangerous. Plain water, or some other liquid like alcohol, can boil before the proper coolant mix will. Your vehicle's coolant warning system is set for the proper coolant mix. With plain water or the wrong mix, your engine could get too hot but you wouldn't get the overheat warning. Your engine could catch fire and you or others could be burned. Use a 50/50 mix of clean water and a proper antifreeze.

### NOTICE:

In cold weather, water can freeze and crack the engine, radiator, heater core and other parts. Use the recommended coolant.



**⚠ CAUTION:**

You can be burned if you spill coolant on hot engine parts. Coolant contains ethylene glycol and it will burn if the engine parts are hot enough. Don't spill coolant on a hot engine.

When the coolant in the coolant recovery tank is at FULL COLD, start your vehicle.

If the overheat warning continues, there's one more thing you can try. You can add the proper coolant mix directly to the radiator but be sure the cooling system is cool before you do it.

**⚠ CAUTION:**

Steam and scalding liquids from a hot cooling system can blow out and burn you badly. They are under pressure, and if you turn the radiator pressure cap -- even a little -- they can come out

**CAUTION: (Continued)**

**CAUTION: (Continued)**

at high speed. Never turn the cap when the cooling system, including the radiator pressure cap, is hot. Wait for the cooling system and radiator pressure cap to cool if you ever have to turn the pressure cap.



## How to Add Coolant to the Radiator



1. You can remove the radiator pressure cap when the cooling system, including the radiator pressure cap and upper radiator hose, is no longer hot.

Turn the pressure cap slowly to the left until it first stops. (Don't press down while turning the pressure cap.)

If you hear a hiss, wait for that to stop. A hiss means there is still some pressure left.



2. Then keep turning the pressure cap, but now push down as you turn it. Remove the pressure cap.



3. Fill the radiator with the proper mix, up to the base of the filler neck.



4. Then fill the coolant recovery tank to FULL COLD.
5. Put the cap back on the coolant recovery tank, but leave the radiator pressure cap off.



6. Start the engine and let it run until you can feel the upper radiator hose getting hot. Watch out for the engine fans.
7. By this time the coolant level inside the radiator filler neck may be lower. If the level is lower, add more of the proper mix through the filler neck until the level reaches the base of the filler neck.

8. Then replace the pressure cap.



At any time during this procedure if coolant begins to flow out of the filler neck, reinstall the pressure cap. Be sure the arrows on the pressure cap line up like this.

## If a Tire Goes Flat

It's unusual for a tire to "blow out" while you're driving, especially if you maintain your tires properly. If air goes out of a tire, it's much more likely to leak out slowly. But if you should ever have a "blowout," here are a few tips about what to expect and what to do:

If a front tire fails, the flat tire will create a drag that pulls the vehicle toward that side. Take your foot off the accelerator pedal and grip the steering wheel firmly. Steer to maintain lane position, then gently brake to a stop well out of the traffic lane.

A rear blowout, particularly on a curve, acts much like a skid and may require the same correction you'd use in a skid. In any rear blowout, remove your foot from the accelerator pedal. Get the vehicle under control by steering the way you want the vehicle to go. It may be very bumpy and noisy, but you can still steer. Gently brake to a stop, well off the road if possible.

If a tire goes flat, the next part shows how to use your jacking equipment to change a flat tire safely.

## Changing a Flat Tire

If a tire goes flat, avoid further tire and wheel damage by driving slowly to a level place. Turn on your hazard warning flashers.

### CAUTION:

Changing a tire can cause an injury. The vehicle can slip off the jack and roll over you or other people. You and they could be badly injured. Find a level place to change your tire. To help prevent the vehicle from moving:

1. Set the parking brake firmly.
2. Put the shift lever in PARK (P).
3. Turn off the engine.

To be even more certain the vehicle won't move, you can put blocks at the front and rear of the tire farthest away from the one being changed. That would be the tire on the other side of the vehicle, at the opposite end.



The following steps will tell you how to use the jack and change a tire.



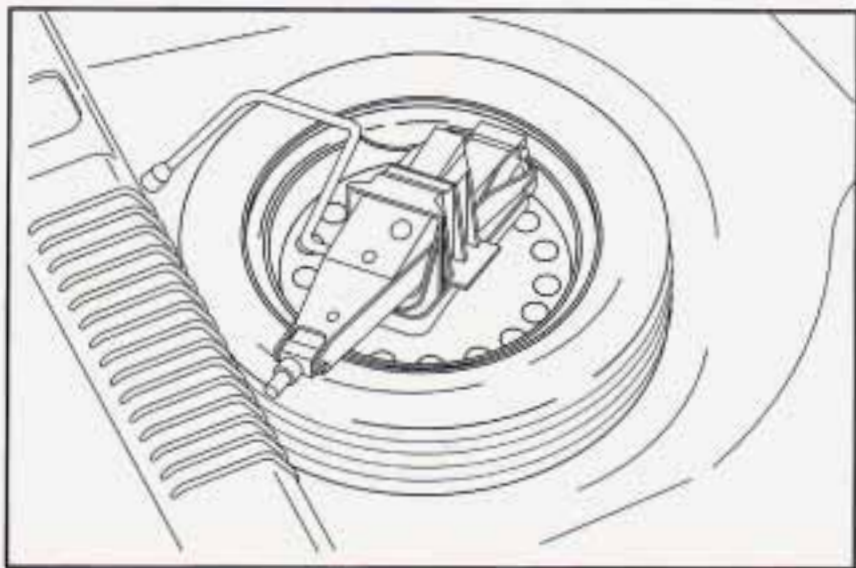

The equipment you'll need is in the trunk. Remove the wrench, jack and spare tire and place them near the flat tire.

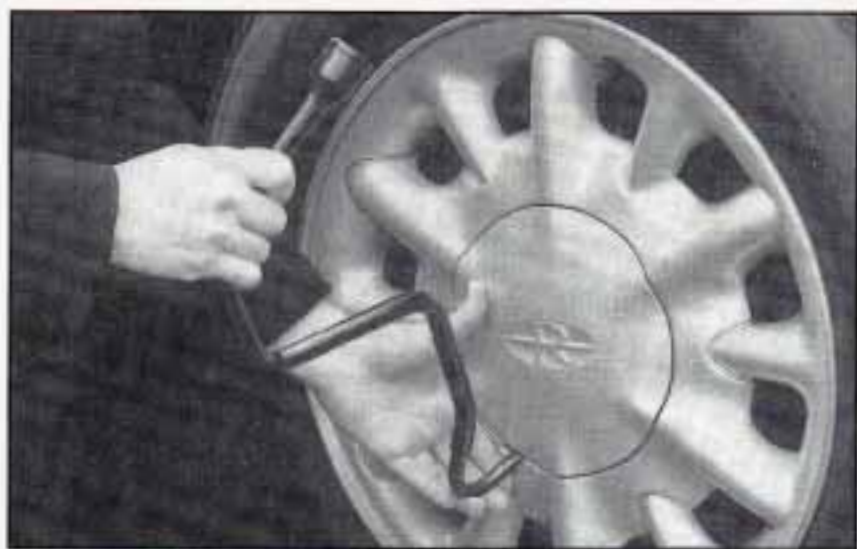

Your Buick has a wheel cover which must be taken off to reach the wheel nuts. Insert the hooked end of the wrench into the notch in the center cover. Pry carefully, so the center cover is not scratched.



Using the wheel wrench, loosen all the wheel nuts. Don't remove them yet.

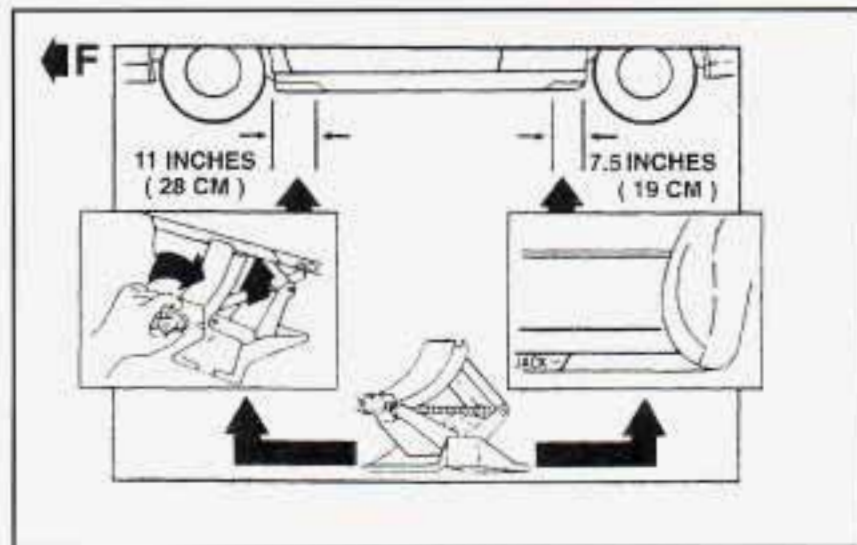

Position the jack under the vehicle. There is a notch in the frame near each of the wheels. The plastic fascia has the word JACK stamped near where the jack should be positioned. Fit the top of the jack into the notch nearest the wheel with the flat tire.

**⚠ CAUTION:**

Getting under a vehicle when it is jacked up is dangerous. If the vehicle slips off the jack, you could be badly injured or killed. Never get under a vehicle when it is supported only by a jack.

**NOTICE:**

Raising your vehicle with the jack improperly positioned will damage the vehicle or may allow the vehicle to fall off the jack. Be sure to fit the jack lift head into the proper location before raising your vehicle.



Raise the vehicle by rotating the wheel wrench clockwise. Raise the vehicle far enough off the ground so there is enough room for the spare tire to fit.

Remove all the wheel nuts and take off the flat tire.

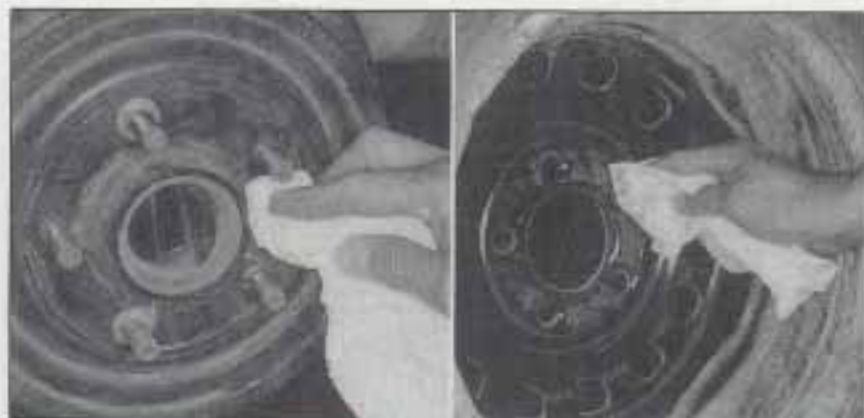

Remove any rust or dirt from the wheel bolts, mounting surfaces and spare wheel.

 **CAUTION:**

Never use oil or grease on studs or nuts. If you do, the nuts might come loose. Your wheel could fall off, causing a serious accident.

 **CAUTION:**

Rust or dirt on the wheel, or on the parts to which it is fastened, can make the wheel nuts become loose after a time. The wheel could come off and cause an accident. When you change a wheel, remove any rust or dirt from the places where the wheel attaches to the vehicle. In an emergency, you can use a cloth or a paper towel to do this; but be sure to use a scraper or wire brush later, if you need to, to get all the rust or dirt off.



Place the spare on the wheel mounting surface.



Replace the wheel nuts with the rounded end of the nuts toward the wheel. Tighten each nut by hand until the wheel is held against the hub.



Lower the vehicle by rotating the wheel wrench counterclockwise. Lower the jack completely.

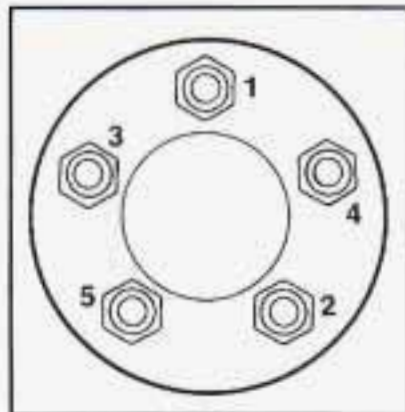

Using the wheel wrench, tighten the wheel nuts firmly in a criss-cross sequence as shown.

Then replace the wheel cover. Be sure to position the alignment pin on the cover with the notch in the wheel. Apply pressure around the edge of the cap to snap it in place.

**⚠ CAUTION:**

**Incorrect wheel nuts or improperly tightened wheel nuts can cause the wheel to become loose and even come off. This could lead to an accident. Be sure to use the correct wheel nuts. If you have to replace them, be sure to get the right kind. Stop somewhere as soon as you can and have the nuts tightened with a torque wrench to 100 lb ft (140 N·m).**

Don't try to put a wheel cover on your compact spare tire. It won't fit. Store the wheel cover in the trunk until you have the flat tire repaired or replaced.

**NOTICE:**

**Wheel covers won't fit on your compact spare. If you try to put a wheel cover on your compact spare, you could damage the cover or the spare.**

Return the equipment to the trunk in the order shown on the diagram.

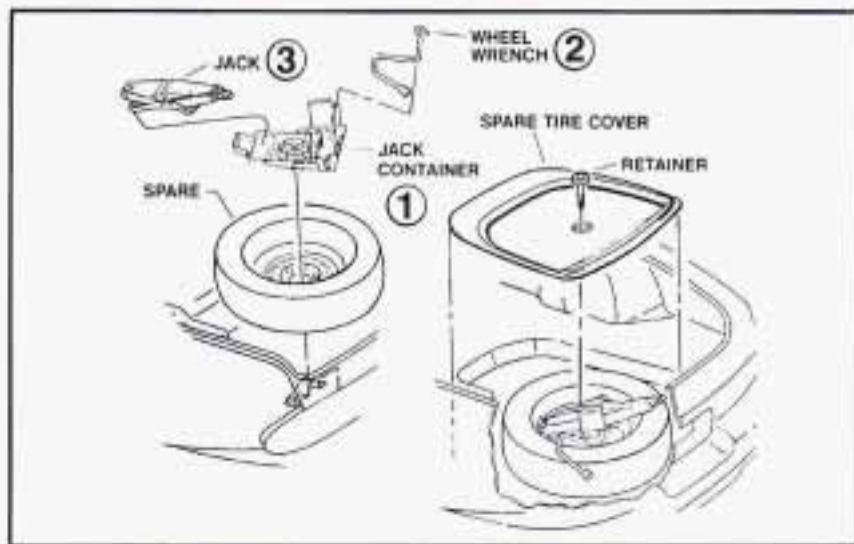

## Compact Spare Tire

Although the compact spare was fully inflated when your vehicle was new, it can lose air after a time. Check the inflation pressure regularly. It should be 60 psi (420 kPa). After installing the compact spare on your vehicle, you should stop as soon as possible and make sure your spare tire is correctly inflated. The compact spare is made to perform well at posted speed limits for distances up to 3,000 miles (5 000 km), so you can finish your trip and have your full-size tire repaired or replaced where you want. Of course, it's best to replace your spare with a full-size tire as soon as you can. Your spare will last longer and be in good shape in case you need it again.

### CAUTION:

Storing a jack, a tire or other equipment in the passenger compartment of the vehicle could cause injury. In a sudden stop or collision, loose equipment could strike someone. Store all these in the proper place.

## **NOTICE:**

**Don't take your compact spare through an automatic car wash with guide rails. The compact spare can get caught on the rails. That can damage the tire and wheel, and maybe other parts of your vehicle.**

Don't use your compact spare on some other vehicle.

And don't mix your compact spare or wheel with other wheels or tires. They won't fit. Keep your spare and its wheel together.

## **NOTICE:**

**Tire chains won't fit your compact spare. Using them will damage your vehicle and destroy the chains too. Don't use tire chains on your compact spare.**

## **If You're Stuck: In Sand, Mud, Ice or Snow**

What you don't want to do when your vehicle is stuck is to spin your wheels too fast. The method known as "rocking" can help you get out when you're stuck, but you must use caution.



## **CAUTION:**

**If you let your tires spin at high speed, they can explode and you or others could be injured. And, the transaxle or other parts of the vehicle can overheat. That could cause an engine compartment fire or other damage. When you're stuck, spin the wheels as little as possible. Don't spin the wheels above 35 mph (55 km/h) as shown on the speedometer.**



## **NOTICE:**

**Spinning your wheels can destroy parts of your vehicle as well as the tires. If you spin the wheels too fast while shifting your transaxle back and forth, you can destroy your transaxle.**

For information about using tire chains on your vehicle, see "Tire Chains" in the Index.

## **Rocking your vehicle to get it out:**

First, turn your steering wheel left and right. That will clear the area around your front wheels. If your vehicle has traction control, you should turn the system off. (See "Traction Control System" in the Index.) Then shift back and forth between REVERSE (R) and a forward gear, spinning the wheels as little as possible. Release the accelerator pedal while you shift, and press lightly on the accelerator pedal when the transaxle is in gear. If that doesn't get you out after a few tries, you may need to be towed out. If you do need to be towed out, see "Towing Your Vehicle" in the Index.



## Section 6 Service and Appearance Care

Here you will find information about the care of your Buick. This section begins with service and fuel information, and then it shows how to check important fluid and lubricant levels. There is also technical information about your vehicle, and a part devoted to its appearance care.

### Service

Your Buick dealer knows your vehicle best and wants you to be happy with it. We hope you'll go to your dealer for all your service needs. You'll get genuine GM parts and GM-trained and supported service people.

We hope you'll want to keep your GM vehicle all GM. Genuine GM parts have one of these marks:



## Doing Your Own Service Work

If you want to do some of your own service work, you'll want to get the proper Buick Service Manual. It tells you much more about how to service your Buick than this manual can. To order the proper service manual, see "Service and Owner Publications" in the Index.

Your vehicle has an air bag system. Before attempting to do your own service work, see "Servicing Your Air Bag-Equipped Buick" in the Index.

You should keep a record with all parts receipts and list the mileage and the date of any service work you perform. See "Maintenance Record" in the Index.



### CAUTION:

**You can be injured if you try to do service work on a vehicle without knowing enough about it.**

- **Be sure you have sufficient knowledge, experience, and the proper replacement parts and tools before you attempt any vehicle maintenance task.**
- **Be sure to use the proper nuts, bolts and other fasteners. "English" and "metric" fasteners can be easily confused. If you use the wrong fasteners, parts can later break or fall off. You could be hurt.**

### NOTICE:

**If you try to do your own service work without knowing enough about it, your vehicle could be damaged.**

## Fuel

### 3800 L36 (Code K) Engine

The 8th digit of your vehicle identification number (VIN) shows the code letter for your engine. You will find the VIN at the top left of your instrument panel. (See “Vehicle Identification Number” in the Index.)

Use regular unleaded gasoline rated at 87 octane or higher. It should meet specifications ASTM D4814 in the United States and CGSB 3.5-92 in Canada. These fuels should have the proper additives, so you should not have to add anything to the fuel.

In the United States and Canada, it's easy to be sure you get the right kind of gasoline (unleaded). You'll see UNLEADED right on the pump. And only unleaded nozzles will fit into your vehicle's filler neck.

Be sure the posted octane is at least 87. If the octane is less than 87, you may get a heavy knocking noise when you drive. If it's bad enough, it can damage your engine.

If you're using fuel rated at 87 octane or higher and you still hear heavy knocking, your engine needs service. But don't worry if you hear a little pinging noise when you're accelerating or driving up a hill. That's normal, and you don't have to buy a higher octane fuel to get rid

of pinging. It's the heavy, constant knock that means you have a problem.

What about gasoline with blending materials that contain oxygen (oxygenates), such as MTBE or alcohol?

*MTBE* is “methyl tertiary-butyl ether.” Fuel that is no more than 15% MTBE is fine for your vehicle.

*Ethanol* is ethyl or grain alcohol. Properly-blended fuel that is no more than 10% *ethanol* is fine for your vehicle.

*Methanol* is methyl or wood alcohol.

### **NOTICE:**

**Fuel that is more than 5% methanol is bad for your vehicle. Don't use it. It can corrode metal parts in your fuel system and also damage plastic and rubber parts. That damage wouldn't be covered under your warranty. And even at 5% or less, there must be “cosolvents” and corrosion preventers in this fuel to help avoid these problems.**

## Gasolines for Cleaner Air

Your use of gasoline with deposit control additives will help prevent deposits from forming in your engine and fuel system. That helps keep your engine in tune and your emission control system working properly. It's good for your vehicle, and you'll be doing your part for cleaner air.

Many gasolines are now blended with oxygenates. General Motors recommends that you use gasolines with these blending materials, such as MTBE and ethanol. By doing so, you can help clean the air, especially in those parts of the country that have high carbon monoxide levels.

In addition, some gasoline suppliers are now producing reformulated gasolines. These gasolines are specially designed to reduce vehicle emissions. General Motors recommends that you use reformulated gasoline. By doing so, you can help clean the air, especially in those parts of the country that have high ozone levels.

You should ask your service station operators if their gasolines contain deposit control additives and oxygenates, and if they have been reformulated to reduce vehicle emissions.

## Fuel

### 3800 Supercharged L67 (Code 1) Engine

The 8th digit of your vehicle identification number (VIN) shows the code letter for your engine. You will find the VIN at the top left of your instrument panel. (See "Vehicle Identification Number" in the Index.)

Use premium unleaded gasoline rated at 91 octane or higher for best performance. You may use middle grade or regular unleaded gasolines, but your vehicle may not accelerate as well. The gasoline you use should meet specifications ASTM D4814 in the United States and CGSB 3.5-92 in Canada. These fuels should have the proper additives, so you should not have to add anything to the fuel.

In the United States and Canada, it's easy to be sure you get the right kind of gasoline (unleaded). You'll see UNLEADED right on the pump. And only unleaded nozzles will fit into your vehicle's filler neck.

Be sure the posted octane for premium is at least 91 (at least 89 for middle grade and 87 for regular). If the octane is less than 87, you may get a heavy knocking noise when you drive. If it's bad enough, it can damage your engine.

If you're using fuel rated at 91 octane or higher and you still hear heavy knocking, your engine needs service.

But don't worry if you hear a little pinging noise when you're accelerating or driving up a hill. That's normal and you don't have to buy a higher octane fuel to get rid of pinging. It's the heavy, constant knock that means you have a problem.

What about gasoline with blending materials that contain oxygen (oxygenates), such as MTBE or alcohol?

*MTBE* is "methyl tertiary-butyl ether." Fuel that is no more than 15% *MTBE* is fine for your vehicle.

*Ethanol* is ethyl or grain alcohol. Properly-blended fuel that is no more than 10% *ethanol* is fine for your vehicle.

*Methanol* is methyl or wood alcohol.

## **NOTICE:**

**Fuel that is more than 5% methanol is bad for your vehicle. Don't use it. It can corrode metal parts in your fuel system and also damage plastic and rubber parts. That damage wouldn't be covered under your warranty. And even at 5% or less, there must be "cosolvents" and corrosion preventers in this fuel to help avoid these problems.**

## **Gasolines for Cleaner Air**

Your use of gasoline with deposit control additives will help prevent deposits from forming in your engine and fuel system. That helps keep your engine in tune and your emission control system working properly. It's good for your vehicle, and you'll be doing your part for cleaner air.

Many gasolines are now blended with oxygenates. General Motors recommends that you use gasolines with these blending materials, such as *MTBE* and *ethanol*. By doing so, you can help clean the air, especially in those parts of the country that have high carbon monoxide levels.

In addition, some gasoline suppliers are now producing reformulated gasolines. These gasolines are specially designed to reduce vehicle emissions. General Motors recommends that you use reformulated gasoline. By doing so, you can help clean the air, especially in those parts of the country that have high ozone levels.

You should ask your service station operators if their gasolines contain deposit control additives and oxygenates, and if they have been reformulated to reduce vehicle emissions.

## Fuels in Foreign Countries

If you plan on driving in another country outside the U.S. or Canada, unleaded fuel may be hard to find. Do not use leaded gasoline. If you use even one tankful, your emission controls won't work well or at all. With continuous use, spark plugs can get fouled, the exhaust system can corrode, and your engine oil can deteriorate quickly. Your vehicle's oxygen sensor will be damaged. All of that means costly repairs that wouldn't be covered by your warranty.

To check on fuel availability, ask an auto club, or contact a major oil company that does business in the country where you'll be driving.

You can also write us at the following address for advice. Just tell us where you're going and give your Vehicle Identification Number (VIN).

General Motors Overseas Distribution Corporation  
North American Export Sales (NAES)  
1908 Colonel Sam Drive  
Oshawa, Ontario L1H 8P7

## Filling Your Tank



The cap is behind a hinged door on the left side of your vehicle.



### **CAUTION:**

**Gasoline vapor is highly flammable. It burns violently, and that can cause very bad injuries. Don't smoke if you're near gasoline or refueling your vehicle. Keep sparks, flames, and smoking materials away from gasoline.**



The release button is on the driver's door armrest.



The fuel door can also be opened by using the release in the trunk compartment, on the driver's side of the vehicle.

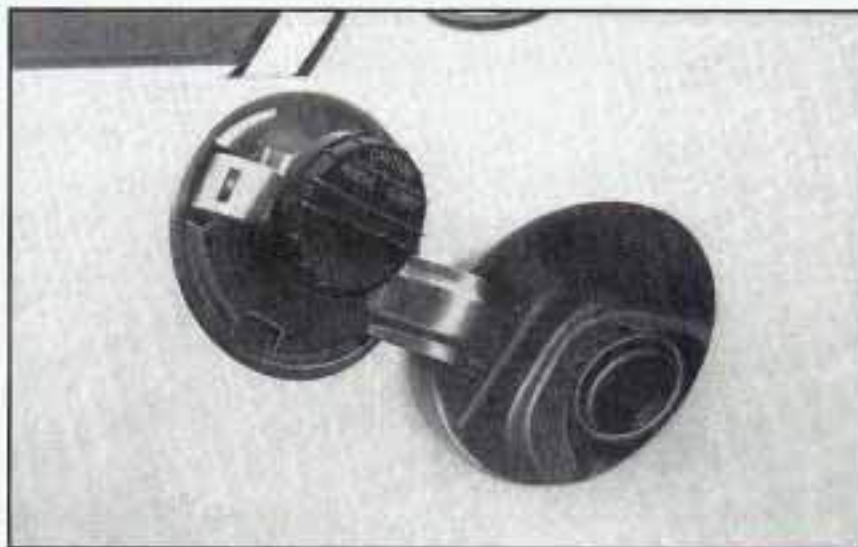

To take off the cap, turn it slowly to the left (counterclockwise).



**⚠ CAUTION:**

If you get gasoline on yourself and then something ignites it, you could be badly burned. Gasoline can spray out on you if you open the fuel filler cap too quickly. This spray can happen if your tank is nearly full, and is more likely in hot weather. Open the fuel filler cap slowly and wait for any "hiss" noise to stop. Then unscrew the cap all the way.

Be careful not to spill gasoline. Clean gasoline from painted surfaces as soon as possible. See "Cleaning the Outside of Your Buick" in the Index.

When you put the cap back on, turn it to the right until you hear at least three clicks.

**NOTICE:**

If you need a new cap, be sure to get the right type. Your dealer can get one for you. If you get the wrong type, it may not fit or have proper venting, and your fuel tank and emissions system might be damaged.

## Checking Things Under the Hood

### Hood Release

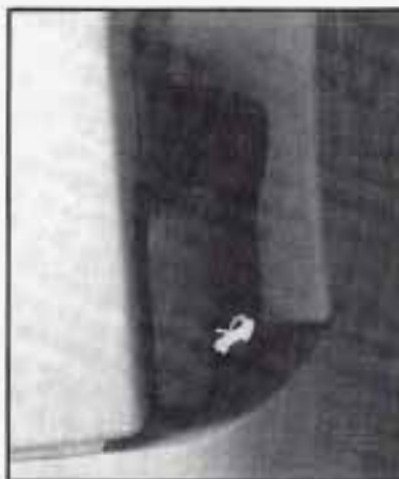

Pull the handle inside the vehicle to open the hood. The handle is located on the lower left side of the instrument panel, next to the parking brake release.

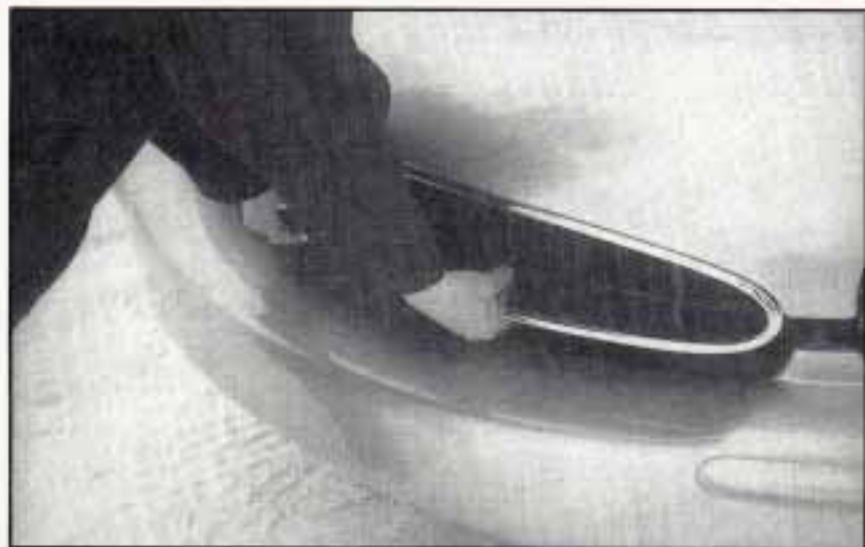

Then go to the front of the vehicle and locate the secondary hood release. It is under the front edge of the grille, slightly right of center as you face the vehicle.

Push up on the secondary hood release lever as you lift up the hood.



**⚠ CAUTION:**

**An electric fan under the hood can start up and injure you even when the engine is not running. Keep hands, clothing and tools away from any underhood electric fan.**

**⚠ CAUTION:**

Things that burn can get on hot engine parts and start a fire. These include liquids like gasoline, oil, coolant, brake fluid, windshield washer and other fluids, and plastic or rubber. You or others could be burned. Be careful not to drop or spill things that will burn onto a hot engine.

Before closing the hood, be sure all the filler caps are on properly. Then pull the hood down and close it firmly.

## Engine Accessory Belt (L36)

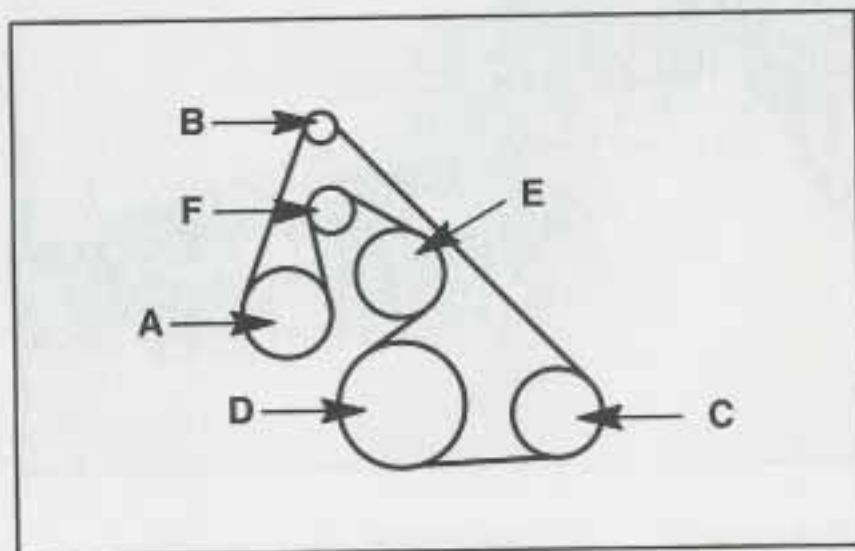

The 3800 (L36) engine uses an engine accessory belt. This diagram shows the features connected by the belt routing. See "Maintenance Schedule" in the Index for when to check the belt.

- |                     |                 |
|---------------------|-----------------|
| A. Power Steering   | D. Crank        |
| B. Alternator       | E. Coolant Pump |
| C. Air Conditioning | F. Tensioner    |

## 3800 Supercharged (L67) Engine (Option)

Your vehicle may have a 3800 Supercharged engine. Buick chose supercharging rather than turbocharging because Buick emphasizes smooth, refined power.

The supercharger is a device which is designed to pump more air into the engine than it would normally use. This air, mixed with fuel, creates increased engine power. Since the supercharger is a pump and is driven from an engine accessory drive belt, increased pressure is available at all driving conditions.

The powertrain control module (PCM), works with a vacuum control to regulate the increased pressure required during specific driving conditions. When this increased pressure or boost is not desired, such as during idling and light throttle cruising, the excess air that the supercharger is pumping is routed through a bypass. All of these controls working together provide high performance, character and fuel efficiency in the 3800 V6 Supercharged Buick engine.

The power steering pump uses a remote reservoir mounted on the throttle and cruise control cable bracket. See "Maintenance Schedule" in the Index for when you should check the fluid.

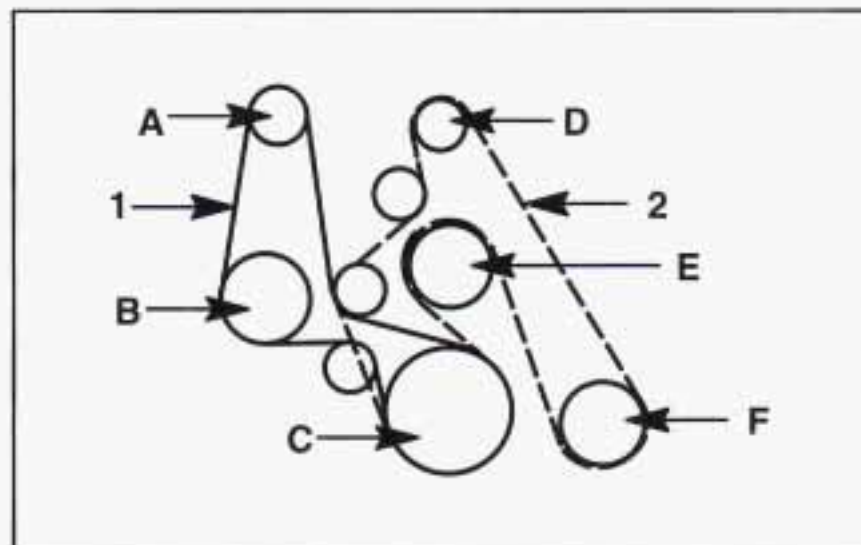

- |                   |                     |
|-------------------|---------------------|
| 1. Front Belt     | C. Crank            |
| 2. Back Belt      | D. Supercharger     |
| A. Alternator     | E. Coolant Pump     |
| B. Power Steering | F. Air Conditioning |

The Supercharged 3800 engine uses two accessory drive belts. One belt drives the generator and the power steering pump. The second belt drives the supercharger, coolant pump and air conditioning compressor. Each belt has its own tensioner and idler pulley.

## Engine Oil

CHECK OIL  
LEVEL

If the CHECK OIL LEVEL light on the instrument panel comes on, it means you need to check your engine oil level right away.

For more information, see “Check Oil Level Light” in the Index. You should check your engine oil level regularly; this is an added reminder.

It's a good idea to check your engine oil every time you get fuel. In order to get an accurate reading, the oil must be warm and the vehicle must be on level ground.



The engine oil dipstick is directly behind the engine fan.

Turn off the engine and give the oil a few minutes to drain back into the oil pan. If you don't, the oil dipstick might not show the actual level.

## To Check Engine Oil

Pull out the dipstick and clean it with a paper towel or cloth, then push it back in all the way. Remove it again, keeping the tip down, and check the level.



## When to Add Oil

If the oil is at or below the ADD mark, then you'll need to add some oil. But you must use the right kind. This part explains what kind of oil to use. For crankcase capacity, see "Capacities and Specifications" in the Index.

### **NOTICE:**

**Don't add too much oil. If your engine has so much oil that the oil level gets above the cross-hatched area that shows the proper operating range, your engine could be damaged.**

Add engine oil at the engine oil fill cap next to the oil dipstick.

Just fill it enough to put the level somewhere in the proper operating range. Push the dipstick all the way back in when you're through.

## What Kind of Oil to Use

Oils of the proper quality for your vehicle can be identified by looking for the “Starburst” symbol. The “Starburst” symbol indicates that the oil has been certified by the American Petroleum Institute (API), and is preferred for use in your gasoline engine.



If you change your own oil, be sure you use oil that has the “Starburst” symbol on the front of the oil container. If you have your oil changed for you, be sure the oil put into your engine is American Petroleum Institute certified for gasoline engines.

You should also use the proper viscosity oil for your vehicle, as shown in the following chart:

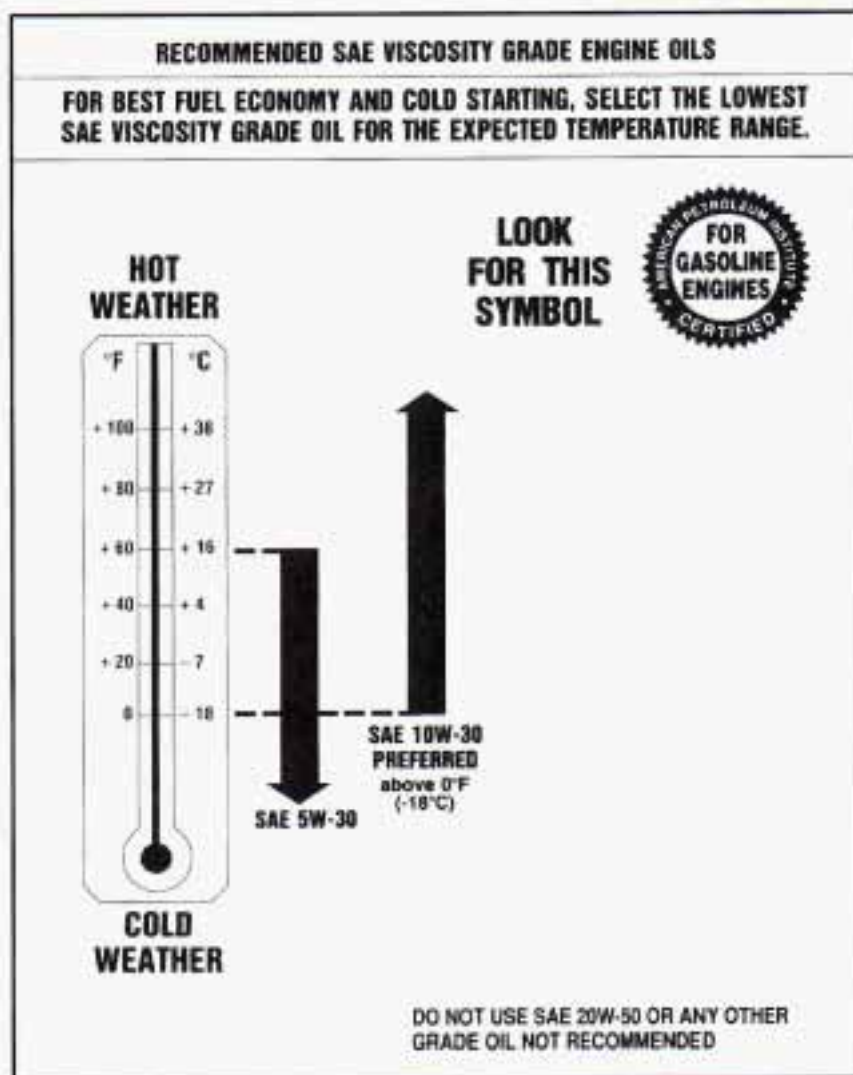

As shown in the chart, SAE 10W-30 is best for your vehicle. However, you can use SAE 5W-30 if it's going to be colder than 60°F (16°C) before your next oil change. When it's very cold, you should use SAE 5W-30. These numbers on an oil container show its viscosity, or thickness. Do not use other viscosity oils, such as SAE 20W-50.

## **NOTICE:**

**Use only engine oil with the American Petroleum Institute Certified For Gasoline Engines "Starburst" symbol. Failure to use the proper oil can result in engine damage not covered by your warranty.**

GM Goodwrench<sup>®</sup> oil (in Canada, GM Engine Oil) meets all the requirements for your vehicle.

## **Engine Oil Additives**

Don't add anything to your oil. Your Buick dealer is ready to advise if you think something should be added.

## **When to Change Engine Oil**

See if any one of these is true for you:

- Most trips are less than 5 to 10 miles (8 to 16 km). This is particularly important when outside temperatures are below freezing.
- Most trips include extensive idling (such as frequent driving in stop and go traffic).
- Most trips are through dusty areas.
- You frequently tow a trailer or use a carrier on top of your vehicle.

If any one of these is true for your vehicle, then you need to change your oil and filter every 3,000 miles (5 000 km) or 3 months -- whichever comes first.

If none of them is true, change the oil and filter every 7,500 miles (12 500 km) or 12 months -- whichever comes first.

## **Engine Coolant Heater (Option)**

An engine coolant heater can be a big help if you have to park outside in very cold weather, 0°F (-18°C) or colder. If your vehicle has this option, see "Engine Coolant Heater" in the Index.



## What to Do with Used Oil

Did you know that used engine oil contains certain elements that may be unhealthy for your skin and could even cause cancer? Don't let used oil stay on your skin for very long. Clean your skin and nails with soap and water, or a good hand cleaner. Wash or properly throw away clothing or rags containing used engine oil. (See the manufacturer's warnings about the use and disposal of oil products.)

Used oil can be a real threat to the environment. If you change your own oil, be sure to drain all free-flowing oil from the filter before disposal. Don't ever dispose of oil by putting it in the trash, pouring it on the ground, into sewers, or into streams or bodies of water. Instead, recycle it by taking it to a place that collects used oil. If you have a problem properly disposing of your used oil, ask your dealer, a service station or a local recycling center for help.

## Air Cleaner



As you face the front of the vehicle, the air cleaner is in the front right section of the engine compartment. There is a filter inside the air cleaner.

Remove the air cleaner assembly as follows:

1. Remove the air duct clamp and separate the duct from the air cleaner cover.
2. Remove the air cleaner cover and detach the electrical connector.
3. Tilt and pull the cover toward the engine to disengage it from the assembly.
4. Remove the old filter and install the new one.

To reinstall the air cleaner assembly, slide the base sections into their former positions and replace the filter cover. Reattach the electrical connector and air duct, and tighten the clamp.

Refer to the Maintenance Schedule to determine when to replace the air filter.

See "Scheduled Maintenance Services" in the Index.



### **CAUTION:**

Operating the engine with the air cleaner off can cause you or others to be burned. The air cleaner not only cleans the air, it stops flame if the engine backfires. If it isn't there, and the engine backfires, you could be burned. Don't drive with it off, and be careful working on the engine with the air cleaner off.

### **NOTICE:**

If the air cleaner is off, a backfire can cause a damaging engine fire. And, dirt can easily get into your engine, which will damage it. Always have the air cleaner in place when you're driving.

## Supercharger Oil



Unless you are technically qualified and have the proper tools, you should let your dealer or a qualified service center perform this maintenance.

### When to Check

Check oil level every 30,000 miles (50 000 km) or every 36 months.

### What Kind of Oil to Use

See “Recommended Fluids and Lubricants” in the Index and use only the recommended oil.

### How to Check and Add Oil

Check oil only when the engine is cold. Allow the engine to cool two to three hours after running.



#### **CAUTION:**

**If you remove the supercharger oil fill plug while the engine is hot, pressure may cause hot oil to blow out of the oil fill hole. You may be burned. Do not remove the plug until the engine cools.**

1. Remove the wiring harness shield.
2. Clean the area around the oil fill plug before removing it.
3. Remove the oil fill plug using a 3/16-inch Allen wrench.
4. The oil level is correct when it just reaches the bottom of the threads of the inspection hole.
5. Replace the oil plug with the O-ring in place. Torque to 88 lb in (10 N·m).
6. Replace the wiring harness shield.

## Automatic Transaxle Fluid

### When to Check and Change

A good time to check your automatic transaxle fluid level is when the engine oil is changed. Refer to the Maintenance Schedule to determine when to change your fluid. See “Scheduled Maintenance Services” in the Index.

### How to Check

Because this operation can be a little difficult, you may choose to have this done at your Buick dealer Service Department.

If you do it yourself, be sure to follow all the instructions here, or you could get a false reading on the dipstick.

#### **NOTICE:**

**Too much or too little fluid can damage your transaxle. Too much can mean that some of the fluid could come out and fall on hot engine parts or exhaust system parts, starting a fire. Be sure to get an accurate reading if you check your transaxle fluid.**

Wait at least 30 minutes before checking the transaxle fluid level if you have been driving:

- When outside temperatures are above 90°F (32°C).
- At high speed for quite a while.
- In heavy traffic -- especially in hot weather.
- While pulling a trailer.

To get the right reading, the fluid should be at normal operating temperature, which is 180°F to 200°F (82°C to 93°C).

Get the vehicle warmed up by driving about 15 miles (24 km) when outside temperatures are above 50°F (10°C). If it's colder than 50°F (10°C), you may have to drive longer.

### To check the fluid level

1. Park your vehicle on a level place. Keep the engine running.
2. With the parking brake applied, place the shift lever in PARK (P).
3. With your foot on the brake pedal, move the shift lever through each gear range, pausing for about three seconds in each range. Then, position the shift lever in PARK (P).
4. Let the engine run at idle for three to five minutes.

Then, without shutting off the engine, follow these steps:



1. Pull out the dipstick and wipe it with a clean rag or paper towel.

2. Push it back in all the way, wait three seconds and then pull it back out again.



3. Check both sides of the dipstick, and read the lower level. The fluid level must be in the cross-hatched area.
4. If the fluid level is in the acceptable range, push the dipstick back in all the way.

## How to Add Fluid

Refer to the Maintenance Schedule to determine what kind of transaxle fluid to use. See “Recommended Fluids and Lubricants” in the Index.

If the fluid level is low, add only enough of the proper fluid to bring the level into the cross-hatched area on the dipstick.

1. Pull out the dipstick.
  2. Using a long-neck funnel, add enough fluid at the dipstick hole to bring it to the proper level. It doesn't take much fluid, generally less than a pint (0.5L). *Don't overfill.* We recommend you use only fluid labeled DEXRON<sup>®</sup>-III, because fluid with that label is made especially for your automatic transaxle. Damage caused by fluid other than DEXRON<sup>®</sup>-III is not covered by your new vehicle warranty.
- After adding fluid, recheck the fluid level as described under “How to Check.”
  - When the correct fluid level is obtained, push the dipstick back in all the way.

## Engine Coolant

The following explains your cooling system and how to add coolant when it is low. If you have a problem with engine overheating, see “Engine Overheating” in the Index.

The proper coolant for your Buick will:

- Give freezing protection down to  $-34^{\circ}\text{F}$  ( $-37^{\circ}\text{C}$ ).
- Give boiling protection up to  $262^{\circ}\text{F}$  ( $128^{\circ}\text{C}$ ).
- Protect against rust and corrosion.
- Help keep the proper engine temperature.
- Let the warning lights work as they should.

### What to Use

Use a mixture of one-half *clean water* (preferably distilled) and one-half antifreeze that meets “GM Specification 1825-M,” which won't damage aluminum parts. You can also use a recycled coolant conforming to GM Specification 1825-M with a complete coolant flush and refill. Use GM Engine Coolant Supplement (sealer) with any complete coolant flush and refill. If you use this mixture, you don't need to add anything else.

## CAUTION:

Adding only plain water to your cooling system can be dangerous. Plain water, or some other liquid like alcohol, can boil before the proper coolant mix will. Your vehicle's coolant warning system is set for the proper coolant mix. With plain water or the wrong mix, your engine could get too hot but you wouldn't get the overheat warning. Your engine could catch fire and you or others could be burned. Use a 50/50 mix of clean water and a proper antifreeze.

## NOTICE:

If you use an improper coolant mix, your engine could overheat and be badly damaged. The repair cost wouldn't be covered by your warranty. Too much water in the mix can freeze and crack the engine, radiator, heater core and other parts.

## Adding Coolant

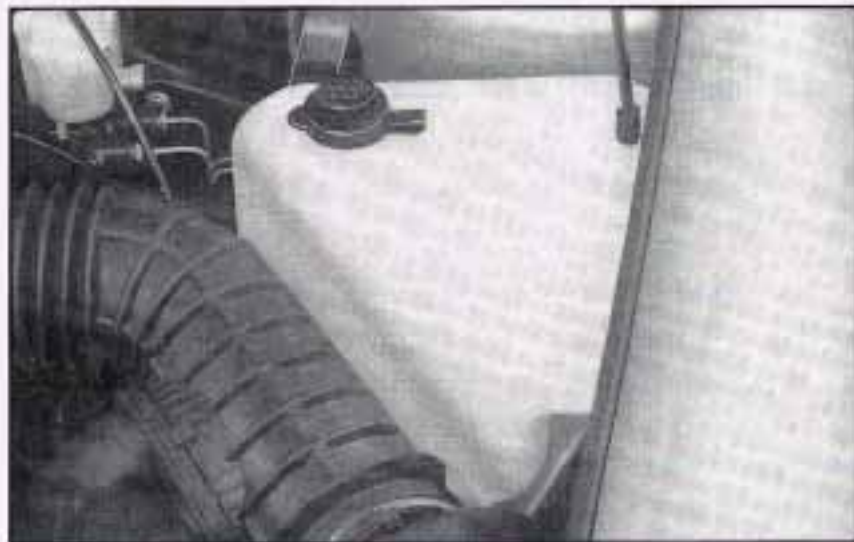

The engine coolant recovery tank is located on the driver's side of the engine compartment.

### To Check Coolant

When your engine is cold, the coolant level should be at FULL COLD or a little higher. When your engine is warm, the level should be up to FULL HOT or a little higher.

**LOW  
COOLANT  
LEVEL**

If this light comes on, it means you're low on engine coolant.

**To Add Coolant**

If you need more coolant, add the proper mix *at the coolant recovery tank*.



**CAUTION:**

Turning the radiator pressure cap when the engine and radiator are hot can allow steam and scalding liquids to blow out and burn you badly. With the coolant recovery tank, you will almost never have to add coolant at the radiator. Never turn the radiator pressure cap -- even a little -- when the engine and radiator are hot.

Add coolant mix at the recovery tank, but be careful not to spill it.



**CAUTION:**

You can be burned if you spill coolant on hot engine parts. Coolant contains ethylene glycol, and it will burn if the engine parts are hot enough. Don't spill coolant on a hot engine.



## Radiator Pressure Cap

### **NOTICE:**

Your radiator cap is a 15 psi (105 kPa) pressure-type cap and must be tightly installed to prevent coolant loss and possible engine damage from overheating. Be sure the arrows on the cap line up with the overflow tube on the radiator filler neck.

When you replace your radiator pressure cap, an AC<sup>®</sup> cap is recommended.

## Thermostat

Engine coolant temperature is controlled by a thermostat in the engine coolant system. The thermostat stops the flow of coolant through the radiator until the coolant reaches a preset temperature.

When you replace your thermostat, an AC<sup>®</sup> thermostat is recommended.

## Power Steering Fluid

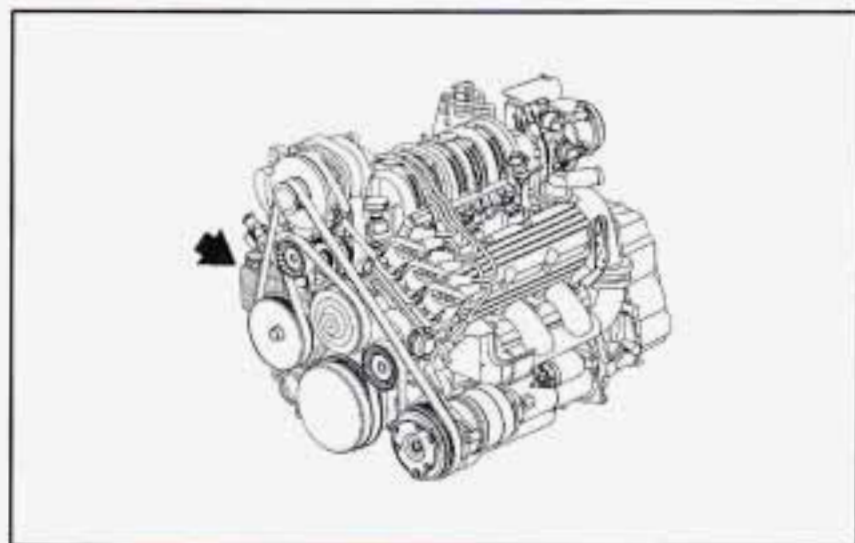

As shown in this diagram, the power steering fluid reservoir on the L36 engine is located below the alternator and behind the accessory drive belt.

The power steering fluid reservoir on the L67 engine is to the right of the supercharger and in front of the transaxle fluid dipstick.

## How To Check Power Steering Fluid

When the engine compartment is cool, unscrew the cap and wipe the dipstick with a clean rag. Replace the cap and completely tighten it. Then remove the cap again and look at the fluid level on the dipstick.

The level should be at the **FULL COLD** mark. Add enough fluid to bring the level up to the mark.

A fluid loss in this system could indicate a problem. Have the system inspected and repaired.

### What to Add

Refer to the Maintenance Schedule to determine what kind of fluid to use. See "Recommended Fluids and Lubricants" in the Index.

### **NOTICE:**

**When adding power steering fluid or making a complete fluid change, always use the proper fluid. Failure to use the proper fluid can cause leaks and damage hoses and seals.**

## Windshield Washer Fluid

### What to Use

When you need windshield washer fluid, be sure to read the manufacturer's instructions before use. If will be operating your vehicle in an area where the temperature may fall below freezing, use a fluid that has sufficient protection against freezing.



### To Add

Open the cap labeled **WASHER FLUID ONLY**. Add washer fluid until the tank is full.

## NOTICE:

- When using concentrated washer fluid, follow the manufacturer's instructions for adding water.
- Don't mix water with ready-to-use washer fluid. Water can cause the solution to freeze and damage your washer fluid tank and other parts of the washer system. Also, water doesn't clean as well as washer fluid.
- Fill your washer fluid tank only 3/4 full when it's very cold. This allows for expansion, which could damage the tank if it is completely full.
- Don't use radiator antifreeze in your windshield washer. It can damage your washer system and paint.

## Brakes

### Brake Master Cylinder

Your brake master cylinder is here. It is filled with DOT-3 brake fluid.

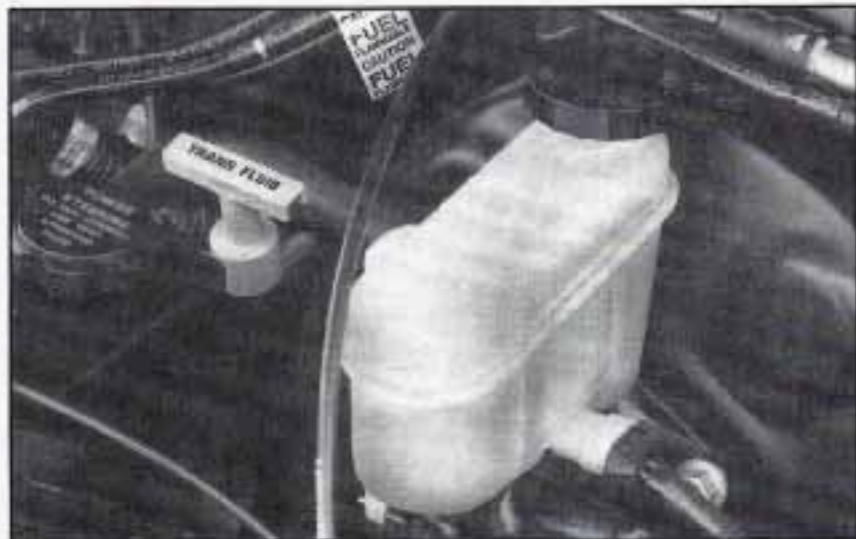

There are only two reasons why the brake fluid level in your master cylinder might go down. The first is that the brake fluid goes down to an acceptable level during normal brake lining wear. When new linings are put in, the fluid level goes back up. The other reason is that fluid is leaking out of the brake system. If it is, you

should have your brake system fixed, since a leak means that sooner or later your brakes won't work well, or won't work at all. So, it isn't a good idea to "top off" your brake fluid. Adding brake fluid won't correct a leak. If you add fluid when your linings are worn, then you'll have too much fluid when you get new brake linings. You should add (or remove) brake fluid, as necessary, only when work is done on the brake hydraulic system.



### **CAUTION:**

**If you have too much brake fluid, it can spill on the engine. The fluid will burn if the engine is hot enough. You or others could be burned, and your vehicle could be damaged. Add brake fluid only when work is done on the brake hydraulic system.**

When your brake fluid falls to a low level, your brake warning light will come on. A chime will sound if you try to drive with this warning light on. See "Brake System Warning Light" in the Index.

### **What to Add**

When you do need brake fluid, use only DOT-3 brake fluid -- such as Delco Supreme 11<sup>®</sup> (GM Part No. 1052535). Use new brake fluid from a sealed container only, and always clean the brake fluid reservoir cap before removing it.

### **NOTICE:**

- **Don't let someone put in the wrong kind of fluid. For example, just a few drops of mineral-based oil, such as engine oil, in your brake system can damage brake system parts so badly that they'll have to be replaced.**
- **Brake fluid can damage paint, so be careful not to spill brake fluid on your vehicle. If you do, wash it off immediately. See "Appearance Care" in the Index.**

## Brake Wear

Your Buick has four-wheel disc brakes.

Disc brake pads have built-in wear indicators that make a high-pitched warning sound when the brake pads are worn and new pads are needed. The sound may come and go or be heard all the time your vehicle is moving (except when you are pushing on the brake pedal firmly).



### CAUTION:

The brake wear warning sound means that sooner or later your brakes won't work well. That could lead to an accident. When you hear the brake wear warning sound, have your vehicle serviced.

### NOTICE:

**Continuing to drive with worn-out brake pads could result in costly brake repair.**

Some driving conditions or climates may cause a brake squeal when the brakes are first applied or lightly applied. This does not mean something is wrong with your brakes.

Brake linings should always be replaced as complete axle sets.

### Brake Pedal Travel

See your dealer if the brake pedal does not return to normal height, or if there is a rapid increase in pedal travel. This could be a sign of brake trouble.

### Brake Adjustment

Every time you apply the brakes, with or without the vehicle moving, your brakes adjust for wear.

## Replacing Brake System Parts

The braking system on a modern vehicle is complex. Its many parts have to be of top quality and work well together if the vehicle is to have really good braking. Vehicles we design and test have top-quality GM brake parts in them, as your Buick does when it is new. When you replace parts of your braking system -- for example, when your brake linings wear down and you have to have new ones put in -- be sure you get new genuine GM replacement parts. If you don't, your brakes may no longer work properly. For example, if someone puts in brake linings that are wrong for your vehicle, the balance between your front and rear brakes can change -- for the worse. The braking performance you've come to expect can change in many other ways if someone puts in the wrong replacement brake parts.

## Battery

Every new Buick has a Delco Freedom<sup>®</sup> battery. You never have to add water to one of these. When it's time for a new battery, we recommend a Delco Freedom<sup>®</sup> battery. Get one that has the replacement number shown on the original battery's label.

The battery is located under the rear seat cushion. To access the battery, see "Removing the Rear Seat Cushion" in the Index. You don't need to access the battery to jump start your vehicle. See "Jump Starting" in the Index.



### CAUTION:

**A battery that isn't properly vented can let sulfuric acid fumes into the area under the rear seat cushion. These fumes can damage your rear seat safety belt systems. You may not be able to see this damage, and the safety belts might not provide the protection needed in a crash. If a replacement battery is ever needed, it must be vented in the same manner as the original battery. Always make sure that the vent hose is properly reattached before reinstalling the seat cushion.**

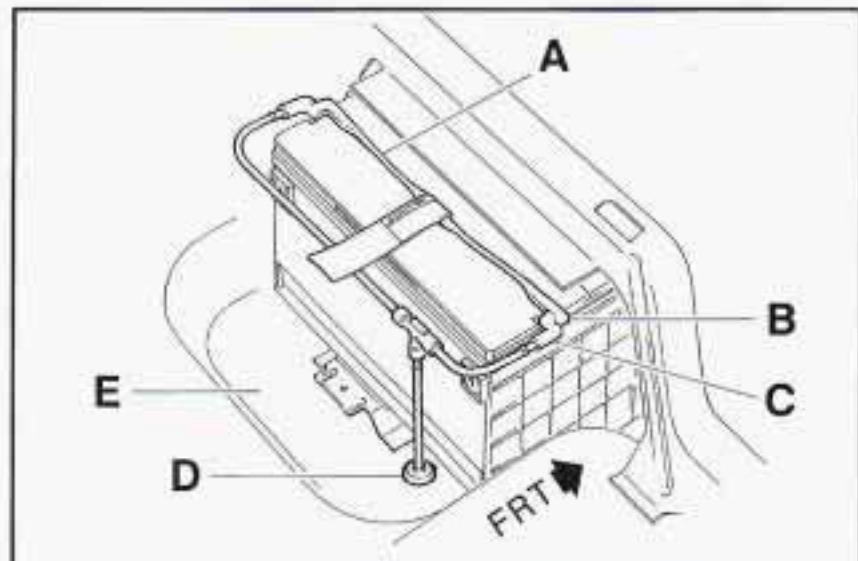

To be sure the vent hose (A) is properly attached, the vent hose connectors (B) must be securely reattached to the vent outlets (C) on each side of the battery, and the vent assembly grommet (D) must be secured to the floor pan (E).

## Vehicle Storage

If you're not going to drive your vehicle for 25 days or more, take off the black, negative (-) cable from the battery. This will help keep your battery from running down.



### CAUTION:

Batteries have acid that can burn you and gas that can explode. You can be badly hurt if you aren't careful. See "Jump Starting" in the Index for tips on working around a battery without getting hurt.

Contact your dealer to learn how to prepare your vehicle for longer storage periods.

## Halogen Bulbs

### CAUTION:

Halogen bulbs have pressurized gas inside and can burst if you drop or scratch the bulb. You or others could be injured. Take special care when handling and disposing of halogen bulbs.

## Headlamp Bulb Replacement



The right high beam headlamp access area is next to the radiator pressure cap.

The right low beam headlamp access area is to the right and slightly behind the high beam area.

The left high beam headlamp access area is located near the air cleaner.

The left low beam headlamp access area is behind and between the high beam area and the air cleaner.

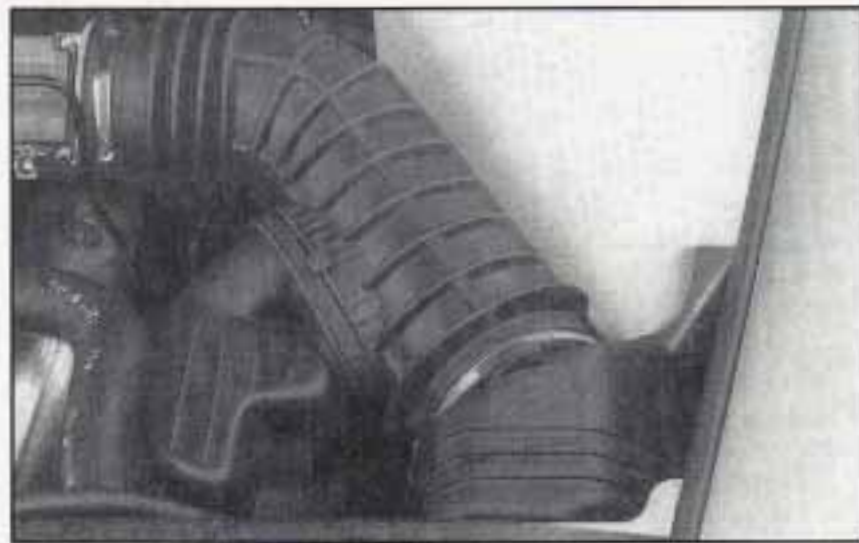



If more hand clearance is required, remove the air cleaner assembly as follows:

1. Remove the air duct clamp and separate the duct from the air cleaner cover.
2. Remove the air cleaner cover and detach the electrical connector.
3. Tilt and pull the cover toward the engine to disengage it from the assembly.
4. Remove the filter.
5. Slide the air cleaner assembly toward the engine to disengage and remove it.

To reinstall the air cleaner assembly, slide the base sections into their former positions. Install the filter and replace the cover. Reattach the electrical connector and air duct, and tighten the clamp.

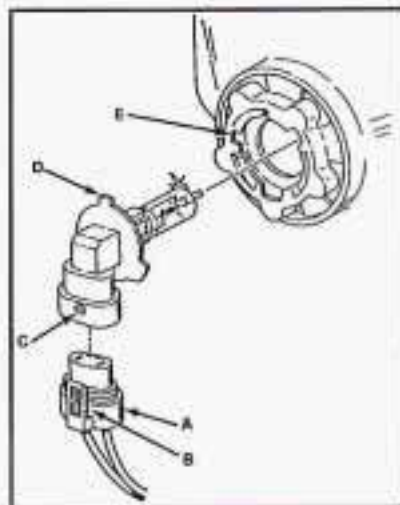

Turn the bulb socket 1/4 turn toward the center of the engine compartment, while pressing it firmly.

Remove the wire connector from the bulb by lifting the lock tab and pulling it away from the plastic base.

To reassemble, attach the wire connector (A) to the plastic base making sure the lock tab (B) is over the lock (C). Install the bulb by putting the small tab (D) into the small notch in the lamp (E). Turn the bulb socket 1/4 turn making sure the tab is properly engaged in the panel slot.

## Headlamp Aiming

Your vehicle has the composite headlamp system. These headlamps have horizontal and vertical aim indicators. The aim has been pre-set at the factory and should need no further adjustment.

If your vehicle is damaged in an accident and the headlamp aim seems to be affected, see your Buick dealer. Headlamps on damaged vehicles may require recalibration of the horizontal aim by your Buick dealer.

To check the aim, the vehicle should be properly prepared as follows:

- The vehicle must have all four tires on a perfectly level surface.
- The vehicle should not have any snow, ice, or mud attached to it.
- There should not be any cargo or loading of vehicle, except it should have a full tank of gas and one person or 160 pounds (75 kg) on the driver's seat.
- Tires should be properly inflated.

### **NOTICE:**

**To make sure your headlamps are aimed properly, read all the instructions before beginning. Failure to follow these instructions could cause damage to headlamp parts.**

State inspection stations will allow a vertical reading of plus 0.76 degrees or minus 0.76 degrees from the center of the bubble.

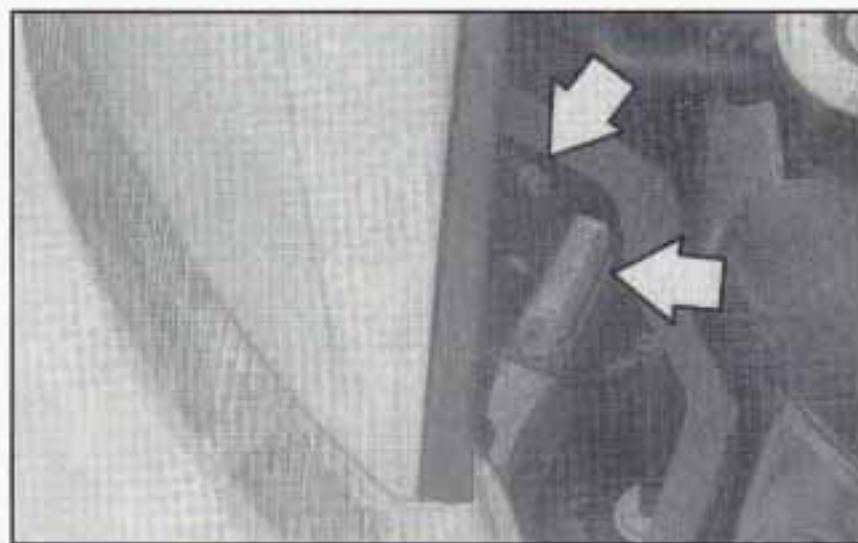

It is recommended that the upper limit not exceed plus 0.4 degrees from the center of the bubble. Other drivers may flash their bright lights at you if your adjustment is much above plus 0.4 degrees.

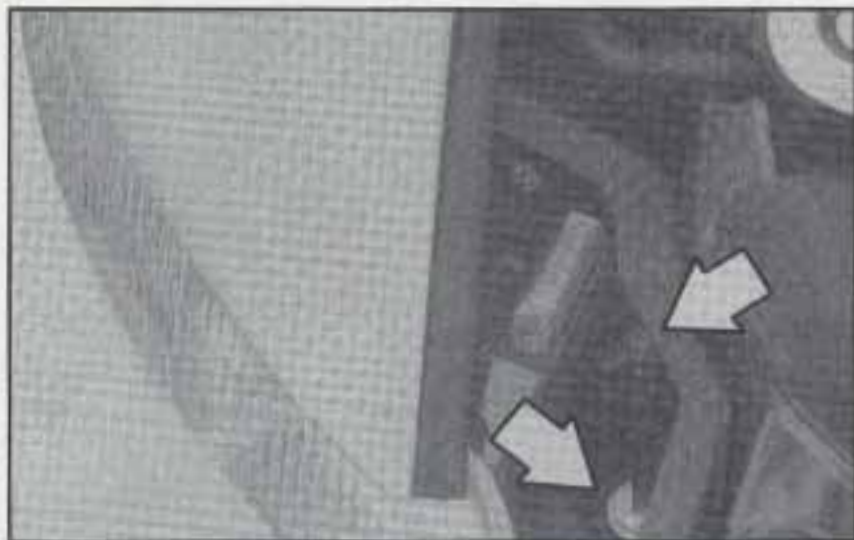

The headlamp aiming device is under the hood, directly behind the headlamps.

If you find that the headlamp aiming needs adjustment, follow these steps:

1. Start by checking the vertical headlamp aim first. Turn the vertical aiming screw until the bubble inside the level is centered at zero.
2. After the vertical aim is correct, check the horizontal aim for each headlamp and adjust as necessary. Turn the horizontal aiming screw until the pointer is lined up with the zero.
3. Re-check the vertical aim to make sure it remains correct after the horizontal aim adjustment. Adjust as necessary.

## Taillamp Bulb Replacement



1. Remove the screws that secure the trunk trim over the taillamp area.

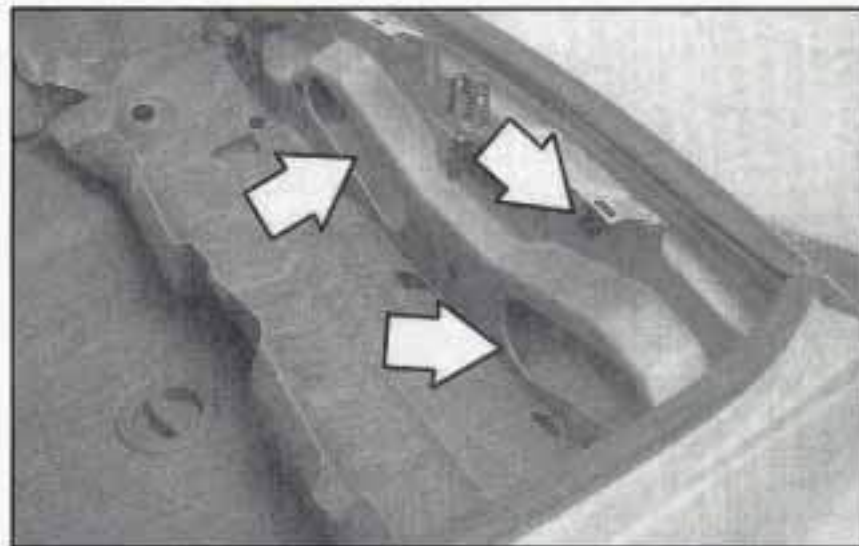

2. Remove the plastic wingnuts that hold the taillamp assembly in place.



3. Pull the taillamp assembly away from the vehicle carefully, to avoid scratching the paint. The taillamp has safety straps to help you hold the assembly while replacing the bulb.



4. Remove the bulb socket assembly by squeezing the plastic lock and turning it 1/4 turn counterclockwise.



5. Pull the bulb straight out to remove it from the socket.
6. Install a new bulb into the socket. Reverse the instructions to replace the taillamp assembly.

## Tires

We don't make tires. Your new vehicle comes with high-quality tires made by a leading tire manufacturer. These tires are warranted by the tire manufacturers and their warranties are delivered with every new Buick. If your spare tire is a different brand than your road tires, you will have a tire warranty folder from each of these manufacturers.



### **CAUTION:**

Poorly maintained and improperly used tires are dangerous.

- **Overloading your tires can cause overheating as a result of too much friction. You could have an air-out and a serious accident. See "Loading Your Vehicle" in the Index.**
- **Underinflated tires pose the same danger as overloaded tires. The resulting accident could cause serious injury. Check all tires frequently to maintain the recommended pressure. Tire pressure should be checked when your tires are cold.**

**CAUTION: (Continued)**

**CAUTION: (Continued)**

- **Overinflated tires are more likely to be cut, punctured, or broken by a sudden impact, such as when you hit a pothole. Keep tires at the recommended pressure.**
- **Worn, old tires can cause accidents. If your tread is badly worn, or if your tires have been damaged, replace them.**

## **Inflation - Tire Pressure**

The Tire-Loading Information label which is located on the rear edge of the driver's door shows the correct inflation pressures for your tires, when they're cold. "Cold" means your vehicle has been sitting for at least three hours or driven no more than a mile.

## **NOTICE:**

**Don't let anyone tell you that underinflation or overinflation is all right. It's not. If your tires don't have enough air (underinflation) you can get:**

- **Too much flexing**
- **Too much heat**
- **Tire overloading**
- **Bad wear**
- **Bad handling**
- **Bad fuel economy.**

**If your tires have too much air (overinflation), you can get:**

- **Unusual wear**
- **Bad handling**
- **Rough ride**
- **Needless damage from road hazards.**

## When to Check

Check your tires once a month or more.

Don't forget your compact spare tire. It should be at 60 psi (420 kPa).

## How to Check

Use a good quality pocket-type gage to check tire pressure. Simply looking at the tires will not tell you the pressure, especially if you have radial tires -- which may look properly inflated even if they're underinflated.

If your tires have valve caps, be sure to put them back on. They help prevent leaks by keeping out dirt and moisture.

## Tire Inspection and Rotation

Tires should be inspected every 6,000 to 8,000 miles (10 000 to 13 000 km) for any signs of unusual wear. If unusual wear is present, rotate your tires as soon as possible and check wheel alignment. Also check for damaged tires or wheels. See "When it's Time for New Tires" and "Wheel Replacement" later in this section for more information.

The purpose of regular rotation is to achieve more uniform wear for all tires on the vehicle. The first rotation is the most important. See "Scheduled Maintenance Services" in the Index for scheduled rotation intervals.

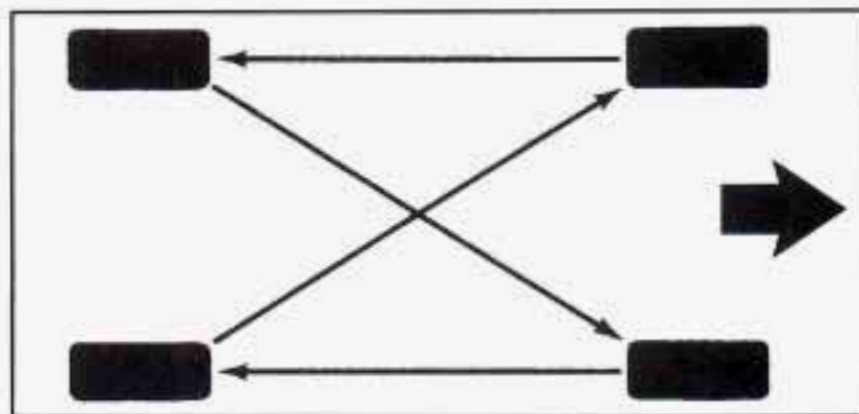

When rotating your tires, always use the correct rotation pattern shown here.

Don't include the compact spare tire in your tire rotation.



After the tires have been rotated, adjust the front and rear inflation pressures as shown on the Tire-Loading Information label. Make certain that all wheel nuts are properly tightened. See "Wheel Nut Torque" in the Index.

### CAUTION:

Rust or dirt on a wheel, or on the parts to which it is fastened, can make wheel nuts become loose after a time. The wheel could come off and cause an accident. When you change a wheel, remove any rust or dirt from places where the wheel attaches to the vehicle. In an emergency, you can use a cloth or a paper towel to do this; but be sure to use a scraper or wire brush later, if you need to, to get all the rust or dirt off. (See "Changing a Flat Tire" in the Index.)

## When it's Time for New Tires

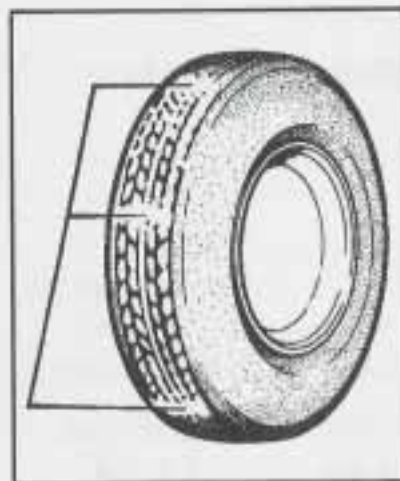

One way to tell when it's time for new tires is to check the treadwear indicators, which will appear when your tires have only 1/16 inch (1.6 mm) or less of tread remaining.

You need a new tire if:

- You can see the indicators at three or more places around the tire.
- You can see cord or fabric showing through the tire's rubber.
- The tread or sidewall is cracked, cut or snagged deep enough to show cord or fabric.
- The tire has a bump, bulge or split.
- The tire has a puncture, cut, or other damage that can't be repaired well because of the size or location of the damage.

## Buying New Tires

To find out what kind and size of tires you need, look at the Tire-Loading Information label.

The tires installed on your vehicle when it was new had a Tire Performance Criteria Specification (TPC Spec) number on each tire's sidewall. When you get new tires, get ones with that same TPC Spec number. That way, your vehicle will continue to have tires that are designed to give proper endurance, handling, speed rating, traction, ride and other things during normal service on your vehicle. If your tires have an all-season tread design, the TPC number will be followed by an "MS" (for mud and snow).

If you ever replace your tires with those not having a TPC Spec number, make sure they are the same size, load range, speed rating and construction type (bias, bias-belted or radial) as your original tires.



### **CAUTION:**

**Mixing tires could cause you to lose control while driving. If you mix tires of different sizes or types (radial and bias-belted tires), the vehicle may not handle properly, and you could have a crash. Be sure to use the same size and type tires on all four wheels.**

**It's all right to drive with your compact spare, though. It was developed for use on your vehicle.**

## Uniform Tire Quality Grading

The following information relates to the system developed by the United States National Highway Traffic Safety Administration which grades tires by treadwear, traction and temperature performance. (This applies only to vehicles sold in the United States.)

## **Treadwear**

The treadwear grade is a comparative rating based on the wear rate of the tire when tested under controlled conditions on a specified government test course. For example, a tire graded 150 would wear one and a half (1 1/2) times as well on the government course as a tire graded 100. The relative performance of tires depends upon the actual conditions of their use, however, and may depart significantly from the norm due to variations in driving habits, service practices and differences in road characteristics and climate.

## **Traction - A, B, C**

The traction grades, from highest to lowest are: A, B, and C. They represent the tire's ability to stop on wet pavement as measured under controlled conditions on specified government test surfaces of asphalt and concrete. A tire marked C may have poor traction performance.

Warning: The traction grade assigned to this tire is based on braking (straight-ahead) traction tests and does not include cornering (turning) traction.

## **Temperature - A, B, C**

The temperature grades are A (the highest), B, and C, representing the tire's resistance to the generation of

heat and its ability to dissipate heat when tested under controlled conditions on a specified indoor laboratory test wheel. Sustained high temperature can cause the material of the tire to degenerate and reduce tire life, and excessive temperature can lead to sudden tire failure. The grade C corresponds to a level of performance which all passenger car tires must meet under the Federal Motor Vehicle Safety Standard No. 109. Grades B and A represent higher levels of performance on the laboratory test wheel than the minimum required by law.

Warning: The temperature grade for this tire is established for a tire that is properly inflated and not overloaded. Excessive speed, underinflation, or excessive loading, either separately or in combination, can cause heat buildup and possible tire failure.

These grades are molded on the sidewalls of passenger car tires.

While the tires available as standard or optional equipment on General Motors vehicles may vary with respect to these grades, all such tires meet General Motors performance standards and have been approved for use on General Motors vehicles. All passenger type (P Metric) tires must conform to Federal safety requirements in addition to these grades.

## Wheel Alignment and Tire Balance

The wheels on your vehicle were aligned and balanced carefully at the factory to give you the longest tire life and best overall performance.

In most cases, you will not need to have your wheels aligned again. However, if you notice unusual tire wear or your vehicle pulling one way or the other, the alignment may need to be reset. If you notice your vehicle vibrating when driving on a smooth road, your wheels may need to be rebalanced.

## Wheel Replacement

Replace any wheel that is bent, cracked, or badly rusted or corroded. If wheel nuts keep coming loose, the wheel, wheel bolts, and wheel nuts should be replaced. If the wheel leaks air, replace it (except some aluminum wheels, which can sometimes be repaired). See your Buick dealer if any of these conditions exist.

Your dealer will know the kind of wheel you need.

Each new wheel should have the same load carrying capacity, diameter, width, offset, and be mounted the same way as the one it replaces.

If you need to replace any of your wheels, wheel bolts, or wheel nuts, replace them only with new GM original

equipment parts. This way, you will be sure to have the right wheel, wheel bolts, and wheel nuts for your Buick model.



### **CAUTION:**

**Using the wrong replacement wheels, wheel bolts, or wheel nuts on your vehicle can be dangerous. It could affect the braking and handling of your vehicle, make your tires lose air and make you lose control. You could have a collision in which you or others could be injured. Always use the correct wheel, wheel bolts, and wheel nuts for replacement.**

### **NOTICE:**

**The wrong wheel can also cause problems with bearing life, brake cooling, speedometer/odometer calibration, headlamp aim, bumper height, vehicle ground clearance, and tire or tire chain clearance to the body and chassis.**

## Used Replacement Wheels

### CAUTION:

Putting a used wheel on your vehicle is dangerous. You can't know how it's been used or how many miles it's been driven. It could fail suddenly and cause an accident. If you have to replace a wheel use a new GM original equipment wheel.

## Tire Chains

### NOTICE:

Use tire chains only where legal and only when you must. Use only SAE Class "S" type chains that are the proper size for your tires. Install them on the front tires and tighten them as tightly as possible with the ends securely fastened. Drive slowly and follow the chain manufacturer's instructions. If you can hear the chains contacting your vehicle, stop and retighten them. If the contact continues, slow down until it stops. Driving too fast or spinning the wheels with chains on will damage your vehicle.

## Appearance Care

Remember, cleaning products can be hazardous. Some are toxic. Others can burst into flame if you strike a match or get them on a hot part of the vehicle. Some are dangerous if you breathe their fumes in a closed space. When you use anything from a container to clean your Buick, be sure to follow the manufacturer's warnings and instructions. And always open your doors or windows when you're cleaning the inside.

*Never* use these to clean your vehicle:

- Gasoline
- Benzene
- Naphtha
- Carbon Tetrachloride
- Acetone
- Paint Thinner
- Turpentine
- Lacquer Thinner
- Nail Polish Remover

They can all be hazardous -- some more than others -- and they can all damage your vehicle, too.

Don't use any of these unless this manual says you can. In many uses, these will damage your vehicle:

- Alcohol
- Laundry Soap
- Bleach
- Reducing Agents

## Cleaning the Inside of Your Buick

Use a vacuum cleaner often to get rid of dust and loose dirt. Wipe vinyl or leather with a clean, damp cloth.

Your Buick dealer has two GM cleaners, a solvent-type spot lifter and a foam-type powdered cleaner. They will clean normal spots and stains very well. Do not use them on vinyl or leather.

Here are some cleaning tips:

- Always read the instructions on the cleaner label.
- Clean up stains as soon as you can -- before they set.
- Use a clean cloth or sponge, and change to a clean area often. A soft brush may be used if stains are stubborn.
- Use solvent-type cleaners in a well-ventilated area only. If you use them, don't saturate the stained area.
- If a ring forms after spot cleaning, clean the entire area immediately or it will set.

## Using Foam-Type Cleaner on Fabric

- Vacuum and brush the area to remove any loose dirt.
- Always clean a whole trim panel or section. Mask surrounding trim along stitch or welt lines.
- Mix Multi-Purpose Powdered Cleaner following the directions on the container label.
- Use suds only and apply with a clean sponge.
- Don't saturate the material.
- Don't rub it roughly.
- As soon as you've cleaned the section, use a sponge to remove the suds.
- Rinse the section with a clean, wet sponge.
- Wipe off what's left with a slightly damp paper towel or cloth.
- Then dry it immediately with a blow dryer or a heat lamp.

### **NOTICE:**

**Be careful. A blow dryer may scorch the fabric.**

- Wipe with a clean cloth.

## Using Solvent-Type Cleaner on Fabric

First, see if you have to use solvent-type cleaner at all. Some spots and stains will clean off better with just water and mild soap.

If you need to use a solvent:

- Gently scrape excess soil from the trim material with a clean, dull knife or scraper. Use very little cleaner, light pressure and clean cloths (preferably cheesecloth). Cleaning should start at the outside of the stain, "feathering" toward the center. Keep changing to a clean section of the cloth.
- When you clean a stain from fabric, immediately dry the area with a blow dryer to help prevent a cleaning ring. (See the previous NOTICE.)

## Special Cleaning Problems

### Greasy or Oily Stains

Stains caused by grease, oil, butter, margarine, shoe polish, coffee with cream, chewing gum, cosmetic creams, vegetable oils, wax crayon, tar and asphalt can be removed as follows:

- Carefully scrape off excess stain.
- Follow the solvent-type instructions described earlier.
- Shoe polish, wax crayon, tar and asphalt will stain if left on a vehicle seat fabric. They should be removed as soon as possible. Be careful, because the cleaner will dissolve them and may cause them to spread.

### Non-Greasy Stains

Stains caused by catsup, coffee (black), egg, fruit, fruit juice, milk, soft drinks, wine, vomit, urine and blood can be removed as follows:

- Carefully scrape off excess stain, then sponge the soiled area with cool water.
- If a stain remains, follow the foam-type instructions described earlier.

- If an odor lingers after cleaning vomit or urine, treat the area with a water/baking soda solution: 1 teaspoon (5 ml) of baking soda to 1 cup (250 ml) of lukewarm water.
- If needed, clean lightly with solvent-type cleaner.

### Combination Stains

Stains caused by candy, ice cream, mayonnaise, chili sauce and unknown stains can be removed as follows:

- Carefully scrape off excess stain, then clean with cool water and allow to dry.
- If a stain remains, clean it with solvent-type cleaner.

### Cleaning Vinyl

Use warm water and a clean cloth.

- Rub with a clean, damp cloth to remove dirt. You may have to do it more than once.
- Things like tar, asphalt and shoe polish will stain if you don't get them off quickly. Use a clean cloth and a GM Vinyl/Leather Cleaner or equivalent product.



## Cleaning Leather

Use a soft cloth with lukewarm water and a mild soap or saddle soap.

- For stubborn stains, use a GM Vinyl/Leather Cleaner or equivalent product.
- *Never* use oils, varnishes, solvent-based or abrasive cleaners, furniture polish or shoe polish on leather.
- Soiled leather should be cleaned immediately. If dirt is allowed to work into the finish, it can harm the leather.

## Cleaning the Top of the Instrument Panel

Use only mild soap and water to clean the top surfaces of the instrument panel. Sprays containing silicones or waxes may cause annoying reflections in the windshield and even make it difficult to see through the windshield under certain conditions.

## Cleaning Speaker Covers

Vacuum around a speaker cover gently, so that the speaker won't be damaged. If something gets on one of them, follow the steps earlier under "Using Solvent-Type Cleaner on Fabric." Use as little solvent as you can.

## Care of Safety Belts

Keep belts clean and dry.



### CAUTION:

Do not bleach or dye safety belts. If you do, it may severely weaken them. In a crash they might not be able to provide adequate protection. Clean safety belts only with mild soap and lukewarm water.

## Glass

Glass should be cleaned often. GM Glass Cleaner (GM Part No. 1050427) or a liquid household glass cleaner will remove normal tobacco smoke and dust films.

Don't use abrasive cleaners on glass, because they may cause scratches. Avoid placing decals on the inside rear window, since they may have to be scraped off later. If abrasive cleaners are used on the inside of the rear window, an electric defogger element may be damaged. Any temporary license should not be attached across the defogger grid.

## **Cleaning the Outside of the Windshield and Wiper Blades**

If the windshield is not clear after using the windshield washer, or if the wiper blade chatters when running, wax or other material may be on the blade or windshield.

Clean the outside of the windshield with GM Windshield Cleaner, Bon-Ami Powder<sup>®</sup> (GM Part No. 1050011). The windshield is clean if beads do not form when you rinse it with water.

Clean the blade by wiping vigorously with a cloth soaked in full strength windshield washer solvent. Then rinse the blade with water.

Wiper blades should be checked on a regular basis and replaced when worn.

## **Weatherstrips**

Silicone grease on weatherstrips will make them last longer, seal better, and not stick or squeak. Apply silicone grease with a clean cloth at least every six months. During very cold, damp weather more frequent application may be required. (See "Recommended Fluids and Lubricants" in the Index.)

## **Cleaning the Outside of Your Buick**

The paint finish on your vehicle provides beauty, depth of color, gloss retention and durability.

### **Washing Your Vehicle**

The best way to preserve your vehicle's finish is to keep it clean by washing it often with lukewarm or cold water.

Don't wash your vehicle in the direct rays of the sun. Don't use strong soaps or chemical detergents. Use liquid hand, dish or car washing (mild detergent) soaps. Don't use cleaning agents that are petroleum based, or that contain acid or abrasives. All cleaning agents should be flushed promptly and not allowed to dry on the surface, or they could stain. Dry the finish with a soft, clean chamois or a 100% cotton towel to avoid surface scratches and water spotting.

High pressure car washes may cause water to enter your vehicle.

## Finish Care

Occasional waxing or mild polishing of your Buick by hand may be necessary to remove residue from the paint finish. You can get GM approved cleaning products from your dealer. (See “Appearance Care and Maintenance Materials” in the Index.)

Your Buick has a “basecoat/clearcoat” paint finish. The clearcoat gives more depth and gloss to the colored basecoat. Always use waxes and polishes that are non-abrasive and made for a basecoat/clearcoat paint finish.

### **NOTICE:**

**Machine compounding or aggressive polishing on a basecoat/clearcoat paint finish may dull the finish or leave swirl marks.**

Foreign materials such as calcium chloride and other salts, ice melting agents, road oil and tar, tree sap, bird droppings, chemicals from industrial chimneys, etc. can damage your vehicle’s finish if they remain on painted surfaces. Wash the vehicle as soon as possible. If necessary, use non-abrasive cleaners that are marked safe for painted surfaces to remove foreign matter.

Exterior painted surfaces are subject to aging, weather and chemical fallout that can take their toll over a period of years. You can help to keep the paint finish looking new by keeping your Buick garaged or covered whenever possible.

## Aluminum Wheels

Your aluminum wheels have a protective coating similar to the painted surface of your vehicle. Don’t use strong soaps, chemicals, chrome polish, abrasive cleaners or abrasive cleaning brushes on them because you could damage this coating. After rinsing thoroughly, a wax may be applied.

### **NOTICE:**

**Don’t use an automatic car wash that has hard silicon carbide cleaning brushes. These brushes can take the protective coating off your aluminum wheels.**

## **Tires**

To clean your tires, use a stiff brush with a tire cleaner.

When applying a tire dressing always take care to wipe off any overspray or splash from painted surfaces.

Petroleum-based products may damage the paint finish.

## **Sheet Metal Damage**

If your vehicle is damaged and requires sheet metal repair or replacement, make sure the body repair shop applies anti-corrosion material to the parts repaired or replaced to restore corrosion protection.

## **Finish Damage**

Any stone chips, fractures or deep scratches in the finish should be repaired right away. Bare metal will corrode quickly and may develop into a major repair expense.

Minor chips and scratches can be repaired with touch-up materials available from your dealer or other service outlets. Larger areas of finish damage can be corrected in your dealer's body and paint shop.

## **Underbody Maintenance**

Chemicals used for ice and snow removal and dust control can collect on the underbody. If these are not removed, accelerated corrosion (rust) can occur on the underbody parts such as fuel lines, frame, floor pan, and exhaust system even though they have corrosion protection.

At least every spring, flush these materials from the underbody with plain water. Clean any areas where mud and other debris can collect. Dirt packed in closed areas of the frame should be loosened before being flushed. Your dealer or an underbody car washing system can do this for you.

## **Chemical Paint Spotting**

Some weather and atmospheric conditions can create a chemical fallout. Airborne pollutants can fall upon and attack painted surfaces on your vehicle. This damage can take two forms: blotchy, ringlet-shaped discolorations, and small irregular dark spots etched into the paint surface.

Although no defect in the paint job causes this, Buick will repair, at no charge to the owner, the surfaces of new vehicles damaged by this fallout condition within 12 months or 12,000 miles (20 000 km) of purchase, whichever comes first.

## Appearance Care and Maintenance Materials

You can get these from your GM Parts Department.

PART NUMBER	SIZE	DESCRIPTION	USAGE
12345343	16 oz. (0.473L)	Goodwrench® Liquid Wax	Exterior polish
1052277	12 oz. (0.354L)	Spray-A-Squeak Silicone Grease	Weatherstrips, Stops squeaks
1052863	1 oz. (0.028kg)		
1050172	16 oz. (0.473L)	Tar and Road Oil Remover	Also removes old waxes, polishes
1050173	16 oz. (0.473L)	Chrome Cleaner and Polish	Removes rust and corrosion
1050174	16 oz. (0.473L)	White Sidewall Tire Cleaner	Cleans white and black tires
1050214	32 oz. (0.946L)	Vinyl/Leather Cleaner	Spot and stain removal
1050244	16 oz. (0.473L)	Fabric Cleaner	Spot and stain removal
1050427	23 oz. (0.680L)	Glass Cleaner	Also spot cleans vinyls
1050429	6 lbs. (2.72kg)	Multi-Purpose Powdered Cleaner	Cleans vinyl and cloth, also, tires and mats
1052349	12 oz. (0.340kg)	Lubriplate (White Grease)	For hood, trunk, door hinges and latches
1051055	16 oz. (0.473L)	Preservatone	Vinyl top dressing
1051398*	6 oz. (0.237L)	Spot Lifter	For cloth
1051515	32 oz. (0.946L)	Washer Solvent	Windshield-washing system
1052870	16 oz. (0.473L)	Wash-Wax (conc.)	Exterior wash

\* Not recommended for pigskin suede leather.

See your General Motors Parts Departments for these products.

See your Maintenance Schedule for other products.

## Vehicle Identification Number (VIN)



This is the legal identifier for your Buick. It appears on a plate in the front corner of the instrument panel, on the driver's side. You can see it if you look through the windshield from outside your vehicle. The VIN also appears on the Vehicle Certification and Service Parts labels and the certificates of title and registration.

### Engine Identification

The eighth character in your VIN is the engine code. This code will help you identify your engine, specifications, and replacement parts.

## Service Parts Identification Label

You'll find this label in the trunk, on the antenna side, behind the trim. It's very helpful if you ever need to order parts. On this label is:

- your VIN,
- the model designation,
- paint information, and
- a list of all production options and special equipment.

Be sure that this label is not removed from the vehicle.

## Add-On Electrical Equipment

### NOTICE:

**Don't add anything electrical to your Buick unless you check with your dealer first. Some electrical equipment can damage your vehicle and the damage wouldn't be covered by your warranty. Some add-on electrical equipment can keep other components from working as they should.**

Your vehicle has an air bag system. Before attempting to add anything electrical to your Buick, see "Servicing Your Air Bag-Equipped Buick" in the Index.

## Fuses and Circuit Breakers

The wiring circuits in your car are protected from short circuits by a combination of fuses, circuit breakers, and fusible thermal links in the wiring itself.

Look at the silver-colored band inside the fuse. If the band is broken or melted, replace the fuse. Be sure you replace a bad fuse with a new one of the identical size and rating.

### Headlamps

The headlamp wiring is protected by a circuit breaker. An electrical overload will cause the lamps to go on and off, or in some cases to remain off. If this happens, have your headlamp wiring checked right away.

### Windshield Wipers

The windshield wiper motor is protected by a circuit breaker and a fuse. If the motor overheats due to heavy snow, etc., the wiper will stop until the motor cools. If the overload is caused by some electrical problem and not snow, etc., be sure to get it fixed.

## Power Windows and Other Power Options

Circuit breakers in the fuse panel protect the power windows and other power accessories. When the current load is too heavy, the circuit breaker opens and closes, protecting the circuit until the problem is fixed or goes away.



There is a fuse panel located at the end of the instrument panel near the driver's door.

There is an underhood electrical center and two other fuse panels located under the rear seat.

## Removing the Rear Seat Cushion

To access the battery and main fuse boxes, the rear seat cushion must be removed. You may wish to have your dealer do this for you.

### **NOTICE:**

The battery and main fuse boxes are located under the rear seat cushion. The battery's ground terminal and some relay wires are exposed. To help avoid damage to the battery and wires, be careful when removing or reinstalling the seat cushion. Do not remove covers from covered parts. Do not store anything under the seat, as objects could touch exposed wires and cause a short.

### To Remove the Rear Seat Cushion

1. Pull up on the front of the cushion to release the front hooks.
2. Pull the cushion up and out toward the front of the vehicle.

### To Reinstall the Rear Seat Cushion

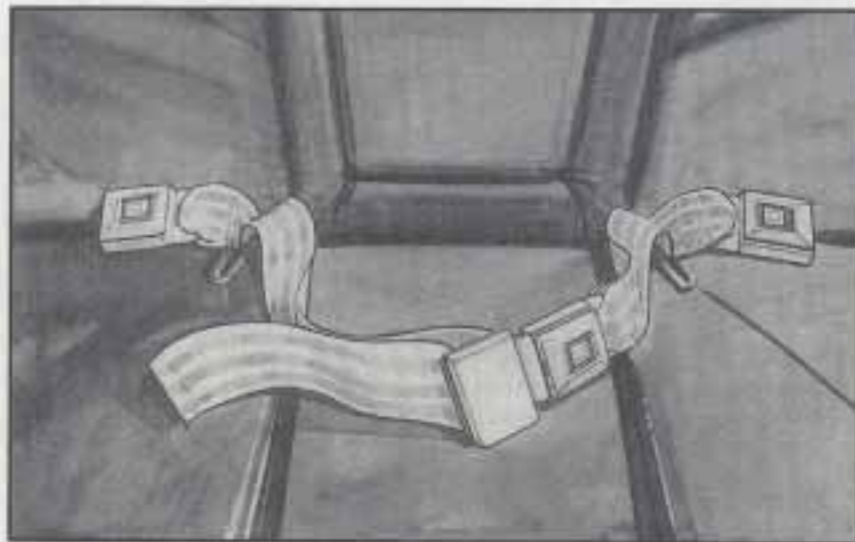



 **CAUTION:**

A safety belt that isn't properly routed through the seat cushion or is twisted won't provide the protection needed in a crash. If the safety belt hasn't been routed through the seat cushion at all, it won't be there to work for the next passenger. The person sitting in that position could be badly injured. After reinstalling the seat cushion, always check to be sure that the safety belts are properly routed and are not twisted.

1. Buckle the center passenger position safety belt, then route the safety belts through the proper slots in the seat cushion. Don't let the safety belts get twisted.
2. Slide the rear of the cushion up and under the seatback so the rear locating guides hook into the wire loops on the back frame.
3. With the seat cushion lowered, push rearward and then press down on the seat cushion until the spring locks on both ends engage.
4. Check to make sure the safety belts are properly routed and that no portion of any safety belt is trapped under the seat. Also make sure the seat cushion is secured.

## Fuse Block

### Instrument Panel

AIR BAG	INJ	ABS	LR EXT LPS
TURN LPS	CRUISE CONT	HVAC CONT	RH EXT LPS
HVAC RELAY	MAF	AUX PWR	INT LPS
CHIME			
		RADIO	CLNG FAN
		WSW	EGR
PCM	C/LTR	CRANK	HVAC BLOWER

## Fuse Usage

Position	Description
1.	Air Bag
2.	Injectors
3.	Anti-Lock Brake System
4.	Left Exterior Lamps
5.	Turn Signal Lamps
6.	Cruise Control
7.	Climate Control
8.	Right Exterior Lamps
9.	HVAC Relay
10.	MAF
11.	Auxiliary Power
12.	Interior Lamps
13.	Chime
19.	Radio
20.	Clng Fan
23.	Windshield Wipers
24.	EGR
25.	PCM
26.	Cigarette Lighter
27.	Crank
28.	HVAC Blower

## Electrical Center

### Engine Compartment

AIR CONDITIONING- CENTER			
HORN			
COOLING FAN #2		COOLING FAN #3	
COOLING FAN	ABS MAIN	ABS PUMP MOTOR	
		HORN	FLASH TO PASS

## Fuse Usage

Position	Description
1.	Air Conditioning Compressor
2.	Not Used
3.	Not Used
4.	Horn
5.	Not Used
6.	Not Used
7.	Cooling Fan #2
8.	Cooling Fan #3
9.	Cooling Fan
10.	ABS Main
11.	ABS Pump Motor
12.	Not Used
13.	Horn
14.	Flash To Pass

## Electrical Center

### Under Rear Seat

INTR LP		ELC		TRUNK REL	
OPEN		F/PMP		D/DOOR UNLOCK	
OPEN	DEFG-RR #2			DEFG-RR #1	
OPEN					
OPEN					
OPEN					
OPEN	SPARE	SPARE	SPARE	OPEN	OPEN
OPEN	DAP ACSRY			DAP IGN	
OPEN					
OPEN					
OPEN					

## Fuse Usage

Position	Description
1.	Interior Lamps Relay
2.	Electronic Level Control
3.	Trunk Release Relay
4.	Not Used
5.	Fuel Pump Relay
6.	Driver Door Unlock Relay
7-10	Not Used
11.	Rear Defogger Relay (Lower Zone)
12.	Rear Defogger Relay (Upper Zone)
13.	Not Used
14.	Spare
15.	Spare
16.	Spare
17-22	Not Used
23.	Direct Accessory Power-Accessory
24.	Direct Accessory Power-Ignition

## Electrical Center

### Under Rear Seat

SPARE	SPARE	OPEN	PWR WDO/SUNRF CB		
SPARE	SPARE	OPEN			
SPARE	SPARE	OPEN	PWR ST CB		
SPARE	SPARE	OPEN			
PWR ST	HDLP CB	HVAC BLO MTR	PCM/ VATS	IGN 3	IGN 1
DEFOG RR	TRUNK FDR REL	HTD ST	ELC/ UP	EXT LP	OPEN
PWR DR LK	INTR LP	HZRD/STOP	PARK LP		
OPEN	B/ULP	F/DR REL	TRUNK REL		
BATT THER	IP2	1P1	ELC		
F/PMP	OPEN	OPEN	OPEN		

## Fuse Usage

Position	Description
1.	Spare
2.	Spare
4.	Breaker-Power Windows/Sunroof
5-6	Spare
8-9	Spare
11.	Breaker-Power Seats
12-13	Spare
15.	Power Seats
16.	Breaker-Headlamps
17.	HVAC Blower Motor
18.	Power Control Module/PASS-Key®II
19.	Ignition 3
20.	Ignition 1
21.	Rear Defogger
22.	Trunk and Fuel Door Release
23.	Heated Seat
24.	Electronic Level Control/Instrument Panel
25.	Exterior Lamps
27.	Power Door Locks
28.	Interior Lamps
29.	Hazard Lights/Stop Lights
30.	Parking Lamps
32.	Back-up Lamps
33.	Fuel Door Release
34.	Trunk Release
35.	Battery Thermistor
36.	Instrument Panel #2
37.	Instrument Panel #1
38.	Electronic Level Control
39.	Fuel Pump

## Riviera Dimensions

Inches Unless Otherwise Noted

### Overall:

Length .....	207.2
Width .....	75.0
Height .....	55.2
Wheelbase .....	113.8
Front Tread .....	62.5
Rear Tread .....	62.6

### Interior Front:

Leg Room .....	42.6
Head Room .....	38.2
Shoulder Room .....	57.9
Hip Room .....	53.7

### Interior Rear:

Leg Room .....	37.3
Head Room .....	36.2
Shoulder Room .....	57.9
Hip Room .....	52.8

**Trunk Capacity – Cu. Ft.** ..... 17.4

### Passengers:

Front .....	2/3
Rear .....	3

**Base Curb Weight – Lbs.** ..... 3742  
Supercharged ..... 3782

## Replacement Light Bulbs

Application	Number	Application	Number
<b>Exterior</b>		<b>Interior Illumination</b>	
Headlamp		Ashtray .....	161
High Beam .....	9005	Rail Courtesy, Reading .....	168
Low Beam .....	9006	Door Warning .....	168
Cornering .....	3057	Engine Compartment .....	561
Park/Turn .....	3057	Footwell Courtesy .....	168
Sidemarkers, Front .....	194	Glove Box .....	194
Backup .....	3057	Luggage Compartment .....	93
High Level Stop .....	1156	Vanity Mirror .....	7065
License .....	194		
Sidemarkers, Rear .....	194		
Tail .....	194		
Tail/Turn .....	3057		

## Capacities and Specifications

### Engine Code 1 (L67) 3.8L V-6 SFI

#### Belt Tensions —

Automatically controlled by a Self-Tension idler pulley. Tension adjustment should never be necessary.

#### Cooling System Capacity —

13 quarts/12.5 liters

#### Crankcase Capacity —

5 quarts/4.75 liters (oil change with filter change)

#### Air Conditioning Capacity —

R-134a — 2.0 lbs. (0.9 kilograms)

#### Fuel Tank Capacity —

19.4 gallons/73.4 liters

#### Transaxle —

Drain and Refill — 6 quarts/5.6 liters

#### Maintenance Item Part Numbers —

Air Filter — A1096C

Fuel Filter — GF580

Oil Filter — PF47

PCV Valve — CV892C

Radiator Cap — RC27

Spark Plug — 41-601, Gap 0.060 inch (1.52 mm)

---

**Air Conditioning Refrigerants** – Not all air conditioning refrigerants are the same. If the air conditioning system in your vehicle needs refrigerant, be sure the proper refrigerant is used. If you're not sure ask your Buick dealer. For additional information, see your "Warranty and Owner Assistance Information" booklet.



## Capacities and Specifications

### Engine Code K (L36) 3.8L V-6 MFI

#### Belt Tensions —

Automatically controlled by a Self-Tension idler pulley. Tension adjustment should never be necessary.

#### Cooling System Capacity —

13 quarts/12.5 liters

#### Crankcase Capacity —

5 quarts/4.75 liters (oil change with filter change)

#### Air Conditioning Capacity —

R-134a — 2.0 lbs. (0.9 kilograms)

#### Fuel Tank Capacity —

19.4 gallons/73.4 liters

#### Transaxle —

Drain and Refill — 6 quarts/5.6 liters

#### Maintenance Item Part Numbers —

Air Filter — A1096C

Fuel Filter — GF580

Oil Filter — PF47

PCV Valve — CV892C

Radiator Cap — RC27

Spark Plug — 41-606, Gap 0.060 inch (1.52 mm)

**Air Conditioning Refrigerants** – Not all air conditioning refrigerants are the same. If the air conditioning system in your vehicle needs refrigerant, be sure the proper refrigerant is used. If you're not sure ask your Buick dealer. For additional information, see your "Warranty and Owner Assistance Information" booklet.



## Section 7 Maintenance Schedule

**IMPORTANT:**  
KEEP ENGINE OIL  
AT THE PROPER  
LEVEL AND CHANGE AS  
RECOMMENDED

This section covers the maintenance required for your Buick. Your vehicle needs these services to retain its safety, dependability and emission control performance.



***Protection  
Plan***

*Have you purchased the GM Protection Plan? The Plan supplements your new vehicle warranties. See your Buick dealer for details.*

### Introduction

#### Your Vehicle and the Environment

Proper vehicle maintenance not only helps to keep your vehicle in good working condition, but also helps the environment. All recommended maintenance procedures are important. Improper vehicle maintenance or the removal of important components can significantly affect the quality of the air we breathe. Improper fluid levels or even the wrong tire inflation can increase the level of emissions from your vehicle. To help protect our environment, and to help keep your vehicle in good condition, please maintain your vehicle properly.

## How This Section is Organized

The remainder of this section is divided into five parts:

**“Part A: Scheduled Maintenance Services”** shows what to have done and how often. Some of these services can be complex, so unless you are technically qualified and have the necessary equipment, you should let your dealer’s service department or another qualified service center do these jobs.

### CAUTION:

Performing maintenance work on a vehicle can be dangerous. In trying to do some jobs, you can be seriously injured. Do your own maintenance work only if you have the required know-how and the proper tools and equipment for the job. If you have any doubt, have a qualified technician do the work.

If you are skilled enough to do some work on your vehicle, you will probably want to get the service information GM publishes. See “Service and Owner Publications” in the Index.

**“Part B: Owner Checks and Services”** tells you what should be checked whenever you stop for fuel. It also explains what you can easily do to help keep your vehicle in good condition.

**“Part C: Periodic Maintenance Inspections”** explains important inspections that your Buick dealer’s service department or another qualified service center should perform.

**“Part D: Recommended Fluids and Lubricants”** lists some products GM recommends to help keep your vehicle properly maintained. These products, or their equivalents, should be used whether you do the work yourself or have it done.

**“Part E: Maintenance Record”** provides a place for you to record the maintenance performed on your vehicle. Whenever any maintenance is performed, be sure to write it down in this part. This will help you determine when your next maintenance should be done. In addition, it is a good idea to keep your maintenance receipts. They may be needed to qualify your vehicle for warranty repairs.

## Part A: Scheduled Maintenance Services

### Using Your Maintenance Schedule

We at General Motors want to help you keep your vehicle in good working condition. But we don't know exactly how you'll drive it. You may drive very short distances only a few times a week. Or you may drive long distances all the time in very hot, dusty weather. You may use your vehicle in making deliveries. Or you may drive it to work, to do errands or in many other ways.

Because of all the different ways people use their GM vehicles, maintenance needs vary. You may even need more frequent checks and replacements than you'll find in the schedules in this section. So please read this section and note how you drive. If you have any questions on how to keep your vehicle in good condition, see your Buick dealer.

This part tells you the maintenance services you should have done and when you should schedule them. If you go to your dealer for your service needs, you'll know that GM-trained and supported service people will perform the work using genuine GM parts.

The proper fluids and lubricants to use are listed in Part D. Make sure whoever services your vehicle uses these. All parts should be replaced and all necessary repairs done before you or anyone else drives the vehicle.

These schedules are for vehicles that:

- carry passengers and cargo within recommended limits. You will find these limits on your vehicle's Tire-Loading Information label. See "Loading Your Vehicle" in the Index.
- are driven on reasonable road surfaces within legal driving limits.
- use the recommended unleaded fuel. See "Fuel" in the Index.

### Selecting the Right Schedule

First you'll need to decide which of the two schedules is right for your vehicle. Here's how to decide which schedule to follow:

# Maintenance Schedule

## Schedule I Definition

Follow Maintenance Schedule I if any one of these is true for your vehicle:

- Most trips are less than 5 to 10 miles (8 to 16 km). This is particularly important when outside temperatures are below freezing.
- Most trips include extensive idling (such as frequent driving in stop-and-go traffic).
- Most trips are through dusty areas.
- You frequently tow a trailer or use a carrier on top of your vehicle.

Schedule I should also be followed if the vehicle is used for delivery service, police, taxi, or other commercial application.

## Schedule I Intervals

**Every 3,000 Miles (5 000 km) or 3 Months,  
Whichever Occurs First**

Engine Oil and Filter Change

## Schedule I Intervals

**Every 6,000 Miles (10 000 km) or 6 Months,  
Whichever Occurs First**

Chassis Lubrication

**At 6,000 Miles (10 000 km) - Then Every  
12,000 Miles (25 000 km)**

Tire Rotation

**Every 15,000 Miles (25 000 km)**

Air Cleaner Filter Inspection, if driving in dusty conditions

**Every 30,000 Miles (50 000 km)**

Air Cleaner Filter Replacement

Spark Plug Replacement

Spark Plug Wire Inspection

Fuel Tank, Cap and Lines Inspection

Engine Accessory Drive Belt Inspection (or every 24 months, whichever occurs first)

Cooling System Service (or every 24 months, whichever occurs first)

Supercharger Oil Check (or every 36 months, whichever occurs first)

(3.8L Code 1 engine only)

**Every 50,000 Miles (83 000 km)**

Automatic Transaxle Service (severe conditions only)

# Maintenance Schedule

## Schedule II Definition

Follow Schedule II *only* if none of the conditions from Schedule I is true.

## Schedule II Intervals

### Every 7,500 Miles (12 500 km)

Engine Oil and Filter Change (or every 12 months, whichever occurs first)

Chassis Lubrication (or every 12 months, whichever occurs first)

### At 7,500 Miles (12 500 km) - Then Every 15,000 Miles (25 000 km)

Tire Rotation

### Every 30,000 Miles (50 000 km)

Engine Accessory Drive Belt Inspection (or every 24 months, whichever occurs first)

Cooling System Service (or every 24 months, whichever occurs first)

Spark Plug Replacement

Spark Plug Wire Inspection

Supercharger Oil Check (or every 36 months, whichever occurs first) (3.8L Code 1 Engine Only)

Air Cleaner Filter Replacement

Fuel Tank, Cap and Lines Inspection

### Every 50,000 Miles (83 000 km)

Automatic Transaxle Service (severe conditions only)

## Maintenance Schedule I

The services shown in this schedule up to 100,000 miles (166 000 km) should be performed after 100,000 miles (166 000 km) at the same intervals.

### Footnotes

† The U.S. Environmental Protection Agency or the California Air Resources Board has determined that the failure to perform this maintenance item will not nullify the emission warranty or limit recall liability prior to the completion of vehicle useful life. We, however, urge that all recommended maintenance services be performed at the indicated intervals and the maintenance be recorded.

### 3,000 Miles (5 000 km)

- Change engine oil and filter (or every 3 months, whichever occurs first).

*An Emission Control Service.*

DATE	ACTUAL MILEAGE	SERVICED BY:

## Maintenance Schedule I

### 6,000 Miles (10 000 km)

- Change engine oil and filter (or every 3 months, whichever occurs first).  
*An Emission Control Service.*
- Lubricate the suspension and steering linkage, transaxle shift linkage, parking brake cable guides and the underbody contact points and linkage (or every 6 months, whichever occurs first).
- Rotate tires. See "Tire Inspection and Rotation" in the Index for proper rotation pattern and additional information.

DATE	ACTUAL MILEAGE	SERVICED BY:

### 9,000 Miles (15 000 km)

- Change engine oil and filter (or every 3 months, whichever occurs first).  
*An Emission Control Service.*

DATE	ACTUAL MILEAGE	SERVICED BY:



## Maintenance Schedule I

### 12,000 Miles (20 000 km)

- Change engine oil and filter (or every 3 months, whichever occurs first).  
*An Emission Control Service.*
- Lubricate the suspension and steering linkage, transaxle shift linkage, parking brake cable guides and the underbody contact points and linkage (or every 6 months, whichever occurs first).

DATE	ACTUAL MILEAGE	SERVICED BY:

### 15,000 Miles (25 000 km)

- Change engine oil and filter (or every 3 months, whichever occurs first).  
*An Emission Control Service.*
- Inspect air cleaner filter if you are driving in dusty conditions. Replace filter if necessary. *An Emission Control Service.*

DATE	ACTUAL MILEAGE	SERVICED BY:

## Maintenance Schedule I

### 18,000 Miles (30 000 km)

- Change engine oil and filter (or every 3 months, whichever occurs first).  
*An Emission Control Service.*
- Lubricate the suspension and steering linkage, transaxle shift linkage, parking brake cable guides and the underbody contact points and linkage (or every 6 months, whichever occurs first).
- Rotate tires. See "Tire Inspection and Rotation" in the Index for proper rotation pattern and additional information.

DATE	ACTUAL MILEAGE	SERVICED BY:

### 21,000 Miles (35 000 km)

- Change engine oil and filter (or every 3 months, whichever occurs first).  
*An Emission Control Service.*

DATE	ACTUAL MILEAGE	SERVICED BY:

## Maintenance Schedule I

### 24,000 Miles (40 000 km)

- Change engine oil and filter (or every 3 months, whichever occurs first).  
*An Emission Control Service.*
- Lubricate the suspension and steering linkage, transaxle shift linkage, parking brake cable guides and the underbody contact points and linkage (or every 6 months, whichever occurs first).

DATE	ACTUAL MILEAGE	SERVICED BY:

### 27,000 Miles (45 000 km)

- Change engine oil and filter (or every 3 months, whichever occurs first).  
*An Emission Control Service.*

DATE	ACTUAL MILEAGE	SERVICED BY:

## Maintenance Schedule I

### 30,000 Miles (50 000 km)

- Change engine oil and filter (or every 3 months, whichever occurs first).  
*An Emission Control Service.*
- Lubricate the suspension and steering linkage, transaxle shift linkage, parking brake cable guides and the underbody contact points and linkage (or every 6 months, whichever occurs first).
- Inspect engine accessory drive belt (or every 24 months, whichever occurs first).  
*An Emission Control Service.*
- Drain, flush and refill cooling system (or every 24 months, whichever occurs first). See "Engine Coolant" in the Index for what to use. Inspect hoses. Clean radiator, condenser, pressure cap and neck. Pressure test the cooling system and pressure cap.  
*An Emission Control Service.*
- Replace spark plugs. *An Emission Control Service.*
- Inspect spark plug wires. *An Emission Control Service. †*
- Replace air cleaner filter. Replace filter more often under dusty conditions.  
*An Emission Control Service.*
- Inspect fuel tank, cap and lines for damage or leaks. Inspect fuel cap gasket for any damage. Replace parts as needed.  
*An Emission Control Service. †*
- For supercharged engines only: Check the supercharger oil level and add oil as needed (or every 36 months, whichever occurs first). See "Recommended Fluids and Lubricants" in this section.  
*An Emission Control Service. †*

(Continued)

## Maintenance Schedule I

### 30,000 Miles (50 000 km) (Continued)

- Rotate tires. See "Tire Inspection and Rotation" in the Index for proper rotation pattern and additional information.

DATE	ACTUAL MILEAGE	SERVICED BY:

### 33,000 Miles (55 000 km)

- Change engine oil and filter (or every 3 months, whichever occurs first).  
*An Emission Control Service.*

DATE	ACTUAL MILEAGE	SERVICED BY:

## Maintenance Schedule I

### *36,000 Miles (60 000 km)*

- Change engine oil and filter (or every 3 months, whichever occurs first).  
*An Emission Control Service.*
- Lubricate the suspension and steering linkage, transaxle shift linkage, parking brake cable guides and the underbody contact points and linkage (or every 6 months, whichever occurs first).

DATE	ACTUAL MILEAGE	SERVICED BY:

### *39,000 Miles (65 000 km)*

- Change engine oil and filter (or every 3 months, whichever occurs first).  
*An Emission Control Service.*

DATE	ACTUAL MILEAGE	SERVICED BY:

## Maintenance Schedule I

### 42,000 Miles (70 000 km)

- Change engine oil and filter (or every 3 months, whichever occurs first).  
*An Emission Control Service.*
- Lubricate the suspension and steering linkage, transaxle shift linkage, parking brake cable guides and the underbody contact points and linkage (or every 6 months, whichever occurs first).
- Rotate tires. See "Tire Inspection and Rotation" in the Index for proper rotation pattern and additional information.

DATE	ACTUAL MILEAGE	SERVICED BY:

### 45,000 Miles (75 000 km)

- Change engine oil and filter (or every 3 months, whichever occurs first).  
*An Emission Control Service.*
- Inspect air cleaner filter if you are driving in dusty conditions. Replace filter if necessary. *An Emission Control Service.*

DATE	ACTUAL MILEAGE	SERVICED BY:

## Maintenance Schedule I

### *48,000 Miles (80 000 km)*

- Change engine oil and filter (or every 3 months, whichever occurs first).  
*An Emission Control Service.*
- Lubricate the suspension and steering linkage, transaxle shift linkage, parking brake cable guides and the underbody contact points and linkage (or every 6 months, whichever occurs first).

DATE	ACTUAL MILEAGE	SERVICED BY:

### *50,000 Miles (83 000 km)*

- Change automatic transaxle fluid and filter if the vehicle is mainly driven under one or more of these conditions:
  - In heavy city traffic where the outside temperature regularly reaches 90°F (32°C) or higher.
  - In hilly or mountainous terrain.
  - When doing frequent trailer towing.
  - Uses such as found in taxi, police or delivery service.

*If you do not use your vehicle under any of these conditions, the fluid and filter do not require changing.*

DATE	ACTUAL MILEAGE	SERVICED BY:



## Maintenance Schedule I

### 51,000 Miles (85 000 km)

- Change engine oil and filter (or every 3 months, whichever occurs first).

*An Emission Control Service.*

DATE	ACTUAL MILEAGE	SERVICED BY:

### 54,000 Miles (90 000 km)

- Change engine oil and filter (or every 3 months, whichever occurs first).

*An Emission Control Service.*

- Lubricate the suspension and steering linkage, transaxle shift linkage, parking brake cable guides and the underbody contact points and linkage (or every 6 months, whichever occurs first).

- Rotate tires. See "Tire Inspection and Rotation" in the Index for proper rotation pattern and additional information.

DATE	ACTUAL MILEAGE	SERVICED BY:

## Maintenance Schedule I

### 57,000 Miles (95 000 km)

- Change engine oil and filter (or every 3 months, whichever occurs first).

*An Emission Control Service.*

### 60,000 Miles (100 000 km)

- Change engine oil and filter (or every 3 months, whichever occurs first).

*An Emission Control Service.*

- Lubricate the suspension and steering linkage, transaxle shift linkage, parking brake cable guides and the underbody contact points and linkage (or every 6 months, whichever occurs first).

- Inspect engine accessory drive belt (or every 24 months, whichever occurs first).

*An Emission Control Service.*

*(Continued)*

DATE	ACTUAL MILEAGE	SERVICED BY:

## Maintenance Schedule I

### 60,000 Miles (100 000 km) (Continued)

- Drain, flush and refill cooling system (or every 24 months, whichever occurs first). See "Engine Coolant" in the Index for what to use. Inspect hoses. Clean radiator, condenser, pressure cap and neck. Pressure test the cooling system and pressure cap.

*An Emission Control Service.*

- Replace spark plugs. *An Emission Control Service.*
- Inspect spark plug wires. *An Emission Control Service. †*
- Replace air cleaner filter. Replace filter more often under dusty conditions. *An Emission Control Service.*

- Inspect fuel tank, cap and lines for damage or leaks. Inspect fuel cap gasket for any damage. Replace parts as needed.

*An Emission Control Service. †*

- For supercharged engines only: Check the supercharger oil level and add oil as needed (or every 36 months, whichever occurs first). See "Recommended Fluids and Lubricants" in this section.

*An Emission Control Service. †*

DATE	ACTUAL MILEAGE	SERVICED BY:

## Maintenance Schedule I

### 63,000 Miles (105 000 km)

- Change engine oil and filter (or every 3 months, whichever occurs first).

*An Emission Control Service.*

DATE	ACTUAL MILEAGE	SERVICED BY:

### 66,000 Miles (110 000 km)

- Change engine oil and filter (or every 3 months, whichever occurs first).  
*An Emission Control Service.*
- Lubricate the suspension and steering linkage, transaxle shift linkage, parking brake cable guides and the underbody contact points and linkage (or every 6 months, whichever occurs first).
- Rotate tires. See "Tire Inspection and Rotation" in the Index for proper rotation pattern and additional information.

DATE	ACTUAL MILEAGE	SERVICED BY:

## Maintenance Schedule I

### *69,000 Miles (115 000 km)*

- Change engine oil and filter (or every 3 months, whichever occurs first).

*An Emission Control Service.*

### *72,000 Miles (120 000 km)*

- Change engine oil and filter (or every 3 months, whichever occurs first).  
*An Emission Control Service.*
- Lubricate the suspension and steering linkage, transaxle shift linkage, parking brake cable guides and the underbody contact points and linkage (or every 6 months, whichever occurs first).

DATE	ACTUAL MILEAGE	SERVICED BY:

DATE	ACTUAL MILEAGE	SERVICED BY:

## Maintenance Schedule I

### 75,000 Miles (125 000 km)

- Change engine oil and filter (or every 3 months, whichever occurs first).  
*An Emission Control Service.*
- Inspect air cleaner filter if you are driving in dusty conditions. Replace filter if necessary. *An Emission Control Service.*

DATE	ACTUAL MILEAGE	SERVICED BY:

### 78,000 Miles (130 000 km)

- Change engine oil and filter (or every 3 months, whichever occurs first).  
*An Emission Control Service.*
- Lubricate the suspension and steering linkage, transaxle shift linkage, parking brake cable guides and the underbody contact points and linkage (or every 6 months, whichever occurs first).
- Rotate tires. See "Tire Inspection and Rotation" in the Index for proper rotation pattern and additional information.

DATE	ACTUAL MILEAGE	SERVICED BY:

## Maintenance Schedule I

### *81,000 Miles (135 000 km)*

- Change engine oil and filter (or every 3 months, whichever occurs first).

*An Emission Control Service.*

### *84,000 Miles (140 000 km)*

- Change engine oil and filter (or every 3 months, whichever occurs first).

*An Emission Control Service.*

- Lubricate the suspension and steering linkage, transaxle shift linkage, parking brake cable guides and the underbody contact points and linkage (or every 6 months, whichever occurs first).

DATE	ACTUAL MILEAGE	SERVICED BY:

DATE	ACTUAL MILEAGE	SERVICED BY:

## Maintenance Schedule I

### 87,000 Miles (145 000 km)

- Change engine oil and filter (or every 3 months, whichever occurs first).

*An Emission Control Service.*

### 90,000 Miles (150 000 km)

- Change engine oil and filter (or every 3 months, whichever occurs first).  
*An Emission Control Service. \**
- Lubricate the suspension and steering linkage, transaxle shift linkage, parking brake cable guides and the underbody contact points and linkage (or every 6 months, whichever occurs first).
- Inspect engine accessory drive belt (or every 24 months, whichever occurs first).

*An Emission Control Service.*

*(Continued)*

DATE	ACTUAL MILEAGE	SERVICED BY:



## Maintenance Schedule I

### 90,000 Miles (150 000 km) (Continued)

- Drain, flush and refill cooling system (or every 24 months, whichever occurs first). See "Engine Coolant" in the Index for what to use. Inspect hoses. Clean radiator, condenser, pressure cap and neck. Pressure test the cooling system and pressure cap.  
*An Emission Control Service.*
- Replace spark plugs. *An Emission Control Service.*
- Inspect spark plug wires. *An Emission Control Service. †*
- Replace air cleaner filter. Replace filter more often under dusty conditions.  
*An Emission Control Service.*
- Inspect fuel tank, cap and lines for damage or leaks. Inspect fuel cap gasket for any damage. Replace parts as needed.  
*An Emission Control Service. †*

- For supercharged engines only: Check the supercharger oil level and add oil as needed (or every 36 months, whichever occurs first). See "Recommended Fluids and Lubricants" in this section.  
*An Emission Control Service. †*
- Rotate tires. See "Tire Inspection and Rotation" in the Index for proper rotation pattern and additional information.

DATE	ACTUAL MILEAGE	SERVICED BY:

## Maintenance Schedule I

### *93,000 Miles (155 000 km)*

- Change engine oil and filter (or every 3 months, whichever occurs first).  
*An Emission Control Service.*

DATE	ACTUAL MILEAGE	SERVICED BY:

### *96,000 Miles (160 000 km)*

- Change engine oil and filter (or every 3 months, whichever occurs first).  
*An Emission Control Service.*
- Lubricate the suspension and steering linkage, transaxle shift linkage, parking brake cable guides and the underbody contact points and linkage (or every 6 months, whichever occurs first).

DATE	ACTUAL MILEAGE	SERVICED BY:

## Maintenance Schedule I

### 99,000 Miles (165 000 km)

- Change engine oil and filter (or every 3 months, whichever occurs first).

*An Emission Control Service.*

DATE	ACTUAL MILEAGE	SERVICED BY:

### 100,000 Miles (166 000 km)

- Change automatic transaxle fluid and filter if the vehicle is mainly driven under one or more of these conditions:

- In heavy city traffic where the outside temperature regularly reaches 90°F (32°C) or higher.
- In hilly or mountainous terrain.
- When doing frequent trailer towing.
- Uses such as found in taxi, police or delivery service.

*If you do not use your vehicle under any of these conditions, the fluid and filter do not require changing.*

DATE	ACTUAL MILEAGE	SERVICED BY:

## Maintenance Schedule II

The services shown in this schedule up to 100,000 miles (166 000 km) should be performed after 100,000 miles (166 000 km) at the same intervals.

### Footnotes

† The U.S. Environmental Protection Agency or the California Air Resources Board has determined that the failure to perform this maintenance item will not nullify the emission warranty or limit recall liability prior to the completion of vehicle useful life. We, however, urge that all recommended maintenance services be performed at the indicated intervals and the maintenance be recorded.

### 7,500 Miles (12 500 km)

- Change engine oil and filter (or every 12 months, whichever occurs first).  
*An Emission Control Service.*
- Lubricate the suspension and steering linkage, transaxle shift linkage, parking brake cable guides and the underbody contact points and linkage (or every 12 months, whichever occurs first).
- Rotate tires. See "Tire Inspection and Rotation" in the Index for proper rotation pattern and additional information.

DATE	ACTUAL MILEAGE	SERVICED BY:

## Maintenance Schedule II

### 15,000 Miles (25 000 km)

- Change engine oil and filter (or every 12 months, whichever occurs first).  
*An Emission Control Service.*
- Lubricate the suspension and steering linkage, transaxle shift linkage, parking brake cable guides and the underbody contact points and linkage (or every 12 months, whichever occurs first).

DATE	ACTUAL MILEAGE	SERVICED BY:

### 22,500 Miles (37 500 km)

- Change engine oil and filter (or every 12 months, whichever occurs first).  
*An Emission Control Service.*
- Lubricate the suspension and steering linkage, transaxle shift linkage, parking brake cable guides and the underbody contact points and linkage (or every 12 months, whichever occurs first).
- Rotate tires. See "Tire Inspection and Rotation" in the Index for proper rotation pattern and additional information.

DATE	ACTUAL MILEAGE	SERVICED BY:

## Maintenance Schedule II

### 30,000 Miles (50 000 km)

- Change engine oil and filter (or every 12 months, whichever occurs first).  
*An Emission Control Service.*
- Lubricate the suspension and steering linkage, transaxle shift linkage, parking brake cable guides and the underbody contact points and linkage (or every 12 months, whichever occurs first).
- Inspect engine accessory drive belt (or every 24 months, whichever occurs first).  
*An Emission Control Service.*
- Drain, flush and refill cooling system (or every 24 months, whichever occurs first). See "Engine Coolant" in the Index for what to use. Inspect hoses. Clean radiator, condenser, pressure cap and neck. Pressure test the cooling system and pressure cap.  
*An Emission Control Service.*
- Replace spark plugs. *An Emission Control Service.*

- Inspect spark plug wires. *An Emission Control Service.* †
- Replace air cleaner filter. *An Emission Control Service.*
- Inspect fuel tank, cap and lines for damage or leaks. Inspect fuel cap gasket for any damage. Replace parts as needed.  
*An Emission Control Service.* †
- For supercharged engines only: Check the supercharger oil level and add oil as needed (or every 36 months, whichever occurs first). See "Recommended Fluids and Lubricants" in this section. *An Emission Control Service.* †

DATE	ACTUAL MILEAGE	SERVICED BY:

## Maintenance Schedule II

### 37,500 Miles (62 500 km)

- Change engine oil and filter (or every 12 months, whichever occurs first).  
*An Emission Control Service.*
- Lubricate the suspension and steering linkage, transaxle shift linkage, parking brake cable guides and the underbody contact points and linkage (or every 12 months, whichever occurs first).
- Rotate tires. See "Tire Inspection and Rotation" in the Index for proper rotation pattern and additional information.

DATE	ACTUAL MILEAGE	SERVICED BY:

### 45,000 Miles (75 000 km)

- Change engine oil and filter (or every 12 months, whichever occurs first).  
*An Emission Control Service.*
- Lubricate the suspension and steering linkage, transaxle shift linkage, parking brake cable guides and the underbody contact points and linkage (or every 12 months, whichever occurs first).

DATE	ACTUAL MILEAGE	SERVICED BY:

## Maintenance Schedule II

### 50,000 Miles (83 000 km)

- Change automatic transaxle fluid and filter if the vehicle is mainly driven under one or more of these conditions:
  - In heavy city traffic where the outside temperature regularly reaches 90°F (32°C) or higher.
  - In hilly or mountainous terrain.
  - When doing frequent trailer towing.
  - Uses such as found in taxi, police or delivery service.

*If you do not use your vehicle under any of these conditions, the fluid and filter do not require changing.*

DATE	ACTUAL MILEAGE	SERVICED BY:

### 52,500 Miles (87 500 km)

- Change engine oil and filter (or every 12 months, whichever occurs first).  
*An Emission Control Service.*
- Lubricate the suspension and steering linkage, transaxle shift linkage, parking brake cable guides and the underbody contact points and linkage (or every 12 months, whichever occurs first).
- Rotate tires. See “Tire Inspection and Rotation” in the Index for proper rotation pattern and additional information.

DATE	ACTUAL MILEAGE	SERVICED BY:



## Maintenance Schedule II

### 60,000 Miles (100 000 km)

- Change engine oil and filter (or every 12 months, whichever occurs first).  
*An Emission Control Service.*
- Lubricate the suspension and steering linkage, transaxle shift linkage, parking brake cable guides and the underbody contact points and linkage (or every 12 months, whichever occurs first).
- For supercharged engines only: Check the supercharger oil level and add oil as needed (or every 36 months, whichever occurs first). See "Recommended Fluids and Lubricants" in this section.  
*An Emission Control Service. †*
- Inspect engine accessory drive belt (or every 24 months, whichever occurs first).  
*An Emission Control Service.*
- Drain, flush and refill cooling system (or every 24 months, whichever occurs first). See "Engine Coolant" in the Index for what to use. Inspect hoses. Clean radiator, condenser, pressure cap and neck. Pressure test the cooling system and pressure cap.  
*An Emission Control Service.*
- Replace spark plugs. *An Emission Control Service.*
- Inspect spark plug wires. *An Emission Control Service. †*
- Replace air cleaner filter. *An Emission Control Service.*

## Maintenance Schedule II

- Inspect fuel tank, cap and lines for damage or leaks. Inspect fuel cap gasket for any damage. Replace parts as needed.  
*An Emission Control Service. †*

DATE	ACTUAL MILEAGE	SERVICED BY:

### 67,500 Miles (112 500 km)

- Change engine oil and filter (or every 12 months, whichever occurs first).  
*An Emission Control Service.*
- Lubricate the suspension and steering linkage, transaxle shift linkage, parking brake cable guides and the underbody contact points and linkage (or every 12 months, whichever occurs first).
- Rotate tires. See "Tire Inspection and Rotation" in the Index for proper rotation pattern and additional information.

DATE	ACTUAL MILEAGE	SERVICED BY:

## Maintenance Schedule II

### 75,000 Miles (125 000 km)

- Change engine oil and filter (or every 12 months, whichever occurs first).  
*An Emission Control Service.*
- Lubricate the suspension and steering linkage, transaxle shift linkage, parking brake cable guides and the underbody contact points and linkage (or every 12 months, whichever occurs first).

DATE	ACTUAL MILEAGE	SERVICED BY:

### 82,500 Miles (137 500 km)

- Change engine oil and filter (or every 12 months, whichever occurs first).  
*An Emission Control Service.*
- Lubricate the suspension and steering linkage, transaxle shift linkage, parking brake cable guides and the underbody contact points and linkage (or every 12 months, whichever occurs first).
- Rotate tires. See "Tire Inspection and Rotation" in the Index for proper rotation pattern and additional information.

DATE	ACTUAL MILEAGE	SERVICED BY:

## Maintenance Schedule II

### 90,000 Miles (150 000 km)

- Change engine oil and filter (or every 12 months, whichever occurs first).  
*An Emission Control Service.*
- Lubricate the suspension and steering linkage, transaxle shift linkage, parking brake cable guides and the underbody contact points and linkage (or every 12 months, whichever occurs first).
- Inspect engine accessory drive belt (or every 24 months, whichever occurs first).  
*An Emission Control Service.*
- Drain, flush and refill cooling system (or every 24 months, whichever occurs first). See "Engine Coolant" in the Index for what to use. Inspect hoses. Clean radiator, condenser, pressure cap and neck. Pressure test the cooling system and pressure cap.  
*An Emission Control Service.*
- Replace spark plugs. *An Emission Control Service.*
- Inspect spark plug wires. *An Emission Control Service.* †
- Replace air cleaner filter. *An Emission Control Service.*
- Inspect fuel tank, cap and lines for damage or leaks. Inspect fuel cap gasket for any damage. Replace parts as needed. *An Emission Control Service.* †
- For supercharged engines only: Check the supercharger oil level and add oil as needed (or every 36 months, whichever occurs first). See "Recommended Fluids and Lubricants" in this section. *An Emission Control Service.* †

DATE	ACTUAL MILEAGE	SERVICED BY:

## Maintenance Schedule II

### 97,500 Miles (162 500 km)

- Change engine oil and filter (or every 12 months, whichever occurs first).  
*An Emission Control Service.*
- Lubricate the suspension and steering linkage, transaxle shift linkage, parking brake cable guides and the underbody contact points and linkage (or every 12 months, whichever occurs first).
- Rotate tires. See "Tire Inspection and Rotation" in the Index for proper rotation pattern and additional information.

DATE	ACTUAL MILEAGE	SERVICED BY:

### 100,000 Miles (166 000 km)

- Change automatic transaxle fluid and filter if the vehicle is mainly driven under one or more of these conditions:
  - In heavy city traffic where the outside temperature regularly reaches 90°F (32°C) or higher.
  - In hilly or mountainous terrain.
  - When doing frequent trailer towing.
  - Uses such as found in taxi, police or delivery service.

*If you do not use your vehicle under any of these conditions, the fluid and filter do not require changing.*

DATE	ACTUAL MILEAGE	SERVICED BY:

## **Part B: Owner Checks and Services**

Listed below are owner checks and services which should be performed at the intervals specified to help ensure the safety, dependability and emission control performance of your vehicle.

Be sure any necessary repairs are completed at once. Whenever any fluids or lubricants are added to your vehicle, make sure they are the proper ones, as shown in Part D.

### **At Each Fuel Fill**

*It is important for you or a service station attendant to perform these underhood checks at each fuel fill.*

#### **Engine Oil Level**

Check the engine oil level and add the proper oil if necessary. See "Engine Oil" in the Index for further details.

#### **Engine Coolant Level**

Check the engine coolant level and add the proper coolant mix if necessary. See "Coolant" in the Index for further details.

#### **Windshield Washer Fluid Level**

Check the windshield washer fluid level in the windshield washer tank and add the proper fluid if necessary. See "Windshield Washer Fluid" in the Index for further details.

### **At Least Once a Month**

#### **Tire Inflation**

Check tire inflation. Make sure tires are inflated to the pressures specified on the Tire-Loading Information label located on the rear edge of the driver's door. See "Tires" in the Index for further details.

#### **Cassette Deck**

Clean cassette deck. Cleaning should be done every 50 hours of tape play. See "Audio Systems" in the Index for further details.

#### **Power Antenna**

Clean power antenna mast. See "Audio Systems" in the Index for further details.

## At Least Once a Year

### Key Lock Cylinders

Lubricate the key lock cylinders with the lubricant specified in Part D.

### Body Lubrication

Lubricate all body door hinges. Also lubricate all hinges and latches, including those for the hood, glove box door, console door and any folding seat hardware. Part D tells you what to use. More frequent lubrication may be required when exposed to a corrosive environment.

### Starter Switch

 **CAUTION:**

**When you are doing this check, the vehicle could move suddenly. If it does, you or others could be injured. Follow the steps below.**

1. Before you start, be sure you have enough room around the vehicle.

2. Firmly apply both the parking brake (see "Parking Brake" in the Index if necessary) and the regular brake.

NOTE: Do not use the accelerator pedal, and be ready to turn off the engine immediately if it starts.

3. Try to start the engine in each gear. The starter should work only in PARK (P) or NEUTRAL (N). If the starter works in any other position, your vehicle needs service.

### Brake-Transaxle Shift Interlock -- BTSI

 **CAUTION:**

**When you are doing this check, the vehicle could move suddenly. If it does, you or others could be injured. Follow the steps below.**

1. Before you start, be sure you have enough room around the vehicle. It should be parked on a level surface.
2. Firmly apply the parking brake (see "Parking Brake" in the Index if necessary).

NOTE: Be ready to apply the regular brake immediately if the vehicle begins to move.

3. With the engine off, turn the key to the RUN position, but don't start the engine. Without applying the regular brake, try to move the shift lever out of PARK (P) with normal effort. If the shift lever moves out of PARK (P), your vehicle's BTSI needs service.

### Steering Column Lock

While parked, and with the parking brake set, try to turn the key to LOCK in each shift lever position.

- The key should turn to LOCK only when the shift lever is in PARK (P).
- The key should come out only in LOCK.

### Parking Brake and Automatic Transaxle PARK (P) Mechanism Check



#### CAUTION:

When you are doing this check, your vehicle could begin to move. You or others could be injured and property could be damaged. Make sure there is room in front of your vehicle in case it begins to roll. Be ready to apply the regular brake at once should the vehicle begin to move.

Park on a fairly steep hill, with the vehicle facing downhill. Keeping your foot on the regular brake, set the parking brake.

- To check the parking brake: With the engine running and transaxle in NEUTRAL (N), slowly remove foot pressure from the regular brake pedal. Do this until the vehicle is held by the parking brake only.
- To check the PARK (P) mechanism's holding ability: Shift to PARK (P). Then release all brakes.

### Underbody Flushing

At least every spring, use plain water to flush any corrosive materials from the underbody. Take care to clean thoroughly any areas where mud and other debris can collect.



## **Part C: Periodic Maintenance Inspections**

Listed below are inspections and services which should be performed at least twice a year (for instance, each spring and fall). You should let your GM dealer's service department or other qualified service center do these jobs. Make sure any necessary repairs are completed at once.

### **Restraint Systems**

Now and then, make sure all your belts, buckles, latch plates, retractors, anchorages and reminder systems are working properly. Look for any loose parts or damage. If you see anything that might keep a restraint system from doing its job, have it repaired.

### **Steering, Suspension and Front-Wheel-Drive Axle Boot and Seal Inspection**

Inspect the front and rear suspension and steering system for damaged, loose or missing parts, signs of wear, or lack of lubrication. Inspect the power steering lines and hoses for proper hookup, binding, leaks, cracks, chafing, etc. Clean and then inspect the drive axle boot seals for damage, tears or leakage. Replace seals if necessary.

### **Exhaust System Inspection**

Inspect the complete exhaust system. Inspect the body near the exhaust system. Look for broken, damaged, missing or out-of-position parts as well as open seams, holes, loose connections, or other conditions which could cause a heat build-up in the floor pan or could let exhaust fumes into the vehicle. See "Engine Exhaust" in the Index.

### **Throttle Linkage Inspection**

Inspect the throttle linkage for interference or binding, and for damaged or missing parts. Replace parts as needed. Accelerator and cruise control cables should not be lubricated.

### **Brake System Inspection**

Inspect the complete system. Inspect brake lines and hoses for proper hookup, binding, leaks, cracks, chafing, etc. Inspect disc brake pads for wear and rotors for surface condition. Inspect other brake parts, including calipers, parking brake, etc. You may need to have your brakes inspected more often if your driving habits or conditions result in frequent braking.

## Part D: Recommended Fluids and Lubricants

NOTE: Fluids and lubricants identified below by name, part number or specification may be obtained from your GM dealer.

USAGE	FLUID/LUBRICANT
Engine Oil	Engine oil with the American Petroleum Institute Certified For Gasoline Engines "Starburst" symbol of the proper viscosity. To determine the preferred viscosity for your vehicle's engine, see "Engine Oil" in the Index.
Engine Coolant	50/50 mixture of water (preferably distilled) and good quality ethylene glycol base antifreeze (GM Part No. 1052753 or equivalent) conforming to GM Specification 1825M or approved recycled coolant conforming to GM Specification 1825M.

USAGE	FLUID/LUBRICANT
Coolant Supplement	GM Part No. 3634621 or equivalent with a complete flush and refill.
Hydraulic Brake System	Delco Supreme 11 <sup>®</sup> Brake Fluid (GM Part No. 1052535 or equivalent DOT-3 brake fluid).
Parking Brake Guides	Chassis lubricant (GM Part No. 1052497 or equivalent) or lubricant meeting requirements of NLGI Grade 2, Category LB or GC-LB.
Power Steering System	GM Hydraulic Power Steering Fluid (GM Part No. 1052884 or equivalent).
Automatic Transaxle	DEXRON <sup>®</sup> -III Automatic Transmission Fluid.
Key Lock Cylinders	Lubricate with Multi-Purpose Lubricant (GM Part No. 12345120) or synthetic SAE 5W-30 engine oil.

USAGE	FLUID/LUBRICANT
Supercharger	Supercharger Oil (GM Part No. 12345982). See "Supercharger Oil" in the Index.
Automatic Transaxle Shift Linkage	Engine oil.
Chassis Lubrication	Chassis lubricant (GM Part No. 1052497 or equivalent) or lubricant meeting requirements of NLGI Grade 2, Category LB or GC-LB.
Windshield Washer Solvent	GM Optikleen <sup>®</sup> Washer Solvent (GM Part No. 1051515) or equivalent.

USAGE	FLUID/LUBRICANT
Hood Latch Assembly	
a. Pivots and Spring Anchor	a. Engine oil.
b. Release Pawl	b. Chassis lubricant (GM Part No. 1052497 or equivalent) or lubricant meeting requirements of NLGI Grade 2, Category LB or GC-LB.
Hood and Door Hinges	Engine oil or Lubriplate Lubricant (GM Part No. 1050109).
Weatherstrip Conditioning	Dielectric Silicone Grease (GM Part No. 12345579 or equivalent).

See "Specifications Chart" in the Index for recommended replacement filters, valves and spark plugs.

## Part E: Maintenance Record

After the scheduled services are performed, record the date, odometer reading and who performed the service in the boxes provided after the maintenance interval. Any additional information from “Owner Checks and

Services” or “Periodic Maintenance” can be added on the following record pages. Also, you should retain all maintenance receipts. Your owner information portfolio is a convenient place to store them.

<b>Maintenance Record</b>			
<b>DATE</b>	<b>ODOMETER READING</b>	<b>SERVICED BY</b>	<b>MAINTENANCE PERFORMED</b>





## Section 8 Customer Assistance Information

Here you will find out how to contact Buick if you need assistance. This section also tells you how to obtain service publications and how to report any safety defects. This section includes information on: Customer Satisfaction Procedure, Customer Assistance for Hearing or Speech Impaired, BBB Auto Line -- Alternative Dispute Resolution Program, Reporting Safety Defects, Roadside Assistance, and Service and Owner Publications.

### Customer Satisfaction Procedure

Your satisfaction and goodwill are important to your dealer and Buick. Normally, any concern with the sales transaction or the operation of your vehicle will be resolved by your dealer's Sales or Service Departments. Sometimes, however, despite the best intentions of all concerned, misunderstandings can occur. If your concern has not been resolved to your satisfaction, the following steps should be taken:

**STEP ONE** -- Discuss your concern with a member of dealership management. Normally, concerns can often be quickly resolved at that level. If the matter has already been reviewed with the Sales, Service, or Parts Manager, contact the owner of the dealership or the General Manager.

**STEP TWO** -- If after contacting a member of dealership management, it appears your concern cannot be resolved by the dealership without further help, contact the Buick Customer Assistance Center by calling 1-800-521-7300. In Canada, contact GM of Canada Customer Assistance Center in Oshawa by calling 1-800-263-3777 (English) or 1-800-263-7854 (French).

In Mexico, call (525) 254-3777. In Puerto Rico, call 1-800-496-9992 (English) or 1-800-496-9993 (Spanish). In the U.S. Virgin Islands, call 1-800-496-9994. In all other overseas locations, contact GM North American Export Sales in Canada by calling 1-905-644-4112.

For prompt assistance, please have the following information available to give the Customer Assistance Representative:

- Your name, address, home and business telephone numbers
- Vehicle Identification Number (This is available from the vehicle registration or title, or the plate at the left top of the instrument panel and visible through the windshield.)
- Dealership name and location
- Vehicle delivery date and present mileage
- Nature of concern

We encourage you to call the toll-free number listed previously in order to give your inquiry prompt attention. However, if you wish to write Buick, write to:

Buick Motor Division  
Customer Assistance Center  
902 E. Hamilton Avenue  
Flint, MI 48550

Refer to your Warranty and Owner Assistance Information booklet for addresses of Canadian and GM Overseas offices.

When contacting Buick, please remember that your concern will likely be resolved in the dealership, using the dealership's facilities, equipment and personnel. That is why we suggest you follow Step One first if you have a concern.

## **Customer Assistance for the Hearing or Speech Impaired (TDD)**

To assist customers who have hearing difficulties, Buick has installed special TDD (Telecommunication Devices for the Deaf) equipment at its Customer Assistance Center. Any hearing or speech impaired customer who has access to a TDD or a conventional teletypewriter (TTY) can communicate with Buick by dialing: 1-800-TD-BUICK. (TDD users in Canada can dial 1-800-263-3830.)

## **GM Participation in BBB AUTO LINE -- Alternative Dispute Resolution Program\***

\*This program may not be available in all states, depending on state law. Canadian owners refer to your Warranty and Owner Assistance Information booklet. General Motors reserves the right to change eligibility limitations and/or to discontinue its participation in this program.

Both Buick and your Buick dealer are committed to making sure you are completely satisfied with your new vehicle. Our experience has shown that, if a situation arises where you feel your concern has not been adequately addressed, the Customer Satisfaction Procedure described earlier in this section is very successful.

There may be instances where an impartial third-party can assist in arriving at a solution to a disagreement regarding vehicle repairs or interpretation of the New Vehicle Limited Warranty. To assist in resolving these disagreements Buick voluntarily participates in BBB AUTO LINE.

BBB AUTO LINE is an out-of-court program administered by the Better Business Bureau system to settle disputes between customers and automobile manufacturers. This program is available free of charge to customers who currently own or lease a GM vehicle.

If you are not satisfied after following the Customer Satisfaction Procedure, you may contact the BBB using the toll-free telephone number, or write them at the following address:

BBB AUTO LINE  
Council of Better Business Bureaus  
4200 Wilson Boulevard  
Suite 800  
Arlington, VA 22203  
Telephone: 1-800-955-5100

To file a claim, you will be asked to provide your name and address, your Vehicle Identification Number (VIN), and a statement of the nature of your complaint. Eligibility is limited by vehicle age and mileage, and other factors.



We prefer you utilize the Customer Satisfaction Procedure before you resort to AUTO LINE, but you may contact the BBB at any time. The BBB will attempt to resolve the complaint serving as an intermediary between you and Buick. If this mediation is unsuccessful, an informal hearing will be scheduled where eligible customers may present their case to an impartial third-party arbitrator.

The arbitrator will make a decision which you may accept or reject. If you accept the decision, GM will be bound by that decision. The entire dispute resolution procedure should ordinarily take about forty days from the time you file a claim until a decision is made.

Some state laws may require you to use this program before filing a claim with a state-run arbitration program or in the courts. For further information, contact the BBB at 1-800-955-5100 or the Buick Customer Assistance Center at 1-800-521-7300.

## **REPORTING SAFETY DEFECTS TO THE UNITED STATES GOVERNMENT**

If you believe that your vehicle has a defect which could cause a crash or could cause injury or death, you should immediately inform the National Highway Traffic Safety Administration (NHTSA), in addition to notifying General Motors.

If NHTSA receives similar complaints, it may open an investigation, and if it finds that a safety defect exists in a group of vehicles, it may order a recall and remedy campaign. However, NHTSA cannot become involved in individual problems between you, your dealer, or General Motors.

To contact NHTSA, you may either call the Auto Safety Hotline toll-free at 1-800-424-9393 (or 366-0123 in the Washington, D.C. area) or write to:

NHTSA, U.S. Department of Transportation  
Washington, D.C. 20590

You can also obtain other information about motor vehicle safety from the Hotline.

## REPORTING SAFETY DEFECTS TO THE CANADIAN GOVERNMENT

If you live in Canada, and you believe that your vehicle has a safety defect, you should immediately notify Transport Canada, in addition to notifying General Motors of Canada Limited. You may write to:

Transport Canada  
Box 8880  
Ottawa, Ontario K1G 3J2

## REPORTING SAFETY DEFECTS TO GENERAL MOTORS

In addition to notifying NHTSA (or Transport Canada) in a situation like this, we certainly hope you'll notify us. Please call us at 1-800-521-7300, or write:

Buick Motor Division  
Customer Assistance Center  
902 E. Hamilton Avenue  
Flint, MI 48550

In Canada, please call us at 1-800-263-3777 (English) or 1-800-263-7854 (French). Or, write:

General Motors of Canada Limited  
Customer Assistance Center  
1908 Colonel Sam Drive  
Oshawa, Ontario L1H 8P7

## Courtesy Transportation

To Buick Motor Division, Quality Means Service -- and service means "keeping you on the road."

Included with your 1995 Buick new car warranty, (36 months or 36,000 miles), is Courtesy Transportation, a program which will provide Buick retail customers with:

- Reimbursement toward a loaner vehicle, courtesy of Buick Motor Division, for up to five days for vehicles requiring overnight warranty repairs. Also, reimbursement up to \$30 a day (five days maximum) may be available for the cost of a rental car, bus or even a cab.
- A free one-way shuttle ride up to 10 miles from the dealership is available for customers whose vehicles require same-day warranty repairs.

Courtesy Transportation is Buick's way of extending the Premium Service you've come to expect from Buick and its 3,000 dealers. Please review the Courtesy Transportation glove box card contained in your vehicle, or consult your Buick dealer for details.

**In Canada**, please consult your GM dealer for information on Courtesy Transportation.

## Roadside Assistance

Buick Motor Division is proud to offer Buick Roadside Assistance to customers for vehicles covered under the 36 month/36,000 mile new car warranty (whichever comes first).

Our commitment to Buick owners has always included superior service through our network of 3,000 Buick dealers. Buick Roadside Assistance provides an extra measure of convenience and security.

Buick Roadside Assistance:

- Provides owners with access to minor repairs or towing for disabled vehicles.
- Takes the anxiety out of uncertain situations by providing easy access to service professionals trained to work with Buick owners, 24 hours a day, 365 days a year, including weekends and holidays.

For details on Buick Roadside Assistance, please consult your Buick Roadside Assistance owner booklet included with your owner's manual. For needed assistance, call the Buick Roadside Assistance toll-free hotline: 1-800-252-1112.

## Canada Roadside Assistance

Vehicles purchased in Canada have an extensive Roadside Assistance program accessible from anywhere in Canada or the United States. Please refer to the separate brochure provided by the dealer or call 1-800-268-6800 for emergency services.

## Service and Owner Publications

Service manuals, service bulletins, owner's manuals and other service literature are available for purchase for all current and many past model General Motors vehicles.

Toll-free telephone numbers for ordering information:

United States 1-800-551-4123

Canada 1-800-668-5539

## **Service Manuals**

Service manuals contain diagnostic and repair information for all chassis and body systems. They may be useful for owners who wish to get a greater understanding of their vehicle. They are also useful for owners with the appropriate skill level or training who wish to perform "do-it-yourself" service. These are authentic General Motors service manuals meant for professional, qualified technicians.

## **Service Bulletins**

Service bulletins covering various subjects are regularly sent to all General Motors dealerships/retail facilities. GM monitors product performance in the field. When service methods are found which promote better service on GM vehicles, bulletins are created to help the technician perform better service. Service bulletins may

involve any number of vehicles. Some will describe inexpensive service, others will describe expensive service. Some will advise new or unexpected conditions, and others may help avoid future costly repairs. An important reminder ... service bulletins are meant for qualified technicians. Since these bulletins are issued throughout the model year and beyond, an index is required and published quarterly to help identify specific bulletins. Subscriptions are available. You can order an index at the toll-free numbers listed previously, or ask a GM dealer/retailer to see an index or individual bulletin.

## **Owner Publications**

Owner's manuals, warranty folders and various owner assistance booklets provide owners with general operation and maintenance information.





## Section 9 Index

- A**dding
- Automatic Transaxle Fluid ..... 6-21
  - Brake Fluid ..... 6-27
  - Electrical Equipment ..... 2-17, 3-19, 6-53
  - Engine Coolant ..... 6-23
  - Engine Oil ..... 6-13
  - Power Steering Fluid ..... 6-25
  - Sound Equipment ..... 3-19
  - Supercharger Oil ..... 6-18
  - Windshield Washer Fluid ..... 2-35, 6-25
- Aiming, Headlamp ..... 6-33
- Air Bag
- How Does it Restrain ..... 1-22
  - How it Works ..... 1-20
  - Location ..... 1-20
  - Readiness Light ..... 1-19, 2-57
  - Servicing ..... 1-23
  - What Makes it Inflate ..... 1-21
  - What Will You See After it Inflates ..... 1-22
  - When Should it Inflate ..... 1-21
- Air Cleaner ..... 6-16
- Air Conditioning ..... 3-3
- Air Outlets ..... 3-1
- Alarm, Universal Theft Deterrent ..... 2-11
- Alignment and Balance, Tires ..... 6-43
- Aluminum Wheels, Cleaning ..... 6-50
- Antenna, Power Mast Care ..... 3-21
- Antifreeze ..... 6-21
- Adding ..... 6-23
  - Checking ..... 6-22
- Anti-Lock Brakes ..... 4-6
- Anti-Lock Brake System Warning Light ..... 2-59, 4-6
- Anti-Theft Feature, Delco-Loc II ..... 3-16
- Appearance Care ..... 6-45
- Appearance Care and Maintenance Materials ..... 6-52
- Ashtrays
- Front ..... 2-52
  - Rear ..... 2-53
- Astrorooft ..... 2-46
- Audio Systems ..... 3-5
- Automatic Door Locks ..... 2-4
- Automatic Inside Mirror ..... 2-43
- Automatic Transaxle ..... 2-19
- Automatic Overdrive Position ..... 2-21
  - First Gear (1) Position ..... 2-22
  - Neutral (N) Position ..... 2-20

Park (P) Position	2-19
Reverse (R) Position	2-20
Second Gear (2) Position	2-21
Shifting	2-19
Third Gear (3) Position	2-21
Automatic Transaxle Fluid	6-19
Adding	6-21
Checking	6-19
Auxiliary Power Receptacle	2-46

<b>B</b> attery	6-29
Light	2-58
Replacement, Remote Keyless Entry	2-8
Warnings	5-2, 5-3
BBB Auto Line	8-3
Belt, Engine Accessory (3800)	6-10
Belt, Engine Accessory (Supercharged 3800)	6-11
Blizzard	4-26
Brake	
Adjustment	6-28
Fluid, Adding	6-27
Master Cylinder	6-26
Parking	2-22
Pedal Travel	6-28
Shift Reminder Light	2-26
System Parts, Replacing	6-29
System Warning Light	2-58
Transaxle Shift Interlock	2-26, 7-38
Wear	6-28

Brakes, Anti-Lock	4-6
Brakes, Trailer	4-34
Braking	4-5
Braking, In Emergencies	4-9
Break-In, New Vehicle	2-14
BTSI (Brake-Transaxle Shift Interlock)	2-26, 7-38
Bulb Replacement	6-62
Headlamps	6-31
Taillamps	6-35

<b>C</b> anadian Roadside Assistance	8-6
Capacities and Specifications	6-63, 6-64
Carbon Monoxide	2-27, 4-27, 4-33
Cassette Tape Player Care	3-20
Center Passenger Position	1-25
Certification/Tire Label	4-28
Chains, Safety	4-34
Chains, Tire	6-44
Changing a Flat Tire	5-19
Check Oil Level Light	2-64
Checking	
Automatic Transaxle Fluid	6-19
Brake Fluid	6-27
Engine Coolant	6-22
Engine Oil	6-13
Power Steering Fluid	6-25
Restraint Systems	1-45
Things Under the Hood	6-8
Chemical Paint Spotting	6-51

Child Restraints .....	1-33	Console and Cupholder .....	2-54
Securing in a Rear Outside Seat Position .....	1-36	Console Shift Lever .....	2-25
Securing in the Center Rear Seat Position .....	1-37	Control of a Vehicle .....	4-5
Securing in the Right Front Seat Position .....	1-39	Control, Loss of .....	4-13
Top Strap .....	1-35	Convenience Net .....	2-45
Where to Put .....	1-33	Convex Outside Mirror .....	2-45
Cigarette Lighter .....	2-53	Coolant .....	6-21
Circuit Breaker, Power Windows and Other		Heater, Engine .....	2-18, 6-15
Power Options .....	6-54	How to Add to the Coolant Recovery Tank .....	5-14
Cleaner, Air .....	6-16	How to Add to the Radiator .....	5-16
Cleaning		Recovery Tank .....	5-14
Aluminum Wheels .....	6-50	Cooling System .....	5-12
Fabric .....	6-46	Courtesy Lamps .....	2-40
Glass .....	6-48	Courtesy Transportation .....	8-5
Inside of Your Buick .....	6-45	Cruise Control .....	2-35
Leather .....	6-48	Erasing Speed Memory .....	2-39
Outside of the Windshield and Wiper Blades .....	6-49	Getting Out of .....	2-39
Outside of Your Buick .....	6-49	Passing Another Vehicle While Using .....	2-39
Speaker Covers .....	6-48	To Increase Speed .....	2-38
Special Problems .....	6-47	To Reduce Speed .....	2-39
Stains .....	6-47	To Resume a Set Speed .....	2-37
Tires .....	6-51	To Set .....	2-36
Top of the Instrument Panel .....	6-48	Traction Control Activated .....	2-36
Vinyl .....	6-47	Use on Hills .....	2-39
Climate Control, Dual Automatic ComforTemp .....	3-2	Cupholder .....	2-54
Clock, Setting the .....	3-7, 3-9, 3-13	Customer Assistance for the Hearing or	
Comfort Controls .....	3-1	Speech Impaired .....	8-2
Compact Disc Player .....	3-11, 3-14	Customer Assistance Information .....	8-1
Compact Disc Player Care .....	3-21	Customer Satisfaction Procedure .....	8-1
Compact Spare Tire .....	5-26		



Damage, Finish	6-51
Damage, Sheet Metal	6-51
Daytime Running Lamps	2-41
Dead Battery	5-2
Defects, Reporting	8-4
Defensive Driving	4-1
Defogger, Rear Window	3-5
Defrosting	3-4
Delco-Loc II Anti-Theft Feature	3-16
Dimensions Chart	6-61
Door	
Ajar Light	2-63
Locks	2-3
Driver Position	1-11
Driving	
At Night	4-14
City	4-19
Defensive	4-1
Drunken	4-2
Freeway	4-20
In a Blizzard	4-26
In Foreign Countries	6-6
In the Rain	4-16
On Curves	4-9
On Grades	4-36
On Hill and Mountain Roads	4-22
On Snow and Ice	4-25
Through Deep Standing Water	2-17
Winter	4-24
With a Trailer	4-34

Drunken Driving	4-2
Dual Automatic ComforTemp Climate Control	3-2

<b>E</b> lectric Mirror Control	2-44
Electrical Equipment, Adding	2-17, 3-19, 6-53
Electronic Level Control	2-53
Engine	
Accessory Belt (3800)	6-10
Accessory Belt (Supercharged 3800)	6-11
Exhaust	2-27
Identification	6-53
Overheating	5-11
Running it While You're Parked	2-28
Starting	2-16
Supercharged	6-11
Engine Coolant	6-21
Adding	6-23
Checking	6-22
Heater	2-18, 6-15
Temperature Gage	2-61
Temperature Warning Light	2-61
Engine Oil	6-12
Adding	6-13
Additives	6-15
Checking	6-13
Pressure Light	2-63
What Kind to Use	6-14
What to do with Used Oil	6-16
When to Change	6-15

Ethanol (In Fuel)	6-3, 6-5
Exhaust, Engine	2-27
Expectant Mothers, Use of Safety Belts	1-24
Express Down Window	2-29
Extender, Safety Belt	1-45

<b>F</b> abric Cleaning	6-46
Filling Your Tank	6-6
Finish Care	6-50
Finish Damage	6-51
First Gear (1)	2-22
Flash-To-Pass Feature	2-32
Flashers, Hazard Warning	5-1
Flat Tire, Changing	5-19
Foreign Countries, Fuel	6-6
French Language Manual	ii
Front Seat Reading Lamps	2-42
Front Seatback Latches	1-5
Front Towing Hookups	5-9
<b>Fuel</b>	
Door Release, Remote	6-7
Filling Your Tank	6-6
Gage	2-66
In Foreign Countries	6-6
3800 Engine	6-3
3800 Supercharged Engine	6-4
Fuses and Circuit Breakers	6-54

<b>G</b> age	
Engine Coolant Temperature	2-61
Fuel	2-66
Garage Door Opener Storage	2-47
Gasolines for Cleaner Air	6-4, 6-5
GAWR (Gross Axle Weight Rating)	4-29
Gear Positions	2-19
Glass, Cleaning	6-48
GVWR (Gross Vehicle Weight Rating)	4-29

<b>H</b> alogen Bulbs	6-31
Hazard Warning Flashers	5-1
Head Restraints	1-5
Headlamp	2-40
Aiming	6-33
Bulb Replacement	6-31
High-Low Beam Changer	2-32
Warning	2-40
Wiring	6-54
Hearing or Speech Impaired, Customer Assistance	8-2
Heated Seat	1-5
Heater	3-4
Heritage Pages	iii
High Beam Lamps, How to Change	2-32
Highway Hypnosis	4-22
Hill and Mountain Roads	4-22
Hitches, Trailer	4-33
HomeLink™ Universal Transmitter	2-51
Hood Release	6-8

Horn	2-29
Hydroplaning	4-18

<b>If You're Stuck: In Sand, Mud, Ice or Snow</b>	5-27
---	------

Ignition Key Positions	2-14
------------------------	------

Ignition Switch	2-14
-----------------	------

Illuminated Entry System	2-7
--------------------------	-----

**Inspections**

Brake System	7-40
--------------	------

Exhaust Systems	7-40
-----------------	------

Restraint Systems	7-40
-------------------	------

    Steering, Suspension and Front-Wheel-Drive

Axle Boot and Seal	7-40
--------------------	------

Throttle Linkage	7-40
------------------	------

Instrument Panel	2-55
------------------	------

Instrument Panel, Cleaning	6-48
----------------------------	------

<b>Jack, Tire</b>	5-20
-------------------	------

Jump Starting	5-2
---------------	-----

<b>Key Lock Cylinders</b>	7-38
---------------------------	------

Key Reminder Warning	2-3
----------------------	-----

Keys	2-1
------	-----

<b>Lamp, Malfunction Indicator</b>	2-62
------------------------------------	------

Lamps	2-40
-------	------

Courtesy	2-40
----------	------

Daytime Running	2-41
-----------------	------

Larger Children, Safety Belt Use	1-42
----------------------------------	------

Latches, Front Seatback	1-5
-------------------------	-----

Leaving Your Vehicle	2-5
----------------------	-----

Leaving Your Vehicle with the Engine Running	2-25
--	------

Level Control, Electronic	2-53
---------------------------	------

License Plate Holder, Rear	2-54
----------------------------	------

**Light**

Air Bag Readiness	1-19, 2-57
-------------------	------------

Anti-Lock Brake System Warning	2-59, 4-6
--------------------------------	-----------

Battery	2-58
---------	------

Brake System Warning	2-58
----------------------	------

Check Oil Level	2-64
-----------------	------

Door Ajar	2-63
-----------	------

Engine Coolant Temperature Warning	2-61
------------------------------------	------

Engine Oil Pressure	2-63
---------------------	------

Low Coolant Warning	2-62
---------------------	------

Low Fuel	2-66
----------	------

Safety Belt Reminder	1-6, 2-57
----------------------	-----------

Service Engine Soon	2-62
---------------------	------

Traction Control System Warning	2-60
---------------------------------	------

Traction Off Warning	4-8
----------------------	-----

Lighter	2-53
---------	------

Loading Your Vehicle	4-28
----------------------	------

**Lock**

Automatic Door	2-4
----------------	-----

Door	2-3
------	-----

Power Door	2-4
------------	-----

Steering Column	7-39
-----------------	------

Torque	2-26
--------	------

Long Trip, Before Leaving on a	4-21
--------------------------------	------

Loss of Control .....	4-13
Low Coolant Warning Light .....	2-62
Low Fuel Light .....	2-66
Lubrication, Body .....	7-38
Lumbar Controls, Power Seat .....	1-2

## Maintenance

Underbody .....	6-51
When Trailer Towing .....	4-36
Maintenance Record .....	7-43
Maintenance Schedule .....	7-1
Owner Checks and Services .....	7-37
Periodic Maintenance Inspections .....	7-40
Recommended Fluids and Lubricants .....	7-41
Schedule I .....	7-6
Schedule I Definition .....	7-4
Schedule II .....	7-27
Schedule II Definition .....	7-5
Scheduled Maintenance Services .....	7-3
Malfunction Indicator Lamp (Service Engine Soon Light) .....	2-62
Manual Inside Mirror .....	2-43
Memory Seat and Mirrors .....	1-2
Methanol (In Fuel) .....	6-3, 6-5
Mirrors .....	2-43
Automatic Inside .....	2-43
Convex Outside .....	2-45
Electric Control .....	2-44
Manual Inside .....	2-43

Outside .....	2-44
Visor Vanity .....	2-54
MTBE (In Fuel) .....	6-3, 6-5

<b>N</b> et, Convenience .....	2-45
Neutral (N) Position .....	2-20
New Vehicle "Break-In" .....	2-14
Night Vision .....	4-15

<b>O</b> dometer .....	2-55
Odometer, Trip .....	2-55
Off-Road Recovery .....	4-11

## Oil

Engine .....	6-12
Supercharger .....	6-18
Opener, Garage Door .....	2-47

## Ordering

Owner Publications .....	8-7
Service and Owner Publications .....	8-6
Service Bulletins .....	8-7
Service Manuals .....	8-7

Outlets, Rear .....	3-2
Outside Mirrors .....	2-44
Overdrive Position .....	2-21
Overheated Engine .....	5-11
Owner Checks and Services .....	7-37
Owner Publications, Ordering .....	8-7

<b>P</b> aint Spotting, Chemical .....	6-51
<b>P</b> ark (P)	
Position .....	2-19
Shifting Into .....	2-23
Shifting Out of .....	2-26
<b>P</b> arking	
At Night .....	2-10
Brake .....	2-22
Lots .....	2-10
On Hills While Towing a Trailer .....	4-36
Over Things That Burn .....	2-27
<b>P</b> ASS-Key® II .....	2-12
<b>P</b> assenger Zone Comfort Control .....	3-4
<b>P</b> assing .....	4-12
<b>P</b> eriodic Maintenance Inspections .....	7-40
<b>P</b> ower	
Antenna Mast Care .....	3-21
Door Locks .....	2-4
Retained Accessory .....	2-16
Steering .....	4-9
Windows .....	2-29
<b>P</b> ower Seat .....	1-1
Adjusting .....	1-1
Lumbar Controls .....	1-2
Memory Function .....	1-2
Seatback Recliner .....	1-3
<b>P</b> ower Steering Fluid .....	6-24
Adding .....	6-25
Checking .....	6-25
<b>P</b> regnancy, Use of Safety Belts .....	1-24

<b>P</b> roblems on the Road .....	5-1
<b>P</b> rogrammable Automatic Door Locks .....	2-4
<b>P</b> ublications, Service and Owner .....	8-6

<b>R</b> adiator .....	5-16
<b>R</b> adiator Pressure Cap .....	6-24
<b>R</b> adio Reception, Understanding .....	3-18
<b>R</b> adios	
AM/FM Stereo with Cassette Tape and Compact Disc Players .....	3-8
AM/FM Stereo with Cassette Tape Player .....	3-6
AM/FM Stereo with Compact Disc Player .....	3-12
<b>R</b> ain, Driving In .....	4-16
<b>R</b> eading Lamps .....	2-42
<b>R</b> ear License Plate Holder .....	2-54
<b>R</b> ear Outlets .....	3-2
<b>R</b> ear Safety Belt Comfort Guides .....	1-30
<b>R</b> ear Seat Outside Position .....	1-26
<b>R</b> ear Seat Passengers .....	1-26
<b>R</b> ear Towing Hookups .....	5-10
<b>R</b> ear Window Defogger .....	3-5
<b>R</b> earview Mirror	
Automatic .....	2-43
Manual .....	2-43
<b>R</b> eclining Front Seatbacks .....	1-3
<b>R</b> ecommended Fluids and Lubricants .....	7-41
<b>R</b> eminder Light, Brake to Shift .....	2-26
<b>R</b> emote Fuel Door Release .....	6-7
<b>R</b> emote Keyless Entry System .....	2-6

Remote Trunk Release .....	2-8	Lap Belt .....	1-25
Removing the Rear Seat Cushion .....	6-55	Lap-Shoulder .....	1-11, 1-26
Replacement Bulbs .....	6-62	Questions People Ask .....	1-10
Replacement, Wheel .....	6-43	Rear Comfort Guides .....	1-30
Replacing Safety Belts .....	1-46	Rear Seat Outside Passenger Positions .....	1-26
Replacing Seat and Restraint System Parts		Rear Seat Passengers .....	1-26
After a Crash .....	1-46	Replacing After a Crash .....	1-46
Restraints		Right Front Passenger Position .....	1-25
Checking Your .....	1-45	Shoulder Belt Tightness Adjustment .....	1-13
Child .....	1-33	Use by Children .....	1-32
Head .....	1-5	Use by Larger Children .....	1-42
Replacing Parts After a Crash .....	1-46	Use by Smaller Children and Babies .....	1-32
Retained Accessory Power .....	2-16	Use During Pregnancy .....	1-24
Reverse (R) Position .....	2-20	Why They Work .....	1-7
Right Front Passenger Position .....	1-25	Safety Chains .....	4-34
Roadside Assistance .....	8-6	Safety Defects	
Rocking Your Vehicle .....	5-28	Reporting to General Motors .....	8-5
Rotation, Tire .....	6-39	Reporting to the Canadian Government .....	8-5
		Reporting to the United States Government .....	8-4
<b>S</b> afety Belt Extender .....	1-45	Safety Warnings and Symbols .....	viii
Safety Belt Reminder Light .....	1-6, 2-57	Scheduled Maintenance Services .....	7-3
Safety Belts .....	1-6	Seat, Heated .....	1-5
Adults .....	1-11	Seatback, Power Recliner .....	1-3
Care of .....	6-48	Seats .....	1-1
Center Passenger Position .....	1-25	Lumbar .....	1-2
Driver Position .....	1-11	Power .....	1-1
Extender .....	1-45	Reclining Front .....	1-3
How to Wear Properly .....	1-11	Securing a Child Restraint .....	1-36
Incorrect Usage .....	1-14, 1-43, 1-44	Second Gear (2) .....	2-21

Security System (PASS-Key <sup>®</sup> II) . . . . .	2-12	Steam, If Coming From Your Engine . . . . .	5-11
Service . . . . .	6-1	Steering . . . . .	4-9
Service and Appearance Care . . . . .	6-1	Column Lock . . . . .	7-39
Service and Owner Publications . . . . .	8-6	Column Shift Lever . . . . .	2-23
Service Bulletins, Ordering . . . . .	8-7	In Emergencies . . . . .	4-10
Service Engine Soon Light . . . . .	2-62	Power . . . . .	4-9
Service Manuals, Ordering . . . . .	8-7	Variable Effort . . . . .	2-29
Service Parts Identification Label . . . . .	6-53	Wheel Controls . . . . .	3-15
Service Work, Doing Your Own . . . . .	6-2	Wheel, Tilt . . . . .	2-30
Servicing Your Air Bag-Equipped Buick . . . . .	1-23	Storage, Of Your Vehicle . . . . .	6-30
Sheet Metal Damage . . . . .	6-51	Stuck, If You Are . . . . .	5-27
Shift Lever . . . . .		Supercharged Engine, 3800 (L67) . . . . .	6-11
Console . . . . .	2-25	Supercharger Oil . . . . .	6-18
Steering Column . . . . .	2-23	Checking . . . . .	6-18
Shifting . . . . .		What Kind to Use . . . . .	7-42
Automatic Transaxle . . . . .	2-19	When To Add . . . . .	6-18
Into Park (P) . . . . .	2-23	Supplemental Restraint System (SRS) . . . . .	1-18
Out of Park (P) . . . . .	2-26	Symbols, Vehicle . . . . .	x
Shoulder Belt Tightness Adjuster . . . . .	1-13		
Signaling Turns . . . . .	2-31	<b>T</b> achometer . . . . .	2-65
Skidding . . . . .	4-13	Taillamps, Bulb Replacement . . . . .	6-35
Sound Equipment, Adding . . . . .	3-19	Tape Player Care . . . . .	3-20
Spare Tire, Compact . . . . .	5-26	Theft . . . . .	2-10
Speaker Covers, Cleaning . . . . .	6-48	Theft Deterrent, Universal . . . . .	2-11
Specifications Chart . . . . .	6-63, 6-64	Thermostat . . . . .	6-24
Speedometer . . . . .	2-55	Third Gear (3) . . . . .	2-21
Stains, Cleaning . . . . .	6-47	Tilt Steering Wheel . . . . .	2-30
Starter Switch . . . . .	7-38	Time Out Feature . . . . .	2-41
Starting Your Engine . . . . .	2-16		

Time, Setting the	3-7, 3-9, 3-13	Trailer Tongue Weight	4-32
Tire Chains	6-44	Trailer Towing	4-30
Tire Inspection and Rotation	6-39	Brakes	4-34
Tire Loading	4-28	Driving on Grades	4-36
Tires	6-37	Driving with a Trailer	4-34
Alignment and Balance	6-43	Hitches	4-33
Buying New	6-41	Maintenance	4-36
Changing a Flat	5-19	Parking on Hills	4-36
Inflation	6-38	Safety Chains	4-34
Inspection and Rotation	6-39	Total Weight on Your Vehicle's Tires	4-33
Spare, Compact	5-26	Turn Signals	4-35
Temperature	6-42	Weight of a Trailer	4-32
Traction	6-42	Transaxle Fluid	6-19
Treadwear	6-42	Transmitter, HomeLink™ Universal	2-51
Uniform Quality Grading	6-41	Transmitters, Matching to Your Vehicle	2-7
Wear Indicators	6-40	Trip Odometer	2-55
Wheel Replacement	6-43	Trunk Release, Remote	2-8
When It's Time for New	6-40	Trunk Security Release	2-9
Top Strap	1-35	Turn Signal	
Torque Lock	2-26	Headlamp Beam Lever	2-30
Torque, Wheel Nut	5-25	Lane Change Indicator	2-31
Towing a Trailer	4-30	Reminder	2-32
Towing Your Vehicle	5-6	When Towing a Trailer	4-35
Front	5-9	Twilight Sentinel	2-41
Rear	5-10		
Traction Control System	4-8	<b>U</b> nderbody Maintenance	6-51
Traction Control System Warning Light	2-60	Universal Theft Deterrent	2-11
Traction Off Warning Light	4-8		



<b>V</b> ehicle	
Control of a	4-5
Damage Warnings	ix
Dimensions Chart	6-61
Identification Number (VIN)	6-53
Loading	4-28
Storage	6-30
Symbols	x
Leaving Your	2-5
Vision, Night	4-15
Visor Vanity Mirrors	2-54
<b>W</b> arning Devices	5-2
Warning Flashers, Hazard	5-1
Warning Lights, Gages and Indicators	2-56
Washing Your Vehicle	6-49
Water, Driving Through Deep Standing	2-17
Weatherstrips	6-49
Wheel Nut Torque	5-25
Wheel Replacement	6-43
Wheel Replacement, Used	6-44
Window, Express Down	2-29
Windows, Power	2-29
Windshield Washer	2-34
Windshield Washer Fluid	2-34, 6-25
Windshield Wiper, Circuit Breaker	6-54
Windshield Wipers	2-33
Winter, Driving in	4-24
Wiring, Headlamp	6-54
Wrecker Towing	5-6





THIS MANUAL IS PRINTED ON RECYCLED PAPER USING  
MINIMUM 50% WASTEPAPER, 10% POST CONSUMER WASTE