

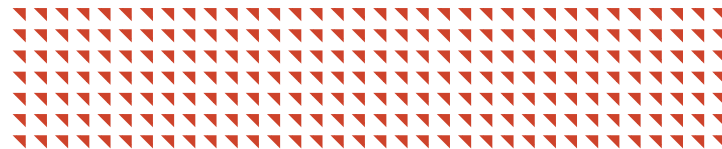

CITROËN C-ZERO



HANDBOOK

CRÉATIVE TECHNOLOGIE

<https://www.automotive-manuals.net/>

Access to the Handbook



From the appropriate Store, download the **Scan My Citroën** smartphone application.

Then select:

- the vehicle,
- the print edition corresponding to the date of 1st registration of your vehicle.

Download the content of the vehicle's **Handbook**.



The **Handbook** is available on the CITROËN website, in the "MyCitroën" section or at the following address:
<http://service.citroen.com/ddb/>

Select:

- the language,
- the vehicle, its body style,
- the print edition of your handbook corresponding to the date of 1st registration of your vehicle.



Direct access to the **Handbook**.



This symbol indicates the latest information available.

Welcome

Thank you for choosing a Citroën C-Zero.

This document presents the information and recommendations required for you to be able to explore your vehicle in complete safety.

Your vehicle will be fitted with only some of the equipment described in this document, depending on its trim level, version and the specification for the country in which it was sold.

The descriptions and illustrations are given without any obligation. Automobiles CITROËN reserves the right to modify the technical specifications, equipment and accessories without having to update this edition of the guide.

If ownership of your vehicle is transferred, please ensure this **Complete Handbook** is passed on to the new owner.

In this document you will find all of the instructions and recommendations on use that will allow you to enjoy your vehicle to the fullest. It is strongly recommended that you familiarise yourself with it, as well as the Maintenance and Warranty Guide which will provide you with information about warranties, servicing and roadside assistance associated with your vehicle.

Key



Safety warning



Additional information



Contributes to the protection of the environment



Left-hand drive vehicle



Right-hand drive vehicle

<p>Overview ■</p> <hr/> <p>Eco-driving ■</p>	<p>Access 2</p> <p>Remote control key 19</p> <p>Doors 21</p> <p>Boot 21</p> <p>Electric windows 22</p> <p>Charging flaps 23</p>	<p>Lighting and visibility 4</p> <p>Lighting control stalk 40</p> <p>Headlamp beam height adjustment 42</p> <p>Wiper control stalk 42</p> <p>Courtesy lamp 43</p>
<p>Dashboard instruments 1</p> <p>Instrument panel 7</p> <p>Warning and indicator lamps 7</p> <p>Main battery state of charge indicator 14</p> <p>Energy consumption/generation indicator 14</p> <p>Instrument panel display screen 15</p>	<p>Ease of use and comfort 3</p> <p>Front seats 24</p> <p>Rear seats 25</p> <p>Mirrors 26</p> <p>Interior fittings 27</p> <p>Ventilation 29</p> <p>Recommendations for ventilation and air conditioning 30</p> <p>Heating 31</p> <p>Air conditioning 32</p> <p>Front demist – defrost 34</p> <p>Rear screen demist – defrost 34</p> <p>Remote control 34</p>	<p>Safety 5</p> <p>General safety recommendations 45</p> <p>Hazard warning lamps 46</p> <p>Brake lamps, automatic operation 46</p> <p>Horn 46</p> <p>Horn for pedestrians 46</p> <p>Emergency or assistance call 47</p> <p>Braking assistance systems 48</p> <p>Trajectory control systems 49</p> <p>Engine brake reduction indicator lamp 50</p> <p>Seat belts 51</p> <p>Airbags 54</p> <p>Child seats 57</p> <p>Deactivating the passenger's front airbag 58</p> <p>ISOFIX mountings and child seats 63</p> <p>Advice on child seats 66</p> <p>Child lock 67</p>

Driving	6	In the event of a breakdown	8	Audio equipment and telematics	8
Driving recommendations	68	Ancillaries battery	88	Bluetooth® audio system	88
Starting-switching off the vehicle	68	Temporary puncture repair kit	90	KENWOOD – KDC-X7000DAB	90
Parking brake	69	Spare wheel	93		
Drive selector	69	Changing a bulb	95		
Tyre under-inflation detection	70	Changing a fuse	101		
		Towing the vehicle	105		
Practical information	7	Technical data	9	Alphabetical index	9
Recharging the main battery	75	Motor and main battery	106		
Snow chains	82	Weights	107		
Bonnet	83	Dimensions	108		
Front compartment	84	Identification markings	109		
Rear compartment	84				
Checking levels	85				
Checks	86				
Changing a wiper blade	87				
Washing precautions	87				

Access to additional videos



 bit.ly/helpPSA

Instruments and controls

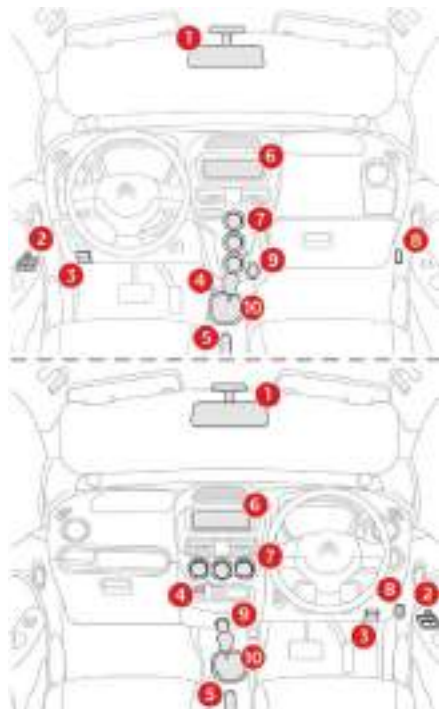

1
Interior rear view mirror
2
Electric window controls
3
Opening of the charging flaps
4
USB player
5
Parking brake
6
Audio system
7
Ventilation Heating Manual air conditioning Automatic air conditioning Windscreen demisting/defrosting Rear screen demisting/defrosting
8
Bonnet release

9
12 V accessory socket
10
Drive selector

Instruments and controls (continued)

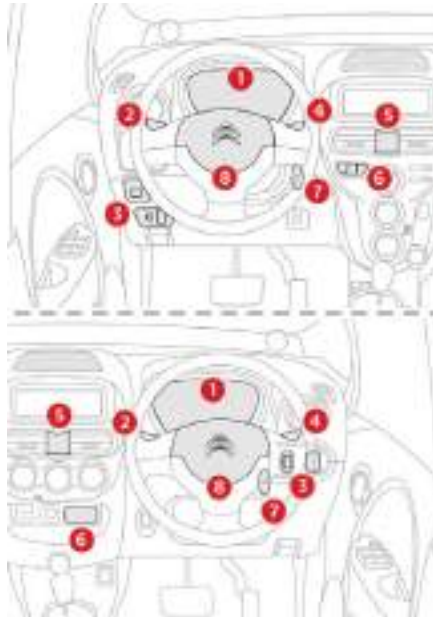
**1**

Instrument panel
Warning and indicator lamps
Indicators:
- main battery state of charge indicator
- energy consumption/generation indicator
- speedometer
- total distance recorder
- trip distance recorder
- lighting dimmer
- service indicator
- range indicator

2

Lighting control stalk
Direction indicators
Automatic illumination of brake lamps

3

Door mirrors
Headlamp adjustment
Horn for pedestrians

4

Wiper control stalk

5

Hazard warning lamps

6

Emergency or assistance call

7

Ignition switch, starting/
switching off the vehicle

8

Horn

For driving more economically and greater range

Practical everyday advice to optimise your vehicle's range whilst conserving the energy of your battery.

Drive smoothly

The electrical consumption of your vehicle depends very strongly on the route you take, your style of driving and your speed. In all cases, adopt a smooth driving style.



Favour the use of the Eco zone indicated on the energy consumption/generation indicator: press the accelerator pedal gradually, without

sudden movements and, if the conditions allow, try to drive at a steady and moderate speed.

Recover energy

Driving with anticipation allows you to recover energy and increase the range of the vehicle.



Use the Charge zone in the energy consumption/generation indicator whenever possible: anticipate slowing traffic and, if the conditions allow, favour the use of deceleration over braking.

Control the use of your electrical equipment

The heating and air conditioning operate using energy supplied by the main battery.

Excessive use reduces the range of your vehicle significantly. Consider switching them off as soon as you have reached the desired level of comfort and check the settings at every start.

Also limit the use of demisting and defrosting and of the heated seat.

Limit the causes of excessive consumption

As with any vehicle, limit the load being carried and keep aerodynamic resistance to a minimum (leaving windows open above 30 mph (50 km/h), roof bars, roof box, etc.).

Comply with servicing instructions

Check the tyre pressures regularly and follow the schedule of servicing operations recommended by CITROËN.

Instrument panel

Panel that brings together the different dials and vehicle operation indicator lamps.

Dials



1. Main battery state of charge indicator.
Reminder of the drive selector position.
2. Energy consumption/generation indicator.
3. Speedometer.
Engine brake temporary reduction indicator.
4. Display screen.

5. Display screen management button.
Displays the different functions successively.
Resets the selected function to zero (trip distance recorder or service indicator).
Sets the lighting dimmer intensity.

Display screen



- A. Total distance recorder.
- B. Trip distance recorder (journey A or B).
- C. Instrument panel lighting dimmer.
- D. Distance remaining until service due.
- E. Time remaining until service due.
- F. Under-inflation detection.
- G. Remaining range indicator.

Warning and indicator lamps

Visual identifiers informing the driver that a system is in operation, switched off (on/off indicator lamps) or has developed a fault (warning lamp).

When the ignition is switched on

Certain warning lamps come on for a few seconds when the vehicle's ignition is switched on.

When the vehicle is started, these same warning lamps should go off.

If they remain on, before driving refer to the information on the warning lamp concerned.

Associated warnings

The illumination of certain warning lamps may be accompanied by an audible signal. There are two types of lighting for warning lamps, fixed (continuous) or flashing.

! Certain warning lamps may come on in one of two modes. Only by relating the type of lighting to the operating status of the vehicle can it be ascertained whether the situation is normal or whether a fault has occurred.

Warning lamps

When the engine is running or the vehicle is being driven, the lighting of one of the following warning lamps indicates a fault which requires action on the part of the driver.

Any fault resulting in the lighting of a warning lamp must be investigated further.

If you encounter any problems, contact a CITROËN dealer or a qualified workshop.



Operation indicator lamps

The lighting of one of the following indicator lamps confirms that the corresponding system is on.

This may be accompanied by an audible signal.

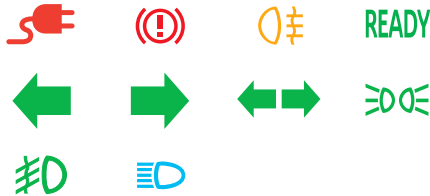













Deactivation indicator lamps





If one of the following indicator lamps comes on, this confirms that the corresponding system has been switched off intentionally.





This may be accompanied by an audible signal.











Warning/indicator lamp	State	Cause	Action/Observations	
Red warning/indicator lamps				
	Main battery charge (normal or fast)	Fixed.	The main battery is being charged.	The lamp goes out once charging is complete.
		Flashing.	The recharging cable is connected to the vehicle's socket, but the main battery is not being charged.	Check the recharging cable connection.
	Ancillaries battery charge	Fixed.	The ancillaries battery charging circuit has a fault (dirty or loose terminals, converter fault, etc.).	The warning lamp should go off when the engine is started. If it does not go off, contact a CITROËN dealer or a qualified workshop.
	Front seat belt not fastened/unfastened	Fixed, then flashing, accompanied by an audible signal.	The driver and/or front passenger has not fastened or has unfastened their seat belt.	Pull the strap then insert the tongue in the buckle.
	Rear right seat belt unfastened	Fixed.	The rear right passenger has unfastened their seat belt.	Pull the strap then insert the tongue in the buckle.
	Rear left seat belt unfastened	Fixed.	The rear left passenger has unfastened their seat belt.	Pull the strap then insert the tongue in the buckle.
	Airbags	Temporarily on.	This warning lamp comes on for a few seconds when you turn on the ignition, then goes off.	If it does not go off, contact a CITROËN dealer or a qualified workshop.
		Fixed.	One of the airbag or seat belt pyrotechnic pretensioner systems has a fault.	Have them checked by a CITROËN dealer or a qualified workshop.

Warning/indicator lamp		State	Cause	Action/Observations
	Door(s) open/Boot open	Fixed, accompanied by an audible signal.	A door or the boot is still open.	Close the door or boot.
	Parking brake	Fixed.	The parking brake is applied or not properly released.	Release the parking brake to switch off the warning light, keeping your foot on the brake pedal. Observe the safety recommendations. For more information on the Parking brake , refer to the corresponding section.
	Braking	Fixed.	The brake fluid level has dropped significantly. There is a braking assistance system fault.	Stop as soon as it is safe to do so. Top up with brake fluid approved by CITROËN. If the problem persists, have the system checked by a CITROËN dealer or a qualified workshop.
 + 		Fixed, associated with the ABS warning lamp.	The electronic brake force distribution (EBFD) system is faulty.	You must stop as soon as it is safe to do so. Have it checked by a CITROËN dealer or a qualified workshop.
Orange warning/indicator lamps				
	Anti-lock Braking System (ABS)	Fixed.	The anti-lock braking system has a fault.	The vehicle retains conventional braking capabilities. Drive carefully at reduced speed and contact a CITROËN dealer or a qualified workshop without delay.

Warning/indicator lamp		State	Cause	Action/Observations
	Dynamic stability control and anti-slip regulation (DSC/ASR)	Flashing.	Activation of the DSC/ASR systems.	The systems optimise traction and allow improved directional stability of the vehicle. Adapt your driving style and moderate your speed.
		Fixed.	DSC/ASR systems fault.	Have them checked by a CITROËN dealer or a qualified workshop.
		Fixed.	The DSC/ASR deactivation button is active. DSC/ASR is deactivated. DSC: Dynamic stability control. ASR: Anti-slip regulation.	Press the button to activate the DSC/ASR. The DSC/ASR system is activated automatically when the vehicle is started.
EPS	Electric power steering	Fixed.	Electric power steering fault.	Drive carefully at reduced speed. Have it checked by a CITROËN dealer or a qualified workshop.
	Main battery protection system	Fixed.	The state of charge of the main battery is insufficient or the temperature of the main battery is insufficient.	Limited engine power available. Recharge the main battery as soon as possible. If the warning lamp does not go off, contact a CITROËN dealer or a qualified workshop.

Warning/indicator lamp		State	Cause	Action/Observations
	Under-inflation	Fixed.	The pressure in one or more of the tyres is too low.	Check the pressure in the tyres as soon as possible. This check should preferably be carried out when the tyres are cold. You must reinitialise the system after adjusting one or more tyre pressures and after changing one or more wheels. For more information on Tyre under-inflation detection , refer to the corresponding section.
		Flashing, then fixed.	The function is faulty and/or at least one of the wheels has no sensor detected.	Tyre pressure monitoring is no longer ensured. Have the system checked by a Citroën dealer or a qualified workshop.
	Main electrical system self-diagnostic system	Fixed.	Fault in the main electrical system.	You must stop as soon as it is safe to do so. Have it checked by a CITROËN dealer or a qualified workshop.
	Passenger's airbag system	Fixed, in the central console.	The control switch, located in the glove box or in the central console (depending on equipment), is set to the "OFF" position. The passenger's front airbag is deactivated.	Set the control switch to the "ON" position to activate the passenger's front airbag. In this case, do not install a "rearward facing" child seat on the front passenger seat. Remember to check the status of this control switch before starting your vehicle.
	Rear foglamp	Fixed.	The rear foglamp has been switched on using the ring on the lighting control stalk.	Turn the ring on the lighting control stalk to the rear to switch off the rear foglamp.

Warning/indicator lamp	State	Cause	Action/Observations	
Green warning/indicator lamps				
 READY	Ready (ready to drive)	Fixed, accompanied by an audible signal when it comes on.	The vehicle is ready to drive, you can operate the accelerator now.	The lamp stays on as long as the vehicle is powered up.
	Left-hand direction indicator	Flashing with audible signal.	The lighting control stalk has been moved down.	
	Right-hand direction indicator	Flashing with audible signal.	The lighting control stalk has been moved up.	
	Hazard warning lamps	Flashing with audible signal.	The hazard warning lamps switch, located on the dashboard, has been operated.	The left-hand and right-hand direction indicators and their associated lamps flash simultaneously.
	Sidelamps and/or dipped beam headlamps	Fixed.	The sidelamps and/or dipped beam headlamps have been switched on.	
	Front foglamps	Fixed.	The front foglamps have been switched on using the ring on the lighting control stalk.	Turn the ring on the lighting control stalk twice rearwards to switch off the front foglamps.
Blue warning/indicator lamps				
	Main beam headlamps	Fixed.	The lighting control stalk has been pulled towards you.	Pull the lighting control stalk to return to dipped beam headlamps.
Black warning/indicator lamps				
	Motor braking reduction	Flashing.	The main battery is fully charged, the motor braking is temporarily reduced.	Anticipate when you need to brake: use the brake pedal to slow down or stop the vehicle.

Main battery state of charge indicator

Display

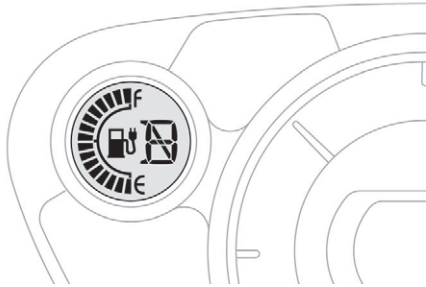

The state of charge of the main battery is displayed continuously in the instrument panel.

Low energy alerts

Four successive energy level alerts indicate that the energy available in the main battery has dropped to a low level:

- 2 lit and flashing bars on the energy gauge in the instrument panel: starting to use the reserve.
- The final bar on the energy gauge flashes.
- The final bar disappears: the range display disappears, the heating and air conditioning are cut off.



- Display of this warning lamp in the instrument panel: progressive reduction in available engine power.

Energy consumption/generation indicator

System informing the driver of the level of energy consumption or generation by the main battery.

"Neutral" position

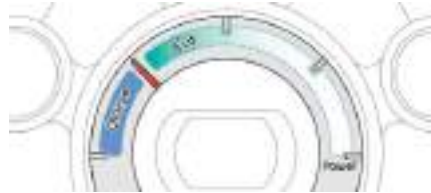

On switching on the ignition, your vehicle neither consumes nor generates energy through its electric drive train: the needle is in the "neutral" position (provided the heating and air conditioning are off).

Energy consumption



The needle moves to the right, in proportion to the consumption of energy by the vehicle.

"Eco" zone

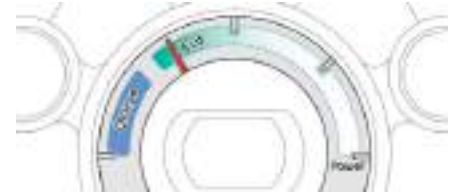

The needle is in this zone when the vehicle is used in a way that limits the consumption of electric energy and optimises its range.

"Charge" zone



The needle moves to the left, in proportion to the level of charge going into the main battery, during periods of deceleration and braking.

i In cold weather, the capacity to regenerate through braking is reduced.

Instrument panel display screen

When the switch is in the "ON" position, you can display various information on the screen by successively pressing button **A**.

Total distance recorder

System which measures the total distance travelled by the vehicle during its life.



Press button **A**.
The total distance appears in the display.

Switching the speedometer unit

When the total distance recorder is displayed, hold button **A** down for a few seconds to change the speedometer unit (mph or km/h). When remaining range indicator is displayed in the unit (miles or km) corresponding to that of the speedometer unit (mph or km/h).

Trip distance recorder (trip A or B)

These two trips indicate the distance travelled since the trip recorder was last reset.



Press button **A** to display the desired trip.

Reset

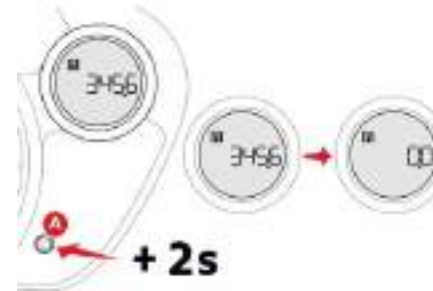

With the ignition on, when one of the trips **A** or **B** is displayed, press the button for more than two seconds.

Lighting dimmer

System that allows the brightness of the instruments and controls to be adjusted manually to suit the ambient light level.



With the headlamps on or off, press button **A** to select the function, then hold it down to adjust the brightness of the instruments and controls lighting to "day" or "night".

The brightness of the lighting increases every time you press button **A**.

When the lighting reaches the maximum setting, press again to move to the minimum setting.

Release button **A** as soon as the lighting reaches the desired brightness.

The setting is registered as soon as you release button **A** and is stored when the ignition switch is turned to OFF.

Service indicator

System which informs the driver when the next service is due, in accordance with the manufacturer's servicing schedule. This due date is calculated from the last reset of the service indicator.

There are two different ways to indicate when the next service is due:

- remaining distance (in kilometres or miles),
- time (in months) left before the next service.

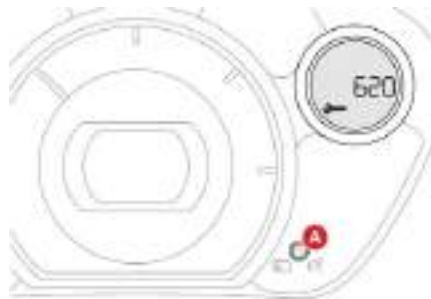

Once the ignition is switched on, press button **A** successively until the service indicator is displayed in the desired units.

Operation

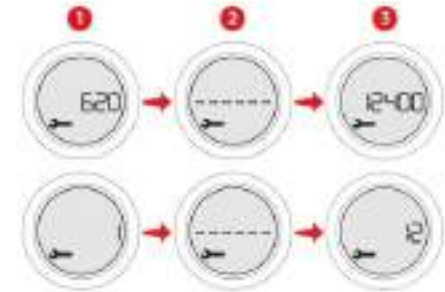

1. The display shows the distance or time remaining before the next service.
2. The display shows that the service is due. Each time the ignition is switched on, the service spanner is displayed for a few seconds to notify you that the service must be carried out very soon.
3. Once the service has been completed, the distance or the time remaining before the next service is displayed.

Resetting the service indicator

After each service, the service indicator must be reset to zero.



The procedure for resetting to zero is as follows:

- ☞ Turn off the ignition (switch to LOCK or ACC position).
- ☞ Press the reset button **A** in succession until the service indicator is displayed.
- ☞ Press and hold the reset button down for a few seconds to make **the spanner flash**.
- ☞ Press the reset button whilst the spanner is flashing to move the display "---" to "**CLEAR**".

The distance (or the time) remaining before the next service is displayed.

i The distance "---" indicating that the service is now due is reset automatically after a certain time and a certain distance travelled. The display will then indicate the remaining time before the next service.

Under-inflation detection

You must reinitialise the under-inflation detection system after adjusting one or more tyre pressures and after changing one or more wheels.



The procedure for this is as follows.

- ☞ Press button **A** to select the system.
- ☞ Press and hold button **A** down for **at least three seconds**.

An audible signal sounds and the under-inflation warning lamp flashes slowly until reinitialisation has been completed.

Choice of set of tyres fitted

If you have registered a second set of tyres with sensor, after every change, select the corresponding set in the instrument panel display screen.

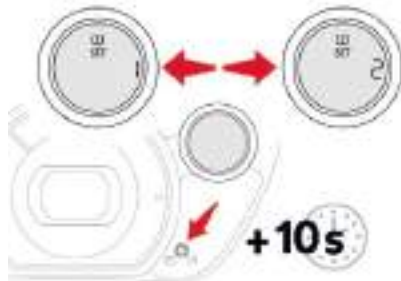

The procedure for this is as follows.

- ☞ Press button **A** to select the system.
- ☞ Press and hold button **A** for **more than ten seconds** to move from tyre set 1 to tyre set 2 in succession or vice versa.

Range indicator

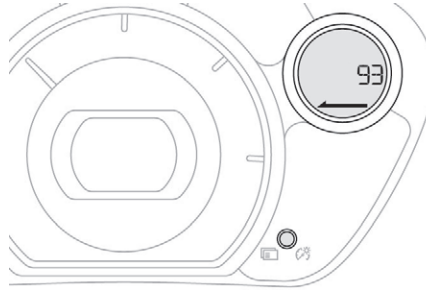

This function provides you with an estimated range that your vehicle can still travel, taking into account your recent conditions of use (driving style, use of heating, air conditioning, etc.).

- i** When the remaining range is too low, "---" is displayed in the instrument panel. The remaining range can be displayed in miles or kilometres. For more information on the **distance recorder**, and the unit change in particular, refer to the corresponding section.

Remote control key

System used to lock or unlock the vehicle's central locking system with a key or remotely. It also starts the vehicle and provides anti-theft protection.

Unfolding/folding the key



☞ Press button **A** to unfold or fold the key.

Unlocking the vehicle

Unlocking using the remote control



☞ Press the open padlock button to unlock the vehicle.

Unlocking is confirmed by illumination of the interior courtesy lamp for about 15 seconds and the direction indicators flashing **twice**.

The door mirrors unfold at the same time (depending on version).

Unlocking using the key

☞ Turn the key towards the right in the **driver's door** lock to unlock the vehicle.

Unlocking is confirmed by illumination of the interior courtesy lamp for about 15 seconds and the direction indicators flashing **twice**. However, the door mirrors do not unfold.



The passenger door lock does not allow the locking or unlocking of the other doors and/or of the boot.



The vehicle will lock again automatically after thirty seconds unless a door or the boot is opened. This mechanism helps avoid unlocking by mistake.

Locking the vehicle

Normal locking using the remote control



☞ Press the closed padlock button to lock the vehicle.

Locking is confirmed by the direction indicators flashing **once**.

The door mirrors fold at the same time (depending on version).

Normal locking using the key

☞ Turn the key towards the left in the **driver's door** lock to lock the vehicle.

Locking is confirmed by the direction indicators flashing **once**.

However, the door mirrors do not fold.

Anti-theft protection

Electronic immobiliser

The key contains an electronic chip which has a specific code. When the ignition is switched on, this code must be recognised to enable the vehicle to start.

This electronic immobiliser locks the motor management system a few minutes after the ignition is switched off and prevents the engine being started by anyone who does not have the key.

In the event of a fault, or if your vehicle does not start, contact a CITROËN dealer as soon as possible.

Remote control problem

In the event of a fault with the remote control, you can no longer unlock or lock your vehicle.

- ☞ First of all, use the key in the driver's door lock to unlock or lock your vehicle.
- ☞ Secondly, ask a CITROËN dealer to check the operation of the remote control and to replace the battery if necessary.

! Lost keys

See a CITROËN dealer with the vehicle registration certificate and your ID. A CITROËN dealer can retrieve the key code and the transponder code to order the replacement key.

Remote control

The high frequency remote control is a sensitive system; do not operate it while it is in your pocket as there is a possibility that it may unlock the vehicle without you being aware of it.

Do not repeatedly press the buttons of your remote control when out of range and out of sight of your vehicle, as it may stop working. The remote control does not operate when the key is in the ignition, even when the ignition is switched off.

Locking the vehicle

Driving with the doors locked may make access to the passenger compartment by the emergency services more difficult in an emergency.

As a safety precaution (with children on board), remove the key from the ignition when leaving the vehicle, even for a short time.

Anti-theft protection

Do not make any modifications to the electronic vehicle immobiliser system; this could cause malfunctions.

When purchasing a second-hand vehicle

Have the key codes memorised by a CITROËN dealer, to ensure that the keys in your possession are the only ones which can start the vehicle.

Doors Opening

From outside

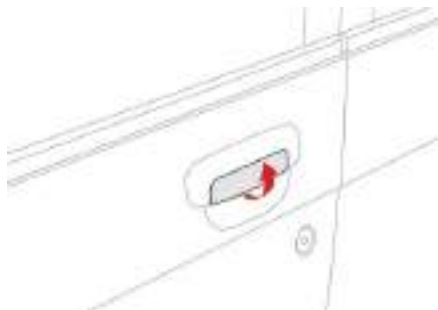

- ☞ After unlocking the vehicle using the remote control or the key, pull the door handle.

From inside



- ☞ Pull the front or rear door control to open the door.

If the doors are locked:

- opening the driver's door unlocks the other doors,
- the front passenger door or the rear doors must first be manually unlocked using the lock control before being opened.

Closing



If a door or the boot is not properly closed, this warning lamp comes on in the instrument panel until the relevant door or the boot is closed.

Locking/unlocking from inside



- ☞ Push the driver's door button forwards to lock or rearwards to unlock the entire vehicle.

! The front and rear passenger door buttons lock/unlock only the corresponding door.

Boot Opening



- ☞ After unlocking the vehicle using the remote control or the key, press the handle **A**, then raise the tailgate.

Closing



- ☞ Pull the handle **B** and guide the tailgate downwards.
- ☞ Release the handle and gently press on the outside surface of the tailgate to close it.

Electric windows

System designed for opening or closing a window manually or automatically. Equipped with a deactivation system to prevent misuse of the rear controls.

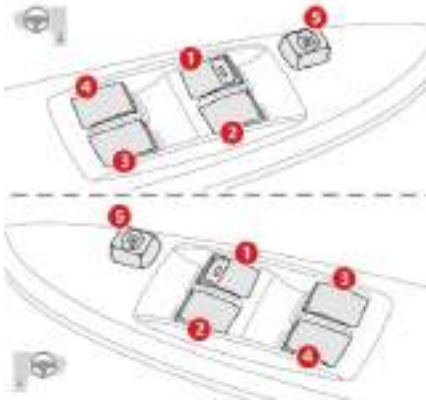

1. Driver's electric window.
2. Passenger's electric window
3. Rear right electric window.
4. Rear left electric window.
5. Deactivating the passenger and rear window controls.

Operation

With the ignition on:

- ☞ Press the control to open or pull it to close, without passing the point of resistance. The window stops as soon as the control is released.

Automatic mode (driver's side)

- ☞ Press the control beyond the point of resistance to open. The driver's window opens fully when the control is released.
- ☞ Pressing the control again stops the movement of the window.

i The electric window controls remain operational for approximately 30 seconds after switching off the ignition. The windows can no longer be opened or closed once the driver's door is closed.

Deactivating the passenger and rear window controls

- ☞ For your children's safety, press control **5** to deactivate the passenger and rear window controls irrespective of their position. If the button is pushed, operation is deactivated. If the button is raised, operation is reactivated.

! Always remove the key from the ignition when leaving the vehicle, even for a short time.

In the event of contact during operation of the electric windows, you must reverse the movement of the window. To do this, press the corresponding control.

When operating the passenger electric window switches, the driver must ensure that no-one is preventing correct closing of the windows.

The driver must ensure that the passengers use the electric windows correctly.

Be aware of children when operating the windows.

- ☞ Pull control **A** in the lower part of the dashboard, driver's side, to unlock the access flap.



- ☞ Open the access flap on the right-hand side of the vehicle.
- ☞ Press on latch **B** to open the socket cover.

- ☞ Pull control **C** under the driver's seat, near the door, to unlock the access flap.

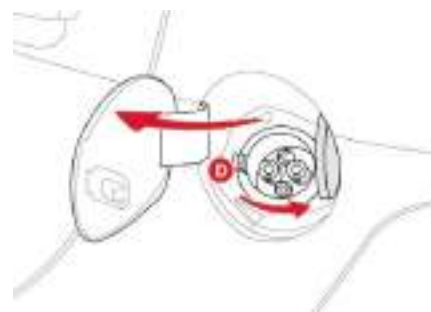

- ☞ Open the access flap on the left-hand side of the vehicle.
- ☞ Press on latch **D** to open the socket cover.

Charging flaps

Normal charging

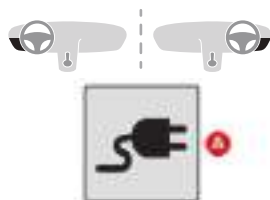

Fast charging

(Depending on equipment.)

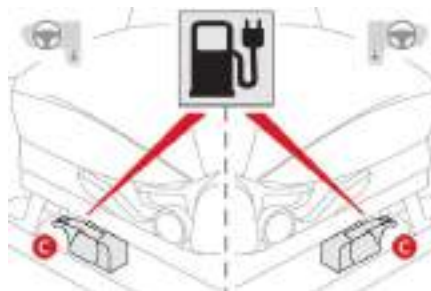

i For more information on **Recharging the main battery**, refer to the corresponding section.

Front seats

Manual adjustments



1. Adjusting the height of the head restraint.
2. Adjusting the seat backrest angle.
Operate the control lever and adjust the position of the backrest forwards or backwards.
3. Adjusting the height of the driver's seat cushion.
Raise or lower the control lever the number of times required to obtain the desired position.
4. Seat forwards-backwards adjustment.
Raise the control bar and slide the seat forwards or backwards.

Adjusting the height of the head restraint

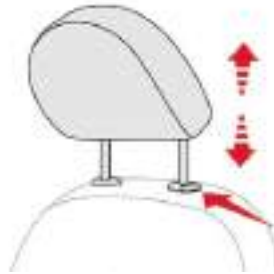

- ☞ To raise it, pull it upwards.
- ☞ To lower it, push it down while pressing the height adjustment button.
- ☞ To remove it, move it to the high position, then remove it while pressing the height adjustment button.
- ☞ To replace it, engage the head restraint rods in the holes while pressing the height adjustment button.

! Never drive with the head restraints removed and in the vehicle, they may become projectiles in severe braking situations - they must always be in place and properly adjusted.
After installing the head restraint, make sure that the height adjustment button has properly locked in place.
The adjustment is correct when the top of the head restraint is aligned with the top of the head of the person seated.

Heated seat control

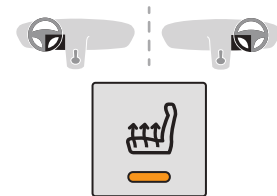

Press the switch on the dashboard to turn on the driver's seat heating.
The indicator lamp in the switch comes on.
The temperature is controlled automatically.
Pressing a second time stops operation.



When the seat and passenger compartment have reached an adequate temperature, you can switch off the function; reducing the consumption of electrical current reduces fuel consumption.

! Do not use the function when the seat is empty.

Prolonged use is not recommended for those with sensitive skin.

There is a risk of burns for people whose perception of heat is impaired (illness, taking medication, etc.).

There is a risk of overheating the system if material with insulating properties is used, such as cushions or seat covers.

Do not use the system:

- if wearing damp clothing,
- if child seats are fitted.

To avoid breaking the heating element in the seat:

- do not place heavy objects on the seat,
- do not kneel or stand on the seat,
- do not place sharp objects on the seat,
- do not spill liquids onto the seat.

To avoid the risk of short-circuit:

- do not use liquid products for cleaning the seat,
- never use the heating function when the seat is damp.

Rear seats

Bench seat consisting of two adjustable and foldable backrests and a fixed seat cushion.

Rear head restraints



These have a high position (for comfort and better safety) and a low position (to give the driver better rear visibility). They can also be removed.

To remove a head restraint:

- ☞ pull the head restraint fully upwards,
- ☞ then press on the lug.

! Never drive with passengers seated at the rear while the head restraints are removed; they must be in place and in the high position.

Adjusting the seat backrest angle



To adjust the backrest:

- ☞ pull the control forwards to release the backrest.
- ☞ adjust the backrest, then release the control.

There are seven possible adjustment notches for adjusting the angle.

! Always check that the backrest is fixed properly.

3

Folding the backrest



1. Place the head restraints in the low position or remove them if necessary.



2. Pull the control forwards to release the seat backrest.



3. Tilt the backrest forwards.

Returning the backrest to the normal position



- ☞ Put the seat backrest in the upright position and lock it in place.
- ☞ Refit or put the head restraints back in place.

! When returning the seat backrest to its normal position, take care not to trap the seat belts and their buckles.

Mirrors

Door mirrors

Adjustment

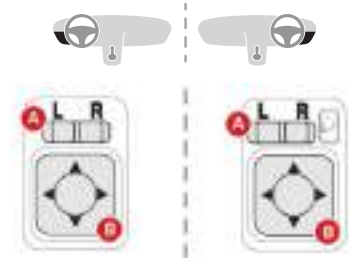

Adjustment is possible when the switch is in position "ON" or "ACC".

- ☞ Move control **A** to the right or to the left to select the corresponding mirror.
- ☞ Move control **B** in any of the four directions to adjust the mirror.

After adjustment, return control **A** to the central position.

Electric door mirror folding/ unfolding

(Depending on version.)



- ☞ Ignition switch in the "ON" or "ACC" position: press control **C** to unfold them.
- ☞ Ignition switch in the "LOCK" position: press control **C** **within 30 seconds** to fold them.

! The door mirrors can also be folded manually. However, they must **never be unfolded manually** because they may not remain in position when driving. Always use control **C** to unfold them.

Rear view mirror



Adjust the rear view mirror by moving it upwards, downwards and/or to the left or right.

The rear view mirror has two positions:

- day (normal),
- night (anti-dazzle).

To change from one to the other, push or pull the lever on the lower edge of the mirror.

Interior fittings

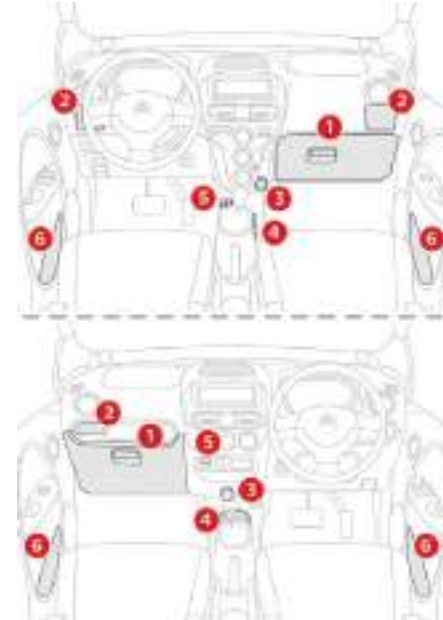

1. **Glove box**
2. **Retractable cup holders**
Press the lid to open the cup holder.
3. **12 V accessory socket (120 W)**
Observe the maximum power rating to avoid damaging your accessory.

3

4. Open storage compartment
5. USB player
6. Door pocket

Sun visor

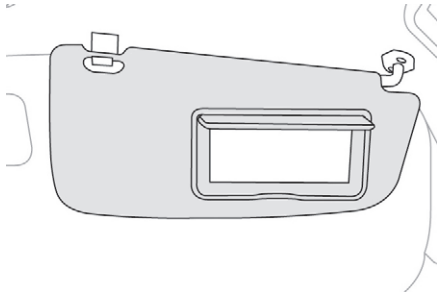

The sun visors fold forwards and sideways when unhooked. They are fitted with a vanity mirror and ticket holder.

Glove box

- ! Never drive with the glove box open when a passenger is at the front – risk of injury in the event of sharp deceleration!

12 V accessory socket

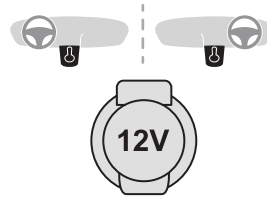

- ☞ To connect a 12 V accessory (max. power: 120 W), lift the cover and connect a suitable adaptor.

- ! The connection of an electrical device not approved by CITROËN, such as a USB charger, may adversely affect the operation of vehicle electrical systems, causing faults such as poor radio reception or interference with displays in the screens.

Mats

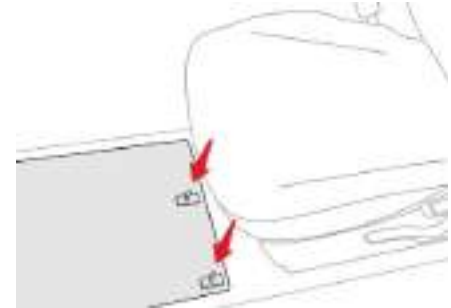

To take out the driver's side mat, move the seat back as far as possible and remove the fixings. To re-install, position it correctly on the pins and snap on the fixings. Check that the mat is secured correctly.

- ! To avoid any risk of jamming the pedals:
 - Only use mats which are suited to the fixings already present in the vehicle; these fixings must be used.
 - Never place one mat on top of another.

USB player

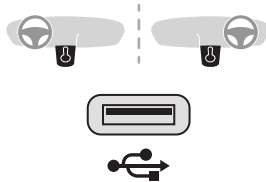

This USB port allows the connection of a portable device, such as an iPod® type of digital audio player, or a USB memory stick. It reads the audio files which are sent to your audio system, to be listened to through the vehicle's speakers.

You can manage these files using the audio system controls.

When connected to the USB port, the portable device can be charged automatically.

i For more information on how to use this equipment, refer to the section on **Audio equipment and telematics**.

Ventilation

System which creates and maintains good conditions of comfort and visibility in the vehicle's passenger compartment.

Air intake

The air circulating in the passenger compartment is filtered and originates either from the outside via the grille located at the base of the windscreen or from the inside in air recirculation mode.

Controls

The incoming air follows various routes depending on the controls selected. The temperature control gives you the desired level of comfort by mixing the air of the various circuits.

The air distribution control is used to select the air vents to be used in the passenger compartment.

The air flow control enables you to increase or reduce the speed of the ventilation fan.

These controls are grouped together on control panel **A** on the centre console.

Air distribution

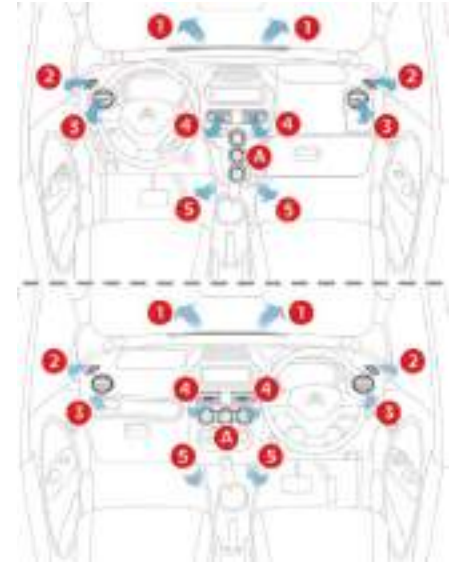

1. Windscreen demisting/defrosting vents.
2. Front side window demisting/defrosting vents.
3. Adjustable and closable side air vents.
4. Adjustable and closable central air vents.
5. Air outlets to the front footwells.

Recommendations for ventilation and air conditioning

- i** In order for these systems to be fully effective, follow the operation and maintenance guidelines below:
 - ☞ If after an extended stop in sunshine, the interior temperature is very high, first ventilate the passenger compartment for a few moments by opening the windows. Put the air flow control at a setting high enough to quickly change the air in the passenger compartment.
 - ☞ The condensation created by the air conditioning results in a discharge of water under the vehicle which is perfectly normal.
 - ☞ To ensure that the air is distributed evenly, keep the external air intake grilles at the base of the windscreen, the nozzles, the vents, the air outlets and the air extractor in the boot free from obstructions.
 - ☞ In normal conditions, use the intake of exterior air as prolonged use of air recirculation may cause misting of the windscreen and side windows.
 - ☞ Operate the air conditioning system for 5 to 10 minutes, once or twice a month to keep it in good working order.
- ☞ Ensure that the passenger compartment filter is in good condition and have the filter elements replaced regularly.
- ☞ To ensure correct operation of the air conditioning system, you are also advised to have it checked regularly.
- ☞ If the system does not produce cold air, do not use it and contact a CITROËN dealer or a qualified workshop.

 The heating and air conditioning operate using the energy supplied by the main battery. Their use increases the vehicle's consumption of electrical energy and reduces its range. Remember to switch off the heating or air conditioning as soon as you judge it to no longer be necessary.

i Ventilation, heating, and air conditioning can be activated during **normal charging** of the vehicle when the ignition is set to the **ACC** position. During **fast charging** of the vehicle, ventilation, heating, and air conditioning cannot be activated.

Heating

Adjustments can be made manually or automatically.

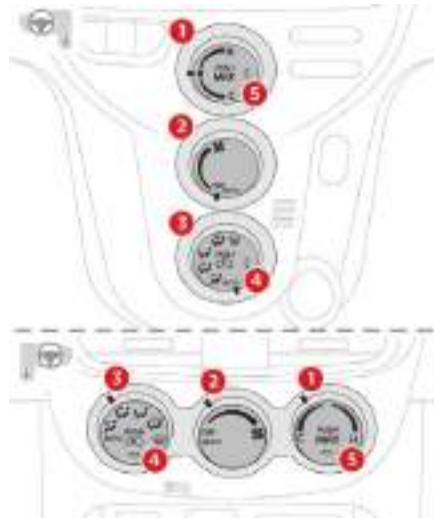

1. Adjusting the temperature
2. Adjusting the air flow
3. Adjusting the air distribution
4. Intake of exterior air/Recirculation of interior air
5. "Max" button

Temperature adjustment



- ☞ Turn the dial to the right to raise the temperature and to the left to lower it.

i When the dial is positioned on "●", the fan air will be at exterior temperature. If you move the dial to "●" while using the heating or air conditioning, these will stop immediately.

Air flow adjustment



- ☞ Turn the dial to the right to increase the air flow and to the left to decrease it.

i With the dial in "AUTO" position, the air flow is adjusted automatically according to the interior temperature.

Air distribution adjustment



- ☞ Place the dial in the desired position to distribute air to:



central and side vents,



central, side and footwell vents,



footwells,



windscreen, side windows and footwells,



windscreen and side windows.

The air distribution can be adapted by placing the dial in an intermediate position.

i With the dial in "AUTO" position, air distribution is adjusted automatically, according to the temperature selected.

Air intake/air recirculation

The intake of exterior air prevents the formation of mist on the windscreen and side windows.

The recirculation of interior air isolates the passenger compartment from exterior odours and smoke.

Return to exterior air intake as soon as possible to prevent deterioration of the air quality and the formation of mist.



- ☞ Press this button to recirculate the interior air. The indicator lamp comes on to confirm this.
- ☞ Press the button again to permit the intake of exterior air. The indicator lamp switches off to confirm this.

"MAX" button

This button allows the passenger compartment to be quickly heated or cooled. It only works when the fan flow control is not in the "OFF" position.



Press this button. The corresponding indicator lamp comes on.

Then place the temperature adjustment control on the desired position:

- on "●" for maximum ventilation,
- between "●" and "H" for maximum heating,
- between "C" and "●" for maximum air conditioning.

Air conditioning

Adjustments can be made manually or automatically.

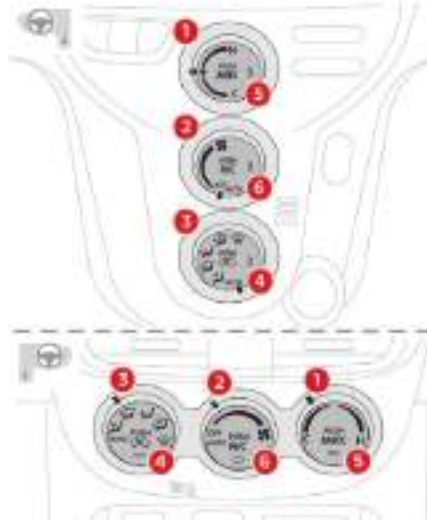

1. Adjusting the temperature
2. Adjusting the air flow
3. Adjusting the air distribution
4. Intake of exterior air/Recirculation of interior air
5. "Max" button
6. Air conditioning on/off

Temperature adjustment



- ☞ Turn the dial to the right to raise the temperature and to the left to lower it.

i When the dial is positioned on "●", the fan air will be at exterior temperature. If you move the dial to "●" while using the heating or air conditioning, these will stop immediately.

Air flow adjustment



- ☞ Turn the dial to the right to increase the air flow and to the left to decrease it.

i With the dial in "AUTO" position, the air flow is adjusted automatically, according to the interior temperature.

Air distribution adjustment



- ☞ Place the dial in the desired position to distribute air to:



central and side vents,



central, side and footwell vents,



footwells,



windscreen, side windows and footwells,



windscreen and side windows.

The air distribution can be adapted by placing the dial in an intermediate position.

i With the dial in "AUTO" position, air distribution is adjusted automatically, according to the temperature selected.

Air intake/air recirculation

The intake of exterior air prevents the formation of mist on the windscreen and side windows. The recirculation of interior air isolates the passenger compartment from exterior odours and smoke.

Return to exterior air intake as soon as possible to prevent deterioration of the air quality and the formation of mist.



- ☞ Press this button to recirculate the interior air. The indicator lamp comes on to confirm this.
- ☞ Press the button again to permit the intake of exterior air. The indicator lamp switches off to confirm this.

"MAX" button

This button allows the passenger compartment to be quickly heated or cooled. It only works when the air flow control is not in the "OFF" position.



- ☞ Press this button. The corresponding indicator lamp comes on.

Then place the temperature adjustment control on the desired position:

- on "●" for maximum ventilation,
- between "●" and "H" for maximum heating,
- between "C" and "●" for maximum air conditioning.

Air conditioning on/off



The air conditioning is designed to operate efficiently in all seasons, with the windows closed.

It enables you to:

- lower the temperature, in summer,
- increase the effectiveness of the demisting in winter, above 3°C.

Switching on

- ☞ Press the A/C button. The associated indicator lamp comes on.

The air conditioning does not operate when the air flow adjustment is set to off.

i To obtain cool air sooner, you can use air recirculation for a few moments. Then return to the intake of exterior air.

Switching off

- ☞ Press the A/C button again. The associated indicator lamp goes off. Switching off may result in some discomfort (humidity, misting).

3

Front demist – defrost



Place the air distribution adjustment control in this position.

The intake of exterior air is selected (indicator lamp off) and, depending on equipment, the air conditioning comes on (indicator lamp lit).



Place the temperature adjustment control between "●" and "H".



Place the air flow adjustment control in the desired position.



i For fast demisting/defrosting, you can also press the "MAX" button.

Rear screen demist – defrost

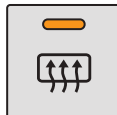

Switching on



i Press this button to demist/defrost the rear screen and, depending on version, the door mirrors. The button indicator lamp comes on.

Switching off

Demisting/defrosting switches off automatically to prevent an excessive consumption of electricity.



i It is possible to stop the demisting/defrosting operation before it is switched off automatically by pressing the button again. The warning lamp for the button goes out.



Switch off the demisting/defrosting of the rear screen and door mirrors as soon as appropriate in order to control the vehicle's electrical consumption and optimise its range.

Remote control

(Depending on equipment.)

The remote control can be used to control the following functions remotely:

- Check the vehicle's charge status.
- Recharge programming: start time and charge duration.
- Activate the air conditioning functions (heating, air conditioning, demist - defrost).



To programme recharging, the following conditions must be met:

- Place the drive selector in position **P**.
- Place the switch to **LOCK**.
- Connect the vehicle with the normal recharging cable.



The remote control range is approximately 100 metres.

Buttons



1. On/off, data transmission.
2. MODE: allows you to scroll through the different available functions (charge start, charge duration, thermal comfort).
3. Immediate vehicle charging (reset programmings to zero).
4. Settings.

Display screen



1. Data transmission status indicator.
2. Recharge indicator.
3. Fault indicator.
4. Battery charge status indicator.
5. Recharge programming function status indicator.
6. Charge time remaining indicator.
7. Thermal comfort function status indicator.

On/Off



Extend the aerial.
Press and hold this button to switch the remote control on or off.

i The remote control will switch off automatically if no action takes place within thirty seconds.

3

Charge start programming

This function is used to set the remaining time before starting to charge your vehicle. (Example: it is 7 p.m. when the system is programmed and the programmed charge time is two hours: charging will start at 9 p.m.). Switch on the remote control.



This symbol is displayed on the screen.

Use the arrows to adjust the charge start time: each press adjusts the time in half-hourly intervals.

Press the on/off button briefly to send the data to the vehicle.

- i** If the charge start is programmed without programming the charge duration, the battery will be charged fully.

Charge duration programming

This function is used to set the charging time for your vehicle.

Switch on the remote control.

Press the MODE button to select the charge duration programming.



This symbol is displayed on the screen.

Use the arrows to adjust the charging time: each press adjusts the time in half-hourly intervals.

Press the on/off button briefly to send the data to the vehicle.

- i** The charge duration can be programmed for between 0.5 and 19.5 hours. However, you can also select the duration "-h": in this case, charging will stop when the battery is fully charged. This duration is the value entered by default.

- i** If the charge duration is programmed without programming the start time, the battery will be charged immediately for a duration corresponding to the one programmed.

Cancelling programmings

With the remote control



Press the charge immediately button, then press the on/off button briefly to send the data to the vehicle.

With the switch

Turn the vehicle's ignition switch to the **ON** position then turn it to **LOCK**.

- i** Any programming carried out with remote control is cancelled automatically every time the vehicle is started.

Thermal comfort programming

This function is used to programme the running of the:

- heating,
- air conditioning,
- demisting.

- i** To programme the heating, air conditioning or demisting functions, the following conditions must be met.

- The drive selector is in position **P**.
- The ignition switch is on **LOCK**.
- The vehicle is connected with the normal recharging cable.
- All the doors are closed properly.
- The battery is sufficiently charged (one bar minimum).

- i** For maximum efficiency in programming the thermal comfort, make sure that all the vehicle's windows are closed.

Function activation

Switch on the remote control.
Press the MODE button to select the thermal comfort programming.

COOL HEAT  **A/C OFF**

One of these symbols is displayed on the screen. It tells you the current status of the thermal comfort.

Use the arrows to select the desired function.
Press the on/off button briefly to send the data to the vehicle.

Available functions

COOL

Cooling: running the air conditioning and ventilation in the passenger compartment using the central air vents.

HEAT

Heating: running the heating in the passenger compartment and the ventilation via the inside air vents. The driver's seat heating will also be activated if the function was activated.



Demisting: running the demisting/defrosting of the rear screen and the door mirrors (depending on version), the ventilation and heating in the passenger compartment, via the side air vents, and the driver's seat heating, if the function was activated.

A/C OFF

Deactivating the thermal comfort programming function and cancelling the programming.

Battery charge indicator

You can use the remote control to check the main battery charge status.



Battery full.



Battery half-charged.



Battery low.



Battery empty.

Changing batteries

Battery type: CR2032

Unclip the case and change the two batteries.





Do not throw away used batteries, take them to an approved collection point.

3

Malfunctions

Remote control



Warning/ indicator lamp	State	Causes	Action/Observations
ERROR	Flashes within approximately ten seconds after switching on the remote control.	There is a malfunction.	Switch the remote control off and then on again.
ERROR 	Flash within approximately one second after switching on the remote control.	Electrical interference is preventing the remote control or data transmission from operating.	Move away from the interference sources.
ERROR 	Flash within approximately ten seconds after switching on the remote control.	The aerial is not extended.	Extend the aerial.
		You are outside the range of the remote control.	Move nearer to the vehicle.
		The ignition switch is not in the LOCK position.	Turn the switch to LOCK .

Charge programming

Warning/ indicator lamp	State	Causes	Action/Observations
ERROR 	Flash for a few seconds.	The charging cable is not connected properly.	Check the cable.
		There is a problem with your electrical installation.	Have it checked by a qualified electrician.
ERROR	Flashes for a few seconds.	The drive selector is not in position P .	Place the drive selector in position P .

3

Thermal comfort programming

Warning/ indicator lamp	State	Causes	Action/Observations
ERROR 	Flash for a few seconds.	The charging cable is not connected properly.	Check the cable.
		There is a problem with your electrical installation.	Have it checked by a qualified electrician.
ERROR 	Flash for a few seconds.	The main battery is not sufficiently charged.	Charge the battery and start the programming again.
ERROR	Flashes for a few seconds.	A vehicle door is still open.	Close all the doors and start the programming again.
		The drive selector is not in position P .	Place the drive selector in position P .

Lighting control stalk

Main lighting

The various front and rear lamps of the vehicle are designed to adapt the lighting gradually to the climatic conditions and thus give the driver better visibility:

- sidelamps, to be seen,
- dipped beam headlamps to see without dazzling other drivers,
- main beam headlamps to see clearly when the road is clear.

Additional lighting



Other lamps are fitted to meet particular driving conditions:

- a rear foglamp to be seen from afar,
- front foglamps for even greater visibility,
- daytime running lamps to be seen during the day.

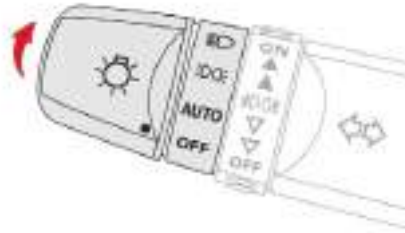
Selection ring for main lighting mode



Turn it to align the desired symbol with the mark.

-  Dipped or main beam headlamps.
-  Sidelamps.
- AUTO** Automatic illumination of headlamps.
- OFF** Lighting off.

Headlamp dipping stalk

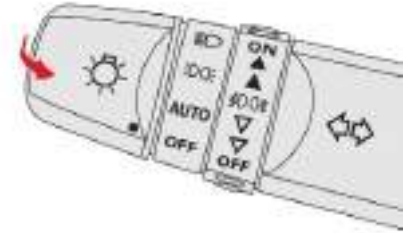

Pull the stalk to switch the lighting between dipped/main beam headlamps.

In the lighting off and sidelamps modes, the driver can switch on the main beam headlamps temporarily ("headlamp flash") by maintaining a pull on the stalk.

Displays

Illumination of the corresponding indicator lamp in the instrument panel confirms that the lighting selected is on.

Front and rear foglamps

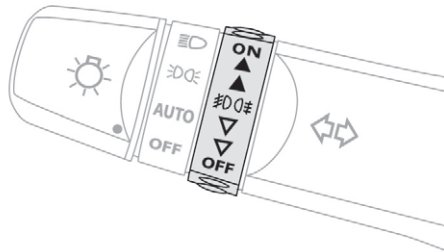

Fog lamps selection ring.
They operate with the sidelamps and dipped or main beam headlamps.



Front and rear foglamps:

- ☞ Turn the ring forwards once to switch on the front foglamps.
- ☞ Turn the ring forwards twice to switch on the rear foglamp.
- ☞ Turn the ring backwards once to switch off the rear foglamp.
- ☞ Turn the ring backwards twice to switch off the front foglamps.

The ring automatically returns to its initial position.
The rear foglamp switches off automatically when you switch off the sidelamps and dipped or main beam headlamps.

! It is prohibited to switch on the front or rear foglamps in fine weather or in rain, night or day. In these situations, the power of their beams may dazzle other drivers. Do not forget to switch off the front foglamps and the rear foglamp when they are no longer necessary.

i **When lighting is left on**
When the driver's door is opened, with the ignition off, an audible signal warns the driver that the vehicle's lighting is left on. In this case, switching off the lighting stops the audible signal.

Direction indicators (flashing)

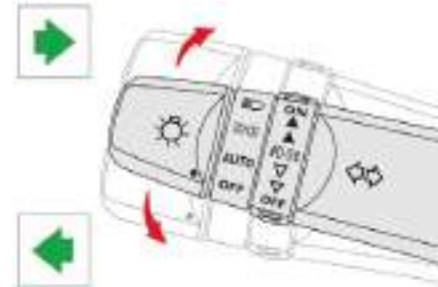

- ☞ Left: lower the lighting control stalk passing the point of resistance.
- ☞ Right: raise the lighting control stalk passing the point of resistance.

Daytime running lamps

Specific daytime lighting to make the vehicle more visible.

The daytime running lamps light up automatically when the engine starts if no other lamps are on.

They cannot be deactivated.

i Although these lamps are located in the same lamp unit as the front foglamps, they operate with a specific bulb. Their use complies with the Highway Code.

4

Automatic illumination/ switching off of the headlamps

Automatic illumination

When the lighting control stalk ring is in the **AUTO** position, the sidelamps and dipped beam headlamps are switched on automatically, without any action on the part of the driver, when a low level of ambient light is detected.

As soon as the level of light becomes sufficient again, the lights are switched off automatically. The sensor is located at the bottom of the windscreen.

! Do not cover the sunshine sensor, as the associated functions would no longer be controlled.

i In fog or snow, the sunshine sensor may detect sufficient light. The headlamps may not come on automatically.

Automatic switching off

When the lighting control stalk is in the "AUTO" position, if the ignition key is in the "LOCK" or "ACC" position or is removed, the headlamps will automatically switch off **when the driver's door is opened**.

Headlamp beam height adjustment

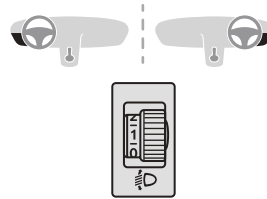

To avoid causing a nuisance to other road users, the height of the halogen headlamp beams must be adjusted according to the load in the vehicle.

0. Driver only or driver + 1 front passenger.
1. or 2. 4 passengers (including driver).
3. 4 passengers (including driver) + maximum authorised load.
4. Driver + maximum authorised load.

i The initial setting is position "0".

Wiper control stalk

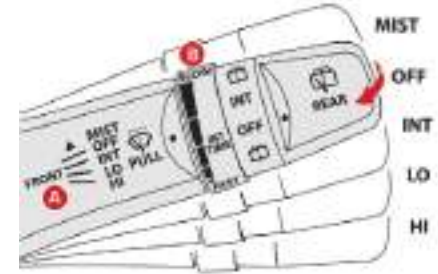

The wipers are controlled directly by the driver using control **A** and ring **B**.

i In wintry conditions, remove snow, ice or frost present on the windscreen, around the wiper arms and blades and the windscreen seal before operating the wipers.

! Do not operate the wipers on a dry windscreen. Under extremely hot or cold conditions, ensure that the wiper blades are not stuck to the windscreen before operating the wipers.

Windscreen wipers

- A. Wiping speed control lever: raise or lower the lever to the desired position.

MIST

Single wipe.

OFF

Off.

INT

Intermittent (manually adjustable speed).

LO

Slow.

HI

Fast.

- B. Intermittent adjustment ring.
 Turn this ring to increase or decrease wiping frequency in intermittent mode.

Front screenwash

Pull the wiper control stalk towards you. The screenwash and then the wipers operate for a preset time.

Rear wiper

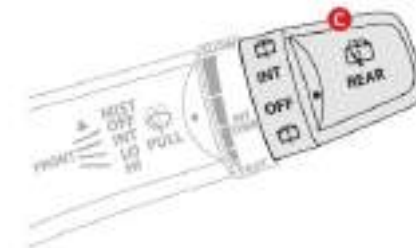

- C. Rear wiper selection ring.

• **OFF**

Off.

• **INT**

Intermittent wiping.

The wiper wipes twice then switches to intermittent mode with an interval of a few seconds.



Wash-wipe.

Hold the ring in this position to operate the screenwash and to carry out several wipes with the wipers.

Courtesy lamp

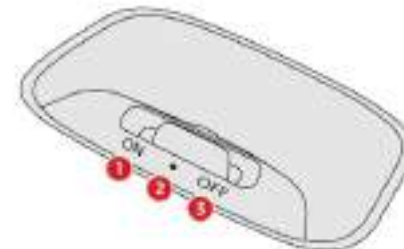

Position 1 "ON"

The courtesy lamp is permanently on.

Position 2 "•"

The courtesy lamp comes on when a door or the boot is opened; when the door or boot is closed again, the lighting dims gradually for a few seconds before going out. However, the courtesy lamp goes out immediately when the doors and boot are closed and you lock the vehicle from the inside or with the remote control.

4

Position 3 "OFF"

The courtesy lamp is permanently off.

! Before leaving the vehicle, check that the courtesy lamp is not still on.

If it remains permanently on, it will discharge the ancillaries battery even if the main battery is charged or charging. It will then no longer be possible to start the vehicle.

General safety recommendations

! Labels are attached in different places on your vehicle. They include safety warnings as well as identification information for your vehicle. Do not remove them: they are an integral part of your vehicle.

! For any work on your vehicle, use a qualified workshop that has the technical information, skills and equipment required, all of which a CITROËN dealer is able to provide.

! **We draw your attention to the following points:**

- The fitting of electrical equipment or accessories not listed by CITROËN may cause excessive current consumption and faults and failures with the electrical system of your vehicle. Contact a CITROËN dealer for information on the range of recommended accessories.
- As a safety measure, access to the diagnostic socket, used for the vehicle's electronic systems, is reserved strictly for CITROËN dealers or qualified workshops, equipped with the special tools required (risk of malfunctions of the vehicle's electronic systems that could cause breakdowns or serious accidents). The manufacturer cannot be held responsible if this advice is not followed.
- Any modification or adaptation not intended or authorised by CITROËN or carried out without meeting the technical requirements defined by the manufacturer will result in the suspension of the legal and contractual warranties.

! **Installation of accessory radio communication transmitters**

Before installing a radio communication transmitter, you must contact a CITROËN dealer for the specification of transmitters which can be fitted (frequency, maximum power, antenna position, specific installation requirements), in line with the Vehicle Electromagnetic Compatibility Directive (2004/104/EC).

! Depending on country regulations, some safety equipment may be compulsory: high visibility safety vests, warning triangles, breathalysers, spare bulbs, spare fuses, fire extinguisher, first aid kit, mud flaps at the rear of the vehicle, etc.

Hazard warning lamps

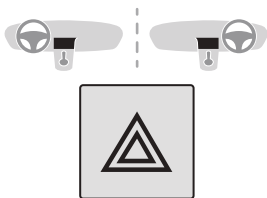

- When you press this red button, all four direction indicators flash. They can operate with the ignition off.

Brake lamps, automatic operation



- The brake lamps may light up automatically when you release the accelerator pedal. Their illumination is not systematic and depends on the rate of deceleration.

Horn



- Press the central part of the steering wheel.

Horn for pedestrians

- (Depending on equipment.) System to alert pedestrians to the presence of the vehicle.

Operation

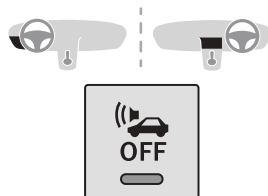

- When the vehicle is started, illumination of the button indicator lamp for a few seconds indicates system activation.

- The horn sounds when the vehicle speed is between 0 and 22 mph (35 km/h),

Deactivation

- In certain driving conditions you can deactivate the system.



- Press this button.

- The button indicator lamp comes on and the audible signal stops. Another press reactivates the system. The button indicator lamp goes off.

- Before deactivating the system, make sure that you are not driving in an area frequented by pedestrians.

- The system is reactivated automatically at every new start.

Malfunction

- The button indicator lamp flashes if the system malfunctions. Contact a CITROËN dealer or a qualified workshop to have the system checked.

Emergency or assistance call

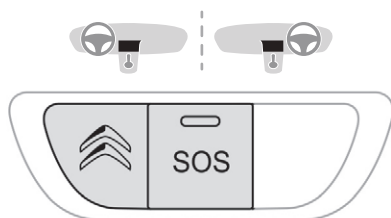

Localised Emergency Call

 In an emergency, press this button for more than 2 seconds.

The flashing green indicator lamp and the voice message confirm that the call has been made to the "Localised Emergency Call" call centre*.

 Pressing this button again immediately cancels the request. The green indicator lamp goes off.

The green indicator lamp remains on (without flashing) when communication is established. It goes off at the end of the call.

"Localised Emergency Call" immediately locates your vehicle, contacts you in your own language** and – if necessary – requests that relevant emergency services be dispatched**. In countries where the service is not available, or when the locating service has been

expressly declined, the call is sent directly to the emergency services (112) without the vehicle location.

! If an impact is detected by the airbag control unit, and independently of the deployment of any airbags, an emergency call is made automatically.

i If you benefit from the Citroën Connect Box offer with the SOS and assistance pack included, there are additional services available to you in your personal space, via the website for your country.

* In accordance with the general conditions of use for the service available from dealers and subject to technological and technical limitations.

** As per the geographic coverage of "Localised Emergency Call", "Localised Assistance Call" and the official national language chosen by the owner of the vehicle. The list of countries covered and telematic services is available from dealers or on the website for your country.

Operation of the system

 When the ignition is switched on, the green indicator lamp comes on for 3 seconds indicating that the system is operating correctly.

 If the orange indicator lamp flashes then goes off: the system has a fault.

If the orange indicator lamp is permanently on: the back-up battery should be replaced. In both cases, the emergency and assistance calls service may not work. Contact a qualified repairer as soon as possible.

i The fault with the system does not prevent the vehicle being driven.

Localised Assistance Call

 Press this button for more than 2 seconds to request assistance if the vehicle breaks down.

A voice message confirms that the call has been made**.

 Pressing this button again immediately cancels the request.

Safety

The cancellation is confirmed by a voice message.

Geo-location



You can deactivate geo-location by simultaneously pressing the "Localised Emergency Call" and "Localised Assistance Call" buttons, followed by pressing "Localised Assistance Call" to confirm.



To reactivate geolocation, simultaneously press the "Localised Emergency Call" and "Localised Assistance Call" buttons again, followed by a press on "Localised Assistance Call" to confirm.

- i** If you purchased your vehicle outside the CITROËN dealer network, we invite you to have a dealer check the configuration of these services and, if desired, modify it to suit your wishes.
In a multi-lingual country, configuration is possible in the official national language of your choice.

i For technical reasons and in particular to improve the quality of telematic services to customers, the manufacturer reserves the right to carry out updates to the vehicle's on-board telematic system.

** As per the geographic coverage of "Localised Emergency Call", "Localised Assistance Call" and the official national language chosen by the owner of the vehicle. The list of countries covered and telematic services is available from dealers or on the website for your country.

Braking assistance systems

Group of supplementary systems which help you to obtain optimum braking in complete safety in emergency situations:

- anti-lock braking system (ABS),
- electronic brake force distribution (EBFD),
- emergency braking assistance (EBA).

Anti-lock braking system and electronic brake force distribution

Linked systems which improve the stability and manoeuvrability of your vehicle when braking, in particular on poor or slippery surfaces.

Activation

The anti-lock braking system comes into operation automatically when there is a risk of wheel lock.

Normal operation of the ABS may make itself felt by slight vibrations of the brake pedal.

! If you need to brake in an emergency, press very firmly and maintain this pressure.

Malfunction

Stationary vehicle



If this warning lamp comes on, it indicates an anti-lock braking system malfunction that could cause control of the vehicle to be lost during braking.

Contact a CITROËN dealer or a qualified workshop.

i The warning lamp comes on for a few seconds when switching on (ON position). If it does not go out or come on, contact a CITROËN dealer or a qualified workshop.

Moving vehicle



If this warning lamp remains on constantly, it indicates an anti-lock braking system malfunction that could cause control of the vehicle to be lost during braking.

You must stop as soon as it is safe to do so. Contact a CITROËN dealer or a qualified workshop.



If both these warning lamps come on, they indicate a malfunction in the electronic brake force distribution that could cause control of the vehicle to be lost during braking.



You must stop as soon as it is safe to do so. Contact a CITROËN dealer or a qualified workshop. When replacing wheels (tyres and rims), ensure that they comply with manufacturer recommendations.

Emergency braking assistance

System which, in an emergency, enables you to obtain the optimum braking pressure more quickly, thus reducing the stopping distance.

Activation

It is triggered by the speed at which the brake pedal is pressed. The effect of this is a reduction in the resistance of the pedal and an increase in braking efficiency.

! In emergency braking, press very firmly and maintain this pressure.

Trajectory control systems

Anti-slip regulation (ASR) and dynamic stability control (DSC)

The anti-slip regulation (also known as traction control) optimises traction to prevent skidding of the wheels, by acting on the brakes of the driving wheels and on the engine.

The stability control acts on the brake of one or more wheels and on the engine to keep the vehicle on the trajectory required by the driver, within the limits of the laws of physics.

Activation

These systems are activated automatically every time the vehicle is started. They come into operation in the event of a problem with grip or trajectory.



This is indicated by flashing of this warning lamp in the instrument panel.

Deactivation

In exceptional conditions (starting a vehicle which is bogged down, stuck in snow, on soft ground, etc.), it may be advisable to deactivate the ASR and DSC systems, so that the wheels can regain grip.

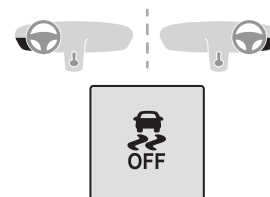

☞ Press this button until the corresponding symbol appears in the instrument panel.



The display of this symbol indicates that the ASR and DSC systems are deactivated.

! Excessive wheel slippage may damage the differential of your vehicle.

Reactivation

These systems are not reactivated automatically.

☞ Press the button again to reactivate them manually.

The symbol going off in the instrument panel indicates reactivation of the ASR and DSC systems.

Operating fault



Illumination of these warning lamps in the instrument panel indicates malfunction of these systems.

Contact a CITROËN dealer or a qualified workshop to have the ASR/DSC systems checked.

! Although the ASR/DSC systems help improve safety in normal driving, they should not encourage the driver to take extra risks or drive at high speed. The risk of loss of traction increases in conditions of reduced grip (rain, snow, ice). For your safety, you should therefore keep these systems activated at all times, particularly in poor conditions. The correct operation of these systems depends on observing the manufacturer's recommendations regarding wheels (tyres and rims), braking system components and electronic components, as well as assembly and repair procedures used by the CITROËN dealer network. After an impact, have these systems checked by a CITROËN dealer or a qualified workshop.

Engine brake reduction indicator lamp



Your vehicle is equipped with a system for the recovery of energy during deceleration which uses the engine brake.

It recovers into the traction battery some of the energy generated when the vehicle slows down (e.g. on a long descent) to improve the range of the battery and so the distance that can be travelled between charges.

When the traction battery has been charged fully and for the first few miles (or kilometres) of use of the vehicle, the engine brake is reduced temporarily.



This indicator lamp flashes on the instrument panel, inviting you to adapt your driving accordingly.

We therefore recommend that you anticipate your braking as much as possible: use the brake pedal to slow down or stop the vehicle.

i The braking power is never reduced while the indicator lamp is flashing.

Seat belts

Front seat belts

The front seat belts are fitted with a pretensioning and force limiting system. This system improves safety in the front seats in the event of a front or side impact. Depending on the severity of the impact, the pretensioning system instantly tightens the seat belts against the body of the occupants. The pretensioning seat belts are active when the ignition is on. The force limiter reduces the pressure of the seat belt on the passenger's chest, thus improving their protection.

Fastening



- ☞ Pull the strap then insert the tongue in the buckle.
- ☞ Check that the seat belt is fastened correctly by pulling the strap.

Unfastening

- ☞ Press the red button on the buckle.

Front seat belt not fastened/ unfastened warning lamp



When the ignition is switched on, this warning lamp comes on for a few seconds, accompanied by an audible signal, if the driver and/or the passenger have not fastened their seat belt.

Within one minute after switching on the ignition, if the driver does not fasten their seat belt, this warning lamp flashes, accompanied by an intermittent audible signal. After about 90 seconds, the warning lamp and the audible signal will go off, then come on again and stay on until the driver fastens their seat belt.

While the **vehicle is in motion**, if the seat belt is unfastened, you will be notified by the same alerts.

Rear seat belts



The rear seats are equipped with two 3-point seat belts each fitted with an inertia reel.

5

Fastening

- ☞ Pull the strap then insert the tongue in the buckle.
- ☞ Check that the seat belt is fastened correctly by pulling the strap.

Unfastening

- ☞ Press the red button on the buckle.

Seat belt unfastened warning lamps



Rear right seat belt warning lamp.



Rear left seat belt warning lamp.

Illumination of one of these warning lamps in the instrument panel indicates that a rear passenger has unfastened their seat belt.

Advice

I The driver must ensure that passengers use the seat belts correctly and that they are all restrained securely before setting off. Wherever you are seated in the vehicle, always fasten your seat belt, even for short journeys.

Do not interchange the seat belt buckles as they will not completely fulfil their role.

The seat belts are equipped with an inertia reel which allows the strap length to automatically adjust to your shape. The seat belt returns to its storage position automatically when it is not used.

Before and after use, ensure that the seat belt is reeled in correctly.

The lower part of the strap must be positioned as low as possible on the pelvis.

The upper part must be positioned in the hollow of the shoulder.

The inertia reels are fitted with a device which automatically locks the strap in the event of a collision or emergency braking or if the vehicle rolls over. You can release the device by pulling the strap firmly and then releasing it so that it reels in slightly.

In order to be effective, a seat belt:

- Must be tightened as close to the body as possible,
- Must be pulled in front of you with a smooth movement, ensuring that it is not twisted,
- Must only be used to secure one person,
- Must not show signs of tearing or fraying,
- Must not be changed or modified, in order to avoid affecting its performance.

In accordance with current safety regulations, for all repairs on your vehicle's seat belts, go to a qualified workshop with the skills and equipment needed, which a CITROËN dealer is able to provide.

Have your seat belts checked regularly by a CITROËN dealer or by a qualified workshop, particularly if the straps show signs of damage.

Clean the seat belt straps with soapy water or a textile cleaning product, sold by CITROËN dealers.

After folding or moving a seat or a rear bench seat, ensure that the seat belt is positioned and reeled in correctly.

Instructions for children

Use a suitable child seat, if the passenger is less than 12 years old or shorter than one and a half metres.

Never use the same seat belt to secure more than one person.

Never allow a child to travel on your lap.

For more information on **Child seats**, refer to the corresponding section.

In the event of an impact

Depending on the nature and seriousness of the impacts, the pyrotechnic device may trigger before and independently of airbag deployment. Deployment of the pretensioners is accompanied by a slight discharge of harmless smoke and a noise, due to the activation of the pyrotechnic cartridge incorporated in the system.

In all cases, the airbag warning lamp comes on.

After an impact, have the seat belt system checked and, if necessary, replaced by a CITROËN dealer or a qualified workshop.

Airbags

The airbags are designed to help enhance the safety of occupants in the event of a serious collision. They complement the action of the safety belts equipped with force limiters. If a collision occurs, the electronic detectors record and analyse the front and side impacts sustained in the impact detection zones:

- if there is a violent impact, the airbags deploy instantly and help better protect occupants of the vehicle; immediately after the impact, the airbags deflate rapidly in order not to hinder the visibility or the possible exit of the occupants.
- in the case of a minor or rear impact or in certain roll-over conditions, the airbags may not be deployed; the seat belt alone contributes towards ensuring your protection in these situations.

! The airbags do not operate when the ignition is switched off.

This equipment will only deploy once. If a second impact occurs (during the same or a subsequent accident), the airbag will not be deployed again.

Impact detection zones

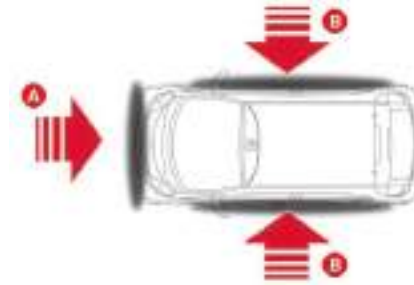

- A. Front impact zone.
- B. Side impact zone.

i Airbag deployment generates slight smoke emissions and a noise, due to the activation of the pyrotechnic cartridge incorporated in the system. This smoke is not harmful, but sensitive individuals may experience slight irritation. The detonation noise associated with the deployment of an air bag may result in a slight loss of hearing for a short time.

Front airbags

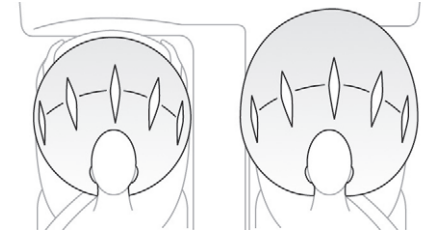

This system protects the driver and front passenger from the risk of injury to the head and chest in the event of a severe frontal impact.

The driver's airbag is fitted in the centre of the steering wheel; the front passenger's airbag is fitted in the dashboard above the glove box.

Activation

The airbags are deployed (except the passenger's front airbag if it is deactivated) in the event of a severe frontal impact to all or part of the frontal impact zone **A**, in the longitudinal centreline of the vehicle on a horizontal plane and directed from the front to the rear of the vehicle.

The front airbag inflates between the front occupant of the vehicle and the dashboard, to cushion their forward movement.

Malfunction



If this warning lamp comes on in the instrument panel, contact a CITROËN dealer or a qualified workshop without delay to have the system checked. The airbags may no longer be deployed in the event of a serious impact.

In this case, do not install a child seat nor allow a passenger to sit in the front passenger seat.

Lateral airbags



This system protects the driver and front passenger in the event of a severe side impact to minimise the risk of injury to the chest, between hip and shoulder. Each lateral airbag is fitted in the seat backrest frame, door side.

Deployment

A lateral airbag is deployed unilaterally in the event of a severe side impact applied to all or part of side impact zone **B**, perpendicular to the longitudinal centreline of the vehicle on a horizontal plane and directed from the outside towards the inside of the vehicle.

The lateral airbag inflates between the hip and shoulder of the front occupant and the corresponding door trim panel.

Impact detection zones

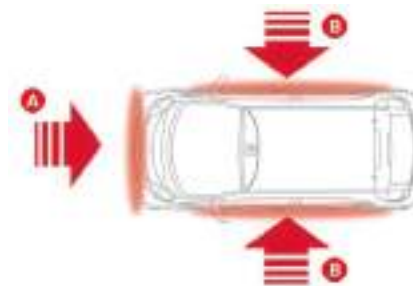

- A. Front impact zone.
- B. Side impact zone.

Curtain airbags

This system protects the driver and passengers in the event of a severe lateral impact in order to limit the risk of injury to the head.

Each curtain airbag is built into the pillars and the upper passenger compartment area.

Deployment

Each curtain airbag is deployed at the same time as the corresponding lateral airbag in the event of a serious side impact applied to all or part of the side impact zone **B**, perpendicular to the longitudinal centreline of the vehicle on a horizontal plane and directed from the outside towards the inside of the vehicle.

The curtain airbag inflates between the front or rear occupant of the vehicle and the windows.

Malfunction



If this warning lamp comes on in the instrument panel, contact a CITROËN dealer or a qualified workshop to have the system checked. The airbags may no longer be deployed in the event of a serious impact.

! In the event of a minor impact or bump on the side of the vehicle or if the vehicle rolls over, the airbag may not be deployed. In the event of a rear or front collision, the airbag is not deployed.

5

Advice

! For the airbags to be fully effective, observe the safety recommendations below.

Adopt a normal and upright sitting position.

Wear a correctly adjusted seat belt.

Do not leave anything between the occupants and the airbags (a child, pet, object, etc.), nor fix or attach anything close to or in the way of the airbag release trajectory; this could cause injuries during their deployment.

Never modify the original definition of your vehicle, particularly in the area directly around the airbags.

After an accident or if the vehicle has been stolen, have the airbag systems checked.

All work on the airbag systems must be carried out by a CITROËN dealer or a qualified workshop.

Even if all of the precautions mentioned are observed, a risk of injury or of minor burns to the head, chest or arms when an airbag is deployed cannot be ruled out. The bag inflates almost instantly (within a few milliseconds) then deflates within the same time discharging the hot gas via openings provided for this purpose.

Front airbags

Do not drive holding the steering wheel by its spokes or resting your hands on the centre part of the wheel.

Passengers must not place their feet on the dashboard.

Do not smoke as deployment of the airbags can cause burns or the risk of injury from a cigarette or pipe.

Never remove or pierce the steering wheel or hit it violently.

Do not fit or attach anything to the steering wheel or dashboard, this could cause injuries in case of airbag deployment.

Lateral airbags

Use only approved covers on the seats, compatible with the deployment of the lateral airbags. For information on the range of seat covers suitable for your vehicle, contact a CITROËN dealer.

Do not attach anything to or hang anything from the seat backrests (clothes, etc.) as this could cause injuries to the thorax or arm when the lateral airbag is deployed.

Do not sit with the upper part of the body any nearer to the door than necessary.

Curtain airbags

Do not attach anything or hang anything to the roof, as this could cause head injuries when the curtain airbag is deployed.

If fitted to your vehicle, do not remove the grab handles installed on the roof, they play a part in securing the curtain airbags.

General points relating to child seats

- i The regulations on carrying children are specific to each country. Refer to the legislation in force in your country.

For maximum safety, please observe the following recommendations:

- In accordance with European regulations, **all children under the age of 12 or less than one and a half metres tall must travel in approved child seats suited to their weight**, on seats fitted with a seat belt or ISOFIX mountings
- **Statistically, the safest seats in your vehicle for carrying children are the rear seats.**
- **A child weighing less than 9 kg must travel in the rearward facing position both in the front and in the rear.**

- i **It is recommended** that children travel on the **rear seats** of your vehicle:
 - **Rearward facing** up to the age of 3.
 - **Forward facing** from the age of 3.

Child seat at the rear

"Rearward facing"

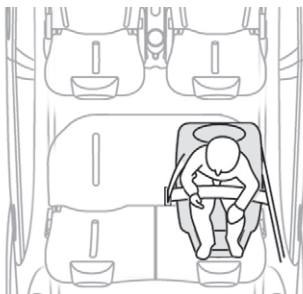

When a "rearward facing" child seat is installed **on a rear passenger seat**, move the vehicle's front seat forwards and straighten the backrest so that the rearward facing child seat does not touch the vehicle's front seat.

"Forward facing"

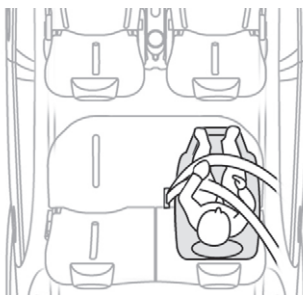

When a "forward facing" child seat is installed **on a rear passenger seat**, move the vehicle's front seat forward and straighten the backrest so that the legs of the child in the forward facing child seat do not touch the vehicle's front seat.

- i Ensure that the seat belt is correctly tensioned.
 For child seats with a support leg, ensure that this is in firm contact with the floor. If necessary, adjust the passenger seat.

Child seat at the front

"Rearward facing"

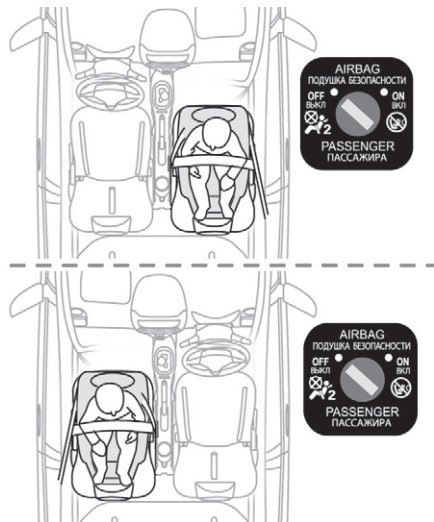

When a "rearward facing" child seat is installed on the **front passenger seat**, adjust the seat to the intermediate longitudinal position, with the backrest straightened.

! The passenger's front airbag must be deactivated. Otherwise, **the child would risk being seriously injured or killed if the airbag were deployed.**

"Forward facing"

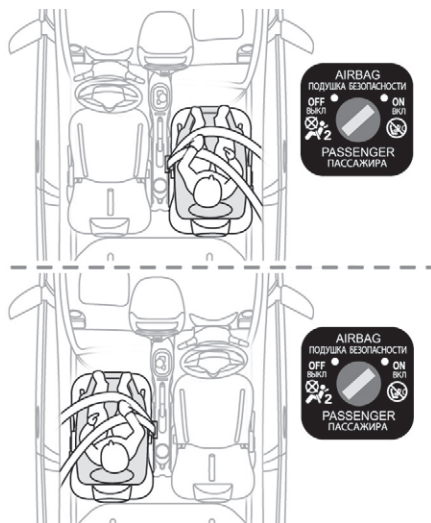

When a "forward facing" child seat is installed on the **front passenger seat**, adjust the vehicle's seat to the intermediate longitudinal position with seat backrest straightened and leave the passenger's front airbag activated.

i Ensure that the seat belt is correctly tensioned.
For child seats with a support leg, ensure that this is in firm contact with the floor. If necessary adjust the passenger seat.

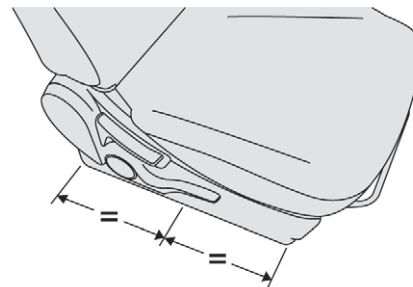

Passenger seat adjusted to the intermediate longitudinal position.

Deactivating the passenger's front airbag

! Never install a rearward facing child restraint system on a seat protected by an active front airbag. This could cause the death or serious injury of the child.





The warning label present on both sides of the passenger's sun visor repeats this advice. In line with current legislation, this warning is available in all of the languages required on the following pages.

Passenger airbag OFF



i For more information on the **Airbags**, refer to the corresponding section.

Deactivation

Only the passenger's front airbag can be deactivated.

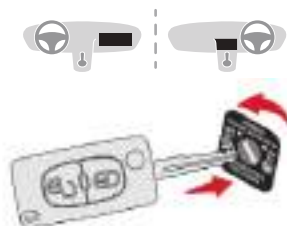

- ☞ **With the ignition off**, insert the key in the passenger airbag deactivation switch,
- ☞ Turn it to the **"OFF"** position,
- ☞ Remove the key.



When the ignition is on, this warning lamp comes on in the central console and stays on for as long as the airbag is deactivated.

! To ensure the safety of your child, the passenger's airbag must be deactivated when you install a "rearward facing" child seat on the front passenger seat. Otherwise, the child would risk being seriously injured or killed should the airbag be deployed.

Reactivation

When you remove the child seat, turn the switch to the **ON** position to reactivate the airbag and so to ensure the safety of your front passenger in the event of an impact. The associated warning lamp goes off.

5

AR	لا يجب أبدا تركيب نظام الأمان للطاقم باتجاه الورااء على مائدة سيارة تجهيز بواسطة امان حوائية انسية معلقة، فقد يؤدي هذا إلى التسبب بموت العائل أو بإصابات خطيرة ليه.
BG	НИКОГА НЕ инсталирайте детско столче на седалка с АКТИВИРАНА предна ВЪЗДУШНА ВЪЗГЛАВНИЦА. Това може да причини СМЪРТ или СЕРИОЗНО НАРАНЯВАНЕ на детето.
CS	NIKDY neumístujte dětské zádržné zařízení orientované směrem dozadu na sedadlo chráněné AKTIVOVANÝM čelním AIRBAGEM. Hrozí nebezpečí SMRTI DÍTĚTE nebo VÁŽNÉHO ZRANĚNÍ.
DA	Brug ALDRIG en bagudvendt barnestol på et sæde, der er beskyttet af en AKTIV AIRBAG. BARNET risikerer at blive ALVORLIGT KVÆSTET eller DRÆBT.
DE	Montieren Sie auf einem Sitz mit AKTIVIERTEM Front-Airbag NIEMALS einen Kindersitz oder eine Babyschale entgegen der Fahrtrichtung, das Kind könnte schwere oder sogar tödliche Verletzungen erleiden.
EL	Μη χρησιμοποιείτε ΠΟΤΕ παιδικό κάθισμα με την πλάτη του προς το εμπρός μέρος του αυτοκινήτου, σε μια θέση που προστατεύεται από ΜΕΤΩΠΙΚΟ αερόσακο που είναι ΕΝΕΡΓΟΣ. Αυτό μπορεί να έχει σαν συνέπεια το ΘΑΝΑΤΟ ή το ΣΟΒΑΡΟ ΤΡΑΥΜΑΤΙΣΜΟ του ΠΑΙΔΙΟΥ
EN	NEVER use a rearward facing child restraint on a seat protected by an ACTIVE AIRBAG in front of it, DEATH or SERIOUS INJURY to the CHILD can occur
ES	NO INSTALAR NUNCA un sistema de retención para niños de espaldas al sentido de la marcha en un asiento protegido mediante un AIRBAG frontal ACTIVADO, ya que podría causar lesiones GRAVES o incluso la MUERTE del niño.
ET	Ärge MITTE KUNAGI paigaldage "seljaga sõidusuunas" lapseistet juhi kõrvalistmele, mille ESITURVAPADI on AKTIVEERITUD. Turvapadja avanemine võib last TÕSISELT või ELUOHTLIKULT vigastada.
FI	ÄLÄ KOSKAAN aseta lapsen turvaistuinta selkää ajosuuntaan istuimelle, jonka edessä suojana on käyttööön aktivoitu TURVATYYNY. Sen laukeaminen voi aiheuttaa LAPSEN KUOLEMAN tai VAKAVAN LOUKKAANTUMISEN.
FR	NE JAMAIS installer de système de retenue pour enfants faisant face vers l'arrière sur un siège protégé par un COUSSIN GONFLABLE frontal ACTIVÉ. Cela peut provoquer la MORT de l'ENFANT ou le BLESSER GRAVEMENT.
HR	NIKADA ne postavljati dječju sjedalicu leđima u smjeru vožnje na sjedalo zaštićeno UKLJUČENIM prednjim ZRAČNIM JASTUKOM. To bi moglo uzrokovati SMRT ili TEŠKU OZLJEDU djeteta.
HU	SOHA ne használjon menetiránynak háttal beszerelt gyermekülést AKTIVÁLT (BEKAPCSOLT) FRONTLÉGSZÁKKAL védett ülésen. Ez a gyermek HALÁLÁT vagy SÚLYOS SÉRÜLÉSÉT okozhatja.
IT	NON installare MAI seggiolini per bambini posizionati in senso contrario a quello di marcia su un sedile protetto da un AIRBAG frontale ATTIVATO. Ciò potrebbe provocare la MORTE o FERITE GRAVI al bambino.
LT	NIEKADA neįrenkite vaiko prietaikymo priemonės su atgal atgręžtu vaiku ant sėdynės, kuri saugoma VEIKIANČIOS priekinės ORO PAGALVĖS. Išsiskleidus oro pagalvei vaikas gali būti MIRTINAI arba SUNKIAI TRAUMUOTAS.
LV	NEKAD NEuzstādiēt uz aizmuguri vērstu bērnu sēdekļi priekšējā pasažiera sēdvietā, kurā ir AKTIVIZĒTS priekšējais DROŠĪBAS GAISA SPILVENS. Tas var izraisīt BĒRNA NĀVI vai radīt NOPIETNUS IEVAINOJUMUS.

MT	Qatt m'ghandek thalli tifel/tifla marbut f'siggu dahru lejn l-Airbag attiva, ghaliex tista' tikkawza korriment serju jew anke mewt lit-tifel/tifla
NL	Plaats NOOIT een kinderzitje met de rug in de rijrichting op een zitplaats waarvan de AIRBAG is INGESCHAKELD. Bij het afgaan van de airbag kan het KIND LEVENSGEVAARLIJK GEWOND RAKEN
NO	Installer ALDRI et barnesete med ryggen mot kjøretretningen i et sete som er beskyttet med en frontal AKTIVERT KOLLISJONSPUTE, BARNET risikerer å bli DREPT eller HARDT SKADET.
PL	NIGDY nie instalować fotelika dziecięcego w pozycji "tyłem do kierunku jazdy" na siedzeniu wyposażonym w CZŁOWĄ PODUSZKĘ POWIETRZNĄ w stanie AKTYWNYM. Może to doprowadzić do ŚMIERCI DZIECKA lub spowodować u niego POWAŻNE OBRAŻENIA CIAŁA.
PT	NUNCA instale um sistema de retenção para crianças de costas para a estrada num banco protegido por um AIRBAG frontal ACTIVADO. Esta instalação poderá provocar FERIMENTOS GRAVES ou a MORTE da CRIANÇA.
RO	Nu instalati NICIODATA un sistem de retenere pentru copii, dispus cu spatele in directia de mers, pe un loc din vehicul protejat cu AIRBAG frontal ACTIVAT. Aceasta ar putea provoca MOARTEA COPILULUI sau RANIREA lui GRAVA.
RU	ВО ВСЕХ СЛУЧАЯХ ЗАПРЕЩАЕТСЯ использовать обращенное назад детское удерживающее устройство на сиденье, защищенном ФУНКЦИОНИРУЮЩЕЙ ПОДУШКОЙ БЕЗОПАСНОСТИ, установленной перед этим сиденьем. Это может привести к ГИБЕЛИ РЕБЕНКА или НАНЕСЕНИЮ ЕМУ СЕРЬЕЗНЫХ ТЕЛЕСНЫХ ПОВРЕЖДЕНИЙ
SK	NIKDY neinštalujte detské zádržné zariadenie orientované smerom dozadu na sedadlo chránené AKTIVOVANÝM čelným AIRBAGOM. Mohlo by dôjsť k SMRTEĽNÉMU alebo VÁŽNEMU PORANENIU DIEŤAŤA.
SL	NIKOLI ne nameščajte otroškega sedeža s hrbtom v smeri vožnje, če je VARNOSTNA BLAZINA pred sprednjim sopotnikovim sedežem AKTIVIRANA. Takšna namestitve lahko povzroči SMRT OTROKA ali HUDE POŠKODBE.
SR	NIKADA ne koristite dečje sedište koje se okreće unazad na sedištu zaštićenim AKTIVNIM VAZDUŠNIM JASTUKOM ispred njega, jer mogu nastupiti SMRT ili OZBILJNA POVREDA DETETA.
SV	Passagerarkrockkudden fram MÅSTE vara avaktiverad om en bakåtvänd bilbarnstol installerad på denna plats. Annars riskerar barnet att DÖDAS eller SKADAS ALLVARLIGT.
TR	KESİNLKLE HAVA YASTIĞI AKTİF olan ön koltuğa yûzû arkaya dönük bir çocuk koltuğu yerleştirmeyiniz. Bu ÇOCUĞUN ÖLMESİNE veya ÇOK AĞIR YARALANMASINA sebep olabilir.

Recommended child seats

Range of recommended child seats which are secured using a **three-point seat belt**.

Group 0+: from birth to 13 kg

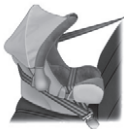

L1
"RÖMER Baby-Safe Plus"
Installed in the rearward facing position.



Groups 2 and 3: from 15 to 36 kg



L5
"RÖMER KIDFIX"
Can be fitted to the vehicle's ISOFIX mountings.
The child is restrained by the seat belt.

Installing a child seat attached with the seat belt

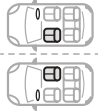
In accordance with European regulations, this table indicates the options for installing child seats secured using a seat belt and universally approved **(a)** according to the weight of the child and the seating position in the vehicle.

		Weight of the child/indicative age			
		Under 13 kg (groups 0 (b) and 0+) Up to about 1 year old	9-18 kg (group 1) From about 1 to 3 years old	15-25 kg (group 2) From about 3 to 6 years old	22-36 kg (group 3) From about 6 to 10 years old
Seat position	Front passenger seat (c) (e)	 L1	RÖMER Duo Plus ISOFIX (secured using the seat belt)	X	X
	Outer rear seats (d)	 U	U	U	U

- (a)** Universal child seat: child seat that can be installed in all vehicles using the seat belt.
- (b)** Group 0: from birth to 10 kg. Carry-cots and car beds cannot be installed on the front passenger seat.

- (c)** Refer to the current legislation in your country before installing your child on this seat.
- (d)** To install a child seat at the rear, rearward or forward facing, move the front seat forward, then adjust the backrest to an upright position to allow enough room for the child seat and the child's legs.

(e) When a rearward facing child seat is installed on the **front passenger seat**, it is essential to deactivate the passenger's airbag. Otherwise, **the child would risk being seriously injured or killed if the airbag were deployed**. When a forward facing child seat is installed on the **front passenger seat**, the passenger's airbag must remain activated.

U: Seat suitable for the installation of a child seat secured using a seat belt and universally approved, rearward facing and/or forward facing.

X: Seat not suitable for the installation of a child seat of the weight group indicated.

! Remove and stow the head restraint before installing a child seat with backrest on a passenger seat. Refit the head restraint once the child seat has been removed.

ISOFIX mountings

Your vehicle has been approved in accordance with the **latest** ISOFIX regulation.

The seats shown below are fitted with ISOFIX compliant mountings:

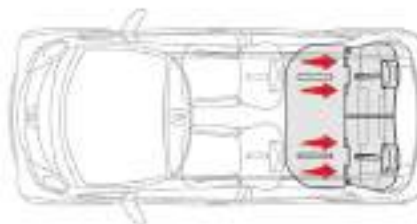

There are three rings for each seat:



- two rings **A**, located between the vehicle's seat backrest and cushion, indicated by a marking,



- a ring **B**, for fixing the upper strap, called **TOP TETHER** and located in the boot. Its position is indicated by a marking.

The **TOP TETHER** is used to secure the upper strap of child seats that have them. This device limits forward tipping of the child seat, in the event of a front impact.

This ISOFIX mounting system provides fast, reliable and safe fitting of the child seat in your vehicle.

The **ISOFIX child seats** are fitted with two latches which are secured to the two rings **A**. Some also have an **upper strap** which is attached to ring **B**.

5

Safety

To secure the child seat to the TOP TETHER:

- pass the child seat strap over the centre of the vehicle's seat backrest,
- lift the TOP TETHER cover,
- secure the upper strap fixing to the ring **B**,
- tighten the upper strap.

i The incorrect installation of a child seat in a vehicle compromises the child's protection in the event of an accident.

! Strictly observe the fitting instructions provided with the child seat.

For information on the possibilities for installing ISOFIX child seats in your vehicle, refer to the summary table.

Recommended ISOFIX child seats

i Also consult the installation guide from the child seat's manufacturer to find out how to install and remove the seat.

"RÖMER Baby-Safe Plus and its ISOFIX base" (size category: E)

Group 0+: from birth to 13 kg



Installed "rearward facing" using an ISOFIX base which is attached to rings **A**. The base has a height adjustable support leg that rests on the vehicle's floor.

This child seat can also be secured with a seat belt. In this case, only the shell is used and attached to the vehicle seat using the three-point seat belt.

"RÖMER Duo Plus ISOFIX" (size category: B1)

Group 1: 9-18 kg



Installed only in the "forward facing" position. Attached to rings **A** and upper ring **B**, referred to as TOP TETHER, using an upper strap.

Three seat body angles: sitting, reclining, lying down.

We recommend the lying down position. This child seat can also be used on seats not equipped with ISOFIX mountings. In this case, it must be secured to the vehicle's seat by the three-point seat belt. Adjust the position of the vehicle's front seat so that the child's feet are not touching the backrest.

Summary table of ISOFIX child seat locations

In line with European regulations, this table indicates the options for installing ISOFIX child seats on the vehicle seats fitted with ISOFIX mountings. In the case of universal and semi-universal ISOFIX child seats, the ISOFIX size category, determined by a letter from **A** to **G**, is indicated on the child seat next to the ISOFIX logo.

	Weight of the child/indicative age									
	Under 10 kg (group 0) Up to about 6 months old		Under 10 kg (group 0) Under 13 kg (group 0+) Up to about 1 year old			9-18 kg (group 1) From about 1 to 3 years old				
Type of ISOFIX child seat	Carry-cot*		"Rearward facing"			"Rearward facing"		"Forward facing"		
ISOFIX size category	F	G	C	D	E	C	D	A	B	B1
ISOFIX universal and semi-universal child seats which can be installed on the rear outer seats	X		X	X	RÖMER BabySafe Plus ISOFIX	X	X	IUF		

IUF: seat suitable for the installation of an Isofix Universal seat, "Forward facing", secured using the top tether.

X: seat which is not suitable for the installation of an ISOFIX seat of the size category indicated.

! Remove and stow the head restraint before installing a child seat with backrest on a passenger seat. Refit the head restraint once the child seat has been removed.

* Carry-cots and car beds cannot be installed on the front passenger seat.

Advice on child seats

! The incorrect installation of a child seat in a vehicle compromises the child's protection in the event of an accident.

Ensure that there is no seat belt or seat belt buckle under the child seat, as this could destabilise it.

Remember to fasten the seat belts or the child seat harnesses **keeping the slack relative to the child's body to a minimum**, even for short journeys.

When installing a child seat using the seat belt, ensure that the seat belt is tightened correctly on the child seat and that it secures the child seat firmly on the seat of your vehicle. If your passenger seat is adjustable, move it forwards if necessary.

At rear seating places, always leave sufficient space between the front seat and:

- a "rearward facing" child seat,
- the feet of a child seated in a "forward facing" child seat.

To do this, move the front seat forwards and, if necessary, move its backrest into the upright position.

For optimal installation of the "forward facing" child seat, verify that its backrest is as close as possible to the backrest of the vehicle seat, or if possible in contact with it.

You must remove the head restraint before installing a child seat with backrest on a passenger seat. Ensure that the head restraint is stored or attached securely to prevent it from being thrown around the vehicle in the event of sharp braking. Refit the head restraint when the child seat is removed.

Children in the front

The legislation on carrying a child on the front passenger seat is specific to each country. Refer to the legislation in force in your country.

Deactivate the passenger airbag when a "rearward facing" child seat is installed on the front passenger seat. Otherwise, the child may be seriously injured or killed were the airbag to be deployed.

Installing a booster seat

The chest part of the seat belt must be positioned on the child's shoulder without touching the neck.

Ensure that the lap part of the seat belt passes correctly over the child's thighs. CITROËN recommends using a booster seat with a backrest, equipped with a belt guide at shoulder level.

As a safety precaution, do not leave:

- a child or children alone and unattended in a vehicle,
- a child or an animal in a car which is exposed to the sun, with the windows closed,
- the keys within reach of children inside the vehicle.

To prevent accidental opening of the doors and rear windows, use the child lock. Take care not to open the rear windows by more than one third.

To protect young children from the rays of the sun, fit side blinds on the rear windows.

Child lock

Mechanical system to prevent opening of a rear door using its interior control.

The control is located on the edge of each rear door.

Locking

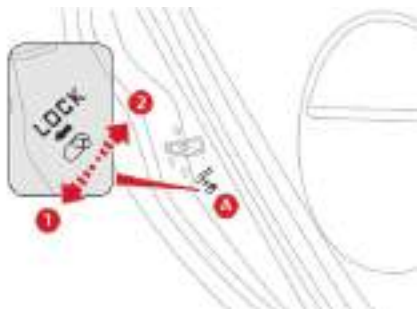

☞ Move control **A** down to position **1**.

Unlocking

☞ Move control **A** up to position **2**.

Driving recommendations

Observe the driving regulations and remain vigilant whatever the traffic conditions. Pay close attention to the traffic and keep your hands on the steering wheel so that you are ready to react at any time to any eventuality. As a safety measure, the driver must only carry out any operations that require close attention when the vehicle is stationary. On a long journey, a break every two hours is strongly recommended. In bad weather, drive smoothly, anticipate the need to brake and increase the distance from other vehicles.

Important!

! Never drive with the parking brake applied – Risk of overheating and damage to the braking system!

! Never leave a vehicle unsupervised with the motor running. If you have to leave your vehicle with the motor running, apply the parking brake and put the drive selector into position **N** or **P**.

Driving on flooded roads

We strongly advise against driving on flooded roads, as this could cause serious damage to the motor or gearbox, as well as to the electrical systems of your vehicle. If you are obliged to drive through water:



- check that the depth of water does not exceed 6 inches (15 cm), taking account of waves that might be generated by other users,
- drive as slowly as possible. In all cases, do not exceed 6 mph (10 km/h).

On leaving the flooded road, as soon as circumstances allow, make several light brake applications to dry the brake discs and pads. If in doubt about the state of your vehicle, contact a CITROËN dealer or a qualified workshop.

Starting-switching off the vehicle

Ignition switch

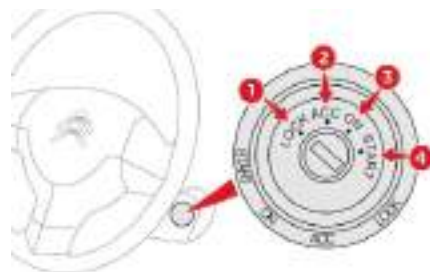

- Position 1: **LOCK**. The steering is locked.
- Position 2: **ACC**. The accessories (audio system, 12V socket, etc.) can be used.
- Position 3: **ON**. Switching on the ignition.
- Position 4: **START**. "Ready" lamp lights up. Engine operation.

! If you use accessories for a prolonged period of time (with the switch in position **ACC**), you risk discharging the ancillaries battery. Starting your vehicle will then no longer be possible. **Be careful.**

Starting

- ☞ Check that the drive selector is in position **P**.
- ☞ Insert the key in the ignition switch.
- ☞ Turn the key to position **4 (START)**.

READY

- ☞ Hold the key in that position for a few seconds until the "**READY**" indicator lights up and an audible signal sounds.
- ☞ Release the key.
The switch will automatically return to position **3 (ON)**.

Switching off

- ☞ Immobilise the vehicle.
- ☞ Keep your foot on the brake pedal.
- ☞ Place the drive selector in position **P**.
- ☞ Apply the parking brake.
- ☞ Turn the key to position **1 (LOCK)**.
- ☞ Remove the key from the ignition switch.

i Avoid attaching heavy objects to the key, which would weigh down on its blade in the ignition switch and could cause a malfunction.

Parking brake Application

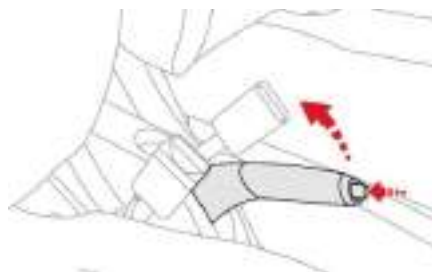

- ☞ Pull the parking brake lever fully up to immobilise your vehicle.

Release

- ☞ Pull the parking brake lever up gently, press the release button then lower the lever fully.



When the vehicle is moving, if the brake remains applied or is not fully released, this warning lamp comes on.



When parking on a slope, direct your wheels against the kerb, apply the parking brake, put the drive selector in position **P** and switch off the ignition.

Drive selector Selector positions

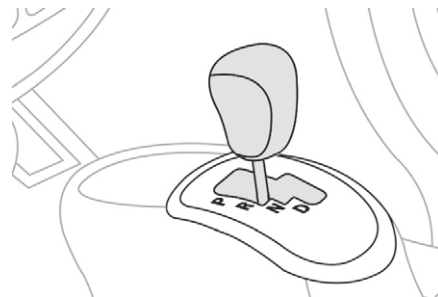

- P.** Park.
This position allows you to start the vehicle.
To exit position **P**, you must have your foot on the brake.
- R.** Reverse.
- N.** Neutral.
- D.** Drive (forward).

Displays in the instrument panel

When you move the drive selector in the gate to select a position, the corresponding symbol appears in the instrument panel.

6

Starting the vehicle



With the engine running, **P** appears on the instrument panel display screen.

- ☞ Press the brake pedal to exit position **P**.



- ☞ Select forward drive (**D**) or reverse (**R**).
- ☞ Release the parking brake.

- ☞ Take your foot off the brake pedal, and the vehicle will move at a low speed to make manoeuvring easier.
- ☞ Accelerate to move forward or backward.
- ☞ "**D**" or "**R**" appears on the instrument panel display screen.

Switching off the vehicle

To switch off the engine, select position **P**. You must without fail apply the parking brake to immobilise the vehicle.

To remove the key from the ignition, the drive selector must be in position **P**.

! To tow your vehicle, the drive selector must be in position **N**.
For more information on **Towing the vehicle**, refer to the corresponding section.

Tyre under-inflation detection

System which automatically checks the pressures of all four tyres from when the ignition is switched on.

The pressure sensors are located in the valves of each tyre.

The system triggers an alert as soon as it detects a drop in the pressure of one or more tyres by comparison with the reference pressure stored in the system. This reference pressure must be reinitialised after every tyre pressure adjustment or wheel change.

The system operates provided that the sensor identifiers have been first logged by a CITROËN dealer or a qualified workshop.

You can log two sets of tyres (for example: wheels with "all weather" tyres and wheels with "winter" tyres).

! The tyre under-inflation detection system is a driving aid which does not replace the need for vigilance on the part of the driver.

! This system still requires you to check the tyre inflation pressure every month as well as before a long journey.

Driving with under-inflated tyres impairs handling, extends braking distances and causes premature tyre wear, particularly in adverse conditions (heavy loads, high speeds, long journeys).

 Driving with under-inflated tyres increases fuel consumption.

! The tyre pressure specifications for your vehicle can be found on the tyre pressure label.

For more information on the **Identification markings**, refer to the corresponding section.

Tyre pressures should be checked when the tyres are "cold" (vehicle stopped for 1 hour or after a journey of less than 6 miles (10 km) at moderate speeds). Otherwise, add 0.3 bar to the values indicated on the label.

Under-inflation alert



This is indicated by the fixed illumination of this warning lamp.

- ☞ Reduce speed immediately, avoid excessive steering movements and sudden braking.
- ☞ Stop as soon as it is safe to do so.

! Detection of loss of pressure does not always bring about a visible deformation of the tyre. Do not make do with just a visual check.

- ☞ Check the pressures of the four tyres when "cold" using the compressor from the temporary puncture repair kit. If it is not possible to carry out this check straight away, drive carefully at reduced speed.
- or
- ☞ In case of a puncture, use the temporary puncture repair kit.

i The alert persists until the reference pressure values are reinitialised once the tyre or tyres concerned are reinflated, repaired or replaced. In case of tyre repair or replacement, the sensor identifiers must be logged by a CITROËN dealer or a qualified workshop.

Resetting the reference pressures

The system must be reinitialised after any adjustment to the pressures of one or more tyres, and after changing one or more wheels.

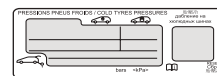

! Before reinitialising the system, ensure that the pressures of the four tyres are correct for the use of the vehicle and in line with the recommendations on the tyre pressure label.

The under-inflation detection system does not give a warning if a pressure is incorrect at the time of reinitialisation.



Reinitialisation of the system is done via the display screen of the instrument panel, with the ignition on and the vehicle stationary.

- ☞ Press button **A** to select the system.
- ☞ To reinitialise the under-inflation detection system press button **A** and hold it down for **at least 3 seconds**.

The flashing of the warning lamp in the instrument panel confirms that the system has been reinitialised.

The warning lamp will then go off after driving for about a hundred metres.

! The under-inflation alert can only be relied on if the reinitialisation of the system has been done with the pressures in the four tyres correctly adjusted.

Malfunction



The flashing and then fixed illumination of the under-inflation warning lamp indicates a fault with the system.

In this case, the pressure in the tyres is no longer monitored.

This alert is also displayed if:

- one or more wheels is not fitted with a sensor,
- there is a wireless device using the same frequency near the vehicle,
- there is snow or ice build-up in the wings or in the rims,
- the tyre pressure monitoring system battery charge level is insufficient,
- the wheel sensor identifiers have not been logged by a CITROËN dealer or a qualified workshop.

i Go to a CITROËN dealer or a qualified workshop to have the system checked or, following a puncture, to have the original wheel, equipped with a sensor, refitted with a tyre.

! Any tyre repair or replacement on a wheel fitted with this system must be carried out by a CITROËN dealer or a qualified workshop.

If you fit the second set of tyres stored in the system, the malfunction alert will appear until this second set is selected in the configuration menu.

Managing sets of tyres

If you have registered a second set of tyres with a CITROËN dealer or a qualified workshop, every time the set of tyres is changed (e.g. "winter" tyre), select the set you have just installed in the configuration menu.

! Once the new set has been fitted, check and adjust the pressure to the value stated on the tyre pressure label.
For more information on the **Identification markings**, refer to the corresponding section.

The other set of tyres is selected via the instrument panel display screen, with the ignition on and the vehicle stationary.

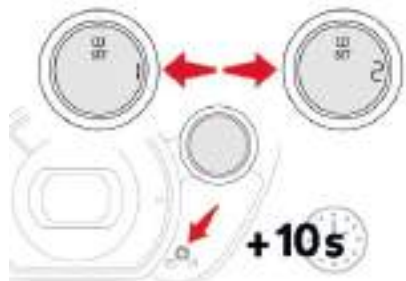

- ☞ Press button **A** to select the system.
- ☞ Press button **A** and hold it down for **more than 10 seconds** to move from tyre set **1** to tyre set **2** in succession or vice versa.

i The system resets the reference pressure automatically based on the pressure noted in the new set (the under-inflation detection lamp flashes during the operation).

TOTAL & CITROËN

PARTNERS IN THE FUTURE OF THE AUTOMOBILE

The TOTAL and CITROËN teams combine their talents to optimise energy efficiency and reduce the impact on the environment.

The partnership between our two groups on an international scale does not just come down to producing and maintaining mainstream vehicles: our positions as industrial leaders allow us to meet the environmental challenges of today and tomorrow. Guaranteeing an environmentally responsible mobility to everyone is more than a desire, it's our passion.

Innovation is underway, the future of the automobile depends on it and we are responding together.



CITROËN prefers TOTAL



Recharging the main battery

Two types of charging are available: normal or fast.

Normal charging is the preferred procedure; it is carried out via a domestic electricity network. Fast charging is carried out via a compatible fast charging point.

Normal charging



During charging, if you have a pacemaker or another electric medical device, you must not stay inside or close to the vehicle, the charging cable, the charging unit or just the charging point, even for a short time.

It is crucial to speak to your doctor and find out about the precautions to take, and to respect them.

i Before making any connection, check that the electrical installation that you want to use meets standards* and is compatible with the amperage of your control unit. In case of doubt, contact a professional installer.

There are power points available that are designed specifically for charging electric vehicles.

For power points dedicated to charging an electric vehicle, refer to the corresponding installation recommendations.

In all cases, it is recommended that you first have an initial check and then regular checks on your installation carried out by a qualified electrician.

! In most European countries, CITROËN has established a partnership with a specialist company that can offer a check and update of your electrical installation. For more information, contact a CITROËN dealer.

! Use only the original CITROËN charging cable.

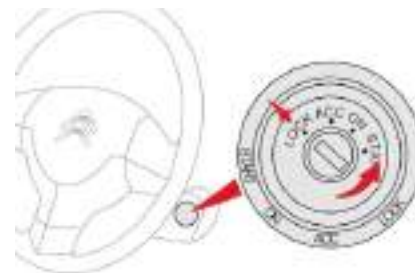

- ☞ Apply the parking brake and place the drive selector in position **P**.
- ☞ Switch off the electrical consumers and turn the ignition switch to position **"LOCK"**.

i In the event of damage to the charging cable or control unit, stop use immediately. For replacements, or in case of doubt, contact a CITROËN dealer.



- ☞ Pull lever **1** on the lower part of the dashboard, driver's side, to open the access flap to the normal charging socket (right-hand side of the vehicle).

* (e.g. for France: Standard NF C 15-100)

Practical information

- ☞ Take the charging cable stored in the bag supplied for this purpose. This cable is equipped with a control unit.
- ☞ Connect the charging cable to a compatible electrical socket that meets the required standards. On connection, the 3 control unit indicator lamps for **POWER**, **FAULT** and **CHARGING** come on simultaneously for a moment, then only the green **POWER** indicator lamp stays on.

! If the exterior temperature is below -25°C, charging may not be possible.



! Do not use an electrical extension lead, multi-socket, adapter or timer.

i Use the cord supplied to hook the control unit, so that it does not weigh down on the power point (risk of damage to the charging cable or power point).

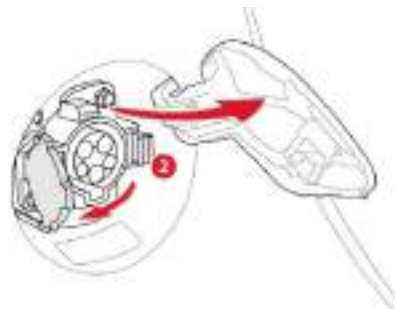

☞ Press the latch 2 to open the socket cover.

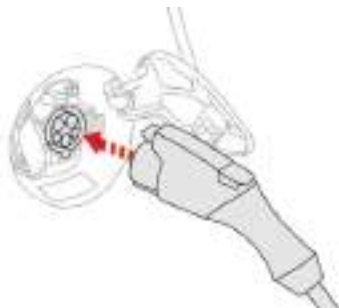

- ☞ Ensure that there is no foreign body on the vehicle socket.
- ☞ Remove the protective cover from the charging cable.
- ☞ Insert the charging plug into the socket without pressing the button, **until it clicks into place**.

! Do not touch the metal adaptor of the normal charging socket, or that of the charging cable (risk of electrocution and/or malfunction).

! Never connect or disconnect the cable or charging plug **with wet hands** (risk of electrocution).



- ☞ Check that the charging warning lamp in the instrument panel and the green **CHARGING** indicator lamp in the control unit are on fixed (not flashing).

If this is not the case, charging has not started; repeat the procedure ensuring that all connections are correct.

The main battery state of charge indicator is displayed in the instrument panel and the number of bars lit progresses as the battery is charged.

i The start of charging may be accompanied by the sound of pulsed air. This noise is completely normal.

i The charge may be interrupted at any time by withdrawing the charging plug from the vehicle socket.

! If, as an exception, you have to interrupt the charge by disconnecting the charging cable from the wall-mounted power point, it is essential to first press the **Manual Stop** button on the control unit.

Control unit



It has four indicator lamps:

- **STOP**: lit red.
It indicates that charging has been interrupted by pressing the **Manual Stop** button. This action is essential before disconnecting the charging cable from the wall-mounted power point during recharging.

- **POWER**: lit green.
It indicates that the electrical connection is secured. If it does not light up, check that the connections are correct. If the problem persists, contact a CITROËN dealer or a qualified workshop.
- **FAULT**: lit red.
It indicates that there is a fault. Check that the connections are correct. If this indicator lamp does not go out, contact a CITROËN dealer or a qualified workshop.
- **CHARGING**: lit green.
It indicates that charging is under way. If it does not light up, check that the connections are correct. If the problem persists, contact a CITROËN dealer or a qualified workshop.

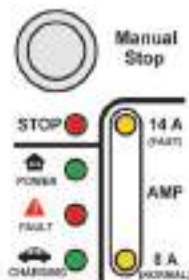

This type of control unit is equipped with an electric socket detection system (depending on the country). It detects the amperage that your

domestic power point is able to support and chooses the most suitable amperage for safe recharging:

- **14 A (FAST)**: if your power supply supports it.
- **8 A (NORMAL)**: if your power supply is standard.



The charging warning lamp in the instrument panel going off and the flashing of the green **CHARGING** warning lamp indicate that charging is complete.

- ☞ Press the button to release the charging plug.
- ☞ Refit the protective cover on the charging cable.
- ☞ Close the socket cover, then the access flap.
- ☞ Disconnect the charging cable from the power point.
- ☞ Store the charging cable in the bag supplied for this purpose.

i As a safety measure, the motor will not start when the charging cable is connected to the vehicle's socket. In addition, any attempt to start during the charging process will interrupt the procedure. It will then be necessary to disconnect and reconnect the charging plug to continue charging.

! If the ancillaries battery is discharged, charging of the main battery is no longer possible.

! During charging, never do any work under the bonnet of the vehicle, even with the ignition off, because the fan could start operating at any time (risk of physical injury).

Wait at least one hour after the end of the charging procedure before doing any work under the bonnet, because certain areas could be extremely hot (risk of burns).

! After recharging, ensure that the socket cover and access flap are closed. Take care to avoid allowing water or dust to enter the socket, under its cover or in the charging plug (risk of fire or electrocution).

! After removing the charging plug from the vehicle's socket, do not leave the cable connected to the wall-mounted power point (risk of short-circuit or of electrocution in the event of contact with or immersion in water).

! In the event of an accident or impact on the vehicle chassis (contact with a raised kerb, a bollard, an urban roadside fixture, etc.), the electrical circuit or the main battery could be damaged. Have your vehicle checked by a CITROËN dealer or a qualified workshop. Never touch the 300 V components or any orange cables.

! In the case of serious damage to the main battery, never touch any fluids leaking from this component. In the event of skin contact, wash abundantly with water and contact a doctor as soon as possible.

! **To optimise the service life of the main battery, recharge it completely every two weeks.**

For a complete charge, follow the normal charging procedure (domestic electricity supply) without interruption until it stops automatically (confirmed by the charging warning lamp going off in the instrument panel).



In addition, **every 3 months, make sure that you charge the main battery fully starting from a charge level less than or equal to 2 bars.**

i **Immobilising the vehicle for a long period**

When your vehicle is to be immobilised for an indeterminate period, carry out a complete charge of the main battery every three months (following the normal charging procedure).

Before carrying out the charging operation, ensure that the ancillaries battery is not disconnected or discharged. For more information on the **Ancillaries battery**, refer to the corresponding section.















States of the control unit













-  Lit in the corresponding indicator lamp colour.
- 

 Flashing in the corresponding indicator lamp colour.



 Off.

POWER 	FAULT 	CHARGING 	
			Once the charging cable is connected to a power point, all of the lamps come on for about half a second.
			Once you have finished initialising: <ul style="list-style-type: none"> • while the charging cable is not connected to the vehicle's socket, • while the charging cable is connected to the vehicle's socket, but charging is not taking place.
			While the traction battery is charging.
			When the charge has finished.



POWER 	FAULT 	CHARGING 	
			When current leakage is detected or the charging cable has a fault. <ul style="list-style-type: none"> - Stop the charging procedure immediately and contact a CITROËN dealer or a qualified workshop.
			When the charging cable has a fault. <ul style="list-style-type: none"> - Stop the charging procedure immediately and contact a CITROËN dealer or a qualified workshop.
			If the lamp on the control unit does not come on when connecting the charging cable to the power point, check the circuit breaker for the power point: <ul style="list-style-type: none"> • if the circuit breaker has tripped, your installation may not be compatible with use of the charging cable: <ul style="list-style-type: none"> - contact a qualified electrician to check and repair your electrical installation. • if the circuit breaker has not tripped: <ul style="list-style-type: none"> - do not use the charging cable and contact a CITROËN dealer or a qualified workshop.

<https://www.automotive-manuals.net/>

Use of a public charging point for normal charging

Several types of electric socket can be used to charge your vehicle.

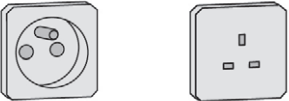
Before beginning to charge the vehicle, use the following table to identify the type of socket and obtain the corresponding charging cable.

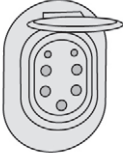
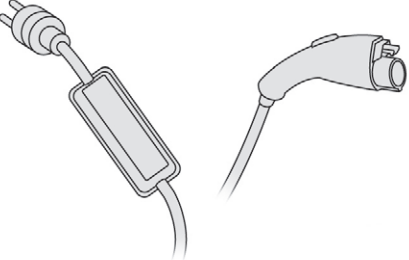
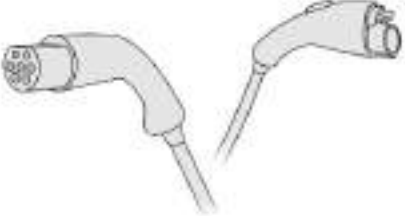
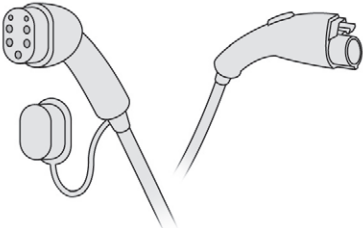
Domestic socket 	"Mode 3 – Type 2" socket 	"Mode 3 – Type 3" socket 
"Mode 2" cable (supplied with your vehicle) 	"Mode 3 – Type 2" cable (available as an accessory) 	"Mode 3 – Type 3" cable (available as an accessory) 

i Some public charging points have their own charging cable.
In this case, use the cable supplied.

The charge will be limited to 16 A maximum in mode 3, regardless of the power of the charging point.
For more information on charging durations, refer to the **Motor and main battery** section.

Fast charging

(Depending on equipment.)



If you have a pacemaker or any other electric medical device, you must not use fast charging. Do not approach a fast charging point. However, if this happens, leave the area as quickly as possible. If necessary, ask another person to charge your vehicle.

! Ensure that the charging point and its cable are compatible with your vehicle.

- ☞ Apply the parking brake and place the drive selector in position **P**.
- ☞ Switch off the electrical consumers and turn the ignition switch to position **"LOCK"**.

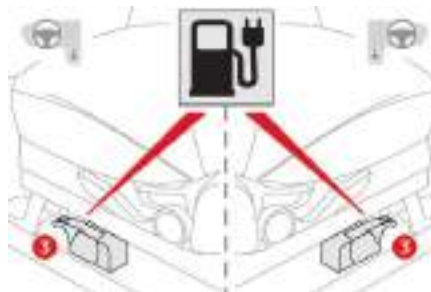

- ☞ Pull lever **3** below the driver's seat on the door side to open the access flap to the fast charging socket (left-hand side of the vehicle).

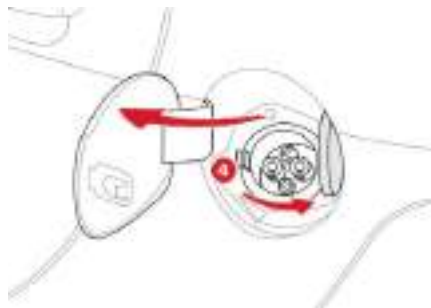

- ☞ Press the latch **4** to open the socket cover.
- ☞ Ensure that there is no foreign body on the vehicle socket.

! Do not touch the metal adaptor of the fast charging socket, or that of the charging cable. Risk of electrocution and/or malfunctions.



- ☞ Connect the charging point's cable to the vehicle's socket following the instructions for use of the charging point.



- ☞ Check that the charging warning lamp in the instrument panel is permanently lit.

If this is not the case, charging has not started; check the instructions for use of the charging point.

7

i During fast charging, the vehicle's air conditioning may start up automatically, if necessary, to cool the main battery. It is therefore completely normal to hear a ventilation noise from the exterior and to see a puddle of water form under the vehicle.

i Fast charging stops automatically when the main battery is about 80% charged. It is possible to achieve a 100% charge by starting the procedure again. However, the time required to complete the charge will be relatively long, as the charging speed will have slowed down.

The charging warning lamp in the instrument panel going off indicates that charging is complete.

- ☞ Disconnect the charging cable following the instructions for use of the charging point.
- ☞ Close the socket cover, then the access flap.

i As a safety measure, the engine will not start when the charging cable is connected to the vehicle's socket. In addition, any attempt to start during charging will interrupt the procedure. It will be necessary to disconnect and reconnect the charging cable to the vehicle's socket and then to begin charging again, following the instructions for use of the charging point.

! After recharging, ensure that the socket cover and access flap are closed. Take care to avoid allowing water or dust to enter the socket, under its cover or in the charging plug (risk of fire or electrocution).

i If the exterior temperature is below 0°C, charging times may be longer. If the exterior temperature is below -25°C, charging may not be possible.

i **Immobilising the vehicle for a long period**
When your vehicle is to be immobilised for an indeterminate period, carry out a complete charge of the main battery every three months (following the normal charging procedure). Before carrying out the charging operation, ensure that the ancillaries battery is not disconnected or discharged. For more information on the **ancillaries battery**, refer to the corresponding section.

Snow chains

The snow chains must be fitted only to the rear wheels (rear wheel drive car).

i Take account of the legislation in force in your country on the use of snow chains and the maximum authorised speed.

Installation tips

- ☞ If you have to fit the chains during a journey, stop the vehicle on a flat surface on the side of the road.
- ☞ Apply the parking brake and if necessary put wheel chocks against the wheels to prevent your vehicle from sliding.
- ☞ Fit the chains following the instructions provided by the manufacturer.
- ☞ Move off gently and drive for a few seconds, without exceeding 30 mph (50 km/h).
- ☞ Stop your vehicle and check that the snow chains are correctly tightened.

i It is strongly recommended that before you leave, you practise fitting the snow chains on a level and dry surface.

! Avoid driving with snow chains on roads that have been cleared of snow, to avoid damaging your vehicle's tyres and the road surface. If your vehicle is fitted with alloy wheels, check that no part of the chain or its fixings is in contact with the wheel rim.

Use only the chains designed to be fitted to the type of wheel fitted to your vehicle:

Original tyre size	Maximum link size
175/55 R15	9 mm
145/65 R15	cannot be fitted with chains

i For more information on snow chains, contact a CITROËN dealer or a qualified workshop.

Bonnet

Protects and provides access to the front compartment components for checking various fluid levels, charging the ancillaries battery, changing fuses, etc.

Opening

☞ Open the right-hand front door.



☞ Pull the interior bonnet release lever **A** located at the bottom of the door frame.



☞ Push the exterior safety catch **B** to the left and raise the bonnet.

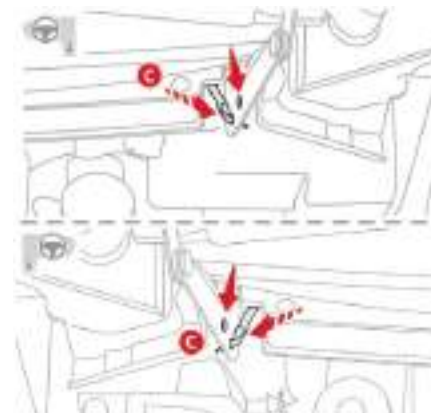

- ☞ Fully raise the bonnet and pull the support stay **C** located on the right-hand side out of its housing.
- ☞ Insert the support stay **C** into one of the two support slots to hold the bonnet open.

i The location of the interior bonnet release lever prevents opening of the bonnet if the right-hand front door is closed.

Closing

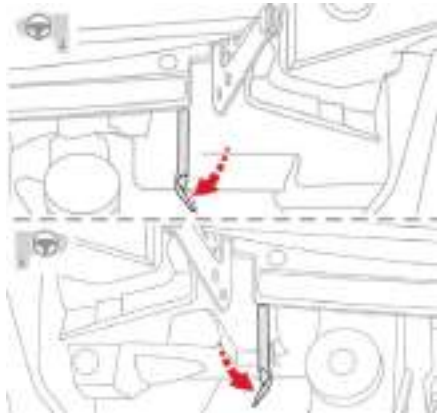

- ☞ Take the support stay out of the support slot.
- ☞ Replace the support stay in its housing.
- ☞ Lower the bonnet and drop it near the end of its travel.
- ☞ Pull on the bonnet to check that it is fully latched.

! Do not press down on the centre of the bonnet if not properly latched, as this could deform it. Instead, re-open the bonnet completely and close it again.

Front compartment

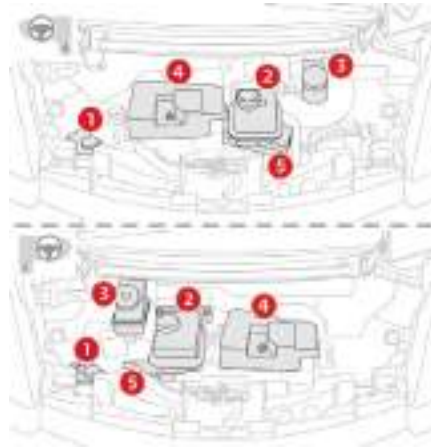

1. Screenwash fluid reservoir.
2. Heating system fluid reservoir.
3. Brake fluid reservoir.
4. Ancillaries battery.
5. Fusebox.

! In order to avoid damaging the electrical units, it is expressly prohibited to use high pressure washing to clean the front compartment.

Rear compartment

Located below the boot floor, this compartment provides access to the coolant reservoir.

- ☞ Open the boot.

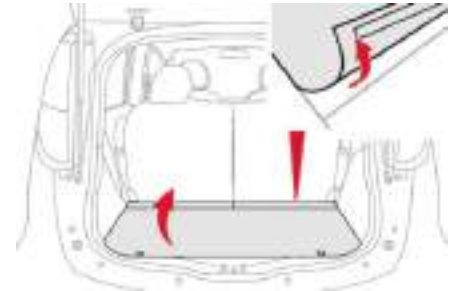

- ☞ Detach the adhesive strap securing the carpet.
- ☞ Remove the boot carpet.



- ☞ Remove the four "butterfly" screws.
- ☞ Remove the protective cover.

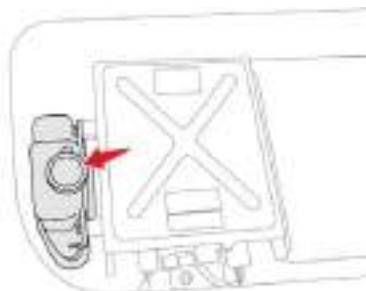

- ☞ Check the coolant level and top it up if necessary.

! For more information on **Checking levels**, refer to the corresponding section. During operations in this compartment, you must observe the safety instructions provided on the labels.

Checking levels

Check all of these levels regularly, in line with the manufacturer's service schedule. Top them up if necessary, unless otherwise indicated. Before topping up, make sure that the fluid conforms to the manufacturer's recommendations.

If a level drops significantly, have the corresponding system checked by a CITROËN dealer or a qualified workshop.

! Never work in the compartments while the "Ready" lamp is on or your vehicle is charging.

When working in the front and rear compartments, be careful because some areas of the compartments may be extremely hot (risk of burns): wait at least one hour after switching off the vehicle or until the end of the charging process before any such work.

Used products

! Avoid prolonged contact of used fluids with the skin. Most of these fluids are harmful to health or indeed very corrosive.

☘ Do not discard used fluids into sewers or onto the ground. Take used fluids to a CITROËN dealer or a qualified workshop and dispose of them in containers provided for this purpose.

Front compartment

Brake fluid level



The brake fluid level should be between the "MIN" and "MAX" marks. If not, check the brake pad wear.

Heating system fluid level

The fluid level should be between the marks "L" (MIN) and "F" (MAX).

Changing the fluid

This fluid does not need to be changed.

Screenwash fluid level



Top up the level when necessary.

Fluid specification

For optimum cleaning and to avoid freezing, this fluid must not be topped up or replaced with plain water.

Ancillaries battery electrolyte level

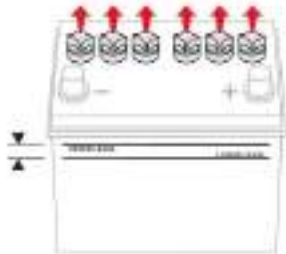

To check this level, you must remove the battery cover.

For more information on the **ancillaries battery**, refer to the corresponding section.

The level of this fluid must be between the "LOWER LEVEL" (MIN) and "UPPER LEVEL" (MAX) marks.

If necessary, top up with distilled water by removing the plugs from the battery's different compartments.

i Check the electrolyte level at least once a month.

Rear compartment

Coolant level



The level of this fluid must be between the "L" (MIN) and "F" (MAX) marks.

As the cooling system is pressurised, wait at least one hour after switching off the motor before carrying out any work.

To avoid any risk of burns, unscrew the cap by two turns to allow the pressure to drop. When the pressure has dropped, remove the cap and top up the level.

Changing the fluid

This fluid does not need to be changed.

Checks

Unless otherwise indicated, check these components in accordance with the manufacturer's service schedule. Otherwise, have them checked by a CITROËN dealer or a qualified workshop.

Passenger compartment filter



Depending on the environment (e.g. dusty atmosphere) and the use of the vehicle (e.g. city driving), **replace it twice as often if necessary.**

A clogged passenger compartment filter may have an adverse effect on the performance of the air conditioning system and generate undesirable odours.

Brake pads



Brake wear depends on the style of driving, particularly in the case of vehicles used in town, over short distances. It may be necessary to have the condition of the brakes checked, even between vehicle services.

Unless there is a leak in the circuit, a drop in the brake fluid level indicates that the brake pads are worn.

Brake disc/drum wear



For information on checking brake disc/drum wear, contact a CITROËN dealer or a qualified workshop.

Parking brake



If excessive travel or a loss of effectiveness of this system is noticed, the parking brake must be checked, even between two services.

This system must be checked by a CITROËN dealer or a qualified workshop.

! Only use products recommended by CITROËN or products of equivalent quality and specification.

In order to optimise the operation of components as important as those in the braking system, CITROËN selects and offers very specific products.

After washing the vehicle, dampness, or in wintry conditions, ice can form on the brake discs and pads: braking efficiency may be reduced. Make light brake applications to dry and defrost the brakes.

Changing a wiper blade

Removing front or rear wiper blades

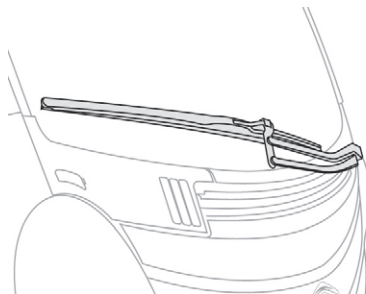

- ☞ Raise the corresponding wiper arm.
- ☞ Take off the wiper blade by sliding it to the outside.

Fitting front or rear wipers

- ☞ Put the new wiper blade in place and secure it.
- ☞ Carefully lower the wiper arm.

Washing precautions

! Never wash the vehicle while the battery is on charge.

! Before washing the vehicle, check that the access flaps and the charging socket covers (normal and fast) are closed properly.

! In order to avoid damaging the electric units, the use of a high pressure jet wash is strictly forbidden:

- under the bonnet,
- under the chassis.

i Do not use a pressure greater than 80 bars when washing the bodywork.

7

In the event of a breakdown

Ancillaries battery

All of the electrical components on your vehicle (with the exception of the electric motor, the heating and the air conditioning) are powered by the ancillaries battery.

It is located in the front compartment under the bonnet and is charged by the main battery during phases of operation ("Ready" lamp on in the instrument panel) and charging.

! If the ancillaries battery is discharged, the electric motor cannot be started and charging of the main battery is no longer possible.

! It is not recommended to disconnect the battery. However, during a prolonged period of more than one month without using your vehicle, it may be necessary, in winter, to disconnect the battery and store it to prevent the electrolyte freezing.

! After prolonged disconnection of the battery, you must consult a CITROËN dealer or a qualified workshop in order to have the electronic computer reset.

Access to the battery

- ☞ Open the bonnet using the interior release lever and then the exterior safety catch.
- ☞ Secure the bonnet stay.

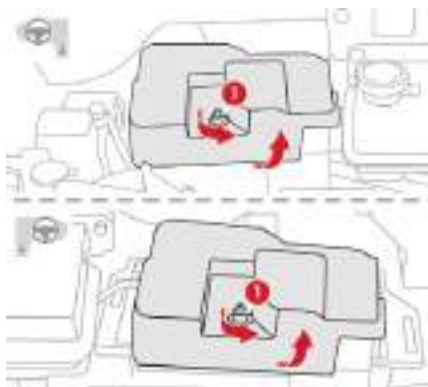

- ☞ Loosen the nut 1.
- ☞ Remove the protective cover from the battery for access to the two terminals.

Starting using another battery

! Make sure the electrolyte is not frozen. Check the level and top up with distilled water, if necessary. For more information on **Checking levels**, refer to the corresponding section.

! Ensure that the back-up battery is a 12 V battery.

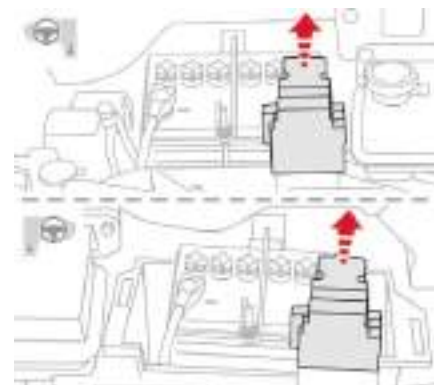

- ☞ Lift the protective cover from the (+) terminal,

Charging the battery using a battery charger

- ☞ Remove the battery protective cover.

! Make sure the electrolyte is not frozen.
Check the level and top up with distilled water, if necessary.
For more information on **Checking levels**, refer to the corresponding section.

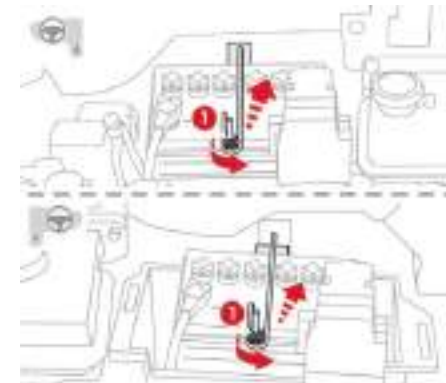

- ☞ Unscrew nut 1 and remove the retaining clip.

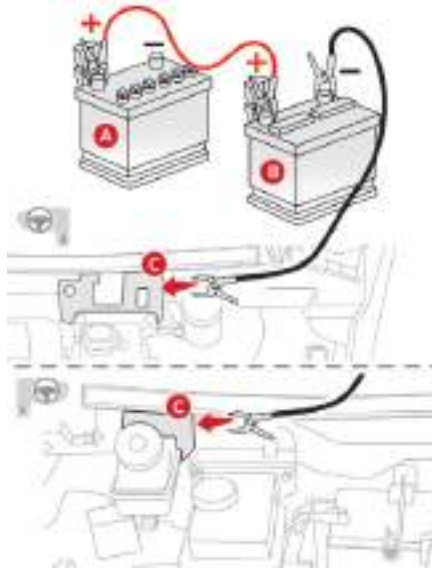

- ☞ Connect one end of the red cable to the (+) terminal of the flat battery **A**, then the other end to the (+) terminal of the back-up battery **B**.
- ☞ Connect one end of the green or black cable to the (-) terminal of the back-up battery **B**.
- ☞ Connect the other end of the green or black cable to the earth point **C** of your broken down vehicle.

- ☞ Start the engine of the vehicle with the good battery and wait for a few minutes.
- ☞ Operate the ignition switch of your vehicle until the "Ready" lamp comes on.
- ☞ Disconnect the jump cables in reverse order.
- ☞ Refit the protective cover on the battery and tighten the retaining nut.

If the "Ready" warning lamp does not come on, proceed as follows:

- ☞ Leave the cables connected.
- ☞ Set the ignition switch of your vehicle to the "LOCK" position.
- ☞ Charge the main battery, following the normal charging procedure.
- ☞ When the charging indicator lamp comes on constantly (fixed) in the instrument panel, disconnect the cables.
- ☞ Allow the charging to continue for at least one hour.
- ☞ Operate the ignition switch of your vehicle until the "Ready" lamp comes on.

If the problem persists, contact a CITROËN dealer or a qualified workshop.

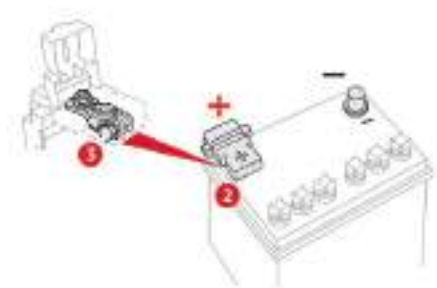

- ☞ Disconnect the cable from the (-) terminal.
- ☞ Lift the protective cover from the (+) terminal **2**.
- ☞ Slacken the nut **3**.
- ☞ Disconnect the cable from the (+) terminal.
- ☞ Remove the battery.
- ☞ Charge the battery following the instructions on use provided by the manufacturer of the battery charger.
- ☞ Reconnect the battery starting with the cable on the (+) terminal.

i Ensure that the terminals and connectors are clean. If they are covered with sulphate (whitish or greenish deposit), remove and clean them.

! Do not charge the battery without first disconnecting the terminals and removing the battery from the front compartment. Do not disconnect the terminals when the "Ready" lamp is on, nor when the vehicle is on charge.

Before disconnecting

Wait 2 minutes after switching off the ignition before disconnecting the battery.

After reconnection

Following reconnection of the battery, switch on the ignition and wait 1 minute before starting, to permit initialisation of the electronic systems. However, if minor problems persist following this operation, contact a CITROËN dealer or a qualified workshop.

Remember to reinitialise the audio system yourself.

🍀 Batteries contain harmful substances such as sulphuric acid and lead. They must be disposed of in accordance with local regulations and must not, in any circumstances, be discarded with household waste.
Take used remote control batteries and vehicle batteries to a designated collection point.

Temporary puncture repair kit

i Scan the QR code on page 3 to view explanatory videos.

Complete kit comprising a compressor and a sealant bottle, which allows the **temporary repair** of a tyre so that you can drive to the nearest garage.

It is designed to repair most punctures which could affect the tyre, located on the tyre tread or shoulder.

Access to the kit

This kit is stored in the storage box located under the rear bench seat, right-hand side. Therefore, to access the kit you must remove the rear seat.

Removing the rear seat



- ☞ Pull the controls **A** forwards to unlock the two seat locks.



- ☞ Raise the front of the seat and tip upwards to remove it.

Removing the metal cover plate

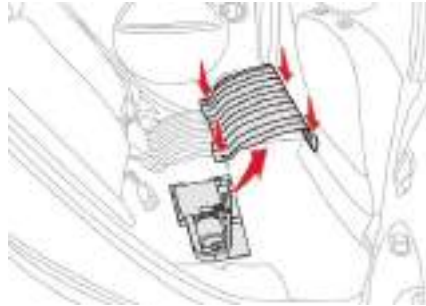

- ☞ Loosen the four "butterfly" screws.
- ☞ Remove the metal cover plate. You can then access the repair kit.

Refitting the rear seat



- ☞ Put the metal cover plate back in place.
- ☞ Retighten the four "butterfly" screws.

- ☞ Insert the metal hooks into the bench seat backrest.
- ☞ Tip the seat downwards and press to lock the two locks.
- ☞ Check that the seat is locked properly.

! When refitting the seat, take care not to trap the seat belt buckles.

Composition of the kit



1. 12 V compressor with a built-in pressure gauge to check and adjust the pressure of the tyre.

In the event of a breakdown

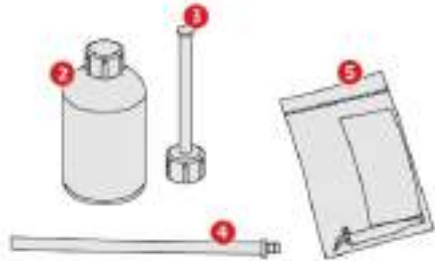

2. Sealant bottle for the temporary repair of a tyre.
3. Injection hose.
4. Suction hose, to extract the sealant if necessary.
5. Bag containing a spare valve core, a tool for removing/refitting the valve core, and a speed limit sticker.

! The speed limit sticker must be affixed to the vehicle's steering wheel to remind you that a wheel is in temporary use. Do not exceed a speed of 50 mph (80 km/h) when driving with a tyre repaired using this type of kit.

Repair procedure

Sealing

- ☞ Switch off the ignition.
- ☞ Make a mark on the provided speed limit sticker to identify which wheel needs repairing, and affix it to the vehicle's steering wheel to remind you that a wheel is in temporary use.

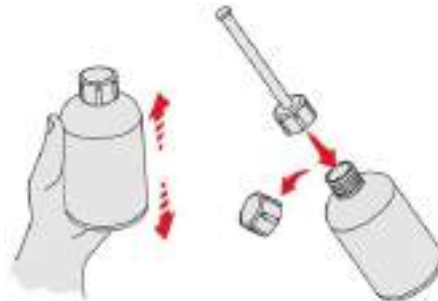

- ☞ Shake the bottle of sealant, remove the cap and screw on the injection hose.

i Avoid removing any foreign bodies which have penetrated into the tyre.



- ☞ Remove the valve cap from the tyre to be repaired.
- ☞ Unscrew the valve core using the removing/refitting tool, and keep it in a clean place.
- ☞ Connect the injection hose to the valve of the tyre to be repaired.

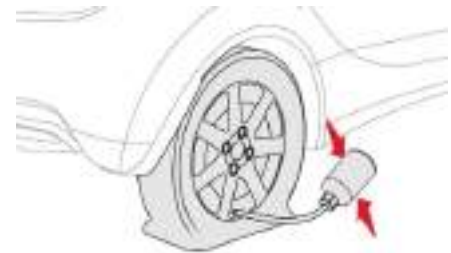

- ☞ Press on the sealant bottle (turned upside down) several times with the hand in order to inject the **entire content** into the tyre.

- ☞ Remove the injection hose.
- ☞ Replace the valve core using the tool.

! Take care, this product is harmful if swallowed and causes irritation to the eyes.

Keep this product out of the reach of children.

The use-by date is marked on the bottle. After use, do not discard the bottle by the roadside, take it to a CITROËN dealer or an authorised waste disposal site. Do not forget to obtain a new sealant bottle, available from a CITROËN dealer or a qualified workshop.

Inflation

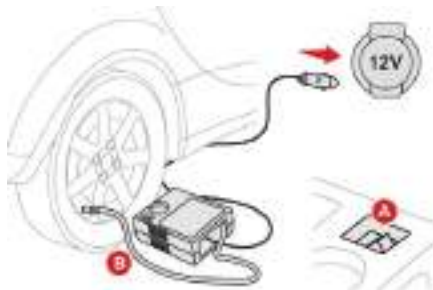

- ☞ Check that switch **A** of the compressor is in the "OFF" position.
- ☞ Uncoil the compressor hose **B** fully.
- ☞ Connect the hose to the sealed tyre's valve.
- ☞ Connect the compressor's electrical connector to the vehicle's 12V socket (ignition switch in "ON" or "ACC" position).
- ☞ Switch on the compressor by setting switch **A** in the "ON" position.
- ☞ Adjust the pressure using the compressor in accordance with the vehicle's tyre pressure label located on the driver's door aperture. A significant loss of pressure indicates that the puncture has not been fully sealed; contact a CITROËN dealer or qualified workshop for your vehicle to be repaired.
- ☞ Remove the compressor and stow the kit.
- ☞ Drive immediately at reduced speed (50 mph (80 km/h) max) limiting the distance travelled to approximately 120 miles (200 km).

! If after approximately five to seven minutes, the required pressure is not reached, this indicates that the tyre is not repairable; contact a CITROËN dealer or a qualified workshop for your vehicle to be recovered.

! As soon as possible, go to a CITROËN dealer or a qualified workshop. You must inform the technician that you have used this kit. After inspection, the technician will let you know if the tyre can be repaired or if it must be replaced.

Spare wheel

i Scan the QR code on page 3 to view explanatory videos.

! Parking the vehicle

Park the vehicle where it does not block traffic: the ground must be level, stable and non-slippery.

Apply the parking brake, switch off the ignition and put the drive selector in position **P** in order to block the wheels. If necessary, place a chock under the wheel diagonally opposite to the wheel to be changed.

Make absolutely certain that all the occupants have left the vehicle and are waiting in a safe area.

Never go underneath a vehicle raised using a jack; use an axle stand.

In the event of a breakdown

Necessary tools

- A jack: used to raise the vehicle.
- A wheelbrace: for removing the wheel bolts.
- A handle: used to operate the jack.

These tools are not supplied with your vehicle.

Wheel with trim

When removing the wheel, first remove the wheel trim by pulling at the valve passage using the wheelbrace.

When refitting the wheel, refit the wheel trim, starting by placing its aperture in line with the valve and then pushing it into place all round its edge with the palm of your hand.

Removing a wheel

- ☞ Loosen the bolts using the wheelbrace.

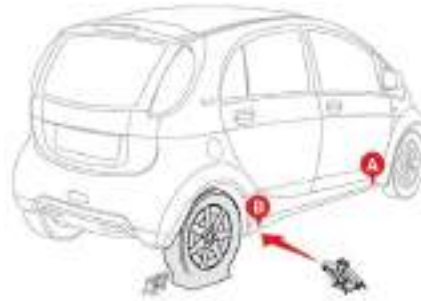

- ☞ Place the foot of the jack on the ground and ensure that it is directly below the front **A** or rear **B** jacking point provided on the underbody, whichever is closest to the wheel to be changed.

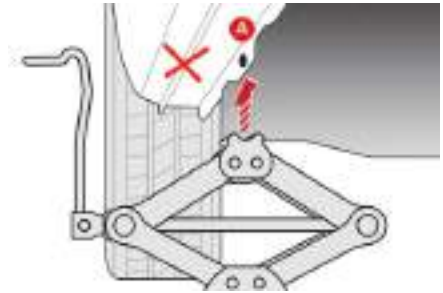
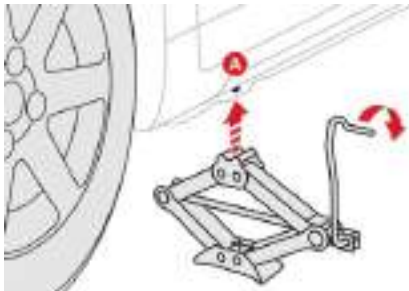

- ☞ Extend the jack until its head comes into contact with the jacking point **A** or **B**, whichever is used, having the contact surface **A** or **B** on the vehicle correctly engaged with the central part of the head of the jack.
- ☞ Raise the vehicle until there is sufficient space between the wheel and the ground.

! Ensure that the jack is stable. If the ground is slippery or loose, the jack may slip or collapse – Risk of injury!
Ensure that the jack is positioned only at one of jacking points, **A** or **B**, under the vehicle, making sure that the vehicle's contact surface is centred on the head of the jack. Otherwise, there is a risk of damage to the vehicle and/or the jack collapsing – Risk of injury!

Changing a bulb

- ! The headlamps have polycarbonate lenses with a protective coating:
 - ☞ **do not clean them using a dry or abrasive cloth, nor with a detergent or solvent product,**
 - ☞ use a sponge and soapy water or a pH neutral product,
 - ☞ when using a high pressure washer on persistent marks, do not keep the lance directed towards the lamps or their edges for too long, so as not to damage their protective coating and seals.

- ! Changing a bulb must only be done after the lamp has been switched off for several minutes (risk of serious burns).
 - ☞ Do not touch the bulb directly with your fingers, use a lint-free cloth.
- It is essential only to use anti-ultraviolet (UV) type bulbs, so as not to damage the lamp.
- Always replace a failed bulb with a new bulb with the same type and specification.

8

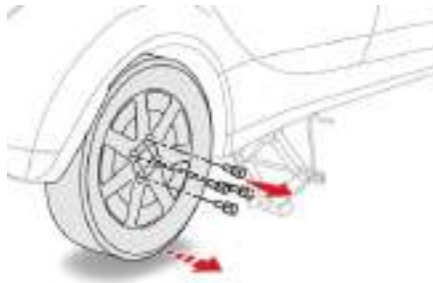

- ☞ Remove the bolts and store them in a clean place.
- ☞ Remove the wheel.

Fitting a wheel

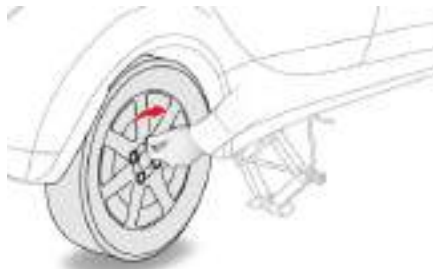

- ☞ Put the wheel in place on the hub.
- ☞ Screw in the bolts by hand to the stop.
- ☞ Pre-tighten the bolts using the wheelbrace.

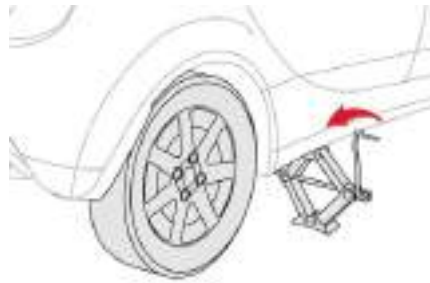

- ☞ Lower the vehicle fully.
- ☞ Fold the jack and detach it.

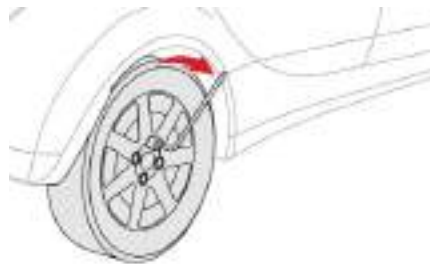

- ☞ Tighten the bolts using the wheelbrace.

- ! **After changing a wheel**
Have the tightness of the bolts and the pressure of the new wheel checked by a CITROËN dealer or a qualified workshop without delay.

Front lamps



1. Direction indicators (W21W – 21 W).
2. Sidelamps (W5W – 5 W).
3. Main beam headlamps (HB3 – 60 W).
4. Dipped beam headlamps (H11 – 55 W).



5. Front foglamps (H8 – 35 W).
6. Daytime running lamps (P13W – 13 W).

Access to bulbs

To replace a faulty bulb, you must first remove the lamp unit.

To remove the lamp unit:

- ☞ Open the bonnet.

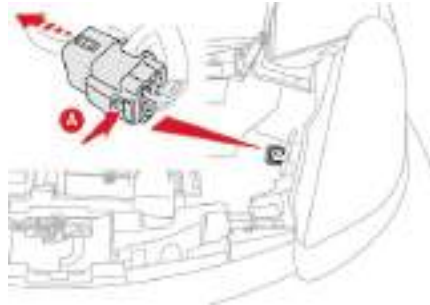

- ☞ Press tab **A** to release the connector.



- ☞ Lift cover **B** with a screwdriver wrapped with a cloth.

- ☞ Unscrew the mounting nut **C** until the head of the nut touches the trim.

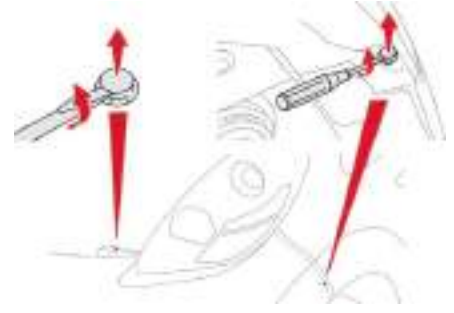

- ☞ Remove the clips holding the bumper using a screwdriver.
- ☞ Lift the bumper gently.

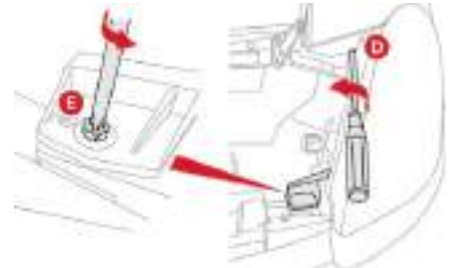

- ☞ Unscrew the mounting nut **D** while holding the bumper aside.
- ☞ Unscrew the mounting nut **E**.

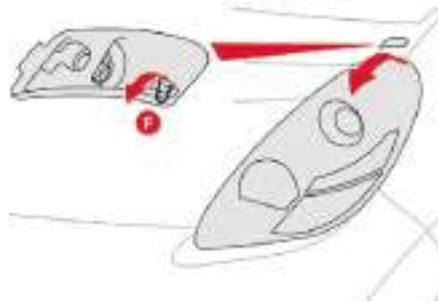

- ☞ Pull the lamp unit towards you and release the tab **F** to remove it completely.

Direction indicators

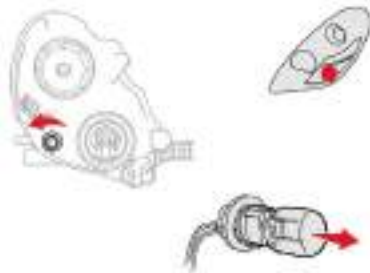

- ☞ Turn the bulb holder to the left and pull it out.
 - ☞ Pull out the bulb and replace it.
- To refit, carry out these operations in reverse order.

i Amber coloured bulbs must be replaced with bulbs of identical specification and colour.

Sidelamps

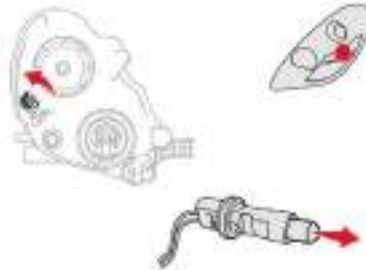

- ☞ Turn the bulb holder to the left and pull it out.
 - ☞ Pull the bulb out and replace it.
- To refit, carry out these operations in reverse order.

Main beam headlamps

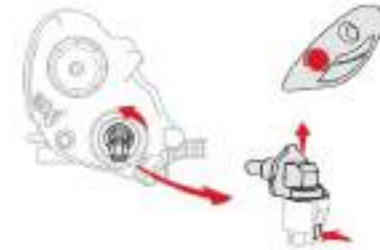

- ☞ Turn the bulb holder to the left and pull it out.
 - ☞ Remove the bulb by pressing the tab.
 - ☞ Replace the bulb.
- To refit, carry out these operations in reverse order.

In the event of a breakdown

Dipped beam headlamps

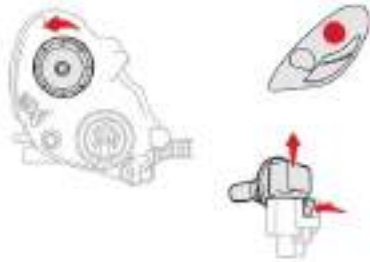

- ☞ Turn the bulb holder to the left and pull it out.
- ☞ Remove the bulb by pressing the tab.
- ☞ Replace the bulb.

To refit, carry out these operations in reverse order.

Front foglamps/Daytime running lamps

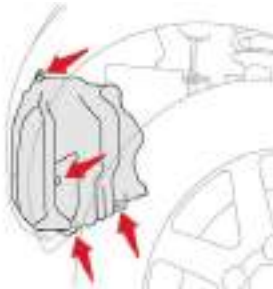

- ☞ Turn your wheels to full lock for easier access.
- ☞ Remove the clips retaining the bulb holder protective cover.
- ☞ Move the cover aside.

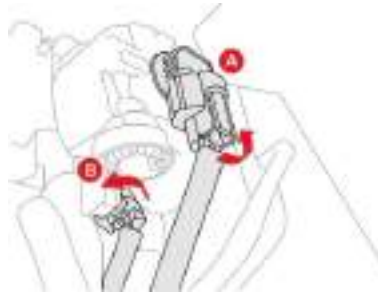

- ☞ Turn the bulb holder (**A** for foglamps, **B** for daytime running lamps) to the left and remove it.
 - ☞ Remove the bulb and replace it.
- To refit, carry out these operations in reverse order.

Integrated direction indicator side repeaters (WY5W – 5 W)

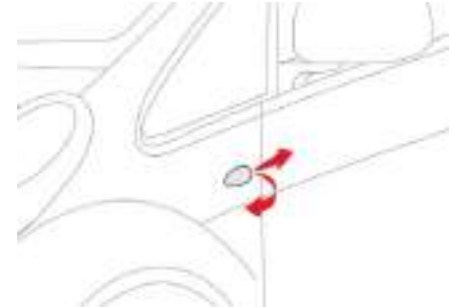

- ☞ Push the repeater towards the rear and release it.
- ☞ Turn the bulb holder to the left and remove it.
- ☞ Remove the bulb and replace it.

To refit, carry out these operations in reverse order.

Rear lamps



1. **Brake lamps/Sidelamps (21 W/15 W or LEDs).**
2. **Direction indicators (WY21W – 21 W).**
3. **Reversing lamps (W21W – 21 W).**

i In some climatic conditions (low temperature, humidity), the presence of mist on the internal surface of the headlamp and rear lamp glass is normal; this disappears a few minutes after the lamps are switched on.

Access to bulbs

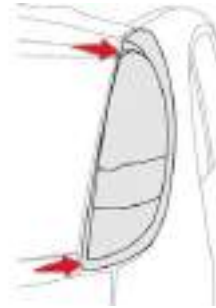

- ☞ Remove the two screws.
- ☞ Remove the headlamp unit by pulling it towards you.

i Amber colour bulbs such as direction indicators must be replaced with bulbs of identical specification and colour.

Brake lamps/Sidelamps (21 W/15 W)

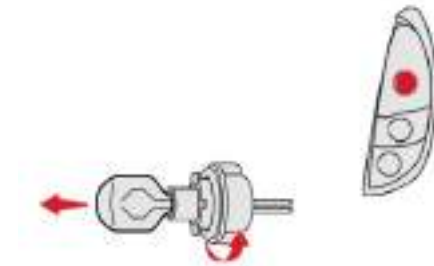

- ☞ Turn the bulb holder to the left and remove it.
 - ☞ Pull out the bulb and replace it.
- To refit, carry out these operations in reverse order.

Brake lamps/sidelamps (LED)

All work on LED lamps must be carried out only by a CITROËN dealer or a qualified workshop.

In the event of a breakdown

Direction indicators

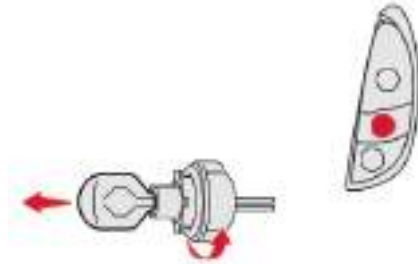

- ☞ Turn the bulb holder to the left and remove it.
 - ☞ Pull out the bulb and replace it.
- To refit, carry out these operations in reverse order.

Reversing lamps

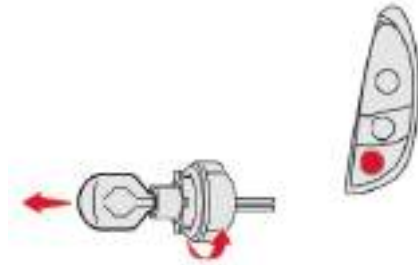

- ☞ Turn the bulb holder to the left and remove it.
 - ☞ Pull out the bulb and replace it.
- To refit, carry out these operations in reverse order.

Rear foglamp (W21W – 21W)

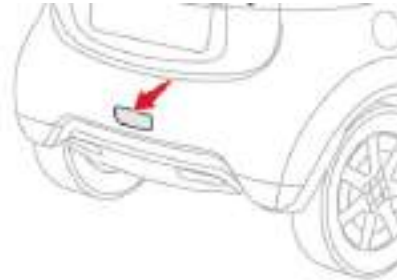

- ☞ Remove the cover.
 - ☞ Turn the bulb holder to the left and remove it.
 - ☞ Pull the bulb out and replace it.
- To refit, carry out these operations in reverse order.

Third brake lamp (W5W – 5W)

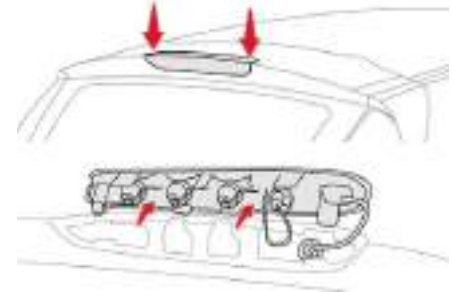

- ☞ Remove the two screws.
 - ☞ Remove the bulb holder.
 - ☞ Remove the bulb and replace it.
- To refit, carry out these operations in reverse order.

Number plate lamps (W5W – 5W)

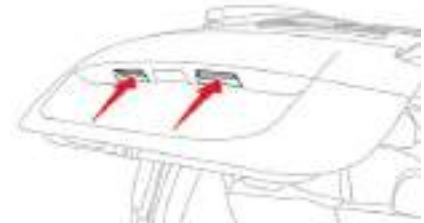

- ☞ Push the cover inwards.

- ☞ Turn the bulb holder and remove it.
 - ☞ Remove the bulb and replace it.
- To refit, carry out these operations in reverse order.

Changing a fuse

Access to the tools

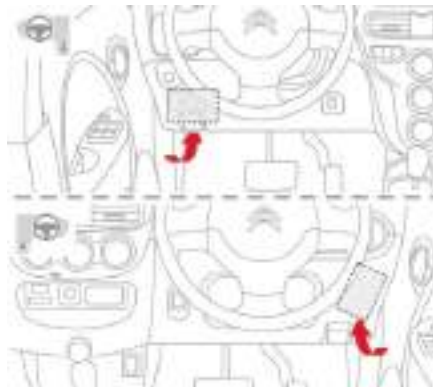

The extraction tweezers are fitted to the back of the dashboard fusebox cover.

To access them:

- ☞ Unclip the protective cover and remove it completely by pulling it towards you.
- ☞ Pull out the tweezers.

Changing a fuse

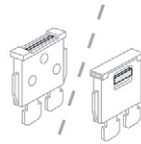

Good

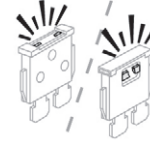

Failed



Tweezers

Before changing a fuse, the cause of the fault must be found and rectified.

- ☞ Make sure that the ignition switch is set to the "LOCK" position.
- ☞ Identify the failed fuse by checking the condition of its filament.
- ☞ Use the special tweezers to extract the fuse from its housing.
- ☞ Always replace the faulty fuse with a fuse of the same rating.
- ☞ Check that the number marked on the fusebox, the rating marked on the fuse and the following tables all agree.

i Your vehicle's electrical system is designed to operate with standard or optional equipment. Before installing other electrical equipment or accessories on your vehicle, contact a CITROËN dealer or a qualified workshop.

! CITROËN accepts no responsibility for the cost incurred in repairing your vehicle or for rectifying malfunctions resulting from the installation of accessories not supplied and not recommended by CITROËN and not installed in accordance with its specifications, in particular when the combined power consumption of all of the additional equipment connected exceeds 10 milliamperes.

In the event of a breakdown

Fuses in the dashboard

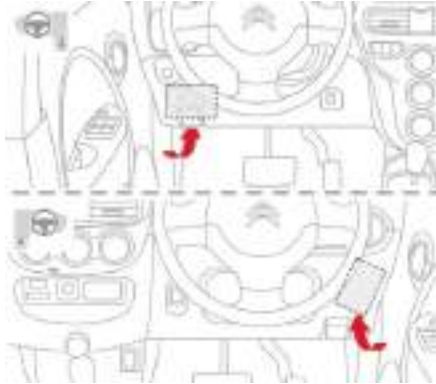

The fusebox is located in the lower dashboard.

Access to the fuses

- ☞ Unclip the protective cover and remove it completely by pulling it towards you.

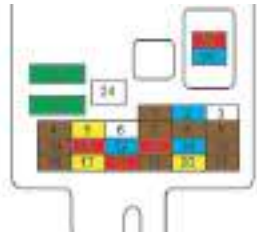

Fuse No.	Rating	Functions
1	7.5 A	Front and rear left sidelamps.
2	15 A	Accessory socket.
3	-	Not used.
4	7.5 A	Starter motor.
5	20 A	Audio system.
6	-	Not used.
7	7.5 A	Dashboard consumers, front and rear right sidelamps.
8	7.5 A	Electric door mirrors.
9	7.5 A	Supervisor.
10	7.5 A	Air conditioning.
11	10 A	Rear foglamp.
12	15 A	Door locks.
13	10 A	Courtesy lamp.

Fuse No.	Rating	Functions
14	15 A	Rear wiper.
15	7.5 A	Instrument panel.
16	7.5 A	Heating.
17	20 A	Heated seat.
18	10 A	Option.
19	7.5 A	Door mirrors defrosting.
20	20 A	Windscreen wipers.
21	7.5 A	Airbags.
22	30 A	Rear screen defrosting.
23	30 A	Heating.
24	-	Not used.
25	10 A	Radio.
26	15 A	Passenger compartment fuse.

Fuses in the front compartment

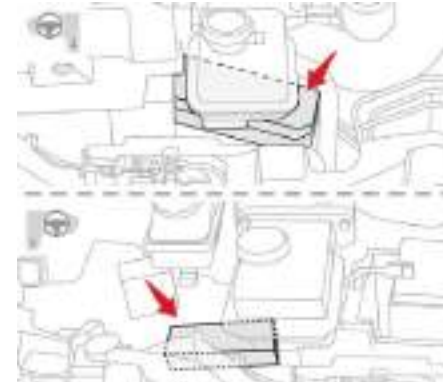

The fusebox is located in the front compartment, under the heating system fluid reservoir. Only these fuses can be replaced.

i Replacement of the fuses in other boxes (vacuum pump and ancillaries battery) requires the involvement of a CITROËN dealer or a qualified workshop.

In the event of a breakdown

Access to the fuses

- ☞ Open the bonnet.
- ☞ Unclip the protective cover and remove it completely by pulling it towards you.
- ☞ Change the fuse.
- ☞ When you have finished, close the cover very carefully to ensure correct sealing of the fusebox.

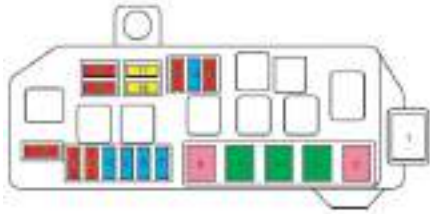

Fuse No.	Rating	Functions
1	-	Not used.
2	30 A	Internal fuse.
3	40 A	Electric motor.
4	40 A	Radiator fan.
5	40 A	Electric windows.
6	30 A	Vacuum pump.
7	15 A	Main battery control unit.
8	15 A	Third brake lamp.
9	15 A	Front foglamps.
10	15 A	Water pump.
11	10 A	On-board charger.
12	10 A	Direction indicators.
13	10 A	Horn.
14	10 A	Daytime running lamps.
15	15 A	Battery fan.
16	10 A	Air conditioning compressor.
17	20 A	Right-hand dipped beam headlamp.
18	20 A	Left-hand dipped beam headlamp, headlamps adjustment.
19	10 A	Right-hand main beam headlamp.
20	10 A	Left-hand main beam headlamp.

Towing the vehicle

Procedure for having your vehicle towed using a fixed towing eye.

! General recommendations

Observe the legislation in force in your country.

Ensure that the weight of the towing vehicle is higher than that of the towed vehicle.

The driver must remain at the wheel of the towed vehicle and must have a valid driving licence.

When towing a vehicle with all four wheels on the ground, always use an approved towing arm; rope and straps are prohibited.

The towing vehicle must move off gently.

When the vehicle is towed with its engine off, there is no longer braking and steering assistance.

In the following cases, you must always call on a professional recovery service:

- vehicle broken down on a motorway or main road,
- four-wheel drive vehicle,
- when it is not possible to put the gearbox into neutral, to unlock the steering, or to release the parking brake,
- towing with only two wheels on the ground,
- where there is no approved towbar available.

Towing your vehicle

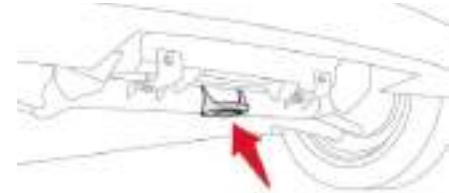

The towing eye is welded to the chassis under the front bumper.

- ☞ Install the towbar.
- ☞ Start your vehicle ("Ready" lamp on).
- ☞ Move the drive selector to position **N**.
- ☞ Release the parking brake.
- ☞ Turn on your vehicle's hazard warning lamps.
- ☞ Have your vehicle towed for **no more than 20 miles (30 km) without exceeding the speed of 20 mph (30 km/h)**.

! Failure to comply with these operations may cause damage to the braking components and the electric motor.

! Towing another vehicle

Your vehicle cannot in any circumstances be used to tow another vehicle.

Motor and main battery

Model code:	1 N ZKY Z
Electric motor	Y51
Technology	Synchronous with permanent neodymium magnets
Max power: EU standard (kW)	49
Max power motor speed (rpm)	4,000 to 8,800
Max torque: EU standard (Nm)	196
Max torque speed (rpm)	0 to 300
Main battery	Lithium-Ion
Energy capacity when new (kWh)	14.5
Normal charge	
Voltage (V) AC	230
Recharging time ^{(*)(**)} : - 16 A - 14 A - 10 A - 8 A	Approximately 6 hours 6 hours 8 hours 11 hours
Fast charge	
Voltage (V) DC	300
Charging time (80% charge)**	30 minutes

* Depending on the country's electricity grid.

** Time measured for exterior temperatures between 20 and 25°C. Depending on the use of radio equipment and/or air conditioning, recharging time may increase.

Range varies depending on the exterior climatic conditions, the driver's driving style, the use of electrical systems, the frequency of normal or rapid charges, and ageing of the main battery.

Weights (in kg)

Electric motor	Y51
Main battery	Lithium-Ion
Model code:	1 N ZKY Z
Unladen weight	1,065
Kerb weight	1,140
Gross vehicle weight (GVW)	1,450
Gross train weight (GTW)	1,450
Maximum load on the roof (including the roof bars weight)	43

! Your vehicle cannot be fitted with a towbar. It cannot tow a trailer.

Dimensions (in mm)

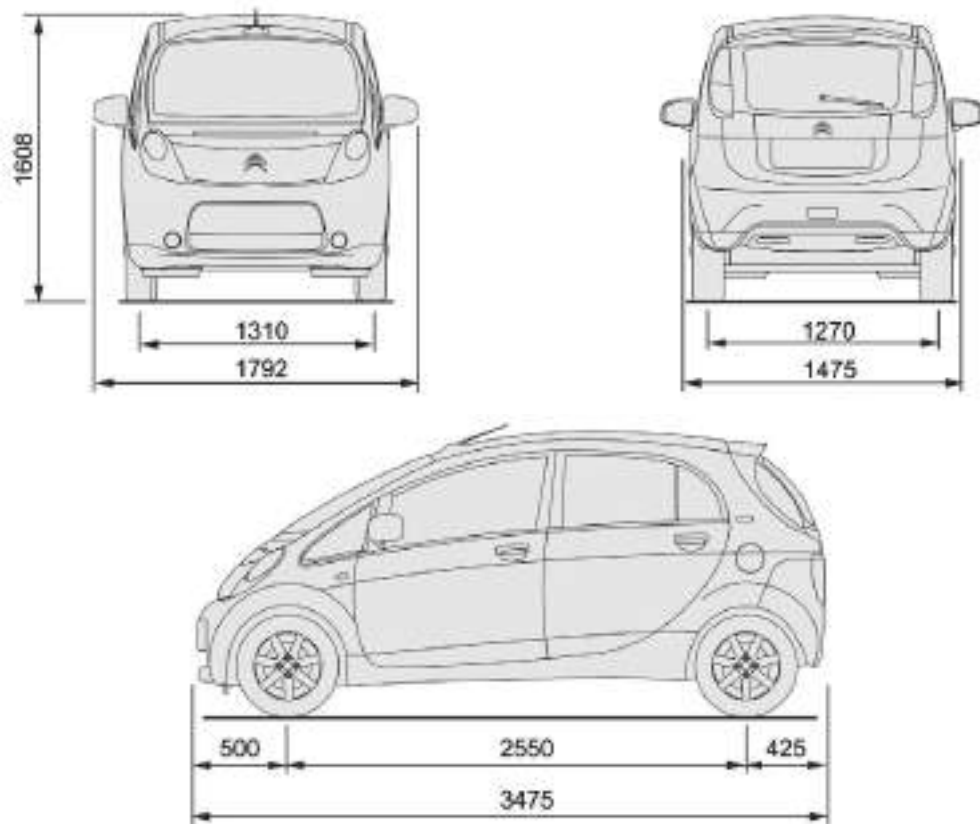

<https://www.automotive-manuals.net/>

Identification markings

Various visible markings for the identification of your vehicle.

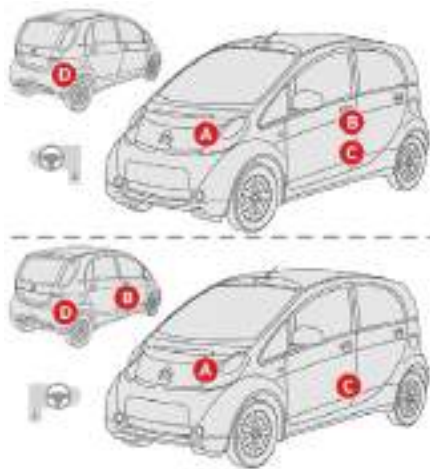

A. After-Sales - Replacement Parts identification plate.

This plate is affixed by rivets on the inner side of the front bonnet.

It includes the following information:

- the model of the vehicle,
- the paint code,
- the type, variant, version, etc. (model code).

B. Tyre identification label.

This label is affixed to the centre pillar on the driver's side.

It bears the following information:

- the tyre inflation pressures (in bars),
- the tyre specifications,
- the tyre type.

C. Manufacturer's plate.

This plate is affixed by rivets to the centre pillar on the left-hand side.

D. VIN (Vehicle Identification Number).

This number is engraved on the wheel arch, inside the boot on the right-hand side.

- i The vehicle may be originally equipped with tyres with higher load and speed indices than those indicated on the label, without affecting inflation pressure.

Checking tyre pressures

The tyre pressures should be checked when cold at least monthly.

The pressures given on the label are valid for cold tyres. If you have driven for more than 10 minutes or more than 6 miles (10 kilometres) at more than 30 mph (50 km/h), the tyres will be warm; in this case 0.3 bar (30 kPa) should be added to the pressures given on the label.

! Never reduce the pressure of a warm tyre.



Insufficient tyre pressure increases the electric power consumption of your vehicle, thus reducing its range.



Bluetooth® audio system



Contents

First steps	1
Radio	2
Media	3
Telephone	6
Audio settings	8
Configuration	8
Frequently asked questions	9

! For safety reasons, the vehicle must always be stationary for the driver to perform operations that require close attention.

When the engine is switched off and to prevent discharging of the battery, the system switches off after activation of energy economy mode.

! After a battery disconnection, a code must be entered to access the audio system functions.

You can try five times at most. There is approximately fifteen minutes waiting time between each of the last two tries.

Go to the end of this document to recover the label indicating the code:



First steps



On/Off, volume adjustment.



Adjust audio options: sound ambience, treble, bass, loudness, distribution, left/right balance, front/rear balance, automatic volume.



Automatic search for a lower radio frequency.

Select the previous CD, USB track. Scroll in a list.

Press and hold: rewind.



Display the list of stations received, the CD/USB tracks or folders.

Press and hold: update the list of stations received.



Cancel the current operation.

Go up one level (menu or folder).



Automatic search for a higher radio frequency.

Select the next CD, USB track.

Scroll in a list.

Press and hold: fast forward.



Access to the main menu.



Select preset radio station.
Radio, press and hold: store a station.
Other than radio: see the corresponding sections.



Eject CD.



Select the source:
Radio: FM1, FM2, CD, USB, AUX, Streaming.
Telephone: accept an incoming call.
Telephone, press and hold: end a call, access the calls log for the connected telephone.

Radio

Presetting a station



Press **SRC/TEL** repeatedly to select the FM1, FM2 or AM waveband.



Press and hold a button to preset the station being listened to. The name of the station is displayed and an audible signal confirms that it has been preset.

i The external environment (hills, buildings, tunnels, basement car parks, etc.) may block reception, including in RDS tracking mode. This is a normal effect of the way in which radio waves are transmitted and does not indicate any failure of the audio equipment.

Selecting a station



Press a button to listen to the corresponding preset station.

Managing a list

LIST

Press **LIST** to display the list of stations received in alphabetical order.



Select the desired radio station using one of the buttons.

OK

Confirm with "**OK**".



Briefly press one of the buttons to change to the next or previous letter.

LIST

Press and hold **LIST** to build or update the list of stations; audio reception is cut momentarily.

Entering a frequency

MENU Press **MENU**.



Select "**Radio**".



Select "**Enter or Write freq.**".



Press **+**,

or



press **-** to select the desired frequency.

OK

Confirm with "**OK**".

RDS

i RDS, if activated, allows you to continue listening to the same station by automatically retuning to alternative frequencies. However, in certain conditions, coverage of an RDS station may not be assured throughout the entire country as radio stations do not cover 100% of the territory. This explains the loss of reception of a station that can occur during a journey.

MENU

With source FM1 or FM2, press **MENU**.



Select "**Radio**".

 Select or deselect **"RDS"** to switch RDS on or off.

OK Confirm with **"OK"** to save the setting.

Receiving TA messages

i The TA (Traffic Announcement) function gives priority to TA alert messages. To operate, this function needs good reception of a radio station transmitting this type of message. When a traffic report is transmitted, the current audio source (radio, CD, USB, etc.) is interrupted automatically to play the TA message. Normal playback resumes at the end of the transmission of the message.

MENU Press **MENU**.

 Select **"Radio"**.

 Select or deselect **"TA"** to activate or deactivate the reception of traffic messages.

OK Confirm with **"OK"** to save the setting.

Displaying RADIO TEXT

i Radio Text is information transmitted by the radio station related to the current programme or song.

MENU With the radio displayed on the screen, press **MENU**.

 Select **"Radio"**.

 Select or deselect **"TXT"** to activate or deactivate the display of Radio Text.

OK Confirm with **"OK"** to save the setting.

Media

USB port



This unit comprises a USB port and a jack socket, depending on model.

! The system constitutes playlists (in temporary memory), whose creation time can be from a few seconds to several minutes at the first connection. Limiting the number of non-music files and the number of folders reduces this waiting time. The playlists are update every time the ignition is switched off or a USB memory stick is connected. The lists are memorised: if there is no change in the lists, the next loading time will be shorter.

Connect a USB memory stick to the USB port or connect a USB device to the USB port using a suitable cable (not supplied).

! To protect the system, do not use a USB hub.

SRC / Press **SRC/TEL** repeatedly to select **"USB"**.

◀▶ Press one of these buttons to select the previous or next track in the list.



Press one of these buttons to select the next or previous folder in the order chosen.



Press and hold one of these buttons for fast forward or rewind.

LIST

Press **LIST** to display the structure of the folders in the compilation.



Select a line in the list.

OK

Confirm with "**OK**".



Go up a level in the structure.

MENU

Press **MENU**.



Select "**Media**".



Select or deselect "**TA**" to activate or deactivate the reception of traffic messages.



Select the play mode: "**Normal**", "**Random**", "**Random all**" or "**Repeat**".

CD player

Insert a CD in the player; play begins automatically.

Insert an MP3 compilation in the CD player. The audio system searches for all of the music tracks, which may take anything between a few seconds and several tens of seconds, before play begins.



Press the **SRC/TEL** button repeatedly to select "**CD**".



Press one of these buttons to go to the previous/next track in the list.



Press one of these buttons to select the previous or next folder in the order chosen.



Press and hold one of these buttons for fast forward or rewind.

LIST

Press **LIST** to display the structure of the folders of the compilation.



Select a line in the list.

OK

Confirm with "**OK**".

Return to the top level of the folder structure to select the order of tracks.

- By **Folders** (CD or USB): all folders containing audio files recognised on the peripheral device, in alphabetical order without following the folder structure.
- By **Artist** (USB only): all of the artist names defined in the ID3 Tags, in alphabetical order.
- By **Genre** (USB only): all of the genres defined in the ID3 Tags.
- By **Playlist** (CD or USB): if playlists have been saved.

Information and advice

The audio system will only play files with ".mp3", ".wma" and ".wav" extensions on a CD and can also play files with ".ogg" extension only on USB.

It is recommended that file names be of no more than 20 characters and avoiding special characters (e.g. "?; ù) so as to avoid any problem reading or displaying the files.

In order to be able to play a recorded CDR or CDRW, when recording it is preferable to select ISO 9660 level 1 or 2 standards or the Joliet standard.

If the disc is recorded in another format, it may not be played correctly.

It is recommended that the same recording standard is always used for an individual disc, with as low a speed as possible (4x maximum) for optimum sound quality.

In the particular case of a multi-session CD, the Joliet standard is recommended.

The playlists accepted on CD, MP3, iPod and USB connection are types ".m3u" and ".wpl". The number of files recognised is limited to 5,000 in 500 folders on a maximum of 8 levels.

On a single disc, the CD player can read up to 255 MP3 files spread over 8 folder levels with a maximum of 192 folders. However, it is recommended that this be kept to two levels so as to limit the time taken to access and play the CD.

During play, the folder structure is not observed.

Do not connect a hard disk or USB device other than audio players to the USB port. This may cause damage to your installation.

Use only USB memory sticks formatted to FAT 32 (File Allocation Table).

! To protect the system, do not use a USB hub.

i The use of genuine Apple® USB cables is recommended to ensure correct operation.

Bluetooth® audio streaming

Streaming allows music files on the telephone to be heard through the vehicle's speakers.

Connect the telephone: see the "**Telephone**" section.

In the "**Bluetooth: Audio**" menu, select the telephone to be connected.

The audio system connects automatically to a newly paired telephone.

SRC / Activate the streaming source by pressing the **SRC/TEL** button. In certain cases, playing the audio files must be initiated from the keypad.

The control of standard tracks is possible via the audio system control buttons and the steering mounted controls, if the telephone supports the function.

Contextual information can be displayed on the screen.

The audio quality depends on the quality of the transmission from the telephone.

Connecting Apple® players



Connect the Apple® player to the USB port using a suitable cable (not supplied). Play starts automatically.

Management of the device is via the audio system controls.

The classifications available are those of the portable device connected (artists/albums/genres/playlists/audio books/podcasts).

The version of software in the audio system may not be compatible with the generation of your Apple® player.

Telephone

Pairing a Bluetooth® telephone

! As a safety measure and because it requires sustained attention by the driver, the pairing of a Bluetooth mobile telephone with the Bluetooth hands-free system of your audio system must be done with the vehicle stationary and the ignition on.

Visit www.citroen.co.uk for more information (compatibility, more help, etc).

Activate the telephone's Bluetooth function and ensure that it is set as visible to all (refer to the telephone user guide).

MENU Press the **MENU** button.



Select "**Bluetooth**".



Select "**Search**".

A window is displayed with "**Searching device**".

i The services available depend on the network, the SIM card and the compatibility of the Bluetooth telephone used.
Check the instructions for your telephone and with your service provider for the services to which you have access.



In the list, select a telephone to pair.

OK

Confirm with "**OK**".



Only one telephone can be paired at a time.
In some cases, the Bluetooth address of the telephone may appear instead of the name of the telephone.

A virtual keypad is displayed on the screen: choose a 4-digit code.

OK

Confirm with "**OK**".

A message is displayed on the screen of the telephone: enter the same code and confirm.

If pairing fails, the number of attempts is not restricted.

A message appears in the screen to confirm the result of the connection.

i Pairing can also be initiated from the telephone by searching for detected Bluetooth devices.

i The directory and the call list can be accessed after the necessary synchronisation period (if the telephone is compatible).
Automatic connection must be configured in the telephone to allow the connection each time the vehicle is started.

Managing connections

MENU Press the **MENU** button.



Select "**Bluetooth**".



Select "**Manage connections**" or "**BT management**" and confirm. The list of paired telephones is displayed.



Indicates connection of the audio profile.



Indicates the hands-free telephone profile.



In the list, select a telephone to pair.



OK

Confirm with "**OK**".



Select or deselect:

- **"Tel.":** hands-free connection
- **"Audio":** play audio files

OK

"OK" to confirm the choice.



"Delete" to delete the pairing.



It is not possible to pair more than 5 telephones, Press **MENU** and select **"Bluetooth"**. Select **"Manage connections"** or **"BT management"**. If 5 telephones are already paired, select the telephone to delete by pressing **"OK"** and selecting **"Delete"** (refer to the "Managing connections" section).

Making a call

From the directory

MENU

Press the **MENU** button.



Select **"Telephone"**.



Select **"Call"**.



Select **"Directory"**.



Select the desired number.

OK

Confirm with **"OK"** to start the call.

Making a call

Recently called numbers

(Depending on the compatibility of the phone)

SRC /

Press and hold **SRC/TEL** to display the calls list.



For access to the calls list, it is also possible to press **MENU**, select **"Telephone"**, then select **"Call"** and finally select **"Calls list"**.



In the calls list, select from: **"Missed calls"**, **"Dialled calls"** or **"Answered calls"**.



Scroll through the calls list.

OK

Confirm with **"OK"**.



Press one of these buttons to go to the previous or next page in the list.

OK

"OK" starts the call.



The calls list includes calls sent and received in the vehicle using the connected telephone. It is possible to make a call directly from the telephone; park the vehicle first as a safety measure.

Receiving a call

An incoming call is announced by a ring and a superimposed display in the screen.

SRC /

Press **SRC/TEL**.

or



select **"YES"** to accept the call,

or



select **"NO"** to reject the call.



Pressing and holding the back button

or



SRC/TEL also rejects an incoming call.

Managing calls

Hang up



In the contextual menu, select "**Hang up**" to end the call.



Pressing and holding **SRC/TEL** also ends the call.

Secret – Mute

(so that the other person cannot hear)

In the contextual menu:



Select "**Micro OFF**" to switch off the microphone.



Select "**Micro OFF**" to switch the microphone on again.

Combined/telephone mode

(to leave the vehicle without ending the call)

In the contextual menu:



Select "**Combined/Telephone mode**" to transfer the call to the telephone.





Select "**Combined/Telephone mode**" to transfer the call to the vehicle.

In some cases, the combined/telephone mode has to be activated from the telephone. The Bluetooth connection will be restored automatically if the ignition has been switched off, then on again (depending on the compatibility of the telephone).

Audio settings



Press  to display the audio settings menu.
Press  to go to the next setting.

The settings available are:

- AMBIANCE: BASS, TREBLE and LOUDNESS.
- BALANCE (left/right balance), FADER (front/rear balance).

- SOUND DIST. (driver or passenger).
- AUTO VOLUME.

The distribution, or spatialisation of sound, is an audio process which allows the sound quality to be improved according to the setting chosen, corresponding to the position of the listeners in the vehicle.

The AMBIANCE, TREBLE and BASS audio settings are different and independent for each sound source.

Configuration

Display and language settings

MENU Press the **MENU** button.



Select "**Config.**".



Select "**Displaying**" to activate or deactivate scrolling text.



Select "**Language**" to modify the display language.



Select "**Version**" for information on the software.



Select "**System**" when you want to install an update. Information can be obtained from a CITROËN dealer.



Select "**Unit**" to modify the units for temperature (Celsius, Fahrenheit).

Frequently asked questions

The following information groups together the answers to the most frequently asked questions concerning your audio system.

QUESTION	RESPONSE	SOLUTION
There is a difference in sound quality between the different audio sources (radio, CD, etc.).	For optimum sound quality, the audio settings (volume, bass, treble, ambience, loudness) can be adapted to the different sound sources, which may result in audible differences when changing source (radio, CD, etc.).	Check that the audio settings (volume, bass, treble, ambience, loudness) are adapted to the sources being listened to. It is advisable to set the AUDIO functions (bass, treble, front-rear balance, left-right balance) to the middle position, select the musical ambience and set the loudness correction to the "Active" position in CD mode or to the "Inactive" position in radio mode.
When changing the settings for treble and bass, the ambience setting is deselected. When changing the ambience setting, treble and bass are reset to zero.	Choosing an ambience imposes settings for treble and bass. Modifying one without the other is only possible with a personalised ambience.	Modify the treble and bass settings or the ambience setting to obtain the desired sound quality.
When changing the balance setting, distribution is deselected.	Choosing the "driver" distribution setting imposes a balance setting.	Modify the balance or distribution settings to obtain the desired sound quality.
The reception quality of the tuned radio station gradually deteriorates or the stored stations are not working (no sound, 87.5 MHz is displayed..).	The vehicle is too far from the transmitter of the station or no transmitter is present in the geographical area.	Activate the RDS function and search for the station again to enable the system to check whether there is a more powerful transmitter in the geographical area.
	The surroundings (hills, buildings, tunnels, underground car park, etc.) are blocking reception, including in RDS tracking mode.	This phenomenon is normal and does not indicate a failure of the audio equipment.
	The aerial is missing or has been damaged (for example when going through a car wash or into an underground car park).	Have the aerial checked by a CITROËN dealer.

Sound cut-outs of 1 to 2 seconds in radio mode.	During this brief sound cut-out, the RDS searches for any frequency permitting better reception of the station.	Deactivate the RDS function if the phenomenon is too frequent and always on the same route.
Traffic announcement TA is displayed. I do not receive any traffic information.	The radio station does not broadcast traffic information.	Tune to a radio station which broadcasts traffic information.
The stored stations are not found (no sound, 87.5 MHz is displayed...).	An incorrect waveband is selected.	Press the SRC/TEL button to return to the waveband (FM1 or FM2) on which the stations are stored.
The CD is ejected every time or is not played.	The CD is upside down, cannot be read, does not contain audio files or contains audio files of a format that cannot be played by the audio system. The CD is protected by an anti-pirating system not recognised by the audio system.	<ul style="list-style-type: none"> - Check that the CD is inserted in the player the right way up. - Check the condition of the CD: the CD cannot be played if it is too badly damaged. - Check the content in the case of a recorded CD: consult the advice in the "Audio" section. - The audio system's CD player does not play DVDs. - Because of low quality, certain burned CDs will not be read by the audio system.
The CD sound is of poor quality.	The CD used is scratched or of poor quality.	Insert good quality CDs and store them in suitable conditions.
	The audio settings (bass, treble, ambiances) are unsuitable.	Return bass and treble settings to 0, without selecting an ambience.
The Bluetooth connection cuts out.	The battery of the peripheral device may not be sufficiently charged.	Charge the battery of the peripheral device.
The "USB peripheral/device error" or "Peripheral/Device not recognised" message appears on the screen.	The USB memory stick is not recognised.	Use only USB memory sticks formatted to FAT 32 (28-bit file allocation table).

A telephone connects automatically, disconnecting another telephone.	Automatic connection overrides manual connection.	Modify the telephone settings to remove automatic connection.
The iPod is not recognised when connecting to the USB port.	The iPod is of a generation that is not compatible with the USB.	
The hard disk or device is not recognised when connecting to the USB port.	Some hard disks and devices need a power supply greater than is provided by the audio system.	Connect the device to the 230 V socket, the 12 V socket or an external power supply. Caution: ensure that the device does not transmit a voltage greater than 5 V (risk of destruction of the system).
When streaming, the sound cuts out momentarily.	Some telephones prioritise connection of the "hands-free" profile.	Delete the "hands-free" connection profile to improve streaming.
In "Random all" play, not all of the tracks are played.	In "Random all" play, the system can only take into account up to 999 tracks.	
With the engine off, the audio system switches off after a few minutes of use.	When the engine is switched off, the audio system operating time depends on the battery charge. The switch-off is normal: the audio system switches to economy mode and switches off to prevent discharging the vehicle's battery.	Start the vehicle's engine to increase the battery charge.
The message "the audio system is overheated" appears on the display.	In order to protect the installation if the surrounding temperature is too high, the audio system switches to an automatic thermal protection mode leading to a reduction of the volume or stopping of the playing of the CD.	Switch the audio system off for a few minutes to allow the system to cool.

KENWOOD – KDC-X7000DAB





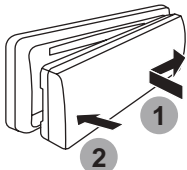

! As a safety measure, the vehicle must be stationary when the driver carries out operations that require sustained attention.

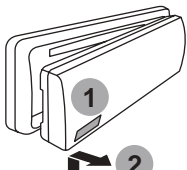

Fit the control panel.



Remove the control panel.

-  Short press: on.
Long press: off.
-  Rotate: set the audio volume, navigate in a list.
Press: confirm.
- SRC** Change the audio source.
-  Short press: accept an incoming call, switch between two calls, enter Bluetooth mode.
Long press: smartphone voice commands via the system.
-  Short press: find a service.
Long press: update list of stations received.
-  Abandon the current operation.
Go up one level in the menu.
Reject or end a call.

BAND Select an analogue band FM1/FM2/FM3/MW/LW.
Select a digital band DB1/DB2/DB3.



Navigate in a list.

SEEK

Change the search method (automatic or manual).



Short press: find a radio station, frequency or service, find the previous/next track or file, navigate in a list.
Long press: fast forward or rewind.

1

Short press: select a preset radio station.
Long press: add a radio station to presets.

For more information, refer to the KENWOOD user guide provided with the system.

<https://www.automotive-manuals.net/>

A

ABS and EBFD systems48
 Accessories45
 Access to bulbs 96, 99
 Adjusting headlamps42
 Adjusting head restraints24
 Adjusting seats 24-26
 Advice on driving68
 Airbags 9, 54, 58-59
 Airbags, curtain55-56
 Airbags, front54-56, 59
 Airbags, lateral55-56
 Air conditioning 30-32, 30-33
 Air vents29
 Anti-lock braking system (ABS)48
 Anti-slip regulation (ASR)34
 Assistance call47-48
 Audio streaming (Bluetooth)5

B

Battery9
 Battery, ancillaries 85-86, 88-89
 Battery, main75, 106
 Bluetooth (hands-free)6
 Bonnet83-84
 Bonnet stay83-84
 Brake discs86-87
 Brake lamps46, 99
 Brake lamps, automatic operation46
 Brakes 10, 86-87
 Braking assistance system48
 Bulbs (changing)95-96, 99
 Bulbs (changing, type) 96, 99

C

CD, MP33-4
 Changing a bulb 95-96, 99
 Changing a fuse 101,104
 Changing a wheel 93-95
 Changing a wiper blade87
 Charging, fast81
 Charging, normal75, 78
 Charging time106
 Checking the levels85-86
 Checking tyre pressures (using the kit) 90-93
 Checks84, 86-87
 Checks, routine86-87
 Child lock65, 67
 Children62-65
 Child seats 53, 57-58, 62
 Child seats, conventional62
 Child seats, ISOFIX63-65
 Closing the boot21-22
 Closing the doors21
 Compartment, front84
 Compartment, rear84
 Control, heated seats25
 Control stalk, lighting 13, 40
 Control stalk, wiper42
 Control unit77
 Courtesy lamp43-44
 Cup holder27

D

Daytime running lamps 41, 98
 Deactivating the passenger airbag 54-55, 58-59
 Demisting/defrosting34
 Dimensions108
 Direction indicators 13, 41, 97, 100
 Display screen15-16

Door pockets27-28
 Doors21
 Dynamic stability control (DSC)49

E

Electric motor (technical data)106
 Electronic brake force distribution (EBFD)48
 Emergency braking assistance (EBA)48-49
 Emergency braking system49
 Emergency call47-48
 Environment6

F

Filter, passenger compartment86
 Fitting a wheel 93-95
 Fittings, interior27
 Fitting the mat28
 Flaps, charging23
 Foglamp, rear 12, 41, 100
 Foglamps41
 Foglamps, front 13, 41, 98
 Folding/unfolding the door mirrors27
 Fusebox, dashboard102-103
 Fusebox, engine compartment 103-104
 Fuses101
 Glove box27

H

Hazard warning lamps46
 Headlamp adjustment42
 Headlamps, automatic illumination42
 Headlamps, dipped beam98

Headlamps, main beam..... 13, 97
 Head restraints..... 24-26
 Heating..... 29, 31-32
 Horn.....46
 Horn for pedestrians.....46

Level, heating system fluid 85-86
 Level, screenwash fluid 85-86
 Levels and checks 84-86
 Lighting, automatic switching off 42
 Lighting dimmer 16
 Locking from the inside.....21
 Locking/unlocking a door from the inside.....21

Port, USB..... 29, 3-4
 Power steering..... 109
 Pressures, tyres 70-72, 11
 Pre-tensioning seat belts.....53
 Protecting children54, 57-58, 62-65, 67
 Puncture..... 90-93

I

Immobiliser, electronic..... 19-20
 Indicator, energy consumption/generation..... 14-15
 Indicator lamps, operation7-8
 Indicators, direction41
 Inflating tyres (using the kit)..... 90-93
 Instrument panel7
 ISOFIX mountings and child seats.....63, 65

J

Jack..... 93-95

K

Kit, hands-free6
 Kit, temporary puncture repair..... 90-93

L

Labels, identification..... 109
 Lamps, front96
 Lamps, rear99
 Level, brake fluid 85-86
 Level, engine coolant..... 85-86
 Level, headlamp wash85

M

Markings, identification..... 109
 Mat28
 Mirror, rear view27
 Mirrors, door..... 26
 Mountings, ISOFIX63, 65
 MP3 CD..... 3-4

N

Number plate lamps..... 100

O

Opening the bonnet 83-84
 Opening the boot21-22
 Opening the doors21

P

Pads, brake86-87
 Parking brake..... 69, 86-87
 Player, MP3 CD..... 3-4
 Player, USB.....3

R

Radio2
 Range..... 15, 18
 Recharging the main battery75
 Recirculation, air31
 Recirculation/exterior air intake..... 31-32
 Reminder, lighting on41
 Remote control..... 20, 34-39
 Remote control key 19-20
 Removing a wheel 93-95
 Removing the mat.....28
 Replacing bulbs 95-96, 99
 Replacing fuses 101,104
 Replacing the passenger compartment filter86
 Reservoir, headlamp wash85
 Reservoir, screenwash 85-86
 Reversing lamps100

S

Safety, children54, 57-58, 62-64
 Screenwash43
 Seat belts 51-53, 62
 Seats, front.....24
 Seats, heated..... 24-25
 Seats, rear..... 25-26
 Selector, drive 69-70
 Serial number, vehicle109

Service indicator	16-17
Sidelamps	13, 97, 99
Side repeater	98
Snow chains.....	82
Socket, 12 V accessory	27-28
Speedometer	7
Starting/switching off the vehicle.....	68-70
Station, radio.....	2
Sun visor	28

T

Tables of fuses.....	102-104
Technical data.....	106,107
Third brake lamp	100
Total distance recorder	15
Towing another vehicle	105
Traction control (ASR)	49
Traffic information (TA)	3
Trajectory control systems.....	49
Tyres.....	70-72, 109
Tyre under-inflation detection...12, 17-18, 70-72	

U

Unlocking from the inside	21
USB.....	3

V

Ventilation	29-32
-------------------	-------

W

Warning and indicator lamps	7-13
Weights	107
Wheel, spare.....	93, 109
Window controls	22
Wiper, rear.....	43
Wiper blades (changing).....	87
Wipers.....	42

<https://www.automotive-manuals.net/>

<https://www.automotive-manuals.net/>

<https://www.automotive-manuals.net/>

<https://www.automotive-manuals.net/>

<https://www.automotive-manuals.net/>

Automobiles CITROËN declares, by application of the provisions of the European legislation (Directive 2000/53) relating to End of Life Vehicles, that it achieves the objectives set by this legislation and that recycled materials are used in the manufacture of the products that it sells.

Reproduction or translation of all or part of this document is prohibited without written authorisation from Automobiles CITROËN.

Printed in the EU
Anglais

07/2017

Automobiles CITROËN
Siège social : 7, rue Henri Sainte-Claire Déville - 92500 RUEIL-MALMAISON
www.citroen.com
Société anonyme au capital de 159 000 000 € - R.C.S.NANTERRE : 642 050 199



